

Pictorial index	Search by illustration	
For safety and security	Make sure to read through them (Main topics: Child seat, theft deterrent system)	1
Vehicle status information and indicators	Reading driving-related information (Main topics: Meters, multi-information display)	2
Before driving	Opening and closing the doors and windows, adjustment before driving (Main topics: Keys, doors, seats, power windows)	3
Driving	Operations and advice which are necessary for driving (Main topics: Starting hybrid system, refueling)	4
Interior features	Usage of the interior features (Main topics: Air conditioner, storage features)	5
Maintenance and care	Caring for your vehicle and maintenance procedures (Main topics: Interior and exterior, light bulbs)	6
When trouble arises	What to do in case of malfunction and emergency (Main topics: 12-volt battery discharge, flat tire)	7
Vehicle specifications	Vehicle specifications, customizable features (Main topics: Fuel, oil, tire inflation pressure)	8
For owners	Reporting safety defects for U.S. owners, and seat belt, SRS airbag and headlight aim instructions for Canadian owners	9
Index	Search by symptom	
	Search alphabetically	

For your information.....	6
Reading this manual	13
How to search.....	14
Pictorial index	16

1 For safety and security

1-1. For safe use

Before driving.....	28
For safe driving	29
Seat belts	31
SRS airbags.....	35
Front passenger occupant classification system	44
Exhaust gas precautions..	49

1-2. Child safety

Riding with children	50
Child restraint systems.....	51

1-3. Emergency assistance

Safety Connect	65
----------------------	----

1-4. Hybrid system

Hybrid system features	70
Hybrid system precautions	74

1-5. Theft deterrent system

Immobilizer system	79
--------------------------	----

2 Vehicle status information and indicators

2-1. Instrument cluster

Warning lights and indicators	82
Gauges and meters	87
Multi-information display ..	92
Energy monitor/consumption screen	102

3 Before driving

3-1. Key information

Keys	108
Digital Key	111

3-2. Opening, closing and locking the doors

Side doors	113
Back door	119
Smart key system.....	131

3-3. Adjusting the seats

Front seats	137
Rear seats	138
Head restraints.....	140

3-4. Adjusting the steering wheel and mirrors

Steering wheel.....	143
Inside rear view mirror...	144
Digital Rear-view Mirror.	145
Outside rear view mirrors	153

3-5. Opening, closing the windows

Power windows	155
---------------------	-----

3-6. Favorite settings

Driving position memory	158
My Settings.....	162

4 Driving

4-1. Before driving

Driving the vehicle	167
Cargo and luggage.....	174
Vehicle load limits.....	177
Trailer towing.....	178

Dinghy towing	179	Dynamic radar cruise control	259
4-2. Driving procedures		Cruise control	269
Power (ignition) switch ..	180	Emergency Driving Stop System	272
EV drive mode	185	BSM (Blind Spot Monitor)	275
Transmission.....	187	Safe Exit Assist	280
Turn signal lever	192	Intuitive parking assist... ..	284
Parking brake.....	193	RCTA (Rear Cross Traffic Alert) function	294
Brake Hold	196	RCD (Rear Camera Detection) function.....	299
4-3. Operating the lights and wipers		PKSB (Parking Support Brake).....	303
Headlight switch.....	199	Parking Support Brake function (static objects to the front and rear/static objects around the vehicle).....	309
AHB (Automatic High Beam)	202	Parking Support Brake function (rear-crossing vehicles)	313
Windshield wipers and washer.....	205	Parking Support Brake function (rear pedestrians) .	314
4-4. Refueling		Toyota Teammate Advanced Park	316
Opening the fuel tank cap	210	Driving mode select switch	343
4-5. Using the driving support systems		Driving assist systems... ..	345
Toyota Safety Sense 3.0 software update.....	213	4-6. Driving tips	
Toyota Safety Sense 3.0.....	215	Hybrid Electric Vehicle driving tips	351
PCS (Pre-Collision System)	222	Winter driving tips.....	353
LTA (Lane Tracing Assist)	234		
LCA (Lane Change Assist)	239		
LDA (Lane Departure Alert)	242		
PDA (Proactive driving assist).....	248		
FCTA (Front Cross Traffic Alert).....	254		
RSA (Road Sign Assist)	257		



5 Interior features

5-1. Using the air conditioning system and defogger

- Automatic air conditioning system..... 358
- Heated steering wheel/seat heaters/seat ventilators 365

5-2. Using the interior lights

- Interior lights list 368

5-3. Using the storage features

- List of storage features . 371
- Luggage compartment features 375

5-4. Using the other interior features

- Other interior features ... 378
- Garage door opener..... 389

6 Maintenance and care

6-1. Maintenance and care

- Cleaning and protecting the vehicle exterior 398
- Cleaning and protecting the vehicle interior 402

6-2. Maintenance

- Maintenance requirements 405
- General maintenance.... 406
- Emission inspection and maintenance (I/M) programs 409

6-3. Do-it-yourself maintenance

- Do-it-yourself service precautions..... 410

- Hood..... 412
- Positioning a floor jack .. 413
- Engine compartment 415
- 12-volt battery..... 422
- Tires 425
- Tire inflation pressure.... 438
- Wheels 440
- Air conditioning filter 441
- Cleaning the hybrid battery (traction battery) air intake vent..... 443
- Electronic key battery 446
- Checking and replacing fuses 448
- Headlight aim 451
- Exterior lights..... 452

7 When trouble arises

7-1. Essential information

- Emergency flashers..... 454
- If your vehicle has to be stopped in an emergency 455
- If the vehicle is submerged or water on the road is rising 456

7-2. Steps to take in an emergency

- If your vehicle needs to be towed..... 457
- If you think something is wrong..... 461
- If a warning light turns on or a warning buzzer sounds 463
- If a warning message is displayed..... 475

If you have a flat tire (vehicles without spare tire) **483**

If you have a flat tire (vehicles with spare tire) **495**

If the hybrid system will not start **503**

If you lose your keys **504**

If the electronic key does not operate properly **505**

If the 12-volt battery is discharged **507**

If your vehicle overheats **512**

If the vehicle becomes stuck **515**

8 Vehicle specifications

8-1. Specifications

Maintenance data (fuel, oil level, etc.)..... **518**

Fuel information **526**

Tire information **528**

8-2. Customization

Customizable features .. **538**

8-3. Initialization

Items to initialize **553**

9 For owners

9-1. For owners

Reporting safety defects for U.S. owners..... **556**

Reporting safety defects for Canadian owners **557**

Seat belt instructions for Canadian owners (in French)..... **557**

SRS airbag instructions for Canadian owners (in French)..... **559**

Headlight aim instructions for Canadian owners (in French)..... **566**

Index

What to do if... (Troubleshooting) **568**

Alphabetical Index **570**

1

2

3

4

5

6

7

8

9

For your information

Main Owner's Manual

Please note that this manual applies to all models and explains all equipment, including options. Therefore, you may find explanations for equipment not installed on your vehicle and the illustrations used may differ from your vehicle.

All specifications provided in this manual are current at the time of printing. Over time, your vehicle may receive updates that modify the vehicle and make material in this manual incomplete and/or inaccurate. Because of Toyota's interest in continual product improvement, Toyota reserves the right to make changes to this manual at any time without notice.

If Toyota chooses to update the manual, updated versions can be viewed by selecting your vehicle by model and year at the following URL or on your mobile device if you have access to the Toyota app.

www.toyota.com/owners

Noise from under vehicle after turning off the hybrid system

Approximately five hours after the hybrid system is turned off,

you may hear sound coming from under the vehicle for several minutes. This is the sound of a fuel evaporation leakage check and, it does not indicate a malfunction.

Accessories, spare parts and modification of your Toyota

A wide variety of non-genuine spare parts and accessories for Toyota vehicles are currently available in the market. You should know that Toyota does not warrant these products and is not responsible for their performance, repair, or replacement, or for any damage they may cause to, or adverse effect they may have on, your Toyota vehicle.

This vehicle should not be modified with non-genuine Toyota products. Modification with non-genuine Toyota products could affect its performance, safety or durability, and may even violate governmental regulations. In addition, damage or performance problems resulting from the modification may not be covered under warranty.

Also, remodeling like this will have an effect on advanced safety equipment such as Toyota Safety Sense 3.0 and there is a danger that it will not

work properly or the danger that it may work in situations where it should not be working.

Cyber Attack Risk

Installing electronic devices and radios increases the risk of cyber attacks through the installed parts, which may lead to unexpected accidents and leakage of personal information. Toyota does not make any guarantees for problems caused by installing non-genuine Toyota products.

Installation of a mobile two-way radio system

The installation of a mobile two-way radio system in your vehicle could affect electronic systems such as:

- Hybrid system
- Multiport fuel injection system/sequential multiport fuel injection system
- Toyota Safety Sense 3.0
- Anti-lock brake system
- SRS airbag system
- Seat belt pretensioner system

Be sure to check with your Toyota dealer for precautionary measures or special instructions regarding installation of a mobile two-way radio system.

High voltage parts and cables

on the Hybrid Electric Vehicles emit approximately the same amount of electromagnetic waves as the conventional gasoline powered vehicles or home electronic appliances despite of their electromagnetic shielding.

Unwanted noise may occur in the reception of the mobile two-way radio.

Vehicle data recording

This vehicle is equipped with sophisticated computers that record certain data regarding vehicle controls and operations.

■ Data recorded by the computers*1

*1: The recorded data varies according to the vehicle grade level and options with which it is equipped.

Certain data, such as the following, is recorded depending on the operation timing and status of each function.

- Basic vehicle behavior related data (engine speed/electric motor speed, accelerator/brake pedal operation, vehicle speed, etc.)
- Operating state of the driving support systems (recorded during system operation, includes basic vehicle behavior related data)
- Driving support system sen-

sor data

- Image data (images from the front, rear and side cameras)^{*2}

^{*2}: The vehicle has multiple cameras. For details on from which cameras images are recorded, contact your Toyota dealer.

- Location information

These computers do not record conversations, sounds, or images of the inside of the vehicle.

Also, personal information which may be used to identify the owner of the vehicle (name, gender, age, etc.) is not recorded.

■ Usage of recorded data and personal information by the Toyota Safety Sense 3.0

The operating state of each system, data from each sensor, image data (images from the front/rear cameras), and position information is recorded by the Toyota Safety Sense 3.0 in the following situations. Toyota obtains this information when the vehicle is brought to the dealership or when sent to the Toyota servers.

- In certain collisions or collision-like situations
- When driving on roads with certain traffic situations, such as congestion, poor road surfaces, poor weather, etc.

- When driving on certain roads, such as roads which were recently opened or extended

- After the hybrid system is started, for a certain amount of time

To learn more about the vehicle data collected, used and shared by Toyota, please visit www.toyota.com/privacyvts/.

■ Data provision and use purpose by third parties

Data recorded by the computers may be used for collision analysis, malfunction diagnosis, automated driving, advanced safety and map related technologies (technology, product development, product improvement, etc.) and products and services which use data (maps used for automated driving and advanced safety technologies, driving condition analysis, analysis of the driving environment, such as road infrastructure, traffic condition communication, etc. Herein referred to as "individual services".)

Also, this data may be used for customer support related to a collision, collision analysis or resolution.

In situations such as the following, Toyota may disclose the recorded data to a third party:

- When the consent of the vehi-

cle owner (or the lessee if the vehicle is leased) has been given

- When officially requested by the police, a court of law or a government agency
- When it is to be used by Toyota in a lawsuit
- When data is to be used research purposes after processing so that the data is not tied to a specific vehicle or vehicle owner

In addition to the above, Toyota may disclose the data recorded by the Toyota Safety Sense 3.0 to a third party in the following situations:

- When separate consent of the vehicle owner (or the lessee if the vehicle is leased) has been given. This includes situations when the user subscribes to an individual service which is provided by a second party and uses vehicle recorded data, where the provider has obtained the user's consent for providing data to a third-party
- When providing data to a company involved in autonomous driving software, etc. for the purpose of research and development (technology, product development, product improvement, etc.) of automated driving, advanced

safety and map related technologies

- When providing image data and position information to a company involved in map creation, etc. for the purpose of research and development map related technologies
- When providing image data and position information to a local government for the purpose of road maintenance, etc.
- When providing processed image data and position information to traffic condition communication individual services
- When providing image data from near a fire, or other area that emergency services are dispatched, to the fire department of a local government which has entered a separate contract with Toyota

Image information recorded by the vehicle can be erased by your Toyota dealer.

The image recording function can be disabled. However, if the function is disabled, data from when systems operate will not be available.

If you wish to stop the collection of Toyota Safety Sense 3.0 data by the Toyota servers for the purpose of research and development and provision to individual services, contact your Toyota dealer.

Usage of data collected through Safety Connect (U.S.mainland only)

If your Toyota has Safety Connect and if you have subscribed to those services, please refer to the Safety Connect Telematics Subscription Service Agreement for information on data collected and its usage.

- To learn more about the vehicle data collected, used and shared by Toyota, please visit www.toyota.com/privacyvts/.

Event data recorder

This vehicle is equipped with an event data recorder (EDR). The main purpose of an EDR is to record, in certain crash or near crash-like situations, such as an air bag deployment or hitting a road obstacle, data that will assist in understanding how a vehicle's systems performed. The EDR is designed to record data related to vehicle dynamics and safety systems for a short period of time, typically 30 seconds or less.

The EDR in this vehicle is designed to record such data as:

- How various systems in your vehicle were operating;
- Whether or not the driver and passenger safety belts were

buckled/fastened;

- How far (if at all) the driver was depressing the accelerator and/or brake pedal; and,
- How fast the vehicle was traveling.

These data can help provide a better understanding of the circumstances in which crashes and injuries occur.

NOTE: EDR data are recorded by your vehicle only if a non-trivial crash situation occurs; no data are recorded by the EDR under normal driving conditions and no personal data (e.g., name, gender, age, and crash location) are recorded. However, other parties, such as law enforcement, could combine the EDR data with the type of personally identifying data routinely acquired during a crash investigation.

To read data recorded by an EDR, special equipment is required, and access to the vehicle or the EDR is needed. In addition to the vehicle manufacturer, other parties, such as law enforcement, that have the special equipment, can read the information if they have access to the vehicle or the EDR.

- Disclosure of the EDR data

Toyota will not disclose the data recorded in an EDR to a third party except when:

- An agreement from the vehicle's owner (or the lessee for a leased vehicle) is obtained
- In response to an official request by the police, a court of law or a government agency
- For use by Toyota in a lawsuit

However, if necessary, Toyota may:

- Use the data for research on vehicle safety performance
- Disclose the data to a third party for research purposes without disclosing information about the specific vehicle or vehicle owner

Scrapping of your Toyota

The SRS airbag and seat belt pretensioner devices in your Toyota contain explosive chemicals. If the vehicle is scrapped with the airbags and seat belt pretensioners left as they are, this may cause an accident such as fire. Be sure to have the systems of the SRS airbag and seat belt pretensioner removed and disposed of by a qualified service shop or by your Toyota dealer before you scrap your vehicle.

Perchlorate Material

Special handling may apply, See www.dtsc.ca.gov/hazardouswaste/perchlorate.

Your vehicle has components that may contain perchlorate.

These components may include the airbags, seat belt pretensioners, wireless remote control batteries, and the batteries in the tire pressure warning valve and transmitters.

“QR code”

The word “QR Code” is registered trademark of DENSO WAVE INCORPORATED in Japan and other countries.

WARNING

■ General precautions while driving

Driving under the influence: Never drive your vehicle when under the influence of alcohol or drugs that have impaired your ability to operate your vehicle. Alcohol and certain drugs delay reaction time, impair judgment and reduce coordination, which could lead to an accident that could result in death or serious injury.

Defensive driving: Always drive defensively. Anticipate mistakes that other drivers or pedestrians might make and be ready to avoid accidents.

Driver distraction: Always give your full attention to driving. Anything that distracts the driver, such as adjusting controls, talking on a cellular phone or reading can result in a collision with resulting death or serious injury to you, your occupants or others.

**WARNING****■ General precaution regarding children's safety**



Never leave children unattended in the vehicle, and never allow children to have or use the key.

Children may be able to start the vehicle or shift the vehicle into neutral. There is also a danger that children may injure themselves by playing with the side windows, or other features of the vehicle. In addition, heat build-up or extremely cold temperatures inside the vehicle can be fatal to children.

Reading this manual



Explains symbols used in this manual

Symbols in this manual

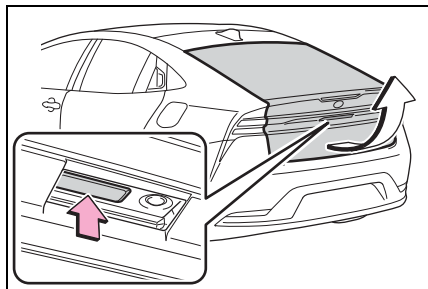

Symbols	Meanings
	WARNING: Explains something that, if not obeyed, could cause death or serious injury to people.
	NOTICE: Explains something that, if not obeyed, could cause damage to or a malfunction in the vehicle or its equipment.
1 2 3...	Indicates operating or working procedures. Follow the steps in numerical order.

Symbols in illustrations

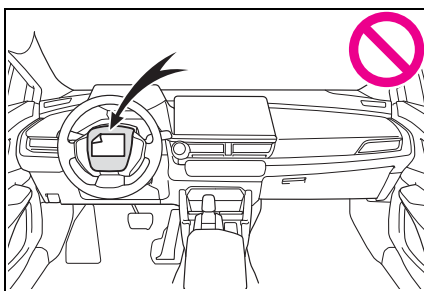

Symbols	Meanings
	Indicates the action (pushing, turning, etc.) used to operate switches and other devices.
	Indicates the outcome of an operation (e.g. a lid opens).



Symbols	Meanings
	Indicates the component or position being explained.
	Means Do not, Do not do this, or Do not let this happen.

How to search

■ Searching by name

- Alphabetical index: →P.570

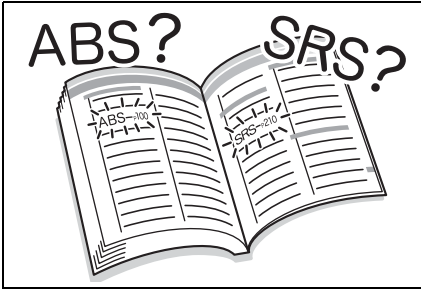

■ Searching by installation position

- Pictorial index: →P.16

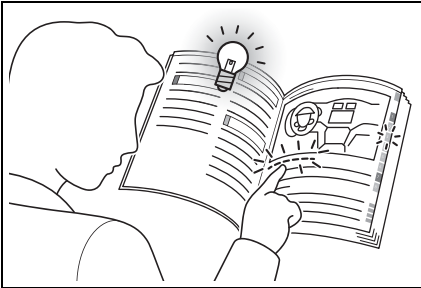

■ Searching by symptom or sound

- What to do if... (Troubleshooting): →P.568



■ Searching by title

- Table of contents: →P.2

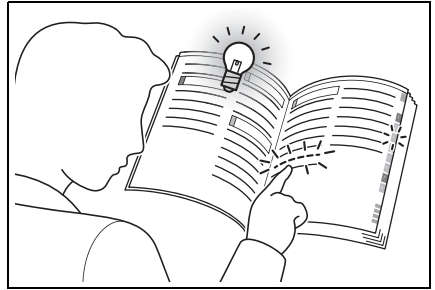

Pictorial index

■ Exterior

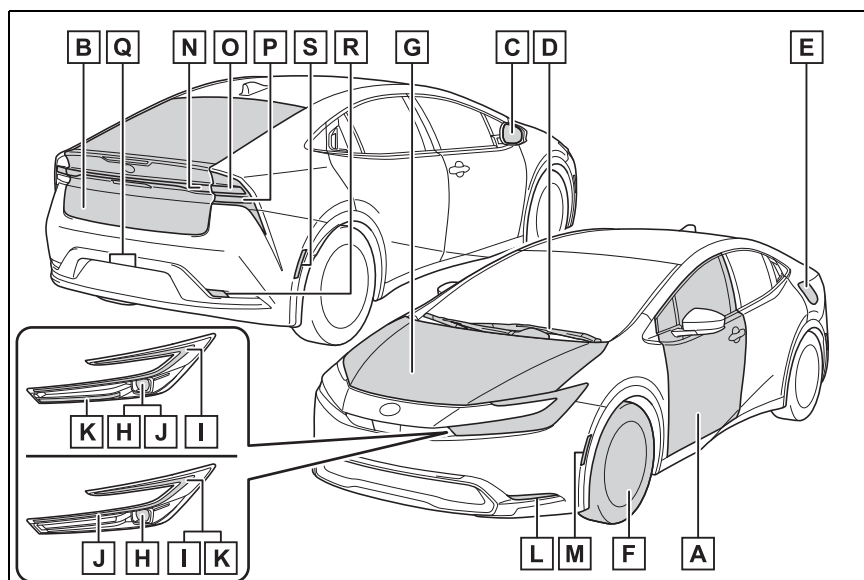

The shape of the headlights may differ depending on the grade, etc.

- A Side doorsP.113**
 - Locking/unlockingP.113
 - Opening/closing the side windowsP.155
 - Locking/unlocking by using the mechanical keyP.505
 - Warning messagesP.475
- B Back doorP.119**
 - Locking/unlockingP.120
 - Opening from inside the cabin *P.123
 - Opening from outside.....P.121, 122
 - Warning messagesP.475
- C Outside rear view mirrorsP.153**
 - Adjusting the mirror angleP.153
 - Folding the mirrorsP.154
 - Defogging the mirrors *P.360
- D Windshield wipersP.205**

Precautions for winter season.....	P.353
To prevent freezing (windshield de-icer)*	P.363
Precautions against car wash (vehicles with rain-sensing windshield wipers)	P.399
E Fuel filler door	P.210
Refueling method	P.210
Fuel type/fuel tank capacity	P.519
F Tires	P.425
Tire size/inflation pressure	P.524
Winter tires/tire chain	P.353
Checking/rotation/tire pressure warning system	P.425
Coping with flat tires.....	P.495
G Hood.....	P.412
Opening	P.412
Engine oil	P.520
Coping with overheat	P.512
Warning messages	P.475

Exterior lights for driving

(Replacing: P.452)

H Headlights.....	P.199
I Parking lights	P.199
J Daytime running lights	P.199
K Front turn signal lights.....	P.192
L LED accessories lamp*	P.199
M Front side marker lights	P.199
N Tail lights*	P.199
O Stop lights/tail lights.....	P.199
P Rear turn signal lights	P.192
Q License plate lights.....	P.199

R Back-up lights

Shifting the shift position to RP.187

S Rear side marker lightsP.199

*: If equipped

■ Instrument panel

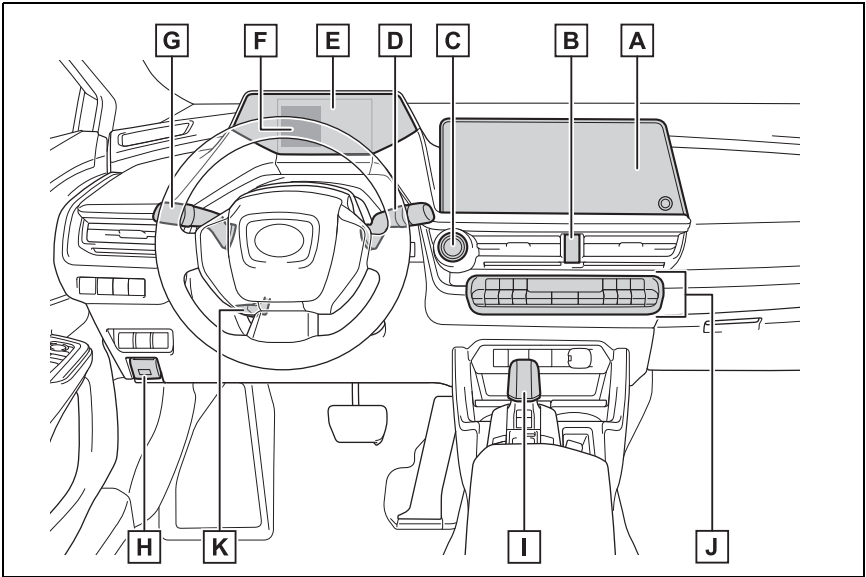

- A Audio system** *1
- B Emergency flasher switch**.....P.454
- C Power switch**P.180
 - Starting the hybrid system/changing the modesP.180
 - Emergency stop of the hybrid systemP.455
 - When the hybrid system will not startP.503
 - Warning messagesP.475
- D Windshield wipers and washer switch**P.205
 - Usage.....P.205
 - Adding washer fluid.....P.421
 - Warning messagesP.421
- E Meters**P.87
 - Reading the meters/adjusting the instrument panel light .P.87, 91
 - Warning lights/indicator lightsP.82
 - When the warning lights come on.....P.463

F	Multi-information display	P.92
	Display	P.92
	Energy monitor.....	P.102
	When the warning messages are displayed	P.475
G	Turn signal lever	P.192
	Headlight switch	P.199
	Headlights/parking lights/tail lights/ license plate lights/daytime running lights.....	P.199
H	Hood lock release lever	P.412
I	Shift lever.....	P.187
	Changing the shift position.....	P.187
	Precautions against towing	P.457
J	Air conditioning system	P.358
	Usage.....	P.358
	Rear window defogger	P.360
	Seat heaters* ²	P.366
	Seat ventilators* ²	P.367
K	Tilt and telescopic steering lock release lever.....	P.143

*1: Refer to "MULTIMEDIA OWNER'S MANUAL".

*2: If equipped

■ Switches

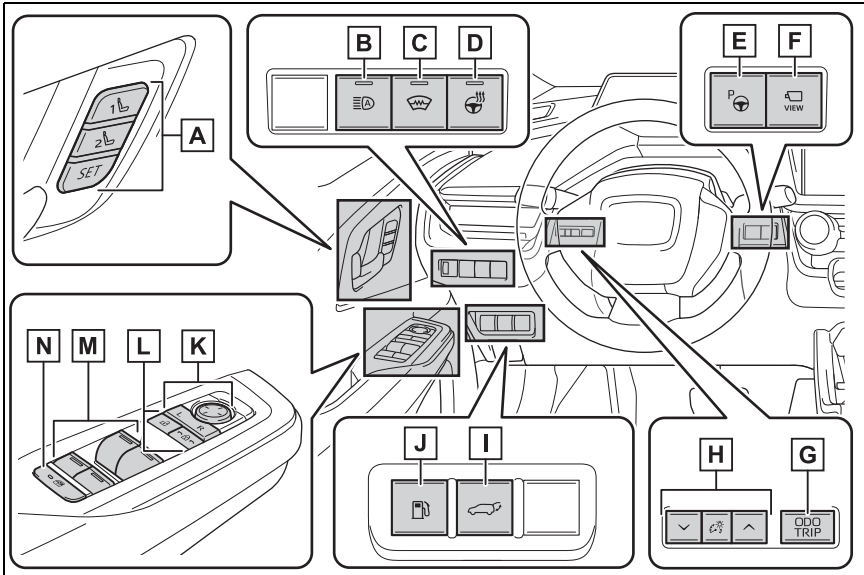

- A** Driving position memory switches *1P.159
- B** Automatic High Beam switchP.202
- C** Windshield de-icer switch*1P.363
- D** Heated steering wheel switch *1P.366
- E** Advanced Park (parking assist system) main switch *1 ..P.316
- F** Camera switch *1, 2
- G** “ODO TRIP” switchP.91
- H** Instrument panel light control switchesP.91
- I** Power back door switch *1P.123
- J** Fuel filler door opener switchP.210
- K** Outside rear view mirror switchesP.153
- L** Door lock switchesP.115
- M** Power window switchesP.155
- N** Window lock switchP.157

*1: If equipped

*2: Refer to "MULTIMEDIA OWNER'S MANUAL".

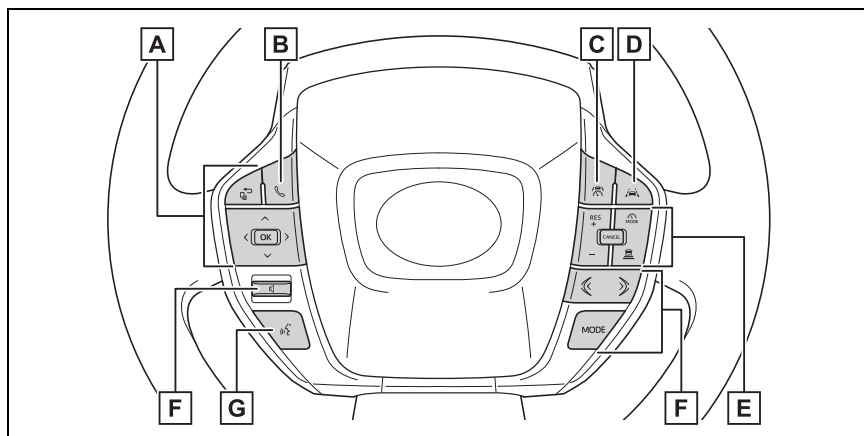

- A** Meter control switchesP.92
- B** Phone switch*
- C** Driving assist switchP.262, 269
- D** LTA (Lane Tracing Assist) switchP.234
- E** Cruise control switches
 - Dynamic radar cruise controlP.259
 - Cruise controlP.269
- F** Audio remote control switches*
- G** Talk switch*

*: Refer to "MULTIMEDIA OWNER'S MANUAL".

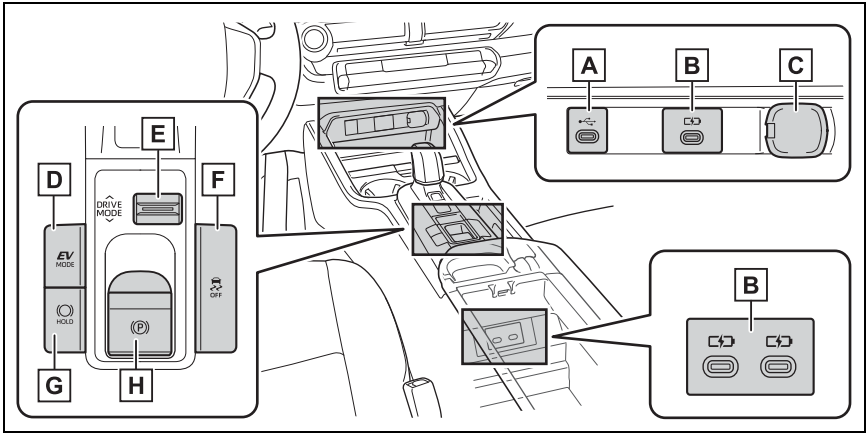

- A** USB port*
- B** USB Type-C charging portsP.379
- C** Power outletP.378
- D** EV drive mode switch.....P.185
- E** Driving mode select switch.....P.343
- F** VSC OFF switchP.346
- G** Brake hold switchP.196
- H** Parking brake switchP.193
 - Applying/releasing.....P.193
 - Precautions against winter seasonP.354
 - Warning buzzer/messageP.195, 469

*: Refer to “MULTIMEDIA OWNER’S MANUAL”.

Interior

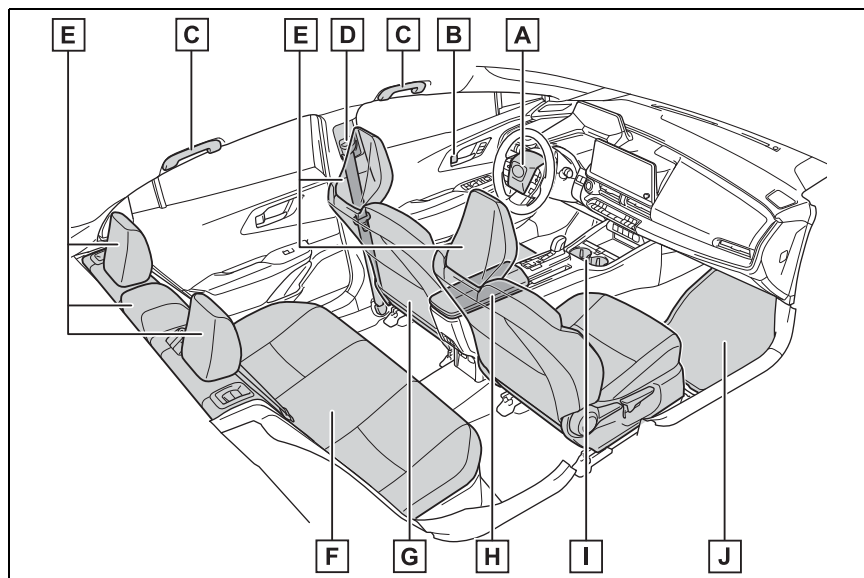

A	SRS airbags	P.35
B	Inside lock buttons	P.115
C	Assist grips	P.387
D	Seat belts	P.31
E	Head restraints	P.140
F	Rear seats	P.138
G	Front seats	P.137
H	Console box	P.372
I	Cup holders	P.372
J	Floor mats	P.28

■ Ceiling

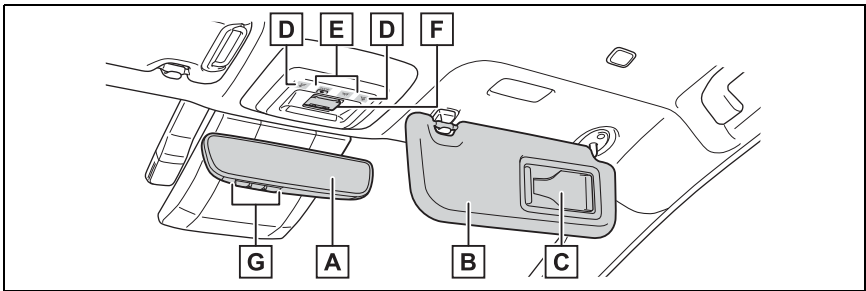

A	Inside rear view mirror ^{*1}	P.144
	Digital Rear-view Mirror ^{*1}	P.145
B	Sun visors	P.378
C	Vanity mirrors	P.378
D	Personal lights ^{*2}	P.369
E	Interior lights	P.369
F	“SOS” button ^{*1}	P.65
G	Garage door opener buttons ^{*1}	P.389

^{*1}: If equipped

^{*2}: The illustration shows the front, but they are also equipped in the rear.

For safety and security

1

1-1. For safe use

Before driving	28
For safe driving	29
Seat belts	31
SRS airbags	35
Front passenger occupant classification system	44
Exhaust gas precautions	49

1-2. Child safety

Riding with children	50
Child restraint systems...	51

1-3. Emergency assistance

Safety Connect	65
----------------------	----

1-4. Hybrid system

Hybrid system features ..	70
Hybrid system precautions	74

1-5. Theft deterrent system

Immobilizer system	79
--------------------------	----

Before driving

Observe the following before starting off in the vehicle to ensure safety of driving.

Installing floor mats

Use only floor mats designed specifically for vehicles of the same model and model year as your vehicle. Fix them securely in place onto the carpet.

- 1 Insert the retaining hooks (clips) into the floor mat eye-lets.

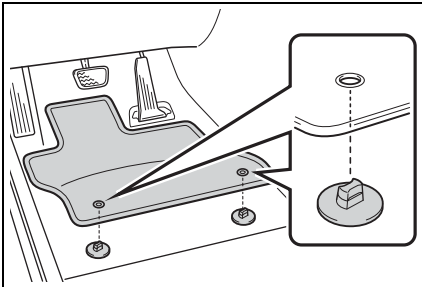

- 2 Turn the upper knob of each retaining hook (clip) to secure the floor mats in place.

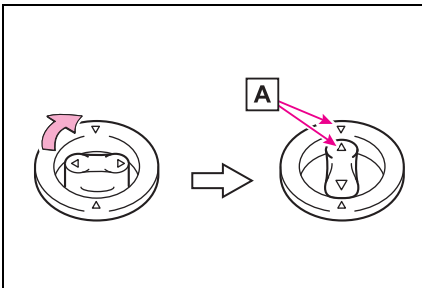

Always align the \triangle marks **A**.

The shape of the retaining hooks (clips) may differ from that shown in the illustration.

⚠ WARNING

Observe the following precautions.

Failure to do so may cause the driver's floor mat to slip, possibly interfering with the pedals while driving. An unexpectedly high speed may result or it may become difficult to stop the vehicle. This could lead to an accident, resulting in death or serious injury.

■ When installing the driver's floor mat

- Do not use floor mats designed for other models or different model year vehicles, even if they are Toyota Genuine floor mats.
- Only use floor mats designed for the driver's seat.
- Always install the floor mat securely using the retaining hooks (clips) provided.
- Do not use two or more floor mats on top of each other.
- Do not place the floor mat bottom-side up or upside-down.

⚠ WARNING

■ Before driving

- Check that the floor mat is securely fixed in the correct place with all the provided retaining hooks (clips). Be especially careful to perform this check after cleaning the floor.

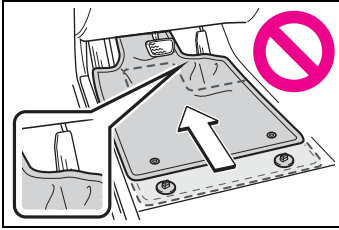

- With the hybrid system stopped and the shift position in P, fully depress each pedal to the floor to make sure it does not interfere with the floor mat.

For safe driving

For safe driving, adjust the seat and mirror to an appropriate position before driving.

Correct driving posture

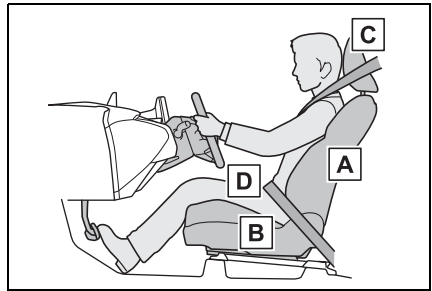

- A** Adjust the angle of the seat-back so that you are sitting straight up and so that you do not have to lean forward to steer. (→P.137)
- B** Adjust the seat so that you can depress the pedals fully and so that your arms bend slightly at the elbow when gripping the steering wheel. (→P.137)
- C** Lock the head restraint in place with the center of the head restraint closest to the top of your ears. (→P.140)
- D** Wear the seat belt correctly. (→P.32)

**WARNING**

Observe the following precautions.

Failure to do so may result in death or serious injury.

- Do not adjust the position of the driver's seat while driving. Doing so could cause the driver to lose control of the vehicle.
- Do not place a cushion between the driver or passenger and the seatback. A cushion may prevent correct posture from being achieved, and reduce the effectiveness of the seat belt and head restraint.
- Do not place anything under the front seats. Objects placed under the front seats may become jammed in the seat tracks and stop the seat from locking in place. This may lead to an accident and the adjustment mechanism may also be damaged.
- Always observe the legal speed limit when driving on public roads.
- When driving over long distances, take regular breaks before you start to feel tired. Also, if you feel tired or sleepy while driving, do not force yourself to continue driving and take a break immediately.

properly wear the vehicle's seat belt. (→P.51)

Adjusting the mirrors

Make sure that you can see backward clearly by adjusting the inside rear view mirror (if equipped), Digital Rear-view Mirror (if equipped) and outside rear view mirrors properly. (→P.144, 145, 153)

Correct use of the seat belts

Make sure that all occupants are wearing their seat belts before driving the vehicle. (→P.32)

Use a child restraint system appropriate for the child until the child becomes large enough to

Seat belts

Make sure that all occupants are wearing their seat belts before driving the vehicle.

WARNING

Observe the following precautions to reduce the risk of injury in the event of sudden braking, sudden swerving or an accident. Failure to do so may cause death or serious injury.

■ Wearing a seat belt

- Ensure that all passengers wear a seat belt.
- Always wear a seat belt properly.
- Each seat belt should be used by one person only. Do not use a seat belt for more than one person at once, including children.
- Toyota recommends that children be seated in the rear seat and always use a seat belt and/or an appropriate child restraint system.
- To achieve a proper seating position, do not recline the seat more than necessary. The seat belt is most effective when the occupants are sitting up straight and well back in the seats.
- Do not wear the shoulder belt under your arm.
- Always wear your seat belt low and snug across your hips.

■ Pregnant women

Obtain medical advice and wear the seat belt in the proper way. (→P.32)

Women who are pregnant should position the lap belt as low as possible over the hips in the same manner as other occupants, extending the shoulder belt completely over the shoulder and avoiding belt contact with the rounding of the abdominal area.

If the seat belt is not worn properly, not only the pregnant woman, but also the fetus could suffer death or serious injury as a result of sudden braking or a collision.

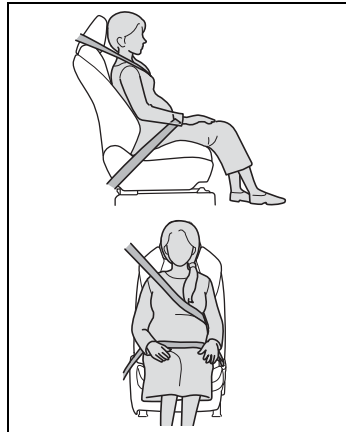

■ People suffering illness

Obtain medical advice and wear the seat belt in the proper way. (→P.32)

■ When children are in the vehicle

→P.59

■ Seat belt damage and wear

- Do not damage the seat belts by allowing the belt, plate, or buckle to be jammed in the door.

WARNING

- Inspect the seat belt system periodically. Check for cuts, fraying, and loose parts. Do not use a damaged seat belt until it is replaced. Damaged seat belts cannot protect an occupant from death or serious injury.
- Ensure that the belt and plate are locked and the belt is not twisted.
If the seat belt does not function correctly, immediately contact your Toyota dealer.
- Replace the seat assembly, including the belts, if your vehicle has been involved in a serious accident, even if there is no obvious damage.
- Do not attempt to install, remove, modify, disassemble or dispose of the seat belts. Have any necessary repairs carried out by your Toyota dealer. Inappropriate handling may lead to incorrect operation.

Correct use of the seat belts

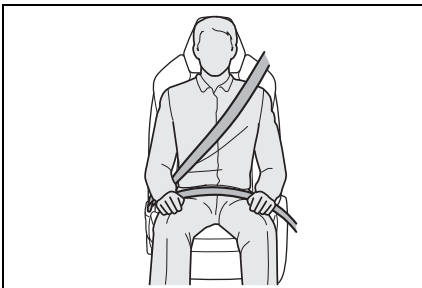

- Extend the shoulder belt so that it comes fully over the shoulder, but does not come into contact with the neck or slide off the shoulder.

- Position the lap belt as low as possible over the hips.
- Adjust the position of the seatback.
Sit up straight and well back in the seat.
- Do not twist the seat belt.

■ Child seat belt usage

The seat belts of your vehicle were principally designed for persons of adult size.

- Use a child restraint system appropriate for the child, until the child becomes large enough to properly wear the vehicle's seat belt. (→P.51)
- When the child becomes large enough to properly wear the vehicle's seat belt, follow the instructions regarding seat belt usage. (→P.31)

■ Seat belt extender

If your seat belts cannot be fastened securely because they are not long enough, a personalized seat belt extender is available from your Toyota dealer free of charge.

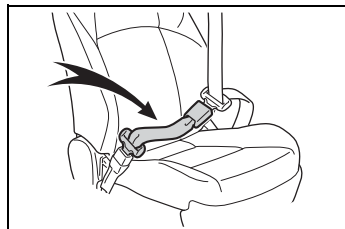

WARNING

■ Using a seat belt extender

Observe the following precautions to reduce the risk of injury in the event of sudden braking, sudden swerving or an accident. Failure to do so may cause death or serious injury.

**WARNING**

- Do not wear the seat belt extender if you can fasten the seat belt without the extender.
- Do not use the seat belt extender when installing a child restraint system because the belt will not securely hold the child restraint system, increasing the risk of death or serious injury in the event of an accident.
- The personalized extender may not be safe on another vehicle, when used by another person, or at a different seating position other than the one originally intended.

**NOTICE****When using a seat belt extender**

When releasing the seat belt, press on the buckle release button on the extender, not on the seat belt. This helps prevent damage to the vehicle interior and the extender itself.

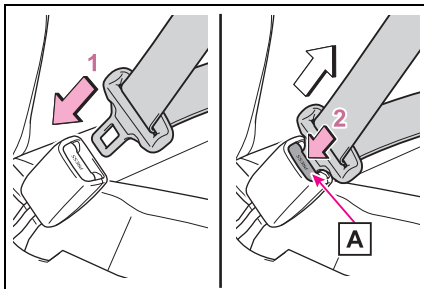
Fastening and releasing the seat belt

- 1 To fasten the seat belt, push the plate into the buckle until

a click sound is heard.

- 2 To release the seat belt, press the release button **A**.

Emergency locking retractor (ELR)

The retractor will lock the belt during a sudden stop or on impact. It may also lock if you lean forward too quickly. A slow, easy motion will allow the belt to extend so that you can move around fully.

Automatic locking retractor (ALR)

When a passenger's shoulder belt is completely extended and then retracted even slightly, the belt is locked in that position and cannot be extended. This feature is used to hold a child restraint system (CRS) firmly. To free the belt again, fully retract the belt and then pull the belt out once more.

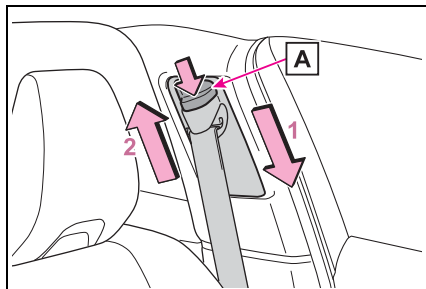
Adjusting the seat belt shoulder anchor height (front seats)

- 1 Push the seat belt shoulder anchor down while pressing the release button **A**.
- 2 Push the seat belt shoulder anchor up while pressing the release button **A**.

Move the height adjuster up and down as needed until you hear a click.

WARNING

■ Adjustable shoulder anchor

Always make sure the shoulder belt is positioned across the center of your shoulder. The belt should be kept away from your neck, but not falling off your shoulder. Failure to do so could reduce the amount of protection in an accident and cause death or serious injuries in the event of a sudden stop, sudden swerve or accident.

Seat belt pretensioners (front seats and outboard rear seats)

When the vehicle is subjected to a severe frontal or side impact or rollover, the pretensioners retract the seat belts of the front seats and rear outer seats to securely restrain the occupants.

The pretensioners will not operate in minor frontal or side impacts, or rear impacts.

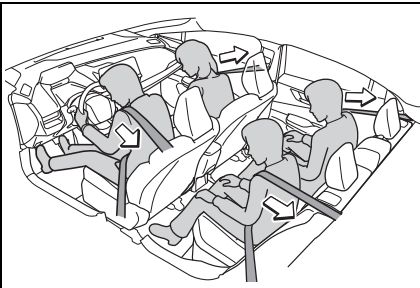

■ Replacing the belt after the pretensioner has been activated

If the vehicle is involved in multiple

collisions, the pretensioner will activate for the first collision, but will not activate for the second or subsequent collisions.

■ PCS-linked control

If the PCS (Pre-Collision System) determines that the possibility of a collision with a vehicle is high, the seat belt pretensioners will be prepared to operate.

WARNING

■ Seat belt pretensioners

Observe the following precautions to reduce the risk of injury in the event of sudden braking or an accident.

Failure to do so may result in death or serious injury.

- Do not place anything, such as a cushion, on the front passenger's seat. Doing so will disperse the passenger's weight, which prevents the sensor from detecting the passenger's weight properly. As a result, the seat belt pretensioner for the front passenger's seat may not operate in the event of a collision.
- If a pretensioner has operated, the SRS warning light will illuminate. In this situation, the seat belt cannot be used and must be replaced by your Toyota dealer.

SRS airbags

The SRS airbags deploy when the vehicle is subjected to certain types of severe impact that may cause significant injury to the occupants. The airbags work together with the seat belts to help reduce the risk of death or serious injury.

SRS airbag system

■ Location of the SRS airbags

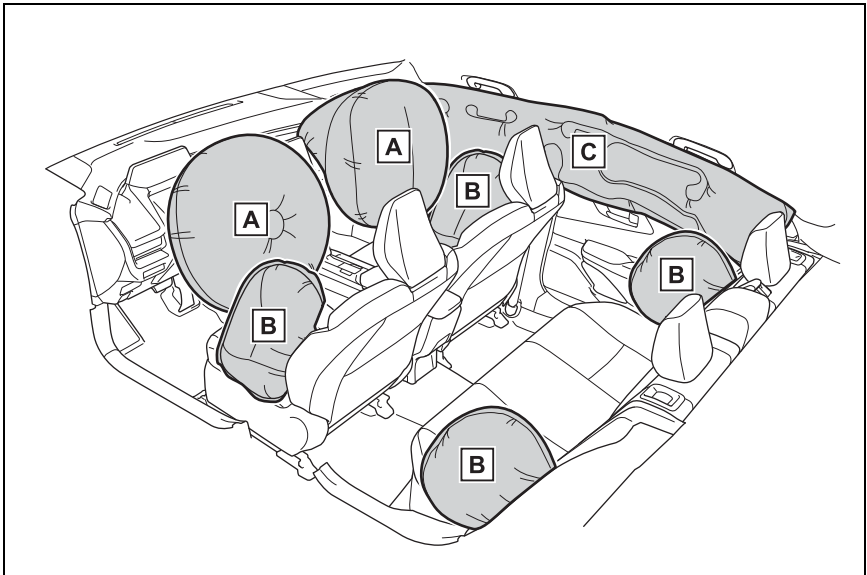

A SRS driver airbag/front passenger airbag

Help reduce impact to the head and chest of the driver and front passenger

B SRS side airbags

- Help reduce impact to the chest of the occupants of the front seats
- Help reduce impact to the chest of the occupants of the rear outer seats

C SRS curtain shield airbags

- Help reduce impact to the heads of the occupants of the front and rear outer seats
- Can help prevent the occupants from being thrown from the vehicle in the event of a vehicle rollover

■ SRS airbag system components

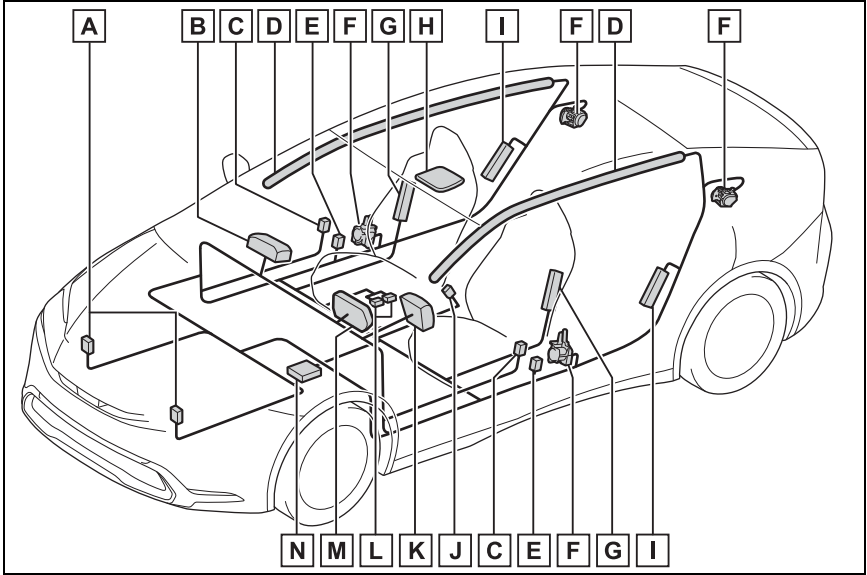

- A** Front impact sensors
- B** Front passenger airbag
- C** Side impact sensors (front door)
- D** Curtain shield airbags
- E** Side impact sensors (front)
- F** Seat belt pretensioners and force limiters
- G** Front side airbags
- H** “PASSENGER AIR BAG ON” and “PASSENGER AIR BAG OFF” indicator lights
- I** Rear side airbags
- J** Front passenger’s seat belt buckle switch
- K** Driver airbag
- L** Front passenger occupant classification sensors
- M** SRS warning light
- N** Airbag sensor assembly

Your vehicle is equipped with ADVANCED AIRBAGS designed based on US motor vehicle safety standards (FMVSS208). The air-

bag sensor assembly (ECU) controls airbag deployment based on information obtained from the sensors, etc., shown in the system components diagram above. This information includes crash severity and occupant information. As the airbags deploy, a chemical reaction in the inflators quickly fills the airbags with non-toxic gas to help restrain the motion of the occupants.

■ If the SRS airbags deploy (inflate)

- Slight abrasions, burns, bruising, etc., may be sustained from SRS airbags, due to the extremely high speed of deployment (inflation) by hot gases.
- A loud noise and white powder will be emitted.
- Parts of the airbag module (steering wheel hub, airbag cover and inflator) as well as the parts around the airbags may be hot for several minutes. The airbag itself may also be hot.
- The windshield may crack.
- The hybrid system will be stopped and fuel supply to the engine will be stopped. (→P.78)
- The brakes and stop lights will be controlled automatically. (→P.346)
- The interior lights will turn on automatically. (→P.368)
- The emergency flashers will turn on automatically. (→P.454)
- For Safety Connect subscribers, if any of the following situations occur, the system is designed to send an emergency call to the response center, notifying them of the vehicle's location (without needing to push the "SOS" button) and an agent will attempt to speak with the occupants to ascertain the level of emergency and assistance required. If the occupants are unable to communicate, the agent automatically treats the call as an emergency and helps to dispatch the necessary emergency

services. (→P.65)

- When an SRS airbag has been deployed
- When a seat belt pretensioner has operated
- When the vehicle has been involved in a severe rear-end collision

■ The SRS airbags deploy in a frontal impact when

- The following SRS airbags will deploy in the event of an impact that exceeds a threshold level (level of force corresponding to an approximately 12 - 18 mph [20 - 30 km/h] frontal collision with a fixed wall that does not move or deform):
 - SRS front airbags
- The threshold level at which the SRS airbags will deploy will be higher than normal in the in the following situations:
 - When the vehicle collides with an object, such as a parked vehicle or sign pole, which moves or deforms on impact
 - If the vehicle is involved in an underride collision, such as a collision in which the front of the vehicle underrides, or goes under, the bed of a truck
- Depending on the type of collision, only the following may deploy:
 - Seat belt pretensioners
- The SRS airbags for the front passenger's seat will not deploy if there is no passenger in the front passenger seat. However, the SRS airbags for the front passenger's seat may deploy, even if the seat is unoccupied, if luggage is put on the seat.

- In the event of an especially severe frontal collision, the left and right SRS curtain shield airbags may also deploy.

■ The SRS airbags deploy in a side impact when

- The following SRS airbags will deploy in the event of an impact that exceeds the set threshold level (level of force corresponding to the impact force produced by an approximately 3300 lb. [1500 kg] vehicle colliding with the passenger compartment at a perpendicular angle at an approximate speed of 12 - 18 mph [20 - 30 km/h]):

- SRS side airbags
- SRS curtain shield airbags

- In the event of a side collision, regardless of the impacted side, both the left and right SRS curtain shield airbags will deploy.

- If the vehicle is involved in a rollover, the following SRS airbags will deploy:

- Both left and right SRS curtain shield airbags

■ The SRS airbags deploy in an underside impact when

- The following airbags may deploy if the underside of the vehicle collides with a hard object:

- SRS front airbags
- SRS side airbags
- SRS curtain shield airbags

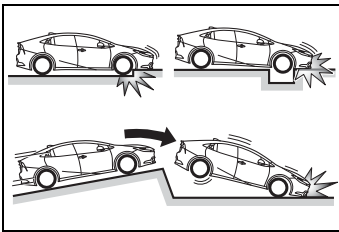

- The following airbags may deploy if the vehicle becomes significantly tilted or is strongly impacted by skidding into a curb, etc.:
- SRS curtain shield airbags

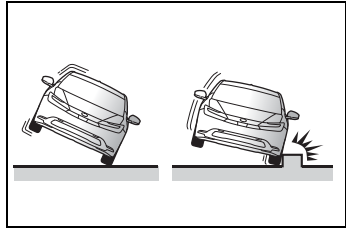

■ The SRS side airbags will not deploy when

- The following SRS airbags will not normally deploy in side or rear collisions, vehicle rollovers, or low speed frontal collisions. However, if such a collision causes sufficient sudden deceleration, the SRS airbags may deploy.
- SRS front airbags

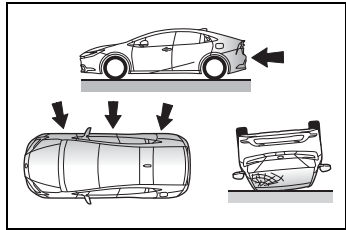

- The following SRS airbags may not deploy if the vehicle is collided with at a certain angle or in a side collision where an area of the vehicle other than the passenger compartment is collided with:
- SRS side airbags
- SRS curtain shield airbags

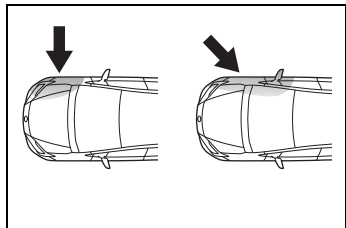

- The following SRS airbags will not normally deploy in front or rear collisions, vehicle rollovers, or low speed side collisions:
- SRS side airbags

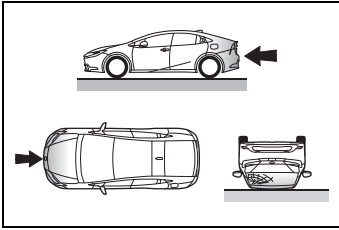

- The following SRS airbags will not normally deploy in rear collisions, end over end vehicle rollovers, or low speed front or side collisions:
- SRS curtain shield airbags

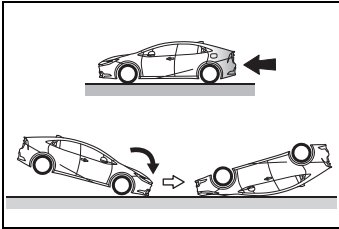

■ When to contact your Toyota dealer

In the following situations, the vehicle will require inspection and/or repair. Contact your Toyota dealer as soon as possible.

- When any of the SRS airbags have been deployed
- When the front of the vehicle is damaged or deformed, or was involved in a collision that was not severe enough to cause any of the following SRS airbags to deploy:
- SRS front airbags

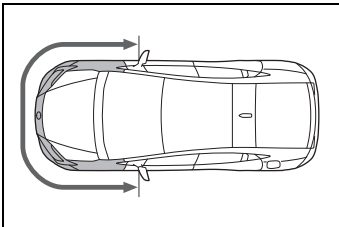

- When a door or its surrounding area is damaged, deformed or has had a hole made in it, or was involved in a collision that was not

severe enough to cause any of the following SRS airbags to deploy:

- SRS side airbags
- SRS curtain shield airbags

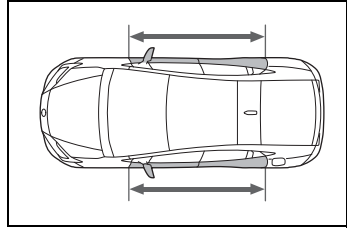

- When the pad section of the steering wheel or the dashboard near the front passenger SRS airbag is scratched, cracked, or otherwise damaged.

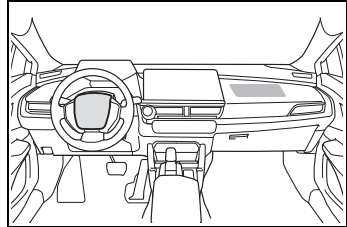

- When the surface of a seat with an SRS side airbag is scratched, cracked, or otherwise damaged.

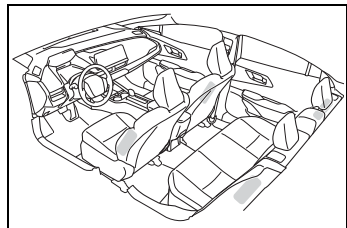

- When the part of a front pillar, rear pillar or roof side rail garnish (padding) which covers a SRS curtain shield airbag is scratched, cracked, or otherwise damaged.

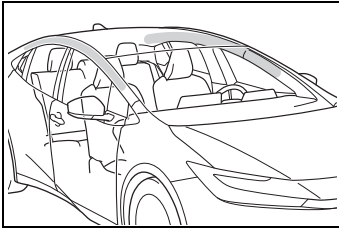

⚠ WARNING

■ SRS airbag precautions

Observe the following precautions. Failure to do so may result in death or serious injury.

- The driver and all passengers must wear their seat belts correctly. The SRS airbags are supplemental devices to be used with the seat belts.
- The SRS driver airbag deploys with considerable force, and can cause death or serious injury, especially if the driver is very close to the airbag. The National Highway Traffic Safety Administration (NHTSA) advises:

Since the risk zone for the driver's airbag is the first 2 - 3 in. (50 - 75 mm) of inflation, placing yourself 10 in. (250 mm) from your driver airbag provides you with a clear margin of safety. This distance is measured from the center of the steering wheel to your breastbone. If your current driving position places you less than 10 in. (250 mm) away from the driver airbag, you can change your driving position in several ways:

- Move your seat to the rear as far as possible while still being able to reach the pedals comfortably.

- Slightly recline the seatback. Although vehicle designs vary, many drivers can achieve the 10 in. (250 mm) distance, even with the driver seat all the way forward, simply by reclining the seatback somewhat. If reclining the seatback makes it hard to see the road, raise yourself by using a firm, non-slippery cushion, or raise the seat if your vehicle has that feature.
- If your steering wheel is adjustable, tilt it downward. This points the airbag toward your chest instead of your head and neck. The seat should be adjusted as recommended by the NHTSA, while still being able to control the vehicle with the pedals and steering wheel, and maintaining your view of the instrument panel controls.
- If a seat belt extender has been connected to the passenger's seat belt buckle but the latch plate of the passenger's seat belt has not been fastened to the seat belt extender, the SRS airbag system will judge that the occupant is wearing the seat belt even though the seat belt has not been fastened. In this case, the SRS front airbags for the passenger may not deploy correctly in a collision, resulting in death or serious injury. Be sure to wear the seat belt correctly when using a seat belt extender.

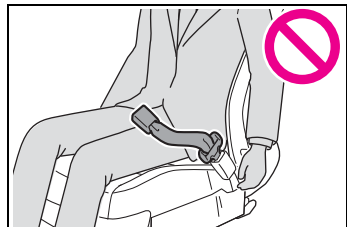

⚠ WARNING

- The SRS front passenger airbag deploys with considerable force, and can cause death or serious injury, especially if the front passenger is very close to the airbag. The front passenger seat should be positioned as far possible from the airbag with the seatback adjusted so that the passenger is sat upright.
- Improperly seated and/or restrained infants and children can be killed or seriously injured by a deploying airbag. An infant or child who is too small to use a seat belt should be properly secured using a child restraint system. Toyota strongly recommends that all infants and children be placed in the rear seats of the vehicle and properly restrained. The rear seats are safer for infants and children than the front passenger seat. (→P.51)
- Do not sit on the edge of the seat or lean against the dashboard.

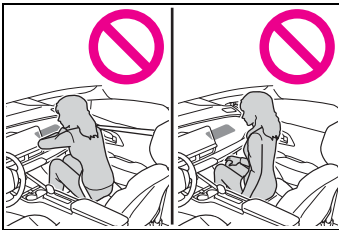

- Do not allow a child to stand in front of the SRS front passenger airbag or sit on the lap of a front passenger.

- Front seat occupants should never hold items on their lap.

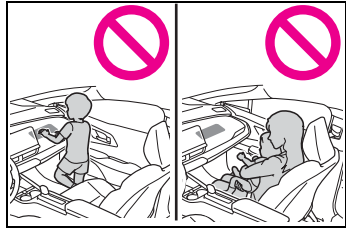

- Do not lean against the door, roof side rail, or front, side, or rear pillar.



- Do not allow anyone to kneel on a seat toward the door or put their head or hands outside the vehicle.

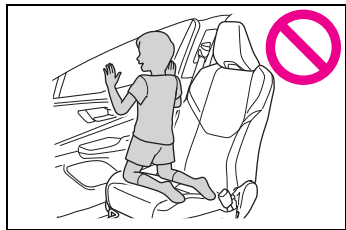

- Do not attach anything to or lean anything against areas such as the dashboard or steering wheel pad.

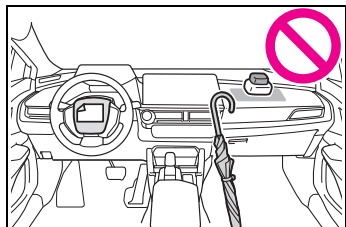

⚠ WARNING

- Do not attach anything to areas such as the doors, windshield, side windows, front or rear pillars, roof side rails and assist grips. (With the exception of the speed limit label →P.486)

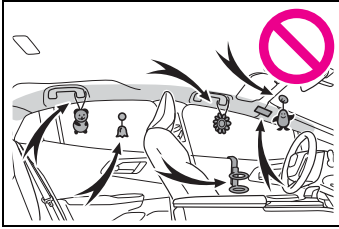

- Do not use seat accessories which cover the parts from which the SRS airbags deploy, as they may interfere with inflation of the SRS airbags. Such accessories may prevent the SRS airbags from deploying correctly, may disable the system or cause the SRS airbags to inflate unintentionally, possibly resulting in death or serious injury.
- Do not strike or apply significant force to the SRS airbag system components, front doors or their surrounding area. Doing so may cause the SRS airbags to malfunction.
- Do not touch any components of the SRS airbags immediately after the SRS airbags have deployed (inflated) as they may be hot.
- If breathing becomes difficult after the SRS airbags have deployed, open a door or window to allow fresh air in, or leave the vehicle if it is safe to do so. Wash off any residue as soon as possible to prevent skin irritation.

- If a part where an SRS airbag is stored is damaged or cracked, have it replaced by your Toyota dealer.
- Do not place anything, such as a cushion, on the front passenger's seat. Doing so will disperse the passenger's weight, which prevents the sensor from detecting the passenger's weight properly. As a result, the SRS front airbags for the front passenger's seat may not deploy in the event of a collision.

■ Modification and disposal of SRS airbag system components

Do not dispose of your vehicle or perform any of the following modifications without consulting your Toyota dealer. The SRS airbags may malfunction or deploy unintentionally, possibly leading to death or serious injury.

- Removal, installation, disassembly or repair of the SRS airbags
- Repair, removal or modification of the following parts or their surrounding
 - Steering wheel
 - Instrument panel
 - Dashboard
 - Seats
 - Seat upholstery
 - Front pillars
 - Side pillars
 - Rear pillars
 - Roof side rails
 - Front door panels

**WARNING**

- Front door trim
- Front door speakers
- Modifications to the front door panels (such as making holes in them)
- Repair or modification of the following parts or their surrounding
 - Front fender
 - Front bumper
 - Sides of the vehicle interior
- Installation of the following parts or accessories
 - Bull bars or kangaroo bars
 - Snow plows
 - Winches
 - Roof luggage carriers
- Modifications to the vehicle's suspension
- Installation of electronic devices such as mobile two-way radios (RF-transmitter) and CD players
- Modifications to your vehicle for a person with a physical disability

Front passenger occupant classification system

Your vehicle is equipped with a front passenger occupant classification system. This system detects the conditions of the front passenger seat and activates or deactivates the following SRS airbags.

- SRS front passenger airbag

System components

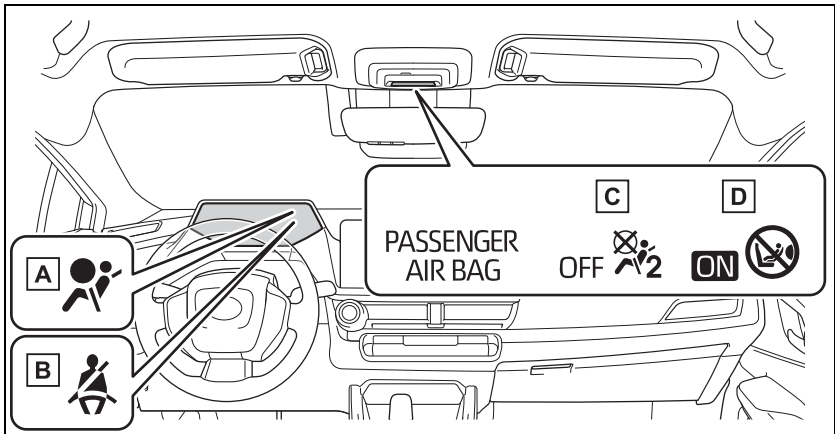

- A** SRS warning light
- B** Driver's and front passenger's seat belt reminder light
- C** "PASSENGER AIR BAG OFF" indicator light
- D** "PASSENGER AIR BAG ON" indicator light

⚠ WARNING

■ Front passenger occupant classification system precautions

Observe the following precautions regarding the front passenger occupant classification system. Failure to do so may cause death or serious injury.

- Wear the seat belt properly.

- Make sure the front passenger's seat belt plate has not been left inserted into the buckle before someone sits in the front passenger seat.

**WARNING**

- Make sure the “PASSENGER AIR BAG OFF” indicator light is not illuminated when using the seat belt extender for the front passenger seat. If the “PASSENGER AIR BAG OFF” indicator light is illuminated, disconnect the extender tongue from the seat belt buckle, and reconnect the seat belt. Reconnect the seat belt extender after making sure the “PASSENGER AIR BAG ON” indicator light is illuminated. If you use the seat belt extender while the “PASSENGER AIR BAG OFF” indicator light is illuminated, the SRS airbags for the front passenger will not activate, which could cause death or serious injury in the event of a collision.
 - Do not apply a heavy load to the front passenger seat or equipment (e.g. seatback pocket).
 - Do not put weight on the front passenger seat by putting your hands or feet on the front passenger seat seatback from the rear passenger seat.
 - Do not let a rear passenger lift the front passenger seat with their feet or press on the seatback with their legs.
 - Do not put objects under the front passenger seat.
- Do not recline the front passenger seatback so far that it touches a rear seat. This may cause the “PASSENGER AIR BAG OFF” indicator light to be illuminated, which indicates that the SRS airbags for the front passenger will not activate in the event of a severe accident. If the seatback touches the rear seat, return the seatback to a position where it does not touch the rear seat. Keep the front passenger seatback as upright as possible when the vehicle is moving. Reclining the seatback excessively may lessen the effectiveness of the seat belt system.
 - If an adult sits in the front passenger seat, the “PASSENGER AIR BAG ON” indicator light is illuminated. If the “PASSENGER AIR BAG OFF” indicator is illuminated, ask the passenger to sit up straight, well back in the seat, feet on the floor, and with the seat belt worn correctly. If the “PASSENGER AIR BAG OFF” indicator still remains illuminated, either ask the passenger to move to the rear seat, or if that is not possible, move the front passenger seat fully rearward.
 - When it is unavoidable to install a forward-facing child restraint system on the front passenger seat, install the child restraint system on the front passenger seat in the proper order. (→P.54)
 - Do not modify or remove the front seats.

**WARNING**

- Do not kick the front passenger seat or subject it to severe impact. Otherwise, the SRS warning light may come on to indicate a malfunction of the front passenger occupant classification system. In this case, contact your Toyota dealer immediately.
- Child restraint systems installed on the rear seat should not contact the front seatbacks.
- Do not use a seat accessory, such as a cushion and seat cover, that covers the seat cushion surface.
- Do not modify or replace the upholstery of the front seat.

Front passenger occupant classification system conditions and operation

■ Adult*1

Indicators/warning lights	“PASSENGER AIR BAG ON” and “PASSENGER AIR BAG OFF” indicator lights	“PASSENGER AIR BAG ON”
	SRS warning light	Off
	Driver’s and front passenger’s seat belt reminder light	Off*2 or flashing*3
Devices	Front passenger airbag	Activated

■ Child*4

Indicators/warning lights	“PASSENGER AIR BAG ON” and “PASSENGER AIR BAG OFF” indicator lights	“PASSENGER AIR BAG OFF” or “PASSENGER AIR BAG ON”*4
	SRS warning light	Off
	Driver’s and front passenger’s seat belt reminder light	Off*2 or flashing*3
Devices	Front passenger airbag	Deactivated or activated*4

■ Child restraint system with infant*5

Indicators/warning lights	“PASSENGER AIR BAG ON” and “PASSENGER AIR BAG OFF” indicator lights	“PASSENGER AIR BAG OFF”*6
	SRS warning light	Off
	Driver’s and front passenger’s seat belt reminder light	Off*2 or flashing*3
Devices	Front passenger airbag	Deactivated

■ Unoccupied

Indicators/warning lights	“PASSENGER AIR BAG ON” and “PASSENGER AIR BAG OFF” indicator lights	“PASSENGER AIR BAG OFF”
	SRS warning light	Off
	Driver’s and front passenger’s seat belt reminder light	
Devices	Front passenger airbag	Deactivated

■ System malfunction

Indicators/warning lights	“PASSENGER AIR BAG ON” and “PASSENGER AIR BAG OFF” indicator lights	“PASSENGER AIR BAG OFF”
	SRS warning light	On
	Driver's and front passenger's seat belt reminder light	
Devices	Front passenger airbag	Deactivated

*1: The system judges a person of adult size as an adult. When a smaller adult sits in the front passenger seat, the system may not recognize them as an adult depending on their physique and posture.

*2: In the event the front passenger is wearing a seat belt.

*3: In the event the front passenger does not wear a seat belt.

*4: For some children, child in seat, child in booster seat or child in convertible seat, the system may not recognize them as a child. Factors which may affect this can be the physique or posture.

*5: Never install a rear-facing child restraint system on the front passenger seat. A forward-facing child restraint system should only be installed on the front passenger seat when it is unavoidable. (→P.54)

*6: In case the indicator light is not illuminated, consult this manual on how to install the child restraint system properly. (→P.51)

Exhaust gas precautions

Harmful substance to the human body is included in exhaust gases if inhaled.

WARNING

Exhaust gases contain harmful carbon monoxide (CO), which is colorless and odorless. Observe the following precautions. Failure to do so may cause exhaust gases to enter the vehicle and may lead to an accident caused by light-headedness, or may lead to death or a serious health hazard.

■ **Important points while driving**

- Keep the back door closed.
- If you smell exhaust gases in the vehicle even when the back door is closed, open the side windows and have the vehicle inspected at your Toyota dealer as soon as possible.

■ **When parking**

- If the vehicle is in a poorly ventilated area or a closed area, such as a garage, stop the hybrid system.
- Do not leave the vehicle with the hybrid system operating for a long time.
If such a situation cannot be avoided, park the vehicle in an open space and ensure that exhaust fumes do not enter the vehicle interior.

- Do not leave the hybrid system operating in an area with snow build-up, or where it is snowing. If snowbanks build up around the vehicle while the hybrid system operating, exhaust gases may collect and enter the vehicle.

■ **Exhaust pipe**

The exhaust system needs to be checked periodically. If there is a hole or crack caused by corrosion, damage to a joint or abnormal exhaust noise, be sure to have the vehicle inspected and repaired by your Toyota dealer.

Riding with children

Observe the following precautions when children are in the vehicle.

Use a child restraint system appropriate for the child, until the child becomes large enough to properly wear the vehicle's seat belt.

- It is recommended that children sit in the rear seats to avoid accidental contact with the shift lever, wiper switch, etc.
- Use the rear door child-protector lock or the window lock switch to avoid children opening the door while driving or operating the power window accidentally.
(→P.117, 157)
- Do not let small children operate equipment which may catch or pinch body parts, such as the power window, hood, back door, seats, etc.



WARNING

■ When children are in the vehicle

Never leave children unattended in the vehicle, and never allow children to have or use the key.

Children may be able to start the vehicle or shift the vehicle into neutral. There is also a danger that children may injure themselves by playing with the side windows or other features of the vehicle. In addition, heat build-up or extremely cold temperatures inside the vehicle can be fatal to children.

Child restraint systems

Before installing a child restraint system in the vehicle, there are precautions that need to be observed, different types of child restraint systems, as well as installation methods, etc., written in this manual.

Use a child restraint system when riding with a small child that cannot properly use a seat belt. For the child's safety, install the child restraint system to a rear seat. Be sure to follow the installation method that is in the operation manual enclosed with the restraint system.

Table of contents

- Points to remember: P.51
- Child restraint system: P.53
- When using a child restraint system: P.54
- Child restraint system installation method
 - Fixed with a seat belt: P.55
 - Fixed with a child restraint LATCH anchor: P.60
 - Using an anchor bracket (for top tether strap): P.62

Points to remember

The laws of all 50 states of the U.S.A. as well as Canada now require the use of child restraint systems.

- Prioritize and observe the warnings, as well as the laws and regulations for child restraint systems.
- Use a child restraint system until the child becomes large enough to properly wear the vehicle's seat belt.
- Choose a child restraint system that suits your vehicle and is appropriate to the age and size of the child.



WARNING

■ When a child is riding

Observe the following precautions.

Failure to do so may result in death or serious injury.

- For effective protection in automobile accidents and sudden stops, a child must be properly restrained, using a seat belt or child restraint system which is correctly installed. For installation details, refer to the operation manual enclosed with the child restraint system. General installation instructions are provided in this manual.

**WARNING**

- Toyota strongly urges the use of a proper child restraint system that conforms to the weight and size of the child, installed on the rear seat. According to accident statistics, the child is safer when properly restrained in the rear seat than in the front seat.
- Holding a child in your or someone else's arms is not a substitute for a child restraint system. In an accident, the child can be crushed against the windshield or between the holder and the interior of the vehicle.

■ Handling the child restraint system

If the child restraint system is not properly fixed in place, the child or other passengers may be seriously injured or even killed in the event of sudden braking, sudden swerving, or an accident.

- If the vehicle were to receive a strong impact from an accident, etc., it is possible that the child restraint system has damage that is not readily visible. In such cases, do not reuse the restraint system.
- Make sure you have complied with all installation instructions provided with the child restraint system manufacturer and that the system is properly secured.
- Keep the child restraint system properly secured on the seat even if it is not in use. Do not store the child restraint system unsecured in the passenger compartment.
- If it is necessary to detach the child restraint system, remove it from the vehicle or store it securely in the luggage compartment.

Child restraint system

■ Types of child restraint system installation methods

Confirm with the operation manual enclosed with the child restraint system about the installation of the child restraint system.

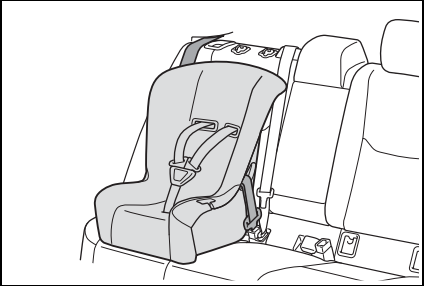
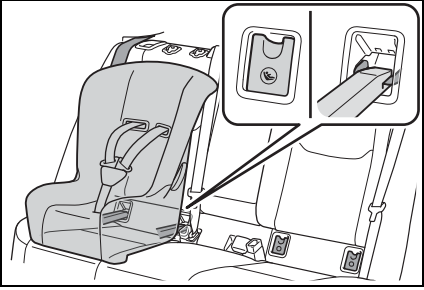
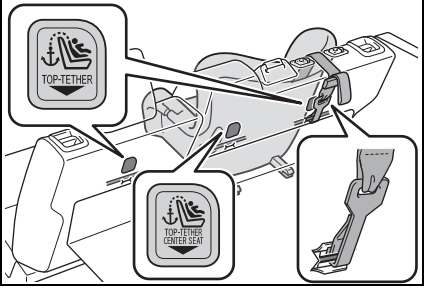
Installation method		Page
Seat belt attachment		P.55
Child restraint LATCH anchors attachment		P.60
Anchor brackets (for top tether strap) attachment		P.62

When using a child restraint system

■ When installing a child restraint system to a front passenger seat

For the safety of a child, install child restraint system to a rear seats. When installing child restraint system to a front passenger seat is unavoidable, adjust the seat as follows and install the child restraint system.

- Adjust the seatback angle to the most upright position.

If there is a gap between the child restraint system and the seatback, adjust the seatback angle until good contact is achieved.

- Move the front seat fully rearward.
- Move the seat to the uppermost position
- If the head restraint interferes with the child restraint system installation and the head restraint can be removed, remove the head restraint. Otherwise, put the head restraint in the upper most position.

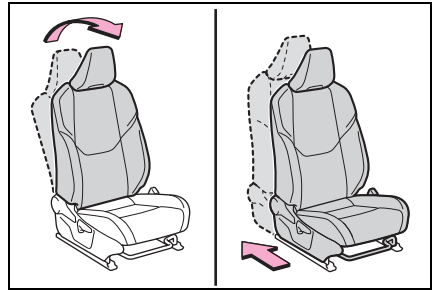

⚠ WARNING

■ When using a child restraint system

Observe the following precautions.

Failure to do so may result in death or serious injury.

- Never install a rear-facing child restraint system on the front passenger seat even if the “AIR BAG OFF” indicator light is illuminated. In the event of an accident, the force of the rapid inflation of the front passenger airbag can cause death or serious injury to the child if the rear-facing child restraint system is installed on the front passenger seat.
- A forward-facing child restraint system may be installed on the front passenger seat only when it is unavoidable. A child restraint system that requires a top tether strap should not be used in the front passenger seat since there is no top tether strap anchor for the front passenger seat.

⚠ WARNING

- A forward-facing child restraint system may be installed on the front passenger seat only when it is unavoidable. When installing a forward-facing child restraint system on the front passenger seat, adjust the seat-back angle to the most upright position, move the seat to the rearmost position, even if the "AIR BAG OFF" indicator light is illuminated.

If the head restraint interferes with the child restraint system installation and the head restraint can be removed, remove the head restraint.



- Do not allow the child to lean his/her head or any part of his/her body against the door or the area of the seat, front or rear pillars, or roof side rails from which the SRS side airbags or SRS curtain shield airbags deploy even if the child is seated in the child restraint system. It is dangerous if the SRS side and curtain shield airbags inflate, and the impact could cause death or serious injury to the child.



- When a booster seat is installed, always ensure that the shoulder belt is positioned across the center of the child's shoulder. The belt should be kept away from the child's neck, but not so that it could fall off the child's shoulder.
- Use a child restraint system suitable to the age and size of the child and install it to the rear seat.
- If the driver's seat interferes with the child restraint system and prevents it from being attached correctly, attach the child restraint system to the right-hand rear seat.

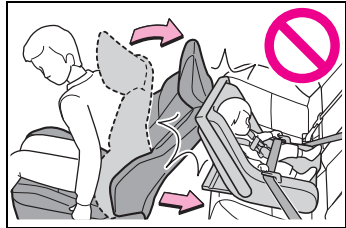

- Adjust the front passenger seat so that it does not interfere with the child restraint system.

Child restraint system fixed with a seat belt

A child restraint system for a small child or baby must itself be properly restrained on the seat with the lap portion of the lap/shoulder belt.

■ Installing child restraint system using a seat belt (child restraint lock function belt)

Install the child restraint system in accordance to the operation

manual enclosed with the child restraint system.

■ Rear-facing — Infant seat/convertible seat

1 Adjust the rear seat.

If there is a gap between the child restraint system and the seatback, adjust the seatback angle until good contact is achieved.

2 Place the child restraint system on the rear seat facing the rear of the vehicle.

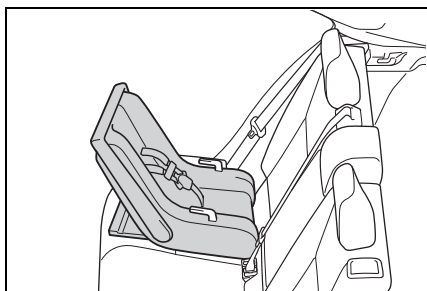

3 Run the seat belt through the child restraint system and insert the plate into the buckle. Make sure that the belt is not twisted.

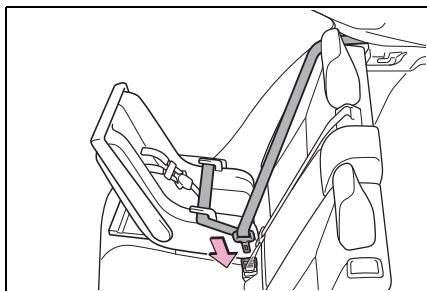

4 Fully extend the shoulder belt and allow it to retract to put it

in lock mode. In lock mode, the belt cannot be extended.

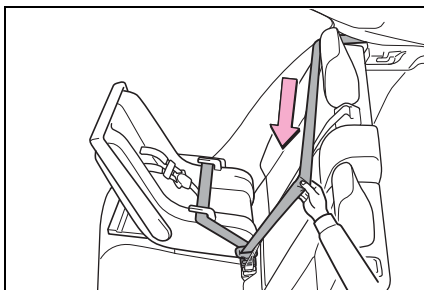

5 While pushing the child restraint system down into the rear seat, allow the shoulder belt to retract until the child restraint system is securely in place.

After the shoulder belt has retracted to a point where there is no slack in the belt, pull the belt to check that it cannot be extended.

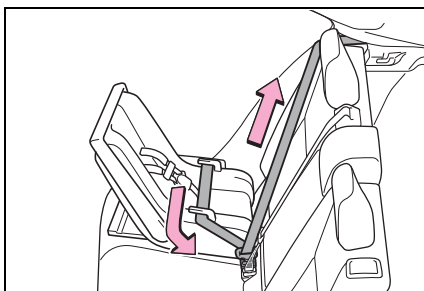

6 After installing the child restraint system, rock it back and forth to ensure that it is installed securely. (→P.59)

■ Forward-facing — Convertible seat

1 Adjust the seat.

When using the front passenger seat: If installing the child restraint system to the front passenger seat is unavoidable, refer to P.54 for front passenger seat adjustment.

When using the rear seat: If there is a gap between the child restraint system and the seatback, adjust the seatback angle until good contact is achieved.

- If the head restraint interferes with the child restraint system installation and the head restraint can be removed, remove the head restraint. (→P.140)

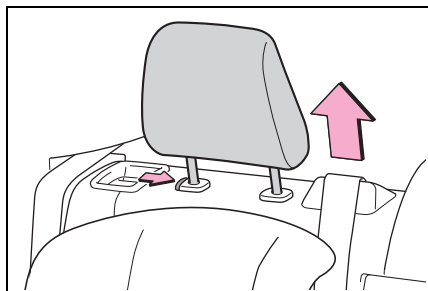

- Place the child restraint system on the seat facing the front of the vehicle.

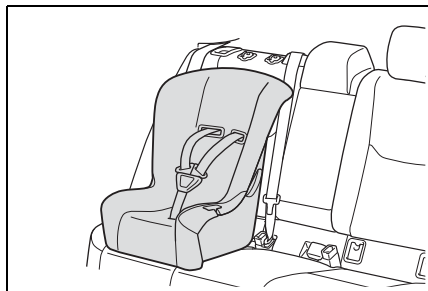

- Run the seat belt through the child restraint system and insert the plate into the

buckle. Make sure that the belt is not twisted.

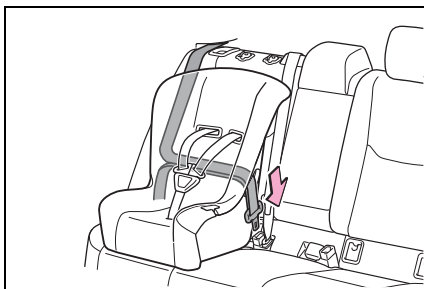

- Fully extend the shoulder belt and allow it to retract to put it in lock mode. In lock mode, the belt cannot be extended.

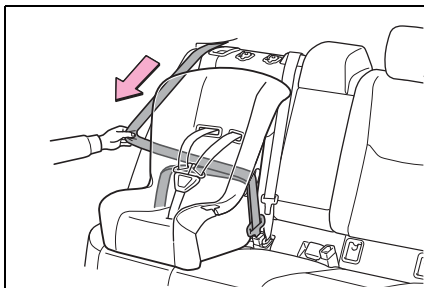

- While pushing the child restraint system into the rear seat, allow the shoulder belt to retract until the child restraint system is securely in place.

After the shoulder belt has retracted to a point where there is no slack in the belt, pull the belt to

check that it cannot be extended.

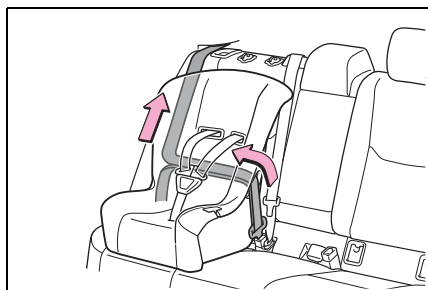

- 7 If the child restraint has a top tether strap, follow the child restraint manufacturer's operation manual regarding the installation, using the top tether strap to latch onto the top tether strap anchor. (→P.62)
- 8 After installing the child restraint system, rock it back and forth to ensure that it is installed securely. (→P.59)

■ Booster seat

- 1 If installing the child restraint system to the front passenger seat is unavoidable, refer to P.54 for front passenger seat adjustment.
- 2 High back type: If the head restraint interferes with your child restraint system, and the head restraint can be

removed, remove the head restraint. (→P.140)

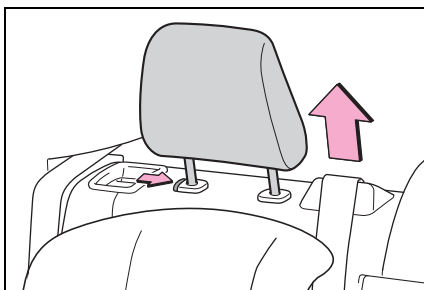

- 3 Place the child restraint system on the seat facing the front of the vehicle.

▶ Booster type

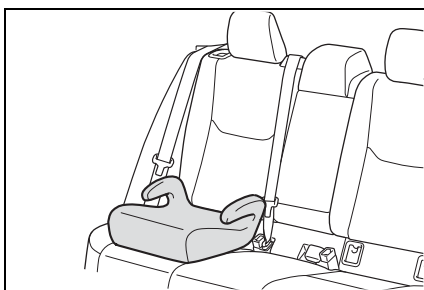

▶ High back type

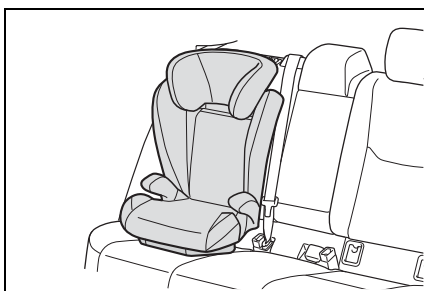

- 4 Sit the child in the child restraint system. Fit the seat belt to the child restraint system according to the manufacturer's instructions and insert the plate into the

buckle. Make sure that the belt is not twisted.

Check that the shoulder belt is correctly positioned over the child's shoulder and that the lap belt is as low as possible. (→P.31)

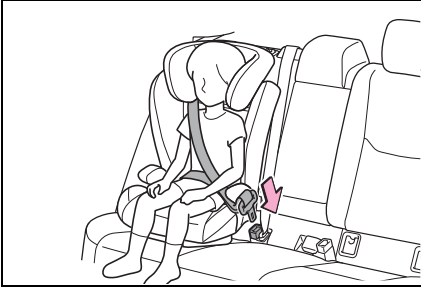

■ Removing a child restraint system installed with a seat belt

Press the buckle release button and fully retract the seat belt.

When releasing the buckle, the child restraint system may spring up due to the rebound of the seat cushion. Release the buckle while holding down the child restraint system.

Since the seat belt automatically reels itself, slowly return it to the stowing position.

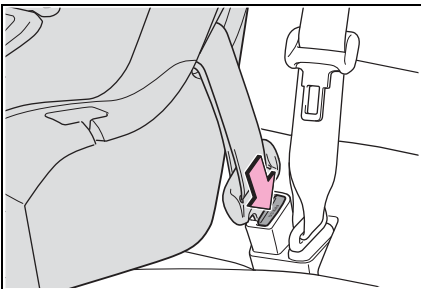

⚠ WARNING

■ When installing a child restraint system

Observe the following precautions.

Failure to do so may result in death or serious injury.

- Do not allow children to play with the seat belt. If the seat belt becomes twisted around a child's neck, it may lead to choking or other serious injuries that could result in death. If this occurs and the buckle cannot be unfastened, scissors should be used to cut the belt.
- Ensure that the belt and plate are securely locked and the seat belt is not twisted.
- Shake the child restraint system left and right, and forward and backward to ensure that it has been securely installed.
- After securing a child restraint system, never adjust the seat.
- When a booster seat is installed, always ensure that the shoulder belt is positioned across the center of the child's shoulder. The belt should be kept away from the child's neck, but not so that it could fall off the child's shoulder.
- Follow all installation instructions provided by the child restraint system manufacturer.

WARNING

When securing some types of child restraint systems in rear seats, it may not be possible to properly use the seat belts in positions next to the child restraint without interfering with it or affecting seat belt effectiveness. Be sure your seat belt fits snugly across your shoulder and low on your hips. If it does not, or if it interferes with the child restraint, move to a different position. Failure to do so may result in death or serious injury.

When installing a booster seat

To prevent the belt from going into ALR lock mode, do not fully extend the shoulder belt. ALR mode causes the belt to tighten only. This could cause injury or discomfort to the child. (→P.33)

Do not use a seat belt extender

If a seat belt extender is used when installing a child restraint system, the seat belt will not securely hold the child restraint system, which could cause death or serious injury to the child or other passengers in the event of sudden braking, sudden swerving or an accident.

Child restraint system fixed with a child restraint LATCH anchor

Child restraint LATCH anchors

LATCH anchors are provided for the outboard rear seats. (Marks displaying the location of the anchors are attached to the

seats.)

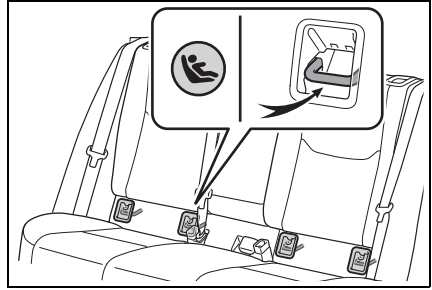

When installing in the rear outboard seats

Install the child restraint system in accordance to the operation manual enclosed with the child restraint system.

- 1 If the head restraint interferes with the child restraint system installation and the head restraint can be removed, remove the head restraint. (→P.140)

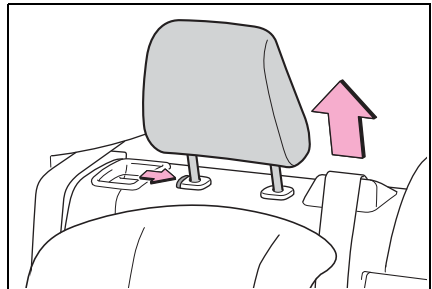

- ▶ With flexible lower attachments
- 2 Remove the anchor covers, and latch the hooks of the lower attachments onto the LATCH anchors. For owners in Canada: The symbol on a child restraint system indicates **A**

the presence of a lower connector system.

The bars are installed behind the anchor covers.

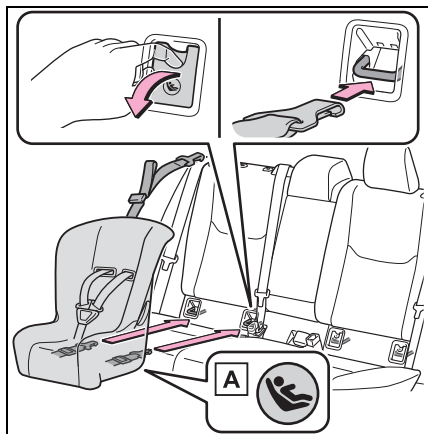

A Canada only

► With rigid lower attachments

- 2 Remove the anchor covers, and latch the buckles onto the LATCH anchors. For owners in Canada: The symbol on a child restraint system indicates **A** the presence of a lower connector system.

The bars are installed behind the

anchor covers.

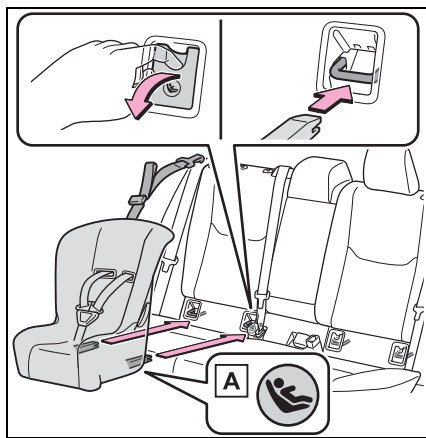

A Canada only

- 3 If the child restraint has a top tether strap, follow the child restraint manufacturer's operation manual regarding the installation, using the top tether strap to latch onto the top tether strap anchor. (→P.62)
- 4 After installing the child restraint system, rock it back and forth to ensure that it is installed securely. (→P.59)

■ **When installing in the rear center seat**

There are no LATCH anchors behind the rear center seat. However, the inboard LATCH anchors of the outboard seats, which are 15.72 in. (399.4 mm) apart, can be used if the child restraint system manufacturer's instructions permit use of those anchors with the anchor spacing stated.

Child restraint systems with rigid lower attachments cannot be installed in the center seat. This type of child restraint system can only be installed in the outboard seat.

■ Laws and regulations pertaining to anchors

The LATCH system conforms to FMVSS225 or CMVSS210.2. Child restraint systems conforming to FMVSS213 or CMVSS213 specifications can be used. This vehicle is designed to conform to SAE J1819.

⚠ WARNING

■ When installing a child restraint system

Observe the following precautions. Failure to do so may result in death or serious injury.

- When using the LATCH anchors, be sure that there are no foreign objects around the anchors and that the seat belt is not caught behind the child restraint system.
- Follow all installation instructions provided by the child restraint system manufacturer.
- Never attach two child restraint system attachments to the same anchor. In a collision, one anchor may not be strong enough to hold two child restraint system attachments and may break. If the LATCH anchors are already in use, use the seat belt to install a child restraint system in the center seat.

- When securing some types of child restraint systems in rear seats, it may not be possible to properly use the seat belts in positions next to the child restraint without interfering with it or affecting seat belt effectiveness. Be sure your seat belt fits snugly across your shoulder and low on your hips. If it does not, or if it interferes with the child restraint, move to a different position. Failure to do so may result in death or serious injury.
- If the seat is adjusted, reconfirm the security of the child restraint system.

Using an anchor bracket (for top tether strap)

■ Anchor brackets (for top tether strap)

Anchor brackets are provided for each rear seat.

Use anchor brackets when fixing the top tether strap.

▶ Outboard rear seats

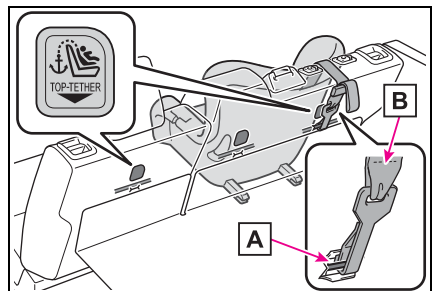

A Anchor brackets

B Top tether strap

► Center rear seat

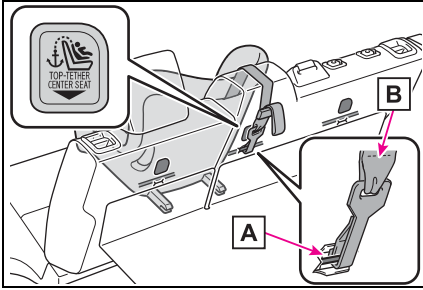

- A** Anchor brackets
- B** Top tether strap

■ **Fixing the top tether strap to the anchor bracket**

Install the child restraint system in accordance to the operation manual enclosed with the child restraint system.

► Outboard rear seats

- 1 Remove the head restraint. (→P.140)

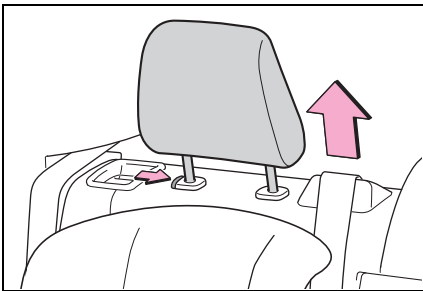

- 2 Latch the hook onto the anchor bracket and tighten the top tether strap.

Make sure the top tether strap is

securely latched. (→P.59)

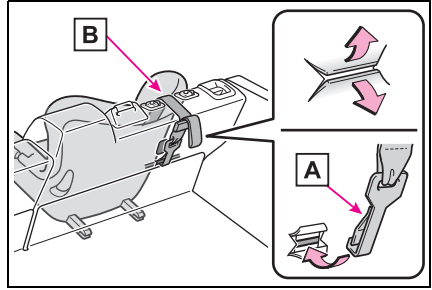

- A** Hook
- B** Top tether strap

- 3 If the head restraint does not interfere with the child restraint system installation, install the head restraint.

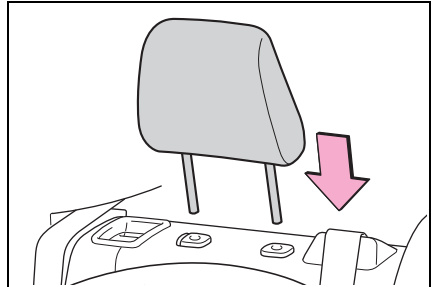

► Center rear seat

- 1 Latch the hook onto the anchor bracket and tighten the top tether strap.

Make sure the top tether strap is securely latched.

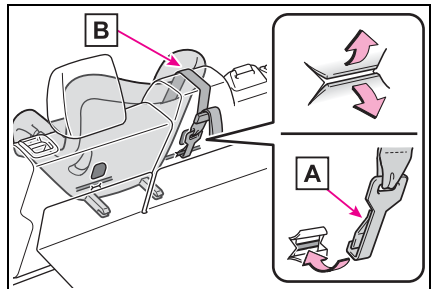

- A Hook
- B Top tether strap

■ **Laws and regulations pertaining to anchors**

The LATCH system conforms to FMVSS225 or CMVSS210.2. Child restraint systems conforming to FMVSS213 or CMVSS213 specifications can be used. This vehicle is designed to conform to SAE J1819.



WARNING

■ **When installing a child restraint system**

Observe the following precautions.

Failure to do so may result in death or serious injury.

- Firmly attach the top tether strap and make sure that the belt is not twisted.
- Do not attach the top tether strap to anything other than the anchor bracket.
- After securing a child restraint system, never adjust the seat.
- Follow all installation instructions provided by the child restraint system manufacturer.
- Outboard rear seat: When installing the child restraint system with the head restraint being raised, after the head restraint has been raised and then the anchor bracket has been fixed, do not lower the head restraint.

Safety Connect*

*: If equipped

Safety Connect is a subscription-based telematics service that uses Global Positioning System (GPS) data and embedded cellular technology to provide safety and security features to subscribers. Safety Connect is supported by Toyota's designated response center, which operates 24 hours per day, 7 days per week.

Safety Connect service is available by subscription on select, telematics hardware-equipped vehicles.

By using the Safety Connect service, you are agreeing to be bound by the Telematics Subscription Service Agreement and its Terms and Conditions, as in effect and amended from time to time, a current copy of which is available at Toyota.com in the United States, Toyotapr.com in Puerto Rico and Toyota.ca in Canada. All use of the Safety Connect service is subject to such then-applicable Terms and Conditions.

System components

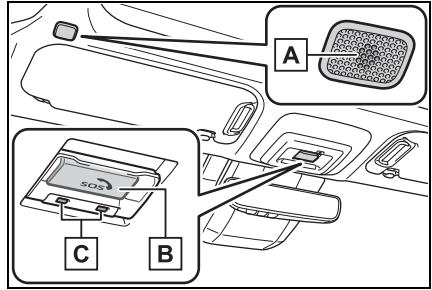

- A** Microphone
- B** "SOS" button
- C** LED light indicators

Services

Subscribers have the following Safety Connect services available:

- Automatic Collision Notification*

Helps drivers receive necessary response from emergency service providers. (→P.67)

*: U.S. Patent No. 7,508,298 B2

- Stolen Vehicle Location

Helps drivers in the event of vehicle theft. (→P.67)

- Emergency Assistance Button ("SOS")

Connects drivers to response-center support. (→P.67)

- Enhanced Roadside Assistance

Provides drivers various on-road assistance. (→P.68)

Subscription

After you have signed the Telematics Subscription Service Agreement and are enrolled, you can begin receiving services.

A variety of subscription terms are available for purchase. Contact your Toyota dealer, call the following appropriate Customer Experience Center or push the “SOS” button in your vehicle for further subscription details.

- The United States

1-800-331-4331

- Canada

1-888-869-6828

- Puerto Rico

1-877-855-8377

■ Safety Connect Services Information

- Phone calls using the vehicle’s Bluetooth® technology will not be possible when Safety Connect is active and in use.
- Safety Connect is available beginning Fall 2009 on select Toyota models (in the contiguous United States only). Contact with the Safety Connect response center is dependent upon the telematics device being in operative condition, cellular connection availability, and GPS satellite signal reception, which can limit the ability to reach the response center or receive emergency service support. Enrollment and Telematics Subscription Service Agreement are required. A variety of subscription terms are available; charges

vary by subscription term selected and location.

- Automatic Collision Notification, Emergency Assistance and Stolen Vehicle Location are available in the United States, including Hawaii and Alaska, Puerto Rico and Canada, and Enhanced Roadside Assistance are available in the United States, Puerto Rico and Canada.
- Automatic Collision Notification, Emergency Assistance, Stolen Vehicle and Enhanced Road Assistance are not available in the U.S. Virgin Islands. For vehicles first sold in the U.S. Virgin Islands, no Safety Connect services will function in or outside the U.S. Virgin Islands.
- Safety Connect services are not subject to section 255 of the Telecommunications Act and the device is not TTY compatible.

■ Languages

The Safety Connect response center will offer support in multiple languages. The Safety Connect system will offer voice prompts in English, Spanish, and French. Please indicate your language of choice when enrolling.

■ When contacting the response center

You may be unable to contact the response center if the network is busy.

Safety Connect LED light Indicators

When the power switch is turned to ON, the red indicator light comes on for 2 seconds then turns off. Afterward, the green indicator light comes on, indicating that the service is active.

The following indicator light patterns indicate specific system usage conditions:

- Green indicator light on = Active service
- Green indicator light flashing = Safety Connect call in process
- Red indicator light (except at vehicle start-up) = System malfunction (contact your Toyota dealer)
- No indicator light (off) = Safety Connect service not active

Safety Connect services

■ Automatic Collision Notification

In case of either airbag deployment or severe rear-end collision, the system is designed to automatically call the response center. The responding agent receives the vehicle's location and attempts to speak with the vehicle occupants to assess the level of emergency. If the occupants are unable to communicate, the agent automatically treats the call as an emergency, contacts the nearest emergency services provider to describe the situation, and requests that assistance be sent to the location.

■ Stolen Vehicle Location

If your vehicle is stolen, Safety Connect can work with local authorities to assist them in locating and recovering the vehicle. After filing a police report, call the Customer Experience Center at 1-800-331-4331 in the United States, 1-877-855-8377 in Puerto Rico or 1-888-869-6828 in Canada, and follow the prompts for Safety Connect to initiate this service.

In addition to assisting law enforcement with recovery of a stolen vehicle, Safety-Connect-equipped vehicle location data may, under certain circumstances, be shared with third parties to locate your vehicle. Further information is available at Toyota.com in the United States, Toyotapr.com in Puerto Rico and Toyota.ca in Canada.

■ Emergency Assistance Button (“SOS”)

In the event of an emergency on the road, push the “SOS” button to reach the Safety Connect response center. The answering agent will determine your vehicle's location, assess the emergency, and dispatch the necessary assistance required.

If you accidentally press the “SOS” button, tell the response-center agent that you are not experiencing an emergency.

■ **Enhanced Roadside Assistance**

Enhanced Roadside Assistance adds GPS data to the already included warranty-based Toyota roadside service.

Subscribers can press the “SOS” button to reach a Safety Connect response-center agent, who can help with a wide range of needs, such as: towing, flat tire, fuel delivery, etc. For a description of the Enhanced Roadside Assistance services and their limitations, please see the Safety Connect Terms and Conditions, which are available at Toyota.com in the United States, Toyotapr.com in Puerto Rico and Toyota.ca in Canada.

Safety information for Safety Connect

Important! Read this information before using Safety Connect.

■ **Exposure to radio frequency signals**

The Safety Connect system installed in your vehicle is a low-power radio transmitter and receiver. It receives and also sends out radio frequency (RF) signals.

In August 1996, the Federal Communications Commission (FCC) adopted RF exposure guidelines with safety levels for

mobile wireless phones. Those guidelines are consistent with the safety standards previously set by the following U.S. and international standards bodies.

- ANSI (American National Standards Institute) C95.1 [1992]
- NCRP (National Council on Radiation Protection and Measurement) Report 86 [1986]
- ICNIRP (International Commission on Non-Ionizing Radiation Protection) [1996]

Those standards were based on comprehensive and periodic evaluations of the relevant scientific literature. Over 120 scientists, engineers, and physicians from universities, and government health agencies and industries reviewed the available body of research to develop the ANSI Standard (C95.1).

The design of Safety Connect complies with the FCC guidelines in addition to those standards.

■ **Free/Open Source Software Information**

This product contains Free/Open Source Software (FOSS). The license information and/or the source code of such FOSS can be found at the following URL.

[https://opensource.lge.com/
osSch/
list?types=ALL&search=TL21BNU](https://opensource.lge.com/osSch/list?types=ALL&search=TL21BNU)

Hybrid system features

Your vehicle is a Hybrid Electric Vehicle. It has characteristics different from conventional vehicles. Be sure you are closely familiar with the characteristics of your vehicle, and operate it with care.

The hybrid system combines the use of a gasoline engine and an electric motor (traction motor) according to driving conditions, improving fuel efficiency and reducing exhaust emissions.

System components

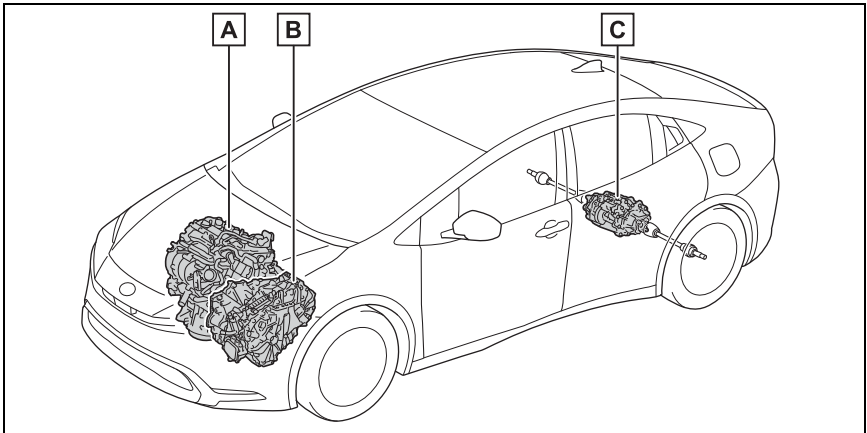

The illustration is an example for explanation and may differ from the actual item.

- A** Gasoline engine
- B** Front electric motor (traction motor)
- C** Rear electric motor (traction motor) (AWD models)

■ When stopped/during start off

The gasoline engine stops* when the vehicle is stopped. During start off, the electric motor (traction motor) drives the vehicle. At slow speeds or when

traveling down a gentle slope, the engine is stopped* and the electric motor (traction motor) is used.

When the shift position is in N, the hybrid battery (traction battery) is not being charged.

*: When the hybrid battery (traction battery) requires charging or the engine is warming up, etc., the gasoline engine will not automatically stop. (→P.71)

■ During normal driving

The gasoline engine is predominantly used. The electric motor (traction motor) charges the hybrid battery (traction battery) as necessary.

■ When accelerating sharply

When the accelerator pedal is depressed heavily, the power of the hybrid battery (traction battery) is added to that of the gasoline engine via the electric motor (traction motor).

■ When braking (regenerative braking)

The wheels operate the electric motor (traction motor) as a power generator, and the hybrid battery (traction battery) is charged.

■ Regenerative braking

In the following situations, kinetic energy is converted to electric energy and deceleration force can be obtained in conjunction with the recharging of the hybrid battery (traction battery).

- The accelerator pedal is released while driving with the shift position in D or B.
- The brake pedal is depressed while driving with the shift position in D or B.

■ EV indicator

The EV indicator comes on when

the vehicle is driven using only the electric motor (traction motor) or the gasoline engine is stopped.

The on/off operation of the EV indicator can be changed. (→P.96)

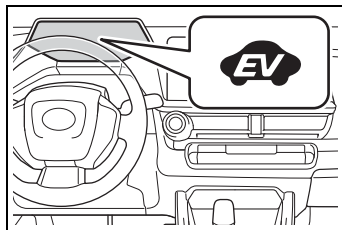

■ Conditions in which the gasoline engine may not stop

The gasoline engine starts and stops automatically. However, it may not stop automatically in the following conditions*:

- During gasoline engine warm-up
- During hybrid battery (traction battery) charging
- When the temperature of the hybrid battery (traction battery) is high or low
- When the heater is switched on

*: Depending on the circumstances, the gasoline engine may also not stop automatically in other situations.

■ Charging the hybrid battery (traction battery)

As the gasoline engine charges the hybrid battery (traction battery), the battery does not need to be charged from an outside source. However, if the vehicle is left parked for a long time the hybrid battery (traction battery) will slowly discharge. For this reason, be sure to drive the vehicle at least once every few months for at least 30 minutes or 10 miles (16 km). If the hybrid battery (traction battery) becomes fully discharged and you are unable to start the hybrid system, contact your Toyota dealer.

■ Charging the 12-volt battery

→P.509

■ After the 12-volt battery has discharged or when the terminal has been removed and installed during exchange, etc.

The gasoline engine may not stop even if the vehicle is being driven by the hybrid battery (traction battery). If this continues for a few days, contact your Toyota dealer.

■ Sounds and vibrations specific to a Hybrid Electric Vehicle

Because there is no engine sound or vibration, it is easy to mistake the hybrid vehicle for being off when it is actually still running, as indicated by the "READY" indicator being illuminated. For safety, make sure to always shift the shift position to P and apply the parking brake when parked.

The following sounds or vibrations may occur when the hybrid system is operating and are not a malfunction:

- Motor sounds may be heard from the engine compartment.
- Sounds may be heard from the hybrid battery (traction battery) under the rear seats when the hybrid system starts or stops.
- Relay operating sounds such as a snap or soft clank will be emitted from the hybrid battery (traction battery), under the rear seats, when the hybrid system is started or stopped.
- Sounds from the hybrid system may be heard when the back door is open.
- Sounds may be heard from the transmission when the gasoline engine starts or stops, when driving at low speeds, or during idling.
- Engine sounds may be heard when accelerating sharply.
- Sounds may be heard due to regenerative braking when the

brake pedal is depressed or as the accelerator pedal is released.

- Vibration may be felt when the gasoline engine starts or stops.
- Cooling fan sounds may be heard from the air intake vent under the rear seat.

■ Maintenance, repair, recycling, and disposal

Contact your Toyota dealer regarding maintenance, repair, recycling and disposal. Do not dispose of the vehicle yourself.

Acoustic Vehicle Alerting System

When driving with the gasoline engine stopped, a sound, which changes in accordance with the driving speed, will be played in order to warn people nearby of the vehicle's approach. The sound will stop when the vehicle speed exceeds approximately 22 mph (35 km/h).

■ Acoustic Vehicle Alerting System

In the following cases, the Acoustic Vehicle Alerting System may be difficult for surrounding people to hear.

- In very noisy areas
- In the wind or the rain

Also, as the Acoustic Vehicle Alerting System is installed on the front of the vehicle, it may be more difficult to hear from the rear of the vehicle compared to the front.

■ If "Acoustic Vehicle Alerting System Malfunction Visit your Dealer" is displayed on the multi-information display

The system may be malfunctioning. Have the vehicle inspected by your

Toyota dealer.

Predictive efficient drive (vehicles with navigation system)*

*: This function can only be used in the mainland U.S.A. It cannot be used in other states and territories, including Alaska and Hawaii.

This system operates based on the driving situation and traffic information to enhance fuel economy.

For details about Predictive efficient drive, refer to “MULTIMEDIA OWNER’S MANUAL”.

■ Predictive deceleration support

- When the vehicle approaches to predictive deceleration support points registered in the navigation system, “Reference operation range” (A) of the ECO Accelerator Guidance (→P.93) on the multi-information display will be turned off to encourage the driver to reduce excessive acceleration.

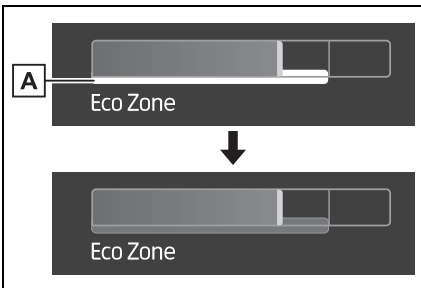

- The engine braking force will be increased according to the driving conditions to more efficiently charge the hybrid battery (traction battery) after the accelerator pedal is released.

■ Predictive SOC (State of charge) control

The following types of control are performed based on data such as road and traffic information during route guidance by the navigation system to help ensure that the vehicle efficiently uses electricity.

- When there is a long downhill slope along the route, the system reduces the hybrid battery (traction battery) level before reaching the slope to help ensure charging capacity for regenerative braking while traveling downhill.
- When traffic congestion is predicted along the route, the system helps ensure a certain battery level before reaching congested roads to reduce the frequency of starting the engine to charge the hybrid battery (traction battery) due to low battery levels.

Hybrid system precautions

Take care when handling the hybrid system, as it is a high voltage system (about 600V at maximum) as well as contains parts that become extremely hot when the hybrid system is operating. Obey the warning labels attached to the vehicle.

System components

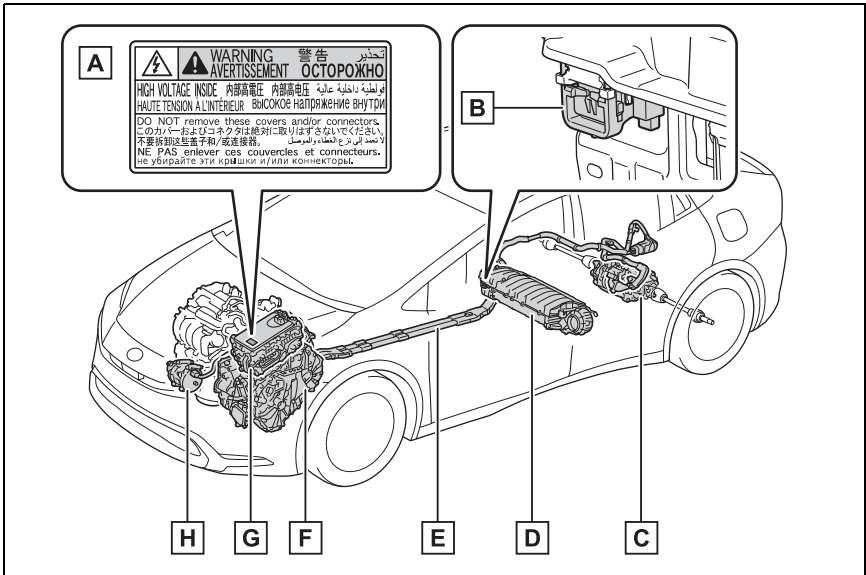

The illustration is an example for explanation and may differ from the actual item.

- A** Warning label
- B** Service plug
- C** Rear electric motor (traction motor) (AWD models)
- D** Hybrid battery (traction battery)
- E** High voltage cables (orange)
- F** Front electric motor (traction motor)
- G** Power control unit
- H** Air conditioning compressor

■ Running out of fuel

When the vehicle has run out of fuel and the hybrid system cannot be started, refuel the vehicle with at least enough gasoline to make the low fuel level warning light (→P.470) go off. If there is only a small amount of fuel, the hybrid system may not be able to start. (The standard amount of fuel is about 2.3 gal. [8.8 L, 1.9 Imp.gal.], when the vehicle is on a level surface. This value may vary when the vehicle is on a slope. Add extra fuel when the vehicle is inclined.)

■ Electromagnetic waves

- High voltage parts and cables on Hybrid Electric Vehicles incorporate electromagnetic shielding, and therefore emit approximately the same amount of electromagnetic waves as conventional gasoline powered vehicles or home electronic appliances.
- Your vehicle may cause sound interference in some third party-produced radio parts.

■ Hybrid battery (traction battery)

The hybrid battery (traction battery) has a limited service life. The lifespan of the hybrid battery (traction battery) can change in accordance with driving style and driving conditions.

■ Starting the hybrid system in an extremely cold environment

When the hybrid battery (traction battery) is extremely cold (below approximately -22°F [-30°C]) under the influence of the outside temperature, it may not be possible to start the hybrid system. In this case, try to start the hybrid system again after the temperature of the hybrid battery increases due to the outside temperature increase etc.

⚠ WARNING

■ High voltage precautions

This vehicle has high voltage DC and AC systems as well as a 12-volt system. DC and AC high voltage is very dangerous and can cause severe burns and electric shock that may result in death or serious injury.

- Never touch, disassemble, remove or replace the high voltage parts, cables or their connectors.
- The hybrid system will become hot after starting as the system uses high voltage. Be careful of both the high voltage and the high temperature, and always obey the warning labels attached to the vehicle.
- Never try to open the service plug access hole located underneath the rear seats. The service plug is used only when the vehicle is serviced and is subject to high voltage.

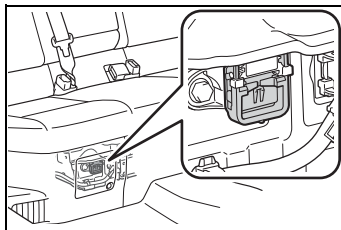

■ Road accident cautions

Observe the following precautions to reduce the risk of death or serious injury:

- Stop the vehicle in a safe place to prevent subsequent accidents. While depressing the brake pedal, apply the parking brake and shift the shift position to P to stop the hybrid system. Then, slowly release the brake pedal.

**WARNING**

- Do not touch the high voltage parts, cables and connectors.
- If electric wires are exposed inside or outside your vehicle, an electric shock may occur. Never touch exposed electric wires.
- Do not touch the battery if liquid is leaking from or adhering to it. If electrolyte (carbonic-based organic electrolyte) from the hybrid battery (traction battery) comes into contact with the eyes or skin, it could cause blindness or skin wounds. In the unlikely event that it comes into contact with the eyes or skin, wash it off immediately with a large amount of water, and seek immediate medical attention.
- If electrolyte is leaking from the hybrid battery (traction battery), do not approach the vehicle. Even in the unlikely event that the hybrid battery (traction battery) is damaged, the internal construction of the battery will prevent a large amount of electrolyte from leaking out. However, any electrolyte that does leak out will give off a vapor. This vapor is an irritant to skin and eyes and could cause acute poisoning if inhaled.
- Do not bring burning or high-temperature items close to the electrolyte. The electrolyte may ignite and cause a fire.
- If a fire occurs in the Hybrid Electric Vehicle, leave the vehicle as soon as possible. Never use a fire extinguisher that is not meant for electric fires. Using even a small amount of water may be dangerous.

- If your vehicle needs to be towed, do so with four wheels raised. If the wheels connected to the electric motor (traction motor) are on the ground when towing, the motor may continue to generate electricity. This may cause a fire. (→P.457)
- Carefully inspect the ground under the vehicle. If you find that liquid has leaked onto the ground, the fuel system may have been damaged. Leave the vehicle as soon as possible.
- **Hybrid battery (traction battery)**
- Never resell, hand over or modify the hybrid battery. To prevent accidents, hybrid batteries that have been removed from a disposed vehicle are collected through Toyota dealer. Do not dispose of the battery yourself.
- Your vehicle contains a sealed lithium-ion battery.

Unless the battery is properly collected, the following may occur, resulting in death or serious injury:

- The hybrid battery may be illegally disposed of or dumped, and it is hazardous to the environment or someone may touch a high voltage part, resulting in an electric shock.
- The hybrid battery is intended to be used exclusively with your Hybrid Electric Vehicle. If the hybrid battery is used outside of your vehicle or modified in any way, accidents such as electric shock, heat generation, smoke generation, an explosion and electrolyte leakage may occur.

**WARNING**

When reselling or handing over your vehicle, the possibility of an accident is extremely high because the person receiving the vehicle may not be aware of these dangers.

- If your vehicle is disposed of without the hybrid battery having been removed, there is a danger of serious electric shock if high voltage parts, cables and their connectors are touched. In the event that your vehicle must be disposed of, the hybrid battery must be disposed of by your Toyota dealer or a qualified service shop. If the hybrid battery is not disposed of properly, it may cause electric shock that can result in death or serious injury.

**NOTICE****Hybrid battery (traction battery)**

Do not carry large amounts of water such as water cooler bottles in the vehicle. If water spills onto the hybrid battery (traction battery), the battery may be damaged. Have the vehicle inspected by your Toyota dealer.

Hybrid battery (traction battery) air intake vent

There is an air intake vent under the left side of the rear seat with the purpose of cooling the hybrid battery (traction battery).

If the vent is blocked, it may interfere with the cooling of the hybrid battery (traction battery).

If input/output of the hybrid bat-

tery (traction battery) becomes limited and the distance that the vehicle can be driven using the electric motor (traction motor) is reduced, the fuel economy may be reduced.

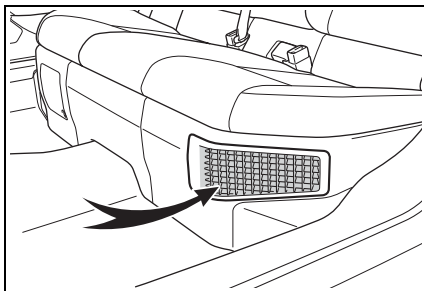
**NOTICE****Hybrid battery (traction battery) air intake vent**

- Make sure not to block the air intake vent with anything, such as a seat cover, plastic cover, or luggage. The input/output of the hybrid battery (traction battery) may be restricted, leading to a reduction in hybrid battery (traction battery) output and a malfunction.
- Periodically clean the air intake vent to prevent it from clogging. (→P.443)
- Do not get water or foreign materials in the air intake vent as this may cause a short circuit and damage the hybrid battery (traction battery).
- There is a filter installed to the air intake vent. When the filter remains noticeably dirty even after cleaning the air intake vent, filter cleaning or replacement is recommended. For information regarding filter cleaning or replacement, refer to P.443.



NOTICE

- If “Maintenance Required for Traction Battery Cooling Parts See Owner’s Manual” is shown on the multi-information display, the air intake vent and filter may be clogged. Refer to P.443 for information on how to clean the air intake vent.

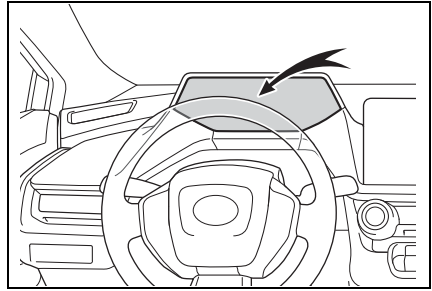

Emergency shut off system

When a certain level of impact is detected by the impact sensor, the emergency shut off system blocks the high voltage current and stops the fuel pump to minimize the risk of electrocution and fuel leakage. If the emergency shut off system activates, your vehicle will not restart. To restart the hybrid system, contact your Toyota dealer.

Hybrid warning message

A message is automatically displayed when a malfunction occurs in the hybrid system or an improper operation is attempted.

If a warning message is shown on the multi-information display, read the message and follow the instructions.

- **If a warning light comes on, a warning message is displayed, or the 12-volt battery is disconnected**

The hybrid system may not start. In this case, try to start the system again. If the “READY” indicator does not come on, contact your Toyota dealer.

Immobilizer system

The vehicle's keys have built-in transponder chips that prevent the hybrid system from starting if a key has not been previously registered in the vehicle's on-board computer.

Never leave the keys inside the vehicle when you leave the vehicle.

This system is designed to help prevent vehicle theft but does not guarantee absolute security against all vehicle thefts.

Operating the system

The indicator light flashes after the power switch has been turned to off to indicate that the system is operating.

The indicator light stops flashing after the power switch has been turned to ACC or ON to indicate that the system has been canceled.

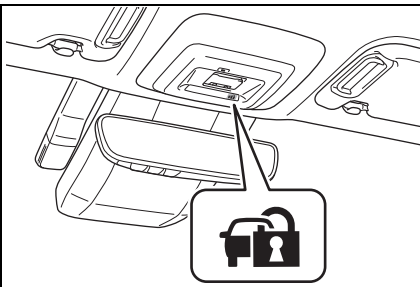

■ System maintenance

The vehicle has a maintenance-free type immobilizer system.

■ Conditions that may cause the system to malfunction

- If the grip portion of the key is in contact with a metallic object
- If the key is in close proximity to or touching a key to the security system (key with a built-in transponder chip) of another vehicle

⚠ NOTICE

■ To ensure the system operates correctly

Do not modify or remove the system. If modified or removed, the proper operation of the system cannot be guaranteed.

Vehicle status information and indicators

2

2-1. Instrument cluster

- Warning lights and indicators 82
- Gauges and meters 87
- Multi-information display 92
- Energy monitor/consumption screen..... 102

Warning lights and indicators

The warning lights and indicators on the instrument cluster, overhead console panel and outside rear view mirrors inform the driver of the status of the vehicle's various systems.

Instrument cluster

For the purpose of explanation, the following illustrations display all warning lights and indicators illuminated.

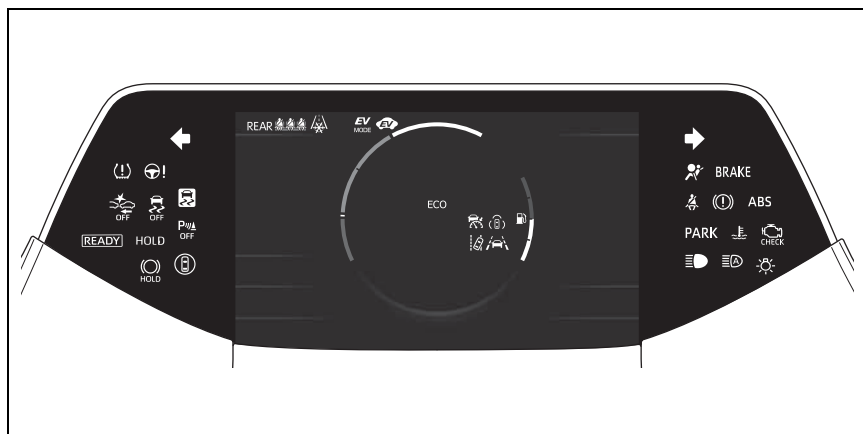



The units used on the meters and some indicators may differ depending on the target region.

Warning lights

Warning lights inform the driver of malfunctions in the indicated vehicle's systems.

BRAKE Brake system warning light^{*1} (→P.463)
(U.S.A.)

 Brake system warning light^{*1} (→P.463)
(Canada) (Red)















 Brake system warning light^{*1} (→P.463)
(Yellow)

 Charging system warning light^{*2} (→P.463)

 High coolant temperature warning light (→P.464)

 Low engine oil pressure warning light^{*2} (→P.464)

 Hybrid system overheat warning light^{*2} (→P.464)

	Malfunction indicator lamp* ¹ (→P.464) (U.S.A.)
	Malfunction indicator lamp* ¹ (→P.464) (Canada)
	SRS warning light* ¹ (→P.465)
	ABS warning light* ¹ (→P.465) (U.S.A.)
	ABS warning light* ¹ (→P.465) (Canada)
	Electric power steering system warning light* ¹ (→P.466) (Red)
	Electric power steering system warning light* ¹ (→P.466) (Yellow)
	PCS warning light* ¹ (→P.466)
	LTA indicator (→P.466) (Orange)
	LDA indicator (→P.466) (Orange)
	PDA indicator (→P.467) (Orange)
	Cruise control indicator (→P.467) (Orange)
	Dynamic radar cruise control indicator (→P.467) (Orange)
	Driving assist information indicator* ¹ (→P.467)

 Intuitive parking assist OFF indicator*³ (→P.468)

 Slip indicator light*¹
(→P.468)

 Inappropriate pedal operation warning light*²
(→P.468)

 Brake hold operated indicator*¹ (→P.469)
(Flashes)

 Parking brake indicator
(U.S.A.) (→P.469)
(Flashes)

 Parking brake indicator
(Canada) (→P.469)
(Flashes)

 Tire pressure warning light*¹ (→P.469)

 Low fuel level warning light (→P.470)

 Driver's and front passenger's seat belt reminder light (→P.470)

 Rear passengers' seat belt reminder light (→P.470)

*¹: These lights turn on when the power switch is turned to ON to indicate that a system check is being performed. They will turn off after the hybrid system is on, or after a few seconds. There may be a malfunction in a system if the light does not come on, or turn off. Have the vehicle inspected by your Toyota dealer.

*²: This light illuminates on the multi-information display with a message.

*3: Intuitive parking assist OFF indicator turns on when the power switch is turned to ON while the Intuitive parking assist function is on. It will turn off after a few seconds.



WARNING

■ If a safety system warning light does not come on

Should a safety system light such as the ABS and SRS warning light not come on when you start the hybrid system, this could mean that these systems are not available to help protect you in an accident, which could result in death or serious injury. Have the vehicle inspected by your Toyota dealer immediately if this occurs.

Indicators

The indicators inform the driver of the operating state of the vehicle's various systems.



Turn signal indicator
(→P.192)



Headlight indicator
(→P.199)
(U.S.A.)



Tail light indicator
(→P.199)
(Canada)



Headlight high beam indicator (→P.201)



AHB indicator (→P.202)



Smart key system indicator*1 (→P.180)



LTA indicator (→P.237)



LTA indicator (→P.237)



LTA indicator (→P.237)
(Orange)
(Flashes)



LDA indicator*2 (→P.246)



LDA indicator (→P.246)



LDA indicator (→P.246)
(Orange)
(Flashes)



LDA OFF indicator*3, 4
(→P.246)



PDA indicator (→P.252)



PDA indicator (→P.252)



Cruise control indicator
(→P.269)



















Cruise control indicator
(→P.269)





Dynamic radar cruise control indicator (→P.259)



Dynamic radar cruise control indicator (→P.259)

	Intuitive parking assist OFF indicator* ^{4, 5} (→P.285)
	Slip indicator light* ⁶ (→P.346) (Flashes)
	VSC OFF indicator* ^{4, 6} (→P.346)
	PCS warning light* ^{4, 6} (→P.222)
	Driving assist information indicator* ^{4, 6} (→P.281, 295, 300, 305)
	BSM outside rear view mirror indicators* ⁷ (if equipped) (→P.275)
	Brake hold standby indica- tor* ⁶ (→P.196)
	Brake hold operated indi- cator* ⁶ (→P.196)
	Security indicator* ⁸ (→P.79)
	“READY” indicator (→P.180)
	Low outside temperature indicator* ⁹ (→P.90)
	EV indicator (→P.71)
	Parking brake indicator (→P.193) (U.S.A.)
	Parking brake indicator (→P.193) (Canada)
	EV drive mode indicator (→P.185)
	Eco drive mode indicator (→P.343)

 Sport mode indicator
(→P.343)

 Custom mode indicator
(→P.343)

 “PASSENGER AIR
BAG” indicator
lights*⁸ (→P.44)

*¹: This light illuminates on the multi-information display with a message.

*²: Except for Puerto Rico

*³: For Puerto Rico

*⁴: The light comes on when the system is turned off.

*⁵: Intuitive parking assist OFF indicator turns on when the power switch is turned to ON while the Intuitive parking assist function is on. It will turn off after a few seconds.

*⁶: These lights turn on when the power switch is turned to ON to indicate that a system check is being performed. They will turn off after the hybrid system is on, or after a few seconds. There may be a malfunction in a system if the lights do not turn on, or turn off. Have the vehicle inspected by your Toyota dealer.

*⁷: This light illuminates on the outside rear view mirrors.

*⁸: This light illuminates on the overhead console panel.

*⁹: When the outside temperature is approximately 37°F (3°C) or lower, the indicator will flash for approximately 10 seconds, then stay on.

■ **BSM (Blind Spot Monitor) outside rear view mirror indicators (if equipped)**

In order to confirm operation, the BSM outside rear view mirror indicators illuminate in the turning the BSM function/RCTA function on (→P.275).

If the system is functioning correctly, the BSM outside rear view mirror indicators will turn off after a few seconds.

If the BSM outside rear view mirror indicators do not illuminate or do not turn off, there may be a malfunction in the system. If this occurs, have the vehicle inspected by your Toyota dealer.

Gauges and meters

The meters display various drive information.

Meter display

► Main meter in center position

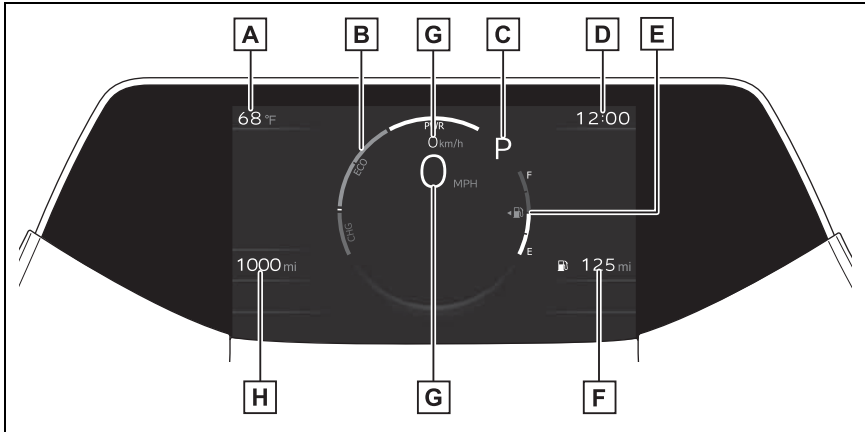

The units used on the meter and display may differ depending on the target region.

A Outside temperature (→P.90)

B Hybrid System Indicator

Displays hybrid system output or regeneration level. (→P.89)

C Shift position indicator

Displays the selected shift position. (→P.187)

D Clock

The GPS clock's time is automatically adjusted by utilizing GPS time information. For details, refer to the "MULTIMEDIA OWNER'S MANUAL".

E Fuel gauge

Displays the quantity of fuel remaining in the tank.

F Distance to empty

Displays driving range with remaining fuel. (→P.89)

G Speedometer

Displays the vehicle speed.

H Odometer, trip meter and oil maintenance

Odometer:

Displays the total distance that the vehicle has been driven.

Trip meter:

Displays the distance the vehicle has been driven since the meter was last reset. Trip meters “A” and “B” can be used to record and display different distances independently.

Oil maintenance:

Displays the distance until the next engine oil change.

► Main meter moved to the right

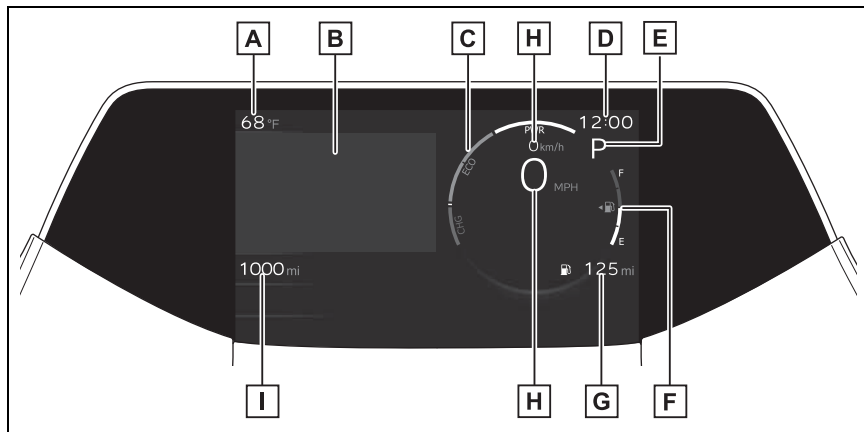

The units used on the meter and display may differ depending on the target region.

A Outside temperature (→P.90)

B Multi-information display

Presents the driver with a variety of driving-related data. (→P.92)

Displays warning messages if a malfunction occurs. (→P.475)

C Hybrid System Indicator

Displays hybrid system output or regeneration level. (→P.92)

D Clock

The GPS clock's time is automatically adjusted by utilizing GPS time information. For details, refer to the "MULTIMEDIA OWNER'S MANUAL".

E Shift position indicator

Displays the selected shift position. (→P.187)

F Fuel gauge

Displays the quantity of fuel remaining in the tank.

G Distance to empty

Displays driving range with remaining fuel. (→P.89)

H Speedometer

Displays the vehicle speed.

I Odometer, trip meter and oil maintenance

Odometer:

Displays the total distance that the vehicle has been driven.

Trip meter:

Displays the distance the vehicle has been driven since the meter was last reset. Trip meters “A” and “B” can be used to record and display different distances independently.

Oil maintenance:

Displays the distance until the next engine oil change.

■ The meters and display illuminate when

The power switch is in ON.

■ Hybrid System Indicator

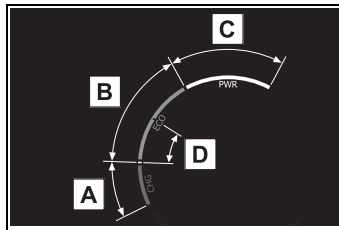

A Charge area

Shows regeneration* status. Regenerated energy will be used to charge the hybrid battery (traction battery).

B Eco area

Shows that the vehicle is being driven in an Eco-friendly manner.

By keeping the indicator needle within Eco area, more Eco-friendly driving can be achieved.

C Power area

Shows that an Eco-friendly driving range is being exceeded (during full power driving etc.)

D Hybrid Eco area

Shows that gasoline engine power is not being used very often.

The gasoline engine will automatically stop and restart under various conditions.

*: When used in this manual, “regeneration” refers to the conversion of energy created by the movement of the vehicle into electrical energy.

In the following situation, the Hybrid System Indicator does not operate.

- “READY” indicator is not illuminated.
- The shift position is in a range other than D or B.

■ Distance to empty

- This distance is computed based

on your average fuel consumption. As a result, the actual distance that can be driven may differ from that displayed.

- When only a small amount of fuel is added to the tank, the display may not be updated. When refueling, turn the power switch off. If the vehicle is refueled without turning the power switch off, the display may not be updated.
- When “Refuel” is displayed, the remaining fuel amount is low and the distance that can be driven with the remaining fuel cannot be calculated. Refuel immediately.

■ Outside temperature display

- Displays the outside temperature within the range of -40°F (-40°C) to 140°F (60°C).
- When the outside temperature is approximately 37°F (3°C) or lower, the indicator  will flash for approximately 10 seconds, then stay on.
- In the following situations, the correct outside temperature may not be displayed, or the display may take longer than normal to change.
 - When stopped, or driving at low speeds (less than 12 mph [20 km/h])
 - When the outside temperature has changed suddenly (at the entrance/exit of a garage, tunnel, etc.)
- When “--” or “E” is displayed, the system may be malfunctioning. Take your vehicle to your Toyota dealer.

■ Liquid crystal display

Small spots or light spots may appear on the display. This phenomenon is characteristic of liquid crystal displays, and there is no problem continuing to use the display.

■ Open Source Software Information

Copyright (c) 2009-2018 ARM Limited.

Licensed under the Apache License, Version 2.0 (the “License”); you may not use this file except in compliance with the License.

You may obtain a copy of the License at

<http://www.apache.org/licenses/LICENSE 2.0>

Unless required by applicable law or agreed to in writing, software distributed under the License is distributed on an “AS IS” BASIS, WITHOUT WARRANTIES OR CONDITIONS OF ANY KIND, either express or implied. See the License for the specific language governing permissions and limitations under the License.

WARNING

■ The information display at low temperatures

Allow the interior of the vehicle to warm up before using the liquid crystal information display. At extremely low temperatures, the display monitor may respond slowly, and display changes may be delayed.

NOTICE

■ To prevent damage to the engine and its components

The engine may be overheating if “Engine Coolant Temp High Stop in a Safe Place See Owner’s Manual” is shown on the multi-information display. In this case, immediately stop the vehicle in a safe place, and check the engine after it has cooled completely. (→P.512)

Switching the meter display

The multi-information display can be switched between display and hidden.

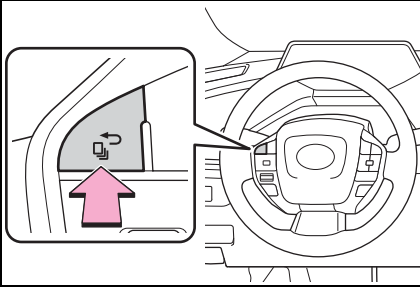

Using the “ODO TRIP” switch

Switches the items of the odometer, trip meter A, trip meter B and  (oil maintenance) by pressing the “ODO TRIP” switch.

When the trip meter is displayed, pressing and holding the switch will reset the trip meter.

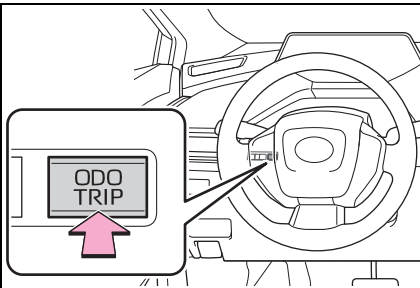

■ Pop-up display

Distance until the next engine oil change will be displayed when a

warning message indicating that oil maintenance is required or should be performed soon is displayed.

Adjusting meter brightness

The meter brightness can be adjusted.

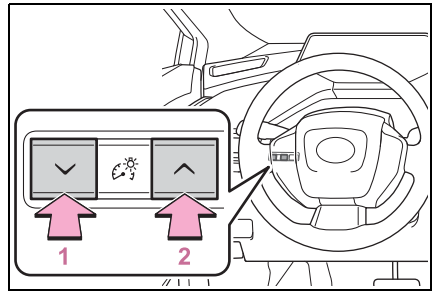

- 1 Darker
- 2 Brighter

■ Brightness of the meter lights (day mode and night mode)

The brightness of the meter lights can be adjusted individually.

In the following situations, the meters changes between day mode and night mode.

- Day mode: When the tail lights are off or when the tail lights are on but the surrounding area is bright
- Night mode: When the tail lights are on and the surrounding area is dark

Multi-information display

The multi-information display is used to display fuel efficiency related information and various types of driving-related information. The multi-information display can also be used to change the display settings and other settings.

Display contents

Following information is displayed on the multi-information display.

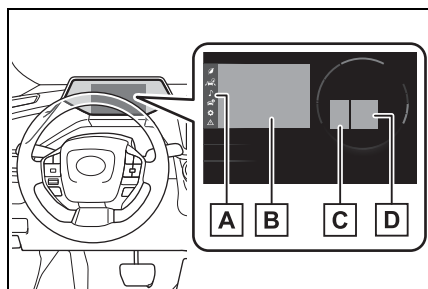

A Menu icons (→P.93)

B Information display area

A variety of information can be displayed by selecting a menu icon. Additionally, warning or suggestion/advice pop-up displays will be displayed in some situations.

C RSA (Road Sign Assist) (if equipped)

Displays recognized signs while the RSA (Road Sign Assist) is operating. (→P.257)

D Driving support system information (→P.95)

■ The multi-information display is displayed when

The power switch is in ON.

■ Liquid crystal display

(→P.90)

Changing the display

The multi-information display is operated using the meter control switches.

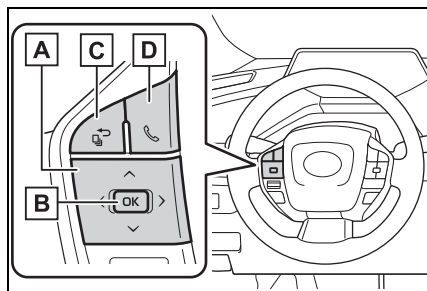

A : Select menu icons, scroll the screen and move the cursor

: Change displayed content, scroll the screen and move the cursor

B Press: Enter/Set
Press and hold: Reset/Display customizable items

C Return to the previous screen/Move the main meter

D Call sending/receiving and history display

Linked with the hands-free system, sending or receiving call is displayed. For details regarding the

hands-free system, refer to “MULTIMEDIA OWNER’S MANUAL”.

⚠ WARNING







■ Caution for use while driving

For safety, avoid operating the meter control switch while driving as much as possible, and do not look continuously at the multi-information display while driving. Stop the vehicle and operate the meter control switch. Failure to do so may cause a steering wheel operation error, resulting in an unexpected accident.

Menu icons

Information related to each icon can be displayed by selecting the icon with the meter control switches.

Some of the information may be displayed automatically depending on the situation.

Icon	Display
	Driving information display (→P.93)
	Driving support system information display (→P.95)
	Audio system-linked display (→P.96)
	Vehicle information display (→P.96)
	Settings display (→P.96)
	Warning message display (→P.101)

Driving information display

Select to display fuel consumption data in various forms.

■ Fuel Economy

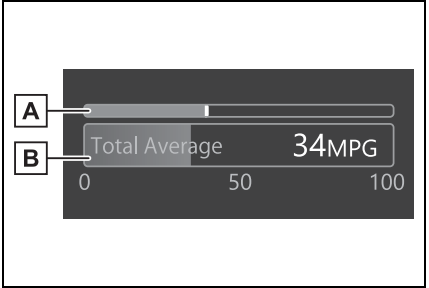

A Current fuel consumption
Displays the instantaneous current fuel consumption.

B Average fuel economy
Displays the average fuel economy since the function was reset, the average fuel economy after starting or refueling. *1, 2, 3

The average fuel economy selected by “Fuel Economy” on the  screen is displayed.

*1: Use the displayed fuel consumption as a reference only.

*2: Average fuel economy after starting is reset each time the hybrid system stops.

*3: Average fuel economy since the function was reset can be reset by pressing and holding .

■ ECO Accelerator Guidance/“Eco Score”

Displays a reference operation range for using the accelerator

pedal according to driving conditions, and a score result that evaluates the current driving status.

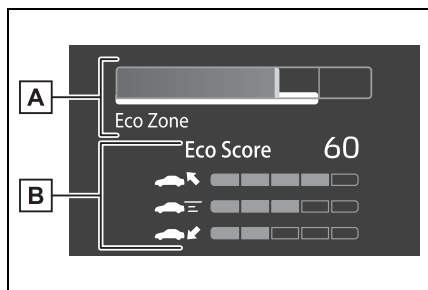

A ECO Accelerator Guidance

B “Eco Score”

● ECO Accelerator Guidance

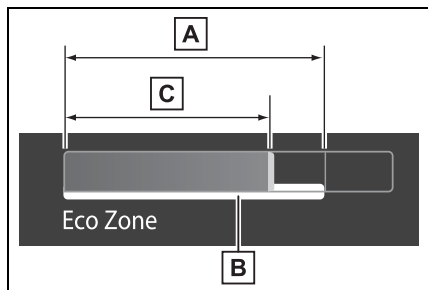

A ECO area

Shows that the vehicle is being driven in an Eco-friendly manner.

B Reference operation range

A zone is displayed in blue under the Eco area which can be used as a reference operation range for using the accelerator pedal according to driving conditions such as starting off and cruising.

C Current acceleration

The ECO Accelerator Guidance display changes according to the driving status, such as when start-

ing off or cruising.

It is easier to drive in an Eco-friendly manner by driving according to the display showing the accelerator pedal operations and staying within the reference operation range.

● “Eco Score”

The driving status for the following 3 situations are evaluated in 5 levels: Smooth start-off acceleration (“Start”), driving without sudden acceleration (“Cruise”) and smooth stopping (“Stop”). Each time the vehicle is stopped, a score result is displayed out of a perfect score of 100 points.

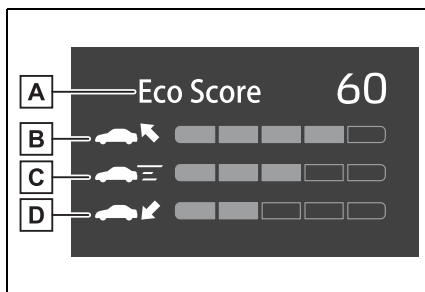

A Score result

B Eco start status

C Eco cruise status

D Eco stop status

3 situations are displayed with each icon while driving.

How to read the bar display:

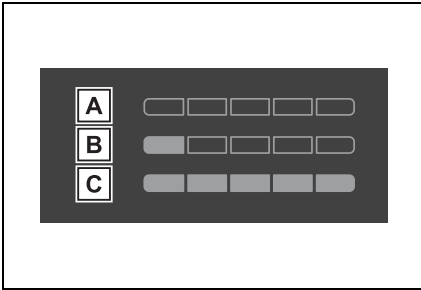

A Not yet evaluated

B Low

C High

After the hybrid system is started, the Eco score will not be displayed until the vehicle speed exceeds approximately 30 km/h (19 mph). The Eco score will be reset each time the hybrid system is started.

■ EV Ratio/EV Driving Ratio

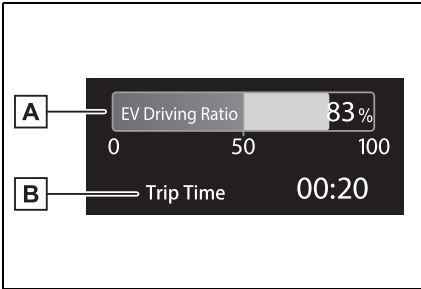

A EV driving ratio after starting

The percent traveled using only electric motor power after starting the hybrid system is displayed.*

B Elapsed time after starting

Displays the elapsed time since hybrid system start.*

*: It is reset each time the hybrid system stops.

■ ECO Accelerator Guidance/"Eco Score" will not operate when

The ECO Accelerator Guidance/"Eco Score" will not operate in the following situations:

- The Hybrid System Indicator is not operating.
- The vehicle is being driven using the dynamic radar cruise control.

Driving support system information display

Select to display the operational status of the following systems:

- LTA (Lane Tracing Assist) (→P.234)
- LCA (Lane Change Assist) (if equipped) (→P.239)
- LDA (Lane Departure Alert) (→P.242)
- PDA (Proactive driving assist) (→P.248)
- Dynamic radar cruise control (→P.259)
- Cruise Control (→P.269)

■ Navigation system-linked display (if equipped)

Select to display the following navigation system-linked information.

- Route guidance to destination
- Compass

Audio system-linked display

Select to enable selection of an audio source or track on the display.

Vehicle information display

■ Drive information

Displays drive information such as the following:

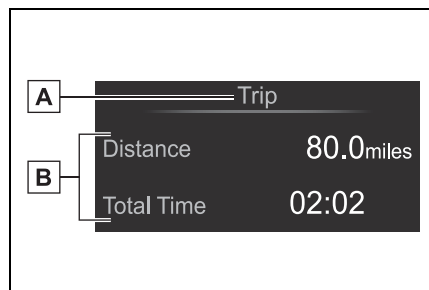

A Drive information type

B Drive information items

Displays the following depending on which drive information type and drive information items were selected in . (→P.96)

● After start

- Distance: Displays the distance driven since hybrid system start
- Elapsed time: Displays the elapsed time since hybrid system start
- Average vehicle speed: Displays the average vehicle speed since hybrid system start

● After reset

- Distance: Displays the distance driven since the display was reset*
- Elapsed time: Displays the elapsed time since the display was reset*
- Average vehicle speed: Displays the average vehicle speed since the display was reset*

*: To reset, display the desired item and press and hold the meter control switch.

■ Energy monitor

→P.102

■ Tire pressure

→P.427

■ AWD system display (AWD models)

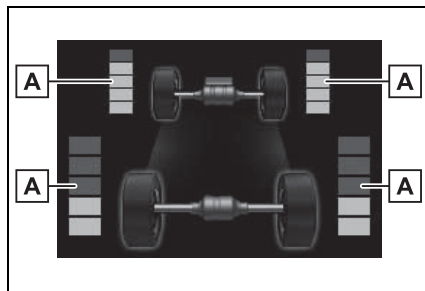

A Torque distribution display

Displays the drive status of each wheel in 6 steps from 0 to 5.









The illustration used is intended as an example, and may differ from the image that is actually displayed on the multi-information display.

Settings display

Vehicle settings and the content

displayed on the screen can be changed by using the meter control switches.

■ Setting procedure

- 1 Operate  or  of the meter control switches and select .
- 2 Operate  or  of the meter control switches and select the desired item.
 - If the function is turned on and off or the volume, etc. is changed on the setting screen, the setting is changed each time  is pressed.
 - For functions that allow operation contents, display contents, etc., of function to be selected, the setting screen is displayed by pressing and holding . When the setting screen is displayed, select the setting or desired value (time, etc.) with .
- 3 After changing the settings, press  of the meter control switches.

■ LDA (Lane Departure Alert) (→P.242)

Select to set up the following items.

- Lane Departure Alert on/off
Select to enable/disable Lane Departure Alert system.
- “Alert Options”
Select to set the alert type.

- “Alert Timing”

Select to set the alert timing.

■ BSM (Blind Spot Monitor) (if equipped) (→P.275)

Select to set up the following items.

- BSM (Blind Spot Monitor) on/off
Select to enable/disable the BSM system.
- “Support timing”
Select to change the alert timing for an approaching vehicle.
- “Brightness”
Select to switch the brightness of the outside rear view mirror indicators. (→P.275)
- “Buzzer alert”
Select to enable/disable the buzzer alert which sounds when BSM system is operated.
-  PCS (Pre-Collision System) (→P.222)

Select to set up the following items.

- PCS on/off
Select to enable/disable the pre-collision system.
- “Warning timing”
Select to change the pre-collision warning timing.
-  PDA (Proactive driving assist) (→P.248)

- PDA on/off

Select to enable/disable the PDA

system.

- “Sensitivity”

Select to change the alert timing for a detected object.

- SA (Steering Assist)

Select to enable/disable the Steering Assist function.

- DA (Deceleration Assist)

Select to enable/disable the Deceleration Assist function.

- OAA (Obstacle Anticipation Assist)

Select to enable/disable the Obstacle Anticipation Assist function.

-  **Intuitive parking assist (→P.284)**

Select to set up the following items.

- Intuitive parking assist on/off
Select to enable/disable the intuitive parking assist.

- “Volume”

Select to set the volume of the buzzer which sounds when the RCTA (if equipped), the RCD (if equipped) or intuitive parking assist function is operated.

-  **RCTA (Rear Cross Traffic Alert) (if equipped) (→P.294)**

Select to set up the following items.

- RCTA (Rear Cross Traffic Alert) on/off

Select to enable/disable the

RCTA system.

- “Volume”

Select to set the volume of the buzzer which sounds when the RCTA, the RCD (if equipped) and the Intuitive parking assist is operated.

-  **RCD (Rear Camera Detection) function (if equipped) (→P.299)**

Select to enable/disable the Rear Camera Detection function.

-  **PKSB (Parking Support Brake System) (if equipped) (→P.303)**

Select to enable/disable the Parking Support Brake function.

-  **SEA (Safe Exit Assist) (if equipped) (→P.280)**

Select to set up the following items.

- Safe Exit Assist on/off
Select to enable/disable the Safe Exit Assist system.

- “Sensitivity”

Select to change the alert timing for a vehicle or bicycle.

- Mirror indicate on/off

Select to enable/disable the outside rear view mirrors display.

■ **RSA (Road Sign Assist) (if equipped)** (→P.257)

Select to set up the following items.

● Road Sign Assist on/off

Select to enable/disable the RSA (Road Sign Assist).

● “Notification Method”

Select to change each notification method used to notify the driver when the system recognizes excess speed and Do Not Enter sign.

● “Notification Level”

Select to change each notification level used to notify the driver when the system recognizes excess speed.

■ **DRCC (→P.259)**

Select to set up the following items.

● “Acceleration Setting”

Select to change the setting for when vehicle accelerates until the set vehicle speed is reached.

● “Guide message”

Select to enable/disable the guide message display. (→P.262)

● “Curve Speed Reduction”

Select to change the curve speed reduction function setting. (→P.266)

■ **Vehicle Settings**

● Driver Break Suggestion (→P.245)

Select to enable/disable the drive break suggestion.

● LCA (Lane Change Assist) (if equipped) (→P.239)

Select to enable/disable Lane Change Assist system.

● FCTA (Front Cross Traffic Alert) (if equipped) (→P.254)

Select to change the settings for Front Cross Traffic Alert system.

● “TPWS setting” (Tire Pressure Warning System) (→P.427)

• “Tire Set Switching”

Select to register the tire pressure warning system sensor ID code set. (→P.436)

• “Tire Rotation”

Select to register the position of each wheel after performing a tire rotation. (→P.430)

• “Tire Pressure Setting”

Select to perform the tire inflation pressure setting procedure of the tire pressure warning system. (→P.431)

• “Pressure unit setting”

Select to change the units of measure displayed. (→P.539)

● PBD (Power Back Door) (if equipped) (→P.122)

Select to set up the following items.

• System settings

Select to enable/disable the power back door system.

• “Opening Adjustment”

Select the open position when

power back door is fully open.

- “Volume”



Select to set the volume of the buzzer which sounds when the power back door system operates.

- “Scheduled Maintenance”

Select to reset the scheduled maintenance information (message indicating maintenance is required and distance until the next maintenance) after all maintenance is performed.

- Oil Maintenance
Select to reset the Oil maintenance. (→P.417)
- Rear Seat Reminder
(→P.116)
Select to enable/disable the rear seat reminder function.

■ Settings

- “Language”
Select to change the language on the multi-information display.
- “Units”
Select to change the unit of measure for fuel consumption.
- “Meter Type”
Select to enable/disable Hybrid System Indicator. (→P.89)
-  EV indicator
Select to enable/disable the EV indicator.
-  (Driving information display settings)

Select to set up the following items.

- “Hybrid System”

Select to enable/disable the ECO Accelerator Guidance (→P.89).

- “Fuel Economy”
Select to change the display on Fuel Economy. (→P.93)

-  (Audio settings)

Select to enable/disable  screen.

-  (Vehicle information display settings)

- “Display Contents”

Select to display the following items.

“AWD” (AWD models):

Select to enable/disable the AWD system display. (→P.96)

- “Drive Info Type”

Select to change the drive information type display between trip and total. (→P.93)

- “Drive Info Items”

Select to set the items on the upper and lower side of the drive information screen from three items, average speed, distance and total time.

- Pop-Up Display
Select to enable/disable the pop-up displays, which may appear in some situations.

- Default Settings
Select to reset the meter display settings.

■ Tire pressure

- It may take a few minutes to dis-

play the tire inflation pressure after the power switch is turned to ON. It may also take a few minutes to display the tire inflation pressure after inflation pressure has been adjusted.

- “---” may be displayed if the tire position information cannot be determined due to unfavorable radio wave conditions.
 - Tire inflation pressure changes with temperature. The displayed values may also be different from the values measured using a tire pressure gauge.
- **Suspension of the settings display**
- In the following situations, operation of the settings display will be temporarily suspended.
 - When a warning message appears on the multi-information display
 - When the vehicle begins to move
 - Settings for functions not equipped to the vehicle are not displayed.
 - When a function is turned off, the related settings for that function are not selectable.



WARNING

■ Cautions during setting up the display

As the hybrid system needs to be operating during setting up the display, ensure that the vehicle is parked in a place with adequate ventilation. In a closed area such as a garage, exhaust gases including harmful carbon monoxide (CO) may collect and enter the vehicle. This may lead to death or a serious health hazard.



NOTICE

■ During setting up the display

To prevent 12-volt battery discharge, ensure that the hybrid system is operating while setting up the display features.

Warning message display

Select to display warning messages and measures to be taken if a malfunction is detected. (→P.475)

Suggestion function

Displays suggestions to the driver in the following situations. To select a response to a displayed suggestion, use the meter control switches.

■ Suggestion to enable the power back door (if equipped)

If the power back door system is disabled (setting on  set to off) and the power back door switch on the instrument panel is operated, a suggestion message will be displayed asking if you wish to enable the power back door system. To enable the power back door system, select “Yes”.

After enabling the power back door system, press the power back door switch again to open or close the power back door.

■ Suggestion to turn off the headlights

If the headlights are left on for a certain amount of time after the power switch has been turned off, a suggestion message will be displayed.

When the headlight switch is in the AUTO position: The message asking if you wish to turn the headlights off is displayed. To turn the headlights off, select "Yes".

If the driver's door is opened after the power switch is turned off, this suggestion message will not be displayed.

■ Suggestion to close the power windows (Driving at high speeds)

If the vehicle speed exceeds a certain speed with a power window open, a suggestion message will be displayed asking if you wish to close the power windows. To close all of the power windows, select "Yes".

■ Customization

The suggestion function can be turned on/off. (Customizable features: →P.539)

Energy monitor/consumption screen

You can view the status of your hybrid system and fuel consumption information on the multi-information display and Multimedia Display.

System components

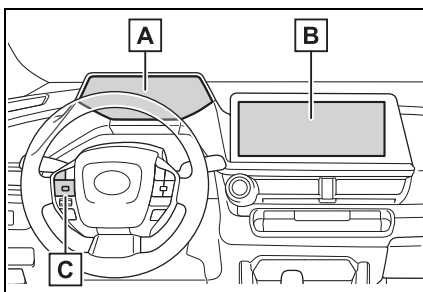

- A** Multi-information display
- B** Multimedia Display
- C** Meter control switches

Energy monitor

The energy monitor can be used to check the vehicle drive status, hybrid system operation status and energy regeneration status.

■ Display procedure

- ▶ Multi-information display

Use the meter control switches, display the energy monitor on the multi-information display.

For detail regarding the multi-information display, refer to P.92.

► Multimedia Display

Touch  on the main menu, then touch “Energy flow” on the sub menu.

For detail regarding the Multimedia Display, refer to “MULTIMEDIA OWNER’S MANUAL”.

■ Reading the display

The arrows will appear in accordance with the energy flow. When there is no energy flow, arrows will not be displayed.

The color of the arrows will change as follows

Blue: When the hybrid battery (traction battery) is regenerated or charged.

Orange: When the hybrid battery (traction battery) is in use.

Red: When the gasoline engine is in use.

► Multi-information display

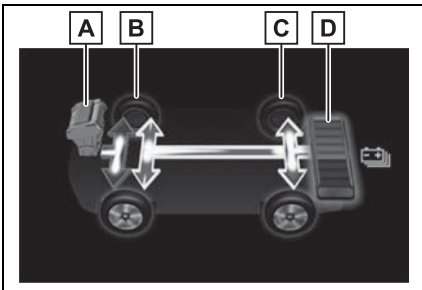

The image shows all the arrows as an example. The actual display will vary depending on conditions.

- A** Gasoline engine
- B** Front tires
- C** Rear tires *

- D** Hybrid battery (traction battery)

*: For 2WD models, the arrows to

- C** are not displayed.

► Multimedia Display

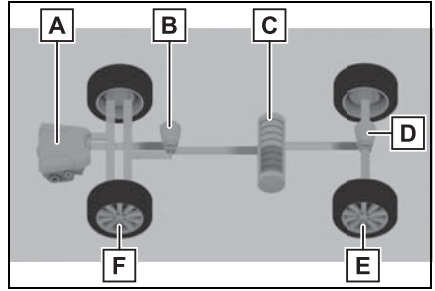

The image shows all the arrows as an example. The actual display will vary depending on conditions.

- A** Gasoline engine
- B** Front electric motor (traction motor)
- C** Hybrid battery (traction battery)
- D** Rear electric motor (traction motor)*
- E** Rear tires *
- F** Front tires

*: For 2WD models, the icon **D**

and the arrows to **E** are not displayed.

■ Hybrid battery (traction battery) status

The display changes in 8 levels according to the remaining charge amount of the hybrid battery (traction battery).

- The figure shows the multi-information display as an example for

explanation.

- These images are examples only, and may vary slightly from actual conditions.

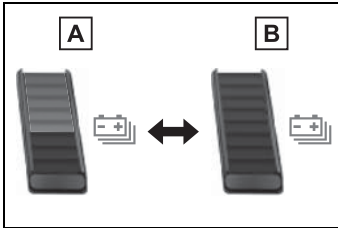

A Low

B High

■ Remaining charge amount warning of hybrid battery (traction battery)

- The buzzer sounds intermittently when the hybrid battery (traction battery) remains without charging while the shift position is in N, or the remaining charge amount drops below a certain level. If the remaining charge amount drops further, the buzzer sounds continuously.
- When a warning message is shown on the multi-information display and the buzzer sounds, follow the instructions displayed on the screen to perform troubleshooting.

Consumption screen

For detail regarding the Multi-media Display, refer to “MULTI-MEDIA OWNER’S MANUAL”.

■ Display procedure

Touch  on the main menu, then touch “Trip information” on the sub menu.

■ Current fuel consumption screen

If a screen other than current fuel consumption screen is displayed, touch “Current”.

Use the displayed average fuel consumption as a reference.

The image is an example only, and may vary slightly from actual conditions.

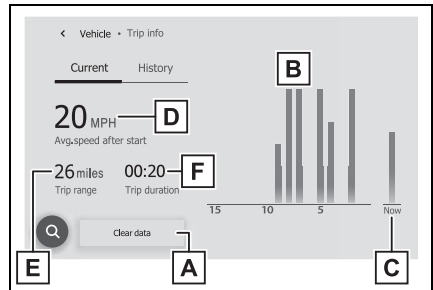

A Resetting the consumption data

B Fuel consumption in the past 15 minutes

C Current fuel consumption

D Average vehicle speed since the hybrid system was started.

E Trip range

F Elapsed time since the hybrid system was started.

■ History screen

If a screen other than history screen is displayed, touch “History”.

Use the displayed average fuel consumption as a reference.

The image is an example only, and

may vary slightly from actual conditions.

can be driven may differ from that displayed.

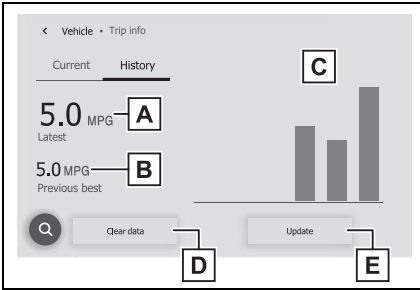

- A** Latest fuel consumption
- B** Best recorded fuel consumption
- C** Previous fuel consumption record
- D** Resetting the history data
- E** Updating the latest fuel consumption data

■ Updating the history data

Update the latest fuel consumption by touching “Update” to measure the current fuel consumption again.

■ Resetting the data

The fuel consumption data can be deleted by touching “Clear data”.

■ Using the voice control system

Fuel consumption, trip range, etc. can be checked using the voice control system.

For details regarding the voice control system, refer to “MULTIMEDIA OWNER’S MANUAL”.

■ Trip range

Displays the estimated maximum distance that can be driven with the quantity of fuel remaining.

This distance is computed based on your average fuel consumption. As a result, the actual distance that

3-1. Key information

Keys	108
Digital Key	111

3-2. Opening, closing and locking the doors

Side doors	113
Back door	119
Smart key system	131

3-3. Adjusting the seats

Front seats	137
Rear seats	138
Head restraints	140

3-4. Adjusting the steering wheel and mirrors

Steering wheel	143
Inside rear view mirror	144
Digital Rear-view Mirror	145
Outside rear view mirrors	153

3-5. Opening, closing the windows

Power windows	155
---------------------	-----

3-6. Favorite settings

Driving position memory	158
My Settings	162

Keys

Key types

The following keys are provided with the vehicle.

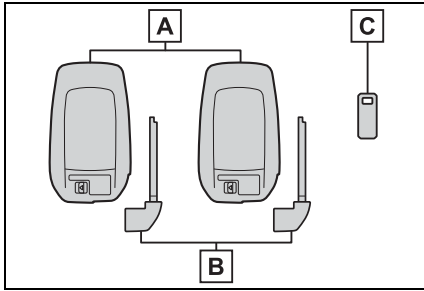

A Electronic keys

- Operating the smart key system (→P.131)
- Operating the wireless remote control function

B Mechanical keys

C Key number plate

■ When riding in an aircraft

When bringing an electronic key onto an aircraft, make sure you do not press any buttons on the electronic key while inside the aircraft cabin. If you are carrying an electronic key in your bag etc., ensure that the buttons are not likely to be pressed accidentally. Pressing a button may cause the electronic key to emit radio waves that could interfere with the operation of the aircraft.

■ Electronic key battery depletion

- The standard battery life is 1 to 2 years.
- If the battery becomes low, an alarm will sound in the cabin and a message will be displayed on the multi-information display when the

hybrid system stops.

- To reduce key battery depletion when the electronic key is to not be used for long periods of time, set the electronic key to the battery-saving mode. (→P.133)
- As the electronic key always receives radio waves, the battery will become depleted even if the electronic key is not used. The following symptoms indicate that the electronic key battery may be depleted. Replace the battery when necessary.
 - The smart key system or the wireless remote control does not operate.
 - The detection area becomes smaller.
 - The LED indicator on the key surface does not turn on.

You can replace the battery by yourself (→P.446). However, as there is a danger that the electronic key may be damaged, it is recommended that replacement is carried out by your Toyota dealer.

- To avoid serious deterioration, do not leave the electronic key within 3 ft. (1 m) of the following electrical appliances that produce a magnetic field:
 - TVs
 - Personal computers
 - Cellular phones, cordless phones and battery chargers
 - Table lamps
 - Induction cookers
- If the electronic key is near the vehicle for longer than necessary, even if the smart key system is not operated, the key battery may become depleted faster than normal. When not operating the smart key system, it is recommended to not stay with the electronic key near the vehicle longer than necessary.

■ **If a message regarding the state of the electronic key or power switch mode, etc. is shown**

To prevent trapping the electronic key inside the vehicle, leaving the vehicle carrying the electronic key on your person without turning the power switch to OFF or other passengers from unintentionally taking the key out of the vehicle, etc., a message that prompts the user to confirm the state of the electronic key or power switch mode may be shown on the multi-information display. In those cases, follow the instructions on the display immediately.

■ **If “Key Battery Low Replace Key Battery” is displayed on the multi-information display**

The electronic key has a low battery. Replace the electronic key battery. (→P.446)

■ **Replacing the battery**

→P.446

■ **Confirmation of the registered key number**

The number of keys already registered to the vehicle can be confirmed. Ask your Toyota dealer for details.

■ **If “A New Key has been Registered Contact Your Dealer for Details” is displayed on the multi-information display**

This message will be displayed each time the driver's door is opened when the doors are unlocked from the outside for approximately 10 days after a new electronic key has been registered. If this message is displayed but you have not had a new electronic key registered, ask your Toyota dealer to check if an unknown electronic key (other than those in your possession) has been registered.

 NOTICE

■ **To prevent key damage**

- Do not drop the keys, subject them to strong shocks or bend them.
- Do not expose the keys to high temperatures for long periods of time.
- Do not get the keys wet or wash them in an ultrasonic washer, etc.
- Do not attach metallic or magnetic materials to the keys or place the keys close to such materials.
- Do not disassemble the keys.
- Do not attach a sticker or anything else to the surface of the electronic key.
- Do not place the keys near objects that produce magnetic fields, such as TVs, audio systems and induction cookers.
- Do not place the keys near medical electrical equipment such as low-frequency therapy equipment or microwave therapy equipment, and do not receive medical attention with the keys on your person.

■ **Carrying the electronic key on your person**

Carry the electronic key 3.9 in. (10 cm) or more away from electric appliances that are turned on. Radio waves emitted from electric appliances within 3.9 in. (10 cm) of the electronic key may interfere with the key, causing the key to not function properly.

■ **In case of a smart key system malfunction or other key-related problems**

→P.505

 NOTICE

■ When an electronic key is lost
→P.504

Wireless remote control

The electronic keys are equipped with the following wireless remote control:

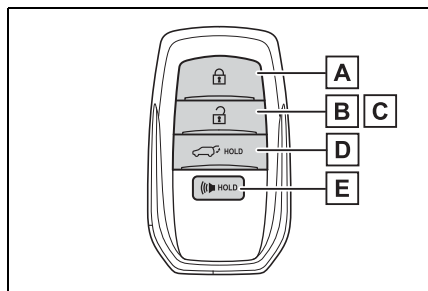

- A** Locks all the doors (→P.113)
- B** Unlocks all the doors (→P.113)
- C** Opens the side windows* (→P.113)
- D** Opens and closes the power back door (if equipped) (→P.122)
- E** Sounds the alarm

*: This setting must be customized at your Toyota dealer.

■ Theft deterrent panic mode

When  is pressed for longer than about 1 second, an alarm will sound intermittently and the vehicle lights will flash to deter any person from trying to break into or damage your vehicle.

To stop the alarm, press any button

on the electronic key.

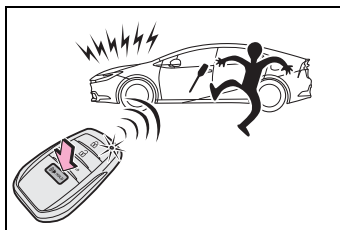

Using the mechanical key

To take out the mechanical key, slide the release lever **A** and take the key out.

The mechanical key can only be inserted in one direction, as the key only has grooves on one side. If the key cannot be inserted in a lock cylinder, turn it over and re-attempt to insert it.

After using the mechanical key, store it in the electronic key. Carry the mechanical key together with the electronic key. If the electronic key battery is depleted or the entry function does not operate properly, you will need the mechanical key. (→P.505)

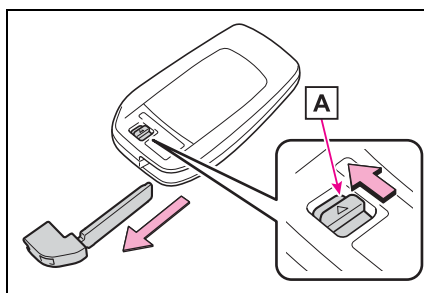

■ If you lose your mechanical keys

→P.504

■ If a wrong key is used

The key cylinder rotates freely to isolate inside mechanism.

Digital Key*

*: If equipped

A smartphone can be used instead of the electronic key of the vehicle by installing the dedicated Digital Key App on a smartphone. Also, Digital Key can be shared with your family or friends using the Digital Key App.

■ Free/open source software information

This product contains Free/open source software (FOSS). License information and/or the source code of this FOSS can be obtained at the following URL:

<https://www.denso.com/global/en/opensource/dkey/toyota/>

Digital key usage conditions

In order to use the Digital Key, you need to install the Toyota App, Register the Vehicle to the customer's Toyota App profile, and subscribe to Remote Services, and enroll in Digital Key.

Digital key precautions

- A Digital Key can be used when the smartphone and server can communicate. The Digital Key may become unusable if the smartphone is not connected to the Internet.

Be sure to carry the electronic key of the vehicle if traveling to a location with unreliable communications.

- If the smartphone battery is depleted, the smartphone cannot be used as Digital Key. If the battery level is low, be sure to charge the smartphone prior to going out.
- The Digital Key system is related to the smart key system. If the smart key system has been deactivated in the vehicle customization setting, the Digital Key will also be disabled.
- Depending on the radio wave environment, the Digital Key may not be able to be used. (→P.133)
- When transferring vehicle ownership, make sure to delete the Digital Keys.
- If the vehicle is not operated for 14 days or more, the Digital Key will not connect automatically. Therefore, it may take some time before the system operates after a door handle is touched.
- A part of the services may be stopped for a certain period of time due to server maintenance. However, registered Digital Keys can be used during the maintenance.
- A smartphone with the Digital

Key App enabled will be able to lock and unlock the doors, start the hybrid system and perform any other operations as same as the electronic key of the vehicle. Be especially careful not to lose the smartphone or allow it to be stolen. If the smartphone is lost or stolen, contact your Toyota dealer immediately.

- When taking your vehicle to a Toyota dealer for an inspection or repairs, make sure to bring an electronic key.
- With the Digital Key alone, no vehicle lights will illuminate when approached to the vehicle.

Side doors

The vehicle can be locked and unlocked using the entry function, wireless remote control, door lock switches or inside lock buttons.

Unlocking and locking the doors from the outside

■ Using the entry function

Carry the electronic key to enable this function.

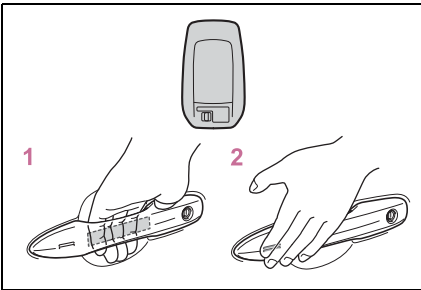

- 1 Grip the driver's door handle to unlock the door. Holding the driver's door handle for approximately 2 seconds unlocks all the doors. Grip the front passenger's door handle with the sensor (if equipped) to unlock all the doors*.

Make sure to touch the sensor on the back of the handle.

The doors cannot be unlocked for 3 seconds after the doors are locked.

*: The door unlock settings can be changed. (→P.113)

- 2 Touch the lock sensor (the indentation on the surface of the door handle) to lock the doors.

Check that the door is securely locked.

■ Using the wireless remote control

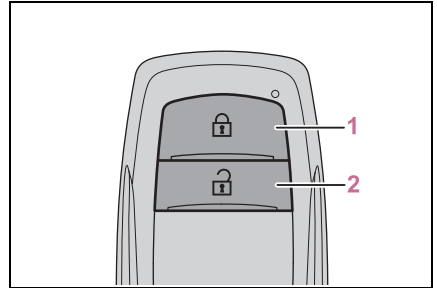

- 1 Locks all the doors

Check that the door is securely locked.

- 2 Unlocks all the doors



Pressing the button unlocks the driver's door. Pressing the button again within 5 seconds unlocks the other doors.



Press and hold to open the side windows.*

*: This setting must be customized at your Toyota dealer.



■ Switching the door unlock function

It is possible to set which doors the entry function unlocks using the wireless remote control. Perform the switching operation in the vehicle or within approximately 3.2 ft. (1 m) of the vehicle.

- 1 Turn the power switch to OFF.
- 2 When the indicator light on the key surface is not on, press and hold  ,  (if equipped)

or  for approximately 5 seconds while pressing and holding .

The setting changes each time an operation is performed, as shown below. (When changing the setting continuously, release the buttons, wait for at least 5 seconds, and repeat step 2.)

Multi-information display/Beep	Unlocking function
 <p data-bbox="93 760 277 808">Exterior: Beeps 3 times</p>	<p data-bbox="293 553 497 675">Holding the driver's door handle unlocks only the driver's door.</p> <p data-bbox="293 695 497 914">Holding the front passenger's door handle with the sensor (if equipped) unlocks all the doors.</p>
 <p data-bbox="104 1104 267 1153">Exterior: Beeps twice</p>	<p data-bbox="293 935 497 1214">Holding the driver's door handle or front passenger's door handle with the sensor (if equipped) unlocks all the doors.</p>

■ Operation signals

Doors: A buzzer sounds and the emergency flashers flash to indicate that the doors have been locked/unlocked. (Locked: Once; Unlocked: Twice)

Side windows: A buzzer sounds to indicate that the side windows are operating.

■ Security feature

If a door is not opened within approximately 60 seconds after the vehicle is unlocked, the security feature automatically locks the vehicle again. (However, depending on the location of the electronic key, the key may be detected as being in the vehicle. In this case, vehicle may be unlocked.)

■ When the door cannot be locked by the lock sensor on the surface of the door handle

When the door cannot be locked even if the lock sensor on the surface of the door handle is touched by a finger, touch the lock sensor with the palm.

When gloves are being worn, remove the gloves.

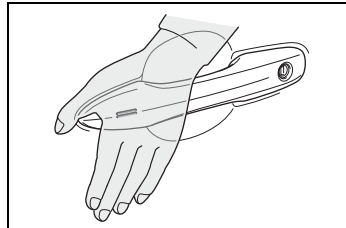

■ Door lock buzzer

If an attempt to lock the doors using the entry function is made when a door other than the door you are locking is open, a buzzer sounds continuously for 5 seconds. Fully close all the doors, and lock the vehicle once more.

■ Conditions affecting the operation of the smart key system or wireless remote control

→P.133

■ If the smart key system or the wireless remote control does not operate properly

- Use the mechanical key to lock and unlock the doors. (→P.505)
- Replace the key battery with a new one if it is depleted. (→P.446)

■ If the 12-volt battery is discharged

The doors cannot be locked and unlocked using the smart key system or wireless remote control. Lock or unlock the doors using the mechanical key. (→P.505)

■ Customization

Settings (e.g. unlocking function using a key) can be changed. (Customizable features: →P.538)

⚠ WARNING

■ When using the wireless remote control and operating the power windows

Operate the power window after checking to make sure that there is no possibility of any passenger having any of their body parts caught in the side window. Also, do not allow children to operate the wireless remote control. It is possible for children and other passengers to get caught in the power window.

Unlocking and locking the doors from the inside

■ Using the door lock switches

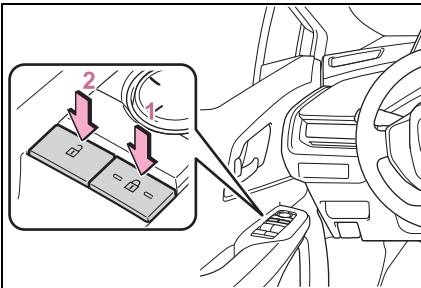

- 1 Locks all the doors
- 2 Unlocks all the doors

■ Using the inside lock buttons



- 1 Locks the door
- 2 Unlocks the door

The front doors can be opened by pulling the inside handle even if the lock buttons are in the lock position.

■ Locking the front doors from the outside without a key

- 1 Move the inside lock button to the lock position.
- 2 Close the door.

The door cannot be locked if the power switch is in ACC or ON, or the electronic key is left inside the vehicle.

Depending on the position of the electronic key, the key may not be detected correctly and the door may be locked.

■ When all the doors are locked with the entry function or wireless remote control

- The doors cannot be unlocked with the door lock switch.
- The door lock switches can be reset by unlocking all the doors with the entry function or wireless remote control.

Opening the doors from the outside

■ Opening the front door

Unlock the door, and pull the door handle.

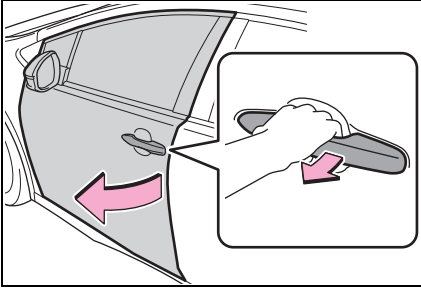

■ Opening the rear door

Unlock the door, and press the door opener switch **A** of the door handle to open the door.

Make sure to securely press the door opener switch **A** on the inner side of the door handle.

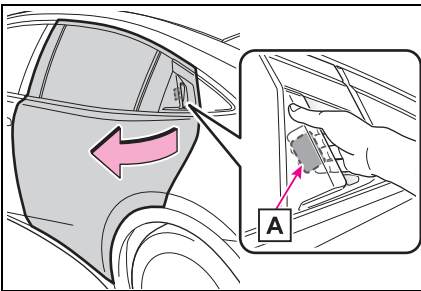

■ Rear door opener switch operating conditions

When all of the following conditions are met:

- The vehicle speed is less than 2 mph (4 km/h)
- The door is unlocked

■ If a rear door cannot be opened using the door opener switch

Check the following:

- The 12-volt battery is not depleted.
- The door is unlocked.

If a door cannot be opened using the door opener switch, the door can be opened using the manual release button. Firmly press the button until the door opens.

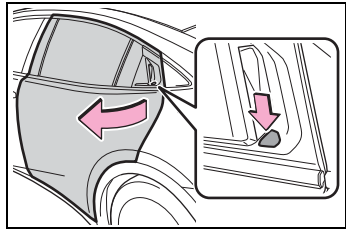

■ When opening the rear door with the manual release button in low temperatures

If the manual release button becomes frozen in low temperatures, it may feel heavier to operate.

■ When the vehicle is subjected to a strong impact

In the event that the vehicle is subjected to a strong impact, the rear door opener switch cannot be operated for approximately 10 seconds. In this case, use the manual release button.

■ If the rear door opener switch is operated repeatedly over a short period of time

The system may restrict operation to prevent overheating. If this happens, refrain from operating the rear door opener switch. Normal operation will return after a short time.

■ Rear seat reminder function

As the first reminder so as not to forget luggage, etc. in the rear seat, when the power switch is turned off after any of the following conditions are met, a buzzer will sound and a message will be displayed on the

multi-information display for approximately 6 seconds.

Also, as the second reminder, when the doors are locked, a buzzer will sound and the emergency flashers will flash for a few seconds, and a message will be displayed on the multi-information display.

- The hybrid system is started within approximately 10 minutes after opening and closing a rear door.
- A rear door has been opened and closed after the hybrid system was started.

The second reminder will not be activated if a rear door was opened before the doors are locked.

However, if a rear door is opened and then closed within approximately 2 seconds, the rear seat reminder function may not operate.

The rear seat reminder function determines that luggage, etc. has been placed in a rear seat based on opening and closing of a rear door. Therefore, depending on the situation, the rear seat reminder function may not operate and you may still forget luggage, etc. in the rear seat, or it may operate unnecessarily.

■ Open door warning buzzer

If the vehicle speed reaches 3 mph (5 km/h), a buzzer sounds to indicate that the door(s) or the hood (on some models) is not fully closed. The open door(s) or hood is displayed on the multi-information display.

■ Customization

The rear seat reminder function can be enabled/disabled. (Customizable features: →P.538)



WARNING

■ To prevent an accident

Observe the following precautions while driving the vehicle. Failure to do so may result in a door opening and an occupant could be thrown out of the vehicle, resulting in death or serious injury.

- Ensure that all doors are properly closed and locked.
- Do not pull the inside handle of the doors while driving. Be especially careful for the front doors, as the doors may be opened even if the inside lock buttons are in locked position.
- Set the rear door child-protector locks when children are seated in the rear seats.

■ When opening or closing a door

Check the surroundings of the vehicle such as whether the vehicle is on an incline, whether there is enough space for a door to open and whether a strong wind is blowing. When opening or closing the door, hold the door handle tightly to prepare for any unpredictable movement.

Rear door child-protector lock

The door cannot be opened from inside the vehicle when the lock is set.

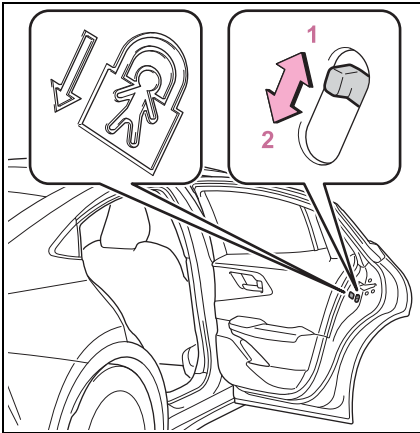

1 Unlock

2 Lock

These locks can be set to prevent children from opening the rear doors. Push down on each rear door switch to lock both rear doors.

Automatic door locking and unlocking systems

The following functions can be set or canceled:

For instructions on customizing, refer to P.538.

Function	Operation
Speed linked door locking function	All doors are automatically locked when vehicle speed is approximately 12 mph (20 km/h) or higher.
Shift position linked door locking function	All doors are automatically locked when the shift position is shifted to a position other than P.
Shift position linked door unlocking function	All doors are automatically unlocked when the shift position is shifted to P.
Driver's door linked door unlocking function	All doors are automatically unlocked when driver's door is opened within approximately 45 seconds after turning the power switch to OFF.

Back door

The back door can be locked/unlocked and opened/closed by the following procedures.

WARNING

Observe the following precautions.

Failure to do so may result in death or serious injury.

■ Before driving

- Make sure that the back door is fully closed.
If the back door is not fully closed, it may open unexpectedly while driving and hit nearby objects or luggage in the luggage compartment may be thrown out, causing an accident.
- Do not allow children to play in the luggage compartment.
If a child is accidentally locked in the luggage compartment, they could have heat exhaustion or other injuries.
- Do not allow a child to open or close the back door.
Doing so may cause the back door to move unexpectedly, or cause the child's hands, head, or neck to be caught by the closing back door.

■ Important points while driving

- Keep the back door closed while driving.
If the back door is left open, it may hit near-by objects or luggage in the luggage compartment may be thrown out, causing an accident.

- Never let anyone sit in the luggage compartment.
In the event of sudden braking, sudden swerving or a collision, they are susceptible to death or serious injury.

■ Operating the back door

Observe the following precautions.

Failure to do so may cause parts of the body to be caught, resulting in death or serious injury.

- Remove any heavy loads, such as snow and ice, from the back door before opening it. Failure to do so may cause the back door to suddenly shut again after it is opened.
- When opening or closing the back door, thoroughly check to make sure the surrounding area is safe.
- If anyone is in the vicinity, make sure they are safe and let them know that the back door is about to open or close.
- Use caution when opening or closing the back door in windy weather as it may move abruptly in strong wind.

WARNING

- Vehicles without power back door: The back door may suddenly shut if it is not opened fully. It is more difficult to open or close the back door on an incline than on a level surface, so beware of the back door unexpectedly opening or closing by itself. Make sure that the back door is fully open and secure before using the luggage compartment.

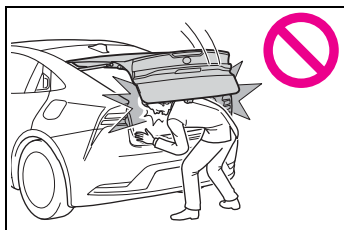

- Vehicles with power back door: The back door may suddenly shut if it is not opened fully, while on a steep incline. Make sure that the back door is secured before using the luggage compartment.
- When closing the back door, take extra care to prevent your fingers, etc. from being caught.

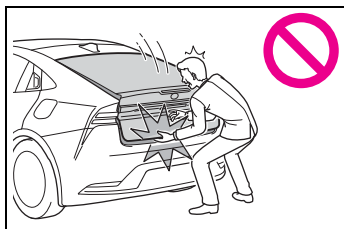

- Vehicles without power back door: When closing the back door, make sure to press it lightly on its outer surface. If the back door handle is used to fully close the back door, it may result in hands or arms being caught.

- Do not pull on the back door damper stay (vehicles without power back door) (→P.122) or back door spindle (vehicles with power back door) (→P.129) to close the back door, and do not hang on the back door damper stay (vehicles without power back door) or back door spindle (vehicles with power back door). Doing so may cause hands to be caught or the back door damper stay (vehicles without power back door) or back door spindle (vehicles with power back door) to break, causing an accident.
- Vehicles without power back door: If a bicycle carrier or similar heavy object is attached to the back door, it may suddenly shut again after being opened, causing someone's hands, head or neck to be caught and injured. When installing an accessory part to the back door, using a genuine Toyota part is recommended.

Unlocking and locking the back door from the outside

■ Using the entry function (if equipped)

Carry the electronic key to enable this function.

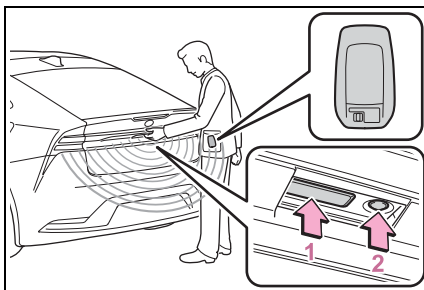

1 Unlocks all the doors

The doors cannot be unlocked for 3 seconds after the doors are locked.

2 Locks all the doors

Check that the door is securely locked.

■ Using the wireless remote control

→P.113

■ Operation signals

→P.114

■ Security feature

→P.114

Unlocking and locking the back door from the inside

■ Using the door lock switches

→P.115

Opening/closing the back door (vehicles without power back door)

■ Open

Raise the back door while pressing up the back door opener switch.

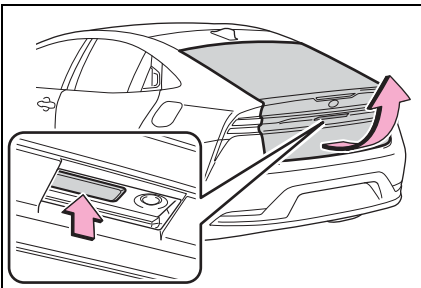

■ Close

Lower the back door using the back door handle **A**, and make sure to push the back door down from the outside to close it.

Be careful not to pull the back door sideways when closing the back door with the handle.

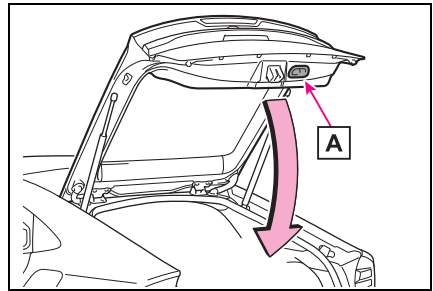

■ Luggage compartment light

● The luggage compartment light turns on when the back door is opened.

● When the power switch is turned to OFF, the light will go off automatically after 20 minutes.

■ If the back door opener is inoperative

The back door can be unlocked from the inside.

1 Remove the cover.

To prevent damage, cover the tip of the screwdriver with a rag.

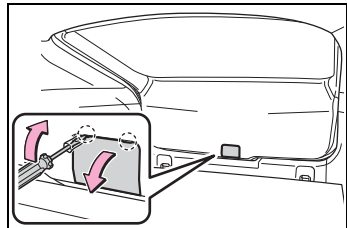

2 Loosen the screw.

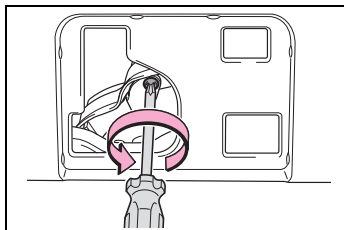

3 Turn the cover.

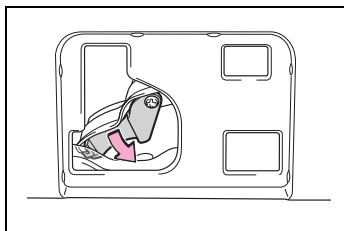

4 Move the lever.

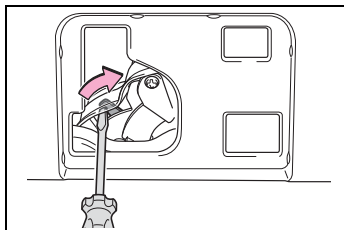

5 When installing, reverse the steps listed.

■ **Open door warning buzzer**

→P.117

 **NOTICE**

■ **Back door damper stays**

The back door is equipped with damper stays that hold the back door in place.

Observe the following precautions.

Failure to do so may cause damage to the back door damper stay, resulting in malfunction.

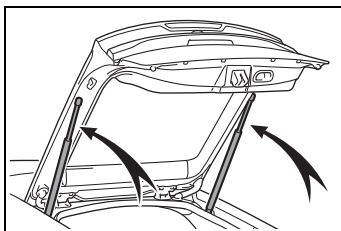

- Do not attach any foreign objects, such as stickers, plastic sheets, or adhesives to the damper stay rod.
- Do not touch the damper stay rod with gloves or other fabric items.
- Do not attach any accessories other than genuine Toyota parts to the back door.
- Do not place your hand on the damper stay or apply lateral forces to it.

Opening/closing the back door (vehicles with power back door)

■ **Using the wireless remote control**

Press and hold the switch.

The power back door automatically opens/closes.

Pressing the switch while the power back door is opening/closing stops

the operation. When the switch is pressed and held again during the halted operation, the back door will perform the reverse operation.

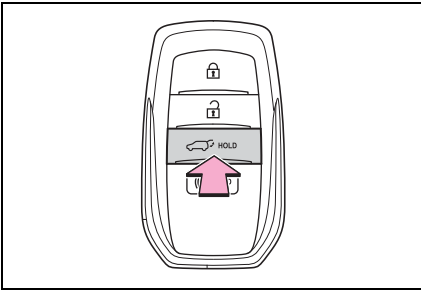

■ Using the power back door switch on the instrument panel

Press and hold the switch.

The power back door automatically opens/closes.

Unlock the back door before operating.

Pressing the switch while the power back door is opening/closing stops the operation. When the switch is pressed and held again during the halted operation, the back door will perform the reverse operation.

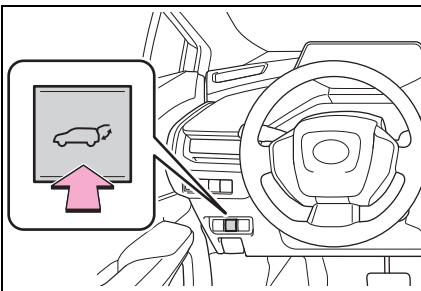

■ Using the switches on the back door

● Open

When the back door is unlocked:

Press the back door opener switch.

When the back door is locked:

While carrying the electronic key on your person, press and hold the back door opener switch.

The power back door automatically opens.

Pressing the switch while the power back door is opening/closing stops the operation.

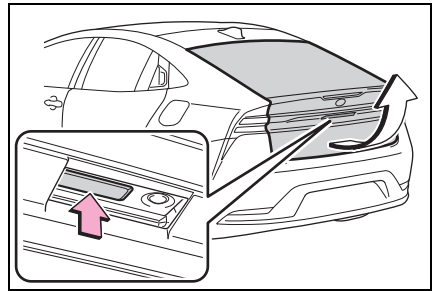

● Close

Press the  switch on the lower part of the back door.

The power back door automatically closes.

Pressing the  switch while the power back door is operating will

stop the operation. When the  switch is pressed again during the halted operation, the back door will perform the reverse operation.

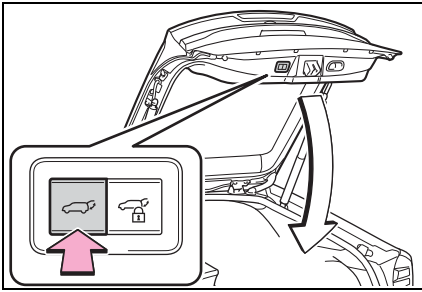

- Close the back door and lock all doors after moving away from the back door (close & lock [Walk-Away] function)

- 1 Close all of the doors except the back door, carrying an electronic key and press the



switch on the lower part of the back door.

A different buzzer than the normal one will sound and the close & lock (Walk-Away) function will go into standby.

- 2 While the buzzer is sounding, move away from the back door.

When the sensor detects that you are away from the back door, the emergency flashers will flash, and the buzzer will sound. Depending on the direction of moving away from the back door, the location and how to hold the electronic key or circumstances, it may not be detected properly.

All the doors other than the back door will be locked, and after the back door is closed, the back door will also be locked. When all the doors have been closed and locked, the buzzer will sound and the emergency flashers will flash.

The standby state is canceled if you do not move away from the back door for 30 seconds. To operate the

function again, perform the procedure again from the beginning.

If you approach the back door carrying the electronic key, the back door operation will stop, all the doors will be unlocked, and the buzzer will sound and the emergency flashers will flash.

If the  switch is pressed after the back door operation has stopped, the close & lock (Walk-Away) function will go into standby again.

- Close the back door and lock all doors (close & lock function)*

*: This setting can be customized by your Toyota dealer.

Close all of the doors except the back door, carrying an electronic

key and press the  switch on the lower part of the back door.

A different buzzer than the normal one will sound and the power back door will begin closing automatically. All the doors except the power back door are locked and then power back door will also be locked at the same time it is closed. Operation signals will indicate that all the doors have been closed and locked. (→P.114)

Pressing the  switch while the power back door is operating will stop the operation. When the switch is pressed again during the halted operation, the back door will be closed.

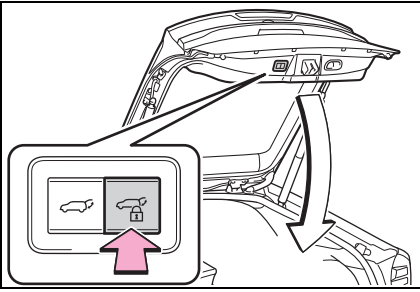

■ Using the back door handle

Lower the back door using the back door handle **A**.

The back door closing assist (→P.126) will be activated, and the power back door will fully close automatically.

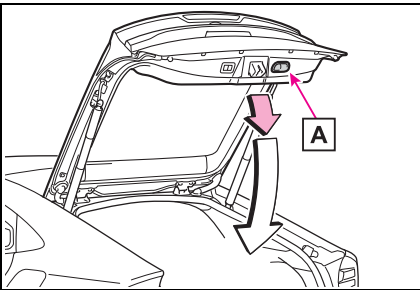

■ Luggage compartment light

- The luggage compartment light turns on when the back door is opened.
- When the power switch is turned to OFF, the light will go off automatically after 20 minutes.

■ Back door closer

In the event that the back door is left slightly open, the back door closer will automatically close it to the fully closed position.

Whatever the state of the power switch, the back door closer operates.

■ Power back door operating conditions

The power back door can automatically open and close under the following conditions:

- When the power back door system is enabled. (→P.96)
- When the power switch is in ON, in addition to the above for the opening operations, the back door operates for any of the following conditions:
 - Parking brake is engaged
 - The brake pedal is depressed
 - The shift position is in P.

■ Operation of the power back door

- A buzzer sounds and the emergency flashers flash twice to indicate that the back door is opening/closing.
- When the power back door system is disabled, the power back door does not operate but it can be opened and closed by hand.
- When the power back door automatically opens, if an abnormality due to people or objects is detected, operation will stop.

■ Jam protection function

Sensors are equipped on both sides of the power back door. If anything obstructs the power back door while it is closing, the back door will automatically operate in the opposite direction or stop.

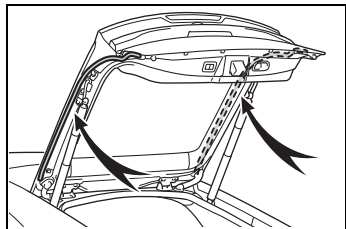

■ Fall-down protection function

While the power back door is opening automatically, applying excessive force to it will stop the opening

operation to prevent the power back door from suddenly shutting.

■ Back door closing assist

If the back door is lowered manually when the back door is stopped at an open position, the back door will fully close automatically.

■ Back door reserve lock function

This function is a function which reserves locking of all doors, beforehand, when the power back door is open.

When the following procedure is performed, all the doors except the power back door are locked and then power back door will also be locked at the same time it is closed.

- 1 Close all doors, except the back door.
- 2 During the power back door closing operation, lock the doors using the smart key system from the side doors (→P.113) or the wireless remote control. (→P.113)

Operation signals will indicate that all the doors have been closed and locked. (→P.114)

- If the electronic key is placed inside the vehicle after starting a close operation via the door reserve lock function, the electronic key may become locked inside the vehicle.
- If the power back door does not fully close due to the operation of the jam protection function, etc., while the back door is automatically closing after a door reserve lock operation is performed, the door reserve lock function is canceled and all the doors will unlock.
- Before leaving the vehicle, make sure that all the doors are closed and locked.

■ Close & lock (Walk-Away) function operating conditions

This function can be operated when all of the following conditions are

met:

- Close & lock (Walk-Away) function is enabled.
- An electronic key is not detected within the vehicle.
- All of the doors other than the power back door are closed.
- The power switch is off.
- The electronic key is within the effective range (detection areas).

■ Situations in which the close & lock (Walk-Away) function may not operate properly

In the following situations, the function may not operate properly:

- When the smart key system does not operate properly.
- When the close & lock function does not operate properly.
- When moving away from the back door while the close & lock (Walk-Away) function is in the standby state.

■ Close & lock function * operating conditions

*: This setting can be customized by your Toyota dealer.



This function can be operated when all of the following conditions are met:

- An electronic key is not detected within the vehicle.
- All of the doors other than the power back door are closed.
- The power switch is in OFF.

■ Situations in which the close & lock function * may not operate properly

*: This setting can be customized by your Toyota dealer.

In the following situations, the close & lock function may not operate properly:

- If the  switch on the lower part of the power back door is pressed by a hand which is holding an electronic key
- If the  switch on the lower part of the power back door is pressed when the electronic key is in a bag, etc. that is placed on the ground
- If the  switch on the lower part of the power back door is pressed with the electronic key not near the vehicle

■ **When reconnecting the 12-volt battery**

To enable the power back door to operate properly, close the back door manually.

■ **If the back door opener is inoperative**

The back door can be unlocked from the inside.

- 1 Remove the cover.

To prevent damage, cover the tip of the screwdriver with a rag.

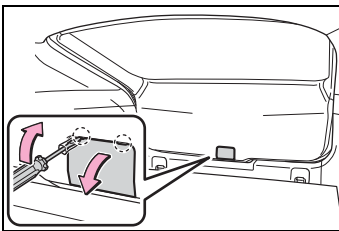

- 2 Loosen the screw.

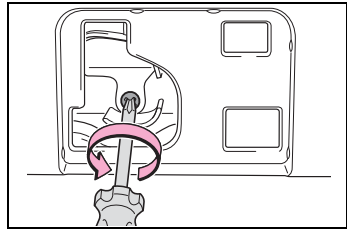

- 3 Turn the cover.

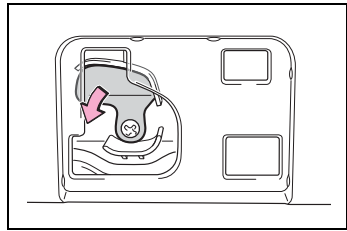

- 4 Move the lever.

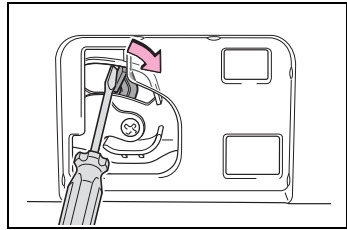

- 5 When installing, reverse the steps listed.

■ **Customization**

Settings (e.g. power back door opening angle) can be changed. (Customizable features: →P.538)

WARNING

Back door closer

- In the event that the back door is left slightly open, the back door closer will automatically close it to the fully closed position. It takes several seconds before the back door closer begins to operate. Be careful not to catch fingers or anything else in the back door, as this may cause bone fractures or other serious injuries.

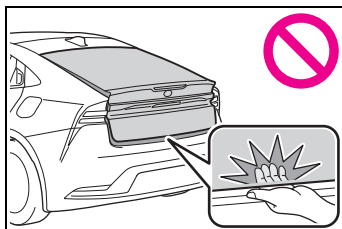

- Use caution when using the back door closer as it still operates when the power back door system is canceled.

Power back door

Observe the following precautions when operating the power back door.

Failure to do so may cause death or serious injury.

- Check the safety of the surrounding area to make sure there are no obstacles or anything that could cause any of your belongings to get caught.
- If anyone is in the vicinity, make sure they are safe and let them know that the back door is about to open or close.

- If the power back door system is turned off while the back door is operating automatically, the automatic operation is stopped. The back door then has to be operated manually. Take extra care when on an incline, as the back door may open or close unexpectedly.
- If the operating conditions of the power back door are no longer met, a buzzer may sound and the back door may stop opening or closing. The back door then has to be operated manually. Take extra care when on an incline, as the back door may open or close abruptly.
- On an incline, the back door may suddenly shut after it opens. Make sure the back door is fully open and secure.
- In the following situations, the power back door may detect an abnormality and automatic operation may be stopped. In this case, the back door has to be operated manually. Take extra care when on an incline, as the back door may open or close abruptly.
 - When the back door contacts an obstacle
 - When the 12-volt battery voltage suddenly drops, such as when the power switch is turned to ON or the hybrid system is started during automatic operation

WARNING

- If a bicycle carrier or similar heavy object is attached to the back door, the power back door may not operate, causing itself to malfunction, or the back door may suddenly shut again after being opened, causing someone's hands, head or neck to be caught and injured. When installing an accessory part to the back door, using a genuine Toyota part is recommended.

■ Jam protection function

Observe the following precautions. Failure to do so may cause death or serious injury.

- Never use any part of your body to intentionally activate the jam protection function.
- The jam protection function may not work if something gets caught just before the back door fully closes. Be careful not to catch fingers or anything else.
- The jam protection function may not work depending on the shape of the object that is caught. Be careful not to catch fingers or anything else.

■ Close & lock (Walk-Away) function

The back door starts to close automatically when leaving the back door. Check the safety of the surrounding area to make sure there are no obstacles or anything that could cause any of your belongings to get caught.

NOTICE

■ Back door spindles

The back door is equipped with spindles that hold the back door in place.

Observe the following precautions.

Failure to do so may cause damage to the back door spindle, resulting in malfunction.

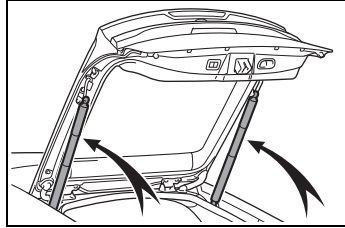

- Do not attach any foreign objects, such as stickers, plastic sheets, or adhesives to the spindle rod.
- Do not attach any accessories other than genuine Toyota parts to the back door.
- Do not place your hand on the spindle or apply lateral forces to it.

■ To prevent back door closer malfunction

Do not apply excessive force to the back door while the back door closer is operating. Applying excessive force may cause the back door closer to malfunction.

■ To prevent damage to the power back door

- Make sure that there is no ice between the back door and frame that would prevent movement of the back door. Operating the power back door when excessive load is present on the back door may cause a malfunction.

**NOTICE**

- Do not apply excessive force to the back door while the power back door is operating.
- Take care not to damage the sensors (installed on the right and left edges of the power back door) with a knife or other sharp object. If the sensor is disconnected, the power back door will not close automatically.

Close & lock function

When closing the power back door using the close & lock function, a different buzzer than the normal one will sound before the operation begins.

To check that the operation has started correctly, check that a different buzzer than the normal one has sounded.

Additionally, when the power back door is fully closed and locked, operation signals will indicate that all of the doors have been locked. (→P.114)

Before leaving the vehicle, make sure that the operational signals have operated and that all of the doors are locked.

Changing settings of the power back door system (vehicles with power back door)

The settings of the power back door system can be changed by displaying "PBD" from " 

Vehicle Settings" on  of the multi-information display. (→P.96)

The changed power back door set-

tings are not reset by turning the power switch to OFF. In order to restore the original settings, they need to be changed back on the  of the multi-information display.

Adjusting the open position of the back door (vehicles with power back door)

The open position of the power back door can be adjusted.

- 1 Stop the back door in the desirable position. (→P.122)
- 2 Press and hold the  switch on the lower part of the back door for approximately 2 seconds.

When the settings are completed, the buzzer sounds 4 times.

When opening the back door the next time, the back door will stop at that position.

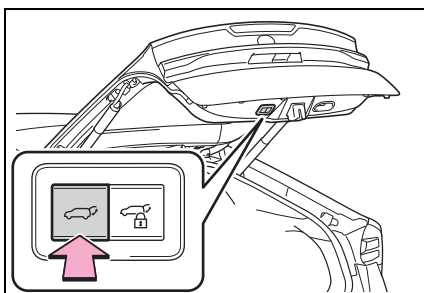

Canceling the adjusted open position of the back door

Press and hold the  switch on the lower part of the back door for approximately 7 seconds.

After the buzzer sounds 4 times, it sounds twice more. When the power back door does the opening operation the next time, the door will open to the initial settings position.

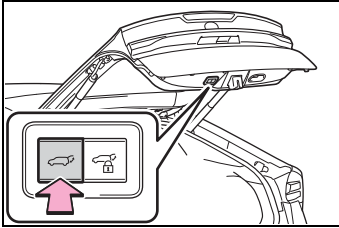

■ Customization

The opening position can be set with the multi-information display. (→P.96)

Priority for the stop position is given to the last position set by either the

 switch on the lower part of the back door multi-information display.

Smart key system

The following operations can be performed simply by carrying the electronic key on your person, for example in your pocket. The driver should always carry the electronic key.

- Locks and unlocks the doors (→P.113)
- Locks and unlocks the back door (if equipped) (→P.120)
- Starts the hybrid system (→P.180)

■ Antenna location

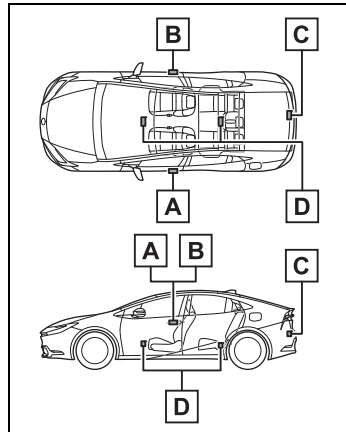

- A** Antenna outside the cabin (driver's side)
- B** Antenna outside the cabin (front passenger's side) (if equipped)
- C** Antenna outside the luggage compartment (if equipped)
- D** Antennas inside the cabin

■ **Effective range (areas within which the electronic key is detected)**

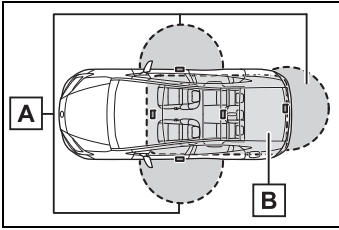

A When locking or unlocking the doors

The system can be operated when the electronic key is within about 2.3 ft. (0.7 m) of the driver's door handle, front passenger's door handle (if equipped) and back door opener switch (if equipped). (Only the doors detecting the key can be operated.)

B When starting the hybrid system or changing power switch modes

The system can be operated when the electronic key is inside the vehicle.

■ **If an alarm sounds or a warning message is displayed**

An alarm sounds and warning message displays shown on the multi-information display are used to protect against unexpected accidents or theft of the vehicle resulting from erroneous operation. When a warning message is displayed, take appropriate measures based on the displayed message.

When only an alarm sounds, circumstances and correction procedures are as follows.

- When an exterior alarm sounds once for 5 seconds

Situation	Correction procedure
An attempt was made to lock the vehicle while a door was open.	Close all of the doors and lock the doors again.

- When an interior alarm pings continuously

Situation	Correction procedure
The power switch was turned to ACC while the driver's door was open (or the driver's door was opened while the power switch was in ACC).	Turn the power switch to OFF and close the driver's door.

■ **If "Key Detected in Vehicle" is shown on the multi-information display**

An attempt was made to lock the doors using the smart key system while the electronic key was still inside the vehicle. Retrieve the electronic key from the vehicle and lock the doors again.

■ **Battery-saving function**



The battery-saving function will be activated in order to prevent the electronic key battery and the 12-volt battery from being discharged while the vehicle is not in operation for a long time.

- In the following situations, the smart key system may take some time to unlock the doors.
 - The electronic key has been left in an area of approximately 11.5 ft. (3.5 m) of the outside of the vehi-

- cle for 40 seconds or longer.
- The smart key system has not been used for 5 days or longer.
- If the smart key system has not been used for 14 days or longer, the doors cannot be unlocked at any doors except the driver's door. In this case, take hold of the driver's door handle, or use the wireless remote control or the mechanical key, to unlock the doors.

■ Turning an electronic key to battery-saving mode

- When battery-saving mode is set, battery depletion is minimized by stopping the electronic key from receiving radio waves.

Press  twice while pressing and holding .

Confirm that the electronic key indicator flashes 4 times.

While the battery-saving mode is set, the smart key system cannot be used. To cancel the function, press any of the electronic key buttons.

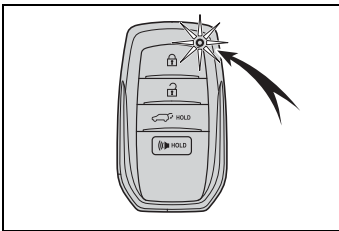

- Electronic keys that will not be used for long periods of time can be set to the battery-saving mode in advance.

■ When electronic key function stops

If the position of the electronic key has not changed for a certain amount of time such as when the electronic key is left somewhere, the function of the electronic key stops to reduce depletion of the battery. In this case, function can automati-

cally be restored by moving the position of the key such as by lifting it up.

■ Conditions affecting operation

The smart key system uses weak radio waves. In the following situations, the communication between the electronic key and the vehicle may be affected, preventing the smart key system, wireless remote control and immobilizer system from operating properly.

- When the electronic key battery is depleted
- Near a TV tower, electric power plant, gas station, radio station, large display, airport or other facility that generates strong radio waves or electrical noise
- When the electronic key is in contact with, or is covered by the following metallic objects
 - Cards to which aluminum foil is attached
 - Cigarette boxes that have aluminum foil inside
 - Metallic wallets or bags
 - Coins
 - Hand warmers made of metal
 - Media such as CDs and DVDs
- When other wireless key (that emits radio waves) is being used nearby
- When carrying the electronic key together with the following devices that emit radio waves
 - Portable radio, cellular phone, cordless phone or other wireless communication devices
 - Another vehicle's electronic key or a wireless key that emits radio waves
 - Personal computers or personal digital assistants (PDAs)
 - Digital audio players
 - Portable game systems
- If window tint with a metallic content or metallic objects are attached to the rear window
- When the electronic key is placed

near a battery charger or electronic devices

- When the vehicle is parked in a pay parking spot where radio waves are emitted.

If the doors cannot be locked/unlocked using the smart key system, lock/unlock the doors by performing any of the following:

- Bring the electronic key close to either front door handle and operate the entry function.
- Operate the wireless remote control.

If the doors cannot be locked/unlocked using the above methods, use the mechanical key. (→P.110)

If the hybrid system cannot be started using the smart key system, refer to P.506.

■ Note for the entry function

- Even when the electronic key is within the effective range (detection areas), the system may not operate properly in the following cases:
 - The electronic key is too close to the window or outside door handle, near the ground, or in a high place when the doors are locked or unlocked.
 - The electronic key is on the instrument panel, luggage compartment or floor, or in the door pockets or glove box when the hybrid system is started or power switch modes are changed.
 - Do not leave the electronic key on top of the instrument panel or near the door pockets when exiting the vehicle. Depending on the radio wave reception conditions, it may be detected by the antenna outside the cabin and the door will become lockable from the outside, possibly trapping the electronic key inside the vehicle.
 - As long as the electronic key is within the effective range, the doors may be locked or unlocked by anyone. However, only the doors detecting the electronic key can be used to unlock the vehicle.
- Even if the electronic key is not inside the vehicle, it may be possible to start the hybrid system if the electronic key is near the window.
- The doors may unlock if a large amount of water splashes on the door handle, such as in the rain or in a car wash when the electronic key is within the effective range. (The doors will automatically be locked after approximately 60 seconds if the doors are not opened and closed.)
- If the wireless remote control is used to lock the doors when the electronic key is near the vehicle, there is a possibility that the door may not be unlocked by the entry function. (Use the wireless remote control to unlock the doors.)
- Touching the door lock sensor while wearing gloves may delay or prevent lock operation. Remove the gloves and touch the lock sensor again.
- When the lock operation is performed using the lock sensor, recognition signals will be shown up to two consecutive times. After this, no recognition signals will be given.
- If the door handle becomes wet while the electronic key is within the effective range, the door may lock and unlock repeatedly. In that case, follow the following correction procedures to wash the vehicle:
 - Place the electronic key in a location 6 ft. (2 m) or more away from the vehicle. (Take care to ensure that the key is not stolen.)
 - Set the electronic key to battery-saving mode to disable the smart key system. (→P.133)
- If the electronic key is inside the vehicle and a door handle

becomes wet during a car wash, a message may be shown on the multi-information display and a buzzer will sound outside the vehicle. To turn off the alarm, lock all the doors.

- The lock sensor may not work properly if it comes into contact with ice, snow, mud, etc. Clean the lock sensor and attempt to operate it again.
 - A sudden approach to the effective range or door handle may prevent the doors from being unlocked. In this case, return the door handle to the original position and check that the doors unlock before pulling the door handle again.
 - If there is another electronic key in the detection area, it may take slightly longer to unlock the doors after the door handle is gripped.
- **When the vehicle is not driven for extended periods**
- To prevent theft of the vehicle, do not leave the electronic key within 6 ft. (2 m) of the vehicle.
 - The smart key system can be deactivated in advance. (→P.542)
 - Battery-saving mode can reduce the power consumption of electronic keys. (→P.133)

■ **To operate the system properly**

Make sure to carry the electronic key when operating the system. Do not get the electronic key too close to the vehicle when operating the system from the outside of the vehicle.

Depending on the position and holding condition of the electronic key, the key may not be detected correctly and the system may not operate properly. (The alarm may go off accidentally, or the door lock prevention may not operate.)

■ **If the smart key system does not operate properly**

- Locking and unlocking the doors: Use the mechanical key. (→P.505)
- Starting the hybrid system: →P.506

■ **Customization**

Settings (e.g. smart key system) can be changed.

(Customizable features: →P.542)

If the smart key system has been deactivated in a customized setting, refer to the explanations for the following operations.

- Locking and unlocking the doors: Use the wireless remote control or mechanical key. (→P.113, 505)
- Starting the hybrid system and changing power switch modes: →P.506
- Stopping the hybrid system: →P.182



WARNING

■ **Caution regarding interference with electronic devices**

- People with implantable cardiac pacemakers, cardiac resynchronization therapy-pacemakers or implantable cardioverter defibrillators should keep away from the smart key system antennas. (→P.131) The radio waves may affect the operation of such devices. If necessary, the entry function can be disabled. Ask your Toyota dealer for details, such as the frequency of radio waves and timing of the emitted radio waves. Then, consult your doctor to see if you should disable the entry function.

**WARNING**

- User of any electrical medical device other than implantable cardiac pacemakers, cardiac resynchronization therapy-pacemakers or implantable cardioverter defibrillators should consult the manufacturer of the device for information about its operation under the influence of radio waves.

Radio waves could have unexpected effects on the operation of such medical devices.

Ask your Toyota dealer for details for disabling the entry function.

Front seats

The seats can be adjusted (longitudinally, vertically, etc.). Adjust the seat to ensure the correct driving posture.

Adjustment procedure

▶ Manual seat

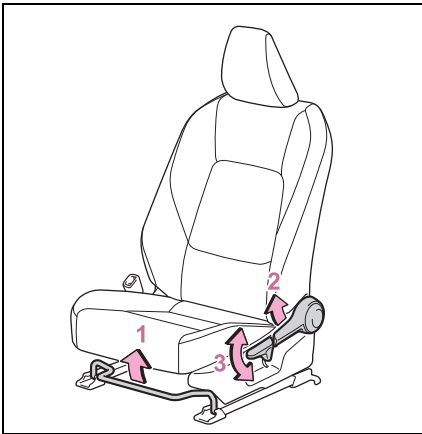

- 1 Seat position adjustment lever
- 2 Seatback angle adjustment lever
- 3 Vertical height adjustment lever

▶ Power seat (if equipped for driver's side)

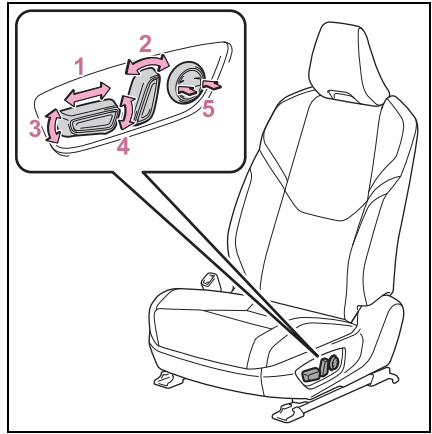

- 1 Seat position adjustment switch
- 2 Seatback angle adjustment switch
- 3 Seat cushion (front) angle adjustment switch
- 4 Vertical height adjustment switch
- 5 Lumbar support adjustment switch

■ When adjusting the seat

Take care when adjusting the seat so that the head restraint does not touch the ceiling.

■ Power easy access system (if equipped)

The driver's seat moves in accordance with power switch mode and the driver's seat belt condition. (→P.158)

**WARNING****■ When adjusting the seat position**

- Take care when adjusting the seat position to ensure that other passengers are not injured by the moving seat.
- Do not put your hands under the seat or near the moving parts to avoid injury. Fingers or hands may become jammed in the seat mechanism.
- Make sure to leave enough space around the feet so they do not get stuck.
- Manual seat only: After adjusting the seat, make sure that the seat is locked in position.

■ Seat adjustment

To reduce the risk of sliding under the lap belt during a collision, do not recline the seat more than necessary.

If the seat is too reclined, the lap belt may slide past the hips and apply restraint forces directly to the abdomen, or your neck may contact the shoulder belt, increasing the risk of death or serious injury in the event of an accident. Adjustments should not be made while driving as the seat may unexpectedly move and cause the driver to lose control of the vehicle.

Rear seats

Folding the seatbacks can be done with lever operation.

Folding down the rear seatbacks**■ Before folding down the seatbacks**

- 1 Park the vehicle in a safe place.

Apply the parking brake (→P.193) and shift the shift position to P. (→P.188)

- 2 Adjust the position of the front seat and the angle of the seatback. (→P.137)

Depending on the position of the front seat, if the seatback is folded backward, it may interfere with the operation of the rear seat.

- 3 Lower the head restraint of the rear outboard seat. (→P.140)
- 4 Vehicles with armrest: Stow the armrest of the rear seat if it is pulled out. (→P.386)

This step is not necessary when operating the left side seat only.

■ Folding down the seatbacks

While pulling the seatback angle adjustment lever **A**, fold the seatback down.

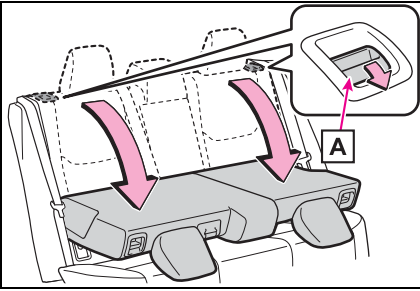

■ Returning the rear seat-backs

To avoid trapping the seat belt between the seat and the inside of the vehicle, pass the seat belt outside the seat belt guide **A** and then return the seatback securely to the locked position.

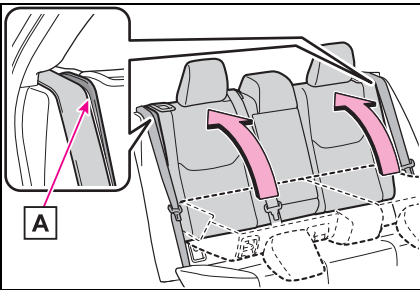

⚠ WARNING

Observe the following precautions. Failure to do so may result in death or serious injury.

■ When folding the rear seat-backs down

- Do not fold the seatbacks down while driving.
- Stop the vehicle on level ground, set the parking brake and shift the shift position to P.

- Do not allow anyone to sit on a folded seatback or in the luggage compartment while driving.
- Do not allow children to enter the luggage compartment.
- Do not operate the rear seat if it is occupied.
- Be careful not to get feet or hands caught in the moving parts or joints of the seats during operation.
- Do not allow children to operate the seat.
- **After returning the rear seat-back to the upright position**
- Make sure that the seatback is securely locked in position by lightly pushing it back and forth. If the seatback is not securely locked, the red marking will be visible on the seatback lock release lever. Make sure that the red marking is not visible.

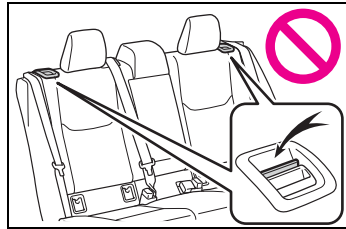

- Check that the seat belts are not twisted or caught in the seatback.

Head restraints

Head restraints are provided for all seats.

WARNING

■ Head restraint precautions

Observe the following precautions regarding the head restraints. Failure to do so may result in death or serious injury.

- Use the head restraints designed for each respective seat.
- Adjust the head restraints to the correct position at all times.
- After adjusting the head restraints, push down on them and make sure they are locked in position.
- Do not drive with the head restraints removed.

Vertical adjustment

■ Front seats

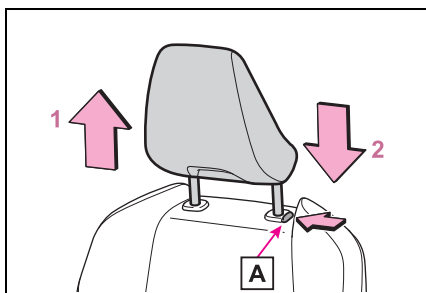

1 Up

Pull the head restraints up.

2 Down

Push the head restraint down while pressing the lock release button

A.

■ Rear outboard seats

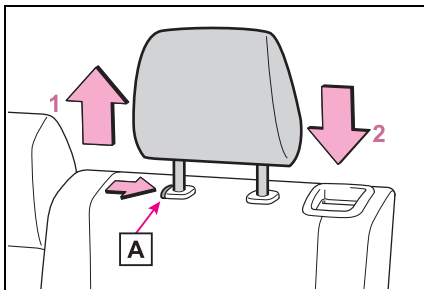

1 Up

Pull the head restraints up.

2 Down

Push the head restraint down while pressing the lock release button

A.

■ Rear center seat

Head restraints cannot be adjusted.

■ Adjusting the height of the head restraints

Make sure that the head restraints are adjusted so that the center of the head restraint is closest to the top of your ears.

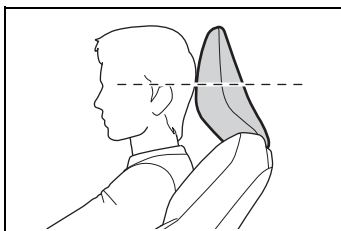

Removing the head restraints

■ Front seats

Pull the head restraint up while pressing the lock release button

A .

If the head restraint touches the ceiling, making the removal difficult, change the seat height or angle. (→P.137)

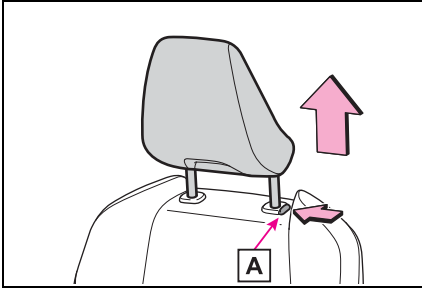

■ Rear outboard seats

- 1 Pull the seatback lock release lever and fold down the seatback until it reaches the position where the head restraints can be removed.

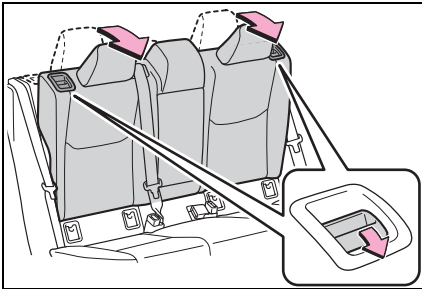

- 2 Pull the head restraint up while pressing the lock release button **A** .

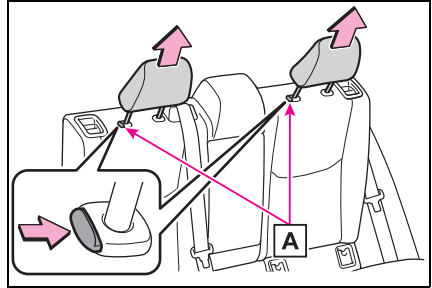

Installing the head restraints

■ Front seats

Align the head restraint with the installation holes and push it down to the lock position.

Press and hold the lock release button **A** when lowering the head restraint.

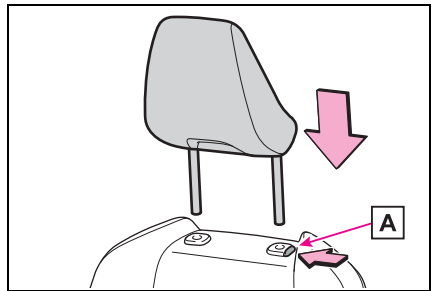

■ Rear outboard seats

- 1 Pull the seatback lock release lever and fold down the seatback until it reaches

the position where the head restraints can be installed.

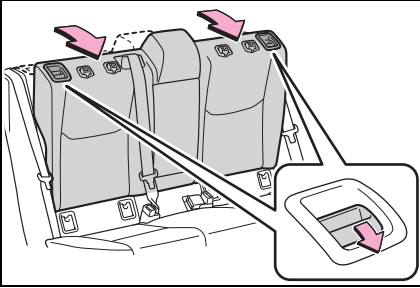

- 2 Align the head restraint with the installation holes and push it down to the lowest lock position.

Press and hold the lock release button **A** when lowering the head restraint.

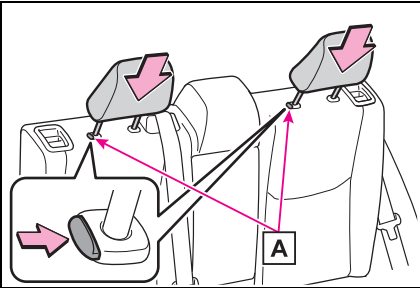

Steering wheel

Adjustment procedure

- 1 Hold the steering wheel and push the lever down.

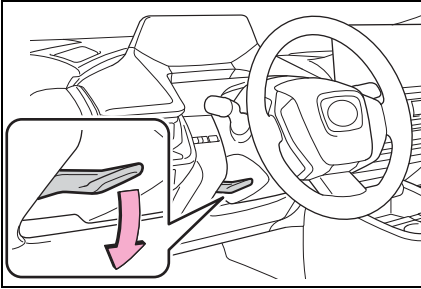

- 2 Adjust to the ideal position by moving the steering wheel horizontally and vertically.

After adjustment, pull the lever up to secure the steering wheel.

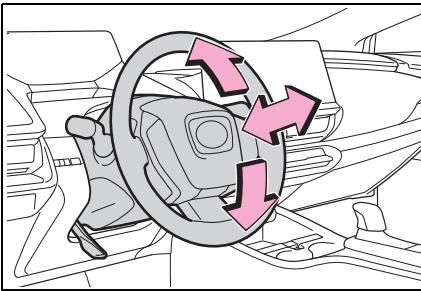

⚠ WARNING

■ Caution while driving

Do not adjust the steering wheel while driving. Doing so may cause the driver to mishandle the vehicle and cause an accident, resulting in death or serious injury.

■ After adjusting the steering wheel

Make sure that the steering wheel is securely locked. Otherwise, the steering wheel may move suddenly, possibly causing an accident, and resulting in death or serious injury. Also, the horn may not sound if the steering wheel is not securely locked.

Sounding the horn

To sound the horn, press on or close to the  mark.

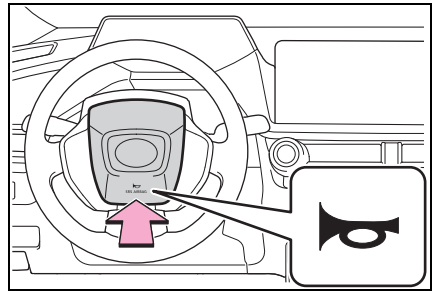

Inside rear view mirror*

*: If equipped

The rear view mirror's position can be adjusted.

Adjusting the height of rear view mirror

The height of the rear view mirror can be adjusted to suit your driving posture.

Adjust the height of the rear view mirror by moving it up and down.

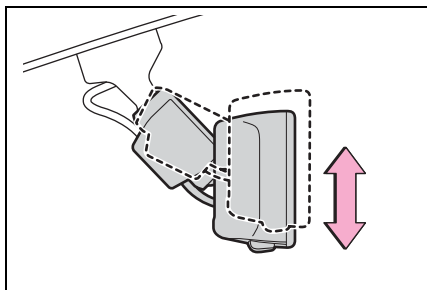

WARNING

■ Caution while driving

Do not adjust the position of the mirror while driving. Doing so may lead to mishandling of the vehicle and cause an accident, resulting in death or serious injury.

Anti-glare function

► Manual anti-glare inside rear view mirror

Reflected light from the headlights of vehicles behind can be

reduced by operating the lever.

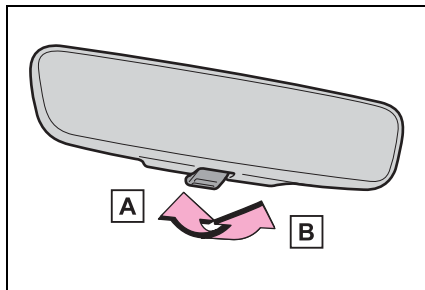

A Normal position

B Anti-glare position

► Auto anti-glare inside rear view mirror

Responding to the level of brightness of the headlights of vehicles behind, the reflected light is automatically reduced.

■ To prevent sensor error (vehicles with auto anti-glare inside rear view mirror)

To ensure that the sensors operate properly, do not touch or cover them.

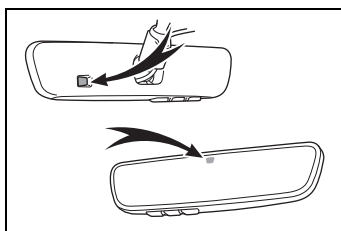

Digital Rear-view Mirror*

*: If equipped

The Digital Rear-view Mirror is a system that uses the camera on the rear of the vehicle and displays its image on the display of the Digital Rear-view Mirror.

The Digital Rear-view Mirror can be changed between optical mirror mode and digital mirror mode by operating the lever.

The Digital Rear-view Mirror allows the driver to see the rear view despite obstructions, such as the head restraints or luggage, ensuring rear visibility. Also, the rear seats are not displayed and privacy of the passengers is enhanced.



WARNING

Observe the following precautions.

Failure to do so may result in death or serious injury.

■ Before using the Digital Rear-view Mirror

- Make sure to adjust the mirror before driving. (→P.147)
- Change to optical mirror mode and adjust the position of the Digital Rear-view Mirror so that the area behind your vehicle can be viewed properly.

- Change to digital mirror mode and adjust the display settings.
- As the range of the image displayed by the Digital Rear-view Mirror is different from that of the optical mirror, make sure to check this difference before driving.

System components

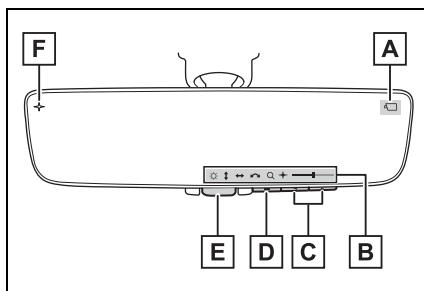

A Camera indicator

Indicates that the camera is operating normally.

B Icon display area

Displays icons, adjusting gauge, etc. (→P.147)

C Select/adjust button

Press to change the setting of the item you want to adjust.

D Menu button

Press to display the icon display area and select the item you want to adjust.

E Lever

Operate to change between digital mirror mode and optical mirror mode.

F Digital anti-glare mode indicator

In digital mirror mode, this indicates

that the anti-glare function is on.
(→P.147)

Changing modes

Operate the lever to change between digital mirror mode and optical mirror mode.

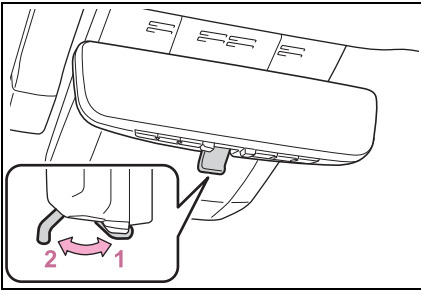

1 Digital mirror mode

Displays an image of the area behind the vehicle.

 will illuminate in this mode.

2 Optical mirror mode

Turns off the display of the Digital Rear-view Mirror allows it to be used as an optical mirror.

■ Digital mirror mode operating condition

The power switch is turned to ON.
When the power switch is changed from ON to OFF or ACC, the image will disappear after several seconds.

■ When using the Digital Rear-view Mirror in digital mirror mode

- If it is difficult to see the Digital Rear-view Mirror image because water, snow, mud, etc. is stuck to the camera lens, operate the camera cleaning washer (→P.205) or change to optical mirror mode.
- When the back door is open, the Digital Rear-view Mirror image

may not display properly. Before driving, make sure the back door is closed.

- If the display is difficult to see due to reflected light, close the sunshade (if equipped).
- Any of the following conditions may occur when driving in the dark, such as at night. None of them indicates that a malfunction has occurred.
 - Colors of objects in the displayed image may differ from their actual color.
 - Depending on the height of the lights of the vehicle behind, the area around the vehicle may appear white and blurry.
 - Automatic image adjustment for brighter surrounding image may cause flickering.

If it is difficult to see the displayed image or flickering bothers you, change to optical mirror mode.

- The Digital Rear-view Mirror may become hot while it is in digital mirror mode. This is not a malfunction.
- Depending on your physical condition or age, it may take longer than usual to focus on the displayed image. In this case, change to optical mirror mode.
- Do not let passengers stare at the displayed image when the vehicle is being driven, as doing so may cause motion sickness.

■ When the system malfunctions

If the symbol shown in the illustration is displayed when using the Digital Rear-view Mirror in digital mirror mode, the system may be malfunctioning. The symbol will disappear in a few seconds. Operate the lever, change to optical mirror mode and have the vehicle inspected by your Toyota dealer.

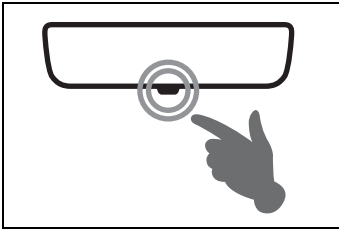

Adjusting the mirror

■ Adjusting the mirror height

The height of the rear view mirror can be adjusted to suit your driving posture.

Change to optical mirror mode, adjusting the height of the rear view mirror by moving it up and down.

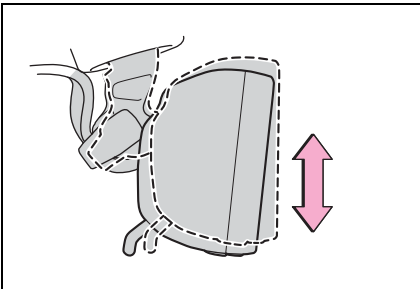



■ Display settings (digital mirror mode)

Settings of the display in the digital mirror mode, on/off operation of the automatic anti-glare function, etc. can be changed.



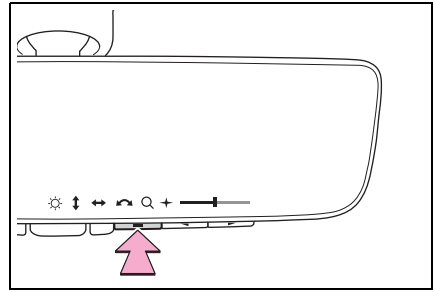



1 Press the menu button.

The icons will be displayed.



- 2 Press the menu button repeatedly and select the item you want to adjust.
- 3 Press  or  to change the setting.

The icons will disappear if a button is not operated for approximately 5 seconds or more.

Icons	Settings
	Select to adjust the brightness of the display.
	Select to adjust the area displayed up/down.
	Select to adjust the area displayed to the left/right.
	Select to adjust the angle of the displayed image.
	Select to zoom in/out the displayed image.
	The digital anti-glare mode can be turned on and off. When enabled, the brightness of the display is reduced at night to reduce headlight glare from vehicles to the rear.

■ Adjusting the display (digital mirror mode)

- The icons will disappear if a button is not operated for approximately 5 seconds or more.
- If the displayed image is adjusted, it may appear distorted. This is not a malfunction.
- If the brightness of the Digital Rear-view Mirror is set too high, it may cause eye strain. Adjust the Digital Rear-view Mirror to an appropriate brightness. If your eyes become tired, change to optical mirror mode.
- The brightness of the Digital Rear-view Mirror will change automatically according to the brightness of the area in front of your vehicle.
- The digital anti-glare mode operates only in locations where the surroundings are dark. Depending on the surrounding illumination environment, the image may not darken and it may not be possible to reduce headlight glare from vehicles to the rear.

■ To prevent the light sensors from malfunctioning

To prevent the light sensors from malfunctioning, do not touch or cover them.

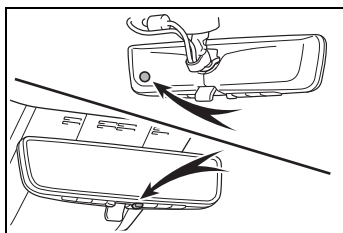

WARNING

Observe the following precautions. Failure to do so may result in death or serious injury.

■ While driving

- Do not adjust the position of the Digital Rear-view Mirror or adjust the display settings while driving. Stop the vehicle and operate the Digital Rear-view Mirror control switches. Failure to do so may cause a steering wheel operation error, resulting in an unexpected accident.
- Always pay attention to the vehicle's surroundings.

The size of the vehicles and other objects may look different when in digital mirror mode and optical mirror mode.

When backing up, make sure to directly check the safety of the area around your vehicle, especially behind the vehicle. Additionally, if a vehicle approaches from the rear in the dark, such as at night, the surrounding area may appear dim.

■ To prevent causes of fire

If the driver continues using the Digital Rear-view Mirror while smoke or odor comes from the mirror, it may result in fire. Stop using the system immediately and contact your Toyota dealer.

Cleaning the Digital Rear-view Mirror

■ Cleaning the mirror surface

If the mirror surface is dirty, the image on the display may be difficult to see.

Clean the mirror surface gently using a soft dry cloth.

■ Cleaning the camera

If it is difficult to see the Digital

Rear-view Mirror image because water, snow, mud, etc. is stuck to the camera lens, operate the camera cleaning washer or change to optical mirror mode. (→P.205)

■ The camera

The camera for the Digital Rear-view Mirror is located as shown.

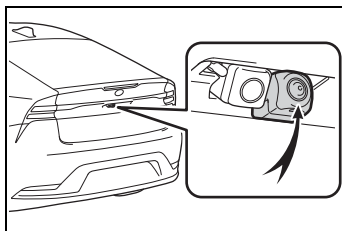

■ Cleaning the camera with washer fluid

- When cleaning the camera, it may be difficult to see the image due to the washer fluid. Therefore, take care in the surrounding area while driving.
- If washer fluid remains on the camera lens surface after cleaning, the image may be difficult to see at night due to the height or inclination of the headlights of the vehicle behind. In this case, change to optical mirror mode.
- Some dirt may not be removed completely after cleaning. In this case, rinse the camera lens with a large quantity of water and then wipe it clean with a soft cloth dampened with water.
- Washer fluid is sprayed onto the camera lens surface. Therefore, the ice, snow, etc. adhering around the camera cannot be removed.

■ The cooling fan

There is a cooling fan in the Digital Rear-view Mirror. Cooling fan sounds may be heard when using

the system.

⚠ NOTICE

■ To prevent the Digital Rear-view Mirror from malfunctioning

- Do not use detergents, such as thinner, benzene, and alcohol to clean the mirror. They may discolor, deteriorate or damage the mirror surface.
- Do not smoke, use matches, use cigarette lighters or allow open flames near the mirror. It may damage the mirror or cause a fire.
- Do not remove, disassemble or modify the mirror.
- Do not block the vent holes of the mirror. Otherwise, the mirror may be hot, leading to a malfunction or a fire.

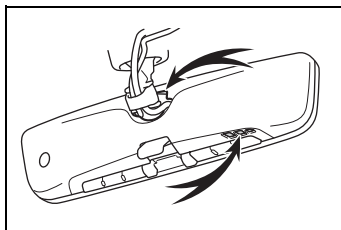

■ To prevent the camera from malfunctioning

- Observe the following precautions, otherwise the Digital Rear-view Mirror may not operate properly.
- Do not strike or hit the camera or subject it to a strong impact, as the camera installation position and angle may be changed.
- Do not remove, disassemble or modify the camera.

**NOTICE**





- When washing the camera, rinse it with a large quantity of water and then wipe it clean with a soft cloth dampened with water. Do not strongly rub the camera lens, as it may be scratched and will not be able to transmit a clear image.
- Do not allow organic solvent, car wax, window cleaner or glass coat to adhere to the camera cover. If this happens, wipe it off as soon as possible.
- Do not apply hot water to the camera in cold weather, as the sudden change of temperature may cause the camera to not operate properly.
- When using a high pressure washer to wash the vehicle, do not directly spray the camera and its surrounding area, as doing so may cause the camera to not operate properly.
- Do not subject the camera to a strong impact as this could cause a malfunction. If this happens, have the vehicle inspected by your Toyota dealer as soon as possible.

If you notice any symptoms

If you notice any of the following symptoms, refer to the following table for the likely cause and the solution.

If the symptom is not resolved by the solution, have the vehicle inspected by your Toyota dealer.

Symptom	Likely cause	Solution
The image is difficult to see.	The mirror surface is dirty.	Clean the mirror surface gently, using a soft dry cloth.
	Sunlight or headlights are shining directly into the Digital Rear-view Mirror.	Change to optical mirror mode. (If the light is coming through, close the sunshade [if equipped].)
The image is difficult to see.	<ul style="list-style-type: none"> • The vehicle is in a dark area. • The vehicle is near a TV tower, broadcasting station, electric power plant, or other location where strong radio waves or electrical noise may be present. • The temperature around the camera is extremely high/low. • The ambient temperature is extremely low. • It is raining or humid. • Sunlight or headlights are shining directly into the camera lens. • The vehicle is under fluorescent lights, sodium lights, mercury lights, etc. • Exhaust gas is obstructing the camera. 	Change to optical mirror mode. (Change back to digital mirror mode when the conditions have improved.)
	Foreign matters such as water droplets or dust is on the camera lens.	<ul style="list-style-type: none"> • Operate the dedicated camera cleaning washer and clean the camera lens. (→P.205) • Change to optical mirror mode.

Symptom	Likely cause	Solution
The image is out of alignment.	The back door is not fully closed.	Fully close the back door.
	The camera or its surrounding area has received a strong impact.	Change to optical mirror mode and have the vehicle inspected by your Toyota dealer.
The display is dim and  is displayed.	The system may be malfunctioning.	Change to optical mirror mode and have the vehicle inspected by your Toyota dealer.
 goes off.		
 is displayed.	The Digital Rear-view Mirror is extremely hot. (The display will gradually become more dim. If the temperature continues to increase, the Digital Rear-view Mirror will turn off.)	Reducing the cabin temperature is recommended to reduce the temperature of the mirror. ( will disappear when the mirror becomes cool.) If  does not disappear even though the mirror is cool, have the vehicle inspected by your Toyota dealer.
The lever cannot be operated properly.	The lever may be malfunctioning.	Change to optical mirror mode and have the vehicle inspected by your Toyota dealer. (To change to optical mirror mode, press and hold the menu button for approximately 10 seconds.)

Outside rear view mirrors

The rear view mirror's position can be adjusted to enable sufficient confirmation of the rear view.

■ When using the outside rear view mirrors in a cold weather

When it is cold and the outside rear view mirrors are frozen, it may not be possible to fold/extend them or adjust the mirror surface. Remove the ice, snow, etc. covering the outside rear view mirrors.

■ Defogging the mirrors (if equipped)

The outside rear view mirrors can be cleared using the mirror defoggers. Turn on the rear window defogger to turn on the outside rear view mirror defoggers. (→P.360)

⚠ WARNING

■ Important points while driving

Observe the following precautions while driving.

Failing to do so may result in loss of control of the vehicle and cause an accident, resulting in death or serious injury.

- Do not adjust the mirrors while driving.
- Do not drive with the mirrors folded.
- Both the driver and passenger side mirrors must be extended and properly adjusted before driving.

■ When the mirror defoggers are operating (if equipped)

Do not touch the rear view mirror surfaces, as they can become very hot and burn you.

Adjustment procedure

- 1 To select a mirror to adjust, turn the switch.

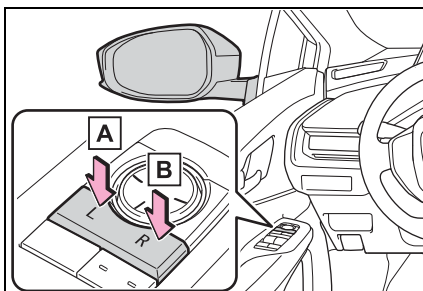

A Left

B Right

- 2 To adjust the mirror, operate the switch.

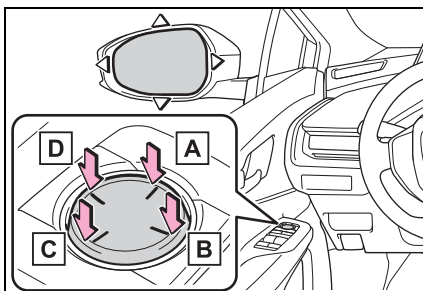

A Up

B Right

C Down

D Left

■ Mirror angle can be adjusted when

The power switch is in ACC or ON.

Folding the mirrors

Push the mirror back in the direction of the vehicle's rear.

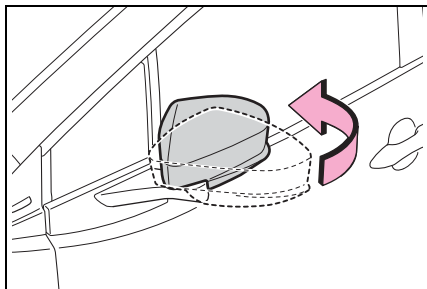
**WARNING****■ When a mirror is moving**

To avoid personal injury and mirror malfunction, be careful not to get your hand caught by the moving mirror.

Power windows

Opening and closing the power windows

The power windows can be opened and closed using the switches.

Operating the switch moves the side windows as follows:

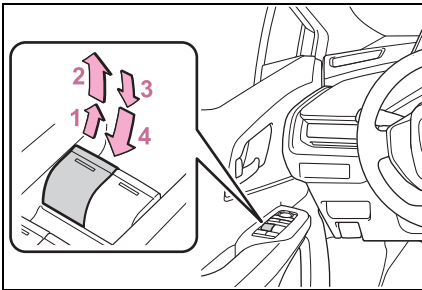

- 1 Closing
- 2 One-touch closing *
- 3 Opening
- 4 One-touch opening *

*: To stop the side window partway, operate the switch in the opposite direction.

■ The power windows can be operated when

The power switch is in ON.

■ Operating the power windows after turning the hybrid system off

The power windows can be operated for approximately 45 seconds even after the power switch is turned to ACC or OFF. They cannot, however, be operated once either front door is opened.

■ Jam protection function

If an object becomes jammed

between the side window and the window frame while the side window is closing, side window movement is stopped and the side window is opened slightly.

■ Catch protection function

If an object becomes caught between the door and side window while the side window is opening, side window movement is stopped.

■ When the power window cannot be opened or closed

When the jam protection function or catch protection function operates unusually and the side window cannot be opened and closed, perform the following operations with the power window switch of that door.

- Stop the vehicle. With the power switch in ON, within 4 seconds of the jam protection function or catch protection function activating, continuously operate the power window switch in the one-touch closing direction or one-touch opening direction so that the side window can be opened and closed.
- If the side window cannot be opened and closed even when performing the above operations, perform the following procedure for function initialization.
 - 1 Turn the power switch to ON.
 - 2 Pull and hold the power window switch in the one-touch closing direction and completely close the side window.
 - 3 Release the power window switch for a moment, resume pulling the switch in the one-touch closing direction, and hold it there for approximately 6 seconds or more.
 - 4 Press and hold the power window switch in the one-touch opening direction. After the side window is completely opened, continue holding the switch for an additional 1 second or more.

- 5 Release the power window switch for a moment, resume pushing the switch in the one-touch opening direction, and hold it there for approximately 4 seconds or more.
- 6 Pull and hold the power window switch in the one-touch closing direction again. After the side window is completely closed, continue holding the switch for a further 1 second or more.

If you release the switch while the side window is moving, start again from the beginning.

If the side window reverses and cannot be fully closed or opened, have the vehicle inspected by your Toyota dealer.

■ Door lock linked power window operation

- The power windows can be opened and closed using the mechanical key.* (→P.505)
- The power windows can be opened using the wireless remote control.* (→P.113)

*: These settings must be customized at your Toyota dealer.

■ Power window open reminder function

A message is shown on the multi-information display when the power switch is turned to OFF and the driver's door is opened with the power windows open.

■ Customization

Settings (e.g. linked door lock operation) can be changed. (Customizable features: →P.544)



WARNING

Observe the following precautions.

Failing to do so may result in death or serious injury.

■ Closing the power windows

- The driver is responsible for all the power window operations, including the operation for the passengers. In order to prevent accidental operation, especially by a child, do not let a child operate the power windows. It is possible for children and other passengers to have body parts caught in the power window. Also, when riding with a child, it is recommended to use the window lock switch. (→P.157)
- Check to make sure that all passengers do not have any part of their body in a position where it could be caught when a power window is being operated.

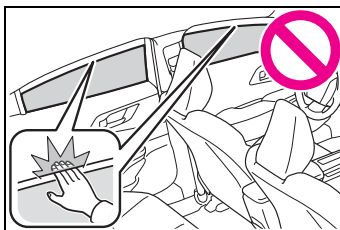

- When using the wireless remote control or mechanical key and operating the power windows, operate the power window after checking to make sure that there is no possibility of any passenger having any of their body parts caught in the side window. Also, do not let a child operate the power window by the wireless remote control or mechanical key. It is possible for children and other passengers to get caught in the power window.
- When exiting the vehicle, turn the power switch to OFF, carry the key and exit the vehicle along with the child. There may be accidental operation, due to mischief, etc., that may possibly lead to an accident.

WARNING

■ Jam protection function

- Never use any part of your body to intentionally activate the jam protection function.
- The jam protection function may not work if something gets jammed just before the side window is fully closed. Be careful not to get any part of your body jammed in the side window.

■ Catch protection function

- Never use any part of your body or clothing to intentionally activate the catch protection function.
- The catch protection function may not work if something gets caught just before the side window is fully opened. Be careful not to get any part of your body or clothing caught in the side window.

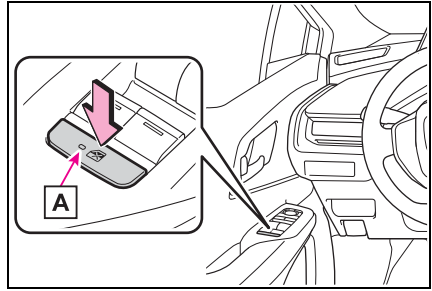

■ The window lock switch can be operated when

The power switch is in ON.

■ When the 12-volt battery is disconnected

The window lock switch is disabled. If necessary, press the window lock switch after reconnecting the 12-volt battery.

Preventing accidental operation (window lock switch)

This function can be used to prevent children from accidentally opening or closing a passenger window.

Press the switch.

The indicator **A** will come on and the passenger windows will be locked.

The passenger windows can still be opened and closed using the driver's switch even if the lock switch is on.

Driving position memory*

*: If equipped

This feature automatically adjusts the positions of the driver's seat to make entering and exiting the vehicle easier or to suit your preferences.

When My Settings is turned on:

Driving positions for the registered drivers (3 patterns) and guest (1 pattern) can be registered in My Settings.

When electronic key assignment is registered for My Settings, the driving position for each driver can be recalled (memory recall function).

When My Settings is turned off:

Up to 2 different driving positions can be recorded.

Each electronic key can be registered to recall your preferred driving position (memory recall function).

For details about My Settings, refer to P.162.

Enabling easier driver entry and exit (power easy access system)

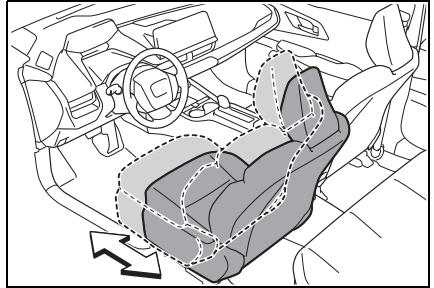

When all of the following have been performed, the driver's seat is automatically adjusted to a position that allows driver to enter and exit the vehicle easily.

- The shift position has been shifted to P.
- The power switch has been turned to OFF.
- The driver's seat belt has been unfastened.

When any of the following has been performed, the driver's seat automatically returns to its original position.

- The power switch has been turned to ACC or ON.
- The driver's seat belt has been fastened.

■ Operation of the power easy access system

- When exiting the vehicle, the power easy access system may not operate if the seat is already close to the rearmost position, etc.
- If the seat position is adjusted

during power easy access system operation, the automatic operation will stop. (The seat will change to manual operation.)

- If the seat position is adjusted during or after the power easy access system operation when the driver is exiting the vehicle, the power easy access system will not operate when entering the vehicle.

■ Jam protection function

If a person or object interferes while the seat is moving automatically, the operation will stop.

■ Customization

The seat movement amount settings of the power easy access system can be customized. (Customizable features: →P.538)

Recording/recalling a driving position

■ Recording procedure

- 1 Check that the shift position is in P.
- 2 Turn the power switch to ON.
- 3 Adjust the driver's seat to the desired positions.
- 4 While pressing the "SET" button, or within 3 seconds after the "SET" button is pressed, press button "1" or "2" until the buzzer sounds.

If the selected button has already been preset, the previously recorded position will be overwrit-

ten.

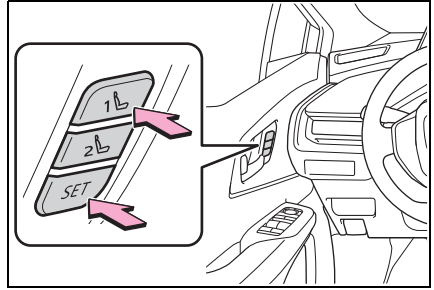

■ Recall procedure

- 1 Check that the shift position is in P.
- 2 Turn the power switch to ON.
- 3 Press one of the buttons for the driving position you want to recall until the buzzer sounds.

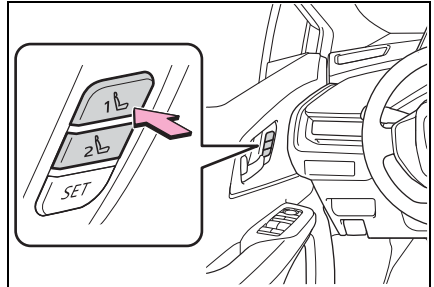

■ To stop the position recall operation part-way through

Perform any of the following:

- Press the "SET" button.
- Press button "1" or "2".
- Operate any of the seat adjustment switches.

■ Jam protection function

If a person or object interferes while the seat is moving automatically, the operation will stop.

■ Using the voice control system (if equipped)

The following operations can be performed using the voice control system:

- Driving position registration
- Recalling the driving position (can be operated only when the shift position is in P)

For details regarding the voice control system, refer to the “MULTIMEDIA OWNER’S MANUAL”.

■ Seat positions that can be memorized (→P.137)

The adjusted positions other than the position adjusted by lumbar support switch can be recorded.

■ Operating the driving position memory after turning the power switch to OFF

Recorded seat positions can be activated up to 180 seconds after the driver’s door is opened and another 60 seconds after it is closed again.

■ In order to correctly use the driving position memory function

If a seat position is already in the furthest possible position and the seat is operated in the same direction, the recorded position may be slightly different when it is recalled.

■ When recalling the driving position

Take care when recalling the driving position so that the head restraint does not touch the ceiling.

■ When the recorded seat position cannot be recalled

The seat position may not be recalled in some situations when the seat position is recorded in a certain range. For details, contact your Toyota dealer.

WARNING

■ Seat adjustment caution

Take care during seat adjustment so that the seat does not strike the rear passenger or squeeze your body against the steering wheel.

Registering/recalling/canceling a driving position to an electronic key (memory recall function)

■ When My Settings is turned off

- Registering procedure

Record your driving position to button “1” or “2” before performing the following:

Carry only the electronic key you want to register, and then close the driver’s door.

If 2 or more electronic keys are in the vehicle, the driving position cannot be recorded properly.

- 1 Check that the shift position is in P.
- 2 Turn the power switch to ON.
- 3 Recall the driving position that you want to record.
- 4 While pressing the recalled button, press and hold the door lock switch (either lock or unlock) until the buzzer sounds.

If the button could not be registered, the buzzer sounds continu-

ously for approximately 3 seconds.

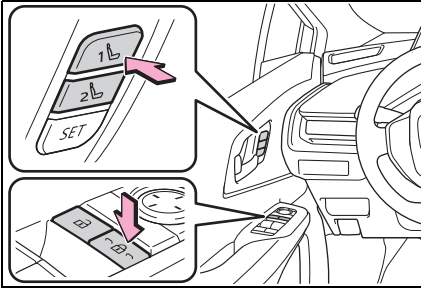

● Recall procedure

- 1 Make sure that the doors are locked before recalling the driving position. Carry the electronic key that has been registered to the driving position, and then unlock and open the driver's door using the smart key system or wireless remote control.

The driver's seat will move to a position slightly behind the recorded position in order to make entering the vehicle easier.

If the driving position is in a position that has already been recorded, the driver's seat will not move.

- 2 Turn the power switch to ACC or ON, or fasten a seat belt.

The driver's seat will move to the recorded position.

● Cancellation procedure

- 1 Carry only the key you want to cancel and then close the driver's door.

If 2 or more keys are in the vehicle, the driving position cannot be canceled properly.

- 2 Check that the shift position is in P.

- 3 Turn the power switch to ON.
- 4 While pressing the "SET" button, press and hold the door lock switch (either lock or unlock) until the buzzer sounds twice.

If the button could not be canceled, the buzzer sounds continuously for approximately 3 seconds.

■ When My Settings is turned on (an individual is identified with an electronic key)

The driving positions can be automatically recalled for each registered driver by registering electronic key assignments in My Settings.

● Registering procedure

When shifting the shift position to P after driving the vehicle, the current driving position will be recorded.

● Recalled procedure

- 1 Carry only the electronic key that has been assigned and registered in My Settings, and then unlock and open the driver's door using the smart key system or wireless remote control.

The driver's seat will move to a position slightly behind the recorded position in order to make entering the vehicle easier.

If the driving position is in a position that has already been recorded, the driver's seat will not move.

- 2 Turn the power switch to ACC or ON.

The driver's seat will move to the recorded position.

- Cancellation procedure

Refer to the “MULTIMEDIA OWNER’S MANUAL”.

- **Recalling the driving position using the memory recall function**

- Different driving positions can be registered for each electronic key. Therefore, the driving position that is recalled may be different depending on the key being carried.
- If the a door other than the driver’s door is unlocked with the smart key system, the driving position cannot be recalled. In this case, press the driving position button which has been set.

- **Jam protection function**

If a person or object interferes while the seat is moving automatically, the operation will stop.

My Settings

Drivers are identified using devices such as electronic keys to store the driving position and vehicle settings for each. Then the information can be recalled the next time the vehicle is driven.

Authentication devices can be assigned in advance to drivers so that they can drive using their preferred settings.

Settings for 3 drivers can be stored in My Settings.

For information on authentication devices registration/deletion, changing the driver’s name, initializing driver registered settings, manually switching drivers and deleting drivers registration, refer to the “MULTIMEDIA OWNER’S MANUAL”.

Types of assigned authentication devices

An individual can be identified using the following authentication devices.

- Electronic key

An individual is identified when the smart key system detects their electronic key. (→P.131)

- Digital Key (if equipped)

An individual is identified when the smart key system detects their Digital Key. (→P.111)

- Bluetooth® devices

An individual can be identified if the same Bluetooth® device that was used as a hands-free phone the last time the vehicle was entered is connected to the audio system.

If an individual is identified by detecting an electronic key, identification by Bluetooth® device will not be performed.

Bluetooth® is a registered trademark of Bluetooth SIG, Inc.

Recalled functions

When an individual is identified from an authentication device, settings for the following functions are recalled.

- Driving position (memory recall function)^{*1}

After an individual is identified, the driving position that was set when driving was last completed is recalled when either of the following operations is performed.

- Identification using electronic key: The door is unlocked and opened using the smart key system or wireless remote control.
- Identification using Digital Key^{*1}: The door is unlocked and opened using the smart key system.

Refer to P.159 for information on driving position registration and

recall.

- Multimedia settings^{*2}

When an individual is identified, the multimedia system settings used when the power switch was last turned off are recalled.

- Vehicle settings^{*2} (items that can be set on the multi-information display and Multimedia Display)

When an individual is identified, the vehicle settings used when the power switch was last turned off are recalled.

^{*1}: If equipped

^{*2}: Some settings are excluded

4-1. Before driving

Driving the vehicle.....	167
Cargo and luggage	174
Vehicle load limits	177
Trailer towing	178
Dinghy towing	179

4-2. Driving procedures

Power (ignition) switch	180
EV drive mode	185
Transmission.....	187
Turn signal lever	192
Parking brake	193
Brake Hold	196

4-3. Operating the lights and wipers

Headlight switch	199
AHB (Automatic High Beam).....	202
Windshield wipers and washer.....	205

4-4. Refueling

Opening the fuel tank cap	210
---------------------------------	-----

4-5. Using the driving support systems

Toyota Safety Sense 3.0 software update.....	213
Toyota Safety Sense 3.0	215
PCS (Pre-Collision System)	222

LTA (Lane Tracing Assist)	234
LCA (Lane Change Assist)	239
LDA (Lane Departure Alert)	242
PDA (Proactive driving assist).....	248
FCTA (Front Cross Traffic Alert).....	254
RSA (Road Sign Assist)	257
Dynamic radar cruise control	259
Cruise control	269
Emergency Driving Stop System	272
BSM (Blind Spot Monitor)	275
Safe Exit Assist	280
Intuitive parking assist	284
RCTA (Rear Cross Traffic Alert) function	294
RCD (Rear Camera Detection) function.....	299
PKSB (Parking Support Brake).....	303
Parking Support Brake function (static objects to the front and rear/static objects around the vehicle)	309

Parking Support Brake function (rear-crossing vehicles)

..... 313

Parking Support Brake function (rear pedestrians)

..... 314

Toyota Teammate

Advanced Park..... 316

Driving mode select switch

..... 343

Driving assist systems 345

4-6. Driving tips

Hybrid Electric Vehicle driving tips..... 351

Winter driving tips 353

Driving the vehicle

The following procedures should be observed to ensure safe driving:

Driving procedure

■ Starting the hybrid system

→P.180

■ Driving

- 1 With the brake pedal depressed, shift the shift position to D.

Check that the shift position indicator shows D.

- 2 If the parking brake is set, release the parking brake. (→P.193)

If the parking brake is in automatic mode, the parking brake will be released automatically. (→P.194)

- 3 Gradually release the brake pedal and gently depress the accelerator pedal to accelerate the vehicle.

■ Stopping

- 1 Depress the brake pedal.
- 2 If necessary, set the parking brake.

If the vehicle is to be stopped for an extended period of time, shift the shift position to P. (→P.188)

■ Parking the vehicle

- 1 Depress the brake pedal to stop the vehicle completely.

- 2 If the parking brake is released, set the parking brake. (→P.193)

If the parking brake is in automatic mode, turning off the power switch will automatically set the parking brake. (→P.193)

- 3 Shift the shift position to P. (→P.188)

Check that the shift position indicator shows P and the parking brake indicator is illuminated.

- 4 Press the power switch to stop the hybrid system.
- 5 Slowly release the brake pedal.
- 6 Lock the door, making sure that you have the electronic key on your person.

If parking on a hill, block the wheels as needed.

■ Starting off on a steep uphill

- 1 Firmly depress the brake pedal and shift the shift position to D.

The hill-start assist control will be activated.

- 2 Set the parking brake. (→P.193)
- 3 Release the brake pedal and gently depress the accelerator pedal to accelerate the vehicle.
- 4 Release the parking brake. (→P.193)

■ For fuel-efficient driving

Keep in mind that Hybrid Electric

Vehicles are similar to conventional vehicles, and it is necessary to refrain from activities such as sudden acceleration. (→P.351)

■ Driving in the rain

- Drive carefully when it is raining, because visibility will be reduced, the windows may become fogged-up, and the road will be slippery.
- Drive carefully when it starts to rain, because the road surface will be especially slippery.
- Refrain from high speeds when driving on an expressway in the rain, because there may be a layer of water between the tires and the road surface, preventing the steering and brakes from operating properly.

■ ECO Accelerator Guidance (→P.93)

It is easier to drive in an Eco-friendly manner by driving while referring to the ECO Accelerator Guidance display. Also, by using the ECO Accelerator Guidance it is easier to increase the “Eco Score” evaluation.

- When starting off:

While staying within the ECO Accelerator Guidance range, gradually depress the accelerator pedal and accelerate to the desired speed. If excessive acceleration is avoided, the “Start” score will increase.

- When driving:

After accelerating to the desired speed, release the accelerator pedal and drive at a stable speed within the ECO Accelerator Guidance range. By keeping the vehicle within the ECO Accelerator Guidance range, the “Cruise” score will increase.

- When stopping:

When stopping the vehicle, early releasing the accelerator pedal will

cause the “Stop” score to increase.

■ Restraining the hybrid system output (Brake Override System)

- When the accelerator and brake pedals are depressed at the same time, the hybrid system output may be restrained.
- A warning message is displayed on the multi-information display while the system is operating.

■ Breaking in your new Toyota

To extend the life of the vehicle, observing the following precautions is recommended:

- For the first 200 miles (300 km):
Avoid sudden stops.
- For the first 600 miles (1000 km):
 - Do not drive at extremely high speeds.
 - Avoid sudden acceleration.
 - Do not drive continuously in low gears.
 - Do not drive at a constant speed for extended periods.

■ Operating your vehicle in a foreign country

Comply with the relevant vehicle registration laws and confirm the availability of the correct fuel. (→P.519)

WARNING

Observe the following precautions. Failure to do so may result in death or serious injury.

■ When starting the vehicle

Always keep your foot on the brake pedal while stopped with the “READY” indicator is illuminated. This prevents the vehicle from creeping.

**WARNING****■ When driving the vehicle**

- Do not drive if you are unfamiliar with the location of the brake and accelerator pedals to avoid depressing the wrong pedal.
- Accidentally depressing the accelerator pedal instead of the brake pedal will result in sudden acceleration that may lead to an accident.
- When backing up, you may twist your body around, leading to a difficulty in operating the pedals. Make sure to operate the pedals properly.
- Make sure to keep a correct driving posture even when moving the vehicle only slightly. This allows you to depress the brake and accelerator pedals properly.
- Depress the brake pedal using your right foot. Depressing the brake pedal using your left foot may delay response in an emergency, resulting in an accident.
- The driver should pay extra attention to pedestrians when the vehicle is powered only by the electric motor (traction motor). As there is no engine noise, the pedestrians may misjudge the vehicle's movement. Even if the Acoustic Vehicle Alerting System is operating, drive with care as pedestrians in the vicinity may still not notice the vehicle if the surrounding area is noisy.

- Do not drive the vehicle over or stop the vehicle near flammable materials such as leaves, paper or rags.
The exhaust system and exhaust gases can be extremely hot. These hot parts may cause a fire if there is any flammable material nearby.
- During normal driving, do not turn off the hybrid system. Turning the hybrid system off while driving will not cause loss of steering or braking control. However, power assist for the steering wheel may be lost making it difficult to steer smoothly before stopping the vehicle depending on the remaining charge in the 12-volt battery or usage conditions. In this situation, you should pull over and stop the vehicle as soon as it is safe to do so.
In the event of an emergency, such as if it becomes impossible to stop the vehicle in the normal way: →P.455
- Use engine braking (downshift) to maintain a safe speed when driving down a steep hill.
Using the brakes continuously may cause the brakes to overheat and lose effectiveness.
(→P.187)
- Do not adjust the position of the steering wheel, the seat, inside rear view mirror (if equipped), Digital Rear-view Mirror (if equipped) or outside rear view mirrors while driving.
Doing so may result in a loss of vehicle control.
- Always check that all passengers' arms, head or other parts of their body are not outside the vehicle.

**WARNING****● AWD models:**

Do not drive the vehicle off-road.

This is not an AWD vehicle designed for off-road driving. Drive with due care if it becomes unavoidable to drive off-road.

- Do not drive across a river or through other bodies of water. This may cause electric/electronic components to short circuit, damage the hybrid system or cause other serious damage to the vehicle.

- Do not drive in excess of the speed limit. Even if the legal speed limit permits it, do not drive over 85 mph (140 km/h) unless your vehicle has high-speed capability tires. Driving over 85 mph (140 km/h) may result in tire failure, loss of control and possible injury. Be sure to consult a tire dealer to determine whether the tires on your vehicle are high-speed capability tires or not before driving at such speeds.

■ When driving on slippery road surfaces

- Sudden braking, acceleration and steering may cause tire slippage and reduce your ability to control the vehicle.
- Sudden acceleration, engine braking due to shifting, or changes in engine speed could cause the vehicle to skid, resulting in an accident.

- After driving through a puddle, lightly depress the brake pedal to make sure that the brakes are functioning properly. Wet brake pads may prevent the brakes from functioning properly. If the brakes on only one side are wet and not functioning properly, steering control may be affected.

■ When shifting the shift position

- Do not let the vehicle roll backward while a forward driving position is selected, or roll forward while the shift position is in R. Doing so may result in an accident or damage to the vehicle.
- Do not shift the shift position to P while the vehicle is moving. Doing so can damage the transmission and may result in a loss of vehicle control.
- Do not shift the shift position to R while the vehicle is moving forward. Doing so can damage the transmission and may result in a loss of vehicle control.
- Do not shift the shift position to a driving position while the vehicle is moving backward. Doing so can damage the transmission and may result in a loss of vehicle control.
- Changing the shift position to N while the vehicle is moving will disengage the hybrid system. Regenerative braking is not available with the hybrid system disengaged.

**WARNING**

- Do not shift the shift position with the accelerator pedal depressed. Changing the shift position to any positions other than P or N may lead to unexpected rapid acceleration of the vehicle that may cause an accident and result in death or serious injury.

After changing the shift position, make sure to confirm the current shift position displayed on the shift position indicator inside the meter.

- **If you hear a squealing or scraping noise (brake pad wear limit indicators)**

Have the brake pads checked and replaced by your Toyota dealer as soon as possible.

Rotor damage may result if the pads are not replaced when needed.

It is dangerous to drive the vehicle when the wear limits of the brake pads and/or those of the brake discs are exceeded.

- **When the vehicle is stopped**

- Do not depress the accelerator pedal unnecessarily.
If the shift position is in any position other than P or N, the vehicle may accelerate suddenly and unexpectedly, causing an accident.
- In order to prevent accidents due to the vehicle rolling away, always keep depressing the brake pedal while stopped with the "READY" indicator is illuminated, and apply the parking brake as necessary.

- If the vehicle is stopped on an incline, in order to prevent accidents caused by the vehicle rolling forward or backward, always depress the brake pedal and securely apply the parking brake as needed.

- Avoid revving or racing the engine.
Running the engine at high speed while the vehicle is stopped may cause the exhaust system to overheat, which could result in a fire if combustible material is nearby.

- **When the vehicle is parked**

- Do not leave glasses, cigarette lighters, spray cans, or soft drink cans in the vehicle when it is in the sun.

Doing so may result in the following:

- Gas may leak from a cigarette lighter or spray can, and may lead to a fire.
- The temperature inside the vehicle may cause the plastic lenses and plastic material of glasses to deform or crack.
- Soft drink cans may fracture, causing the contents to spray over the interior of the vehicle, and may also cause a short circuit in the vehicle's electrical components.
- Do not leave cigarette lighters in the vehicle. If a cigarette lighter is in a place such as the glove box or on the floor, it may be lit accidentally when luggage is loaded or the seat is adjusted, causing a fire.

**WARNING**

- Do not attach adhesive discs to the windshield or windows. Do not place containers such as air fresheners on the instrument panel or dashboard. Adhesive discs or containers may act as lenses, causing a fire in the vehicle.
- Do not leave a door or window open if the curved glass is coated with a metallized film such as a silver-colored one. Reflected sunlight may cause the glass to act as a lens, causing a fire.
- Always apply the parking brake, shift the shift position to P, stop the hybrid system and lock the vehicle.
Do not leave the vehicle unattended while the “READY” indicator is illuminated.
If the vehicle is parked with the shift position in P but the parking brake is not set, the vehicle may start to move, possibly leading to an accident.
- Do not touch the exhaust pipes while the “READY” indicator is illuminated or immediately after turning the hybrid system off. Doing so may cause burns.

■ When taking a nap in the vehicle

Always turn the hybrid system off. Otherwise, if you accidentally shift the shift position or depress the accelerator pedal, this could cause an accident or fire due to hybrid system overheating. Additionally, if the vehicle is parked in a poorly ventilated area, exhaust gases may collect and enter the vehicle, leading to death or a serious health hazard.

■ When braking

- When the brakes are wet, drive more cautiously.
Braking distance increases when the brakes are wet, and this may cause one side of the vehicle to brake differently than the other side. Also, the parking brake may not securely hold the vehicle.
- If the electronically controlled brake system does not operate, do not follow other vehicles closely and avoid hills or sharp turns that require braking.
In this case, braking is still possible, but the brake pedal should be depressed more firmly than usual. Also, the braking distance will increase. Have your brakes fixed immediately.
- The brake system consists of 2 or more individual hydraulic systems; if one of the systems fails, the other(s) will still operate. In this case, the brake pedal should be depressed more firmly than usual and the braking distance will increase. Have your brakes fixed immediately.

■ If the vehicle becomes stuck (AWD vehicles)

Do not spin the wheels excessively when any of the tires is up in the air, or the vehicle is stuck in sand, mud, etc. This may damage the driveline components or propel the vehicle forward or backward, causing an accident.

**NOTICE****■ When driving the vehicle**

- Do not depress the accelerator and brake pedals at the same time during driving, as this may restrain the hybrid system output.

**NOTICE**

● Do not use the accelerator pedal or depress the accelerator and brake pedals at the same time to hold the vehicle on a hill.

■ **Avoiding damage to vehicle parts**

● Do not turn the steering wheel fully in either direction and hold it there for an extended period of time.
Doing so may damage the power steering motor.

● When driving over bumps in the road, drive as slowly as possible to avoid damaging the wheels, underside of the vehicle, etc.

■ **If you get a flat tire while driving**

A flat or damaged tire may cause the following situations. Hold the steering wheel firmly and gradually depress the brake pedal to slow down the vehicle.

- It may be difficult to control your vehicle.
- The vehicle will make abnormal sounds or vibrations.
- The vehicle will lean abnormally.

Information on what to do in case of a flat tire (→P.495)

■ **When encountering flooded roads**

Do not drive on a road that has flooded after heavy rain, etc. Doing so may cause the following serious damage to the vehicle:

- Engine stalling
- Short in electrical components
- Engine damage caused by water immersion

In the event that you drive on a flooded road and the vehicle is flooded, be sure to have your Toyota dealer check the following:

- Brake function
- Changes in quantity and quality of oil and fluid used for the engine, transmission, transaxle, etc.
- Lubricant condition for the bearings and suspension joints (where possible), and the function of all joints, bearings, etc.

If the shift control system is damaged by flooding, it may not be possible to shift the shift position to P, or from P to other positions. In this case, contact your Toyota dealer.

■ **When parking the vehicle**

Always set the parking brake, and shift the shift position to P. Failure to do so may cause the vehicle to move or the vehicle may accelerate suddenly if the accelerator pedal is accidentally depressed.

Sudden start restraint control (Drive-Start Control [DSC])

When the following unusual operation is performed with the accelerator pedal depressed, the hybrid system output may be restrained.

- When the shift lever is shifted to R*.
- When the shift lever is shifted from P or R to forward drive shift position such as D*.

When the system operates, a mes-

sage appears on the multi-information display. Read the message and follow the instruction.

*: Depending on the situation, the shift position may not be changed.

■ Drive-Start Control (DSC)

● When the TRAC is turned off (→P.346), sudden start restraint control also does not operate. If your vehicle have trouble escaping from the mud or fresh snow due to sudden start restraint control operation, deactivate TRAC (→P.346) so that the vehicle may become able to escape from the mud or fresh snow.

Cargo and luggage

Take notice of the following information about storage precautions, cargo capacity and load:

WARNING

■ Things that must not be carried in the luggage compartment

The following things may cause a fire if loaded in the luggage compartment:

- Receptacles containing gasoline
- Aerosol cans

■ Storage precautions

Observe the following precautions.

Failure to do so may prevent the pedals from being depressed properly, may block the driver's vision, or may result in items hitting the driver or passengers, possibly causing an accident.

- Stow cargo and luggage in the luggage compartment whenever possible.
- Do not stack cargo and luggage in the luggage compartment higher than the seatbacks.
- When you fold down the rear seats, long items should not be placed directly behind the front seats.
- Never allow anyone to ride in the luggage compartment. It is not designed for passengers. They should ride in their seats with their seat belts properly fastened.

**WARNING**

- Do not place cargo or luggage in or on the following locations.
 - At the feet of the driver
 - On the front passenger or rear seats (when stacking items)
 - On the luggage cover
 - On the instrument panel
 - On the dashboard
- Secure all items in the occupant compartment.

■ When loading cargo on the roof luggage carrier (if equipped)

Observe the following precautions:

- Place the cargo so that its weight is distributed evenly between the front and rear axles.
- If loading long or wide cargo, never exceed the vehicle overall length or width. (→P.518)
- Before driving, make sure the cargo is securely fastened on the roof luggage carrier.
- Loading cargo on the roof luggage carrier will make the center of gravity of the vehicle higher. Avoid high speeds, sudden starts, sharp turns, sudden braking or abrupt maneuvers, otherwise it may result in loss of control or vehicle rollover due to failure to operate this vehicle correctly and result in death or serious injury.
- If driving for a long distance, on rough roads, or at high speeds, stop the vehicle now and then during the trip to make sure the cargo remains in its place.

- Do not exceed 176.4 lb. (80 kg) cargo weight on the roof luggage carrier.

**NOTICE**

■ When loading cargo on the roof luggage carrier (if equipped)

Be careful not to scratch the surface of the panoramic fixed moon roof with one-touch frosted glass control (if equipped).

Capacity and distribution

Cargo capacity depends on the total weight of the occupants.

(Cargo capacity) = (Total load capacity) - (Total weight of occupants)

Steps for Determining Correct Load Limit —

- (1) Locate the statement “The combined weight of occupants and cargo should never exceed XXX kg or XXX lbs.” on your vehicle’s placard.
- (2) Determine the combined weight of the driver and passengers that will be riding in your vehicle.
- (3) Subtract the combined weight of the driver and passengers from XXX kg or XXX lbs.
- (4) The resulting figure equals the available amount of cargo and luggage load capacity.

For example, if the “XXX” amount equals 1400 lbs. and

there will be five 150 lb passengers in your vehicle, the amount of available cargo and luggage load capacity is 650 lbs. (1400 - 750 (5 × 150) = 650 lbs.)

(5) Determine the combined weight of luggage and cargo being loaded on the vehicle. That weight may not safely exceed the available cargo and luggage load capacity calculated in Step 4.

(6) If your vehicle will be towing a trailer, load from your trailer will be transferred to your vehicle. Consult this manual to determine how this reduces the available cargo and luggage load capacity of your vehicle. (→P.177)

Toyota does not recommend towing a trailer with your vehicle. Your vehicle is not designed for trailer towing.

WARNING

Capacity and distribution

- Do not exceed the maximum axle weight rating or the total vehicle weight rating.
- Even if the total load of occupant's weight and the cargo load is less than the total load capacity, do not apply the load unevenly. Improper loading may cause deterioration of steering or braking control which may cause death or serious injury.

Calculation formula for your vehicle

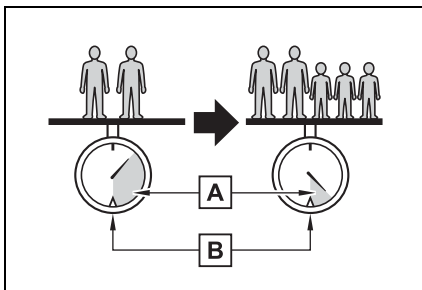

A Cargo capacity

B Total load capacity (vehicle capacity weight) (→P.518)

When 2 people with the combined weight of A lb. (kg) are riding in your vehicle, which has a total load capacity (vehicle capacity weight) of B lb. (kg), the available amount of cargo and luggage load capacity will be C lb. (kg) as follows:

$$B^{*2} \text{ lb. (kg)} - A^{*1} \text{ lb. (kg)} = C^{*3} \text{ lb. (kg)}$$

*1: A = Weight of people

*2: B = Total load capacity

*3: C = Available cargo and luggage load

In this condition, if 3 more passengers with the combined weight of D lb. (kg) get on, the available cargo and luggage load will be reduced E lb. (kg) as follows:

$$C \text{ lb. (kg)} - D^{*4} \text{ lb. (kg)} = E^{*5} \text{ lb. (kg)}$$

*4: D = Additional weight of people

*5: E = Available cargo and luggage

load

As shown in the example above, if the number of occupants increases, the cargo and luggage load will be reduced by an amount that equals the increased weight due to the additional occupants. In other words, if an increase in the number of occupants causes an excess of the total load capacity (combined weight of occupants plus cargo and luggage load), you must reduce the cargo and luggage on your vehicle.

Vehicle load limits

Vehicle load limits include total load capacity, seating capacity, towing capacity and cargo capacity.

- Total load capacity (vehicle capacity weight): →P.518

Total load capacity means the combined weight of occupants, cargo and luggage.

- Seating capacity: →P.518

Seating capacity means the maximum number of occupants whose estimated average weight is 150 lb. (68 kg) per person.

- Towing capacity

Toyota does not recommend towing a trailer with your vehicle.

- Cargo capacity

Cargo capacity may increase or decrease depending on the weight and the number of occupants.

■ Total load capacity and seating capacity

These details are also described on the tire and loading information label. (→P.438)

**WARNING****Overloading the vehicle**

Do not overload the vehicle. It may not only cause damage to the tires, but also degrade steering and braking ability, resulting in an accident.

Trailer towing

Toyota does not recommend towing a trailer with your vehicle. Toyota also does not recommend the installation of a tow hitch or the use of a tow hitch carrier for a wheelchair, scooter, bicycle, etc. Your vehicle is not designed for trailer towing or for the use of tow hitch mounted carriers.



Dinghy towing

Your vehicle is not designed to be dinghy towed (with 4 wheels on the ground) behind a motor home.

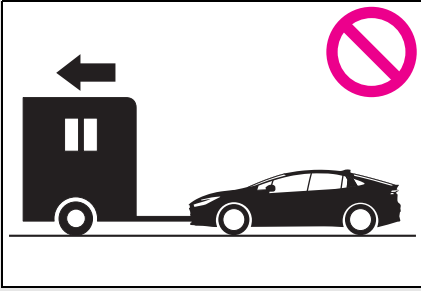

NOTICE

■ **To avoid serious damage to your vehicle**

Do not tow your vehicle with 4 wheels on the ground.

■ **To prevent causing serious damage to the transmission and AWD system (AWD models)**

2WD models: Never tow this vehicle from the rear with the front wheels on the ground. This may cause serious damage to the hybrid transmission.

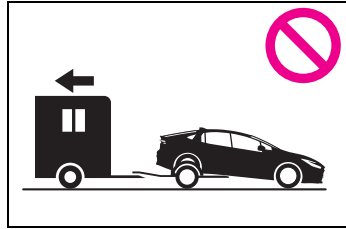

AWD models: Never tow this vehicle with any of the wheels on the ground. This may cause serious damage to the transmission and AWD system.

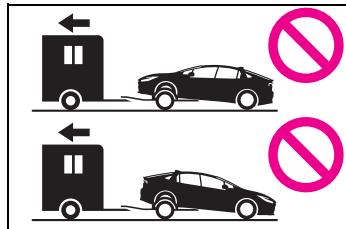

Power (ignition) switch

Performing the following operations when carrying the electronic key on your person starts the hybrid system or changes power switch modes.

Starting the hybrid system

- 1 Pull the parking brake switch to check that the parking brake is set. (→P.193)

The parking brake indicator will come on.

- 2 Firmly depress the brake pedal.

 and a message will be displayed on the multi-information display.

If it is not displayed, the hybrid system cannot be started.

When the shift position is N, the hybrid system cannot start. Shift the shift position to P when starting the hybrid system. (→P.188)

- 3 Press the power switch shortly and firmly.

When operating the power switch, one short, firm press is enough. It is not necessary to press and hold the switch.

If the “READY” indicator turns on, the hybrid system will operate normally.

Continue depressing the brake pedal until the “READY” indicator is illuminated.

The hybrid system can be started

from any power switch mode.

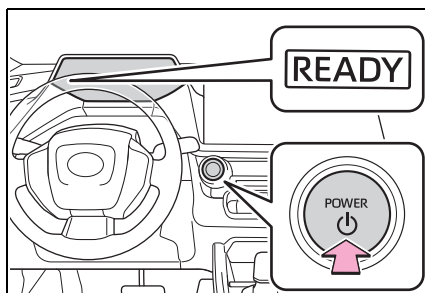

- 4 Check that the “READY” indicator is illuminated.

The vehicle cannot be driven if the “READY” indicator is off.

■ Power switch illumination

According to the situation, the power switch illumination operates as follows.

- When driver’s door or front passenger’s door is opened, the power switch illumination illuminates.
- When the power switch is in OFF and depressing the brake pedal with carrying the electronic key on your person, the power switch illumination blinks.
- When the power switch is in ACC or ON, the power switch illumination illuminates.
- When the power switch mode is changed from ACC or ON to OFF, the power switch illumination illuminates for a certain amount of time. Afterwards, the power switch illumination turns off.

■ If the hybrid system does not start

- The immobilizer system may not have been deactivated. (→P.79) Contact your Toyota dealer.
- If a message related to start-up is shown on the multi-information display, read the message and follow the instructions.

● If the door is unlocked with the mechanical key, the hybrid system cannot be started using the smart key system. Refer to P.506 to start the hybrid system. However, if the electronic key is carried inside the vehicle and the doors are locked (→P.115), the hybrid system can be started.

■ **When the ambient temperature is low, such as during winter driving conditions**

● When starting the hybrid system, the flashing time of the “READY” indicator may be long. Leave the vehicle as it is until the “READY” indicator is steady on, as steady means the vehicle is able to move.

● When the hybrid battery (traction battery) is extremely cold (below approximately -22°F [-30°C]) under the influence of the outside temperature, it may not be possible to start the hybrid system. In this case, try to start the hybrid system again after the temperature of the hybrid battery increases due to the outside temperature increase etc.

■ **Sounds and vibrations specific to a Hybrid Electric Vehicle**

→P.72

■ **If the 12-volt battery is discharged**

The hybrid system cannot be started using the smart key system. Refer to P.507 to restart the hybrid system.

■ **Electronic key battery depletion**

→P.108

■ **Conditions affecting operation**

→P.133

■ **Note for the entry function**

→P.134

■ **If “Smart Key System Malfunction See Owner’s Manual” is displayed on the multi-information display**

The system may be malfunctioning. Have the vehicle inspected by your Toyota dealer immediately.

■ **If the “READY” indicator does not come on**

In the event that the “READY” indicator does not come on even after performing the proper procedures for starting the vehicle, contact your Toyota dealer immediately.

■ **When “Check Fuel Cap” is displayed on the multi-information display**

→P.212

■ **If the hybrid system is malfunctioning**

→P.78

■ **Electronic key battery**

→P.446

■ **Operation of the power switch**

● If the switch is not pressed shortly and firmly, the power switch mode may not change or the hybrid system may not start.

● If attempting to restart the hybrid system immediately after turning the power switch to OFF, the hybrid system may not start in some cases. After turning the power switch to OFF, please wait a few seconds before restarting the hybrid system.

■ **Customization**

If the smart key system has been deactivated in a customized setting, refer to P.506.

**WARNING****When starting the hybrid system**

Always start the hybrid system while sitting in the driver's seat. Do not depress the accelerator pedal while starting the hybrid system under any circumstances. Doing so may cause an accident resulting in death or serious injury.

**NOTICE****When starting the hybrid system**

If the hybrid system becomes difficult to start, have your vehicle checked by your Toyota dealer immediately.

Symptoms indicating a malfunction with the power switch

If the power switch seems to be operating somewhat differently than usual, such as the switch sticking slightly, there may be a malfunction. Contact your Toyota dealer immediately.

Stopping the hybrid system

- 1 Stop the vehicle completely.
- 2 If the parking brake is in manual mode, set the parking brake. (→P.193)
- 3 Press the P position switch. (→P.188)

Check that the shift position indicator shows P and the parking brake indicator is illuminated.

- 4 Press the power switch.

The hybrid system will stop, and the

meter display will be extinguished (the shift position indicator will be extinguished a few seconds after the meter display).

- 5 Release the brake pedal and check that "ACCESSORY" or "POWER ON" is not shown on the meter.

When the shift control system malfunctions

If the shift control system is malfunctioning, when attempting to turn the power switch off, it may not be able to be turned off. In this situation, it may be possible to turn the power switch off by applying the parking brake and then operating the power switch.

If there is a malfunction in the system, have the vehicle inspected by your Toyota dealer immediately.

Automatic hybrid system shut off feature

- The vehicle is equipped with a feature that automatically shuts off the hybrid system when the shift position is in P with the hybrid system operating for an extended period.
- The hybrid system will automatically shut off after approximately 1 hour if it has been left operating while the shift position is in P.
- The timer for the automatic hybrid system shut off feature will reset if the brake pedal is depressed or if the shift position is in a position other than P.
- After the vehicle is parked, if the door is locked with the door lock switch (→P.115) from the inside or the mechanical key (→P.505) from the outside, the automatic hybrid system shut off feature will be disabled. The timer for the automatic hybrid system shut off feature will be re-enabled if the driver's door is opened.

**WARNING****■ Stopping the hybrid system in an emergency**

- If you want to stop the hybrid system in an emergency while driving the vehicle, press and hold the power switch for more than 2 seconds, or press it briefly 3 times or more in succession. (→P.455)
However, do not touch the power switch while driving except in an emergency. Turning the hybrid system off while driving will not cause loss of steering or braking control. However, power assist for the steering wheel may be lost making it difficult to steer smoothly before stopping the vehicle depending on the remaining charge in the 12-volt battery or usage conditions. In this situation, you should pull over and stop the vehicle as soon as it is safe to do so.
- If the power switch is operated while the vehicle is running, a warning message will be shown on the multi-information display and a buzzer sounds.
- When restarting the hybrid system after an emergency shut-down, shift the shift position to N and press the power switch shortly and firmly.

■ When parking

Exhaust gases include harmful carbon monoxide (CO), which is colorless and odorless. Observe the following precautions.

Failure to do so may cause exhaust gases to enter the vehicle and may lead to an accident caused by light-headedness, or may lead to death or a serious health hazard.

- If the vehicle is in a poorly ventilated area or a closed area, such as a garage, stop the hybrid system.
- Do not leave the vehicle with the hybrid system operating for a long time. If such a situation cannot be avoided, park the vehicle in an open space and ensure that exhaust fumes do not enter the vehicle interior.
- Do not leave the hybrid system operating in an area with snow build-up, or where it is snowing. If snowbanks build up around the vehicle while the hybrid system is operating, exhaust gases may collect and enter the vehicle.

Changing power switch modes

Modes can be changed by pressing the power switch with the brake pedal released. (The mode changes each time the switch is pressed.)

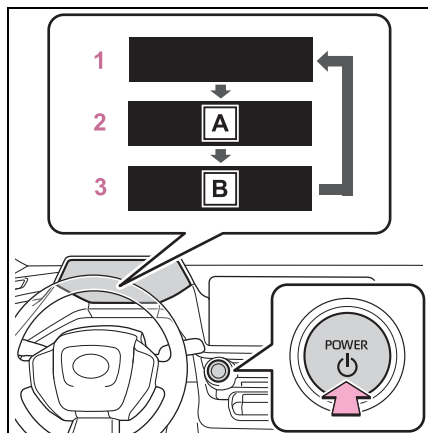

A “ACCESSORY”

B “POWER ON”

1 OFF

The emergency flashers can be used.

2 ACC*

Some electrical components such as the audio system can be used. “ACCESSORY” will be displayed on the meter.

3 ON

All electrical components can be used.

“POWER ON” will be displayed on the meter.

*: ACC mode can be enabled/disabled on the customize menu. (→P.544)

■ **When ACC customization is in off**

- With the power switch is turned off, the multimedia system can still be used for a certain time until the battery saving function starts operating.
- When the safe exit assist is operating, a buzzer will sound and a

voice guidance will be given. (vehicles with safe exit assist)

■ **Auto power off function**

- If the vehicle is left in ACC or ON (the hybrid system is not operating) for more than 20 minutes with the shift position in P, the power switch will automatically turn to OFF.
- If the 12-volt battery is low with the shift position is in P and the power switch is in ACC or ON (the hybrid system is not operating), a buzzer sounds and a message will be displayed on the multi-information display. If this continues, the power switch is automatically turn to OFF.

However, this function cannot entirely prevent the 12-volt battery discharge. Do not leave the vehicle with the power switch in ACC or ON for long periods of time when the hybrid system is not operating.

 **NOTICE**

■ **To prevent 12-volt battery discharge**

- Do not leave the power switch in ACC or ON for long periods of time without the hybrid system on.
- If “ACCESSORY” or “POWER ON” is displayed on the meter, the power switch is not in OFF. Exit the vehicle after turning the power switch to OFF.

EV drive mode

In EV drive mode, electric power is supplied by the hybrid battery (traction battery), and only the electric motor (traction motor) is used to drive the vehicle.

This mode allows you to drive in residential areas early in the morning and late at night, or in indoor parking lots etc. without concern for noises and gas emissions.

However, when the Acoustic Vehicle Alerting System is active, the vehicle may produce sound.

Operating instructions

Turns EV drive mode on/off

When EV drive mode is turned on, the EV drive mode indicator will come on. Pressing the switch when in EV drive mode will return the vehicle to normal driving (using the gasoline engine and electric motor [traction motor]).

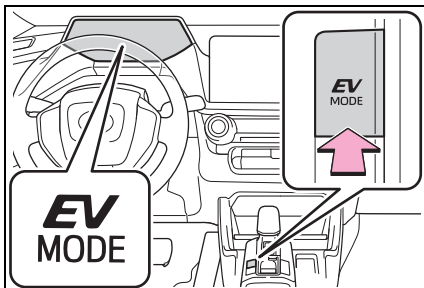

■ Situations in which EV drive mode cannot be turned on

It may not be possible to turn EV drive mode on in the following situations. If it cannot be turned on, a buzzer will sound and a message will be shown on the multi-information display.

- The temperature of the hybrid system is high.

The vehicle has been left in the sun, driven on a hill, driven at high speeds, etc.

- The temperature of the hybrid system is low.

The vehicle has been left for a long period of time etc.

- The gasoline engine is warming up.
- The hybrid battery (traction battery) is low.

The remaining battery level indicated in the Energy monitor display is low. (→P.102)

- Vehicle speed is high.
- The accelerator pedal is depressed firmly or the vehicle is on a hill etc.
- The windshield defogger is in use.

■ Switching to EV drive mode when the gasoline engine is cold

After the hybrid system has started and the “READY” indicator has illuminated, press the EV drive mode switch before the gasoline engine starts to switch to EV drive mode.

However, depending on vehicle conditions, EV drive mode may be canceled and normal driving (using the gasoline engine and electric motor [traction motor]) may be resumed.

■ Automatic cancelation of EV drive mode

When driving in EV drive mode, the gasoline engine may automatically restart in the following situations. When EV drive mode is canceled, a buzzer will sound, the EV drive mode indicator will flash and go off and a message will be shown on the multi-information display.

- The hybrid battery (traction battery) becomes low.

The remaining battery level indicated in the Energy monitor display is low. (→P.102)

- Vehicle speed is high.
- The accelerator pedal is depressed firmly or the vehicle is on a hill etc.

■ Possible driving distance when driving in EV drive mode

EV drive mode's possible driving distance ranges from a few hundred meters to approximately 0.6 mile (1 km). However, depending on vehicle conditions, there are situations when EV drive mode cannot be used.

(The distance that is possible depends on the hybrid battery [traction battery] level and driving conditions.)

■ Fuel economy

The hybrid system is designed to achieve the best possible fuel economy during normal driving (using the gasoline engine and electric motor [traction motor]). Driving in EV drive mode more than necessary may lower fuel economy.



WARNING

■ Caution while driving

When driving in EV drive mode, pay special attention to the area around the vehicle. Because there is no engine noise, pedestrians, people riding bicycles or other people and vehicles in the area may not be aware of the vehicle starting off or approaching them, so take extra care while driving.

Transmission

Select the shift position depending on your purpose and situation.

Shift position purpose and functions

Shift position	Objective or function
P	Parking the vehicle/starting the hybrid system
R	Reversing
N	Neutral (Condition in which the power is not transmitted)
D	Normal driving*
B	Applying engine braking or strong braking when the accelerator pedal has been released on steep downward slopes etc.

*: To improve fuel efficiency and reduce noise, set the shift position in D for normal driving.

■ When driving with dynamic radar cruise control activated

Even when switching the driving mode to sport mode with the intent of enabling engine braking, engine braking will not activate because dynamic radar cruise control will not be canceled.

■ If a message about a shift operation is shown

To prevent the shift position from being selected incorrectly or the vehicle from moving unexpectedly, the shift position may be changed automatically or operating the shift lever may be required. In this case, change the shift position following the messages on the multi-information display.

■ Restraining sudden start (Drive-Start Control)

→P.173

WARNING

■ When driving on slippery road surfaces

Do not accelerate or shift the shift position suddenly. Sudden changes in engine braking may cause the vehicle to spin or skid, resulting in an accident.

NOTICE

■ Hybrid battery (traction battery) charge

If the shift position is in N, the hybrid battery (traction battery) will not be charged. To help prevent the battery from discharging, avoid leaving the N position selected for an extended period of time.

■ Situations where shift control system malfunctions are possible

If any of the following situations occurs, shift control system malfunctions are possible. Immediately stop the vehicle in a safe place on level ground, apply the parking brake, and then contact your Toyota dealer.

NOTICE

- When the warning message indicating the shift control system appears on the multi-information display. (→P.475)
- The display indicates that no shift position is selected for more than a few seconds.

Shift position display and how to change the shift position

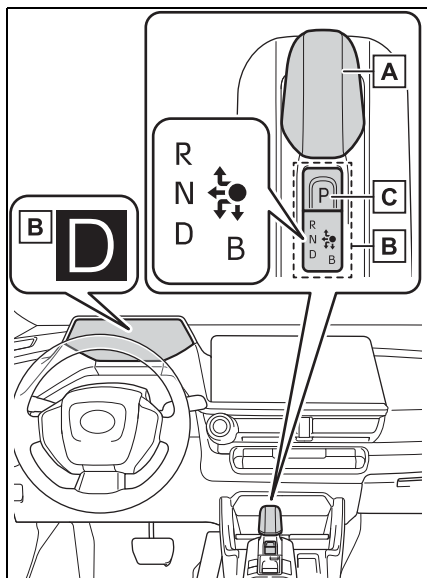

A Shift lever

Operate the shift lever gently and securely in the direction of the arrow on the shift position indicator. To shift to N, slide the shift lever in the direction of the arrow and hold it. Release the shift lever after each shifting operation to allow it to return to its regular position (●). Shifting to B is only possible when

the shift position is in D.

When shifting from P to N, D or R, from N, D, B or R to P, from D or B to R, or from R to D, ensure that the brake pedal is being depressed and the vehicle is stationary.

B Shift position indicator

Meter display:

The current shift position is illuminated.

Shift lever display:

The current shift position is illuminated.

When selecting the shift position, make sure that the shift position has been changed to the desired position by checking the shift position indicator provided on the instrument cluster.

C P position switch

Fully stop the vehicle and set the parking brake, and then press the P position switch.

When the shift position is changed to P, the switch illuminates.

Check that the shift position indicator shows P.

Changing the shift position in each power switch mode

- The shift position cannot be changed when the power switch is in ACC or off.
- When the power switch is in ON, if the READY indicator is not illuminated, the shift position can only be changed to N.
- When the READY indicator is illuminated, the shift position can be changed from P to D, N, or R.
- When the READY indicator is flashing, the shift position cannot be changed from P to any other

position, even if the shift lever is operated. Operate the shift lever again after the READY indicator changes from flashing to illuminated.

■ Shifting the shift position from P to other positions

- While depressing the brake pedal firmly, operate the shift lever. If the shift lever is operated without depressing the brake pedal, the buzzer will sound and the shifting operation will be disabled.
- When selecting the shift position, make sure that the shift position has been changed to the desired position by checking the shift position indicator provided on the instrument cluster.
- The shift position cannot be changed from P to B directly.

■ The shift position cannot be changed when

In the following situations, a buzzer will sound to inform you that the shift position cannot be changed. Use the appropriate operation to attempt to change the shift position again.

- When attempting to change the shift position from P with the brake pedal not depressed
- When attempting to change the shift position from P with the accelerator pedal depressed
- When attempting to change the shift position from N while stopped or driving at an extremely low speed with the brake pedal not depressed
- When attempting to change the shift position from N while stopped or driving at an extremely low speed with the accelerator pedal depressed
- When attempting to change the shift position from P or N to B
- When the P position switch is pressed while driving

When driving at an extremely low

speed, the shift position may change to P.

■ The shift position automatically changes to N when

In the following situations, a buzzer will sound to inform you that the shift position has been changed to N. Use the appropriate operation to attempt to change the shift position again.

- When attempting to change the shift position to R while the vehicle is moving forward

When driving at a low speed, the shift position may change to R.

- When attempting to change the shift position to D while the vehicle is moving backward

When driving at a low speed, the shift position may change to D.

- When attempting to change the shift position from R to B

■ If the N shift position is selected while driving

If the shift lever is moved to N while driving above a certain speed, the shift position will change to N without holding the shift lever in the N position. In this situation, a buzzer will sound and a message will be displayed on the multi-information display to inform you that the shift position has been changed to N.

■ Automatic P position selection function

In the following situations, the shift position is automatically changed to P.

- When pressing the power switch with the vehicle stopped while the power switch is in ON and the shift position is in a position other than P (after the shift position has changed to P, the power switch will turn off)*
- If the driver's door is opened and all of the following conditions are

met, while the shift position is in a position other than P

- The power switch is in ON.
- The driver is not wearing the seat belt.
- The brake pedal is not depressed.

To start off the vehicle after the shift position is changed to P, operate the shift lever again.

- When the vehicle is stopped after the hybrid system has been stopped in an emergency while driving.

- When voltage of the 12-volt battery drops while the shift position is in a position other than P.

* When the power switch is pressed while driving at extremely slow speeds, such as immediately before stopping the vehicle, the shift position may automatically change to P. Make sure that the vehicle is completely stopped before pressing the power switch.

■ **If the shift position cannot be shifted from P**

There is a possibility that the 12-volt battery is discharged. Check the 12-volt battery in this situation. (→P.507)

■ **Customization**

Some functions can be customized. (→P.538)

 **WARNING**

■ **For the shift lever**

- Do not remove the shift lever knob or use anything but a genuine Toyota shift lever knob. Also, do not hang anything on the shift lever. Doing so could prevent the shift lever from returning to position, causing unexpected accidents to occur when the vehicle is in motion.

- In order to prevent the shift position from accidentally being changed, do not touch the shift lever when not using them.

■ **P position switch**

- Do not press the P position switch while the vehicle is moving.

If the P position switch is pressed when driving at very low speeds (for example, directly before stopping the vehicle), the vehicle may stop suddenly when the shift position switches to P, which could lead to an accident.

- In order to prevent the shift position from accidentally being changed, do not touch the P position switch when not using them.

 **NOTICE**

■ **When exiting the vehicle (driver's seat only)**

Check that the shift position indicator shows P and that the parking brake indicator is illuminated before opening the door and exiting the vehicle.

Keeping the shift position in N without activating the automatic P position selection function

- By performing the following operation, the shift position can be held in N until the shift position switches to P without activating the automatic P position selection function.

- 1 Operate the shift lever and change the shift position to N when the hybrid system is operating.
- 2 Return the shift lever to its regular position (●).
- 3 Operate the shift lever to N and hold it there until the buzzer sounds.
- 4 Press the power switch within 5 seconds after the buzzer sounds.

The hybrid system stops with the shift position in N.*

Make sure to check that the buzzer sounds and “Holding N Push P Switch When Done” is displayed on the multi-information display.

- In order to shift to a position other than N, first press the P position switch to change the shift position to P.
- Make sure to operate the shift lever with the hybrid system is operating.
If the hybrid system is not operating, it may not be possible to hold the shift position in N.

*: To keep this state, do not operate the power switch. If the power switch is operated repeatedly, the power switch will turn off after the shift position has automatically changed to P.

Selecting the driving mode

→P.343

Turn signal lever

Operating instructions

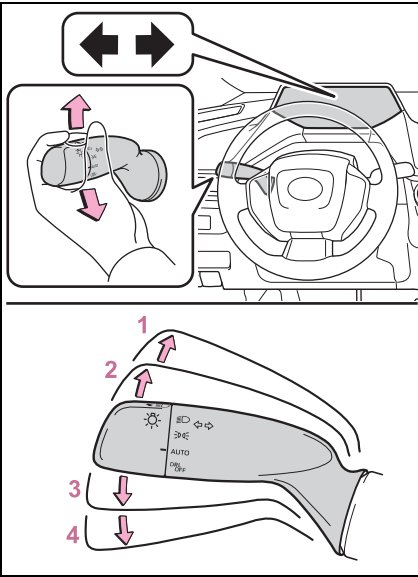

- 1 Right turn
- 2 Lane change to the right
(move the lever partway and release it)

The right hand signals will flash 3 times.

- 3 Lane change to the left
(move the lever partway and release it)

The left hand signals will flash 3 times.

- 4 Left turn

■ Turn signals can be operated when

The power switch is in ON.

■ If the indicator flashes faster than usual

Have the vehicle inspected by your Toyota dealer.

■ If the turn signals stop flashing before a lane change has been performed

Operate the lever again.

■ To discontinue flashing of the turn signals during a lane change

Operate the lever in the opposite direction.

Parking brake

The parking brake can be set or released automatically or manually. In automatic mode, the parking brake can be set or released automatically according to shift position operation. Also, even in automatic mode, the parking brake can be set or released manually.

Operating instructions

■ Using the manual mode

The parking brake can be set and released manually.

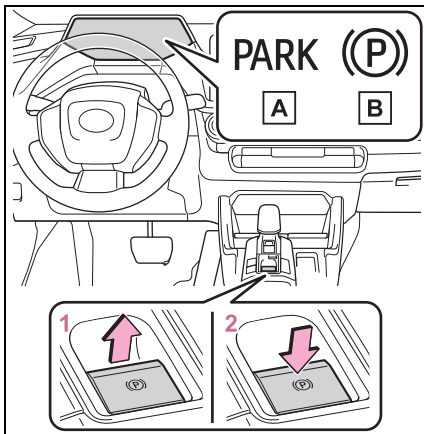

A Parking brake indicator light (for U.S.A.)

B Parking brake indicator light (for Canada)

1 Pull the switch to set the parking brake.

The parking brake indicator light will turn on.

Pull and hold the parking brake switch if an emergency occurs and it is necessary to operate the parking brake while driving.

2 Press the switch to release the parking brake.

- Operate the parking brake switch while depressing the brake pedal.
- Using the parking brake automatic release function, the parking brake can be released by depressing the accelerator pedal. When using this function, slowly depress the accelerator pedal. (→P.194)

Make sure that the parking brake indicator light turns off.

If the parking brake indicator light flashes, operate the switch again. (→P.463)

■ Turning the automatic mode on

While the vehicle is stopped, pull and hold the parking brake switch until a buzzer sounds and a message is shown on the multi-information display.

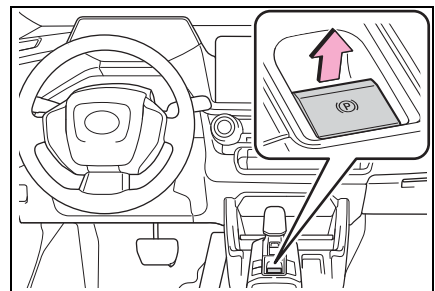

When the automatic mode is turned on, the parking brake operates as follows.

- When the shift position is

shifted from P, the parking brake will be released, and the parking brake indicator light will turn off.

- When the shift position is shifted to P, the parking brake will be set, and the parking brake indicator light will turn on.

Operate the shift position and P position switch with the vehicle stopped and the brake pedal depressed.

The auto function may not operate if the shift lever is moved extremely quickly. In this situation, apply the parking brake manually. (→P.193)

■ Turning the automatic mode off

While the vehicle is stopped and depressing the brake pedal, press and hold the parking brake switch until a buzzer sounds and a message is shown on the multi-information display.

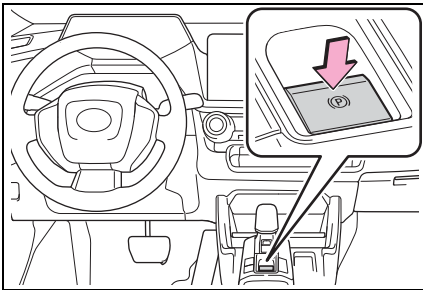

■ Parking brake operation

- When the power switch is not in ON, the parking brake cannot be released using the parking brake

switch.

- When the power switch is not in ON, automatic mode (automatic brake setting and releasing) is not available.

■ Parking brake automatic release function

When all of the following conditions are met, the parking brake can be released by depressing the accelerator pedal.

- The driver's door is closed
- The driver is wearing the seat belt
- The shift position is in a forward driving position or reverse driving position
- The malfunction indicator lamp or brake system warning light is not illuminated.

When depressing the accelerator pedal, depress it slowly.

If the parking brake is not released when the accelerator pedal is depressed, release the parking brake manually.

When the shift position is shifted from P, the parking brake will be released automatically.

■ Parking brake automatic lock function

The parking brake will be set automatically under the following conditions:

- The brake pedal is not depressed
- The driver's door is open
- The driver's seat belt is not fastened
- The shift position is in a position other than P or N

(The shift position is in P during advanced park* operation.)

- The malfunction indicator lamp and brake system warning light are not illuminated

*: If equipped.

■ If “Parking Brake Temporarily Unavailable” is displayed on the multi-information display

If the parking brake is operated repeatedly over a short period of time, the system may restrict operation to prevent overheating. If this happens, refrain from operating the parking brake. Normal operation will return after about 1 minute.

■ If “Parking Brake Unavailable” is displayed on the multi-information display

Operate the parking brake switch. If the message does not disappear after operating the switch several times, the system may be malfunctioning. Have the vehicle inspected by your Toyota dealer.

■ Parking brake operation sound

When the parking brake operates, a motor sound (whirring sound) may be heard. This does not indicate a malfunction.

■ Parking brake indicator light

● Depending on the power switch mode, the parking brake indicator light will turn on and stay on as described below:

ON: Comes on until the parking brake is released.

Not in ON: Stays on for approximately 15 seconds.

● When the power switch is turned off with the parking brake set, the parking brake indicator light will stay on for about 15 seconds. This does not indicate a malfunction.

■ When the parking brake switch malfunctions

Automatic mode (automatic brake setting and releasing) will be turned on automatically.

■ Parking the vehicle

→P.167

■ Parking brake engaged warning buzzer

A buzzer will sound if the vehicle is driven with the parking brake engaged.

“Parking Brake ON” is displayed on the multi-information display (with the vehicle reaching a speed of 3 mph [5 km/h]).

■ If the brake system warning light comes on

→P.463

■ Usage in winter time

→P.354



WARNING

■ When parking the vehicle

Do not leave a child in the vehicle alone. The parking brake may be released unintentionally by a child and there is the danger of the vehicle moving that may lead to an accident resulting in death or serious injury.

■ Parking brake switch

Do not set any objects near the parking brake switch. Objects may interfere with the switch and may lead the parking brake to unexpectedly operate.

■ Parking brake automatic lock function

Never use the automatic parking brake engagement function in place of normal parking brake operation. This function is designed to reduce the risk of a collision due to the driver forgetting to engage the parking brake. Over-reliance on this function to park the vehicle safely may lead to an accident resulting in death or serious injury.



NOTICE

■ When parking the vehicle

Before you leave the vehicle, shift the shift position to P, set the parking brake and make sure that the vehicle does not move.

■ When the system malfunctions

Stop the vehicle in a safe place and check the warning messages.

■ When the vehicle 12-volt battery is discharged

The parking brake system cannot be activated. (→P.507)

■ When the parking brake cannot be released due to a malfunction

Driving the vehicle with the parking brake set will lead to brake components overheating, which may affect braking performance and increase brake wear. Have the vehicle inspected by your Toyota dealer immediately if this occurs.

Brake Hold

The brake hold system keeps the brake applied when the shift position is in D or N with the system on and the brake pedal has been depressed to stop the vehicle. The system releases the brake when the accelerator pedal is depressed with the shift position in D to allow smooth start off.

Enabling the system

Turn the brake hold system on

The brake hold standby indicator (green) **A** comes on. While the system is holding the brake, the brake hold operated indicator (yellow) **B** comes on.

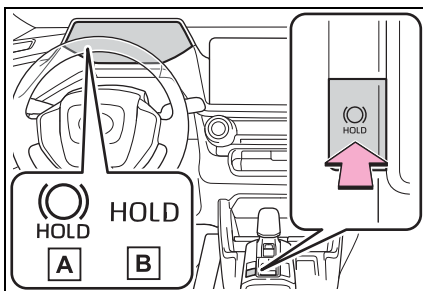

■ Brake hold system operating conditions

The brake hold system cannot be turned on in the following conditions:

- The driver's door is not closed.
- The driver is not wearing the seat belt.

- “Parking Brake Unavailable” or “EPB Malfunction Visit Your Dealer” is displayed on the multi-information display.

If any of the conditions above are detected when the brake hold system is enabled, the system will turn off and the brake hold standby indicator light will go off. In addition, if any of the conditions are detected while the system is holding the brake, a warning buzzer will sound and a message will be shown on the multi-information display. The parking brake will then be set automatically.

■ Brake hold function

- If the brake pedal is left released for a period of about 3 minutes after the system has started holding the brake, the parking brake will be set automatically. In this case, a warning buzzer sounds and a message is shown on the multi-information display.
- To turn the system off while the system is holding the brake, firmly depress the brake pedal and press the button again.
- The brake hold function may not hold the vehicle when the vehicle is on a steep incline. In this situation, it may be necessary for the driver to apply the brakes. A warning buzzer will sound and the multi-information display will inform the driver of this situation. If a warning message is shown on the multi-information display, read the message and follow the instructions.
- When do not wish for the parking brake to operate automatically, press and hold the brake hold switch until the standby indicator (green) turns off, and then turn the power switch off.

■ When the parking brake is set automatically while the system is holding the brakes

Perform any of the following opera-

tions to release the parking brake.

- Depress the accelerator pedal. (The parking brake will not be released automatically if the seat belt is not fastened.)
- Operate the parking brake switch with the brake pedal depressed.

Make sure that the parking brake indicator light goes off. (→P.193)

■ When an inspection at your Toyota dealer is necessary

When the brake hold standby indicator (green) does not illuminate even when the brake hold switch is pressed with the brake hold system operating conditions met, the system may be malfunctioning. Have the vehicle inspected at your Toyota dealer.

■ If “Brake Hold Malfunction Press Brake to Deactivate Visit Your Dealer” or “Brake Hold Malfunction Visit Your Dealer” is displayed on the multi-information display

The system may be malfunctioning. Have the vehicle inspected by your Toyota dealer.

■ Warning messages and buzzers

Warning messages and buzzers are used to indicate a system malfunction or to inform the driver of the need for caution. If a warning message is shown on the multi-information display, read the message and follow the instructions.

■ If the brake hold operated indicator flashes

→P.469

**WARNING****■ When the vehicle is on a steep incline**

Take care when using the brake hold system on a steep incline, exercise caution. The brake hold function may not hold brakes in such situations.

Also, the system may not activate depending on the angle of the slope.

■ When stopped on a slippery road

The system cannot stop the vehicle when the gripping ability of the tires has been exceeded. Do not use the system when stopped on a slippery road.

**NOTICE****■ When parking the vehicle**

The brake hold system is not designed for use when parking the vehicle for a long period of time. Turning the power switch off while the system is holding the brake may release the brake, which would cause the vehicle to move. When operating the power switch, depress the brake pedal, shift the shift position to P and set the parking brake.

Headlight switch

The headlights can be operated manually or automatically.

Turning on the headlights

Operating the  switch turns on the lights as follows:

► U.S.A. (type A)

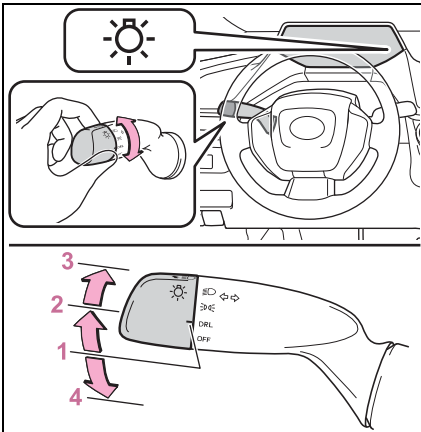

- 1 **DRL** The daytime running lights turn on. (→P.200)
- 2 **☰** The side marker, parking, tail, license plate, instrument panel lights, and daytime running lights (→P.200) turn on.
- 3 **☰** The headlights and all lights listed above (except daytime running lights) turn on.
- 4 **OFF** Off

► U.S.A. (type B)

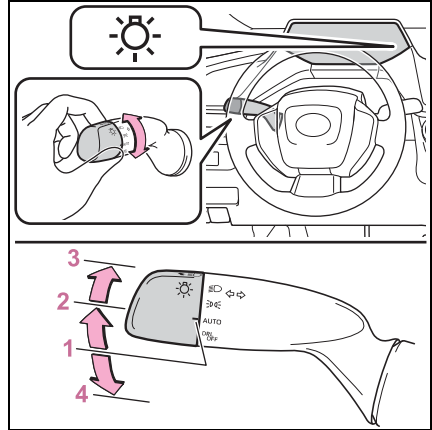

- 1 **AUTO** The headlights, side marker, parking, LED accessories lamp (if equipped), daytime running lights (→P.200) and so on turn on and off automatically.
- 2 **☰** The side marker, parking, LED accessories lamp (if equipped), tail, license plate, instrument panel lights, and daytime running lights (→P.200) turn on.
- 3 **☰** The headlights and all lights listed above (except daytime running lights) turn on.
- 4 **DRL OFF** The daytime running lights turn off.

▶ Canada

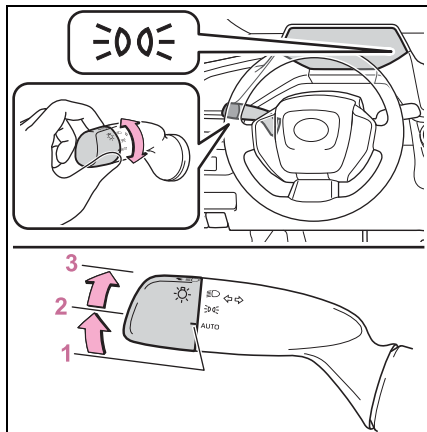

- 1 **AUTO** The headlights, side marker, parking, LED accessories lamp (if equipped), daytime running lights (→P.200) and so on turn on and off automatically.
- 2 **DRL** The side marker, parking, LED accessories lamp (if equipped), tail, license plate, instrument panel lights, and daytime running lights (→P.200) turn on.
- 3 **DRL** The headlights and all lights listed above (except daytime running lights) turn on.

■ **AUTO mode can be used when**

The power switch is in ON.

■ **Daytime running light system**

- U.S.A. (type A): The daytime running lights illuminate using the same lights as the low beam headlight lights, and illuminate dimmer than the low beam headlights.

- To make your vehicle more visible to other drivers during daytime driving, the daytime running lights turn on automatically when all of the following conditions are met. (The daytime running lights are not designed for use at night.)
 - The hybrid system is operating
 - The parking brake is released
 - The headlight switch is in the **DRL**, **DRL** or **AUTO** * position

*: When the surroundings are bright

The daytime running lights remain on after they illuminate, even if the parking brake is set again.

- For the U.S.A.: Daytime running lights can be turned off by operating the switch.
- Compared to turning on the headlights, the daytime running light system offers greater durability and consumes less electricity, so it can help improve fuel economy.

■ **Headlight control sensor (if equipped)**

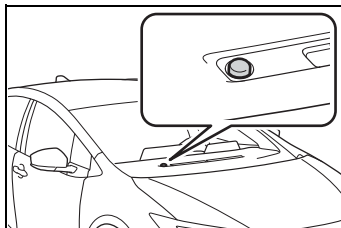

The sensor may not function properly if an object is placed on the sensor, or anything that blocks the sensor is affixed to the windshield. Doing so interferes with the sensor detecting the level of ambient light and may cause the automatic headlight system to malfunction.

■ **Automatic light off system**

- When the headlights are on: The lights turn off 30 seconds after the power switch is turned to OFF and a door is opened and closed. (The

lights turn off immediately if  on the key is pressed after all the doors are closed.)

- When only the tail lights are on: The tail lights turn off automatically if the power switch is turned to OFF and the driver's door is opened.

To turn the lights on again, turn the power switch to ON, or turn the light switch to the OFF,  or AUTO position once and then back to the  or  position.

■ Light reminder buzzer

A buzzer sounds when the driver's door is opened while the lights are turned on with the power switch in OFF (except when the automatic light off system is operated).

■ 12-volt battery-saving function

In order to prevent the 12-volt battery of the vehicle from discharging, if the headlights and/or tail lights are on when the power switch is turned to OFF, the battery saving function will operate and automatically turn off all the lights after approximately 20 minutes.

When any of the following are performed, the 12-volt battery-saving function is canceled once and then reactivated. All the lights will turn off automatically 20 minutes after the 12-volt battery-saving function has been reactivated:

- When the headlight switch is operated
- When a door is opened or closed

■ Windshield wiper linked headlight illumination (if equipped)

When driving during daytime with the headlight switch is in the AUTO position, if the windshield wipers are used, the headlights will turn on

automatically after several seconds to help enhance the visibility of your vehicle.

■ If “Headlight System Malfunction Visit Your Dealer” is displayed on the multi-information display

The system may be malfunctioning. Have the vehicle inspected by your Toyota dealer.

■ Customization

Settings (e.g. light sensor sensitivity) can be changed.
(Customizable features: →P.538)

NOTICE

■ To prevent 12-volt battery discharge

Do not leave the lights on longer than necessary when the hybrid system is not operating.

Turning on the high beam headlights

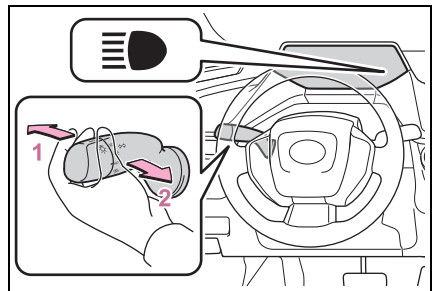

- 1 With the headlights on, push the lever away from you to turn on the high beams.

Pull the lever toward you to the center position to turn the high beams off.

- 2 Pull the lever toward you and release it to flash the high beams once.

You can flash the high beams with the headlights on or off.

AHB (Automatic High Beam)

The Automatic High Beam uses a front camera located on the upper portion of the windshield to detect the brightness of the lights of vehicles ahead, street-lights, etc., and automatically changes the head lights between the high beams and low beams.

WARNING

■ For safe use

Do not overly rely on the Automatic High Beam. Always drive safely, taking care to observe your surroundings and turning the high beams on or off manually if necessary.

■ To prevent unintentional operation of the Automatic High Beam system

- When it is necessary to disable the system: →P.215

Using the Automatic High Beam system

- 1 Press the Automatic High Beam switch.

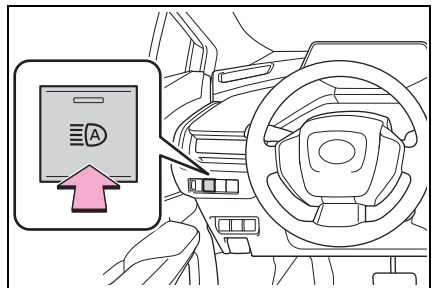

- 2 Turn the headlight switch to the AUTO or  position.

When the headlight switch lever is in the low beam position, the AHB system will be enabled and the AHB indicator will illuminate.

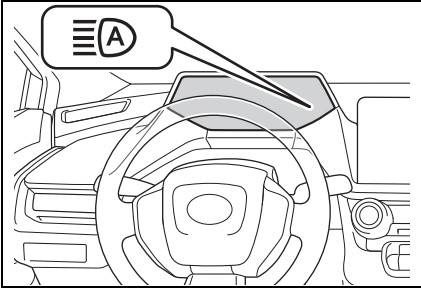

■ Automatic operating conditions of the high beams

- When all of the following conditions are met, the high beams will illuminate automatically:
 - The vehicle speed is approximately 21 mph (34 km/h) or more.
 - The area ahead of the vehicle is dark.
 - There are no vehicles ahead with lights on.
 - There are few streetlights or other lights on the road ahead.
- If any of the following conditions are met, the headlights will change to the low beams:
 - Vehicle speed drops below approximately 17 mph (27 km/h).
 - The area ahead of the vehicle is not dark.
 - There is a vehicle ahead with lights on.
 - There are many streetlights or other lights on the road ahead.

■ Front camera detection

- In the following situations, the high beams may not be automatically changed to the low beams:
 - When a vehicle cuts in front of your vehicle
 - When another vehicle crosses in front of the vehicle

- When vehicles ahead are repeatedly detected and then hidden due to repeated curves, road dividers or roadside trees
- When a vehicle ahead approaches from a far lane
- When a vehicle ahead is far away
- When a vehicle ahead has no lights
- When the lights of a vehicle ahead are dim
- When a vehicle ahead is reflecting strong light, such as own headlights
- Situations in which the sensors may not operate properly: →P.219

- The headlights may change to the low beams if a vehicle ahead that is using fog lights without its headlights turned on is detected.

- House lights, street lights, traffic signals, and illuminated billboards or signs may cause the high beams to change to the low beams, or the low beams to remain on.

- The following may change the timing at which the headlights change to the low beams:

- The brightness of lights of vehicles ahead
- The movement and direction of vehicles ahead
- The distance between the vehicle and a vehicle ahead
- When a vehicle ahead only has lights illuminated on one side
- When a vehicle ahead is a two-wheeled vehicle
- The condition of the road (gradient, curve, condition of the road surface, etc.)
- The number of passengers and amount of luggage

- The headlights may change between the high beams and low beams unexpectedly.

- Bicycles and other small vehicles may not be detected.

- In the following situations, the system may not be able to correctly detect the brightness of the sur-

roundings. This may cause the low beams to remain on or the high beams to flash or dazzle pedestrians or vehicles ahead. In such a case, it is necessary to manually change between the high beams and low beams.

- When there are lights similar to headlights or tail lights in the surrounding area
- When headlights or tail lights of vehicles ahead are turned off, dirty, changing color, or not aimed properly
- When the headlights are repeatedly changing between the high beams and low beams.
- When use of the high beams is inappropriate or when the high beams may be flashing or dazzling pedestrians or other drivers.
- When the vehicle is used in an area in which vehicles travel on the opposite side of the road of the country for which the vehicle was designed, for example using a vehicle designed for right-hand traffic in a left-hand traffic area, or vice versa
- When it is necessary to disable the system: →P.215
- Situations in which the sensors may not operate properly: →P.219

■ Temporarily reducing front camera sensitivity

The sensitivity of the front camera can be temporarily reduced.

- 1 Turn the power switch off with the following conditions met.
 - The headlight switch is in the  or AUTO position.
 - The headlight switch lever is in the low beam position.
 - The automatic High Beam switch is on.
- 2 Turn the power switch to ON.
- 3 Within 60 seconds after performing step 2, push the headlight switch lever to the high beam position then pull it to the original

position quickly 10 times, then leave the lever in its original position.

- 4 If the sensitivity is changed, the Automatic High Beam indicator will blink 3 times.

Turning the high beams on/off manually

■ Changing to the high beams

Push the lever forward.

The AHB indicator will turn off and the headlight high beam indicator will turn on.

Pull the lever to its original position to enable the Automatic High Beam system again.

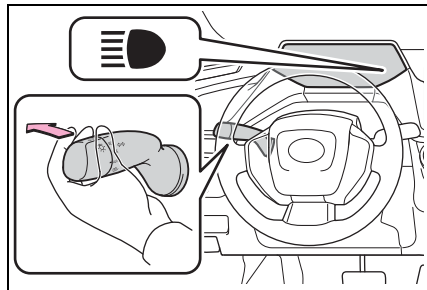

■ Changing to the low beams

Press the Automatic High Beam switch.

The AHB indicator will turn off.

Press the switch to enable the Automatic High Beam system again.

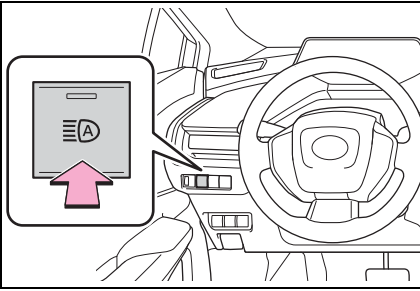

Temporarily changing to the low beams

It is recommended to switch to the low beams when use of the high beams is inappropriate or when the high beams may cause problems or distress to other drivers or pedestrians nearby.

Pull the lever rearward and then return it to its original position.

The high beams will illuminate while the lever is pulled, however, after the lever is returned to its original position, the low beams will remain on for a certain amount of time. After this, the Automatic High Beam system will operate.

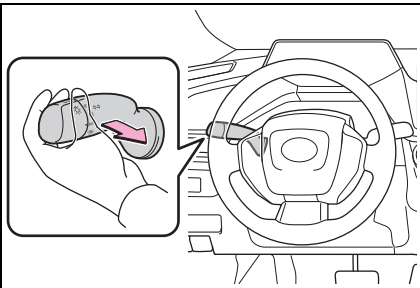

Windshield wipers and washer

Operating the lever can switch between automatic operation and manual operation, or can use the washer.

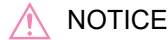

NOTICE

■ When the windshield is dry

Do not use the wipers, as they may damage the windshield.

Operating the wiper lever

Operating the  lever operates the wipers or washer as follows:

► Intermittent windshield wipers

When intermittent windshield wiper operation is selected, wiper interval can also be adjusted.

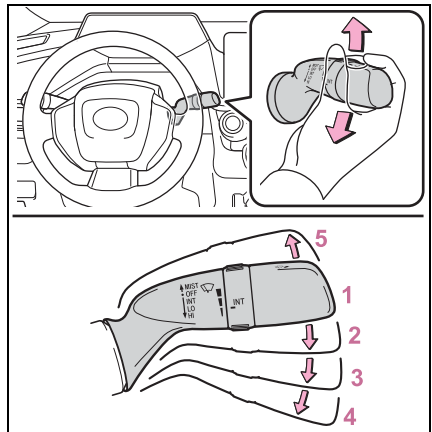

1 OFF
Off

2 INT**Intermittent operation**

The intermittent windshield wiper operates more frequently as vehicle speed becomes higher.

3 LO**Low speed operation****4 HI****High speed operation****5 MIST****Temporary operation**

Wiper intervals can be adjusted when intermittent operation is selected.

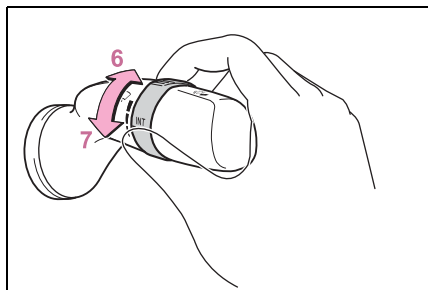

6 Increases the intermittent windshield wiper frequency

7 Decreases the intermittent windshield wiper frequency

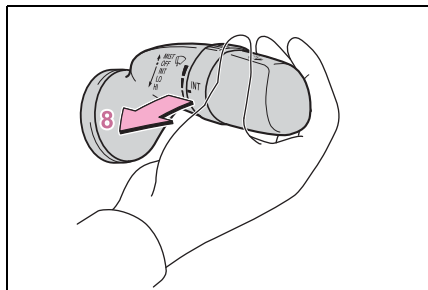

8  Windshield cleaning washer/wiper dual operation

Pulling the lever operates the wipers and washer.

The wipers will automatically operate a couple of times after the washer squirts. (After operating several times, the wipers operate once more time after a short delay to prevent dripping. However, the dripping prevention does not operate while the vehicle is moving.)

► **Rain-sensing windshield wipers**

When **AUTO** is selected, the wipers will operate automatically when the sensor detects falling rain. The system automatically adjusts wiper timing in accordance with rain volume and vehicle speed.

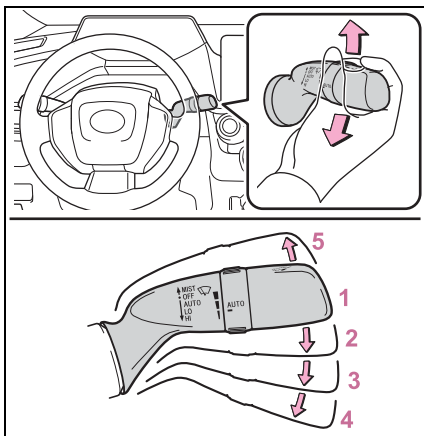

1 OFF *1 or ○ *2

Off

2 AUTO

Rain-sensing operation

3 LO *1 or ▼ *2

Low speed operation

4 HI *1 or ▼ *2

High speed operation

5 MIST *1 or Δ *2

Temporary operation

*1: For the U.S.A.

*2: For Canada

When AUTO is selected, the sensor sensitivity can be adjusted by turning the switch ring.

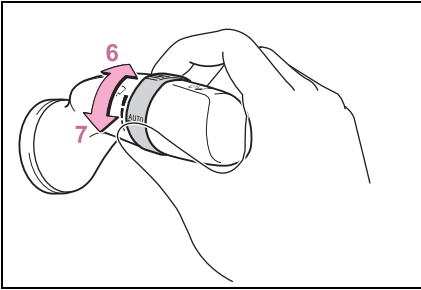

6 Increases the sensitivity

7 Decreases the sensitivity

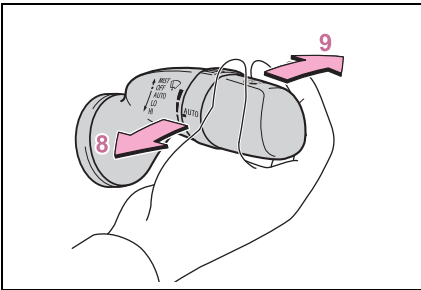

8  Windshield cleaning washer/wiper dual operation

Pulling the lever operates the wipers and windshield cleaning washer.

The wipers will automatically operate a couple of times after the washer squirts. (After operating several times, the wipers operate once more time after a short delay

to prevent dripping. However, the dripping prevention does not operate while the vehicle is moving.)

9  Camera cleaning washer operation (if equipped)

Pushing the lever operates the dedicated camera cleaning washer to clean the following cameras.

- The camera for Digital Rear-view Mirror (if equipped) (→P. 149)
- The camera for rear view monitor system * (if equipped)
- The rear camera for panoramic view monitor * (if equipped)

*: Refer to "MULTIMEDIA OWNER'S MANUAL".

■ **The windshield wiper and washer can be operated when**

The power switch is in ON.

■ **Using the voice control system (if equipped)**

The following operations can be performed using the voice control system:

- Operating the windshield wipers only once
- Operating the windshield cleaning washer (it can be performed only when the vehicle is stopped)

For details regarding the voice control system, refer to "MULTIMEDIA OWNER'S MANUAL".

■ **Effects of vehicle speed on wiper operation**

▶ Vehicles with intermittent windshield wipers

With low speed windshield wiper operation selected, wiper operation will be switched from low speed to intermittent wiper operation when the vehicle is stationary. (However,

when the wiper intervals are adjusted to the highest level, the mode will not switch.)

▶ Vehicles with rain-sensing windshield wipers

With low speed windshield wiper operation selected, wiper operation will be switched from low speed to intermittent wiper operation when the vehicle is stationary. (However, when the sensor sensitivity is adjusted to the highest level, the mode will not switch.)

■ **Raindrop sensor (vehicles with rain-sensing windshield wipers)**

- The raindrop sensor judges the amount of raindrops.

An optical sensor is adopted. It may not operate properly when sunlight from the rising or setting of the sun intermittently strikes the windshield, or if bugs, etc. are present on the windshield.

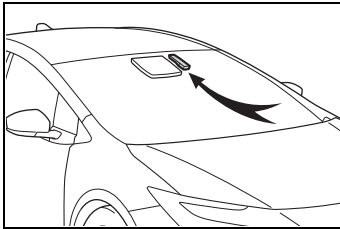

- If the wiper switch is turned to the AUTO position while the power switch is in ON, the wipers will operate once to show that "AUTO" mode is activated.
- When the sensor sensitivity ring is turned toward high while in the "AUTO" mode, the wipers will operate once to indicate that the sensor sensitivity is enhanced.
- If the temperature of the raindrop sensor is 185°F (85°C) or higher, or 5°F (-15°C) or lower, the auto-

matic operation may not occur. In this case, operate the wipers in any mode other than "AUTO".

■ **Front door opening linked windshield wiper stop function (vehicles with rain-sensing windshield wipers)**

When AUTO is selected and the windshield wipers are operating, if a front door is opened while the vehicle is stopped and the P position is selected, operation of the windshield wipers will be stopped to prevent anyone near the vehicle from being sprayed by water from the wipers. When the front door is closed, wiper operation will resume.

■ **If no windshield washer fluid sprays**

Check that the washer nozzles are not blocked if there is washer fluid in the windshield washer fluid reservoir.

⚠ WARNING

■ **Caution regarding the use of windshield wipers in "AUTO" mode (vehicles with rain-sensing windshield wipers)**

The windshield wipers may operate unexpectedly if the sensor is touched or the windshield is subject to vibration in "AUTO" mode. Take care that your fingers or anything else do not become caught in the windshield wipers.

■ **Caution regarding the use of windshield cleaning washer fluid**

When it is cold, do not use the washer fluid until the windshield becomes warm. The fluid may freeze on the windshield and cause low visibility. This may lead to an accident, resulting in death or serious injury.



NOTICE

■ When the washer fluid tank is empty

Do not operate the switch continually as the washer fluid pump may overheat.

■ When a nozzle becomes blocked

In this case, contact your Toyota dealer.

Do not try to clear it with a pin or other object. The nozzle will be damaged.

■ To prevent 12-volt battery discharge

Do not leave the wipers on longer than necessary when the hybrid system is off.

Opening the fuel tank cap

The fuel tank of your vehicle has a special structure, which requires a reduction in fuel tank pressure before refueling. After the opener switch has been pressed, it will take several seconds until the vehicle is ready for refueling.

Before refueling the vehicle

- Close all the doors and windows, and turn the power switch to OFF.
- Confirm the type of fuel.

■ Fuel types

→P.526

■ Fuel tank opening for unleaded gasoline

To help prevent incorrect fueling, your vehicle has a fuel tank opening that only accommodates the special nozzle on unleaded fuel pumps.



WARNING

■ When refueling the vehicle

Observe the following precautions while refueling the vehicle. Failure to do so may result in death or serious injury.

- After exiting the vehicle and before opening the fuel door, touch an unpainted metal surface to discharge any static electricity. It is important to discharge static electricity before refueling because sparks resulting from static electricity can cause fuel vapors to ignite while refueling.
- Always hold the grips on the fuel tank cap and turn it slowly to remove it. A whooshing sound may be heard when the fuel tank cap is loosened. Wait until the sound cannot be heard before fully removing the cap. In hot weather, pressurized fuel may spray out of the filler neck and cause injury.
- Do not allow anyone that has not discharged static electricity from their body to come close to an open fuel tank.
- Do not inhale vaporized fuel. Fuel contains substances that are harmful if inhaled.
- Do not smoke while refueling the vehicle. Doing so may cause the fuel to ignite and cause a fire.
- Do not return to the vehicle or touch any person or object that is statically charged. This may cause static electricity to build up, resulting in a possible ignition hazard.
- **When refueling**
Observe the following precautions to prevent fuel overflowing from the fuel tank:
 - Securely insert the fuel nozzle into the fuel filler neck.
 - Stop filling the tank after the fuel nozzle automatically clicks off.

**WARNING**

- Do not top off the fuel tank.

**NOTICE****Refueling**

- Finish refueling within 30 minutes. If more than 30 minutes passes, the internal valve closes. In this condition, fuel may overflow during the refueling process. Press the fuel filler door opener switch again.
- Make sure that the fuel filler door lock is not pushed by the fuel nozzle boot, etc. If the lock is held, the internal valve closes and fuel may overflow. To prevent it, press the fuel filler door opener switch again.

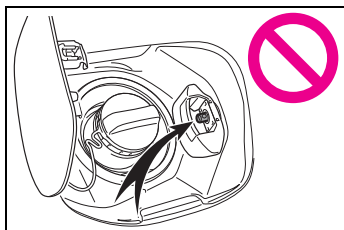

- Do not spill fuel during refueling. Doing so may damage the vehicle, such as causing the emission control system to operate abnormally or damaging fuel system components or the vehicle's painted surface.

Opening the fuel tank cap

- 1 Press the opener switch to open the fuel filler door.

The fuel filler door will open within about 10 seconds of the switch being pressed. Before refueling is possible, a message will be shown on the multi-information display in the instrument cluster to indicate

the progress of the fuel filler door opener.

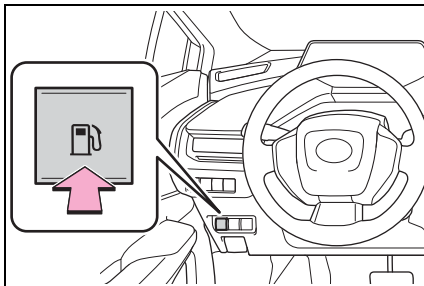

- 2 Turn the fuel tank cap slowly to open and hang it on the back of holder on the fuel filler door.

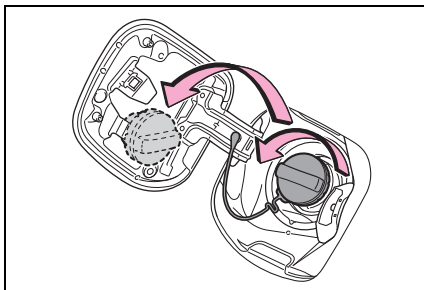
**■ If the fuel filler door cannot be opened**

Consult your Toyota dealer.

Closing the fuel tank cap

After refueling, turn the fuel tank cap until you hear a click. Once the cap is released, it will turn slightly in the opposite direction.

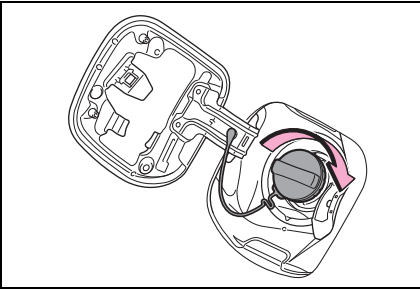

■ **When “Check Fuel Cap” is displayed on the multi-information display**

The fuel tank cap may be unfastened or loose. Turn the power switch to OFF, check the cap and tighten it securely. If the message remains, wait a few seconds and then turn the power switch to OFF once again.



WARNING

■ **When replacing the fuel tank cap**

Do not use anything but a genuine Toyota fuel tank cap designed for your vehicle. Doing so may cause a fire or other incident which may result in death or serious injury.

Toyota Safety Sense 3.0 software update

It is necessary to enter a connected services contract, provided by Toyota, to use these functions. For details, contact your Toyota dealer.



WARNING

■ For safe use

When the Toyota Safety Sense 3.0 software is updated, the operating methods of functions may change. Using this system without knowing the correct operating methods may lead to an accident resulting in death or serious injury.

- Make sure to read the Digital Owner's Manual which corresponds to the software version of the system, available at the Owner's Manual website, before using this system.

Content of the Toyota Safety Sense 3.0 Owner's Manual

This Owner's Manual contains information for Ver.2. For the latest information about the controls, use, warnings/precautions, etc. of each function of Toyota Safety Sense 3.0, refer to the Digital Owner's Manual at the Owner's Manual website.

If the software of this system has been updated after initial purchase of the vehicle, before

using this system, be sure to read the Owner's Manual which corresponds to the software version of the system.

■ Precautions for use

- Be aware that some functions may temporarily be disabled if a legal or safety related issue occurs.
- If a connected services contract has not been entered or has expired, software updates will not be able to be performed wirelessly.

Checking your vehicle's Toyota Safety Sense 3.0 version

If the software of this system has been updated after initial purchase of the vehicle, to access the appropriate Owner's Manual, it is necessary to check the software version of the system and then visit the Owner's Manual website.

■ Checking the version using OneApp

The software version of the system can be checked using OneApp.

■ Using your vehicle's Toyota Safety Sense 3.0 version

- 1 Access the following URL using a computer or smartphone:

► For U.S.A owners

<https://www.toyota.com/owners/resources/warranty-owners-manuals/manual?om=om47e41u.prius.2023.2212.hev.vh>



► For Canadian owners

<https://www.toyota.ca/toyota/owners/manual?om=om47e41u.prius.2023.2212.hev.vh>



- 2 Select the file which includes the previously checked system version.

Updating the software

If a software update is available, a notification will be displayed by OneApp. Follow the instructions displayed on the screen.

■ Software update precautions

- After a software update has been performed, it will not be possible to revert to a previous version.
- Depending on the communication

environment and the content of an update, a software update may take several hours. Although an update will be suspended when the power switch is turned off, it will resume when the power switch is changed back to ON mode.

- Toyota Safety Sense 3.0 can still be used while a software update is being performed.

■ What can be checked using the OneApp

The following items can be checked or performed.

- Software version, update details, precautions, use methods, etc.
- Software update

Toyota Safety Sense 3.0

The Toyota Safety Sense 3.0 consists of the driving assist systems and contributes to a safe and comfortable driving experience:

WARNING

■ Toyota Safety Sense 3.0

The Toyota Safety Sense 3.0 operates under the assumption that the driver will drive safely, and is designed to help reduce the impact to the occupants in a collision and assist the driver under normal driving conditions.

As there is a limit to the degree of recognition accuracy and control performance that this system can provide, do not overly rely on this system. The driver is solely responsible for paying attention to the vehicle's surroundings and driving safely.

■ For safe use

- Do not overly rely on this system. The driver is solely responsible for paying attention to the vehicle's surroundings and driving safely. This system may not operate in all situations and provided assistance is limited. Over-reliance on this system to drive the vehicle safely may lead to an accident resulting in death or serious injury.
- Do not attempt to test the operation of the system, as it may not operate properly, possibly leading to an accident.

- If attention is necessary while performing driving operations or a system malfunction occurs, a warning message or warning buzzer will be operated. If a warning message is displayed on the display, follow the instructions displayed.
- Depending on external noise, the volume of the audio system, etc. it may be difficult to hear the warning buzzer. Also, depending on the road conditions, it may be difficult to recognize the operation of the system.

■ When it is necessary to disable the system

In the following situations, make sure to disable the system.

Failure to do so may lead to the system not operating properly, possibly leading to an accident resulting in death or serious injury.

- When the vehicle is tilted due to being overloaded or having a flat tire
- When driving at extremely high speeds
- When towing another vehicle
- When the vehicle is being transported by a truck, ship, train, etc.
- When the vehicle is raised on a lift and the tires are allowed to rotate freely
- When inspecting the vehicle using a drum tester such as a chassis dynamometer or speedometer tester, or when using an on vehicle wheel balancer
- When the vehicle is driven in a sporty manner or off-road

**WARNING**

- When using an automatic car wash
- When a sensor is misaligned or deformed due to a strong impact being applied to the sensor or the area around the sensor
- When accessories which obstruct a sensor or light are temporarily installed to the vehicle
- When a compact spare tire or tire chains are installed to the vehicle or an emergency tire puncture repair kit has been used
- When the tires are excessively worn or the inflation pressure of the tires is low
- When tires other than the manufacturer specified size are installed
- When the vehicle cannot be driven stably, due to a collision, malfunction, etc.

Driving assist system

- **AHB (Automatic High Beam)**
→P.202
- **PCS (Pre-Collision System)**
→P.222
- **LTA (Lane Tracing Assist)**
→P.234
- **LDA (Lane Departure Alert)**
→P.242

- **LCA (Lane Change Assist)***
→P.239
- **FCTA (Front Cross Traffic Alert)***
→P.254
- **RSA (Road Sign Assist)***
→P.257
- **Dynamic radar cruise control**
→P.259
- **Cruise control**
→P.269
- **Emergency Driving Stop System***
→P.272

*: If equipped

Sensors used by Toyota Safety Sense 3.0

Various sensors are used to obtain the necessary information for system operation.

- **Sensors which detect the surrounding conditions**

- ▶ Front

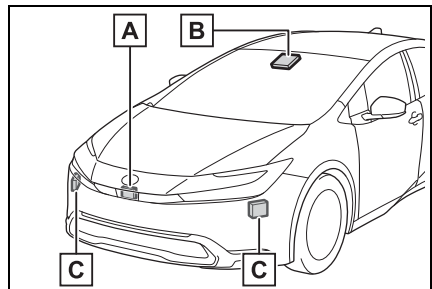

- A** Front radar sensor
- B** Front camera
- C** Front side radar sensors *

* : If equipped

▶ Rear

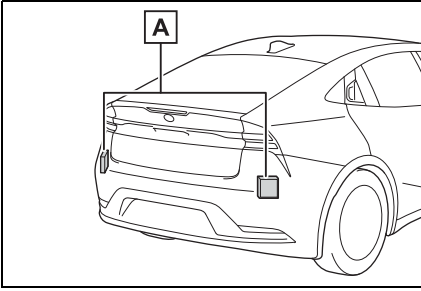

A Rear side radar sensors

⚠ WARNING

■ To prevent malfunction of the radar sensors

Observe the following precautions.

Failure to do so may lead to a radar sensor not operating properly, possibly leading to an accident resulting in death or serious injury.

- Keep the radar sensors and radar sensor covers clean at all times.

Clean the front of a radar sensor or the front or back of a radar sensor cover if it is dirty or covered with water droplets, snow, etc.

When cleaning the radar sensor and radar sensor cover, use a soft cloth to remove dirt so as to not damage them.

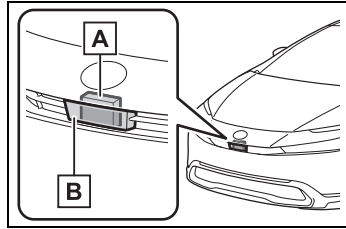

A Radar sensor

B Radar sensor cover

- Vehicles with front side radar sensors: Keep the surrounding area of the front side radar sensors on the front bumper clean at all times.

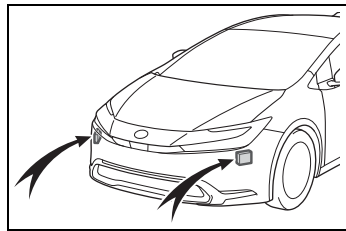

- Do not attach accessories, stickers (including transparent stickers), aluminum tape, etc. to a radar sensor or radar sensor cover and their surrounding area.

**WARNING**

- Do not subject a radar sensor or its surrounding area to impact.

If a radar sensor, the front grille, or front bumper has been subjected to an impact, have the vehicle inspected by your Toyota dealer.

- Do not disassemble the radar sensors.
- Do not modify or paint the radar sensors or radar sensor cover, or replace them with anything other than Toyota genuine parts.
- In the following situations, recalibration of the radar sensors will be necessary. For details, contact your Toyota dealer.
 - When a radar sensor is removed and installed, or replaced
 - When the front bumper or the front grille has been replaced

■ To prevent malfunction of the front camera

Observe the following precautions.

Failure to do so may lead to the front camera not operating properly, possibly leading to an accident resulting in death or serious injury.

- Always keep the windshield clean.
- If the windshield is dirty or covered with an oily film, water droplets, snow, etc., clean the windshield.

- Even if a glass coating agent is applied to the windshield, it will still be necessary to use the windshield wipers to remove water droplets, etc. from the area of the windshield in front of the front camera.
- If the inner side of the windshield where the front camera is installed is dirty, contact your Toyota dealer.
- Do not attach stickers (including transparent stickers) or other items to the area of the windshield in front of the front camera (shaded area in the illustration).

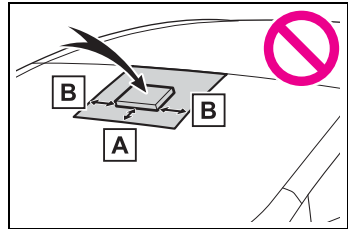

A Approximately 1.6 in. (4 cm)

B Approximately 1.6 in. (4 cm)

- If the part of the windshield in front of the front camera is fogged up or covered with condensation or ice, use the windshield defogger to remove the fog, condensation, or ice.
- If water droplets cannot be properly removed from the area of the windshield in front of the front camera by the windshield wipers, replace the wiper insert or wiper blade.
- Do not attach window tint to the windshield.

**WARNING**

- Replace the windshield if it is damaged or cracked.

If the windshield has been replaced, recalibration of the front camera will be necessary. For details, contact your Toyota dealer.

- Do not allow liquids to contact the front camera.
- Do not allow bright lights to shine into the front camera.
- Do not damage the lens of the front camera or allow it to become dirty.

When cleaning the inside of the windshield, do not allow glass cleaner to contact the lens of the front camera. Do not touch the lens of the front camera.

If the lens of the front camera is dirty or damaged, contact your Toyota dealer.

- Do not subject the front camera to a strong impact.
- Do not change the position or orientation of the front camera or remove it.
- Do not disassemble the front camera.
- Do not modify any parts around the front camera, such as the inside rear view mirror or ceiling.
- Do not attach accessories which may obstruct the front camera to the hood, front grille, or front bumper. For details, contact your Toyota dealer.

- If a surfboard or other long object is to be mounted on the roof, make sure that it will not obstruct the front camera.

- Do not modify or change the headlights and other lights.

■ Front camera installation area on the windshield

If the system determines that the windshield may be fogged up, it will automatically operate the heater to defog the part of the windshield around the front camera. When cleaning, etc., be careful not to touch the area around the front camera until the windshield has cooled sufficiently, as touching it may cause burns.

■ Precautions for use

Vehicles with a display audio: It is necessary to enter a connected services contract, provided by Toyota, to use these functions. For details, contact your Toyota dealer.

- LCA (Lane Change Assist)

→P.239

■ Situations in which the sensors may not operate properly

- When the height or inclination of the vehicle has been changed due to modifications
- When the windshield is dirty, fogged up, cracked or damaged
- When the ambient temperature is high or low
- When mud, water, snow, dead insects, foreign matter, etc., is attached to the front of the sensor
- When in inclement weather such as heavy rain, fog, snow, or a sandstorm
- When water, snow, dust, etc. is thrown up in front of the vehicle, or when driving through mist or smoke

- When the headlights are not illuminated while driving in the dark, such as at night or when in a tunnel
- When the lens of a headlight is dirty and illumination is weak
- When the headlights are misaligned
- When a headlight is malfunctioning
- When the headlights of another vehicle, sunlight, or reflected light shines directly into the front camera
- When the brightness of the surrounding area changes suddenly
- When driving near a TV tower, broadcasting station, electric power plant, radar equipped vehicles, etc., or other location where strong radio waves or electrical noise may be present
- When a wiper blade is blocking the front camera
- When in a location or near objects which strongly reflect radio waves, such as the following:
 - Tunnels
 - Truss bridges
 - Gravel roads
 - Rutted, snow-covered roads
 - Walls
 - Large trucks
 - Manhole covers
 - Guardrail
 - Metal plates
- When near a step or protrusion
- When a detectable vehicle is narrow, such as a small mobility vehicle
- When a detectable vehicle has a small front or rear end, such as an unloaded truck
- When a detectable vehicle has a low front or rear end, such as a low bed trailer

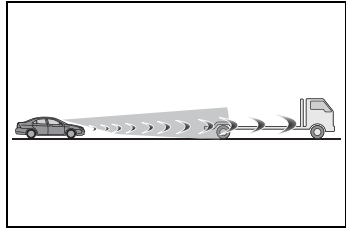

- When a detectable vehicle has extremely high ground clearance

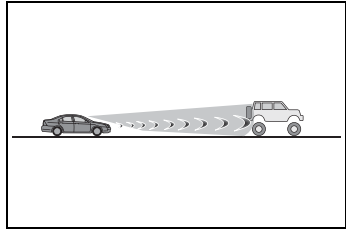

- When a detectable vehicle is carrying a load which protrudes from its cargo area
- When a detectable vehicle has little exposed metal, such as a vehicle which is partially covered with cloth, etc.
- When a detectable vehicle is irregularly shaped, such as a tractor, sidecar, etc.
- When the distance between the vehicle and a detectable vehicle has become extremely short
- When a detectable vehicle is at an angle
- When snow, mud, etc. is attached to a detectable vehicle
- When driving on the following kinds of roads:
 - Roads with sharp curves or winding roads
 - Roads with changes in grade, such as sudden inclines or declines
 - Roads which is sloped to the left or right
 - Roads with deep ruts
 - Roads which are rough and unmaintained
 - Roads which frequently undulate or are bumpy

- When the steering wheel is being operated frequently or suddenly
- When the vehicle is not in a constant position within a lane
- When parts related to this system, the brakes, etc. are cold or extremely hot, wet, etc.
- When the wheels are misaligned
- When driving on slick road surfaces, such as when it is covered with ice, snow, gravel, etc.
- When the course of the vehicle differs from the shape of a curve
- When the vehicle speed is excessively high when entering a curve
- When entering/exiting a parking lot, garage, car elevator, etc.
- When driving in a parking lot
- When driving through an area where there are obstructions which may contact your vehicle, such as tall grass, tree branches, a curtain, etc.
- When driving in strong wind

■ **Situations in which the lane may not be detected**

- When the lane is extremely wide or narrow
- Immediately after changing lanes or passing through an intersection
- When driving in a temporary lane or lane regulated by construction
- When there are structures, patterns, shadows which are similar to lane lines in the surrounding
- When there are multiple white lines for a lane line
- When the lane lines are not clear or driving on a wet road surface
- When a lane line is on a curb
- When driving on a bright, reflective road surface, such as concrete

■ **Situations in which some or all of the functions of the system cannot operate**

- When a malfunction is detected in this system or a related system, such as the brakes, steering, etc.
- When the VSC, TRAC, or other safety related system is operating
- When the VSC, TRAC, or other safety related system is off

■ **Changes in brake operation sound and pedal response**

- When the brakes have been operated, brake operation sounds may be heard and the brake pedal response may change, but this does not indicate a malfunction.
- When the system is operating, the brake pedal may feel stiffer than expected or sink. In either situation the brake pedal can be depressed further. Further depress the brake pedal as necessary.

PCS (Pre-Collision System)

The pre-collision system uses sensors to detect objects (→P.222) in the path of the vehicle. When the system determines that the possibility of a frontal collision with a detectable object is high, a warning operates to urge the driver to take evasive action and the potential brake pressure is increased to help the driver avoid the collision. If the system determines that the possibility of a collision is extremely high, the brakes are automatically applied to help avoid the collision or help reduce the impact of the collision.

The pre-collision system can be disabled/enabled and the warning timing can be changed. (→P.233)



WARNING

■ For safe use

- Driving safely is solely the responsibility of the driver. Pay careful attention to the surrounding conditions in order to ensure safe driving.

Never use the pre-collision system in place of normal braking operations. This system cannot help avoid or reduce the impact of a collision in every situation. Over-reliance on this system to drive the vehicle safely may lead to an accident resulting in death or serious injury.

- Although the pre-collision system is designed to help avoid or help reduce the impact of a collision, its effectiveness may change according to various conditions. Therefore, it may not always be able to achieve the same level of performance.

Read the following items carefully. Do not overly rely on this system and always drive carefully.

- For safe use: →P.215

■ When to disable the pre-collision system

- When it is necessary to disable the system: →P.215

Detectable objects

The system can detect the following as detectable objects. (Detectable objects differ depending on the function.)

- Vehicles
- Bicycles*

- Pedestrians
- Motorcycles*
- Walls

*: Detected as a detectable object only when being ridden.

System functions

■ Pre-collision warning

When the system determines that the possibility of a collision is high, a buzzer will sound and an icon and warning message will be displayed on the multi-information display to urge the driver to take evasive action.

If the detectable object is a vehicle, moderate braking will be performed with the warning.

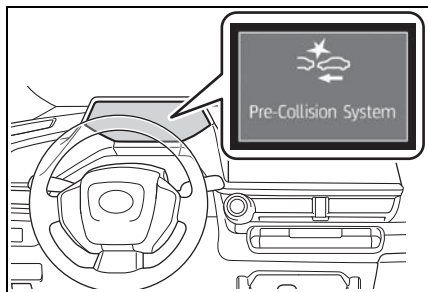

If the system determines that the accelerator pedal is strongly depressed, the following icon and message will be displayed on the multi-information display.

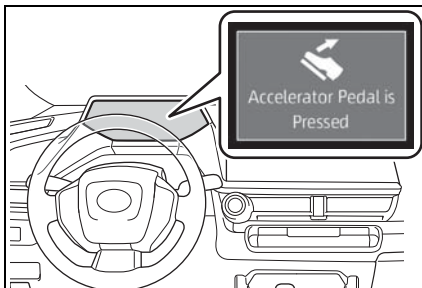

■ Pre-collision brake assist

If the system determines that the possibility of a collision is high and the brake operation by the driver is insufficient, the braking power will be increased.

■ Pre-collision brake control

If the system determines that the possibility of a collision is extremely high, the brakes are automatically applied to help avoid the collision or reduce the impact of the collision.

■ Emergency steering assist

If the system determines that the following conditions are met, assistance will be provided to help enhance vehicle stability and prevent lane departure. During assistance, in addition to the pre-collision warning, the following icon will be displayed on the multi-information display.

- The possibility of a collision is high
- There is sufficient space within the lane to perform evasive steering maneuvers
- The driver is operating the

steering wheel

Vehicles with active steering function: The brakes and steering are controlled to help avoid a collision or reduce the impact of a collision, regardless of the evasive steering maneuvers performed by the driver.

During assistance, the pre-collision warning will operate and a message will be displayed to warn the driver.

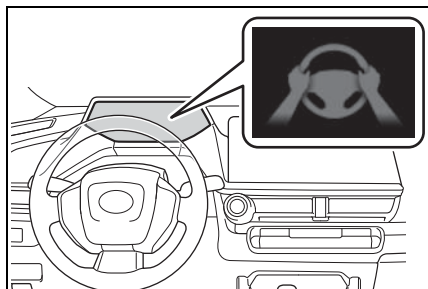

■ **Intersection collision avoidance support (left/right turn)**

In situations such as the following, if the system determines that the possibility of a collision is high, the pre-collision warning and pre-collision braking will operate.

Depending on the intersection, assistance may not operate correctly.

- When turning left/right at an intersection and crossing the path of an oncoming vehicle

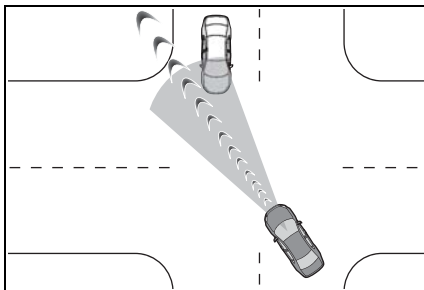

- When turning left/right and a pedestrian or bicycle is detected

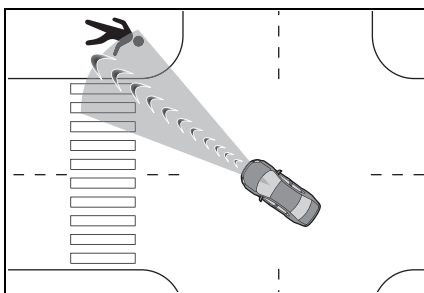

■ **Intersection collision avoidance support (crossing vehicles)**

At an intersection, etc., if the system determines that the possibility of a collision with an approaching vehicle or motorcycle is high, the pre-collision warning and pre-collision braking will operate.

Depending on the intersection, assistance may not operate correctly.

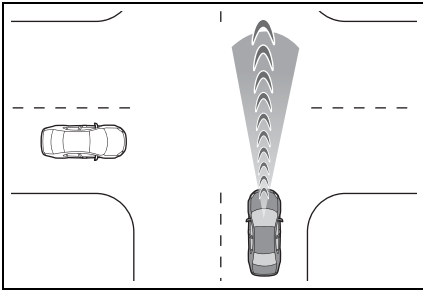

■ Acceleration Suppression at Low Speed

When driving at a low speed, if the accelerator pedal is strongly depressed and the system determines that there is a possibility of a collision, hybrid system output will be restrained or the brakes will be applied weakly to restrict acceleration. During operation, a buzzer will sound and the following icon and message will be displayed on the multi-information display.

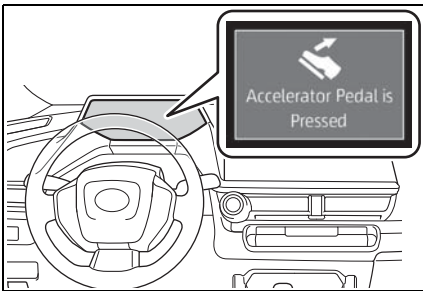

⚠ WARNING

■ Pre-collision braking

- When the pre-collision braking function is operating, a large amount of braking force will be applied.

- The pre-collision braking function is not designed to hold the vehicle stopped. If the vehicle is stopped by pre-collision brake control, the driver should operate the brakes immediately as necessary.

- The pre-collision braking function may not operate if certain operations are performed by the driver. If the accelerator pedal is being depressed strongly or the steering wheel is being turned, the system may determine that the driver is taking evasive action and possibly prevent the pre-collision braking function from operating.

- If the brake pedal is being depressed, the system may determine that the driver is taking evasive action and possibly delay the operation timing of the pre-collision brake control.

■ Acceleration Suppression at Low Speed

If the steering wheel is being turned, the system may determine that the driver is taking evasive action and possibly prevent the Acceleration Suppression at Low Speed function from operating or possibly causing its operation to be canceled.

■ Emergency steering assist

- The emergency steering assist will be canceled when the system determines that lane departure prevention control has completed.
- Depending on operations performed by the driver, emergency steering assist may not operate or operation may be canceled.

**WARNING**

- If the accelerator pedal is depressed strongly, the steering wheel is turned heavily, the brake pedal is depressed, or the turn signal lever is operated, the system may determine that the driver is taking evasive action and the emergency steering assist may not operate.
- While the emergency steering assist is operating, if the accelerator pedal is depressed strongly, the steering wheel is turned heavily, or the brake pedal is depressed, the system may determine that the driver is taking evasive action and emergency steering assist operation may be canceled.
- While the emergency steering assist is operating, if the steering wheel is held or turned in the opposite direction of system operation, emergency steering assist operation will be canceled.

■ Operating conditions of each function of the pre-collision system

The pre-collision system is enabled and the system determines that the possibility of a frontal collision with a detected object is high.

However, the system will not operate in the following situations:

- When the vehicle has not been driven a certain amount after a terminal of the 12-volt battery has been disconnected and reconnected
- When the shift position is in R
- When the VSC OFF indicator is illuminated (only the pre-collision warning function will be operational)

The following are the operational speeds and cancelation conditions of each function:

● Pre-collision warning

Detectable objects	Vehicle speed	Relative speed between your vehicle and object
Preceding vehicles, stopped vehicles	Approximately 3 to 110 mph (5 to 180 km/h)	Approximately 3 to 110 mph (5 to 180 km/h)
Oncoming vehicles	Approximately 20 to 110 mph (30 to 180 km/h)	Approximately 50 to 130 mph (80 to 220 km/h)
Bicycles	Approximately 3 to 50 mph (5 to 80 km/h)	Approximately 3 to 50 mph (5 to 80 km/h)
Pedestrians	Approximately 3 to 50 mph (5 to 80 km/h)	Approximately 3 to 50 mph (5 to 80 km/h)
Preceding motorcycles, stopped motorcycles	Approximately 3 to 110 mph (5 to 180 km/h)	Approximately 3 to 50 mph (5 to 80 km/h)
Oncoming motorcycles	Approximately 20 to 110 mph (30 to 180 km/h)	Approximately 20 to 110 mph (30 to 180 km/h)

While the pre-collision warning is operating, if the steering wheel is operated heavily or suddenly, the pre-collision warning may be cancelled.

● Pre-collision brake assist

Detectable objects	Vehicle speed	Relative speed between your vehicle and object
Preceding vehicles, stopped vehicles	Approximately 20 to 110 mph (30 to 180 km/h)	Approximately 7 to 110 mph (10 to 180 km/h)
Bicycles	Approximately 20 to 50 mph (30 to 80 km/h)	Approximately 20 to 50 mph (30 to 80 km/h)
Pedestrians	Approximately 20 to 50 mph (30 to 80 km/h)	Approximately 20 to 50 mph (30 to 80 km/h)
Preceding motorcycles, stopped motorcycles	Approximately 20 to 110 mph (30 to 180 km/h)	Approximately 7 to 50 mph (10 to 80 km/h)

● Pre-collision braking

Detectable objects	Vehicle speed	Relative speed between your vehicle and object
Preceding vehicles, stopped vehicles	Approximately 3 to 110 mph (5 to 180 km/h)	Approximately 3 to 110 mph (5 to 180 km/h)
Oncoming vehicles	Approximately 20 to 110 mph (30 to 180 km/h)	Approximately 50 to 130 mph (80 to 220 km/h)

Detectable objects	Vehicle speed	Relative speed between your vehicle and object
Bicycles	Approximately 3 to 50 mph (5 to 80 km/h)	Approximately 3 to 50 mph (5 to 80 km/h)
Pedestrians	Approximately 3 to 50 mph (5 to 80 km/h)	Approximately 3 to 50 mph (5 to 80 km/h)
Preceding motorcycles, stopped motorcycles	Approximately 3 to 110 mph (5 to 180 km/h)	Approximately 3 to 50 mph (5 to 80 km/h)
Oncoming motorcycles	Approximately 20 to 110 mph (30 to 180 km/h)	Approximately 20 to 110 mph (30 to 180 km/h)

If either of the following occur while the pre-collision braking function is operating, it will be canceled:

- The accelerator pedal is strongly depressed
- The steering wheel is operated heavily or suddenly
- Emergency steering assist

The emergency steering assist will not operate when the turn signal lights are flashing.

Detectable objects	Vehicle speed	Relative speed between your vehicle and object
Preceding vehicles, stopped vehicles, bicycles, pedestrians, motorcycles	Approximately 25 to 50 mph (40 to 80 km/h)	Approximately 25 to 50 mph (40 to 80 km/h)
Preceding vehicles, stopped vehicles, bicycles, pedestrians, motorcycles	Active steering function (if equipped): * to 50 mph (* to 80 km/h)	Active steering function (if equipped): * to 50 mph (* to 80 km/h)

*: Minimum vehicle speed: Vehicle speed at which evasion using pre-collision brake control is difficult

While the emergency steering assist is operating, if any of the following are performed, emergency steering assist operation may be cancelled:

- The accelerator pedal is strongly depressed
- The steering wheel is operated heavily or suddenly
- The brake pedal is depressed
- Intersection collision avoidance support (left/right turn)

The intersection collision avoidance support (for left/right turning vehicles) will not operate when the turn signal lights are not flashing.

Detectable objects	Vehicle speed	Oncoming vehicle speed	Relative speed between your vehicle and object
Oncoming vehicles	Approximately 3 to 25 mph (5 to 40 km/h)	Approximately 3 to 45 mph (5 to 75 km/h)	Approximately 7 to 70 mph (10 to 115 km/h)
Pedestrians	Approximately 3 to 20 mph (5 to 30 km/h)	-	Approximately 3 to 25 mph (5 to 40 km/h)
Bicycles	Approximately 3 to 20 mph (5 to 30 km/h)	-	Approximately 3 to 30 mph (5 to 50 km/h)
Oncoming motorcycles	Approximately 3 to 25 mph (5 to 40 km/h)	Approximately 3 to 45 mph (5 to 75 km/h)	Approximately 7 to 70 mph (10 to 115 km/h)

● Intersection collision avoidance support (crossing vehicles)

▶ Vehicles without front side radars

Detectable objects	Vehicle speed	Crossing vehicle speed	Relative speed between your vehicle and object
Vehicles, Motorcycles (side)	Approximately 3 to 38 mph (5 to 60 km/h)	<ul style="list-style-type: none"> • Your vehicle speed or less • Approximately 25 mph or less (40 km/h or less) 	Approximately 3 to 38 mph (5 to 60 km/h)

▶ Vehicles with front side radars

Detectable objects	Vehicle speed	Crossing vehicle speed	Relative speed between your vehicle and object
Vehicles, Motorcycles (side)	Approximately 3 to 38 mph (5 to 60 km/h)	Approximately 31 mph or less (50 km/h or less)	Approximately 3 to 38 mph (5 to 60 km/h)

When driving at approximately 29 mph (40 km/h) or more, this system will only operate when the speed of the other vehicle is approximately 29 mph (40 km/h) or less.

The system operates only when the crossing vehicle speed is same as or less than the vehicle speed.

● Acceleration Suppression at Low Speed

The Acceleration Suppression at Low Speed function will not operate when the turn signal lights are flashing.

Detectable objects	Vehicle speed	Relative speed between your vehicle and object
Preceding vehicles, stopped vehicles, Pedestrians, Bicycles, Wall	Approximately 0 to 9 mph (0 to 15 km/h)	Approximately 0 to 9 mph (0 to 15 km/h)

While the Acceleration Suppression at Low Speed function is operating, if any of the following are performed, the low speed sudden acceleration suppression function operation will be cancelled:

- The accelerator pedal is released.
- The steering wheel is operated heavily or suddenly

■ Detection of detectable objects

Objects are detected based on their size, shape, and movement.

Depending on the ambient brightness, movement, posture and direction of a detectable object, it may not be detected and the system may not operate properly.

The system detects shapes, such as the following, as detectable objects.

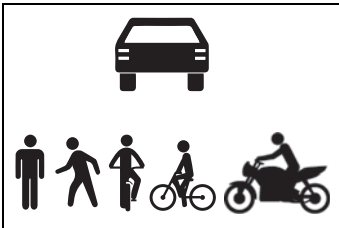

■ Situations in which the system may operate even though the possibility of a collision is not high

- In certain situations, such as the following, the system may determine that the possibility of a collision is high and operate:
 - When passing a detectable object
 - When changing lanes while overtaking a detectable object
 - When suddenly approaching a

detectable object

- When approaching a detectable object or other object on the roadside, such as guardrails, utility poles, trees, walls, etc.
- When there is a detectable object or other object by the roadside at the entrance of a curve

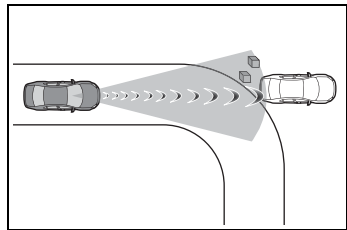

- When there are patterns or a painting ahead of the vehicle that may be mistaken for a detectable object
- When passing a detectable object that is changing lanes or turning left/right

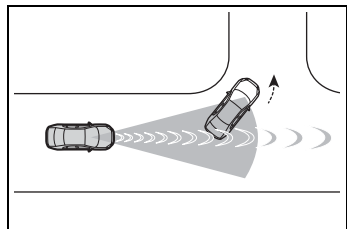

- When passing a detectable object which is stopped to make a left/right turn

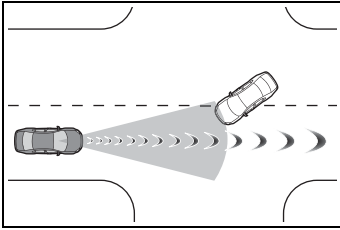

- When a detectable object stops immediately before entering the path of the vehicle
- When passing through a location with a structure above the road (traffic sign, billboard, etc.)

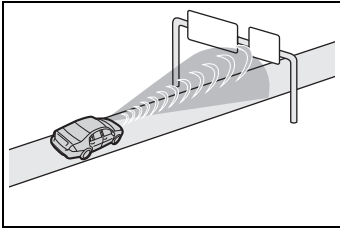

- When approaching an electric toll gate barrier, parking lot barrier, or other barrier that opens and closes
- When turning left/right and an oncoming vehicle, oncoming motorcycle, pedestrian or bicycle crosses in front of the vehicle
- When attempting to turn left/right in front of an oncoming vehicle, oncoming motorcycle, pedestrian or bicycle
- When turning left/right and an oncoming vehicle, oncoming motorcycle, pedestrian or bicycle stops or changes course immediately before entering the path of the vehicle
- When turning left/right and an oncoming vehicle turns left/right in front of the vehicle

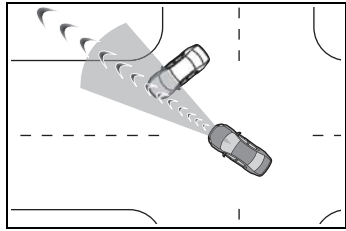

- When the steering wheel is operated toward the path of an oncoming vehicle
- When there is an object moving above or under the road

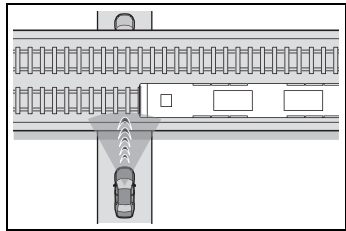

■ Situations in which the system may not operate properly

- In certain situations, such as the following, a detectable object may not be detected by the front sensors, and the system may not operate properly:
 - When a detectable object is approaching your vehicle
 - When your vehicle or a detectable object is wandering
 - When a detectable object makes an abrupt maneuver (such as sudden swerving, acceleration or deceleration)
 - When suddenly approaching a detectable object
 - When the detectable object is near a wall, fence, guardrail, manhole cover, steel plate on the road surface, or another vehicle
 - When there is a structure above a detectable object
 - When part of a detectable object is hidden by another object (large luggage, umbrella, guardrail, etc.)
 - When multiple detectable objects are overlapping
 - When a bright light, such as the sun, is reflecting off of a detect-

able object

- When a detectable object is white and looks extremely bright
- When the color or brightness of a detectable object causes it to blend in with its surroundings
- When a detectable object cuts in front of or suddenly emerges in front of your vehicle
- When approaching a vehicle which is diagonal
- If a bicycle is a child sized bicycle, is carrying a large load, is carrying an extra passenger, is carrying a forward leaning rider, or has an unusual shape (bicycles equipped with a child seat, tandem bicycles, etc.)
- If a pedestrian or bicycle is shorter than approximately 3.2 ft. (1 m) or taller than approximately 6.5 ft. (2 m).
- When the silhouette of a pedestrian or bicycle is unclear (such as when they are wearing a raincoat, long skirt, etc.)
- When a pedestrian is bending forward or squatting
- When a pedestrian or bicycle is moving at high speed
- When a pedestrian is pushing a stroller, wheelchair, bicycle or other vehicle
- When a detectable object blends in with the surrounding area, such as when it is dim (at dawn or dusk) or dark (at night or in a tunnel)
- When the vehicle has not been driven for a certain amount of time after the hybrid system was started
- While turning left/right or a few seconds after turning left/right
- While driving around a curve and a few seconds after driving around a curve
- When turning left/right and an oncoming vehicle is driving in a lane 3 or more lanes from the vehicle
- When turning left/right and the direction of the vehicle differs greatly from the direction traffic flows in the oncoming lane

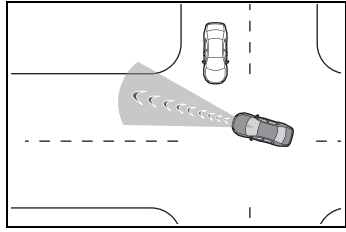

- When turning left/right, a pedestrian or bicycle behind the vehicle comes in front of it as if it overtakes the vehicle

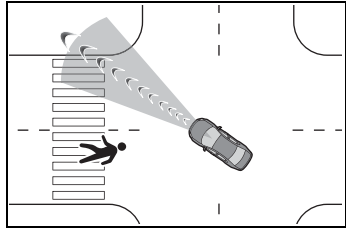

- When at an intersection, the approaching crossing vehicle is long in overall length, such as a large truck, towing trailer, etc.
- In addition to the preceding, in certain situations, such as the following, the emergency steering assist may not operate properly:
 - When a detectable object is too close to the vehicle
 - When there is insufficient space to perform evasive steering maneuvers or an obstruction exists in the evasion direction
 - When there is an oncoming vehicle
- In addition to the preceding, in certain situations, such as the following, walls may not be detected as a target object and the Acceleration Suppression at Low Speed function may not operate properly:
 - When scenery behind the wall is visible, such as a glass door, grid fence, etc.
 - When the wall is slanted or low
 - When the wall is narrow, such as a pole, etc.
 - When the wall is made of plants, such as a hedge, etc.

- When the road, etc. is reflected on the wall
- When the vehicle is approaching the wall at an angle

Changing the pre-collision setting

- The pre-collision system can be enabled/disabled through a customize setting. (→P.545)

The system is enabled each time the power switch is turned to ON.

- When the system is disabled, the PCS warning light will illuminate and a message will be displayed on the multi-information display.
- The pre-collision setting can be changed on the customize settings. (→P.545)
- Vehicles without active steering function: When the pre-collision warning timing is changed, the emergency steering assist timing will also be changed.

When later is selected, the emergency steering assist will not operate in most cases.

- Vehicles with active steering function: When the pre-collision warning timing is changed, the emergency steering assist (excluding the active steering function) timing will also be changed.

When later is selected, the

emergency steering assist (excluding the active steering function) will not operate in most cases.

- When the dynamic radar cruise control is operating, the pre-collision warning will operate at the earlier timing, regardless of the user setting.

LTA (Lane Tracing Assist)

LTA functions

- When driving on a road with clear lane lines with the dynamic radar cruise control operating, lane lines and preceding and surrounding vehicles are detected using the front camera and radar sensor, and the steering wheel is operated to maintain the vehicle's lane position.

Use this function only on highways and expressways.

If the dynamic radar cruise control is not operating, the function will not operate.

In situations where the lane lines are difficult to see or are not visible, such as when in a traffic jam, support will be provided using the path of preceding and surrounding vehicles.

If the system determines that the steering wheel has not been operated for a certain amount of time or the steering wheel is not being firmly gripped, the driver will be alerted and this function will be temporarily canceled.

If the steering wheel is firmly gripped, the function will begin operating again.

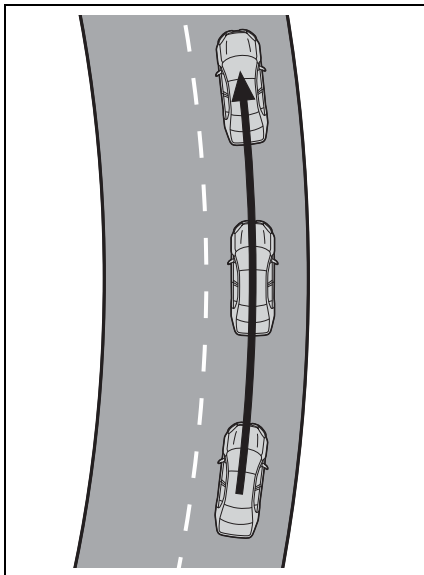

- When the function is operating, if the vehicle is likely to depart from its lane, the driver will be alerted via a display and buzzer.

When the buzzer sounds, check the area around the vehicle and carefully operate the steering wheel to move the vehicle back to the center of the lane.

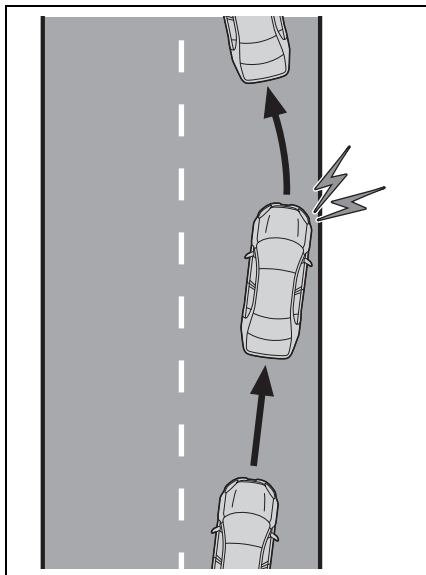

⚠ WARNING

■ Before using the LTA system

- Do not overly rely on the LTA system. The LTA system is not a system which provides automated assistance in driving and it is not a system which reduces the amount of attention necessary for safe driving. The driver is solely responsible for paying attention to their surroundings and operating the steering wheel as necessary to ensure safety. Also, the driver is responsible for taking adequate breaks when fatigued, such as when driving for a long time.
- Failure to perform appropriate driving operations and pay careful attention may lead to an accident.
- When not using the LTA system, turn it off using the LTA switch.

■ Operating conditions of function

This function is operable when all of the following conditions are met:

- The LTA system detects lane lines or the path of preceding or surrounding vehicles.
- The dynamic radar cruise control is operating.
- The lane width is approximately 10 to 13 ft. (3 to 4 m).
- The turn signal lever is not being operated.
- The vehicle is not being driven around a sharp curve.
- The vehicle is not accelerating or decelerating more than a certain amount.
- The steering wheel is not being turned with a large force.
- The hands off steering wheel warning (→P.236) is not operating.
- The vehicle is being driven in the center of a lane.

■ Temporary cancelation of functions

- When the operating conditions are no longer met, a function may be temporarily canceled. However, when the operation conditions are met again, operation of the function will automatically be restored. (→P.235)
- If the operating conditions of a function are no longer met while the function is operating, a buzzer may sound to indicate that the function has been temporarily canceled.
- The steering assist operation of the function can be overridden by the steering wheel operation of the driver.

■ Lane departure warning function when the LTA is operating

- Even if the LDA warning method is changed to vibration of the steering wheel, if the vehicle deviates from the lane while the LTA is operating, the warning buzzer will sound to alert the driver.
- If steering wheel operation equivalent to that necessary for a lane change is detected, the system will determine the vehicle is not deviating from the lane and the warning will not operate.

■ Hands off steering wheel warning operation

- When the system determines the driver is not holding the steering wheel, a message urging the driver to grip the steering wheel and the icon shown in the illustration will be displayed on the multi-information display to warn the driver. If the system detects that the steering wheel is held, the warning will be canceled. When using the system, make sure to grip the steering wheel firmly, regardless of whether the warning is operating or not.



- If no operations are detected for a certain amount of time, the warning will operate and the function will be temporarily canceled. This warning may also operate if the driver only operates steering wheel a small amount continuously.
- Situations in which the hands off steering wheel warning may not operate properly
- Depending on the condition of the

vehicle, handle control condition and road surface, the warning function may not operate.

- Vehicles with LCA: In the following situations, the system may not be able to detect when the driver's hands are off the steering wheel.
 - When a steering wheel cover is installed
 - When the driver is wearing gloves
 - When foreign matter is attached to the steering wheel
 - When the driver is gripping the wood trim, seam of the leather, spokes, or other part of the steering wheel that does not have sensors
- Vehicles with LCA: In the following situations, the hands off steering wheel warning may not operate and the LTA function may continue operating even though the driver's hands are off the steering wheel:
 - When something other than a hand is contacting the steering wheel
 - When a wide object or arms are held across the steering wheel

Enabling/disabling the system

The LTA will change between ON/OFF each time the LTA switch is pressed.

When the LTA is ON, the LTA indicator will illuminate.

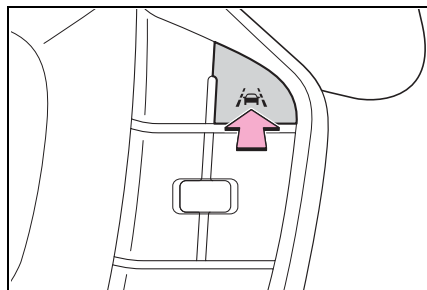

**WARNING**

Situations in which the functions may not operate properly

In the following situations, the functions may not operate properly and the vehicle may depart from its lane. Do not overly rely on these functions. The driver is solely responsible for paying attention to their surroundings and operating the steering wheel as necessary to ensure safety.

- When a preceding or surrounding vehicle changes lanes (Your vehicle may follow the preceding or surrounding vehicle and also change lanes)

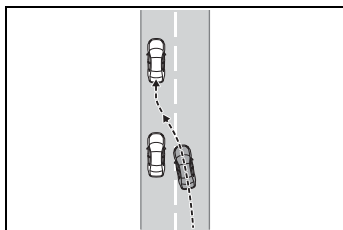









- When a preceding or surrounding vehicle is swaying (Your vehicle may sway accordingly and depart from the lane)

- When a preceding or surrounding vehicle departs from a lane (Your vehicle may follow the preceding or surrounding vehicle and also depart from the lane)
- When a preceding or surrounding vehicle is being driven extremely close to the left/right lane line (Your vehicle may follow the preceding or surrounding vehicle accordingly and depart from the lane)
- When there are moving objects or structures in the surrounding area (Depending on the position of the moving object or structure relative to your vehicle, your vehicle may sway)
- When the vehicle is struck by a crosswind or the turbulence of other nearby vehicles
- Situations in which the sensors may not operate properly: →P.219
- Situations in which the lane may not be detected: →P.221
- When it is necessary to disable the system: →P.215

Operation display of steering wheel operation support

The operating state of the LTA system is indicated.

Indicator	Lane display	Steering icon	Situation
 White	 Gray/White	 Gray	LTA is on standby
 Green	 Green	 Green	LTA is operating
 Orange Flashing	 Orange Flashing	 Green	The vehicle is departing the lane toward the side which the lane display is flashing

LCA (Lane Change Assist)*

*: If equipped

LCA functions

This function is linked to the LTA and provides assistance in performing lane changes through steering wheel operations.

Use this function only on highways and expressways.

The steering assist operation can be overridden by the steering wheel operation of the driver.

The lane change assist function is not designed to operate when changing lanes at a junction.

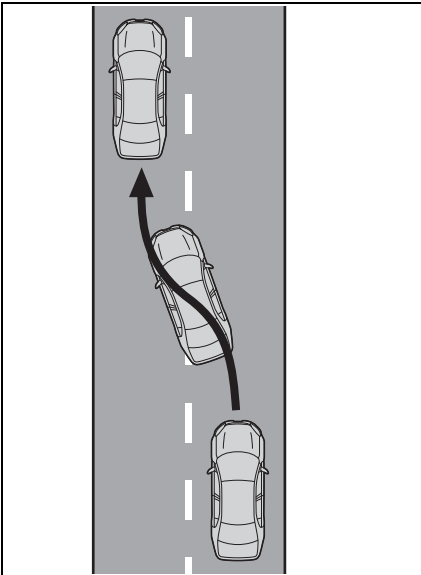

⚠ WARNING

■ Before using the LCA system

● Do not overly rely on the LCA system.

The LCA system is not a system which provides automated assistance in driving and it is not a system which reduces the need for checking an adjacent lane for other vehicles, approaching vehicles, etc. when changing lanes. The driver is solely responsible for paying attention to their surroundings and operating the steering wheel as necessary to ensure safety.

Also, do not use the LCA to change lanes into which a lane change should not be performed (oncoming lanes, road shoulders, etc.).

● Failure to perform appropriate driving operations and pay careful attention may lead to an accident.

■ Operating conditions of function

This function is operable when all of the following conditions are met:

- The LTA is operating.
- The lane change assist function is enabled by a customize setting.
- The vehicle speed is between approximately 55 and 85 mph (90 and 140 km/h).
- The system detects a broken white line on the side which the lane change is to be performed.
- A vehicle is not detected in the lane toward which the turn signal is operated.
- The steering wheel is not being turned with a large force.

- The hands off steering wheel warning (→P.236) is not operating.

■ Cancellation of functions

In the following situations, operation of the LCA may be canceled with the display and buzzer:

- When the operating conditions (→P.235) are no longer met
- When the system can no longer detect lane lines
- When the turn signal lever is operated to the second position (→P.240)
- When the turn signal lever is operated in the opposite direction of the lane change
- When the system detects operation of the steering wheel, brake pedal or accelerator pedal by the driver

If the system detects that a vehicle is quickly approaching in the lane toward which the turn signal is operated a buzzer will sound and a message will be displayed to alert the driver. At the same time the steering wheel may be slightly operated to help keep the vehicle away from the approaching vehicle.

■ Hands off steering wheel warning operation

When the system determines the driver is not holding the steering wheel, a message urging the driver to grip the steering wheel and the icon shown in the illustration will be displayed on the multi-information display to warn the driver. If the system detects that the steering wheel is held, the warning will be canceled. When using the system, make sure to grip the steering wheel firmly, regardless of whether the warning is operating or not.

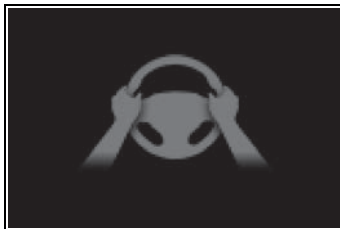

■ Situations in which the hands off steering wheel warning may not operate properly

- Depending on the condition of the vehicle, handle control condition and road surface, the warning function may not operate.
- In the following situations, the system may not be able to detect when the driver's hands are off the steering wheel.
 - When a steering wheel cover is installed
 - When the driver is wearing gloves
 - When foreign matter is attached to the steering wheel
 - When the driver is gripping the wood trim, seam of the leather, spokes, or other part of the steering wheel that does not have sensors
- In the following situations, the hands off steering wheel warning may not operate and the LCA function may continue operating even though the driver's hands are off the steering wheel:
 - When something other than a hand is contacting the steering wheel
 - When a wide object or arms are held across the steering wheel

Operating the LCA

If the turn signal lever is held in the first position, the lane change direction will be displayed and the function will operate.

To change lanes by holding the turn signal lever in the first position without using the LCA, turn the customize setting of the LCA off.

- 1 First position: LCA is operational
- 2 Second position: LCA is not operational

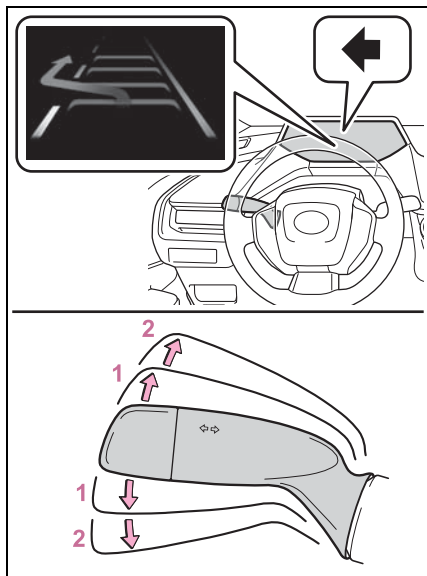

⚠ WARNING

Situations in which the LCA should not be used





- When driving on a one lane road
- When there is no broken white line between the current lane and the lane to be changed to

Enabling/disabling the system

LCA can be enabled/disabled through a customize setting. (→P.545)

Displays and system operation

The operating state of the LCA system is indicated.

LCA display	Steering icon	Condition
 Blue arrow and white line	 Green	LCA is operating
	 Grey	Approaching vehicle detected while LCA is operating
Not displayed	 Grey	Lane line no longer detected while LCA is operating

LDA (Lane Departure Alert)

Basic functions

The LDA system warns the driver if the vehicle may deviate from the current lane or course^{*}, and also can slightly operate the steering wheel to help avoid deviation from the lane or course^{*}.

The front camera is used to detect lane lines or a course^{*}.

*: Boundary between the asphalt and grass, soil, etc., or structures, such as a curb, guardrail, etc.

■ Lane departure alert function

When the system determines that the vehicle might depart from its lane or course^{*}, a warning is displayed on a display, and either a warning buzzer will sound or the steering wheel will vibrate to alert the driver.

Check the area around your vehicle and carefully operate the steering wheel to move the vehicle back to the center of the lane or course^{*}.

Vehicles with BSM: If the system determines that the vehicle may collide with a vehicle in an adjacent lane, the lane departure alert will operate even if the turn signals are operating.

*: Boundary between the asphalt and grass, soil, etc., or structures,

such as a curb, guardrail, etc.

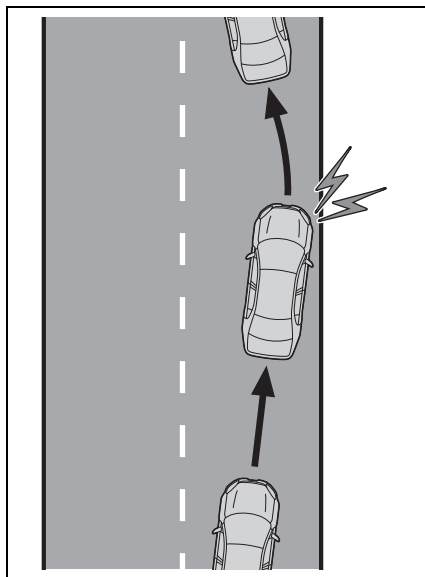

■ Lane departure prevention function

If the system determines that the vehicle is likely to depart from its lane or course^{*}, it provides assistance through steering wheel operations to help avoid deviation from the lane or course.

If the system determines that the steering wheel has not been operated for a certain amount of time or the steering wheel is not being firmly gripped, a warning message may be displayed and a warning buzzer may sound to alert the driver.

Vehicles with BSM: If the system determines that the vehicle may collide with a vehicle in an adjacent lane, the lane departure prevention function will operate even if the turn signals are operating.

*: Boundary between the asphalt and grass, soil, etc., or structures, such as a curb, guardrail, etc.

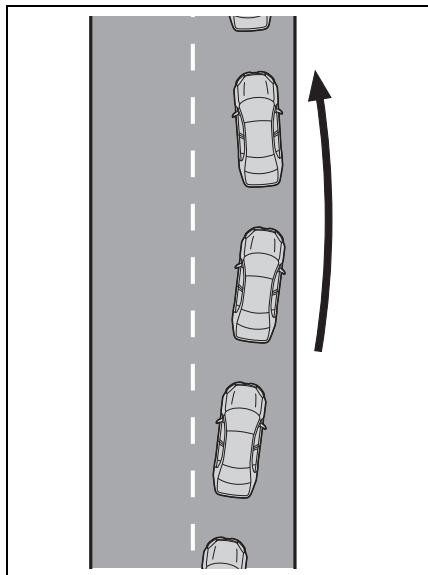

■ Break suggestion function

If the vehicle is swaying, a message will be displayed and a buzzer will sound to urge the driver to take a break.

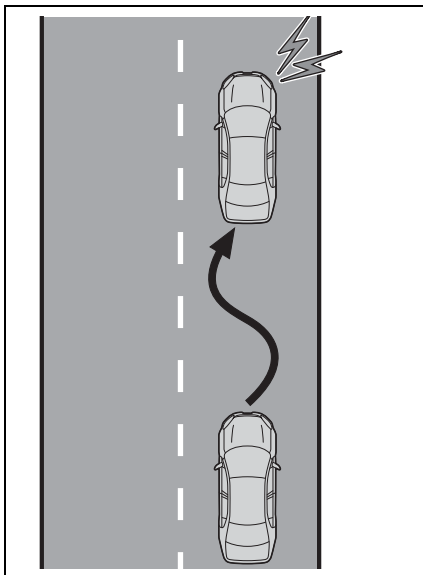

⚠ WARNING

■ Before using the LDA system

- Do not overly rely on the LDA system. The LDA system is not a system which provides automated assistance in driving and it is not a system which reduces the amount of attention necessary for safe driving. The driver is solely responsible for paying attention to their surroundings and operating the steering wheel as necessary to ensure safety. Also, the driver is responsible for taking adequate breaks when fatigued, such as when driving for a long time.
- Failure to perform appropriate driving operations and pay careful attention may lead to an accident.

■ Operating conditions of each function

- Lane departure alert/prevention function

This function is operable when all of

the following conditions are met:

- The vehicle speed is approximately 30 mph (50 km/h) or more.

Operation may be possible when the vehicle speed is approximately 25 mph (40 km/h) or more if vehicles, motorcycles, bicycles, or pedestrians are detected near the lane.

- The system recognizes a lane or course* . (When recognized on only one side, the system will operate only for the recognized side.)
- The lane width is approximately 9.8 ft. (3 m) or more.
- The turn signal lever is not being operated.

(Vehicles with BSM: Except when a vehicle is detected in the direction that the turn signal lever is operated.)

- The vehicle is not being driven around a sharp curve.
- The vehicle is not accelerating or decelerating more than a certain amount.
- The steering wheel is not being turned sufficiently to perform a lane change.
- When the VSC or TRAC system is not turned off

*: Boundary between the asphalt and grass, soil, etc., or structures, such as a curb, guardrail, etc.

■ Temporary cancellation of functions

When the operating conditions are no longer met, a function may be temporarily canceled. However, when the operation conditions are met again, operation of the function will automatically be restored. (→P.243)

■ Operation of the lane departure alert function/lane departure prevention function

- Depending on the vehicle speed,

road conditions, lane departure angle, etc., operation of the lane departure prevention function may not be felt or the function may not operate.

- Depending on the conditions, the warning buzzer may operate even if vibration is selected through a customize setting.
- If a course* is not clear or straight, the lane departure alert function or lane departure prevention function may not operate.
- The lane departure alert function or lane departure prevention function may not operate if the system judges that the vehicle is intentionally being steered to avoid a pedestrian or parked vehicle.
- Vehicles with BSM: It may not be possible for the system to judge if there is danger of a collision with a vehicle in an adjacent lane.
- The steering assist operation of the lane departure prevention function can be overridden by the steering wheel operation of the driver.

*: Boundary between the asphalt and grass, soil, etc., or structures, such as a curb, guardrail, etc.

■ Hands off steering wheel warning operation

In the following situations, a message urging the driver to operate the steering wheel and an icon will be displayed and a buzzer will sound to warn the driver. When using the system, make sure to grip the steering wheel firmly, regardless of whether the warning is operating or not.

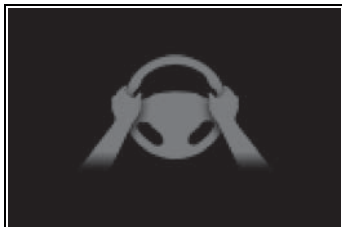

- When the system determines that the driver is not securely holding the steering wheel, or the steering wheel is not being operated when the steering assist operation of the lane departure prevention function is operating

Except for Puerto Rico: The length of time that the warning buzzer operates will become longer as the frequency of the steering assist operating increases. If the system judges that the steering wheel has been operated, the warning buzzer will stop.

For Puerto Rico: The length of time that the warning buzzer operates will become longer as the frequency of the steering assist operating increases. Even if the system judges that the steering wheel has been operated, the warning buzzer will sound for a certain amount of time.

■ Break suggestion function

This function is operable when all of the following conditions are met:

- The vehicle speed is approximately 32 mph (50 km/h) or more.
- The lane width is approximately 9.8 ft. (3 m) or more.

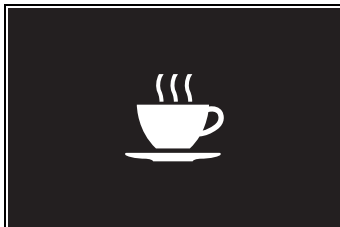

Depending on the condition of the vehicle and road surface, the break suggestion function may not operate.

Changing LDA settings

- The LDA system can be enabled/disabled through a customize setting. (→P.545)
- The settings of the LDA can be changed on the customize settings. (→P.545)

⚠ WARNING

■ Situations in which the system may not operate properly

In the following situations, the system may not operate properly and the vehicle may depart from its lane. Do not overly rely on these functions. The driver is solely responsible for paying attention to their surroundings and operating the steering wheel as necessary to ensure safety.

- When the boundary between the asphalt and grass, soil, etc., or structures, such as a curb, guardrail, etc. is not clear or straight
- When the vehicle is struck by a crosswind or the turbulence of other nearby vehicles
- Situations in which the lane may not be detected: →P.221







**WARNING**







- Situations in which the sensors may not operate properly: →P.219
- Situations in which some or all of the functions of the system cannot operate: →P.221
- When it is necessary to disable the system: →P.215

Displays and system operation











The operating state of the lane departure alert function and steering assist operation of the lane departure prevention function are indicated.

► Except for Puerto Rico

Indicator	Lane display	Steering icon	Condition
Not illuminated	Not illuminated	Not illuminated	System disabled
 White	 Gray	Not illuminated	Lane lines are not detected by the system
 White	 White	Not illuminated	Lane lines are detected by the system
 Orange Flashing	 Orange Flashing	Not illuminated	Lane departure alert function is operating for the side which the lane display is flashing

Indicator	Lane display	Steering icon	Condition
 Green	 Green	 Green	Lane departure prevention function is operating for the side which the lane display is illuminated
 Orange Flashing	 Orange Flashing	 Green	Lane departure alert function/lane departure prevention function is operating for the side which the lane display is flashing

► For Puerto Rico

Indicator	Lane display	Steering icon	Situation
 Orange Illuminated	Not illuminated	Not illuminated	System disabled
Not illuminated	 Gray	Not illuminated	Lane lines are not detected by the system
Not illuminated	 White	Not illuminated	Lane lines are detected by the system
 Orange Flashing	 Orange Flashing	Not illuminated	Lane departure alert function is operating for the side which the lane display is flashing
 Green	 Green	 Green	Lane departure prevention function is operating for the side which the lane display is illuminated
 Orange Flashing	 Orange Flashing	 Green	Lane departure alert function/lane departure prevention function is operating for the side which the lane display is flashing

PDA (Proactive driving assist)

When a detectable object (→P.249) is detected, the proactive driving assist operates the brakes and steering wheel to help prevent the vehicle from approaching too close to the object.



WARNING

■ For safe use

Driving safely is solely the responsibility of the driver.

- The proactive driving assist is designed to provide some assistance for regular braking and steering operations, as well as helping to prevent the vehicle from approaching too close to a detectable object. However, the scope of this assistance is limited.

The driver should perform brake and steering operations as necessary. Read the following items carefully. Do not overly rely on the proactive driving assist and always drive carefully. (→P.251)

- The proactive driving assist is not a system which reduces the amount of attention necessary for safe driving. Even if the system is operating correctly, the surrounding conditions as recognized by the driver and detected by the system may differ. It is necessary for the driver to pay attention, assess risks, and ensure safety. Over-reliance on this system to drive the vehicle safely may lead to an accident resulting in death or serious injury.

- Proactive driving assist is not a system which allows for inattentive driving and is not a system which assists in poor visibility conditions. The driver is solely responsible for paying attention to their surroundings and driving safely.

■ When turning proactive driving assist off

- Situations in which the sensors may not operate properly:
→P.251
- When it is necessary to disable the system: →P.215

System operating conditions and detectable objects

According to the driving conditions, the operation and detectable objects of the proactive driving assist will change as follows.

Function	Conditions	Operation	Detectable objects
Obstacle Anticipation Assist	A detectable object is detected crossing the road	Assistance with some brake operations is provided in order to reduce the possibility of a collision.	<ul style="list-style-type: none"> • Pedestrians • Bicyclists
	A detectable object is detected on the side of the road	Assistance with some brake and steering wheel operations are provided according to the surrounding conditions to help prevent the vehicle from approaching too close to a detected object.	<ul style="list-style-type: none"> • Pedestrians • Bicyclists • Parked vehicles
		Assistance with steering wheel operations is provided within a range that the vehicle will not deviate from its current lane.	

Function	Conditions	Operation	Detectable objects
Deceleration Assist	A preceding vehicle or an adjacent vehicle cutting in front of the vehicle is detected	The vehicle is gently decelerated so that the vehicle-to-vehicle distance will not be excessively short.	<ul style="list-style-type: none"> • Preceding vehicles • Motorcycles
	A curve is detected ahead of the vehicle	The vehicle is gently decelerated if the vehicle speed is determined to be too high for the curve ahead.	None
Steering Assist	Lane is detected	The system anticipates the driver's operation and supports the operation of the steering wheel.	None

■ Vehicle speeds at which the system can operate

- Detectable object crossing the road assistance

Approximately 20 to 35 mph (30 to 60 km/h)

- Detectable object on the side of the road assistance

Approximately 20 to 35 mph (30 to 60 km/h)

- Preceding vehicle deceleration assistance

Approximately 15 mph (20 km/h) or more

- Curve deceleration assistance

Approximately 15 mph (20 km/h) or more

- Steering assist within a lane

Approximately 5 to 80 mph (10 to 140 km/h)

■ System operation will be canceled when

- In the following situations, system operation will be canceled:

- When the dynamic radar cruise control or cruise control is operating
- When the PCS is off
- Situations in which some or all of the functions of the system cannot operate: →P.221
- When the P, R or N shift position is selected

- In the following situations, the brake operation assist will be canceled:

- Approximately 9 mph (15 km/h) or less
- When a certain vehicle speed has been reached, as judged by the system, according to the sur-

rounding conditions

- In the following situations, system operation may be canceled:
 - When the brake control or output restriction control of a driving support system operates (For example: PCS, drive-start control)
 - When the system determines that a detected object has moved away from the vehicle
 - When lane lines can no longer be detected
 - When the brake pedal has been depressed
 - When the accelerator pedal has been depressed
 - When the steering wheel has been operated with more than a certain amount of force
 - When the turn signal lever is operated to the left/right turn position



WARNING

- **Situations in which the system may not operate properly**
- Situations in which the lane may not be detected: →P.221
- When a detectable object stops immediately before entering the path of the vehicle
- When passing extremely close to a detectable object behind a guardrail, fence, etc.
- When changing lanes while overtaking a detectable object
- When passing a detectable object that is changing lanes or turning left/right
- When there are objects (guardrails, power poles, trees, walls, fences, poles, traffic cones, mailboxes, etc.) in the surrounding area
- When there are patterns or a painting ahead of the vehicle that may be mistaken for a detectable object

- When passing through a place with a low structure above the road (tunnel with a low ceiling, traffic sign, signboard, etc.)
- When driving on snowy, icy, or rutted roads
- When a detectable object is approaching your vehicle
- When your vehicle or a detectable object is wandering
- When the movement of a detectable object changes (change in direction, sudden acceleration or deceleration, etc.)
- When suddenly approaching a detectable object
- When a preceding vehicle or motorcycle is not directly in front of your vehicle
- When there is a structure above a detectable object
- When part of a detectable object is hidden by another object (large luggage, umbrella, guardrail, etc.)
- When multiple detectable objects are overlapping
- When a bright light, such as the sun or headlights of another vehicle, is reflecting off of the detectable object
- When the detectable object is white and looks extremely bright
- When the color or brightness of the detectable object causes it to blend in with its surroundings
- When a detectable object cuts in front of or emerges from beside a vehicle

**WARNING**

- When approaching a vehicle ahead which is perpendicular or at an angle to the vehicle, or is facing the vehicle
- If a parked vehicle is perpendicular or at an angle to the vehicle
- When a bicycle is a child sized bicycle, is carrying a large load, is carrying an extra passenger, or has an unusual shape (bicycles equipped with a child seat, tandem bicycles, etc.)
- When a pedestrian or bicyclist is shorter than approximately 3.2 ft. (1 m) or taller than approximately 6.5 ft. (2 m)
- When the silhouette of a pedestrian or bicyclist is unclear (such as when they are wearing a raincoat, long skirt, etc.)
- When a pedestrian or bicyclist is bending forward or squatting
- When a pedestrian or bicyclist is moving at high speed
- When a pedestrian is pushing a stroller, wheelchair, bicycle or other vehicle
- When a detectable object blends in with the surrounding area, such as when it is dim (at dawn or dusk) or dark (at night, in a tunnel, etc.)

- When the lane width is 13.1 ft. (4 m) or more
- When the lane width is 8.2 ft. (2.5 m) or less
- When the vehicle has not been driven for a certain amount of time after the hybrid system was started
- While turning left or right or a few seconds after turning left or right
- While changing lanes or a few seconds after changing lanes
- When entering a curve, driving around a curve and a few seconds after driving around a curve







Changing proactive driving assist settings

- The proactive driving assist can be enabled/disabled through a customize setting. (→P.546)
- The settings of the proactive driving assist can be changed through customize settings. (→P.546)

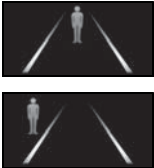
System operation display

Depending on the situation, the following indicators or icons will be displayed.

Some icons cannot be displayed unless the display is changed to the driving safety support function information screen.

Icon	Meaning
	<ul style="list-style-type: none"> • White: Monitoring for detectable objects • Green: Detectable object crossing the road or detectable object on the side of the road assistance operating
	<p>A pedestrian has been detected as crossing the road or on the side of the road and brake or steering assistance is operating</p>
	<p>A vehicle has been detected on the side of the road and brake or steering operation assistance is being performed</p>
	<ul style="list-style-type: none"> • Steering operation assistance is being performed to prevent the vehicle from approaching too close to a detectable object on the side of the road • When the steering assist is operating
	<p>Preceding vehicle deceleration assistance is being performed</p>
	<p>Warning to maintain appropriate vehicle-to-vehicle distance</p>
	<p>Curve deceleration assistance is being performed</p>

■ Hands off steering wheel warning operation

In the following situations, a message urging the driver to grip the steering wheel and the icon shown in the illustration will be displayed on the display to warn the driver. If the

system detects that the steering wheel is held, the warning will be canceled. When using the system, make sure to grip the steering wheel firmly, regardless of whether the warning is operating or not.



- When assistance to a detectable object crossing the road or assistance to a detectable object on the side of the road is performed and the system determines the driver is not holding the steering wheel

If no operations are detected for a certain amount of time, a buzzer will sound, the warning will operate.

This warning may also operate if the driver only operates steering wheel a small amount continuously.

■ Warning operation after preceding vehicle deceleration assistance has ended

After preceding vehicle deceleration assistance has ended, if the driver does not operate the brake pedal or accelerator pedal and the vehicle approaches the preceding vehicle, the display will flash and a buzzer will sound to urge the driver to decelerate. If the system determines that the driver is operating the brake pedal or accelerator pedal, the warning will be canceled.



FCTA (Front Cross Traffic Alert)*

*: If equipped

When approaching an intersection, etc., at a low speed, vehicles approaching from the left and right of the front of the vehicle can be detected and the driver informed of these vehicles.

FCTA system control

- When the system detects a vehicle approaching from the left or right in front of your vehicle when approaching an intersection, a notification will be displayed.
- When the system determines that your vehicle may be about to enter an intersection even though a vehicle is approaching from the left or right in front of your vehicle, a buzzer will sound and a message will be displayed to urge you to depress the brake pedal.
- Multi-information display



WARNING

■ For safe use

Driving safely is solely the responsibility of the driver. Pay careful attention to the surrounding conditions in order to ensure safe driving. The FCTA system is a supplementary system that informs the driver of vehicles approaching from the left and right of the front of the vehicle.

Over-reliance on this system may lead to an accident resulting in death or serious injury. The details of the warning display may differ from the actual traffic conditions. Although the warning display will stop being displayed after a certain amount of time, this does not necessarily indicate that there are no longer any vehicles or pedestrians around your vehicle.

■ FCTA system operating conditions

The system will operate when all of the following conditions are met:

- A shift position other than P or R is selected
- The vehicle speed is approximately 10 mph (15 km/h) or less
- A vehicle is approaching from the left or right in front of your vehicle at a speed between approximately 7 to 37 mph (10 to 60 km/h)
- There are no vehicles in front of

your vehicle

- The accelerator pedal is not being strongly depressed
 - The brake pedal is not being strongly depressed
- **Situations in which the system may operate even though no vehicles are approaching**

In certain situations, such as the following, the system may operate even though no vehicles are approaching:

- When approaching objects on the roadside, such as guardrails, traffic signs, utility poles, street lights, trees, tall grass, walls, etc.
- When passing an object on the side of the road, such as a parked vehicle
- When a vehicle or pedestrian is approaching from the left or right in front of your vehicle in the distance
- When a vehicle or pedestrian is moving within a parking spot, etc., next to the lane your vehicle is in
- When a pedestrian or bicyclist is approaching on a sidewalk
- When a vehicle or pedestrian is moving away from your vehicle
- When an approaching vehicle is decelerating or stops
- When an approaching vehicle makes a left/right turn immediately in front of your vehicle
- When a pedestrian is approaching your vehicle
- When an oncoming vehicle makes a right/left turn
- When your vehicle enters an intersection before a vehicle approaching from the left or right in front of your vehicle
- When stopped at traffic light and a vehicle approaches from the left or right in front of your vehicle
- When making a left/right turn in

front of an approaching vehicle

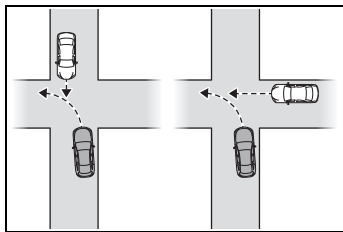

- When an oncoming vehicle approaches and passes
- When being overtaken by another vehicle
- When driving next to another vehicle or a pedestrian
- When a vehicle or pedestrian approaches the side of your vehicle

■ Situations in which the system may not operate properly

In situations such as the following, a vehicle may not be detected by a front side radar sensor and the system may not operate properly:

- If an approaching vehicle moves suddenly (sudden steering, acceleration, deceleration, etc.)

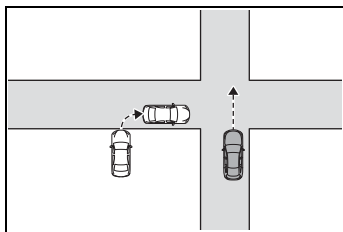

- If a vehicle is approaching from the left or right of the front of your vehicle diagonally
- When a vehicle is approaching from the left or right in front of your vehicle in the distance
- When there is an object between your vehicle and an approaching vehicle
- When several vehicles are approaching with little space between them

- Situations in which the sensors may not operate properly: →P.219
- Situations in which some or all of the functions of the system cannot operate: →P.221

Changing FCTA settings

- The FCTA can be enabled/disabled through a customize setting. (→P.546)
- The following settings of the FCTA can be changed through customize settings. (→P.546)

RSA (Road Sign Assist)*

*: If equipped

The RSA system detects specific road signs using the front camera and/or navigation system (when speed limit information is available) and warns the driver via displays and buzzers.



WARNING

■ For safe use

- Driving safely is solely the responsibility of the driver. Pay careful attention to the surrounding conditions in order to ensure safe driving.
- Do not rely solely upon the RSA. The RSA assists the driver by providing road sign information, but it is not a replacement for the driver's own vision and awareness. Driving safely is solely the responsibility of the driver. Pay careful attention to the surrounding conditions in order to ensure safe driving.

■ Situations in which the RSA should not be used

When it is necessary to disable the system: →P.215

■ Situations in which the system may not operate properly

- Situations in which the sensors may not operate properly: →P.219

detects a sign or information of a sign is available from the navigation system, the sign will be displayed on the display.

- Multiple signs can be displayed.

Depending on the specifications of the vehicle, the number of displayed signs may be limited.

■ Operating conditions of sign display

Signs will be displayed when the following conditions are met:

- The system has detected a sign

In the following situations, a displayed sign may stop being displayed:

- When a new sign has not been detected for a certain distance
- When the system determines that the road being driven on has changed, such as after a left or right turn

■ Situations in which the display function may not operate properly

In the following situations, the RSA system may not operate properly and may not detect signs or may display the incorrect sign. However, this does not indicate a malfunction.

- When a sign is dirty, faded, tilted or bent
- When the contrast of an electronic sign is low
- When all or part of a sign is hidden by a tree, utility pole, etc.
- When a sign is detected by the front camera for a short amount of time
- When the driving state (turning, changing lanes, etc.) is judged incorrectly

Display Function

- When the front camera

- When a sign is immediately after a freeway junction or in an adjacent lane just before merging
- When stickers are attached to the rear of a preceding vehicle
- When a sign similar to a system compatible sign is detected as a system compatible sign
- When a speed limit sign for a frontage road is within detection range of the front camera
- When driving around a round-about
- When a sign intended for trucks, etc. is detected
- When the navigation system map data is out of date
- When the navigation system cannot be used

In this case, the speed limit signs displayed on the multi-information display and navigation system display may differ.

Notification function

In the following situations, the RSA system will output a warning to notify the driver.

- If the vehicle speed exceeds the speed warning threshold of the speed limit sign displayed on the display, the sign display will be emphasized and a buzzer will sound.
- When the RSA system detects a do not enter sign and determines that the vehicle has entered a no-entry area, the do not enter sign displayed on the display will flash and a buzzer will sound.

Operating conditions of the notification functions

- Excess speed notification function

This function will operate when the following condition is met:

- A speed limit road sign is recognized by the system.

- No entry notification function

This function will operate when all of the following conditions are met:

- More than one no entry road signs are recognized by the system simultaneously.
- The vehicle is passing between no entry road signs recognized by the system.

Types of road signs supported

- The following types of road signs can be displayed.

However, non-standard or recently introduced traffic signs may not be displayed.



Speed limit



Do Not Enter



No U-turn



No Turn On Red



Stop



Yield



Warning

- Depending on the specifications of the vehicle, signs may be displayed overlapping.

Changing RSA settings

- The following settings of the RSA can be changed through customize settings. (→P.546)

Dynamic radar cruise control

This dynamic radar cruise control detects the presence of vehicles ahead, determines the current vehicle-to-vehicle distance, and operates to maintain a suitable distance from the vehicle ahead. The desired vehicle-to-vehicle distance can be set by operating the vehicle-to-vehicle distance switch.

Use the dynamic radar cruise control only on highways and expressways.

WARNING

■ For safe use

- Driving safely is solely the responsibility of the driver. Do not overly rely on this system, and pay careful attention to the surrounding conditions in order to ensure safe driving.
- The dynamic radar cruise control provides driving assistance to reduce the driver's burden. However, there are limitations to the assistance provided.

Read the following items carefully. Do not overly rely on this system and always drive carefully.

Conditions under which the system may not operate correctly:
→P.265

**WARNING**

- Set the speed appropriately according to the speed limit, traffic flow, road conditions, weather conditions, etc. The driver is responsible for confirming the set speed.
- Even if the system is operating correctly, the condition of a preceding vehicle as recognized by the driver and detected by the system may differ. Therefore, it is necessary for the driver to pay attention, assess risks, and ensure safety. Over-reliance on this system to drive the vehicle safely may lead to an accident resulting in death or serious injury.

■ Precautions for the driving assist systems

Observe the following precautions, as there are limitations to the assistance provided by the system. Over-reliance on this system may lead to an accident resulting in death or serious injury.

- Details of support provided for the driver's vision

The dynamic radar cruise control is only intended to help the driver in determining the distance between the driver's own vehicle and a designated preceding vehicle. It is not a system which allows for careless or inattentive driving, and is not a system which assists in poor visibility conditions.

The driver must pay attention to their surroundings, even when the vehicle stops.

- Details of support provided for the driver's judgement

The dynamic radar cruise control determines whether the distance between the driver's own vehicle and a designated preceding vehicle is within a set range. It is not capable of making any other type of judgement. Therefore, it is absolutely necessary for the driver to remain vigilant and to determine whether or not there is a possibility of danger.

- Details of support provided for the driver's operation

The dynamic radar cruise control does not include functions which will prevent or avoid collisions with vehicles ahead of your vehicle. Therefore, if there is ever any possibility of danger, the driver must take immediate and direct control of the vehicle and act appropriately in order to ensure safety.

■ Situations in which the dynamic radar cruise control should not be used

Do not use the dynamic radar cruise control in the following situations. As the system will not be able to provide appropriate control, using it may lead to an accident resulting in death or serious injury.

- Roads where there are pedestrians, cyclists, etc.
- When driving on a highway or expressway entrance or exit
- When the approach warning sounds frequently
- Situations in which the sensors may not operate properly: →P.219
- Situations in which the lane may not be detected: →P.221

Basic functions

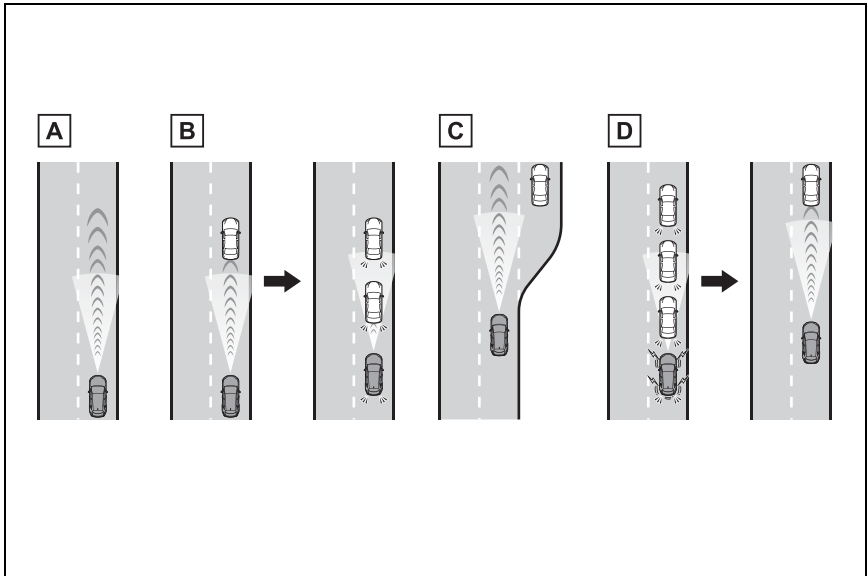

A Constant speed cruising

When there are no vehicles ahead

The vehicle drives at the speed set by the driver.

If the set vehicle speed is exceeded while driving down a hill, the set vehicle speed display will blink and a buzzer will sound.

B Deceleration and follow-up cruising

When a preceding vehicle driving slower than the set vehicle speed is detected

When a vehicle is detected driving ahead of your vehicle, the vehicle automatically decelerates and if a greater reduction in vehicle speed is necessary, the brakes are applied (the stop lights will come on at this time). The vehicle is controlled to maintain the vehicle-to-vehicle distance set by the driver, in accordance with changes in the speed of the preceding vehicle. If vehicle deceleration is not sufficient and the vehicle approaches the vehicle ahead, the approach warning will sound.

C Acceleration

When there are no longer any preceding vehicles driving slower than the set vehicle speed

The vehicle accelerates until the set vehicle speed is reached and then resumes constant speed cruising.

D Starting off

If a preceding vehicle stops, the vehicle will also stop (controlled stop). After the preceding vehicle starts off, pressing the “RES” switch or depressing the accelerator pedal will resume follow-up cruising (start off operation). If a start off operation is not performed, the controlled stop will continue.

System components

■ Meter display

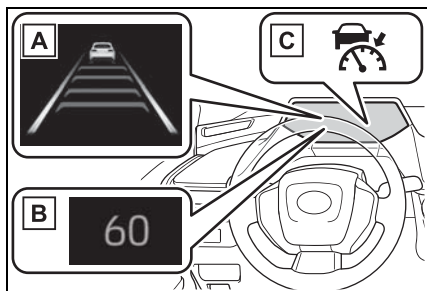

A Multi-information display

B Set vehicle speed

C Indicators

■ Switches

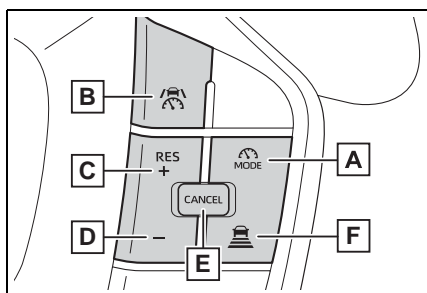

A Driving assist mode select switch

B Driving assist switch

C “+” switch/“RES” switch

D “-” switch

E Cancel switch

F Vehicle-to-vehicle distance switch

Using the dynamic radar cruise control

■ Setting the vehicle speed

- 1 Press the driving assist mode select switch to select dynamic radar cruise control.

The dynamic radar cruise control indicator will illuminate.

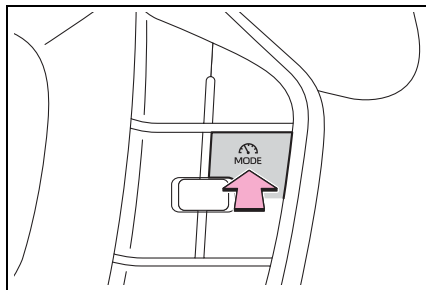

- 2 Using the accelerator pedal, accelerate or decelerate to the desired vehicle speed (approximately 20 mph [30 km/h] or more), and press the driving assist switch to set the set vehicle speed.

The set vehicle speed will be displayed on the multi-information display.

The vehicle speed at the moment the switch is released will be the set

vehicle speed.

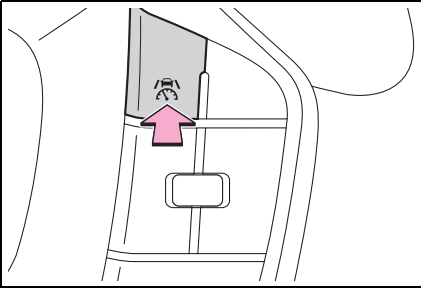

■ Adjusting the set vehicle speed

- Adjusting the set vehicle speed using the switches

To change the set vehicle speed, press the “+” switch or “-” switch until the desired speed is displayed.

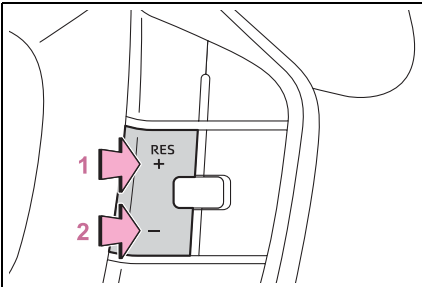

- 1 Increase set vehicle speed
- 2 Decrease set vehicle speed

Short press adjustment: Press the switch

Long press adjustment: Press and hold the switch until the desired set vehicle speed is reached.

The set vehicle speed will increase or decrease as follows:

- For the U.S. mainland and Hawaii

Short press adjustment:

Increases or decreases by 1 mph (1.6 km/h) each time the switch is pressed

Long press adjustment: Increases or decreases in 1 mph (1.6 km/h) increments continuously while the switch is pressed and held

- Except for the U.S. mainland and Hawaii

Short press adjustment: By 0.6 mph (1 km/h) or 1.6 km/h (1 mph) each time the switch is pressed

Long press adjustment: Increases or decreases in 3.1 mph (5 km/h) or 8 km/h (5 mph) increments continuously while the switch is pressed and held

- Increasing the set vehicle speed using the accelerator pedal

- 1 Depress the accelerator pedal to accelerate the vehicle to the desired vehicle speed.
- 2 Press the “+” switch.

■ Canceling/resuming control

- 1 Press the cancel switch or driving assist switch to cancel control.

Control will also be canceled if the brake pedal is depressed. (If the vehicle has been stopped by system control, depressing the

brake pedal will not cancel control.)

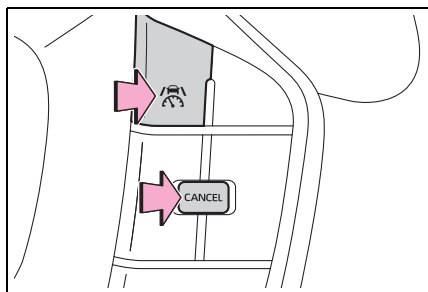

- Press the “RES” switch to resume control.

■ Changing the vehicle-to-vehicle distance

Each time the switch is pressed, the vehicle-to-vehicle distance setting will change as follows:

If a preceding vehicle is detected, the preceding vehicle mark **A** will be displayed.

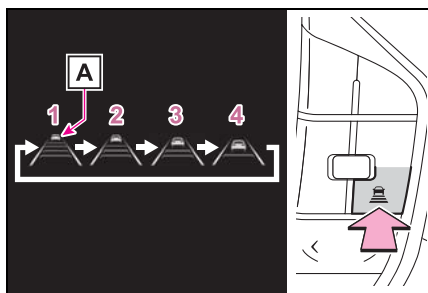

Illustration Number	Vehicle-to-vehicle distance	Approximate Distance (Vehicle Speed: 60 mph [100 km/h])
1	Extra long	Approximately 200 ft. (60 m)
2	Long	Approximately 145 ft. (45 m)

Illustration Number	Vehicle-to-vehicle distance	Approximate Distance (Vehicle Speed: 60 mph [100 km/h])
3	Medium	Approximately 100 ft. (30 m)
4	Short	Approximately 85 ft. (25 m)

The actual vehicle-to-vehicle distance varies in accordance with the vehicle speed. Also, when the vehicle is stopped by system control, it will be stopped at a certain distance from the preceding vehicle, depending on the situation, regardless of the setting.

■ Operating conditions

- The D shift position is selected.
- The desired set speed can be set when the vehicle speed is approximately 20 mph (30 km/h) or more.
- If the vehicle speed is set while driving at below approximately 20 mph (30 km/h), the set vehicle speed will be approximately 20 mph (30 km/h).
- If the vehicle speed is set while driving at a speed that exceeds the system's upper limit, the set vehicle speed will be the system's upper limit.

■ Accelerating after setting the vehicle speed

As with normal driving, acceleration can be performed by depressing the accelerator pedal. After accelerating, the vehicle will return to the set vehicle speed. However, while in vehicle-to-vehicle distance control mode, the vehicle speed may decrease to below the set vehicle speed in order to maintain the distance from the preceding vehicle.

■ When the vehicle is stopped by system control during follow-up cruising

- When the “RES” switch is pressed while the vehicle is stopped by system control, if the preceding vehicle starts off within approximately 3 seconds, follow-up cruising will resume.
- If the preceding vehicle starts off within approximately 3 seconds of the vehicle being stopped by system control, follow-up cruising will resume.

■ Automatic cancellation of vehicle-to-vehicle distance control mode

In the following situations, vehicle-to-vehicle distance control mode will be canceled automatically:

- When the brake control or output restriction control of a driving support system operates (For example: Pre-Collision System, drive-start control)
- When the parking brake has been operated
- When the vehicle is stopped by system control on a steep incline
- When any of the following are detected while the vehicle is stopped by system control:
 - The driver’s seat belt is unfastened
 - The driver’s door is opened
 - Approximately 3 minutes have elapsed since the vehicle was stopped

The parking brake may be activated automatically.

- Situations in which some or all of the functions of the system cannot operate: →P.221

■ Dynamic radar cruise control system warning messages and buzzers

For safe use: →P.215

■ Preceding vehicles that the sensor may not detect correctly

In the following situations, depending on the conditions, if the system cannot provide sufficient deceleration or acceleration is necessary, operate the brake pedal or accelerator pedal.

As the sensor may not be able to correctly detect these types of vehicles, the approach warning (→P.265) may not operate.

- When a vehicle cuts in front of your vehicle or changes lanes away from your vehicle extremely slowly or quickly
- When changing lanes
- When a preceding vehicle is driving at a low speed
- When a vehicle is stopped in the same lane as the vehicle
- When a motorcycle is traveling in the same lane as the vehicle

■ Conditions under which the system may not operate correctly

In the following situations, operate the brake pedal (or accelerator pedal, depending on the situation) as necessary.

As the sensor may not be able to correctly detect a vehicle, the system may not operate properly.

- When a preceding vehicle brakes suddenly
- When changing lanes at low speeds, such as in a traffic jam

Approach warning

In situations where the vehicle approaches a preceding vehicle and the system cannot provide sufficient deceleration, such as if a vehicle cuts in front of the vehicle, a warning display will

flash and a buzzer will sound to alert the driver. Depress the brake pedal to ensure appropriate vehicle-to-vehicle distance.

■ Warnings may not occur when

In the following situations, the warning may not operate even though the vehicle-to-vehicle distance is short.

- When the preceding vehicle is traveling at the same speed or faster than your vehicle
- When the preceding vehicle is traveling at an extremely low speed
- Immediately after the vehicle speed has been set
- When the accelerator pedal is depressed

Curve speed reduction function

When a curve is detected, the vehicle speed will begin being reduced. When the curve ends, the vehicle speed reduction will end.

Depending on the situation, the vehicle speed will then return to the set vehicle speed.

In situations where vehicle-to-vehicle distance control needs to operate, such as when a preceding vehicle cuts in front of your vehicle, the curve speed reduction function will be canceled.



■ Situations in which the curve speed reduction function may not operate

In situations such as the following, the curve speed reduction function may not operate:

- When the vehicle is being driven around a gentle curve
- When the accelerator pedal is being depressed
- When the vehicle is being driven around an extremely short curve

Support for lane change

If your vehicle is being driven at approximately 50 mph (80 km/h) or more and a lane change to the passing lane is performed, when the turn signal lever is operated and the lane is changed, the vehicle will accelerate up to the set speed to assist in overtaking.

The system's recognition of which lane is the passing lane may be based solely on the location of the steering wheel in the vehicle (left-hand drive/right-hand drive). If the vehicle is driven in a location where the passing lane is on the opposite side of that where the vehicle

was originally sold, the vehicle may accelerate when the turn signal lever is operated away from the passing lane. (e.g. The vehicle was manufactured for a right-hand traffic location, but is being driven in a left-hand traffic location. The vehicle may accelerate when the turn signal lever is operated to the right.)

If your vehicle is being driven at approximately 50 mph (80 km/h) or more and the lane is changed to that with a vehicle traveling







slower than your vehicle, when the turn signal lever is operated the vehicle will gradually decelerate to assist in changing lanes.







Changing Dynamic radar cruise control settings

The settings of Dynamic radar cruise control can be changed through customize settings. (→P.547)

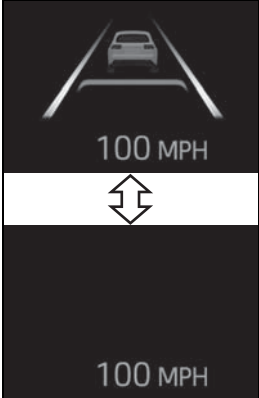
Display and system operation state

The operating state of Dynamic radar cruise control is indicated.

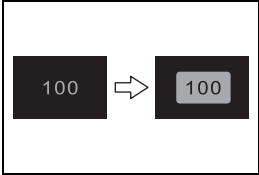
Indicator	Multi-information display		Situation
 White		Vehicle-to-vehicle distance setting: Gray	Dynamic radar cruise control being OFF
 Green		Vehicle-to-vehicle distance setting: Blue Set vehicle speed: Green	Constant speed cruising
 Green		Vehicle-to-vehicle distance setting: Blue Set vehicle speed: Green Preceding vehicle: White	Follow-up cruising

Indicator	Multi-information display		Situation
 Green		Vehicle-to-vehicle distance setting: Orange flashing Set vehicle speed: Green Preceding vehicle: Orange flashing	Approach warning
 Green		Vehicle-to-vehicle distance setting: Gray Set vehicle speed: White Preceding vehicle: Gray	Accelerating with the accelerator pedal
 Green		Set vehicle speed: Green in reverse display	Set vehicle speed being exceeded
 Green		Vehicle-to-vehicle distance setting: Gray Set vehicle speed: White Preceding vehicle: Gray	Vehicle in controlled stop

Cruise control

The vehicle can be driven at a set speed even if the accelerator pedal is not depressed.

Use the cruise control only on highways and expressways.

⚠ WARNING

■ For safe use

- Driving safely is solely the responsibility of the driver. Therefore, do not overly rely on this system. The driver is solely responsible for paying attention to the vehicle's surroundings and driving safely.
- Set the speed appropriately according to the speed limit, traffic flow, road conditions, weather conditions, etc. The driver is responsible for confirming the set speed.

■ Situations in which cruise control should not be used

Do not use the cruise control in the following situations. As the system will not be able to provide appropriate control, using it may lead to an accident resulting in death or serious injury.

- On roads with sharp bends
- On winding roads
- On slippery roads, such as those covered with rain, ice or snow
- On steep downhill, or where there are sudden changes between sharp up and down gradients

Vehicle speed may exceed the set speed when driving down a steep hill.

- When it is necessary to disable the system: →P.215

System Components

■ Meter display

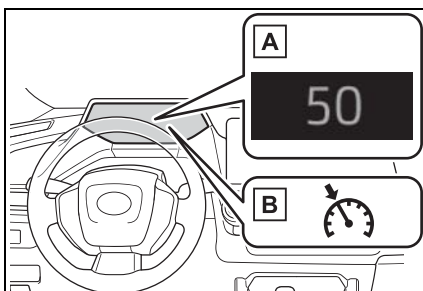

A Set vehicle speed

B Cruise control indicator

■ Switches

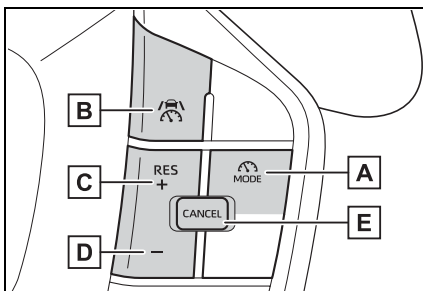

A Driving assist mode select switch

B Driving assist switch

C "+" switch / "RES" switch

D "-" switch

E Cancel switch

Using the cruise control

■ Setting the vehicle speed

- 1 Press the driving assist mode select switch to select cruise control.

The cruise control indicator will illuminate.

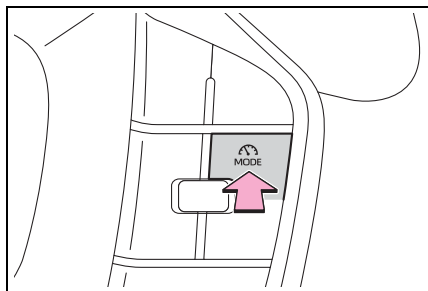

- 2 Using the accelerator pedal, accelerate to the desired vehicle speed (approximately 20 mph [30 km/h] or more), and press the driving assist switch to set the set vehicle speed.

The vehicle speed at the moment the switch is released will be the set vehicle speed.

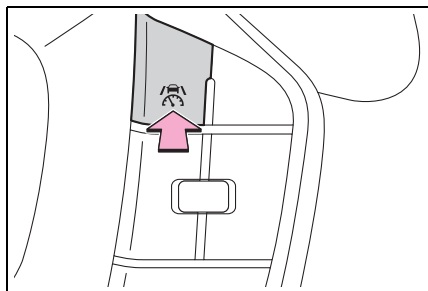

■ Adjusting the set speed

- Adjusting the set vehicle speed using the switches

To change the set vehicle speed, press the "+" or "-" switch until the

desired speed is displayed.

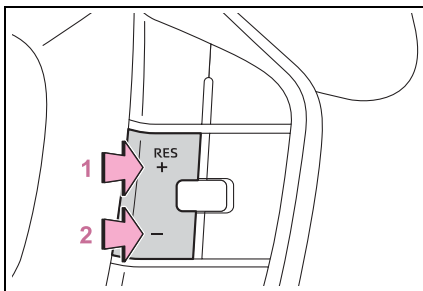

- 1 Increase set vehicle speed
- 2 Decrease set vehicle speed

The set vehicle speed will increase or decrease as follows:

Fine adjustment: By 1 mph (1.6 km/h) or 1 km/h (0.6 mph) each time the switch is pressed

Large adjustment: Increases continuously while the switch is pressed and held

- Increasing the set vehicle speed using the accelerator pedal

- 1 Depress the accelerator pedal to accelerate the vehicle to the desired vehicle speed.
- 2 Press the "+" switch.

■ Canceling/resuming control

- 1 Press the cancel switch or driving assist switch to cancel control.

Control will also be canceled if the

brake pedal is depressed.

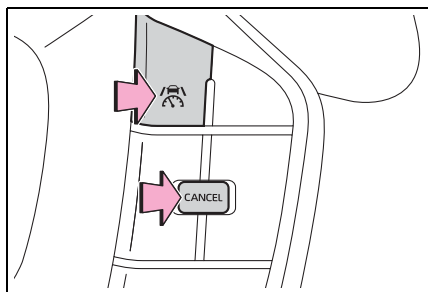

2 Press the “RES” switch to resume control.

Automatic cancellation of the cruise control





In the following situations, the cruise

control will be canceled automatically:

- When the vehicle speed drops approximately 10 mph (16 km/h) or more below the set vehicle speed
- When the vehicle speed drops below approximately 20 mph (30 km/h)
- When the brake control or output restriction control of a driving support system operates (For example: PCS, drive-start control)
- When the parking brake has been operated
- Situations in which some or all of the functions of the system cannot operate: →P.221

Display and system operation state

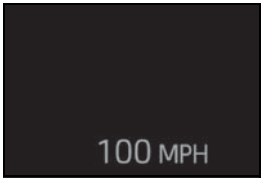
The operating state of cruise control is indicated.

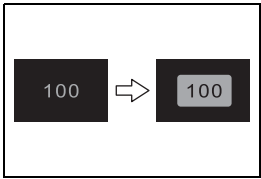
Indicator	Multi-information display		Situation
 White		Blank	Cruise control being OFF
 Green		Set vehicle speed: Green	Constant speed cruising
 Green		Set vehicle speed: Green in reverse display	Set vehicle speed being exceeded

Emergency Driving Stop System*

*: If equipped

The emergency driving stop system is a system which automatically decelerates and stops the vehicle within its lane if the driver becomes unable to continue driving the vehicle, such as if they have suffered a medical emergency, etc.

During LTA (Lane Tracing Assist) control, if the system does not detect driving operations, such as if the driver is not holding the steering wheel, and determines the driver is not responsive, the vehicle will be decelerated and stopped within its current lane to help avoid a collision or reduce the impact of a collision.

WARNING

■ For safe use

- Driving safely is solely the responsibility of the driver. Pay careful attention to the surrounding conditions in order to ensure safe driving. The emergency driving stop system is designed to provide support in an emergency where it is difficult for the driver to continue driving, such as if they have had a medical emergency. It is not designed to support driving while drowsy or in poor physical health, or inattentive driving.
- Although the emergency driving stop system is designed to decelerate the vehicle within its lane to help avoid or help reduce the impact of a collision if the system determines that it is difficult for the driver to continue driving, its effectiveness may change according to various conditions. Therefore, it may not always be able to achieve the same level of performance. Also, if the operating conditions are not met, this function will not operate.
- After the emergency driving stop system operates, if driving becomes possible again, immediately begin driving again or, if necessary, park the vehicle on the shoulder of the road and set a warning reflector and flare to warn other drivers of your stopped vehicle.
- After this system operates, passengers should attend to the driver as necessary and take appropriate hazard prevention measures, such as moving to a place where safety can be ensured, such as the shoulder of the road or behind a guard-rail.

**WARNING**

● This system detects the condition of the driver through the operation of the steering wheel. This system may operate if the driver is aware but intentionally and continuously does not operate the vehicle. Also, the system may not operate if it cannot determine that the driver is not responsive, such as if they are leaning on the steering wheel.

Summary of the system

Operation of this system is separated into 4 control states. Through control state “warning phase 1” and “warning phase 2”, the system determines if the driver is aware and responsive while outputting a warning and controlling the vehicle speed. If the system determines the driver is not responsive, it will operate in control state “deceleration stop phase” and “stop hold phase” and decelerate and stop the vehicle. It will then operate continuously in “stop hold phase”.

■ Operating conditions

This system operates when all of the following conditions are met:

- When the LTA is on
- When the vehicle speed is approximately 30 mph (50 km/h) or more

■ Operation cancelation conditions

In the following situations, system operation will be canceled:

- When LTA control has been canceled (the LTA switch has been pressed, etc.)
- When the dynamic radar cruise control has been canceled
- When driver operations are detected (the steering wheel is held, the brake pedal, accelerator pedal, parking brake, emergency flasher switch, or turn signal lever is operated)
- When the driving assist switch is pressed while in the stop and hold phase
- When the power switch has been turned from ON mode to off
- Situations in which some or all of the functions of the system cannot operate: →P.221

■ LTA control when operation is canceled

When emergency driving stop system operation is canceled, LTA control may also be canceled.

Warning phase 1

If driving operations are not detected after the hands off steering wheel warning operates, a buzzer will sound intermittently and a message will be displayed to warn the driver, and the system will judge if the driver is responsive or not. If driving operations, such as holding the steering wheel, are not performed within a certain amount of time, the system will enter warning phase 2.

Warning phase 2

After entering warning phase 2,

a buzzer will sound in short intervals and a message will be displayed to warn the driver, and the vehicle will slowly decelerate. If driving operations, such as holding the steering wheel, are not performed within a certain amount of time, the system will determine that the driver is not responsive and enter the deceleration stop phase.

The audio system will be muted until the driver becomes responsive.

When the vehicle is decelerating, the brake lights may illuminate, depending on the road conditions, etc.

Deceleration stop phase

After entering the deceleration stop phase, a buzzer will sound continuously and a message will be displayed to warn the driver, and the vehicle will slowly decelerate and stop. After the vehicle stops, the system will enter the stop and hold phase.

Stop hold phase

After the vehicle is stopped, the parking brake will be applied automatically. After entering the stop and hold phase, the buzzer will continue sounding continuously and the emergency flashers (hazard lights) will flash to warn other drivers of the emer-

gency.

■ Restricted functions after the operation is canceled

After shifting to the deceleration stop phase, the following functions will not be available until the hybrid system is re-started even though the emergency driving stop system is canceled:

- LTA
- LCA (if equipped)

BSM (Blind Spot Monitor)*

*: If equipped

The Blind Spot Monitor is a system that uses rear side radar sensors installed on the inner side of the rear bumper on the left and right side to assist the driver in confirming safety when changing lanes.



WARNING

■ Cautions regarding the use of the system

- The driver is solely responsible for safe driving. Always drive safely, taking care to observe your surroundings.
- The Blind Spot Monitor is a supplementary function which alerts the driver that a vehicle is in a blind spot of the outside rear view mirrors or is approaching rapidly from behind into a blind spot. Do not overly rely on the Blind Spot Monitor. As the function cannot judge if it is safe to change lanes, over reliance could lead to an accident resulting in death or serious injury. As the system may not function correctly under certain conditions, the driver's own visual confirmation of safety is necessary.

System components

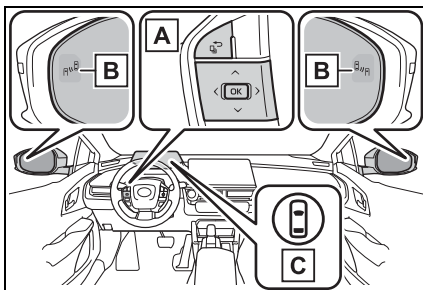

A Meter control switches

Turning the Blind Spot Monitor on/off.

B Outside rear view mirror indicators

When a vehicle is detected in a blind spot of the outside rear view mirrors or approaching rapidly from behind into a blind spot, the outside rear view mirror indicator on the detected side will illuminate. If the turn signal lever is operated toward the detected side, the outside rear view mirror indicator will flash and a buzzer will sound.

C Driving assist information indicator

Illuminates when the Blind Spot Monitor is turned off. At this time, a message will be displayed on the multi-information display.

■ Outside rear view mirror indicator visibility

In strong sunlight, the outside rear view mirror indicator may be difficult to see.

■ Buzzer

If the volume setting of the audio system is high or the surrounding area is loud, it may be difficult to

hear the buzzer.

■ Customization

Some functions can be customized.
(→P.538)



WARNING

■ To ensure the system can operate properly

Blind Spot Monitor sensors are installed behind the left and right sides of the rear bumper respectively. Observe the following to ensure the Blind Spot Monitor can operate correctly.

- Keep the sensors and the surrounding areas on the rear bumper clean at all times. If a sensor or its surrounding area on the rear bumper is dirty or covered with snow, the Blind Spot Monitor may not operate and a warning message will be displayed. In this situation, clear off the dirt or snow and drive the vehicle with the operation conditions of the BSM function (→P.278) satisfied for approximately 10 minutes. If the warning message does not disappear, have the vehicle inspected by your Toyota dealer.

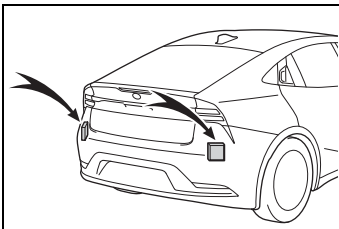

- Do not attach accessories, stickers (including transparent stickers), aluminum tape, etc. to a sensor or its surrounding area on the rear bumper.

- Do not subject a sensor or its surrounding area on the rear bumper to a strong impact. If a sensor is moved even slightly off position, the system may malfunction and vehicles may not be detected correctly. In the following situations, have your vehicle inspected by your Toyota dealer.

- A sensor or its surrounding area is subject to a strong impact.
- If the surrounding area of a sensor is scratched or dented, or part of them has become disconnected.

- Do not disassemble the sensor.
- Do not modify the sensor or surrounding area on the rear bumper.
- If a sensor or the rear bumper needs to be removed/installed or replaced, contact your Toyota dealer.
- The sensors are likely to be affected by paint on the rear bumper. If the rear bumper is not repaired correctly, the Blind Spot Monitor may not operate with a warning message displayed. If any paint repair is needed, contact your Toyota dealer.

Turning the Blind Spot Monitor on/off

The Blind Spot Monitor can be enabled/disabled on  of the multi-information display.
(→P.538)

When the Blind Spot Monitor is off, the driving assist information indicator (→P.84) will illuminate

and a message will be displayed on the multi-information display.

Each time the power switch is turned to ON, the Blind Spot Monitor is enabled.

Blind Spot Monitor operation

■ Objects that can be detected while driving

The Blind Spot Monitor uses rear side radar sensors to detect the following vehicles traveling in adjacent lanes and advises the driver of the presence of such vehicles via the indicators on the outside rear view mirrors.

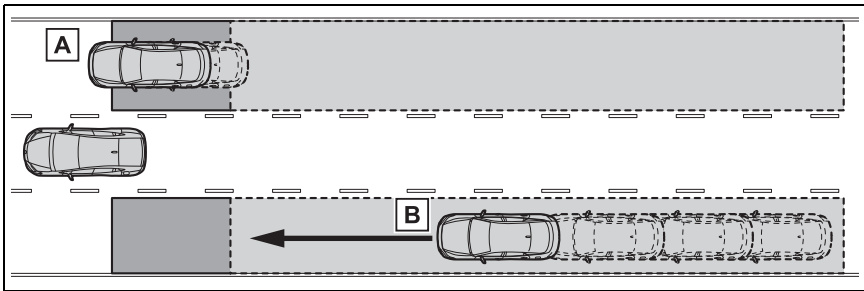

- A** Vehicles that are traveling in areas that are not visible using the outside rear view mirrors (the blind spots)
- B** Vehicles that are approaching rapidly from behind in areas that are not visible using the outside rear view mirrors (the blind spots)

■ Detection range while driving

The areas that vehicles can be detected in are outlined below.

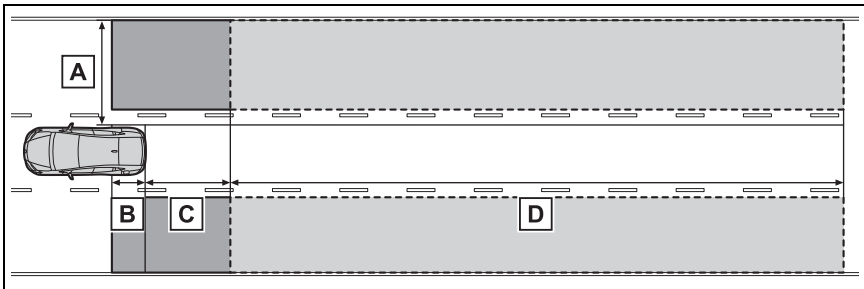

The range of each detection area is:

- A** Approximately 1.6 ft. (0.5 m) to 11.5 ft. (3.5 m) from either side of the vehicle*¹

- B** Approximately 3.3 ft. (1 m) forward of the rear bumper^{*2}
- C** Approximately 9.8 ft. (3 m) from the rear bumper
- D** Approximately 9.8 ft. (3 m) to 230 ft. (70 m) from the rear bumper^{*3}

^{*1}: The area between the side of the vehicle and 1.6 ft. (0.5 m) from the side of the vehicle cannot be detected.

^{*2}: While the vehicle is to being overtaken, up to approximately 9.8 ft. (3 m) forward of the rear bumper will be detected.

^{*3}: The greater the difference in speed between your vehicle and the detected vehicle is, the farther away the vehicle will be detected, causing the outside rear view mirror indicator to illuminate or flash.

■ The Blind Spot Monitor linked function

The LDA (Lane Departure Alert) has a function that uses information of detected vehicles driving in an adjacent lane. For details about the function and its operating conditions, P.242

■ The Blind Spot Monitor is operational when

The Blind Spot Monitor is operational when all of the following conditions are met:

- The power switch is in ON.
- The Blind Spot Monitor is on.
- The shift position is in a position other than R.
- The vehicle speed is approximately 7 mph (10 km/h) or more.

■ The Blind Spot Monitor will detect a vehicle when

The Blind Spot Monitor will detect a vehicle present in the detection area in the following situations:

- A vehicle in an adjacent lane overtakes your vehicle.
- You overtake a vehicle in an adjacent lane slowly.
- Another vehicle enters the detection area when it changes lanes.

■ Situations in which the Blind Spot Monitor cannot detect vehicles

The Blind Spot Monitor cannot detect the following vehicles and other objects:

- Small motorcycles, bicycles, pedestrians, etc.*
- Vehicles traveling in the opposite direction
- Guardrails, walls, signs, parked vehicles and similar stationary objects*
- Following vehicles that are in the same lane*
- Vehicles traveling 2 lanes away from your vehicle*
- Vehicles which are being overtaken rapidly by your vehicle.*

*: Depending on the conditions, detection of a vehicle and/or object may occur.

■ Situations in which the buzzer does not sound

In the following situations, the outside rear view mirror indicator flashes but the buzzer does not sound even when the turn signal lever is operated.

- When another vehicle is detected while the turn signal lever is being operated
- When your vehicle overtakes a vehicle in an adjacent lane with a large speed difference*

*: Depending on the conditions, the buzzer may sound.

■ Conditions under which the system may not function correctly

● The Blind Spot Monitor may not detect vehicles correctly in the following situations:

- When the sensor is misaligned due to a strong impact to the sensor or its surrounding area
- When mud, snow, ice, a sticker, etc. is covering the sensor or surrounding area on the rear bumper
- When driving on a road surface that is wet with standing water during bad weather, such as heavy rain, snow, or fog
- When multiple vehicles are approaching with only a small gap between each vehicle
- When the distance between your vehicle and a following vehicle is short
- When there is a significant difference in speed between your vehicle and the vehicle that enters the detection area
- When the difference in speed between your vehicle and another vehicle is changing
- When a vehicle enters a detection area traveling at about the same speed as your vehicle
- As your vehicle starts from a stop, a vehicle remains in the detection area
- When driving up and down con-

secutive steep inclines, such as hills, dips in the road, etc.

- When driving on roads with sharp bends, consecutive curves, or uneven surfaces
- When vehicle lanes are wide, or when driving on the edge of a lane, and the vehicle in an adjacent lane is far away from your vehicle
- When an accessory (such as a bicycle carrier) is installed to the rear of the vehicle
- When there is a significant difference in height between your vehicle and the vehicle that enters the detection area
- Immediately after the Blind Spot Monitor is turned on
- When towing with the vehicle
- Instances of the Blind Spot Monitor unnecessarily detecting a vehicle and/or object may increase in the following situations:
 - When the sensor is misaligned due to a strong impact to the sensor or its surrounding area
 - When the distance between your vehicle and a guardrail, wall, etc. that enters the detection area is short
 - When driving up and down consecutive steep inclines, such as hills, dips in the road, etc.
 - When vehicle lanes are narrow, or when driving on the edge of a lane, and a vehicle traveling in a lane other than the adjacent lanes enters the detection area
 - When driving on roads with sharp bends, consecutive curves, or uneven surfaces
 - When the tires are slipping or spinning
 - When the distance between your vehicle and a following vehicle is short
 - When an accessory (such as a bicycle carrier) is installed to the rear of the vehicle
 - When towing with the vehicle

Safe Exit Assist*

*: If equipped

The safe exit assist is a system that uses rear side radar sensors installed on the inner side of the rear bumper to help occupants judge if an approaching vehicle or bicycle may collide with a door when exiting, to help reduce the possibility of a collision.

WARNING

■ Cautions regarding the use of the system

- The driver is solely responsible for safe driving. Always drive safely, taking care to observe your surroundings.
- The safe exit assist is a supplementary system that, when the vehicle is stopped, informs occupants of the existence of approaching vehicles and bicycles. As this system alone cannot be used to judge safety, over-reliance on this system may lead to an accident resulting in death or serious injury.

In certain situations, this system may not function to its fullest extent. Therefore it is necessary for the occupants to visually check for safety directly and using the mirrors.

System components

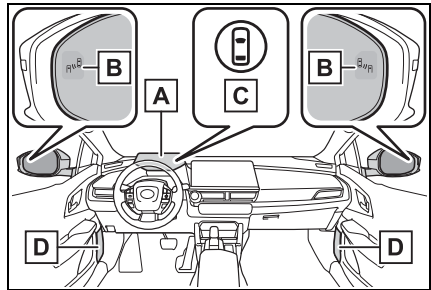

A Multi-information display

Turning the safe exit assist on/off. If collision with a door is likely and the door is opened, the door will be displayed on the multi-information display. Also, if a door is opened when an outside rear view mirror indicator is illuminated, a buzzer will sound as a warning.

B Outside rear view mirror indicators

When a vehicle or bicycle which may collide with a door (other than the back door) when opened is detected, the outside rear view mirror indicator on the detected side will illuminate. If the door on the detected side is opened, the outside rear view mirror indicator will blink.

C Driving assist information indicator

Illuminates when the safe exit assist is turned off. At this time, a message will be displayed on the multi-information display.

D Speakers (voice notifications*)

When the outside rear view mirror indicator blinks, the driver is

informed through voice guidance that the system has operated. After the notification through voice guidance is made, no more voice guidance notifications will be made again until the door is fully closed.

*: If equipped

■ Outside rear view mirror indicator visibility

In strong sunlight, the outside rear view mirror indicator may be difficult to see.

■ Buzzer

If the volume setting of the audio system is high or the surrounding area is loud, it may be difficult to hear the buzzer.

■ Voice notifications (if equipped)

In the following situations, voice notifications will not be output:

- When it is estimated that no occupants are on board*
- After opening a door and entering the vehicle, until the hybrid system is started
- When 3 minutes or more have elapsed since the hybrid system was stopped
- When the language setting of the Multimedia Display has been set to a language that does not support voice notifications
- When all of the doors have been locked from outside the vehicle
- When a door remains open for 1 minute or more after the hybrid system is stopped
- When the ACC mode (→P.538) has been enabled through a cus-

tomize setting on the Multimedia Display and the hybrid system has been stopped

- When the parking assist volume setting on the Multimedia Display has been set to off

*: For each seating position, judgment is made based on the opening and closing of a door, before driving for ingress and after driving for egress.

■ Customization

Some functions can be customized. (→P.538)

WARNING

■ To ensure the system can operate properly

→P.276

Turning the safe exit assist system ON/OFF

The safe exit assist can be enabled/disabled on  of the multi-information display. (→P.538)

When the safe exit assist is off, the driving assist information indicator will illuminate and a message will be displayed on the multi-information display.

Each time the power switch is turned to ON, the safe exit assist is enabled.

Safe exit assist operation

■ Objects that can be detected by the safe exit assist

When the safe exit assist detects the following vehicles or bicycles

behind your vehicle using a rear side radar sensor, the occupants of the vehicle are informed through an outside rear view mirror indicator, buzzer, multi-information display, and voice notification (if equipped).

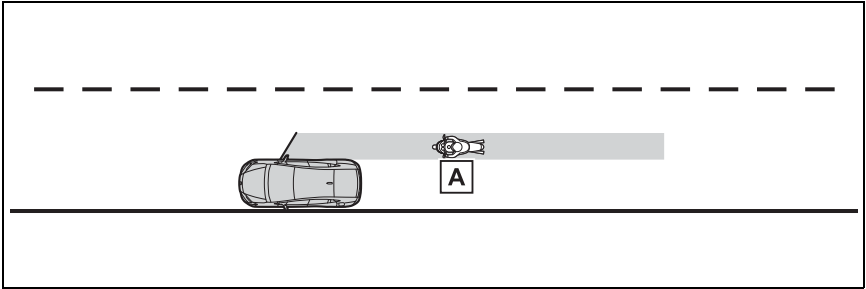

A Vehicle or bicycle which has a high possibility of colliding with a door (other than the back door) when opened

■ The safe exit assist detection areas

The areas that vehicles can be detected in are outlined below.

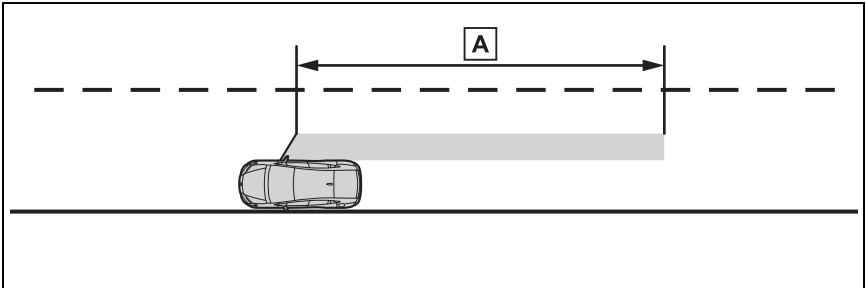

A Approximately 145 ft. (45 m) rearward from the front door*

*: The faster a vehicle or bicycle is approaching, the distance at which an outside rear view mirror indicator will illuminate or blink will become further.

■ The safe exit assist is operational when

The safe exit assist is operational when all of the following conditions are met:

- When the power switch is ON, less than 3 minutes have elapsed since the hybrid system was off, or less than 3 minutes have elapsed since a door was opened and

someone has entered the vehicle (the time which operation is possible may be extended if a door is opened and closed)

- Safe exit assist is on
- The vehicle is stopped.
- The shift position is in a position other than R.

■ The safe exit assist will detect a vehicle when

The safe exit assist will detect a vehicle present in the detection area in the following situations:

- When the vehicle is stopped and a vehicle or bicycle, which is traveling parallel to the vehicle, is approaching within the area that a door opens (other than the back door)

■ Conditions under which the system will not detect a vehicle

- Safe exit assist does not detect the following objects, vehicles, and bicycles:
 - Vehicles or bicycles which are approaching slowly*
 - Vehicles or bicycles which are determined to have a low possibility of colliding with a door (other than the back door) when opened*
 - Vehicles or bicycles which are approaching from directly behind*
 - Vehicles or bicycles which are approaching from the front*
 - Guardrails, walls, signs, parked vehicles, and other stationary objects*
 - Pedestrians, animals, etc.*
- *: Depending on the conditions, detection of a vehicle and/or object may occur.

- In situations such as the following, safe exit assist will not operate:

- When 3 minutes or more have elapsed since the hybrid system off (the time which operation is possible may be extended if a door is opened and closed)
- When your vehicle is not completely stopped

■ Conditions under which the system may not function correctly

- The safe exit assist may not detect vehicles correctly in the following situations:

- When the sensor is misaligned due to a strong impact to the sensor or its surrounding area
 - When mud, snow, ice, a sticker, etc. is covering the sensor or surrounding area on the rear bumper
 - When the vehicle is stopped on a wet road surface, such as in a puddle, while in inclement weather, such as heavy rain, snow, fog, etc.
 - When a vehicle or bicycle approaches from behind a nearby parked vehicle
 - When an approaching vehicle or bicycle suddenly changes direction
 - Immediately after a vehicle or bicycle starts moving
 - When the back door is open
 - When a bicycle carrier, ramp, or other accessory is installed to the back of the vehicle
 - When a parked vehicle, wall, sign, person or other stationary object is behind the vehicle
 - When the vehicle is stopped at an angle to the road
 - When a vehicle is traveling near an approaching vehicle or bicycle
 - When an approaching vehicle or bicycle is traveling along a stationary object, such a wall or sign
 - When a vehicle or bicycle is approaching at high speed
 - When towing with the vehicle
 - When stopped on a steep slope
 - When stopped on a curve or at the exit of a curve
- Instances of the safe exit assist unnecessarily detecting a vehicle and/or object may increase in the following situations:
 - When the sensor is misaligned due to a strong impact to the sensor or its surrounding area
 - When a vehicle or bicycle approaches from behind your vehicle at an angle
 - When the vehicle is stopped at an angle to the road
 - When a vehicle or bicycle approaches from behind a parked vehicle at an angle

- When a parked vehicle, wall, sign, person or other stationary object is behind the vehicle
- When an approaching vehicle or bicycle suddenly changes direction
- When an approaching vehicle or bicycle is traveling along a stationary object, such a wall or sign
- When the back door is open
- When a bicycle carrier, ramp, or other accessory is installed to the back of the vehicle
- When a vehicle or bicycle is approaching at high speed
- When towing with the vehicle
- When stopped on a steep slope
- When stopped on a curve or at the exit of a curve

Intuitive parking assist

The distance from your vehicle to objects, such as a wall, when parallel parking or maneuvering into a garage is measured by the sensors and communicated via the Multimedia Display and a buzzer. Always check the surrounding area when using this system.

System components

■ Types of sensors

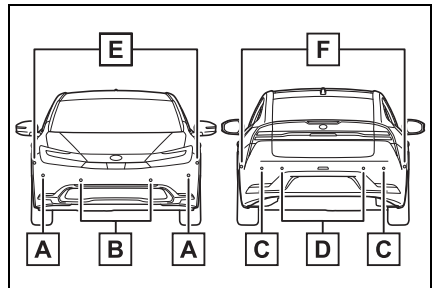

- A** Front corner sensors
- B** Front center sensors
- C** Rear corner sensors
- D** Rear center sensors
- E** Front side sensors *
- F** Rear side sensors *

*: Vehicles with Advanced Park

■ Display

When the sensors detect an object, such as a wall, a graphic is shown on the Multimedia Dis-

play depending on the position and distance to the object.

Display example:

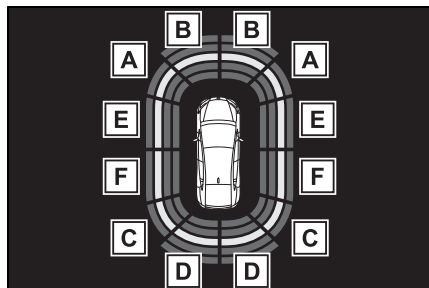

- A** Front corner sensor detection
- B** Front center sensor detection
- C** Rear corner sensor detection
- D** Rear center sensor detection
- E** Front side sensor detection *
- F** Rear side sensor detection *

*: Vehicles with Advanced Park

Turning the intuitive parking assist on/off

The intuitive parking assist can be enabled/disabled on  of the multi-information display. (→P.96)

When the intuitive parking assist function is disabled, the intuitive parking assist OFF indicator (→P.84) illuminates.

To re-enable the system, select  on the multi-information display, select the intuitive parking assist and turn it on. If the system is disabled, it will remain off

even if the power switch is turned to ON after the power switch has been turned off.

WARNING

■ Cautions regarding the use of the system

There is a limit to the degree of recognition accuracy and control performance that this system can provide, do not overly rely on this system. The driver is always responsible for paying attention to the vehicle's surroundings and driving safely.

■ To ensure the system can operate properly

Make sure to observe the following precautions. The system may not operate properly and may lead to an unexpected accident. When these precautions cannot be observed, turn the system off.

- Do not damage the sensors, and always keep them clean.
- Do not attach a sticker or install an electronic component, such as a backlit license plate (especially fluorescent type), fog lights, fender pole or wireless antenna near a radar sensor.
- Do not subject the surrounding area of the sensor to a strong impact. If subjected to an impact, have the vehicle inspected by your Toyota dealer. If the front or rear bumper needs to be removed/installed or replaced, contact your Toyota dealer.
- Do not modify, disassemble or paint the sensors.
- Do not attach a license plate cover.

**WARNING**

- Keep your tires properly inflated.
 - A non-genuine Toyota suspension (lowered suspension, etc.) is installed.
- Notes when washing the vehicle**
- Do not apply intensive bursts of water or steam to the sensor area. Doing so may result in the sensor malfunctioning.
- When using a high pressure washer to wash the vehicle, do not spray the sensors directly, as doing so may cause a sensor to malfunction.
 - When using steam to clean the vehicle, do not direct steam too close to the sensors as doing so may cause a sensor to malfunction.

■ The system can be operated when

- The power switch is in ON.
- The intuitive parking assist function is on.
- The vehicle speed is less than about 6 mph (10 km/h).
- The shift position is in a position other than P.

■ If “Parking Assist Unavailable Sensor Blocked” is displayed on the multi-information display

A sensor may be covered with ice, snow, dirt, etc. Remove the ice, snow, dirt, etc., from the sensor to return the system to normal.

Also, due to ice forming on a sensor at low temperatures, a warning message may be displayed or the sensor may not be able to detect an object. Once the ice melts, the system will return to normal.

If an abnormality is displayed even though there are no water droplets, ice, snow or dirt, the sensor may be operating abnormally. Have the vehicle inspected by your Toyota dealer.

■ If “System Stopped See Owner’s Manual” is displayed on the multi-information display

Water may be continuously flowing over the sensor surface, such as in a heavy rain. When the system determines that it is normal, the system will return to normal.

■ If “System Malfunction Visit Your Dealer” is displayed on the multi-information display

There may be a sensor or voltage malfunction. Have the vehicle inspected by your Toyota dealer.

■ Sensor detection information

- The sensor’s detection areas are limited to the areas around the vehicle’s front and rear bumpers.
- Certain vehicle conditions and the surrounding environment may affect the ability of a sensor to correctly detect an object.
- Objects may not be detected if they are too close to the sensor.
- There will be a short delay between object detection and display. Even at low speeds, there is a possibility that the object will come within the sensor’s detection areas before the display is shown and the warning beep sounds.
- It might be difficult to hear the buzzer due to the volume of the audio system or air flow noise of the air conditioning system.
- It may be difficult to hear the buzzer if buzzers for other systems are sounding.
- If the meter malfunctions, the buzzer may not sound.

■ Objects which the system may not properly detect

The shape of the object may prevent the sensor from detecting it. Pay particular attention to the following objects:

- Wires, fences, ropes, etc.
- Cotton, snow and other materials that absorb sound waves
- Sharply-angled objects
- Low objects
- Tall objects with upper sections projecting outwards in the direction of your vehicle

People may not be detected if they are wearing certain types of clothing.

■ Situations in which the system may not operate properly

Certain vehicle conditions and the surrounding environment may affect the ability of a sensor to correctly detect objects. Particular instances where this may occur are listed below.

- There is dirt, snow, water drops or ice on a sensor. (Cleaning the sensors will resolve this problem.)
- A sensor is frozen. (Thawing the area will resolve this problem.) In especially cold weather, if a sensor is frozen the sensor display may be displayed abnormally, or objects, such as a wall, may not be detected.
- When a sensor or the area around a sensor is extremely hot or cold.

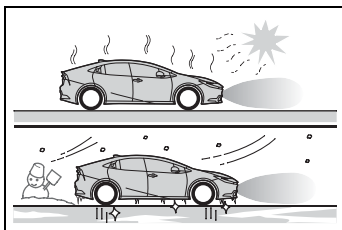

- On an extremely bumpy road, on an incline, on gravel, or on grass.

- When vehicle horns, vehicle detectors, motorcycle engines, air brakes of large vehicles, the clearance sonar of other vehicles or other devices which produce ultrasonic waves are near the vehicle.
- A sensor is coated with a sheet of spray or heavy rain.
- If objects draw too close to the sensor.
- When a pedestrian is wearing clothing that does not reflect ultrasonic waves (ex. skirts with gathers or frills).
- When objects that are not perpendicular to the ground, not perpendicular to the vehicle traveling direction, uneven, or waving are in the detection range.
- When strong winds are blowing.
- When driving in inclement weather such as fog, snow or a sandstorm.
- When an object that cannot be detected is between the vehicle and a detected object.
- If an object such as a vehicle, motorcycle, bicycle or pedestrian cuts in front of the vehicle or runs out from the side of the vehicle.
- If the orientation of a sensor has been changed due to a collision or other impact.
- When equipment such as a towing eyelet, transport hook, bumper protector, bumper trim, bicycle carrier or snow-removal device (snow plow) is installed near the sensor.
- If the front of the vehicle is raised or lowered due to the carried load.
- If the vehicle cannot be driven in a stable manner, such as when the vehicle has been in an accident or is malfunctioning.
- When tire chains, a compact spare tire or an emergency tire puncture repair kit are used.

■ **Situations in which the system may operate even if there is no possibility of a collision**

In some situations, such as the following, the system may operate even though there is no possibility of a collision.

- When driving on a narrow road.

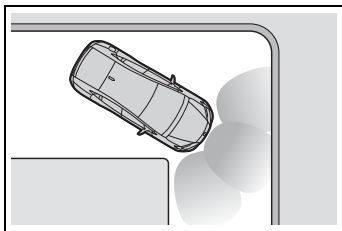

- When driving toward a banner, flag, low-hanging branch or boom barrier (such as those used at railroad crossings, toll gates and parking lots).
- When there is a rut or hole in the surface of the road.
- When driving on a metal cover (grating), such as those used for drainage ditches.
- When driving up or down a steep slope.
- If a sensor is hit by a large amount of water, such as when driving on a flooded road.
- There is dirt, snow, water drops or ice on a sensor. (Cleaning the sensors will resolve this problem.)
- A sensor is coated with a sheet of spray or heavy rain.
- When driving in inclement weather such as fog, snow or a sandstorm.
- When strong winds are blowing.

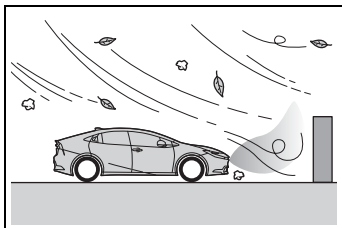

- When vehicle horns, vehicle detectors, motorcycle engines, air brakes of large vehicles, the clearance sonar of other vehicles or other devices which produce ultrasonic waves are near the vehicle.
- If the front of the vehicle is raised or lowered due to the carried load.
- If the orientation of a sensor has been changed due to a collision or other impact.
- The vehicle is approaching a tall or curved curb.
- Driving close to columns (H-shaped steel beams, etc.) in multi-story parking garages, construction sites, etc.
- If the vehicle cannot be driven in a stable manner, such as when the vehicle has been in an accident or is malfunctioning.
- On an extremely bumpy road, on an incline, on gravel, or on grass.

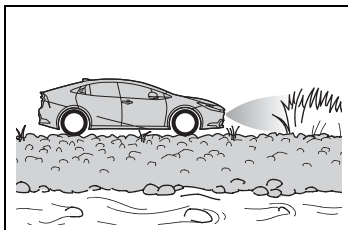

- When tire chains, a compact spare tire or an emergency tire puncture repair kit are used.

Sensor detection display, object distance

■ Detection range of the sensors

- ▶ Vehicles without Advanced Park

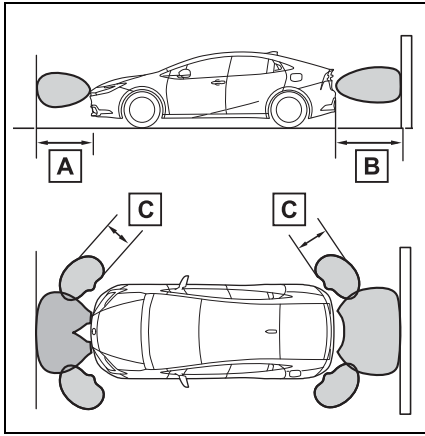

- A** Approximately 3.3 ft. (100 cm)
- B** Approximately 4.9 ft. (150 cm)
- C** Approximately 2.0 ft. (60 cm)

The diagram shows the detection range of the sensors. Note that the

■ The distance and buzzer

- ▶ Vehicles without Advanced Park

Approximate distance to obstacle	Buzzer
Front center sensor: Approximately 3.3 ft. (100 cm) to 2.0 ft. (60 cm)*	Slow
Rear center sensor: Approximately 4.9 ft. (150 cm) to 2.0 ft. (60 cm)*	
Approximately 2.0 ft. (60 cm) to 1.5 ft. (45 cm)*	Medium

sensors cannot detect objects that are extremely close to the vehicle. The range of the sensors may change depending on the shape of the object, etc.

- ▶ Vehicles with Advanced Park

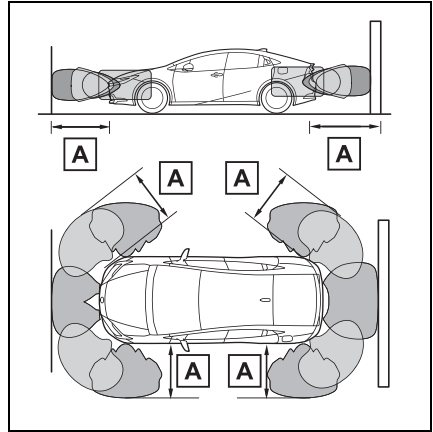

- A** Approximately 6.6 ft. (200 cm)

The diagram shows the detection range of the sensors. Note that the sensors cannot detect objects that are extremely close to the vehicle.

The range of the sensors may change depending on the shape of the object etc.

Approximate distance to obstacle	Buzzer
Approximately 1.5 ft. (45 cm) to 1.0 ft. (30 cm)*	Fast
Approximately 1.0 ft. (30 cm) to 0.5 ft. (15 cm)	Continuous
Less than approximately 0.5 ft. (15 cm)	

*: Automatic buzzer mute function is enabled. (→P.291)

► Vehicles with Advanced Park

Approximate distance to obstacle	Buzzer
Front center sensor: Approximately 6.6 ft. (200 cm) to 3.3 ft. (100 cm) Rear center sensor: Approximately 6.6 ft. (200 cm) to 4.9 ft. (150 cm) Corner sensor: Approximately 6.6 ft. (200 cm) to 2.0 ft. (60 cm) Side sensor: Approximately 6.6 ft. (200 cm) to 5.4 ft. (165 cm)	Does not sound (Display only)
Front center sensor: Approximately 3.3 ft. (100 cm) to 2.0 ft. (60 cm)* Rear center sensor: Approximately 4.9 ft. (150 cm) to 2.0 ft. (60 cm)* Side sensor: Approximately 5.4 ft. (165 cm) to 2.0 ft. (60 cm)*	Slow
Except side sensor: Approximately 2.0 ft. (60 cm) to 1.5 ft. (45 cm)* Side sensor: Approximately 2.0 ft. (60 cm) to 1.3 ft. (40 cm)*	Medium
Except side sensor: Approximately 1.5 ft. (45 cm) to 1.0 ft. (30 cm)* Side sensor: Approximately 1.3 ft. (40 cm) to 1.0 ft. (30 cm)*	Fast

Approximate distance to obstacle	Buzzer
Approximately 1.0 ft. (30 cm) to 0.5 ft. (15 cm)	Continuous
Less than approximately 0.5 ft. (15 cm)	

*: Automatic buzzer mute function is enabled. (→P.291)

■ Buzzer operation and distance to an object

A buzzer sounds when the sensors are operating.

- The buzzer beeps faster as the vehicle approaches a static object. When the vehicle comes within the approximately 1.0 ft. (30 cm) of the static object, the buzzer will sound continuously.
- When 2 or more sensors simultaneously detect a static object, the buzzer sounds for the nearest object.
- After a buzzer begins sounding, if the distance between the vehicle and the detected a static object does not become shorter, the buzzer will be muted automatically. (automatic buzzer mute function)

■ Adjusting the buzzer volume

The buzzer volume of the intuitive parking assist, RCTA (if equipped), and RCD (if equipped) can be adjusted all together on  of the multi-information display. (→P.538)

■ Muting a buzzer temporarily

- When an object is detected, the temporary mute switch is displayed on the Multimedia Display. Select the switch to mute a buzzer of the intuitive parking assist, RCTA (if equipped), and RCD (if equipped) all together.
- Mute will be automatically canceled in the following situations.
 - When the shift position is changed.
 - When the vehicle speed exceeds a certain speed.
 - When there is a malfunction in a sensor or the system is temporarily unavailable.
 - When the operating function is disabled manually.
 - When the power switch is turned off.

Intuitive parking assist object warning function (vehicles with Advanced Park)

The object warning function informs the driver of the existence of objects along the side of the vehicle, using a display and buzzer, if the objects are within the estimated path of the vehicle.

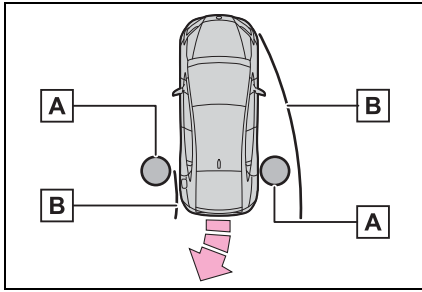

A Object

B Calculated vehicle route

When the vehicle is moving, the side sensors or side cameras can detect objects. While the vehicle is moving, if a detected object can no longer be detected by the side sensors or side cameras, the location of the object relative to the vehicle is estimated. If the object is determined to be in the estimated path of the vehicle, the object warning function will operate.

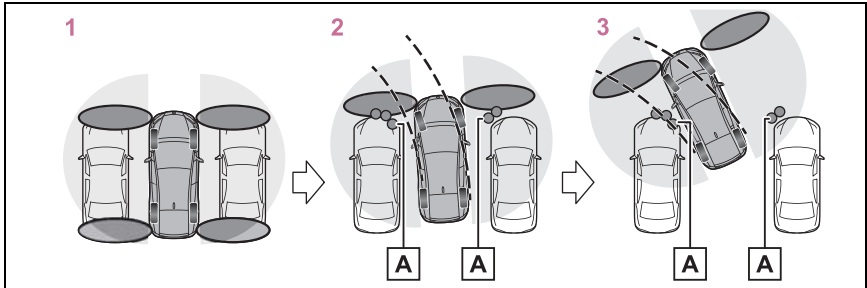

A Object detected by side sensors or side cameras

- 1 The vehicle is stopped and objects along the sides of the vehicle are not detected.
- 2 Objects are detected as the vehicle is moving.
- 3 Even though the objects are outside of the detection area of the side sensors or side cameras, a warning is displayed and a buzzer sounds.

■ The intuitive parking assist object warning function is operational when

- The vehicle moves about 23.0 ft. (7 m) after the hybrid system is started.
- The R shift position is selected.
- After the shift position has been changed from R to D, the vehicle

has moved approximately 23.0 ft. (7 m) or less

-  switch has been pressed and the Multimedia Display is displayed.
- The front or rear sensor detects a stationary object.

■ Detection of objects along the sides of the vehicle

- Objects along the sides of the vehicle are not instantaneously detected. The location of objects in relation to the vehicle is estimated after they are first detected by the front or rear side sensors, or side cameras. Therefore, after the power switch is changed to ON, even if an object is along the side of the vehicle, it may not be detected until the vehicle has been driven a small amount and the side sensors or side cameras completely scan the areas along the sides of the vehicle.
- If a vehicle, person, animal, etc., is detected by a side sensors or side cameras, but then leaves the detection area of the side sensors or side cameras, the system will assume the object has not moved.



WARNING

■ Side sensors and side cameras

In situations such as the following, the function may not operate correctly, possibly leading to an accident. Proceed carefully.

- When starting off shortly after the power switch is turned to ON and a small vehicle or other object which cannot be detected by a front side sensor is next to the vehicle.

In the situation shown in the following illustration, even if the vehicle starts off, the vehicle on the left will not be detected and the object warning function will not operate.

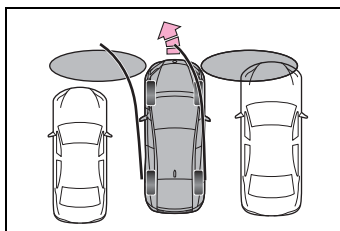

- When an object or person is in a position which cannot be detected by the side sensors or side cameras.
- When, after the side sensors have completed scanning the areas along the sides of the vehicle, a vehicle, person, or other object approaches the side of the vehicle and cannot be detected.
- When the outside rear view mirror is closed, the side sensors or side cameras cannot detect objects.
- If the 12-volt battery was discharged or has been removed and installed, fold and extend the outside rear view mirrors.

RCTA (Rear Cross Traffic Alert) function *

*: If equipped

The RCTA function uses the BSM rear side radar sensors installed behind the rear bumper. This function is intended to assist the driver in checking areas that are not easily visible when backing up.

⚠ WARNING

■ Cautions regarding the use of the system

The driver is solely responsible for safe driving. Always drive safely, taking care to observe your surroundings.

The RCTA function is only a supplementary function which alerts the driver that a vehicle is approaching from the right or left at the rear of the vehicle.

As the RCTA function may not function correctly under certain conditions, the driver's own visual confirmation of safety is necessary.

Over reliance on this function may lead to an accident resulting death or serious injury.

■ To ensure the system can operate properly

→P.276

System components

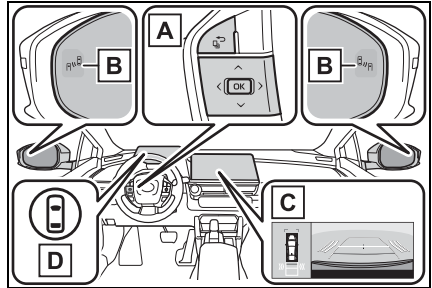

A Meter control switches

Operate the meter control switches to enable/disable the RCTA function on the multi-information display.

B Outside rear view mirror indicators

If a vehicle is detected as approaching from the left or right behind the vehicle, both outside rear view mirror indicators will blink and a buzzer will sound.

C Multimedia Display

If a vehicle approaching from the right or left at the rear of the vehicle is detected, the RCTA icon (→P.295) for the detected side will be displayed on the Multimedia Display. This illustration* shows an example of a vehicle approaching from both sides of the vehicle.

*: Depending on the vehicle grade and equipped options, the actual screen may be different from this illustration.

D Driving assist information indicator

Illuminates when the RCTA is turned off. At this time, a message will be displayed on the multi-infor-

mation display.

Turning the RCTA function on/off

The RCTA can be enabled/disabled on  of the multi-information display. (→P.538)

When the RCTA function is off, the driving assist information indicator (→P.84) will illuminate and a message will be displayed on the multi-information display. Each time the power switch is turned to ON, the RCTA function is enabled.

■ Outside rear view mirror indicator visibility

In strong sunlight, the outside rear view mirror indicator may be difficult to see.

■ Hearing the RCTA buzzer

The RCTA buzzer may be difficult to hear over loud noises, such as if the audio system volume is high.

■ Rear side radar sensors

→P.276

RCTA function

■ Operation of the RCTA function

The RCTA function uses rear side radar sensors to detect vehicles approaching from the right or left at the rear of the vehicle and alerts the driver of the presence of such vehicles by flashing the outside rear view mirror indicators and sounding a

buzzer.

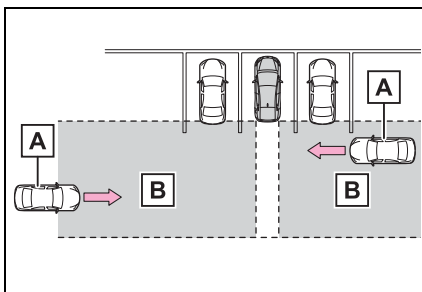

A Approaching vehicles

B Detection areas of approaching vehicles

■ RCTA icon display

When a vehicle approaching from the right or left at the rear of the vehicle is detected, the following will be displayed on the Multimedia Display.

- Example: Vehicles are approaching from both sides of the vehicle

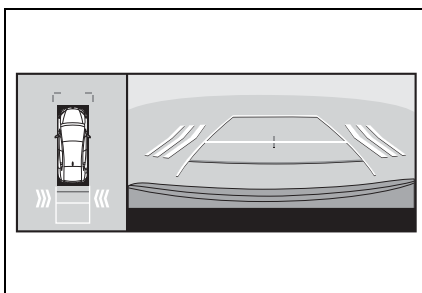

■ RCTA function detection areas

The areas that vehicles can be detected in are outlined below.

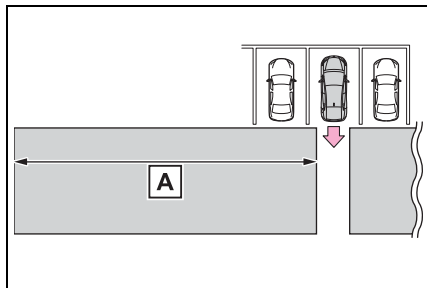

The buzzer can alert the driver of faster vehicles approaching from farther away.

Example:

Approaching vehicle speed	A Approximate alert distance
34 mph (56 km/h) (fast)	98 ft. (30 m)
5 mph (8 km/h) (slow)	13 ft. (4 m)

■ The RCTA function is operational when

The RCTA function operates when all of the following conditions are met:

- The power switch is ON.
- The RCTA function is on.
- The shift position is in R.
- The vehicle speed is less than approximately 9 mph (15 km/h).
- The approaching vehicle speed is between approximately 5 mph (8 km/h) and 34 mph (56 km/h).

■ Setting the buzzer volume

The buzzer volume can be adjusted on the multi-information display.

The buzzer volume of the RCTA, intuitive parking assist, and RCD (if equipped) can be adjusted all

together on  of the multi-informa-

tion display. (→P.538)

■ Muting a buzzer temporarily

When an object is detected, the temporary mute switch is displayed on the Multimedia Display.

Select the switch to mute the buzzer of the intuitive parking assist, RCTA, and RCD (if equipped) all together.

Mute will be canceled automatically in the following situations:

- When the shift position is changed.
- When the vehicle speed exceeds a certain speed.
- When there is a malfunction in a sensor or the system is temporarily unavailable.
- When the operating function is disabled manually.
- When the power switch is turned off.

■ Conditions under which the system will not detect a vehicle

The RCTA function is not designed to detect the following types of vehicles and/or objects:

- Vehicles approaching from directly behind
- Vehicles backing up in a parking space next to your vehicle
- Vehicles that the sensors cannot detect due to obstructions

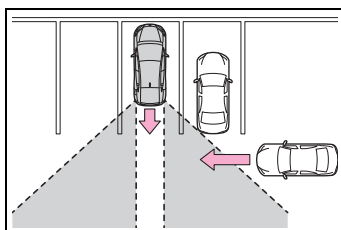

- Guardrails, walls, signs, parked vehicles and similar stationary objects*
- Small motorcycles, bicycles, pedestrians, etc.*

- Vehicles moving away from your vehicle
- Vehicles approaching from the parking spaces next to your vehicle*
- The distance between the sensor and approaching vehicle gets too close

*: Depending on the conditions, detection of a vehicle and/or object may occur.

■ Situations in which the system may not operate properly

The RCTA function may not detect vehicles correctly in the following situations:

- When the sensor is misaligned due to a strong impact to the sensor or its surrounding area
- When mud, snow, ice, a sticker, etc., is covering the sensor or surrounding area on the position above the rear bumper
- When driving on a road surface that is wet with standing water during bad weather, such as heavy rain, snow, or fog
- When multiple vehicles are approaching with only a small gap between each vehicle
- When a vehicle is approaching at high speed
- When equipment that may obstruct a sensor is installed, such as a towing eyelet, bumper protector (an additional trim strip, etc.), bicycle carrier, or snow plow
- When backing up on a slope with a sharp change in grade

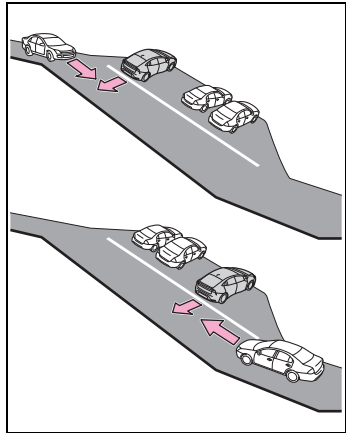

- When backing out of a sharp angle parking spot

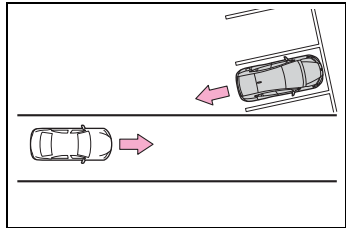

- Immediately after the RCTA function is turned on
- Immediately after the hybrid system is started with the RCTA function on
- When the sensors cannot detect a vehicle due to obstructions
- When towing with the vehicle
- When there is a significant difference in height between your vehicle and the vehicle that enters the detection area
- When a sensor or the area around a sensor is extremely hot or cold
- If the suspension has been modified or tires of a size other than specified are installed
- If the front of the vehicle is raised or lowered due to the carried load
- When turning while backing up

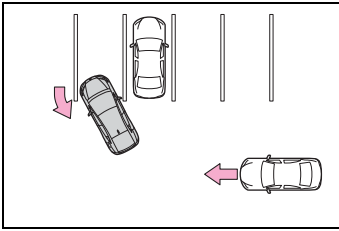

- When a vehicle turns into the detection area

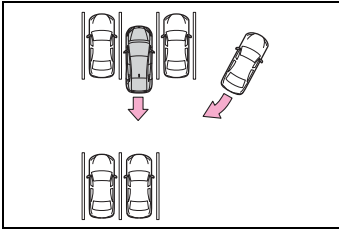

■ **Situations in which the system may operate even if there is no possibility of a collision**

Instances of the RCTA function unnecessarily detecting a vehicle and/or object may increase in the following situations:

- When the parking space faces a street and vehicles are being driven on the street

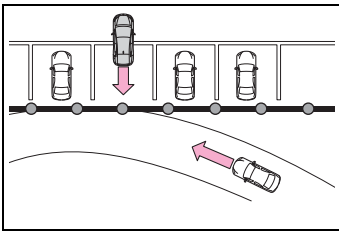

- When the distance between your vehicle and metal objects, such as a guardrail, wall, sign, or parked vehicle, which may reflect electrical waves toward the rear of the vehicle, is short

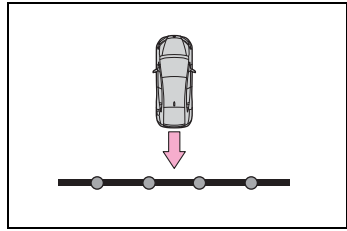

- When equipment that may obstruct a sensor is installed, such as a towing eyelet, bumper protector (an additional trim strip, etc.), bicycle carrier, or snow plow
- When a vehicle passes by the side of your vehicle

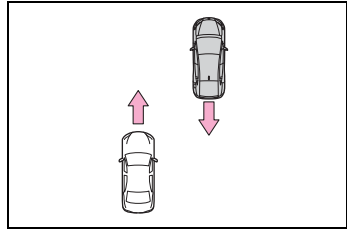

- When a detected vehicle turns while approaching the vehicle

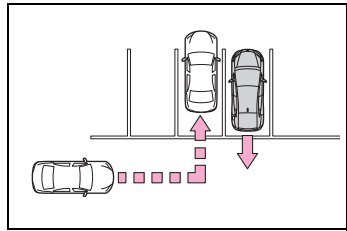

- When there are spinning objects near your vehicle such as the fan of an air conditioning unit
- When water is splashed or sprayed toward the rear bumper, such as from a sprinkler
- Moving objects (flags, exhaust fumes, large rain droplets or snowflakes, rain water on the road surface, etc.)
- When the distance between your vehicle and a guardrail, wall, etc., that enters the detection area is short
- Gratings and gutters

- When a sensor or the area around a sensor is extremely hot or cold
- If the suspension has been modified or tires of a size other than specified are installed
- If the front of the vehicle is raised or lowered due to the carried load
- When towing with the vehicle

RCD (Rear Camera Detection) function *

*: If equipped

When the vehicle is backing up, the rear camera detection function can detect pedestrians in the detection area behind the vehicle. If a pedestrian is detected, a buzzer will sound and an icon will be displayed on the Multimedia Display to inform the driver of the pedestrian.



WARNING

■ Cautions regarding the use of the system

The recognition and control capabilities for this system are limited.

The driver should always drive safely by always being responsible without over relying on the system and have a understanding of the surrounding situations.

■ To ensure the system can operate properly

Observe the following, otherwise there is the danger that could lead to an accident.

- Always clean the camera without damaging it.
- Do not install market electronic parts (such as illuminated license plate, fog lamps, etc.) in the camera vicinity.

WARNING

- Do not subject the camera vicinity to strong impacts. If the vicinity is subjected to a strong impact, have the vehicle inspected by your Toyota dealer.
- Do not disassemble, remodel or paint the camera.
- Do not attach accessories or stickers to the camera.
- Do not install market protection parts (bumper trim, etc.) to the rear bumper.
- Maintain suitable tire air pressure.
- Make sure the back door is completely closed.

■ RCD function is turned off

In the following situations the system turns off. The RCD function may not operate properly and thus there is the danger that an accident may occur.

- The contents mentioned above are not observed.
- Suspensions other than genuine parts are installed.

System components

■ Location of the rear camera

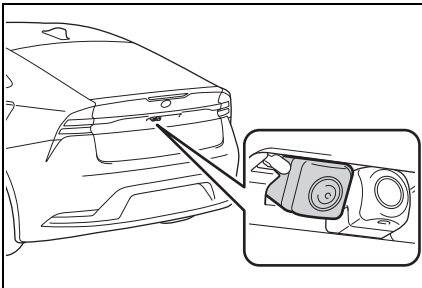

Depending on the vehicle grade and equipped options, the actual rear camera may be different from this illustration.

RCD display

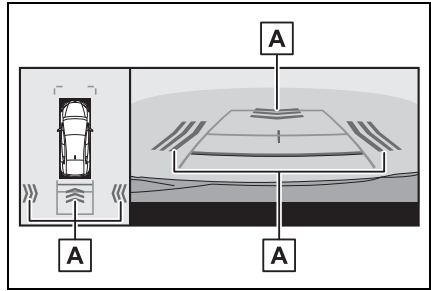

A Pedestrian detection icon

Displayed automatically when a pedestrian is detected behind the vehicle.

Turning the RCD function on/off

The RCD function can be enabled/disabled on  of the multi-information display. (→P.538)

When the RCD function is disabled, the driving assist information indicator (→P.84) illuminates, and a message is displayed on the multi-information display.

Each time the power switch is turned off then changed to ON, the RCD function will be enabled automatically.

When a pedestrian is detected

If a pedestrian is in the area behind the vehicle or if the rear camera detected that a pedestrian is approaching the vehicle from behind, the system urges caution from the driver by sounding the buzzer and displaying the detection of a pedestrian on the Multimedia Display as follows:

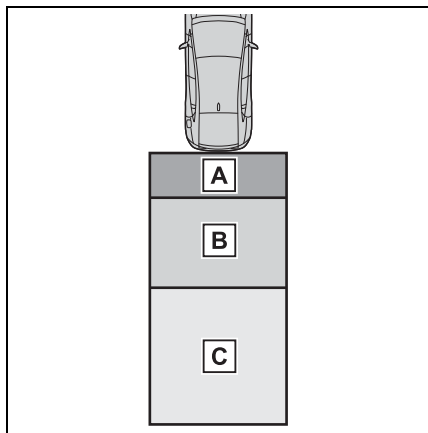

A If a pedestrian is detected in area **A**

Buzzer: Sounds repeatedly

Pedestrian detection icon: Blinks

Blinks

B If a pedestrian is detected in area **B**

Buzzer (When the vehicle is stationary): Sounds 3 times

Buzzer (When the vehicle is backing up, when a pedestrian approaches the rear of the vehicle): Sounds repeat-

edly

edly

Pedestrian detection icon: Blinks

Blinks

C If the system determines that your vehicle may collide with a pedestrian in area **C**

Buzzer: Sounds repeatedly

Pedestrian detection icon: Blinks

Blinks

Blinks

■ The rear camera detection function is operational when

- The power switch is in ON.
- RCD function is on.
- The shift position is in R.
- Advanced Park is not operating (vehicles with Advanced Park)

■ Setting the buzzer volume

The buzzer volume of the intuitive parking assist, RCTA, and RCD can be adjusted all together on  of the multi-information display.

(→P.538)

(→P.538)

■ Muting a buzzer temporarily

When an object is detected, the temporary mute switch is displayed on the Multimedia Display.

Select the switch to mute a buzzer of the intuitive parking assist, RCTA, and RCD all together.

Mute will be automatically canceled in the following situations:

- When the shift position is changed.
- When the vehicle speed exceeds a certain speed.
- When there is a malfunction in a sensor or the system is temporarily unavailable.
- When the operating function is disabled manually.
- When the power switch is turned

off.

■ Situations in which the system may not operate properly

- Some pedestrians, such as the following, may not be detected by the rear camera detection function, preventing the function from operating properly:
 - Pedestrians who are bending forward or squatting
 - Pedestrians who are lying down
 - Pedestrians who are running
 - Pedestrians who suddenly appear from the shadow of the vehicle or a building
 - Pedestrians who are riding moving objects such as a bicycle or skateboard
 - Pedestrians wearing oversized clothing such as a rain coat, long skirt, etc., making their silhouette obscure
 - Pedestrians whose body is partially hidden by an object, such as a cart or umbrella
 - Pedestrians which are obscured by darkness, such as at night
- In some situations, such as the following, pedestrians may not be detected by the rear camera detection function, preventing the function from operating properly:
 - When backing up in inclement weather (rain, snow, fog, etc.)
 - When the rear camera is obscured (dirt, snow, ice, etc. are attached) or scratched
 - When a very bright light, such as the sun, or the headlights of another vehicle, shines directly into the rear camera
 - When backing up in a place where the surrounding brightness changes suddenly, such as at the entrance or exit of a garage or underground parking lot
 - When backing up in a dim environment such as during dusk or in an underground parking lot
 - When the camera position and direction are deviated
 - When a towing hook is attached
 - When towing with the vehicle

- When water droplets are flowing on the camera lens
- When the vehicle height is extremely changed (nose up, nose down, etc.)
- When tire chains or an emergency tire puncture repair kit are used
- When the suspension has been lowered or tires that have a different size than the genuine tires are installed
- When an aftermarket electronic part (backlit license plate, fog light, etc.) is installed near the rear camera
- If a bumper protector, such as an additional trim strip, is installed to the rear bumper

■ Situations in which the system may operate unexpectedly

- Even though there are no pedestrians in the detection area, some objects, such as the following, may be detected, possibly causing the rear camera detection function to operate.
 - Three dimensional objects, such as a pole, traffic cone, fence, or parked vehicle
 - Moving objects, such as a car or motorcycle
 - Objects moving toward your vehicle when backing up, such as flags or puddles (or airborne matter, such as smoke, steam, rain, or snow)
 - Cobblestone or gravel roads, tram rails, road repairs, white lines, pedestrian crossings or fallen leaves on the road
 - Metal covers (gratings), such as those used for drainage ditches
 - Objects reflected in a puddle or on a wet road surface
 - Shadows on the road
- In some situations, such as the following, the rear camera detection function may operate even though there are no pedestrians in the detection area.
 - When backing up toward the roadside or a bump on the road
 - When backing up toward an

- incline/decline
- When the vehicle height is extremely changed (nose up, nose down, etc.)
- If a bumper protector, such as an additional trim strip, is installed to the rear bumper
- When an aftermarket electronic part (backlit license plate, fog light, etc.) is installed near the rear camera
- If the orientation of the rear camera has been changed due to a collision or other impact, or removal and installation
- If a towing eyelet is installed to the rear of the vehicle
- When towing with the vehicle
- When water is flowing over the rear camera lens
- When the rear camera is obscured (dirt, snow, ice, etc. are attached) or scratched
- If there is a flashing light in the detection area, such as the emergency flashers of another vehicle
- When tire chains or an emergency tire puncture repair kit are used.
- Situations in which the rear camera detection function may be difficult to notice
- The buzzer may be difficult to hear if the surrounding area is noisy or the audio system volume is high.
- If the temperature in the cabin is extremely high or low, the Multimedia Display may not operate correctly.

PKSB (Parking Support Brake)*

*: If equipped

The PKSB (Parking Support Brake) is a system that issues warnings and automatically performs braking to help reduce collision damage with operation targets that were detected when traveling at a low speed such as when parking.

This system consists of the following functions: a Parking Support Brake function (static objects to the front and rear) that detects static objects such as walls, a Parking Support Brake function (rear-crossing vehicles)* that detects vehicles approaching from the rear while backing up, a Parking Support Brake function (rear pedestrians)* that detects pedestrians behind the vehicle, and a Parking Support Brake function (static objects around the vehicle) (vehicles with Advanced Park) that detects static objects around the vehicle.

*: If equipped

PKSB (Parking Support Brake) system

The system has detected the following as operation targets. (The operation targets vary depending on the function.)

- Parking Support Brake function (static objects to the front and rear):

→P.309

- Parking Support Brake function (rear-crossing vehicles) (if equipped):

→P.313

- Parking Support Brake function (rear pedestrians) (if equipped):

→P.314

- Parking Support Brake function (static objects around the vehicle) (vehicles with Advanced Park):

→P.309



WARNING

■ Cautions regarding the use of the system

Do not overly rely on the system, as doing so may lead to an accident.

Always drive while checking the safety of the surroundings of the vehicle.

Depending on the vehicle and road conditions, weather, etc., the system may not operate.

The detection capabilities of sensors and radars are limited. Always drive while checking the safety of the surroundings of the vehicle.

- The driver is solely responsible for safe driving. Always drive carefully, taking care to observe your surroundings. The Parking Support Brake system is designed to provide support to lessen the severity of collisions. However, it may not operate in some situations.

- The Parking Support Brake system is not designed to stop the vehicle completely. Additionally, even if the system has stopped the vehicle, it is necessary to depress the brake pedal immediately as brake control will be canceled after approximately 2 seconds.

- It is extremely dangerous to check the system operations by intentionally driving the vehicle into the direction of a wall, etc. Never attempt such actions.

■ When to disable the Parking Support Brake

In the following situations, disable the Parking Support Brake as the system may operate even though there is no possibility of a collision.

**WARNING**

- When inspecting the vehicle using a chassis roller, chassis dynamo or free roller
- When loading the vehicle onto a boat, truck or other transport vessel
- If the suspension has been modified or tires of a size other than specified are installed
- If the front of the vehicle is raised or lowered due to the carried load
- When equipment that may obstruct a sensor is installed, such as a towing eyelet, transport hook, bumper protector (an additional trim strip, etc.), bicycle carrier, or snow plow
- When using automatic car washing devices
- If the vehicle cannot be driven in a stable manner, such as when the vehicle has been in an accident or is malfunctioning
- When the vehicle is driven in a sporty manner or off-road
- When the tires are not properly inflated
- When the tires are very worn
- When tire chains, a compact spare tire or an emergency tire puncture repair kit are used.
- When towing with the vehicle

■ Precautions for the suspension

Do not modify the suspension of the vehicle. If the height or tilt of the vehicle is changed, the sensors may not be able to detect detectable objects and the system may not operate correctly, possibly leading to an accident.

**NOTICE****■ If “System Stopped See Owner’s Manual” is displayed on the multi-information display and the driving assist information indicator is illuminated**

If this message is displayed immediately after the power switch is changed to ON, operate the vehicle carefully, paying attention to your surroundings. It may be necessary to drive the vehicle for a certain amount of time before the system returns to normal. (If the system is not return to normal after driving for a while, clean the sensor or rear camera lens.)

Enabling/Disabling the Parking Support Brake

All of the Parking Support Brake functions (static objects to the front and rear, rear-crossing vehicles [if equipped], rear pedestrians [if equipped], and static objects around the vehicle [vehicles with Advanced Park]) are enabled/disabled simultaneously.

The Parking Support Brake function can be enabled/disabled on  of the multi-infor-

mation display. (→P.97)

When the PKSB (Parking Support Brake) is disabled, the driving assist information indicator (→P.84) illuminates, and a message is displayed on the multi-information display.

If the system switches to OFF (disabled) and the PKSB (Parking Support Brake) is stopped, the PKSB (Parking Support Brake) will not be re-enabled until ON (enabled) is selected again on the multi-information display and the system operates.

If the system is disabled, it will remain off even if the power switch is turned to ON after the power switch has been turned to OFF.

Display and buzzer for hybrid system output restriction control and brake control

If the hybrid system output restriction control or brake control operates, a buzzer will sound and a message will be displayed on the Multimedia Display and multi-information display, to alert the driver.

Depending on the situation, hybrid system output restriction control will operate to either limit acceleration or restrict output as much as possible.

- Hybrid system output restriction control is operating (acceleration restriction)

Acceleration greater than a certain

amount is restricted by the system.

Multimedia Display (vehicles with panoramic view monitor): No warning displayed

Multi-information display: “Object Detected Acceleration Reduced”

Driving assist information indicator: Not illuminated

Buzzer: Does not sound

- Hybrid system output restriction control is operating (output restricted as much as possible)

The system has determined that stronger-than-normal brake operation is necessary.

Multimedia Display (vehicles with panoramic view monitor): “BRAKE!”

Multi-information display: “BRAKE!”

Driving assist information indicator: Not illuminated

Buzzer: Short beep

- Brake control is operating

The system determined that emergency braking is necessary.

Multimedia Display (vehicles with panoramic view monitor): “BRAKE!”

Multi-information display: “BRAKE!”

Driving assist information indicator: Not illuminated

Buzzer: Short beep

- Vehicle stopped by system operation

The vehicle has been stopped by brake control operation.

Multimedia Display (vehicles with panoramic view monitor): “Press Brake Pedal”

Multi-information display: “Accelerator Pedal is Pressed Press Brake Pedal” (If the accelerator pedal is not depressed, “Press Brake Pedal” will be displayed.)

Driving assist information indicator: Illuminated

Buzzer: Sounds repeatedly

System overview

If the Parking Support Brake determines that a collision with a detected object or pedestrian (if equipped) is possible, the hybrid system output will be restricted to restrain any increase in the vehicle speed. (Hybrid system output restriction control: See figure 2.)

Additionally, if the accelerator pedal continues to be depressed, the brakes will be applied automatically to reduce the vehicle speed. (Brake control: See figure 3.)

- Figure 1: When the PKSB (Parking Support Brake) is not operating

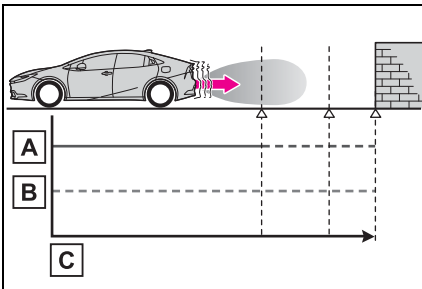

- A Hybrid system output
- B Braking force

- C Time

- Figure 2: When hybrid system output restriction control operates

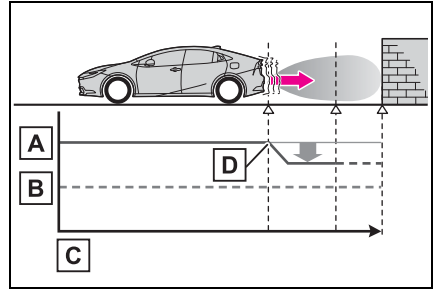

- A Hybrid system output
- B Braking force
- C Time
- D Hybrid system output restriction control begins operating (System determines that possibility of collision with detected object is high)

- Figure 3: When hybrid system output restriction control and brake control operates

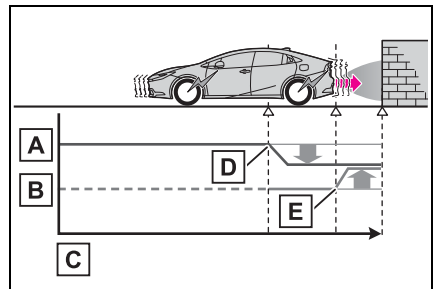

- A Hybrid system output
- B Braking force
- C Time
- D Hybrid system output restriction control begins operating (System determines that possibility of collision with detected object is high)
- E Brake control begins operating (System determines that possibility of collision with detected object is high)

tion control begins operating (System determines that possibility of collision with detected object is high)

- E** Brake control begins operating (System determines that possibility of collision with detected object is extremely high)

■ If the Parking Support Brake has operated

If the vehicle is stopped due to operation of the Parking Support Brake, the Parking Support Brake will be disabled and the driving assist information indicator will illuminate. In addition, even when the PKSB (Parking Support Brake) operates, the brake control is canceled after approximately 2 seconds to start off. Furthermore, the brake control also can be canceled by depressing the brake pedal. Depressing the accelerator pedal again after that allows the vehicle to start off.

■ Re-enabling the Parking Support Brake

To re-enable the Parking Support Brake when it is disabled due to operation of the PKSB (Parking Support Brake), either enable the system again, or turn the power switch off and then back to ON. Additionally, if any of the following conditions are met, the system will be re-enabled automatically and the driving assist information indicator will turn off (→P.84):

- The P shift position is selected
- Drive with no operation targets in the traveling direction of the vehicle
- Change the traveling direction of the vehicle*

*: Except the Parking Support Brake function (rear pedestrian)

■ Buzzer

Regardless of whether the intuitive parking assist is enabled or not (→P.285), if the PKSB (Parking Support Brake) system is enabled (→P.305), the buzzer will sound to notify the driver of the approximate distance to the object when the brake control and the hybrid system output restriction control are operated.

Parking Support Brake function (static objects to the front and rear/static objects around the vehicle)*

*: If equipped

If the sensors detect a static object, such as a wall, in the traveling direction of the vehicle and the system determines that a collision may occur due to the vehicle suddenly moving forward due to an accidental accelerator pedal operation, the vehicle moving in the unintended direction due to the wrong shift position being selected, or while parking or traveling at low speeds, the system will operate to lessen the impact with the detected static object and reduce the resulting damage.

Examples of function operation (static objects to the front and rear)

This function will operate in situations such as the following if an object is detected in the traveling direction of the vehicle.

- When traveling at a low speed and the brake pedal is not depressed, or is depressed late

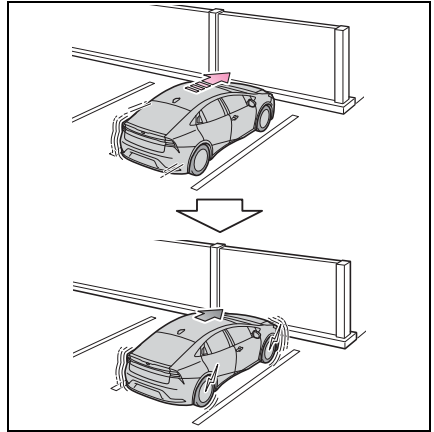

- When the accelerator pedal is depressed excessively

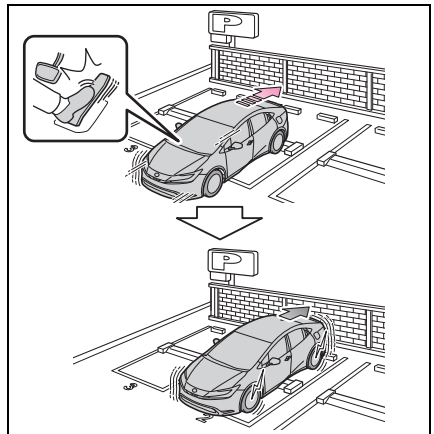

- When the vehicle moves forward due to the incorrect shift position being selected

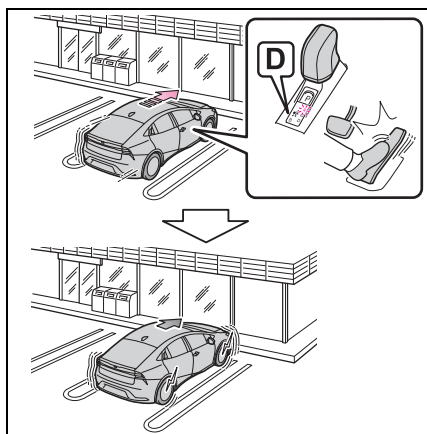

- When moving forward and a collision with a stationary object on the inner side of a turn is likely

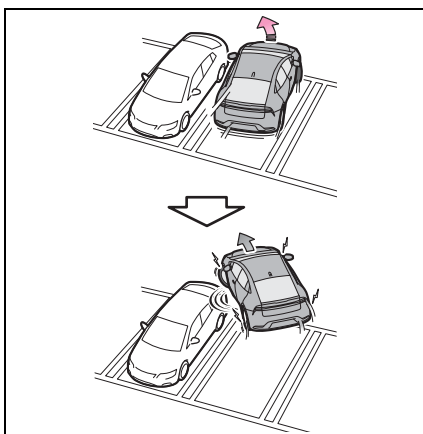

Examples of function operation (static objects around the vehicle) (vehicles with Advanced Park)

The system will operate in the following situations when a stationary object is detected in the surrounding area.

- When reversing and a collision with a stationary object on the outer side of a turn is likely

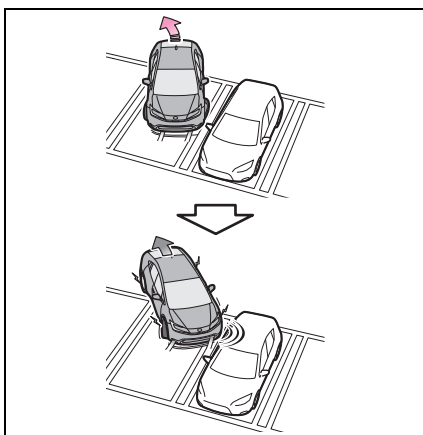

Types of sensors

→P.284

**WARNING****■ To ensure the system can operate properly**

→P.285

■ If the PKSB (Parking Support Brake) operates unnecessarily, such as at a railroad crossing

→P.308

■ Notes when washing the vehicle

→P.286

■ The Parking Support Brake function (static objects to the front and rear) will operate when

The function will operate when the driving assist information indicator is not illuminated (→P.82, 84) and all of the following conditions are met:

- Hybrid system output restriction control
- The Parking Support Brake is enabled.
- The vehicle speed is approximately 9 mph (15 km/h) or less.
- There is a static object in the traveling direction of the vehicle and approximately 6 to 13 ft. (2 to 4 m) away.
- The Parking Support Brake determines that a stronger-than-normal brake operation is necessary to avoid a collision.
- Brake control
- Hybrid system output restriction control is operating
- The Parking Support Brake determines that an immediate brake operation is necessary to avoid a collision.

■ The Parking Support Brake function (static objects around the vehicle)* will operate when

* : Vehicles with Advanced Park

This function is operable when any of the following conditions are met in addition to the operating conditions for stationary objects in around the vehicle.

- After the hybrid system has been started, the vehicle has moved approximately 23.0 ft. (7 m) or less
- The R shift position is selected
- After the shift position has been changed from R to D, the vehicle has moved approximately 23.0 ft. (7 m) or less

■ The Parking Support Brake function (static objects to the front and rear/static objects around the vehicle*) will stop operating when

* : Vehicles with Advanced Park

The function will stop operating if any of the following conditions are met:

- Hybrid system output restriction control
- The Parking Support Brake is disabled.
- The system determines that the collision has become avoidable with normal brake operation.
- The static object is no longer approximately 6 to 13 ft. (2 to 4 m) away from the vehicle or in the traveling direction of the vehicle.
- Brake control
- The Parking Support Brake is disabled.
- Approximately 2 seconds have elapsed since the vehicle was stopped by brake control.
- The brake pedal is depressed after the vehicle is stopped by brake control.
- The static object is no longer approximately 6 to 13 ft. (2 to 4 m) away from the vehicle or in the traveling direction of the vehicle.

■ **Detection range of the Parking Support Brake function (static objects to the front and rear/static objects around the vehicle*)**

*: Vehicles with Advanced Park

The detection range of the Parking Support Brake function (static objects to the front and rear/static objects around the vehicle) differs from the detection range of the intuitive parking assist (→P.284). Therefore, even if the intuitive parking assist detects an object and provides a warning, the Parking Support Brake function (static objects to the front and rear/static objects around the vehicle) may not start operating.

■ **Situations in which the system may not operate properly**

→P.287

■ **Situations in which the system may operate even if there is no possibility of a collision**

→P.288

■ **Situations in which the system may operate even though there is no possibility of a collision (static objects around the vehicle) (vehicles with Advanced Park)**

In addition to the situations in which stationary objects front and rear (→P.311) may not be detected, objects may not be detected by the sensors in the following situations:

● When moving sideways, such as when parallel parking (→P.329)

■ **Detection of objects along the sides of the vehicle (static objects around the vehicle) (vehicles with Advanced Park)**

● Objects along the sides of the vehicle are not instantaneously detected. The location of objects in relation to the vehicle is estimated after they are first detected by the front or rear side sensors,

or side cameras. Therefore, after the power switch is changed to ON, even if an object is along the side of the vehicle, it may not be detected until the vehicle has been driven a small amount and the side sensors or side cameras completely scan the areas along the sides of the vehicle.

● If a vehicle, person, animal, etc., is detected by a side sensors or side cameras, but then leaves the detection area of the side sensors or side cameras, the system will assume the object has not moved.

Parking Support Brake function (rear-crossing vehicles)*

*: If equipped

If a rear radar sensor detects a vehicle approaching from the right or left at the rear of the vehicle and the system determines that the possibility of a collision is high, this function will perform brake control to reduce the likelihood of an impact with the approaching vehicle.

Examples of function operation

This function will operate in situations such as the following if a vehicle is detected in the traveling direction of the vehicle.

- **When reversing, a vehicle is approaching and the brake pedal is not depressed, or is depressed late**

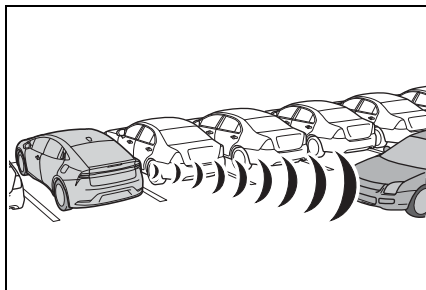

Types of sensors

→P.276

⚠ WARNING

■ **To ensure the system can operate properly**

→P.276

■ The Parking Support Brake function (rear-crossing vehicles) will operate when

The function will operate when the driving assist information indicator is not illuminated (→P.82, 84) and all of the following conditions are met:

- Hybrid system output restriction control
- The Parking Support Brake is enabled.
- The vehicle speed is approximately 9 mph (15 km/h) or less.
- Vehicles are approaching from the right or left at the rear of the vehicle at a traveling speed of approximately 5 mph (8 km/h) or more.
- The shift position is in R.
- The Parking Support Brake determines that a stronger than normal brake operation is necessary to avoid a collision with an approaching vehicle.
- Brake control
- Hybrid system output restriction control is operating
- The Parking Support Brake determines that an emergency brake operation is necessary to avoid a collision with an approaching vehicle.

■ The Parking Support Brake function (rear-crossing vehicles) will stop operating when

The function will stop operating if any of the following conditions are met:

- Hybrid system output restriction control

- The Parking Support Brake is disabled.
- The collision becomes avoidable with normal brake operation.
- A vehicle is no longer approaching from the right or left at the rear of the vehicle.

● Brake control

- The Parking Support Brake is disabled.
- Approximately 2 seconds have elapsed since the vehicle was stopped by brake control.
- The brake pedal is depressed after the vehicle is stopped by brake control.

■ **Detection area of the Parking Support Brake function (rear-crossing vehicles)**

The detection area of the Parking Support Brake function (rear-crossing vehicles) differs from the detection area of the RCTA function (→P.295). Therefore, even if the RCTA function detects a vehicle and provides an alert, the Parking Support Brake function (rear-crossing vehicles) may not start operating.

■ **Situations in which the system may not operate properly**

→P.297

■ **Situations in which the system may operate even if there is no possibility of a collision**

→P.298

Parking Support Brake function (rear pedestrians)*

*: If equipped

If the rear camera sensor detects a pedestrian behind the vehicle while backing up and the system determines that the possibility of colliding with the detected pedestrian is high, a buzzer will sound. If the system determines that the possibility of colliding with the detected pedestrian is extremely high, the brakes will be applied automatically to help reduce the impact of the collision.

Examples of system operation

The system operates when an approaching pedestrian is detected behind the vehicle while backing up, and when the brake pedal is not depressed or is depressed late.

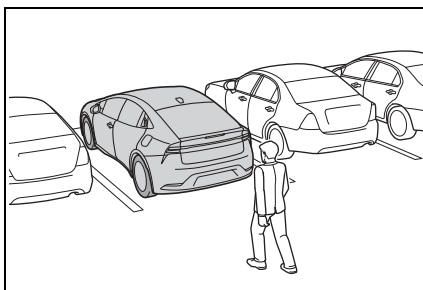

Screen display of rear pedestrian

Displays a message to urge the driver to take evasive action when a pedestrian is detected in the detection area behind the vehicle.

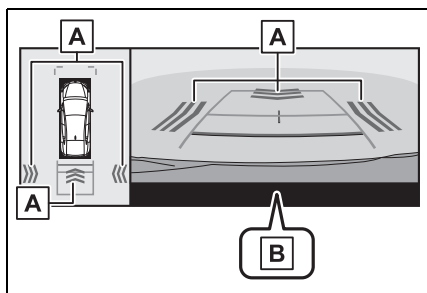

A Pedestrian detection icon

B "BRAKE!"



WARNING

■ If the Parking Support Brake function (rear pedestrians) operates unnecessarily

Depress the brake pedal immediately after the Parking Support Brake function (rear pedestrians) operates. (Operation of the function is canceled by depressing the brake pedal.)

■ Correct use of the Parking Support Brake function (rear pedestrians)

→P.299

■ Parking Support Brake function (rear pedestrians) will operate when

The function will operate when the driving assist information indicator is not illuminated (→P.82, 84) and all of the following conditions are met:

- Hybrid system output restriction

control

- The Parking Support Brake is enabled.
- The vehicle speed is 9 mph (15 km/h) or less.
- The shift position is in R.
- A pedestrian is to the rear of the vehicle
- The PKSB (Parking Support Brake) determines that a stronger-than-normal brake operation is necessary to avoid a collision.

- Brake control
- Hybrid system output restriction control is operating.
- The Parking Support Brake determines that an emergency brake operation is necessary to avoid a collision with a pedestrian.

■ The Parking Support Brake function (rear pedestrians) will stop operating when

The function will stop operating if any of the following conditions are met:

- Hybrid system output restriction control
- The Parking Support Brake is disabled.
- The collision becomes avoidable with normal brake operation.
- The pedestrian is no longer detected behind your vehicle.
- Brake control
- The Parking Support Brake is disabled.
- Approximately 2 seconds have elapsed since the vehicle was stopped by brake control.
- The brake pedal is depressed after the vehicle is stopped by brake control.

■ Re-enabling the Parking Support Brake function (rear pedestrians)

→P.308

■ Detection area of the Parking Support Brake function (rear pedestrians)

The detection area of the Parking

Support Brake function (rear pedestrians) differs from the detection area of the RCD function (→P.299). Therefore, even if the RCD function detects a pedestrian and provides an alert, the Parking Support Brake function (rear pedestrians) may not start operating.

■ **Situations in which the system may not operate properly**

→P.302

■ **Situations in which the system may operate unexpectedly**

→P.302

Toyota Teammate Advanced Park*

*: If equipped

Function description

The Advanced Park is a system which assists in a safe and smooth parking or exiting from a parking space by displaying the blind spots around the vehicle and the target parking spot through a bird's eye view, delivering operation guidance through displays and buzzer operation, and changing the shift position, operating the steering wheel, accelerator pedal, and brake pedal.

Additionally, the panoramic view monitor* can display the area in front, behind, and from above the vehicle, helping confirm the condition of the area around the vehicle.

The turn signal lights will blink automatically when the parking assistance starts until the vehicle reaches the target parking spot, to notify people around the vehicle that parking is being performed.

Depending on the condition of the road surface or the vehicle, the distance between the vehicle and a parking space, etc., it may not be possible to assist in parking in the target space.

*: For details on the panoramic view monitor refer to “MULTIMEDIA OWNER’S MANUAL”.

Functions

■ Perpendicular parking (forward/reverse) function

Assistance is provided from the position the vehicle is stopped near the target parking space until the vehicle is in the parking space. (→P.324)

■ Perpendicular exiting (forward/reverse) function

Assistance is provided from the parked position until the vehicle is in a position where you can easily exit from the parking space. (→P.327)

■ Parallel parking function

Assistance is provided from the position the vehicle is stopped near the target parking space until the vehicle is in the parking space. (→P.329)

■ Parallel exiting function

Assistance is provided from the parked position until the vehicle is in a position where you can easily exit from the parking space. (→P.333)

■ Memory function

Assistance is provided until the vehicle is guided into a previously registered parking space. (→P.335)

WARNING

■ Cautions regarding the use of the system

The recognition and control capabilities for this system are limited. The driver should always drive safely by always being responsible without over relying on the system and have a understanding of the surrounding situations.

- As with a normal vehicle, take care to observe your surroundings while the vehicle is moving.
- Always pay attention to the vehicle’s surroundings while the system is operating and depress the brake pedal as necessary to slow or stop the vehicle.
- When parking, make sure that the vehicle can be parked in the target parking space before beginning operation.
- Depending on the condition of the road surface or the vehicle, the distance between the vehicle and a parking space, etc., it may not be possible to detect a parking space or the system may not be able to provide assistance to the point the vehicle is fully parked.
- This system will guide the vehicle to appropriate positions for changing the direction of travel, however, if you feel that the vehicle is approaching too close to an adjacent parked vehicle at any time, depress the brake pedal and change the shift position. However, if this is performed, the number of times the vehicle changes direction may increase, and the vehicle may be parked at an angle.

**WARNING**

- As following objects may not be detected, make sure to check the safety of the area around your vehicle and depress the brake pedal to stop the vehicle if it may collide with an object.
 - Wires, fences, ropes, etc.
 - Cotton, snow and other materials that absorb sound waves
 - Sharply-angled objects
 - Low objects (curb stones, parking blocks, etc.)
 - Tall objects with upper sections projecting outwards in the direction of your vehicle
 - Even if there is an object in the target parking space, it may not be detected and assistance may be performed.
 - While the system is operating, if it is likely that your vehicle will collide with a nearby vehicle, parking block, object, or person, depress the brake pedal to stop the vehicle and press the Advanced Park main switch to disable the system.
 - Never use only the Multimedia Display to view the area behind the vehicle. The image displayed may differ than the actual situation. Using only the screen when backing up may lead to an accident, such as a collision with another vehicle. When backing up, make sure to look directly or use the mirrors to check the safety of the area around your vehicle, especially behind the vehicle.
- When the ambient temperature is extremely low, the screen may appear dark or the displayed image may become unclear. Also, as moving objects may appear distorted or may not be able to be seen on the screen, make sure to directly check the safety of the area around your vehicle.
 - In the following situations, while the vehicle is stopped and held by Advanced Park, it may be canceled and the vehicle may start moving. Immediately depress the brake pedal. Failure to do so may lead to an accident.
 - When the driver's door is opened
 - When operations instructed by the system are not performed within a certain amount of time
 - When the brake pedal is depressed and the vehicle is stopped for a certain amount of time
 - When the system malfunctions
 - As the steering wheel will turn while this system is operating, pay attention to the following.
 - Be careful so that a necktie, scarf, or arm does not get caught. Keep your upper body away from the steering wheel. Also, keep children away from the steering wheel.
 - Long fingernails may be caught and when the steering wheel is rotating, leading to injury.
 - In an emergency, depress the brake pedal to stop the vehicle, and then press the Advanced Park main switch to disable the system.

**WARNING**

● Do not allow anyone to put their hands outside of a window while this system is operating.

■ **To ensure correct operation of the Advanced Park**

Observe the following precautions. Failing to do so may result in the vehicle being unable to be driven safely and possibly cause an accident.

- Do not use this system in situations such as the following:
 - When in areas other than common parking spaces
 - When the surface of the parking space is sand or gravel and is not clearly defined with parking space lines
 - When the parking space is not level, such as when on a slope or has differences in height
 - Mechanical parking system
 - Parking lot with a device which raises to contact the bottom of the vehicle
 - When the road surface is frozen, slick, or covered with snow
 - When it is extremely hot and the asphalt is melting
 - When there are objects around the vehicle
 - When there is an object between your vehicle and the target parking spot or within the target parking spot (within the displayed blue box)
 - When there is a gutter between your vehicle and the target parking space or within the target parking spot (within the displayed blue box)

- When there is a hole or gutter in the exit direction
- When in high pedestrian or vehicle traffic areas
- When the parking space is in a location that is difficult to park in (too narrow for your vehicle, etc.)
- When images are unclear due to dirt or snow attached to the camera lens, light being shined into the camera or shadows
- When tire chains or a compact spare tire is installed to the vehicle
- When the doors or back door are not completely closed
- When an arm is held outside of a window
- In inclement weather such as heavy rain or snow
- Make sure to use only standard sized tires, such as those that were installed to the vehicle when it was shipped from the factory. Otherwise, Advanced Park may not operate properly. Also, when the tires have been replaced, the displayed position of the lines or box displayed on the screen may become incorrect. When replacing the tires, contact your Toyota dealer.
- In situations such as the following, it may not be possible for the system to provide assistance to a registered parking spot:
 - When the tires are extremely worn or the tire inflation pressure is low
 - When carrying a heavy load
 - When the vehicle is tilted due to the carried load

⚠ WARNING

- When a heater is installed in the surface of the parking space (road surface freeze prevention heater)
- When the wheels are misaligned, such as after a wheel has been subjected to a strong impact
- When a pedestrian or passing vehicle is detected during assistance
- When something is incorrectly detected as a parking line (light, reflections from a building, difference in height on the parking surface, a gutter, painted road lines, redrawn lines, etc.)

If the vehicle deviates greatly from the set parking space in any situation other than the above, have the vehicle inspected by your Toyota dealer.

⚠ NOTICE

■ Precautions for use Advanced Park

If the 12-volt battery was discharged or has been removed and installed, fold and extend the outside rear view mirrors.

Types of cameras and sensors used for the Advanced Park

Cameras and sensors are used to detect parked vehicles, making it easier to identify parking spaces.

▶ Front camera

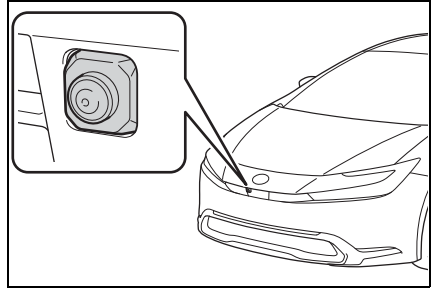

▶ Side cameras

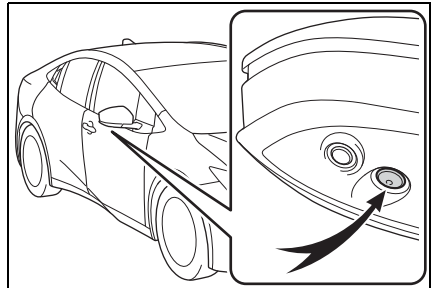

▶ Rear camera

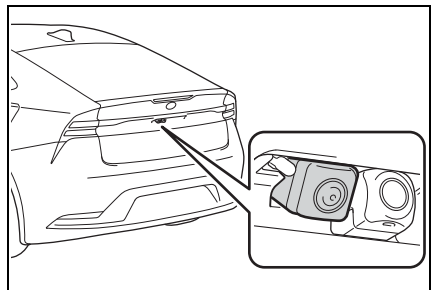

Depending on the vehicle grade and equipped options, the actual rear camera may be different from this illustration.

▶ Sensors

→P.284

■ Camera images

As special cameras are used, the colors in displayed images may differ from the actual color.

■ Precautions for use

For details on the following, refer to “Panoramic view monitor” of “Parking assist system” in the “MULTIMEDIA OWNER’S MANUAL”.

- Displayable range of the screens
- Cameras
- Differences between displayed images and the actual road
- Differences between displayed images and the actual objects

■ Detection range of the cameras and sensors

- If a parked vehicle is behind the target parking space and the distance between it and the vehicle becomes far, it may no longer be able to be detected. Depending on shape or condition of a parked vehicle, the detection range may become short or the vehicle may not be detected.
- Objects other than parked vehicles, such as columns, walls, etc., may not be detected. Also, if they are detected, they may cause the target parking space to be misaligned.

■ Situations in which parking space lines may not be recognized properly

- In situations such as the following, parking space lines on the road surface may not be detected:
 - When the parking space does not use lines (parking space boundaries are marked with rope, blocks, etc.)
 - When the parking space lines are faded or dirty, making them unclear
 - When the road surface is bright, such as concrete, and the contrast between it and the white parking space lines is small
 - When the parking space lines are any color other than yellow or white
 - When the area surrounding the parking space is dark, such as at

night, in an underground parking lot, parking garage, etc.

- When it is raining or has rained and the road surface is wet and reflective or there are puddles
- When the sun is shining directly into a camera, such as in the early morning or evening
- When the parking space is covered with snow or de-icing agent
- When there marks from repairs or other marks on the road surface, or there is a traffic bollard, or other object on the road surface
- When the color or brightness of the road surface is uneven
- When a camera has been splashed by hot or cold water and the lens has fogged up
- When the appearance of the parking space is affected by the shadow of the vehicle or trees
- When a camera lens is dirty or covered with water droplets
- In situations such as the following, the target parking space may not be recognized correctly:
 - When there marks from repairs or other marks on the road surface, or there is a parking block, traffic bollard, or other object on the road surface
 - When it is raining or has rained and the road surface is wet and reflective or there are puddles
 - When the area around the vehicle is dark or backlit
 - When the color or brightness of the road surface is uneven
 - When the parking space is on a slope
 - When there are diagonal lines (access aisle) near the parking space
 - When the appearance of the parking space is affected by the shadow of a parked vehicle (such as shadows from the grille, side step, etc.)
 - When accessories which obstruct the view of the camera are installed
 - When the parking space lines are faded or dirty, making them

- unclear
- When the appearance of the parking space is affected by the shadow of the vehicle or trees

■ Sensor detection information

→P.286

■ Objects which the sensor may not be properly detected

→P.287

■ Situations in which the sensor may not operate properly

→P.287

■ Situations in which parking assistance may not operate even if there is no possibility of a collision

→P.288

⚠ WARNING

■ Precautions for the cameras and sensors

- Due to the characteristics of the camera lens, the position of and distance to people and objects displayed on the screen may differ from the actual situation. For details, refer to “MULTIMEDIA OWNER’S MANUAL”.
- Make sure to observe the precautions for using the intuitive parking assist, otherwise a sensor may not operate correctly, possibly leading to an accident. (→P.285)
- In situations such as the following, the sensors may not operate correctly, possibly leading to an accident. Proceed carefully.
 - When there is a parked vehicle next to the target parking space, if the displayed target parking space is far from the actual target parking space, a sensor may be misaligned. Have the vehicle inspected by your Toyota dealer.

- Do not install any accessories near the detection area of the sensors.

Turning the Advanced Park system on/off

Press the Advanced Park main switch.

If the switch is pressed while assistance is being performed, the assistance will be canceled.

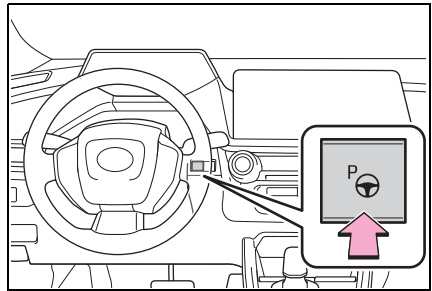

■ Operating conditions of the Advanced Park

Assistance will begin when all of the following conditions are met:

- The brake pedal is depressed
- The vehicle is stopped
- The driver's seat belt is fastened
- The steering wheel is not being operated
- The accelerator pedal is not depressed
- All of the doors and the back door are closed
- The outside rear view mirrors are not folded
- The parking brake is not engaged
- The dynamic radar cruise control are not operating
- ABS, VSC, TRAC, PCS and PKSB are not operating
- The vehicle is not on a steep

slope

- The VSC and TRAC are not turned off

If assistance cannot be started, check the message displayed on the Multimedia Display (→P.342).

Advanced Park guidance screens

Guidance screens are displayed on the Multimedia Display.

- ▶ Guidance screen (When assistance starts)

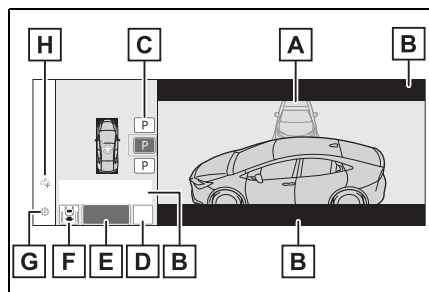

- A** Target parking space box (blue)

- B** Advice display

- C** Parking type change button

If multiple buttons are displayed, depending on the condition of the button its function differs as follows.

P or **P** : Change the target to another parking space.

P or **P** : Select the current target parking space.

(P) : Select to change to the parallel parking function

P : Change the perpendicular parking (forward/reverse) function

- D** "MODE" button

Select to change between the memory function and the perpendicular parking (forward/reverse) function and parallel parking function. (→P.337)

- E** "Start" button

Select to start parking assistance.

- F** Perpendicular parking direction change button

Select to change between the parking (forward) function and parking (reverse) function

: Change the perpendicular parking (forward) function

: Change the perpendicular parking (reverse) function

- G** Customize setting button

Select to display the Advanced Park setting screen. (→P.341)

- H** Registration button

Select to begin registering a parking space.

- ▶ Guidance screen (When reversing)

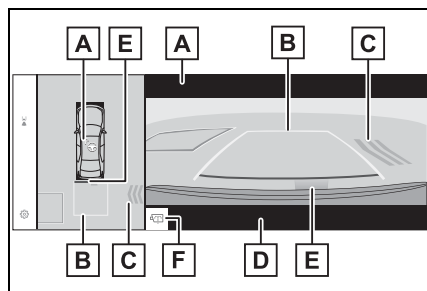

- A** Operation icon

Displayed when the Advanced Park is operating.

- B** Guide lines (yellow and red)

Display points from the center of

the edge of the front or rear bumper to the target stopping position (yellow) ^{*1} and approximately 1 ft. (0.3 m) (red) from the vehicle.

C Moving object warning icon

D Emergency support brake control operation display

“BRAKE!” is displayed.

E Intuitive parking assist display

→P.284

F Rear camera washer switch ^{*2} (if equipped)

Press shortly:

The rear camera washer operates for a certain period of time.

Press and hold:

The rear camera washer operates while the rear camera washer switch remains pressed.

^{*1}: The yellow lateral line is not displayed when the target stopping position is approximately 8.2 ft. (2.5 m) or more away from the vehicle.

^{*2}: Refer to “Panoramic view monitor” of “Parking assist system” in the “MULTIMEDIA OWNER’S MANUAL”.

■ Intuitive parking assist pop-up display

Regardless of whether the intuitive parking assist is off or on (→P.285), if an object is detected by the intuitive parking assist when the Advanced Park is operating, the intuitive parking assist pop up display will automatically be displayed over the guidance display.

■ Brake control operation when Advanced Park is operating

While the Advanced Park is operating, if the system determines that the possibility of collision with detected moving or stationary object is high, the hybrid system output restriction control and brake control will operate.

If brake control operates, Advanced Park operation will be suspended and a message will be displayed on the multi-information display.

■ Buzzer

Depending on surrounding sounds or sounds from other systems, it may be difficult to hear the buzzer of this system.

■ If a black screen is displayed on the Multimedia Display when the Advanced Park is operating

The system is being affected by radio waves or may be malfunctioning. If a radio antenna is installed near a camera, move it to a location as far from the cameras as possible. If a radio antenna is not installed near a camera, and the screen does not return to normal after turning the power switch off and then starting the hybrid system again, have the vehicle inspected by your Toyota dealer.

Perpendicular parking (forward/reverse) function

The perpendicular parking (forward/reverse) function can be used if the target parking space can be detected when the vehicle is stopped close and perpendicular to the center of the parking space. Also, depending on the condition of the parking space, etc., if it is necessary to change the direction of travel of

the vehicle, the shift position can be changed by assistance control.

Parking using the perpendicular parking (forward/reverse) function

- 1 Stop the vehicle at a position close and perpendicular to the center of the target parking space.
- If there are parking space lines

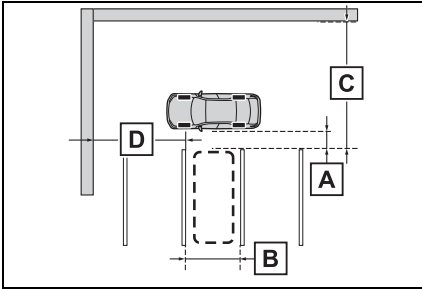

- A** Approximately 3.3 ft. (1 m)*
- B** Approximately 8.2 ft. (2.5 m)*
- C** Approximately 19.7 ft. (6 m) or more*
- D** Approximately 18.0 ft. (5.5 m) or more*

The system can operate even if there is a parking space line on only one side of the target parking space.

*: This is a reference measurement for detection of a parking space. Depending on the surrounding environment, detection may not be possible.

- If there is an adjacent parked vehicle

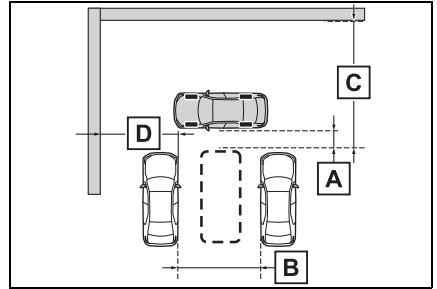

- A** Approximately 3.3 ft. (1 m)*
- B** Approximately 9.8 ft. (3 m) or more*
- C** Approximately 19.7 ft. (6 m) or more*
- D** Approximately 18.0 ft. (5.5 m) or more*



The system can operate even if there is a vehicle on only one side of the target parking space.

*: This is a reference measurement for detection of a parking space. Depending on the surrounding environment, detection may not be possible.

- 2 Press the Advanced Park main switch and check that a possible parking space is dis-

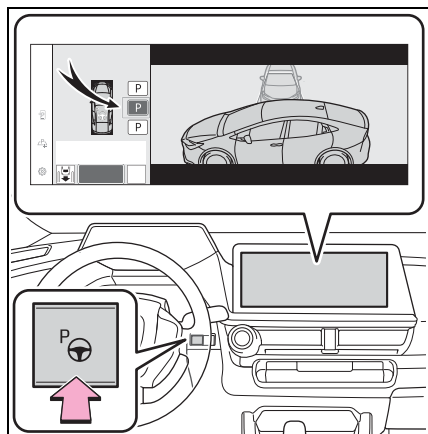
played on the Multimedia Display.



- If a space which your vehicle can be parked is detected, a target parking space box will be displayed.
 - If it is possible to parallel park in the space, select the parking space, and then select **(P)** to change to the parallel parking function.
 - If it is possible to change the direction which a parking space is entered, select the parking space, and then select  or  change the direction.
 - Depending on the surrounding environment, it may not be possible to use this function. According to the information displayed on the Multimedia Display, use the function on another parking space.
- 3 Select “Start” button.

A buzzer will sound, an operation message will be displayed on the multi-information display, and assistance will begin operating.

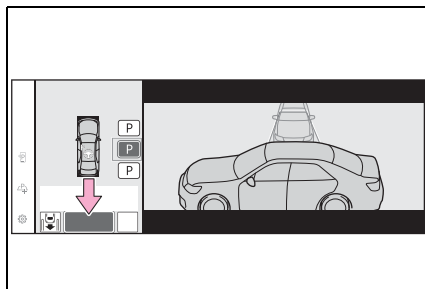

- When the brake pedal is released, “Moving Forward...”, “Backing Up...” will be displayed and the vehicle will begin moving forward/reverse.
- To cancel assistance, press the Advanced Park main switch.

If assistance is canceled, “Advanced Park Canceled” will be displayed.

If you feel that the vehicle is approaching close to a surrounding vehicle, object, person, or gutter: →P.327

- 4 Perform operations as indicated by the advice displays until the vehicle stops in the target parking space.

When the vehicle stops, “Advanced Park Finished” will be displayed and parking assistance will end.

If you select  on the Multimedia Display, the vehicle displayed on the parking assist completion

screen will rotate.

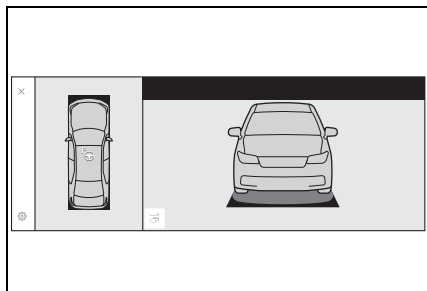

■ **If you feel that the vehicle is approaching close to a surrounding vehicle, object, person, or gutter**

Depress the brake pedal to stop the vehicle and then change the shift position to change the direction of travel of the vehicle. At this time, assist will be suspended. However, if the “Start” button is selected, assist will resume and the vehicle will move in the direction corresponding to the selected shift position.

■ **When the brakes have been operated**

When the brakes have been operated, brake operation sound may be heard. This does not indicate a malfunction.



NOTICE

■ **When using the perpendicular parking (forward/reverse) function**

- Make sure that there are no obstructions within the yellow guide lines and between the vehicle and target parking spot. If there are any obstructions between the vehicle and the target parking space, or between the yellow guide lines, cancel the function.

- As the target parking space will not be able to be set correctly if the surface of the parking space is on a slope or has differences in height, the vehicle may stray from the target parking space or be slanted. Therefore, do not use the function for this kind of parking spot.

- When parking in a narrow parking space, the vehicle may closely approach an adjacent parked vehicle. If a collision seems likely, depress the brake pedal to stop the vehicle.

- If a detected parked vehicle is narrow or parked extremely close to the curb, the position at which assistance will park the vehicle will also be close to the curb. If it seems likely the vehicle will collide with something or drive off of the road, depress the brake pedal to stop the vehicle, and then press the Advance Park main switch to disable the system.

Advanced Park perpendicular exiting (forward/reverse) function

When exiting from a perpendicular parking space, if the system determines that exit is possible the perpendicular exiting (forward/reverse) function can be used. Also, depending on the surrounding environment, if it is necessary to change the direction of travel of the vehicle, the shift position can be changed by assistance control.

Leaving a parking space using the perpendicular exiting (forward/reverse) function

- 1 With the brake pedal depressed and P shift position selected, press the Advanced Park main switch and check that the exit direction selection screen is displayed on the Multimedia Display.

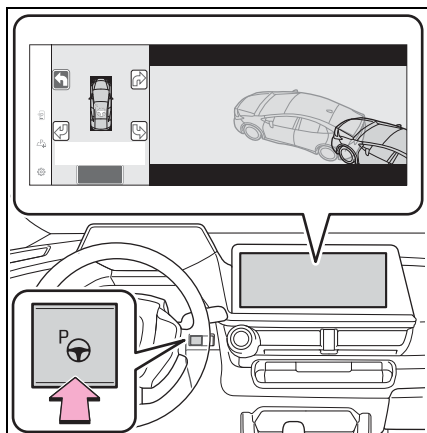

- 2 Select an arrow on the Multimedia Display to select the direction you wish to exit.

If the turn signal lever is operated, only exit to the left or right can be selected.

- 3 Depress the brake pedal and select "Start" button.

A buzzer will sound, an operation message will be displayed on the multi-information display, and

assistance will begin operating.

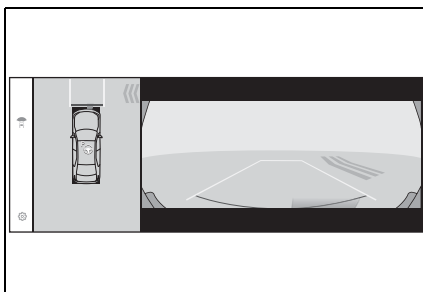

To cancel assistance, press the Advanced Park main switch.

If assistance is canceled, "Advanced Park Canceled" will be displayed.

If you feel that the vehicle is approaching close to a surrounding vehicle, object, person, or gutter: →P.327

- 4 Perform operations as indicated by the advice displays until the vehicle is in a position where exit is possible.

When the vehicle reaches a position where exit is possible, "You can exit by moving the steering wheel" will be displayed. If the steering wheel is operated, "Advanced Park Finished" will be displayed and assistance will end.

As assistance will end while the vehicle is moving, grip the steering wheel and drive forward.

If the steering wheel is not operated, the vehicle will stop at the exit position. Assistance can be ended by depressing the accelerator pedal

or brake pedal.

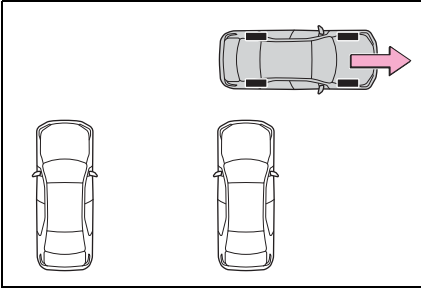

■ If you feel that the vehicle is approaching close to a surrounding vehicle, object, person, or gutter

→P.327

■ **Perpendicular exiting (forward/reverse) function**

Do not use exiting (forward/reverse) function in any situation other than when exiting a parallel parking spot. If assistance is started unintentionally, depress the brake pedal and stop the vehicle, then press the Advanced Park main switch to cancel assistance.

■ **Situations in which the perpendicular exiting (forward/reverse) function will not operate**

In situations such as the following, the perpendicular exiting (forward/reverse) function will not operate:

- When a vehicle which is waiting to park is in the exit direction

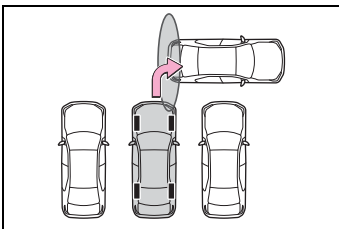

- When a wall, column, or person is detected as near a front or rear center or corner sensor

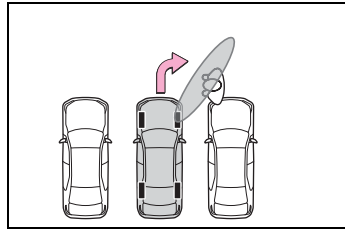

■ **When the brakes have been operated**

→P.327

Advanced Park parallel parking function

The parallel parking function can be used if the target parking space can be detected when the vehicle is stopped close and aligned with the center of the parking space. Also, depending on the condition of the parking space, etc., if it is necessary to change the direction of travel of the vehicle, the shift position can be changed by assistance control.

Parking using the parallel parking function

- 1 Stop the vehicle with it aligned near the center of the target parking space.

- If there are parking space lines

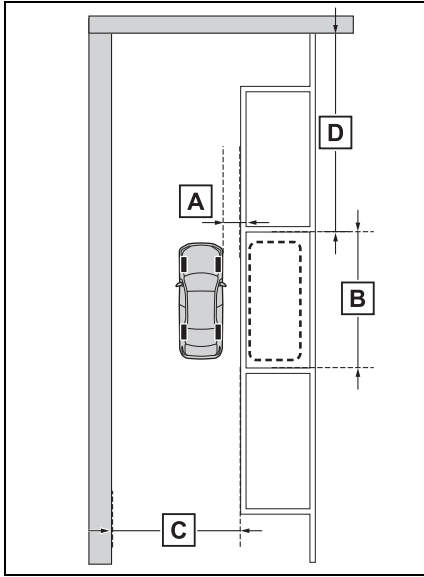

- A** Approximately 3.3 ft. (1 m) *
- B** Approximately 19.7 ft. (6 m) *
- C** Approximately 14.8 ft. (4.5 m) or more *
- D** Approximately 26.2 ft. (8 m) or more *

*: This is a reference measurement for detection of a parking space. Depending on the surrounding environment, detection may not be possible.

- If there is an adjacent parked vehicle

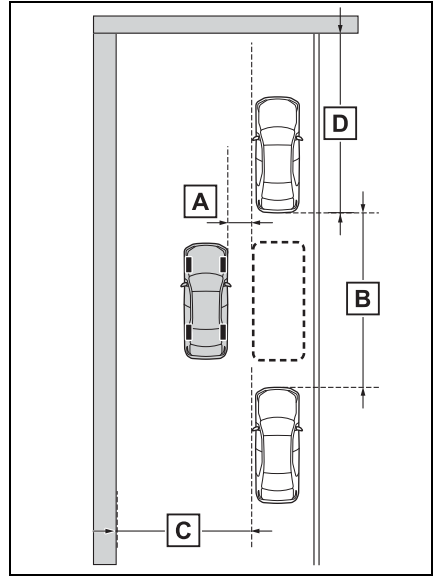



- A** Approximately 3.3 ft. (1 m) *
- B** Approximately 23.0 ft. (7 m) or more *
- C** Approximately 14.8 ft. (4.5 m) or more *
- D** Approximately 26.2 ft. (8 m) or more *

*: This is a reference measurement for detection of a parking space. Depending on the surrounding environment, detection may not be possible.

- 2 Press the Advanced Park main switch and check that a possible parking space is dis-

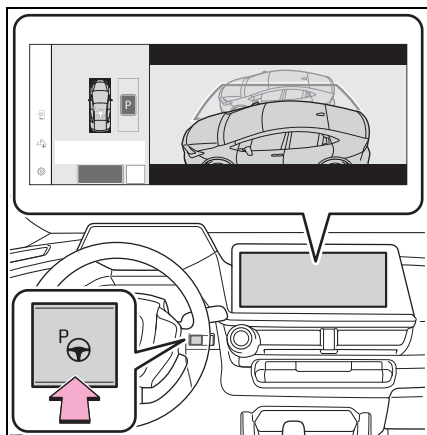
played on the Multimedia Display.



- If a space which your vehicle can be parked is detected, a target parking space box will be displayed.
- If it is possible to perpendicular parking (forward/reverse) in the space, select the parking space, and then select  to change to the perpendicular parking (forward/reverse) function.
- Depending on the surrounding environment, it may not be possible to use this function. According to the information displayed on the Multimedia Display, use the function on another parking space.

3 Select "Start" button.

A buzzer will sound, an operation message will be displayed on the multi-information display, and

assistance will begin operating.

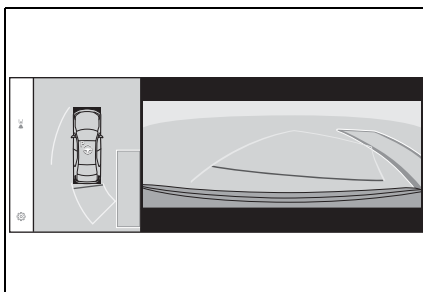

- When the brake pedal is released, "Moving Forward..." will be displayed and the vehicle will begin moving forward.
- To cancel assistance, press the Advanced Park main switch.

If assistance is canceled, "Advanced Park Canceled" will be displayed.

If you feel that the vehicle is approaching close to a surrounding vehicle, object, person, or gutter: →P.327

- 4 Perform operations as indicated by the advice displays until the vehicle stops in the target parking space.

When the vehicle stops, "Advanced Park Finished" will be displayed and parking assistance will end.

If you select  on the Multimedia Display, the vehicle displayed on the parking assist completion

screen will rotate.

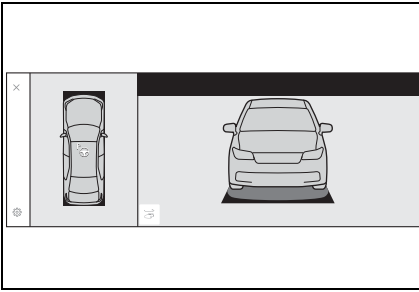

■ **If you feel that the vehicle is approaching close to a surrounding vehicle, object, person, or gutter**

→P.327

■ **“No available parking space” is displayed**

Even if the vehicle is stopped parallel to a parking space, an adjacent parked vehicle may not be detected. In this case, if the vehicle is moved to a position that a parked vehicle can be detected, assistance can be started.

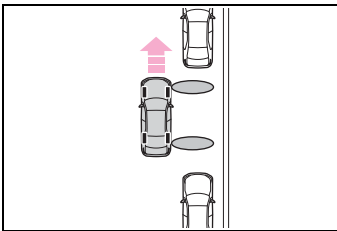

■ **When the brakes have been operated**

→P.327

 **NOTICE**

■ **When using the parallel parking function**

- Make sure that there are no obstructions within the yellow guide lines and between the vehicle and target parking spot. If any obstructions are detected within the yellow guide lines or between the vehicle and the target parking space, the parallel parking function will be cancelled or suspended.
- As the target parking space will not be able to be set correctly if the surface of the parking space is on a slope or has differences in height, the vehicle may stray from the target parking space or be slanted. Therefore, do not use the parallel parking function for this kind of parking spot.
- If an adjacent parked vehicle is narrow or parked extremely close to the curb, the position at which assistance will park the vehicle will also be close to the curb. If it seems likely the vehicle will collide with the curb or drive off of the road, depress the brake pedal to stop the vehicle, and then press the Advanced Park main switch to disable the system.

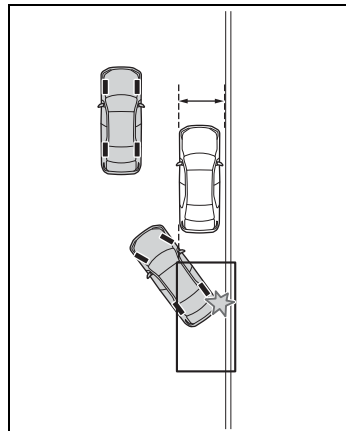



NOTICE

- If there is a wall or other barrier on the inner side of the parking space, the vehicle may stop at a position slightly outside of the set target parking space.

Advanced Park parallel exiting function

When exiting from a parallel parking space, if the system determines that exit is possible the parallel exiting function can be used. Also, depending on the surrounding environment, if it is necessary to change the direction of travel of the vehicle, the shift position can be changed by assistance control.

Leaving a parking space using the parallel exiting function

- 1 With the brake pedal depressed and P shift position selected, press the Advanced Park main switch and check that the exit direction selection screen is dis-

played on the Multimedia Display.

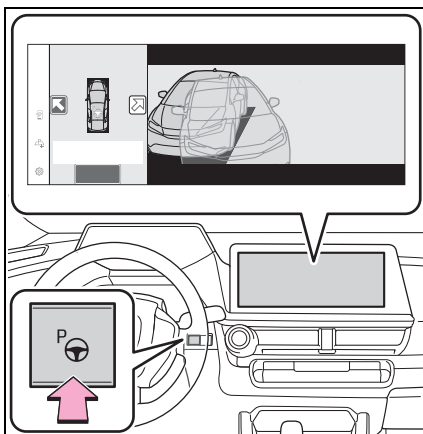

- 2 Select an arrow on the Multimedia Display to select the direction you wish to exit.

If the turn signal lever is operated, only exit to the left or right can be selected.

- 3 Depress the brake pedal and select "Start" button.

A buzzer will sound, an operation message will be displayed on the multi-information display, and assistance will begin operating.

To cancel assistance, press the Advanced Park main switch.

If assistance is canceled, "Advanced Park Canceled" will be displayed.

If you feel that the vehicle is approaching close to a surrounding vehicle, object, person, or gutter: →P.327

- 4 Perform operations as indicated by the advice displays until the vehicle is in a position where exit is possible.

When the vehicle reaches a position where exit is possible, "You can exit by moving the steering

wheel” will be displayed. If the steering wheel is operated, “Advanced Park Finished” will be displayed and assistance will end.

As assistance will end while the vehicle is moving, grip the steering wheel and drive forward.

If the steering wheel is not operated, the vehicle will stop at the exit position. Assistance can be ended by depressing the accelerator pedal or brake pedal.

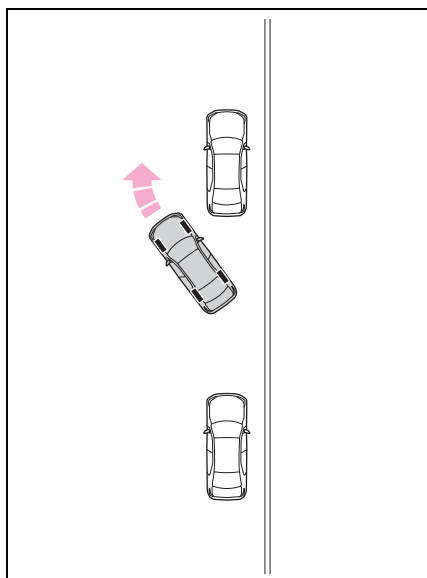

■ **If you feel that the vehicle is approaching close to a surrounding vehicle, object, person, or gutter**

→P.327

■ **Parallel exiting function**

Do not use parallel exiting function in any situation other than when exiting a parallel parking spot. If assistance is started unintentionally, depress the brake pedal and stop the vehicle, then press the Advanced Park main switch to cancel assistance.

■ **Situations in which the parallel exiting function will not operate**

In situations such as the following, the parallel exiting function will not operate:

- When vehicles waiting at a traffic signal in the exit direction

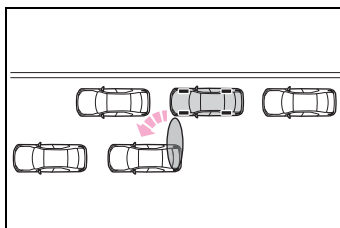

- When a vehicle is stopped in the area behind where the vehicle will exit

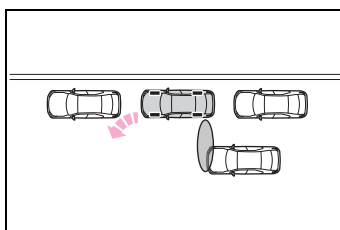

- When a wall, column, or person is detected as near a front or rear side sensor

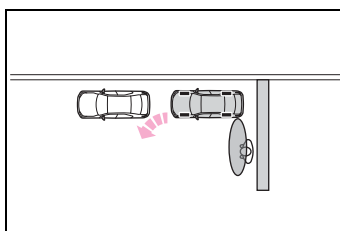

- When the vehicle has been parked on a curb and a side sensor detects the road surface

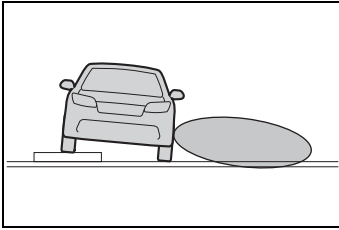

- When a vehicle is not parked in front of the vehicle
- When there is excessive space between the front of the vehicle and a parked vehicle
- **When the brakes have been operated**

→P.327

Advanced Park memory function

The memory function can be used to park in a previously registered parking space, even if there are no parking space lines or adjacent parked vehicles.

Up to 3 parking spaces can be registered.

Registering a parking space

- 1 Stop the vehicle with it aligned near the center of the target parking space.

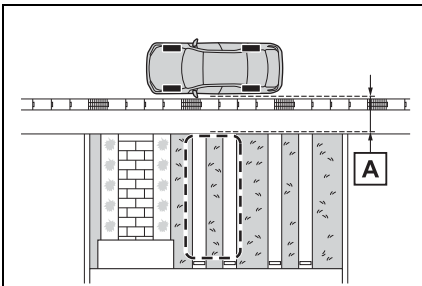

- A Approximately 3.3 ft. (1 m)
- 2 Press the main switch and then select .

If the Advanced Park main switch is pressed at a parking space without parking lines or any adjacent parked vehicles, “No available parking space” may be displayed.

Continuously select and hold .

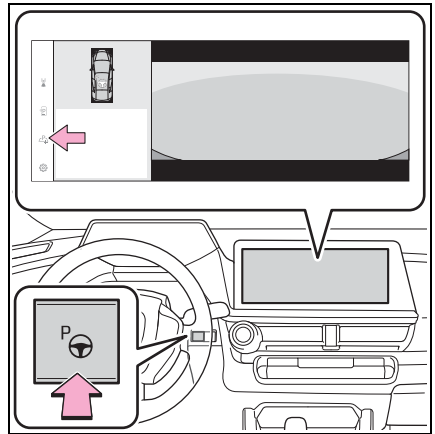

- 3 Select perpendicular parking (forward/reverse) function or parallel parking function.

Only parking spaces for which assist can be performed are displayed.

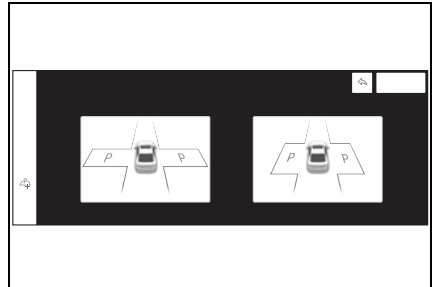

- 4 Select the parking direction.
- When perpendicular parking (forward/reverse) was selected in step

3:

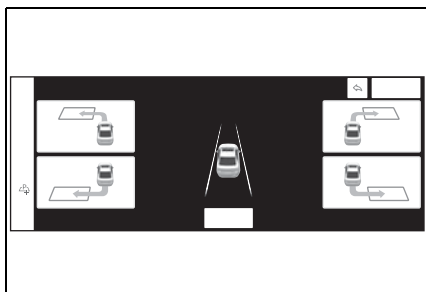

When parallel parking was selected in step 3:

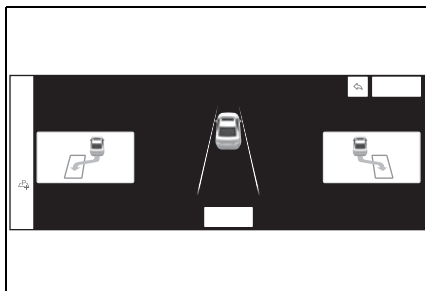

- 5 Using the arrow buttons, adjust the position of the parking space to be registered, and then select “OK” button.

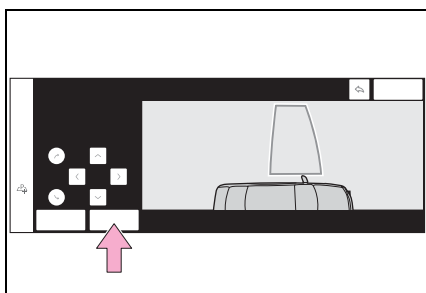

- 6 Select “Start” button.

A buzzer will sound, an operation message will be displayed on the multi-information display, and assistance will begin operating. When the brake pedal is released, “Moving Forward...” will be displayed and the vehicle will begin

moving forward.

If you feel that the vehicle is approaching close to a surrounding vehicle, object, person, or gutter: →P.327

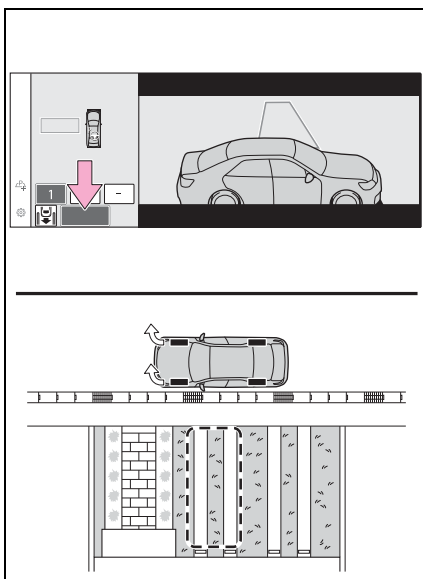

- 7 Perform operations as indicated by the advice displays until the vehicle stops in the target parking space.
- 8 Check the position that the vehicle has stopped. If necessary, adjust the position of the parking spot to be registered using the arrow buttons, and then select “Reg.” button.

“Registration Completed” will be displayed on the Multimedia Dis-

play.

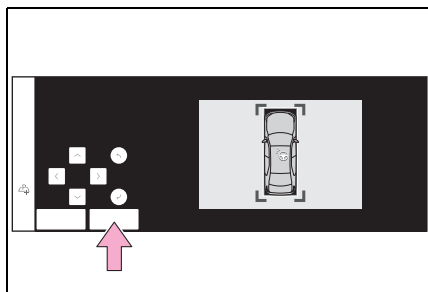

- Register the parking space only if there are no obstructions within the area shown by the thick lines.
- The amount that the position of the parking spot to be registered can be adjusted is limited.

When parking in a parking space registered to the memory function

- 1 Stop the vehicle with it aligned near the center of the target parking space.

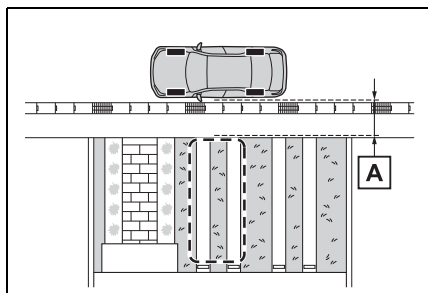

- A** Approximately 3.3 ft. (1 m)
- 2 Press the Advanced Park main switch and check that a possible parking space is dis-

played on the Multimedia Display.

If the “MODE” button is displayed, the button can be touched to change between the memory function, perpendicular parking (forward/reverse) function and parallel parking function.

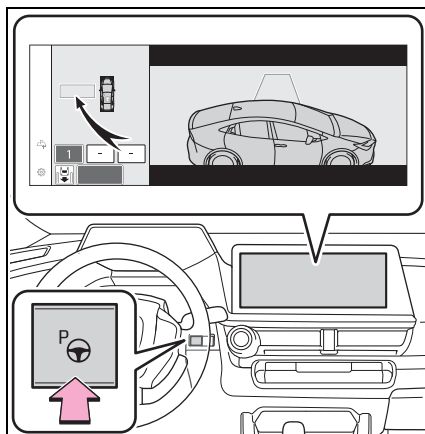

- 3 Select the desired parking space, and then select “Start” button.

Perform the procedure for the perpendicular parking (forward/reverse) function from step 3. (→P.325)

■ **If you feel that the vehicle is approaching close to a surrounding vehicle, object, person, or gutter**

→P.327

■ **When overwriting a registered parking space**

If the maximum number of parking spaces have been registered and $\triangle P$ is selected, a registered parking space can be selected and then overwritten with a new parking space.

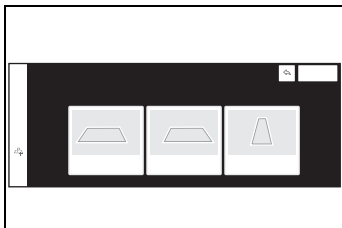

■ When multiple parking spaces are registered

Select the desired parking space, and then select “Start” button.

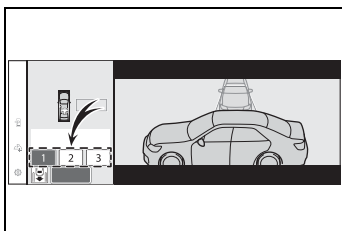

■ When the brakes have been operated

→P.327



NOTICE

■ When using the memory function (→P.327, 332)

- The memory function is a function which provides assistance in parking in a previously registered parking space. If the condition of the road surface, vehicle, or surrounding area differs from when registration was performed, the parking space may not be able to be detected correctly or assistance may not be provided to the point that the vehicle is fully parked.
- Do not register a parking space in situations such as the following, as the set parking space may not be able to be registered or assistance may not be possible later.
 - When a camera lens is dirty or covered with water droplets

- When it is raining or snowing
- When the surrounding area is dark (at night, etc.)
- In situations such as the following, it may not be possible to register a parking space.
 - When there is insufficient space between the road and parking space
 - When the road surface around the parking space does not have any differences the system can recognize
- If a parking space has been registered in situations such as the following, assistance may not be able to be started later or assistance to the registered position may not be possible.
 - When shadows are cast on the parking space (there is a carport over the parking space, etc.)

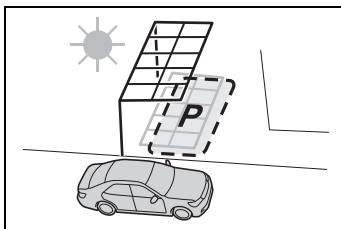

- When there are leaves, garbage, or other objects which will likely move, in the parking space
- When the road surface around the parking space has the same repeating pattern (brick, etc.)

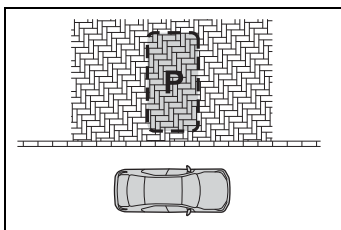



NOTICE

- In situations such as the following, it may not be possible for the system to provide assistance to a registered parking spot:
 - When the appearance of the parking space is affected by the shadow of the vehicle or trees
 - When an object is detected in the registered parking space
 - When a pedestrian or passing vehicle is detected during assistance
 - When the position the vehicle is stopped when assistance is started differs from the position when registration was performed
 - When the registered parking space cannot be reached due to the existence of parking blocks, etc.
 - When the road surface around the parking space has changed (road surface has degraded or been resurfaced)
 - When the sunlight conditions differ from when registration was performed (due to weather or time of day)
 - When the sun is shining directly into a camera, such as in the early morning or evening
 - When the color or brightness of the road surface is uneven
 - When a light is temporarily shined on the parking space (lights of another vehicle, security light, etc.)
 - When the road surface around the parking space has the same repeating pattern

- When there is a low protrusion on the road surface near the parking space
- When the parking space is on a slope
- When a camera has been splashed by hot or cold water and the lens has fogged up
- When a camera lens is dirty or covered with water droplets
- When accessories which obstruct the view of the camera are installed
If assistance is ended during registration, perform registration again.
- When registering a parking space to the memory function, if the road surface cannot be detected “No available parking space to register” will be displayed.
- When using the memory function, make sure to stop immediately in front of the stop position. Otherwise the parking space may not be able to be detected correctly or assistance may not be provided to the point that the vehicle is fully parked.
- Do not use the memory function if a camera has been subjected to a strong impact or images of the panoramic view monitor are misaligned.
- If a camera has been replaced, as the installation angle of the camera will have changed, it will be necessary to reregister parking spaces of the memory function.

Advanced Park cancellation/suspension

■ Assistance will be canceled when

In situations such as the following, Advanced Park operation will be canceled. Firmly hold the steering wheel and depress the brake pedal to stop the vehicle.

As system operation has been canceled, begin the operation again or continue parking manually, using the steering wheel.

- The Advanced Park main switch is pushed
- The shift position has been changed to P
- The parking brake is engaged
- A door or the back door is opened
- The driver's seat belt is unfastened
- The outside rear view mirrors are folded
- The TRAC or VSC is turned off
- The TRAC, VSC or ABS operates
- The power switch is pressed
- The system determines assistance cannot be continued in the current parking environment
- The system malfunctions
- While the vehicle was

stopped, "Cancel" was selected on the Multimedia Display

■ Assistance will be suspended when

In situations such as the following, Advanced Park operation will be suspended.

Assistance can be started again by following the directions displayed on the Multimedia Display.

Also, when assistance is suspended, if the shift position is changed twice with the brake pedal depressed, assistance will be canceled in that shift position. However, if assistance is suspended by changing the shift position, assistance will be canceled if the shift position is changed once.

- The steering wheel is operated
- The accelerator pedal is depressed
- The shift position has been changed
- A moving object or stationary object that may collide with your vehicle has been detected, resulting in the operation of the hybrid system output control/braking control.
- Camera switch is pressed

Changing the Advanced Park settings

Select  on the Multimedia Display, and then select “Advanced Park”.

■ “Speed Profile”

The vehicle speed for when assistance is performed can be set.

This setting cannot be changed when registering a parking space to the memory function.

■ “Obstacle detection range”

The distance from which obstacles will be avoided while assistance is being performed can be set.

■ “Preferred parking method”

The preferred parking direction displayed when at a parking space which perpendicular (forward/reverse) or parallel parking is possible can be set.

■ “Preferred parking direction”

The preferred parking direction displayed when it is possible to pull perpendicular forward or reverse into a parking space can be selected.

■ “Preferred exit direction (perpendicular)”

The preferred exit direction displayed when it is possible to pull forward or reverse to the left or

right out of a parking space can be selected.

■ “Preferred exit direction (parallel)”

The preferred exit direction displayed when it is possible to exit to the left or right from a parallel parking space can be selected.

■ “Camera view when parking”

The display angle of the camera image when using the perpendicular parking (forward/reverse) function or parallel parking function can be set.

■ “Camera view when exiting”

The display angle of the camera image when using the perpendicular exiting (forward/reverse) function or parallel parking exit function can be set.

■ “Parking path adjustment”

The course for when parking assistance is operating can be adjusted inward or outward.

If the tires are worn, the path of vehicle may be offset from the center of the parking space. In this case, use this setting to adjust the parking course.

■ “Road width adjustment”

When parking assistance is started, the amount of lateral movement while the vehicle is moving forward can be

adjusted.

■ “Park position adjustment (forward)”

The position at which perpendicular parking (forward) is completed can be adjusted. (Except when using the memory function.)

■ “Park position adjustment (reverse)”

The position at which perpendicular parking (reverse) is completed can be adjusted. (Except when using the memory function.)

■ “Rear accessory setting”

If an accessory, such as a trailer hitch, has been installed to the rear of the vehicle, the length of the rear of the vehicle can be adjusted to help avoid colliding with objects to the rear of the vehicle.

■ “Clear registered parking space”

The parking spaces registered to the memory function can be deleted. Parking space information cannot be deleted when assistance is being performed or when registering parking space information to the memory function.



NOTICE

- Take care when using the park position adjustment (forward) or park position adjustment (reverse) for adjusting because the vehicle may collide with parking blocks, curb stones, or other low objects.
- If it is likely that your vehicle will collide with a nearby vehicle/object, parking block, curb stone, etc., depress the brake pedal to stop the vehicle and press the Advanced Park main switch to disable the system.

Advanced Park displayed messages

The operating state, assistance operation, etc. of the Advanced Park is displayed on the Multimedia Display. If a message is displayed, respond according to the content displayed.

■ If “No available parking space” is displayed

Move the vehicle to a location where a parking space or parking lines can be detected.

■ If “Unavailable in current condition” is displayed

Move the vehicle to another location and use the system.

■ If “Not enough space to exit” is displayed

The parallel parking exit function cannot be used due to a situation such as the distance between your vehicle and vehicles parked in front of and behind your vehicle being short, the existence of an object in the exit direction, etc.

Check the conditions of the area

around your vehicle and exit from the parking space manually.

■ If “Cannot control speed” is displayed

The system judged that it cannot adjust the speed of the vehicle when using the system in an area with a slope or step and assistance was canceled.

Use the system in a level location.

■ If “Obstacle detected” is displayed

As a moving object or stationary object that may collide with your vehicle has been detected, the hybrid system output control/braking control operates to suspend Advanced Park assistance.

Check the condition of the surrounding area. To resume assistance, select the “Start” button on the Multimedia Display.

■ If “No available parking space to register” is displayed

This message is displayed when $\triangle P_{+}$ is selected at a parking space that cannot be detected.

Operate the system at a parking space where differences in the road surface can be recognized. (→P.335)

Driving mode select switch

The driving modes can be selected to suit the driving and usage conditions.

Selecting a driving mode

Operate the driving mode select switch forward or backward to select the desired driving mode.

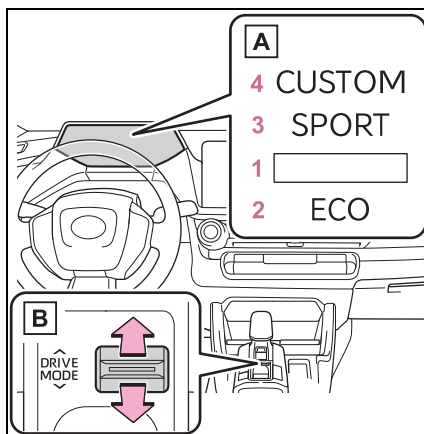

A Indicator

B Driving mode select switch

1 Normal mode

Provides an optimal balance of fuel economy, quietness, and dynamic performance. Suitable for normal driving.

2 Eco drive mode

Helps the driver accelerate in an eco-friendly manner and improve fuel economy through moderate throttle characteristics and by controlling the operation of the air conditioning system (heating/cooling).

When Eco drive mode is selected, Eco drive mode indicator comes on.

3 Sport mode

Controls the hybrid system to provide quick, powerful acceleration. This mode also expands the possible rate of deceleration by operating the accelerator pedal and enables acceleration/deceleration control based on the driver's intentions. This changes the steering feel, making it suitable for when agile driving response is desired, such as when driving on roads with many curves.

When Sport mode is selected, Sport mode indicator comes on.

4 Custom mode

Allows you to drive with the power train, steering wheel and air conditioning system functions set to your preferred settings.

Custom mode settings can only be changed on the drive mode customization display of Multimedia Display. (→P.550)

When the Custom mode is selected, Custom mode indicator comes on.

■ Operation of the air conditioning system in Eco drive mode

When Eco drive mode is selected, the air conditioning system will automatically be changed to eco air conditioning mode.

Eco air conditioning mode controls the heating/cooling operations and fan speed of the air conditioning system to enhance fuel efficiency. To improve air conditioning performance, perform the following operations:

- Adjust the fan speed (→P.359)

- Deactivate Eco drive mode
- Turn off eco air conditioning mode (→P.363)

■ Automatic deactivation of a driving mode

- Sport mode and Custom mode are automatically deactivated and the driving mode returns to normal mode when the power switch is turned to OFF.
- Normal mode and Eco drive mode are not deactivated until another driving mode is selected. (Even if the power switch is turned to OFF, normal mode and Eco drive mode will not be automatically deactivated.)

■ Customization

The custom mode can be changed. (Customizable features: →P.538)

Driving assist systems

To keep driving safety and performance, the following systems operate automatically in response to various driving situations. Be aware, however, that these systems are supplementary and should not be relied upon too heavily when operating the vehicle.

Summary of the driving assist systems

■ ECB (Electronically Controlled Brake System)

The electronically controlled system generates braking force corresponding to the brake operation

■ ABS (Anti-lock Brake System)

Helps to prevent wheel lock when the brakes are applied suddenly, or if the brakes are applied while driving on a slippery road surface

■ Brake assist

Generates an increased level of braking force after the brake pedal is depressed when the system detects a panic stop situation

■ VSC (Vehicle Stability Control)

Helps the driver to control skidding when swerving suddenly or turning on slippery road surfaces.

■ Enhanced VSC (Enhanced Vehicle Stability Control)

Provides cooperative control of the ABS, TRAC, VSC and EPS. Helps to maintain directional stability when swerving on slippery road surfaces by controlling steering performance.

■ TRAC (Traction Control)

Helps to maintain drive power and prevent the drive wheels from spinning when starting the vehicle or accelerating on slippery roads

■ Active Cornering Assist (ACA)

Helps to prevent the vehicle from drifting to the outer side by performing inner wheel brake control when attempting to accelerate while turning

■ Hill-start assist control

Helps to reduce the backward movement of the vehicle when starting on an uphill

■ EPS (Electric Power Steering)

Employs an electric motor to reduce the amount of effort needed to turn the steering

wheel.

■ E-Four (Electronic On-Demand AWD system) (AWD models)

Automatically controls the drive system such as to front-wheel drive or AWD (all wheel drive) according to various running conditions including normal driving, during cornering, on a uphill, when starting off, during acceleration, on a slippery roads due to snow or rain, thus contributing to stable operability and driving stability.

■ The Secondary Collision Brake

When the SRS airbag sensor detects a collision and the system operates, the brakes and brake lights are automatically controlled to reduce the vehicle speed and help reduce the possibility of further damage due to a secondary collision.

■ When the TRAC/VSC/ABS systems are operating

The slip indicator light will flash while the TRAC/VSC/ABS systems are operating.

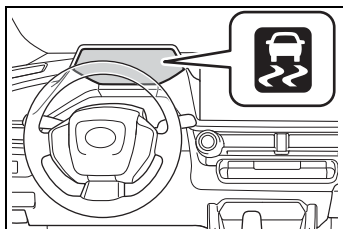

■ Disabling the TRAC system

If the vehicle gets stuck in mud, dirt

or snow, the TRAC system may reduce power from the hybrid system to the wheels.

Pressing  to turn the system off may make it easier for you to rock the vehicle in order to free it.

To turn the TRAC system off, quickly press and release .

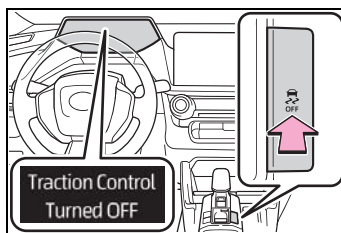

The “Traction Control Turned OFF” will be shown on the multi-information display.

Press  again to turn the system back on.

■ Turning off both TRAC and VSC systems

To turn the TRAC and VSC systems off, press and hold  for more than 3 seconds while the vehicle is stopped.

The VSC OFF indicator light will come on and the “Traction Control Turned OFF” will be shown on the multi-information display.*

Press  again to turn the systems back on.

*: PCS (Pre-Collision System) will also be disabled (only pre-collision warning is available). The PCS warning light will come on and a message will be displayed on the multi-information display.

(→P.226)

■ **When the message is displayed on the multi-information display showing that TRAC has been disabled even if  has not been pressed**

TRAC is temporary deactivated. If the information continues to show, contact your Toyota dealer.

■ **Operating conditions of hill-start assist control**

When all of the following conditions are met, the hill-start assist control will operate:

- The shift position is in a position other than P or N (when starting off forward/backward on an upward incline)
- The vehicle is stopped
- The accelerator pedal is not depressed
- The parking brake is not engaged
- The power switch is in ON

■ **Automatic system cancelation of hill-start assist control**

The hill-start assist control will turn off in any of the following situations:

- Shift the shift position to P or N.
- The accelerator pedal is depressed
- The brake pedal is depressed and the parking brake is engaged
- A maximum of 2 seconds have elapsed after the brake pedal is released
- The power switch is turned to OFF

■ **Sounds and vibrations caused by the ABS, brake assist, VSC, TRAC and hill-start assist control systems**

- A sound may be heard from the engine compartment when the brake pedal is depressed repeatedly, when the hybrid system is started or just after the vehicle begins to move. This sound does

not indicate that a malfunction has occurred in any of these systems.

- Any of the following conditions may occur when the above systems are operating. None of these indicates that a malfunction has occurred.
 - Vibrations may be felt through the vehicle body and steering.
 - A motor sound may be heard also after the vehicle comes to a stop.

■ **ECB operating sound**

ECB operating sound may be heard in the following cases, but it does not indicate that a malfunction has occurred.

- Operating sound heard from the engine compartment when the brake pedal is operated.
- Operating sound heard from the engine compartment when one or two minutes passed after the stop of the hybrid system.

■ **Active Cornering Assist operation sounds and vibrations**

When the Active Cornering Assist is operated, operation sounds and vibrations may be generated from the brake system, but this is not a malfunction.

■ **Automatic reactivation of TRAC and VSC systems**

After turning the TRAC and VSC systems off, the systems will be automatically re-enabled in the following situations:

- When the power switch is turned off
- If only the TRAC system is turned off, the TRAC will turn on when vehicle speed increases
- If both the TRAC and VSC systems are turned off, automatic re-enabling will not occur when vehicle speed increases.

■ **Operating conditions of Active Cornering Assist**

The system operates when the fol-

lowing occurs.

- TRAC/VSC can operate
- The driver is attempting to accelerate while turning
- The system detects that the vehicle is drifting to the outer side
- The brake pedal is released

■ **Reduced effectiveness of the EPS system**

The effectiveness of the EPS system is reduced to prevent the system from overheating when there is frequent steering input over an extended period of time. The steering wheel may feel heavy as a result. Should this occur, refrain from excessive steering input or stop the vehicle and turn the hybrid system off. The EPS system should return to normal within 10 minutes.

■ **Secondary Collision Brake operating conditions**

The system operates when the SRS airbag sensor detects a collision while the vehicle is in motion. However, the system does not operate when the components are damaged.

■ **Secondary Collision Brake automatic cancellation**

The system is automatically cancelled in any of the following situations.

- The vehicle speed drops to approximately 0 mph (0 km/h).
- A certain amount of time elapses during operation
- The accelerator pedal is depressed a large amount

■ **If a message about AWD is shown on the multi-information display (AWD models)**

Perform the following actions.

- “AWD System Overheated Switching to 2WD Mode”

AWD system is overheated. Stop the vehicle in a safe place with the

hybrid system operating.*

If the message disappears after a while, there is no problem. If the message remains, have the vehicle inspected by your Toyota dealer immediately.

- “AWD System Overheated 2WD Mode Engaged”

AWD system has been temporarily released and switched to front-wheel drive due to overheating. Stop the vehicle in a safe place with the hybrid system operating.*

If the message disappears after a while, AWD system will automatically recover. If the message remains, have the vehicle inspected by your Toyota dealer immediately.

- “AWD System Malfunction 2WD Mode Engaged Visit Your Dealer”

A malfunction occurs in the AWD system. Have the vehicle inspected by your Toyota dealer immediately.

*: When stopping the vehicle, do not stop the hybrid system until the display message has turned off.



WARNING

■ **The ABS does not operate effectively when**

- The limits of tire gripping performance have been exceeded (such as excessively worn tires on a snow-covered road).
- The vehicle hydroplanes while driving at high speed on wet or slick roads.

**WARNING****■ Stopping distance when the ABS is operating may exceed that of normal conditions**

The ABS is not designed to shorten the vehicle's stopping distance. Always maintain a safe distance from the vehicle in front of you, especially in the following situations:

- When driving on dirt, gravel or snow-covered roads
- When driving with tire chains
- When driving over bumps in the road
- When driving over roads with potholes or uneven surfaces

■ TRAC/VSC may not operate effectively when

Directional control and power may not be achievable while driving on slippery road surfaces, even if the TRAC/VSC system is operating. Drive the vehicle carefully in conditions where stability and power may be lost.

■ Active Cornering Assist does not operate effectively when

- Do not overly rely on Active Cornering Assist. Active Cornering Assist may not operate effectively when accelerating down slopes or driving on slippery road surfaces.
- When Active Cornering Assist frequently operates, Active Cornering Assist may temporarily stop operating to ensure proper operation of the brakes, TRAC and VSC.

■ Hill-start assist control does not operate effectively when

- Do not overly rely on hill-start assist control. Hill-start assist control may not operate effectively on steep inclines and roads covered with ice.
- Unlike the parking brake, hill-start assist control is not intended to hold the vehicle stationary for an extended period of time. Do not attempt to use hill-start assist control to hold the vehicle on an incline, as doing so may lead to an accident.

■ When the TRAC/ABS/VSC is activated

The slip indicator light flashes. Always drive carefully. Reckless driving may cause an accident. Exercise particular care when the indicator light flashes.

■ When the TRAC/VSC systems are turned off

Be especially careful and drive at a speed appropriate to the road conditions. As these are the systems to help ensure vehicle stability and driving force, do not turn the TRAC/VSC systems off unless necessary.

■ Replacing tires

Make sure that all tires are of the specified size, brand, tread pattern and total load capacity. In addition, make sure that the tires are inflated to the recommended tire inflation pressure level. The ABS, TRAC and VSC systems will not function correctly if different tires are installed on the vehicle. Contact your Toyota dealer for further information when replacing tires or wheels.

**WARNING****■ Handling of tires and the suspension**

Using tires with any kind of problem or modifying the suspension will affect the driving assist systems, and may cause a system to malfunction.

■ Secondary Collision Brake

Do not rely solely upon the Secondary Collision Brake. This system is designed to help reduce the possibility of further damage due to a secondary collision, however, that effect changes according to various conditions. Overly relying on the system may result in death or serious injury.

Hybrid Electric Vehicle driving tips

For economical and ecological driving, pay attention to the following points:

Using Eco drive mode

When using Eco drive mode, the torque corresponding to the accelerator pedal depression amount can be generated more smoothly than it is in normal conditions. In addition, the operation of the air conditioning system (heating/cooling) will be minimized, improving the fuel economy. (→P.343)

Use of Hybrid System Indicator

The Eco-friendly driving is possible by keeping the indicate of Hybrid System Indicator within Eco area. (→P.89)

Changing the shift position

Shift the shift position to D when stopped at a traffic light, or driving in heavy traffic etc. Shift the shift position to P when parking. When using the N, there is no positive effect on fuel consumption. In the N, the gasoline engine operates but electricity

cannot be generated. Also, when using the air conditioning system, etc., the hybrid battery (traction battery) power is consumed.

Accelerator pedal/brake pedal operation

- Drive your vehicle smoothly. Avoid abrupt acceleration and deceleration. Gradual acceleration and deceleration will make more effective use of the electric motor (traction motor) without having to use gasoline engine power.
- Avoid repeated acceleration. Repeated acceleration consumes hybrid battery (traction battery) power, resulting in poor fuel consumption. Battery power can be restored by driving with the accelerator pedal slightly released.

When braking

Make sure to operate the brakes gently and in a timely manner. A greater amount of electrical energy can be regenerated when slowing down.

Delays

Repeated acceleration and deceleration, as well as long waits at traffic lights, will lead to bad fuel economy. Check traffic

reports before leaving and avoid delays as much as possible. When driving in a traffic jam, gently release the brake pedal to allow the vehicle to move forward slightly while avoiding overuse of the accelerator pedal. Doing so can help control excessive gasoline consumption.

Highway driving

Control and maintain the vehicle at a constant speed. Before stopping at a toll booth or similar, allow plenty of time to release the accelerator and gently apply the brakes. A greater amount of electrical energy can be regenerated when slowing down.

Air conditioning

Use the air conditioning only when necessary. Doing so can help reduce excessive gasoline consumption.

In summer: When the ambient temperature is high, use the recirculated air mode. Doing so will help to reduce the burden on the air conditioning system and reduce fuel consumption as well.

In winter: Because the gasoline engine will not automatically cut out until it and the interior of the vehicle are warm, it will con-

sume fuel. Also, fuel consumption can be improved by avoiding overuse of the heater.

Checking tire inflation pressure

Make sure to check the tire inflation pressure frequently. Improper tire inflation pressure can cause poor fuel economy. Also, as snow tires can cause large amounts of friction, their use on dry roads can lead to poor fuel economy. Use tires that are appropriate for the season.

Luggage

Carrying heavy luggage will lead to poor fuel economy. Avoid carrying unnecessary luggage. Installing a large roof rack will also cause poor fuel economy.

Warming up before driving

Since the gasoline engine starts up and cuts out automatically when cold, warming up the engine is unnecessary. Moreover, frequently driving short distances will cause the engine to repeatedly warm up, which can lead to excess fuel consumption.

Winter driving tips

Carry out the necessary preparations and inspections before driving the vehicle in winter. Always drive the vehicle in a manner appropriate to the prevailing weather conditions.

Preparation for winter

- Use fluids that are appropriate to the prevailing outside temperatures.
- Engine oil
- Engine coolant
- Power control unit coolant
- Washer fluid
- Have a service technician inspect the condition of the 12-volt battery.
- Have the vehicle fitted with four snow tires or purchase a set of tire chains for the front tires.*

Ensure that all tires are the same size and brand, and that chains match the size of the tires.

*: Tire chains cannot be mounted on vehicles with 195/50R19 tires.



WARNING

■ Driving with snow tires

Observe the following precautions to reduce the risk of accidents. Failure to do so may result in a loss of vehicle control and cause death or serious injury.

- Use tires of the specified size.
- Maintain the recommended level of air pressure.
- Do not drive in excess of 75 mph (120 km/h), regardless of the type of snow tires being used.
- Use snow tires on all, not just some wheels.

■ Driving with tire chains (except 195/50R19 tires)

Observe the following precautions to reduce the risk of accidents. Failure to do so may result in the vehicle being unable to be driven safely, and may cause death or serious injury.

- Do not drive in excess of the speed limit specified for the tire chains being used, or 30 mph (50 km/h), whichever is lower.
- Avoid driving on bumpy road surfaces or over potholes.
- Avoid sudden acceleration, abrupt steering, sudden braking and shifting operations that cause sudden engine braking.
- Slow down sufficiently before entering a curve to ensure that vehicle control is maintained.
- Do not use LTA (Lane Tracing Assist) system.
- Do not use LDA (Lane Departure Alert) system.



NOTICE

■ Repairing or replacing snow tires

Request repairs or replacement of snow tires from your Toyota dealer or legitimate tire retailers. This is because the removal and attachment of snow tires affects the operation of the tire pressure warning valves and transmitters.

Before driving the vehicle

Perform the following according to the driving conditions:

- Do not try to forcibly open a window or move a wiper that is frozen. Pour warm water over the frozen area to melt the ice. Wipe away the water immediately to prevent it from freezing.
- To ensure proper operation of the climate control system fan, remove any snow that has accumulated on the air inlet vents in front of the windshield.
- Check for and remove any excess ice or snow that may have accumulated on the exterior lights, outside rear view mirrors, windows, vehicle's roof, chassis, around the tires or on the brakes.
- Remove any snow or mud from the bottom of your shoes before getting in the vehicle.

When driving the vehicle

Accelerate the vehicle slowly, keep a safe distance between you and the vehicle ahead, and drive at a reduced speed suitable to road conditions.

When parking the vehicle

- Turn automatic mode of the parking brake off. Otherwise, the parking brake may freeze and not be able to be released automatically.

Also, avoid using the following as the parking brake may operate automatically, even if automatic mode is off.

- Brake hold system
- Park the vehicle and shift the shift position to P without setting the parking brake. The parking brake may freeze up, preventing it from being released. If the vehicle is parked without setting the parking brake, make sure to block the wheels. Failure to do so may be dangerous because it may cause the vehicle to move unexpectedly, possibly leading to an accident.
- When the parking brake is in automatic mode, release the parking brake after shifting the shift position to P.
(→P.194)

- If the vehicle is parked without setting the parking brake, confirm that the shift position cannot be moved out of P.
- If the vehicle is left parked with the brakes damp in cold temperatures, there is a possibility of the brakes freezing.

**WARNING****■ When parking the vehicle**

When parking the vehicle without applying the parking brake, make sure to chock the wheels. If you do not chock the wheels, the vehicle may move unexpectedly, possibly resulting in an accident.

Selecting tire chains

- ▶ Vehicles without 195/50R19 tires

Use the correct tire chain size when mounting the tire chains. Chain size is regulated for each tire size.

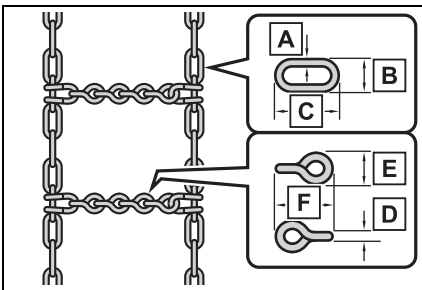

Side chain:

- A** 0.12 in. (3 mm) in diameter
- B** 0.39 in. (10 mm) in width
- C** 1.18 in. (30 mm) in length

Cross chain:

D 0.16 in. (4 mm) in diameter

E 0.55 in. (14 mm) in width

F 0.98 in. (25 mm) in length

- ▶ Vehicles with 195/50R19 tires

Tire chains cannot be mounted. Snow tires should be used instead.

Regulations on the use of tire chains (except 195/50R19 tires)

Regulations regarding the use of tire chains vary depending on location and type of road. Always check local regulations before installing chains.

■ Tire chain installation

Observe the following precautions when installing and removing chains:

- Install and remove tire chains in a safe location.
- Install tire chains on the front tires only. Do not install tire chains on the rear tires.
- Install tire chains on front tires as tightly as possible. Retighten chains after driving 1/4 - 1/2 mile (0.5 - 1.0 km).
- Install tire chains following the instructions provided with the tire chains.

**NOTICE****■ Fitting tire chains**

The tire pressure warning valves and transmitters may not function correctly when tire chains are fitted.

5-1. Using the air conditioning system and defogger

Automatic air conditioning system..... 358

Heated steering wheel/seat heaters/seat ventilators 365

5-2. Using the interior lights

Interior lights list 368

5-3. Using the storage features

List of storage features 371

Luggage compartment features 375

5-4. Using the other interior features

Other interior features . 378

Garage door opener.... 389

Automatic air conditioning system

Air outlets and fan speed are automatically adjusted according to the temperature setting.

Air conditioning controls

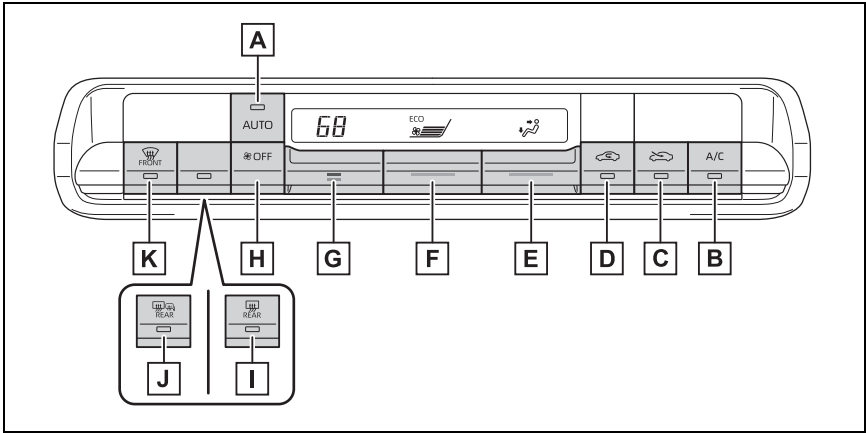

- A** Automatic mode switch
- B** "A/C" switch
- C** Outside air mode switch
- D** Recirculated air mode switch
- E** Airflow mode setting knob
- F** Fan speed setting knob
- G** Temperature setting knob
- H** "OFF" switch
- I** Rear window defogger switch (if equipped)
- J** Rear window and outside rear view mirror defoggers switch (if equipped)
- K** Windshield defogger switch

■ Adjusting the temperature setting

Move the temperature setting

knob upwards to increase the temperature and downwards to decrease the temperature.

If the “A/C” switch is not pressed, the system will blow ambient temperature air or heated air.

■ Setting the fan speed

Move the fan speed setting knob upwards to increase the fan speed and downwards to decrease the fan speed.

The fan speed is shown on the display. (7 levels)

Press the “OFF” switch to turn the fan off.

■ Change the airflow mode

Move the airflow mode setting knob upwards or downwards to change the airflow mode.

The air outlets used are switched each time the knob is operated.

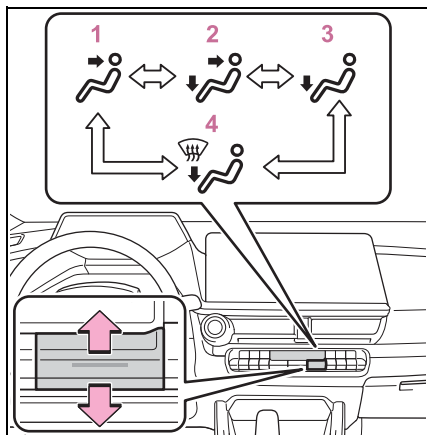

- 1 Air flows to the upper body.
- 2 Air flows to the upper body and feet.
- 3 Air flows to the feet.
- 4 Air flows to the feet and the windshield defogger operates.

■ Switching between outside air and recirculated air modes

- To change to recirculated air mode, press the recirculated air mode switch.

The indicator illuminates on the recirculated air mode switch.

- To change to outside air mode, press the outside air mode switch.

The indicator illuminates on the outside air mode switch.

■ Set cooling and dehumidification function

Press the “A/C” switch.

When the function is on, the indicator illuminates on the “A/C” switch.

■ Defogging the windshield

Defoggers are used to defog the windshield and front side windows.

Press the windshield defogger switch.

Set the outside/recirculated air mode switch to outside air mode if the recirculated air mode is used. (It may switch automatically.)

To defog the windshield and the side windows quickly, turn the air flow and temperature up.

To return to the previous mode, press the windshield defogger switch again when the windshield is defogged.

When the windshield defogger switch is on, the indicator illuminates on the windshield defogger

switch.

■ Defogging the rear window (if equipped)

A defogger is used to defog the rear window.

Press the rear window defogger switch.

When the rear window defogger switch is on, the indicator illuminates on the rear window defogger switch.

The defogger will automatically turn off after 15 minutes.

■ Defogging the rear window and outside rear view mirrors (if equipped)

Defoggers are used to defog the rear window and to remove raindrops, dew and frost from the outside rear view mirrors.

Press the rear window and outside rear view mirror defoggers switch.

When the rear window and outside rear view mirror defoggers switch is on, the indicator illuminates on the rear window and outside rear view mirror defoggers switch.

The defoggers will automatically turn off after 15 minutes.

■ When the outside temperature exceeds 75°F (24°C) and the air conditioning system is on

- In order to reduce the air conditioning power consumption, the air conditioning system may switch to recirculated air mode automatically. This may also reduce fuel consumption.

- Recirculated air mode is selected as a default mode when the power switch is turned to ON.

- It is possible to switch to outside air mode at any time by pressing the outside air mode switch.

■ Fogging up of the windows

- The windows will easily fog up when the humidity in the vehicle is high. Turning the cooling and dehumidification function on will dehumidify the air from the outlets and defog the windshield effectively.

- If you turn the cooling and dehumidification function off, the windows may fog up more easily.

- The windows may fog up if the recirculated air mode is used.

■ When driving on dusty roads

Close all windows. If dust thrown up by the vehicle is still drawn into the vehicle after closing the windows, it is recommended that the air intake mode be set to outside air mode and the fan speed to any setting except off.

■ Outside/recirculated air mode

- Setting to the recirculated air mode temporarily is recommended in preventing dirty air from entering the vehicle interior and helping to cool the vehicle when the outside air temperature is high.
- Outside/recirculated air mode may automatically switch depending on the temperature setting or the inside temperature.

■ When the outside temperature falls to nearly 32°F (0°C)

The dehumidification function may not operate even when "A/C" switch is pressed.

■ Registering air conditioning settings to electronic keys

- Unlocking the vehicle using an electronic key and turning the

power switch to ON will recall that key's registered air conditioning settings.

- When the power switch is turned to OFF, the current air conditioning settings will automatically be registered to the electronic key that was used to unlock the vehicle.
- The system may not operate correctly if more than one electronic key is in the vicinity or if the smart key system is used to unlock the passenger door.

■ Operation of the air conditioning system in the eco air conditioning mode

- In the eco air conditioning mode, the air conditioning system is controlled as follows to prioritize fuel efficiency:
 - Engine speed and compressor operation controlled to restrict heating/cooling capacity
 - Fan speed restricted when automatic mode is selected
- The eco air conditioning mode can be turned on and off using the option screen of the air conditioning control screen. (→P.363)
- When the driving mode is changed to Eco drive mode, the eco air conditioning mode is turned on automatically. (→P.343)
- To improve air conditioning performance, perform the following operations:
 - Adjust the fan speed
 - Deactivate Eco drive mode (→P.343)
 - Turn off eco air conditioning mode (→P.363)

■ Ventilation and air conditioning odors

- To let fresh air in, set the air conditioning system to the outside air mode.
- During use, various odors from inside and outside the vehicle may enter into and accumulate in the

air conditioning system. This may then cause odor to be emitted from the vents.

- In order to suppress odors that occur when the air conditioning system starts, the air flow mode may change to blow air to the feet or air may stop blowing for a short period of time immediately after the air conditioning system is started in automatic mode.
- When parking, the system automatically switches to outside air mode to encourage better air circulation throughout the vehicle, helping to reduce odors that occur when starting the vehicle.

■ Using the voice control system (if equipped)

Air conditioning system can be operated using voice control system.

For details regarding the voice control system, refer to "MULTIMEDIA OWNER'S MANUAL".

■ Air conditioning filter



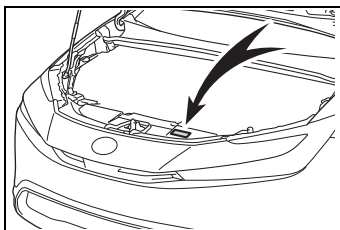

→P.441

■ Air conditioning system refrigerant

- A label regarding the refrigerant of the air conditioning system is attached to the hood at the location shown in the following illustration.



- The meaning of each symbol on the label are as follows:

	Caution
	Air conditioning system
	Air conditioning system lubricant type
	Requires registered technician to service air conditioning system
	Flammable refrigerant

■ Customization

Some functions can be customized. (Customizable features: →P.538)

WARNING

■ To prevent the windshield from fogging up

Do not use the windshield defogger switch during cool air operation in extremely humid weather. The difference between the temperature of the outside air and that of the windshield can cause the outer surface of the windshield to fog up, blocking your vision.

■ When the outside rear view mirror defoggers are operating (if equipped)

Do not touch the rear view mirror surfaces when the outside rear view mirror defoggers are on.

NOTICE

■ To prevent 12-volt battery discharge

Do not leave the air conditioning system on longer than necessary when the hybrid system is off.

■ When repairing/replacing parts of the air conditioning system

Have repair/replacement performed by your Toyota dealer. When a part of the air conditioning system, such as the evaporator, is to be replaced, it must be replaced with a new one.

Using automatic mode

- 1 Press the “AUTO” switch.
- 2 Adjust the temperature setting.
- 3 To stop the operation, press the “OFF” switch.

If the fan speed setting or air flow modes are operated, the automatic mode indicator goes off. However, automatic mode for functions other than that operated is maintained.

■ Using automatic mode

Fan speed is adjusted automatically according to the temperature setting and the ambient conditions.

Therefore, the fan may stop for a while until warm or cool air is ready to flow immediately after the automatic mode switch is pressed.

Cool air may blow around the upper body even when the heater is on due to sunlight.

Windshield de-icer (if equipped)

This feature is used to prevent ice from building up on the windshield and wiper blades.

Press the switch to turn the system on/off.

The indicator comes on when the system is on.

The windshield de-icer will automatically turn off after approximately 15 minutes.

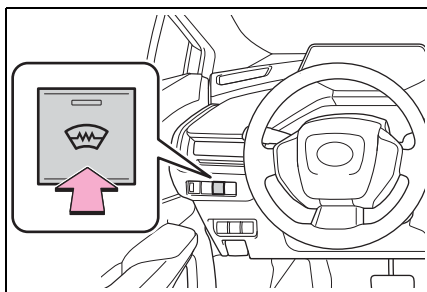

WARNING

■ To prevent burns

Do not touch the glass at lower part of the windshield or to the side of the front pillars when the windshield deicer is on.

Air conditioning control screen

For detail regarding the Multimedia Display, refer to “MULTIMEDIA OWNER’S MANUAL”.

■ Display procedure

1 Touch  on the main menu on the Multimedia Display.

2 Touch “Climate” on the sub menu.

3 Select any screen.

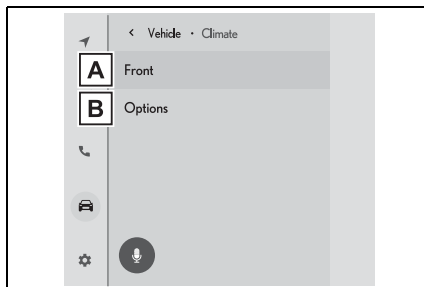

A Displays the air conditioning control screen.

B Displays the option control screen.

■ Air conditioning control screen

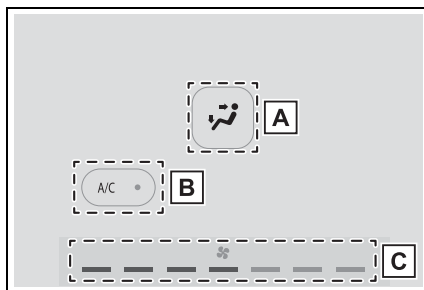

A Select the air flow mode

Each time the switch is touched, the air flow mode changes.

 : Air flows to the upper body

 : Air flows to the upper body and feet

 : Air flows to the feet

 : Air flows to the feet and the

windshield defogger operates

- B** Turns cooling and dehumidification function on/off

Each time the switch is touched, the function turns on/off.

When the function is on, the indicator on the switch illuminates.

- C** Fan speed display

Setting of the fan speed is displayed.

■ Option control screen

The functions can be switched

(ON) and (OFF).

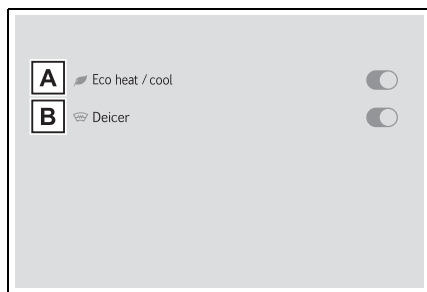

- A** Eco air conditioning mode (→P.361)

- B** Windshield wiper de-icer (if equipped) (→P.363)

Air outlet layout and operations

■ Location of air outlets

The air outlets and air volume change according to the selected air flow mode.

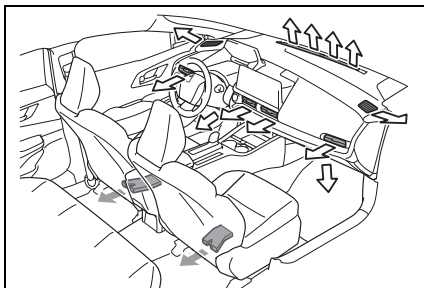

←: If equipped

■ Adjusting the air flow direction

Direct air flow to the left or right, up or down.

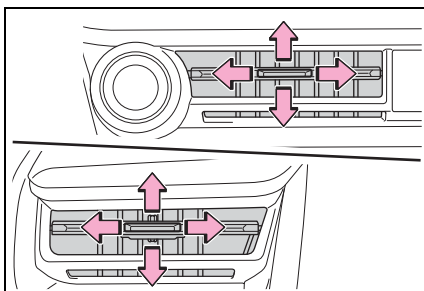

■ Opening and closing the air outlets

- ▶ Left side outlet/right side outlet

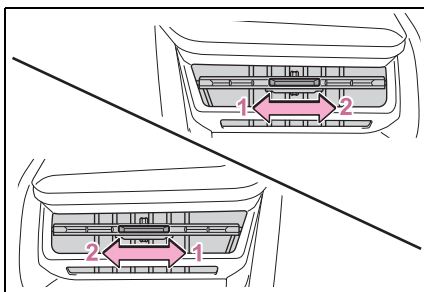

1 Open the vent

2 Close the vent

► Center outlets

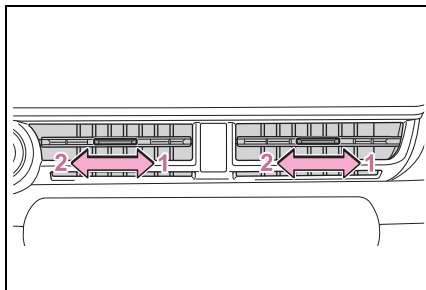

- 1 Open the vent
- 2 Close the vent

 **WARNING**

■ **To not interrupt the windshield defogger from operating**

Do not place anything on the instrument panel which may cover the air outlets. Otherwise, air flow may be obstructed, preventing the windshield defoggers from defogging.

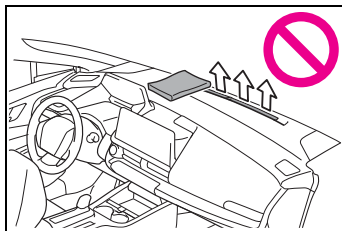

Heated steering wheel^{*} / seat heaters^{*} / seat ventilators^{*}

^{*}: If equipped

- Heated steering wheel

Warm up the grip of the steering wheel

- Seat heaters

Warm up the seat upholstery

- Seat ventilators

Maintain good airflow by sucking air into the front seats

 **WARNING**

■ **To prevent minor burn injuries**

Care should be taken if anyone in the following categories comes in contact with the steering wheel or seats when the heater is on:

- Babies, small children, the elderly, the sick and the physically challenged
- Persons with sensitive skin
- Persons who are fatigued
- Persons who have taken alcohol or drugs that induce sleep (sleeping drugs, cold remedies, etc.)



NOTICE

■ **To prevent damage to the seat heaters and seat ventilators**

Do not put heavy objects that have an uneven surface on the seat and do not stick sharp objects (needles, nails, etc.) into the seat.

■ **To prevent 12-volt battery discharge**

Do not use the functions when the hybrid system is off.

Operating the heated steering wheel

Turns the heated steering wheel on/off

The indicator light comes on when the heated steering wheel is operating.

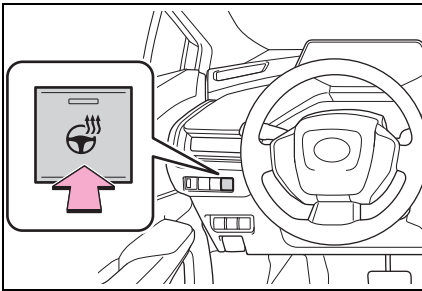

■ **Operation condition**

The power switch is in ON.

Operating the seat heaters

■ **Front seats**

Press the switch to turn the seat heater on/off.

The level indicators **A** come on yellow during operation.

Each time the switch is pressed, the operation condition changes as follows.

Hi (3 segments lit) → Mid (2 segments lit) → Lo (1 segment lit) → Off

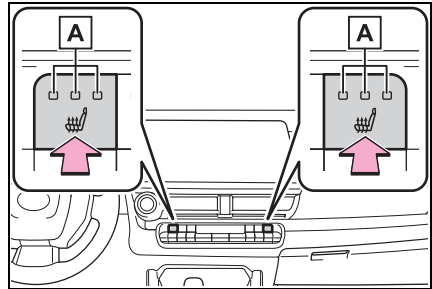

■ **Outboard rear seats (if equipped)**

Press the switch to turn the seat heater on/off.

The indicator on the switch illuminates during operation.

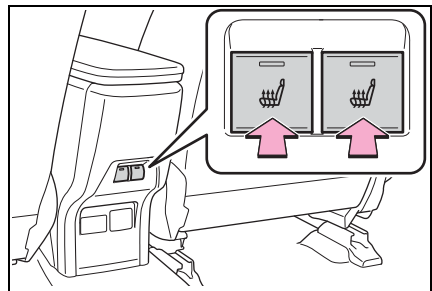

■ **Operation condition**

The power switch is in ON.

**WARNING****■ To prevent causes of over-heating and minor burn injuries**

Observe the following precautions when using a seat heater:

- Do not cover the seat with a blanket or cushion when using the seat heater.
- Do not use seat heater more than necessary.

may increase according to the fan speed of the air conditioning system.

Operating the seat ventilators

Press the switch to turn the seat ventilator on/off.

The level indicators **A** come on green during operation.

Each time the switch is pressed, the operation condition changes as follows.

Hi (3 segments lit) → Mid (2 segments lit) → Lo (1 segment lit) → Off

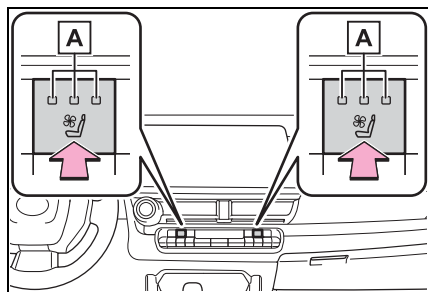
**■ Operation condition**

The power switch is in ON.

■ Air conditioning system-linked control mode

When a seat ventilator is set to Hi, the fan speed of the seat ventilator

Interior lights list

Location of the interior lights

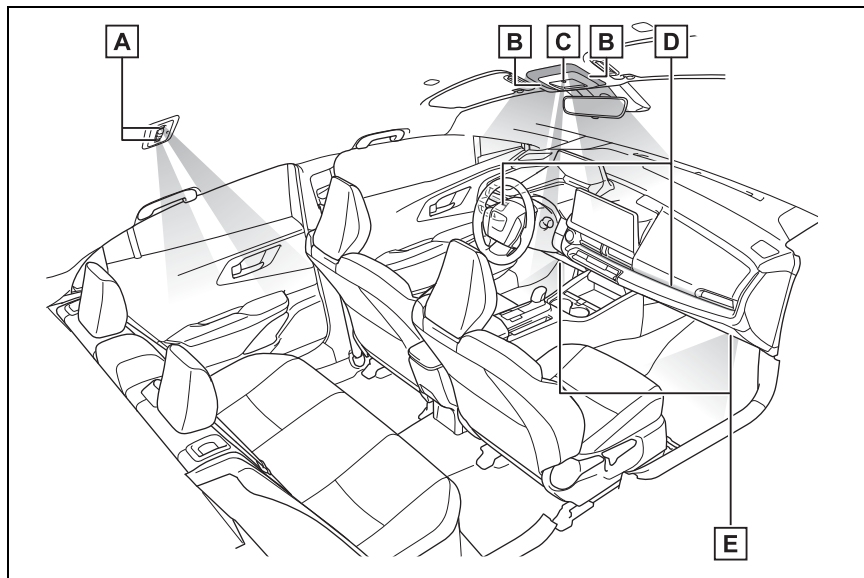

- A** Rear personal lights (→P.369)
- B** Interior lights (→P.369)/Front personal lights (→P.369)
- C** Shift lever light*
- D** Instrument panel ornament lights (if equipped) (→P.370)
- E** Footwell lights (if equipped)

*: The shift lever light turns on/off together with the tail lights.

■ Illuminated entry system

The lights automatically turn on/off according to the power switch mode, the presence of the electronic key, whether the doors are locked/unlocked, and whether the doors are open/closed.

■ To prevent the 12-volt battery from being discharged

If the interior lights remain on when the power switch is turned to OFF, the lights will go off automatically after 20 minutes.

■ Automatic illumination of the interior lights

If any of the SRS airbags deploy (inflate) or in the event of a strong rear impact, the interior lights will turn on automatically. The interior lights will turn off automatically after approximately 20 minutes.

The interior lights can be turned off manually. However, in order to help prevent further collisions, it is recommended that they be left on until safety can be ensured. (The interior lights may not turn on automatically

depending on the force of the impact and conditions of the collision.)

■ Customization

Some functions can be customized. (Customizable features: →P.538)



NOTICE

■ To prevent 12-volt battery discharge

Do not leave the lights on longer than necessary when the hybrid system is off.

Operating the interior light

■ Turning the interior light on/off

Touch the switch.

Each time the switch is touched, the interior light turns on/off.

The rear personal lights turn on/off together with the interior light.

When a door is opened while the door position is on, the light turns on.

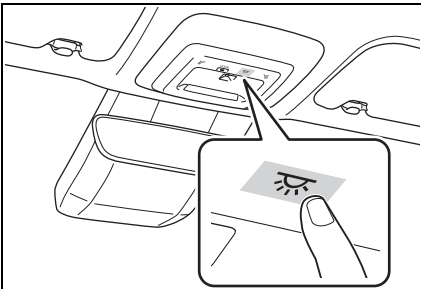

■ Turning the door position on/off

Touch the door-linked interior light switch.

The lights are turned on and off

according to whether the doors are opened/closed while the door position is on.

Each time the switch is touched, the door position turns on/off.

When the door position is on, the indicator **A** on the switch illuminates.

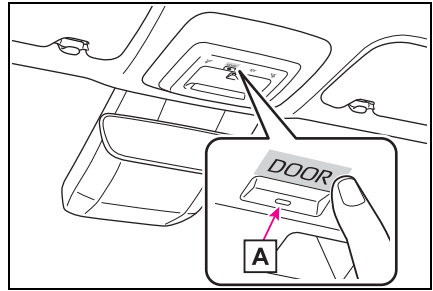

■ When interior light switch and door-linked interior light switch do not respond as normal

- When water, dirt, etc., have adhered to the switch surface
- When operated with a wet hand
- When wearing gloves, etc.

Operating the personal lights

■ Turning the front personal lights on/off

Touch the switch.

Each time the switch is touched, the front personal light turns on/off.

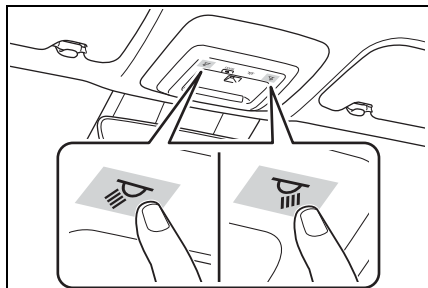

■ Turning the rear personal lights on/off

Press the switch.

Each time the switch is pressed, the rear personal light turns on/off.

If the light is turned on by the interior lights, the rear personal light cannot turn off by pressing the switch.

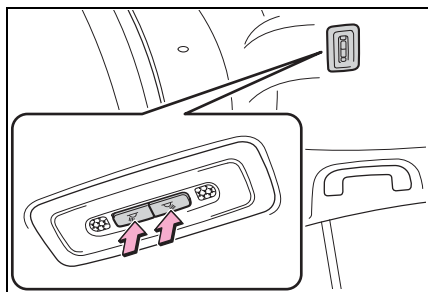

■ When front personal light switch does not respond as normal

- When water, dirt, etc., have adhered to the switch surface
- When operated with a wet hand
- When wearing gloves, etc.

■ Illumination notification (if equipped)

Under the following conditions, the instrument panel ornament lights blink 2 times to notify the

driver.

■ Preceding vehicle start notification

Notifies when the preceding vehicle starts off or accelerates while stopped behind the preceding vehicle.

This function may also operate while driving at extremely slow speeds immediately before stopping the vehicle.

■ PDA (Proactive Driving Assist) linked notifications

Notifies when PDA (Proactive Driving Assist) has detected an operation target. (→P.248)

■ Operation description of illumination notification

- PDA (Proactive Driving Assist) linked notifications do not operate when PDA (Proactive Driving Assist) is disabled through a customize setting. (→P.248)
- When the preceding vehicle is close in distance from the vehicle while stopped, the timing for notifying that the preceding vehicle has started off may be delayed.
- This function does not operate when the front camera or front radar sensor does not operate properly such as during bad weather.

■ Customization

Settings can be changed to enabled and disabled illumination notifications. (Customizable features: →P.538)

List of storage features

Location of the storage features

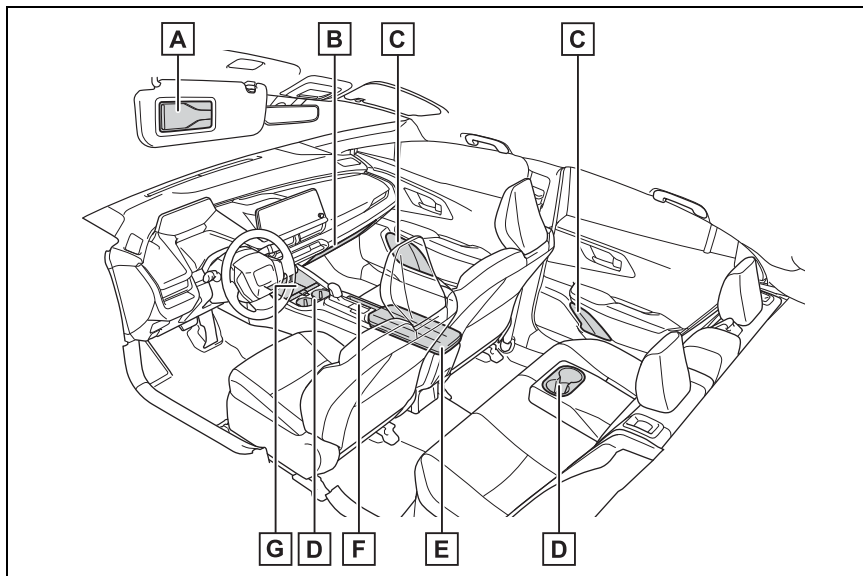

- A** Ticket holders (→P.373)
- B** Glove box (→P.372)
- C** Bottle holders (→P.373)
- D** Cup holders (→P.372)
- E** Console box (→P.372)
- F** Side tray (→P.374)
- G** Open tray (→P.373)



WARNING

Items that should not be left in the vehicle

Do not leave glasses, lighters or spray cans in the storage spaces, as this may cause the following when cabin temperature becomes high:

- Glasses may be deformed by heat or cracked if they come into contact with other stored items.
- Lighters or spray cans may explode. If they come into contact with other stored items, the lighter may catch fire or the spray can may release gas, causing a fire hazard.

Glove box

Pull up the lever to open the glove box.

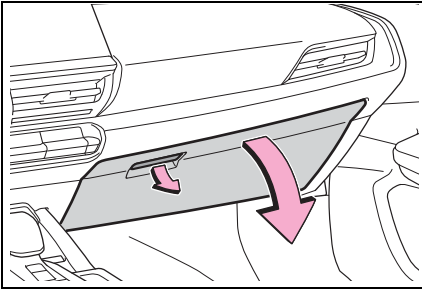

■ Glove box light

The glove box light turns on when the tail lights are on.

⚠ WARNING

■ Caution while driving

Keep the glove box closed. In the event of sudden braking or sudden swerving, an accident may occur due to an occupant being struck by the open glove box or the items stored inside.

Console box

Push the button to release the lock, and open the lid.

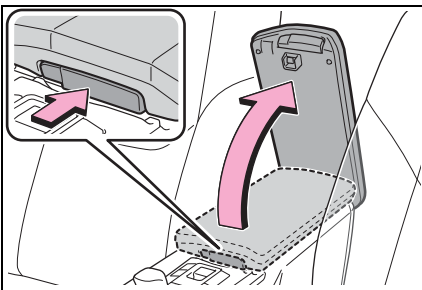

⚠ WARNING

■ Caution while driving

Keep the console box closed.

Injuries may result in the event of an accident or sudden braking.

Cup holders

■ Front

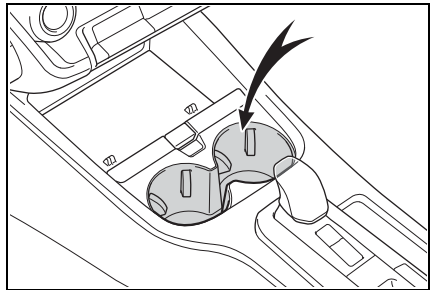

■ Rear (if equipped)

Pull the rear armrest down.

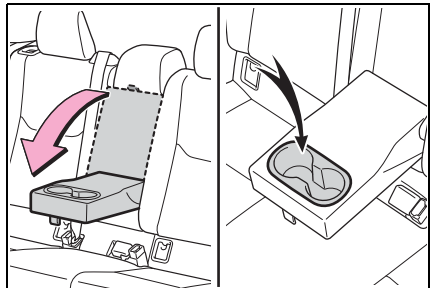

⚠ WARNING

■ Items unsuitable for the cup holders

Do not place anything other than cups, beverage cans or bottles* in the cup holders.

Other items may be thrown out of the holders in the event of an accident or sudden braking, cause injury. If possible, cover hot drinks to prevent burns.

*: Front cup holders only

Bottle holders

Front

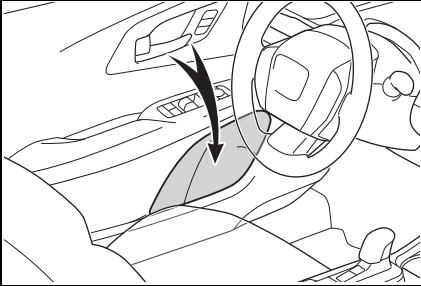

Rear

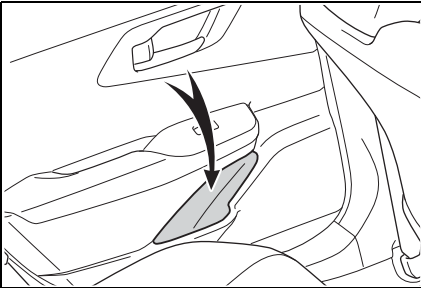

Bottle holders

- When storing a bottle, close the cap.
- The bottle may not be stored depending on its size or shape.



NOTICE

Items that should be not stowed in the bottle holders

Do not place open bottles or glass and paper cups containing liquid in the bottle holders. The contents may spill and glasses may break.

Ticket holders

Flip the sun visor down to use.

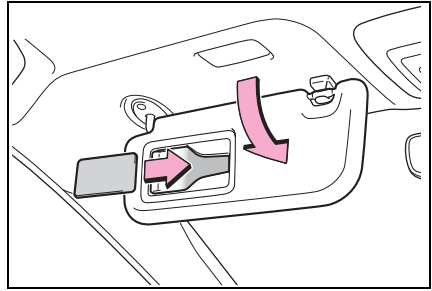

Open tray

Using the upper tray

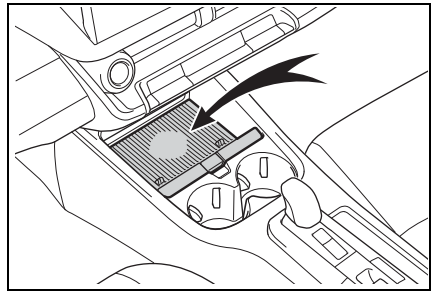

Using the lower tray

Push the knob and remove the upper tray.

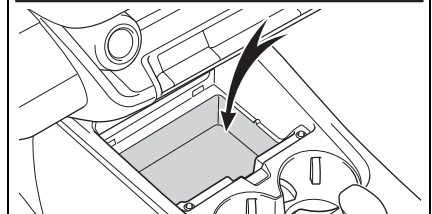
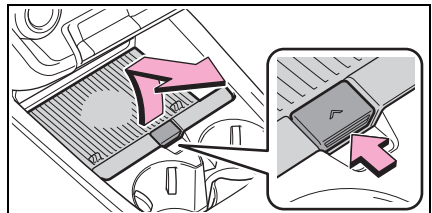

⚠ WARNING**■ Items unsuitable for the open tray**

Observe the following precautions when putting items in the open tray. Failure to do so may cause items to be thrown out of the tray in the event of sudden braking or steering. In these cases, the items may interfere with pedal operation or cause driver distraction, resulting in an accident.

- Do not store items in the tray that can easily shift or roll out.
- Do not stack items in the tray higher than the tray's edge.
- Do not put items in the tray that may protrude over the tray's edge.

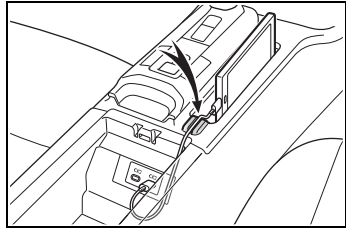
**⚠ WARNING****■ Items unsuitable for the open tray**

Do not store items in the tray that can easily shift or roll out. Failure to do so may cause items to be thrown out of the tray in the event of sudden braking or steering. In these cases, the items may interfere with pedal operation or cause driver distraction, resulting in an accident.

Side tray

The item such as smartphone can be stowed.

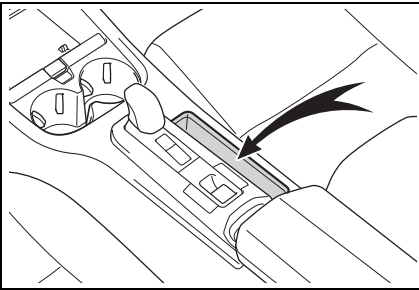
**■ When using USB Type-C charging ports in the console box**

The shape of the console box allows power cables to be passed through when the console box lid is closed.

Luggage compartment features

Cargo hooks

The cargo hooks are provided for securing loose items.

- ▶ Vehicles with emergency tire puncture repair kit (type A)

Raise the hook to use.

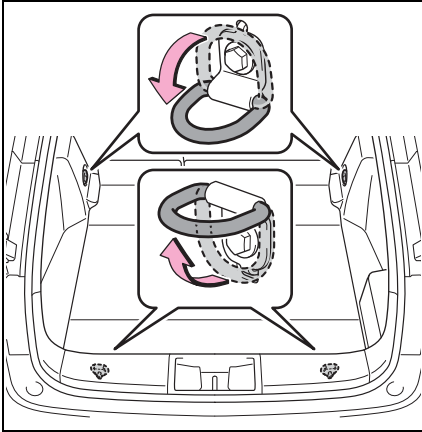

- ▶ Vehicles with emergency tire puncture repair kit (type B) or spare tire

- 1 To use the rear cargo hook, open the deck board.

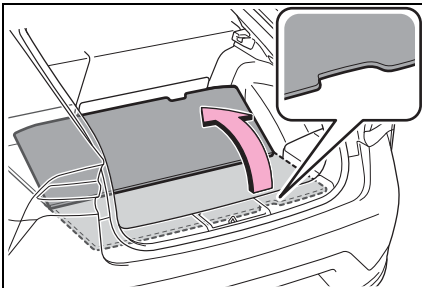

- 2 Raise the hook to use, return the deck board to its original position and close it.

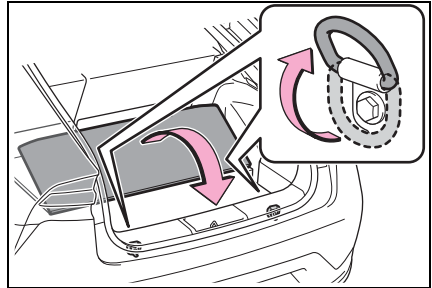

- 3 When using the front cargo hook, raise the hook without opening the deck board.

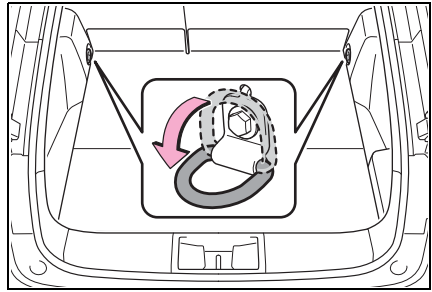

WARNING

- When the cargo hooks are not in use

To avoid injury, always return the cargo hooks to their stowed positions.

Deck under tray

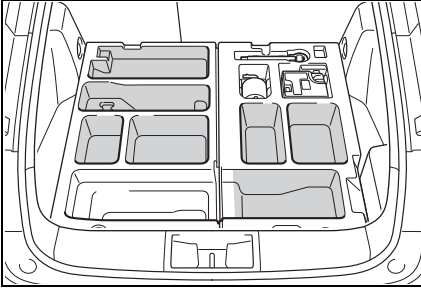

WARNING

■ Caution while driving

Keep the deck board closed.

In the event of sudden braking, an accident may occur due to an occupant being struck by the deck board or the items stored in the deck under tray.

Warning reflector storage

- ▶ Vehicles with emergency tire puncture repair kit (type A)

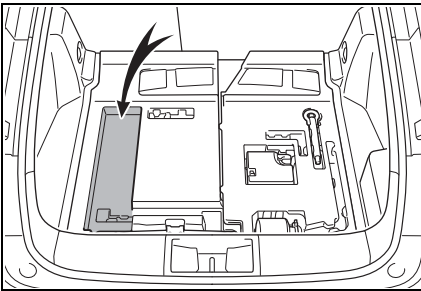

- ▶ Vehicles with emergency tire puncture repair kit (type B)

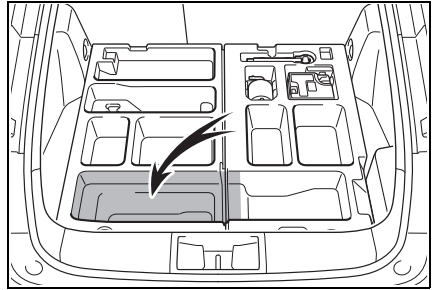

- ▶ Vehicles with compact spare tire

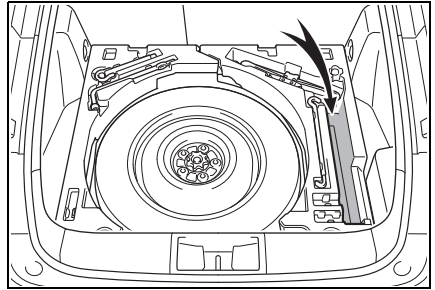

■ Warning reflector

- The warning reflector itself is not included as an original equipment.
- Depending on the size or shape of the reflector, it may not be able to be stowed.

Removing the luggage cover

- 1 Unhook each cord.

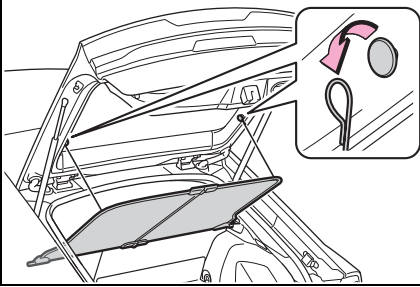

- 2 Remove the luggage cover.

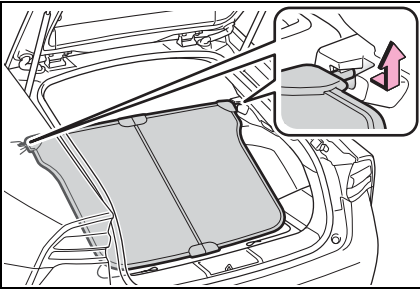

- 3 Fold the luggage cover.

When installing the luggage cover, reverse the steps listed.

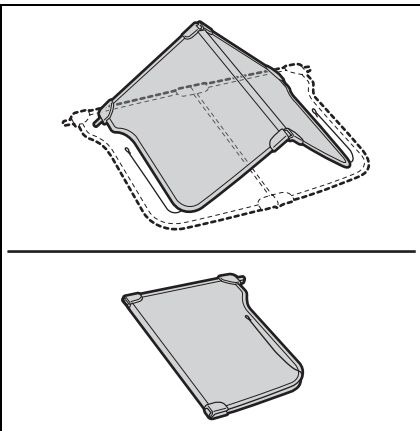

WARNING

■ Luggage cover

- Do not stow items on the luggage cover. In the event of sudden braking or swerving, the items may fly about and strike an occupant.
- Do not allow children to climb on the luggage cover. Doing so may damage the luggage cover.

Other interior features

Sun visors

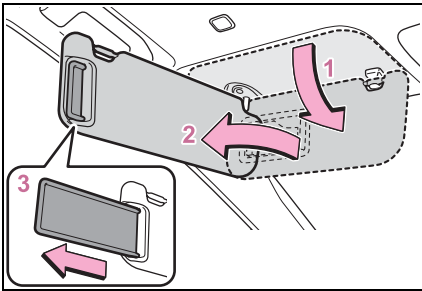

- 1** To set the visor in the forward position, flip it down.
- 2** To set the visor in the side position, flip down, unhook, and swing it to the side.
- 3** To use the side extender, place the visor in the side position, then slide it backward.

Vanity mirrors

Slide the cover to open.

The light turns on when the cover is opened.

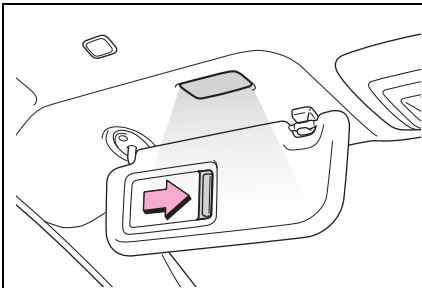

■ Automatic light off to prevent 12-volt battery discharge

If the vanity lights remain on when

the power switch is turned to OFF, the lights will go off automatically after 20 minutes.

⚠ NOTICE

■ To prevent 12-volt battery discharge

Do not leave the vanity lights on for extended periods while the hybrid system is off.

Power outlet

Please use a power supply for electronic goods that use less than 12 VDC /10 A (power consumption of 120 W).

Open the lid.

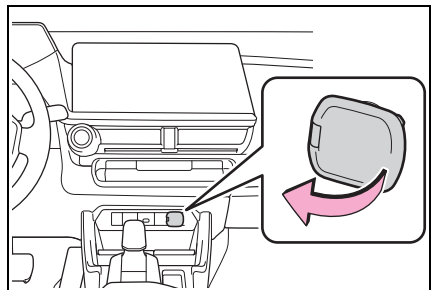

■ The power outlet can be used when

The power switch is in ACC or ON.

■ When stopping the hybrid system

Disconnect electrical devices with charging functions, such as mobile battery packs.
If such devices are left connected, the hybrid system may not stop normally.



NOTICE

■ **When power outlet is not in use**

To avoid damaging the power outlet, close the power outlet lid when the power outlet is not in use.

Foreign objects or liquids that enter the power outlet may cause a short circuit.

■ **To prevent blown fuse**

Do not use an accessory that uses more than 12 V 10 A.

■ **To prevent 12-volt battery discharge**

Do not use the power outlet longer than necessary when the hybrid system is off.

USB Type-C charging ports

The USB Type-C charging ports are used to supply 3 A of electricity at 5 V to external devices. The USB Type-C charging ports are for charging only. They are not designed for data transfer or other purposes.

Depending on the external device, it may not charge properly. Refer to the manual included with the device before using a USB Type-C charging port.

■ Front

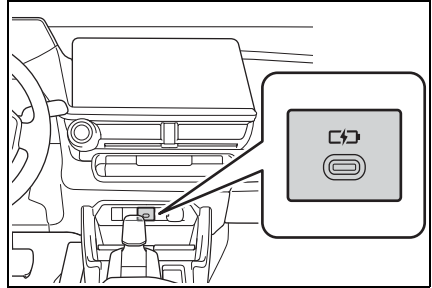

■ Console box

Open the console box.

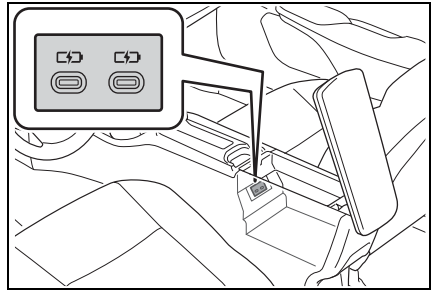

■ Rear

► Vehicles without rear seat heater

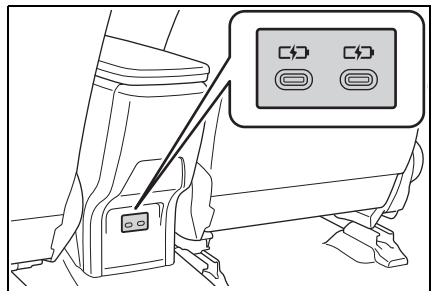

► Vehicles with rear seat heater

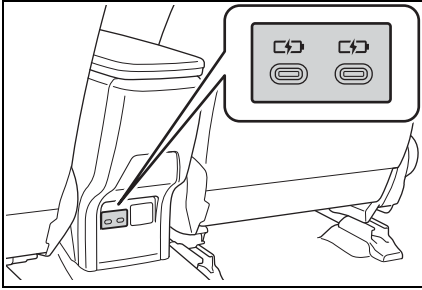

■ **The USB Type-C charging ports can be used when**

The power switch is in ACC or ON.

■ **Situations in which the USB Type-C charging ports may not operate correctly**

- If a device which consumes more than 3 A at 5 V is connected
- If a device designed to communicate with a personal computer, such as a USB memory device, is connected
- If the connected external device is turned off (depending on device)
- If the temperature inside the vehicle is high, such as after the vehicle has been parked in the sun

■ **About connected external devices**

Depending on the connected external device, charging may occasionally be suspended and then start again. This is not a malfunction.



NOTICE

■ **To prevent damage to the USB Type-C charging ports**

- Do not insert foreign objects into the ports.
- Do not spill water or other liquids into the ports.

● Do not apply excessive force to or impact the USB Type-C charging ports.

● Do not disassemble or modify the USB Type-C charging ports.

■ **To prevent damage to external devices**

● Do not leave external devices in the vehicle. The temperature inside the vehicle may become high, resulting in damage to an external device.

● Do not push down on or apply unnecessary force to an external device or the cable of an external device while it is connected.

■ **To prevent 12-volt battery discharge**

Do not use the USB Type-C charging ports for a long period of time when the hybrid system is off.

Wireless charger (if equipped)

A smartphone that is compatible with the Qi standard for wireless charging according to the Wireless Power Consortium can be charged just by placing it on the charge area.

This function cannot be used with smartphones that cannot be placed on the wireless charger. Also, depending on the smartphone, it may not operate as normal. Please read the operation manual for smartphones to be used.

■ The “Qi” logo

The “Qi” logo is a trademark of the Wireless Power Consortium.



■ Name for all parts

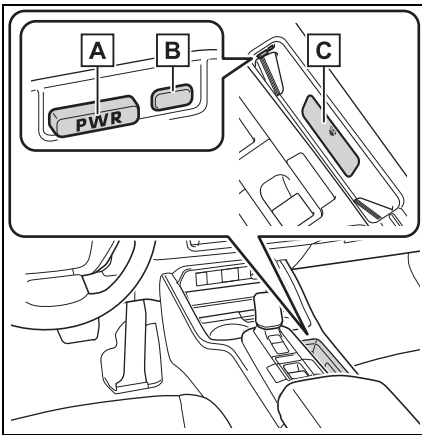

A Power supply switch

B Operation indicator light

C Charge area*

*: Smartphones and wireless chargers contain charging coils. If the charging coil inside the smartphone is detected in the charge area, charging will start. If the charging coil inside the smartphone moves outside of the charge area, charging will automatically stop.

If 2 or more smartphones are placed on the wireless charger, their charging coils may not be properly detected and they may

not be charged.

■ Using the wireless charger

- 1 Press the power supply switch of the wireless charger.

Switches on and off with each press of the power supply switch.

When turned on, the operation indicator light (green) comes on.

Even with the hybrid system off, the on/off state of the power supply switch is memorized.

- 2 Place the smartphone on the wireless charger.

Place the charging side of the smartphone against the wireless charger.

When charging, the operation indicator light (orange) comes on.

When operation indicator light (orange) blinks, no charging is occurring. In this case, remove the smartphone and then readjust the position to near the center of the charge area.

When charging is complete, the operation indicator light (green) comes on.

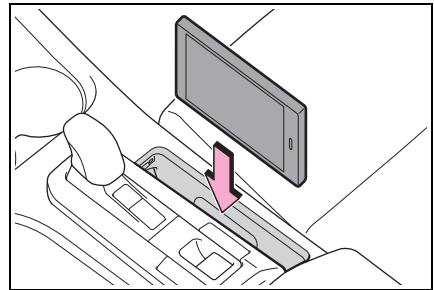

■ Recharging function

- When charging is complete and after a fixed time in the charge suspension state,

charging restarts.

- If the smartphone is moved to somewhere outside of the charge area, charging will stop. In this case, the operation indicator light will blink in orange. Readjust the position of the smartphone to near the center of the charge area.

■ Rapid charging function

- The following smartphones support rapid charging.

- Smartphones compliant with WPC Ver1.2.4 and compatible with rapid charging
- iPhone's with an iOS version that supports 7.5 W charging (iPhone 8 and later models)
- When a smartphone that supports rapid charging is charged, charging automatically switches to the rapid charging function.

■ Lighting conditions of operation indicator light

Operation indicator light	Conditions
Turning off	When the Wireless charger power supply is off
Green (comes on)	On Standby (charging possible state) ^{*1}
	When charging is complete ^{*2}
Orange (comes on)	When placing the smartphone on the charging area (detecting the smartphone)
	Charging ^{*3}

^{*1}: Charging power will not be output during standby. A metallic object will not be heated, if it is placed on the wireless charger in this state.

^{*2}: Depending on the smartphone, there are cases where the operation indicator light will continue being lit up orange even after the charging is complete.

^{*3}: If the smart key system detects the electronic key while charging is occurring, the operation indicator light may illuminate in green.

■ When the wireless charger does not operate properly

When the wireless charger does not operate properly, handle the probable cause based on the following tables.

Operation indicator light	Suspected causes/Handling method
Orange (Flashing repeatedly once every second)	<p>Vehicle to wireless charger communication failure → If the hybrid system is operating, stop and then restart the hybrid system.</p> <p>If the power switch is in ACC, start the hybrid system. (→P.180)</p>
Green (comes on)	<p>The smart key system is detecting the electronic key. → Wait until electronic key detection has completed.</p>
Orange (Repeatedly flashes 3 times continuously)	<p>Foreign substance detection: The abnormal heating prevention function for foreign substances operated due to the presence of a metallic foreign substance in the charge area → Remove the foreign substance from the charge area.</p>
	<p>Smartphone misaligned: The abnormal heating prevention function for foreign substances operated due to the charging coil in the smartphone moving outside of the charge area → Remove the smartphone from the wireless charger, check that the operation indicator light changes back to green, and then place the smartphone so that it is near the center of the wireless charger. Also, if a case or cover is installed to the smartphone, remove it. Also refer to “Situations in which the function may not operate normally”. (→P.384)</p>
Orange (Repeatedly flashes 4 times continuously)	<p>Safety shutdown resulting when the temperature within the wireless charger exceeded the set value → Remove the smartphone from the charging area and start charging after waiting for the operation indicator light to changes back to green.</p>

■ The wireless charger can be operated when

The power switch is in ACC or ON.

■ Usable smartphones

- Qi standard wireless charge standard can be used on compatible devices. However, not all Qi standard devices and compatibility are guaranteed.
- This product is designed for use with smartphones with a power supply of 5 W or less.
- However, charging exceeding 5 W is supported by the following smartphones.
 - Charging at 7.5 W or less is supported by iPhone's that support 7.5 W charging.
 - Charging at 10 W or less is supported by smartphones compliant with EPP output as defined by WPC standard Ver1.2.4.

■ Using the smart key system

Charging will be suspended for the smart key system to detect the electronic key during charging such as when the electronic key has been brought outside the vehicle. When the electronic key is detected, charging will automatically start again.

■ When covers and accessories are attached to smartphones

Do not charge in situations where cover and accessories not able to handle Qi are attached to the smartphone. Depending on the type of cover (including for certain genuine manufacturer parts) and accessory, it may not be possible to charge. When charging is not performed even with the smartphone placed on the charge area, remove the cover and accessories.

■ Noise enters the AM radio while charging

- Turn off the wireless charger and confirm that the noise has

decreased. If the noise decreases, continuously pushing the power supply switch of the wireless charger for 2 seconds, the frequency of the charger can be changed and the noise can be reduced.

Also, on that occasion, the operation indicator light will flash orange 2 times.

- iPhone's use a particular frequency for rapid charging. Depending on the iOS version, rapid charging may not be performed while switching frequencies.

■ Important points of the wireless charger

- If the electronic key cannot be detected within the vehicle interior, charging cannot be done. When the door is opened and closed, charging may be temporarily suspended.
- When charging, the wireless charging device and smartphone will get warmer, however this is not a malfunction. When a smartphone gets warm while charging, charging may stop due to the protection function on the smartphone side. In this case, when the temperature of the smartphone drops significantly, charge again.

■ Cleaning the wireless charger

→P.402

■ Situations in which the function may not operate normally

Devices may not be charged normally in the following situations.

- The smartphone is fully charged
- The smartphone is being charged with a cable connected
- There is foreign matter between the charge area and smartphone
- Charging has caused the smartphone to heat up

- The temperature around the wireless charger is 95°F (35°C) or higher, such as in extreme heat
- The smartphone is placed with its charging side away from the wireless charger
- The smartphone is placed in an area misaligned from the charge area
- A foldable and smartphone is placed outside the charge area
- The vehicle is in an area where strong electrical waves or noise are emitted, such as near a television tower, power plant, gasoline station, broadcasting station, large display, airport, etc.
- The electronic key is not inside the vehicle
- Any of the following objects that is 0.08 in. (2 mm) or thicker is stuck or installed between the charging side of the smartphone and the charge area.
 - Thick cases or covers
 - A case or cover attached with an uneven or tilted surface, so that the charging side is not flat
 - Thick decorations
 - Accessories, such as finger rings, straps, etc.
- When there is a gap between the charging side of the smartphone and the charge area due to a protrusion such as a camera on the charging side of the smartphone.
- When the smartphone is in contact with, or is covered by any of the following metallic objects:
 - A card that has metal on it, such as aluminum foil, etc.
 - A pack of cigarettes that includes aluminum foil
 - A wallet or bag that is made of metal
 - Coins
 - A heating pad
 - CDs, DVDs or other media
 - A metal accessory
 - A case or cover made of metal
 - A flip type case with a magnet on

the charging side of the smartphone

- Electric wave type wireless remote controls are being used nearby
- 2 or more smartphones are placed on the wireless charger at the same time
- When using a smartphone model with an internal charging coil that is not located near the center of the smartphone

If charging is abnormal or the operation indicator light continues to flash for any other reason, the wireless charger may be malfunctioning. Contact your Toyota dealer.

■ If the smartphone OS has been updated

If the smartphone OS has been updated to a newer version, its charging specifications may have changed significantly. For details, check the information on the manufacturer's website.

■ Trademark information

iPhone is a trademark of Apple Inc., registered in the U.S. and other countries.

WARNING

■ Caution while driving

When charging a smartphone, for safety reasons, the driver should not operate the main part of the smartphone while driving.

■ Caution regarding interference with electronic devices

People with implantable cardiac pacemakers, cardiac resynchronization therapy-pacemakers or implantable cardioverters, as well as any other electrical medical device, should consult their physician about the usage of the wireless charger.

**WARNING**

■ **To prevent malfunctions or burns**

Observe the following precautions. Failure to do so may result in a equipment failure and damage, catch fire, burns due to over-heat or electric shock.

- This product is specialized for use with smartphones and cannot charge other devices.
- Do not insert any metallic objects between the charge area and the smartphone while charging
- Do not attach an aluminum sticker or other metallic object to the charge area
- Do not attach an aluminum sticker or other metallic object to the side of the smartphone (or to its case or cover) that touches the charge area
- Do not subject to a strong force or impact
- Do not disassemble, modify or remove
- Do not charge devices other than specified smartphones
- Keep away from magnetic items
- Do not cover with a cloth or similar material

**NOTICE**

■ **To prevent malfunctions and data corruptions**

- Do not spill drinking water or other liquid into the smartphone storage area. When something is spilled or liquid adheres to the storage area, dry with a dry cloth or equivalent before use.

- When charging, bringing a credit, or other magnetic card, or magnetic storage media close to the charge area may clear any stored data due to magnetic influence. Also, do not bring a wristwatch or other precision instrument close to the charge area since doing so may cause it to malfunction.

- Do not charge with a non-contact IC card such as a transportation system IC card inserted between the charging side of a smartphone and the charge area. The IC chip may become extremely hot and damage the smartphone or IC card. Be especially careful not to charge a smartphone inside a case or cover with a non-contact IC card attached.

- Do not leave smartphones inside the vehicle. The inside of the vehicle can become hot in extreme heat, which could cause a malfunction.

■ **To prevent 12-volt battery discharge**

Do not use the wireless charger for a long period of time when the hybrid system is stopped.

Armrest (if equipped)

Fold down the armrest for use.

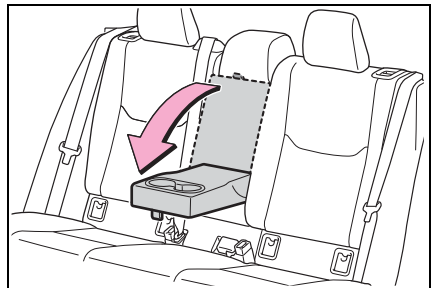

**NOTICE****■ To prevent damage to the armrest**

Do not apply too much load on the armrest.

Assist grips

An assist grip installed on the ceiling can be used to support your body while sitting on the seat.

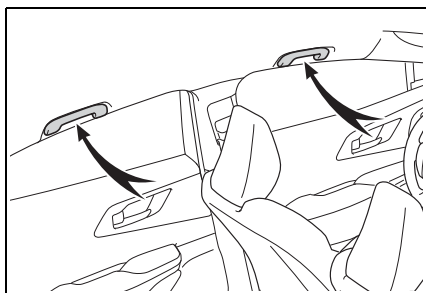
**WARNING****■ Assist grips**

Do not use the assist grip when getting in or out of the vehicle or rising from your seat.

**NOTICE****■ To prevent damage to the assist grip**

Do not hang any heavy object or put a heavy load on the assist grip.

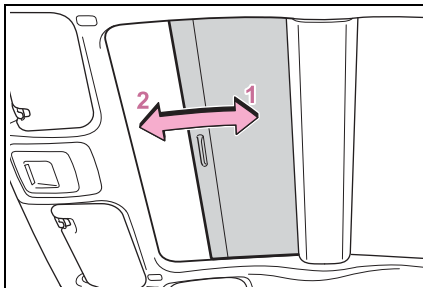
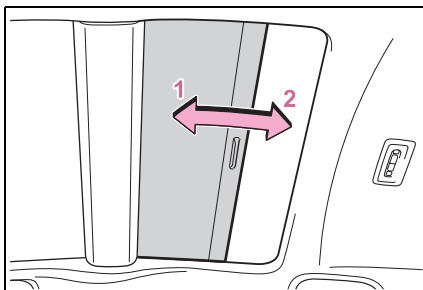
Sunshades (if equipped)**■ Front****1** Open**2** Close**■ Rear****1** Open**2** Close**WARNING**

Observe the following precautions. Failure to do so may result in death or serious injury.

**WARNING**

■ **Opening and closing the sunshade**

Check to make sure that all passengers do not have any part of their body in a position where it could be caught when the sunshade is being operated.

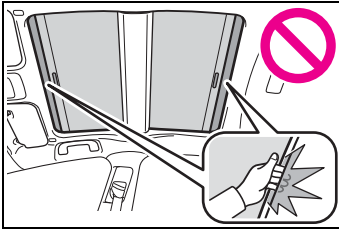

- Do not let a child operate the sunshade. Closing the sunshade on someone can cause death or serious injury.

■ **To prevent burns or injuries**

Do not touch the area between the underside of the glass roof and the sunshade. Your hand may get caught and you could injure yourself. Also, if the vehicle is left in direct sunlight for a long time, the underside of the glass roof could become very hot and could cause burns.

■ **To prevent damage to the sunshade**

Do not hang any heavy object or put a heavy load on the sunshade.

**NOTICE**

■ **To ensure normal operation of the sunshade**

Observe the following precautions.

- Do not place anything where it may hinder the opening/closing of the sunshade.
- Do not place anything on the sunshade.

Garage door opener*

*: If equipped

The garage door opener can be programmed using the HomeLink® to operate garage doors, gates, entry doors, door locks, home lighting systems, security systems, and other devices.

■ HomeLink® programming procedure

The programming procedures can also be found at the following URL.
Website: www.homelink.com/toyota



For support, contact customer support at the following.

Help Line: 1-800-355-3515

System components

The HomeLink® wireless control system in your vehicle has 3 buttons which can be programmed to operate 3 different devices. Refer to the programming methods on the following pages to determine the method which is appropriate for the

device.

- ▶ Vehicles with auto anti-glare inside rear view mirror

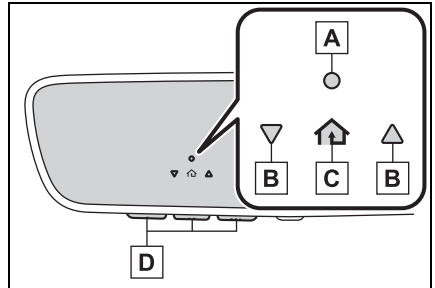

- A** HomeLink® indicator light
- B** Garage door operation indicators
- C** HomeLink® icon

Illuminates while HomeLink® is operating.

- D** Buttons

- ▶ Vehicles with Digital Rear-view Mirror

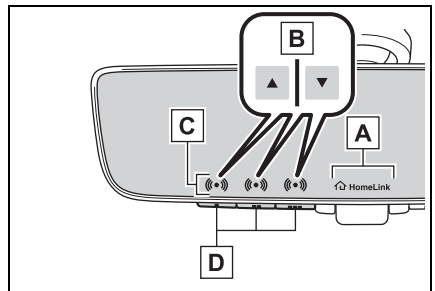

- A** HomeLink® logo
- Appears while HomeLink® is operating.

When the HomeLink® button is pressed, the logo disappears even while the HomeLink® is operating.

- B** Garage door operation indicators

C HomeLink[®] indicator light

Illuminates above each button selected.

D Buttons**Codes stored in the HomeLink[®] memory**

- The registered codes are not erased even if the 12-volt battery cable is disconnected.
- If learning failed when registering a different code to a HomeLink[®] button that already has a code registered to it, the already registered code will not be erased.

**WARNING****When programming a garage door or other remote control device**

The garage door or other device may operate, so ensure people and objects are out of danger to prevent potential harm.

Conforming to federal safety standards

Do not use the HomeLink[®] compatible transceiver with any garage door opener or device that lacks safety stop and reverse features as required by federal safety standards.

This includes any garage door that cannot detect an interfering object. A door or device without these features increases the risk of death or serious injury.

When operating or programming HomeLink[®]

Never allow a child to operate or play with the HomeLink[®] buttons.

Programming HomeLink[®]**Before programming****HomeLink[®]**

- During programming, it is possible that garage doors, gates, or other devices may operate. For this reason, make sure that people and objects are clear of the garage door or other devices to prevent injury or other potential harm.
- It is recommended that a new battery be placed in the remote control transmitter for more accurate programming.
- Garage door opener motors manufactured after 1995 may be equipped with rolling code protection. If this is the case, you may need a stepladder or other sturdy, safe device to reach the “Learn” or “Smart” button on the garage door opener motor.

Programming HomeLink[®]

Steps **2** through **4** must be performed within 60 seconds, otherwise the HomeLink[®] indicator light will stop flashing and programming will not be successfully completed.

- 1** Vehicles with Digital Rear-view Mirror: Press the HomeLink[®] button or menu button

When the HomeLink® button is pressed: Homelink® Training Tutorial will be displayed to assist you programming the HomeLink®.

When Homelink® Training Tutorial is displayed, follow the instructions displayed.

When the menu button is pressed: Press the menu button  and select the "Set Up >". Homelink® Training Tutorial will be displayed to assist you programming the HomeLink®.

When Homelink® Training Tutorial is displayed, follow the instructions displayed.

- 2 Press and release the HomeLink® button you want to program and check that the HomeLink® indicator light flashes (orange).
- 3 Point the remote control transmitter for the device at the rear view mirror, 1 to 3 in. (25 to 75 mm) from the HomeLink® buttons.

Keep the HomeLink® indicator light in view while programming.

- ▶ Vehicles with auto anti-glare inside rear view mirror

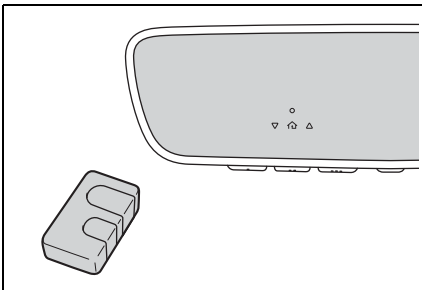

- ▶ Vehicles with Digital Rear-view Mirror

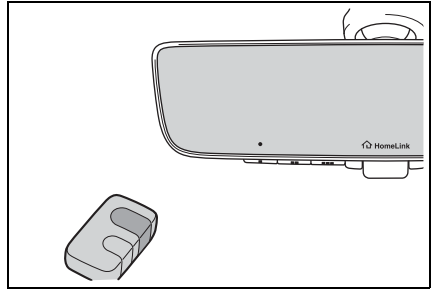

- 4 Program a device.

- ▶ Vehicles with auto anti-glare inside rear view mirror

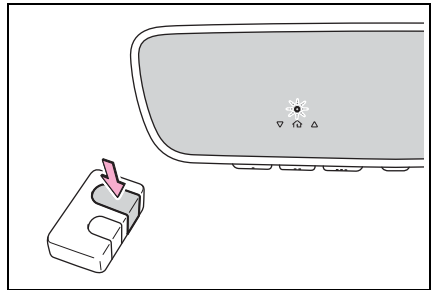

- ▶ Vehicles with Digital Rear-view Mirror

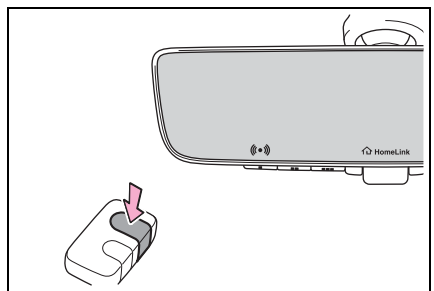

- ▶ Programming a device other than an entry gate (for U.S.A. owners)

Press and hold the remote control transmitter button until the HomeLink® indicator light

changes from slowly flashing orange to rapidly flashing green (rolling code) or continuously lit green (fixed code), then release the button.

- ▶ Programming an entry gate (for U.S.A. owners)/Programming a device in the Canadian market

Press and release the remote control transmitter button at 2 second intervals, repeatedly, until the HomeLink[®] indicator light changes from slowly flashing (orange) to rapidly flashing (green) (rolling code) or continuously lit (green) (fixed code).

5 Test the HomeLink[®] operation by pressing the newly programmed button and observing the HomeLink[®] indicator light:

- HomeLink[®] indicator light illuminates: Programming of a fixed code device has completed. The garage door or other device should operate when a HomeLink[®] button is pressed and released.
- HomeLink[®] indicator light flashes rapidly: The garage door opener motor or other device is equipped with a rolling code. To complete programming, firmly press and hold the HomeLink[®] button for 2 seconds then release it.
- If the garage door or other

device does not operate, proceed to “Programming a rolling code system”.

- 6 Repeat the steps above to program another device for any of the remaining HomeLink[®] buttons.

■ Programming a rolling code system

Two or more people may be needed to complete rolling code programming.

- 1 Locate the “Learn” or “Smart” button on the garage door opener motor in the garage.

This button can usually be found where the hanging antenna wire is attached to the unit. The name and color of the button may vary by manufacturer. Refer to the owner’s manual supplied with the garage door opener motor for details.

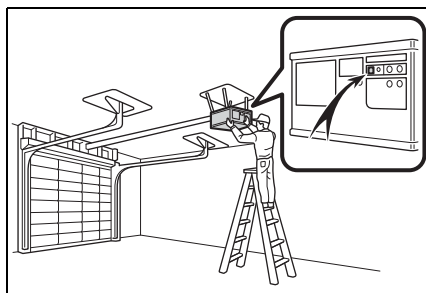

- 2 Press and release the “Learn” or “Smart” button.

Perform step 3 within 30 seconds

after performing step 2.

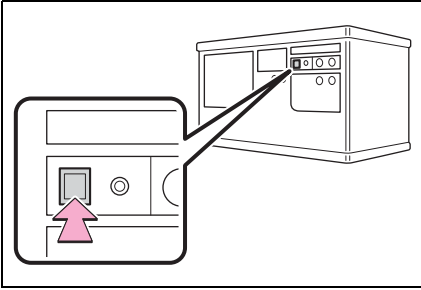

- 3 Press and hold the desired HomeLink[®] button (inside the vehicle) for 2 seconds and release it. Repeat this sequence (press/hold/release) up to 3 times to complete programming.

If the garage door opener motor operates when the HomeLink[®] button is pressed, the garage door opener motor recognizes the HomeLink[®] signal.

- ▶ Vehicles with auto anti-glare inside rear view mirror

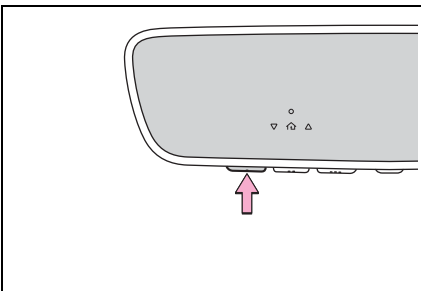

- ▶ Vehicles with Digital Rear-view Mirror

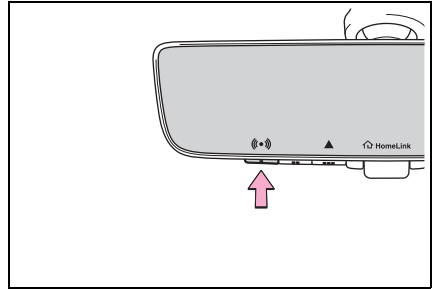

- **Enabling 2-way communication with a garage door (only available for compatible devices)**

When enabled, 2-way communication allows you to check the status of the opening and closing of a garage door through indicators in your vehicle.

2-way communication is only available if the garage door opener motor used is a compatible device. (To check device compatibility, refer to www.homelink.com.)

- 1 Within 5 seconds after programming the garage door opener has been completed, if the garage door opener motor is trained to HomeLink[®], both garage door operation indicators will flash rapidly (green) and the light on the garage door opener motor will blink twice, indicating that 2-way communication is enabled.

If the indicators do not flash, per-

form steps 2 and 3 within the first 10 presses of the HomeLink[®] button after programming has been completed.

- 2 Press a programmed HomeLink[®] button to operate a garage door.
- 3 Within 1 minute of pressing the HomeLink[®] button, after the garage door operation has stopped, press the “Learn” or “Smart” button on the garage door opener motor. Within 5 seconds of the establishment of 2-way communication with the garage door opener, both garage door operation indicators in the vehicle will flash rapidly (green) and the light on the garage door opener motor will blink twice, indicating that 2-way communication is enabled.

■ Reprogramming a single HomeLink[®] button

When the following procedure is performed, buttons which already have devices registered to them can be overwritten:

- 1 Press and hold the desired HomeLink[®] button.
- 2 When the HomeLink[®] indicator starts flashing (orange), release the HomeLink[®] button and perform “Programming HomeLink[®]” step 1 (it takes 20 seconds for the

HomeLink[®] indicator to start flashing).

■ Before programming

- Install a new battery in the transmitter.
- The battery side of the transmitter must be pointed away from the HomeLink[®] buttons.

Operating HomeLink[®]

Press the appropriate HomeLink[®] button. The HomeLink[®] indicator light will turn on.

The status of the opening and closing of a garage door is shown by the garage door operation indicators.

- ▶ Vehicles with auto anti-glare inside rear view mirror

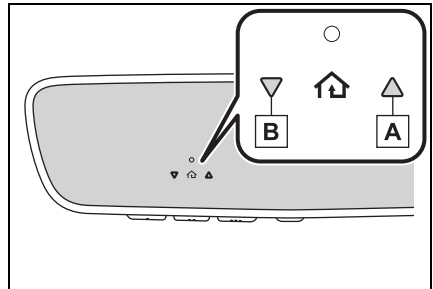

A Opening

B Closing

► Vehicles with Digital Rear-view Mirror

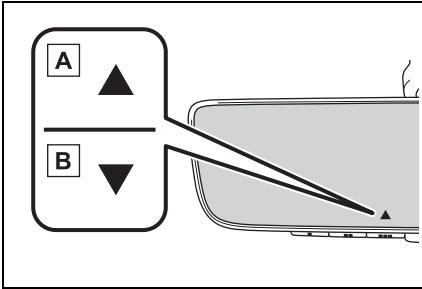

A Opening







B Closing

This function is only available if the garage door opener motor used is a compatible device. (To check device compatibility, refer to www.homelink.com.)

Color	Status
Orange (flashing)	Currently opening/closing
Green	Opening/closing has completed
Red (flashing)	Feedback signals cannot be received

The indicators can operate within approximately 820 ft. (250 m) of the garage door. However, if there are obstructions between the garage door and the vehicle, such as houses and trees, feedback signals from the garage door may not be received.

To recall the previous door operation status, press and release either HomeLink® buttons 

and  or  and  (vehicles with auto anti-glare inside rear view mirror),  and  or  and  (vehicles with Digital Rear-view Mirror) simultaneously. The last recorded status will be displayed for 3 seconds.

Erasing the entire HomeLink® memory (all three codes)

Press and hold the 2 outside buttons for 10 seconds until the HomeLink® indicator light changes from continuously lit (orange) to rapidly flashing (green).

If you sell your vehicle, be sure to erase the programs stored in the HomeLink® memory.

► Vehicles with auto anti-glare inside rear view mirror

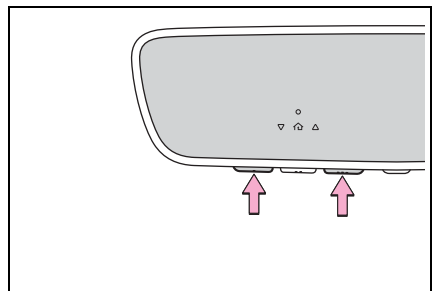

- ▶ Vehicles with Digital Rear-view Mirror

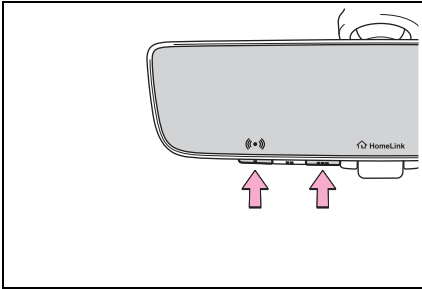

Maintenance and care

6

6-1. Maintenance and care

Cleaning and protecting the vehicle exterior 398

Cleaning and protecting the vehicle interior 402

6-2. Maintenance

Maintenance requirements 405

General maintenance.. 406

Emission inspection and maintenance (I/M) programs 409

6-3. Do-it-yourself maintenance

Do-it-yourself service precautions..... 410

Hood 412

Positioning a floor jack 413

Engine compartment... 415

12-volt battery 422

Tires 425

Tire inflation pressure . 438

Wheels 440

Air conditioning filter.... 441

Cleaning the hybrid battery (traction battery) air intake vent 443

Electronic key battery.. 446

Checking and replacing fuses..... 448

Headlight aim 451

Exterior lights 452

Cleaning and protecting the vehicle exterior

Perform the following to protect the vehicle and maintain it in prime condition:

Cleaning instructions

- Working from top to bottom, liberally apply water to the vehicle body, wheel wells and underside of the vehicle to remove any dirt and dust.
- Wash the vehicle body using a sponge or soft cloth, such as a chamois.
- For hard-to-remove marks, use car wash soap and rinse thoroughly with water.
- Wipe away any water.
- Wax the vehicle when the waterproof coating deteriorates.

If water does not bead on a clean surface, apply wax when the vehicle body is cool.

■ Automatic car washes

- Before washing the vehicle:
 - Fold the mirrors
 - Turn off the power back door

Start washing from the front of the vehicle. Make sure to extend the mirrors before driving.

- Brushes used in automatic car washes may scratch the vehicle

surface, parts (wheel, etc.) and harm your vehicle's paint.

- Rear spoiler may not be washable in some automatic car washes. There may also be an increased risk of damage to vehicle.
- When the shift position needs to be held in N, refer to P.190.

■ High pressure car washes

As water may enter the cabin, do not bring the nozzle tip near the gaps around the doors or perimeter of the windows, or spray these areas continuously.

■ Note for a smart key system

If the door handle becomes wet while the electronic key is within the effective range, the door may lock and unlock repeatedly. In that case, follow the following correction procedures to wash the vehicle:

- Place the key in a position 6 ft. (2 m) or more separate from the vehicle while the vehicle is being washed. (Take care to ensure that the key is not stolen.)
- Set the electronic key to battery-saving mode to disable the smart key system. (→P.132)

■ Wheels and wheel ornaments

- Remove any dirt immediately by using a neutral detergent.
- Wash detergent off with water immediately after use.
- To protect the paint from damage, make sure to observe the following precautions.
 - Do not use acidic, alkaline or abrasive detergent
 - Do not use hard brushes
 - Do not use detergent on the wheels when they are hot, such as after driving or parking in hot weather

■ Brake pads and calipers

Rust may form if the vehicle is parked with wet brake pads or disc rotors, causing them to stick. Before

parking the vehicle after it is washed, drive slowly and apply the brakes several times to dry the parts.

■ Bumpers

Do not scrub with abrasive cleaners.

■ Front side windows water-repellent coating

- The following precautions can extend the effectiveness of the water-repellent coating.
- Remove any dirt, etc., from the front side windows regularly.
- Do not allow dirt and dust to accumulate on the windows for a long period. Clean the windows with a soft, damp cloth as soon as possible.
- Do not use wax or glass cleaners that contain abrasives when cleaning the windows.
- Do not use any metallic objects to remove condensation build up.

■ Plated portions

If dirt cannot be removed, clean the parts as follows:

- Use a soft cloth dampened with an approximately 5% solution of neutral detergent and water to clean the dirt off.
- Wipe the surface with a dry, soft cloth to remove any remaining moisture.
- To remove oily deposits, use alcohol wet wipes or a similar product.



WARNING

■ When washing the vehicle

Do not apply water to the inside of the engine compartment. Doing so may cause the electrical components, etc. to catch fire.

■ When cleaning the windshield (vehicles with rain-sensing windshield wipers)

Set the wiper switch to off. If the wiper switch is in "AUTO", the wipers may operate unexpectedly in the following situations, and may result in hands being caught or other serious injuries and cause damage to the wiper blades.

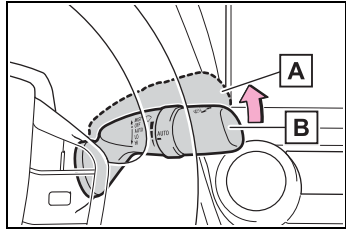

A Off

B AUTO

- When the upper part of the windshield where the raindrop sensor is located is touched by hand
- When a wet rag or similar is held close to the raindrop sensor
- If something bumps against the windshield
- If you directly touch the raindrop sensor body or if something bumps into the raindrop sensor

■ Precautions regarding the exhaust pipes

Exhaust gasses cause the exhaust pipes to become quite hot.

When washing the vehicle, be careful not to touch the pipes until they have cooled sufficiently, as touching hot exhaust pipes can cause burns.

**WARNING****■ Precaution regarding the front and rear bumpers**

If the paint of the front or rear bumper is chipped or scratched, the following systems may not function correctly. If this occurs, consult your Toyota dealer.

- BSM
- Automatic Rear Flashing Hazard Lights
- RCTA
- SEA
- PKSB (if equipped)
- Intuitive parking assist

**NOTICE****■ To prevent paint deterioration and corrosion on the body and components (aluminum wheels, etc.)**

- Wash the vehicle immediately in the following cases:
 - After driving near the sea coast
 - After driving on salted roads
 - If coal tar or tree sap is present on the paint surface
 - If dead insects, insect droppings or bird droppings are present on the paint surface
 - After driving in an area contaminated with soot, oily smoke, mine dust, iron powder or chemical substances
 - If the vehicle becomes heavily soiled with dust or mud
 - If liquids such as benzene and gasoline are spilled on the paint surface

- If the paint is chipped or scratched, have it repaired immediately.
- To prevent the wheels from corroding, remove any dirt and store in a place with low humidity when storing the wheels.

■ To prevent damage to the windshield wiper arms

When lifting the wiper arms away from the windshield pull the driver side wiper arm upward first, and repeat for the passenger's side. When returning the wipers to their original position, do so from the passenger's side first.

■ Cleaning the exterior lights

- Wash carefully. Do not use organic substances or scrub with a hard brush. This may damage the surfaces of the lights.
- Do not apply wax to the surfaces of the lights. Wax may cause damage to the lenses.

■ Cleaning the radiator grille

Observe the following precautions to avoid damage to the radiator grille surface.

- Do not use a hard brush. Use a soft cloth or sponge to wipe.
- Remove any dirt by using a neutral detergent. Do not use waxes or alcohols (e.g. glass cleaner).
- Wash detergent off with water after washing the vehicle.



NOTICE

■ **When using an automatic car wash (vehicles with rain-sensing windshield wipers)**

Set the wiper switch to off position.

If the wiper switch is in "AUTO", the wipers may operate and the wiper blades may be damaged.

■ **When using a high pressure car wash**

- When washing the vehicle, do not spray the camera or its surrounding area directly with a high pressure washer. Shock applied from high pressure water may cause the device to not operate normally.
- Do not spray water directly on the radar which is equipped behind the emblem. Otherwise it may cause the device to be damaged.
- Do not bring the nozzle tip close to boots (rubber or resin manufactured cover), connectors or the following parts. The parts may be damaged if they come into contact with high-pressure water.
 - Traction related parts
 - Steering parts
 - Suspension parts
 - Brake parts
- Keep the cleaning nozzle at least 11.9 in. (30 cm) away from the vehicle body. Otherwise resin section, such as moldings and bumpers, may be deformed and damaged. Also, do not continuously hold the nozzle in the same place.

- Do not spray the lower part of the windshield continuously. If water enters the air conditioning system intake located near the lower part of the windshield, the air conditioning system may not operate correctly.

- Do not wash the underside of the vehicle using a high pressure car washer.

■ **When raising the windshield wiper arms**

Make sure to hold the hook parts of the wiper arms to raise them.

Do not hold only the wiper blades when raising them, or it may cause deformation of the wiper blades.

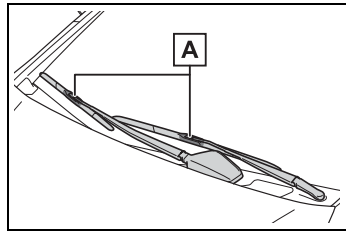

A Hook parts

Cleaning and protecting the vehicle interior

Perform cleaning in a manner appropriate to each component and its material.

Protecting the vehicle interior

- Remove dirt and dust using a vacuum cleaner. Wipe dirty surfaces with a cloth dampened with lukewarm water.
- If dirt cannot be removed, wipe it off with a soft cloth dampened with neutral detergent diluted to approximately 1%.
Wring out any excess water from the cloth and thoroughly wipe off remaining traces of detergent and water.

■ Shampooing the carpets

There are several commercial foaming-type cleaners available. Use a sponge or brush to apply the foam. Rub in overlapping circles. Do not use water. Wipe dirty surfaces and let them dry. Excellent results are obtained by keeping the carpet as dry as possible.

■ Handling the seat belts

Clean with mild soap and lukewarm water using a cloth or sponge. Also check the belts periodically for excessive wear, fraying or cuts.

■ Front side windows with UV protective coating

The front side windows have UV protective coating. To prevent any

damage to the UV protective coating, observe the following:

- If the windows are dirty, gently wipe them with a cloth soaked in water or lukewarm water as soon as possible.
- If the windows are very dirty, do not open and close them repeatedly.

WARNING

■ Water in the vehicle

● Do not splash or spill liquid in the vehicle, such as on the floor, on the rear seats, in the hybrid battery (traction battery) air intake vent or in the luggage compartment. (→P.77)
Doing so may cause the hybrid battery, electrical components, etc. to malfunction or catch fire.

● Do not get any of the SRS components or wiring in the vehicle interior wet. (→P.36)
An electrical malfunction may cause the airbags to deploy or not function properly, resulting in death or serious injury.

● Do not let the wireless charger (→P.380) get wet. Failure to do so may cause the charger to become hot and cause burns or could cause electric shock resulting in death or serious injury.

■ Cleaning the interior (especially instrument panel)

Do not use polish wax or polish cleaner. The instrument panel may reflect off the windshield, obstructing the driver's view and leading to an accident, resulting in death or serious injury.



NOTICE

■ Cleaning detergents

- Do not use the following types of detergent, as they may discolor the vehicle interior or cause streaks or damage to painted surfaces:
 - Non-seat portions: Organic substances such as benzene or gasoline, alkaline or acidic solutions, dye, and bleach
 - Seats: Alkaline or acidic solutions, such as thinner, benzene, and alcohol
- Do not use polish wax or polish cleaner. The instrument panel's or other interior part's painted surface may be damaged.

■ Preventing damage to leather surfaces

Observe the following precautions to avoid damage to and deterioration of leather surfaces:

- Remove any dust or dirt from leather surfaces immediately.
- Do not expose the vehicle to direct sunlight for extended periods of time. Park the vehicle in the shade, especially during summer.
- Do not place items made of vinyl, plastic, or containing wax on the upholstery, as they may stick to the leather surface if the vehicle interior heats up significantly.

■ Water on the floor

Do not wash the vehicle floor with water.

Vehicle systems such as the audio system may be damaged if water comes into contact with electrical components such as the audio system above or under the floor of the vehicle. Water may also cause the body to rust.

■ When cleaning the inside of the windshield

Do not allow glass cleaner to contact the lens. Also, do not touch the lens. (→P.215)

■ Cleaning the inside of the rear window

- Do not use a glass cleaner to clean the rear window, as this may cause damage to the rear window defogger heater wires or antenna. Use a cloth dampened with lukewarm water to gently wipe the window clean. Wipe the window in strokes running parallel to the heater wires or antenna.
- Be careful not to scratch or damage the heater wires or antenna.

■ Cleaning the front side window

Do not use any compound or abrasive product (e.g., glass cleaner, detergent, wax) to clean the windows. It may damage the coating.

Cleaning the areas with satin-finish metal accents (if equipped)

- Remove dirt using a water-dampened soft cloth or synthetic chamois.
- Wipe the surface with a dry, soft cloth to remove any remaining moisture.

■ Cleaning the areas with satin-finish metal accents

The metal areas use a layer of real metal for the surface. It is necessary to clean them regularly. If dirty areas

are left uncleaned for long periods of time, they may be difficult to clean.

Cleaning the leather areas

- Remove dirt and dust using a vacuum cleaner.
- Wipe off any excess dirt and dust with a soft cloth dampened with diluted detergent.

Use a diluted water solution of approximately 5% neutral wool detergent.

- Wring out any excess water from the cloth and thoroughly wipe off all remaining traces of detergent.
- Wipe the surface with a dry, soft cloth to remove any remaining moisture. Allow the leather to dry in a shaded and ventilated area.

Caring for leather areas

Toyota recommends cleaning the interior of the vehicle at least twice a year to maintain the quality of the vehicle's interior.

Cleaning the synthetic leather areas

- Remove dirt and dust using a vacuum cleaner.
- Wipe it off with a soft cloth dampened with neutral detergent diluted to approximately 1%.
- Wring out any excess water

from the cloth and thoroughly wipe off remaining traces of detergent and water.

Maintenance requirements

To ensure safe and economical driving, day-to-day care and regular maintenance are essential. It is the owner's responsibility to perform regular checks. Toyota recommends the following maintenance:

■ Repair and replacement

It is recommended that genuine Toyota parts be used for repairs to ensure performance of each system. If non-Toyota parts are used in replacement or if a repair shop other than a Toyota dealer performs repairs, confirm the warranty coverage.

■ Allow inspection and repairs to be performed by a Toyota dealer

- Toyota technicians are well-trained specialists and are kept up to date with the latest service information. They are well informed about the operations of all systems on your vehicle.
- Keep a copy of the repair order. It proves that the maintenance that has been performed is under warranty coverage. If any problem should arise while your vehicle is under warranty, your Toyota dealer will promptly take care of it.



WARNING

■ If your vehicle is not properly maintained

Improper maintenance could result in serious damage to the vehicle and possible death or serious injury.

■ Handling of the 12-volt battery

- Engine exhaust, some of its constituents, and a wide variety of automobile components contain or emit chemicals known to the State of California to cause cancer and birth defects and other reproductive harm. Work in a well ventilated area.
- Oils, fuels and fluids contained in vehicles as well as waste produced by component wear contain or emit chemicals known to the State of California to cause cancer and birth defects or other reproductive harm. Avoid exposure and wash any affected area immediately.
- 12-volt battery posts, terminals and related accessories contain lead and lead compounds which are known to cause brain damage. Wash your hands after handling. (→P.422)

General maintenance

General maintenance should be performed on a daily basis. This can be done by yourself or by a Toyota dealer.







Scheduled maintenance

Scheduled maintenance should be performed at specified intervals according to the maintenance schedule.





For details about maintenance items and schedules, refer to the "Scheduled Maintenance Guide" or "Owner's Manual Supplement".

■ Resetting the message indicating maintenance is required

After the required maintenance is performed according to the maintenance schedule, please reset the reminder light or message. To reset the reminder light or message, follow the procedure described below:

- 1 Press  or  of the meter control switches on the steering wheel and select .
- 2 Press  or  of the meter control switches and select “ Vehicle Settings”.

Then press and hold .

- 3 Press  or  of the meter control switches and select “Scheduled Maintenance”, and then press .
- 4 Select “Yes” and press .

Do-it-yourself maintenance

You can perform some maintenance procedures by yourself. Please be aware that do-it-yourself maintenance may affect warranty coverage.

The use of Toyota Repair Manuals is recommended.

For details about warranty coverage, refer to the separate “Owner’s Warranty Information Booklet” or “Owner’s Manual Supplement”.

General maintenance

Listed below are the general maintenance items that should be performed at the intervals specified in the “Owner’s Warranty Information Booklet” or “Owner’s Manual Supplement/Scheduled Maintenance Guide”. It is recommended that any problem you notice should be brought to the attention of your Toyota dealer or qualified service shop for advice.

WARNING

■ If the hybrid system is running

Turn the hybrid system off and ensure that there is adequate ventilation before performing maintenance checks.

Engine compartment

Items	Check points
Brake fluid	Is the brake fluid at the correct level? (→P.420)
Engine/power control unit coolant	Is the engine/power control unit coolant at the correct level? (→P.418)
Engine oil	Is the engine oil at the correct level? (→P.415)

Items	Check points
Exhaust system	There should not be any fumes or strange sounds.
Radiator/condenser	The radiator and condenser should be free from foreign objects. (→P.419)
Washer fluid	Is there sufficient washer fluid? (→P.421)

Luggage compartment

Items	Check points
12-volt battery	Check the connections. (→P.422)

Vehicle interior

Items	Check points
Accelerator pedal	<ul style="list-style-type: none"> The accelerator pedal should move smoothly (without uneven pedal effort or catching).
Hybrid transmission "Park" mechanism	<ul style="list-style-type: none"> When parked on a slope and the shift position is in P, is the vehicle securely stopped?

Items	Check points
Brake pedal	<ul style="list-style-type: none"> Does the brake pedal move smoothly? Does the brake pedal have appropriate clearance from the floor? Does the brake pedal have the correct amount of free play?
Brakes	<ul style="list-style-type: none"> The vehicle should not pull to one side when the brakes are applied. The brakes should work effectively. The brake pedal should not feel spongy. The brake pedal should not get too close to the floor when the brakes are applied.
Head restraints	<ul style="list-style-type: none"> Do the head restraints move smoothly and lock securely?
Indicators/buzzers	<ul style="list-style-type: none"> Do the indicators and buzzers function properly?

Items	Check points
Lights	<ul style="list-style-type: none"> • Do all the lights come on? • Are the headlights aimed correctly?(→P.451)
Parking brake	<ul style="list-style-type: none"> • Does the parking brake operate normally? • When parked on a slope and the parking brake is on, is the vehicle securely stopped?
Seat belts	<ul style="list-style-type: none"> • Do the seat belts operate smoothly? • The seat belts should not be damaged.
Seats	<ul style="list-style-type: none"> • Do the seat controls operate properly?
Steering wheel	<ul style="list-style-type: none"> • Does the steering wheel rotate smoothly? • Does the steering wheel have the correct amount of free play? • There should not be any strange sounds coming from the steering wheel.

Vehicle exterior

Items	Check points
Doors	<ul style="list-style-type: none"> • Do the doors operate smoothly?
Engine hood	<ul style="list-style-type: none"> • Does the engine hood lock system work properly?
Fluid leaks	<ul style="list-style-type: none"> • There should not be any signs of fluid leakage after the vehicle has been parked.
Tires	<ul style="list-style-type: none"> • Is the tire inflation pressure correct? • The tires should not be damaged or excessively worn. • Have the tires been rotated according to the maintenance schedule? • The wheel nuts should not be loose.
Windshield wipers/rear window wiper	<ul style="list-style-type: none"> • The wiper blades should not show any signs of cracking, splitting, wear, contamination or deformation. • The wiper blades should clear the windshield/rear window without streaking or skipping.

Emission inspection and maintenance (I/M) programs

Some states have vehicle emission inspection programs which include OBD (On Board Diagnostics) checks. The OBD system monitors the operation of the emission control system.

If the malfunction indicator lamp comes on

The OBD system determines that a problem exists somewhere in the emission control system. Your vehicle may not pass the I/M test and may need to be repaired. Contact your Toyota dealer to service the vehicle.

Your vehicle may not pass the I/M test in the following situations:

- When the 12-volt battery is disconnected or discharged Readiness codes that are set during ordinary driving are erased. Also, depending on your driving habits, the readiness codes may not be completely set.
- When the fuel tank cap is

loose

The malfunction indicator lamp comes on indicating a temporary malfunction and your vehicle may not pass the I/M test.

When the malfunction indicator lamp still remains on after several driving trips

The error code in the OBD system will not be cleared unless the vehicle is driven 40 or more times.

If your vehicle does not pass the I/M test

Contact your Toyota dealer to prepare the vehicle for re-testing.

Do-it-yourself service precautions

If you perform maintenance by yourself, be sure to follow the correct procedure as given in these sections.

Maintenance

Items	Parts and tools
12-volt battery condition (→P.422)	<ul style="list-style-type: none"> • Grease • Conventional wrench (for terminal clamp bolts)
Brake fluid level (→P.420)	<ul style="list-style-type: none"> • FMVSS No.116 DOT 3 or SAE J1703 brake fluid • FMVSS No.116 DOT 4 or SAE J1704 brake fluid • Rag or paper towel • Funnel (used only for adding brake fluid)

Items	Parts and tools
Engine/power control unit coolant level (→P.418)	<ul style="list-style-type: none"> • “Toyota Super Long Life Coolant” or a similar high quality ethylene glycol-based non-silicate, non-amine, non-nitrite and non-borate coolant with long-life hybrid organic acid technology For the U.S.A.: “Toyota Super Long Life Coolant” is pre-mixed with 50% coolant and 50% deionized water. For Canada: “Toyota Super Long Life Coolant” is pre-mixed with 55% coolant and 45% deionized water. • Funnel (used only for adding coolant)
Engine oil level (→P.415)	<ul style="list-style-type: none"> • “Toyota Genuine Motor Oil” or equivalent • Rag or paper towel • Funnel (used only for adding engine oil)
Fuses (→P.448)	<ul style="list-style-type: none"> • Fuse with same amperage rating as original
Headlight aim (→P.451)	<ul style="list-style-type: none"> • Phillips-head screwdriver

Items	Parts and tools
Hybrid battery (traction battery) air intake vent (→P.443)	<ul style="list-style-type: none"> • Vacuum cleaner, etc, • Phillips screw-driver
Radiator and condenser (→P.419)	—
Tire inflation pressure (→P.438)	<ul style="list-style-type: none"> • Tire pressure gauge • Compressed air source
Washer fluid (→P.421)	<ul style="list-style-type: none"> • Water or washer fluid containing antifreeze (for winter use) • Funnel (used only for adding water or washer fluid)

**WARNING**

The engine compartment contains many mechanisms and fluids that may move suddenly, become hot, or become electrically energized. To avoid death or serious injury, observe the following precautions.

■ **When working on the engine compartment**

- Make sure that “POWER ON” on the meter and the “READY” indicator are both off.
- Keep hands, clothing and tools away from the moving fan.
- Be careful not to touch the engine, power control unit, radiator, exhaust manifold, etc. right after driving as they may be hot. Oil and other fluids may also be hot.

● Do not leave anything that may burn easily, such as paper and rags, in the engine compartment.

● Do not smoke, cause sparks or expose an open flame to fuel or the battery. Fuel and battery fumes are flammable.

■ **When working near the electric cooling fan or radiator grille**

Be sure the power switch is OFF.

With the power switch in ON, the electric cooling fan may automatically start to run if the air conditioning is on and/or the coolant temperature is high. (→P.419)

■ **Safety glasses**

Wear safety glasses to prevent flying or falling material, fluid spray, etc., from getting in your eyes.

**NOTICE**

■ **If you remove the air cleaner filter**

Driving with the air cleaner filter removed may cause excessive engine wear due to dirt in the air.

Hood

Release the lock from the inside of the vehicle to open the hood.

Opening the hood

- 1 Pull the hood lock release lever.

The hood will pop up slightly.

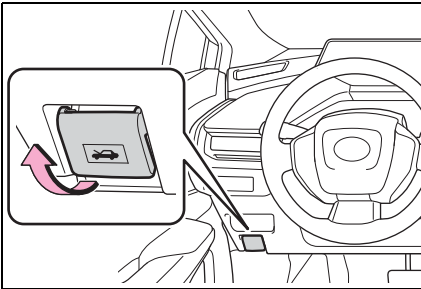

- 2 Push the auxiliary catch lever to the left and lift the hood.

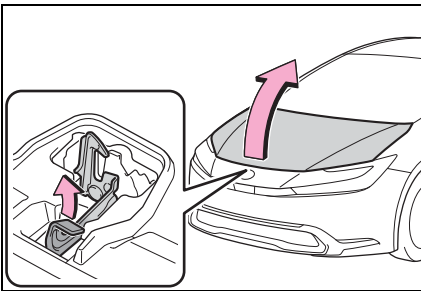

- 3 Hold the hood open by inserting the supporting rod into the slot.

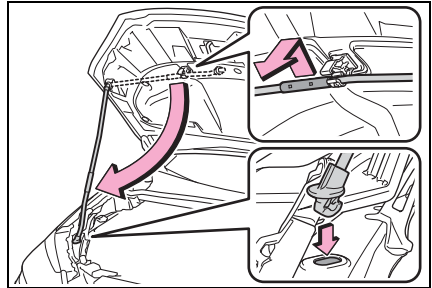

⚠ WARNING

■ Pre-driving check

Check that the hood is fully closed and locked. If the hood is not locked properly, it may open while the vehicle is in motion and cause an accident, which may result in death or serious injury.

■ To prevent injuries

The support rod may be hot after driving the vehicle. Touching the hot support rod may lead to burns or other serious injuries.

■ After installing the support rod into the slot

Make sure the rod supports the hood securely from falling down on to your head or body.

■ When closing the hood

When closing the hood, take extra care to prevent your fingers etc. from being caught.

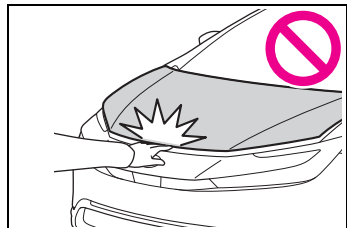

**NOTICE****When closing the hood**

Be sure to return the support rod to its clip before closing the hood. Closing the hood without returning the support rod properly could cause the hood to bend.

Positioning a floor jack

When using a floor jack, follow the instructions in the manual provided with the jack and perform the operation safely.

When raising your vehicle with a floor jack, position the jack correctly.

Improper placement may damage your vehicle or cause injury.

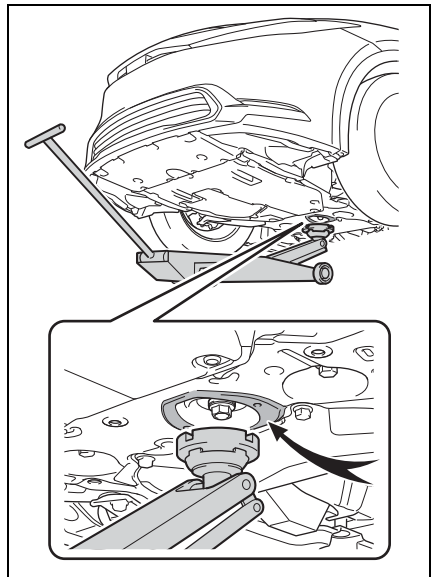
Location of the jack point**Front**

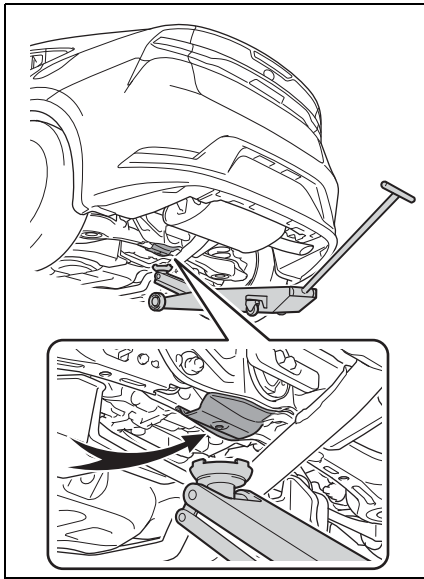
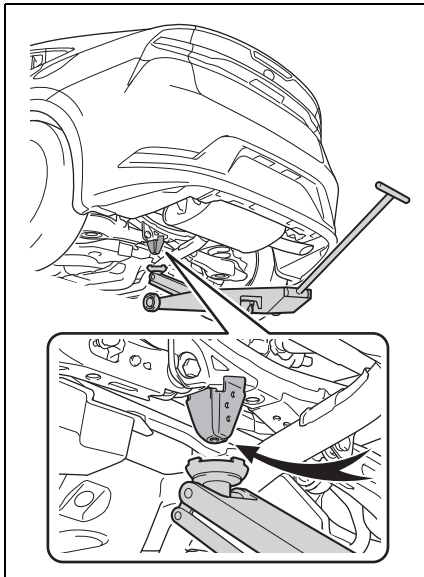
■ Rear**▶ AWD models****▶ 2WD models**

Engine compartment

Components

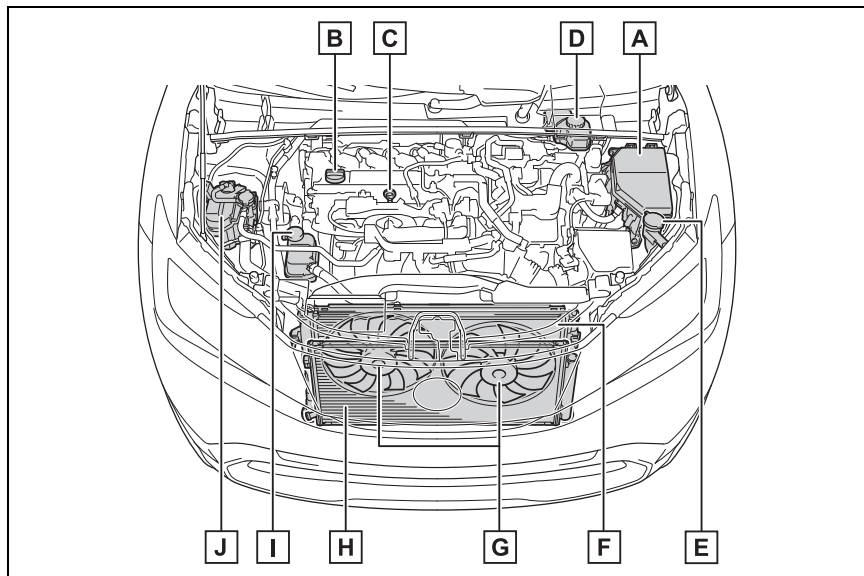

- A** Fuse boxes (→P.448)
- B** Engine oil filler cap (→P.417)
- C** Engine oil level dipstick (→P.415)
- D** Brake fluid reservoir (→P.420)
- E** Washer fluid tank (→P.421)
- F** Radiator (→P.419)
- G** Electric cooling fans
- H** Condenser (→P.419)
- I** Power control unit coolant reservoir (→P.418)
- J** Engine coolant reservoir (→P.418)

■ 12-volt battery

→P.422

Checking the engine oil

With the engine at operating temperature and turned off, check the oil level on the dip-

stick.

- 1 Park the vehicle on level ground. After warming up the engine and turning off the hybrid system, wait about 5 minutes for the oil to drain back into the bottom of the engine.
- 2 Holding a rag under the end, pull the dipstick out.

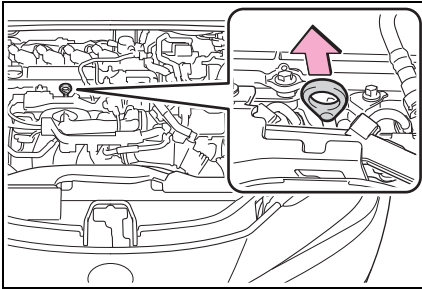

- 3 Wipe the dipstick clean.
- 4 Reinsert the dipstick fully.
- 5 Holding a rag under the end, pull the dipstick out and check whether the oil level is above low level mark.

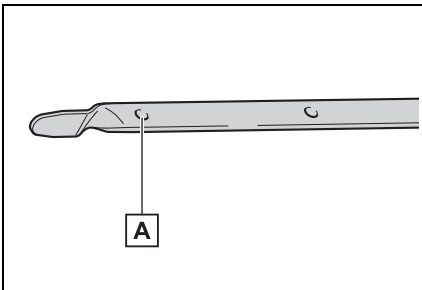

A Low level mark

The shape of the dipstick may differ depending on the type of vehicle or engine.

- 6 Wipe the dipstick and reinsert it fully.

 NOTICE

To prevent serious engine damage

Check the oil level on a regular basis.

■ **Engine oil consumption**

A certain amount of engine oil will be consumed while driving. In the following situations, oil consumption may increase, and engine oil may need to be refilled in between oil maintenance intervals.

- When the engine is new, for example directly after purchasing the vehicle or after replacing the engine
- If low quality oil or oil of an inappropriate viscosity is used
- When driving at high engine speeds or with a heavy load, or when driving while accelerating or decelerating frequently
- When leaving the engine idling for a long time, or when driving frequently through heavy traffic

■ **Engine oil level rise**

If the vehicle is repeatedly driven without the engine warmed up, moisture caused by dew condensation inside the engine or fuel which did not burn mixes into the engine oil, resulting in a rise in engine oil level.

For example, the engine become difficult to be warmed up in the following situations.

- When driving a short distance
- When driving at a low speed
- When the outside temperature is low

When checking the engine oil, make sure that the engine is warmed up. If

the engine oil level exceeds the refill upper limit mark, contact your Toyota dealer.

Adding engine oil

■ Checking the oil type and preparing the items needed

Make sure to check the oil type and prepare the items needed before adding oil.

● Engine oil selection

→P.521

● Oil quantity (Low level mark → Refill upper limit mark)

1.6 qt. (1.5 L, 1.3 Imp. qt.)

● Item

Clean funnel

■ Adding engine oil

If the oil level is below or near the low level mark, add engine oil of the same type as that already in the engine.

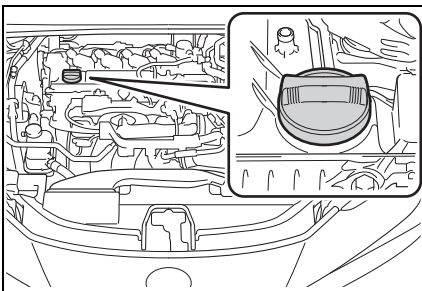

- 1 Remove the oil filler cap by turning it counterclockwise.
- 2 Add engine oil slowly, checking the dipstick.

Make sure that the oil level does not exceed the refill upper limit mark and is between the low level

mark and refill upper limit mark.

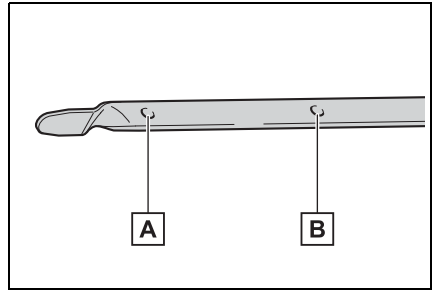

A Low level mark





B Refill upper limit mark

The shape of the dipstick may differ depending on the type of vehicle or engine.

- 3 Install the oil filler cap by turning it clockwise.

■ After changing the engine oil

The engine oil maintenance data should be reset. Perform the following procedures:

- 1 Press **◀** or **▶** of the meter control switches and select  on the multi-information display.
- 2 Press **▲** or **▼** of the meter control switches and select "Vehicle Settings". Then press .
- 3 Press **▲** or **▼** of the meter control switches and select "Oil Maintenance". Then press .
- 4 Select "Yes" and press .

**WARNING**

■ Used engine oil

- Used engine oil contains potentially harmful contaminants which may cause skin disorders such as inflammation and skin cancer, so care should be taken to avoid prolonged and repeated contact. To remove used engine oil from your skin, wash thoroughly with soap and water.
- Dispose of used oil and filters only in a safe and acceptable manner. Do not dispose of used oil and filters in household trash, in sewers or onto the ground. Call your Toyota dealer, service station or auto parts store for information concerning recycling or disposal.
- Do not leave used engine oil within the reach of children.

**NOTICE**

■ When replacing the engine oil

- Be careful not to spill engine oil on the vehicle components.
- Avoid overfilling, or the engine could be damaged.
- Check the oil level on the dipstick every time you refill the vehicle.
- Be sure the engine oil filler cap is properly tightened.

■ If oil is spilled on the engine cover

To prevent the engine cover from being damaged, remove any engine oil from the engine cover as soon as possible using a neutral detergent. Do not use an organic solvent such as brake cleaner.

Checking the coolant

The coolant level is satisfactory if it is between the “MAX” and “MIN” lines on the reservoir when the hybrid system is cold.

■ Engine coolant reservoir

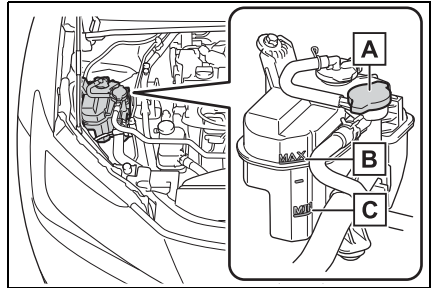

A Reservoir cap

B “MAX” line

C “MIN” line

If the level is on or below the “MIN” line, add coolant up to the “MAX” line. (→P.512)

■ Power control unit coolant reservoir

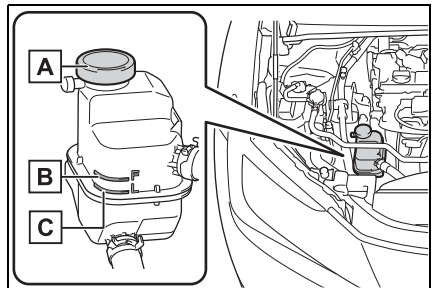

A Reservoir cap

B “F” line

C “L” line

If the level is on or below the “L” line, add coolant up to the “F” line.

(→P.513)

■ Coolant selection

Only use “Toyota Super Long Life Coolant” or a similar high quality ethylene glycol based non-silicate, non-amine, non-nitrite, and non-borate coolant with long-life hybrid organic acid technology.

U.S.A.:

“Toyota Super Long Life Coolant” is a mixture of 50% coolant and 50% deionized water. (Minimum temperature: -31°F [-35°C])

Canada:

“Toyota Super Long Life Coolant” is a mixture of 55% coolant and 45% deionized water. (Minimum temperature: -44°F [-42°C])

For more details about coolant, contact your Toyota dealer.

■ If the coolant level drops within a short time of replenishing

Visually check the radiators, hoses, engine/power control unit coolant reservoir caps, drain cock and water pump.

If you cannot find a leak, have your Toyota dealer, test the cap and check for leaks in the cooling system.



WARNING

■ When the hybrid system is hot

Do not remove the engine/power control unit coolant reservoir caps or the radiator cap.

The cooling system may be under pressure and may spray hot coolant if the cap is removed, causing serious injuries, such as burns.



NOTICE

■ When adding coolant

Coolant is neither plain water nor straight antifreeze. The correct mixture of water and antifreeze must be used to provide proper lubrication, corrosion protection and cooling. Be sure to read the antifreeze or coolant label.

■ If you spill coolant

Be sure to wash it off with water to prevent it from damaging parts or paint.

Checking the radiator and condenser

Check the radiator and condenser, and clear away any foreign objects.

If either of the above parts is extremely dirty or you are not sure of their condition, have your vehicle inspected by your Toyota dealer.



WARNING

■ When the hybrid system is hot

Do not touch the radiator or condenser as they may be hot and cause serious injuries, such as burns.

**WARNING**

■ **When the electric cooling fan is operating**

Do not touch the engine compartment.

With the power switch in ON, the electric cooling fan may automatically start to run if the air conditioning is on and/or the coolant temperature is high. Be sure the power switch is OFF when working near the electric cooling fan or radiator grille.

Checking and adding the brake fluid

■ Checking fluid level

The brake fluid level should be between the "MAX" and "MIN" lines on the tank.

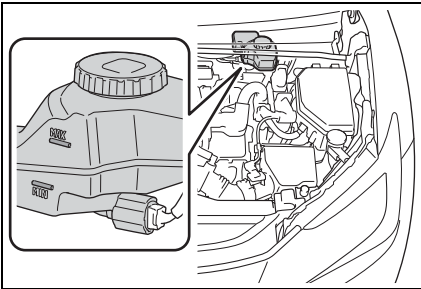

■ Adding fluid

- 1 Slide and lift up the rubber strip to partly remove it, and

then remove the clip remove it as shown in the illustration.

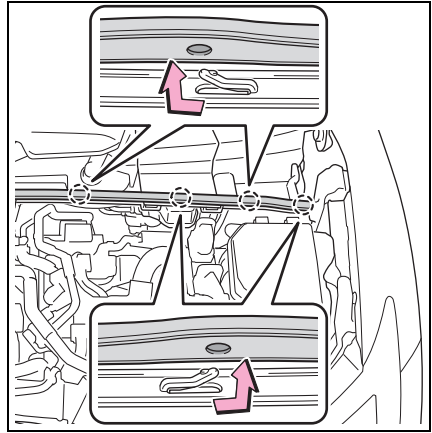

- 2 Disconnect the claws and remove the service cover.

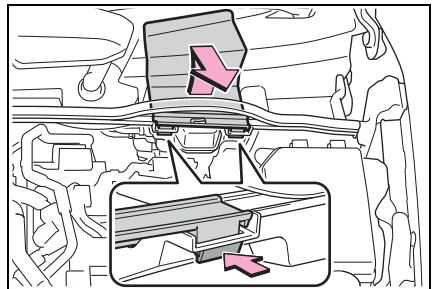

- 3 Remove the reservoir cap.

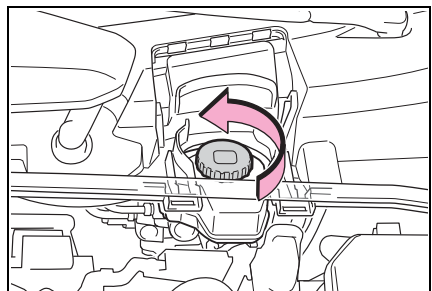

- 4 Add brake fluid slowly while checking the fluid level.

Make sure to check the fluid type and prepare the necessary

item.

Fluid type	FMVSS No.116 DOT 3 or SAE J1703 brake fluid FMVSS No.116 DOT 4 or SAE J1704
Item	Clean funnel

■ Brake fluid can absorb moisture from the air

Excess moisture in the brake fluid can cause a dangerous loss of braking efficiency. Use only newly opened brake fluid.

WARNING

■ When filling the reservoir

Take care as brake fluid can harm your hands and eyes and damage painted surfaces.

If fluid gets on your hands or in your eyes, flush the affected area with clean water immediately.

If you still experience discomfort, see a doctor.

NOTICE

■ If the fluid level is low or high

It is normal for the brake fluid level to go down slightly as the brake pads wear out or when the fluid level in the accumulator is high.

If the reservoir needs frequent refilling, there may be a serious problem.

Adding the washer fluid

If any washer does not work or “Windshield Washer Fluid Low” is shown on the multi-information display, the washer tank may be empty. Add washer

fluid.

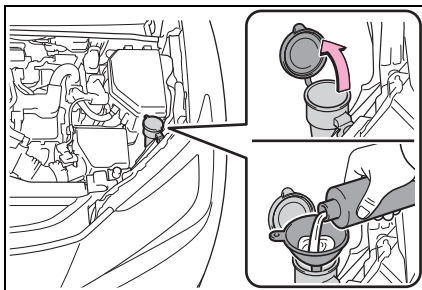

WARNING

■ When adding washer fluid

Do not add washer fluid when the hybrid system is hot or operating as washer fluid contains alcohol and may catch fire if spilled on the hybrid system, etc.

NOTICE

■ Do not use any fluid other than washer fluid

Do not use soapy water or engine antifreeze instead of washer fluid. Doing so may cause streaking on the vehicle's painted surfaces, as well as damaging the pump leading to problems of the washer fluid not spraying.

■ Diluting washer fluid

Dilute washer fluid with water as necessary. Refer to the freezing temperatures listed on the label of the washer fluid bottle.

12-volt battery

Location

The 12-volt battery is located in the right-hand side of luggage compartment.

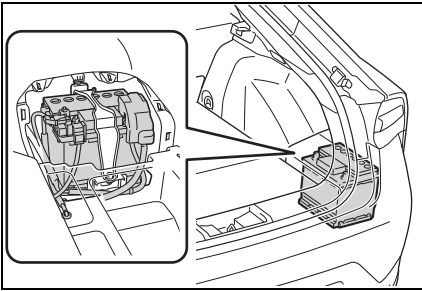

■ Before recharging

When recharging, the 12-volt battery produces hydrogen gas which is flammable and explosive. Therefore, observe the following precautions before recharging:

- If recharging with the 12-volt battery installed on the vehicle, be sure to disconnect the ground cable.
- Make sure the power switch on the charger is off when connecting and disconnecting the charger cables to the 12-volt battery.

■ After recharging/reconnecting the 12-volt battery

- Unlocking the doors using the smart key system may not be possible immediately after reconnecting the 12-volt battery. If this happens, use the wireless remote control or the mechanical key to lock/unlock the doors.
- Start the hybrid system with the power switch in ACC. The hybrid system may not start with the power switch turned off. However, the hybrid system will operate normally from the second

attempt.

- The power switch mode is recorded by the vehicle. If the 12-volt battery is reconnected, the vehicle will return the power switch mode to the status it was in before the 12-volt battery was disconnected. Make sure to turn off the power switch before disconnecting the 12-volt battery. Take extra care when connecting the 12-volt battery if the power switch mode prior to discharge is unknown.

If the hybrid system will not start even after multiple attempts at all methods above, contact your Toyota dealer.

⚠ WARNING

■ Chemicals in the 12-volt battery

The 12-volt battery contains poisonous and corrosive sulfuric acid and may produce hydrogen gas which is flammable and explosive. To reduce the risk of death or serious injury, take the following precautions while working on or near the 12-volt battery:

- Do not cause sparks by touching the 12-volt battery terminals with tools.
- Do not smoke or light a match near the 12-volt battery.
- Avoid contact with eyes, skin and clothes.
- Never inhale or swallow electrolyte.
- Wear protective safety glasses when working near the 12-volt battery.
- Keep children away from the 12-volt battery.

WARNING

■ Where to safely charge the 12-volt battery

Always charge the 12-volt battery in an open area. Do not charge the 12-volt battery in a garage or closed room where there is insufficient ventilation.

■ Emergency measures regarding electrolyte

● If electrolyte gets in your eyes

Flush your eyes with clean water for at least 15 minutes and get immediate medical attention. If possible, continue to apply water with a sponge or cloth while traveling to the nearest medical facility.

● If electrolyte gets on your skin

Wash the affected area thoroughly. If you feel pain or burning, get medical attention immediately.

● If electrolyte gets on your clothes

It can soak through clothing on to your skin. Immediately take off the clothing and follow the procedure above if necessary.

● If you accidentally swallow electrolyte

Drink a large quantity of water or milk. Get emergency medical attention immediately.

■ When there is insufficient 12-volt battery fluid

Do not use if there is insufficient fluid in the 12-volt battery. There is a possible danger that the 12-volt battery may explode.

NOTICE

■ When recharging the 12-volt battery

Never recharge the 12-volt battery while the hybrid system is operating. Also, be sure all accessories are turned off.

Removing the 12-volt battery cover

- 1 Vehicle with high deck: Open the deck board (→P.375)

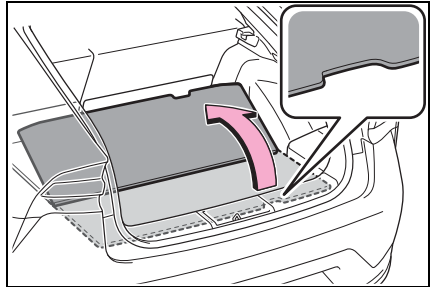

- 2 Hold the handle and pull it toward you, and then the 3 clips will be disengaged

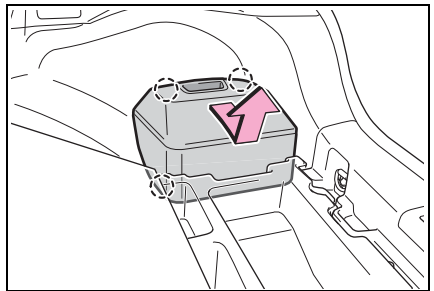

- 3 Taking out the 12-volt battery cover.

When installing, reverse the steps listed.

Exterior

Make sure that the 12-volt battery terminals are not corroded and that there are no loose connections, cracks, or loose clamps.

Have the vehicle inspected by your Toyota dealer.

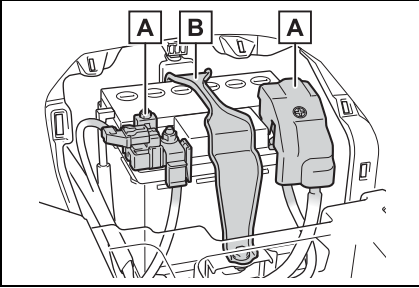

- A** Terminals
- B** Hold-down clamp

Checking the battery condition (if equipped)

Check the battery condition by indicator color.

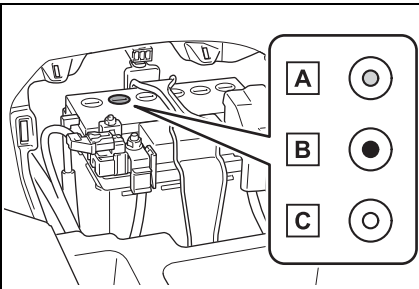

- A** Blue: Good condition
- B** Red: Charging is necessary. Have the vehicle inspected by your Toyota dealer.
- C** Clear: Replacement is necessary.

Tires

Replace or rotate tires in accordance with maintenance schedules and treadwear.

Checking tires

Check if the treadwear indicators are showing on the tires. Also check the tires for uneven wear, such as excessive wear on one side of the tread.

Check the spare tire condition and pressure if not rotated.

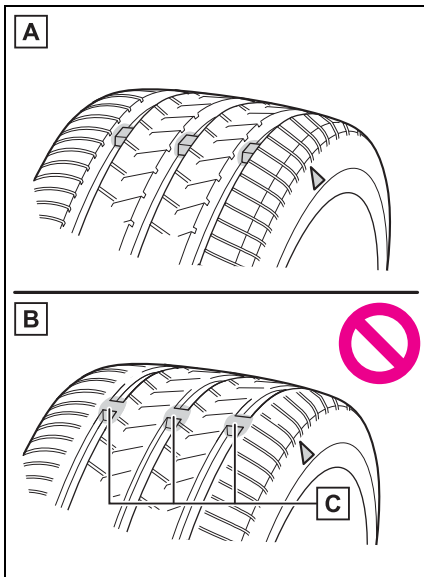

A New tread

B Worn tread

C Treadwear indicator

The location of treadwear indicators is shown by a “TWI” or “△” mark,

etc., molded into the sidewall of each tire.

Replace the tires if the treadwear indicators are showing on a tire.

■ When to replace your vehicle's tires

Tires should be replaced if:

- The treadwear indicators are showing on a tire.
- You have tire damage such as cuts, splits, cracks deep enough to expose the fabric, and bulges indicating internal damage
- A tire goes flat repeatedly or cannot be properly repaired due to the size or location of a cut or other damage

If you are not sure, consult your Toyota dealer.

■ Tire life

Any tire over 6 years old must be checked by a qualified technician even if it has seldom or never been used or damage is not obvious.

■ Low profile tires (vehicles with 195/50R19 tires)

Generally, low profile tires will wear more rapidly and tire grip performance will be reduced on snowy and/or icy roads when compared to standard tires. Be sure to use snow tires on snowy and/or icy roads and drive carefully at a speed appropriate for road and weather conditions.

■ Maximum load of tire

Check that the maximum load of the replacement tire is greater than 1/2 of the Gross Axle Weight Ratings (GAWR) of either the front axle or the rear axle, whichever is greater.

For the GAWR, see the Certification Label. For the maximum load of the tire, see the load limit at maximum cold tire inflation pressure mentioned on the sidewall of the tire. (→P.528)

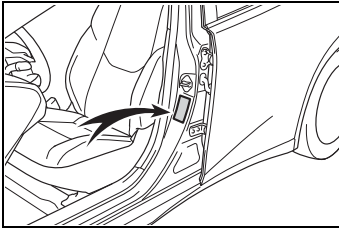

■ Tire types

● Summer tires

Summer tires are high-speed performance tires best suited to highway driving under dry conditions. Since summer tires do not have the same traction performance as snow tires, summer tires are inadequate for driving on snow-covered or icy roads. For driving on snow-covered roads or icy roads, the use of snow tires is recommended. When installing snow tires, be sure to replace all four tires.

● All season tires

All season tires are designed to provide better traction in snow and to be adequate for driving in most winter conditions as well as for use year-round. All season tires, however, do not have adequate traction performance compared with snow tires in heavy or loose snow. Also, all season tires fall short in acceleration and handling performance compared with summer tires in highway driving.

● Snow tires

For driving on snow-covered roads or icy roads, we recommend using snow tires. If you need snow tires, select tires of the same size, construction and load capacity as the originally installed tires. Since your vehicle has radial tires as original equipment, make sure your snow tires also have radial construction. Do not install studded tires without first checking local regulations for possible restrictions. Snow tires should be installed on all wheels. (→P.353)

■ If the tread on snow tires wears down below 0.16 in. (4 mm)

The effectiveness of the tires as snow tires is lost.

⚠ WARNING

■ When inspecting or replacing tires

Observe the following precautions to prevent accidents.

Failure to do so may cause damage to parts of the drivetrain as well as dangerous handling characteristics, which may lead to an accident resulting in death or serious injury.

- Do not mix tires of different makes, models or tread patterns.
Also, do not mix tires of remarkably different treadwear.
- Do not use tire sizes other than those recommended by Toyota.
- Do not mix differently constructed tires (radial, bias-belted or bias-ply tires).
- Do not tow if your vehicle has a compact spare tire installed.
- Do not mix summer, all season and snow tires.
- Do not use tires that have been used on another vehicle.
Do not use tires if you do not know how they were used previously.

**NOTICE****Driving on rough roads**

Take particular care when driving on roads with loose surfaces or potholes.

These conditions may cause losses in tire inflation pressure, reducing the cushioning ability of the tires. In addition, driving on rough roads may cause damage to the tires themselves, as well as the vehicle's wheels and body.

Low profile tires (vehicles with 195/50R19 tires)

Low profile tires may cause greater damage than usual to the tire wheel when sustaining impact from the road surface. Therefore, pay attention to the following:

- Be sure to use proper tire inflation pressure. If tires are under-inflated, they may be damaged more severely.
- Avoid potholes, uneven pavement, curbs and other road hazards. Failure to do so may lead to severe tire and wheel damage.

If tire inflation pressure of each tire becomes low while driving

Do not continue driving, or your tires and/or wheels may be ruined.

Tire rotation

Rotate the tires in the order shown.

To equalize tire wear and extend tire life, Toyota recommends that tire rotation is carried out at the same interval as tire inspection.

Do not fail to initialize the tire pressure warning system after tire rota-

tion.

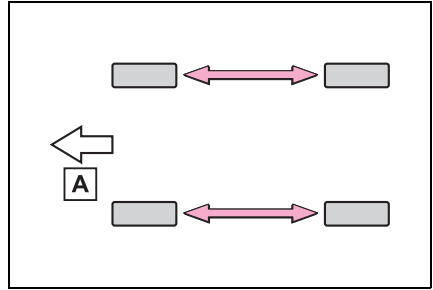

A Front

When rotating the tires

Make sure that the power switch is off. If the tires are rotated while the power switch is in ON, the tire position information will not be updated.

If this accidentally occurs, either turn the power switch to off and then to ON, or initialize the system after checking that the tire pressure is properly adjusted.

Tire pressure warning system

Your vehicle is equipped with a tire pressure warning system that uses tire pressure warning valves and transmitters to detect low tire inflation pressure before serious problems arise.

The tire pressure warning system of this vehicle adopts a 2-type warning system.

- When “Adjust Pressure” is displayed (Normal Warning)

The tire pressure warning light comes on and a buzzer sounds when the tire inflation pressure becomes low due to natural air leakage or outside temperature.

(Ways of coping: →P.469, 524)

- When “Immediately Check tire when Safe” is displayed (Emergency Warning)

The tire pressure warning light comes on and a buzzer sounds when the tire inflation pressure becomes low suddenly due to a blowout. (Ways of coping: →P.469, 483, 495)

However, the system may not be able to detect sudden tire ruptures (bursting, etc.).

- The tire pressure detected by the tire pressure warning system can be displayed on the multi-information display. (→P.92)

The illustration used is intended as an example, and may differ from the image that is actually displayed on the multi-information display.

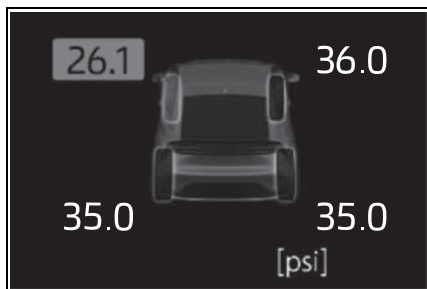



■ How to change the unit

- 1 Park the vehicle in a safe place and turn the power switch off.

Changing the unit cannot be performed while the vehicle is moving.

- 2 Start the hybrid system.

- 3 Use the meter control switches (→P.92) to select  (→P.93).
- 4 Use the meter control switches to select , then press OK .
- 5 Use the meter control switches to select “TPWS setting”, then press OK .
- 6 Use the meter control switches to select “Pressure unit setting”, then press OK .
- 7 Use the meter control switches to select the desired unit and then press OK .

■ Routine tire inflation pressure checks

The tire pressure warning system does not replace routine tire inflation pressure checks. Make sure to check tire inflation pressure as part of your routine of daily vehicle checks.

■ Tire inflation pressure

- It may take a few minutes to display the tire inflation pressure after the power switch is turned to ON.

It may also take a few minutes to display the tire inflation pressure after inflation pressure has been adjusted.

- Tire inflation pressure changes with temperature. The displayed values may also be different from the values measured using a tire pressure gauge.

■ Situations in which the tire pressure warning system may not operate properly

- In the following cases, the tire pressure warning system may not operate properly.
- If non-genuine Toyota wheels are used.
- A tire has been replaced with a tire that is not an OE (Original Equipment) tire.
- A tire has been replaced with a tire that is not of the specified size.
- Tire chains etc. are equipped.
- If a window tint that affects the radio wave signals is installed.
- If there is a lot of snow or ice on the vehicle, particularly around the wheels or wheel housings.
- If the tire inflation pressure is extremely higher than the specified level.
- If wheel without tire pressure warning valves and transmitters are used.
- If the ID code on the tire pressure warning valves and transmitters is not registered in the tire pressure warning computer.
- Performance may be affected in the following situations.
- Near a TV tower, electric power plant, gas station, radio station, large display, airport or other facility that generates strong radio waves or electrical noise
- When carrying a portable radio, cellular phone, cordless phone or other wireless communication device

If tire position information is not correctly displayed due to the radio wave conditions, the display may be corrected by changing the location of the vehicle as the radio wave conditions may change.

- When the vehicle is parked, the time taken for the warning to start or go off could be extended.
- When tire inflation pressure declines rapidly for example when

a tire has burst, the warning may not function.

■ Warning performance of the tire pressure warning system

The warning of the tire pressure warning system will change in accordance with driving conditions. For this reason, the system may give a warning even if the tire pressure does not reach a low enough level, or if the pressure is higher than the pressure that was adjusted to when the system was initialized.

Installing tire pressure warning valves and transmitters

When replacing tires or wheels, tire pressure warning valves and transmitters must also be installed.

When new tire pressure warning valves and transmitters are installed, new ID codes must be registered in the tire pressure warning computer. (→P.434)

■ When replacing the tires and wheels

If the ID code of the tire pressure warning valve and transmitter is not registered, the tire pressure warning system will not work properly. In this case, after driving for about 20 minutes, the tire pressure warning light blinks for 1 minute and stays on to indicate a system malfunction.



NOTICE

Repairing or replacing tires, wheels, tire pressure warning valves, transmitters and tire valve caps

- When removing or fitting the wheels, tires or the tire pressure warning valves and transmitters, contact your Toyota dealer as the tire pressure warning valves and transmitters may be damaged if not handled correctly.
- Make sure to install the tire valve caps. If the tire valve caps are not installed, water could enter the tire pressure warning valves, corrode the valve, and cause sticking and air leaks.
- When replacing tire valve caps, do not use tire valve caps other than those specified. The cap may become stuck.

To avoid damage to the tire pressure warning valves and transmitters

When a tire is repaired with liquid sealants, the tire pressure warning valve and transmitter may not operate properly. If a liquid sealant is used, contact your Toyota dealer or other qualified service shop as soon as possible. Make sure to replace the tire pressure warning valve and transmitter when replacing the tire. (→P.429)

Registration of the position of each wheel after performing a tire rotation



It is necessary to register the position of each wheel after performing a tire rotation.

Wheel position registration can be performed by oneself. Wheel

position registration is performed by driving forward with moderate left and right turns. However, depending on the driving conditions and driving environment, registration may take some time to complete.

- 1 Park the vehicle in a safe place, turn the power switch off and wait 15 minutes or more.
- 2 Start the hybrid system.

The wheel position registration procedure cannot be performed while the vehicle is moving.

- 3 Use the meter control switches (→P.92) to select . (→P.93)
- 4 Use the meter control switches to select , then press OK .
- 5 Use the meter control switches to select “TPWS setting”, then press OK .
- 6 Use the meter control switches to select “Tire Rotation”, then press OK .
- 7 Use the meter control switches to select “OK”, then press OK .

A message indicating that wheel position registration is being performed will be displayed on the multi-information display. “---” will be displayed for the tire inflation pressure of each tire and wheel position registration will begin.

- 8 Drive straight (with occasional left and right turns) at approximately 25 mph (40 km/h) or more for approximately 10 to 30 minutes.

When wheel position registration is complete, a message indicating that registration has been completed and the inflation pressure of each tire will be displayed on the multi-information display.

Even if it is not possible to drive continuously at approximately 25 mph (40 km/h) or more, registration can be completed by driving for a long time. However, if registration does not complete after driving for 1 hour or more, park the vehicle in a safe place and leave it with the power switch in ON for approximately 15 minutes or more, and then perform the driving procedure again.

■ When performing wheel position registration

- Normally, wheel position registration can be completed within approximately 30 minutes.
- Wheel position registration is performed while driving at a vehicle speed of approximately 25 mph (40 km/h) or more.

■ Wheel position registration procedure

- If the power switch is turned off while registering the wheel position, the next time the power switch is turned to ON, the wheel position registration will resume and it will not be necessary to restart the procedure.
- While the position of each wheel is being determined and the inflation pressures are not being displayed, if the inflation pressure of a tire drops, the tire pressure warning light will come on.

■ If the wheel position cannot be registered easily

- In the following situations, wheel position registration may take longer than usual to be completed or may not be possible.
 - Vehicle is not driven at approximately 25 mph (40 km/h) or more
 - Vehicle is driven on unpaved roads
 - If wheel position registration does not complete after driving for 1 hour or more, park the vehicle in a safe place for approximately 15 minutes and then drive the vehicle again.
- If the vehicle is reversed during wheel position registration, all data collected until then will be cleared. Perform driving again.

Setting the tire pressure

In the following situations, it will be necessary to perform the tire inflation pressure setting procedure of the tire pressure warning system.

- When the specified tire inflation pressure has changed, such as due to carried load, etc.
- When the tire inflation pressure is changed such as when the tire size is changed.

If the tire inflation pressure has been adjusted to the specified level, perform the tire inflation setting procedure by selecting specified inflation pressure on the multi-information display.

When the tire inflation pressure is to be other than specified, such as when tires other than the specified size are used, etc., set the tire infla-

tion pressure using the current pressure. Make sure to adjust the tire inflation pressure of each tire to the appropriate level before performing tire pressure setting. The tire pressure warning system operates based on this tire inflation pressure.

■ Setting by selecting a specified tire inflation pressure

1 Start the hybrid system.

The tire inflation pressure cannot be set while the vehicle is moving.

2 Use the meter control switches (→P.92) to select

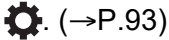

. (→P.93)

3 Use the meter control switches to select , then press OK .

4 Use the meter control switches to select “TPWS setting”, then press OK .

5 Use the meter control switches to select “Tire Pressure Setting”, then press OK .

6 Use the meter control switches to select “Setting by Specified Pressure”, then press OK .

7 Use the meter control switches to select the desired tire pressures, then press OK .

The tire pressure warning light will slowly blink 3 times.

After setting the tire inflation pres-

sure, a message indicating that setting has been completed will be displayed on the multi-information display.

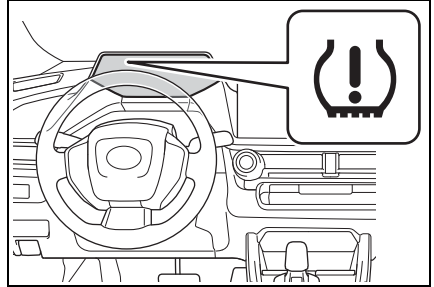

■ If the tire inflation pressure cannot be set easily

- If the tire pressure warning light does not blink 3 times when starting the tire inflation pressure setting procedure, the procedure may not have started. Perform the procedure again from the beginning.
- If tire inflation pressure setting procedure cannot be completed after performing the above procedure, contact your Toyota dealer.

■ Setting using the current tire inflation pressure

WARNING

■ Before performing tire pressure setting

Make sure to adjust the tire inflation pressure of each tire to the appropriate level. Otherwise, the tire pressure warning light may not illuminate even if the tire inflation pressure drops or may illuminate even though the tire inflation pressure is normal.

1 Adjust the tire inflation pressure of each tire to the appropriate level.

Make sure to adjust the tire inflation

pressure with the tires cold.

2 Start the hybrid system.

The tire inflation pressure cannot be set while the vehicle is moving.

3 Use the meter control switches (→P.92) to select  (→P.93).

4 Use the meter control switches to select , then press OK.

5 Use the meter control switches to select “TPWS setting”, then press OK.

6 Use the meter control switches to select “Tire Pressure Setting”, then press OK.

7 Use the meter control switches to select “Setting by Current Pressure”, then press OK.

The tire pressure warning light will slowly blink 3 times and a message indicating that tire inflation pressure is being set will be displayed on the multi-information display.

After setting the tire inflation pressure, a message indicating that setting has been completed will be displayed on the multi-information display.

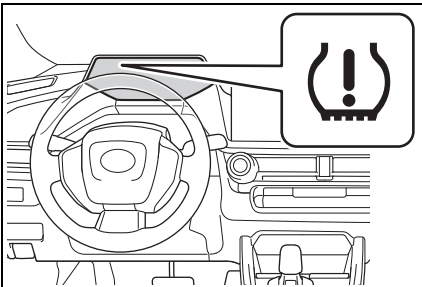

■ Warning performance of the tire pressure warning system

● When performing the tire pressure setting using the current tire inflation pressure, the warning timing of the tire pressure warning system will vary according to the conditions under which tire pressure setting was performed. Therefore, a warning may be output even if the tire inflation pressure drops slightly or if the tire inflation pressure increases above that when the tire inflation pressure was set.

● Make sure to perform the tire pressure setting procedure after adjusting the tire inflation pressure. Also, make sure the tires are cold before performing the tire pressure setting procedure or adjusting the tire inflation pressure.

■ Tire inflation pressure setting procedure

● If the power switch is turned off while setting the tire inflation pressure, the next time the power switch is turned to ON, the setting procedure will resume and it will not be necessary to restart the procedure.

● If the tire inflation pressure setting procedure is started unnecessarily, adjust the tire inflation pressure to the specified level with the tires cold and then perform setting by selecting a specified tire inflation pressure, or perform the tire inflation pressure setting procedure with the current tire inflation pressure.

■ If the tire inflation pressure cannot be set easily

● Normally, the tire inflation pressure setting procedure can be completed in 2 or 3 minutes.

● If the tire pressure warning light does not blink 3 times when starting the tire inflation pressure setting procedure, the procedure

may not have started.

Perform the procedure again from the beginning.

- If tire inflation pressure setting procedure cannot be completed after performing the above procedure, contact your Toyota dealer.

Registering ID codes

The tire pressure warning valve and transmitter is equipped with a unique ID code. When new tire pressure warning valves and transmitters are installed, new ID codes must be registered in the tire pressure warning computer.



- ID codes can be registered by yourself, but depending on the driving conditions and driving environment, registration may take some time to complete.
- When using a wheel set which all of the ID codes have already been registered, the wheel set can be changed in a short amount of time.

Before performing ID code registration, make sure that no wheels with tire pressure warning valve and transmitters installed are near the vehicle.

- 1 Park the vehicle in a safe place, turn the power switch off and wait 15 minutes or more.
- 2 Start the hybrid system.

The ID code registration procedure cannot be performed while the

vehicle is moving.

- 3 Use the meter control switches (→P.92) to select  (→P.93).
- 4 Use the meter control switches to select , then press OK.
- 5 Use the meter control switches to select “TPWS setting”, then press OK.
- 6 Use the meter control switches to select “Tire Set Switching”, then press OK.
- 7 Use the meter control switches to select “Register New Valve / ID”, then press OK.
- 8 Use the meter control switches to select “Tire Set 1” or “Tire Set 2”, then press OK.

If ID codes have already been registered for that wheel set, the tire pressure warning light will slowly blink 3 times, and a message indicating that change is occurring will be displayed on the multi-information display.

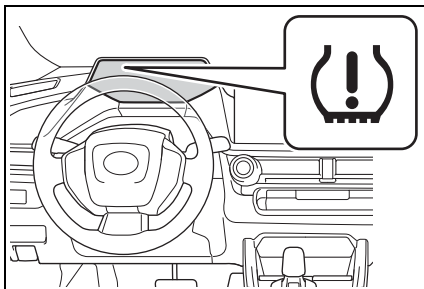

- 9 Use the meter control switches to select Yes then press OK.

The tire pressure warning light will slowly blink 3 times and a message indicating that ID code registration is being performed will be displayed on the multi-information display. Wheel set changing will be canceled and registration will begin.

When registration is being performed, the tire pressure warning light will blink for approximately 1 minute then illuminate and “---” will be displayed for the inflation pressure of each tire on the multi-information display.

- 10 Drive straight (with occasional left and right turns) at approximately 25 mph (40 km/h) or more for approximately 10 to 30 minutes.

When registration is complete, the tire pressure warning light will turn off and a message indicating that registration has been completed will be displayed on the multi-information display.

Registration may take longer than normal to complete if the vehicle speed cannot be maintained at approximately 25 mph (40 km/h) or more. If registration cannot be completed after driving for 1 hour or more, perform the registration procedure again from the beginning.

- 11 If the tire inflation pressure of the wheel set installed differs from that of the previous set, it will be necessary to perform the tire inflation pressure setting procedure of the tire pressure warning system.

If the specified tire inflation pressure is the same, it will not be nec-

essary to perform the tire inflation pressure setting procedure.

■ When registering ID codes

- Normally, ID codes registration can be completed within approximately 30 minutes.
- ID code registration is performed while driving at a vehicle speed of approximately 25 mph (40 km/h) or more.

■ If ID codes are not registered easily

- In the following situations, ID code registration may take longer than usual to be completed or may not be possible.
 - When the vehicle has not been parked for approximately 15 minutes or more before being driven
 - Vehicle is not driven at approximately 25 mph (40 km/h) or more
 - Vehicle is driven on unpaved roads
 - Vehicle is driven near other vehicles and system cannot recognize tire pressure warning valve and transmitters of your vehicle over those of other vehicles
 - Wheel with tire pressure warning valve and transmitter installed is inside or near the vehicle
- If the vehicle is reversed during registration, all data collected until then will be cleared. Perform driving again.
- If the tire pressure warning light does not blink 3 times when starting ID code registration procedure to step 9, the procedure may not have started. Perform the procedure again from the beginning.
- If registration does not complete after driving for 1 hour or more, perform the ID code registration procedure again from the beginning.
- If the ID codes cannot be registered even when performing the above procedure, contact your

Toyota dealer.

■ Canceling ID code registration

To cancel ID code registration after it has been started, select “Register New Valve / ID” again on the multi-information display.

If ID code registration has been canceled, the tire pressure warning light will turn off.

If the warning light does not turn off, ID code registration may not have been cancelled correctly. To cancel registration, select “Register New Valve / ID” on the multi-information display.

Selecting wheel set

Your vehicle is equipped with a tire pressure warning system with a function to register two sets of ID codes. This allows for registration of a second wheel set, for example a winter set.

- The wheel set can be changed only if a second wheel set has been registered to the system. If a second wheel set has not been registered, “Switching Incomplete See Owner’s Manual” will be displayed and it will not be possible to change to the selected wheel set.

ID codes can be registered by yourself.

- Only a change between both registered wheel set is possi-

ble, mixing between these wheel sets is not supported.

- While registering ID codes, it may not be possible to change between wheel sets normally. Cancel registration before changing between wheel sets.

1 Install the desired wheel set.

2 Use the meter control switches (→P.92) to select  (→P.93).

3 Use the meter control switches to select , then press OK .

4 Use the meter control switches to select “TPWS setting”, then press OK .

5 Use the meter control switches to select “Tire Set Switching”, then press OK .

6 Use the meter control switches to select “Register Valve / ID”, then press OK .

7 Use the meter control switches to select the wheel set (“Tire Set 1” or “Tire Set 2”) displayed for the set selection setting, then press OK .

8 Use the meter control switches to select “yes”, then press OK .

The tire pressure warning light will

slowly blink 3 times, a message indicating that change is occurring will be displayed, and the wheel set change will begin.

Wheel set change will begin and the tire pressure warning light will blink for 1 minute and then illuminate. Also, while the change is being performed, “---” will be displayed for the tire inflation pressure of each tire on the multi-information display.

After approximately 2 minutes, the wheel set change will complete, the tire pressure warning light will turn off, and a completion message will be displayed on the multi-information display.

If changing does not complete after approximately 4 minutes, a message indicating that the change could not be completed will be displayed.

Check which wheel set is installed and perform the change procedure again from the beginning.

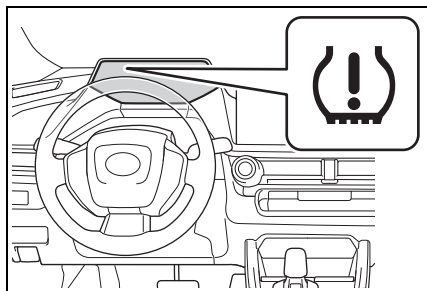

- 9 If the specified tire inflation pressure of the wheel set installed differs from that of the previous set, it will be necessary to perform the tire inflation pressure setting procedure of the tire pressure warning system. (→P.431)

If the specified tire inflation pressure is the same, it will not be necessary to perform the tire inflation

pressure setting procedure.

- 10 Register the position of each wheel.

Tire inflation pressure

Make sure to maintain the proper tire inflation pressure. Tire inflation pressure should be checked at least once per month. However, Toyota recommends that tire inflation pressure be checked once every two weeks. (→P.524)

Checking the specified tire inflation pressure

The recommended cold tire inflation pressure and tire size are displayed on the tire and loading information label. (→P.524)

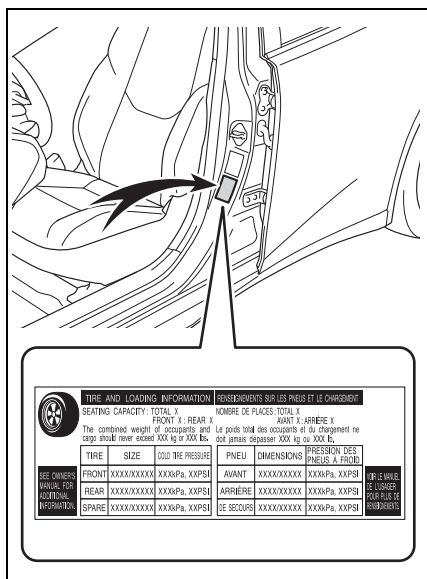

Inspection and adjustment procedure

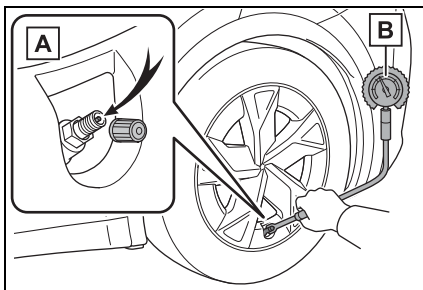

A Tire valve

B Tire pressure gauge

- 1 Remove the tire valve cap.
- 2 Press the tip of the tire pressure gauge onto the tire valve.
- 3 Read the pressure using the gauge gradations.
- 4 If the tire inflation pressure is not at the recommended level, adjust the pressure. If you add too much air, press the center of the valve to deflate.
- 5 After completing the tire inflation pressure measurement and adjustment, apply soapy water to the valve and check for leakage.
- 6 Put the tire valve cap back on.

■ Tire inflation pressure check interval

You should check tire inflation pressure every two weeks, or at least once a month.

Do not forget to check the spare.

■ Effects of incorrect tire inflation pressure

Driving with incorrect tire inflation pressure may result in the following:

- Reduced fuel economy
- Reduced driving comfort and poor handling
- Reduced tire life due to wear
- Reduced safety
- Damage to the drive train

If a tire needs frequent inflating, have it checked by your Toyota dealer.

■ Instructions for checking tire inflation pressure

When checking tire inflation pressure, observe the following:

- Check only when the tires are cold.
If your vehicle has been parked for at least 3 hours or has not been driven for more than 1 mile or 1.5 km, you will get an accurate cold tire inflation pressure reading.
- Always use a tire pressure gauge. It is difficult to judge if a tire is properly inflated based only on its appearance.
- It is normal for the tire inflation pressure to be higher after driving as heat is generated in the tire. Do not reduce tire inflation pressure after driving.
- Never exceed the vehicle capacity weight. Passengers and luggage weight should be placed so that the vehicle is balanced.



WARNING

■ Proper inflation is critical to save tire performance

Keep your tires properly inflated. If the tires are not properly inflated, the following conditions may occur which could lead to an accident resulting in death or serious injury:

- Excessive wear
- Uneven wear
- Poor handling
- Possibility of blowouts resulting from overheated tires
- Air leaking from between tire and wheel
- Wheel deformation and/or tire damage
- Greater possibility of tire damage while driving (due to road hazards, expansion joints, sharp edges in the road, etc.)



NOTICE

■ When inspecting and adjusting tire inflation pressure

Be sure to put the tire valve caps back on.

If a valve cap is not installed, dirt or moisture may get into the valve and cause an air leak, resulting in decreased tire inflation pressure.

Wheels

If a wheel is bent, cracked or heavily corroded, it should be replaced. Otherwise, the tire may separate from the wheel or cause a loss of handling control.

Wheel selection

When replacing wheels, care should be taken to ensure that they are equivalent to those removed in load capacity, diameter, rim width and inset*.

Replacement wheels are available at your Toyota dealer.

*: Conventionally referred to as offset.

Toyota does not recommend using the following:

- Wheels of different sizes or types
- Used wheels
- Bent wheels that have been straightened

■ When replacing wheels

The wheels of your vehicle are equipped with tire pressure warning valves and transmitters that allow the tire pressure warning system to provide advance warning in the event of a loss in tire inflation pressure. Whenever wheels are replaced, tire pressure warning valves and transmitters must be installed. (→P.427, 441)

WARNING

■ When replacing wheels

- Do not use wheels that are a different size from those recommended in the Owner's Manual, as this may result in a loss of handling control.
- Never use an inner tube in a leaking wheel which is designed for a tubeless tire. Doing so may result in an accident, causing death or serious injury.

■ When installing the wheel nuts

- Be sure to install the wheel nuts with the tapered ends facing inward. (→P.499) Installing the nuts with the tapered ends facing outward can cause the wheel to break and eventually cause the wheel to come off while driving, which could lead to an accident resulting in death or serious injury.
- Never use oil or grease on the wheel bolts or wheel nuts. Oil and grease may cause the wheel nuts to be excessively tightened, leading to bolt or disc wheel damage. In addition, the oil or grease can cause the wheel nuts to loosen and the wheel may fall off, causing an accident and resulting in death or serious injury. Remove any oil or grease from the wheel bolts or wheel nuts.

■ Use of defective wheels prohibited

Do not use cracked or deformed wheels.

Doing so could cause the tire to leak air during driving, possibly causing an accident.



NOTICE

■ Replacing tire pressure warning valves and transmitters

- Because tire repair or replacement may affect the tire pressure warning valves and transmitters, make sure to have tires serviced by your Toyota dealer or other qualified service shop. In addition, make sure to purchase your tire pressure warning valves and transmitters at your Toyota dealer.
- Ensure that only genuine Toyota wheels are used on your vehicle. Tire pressure warning valves and transmitters may not work properly with non-genuine wheels.

Aluminum wheel precautions

- Use only Toyota wheel nuts and wrenches designed for use with your aluminum wheels.
- When rotating, repairing or changing your tires, check that the wheel nuts are still tight after driving 1000 miles (1600 km).
- Be careful not to damage the aluminum wheels when using tire chains.
- Use only Toyota genuine balance weights or equivalent and a plastic or rubber hammer when balancing your wheels.

Air conditioning filter

The air conditioning filter must be changed regularly to maintain air conditioning efficiency.

Removal method

- 1 Turn the power switch off.
- 2 Open the glove box and slide off the damper.

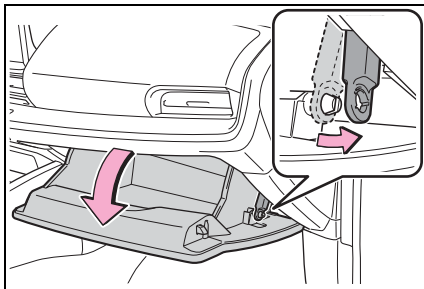

- 3 Push in each side of the glove box to disconnect the claws, and then slowly and fully open the glove box while supporting it.

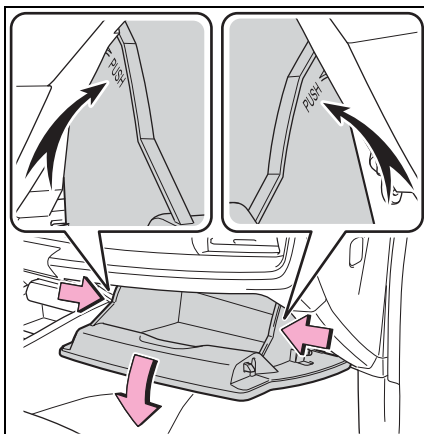

- 4 With the glove box fully open, slightly lift up the glove box and pull toward the seat to detach the bottom of the glove box.

Do not use excessive force if the glove box does not detach when lightly pulled. Instead, pull toward the seat while slightly adjusting the height of the glove box.

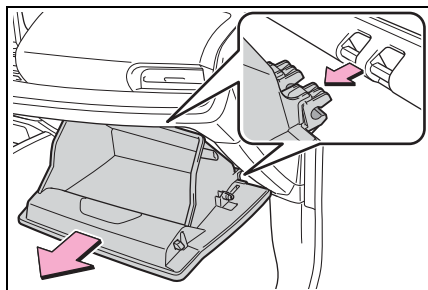

- 5 Unlock the filter cover (A), pull the filter cover out of the claws (B), and remove the filter cover.

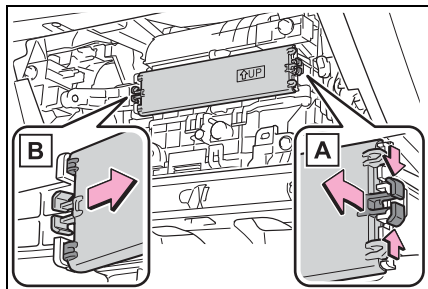

- 6 Remove the filter case.

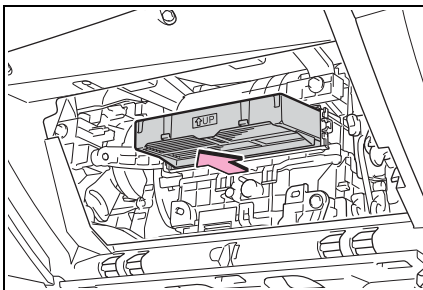

- 7 Remove the air conditioning filter from the filter case and replace it with a new one.

The “↑ UP” marks shown on the filter should be pointing up.

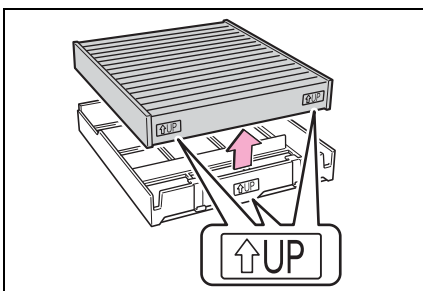

- 8 When installing, reverse the steps listed.

■ Checking interval

Inspect and replace the air conditioning filter according to the maintenance schedule. In dusty areas or areas with heavy traffic flow, early replacement may be required. (For scheduled maintenance information, please refer to the “Owner’s Manual Supplement” or “Scheduled Maintenance”.)

■ If air flow from the vents decreases dramatically

The filter may be clogged. Check the filter and replace if necessary.

 NOTICE

■ **When using the air conditioning system**

Make sure that a filter is always installed. Using the air conditioning system without a filter may cause damage to the system.

■ **When removing the glove box**

Always follow the specified procedure to remove the glove box (→P.441). If the glove box is removed without following the specified procedure, the hinge of the glove box may become damaged.

■ **To prevent damage to the filter cover**

When moving the filter cover in the direction of arrow to release the fitting, pay attention not to apply excessive force to the claws. Otherwise, the claws may be damaged.

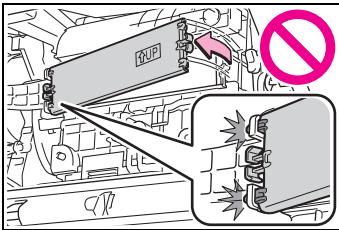

Cleaning the hybrid battery (traction battery) air intake vent

To prevent the fuel economy from being affected, visually inspect the hybrid battery (traction battery) air intake vent periodically for clogs.

If it is dusty or clogged or if “Maintenance Required for Traction Battery Cooling Parts See Owner’s Manual” is displayed on the multi-information display, clean the air intake vent using the following procedures:

■ **Scheduled maintenance of the air intake vent is necessary when**

In some situations such as when the vehicle is used frequently or in heavy traffic or dusty areas, the air intake vent may need to be cleaned more regularly. For details, refer to “Owner’s Warranty Information Booklet” or “Owner’s Manual Supplement”.

■ **Cleaning the air intake vent**

Improper handling of the air intake vent cover and filter may result in damage to them. If you have any concerns about cleaning the filter, contact your Toyota dealer.



NOTICE

■ If “Maintenance Required for Traction Battery Cooling Parts See Owner’s Manual” is displayed on the multi-information display

Clean the air intake vent immediately. If the vehicle is continuously driven with the warning message displayed, it may cause a malfunction or output restriction of the hybrid battery (traction battery).

Cleaning procedure

- 1 Turn the power switch off.
- 2 Remove the air intake vent cover.

Pull the cover as shown in the illustration to disengage the 7 claws, starting from the claw in the upper right corner and pull the cover toward the front of the vehicle to remove it.

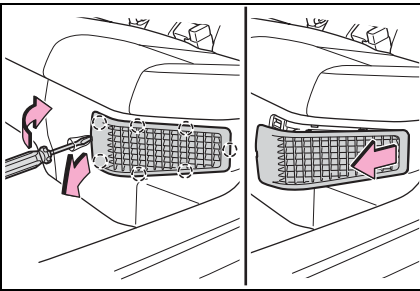

- 3 Remove the filter from the air intake vent cover.

Disengage the claws in the order of **A** and **B** to remove the filter from the cover.

If dust has accumulated on the air intake vent cover, remove the dust

with a vacuum cleaner, etc.

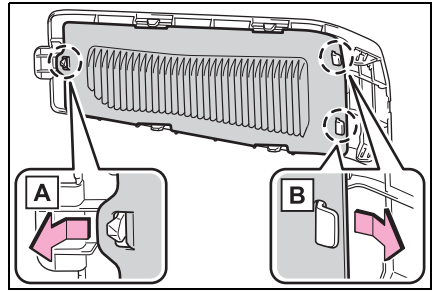

- 4 Remove the dust and sand from the filter.

Using a vacuum cleaner, etc., absorb dust and sand from the filter by profiling the nozzle lightly along the fold.

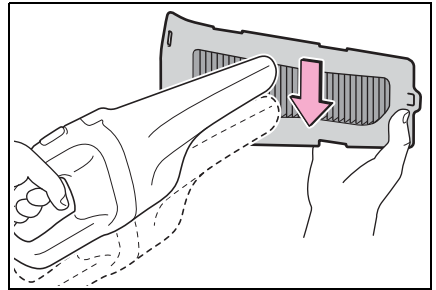

- 5 Hold the filter to the light and check if it is not clogged.

If the dust or sand cannot be removed completely, contact your Toyota dealer.

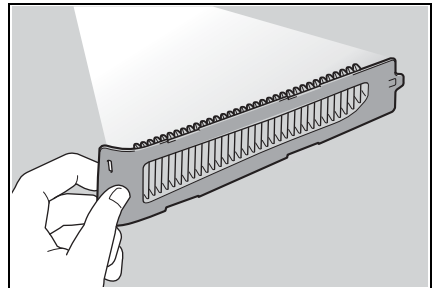

- 6 Reinstall the filter to the cover.

Engage the claws in the order of

B and **A** .

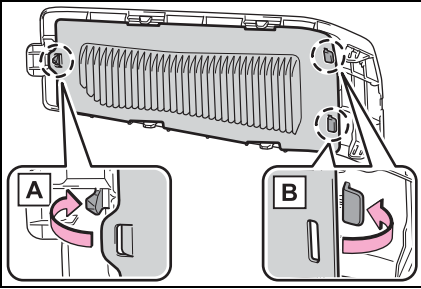

Make sure that the filter is not crooked or deformed when installing it.

7 Install the air intake vent cover.

Insert the tab of the cover as shown in the illustration and push the cover to engage the 7 claws.

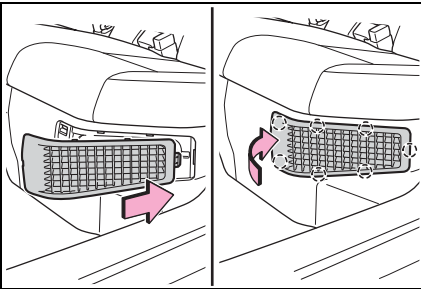

▶ If “Maintenance Required for Traction Battery Cooling Parts See Owner’s Manual” was displayed on the multi-information display

8 Start the hybrid system and check that the warning message is no longer displayed.

It may be necessary to drive the vehicle for approximately 20 minutes before the warning message is displayed again then disappears.

If the warning message does not disappear after some time, have the vehicle inspected by your

Toyota dealer.

■ If the dust or sand on the filter cannot be removed

It is recommended to use a vacuum cleaner with plastic brushes.

⚠ WARNING

■ When cleaning the air intake vent

- Do not use water or other liquids to clean the air intake vent. If water is applied to the hybrid battery (traction battery) or other components, a malfunction or fire may occur.
- Before cleaning the air intake vent, make sure to turn the power switch off to stop the hybrid system.
- Do not put a hand or leg in the air intake vent. If it is caught in a cooling fan, or if it touches a high voltage part that results in an electric shock, death or serious injuries may result.

⚠ NOTICE

■ When cleaning the air intake vent

Do not use an air blow gun, etc. Dust may be blown out, possibly causing a malfunction or output restriction of the hybrid battery (traction battery).

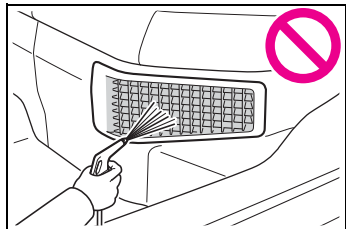



NOTICE

■ To prevent damage to the vehicle

Observe the following precautions:

- Do not allow water or foreign matter to enter the air intake vent.
- Make sure to reinstall the filter and cover to their original positions after cleaning.
- Do not install anything to the air intake vent other than the exclusive filter for this vehicle or use the vehicle without the filter installed.

■ To prevent damage to the filter

Observe the following precautions.

If the filter is damaged, have it replaced with a new filter by your Toyota dealer.

- Do not use an air blow gun, etc.
- Do not press hard a vacuum cleaner, etc. against the filter.
- Do not use a hard brush, such as a metal brush.
- Do not break the fold of the filter.

Electronic key battery

Replace the battery with a new one if it is depleted.

■ If the electronic key battery is depleted

The following symptoms may occur:

- The smart key system and wireless remote control will not function properly.
- The operational range will be reduced.

Items to prepare

Prepare the following before replacing the battery:

- Flathead screwdriver
- Small flathead screwdriver
- Lithium battery CR2450

■ Use a CR2450 lithium battery

- Batteries can be purchased at your Toyota dealer, local electrical appliance shops or camera stores.
- Replace only with the same or equivalent type recommended by the manufacturer.
- Dispose of used batteries according to the local laws.

Replacing the battery

- 1 Release the lock and remove the mechanical key.

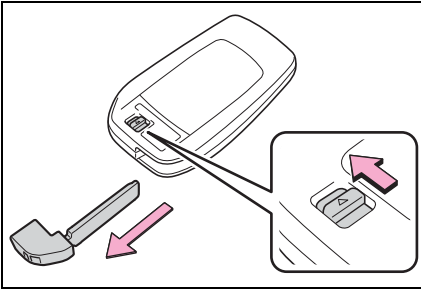

- 2 Remove the key cover.

To prevent damage to the key, cover the tip of the flathead screwdriver with a rag.

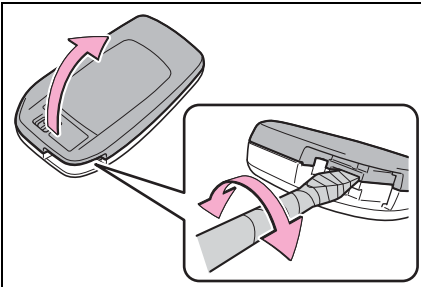

- 3 Remove the depleted battery using a small flathead screwdriver.

When removing the cover, the electronic key module may stick to the cover and the battery may not be visible. In this case, remove the electronic key module in order to remove the battery.

When removing the battery, use a screwdriver of an appropriate size. Insert a new battery with the "+" terminal

facing up.

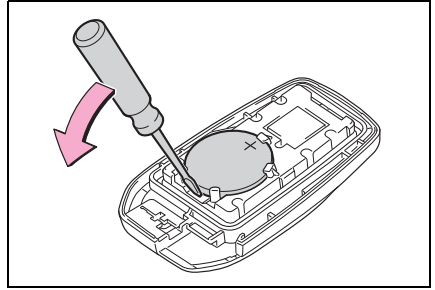

- 4 When installing, reverse the steps listed.

⚠ WARNING

■ Battery precautions

Observe the following precautions.

Failure to do so may result in death or serious injury.

- Do not swallow the battery. Doing so may cause chemical burns.
- A coin battery or button battery is used in the electronic key. If a battery is swallowed, it may cause severe chemical burns in as little as 2 hours and may result in death or serious injury.
- Keep away new and removed batteries from children.
- If the cover cannot be firmly closed, stop using the electronic key and stow the key in the place where children cannot reach, and then contact your Toyota dealer.
- If you accidentally swallow a battery or put a battery into a part of your body, get emergency medical attention immediately.

**WARNING****■ To prevent battery explosion or leakage of flammable liquid or gas**

- Replace the battery with a new battery of the same type. If a wrong type of battery is used, it may explode.
- Do not expose batteries to extremely low pressure due to high altitude or extremely high temperatures.
- Do not burn, break or cut a battery.

**NOTICE****■ When replacing the battery**

Use a flathead screwdriver of appropriate size. Applying excessive force may deform or damage the cover.

■ For normal operation after replacing the battery

Observe the following precautions to prevent accidents:

- Always work with dry hands. Moisture may cause the battery to rust.
- Do not touch or move any other component inside the remote control.
- Do not bend either of the battery terminals.

Checking and replacing fuses

If any of the electrical components do not operate, a fuse may have blown. If this happens, check and replace the fuses as necessary.

Checking and replacing fuses

- 1 Turn the power switch off.
- 2 Open the fuse box cover.
 - ▶ Engine compartment

Push claw **A** and **B** to completely release the lock, and then lift up the cover.

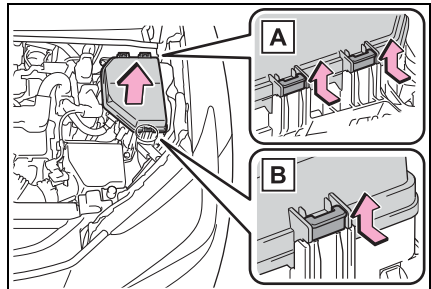

- ▶ Left side instrument panel

Remove the lid.

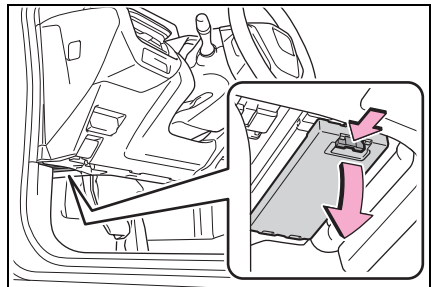

► Right side luggage compartment

Vehicle with high deck: Open the deck board. (→P.375)

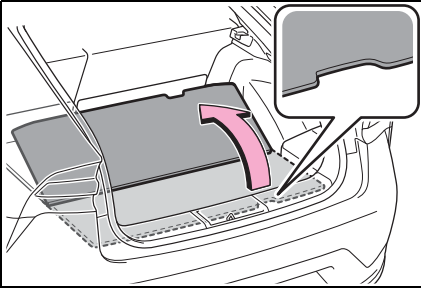

Hold the handle and pull it toward you, and then the 3 clips will be disengaged

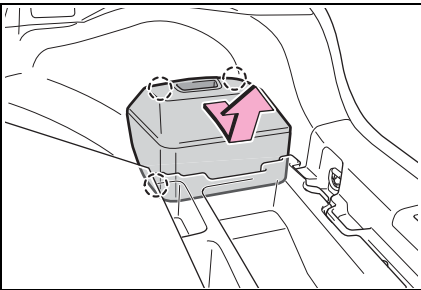

3 Remove the fuse.

Only type A fuse can be removed using the pullout tool.

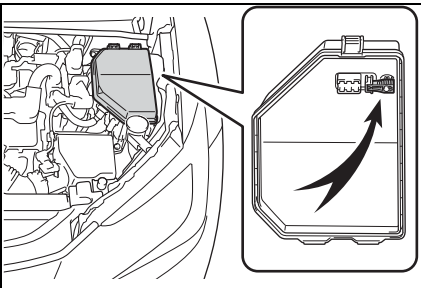

4 Check if the fuse is blown.

Replace the blown fuse with a new fuse of an appropriate amperage rating. The amperage rating can be found on the fuse box lid.

► Type A

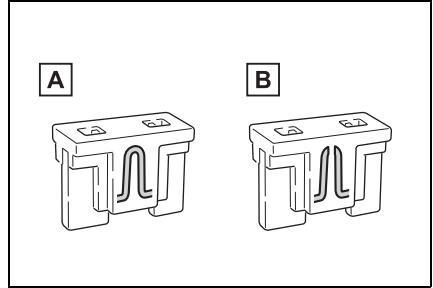

A Normal fuse

B Blown fuse

► Type B

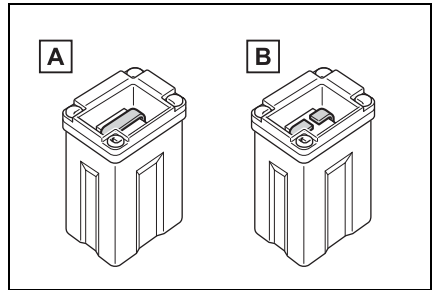

A Normal fuse

B Blown fuse

► Type C

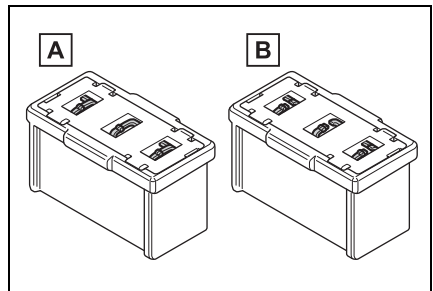

A Normal fuse

B Blown fuse

■ After a fuse is replaced

- When installing the lid, make sure that the tab is installed securely.
- If the lights do not turn on even after the fuse has been replaced, a lights may need replacement. (→P.452)
- If the replaced fuse blows again, have the vehicle inspected by your Toyota dealer.

■ If there is an overload in a circuit

The fuses are designed to blow, protecting the wiring harness from damage.

■ When replacing an electronic component, such as a lights, etc.

Toyota recommends that you use genuine Toyota products designed for this vehicle.

Because certain electronic components are connected to circuits designed to prevent overload, non-genuine parts not designed for this vehicle may be unusable.



NOTICE

■ Before replacing fuses

Have the cause of electrical overload determined and repaired by your Toyota dealer as soon as possible.

■ To prevent damage to the engine compartment fuse box cover

When opening the fuse box, completely release the claw locks before lifting up the cover. Otherwise, the claws may be damaged.



WARNING

■ To prevent system breakdowns and vehicle fire

Observe the following precautions.

Failure to do so may cause damage to the vehicle, and possibly a fire or injury.

- Never use a fuse of a higher amperage rating than that indicated, or use any other object in place of a fuse.
- Always use a genuine Toyota fuse or equivalent. Never replace a fuse with a wire, even as a temporary fix.
- Do not modify the fuses or fuse boxes.

Headlight aim

Vertical movement adjusting bolts

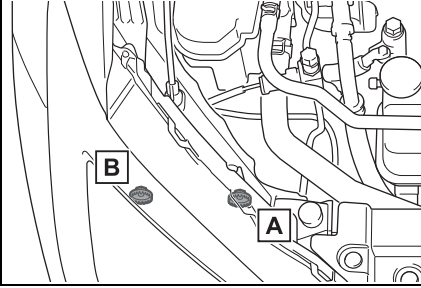

A Adjustment bolt A

B Adjustment bolt B

Before checking the headlight aim

- Make sure the vehicle has a full tank of gasoline and the area around the headlight is not deformed.
- Park the vehicle on level ground.
- Make sure the tire inflation pressure is at the specified level.
- Have someone sit in the driver's seat.
- Bounce the vehicle several times.

Adjusting the headlight aim

- 1 Using a Phillips-head screwdriver, turn bolt A in either direction.

Remember the turning direction and the number of turns.

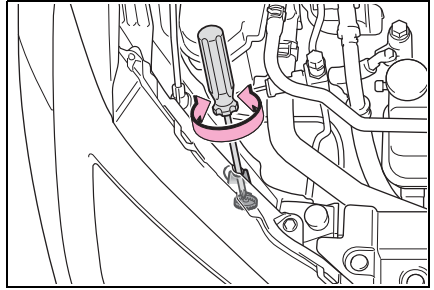

- 2 Turn bolt B the same number of turns and in the same direction as step 1.

If the headlight cannot be adjusted using this procedure, take the vehicle to your Toyota dealer to adjust the headlight aim.

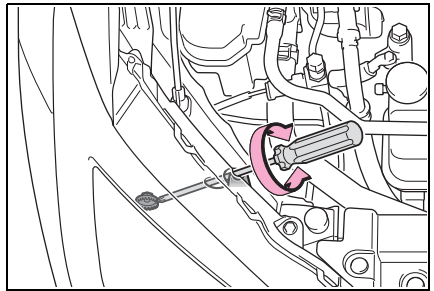

Exterior lights

If any exterior light does not turn on, have it replaced by your Toyota dealer.

■ LED lights

The lights consist of a number of LEDs. If any of the LEDs burn out, take your vehicle to your Toyota dealer to have the light replaced.

■ Condensation build-up on the inside of the lens

Temporary condensation build-up on the inside of the light lens does not indicate a malfunction. Contact your Toyota dealer for more information in the following situations:

- Large drops of water have built up on the inside of the lens.
- Water has built up inside the light.

■ When replacing an electronic component, such as a lights, etc.

→P.450

When trouble arises

7

7-1. Essential information

Emergency flashers 454

If your vehicle has to be stopped in an emergency 455

If the vehicle is submerged or water on the road is rising 456

7-2. Steps to take in an emergency

If your vehicle needs to be towed..... 457

If you think something is wrong 461

If a warning light turns on or a warning buzzer sounds 463

If a warning message is displayed..... 475

If you have a flat tire (vehicles without spare tire) 483

If you have a flat tire (vehicles with spare tire) ... 495

If the hybrid system will not start 503

If you lose your keys ... 504

If the electronic key does not operate properly.. 505

If the 12-volt battery is discharged 507

If your vehicle overheats 512

If the vehicle becomes stuck..... 515

Emergency flashers

The emergency flashers are used to warn other drivers when the vehicle has to be stopped in the road due to a breakdown, etc.

Operating instructions

Press the switch.

All the turn signal lights will flash.

To turn them off, press the switch once again.

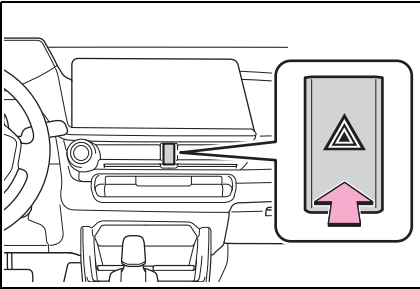

Emergency flashers

- If the emergency flashers are used for a long time while the hybrid system is not operating (while the “READY” indicator is not illuminated), the 12-volt battery may discharge.
- If any of the SRS airbags deploy (inflate) or in the event of a strong rear impact, the emergency flashers will turn on automatically. The emergency flashers will turn off automatically after operating for approximately 20 minutes. To manually turn the emergency flashers off, press the switch twice. (The emergency flashers may not turn on automatically depending on the force of the impact and conditions of the colli-

sion.)

If your vehicle has to be stopped in an emergency

Only in an emergency, such as if it becomes impossible to stop the vehicle in the normal way, stop the vehicle using the following procedure:

Stopping the vehicle

- 1 Steadily step on the brake pedal with both feet and firmly depress it.
Do not pump the brake pedal repeatedly as this will increase the effort required to slow the vehicle.
- 2 Shift the shift position to N.
 - ▶ If the shift position is shifted to N
- 3 After slowing down, stop the vehicle in a safe place by the road.
- 4 Stop the hybrid system.
 - ▶ If the shift position cannot be shifted to N
- 3 Keep depressing the brake pedal with both feet to reduce vehicle speed as much as possible.
- 4 To stop the hybrid system, press and hold the power switch for 2 consecutive seconds or more, or press it

briefly 3 times or more in succession.

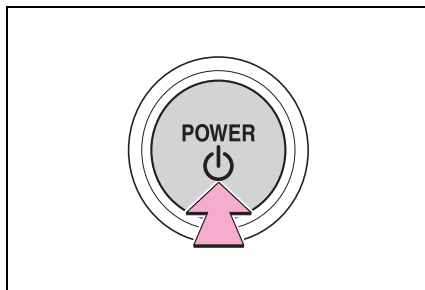

- 5 Stop the vehicle in a safe place by the road.

■ If emergency stopped

The functions of the air conditioning, etc. may be partially limited in order to reduce the power consumption of the 12-volt battery.

⚠ WARNING

■ If the hybrid system has to be turned off while driving

Turning the hybrid system off while driving will not cause loss of steering or braking control. However, power assist for the steering wheel may be lost making it difficult to steer smoothly before stopping the vehicle depending on the remaining charge in the 12-volt battery or usage conditions. Decelerate as much as possible before turning off the hybrid system.

If the vehicle is submerged or water on the road is rising

This vehicle is not designed to be able to drive on roads that are deeply flooded with water. Do not drive on roads where the roads may be submerged or the water may be rising. It is dangerous to remain in the vehicle, if it anticipated that the vehicle will be flooded or set a drift. Remain calm and follow the following.

- If the door can be opened, open the door and exit the vehicle.
- If the door can not be opened, open the window using the power window switch and ensure an escape route.
- If the window can be opened, exit the vehicle through the window.
- If the door and window cannot be opened due to the rising water, remain calm, wait until the water level inside the vehicle rises to the point that the water pressure inside of the vehicle equals the water pressure outside of the vehicle and then open the door after waiting for the rising water to enter the vehicle, and exit the vehicle. When the

outside water level exceeds half the height of the door, the door cannot be opened from the inside due to water pressure.

■ Water level exceeds the floor

When the water level exceeds the floor and time has passed, the electrical equipment will get damaged, the power windows will not operate, the engine and motor stop, and the vehicle may not be able to get moving.

■ Using an emergency escape hammer*

Laminated glass is used in the windshield on this vehicle.

Laminated glass cannot be shattered with an emergency hammer*. Tempered glass is used in the windows on this vehicle.

*: Contact your Toyota dealer or aftermarket accessory manufacturer for further information about an emergency hammer.

WARNING

■ Caution while driving

Do not drive on roads where the roads may be submerged or the water may be rising. Otherwise the vehicle may be damaged and cannot move, as well as become flooded and set a drift, which may lead to death.

If your vehicle needs to be towed

If towing is necessary, we recommend having your vehicle towed by your Toyota dealer or commercial towing service, using a wheel-lift type truck or flat-bed truck.

Use a safety chain system for all towing, and abide by all state/provincial and local laws.

Situations when it is not possible to be towed by another vehicle

In the following situations, it is not possible to be towed by another vehicle using cables or chains, as the front wheels may be locked due to the parking lock. Contact your Toyota dealer or commercial towing service.

- There is a malfunction in the shift control system. (→P.182)
- There is a malfunction in the immobilizer system. (→P.79)
- There is a malfunction in the smart entry & start system. (→P.505)
- The 12-volt battery is discharged. (→P.507)

Situations when it is necessary to contact dealers before towing

The following may indicate a problem with your transmission. Contact your Toyota dealer or commercial towing service before towing.

- The hybrid system warning message is shown on the multi-information display and the vehicle does not move.
- The vehicle makes an abnormal sound.

Towing with a wheel-lift type truck

- ▶ From the front (FF vehicles)

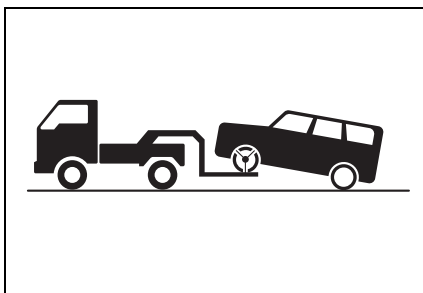

Release the parking brake.

Turn automatic mode off. (→P.194)

- ▶ From the front (AWD vehicles)

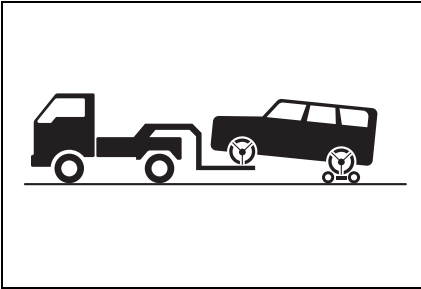

Use a towing dolly under the rear wheels.

- ▶ From the rear

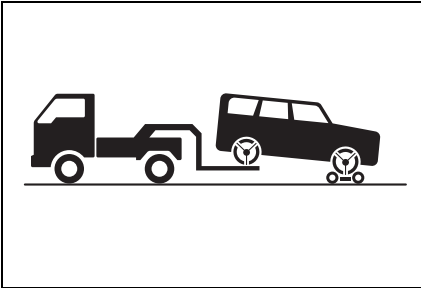

Use a towing dolly under the front wheels.

■ When towing the vehicle

- ▶ FF vehicles

Be sure to transport the vehicle with the front wheels raised or with all four wheels raised off the ground. If the vehicle is towed with the front wheels contacting the ground, the drivetrain and related parts may be damaged or electricity generated by the operation of the motor may cause a fire to occur depending on the nature of the damage or malfunction.

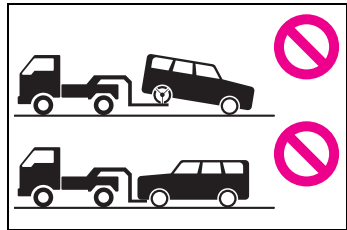

WARNING

Observe the following precautions. Failure to do so may result in death or serious injury.

⚠ WARNING

▶ AWD vehicles

Be sure to transport the vehicle with all four wheels raised off the ground. If the vehicle is towed with the tires contacting the ground, the drivetrain or related parts may be damaged, the vehicle may fly off the truck, or electricity generated by the operation of the motor may cause a fire to occur depending on the nature of the damage or malfunction.

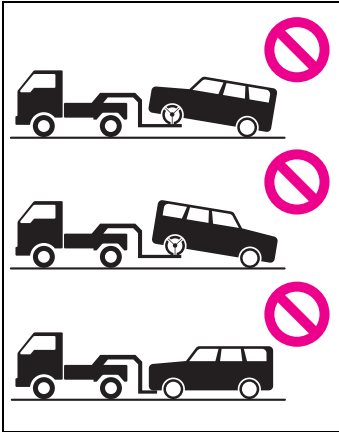

⚠ NOTICE

■ To prevent damage to the vehicle when towing using a wheel-lift type truck

When raising the vehicle, ensure adequate ground clearance for towing at the opposite end of the raised vehicle. Without adequate clearance, the vehicle could be damaged while being towed.

■ Towing with a sling-type truck

Do not tow with a sling-type truck to prevent body damage.

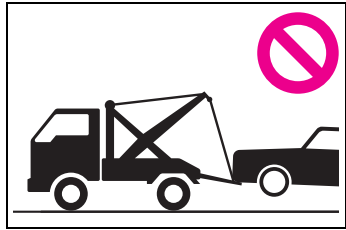

Using a flatbed truck

When using a flat-bed truck to transport the vehicle, use tire strapping belts. Refer to the owner's manual of the flat-bed truck for the tire strapping method.

In order to suppress vehicle movement during transportation, set the parking brake and turn the power switch off.

Emergency towing

If a tow truck is not available in an emergency, your vehicle may be temporarily towed using cables or chains secured to the emergency towing eyelets.

This should only be attempted on hard surfaced roads for short distances at under 18 mph (30 km/h).

A driver must be in the vehicle to steer and operate the brakes. The vehicle's wheels, drive train, axles, steering and brakes

must be in good condition.

Emergency towing procedure

To have your vehicle towed by another vehicle, the towing eyelet must be installed to your vehicle. Install the towing eyelet using the following procedure.

- 1 Take out the wheel nut wrench (if equipped) and towing eyelet. (→P.484, 496)
- 2 Remove the eyelet cover using a flathead screwdriver.

To protect the bodywork, place a rag between the screwdriver and the vehicle body as shown in the illustration.

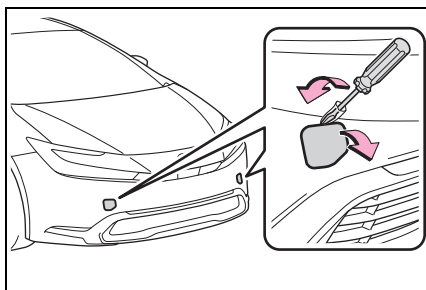

- 3 Insert the towing eyelet into the hole and tighten partially by hand.

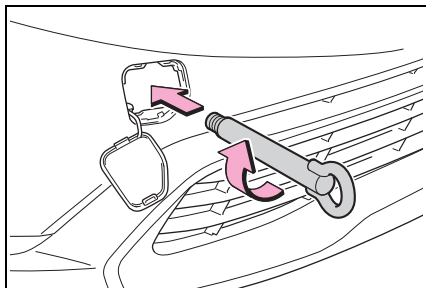

- 4 Tighten down the towing eyelet securely using a wheel nut wrench or hard metal bar.

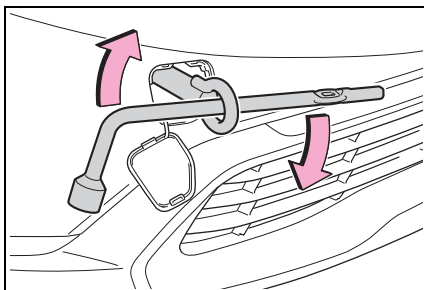

- 5 Securely attach cables or chains to the towing eyelet.

Take care not to damage the vehicle body.

- 6 Enter the vehicle being towed and start the hybrid system.

Turn off the Parking Support Brake function. (if equipped): (→P.305)

If the hybrid system does not start, turn the power switch to ON.

- 7 Shift the shift position to N and release the parking brake.

Turn automatic mode off. (→P.194)

■ While towing

If the hybrid system is off, the power assist for the brakes and steering will not function, making steering and braking more difficult.

■ Wheel nut wrench

- Vehicles with wheel nut wrench: Wheel nut wrench is installed in luggage compartment. (→P.484, 496)
- Vehicles without wheel nut wrench: Wheel nut wrench can be purchased at your Toyota dealer.

**WARNING**

Observe the following precautions. Failure to do so may result in death or serious injury.

■ While towing

● When towing using cables or chains, avoid sudden starts, etc. which place excessive stress on the towing eyelets, cables or chains. The towing eyelets, cables or chains may become damaged, broken debris may hit people, and cause serious damage.

● Do not turn the power switch off. This may lead to an accident as the front wheels will be locked by the parking lock.

■ Installing towing eyelets to the vehicle

Make sure that towing eyelets are installed securely. If not securely installed, towing eyelets may come loose during towing.

**NOTICE****■ To prevent damage to the vehicle during emergency towing**

Do not secure cables or chains to the suspension components.

If you think something is wrong

If you notice any of the following symptoms, your vehicle probably needs adjustment or repair. Contact your Toyota dealer as soon as possible.

Visible symptoms

- Fluid leaks under the vehicle (Water dripping from the air conditioning after use is normal.)
- Flat-looking tires or uneven tire wear
- High coolant temperature warning light flashes or comes on

Audible symptoms

- Changes in exhaust sound
- Excessive tire squeal when cornering
- Strange noises related to the suspension system
- Pinging or other noises related to the hybrid system

Operational symptoms

- Engine missing, stumbling or running roughly
- Appreciable loss of power
- Vehicle pulls heavily to one

side when braking



- Vehicle pulls heavily to one side when driving on a level road
- Loss of brake effectiveness, spongy feeling, pedal almost touches the floor

If a warning light turns on or a warning buzzer sounds

Calmly perform the following actions if any of the warning lights comes on or flashes. If a light comes on or flashes, but then goes off, this does not necessarily indicate a malfunction in the system. However, if this continues to occur, have the vehicle inspected by your Toyota dealer.

Actions to the warning lights or warning buzzers

■ Brake system warning light (warning buzzer)

Warning light	Details/Actions
 (U.S.A.)  (Canada) (red)	Indicates that: <ul style="list-style-type: none"> ● The brake fluid level is low; or ● The brake system is malfunctioning → Immediately stop the vehicle in a safe place and contact your Toyota dealer. Continuing to drive the vehicle may be dangerous.

■ Brake system warning light (warning buzzer)

Warning light	Details/Actions
 (yellow)	Indicates a malfunction in: <ul style="list-style-type: none"> ● The parking brake system; ● The regenerative braking system; or ● The electronically controlled brake system → Have the vehicle inspected by your Toyota dealer immediately.

■ Charging system warning light* (warning buzzer)

Warning light	Details/Actions
	Indicates a malfunction in the vehicle's charging system → Immediately stop the vehicle in a safe place and contact your Toyota dealer.

*: This light illuminates on the multi-information display with a message.

■ High coolant temperature warning light (warning buzzer)

Warning light	Details/Actions
	Indicates that the engine is overheating → Immediately stop the vehicle in a safe place. Handling method (→P.512)

■ Low engine oil pressure warning light* (warning buzzer)

Warning light	Details/Actions
	Indicates that the engine oil pressure is too low → Immediately stop the vehicle in a safe place and contact your Toyota dealer. (→P.417)



*: This light illuminates on the multi-information display with a message.

■ Hybrid system overheat warning light* (warning buzzer)

Warning light	Details/Actions
	Indicates that the hybrid system has overheated → Stop the vehicle in a safe place. Handling method (→P.513)

*: This light illuminates on the multi-information display with a message.

■ Malfunction indicator lamp

Warning light	Details/Actions
 (U.S.A.)	Indicates a malfunction in: <ul style="list-style-type: none"> ● The hybrid system; ● The electronic engine control system; ● The electronic throttle control system; or ● The emission control system (if equipped) → Have the vehicle inspected by your Toyota dealer immediately.
 (Canada)	



■ SRS warning light (warning buzzer)

Warning light	Details/Actions
	Indicates a malfunction in: <ul style="list-style-type: none"> ● The SRS airbag system; or ● The seat belt pretensioner system → Have the vehicle inspected by your Toyota dealer immediately.



This warning light indicates problems with the following:

- Airbag sensor assembly
- Front impact sensors
- Side impact sensors (front door)
- Front passenger occupant classification sensors
- Front passenger's seat belt buckle switch
- SRS warning light
- "PASSENGER AIR BAG ON" indicator light
- "PASSENGER AIR BAG OFF" indicator light
- SRS airbags
- SRS system related wiring harnesses and power sources

■ ABS warning light (warning buzzer)

Warning light	Details/Actions
 (U.S.A.)  (Canada)	Indicates a malfunction in: <ul style="list-style-type: none"> ● The ABS; or ● The brake assist system → Have the vehicle inspected by your Toyota dealer immediately.

■ Electric power steering system warning light (warning buzzer)

Warning light	Details/Actions
 (red)  (yellow)	<p>Indicates a malfunction in the EPS (Electric Power Steering) system</p> <p>→ Have the vehicle inspected by your Toyota dealer immediately.</p>

■ PCS warning light (warning buzzer)

Warning light	Details/Actions
	<p>Indicates a malfunction in the PCS (Pre-Collision System).</p> <p>→ Follow the instructions displayed on the multi-information display.</p> <p>If the PCS (Pre-Collision System) or VSC (Vehicle Stability Control) system is disabled, the PCS warning light will illuminate.</p>

■ LTA indicator (warning buzzer)

Warning light	Details/Actions
 (orange)	<p>Indicates a malfunction in the LTA (Lane Tracing Assist)</p> <p>→ Follow the instructions displayed on the multi-information display.</p>

■ LDA indicator (warning buzzer)

Warning light	Details/Actions
 (orange)	<p>Indicates a malfunction in the LDA (Lane Departure Alert)</p> <p>→ Follow the instructions displayed on the multi-information display.</p>

■ PDA indicator (warning buzzer)

Warning light	Details/Actions
 <p>(orange)</p>	<p>Indicates a malfunction in the PDA (Proactive Driving Assist).</p> <p>→ Follow the instructions displayed on the multi-information display.</p>

■ Cruise control indicator (warning buzzer)

Warning light	Details/Actions
 <p>(orange)</p>	<p>Indicates a malfunction in the cruise control system.</p> <p>→ Follow the instructions displayed on the multi-information display.</p>

■ Dynamic radar cruise control indicator (warning buzzer)

Warning light	Details/Actions
 <p>(orange)</p>	<p>Indicates a malfunction in the dynamic radar cruise control system.</p> <p>→ Follow the instructions displayed on the multi-information display.</p>

■ Driving assist information indicator

Warning light	Details/Actions
	<p>Indicates one of the following systems is malfunctioning.</p> <ul style="list-style-type: none"> ● PCS (Pre-Collision System) ● LDA (Lane Departure Alert) <p>→ Follow the instructions displayed on the multi-information display.</p> <p>Indicates one of the following systems is malfunctioning or disabled.</p> <ul style="list-style-type: none"> ● PKSB (Parking Support Brake) (if equipped) ● RCD (Rear Camera Detection) (if equipped) ● BSM (Blind Spot Monitor) (if equipped) ● RCTA (Rear cross traffic alert) (if equipped) ● Safe Exit Assist (if equipped) <p>→ Follow the instructions displayed on the multi-information display.</p>

■ Intuitive parking assist OFF indicator (warning buzzer)

Warning light	Details/Actions
	<p>When a buzzer sounds: Indicates a malfunction in the Intuitive parking assist function → Have the vehicle inspected by your Toyota dealer immediately.</p> <p>When a buzzer does not sound: Indicates that the system is temporarily unavailable, possibly due to a sensor being dirty or covered with ice, etc. → Follow the instructions displayed on the multi-information display. (→P.475)</p>

■ Slip indicator light

Warning light	Details/Actions
	<p>Indicates a malfunction in:</p> <ul style="list-style-type: none"> ● The VSC system; ● The TRAC system; or ● The hill-start assist control system <p>→ Have the vehicle inspected by your Toyota dealer immediately.</p>

■ Inappropriate pedal operation warning light* (warning buzzer)



Warning light	Details/Actions
	<p>When a buzzer sounds:</p> <ul style="list-style-type: none"> ● Brake Override System is malfunctioning ● Drive-Start Control is malfunctioning ● Drive-Start Control is operating <p>→ Follow the instructions displayed on the multi-information display.</p> <p>When a buzzer does not sound: Brake Override System is operating. → Release the accelerator pedal and depress the brake pedal.</p>

*: This light illuminates on the multi-information display with a message.

■ Brake hold operated indicator (warning buzzer)

Warning light	Details/Actions
 (Flashes)	Indicates a malfunction in the brake hold system → Have the vehicle inspected by your Toyota dealer immediately.

■ Parking brake indicator (warning buzzer)

Warning light	Details/Actions
 (U.S.A.) (Flashes)	It is possible that the parking brake is not fully engaged or released → Operate the parking brake switch once again. This light comes on when the parking brake is not released. If the light turns off after the parking brake is fully released, the system is operating normally.
 (Canada) (Flashes)	

■ Tire pressure warning light (warning buzzer)

Warning light	Details/Actions
	When the light comes on after blinking for approximately 1 minute (a buzzer does not sound): Malfunction in the tire pressure warning system → Have the system checked by your Toyota dealer. When the light comes on (a buzzer sounds): <ul style="list-style-type: none"> ● Low tire inflation pressure from natural causes → After the temperature of the tires has lowered sufficiently, check the inflation pressure of each tire and adjust them to the specified level. ● Low tire inflation pressure from flat tire → Immediately stop the vehicle in a safe place and perform the necessary actions.

■ Low fuel level warning light

Warning light	Details/Actions
	<p>► AWD models</p> <p>Indicates that remaining fuel is approximately 6.0 L (1.7 gal., 1.4 Imp. gal.) or less</p> <p>► 2WD models</p> <p>Indicates that remaining fuel is approximately 6.4 L (1.6 gal., 1.3 Imp. gal.) or less</p> <p>→ Refuel the vehicle.</p>

■ Driver's and front passenger's seat belt reminder light (warning buzzer*)

Warning light	Details/Actions
	<p>Warns the driver and/or front passenger to fasten their seat belts</p> <p>→ Fasten the seat belt.</p> <p>If the front passenger's seat is occupied, the front passenger's seat belt also needs to be fastened to make the warning light (warning buzzer) turn off.</p>

*: Driver's seat belt warning buzzer:

The driver's seat belt warning buzzer sounds to alert the driver that his or her seat belt is not fastened. Once the power switch is turned to ON, the buzzer sounds. If the seat belt is still unfastened, the buzzer sounds intermittently for a certain period of time after the vehicle reaches a certain speed.

Front passenger's seat belt warning buzzer:

The front passenger's seat belt warning buzzer sounds to alert the front passenger that his or her seat belt is not fastened. If the seat belt is unfastened, the buzzer sounds intermittently for a certain period of time after the vehicle reaches a certain speed.

■ Rear passengers' seat belt reminder light*¹ (warning buzzer*²)

Warning light	Details/Actions
	<p>Warns the rear passengers to fasten their seat belts</p> <p>→ Fasten the seat belt.</p>

*¹: Regardless of whether or not a rear passenger is present, this light will

also illuminate for a certain period of time after the rear door is opened and closed.

^{*2}:Rear passengers' seat belt warning buzzer:

The rear passengers' seat belt warning buzzer sounds to alert the rear passenger that his or her seat belt is not fastened. If the seat belt is unfastened, the buzzer sounds intermittently for a certain period of time, after the seat belt is fastened and unfastened and the vehicle reaches a certain speed.

■ Warning buzzer

In some cases, the buzzer may not be heard because of noisy place or an audio sound.

■ Front passenger detection sensor, seat belt reminder and warning buzzer

- If luggage is placed on the front passenger seat, the front passenger detection sensor may cause the warning light to flash and the warning buzzer to sound even if a passenger is not sitting in the seat.
- If a cushion is placed on the seat, the sensor may not detect a passenger, and the warning light may not operate properly.

■ If the malfunction indicator lamp comes on while driving

First check the following:

- Is the fuel tank empty?
If it is, fill the fuel tank immediately.
- Is the fuel tank cap loose?
If it is, tighten it securely.

The light will go off after several driving trips.

If the light does not go off even after several trips, contact your Toyota dealer as soon as possible.

■ Electric power steering system warning light (warning buzzer)

When the 12-volt battery charge becomes insufficient or the voltage temporarily drops, the electric power steering system warning light may

come on and the warning buzzer may sound.

At this time, the functions of the air conditioning, etc. may be partially limited in order to reduce the power consumption of the 12-volt battery.

■ When the tire pressure warning light comes on

Inspect the tires to check if a tire is punctured.

If a tire is punctured: →P.495, 483

If none of the tires are punctured:

Turn the power switch off then turn it to ON.

Check if the tire pressure warning light comes on or blinks.

- ▶ If the tire pressure warning light blinks for approximately 1 minute then stays on

There may be a malfunction in the tire pressure warning system. Have the vehicle inspected by your Toyota dealer immediately.

- ▶ If the tire pressure warning light comes on

After the temperature of the tires has lowered sufficiently, check the inflation pressure of each tire and adjust them to the specified level.

If the warning light does not turn off even after several minutes have elapsed, check that the inflation pressure of each tire is at the specified level and perform the tire inflation pressure setting procedure. (→P.436)

If the warning light does not turn off even after several minutes have elapsed since performing the tire inflation pressure setting procedure, have the vehicle inspected by your Toyota dealer as soon as possible.

■ **The tire pressure warning light may come on due to natural causes**

The tire pressure warning light may come on due to natural causes such as natural air leaks and tire inflation pressure changes caused by temperature. In this case, adjusting the tire inflation pressure will turn off the warning light (after a few minutes).

■ **When a tire is replaced with a compact spare tire (vehicles with compact spare tire)**

The compact spare tire is not equipped with a tire pressure warning valve and transmitter. If a tire goes flat, the tire pressure warning light will not turn off even though the flat tire has been replaced with the spare tire. Replace the spare tire with the standard tire and adjust the tire inflation pressure. The tire pressure warning light will go off after a few minutes.

■ **Conditions that the tire pressure warning system may not function properly**

→P.429



WARNING

■ **If a warning light comes on or a warning buzzer sounds when a warning message is shown on the multi-information display***

Check and follow the message shown on the multi-information display.

Failure to do so may result in death or serious injury.

*: Warning lights illuminate in red or yellow and the warning buzzer beeps once or sounds continuously.

■ **When the electric power steering system warning light comes on**

When the light comes on yellow, the assist to the power steering is restricted. When the light comes on red, the assist to the power steering is lost and handling operations of the steering wheel become extremely heavy. If the steering wheel becomes heavier than usual when operating, hold firmly and operate using more force than usual.

■ **If the tire pressure warning light comes on**

Be sure to observe the following precautions. Failure to do so could cause a loss of vehicle control and result in death or serious injury.

- Stop your vehicle in a safe place as soon as possible. Adjust the tire inflation pressure immediately.

**WARNING**

- If the tire pressure warning light comes on even after tire inflation pressure adjustment, it is probable that you have a flat tire. Check the tires. If a tire is flat, change it with the spare tire and have the flat tire repaired by the nearest Toyota dealer.
- Avoid abrupt maneuvering and braking. If the vehicle tires deteriorate, you could lose control of the steering wheel or the brakes.

■ If a blowout or sudden air leakage should occur

The tire pressure warning system may not activate immediately.

■ Maintenance of the tires

Each tire, including the spare (if provided), should be checked monthly when cold and inflated to the inflation pressure recommended by the vehicle manufacturer on the vehicle placard or tire inflation pressure label (tire and load information label). (If your vehicle has tires of a different size than the size indicated on the vehicle placard or tire inflation pressure label [tire and load information label], you should determine the proper tire inflation pressure for those tires.)

As an added safety feature, your vehicle has been equipped with a tire pressure monitoring system (TPMS-tire pressure warning system) that illuminates a low tire pressure telltale (tire pressure warning light) when one or more of your tires is significantly under-inflated. Accordingly, when the low tire pressure telltale (tire pressure warning light) illuminates, you should stop and check your tires as soon as possible, and inflate them to the proper pressure. Driving on a significantly under-inflated tire causes the tire to overheat and can lead to tire failure. Under-inflation also reduces fuel efficiency and tire tread life, and may affect the vehicle's handling and stopping ability.

Please note that the TPMS (tire pressure warning system) is not a substitute for proper tire maintenance, and it is the driver's responsibility to maintain correct tire pressure, even if under-inflation has not reached the level to trigger illumination of the TPMS low tire pressure telltale (tire pressure warning light).

**WARNING**

Your vehicle has also been equipped with a TPMS (tire pressure warning system) malfunction indicator to indicate when the system is not operating properly. The TPMS (tire pressure warning system) malfunction indicator is combined with the low tire pressure telltale (tire pressure warning light). When the system detects a malfunction, the telltale will flash for approximately one minute and then remain continuously illuminated. This sequence will continue upon subsequent vehicle start-ups as long as the malfunction exists. When the malfunction indicator is illuminated, the system may not be able to detect or signal low tire pressure as intended.

TPMS (tire pressure warning system) malfunctions may occur for a variety of reasons, including the installation of replacement or alternate tires or wheels on the vehicle that prevent the TPMS (tire pressure warning system) from functioning properly. Always check the TPMS (tire pressure warning system) malfunction telltale after replacing one or more tires or wheels on your vehicle to ensure that the replacement or alternate tires and wheels allow the TPMS (tire pressure warning system) to continue to function properly.

**NOTICE****■ To ensure the tire pressure warning system operates properly**

Do not install tires with different specifications or manufacturers as the tire pressure warning system may not operate properly.

If a warning message is displayed

The multi-information display shows warnings of system malfunctions, incorrectly performed operations, and messages that indicate a need for maintenance. When a message is shown, perform the correction procedure appropriate to the message.

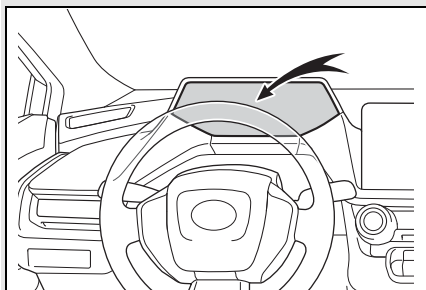

If a warning message is displayed again after the appropriate actions have been performed, contact your Toyota dealer.

Messages and warnings

The warning lights and warning buzzers operate as follows depending on the content of the message. If a message indicates the need for inspection by a dealer, have the vehicle inspected by your Toyota dealer immediately.

Warning light	Warning buzzer*	Warning
—	Sounds	<ul style="list-style-type: none"> • Indicates an important situation, such as when a system related to driving is malfunctioning or that danger may result if the correction procedure is not performed • Indicates a situation, such as when damage to the vehicle or danger may result
Comes on or flashes	Sounds	Indicates an important situation, such as when the systems shown on the multi-information display may be malfunctioning
—	Does not sound	<ul style="list-style-type: none"> • Indicates a condition, such as malfunction of electrical components, their condition, or indicates the need for maintenance • Indicates a situation, such as when an operation has been performed incorrectly, or indicates how to perform an operation correctly

*: A buzzer sounds the first time a message is shown on the multi-information display.

■ Warning messages

The warning messages explained below may differ from the actual messages according to operation conditions and vehicle specifications.

■ If a message about an operation is shown

- If a message about an operation of the accelerator pedal or brake pedal is shown
- A warning message about an operation of the brake pedal may be shown while the driving assist systems such as PCS (Pre-Collision system) or the dynamic radar cruise control is operating. If a warning message is shown, be sure to decelerate the vehicle or follow an instruction shown on the multi-information display.
- A warning message is shown

when Brake Override System operates. (→P.168, 482)

- A warning message is shown when Drive-Start Control or Parking Support Brake (if equipped) (→P.173, 303) operates. Follow the instructions on the multi-information display.
- If a message about an operation of the power switch is shown
An instruction for operation of the power switch is shown when the incorrect procedure for starting the hybrid system is performed or the power switch is operated incorrectly. Follow the instructions shown on the multi-information display to operate the power switch again.
- If a message that indicates the need for the shift lever operation is displayed

To prevent the shift lever from being operated incorrectly or the vehicle from moving unexpectedly, a message that requires shifting the shift position may be displayed on the multi-information display.

In that case, follow the instruction of the message and shift the shift position.

- If a message or image about an open/close state of a part or replenishment of a consumable is shown

Confirm the part indicated by the multi-information display or a warning light, and then perform the coping method such as closing the open door or replenishing a consumable.

■ **If a message that indicates the need for visiting your Toyota dealer is displayed**

The system or part shown on the multi-information display is malfunctioning. Have the vehicle inspected by your Toyota dealer immediately.

■ **If a message that indicates the need for referring to Owner's Manual is displayed**

- If "Engine Coolant Temp High" is shown, follow the instructions, accordingly. (→P.512)
- If the following messages are shown, there may be a malfunction. Immediately have the vehicle inspected by your Toyota dealer.
 - "Hybrid System Malfunction"
 - "Check Engine"
 - "Traction battery system malfunction"
 - "Accelerator System Malfunction"
 - "Smart Key System Malfunction"
 - "Shift System Malfunction Apply Parking Brake Securely When Parking See Owner's Manual"
 - "P Switch Malfunction Apply Parking Brake Securely When Parking

- See Owner's Manual"
- "Shift System Unavailable Apply Parking Brake Securely When Parking See Owner's Manual"
- "Shift System Malfunction See Owner's Manual"
- "Shift System Malfunction Stop in a Safe Place See Owner's Manual"
- "Battery Low Shifting Unavailable See Owner's Manual"

- If the following messages are shown, there may be a malfunction. Immediately stop the vehicle in a safe place and contact your Toyota dealer. Continuing to drive the vehicle may be dangerous.

- "Oil pressure low"
- "Braking Power Low"

- If any of the following messages are shown on the multi-information display, the vehicle may have run out of fuel. Stop the vehicle in a safe place and, if the fuel level is low, refuel the vehicle.

- "Hybrid system stopped"
- "Engine stopped"

- If "Maintenance Required for Traction Battery Cooling Parts See Owner's Manual" is shown, the filter may be clogged, the air intake vent may be blocked, or there may be a gap in the duct. Therefore, perform the following correction procedure.

- Cleaning the hybrid battery (traction battery) air intake vent (→P.443)

If the warning message is shown even if the vent is cleaned, have the vehicle inspected by your Toyota dealer.

- If "12-Volt Battery Charging System Malfunction Stop in a Safe Place See Owner's Manual" is shown

Indicates a malfunction in the vehicle's charging system. Pull over and stop the vehicle as soon as it is safe to do so.

While the message is displayed, the functions of the air conditioning, etc. may be partially limited in order to reduce the power consumption of the 12-volt battery.

■ **If “Hybrid System Overheated Output Power Reduced” is shown**

The message may be shown when driving under severe operating conditions. (For example, when driving up a long steep hill or driving up a steep hill in reverse.)

Coping method: →P.513

■ **If “Traction Battery Needs to be Protected Refrain from the Use of N Position” is shown**

This message may be displayed when the shift position is in N.

As the hybrid battery (traction battery) can not be charged when the shift position is in N, shift the shift position to P when the vehicle is stopped.

■ **If “Traction Battery Needs to be Protected Shift into P to Restart” is shown**

This message is displayed when the hybrid battery (traction battery) charge has become extremely low because the shift position has been left in N for a certain amount of time.

When operating the vehicle, shift to P and restart the hybrid system.

■ **If “Shift is in N Release Accelerator Before Shifting” is shown**

Message is displayed when the accelerator pedal has been depressed and the shift position is in N. Release the accelerator pedal and shift the shift position to D or R.

■ **If “Press Brake when Vehicle is Stopped Hybrid System may Overheat” is shown**

Message is displayed when the accelerator pedal is depressed to maintain the vehicle position when

stopped on a upward slope, etc.

If this continues, the hybrid system may overheat.

Release the accelerator pedal and depress the brake pedal.

■ **If “Shift System Malfunction Shifting Unavailable Drive to a Safe Place and Stop” or “Shift System Malfunction Driving Unavailable” is displayed**

There is a malfunction in the shift control system. Have the vehicle inspected by your Toyota dealer immediately.

■ **If “Auto Power OFF to Conserve Battery” is shown**

Power was turned off due to the automatic power off function.

Next time when starting the hybrid system, operate the hybrid system for approximately 5 minutes to recharge the 12-volt battery.

■ **If “Parking Assist Unavailable Low Visibility See Owner’s Manual” is displayed**

Indicates one of the following systems is disabled.

●  RCD (Rear Camera Detection) (if equipped)

●  PKSB (Parking Support Brake) (if equipped)

Remove any dirt or foreign matter from the rear cameras.

■ **If “System Malfunction Visit Your Dealer” is displayed**

Indicates one of the following systems is disabled.







● PCS (Pre-Collision System)

● LDA (Lane Departure Alert)

● LTA (Lane Tracing Assist)

●  LCA (Lane Change Assist) (if equipped)





● AHB (Automatic High Beam)



- Dynamic radar cruise control
-  RSA (Road Sign Assist) (if equipped)
- PDA (Proactive Driving Assist)
-  BSM (Blind Spot Monitor) (if equipped)
-  RCTA (Rear Cross Traffic Alert) (if equipped)
-  Safe Exit Assist (if equipped)
- Intuitive Parking Assist
-  PKSB (Parking Support Brake) (if equipped)
-  RCD (Rear Camera Detection) (if equipped)

Have the vehicle inspected by your Toyota dealer immediately.

■ If “System Stopped See Owner’s Manual” is displayed

Indicates one of the following systems is disabled.

- PCS (Pre-Collision System)
- LDA (Lane Departure Alert)
- LTA (Lane Tracing Assist)
-  LCA (Lane Change Assist) (if equipped)
- AHB (Automatic High Beam)
- Dynamic radar cruise control
-  RSA (Road Sign Assist) (if equipped)
- PDA (Proactive Driving Assist)
-  BSM (Blind Spot Monitor) (if equipped)
-  RCTA (Rear Cross Traffic Alert) (if equipped)
-  Safe Exit Assist (if equipped)

- Intuitive Parking Assist
-  PKSB (Parking Support Brake) (if equipped)
-  RCD (Rear Camera Detection) (if equipped)

Follow the following correction methods.

- Check the voltage of the battery
- Check the sensors that the Toyota Safety Sense 3.0 uses for foreign matter covering them. Remove them if any. (→P.216)
- Vehicles with RCD (Rear Camera Detection): Check if the back door is open.

Indicates the sensors may not be operating properly. (→P.219, 279, 283, 287, 297, 302)

- Check the rear bumper around the sensors used by the BSM (if equipped), RCTA (if equipped) or Safe Exit Assist (if equipped) for foreign matter covering them. Remove them if any. (→P.276)
- Check the sensors including camera sensors used by the Intuitive parking assist, PKSB (if equipped), or RCD (if equipped) for foreign matter covering them. Remove them if any. (→P.284)
- When problems are solved and the sensors are operational, this indication may disappear by itself.

■ If “System Stopped Front Camera Low Visibility See Owner’s Manual” is displayed

Indicates one of the following systems is disabled.

- PCS (Pre-Collision System)
- LDA (Lane Departure Alert)
- LTA (Lane Tracing Assist)
-  LCA (Lane Change Assist) (if equipped)
- AHB (Automatic High Beam)
- Dynamic radar cruise control

-  RSA (Road Sign Assist) (if equipped)



- PDA (Proactive Driving Assist)

Follow the following correction methods.

- Using the windshield wipers, remove the dirt or foreign matter from the windshield.
- Using the air conditioning system, defog the windshield.
- Close the hood, remove any stickers, etc. to clear the obstruction in front of the front camera.

■ **If “System Stopped Front Camera Out of Temperature Range Wait until Normal Temperature” is displayed**

Indicates one of the following systems is disabled.

- PCS (Pre-Collision System)
- LDA (Lane Departure Alert)
- LTA (Lane Tracing Assist)
-  LCA (Lane Change Assist) (if equipped)
- AHB (Automatic High Beam)
- Dynamic radar cruise control
-  RSA (Road Sign Assist) (if equipped)
- PDA (Proactive Driving Assist)

Follow the following correction methods.

- If the front camera is hot, such as after the vehicle is parked in the sun, use the air conditioning system to decrease the temperature around the front camera
- If a sunshade was used when the vehicle was parked, depending on its type, the sunlight reflected from the surface of the sunshade may cause the temperature of the front camera to become excessively high
- If the front camera is cold, such as after the vehicle is parked in an

extremely cold environment, use the air conditioning system to increase the temperature around the front camera

■ **If “System Stopped Front Radar Sensor Blocked Clean Radar Sensor” is displayed**

Indicates one of the following systems is disabled.

- PCS (Pre-Collision System)
- LDA (Lane Departure Alert)
- LTA (Lane Tracing Assist)
-  LCA (Lane Change Assist) (if equipped)
- AHB (Automatic High Beam)
- Dynamic radar cruise control
- PDA (Proactive Driving Assist)

Follow the following correction methods.

- Check if there is any foreign matter attached to the radar sensor or radar sensor cover and clean them if necessary (→P.217)
- This message may be displayed when driving in an open area with few nearby vehicles or structures, such as a desert, grasslands, suburbs, etc.
The message may be cleared by driving the vehicle in an area with structures, vehicles, etc. nearby.

■ **If “System Stopped Front Radar Sensor Out of Temperature Range Wait until Normal Temperature” is displayed**

Indicates one of the following systems is disabled.

- PCS (Pre-Collision System)
- LDA (Lane Departure Alert)
- LTA (Lane Tracing Assist)
-  LCA (Lane Change Assist) (if equipped)
- AHB (Automatic High Beam)
- Dynamic radar cruise control

- PDA (Proactive Driving Assist)

The temperature of the radar sensor is outside of the operating range. Wait for the temperature to become appropriate.

- If “**System Stopped Front Radar In Self Calibration See Owner’s Manual**” is displayed

Indicates one of the following systems is disabled.

- PCS (Pre-Collision System)
- LDA (Lane Departure Alert)
- LTA (Lane Tracing Assist)
-  LCA (Lane Change Assist) (if equipped)
- AHB (Automatic High Beam)
- Dynamic radar cruise control
- PDA (Proactive Driving Assist)

Follow the following correction methods.

- Check if there is any foreign matter attached to the radar sensor or radar sensor cover and clean them if necessary (→P.217)
- The radar sensor may be misaligned and will be adjusted automatically while driving. Continue driving for a while.

- If “**Unavailable Activation Condition not Satisfied See Owner’s Manual**” is displayed

The  LCA function cannot be used as the operating conditions have not been met.

Operate the turn signal lever again after all of the operating conditions are met.

- If “**Cruise Control Unavailable See Owner’s Manual**” is displayed

Indicates one of the following systems is disabled.

- Dynamic radar cruise control

- Cruise control

A message is displayed when the driving assist switch is pushed repeatedly.

Press the driving assist switch quickly and firmly.

- If “**Engine Oil Level Low Add or Replace**” is displayed

The engine oil level may be low. Check the level of the engine oil, and add engine oil if necessary. (→P.417) This message may be displayed if the vehicle is stopped on a slope. Move the vehicle to a level surface and check if the message disappears.

- If “**Maintenance Required Soon**” is shown

Indicates that all maintenance according to the driven distance on the maintenance schedule* should be performed soon.

Comes on approximately 4500 miles (7200 km) after the message has been reset.

If necessary, perform maintenance. Please reset the message after the maintenance is performed. (→P.406)

*: Refer to the separate “Scheduled Maintenance Guide” or “Owner’s Manual Supplement” for the maintenance interval applicable to your vehicle.

- If “**Maintenance Required Visit Your Dealer**” is shown

Indicates that all maintenance is required to correspond to the driven distance on the maintenance schedule*.

Comes on approximately 5000 miles (8000 km) after the message has been reset. (The indicator will not work properly unless the message has been reset.)

Perform the necessary maintenance.

nance. Please reset the message after the maintenance is performed. (→P.406)

* Refer to the separate “Scheduled Maintenance Guide” or “Owner’s Manual Supplement” for the maintenance interval applicable to your vehicle.

■ **“Engine Maintenance Required Visit Your Dealer” is shown**

The engine or an engine component is malfunctioning. Have the vehicle inspected by your Toyota dealer immediately.

■ **“Oil Maintenance Required Soon” is displayed**

Indicates that the engine oil should be scheduled to be changed.

Check the engine oil and change it if necessary.

After changing the engine oil, make sure to reset the message. (→P.417)

■ **“Oil Maintenance Required” is displayed**

Indicates that the engine oil should be changed.

Check and change the engine oil, and oil filter by your Toyota dealer. After changing the engine oil, make sure to reset the message. (→P.417)

■ **“Accelerator and Brake Pedals Pressed Simultaneously” is shown**

The accelerator and brake pedals are being depressed simultaneously. (→P.168)

Release the accelerator pedal and depress the brake pedal.

■ **Warning buzzer**

→P.471



WARNING

■ **If a warning light comes on or a warning buzzer sounds when a warning message is shown on the multi-information display**

→P.472



NOTICE

■ **“Maintenance Required For Traction Battery At Your Dealer” is shown**

The hybrid battery (traction battery) is scheduled to be inspected or replaced. Have the vehicle inspected by your Toyota dealer immediately.

● Continuing to drive the vehicle without having the hybrid battery (traction battery) inspected will cause the hybrid system not to start.

● If the hybrid system does not start, contact your Toyota dealer immediately.

If you have a flat tire (vehicles without spare tire)

Your vehicle is not equipped with a spare tire, but instead is equipped with an emergency tire puncture repair kit.

A puncture caused by a nail or screw passing through the tire tread can be repaired temporarily using the emergency tire puncture repair kit. (The kit contains a bottle of sealant. The sealant can be used only once to temporarily repair one tire without removing the nail or screw from the tire.)

Depending on the damage condition of the flat tire, it may not be able to repaired with the emergency tire puncture repair kit. (→P.484)

After temporarily repairing the tire with the kit, have the tire repaired or replaced by your Toyota dealer.



WARNING

■ If you have a flat tire

Do not continue driving with a flat tire.

Driving even a short distance with a flat tire can damage the tire and the wheel beyond repair, which could result in an accident.

Driving with a flat tire may cause a circumferential groove on the side wall.

In such a case, the tire may explode when using a repair kit.

Before repairing the vehicle

- Stop the vehicle in a safe place on a hard, flat surface.
- Set the parking brake.
- Shift the shift lever to P.
- Stop the hybrid system.
- Turn on the emergency flashers. (→P.454)
- For vehicles with power back door: Turn off the power back door system. (→P.130)
- Check the degree of the tire damage.

A tire should only be repaired with the emergency tire puncture repair kit if the damage is caused by a nail or screw passing through the tire tread.

- Do not remove the nail or screw from the tire. Removing the object may widen the opening and prevent emergency repair with the repair kit.
- To avoid sealant leakage, move the vehicle until the area of the puncture, if known, is positioned at the top of the tire.

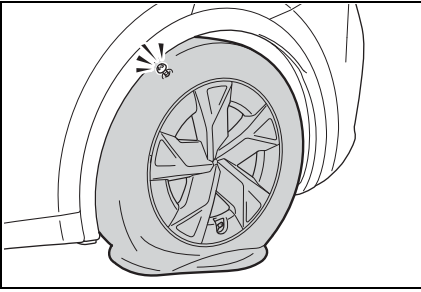

■ **A flat tire that cannot be repaired with the emergency tire puncture repair kit**

In the following cases, the tire cannot be repaired with the emergency tire puncture repair kit. Contact your Toyota dealer.

- When the tire is damaged due to driving without sufficient air pressure
- When the tire lost air pressure due to a crack or damage in the tire sidewall
- When the tire is visibly separated from the wheel
- When the cut or damage to the tread is 0.16 in. (4 mm) long or more
- When the wheel is damaged
- When two or more tires have been punctured
- When there is more than one hole or cut in the damaged tire
- When the sealant has expired

Location of the emergency tire puncture repair kit, jack and tools

- Deck under tray (type A)

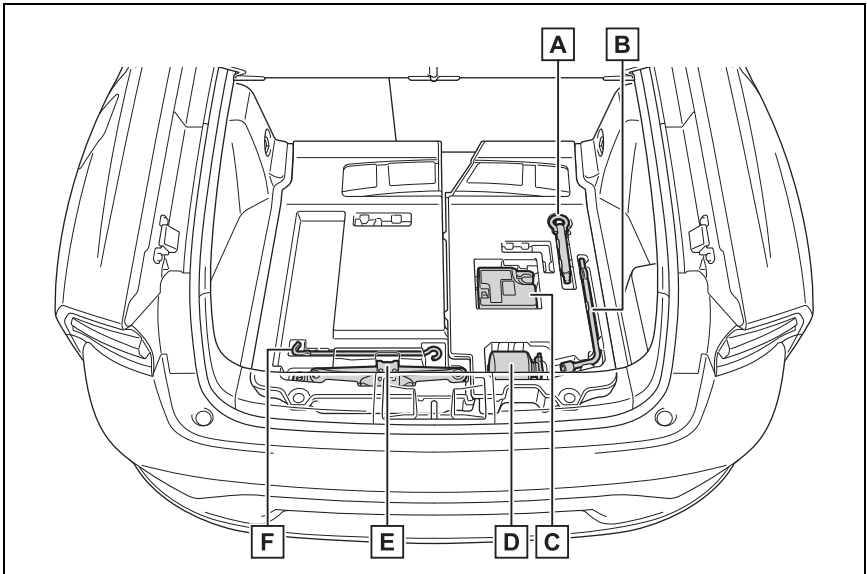

- A** Towing eyelet
- B** Wheel nut wrench (if equipped)^{*1}
- C** Emergency tire puncture repair kit (compressor)

- D** Emergency tire puncture repair kit (bottle)
- E** Jack (if equipped)^{*1, 2}
- F** Jack handle (if equipped)^{*1}

^{*1}: They can be purchased at your Toyota dealer.

^{*2}: Use of the jack (→P.495)

- ▶ Deck under tray (type B)

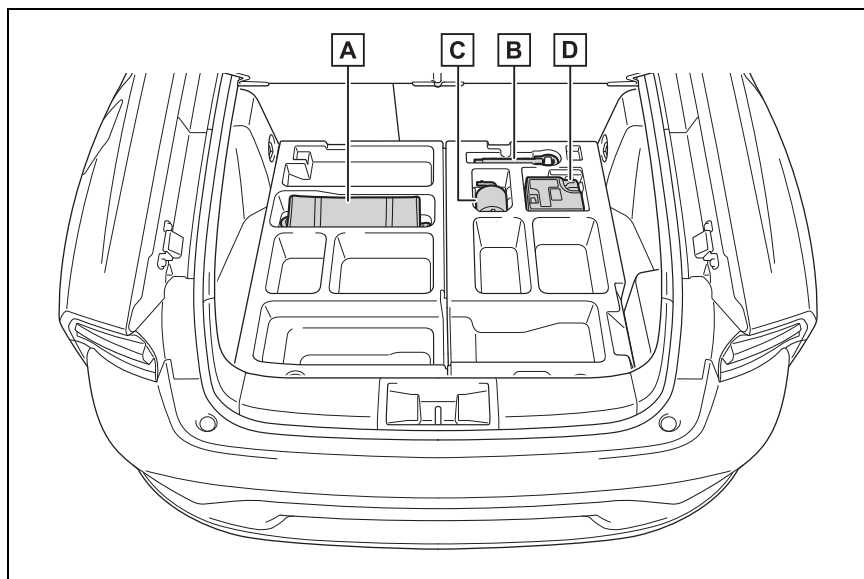

- A** Tool bag^{*}
- B** Towing eyelet
- C** Emergency tire puncture repair kit (bottle)
- D** Emergency tire puncture repair kit (compressor)

^{*}: The tool bag contains Jack, Jack handle and Wheel nut wrench. They can be purchased at your Toyota dealer.

Emergency tire puncture repair kit components

■ Bottle

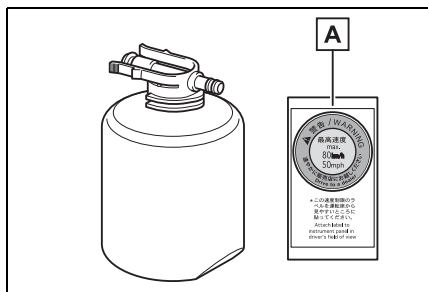

A Sticker

■ Compressor

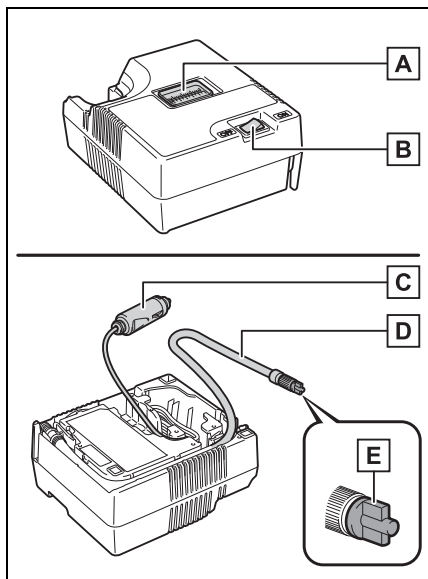

A Air pressure gauge

B Compressor switch

C Power plug

D Hose

E Air release cap

■ Note for checking the emergency tire puncture repair kit

Check the sealant expiry date occasionally. The expiry date is shown on the bottle. Do not use sealant whose expiry date has already passed. Otherwise, repairs conducted using the emergency tire puncture repair kit may not be performed properly.

■ Emergency tire puncture repair kit

- The emergency tire puncture repair kit is for filling the car tire with air.
- The sealant has a limited life span. The expiry date is marked on the bottle. The sealant should be replaced before the expiry date. Contact your Toyota dealer.
- The sealant stored in the emergency tire puncture repair kit can be used only once to temporarily repair a single tire. If the sealant in the bottle and other parts of the kit have been used and need to be replaced, contact your Toyota dealer.
- The compressor can be used repeatedly.
- The sealant can be used when the outside temperature is from -40°F (-40°C) to 140°F (60°C).
- The kit is exclusively designed for size and type of tires originally installed on your vehicle. Do not use it for tires that a different size than the original ones, or for any other purposes.
- If the sealant gets on your clothes, it may stain.
- If the sealant adheres to a wheel or the surface of the vehicle body, the stain may not be removable if it is not cleaned at once. Immediately wipe away the sealant with a wet cloth.
- During operation of the repair kit, a loud operation noise is pro-

duced. This does not indicate a malfunction.

- Do not use to check or to adjust the tire pressure.

⚠ WARNING

■ Do not drive the vehicle with a flat tire

Do not continue driving with a flat tire. Driving even a short distance with a flat tire can damage the tire and the wheel beyond repair.

Driving with a flat tire may cause a circumferential groove on the side wall. In such a case, the tire may explode when using a repair kit.

■ Caution while driving

- Store the repair kit in the luggage compartment. Injuries may result in the event of an accident or sudden braking.
 - The repair kit is exclusively only for your vehicle. Do not use repair kit on other vehicles, which could lead to an accident causing death or serious injury.
 - Do not use repair kit for tires that are different size than the original ones, or for any other purpose. If the tires have not been completely repaired, it could lead to an accident causing death or serious injury.
- #### **■ Precautions for use of the sealant**
- Ingesting the sealant is hazardous to your health. If you ingest sealant, consume as much water as possible, and then immediately consult a doctor.
 - If sealant gets in eyes or adheres to skin, immediately wash it off with water. If discomfort persists, consult a doctor.

Taking out the emergency tire puncture repair kit

- 1 Open the deck board. (→P.375).
 - 2 Take out the emergency tire puncture repair kit.
- ▶ Deck under tray (type A)

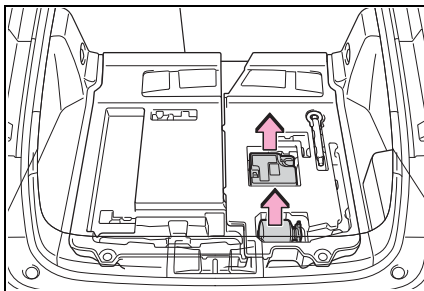

- ▶ Deck under tray (type B)

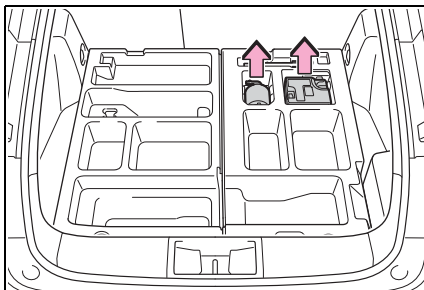

Emergency repair method

- 1 Take out the repair kit from the plastic bag.

Attach the sticker enclosed with the bottle on the specified locations. (See step 10.)

- 2 Pull out the hose and power plug from the bottom side of the compressor.

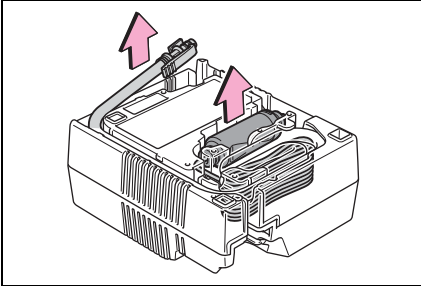

- 3 Connect the bottle to the compressor.

Make sure to press the bottle until its claws are securely engaged to the compressor and no longer visible.

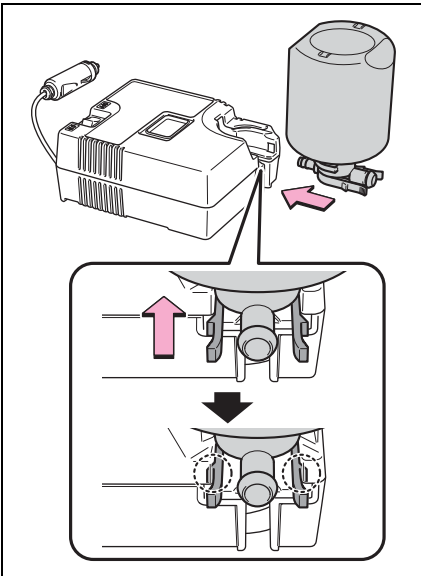

- 4 Connect the hose to the bottle.

Make sure to insert the hose until its claw is securely engaged to the

bottle.

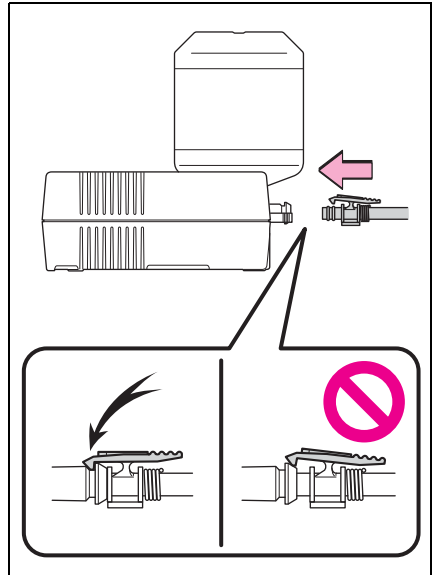

- 5 Remove the valve cap from the valve of the punctured tire.

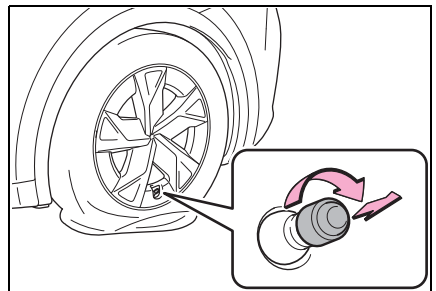

- 6 Extend the hose. Remove the air release cap from the hose.

You will use the air release cap again.

Therefore keep it in a safe place.

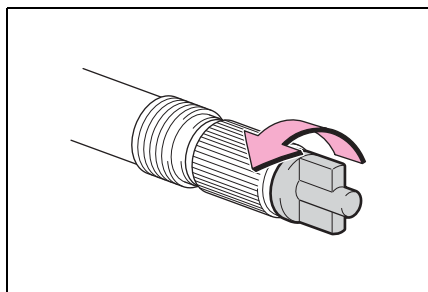

7 Connect the hose to the valve.

Screw the end of the hose clockwise as far as possible.

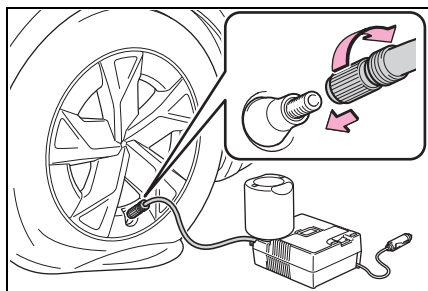

8 Make sure that the compressor switch is off.

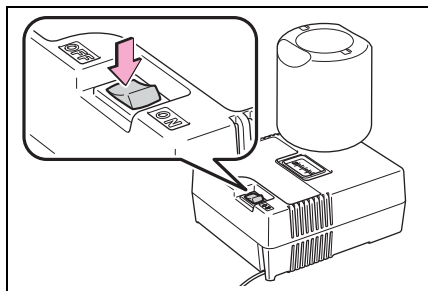

9 Connect the power plug to the power outlet socket. (→P.378)

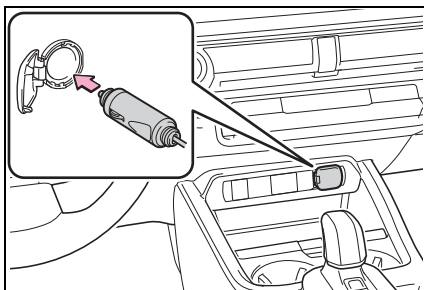

10 Attach the sticker provided with the tire puncture repair kit to a position easily seen from the driver's seat.

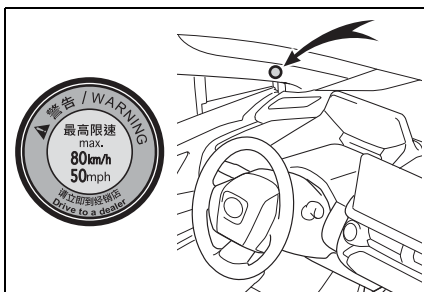

11 Check the specified tire inflation pressure.

Tire inflation pressure is specified on the label on the driver's side pillar as shown. (→P.438)

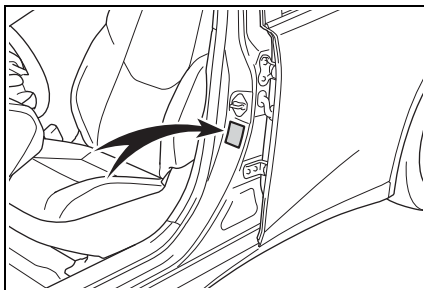

12 Start the hybrid system. (→P.180)

- 13 To inject the sealant and inflate the tire, turn the compressor switch on.

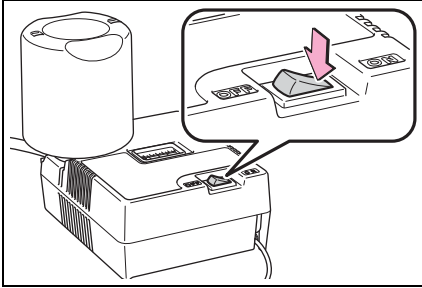

- 14 Inflate the tire until the specified air pressure is reached.

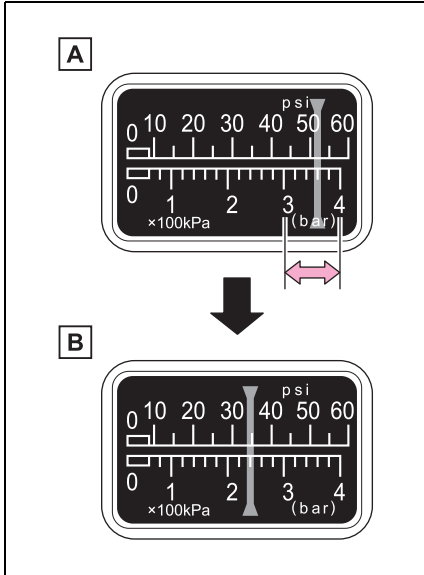

- A** The sealant will be injected and the pressure will spike to between 44 psi (300 kPa, 3.0 kgf/cm² or bar) and 58 psi (400 kPa, 4.0 kgf/cm² or bar), then gradually decrease.
- B** The air pressure gauge will be displayed the actual tire

inflation pressure about 1 to 5 minutes after the switch is turned on.

Turn the compressor switch off and then check the tire inflation pressure. Being careful not to over inflate, check and repeat the inflation procedure until the specified tire inflation pressure is reached.

The tire can be inflated for about 5 to 20 minutes (depending on the outside temperature). If the tire inflation pressure is still lower than the specified point after inflation for 25 minutes, the tire is too damaged to be repaired. Turn the compressor switch off and contact your Toyota dealer.

If the tire inflation pressure exceeds the specified air pressure, let out some air to adjust the tire inflation pressure. (→P.492, 524)

- 15 With the compressor switch off, disconnect the hose from the valve on the tire and then pull out the power plug from the power outlet socket.

Some sealant may leak when the hose is removed.

- 16 Install the valve cap onto the valve of the emergency repaired tire.

- 17 Attach the air release cap to the end of the hose.

If the air release cap is not attached, the sealant may leak and

the vehicle may get dirty.

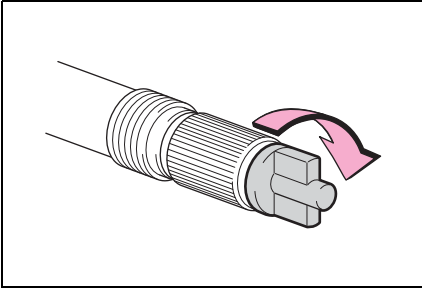

- 18 Temporarily store the bottle in the luggage compartment while it is connected to the compressor.
- 19 To spread the liquid sealant evenly within the tire, immediately drive safely for about 3 miles (5 km) below 50 mph (80 km/h).
- 20 After driving, stop your vehicle in a safe place on a hard, flat surface and reconnect the repair kit.

Remove the air release cap from the hose before reconnecting the hose.

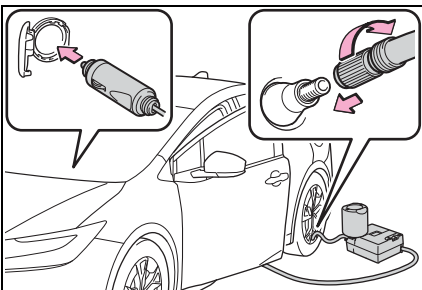

- 21 Turn the compressor switch on and wait for several sec-

onds, then turn it off. Check the tire inflation pressure.

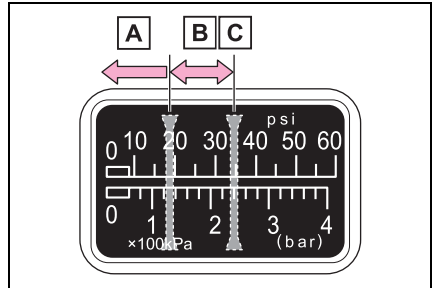

- A** If the tire inflation pressure is under 19 psi (130 kPa, 1.3 kgf/cm² or bar): The puncture cannot be repaired. Contact your Toyota dealer.
- B** If the tire inflation pressure is 19 psi (130 kPa, 1.3 kgf/cm² or bar) or higher, but less than the specified air pressure: Proceed to step 22.
- C** If the tire inflation pressure is the specified air pressure (→P.524): Proceed to step 23.

22 Turn the compressor switch on to inflate the tire until the specified air pressure is reached. Drive for about 3 miles (5 km) and then perform step 20.

23 Attach the air release cap to the end of the hose.

If the air release cap is not attached, the sealant may leak and

the vehicle may get dirty.

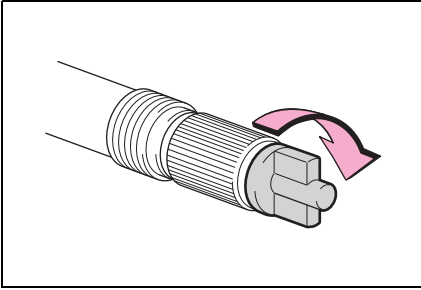

24 Store the bottle in the luggage compartment while it is connected to the compressor.

25 Taking precautions to avoid sudden braking, sudden acceleration and sharp turns, drive carefully at under 50 mph (80 km/h) to the nearest Toyota dealer that is less than 62 miles (100 km) away for tire repair or replacement.

For repair and replacement of a tire or disposal of the tire puncture repair kit, contact your Toyota dealer.

When having the tire repaired or replaced, make sure to tell your Toyota dealer that the sealant is injected.

■ If the tire is inflated to more than the specified air pressure

- 1 Disconnect the hose from the valve.
- 2 Install the air release cap to the end of the hose and push the protrusion on the air release cap into the tire valve to let some air out.

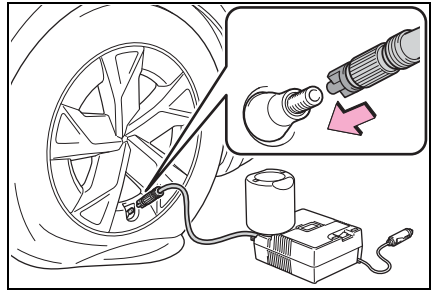

- 3 Disconnect the hose from the valve, remove the air release cap from the hose and then reconnect the hose.
- 4 Turn the compressor switch on and wait for several seconds, and then turn it off. Check that the air pressure indicator shows the specified air pressure.

If the air pressure is under the designated pressure, turn the compressor switch on again and repeat the inflation procedure until the specified air pressure is reached.

■ After a tire is repaired with the emergency tire puncture repair kit

- The tire pressure warning valve and transmitter should be replaced.
- Even if the tire inflation pressure is at the recommended level, the tire pressure warning light may come on/flash.

⚠ WARNING

■ When fixing the flat tire

- Stop your vehicle in a safe and flat area.

**WARNING**

- Do not touch the wheels or the area around the brakes immediately after the vehicle has been driven. After the vehicle has been driven, the wheels and the area around the brakes may be extremely hot. Touching these areas with hands, feet or other body parts may result in burns.
- Connect the valve and hose securely with the tire installed on the vehicle. If the hose is not properly connected to the valve, air leakage may occur as sealant may be sprayed out.
- If the hose comes off the valve while inflating the tire, there is a risk that the hose will move abruptly due to air pressure.
- After inflation of the tire has completed, the sealant may splatter when the hose is disconnected or some air is let out of the tire.
- Follow the operation procedure to repair the tire. If the procedures not followed, the sealant may spray out.
- Keep back from the tire while it is being repaired, as there is a chance of it bursting while the repair operation is being performed. If you notice any cracks or deformation of the tire, turn off the compressor switch and stop the repair operation immediately.
- The repair kit may overheat if operated for a long period of time. Do not operate the repair kit continuously for more than 40 minutes.

- Parts of the repair kit become hot during operation. Be careful handling the repair kit during and after operation. Do not touch the metal part connecting the bottle and the compressor. It will be extremely hot.
- Do not attach the vehicle speed warning sticker to an area other than the one indicated. If the sticker is attached to an area where an SRS airbag is located, such as the pad of the steering wheel, it may prevent the SRS airbag from operating properly.

■ Driving to spread the liquid sealant evenly

Observe the following precautions to reduce the risk of accidents.

Failing to do so may result in a loss of vehicle control and cause death or serious injury.

- Drive the vehicle carefully at a low speed. Be especially careful when turning and cornering.
- If the vehicle does not drive straight or you feel a pull through the steering wheel, stop the vehicle and check the following.
 - Tire condition. The tire may have separated from the wheel.
 - Tire inflation pressure. If the tire inflation pressure is 19 psi (130 kPa, 1.3 kgf/cm² or bar) or less, the tire may be severely damaged.



NOTICE

■ **When performing an emergency repair**

- A tire should only be repaired with the emergency tire puncture repair kit if the damage is caused by a sharp object such as nail or screw passing through the tire tread.
Do not remove the sharp object from the tire. Removing the object may widen the opening and disenable emergency repair with the repair kit.
 - The repair kit is not waterproof. Make sure that the repair kit is not exposed to water, such as when it is being used in the rain.
 - Do not put the repair kit directly onto dusty ground such as sand at the side of the road. If the repair kit vacuums up dust etc., a malfunction may occur.
 - Make sure to stand the kit with the bottle vertical. The kit cannot work properly if it is laid on its side.
- **Precautions for the emergency tire puncture repair kit**
- The repair kit power source should be 12 V DC suitable for vehicle use. Do not connect the repair kit to any other source.
 - If fuel splatters on the repair kit, the repair kit may deteriorate. Take care not to allow fuel to contact it.
 - Place the repair kit in a storage to prevent it from being exposed to dirt or water.
 - Store the repair kit in the luggage compartment out of reach of children.

- Do not disassemble or modify the repair kit. Do not subject parts such as the air pressure indicator to impacts. This may cause a malfunction.

■ **To avoid damage to the tire pressure warning valves and transmitters**

When a tire is repaired with liquid sealants, the tire pressure warning valve and transmitter may not operate properly. If a liquid sealant is used, contact your Toyota dealer or other qualified service shop as soon as possible. After use of liquid sealant, make sure to replace the tire pressure warning valve and transmitter when repairing or replacing the tire. (→P.427)

If you have a flat tire (vehicles with spare tire)

Your vehicle is equipped with a spare tire. The flat tire can be replaced with the spare tire.

For details about tires: →P.425

**WARNING****■ If you have a flat tire**

Do not continue driving with a flat tire.

Driving even a short distance with a flat tire can damage the tire and the wheel beyond repair, which could result in an accident.

Before jacking up the vehicle

- Stop the vehicle in a safe place on a hard, flat surface.
- Set the parking brake.
- Shift the shift position to P.
- Stop the hybrid system.
- Turn on the emergency flashers. (→P.454)
- Turn off the power back door system. (→P.130)

Location of the spare tire, jack and tools

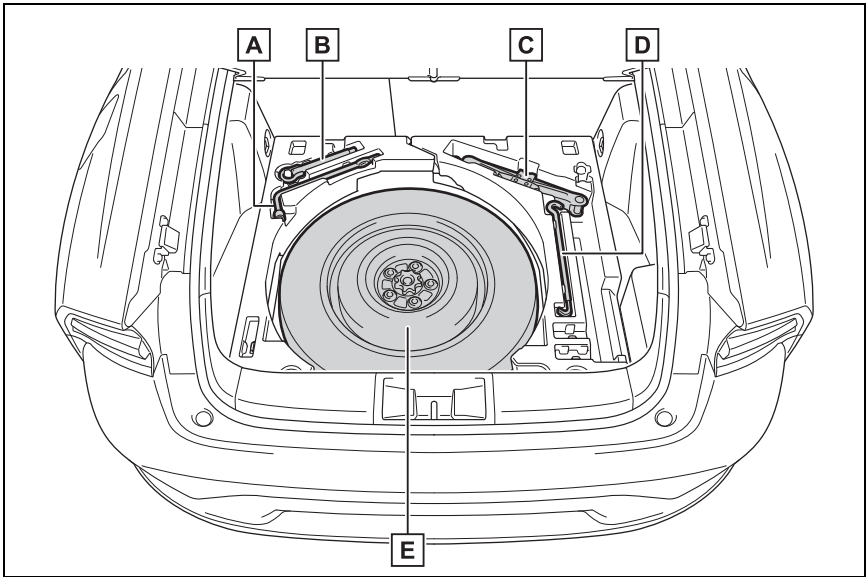

- A** Wheel nut wrench
- B** Towing eyelet
- C** Jack
- D** Jack handle
- E** Spare tire



WARNING

Using the tire jack

Observe the following precautions.

Improper use of the tire jack may cause the vehicle to suddenly fall off the jack, leading to death or serious injury.

- Do not use the tire jack for any purpose other than replacing tires or installing and removing tire chains.

- Only use the tire jack that comes with this vehicle for replacing a flat tire. Do not use it on other vehicles, and do not use other tire jacks for replacing tires on this vehicle.
- Put the jack properly in its jack point.
- Do not put any part of your body under the vehicle while it is supported by the jack.
- Do not start the hybrid system or drive the vehicle while the vehicle is supported by the jack.

⚠ WARNING

- Do not raise the vehicle while someone is inside.
- When raising the vehicle, do not put an object on or under the jack.
- Do not raise the vehicle to a height greater than that required to replace the tire.
- Use a jack stand if it is necessary to get under the vehicle.
- Stop the vehicle on firm, flat and level ground, firmly set the parking brake and shift the shift position to P. Block the wheel diagonally opposite to the one being changed if necessary.
- When lowering the vehicle, make sure that there is no-one near the vehicle. If there are people nearby, warn them vocally before lowering.

Taking out the jack

- 1 Open the deck board (→P.375).
- 2 Take out the jack.

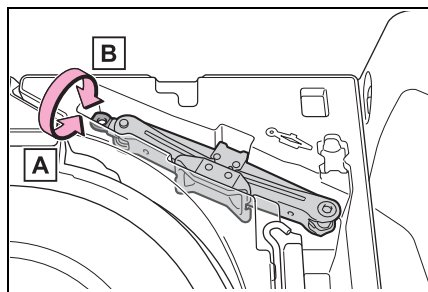

A For tightening

B For loosening

Taking out the spare tire

- 1 Loosen the center fastener that secures the spare tire.

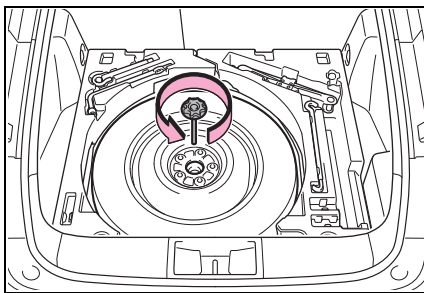
**⚠ WARNING****■ When storing the spare tire**

Be careful not to catch fingers or other body parts between the spare tire and the body of the vehicle.

Replacing a flat tire

- 1 Chock the tires.

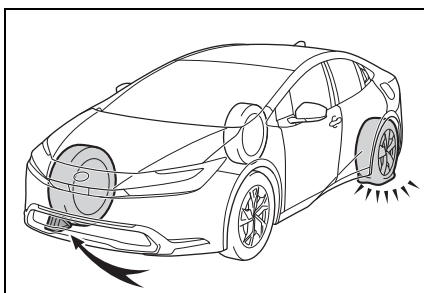

Flat tire	Wheel chock positions
Front left-hand side	Behind the rear right-hand side tire
Front right-hand side	Behind the rear left-hand side tire

Flat tire	Wheel chock positions
Rear left-hand side	In front of the front right-hand side tire
Rear right-hand side	In front of the front left-hand side tire

- 2 For vehicles with the wheel ornament: Remove the wheel ornament using the wrench.

To prevent damage, cover the tip of the wrench with a rag.

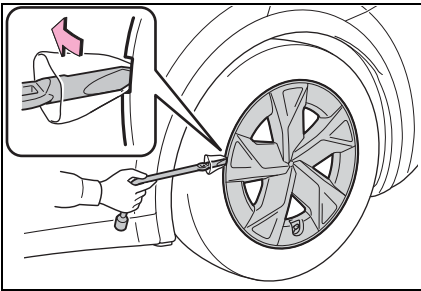

- 3 Using a wheel nut wrench, slightly loosen the wheel nuts (approximately one turn).

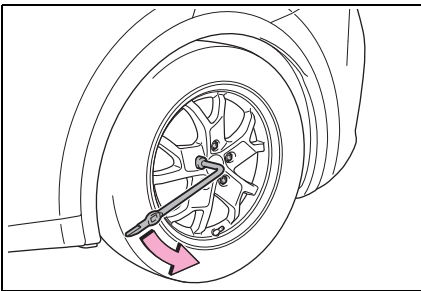

- 4 Turn the tire jack portion **A** by hand until the notch of the

jack is in contact with the jack point.

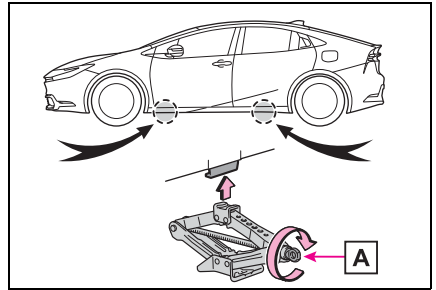

- 5 Assemble the jack handle and the wheel nut wrench as shown in the illustration.

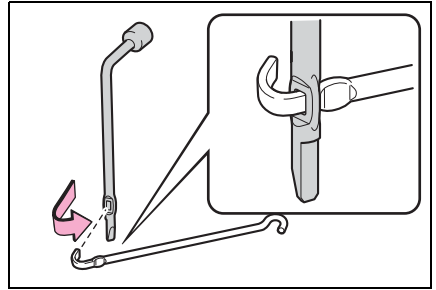

- 6 Raise the vehicle until the tire is slightly raised off the ground.

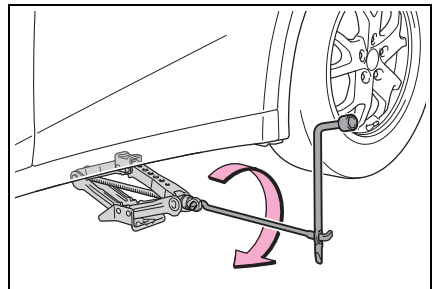

- 7 Remove all the wheel nuts and the tire.

When resting the tire on the ground, place the tire so that the wheel design faces up to avoid

scratching the wheel surface.

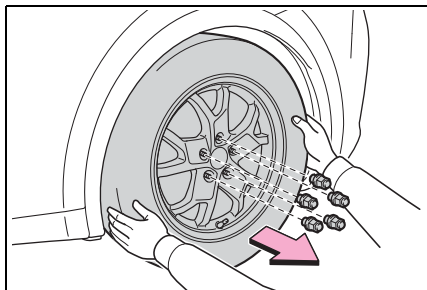

⚠ WARNING

■ Replacing a flat tire

- Do not touch the disc wheels or the area around the brakes immediately after the vehicle has been driven. After the vehicle has been driven the disc wheels and the area around the brakes will be extremely hot. Touching these areas with hands, feet or other body parts while changing a tire, etc. may result in burns.
- Failure to follow these precautions could cause the wheel nuts to loosen and the tire to fall off, resulting in death or serious injury.
- Have the wheel nuts tightened with a torque wrench to 76 ft•lb (103 N•m, 10.5 kgf•m) as soon as possible after changing wheels.
- Do not attach a heavily damaged wheel ornament, as it may fly off the wheel while the vehicle is moving.
- When installing a tire, only use wheel nuts that have been specifically designed for that wheel.

- If there are any cracks or deformations in the bolt screws, nut threads or bolt holes of the wheel, have the vehicle inspected by your Toyota dealer.
- When installing the wheel nuts, be sure to install them with the tapered ends facing inward.
- For vehicles with power back door: In cases such as when replacing tires, make sure to turn off the power back door system (→P.96). Failure to do so may cause the back door to operate unintentionally if the power back door switch is accidentally touched, resulting in hands and fingers being caught and injured.

Installing the spare tire

- 1 Remove any dirt or foreign matter from the wheel contact surface.

If foreign matter is on the wheel contact surface, the wheel nuts may loosen while the vehicle is in motion, causing the tire to come off.

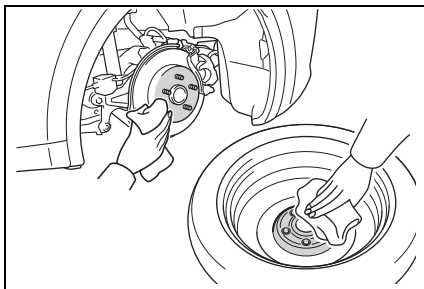

- 2 Install the spare tire and loosely tighten each wheel nut by hand by approximately the same amount.

Tighten the wheel nuts until the

tapered portion **A** comes into loose contact with the disc wheel seat **B**.

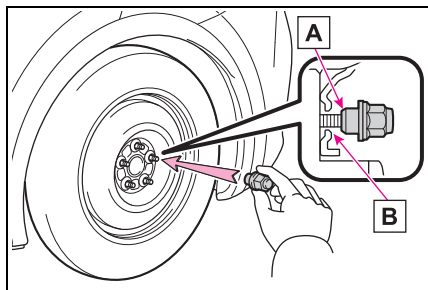

A Tapered portion

B Disc wheel seat

3 Lower the vehicle.

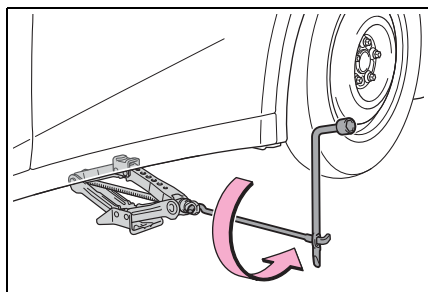

4 Firmly tighten each wheel nut two or three times in the order shown in the illustration.

Tightening torque:
76 ft•lbf (103 N•m, 10.5 kgf•m)

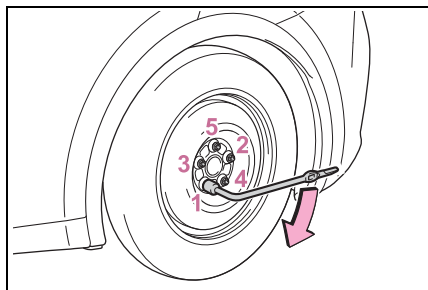

5 For vehicles with the wheel ornament: When reinstalling an original wheel, reinstall the wheel ornament.*

Align the cutout of the wheel ornament with the valve stem as shown.

*: The wheel ornament cannot be installed on the compact spare tire.

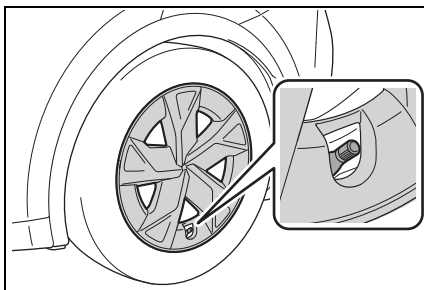

6 Stow the flat tire, tire jack and all tools.

■ The compact spare tire

● The compact spare tire is identified by the label "TEMPORARY USE ONLY" on the tire sidewall. Use the compact spare tire temporarily, and only in an emergency.

● Make sure to check the tire inflation pressure of the compact spare tire. (→P.524)

■ When using the compact spare tire

As the compact spare tire is not equipped with a tire pressure warning valve and transmitter, low inflation pressure of the spare tire will not be indicated by the tire pressure warning system. Also, if you replace the compact spare tire after the tire pressure warning light comes on, the light remains on.

■ When the compact spare tire is attached

The vehicle height may become lower when driving with the compact spare tire compared to when driving with standard tires.

■ If you have a flat front tire on a road covered with snow or ice

Install the compact spare tire on one of the rear wheels of the vehicle. Perform the following steps and fit tire chains to the front tires:

- 1 Replace a rear tire with the compact spare tire.
- 2 Replace the flat front tire with the tire removed from the rear of the vehicle.
- 3 Fit tire chains to the front tires.

■ When stowing the jack

Before storing the jack, adjust the height of the jack to match the shape of the jack holder.

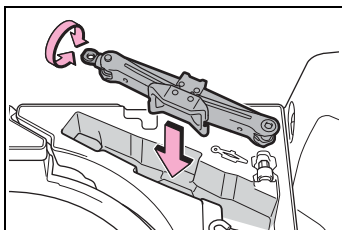

⚠ WARNING

■ When using the compact spare tire

- Remember that the compact spare tire provided is specifically designed for use with your vehicle. Do not use your compact spare tire on another vehicle.
- Do not use more than one compact spare tire simultaneously.
- Replace the compact spare tire with a standard tire as soon as possible.

- Avoid sudden acceleration, abrupt steering, sudden braking and shifting operations that cause sudden engine braking.

■ When the compact spare tire is attached

The vehicle speed may not be correctly detected, and the following systems may not operate correctly:

- ABS & Brake assist
- VSC
- Enhanced VSC (Enhanced Vehicle Stability Control)
- TRAC
- Dynamic radar cruise control
- Cruise control
- PCS (Pre-Collision System)
- EPS
- LTA (Lane Tracing Assist)
- LDA (Lane Departure Alert)
- RCTA (Rear Cross Traffic Alert) function (if equipped)
- AHB (Automatic High Beam)
- BSM (Blind Spot Monitor)
- Safe Exit Assist (if equipped)
- Panoramic view monitor (if equipped)
- Rear view monitor system (if equipped)
- Intuitive parking assist (if equipped)
- Parking Support Brake function (static objects to the front and rear/static objects around the vehicle)

**WARNING**

- Toyota Teammate Advanced Park (if equipped)
- Navigation system (if equipped)

Also, not only can the following systems not be utilized fully, but they may actually negatively affect the drive-train components:

- E-Four (Electronic On-Demand AWD system)

■ Speed limit when using the compact spare tire

Do not drive at speeds in excess of 50 mph (80 km/h) when a compact spare tire is installed on the vehicle.

The compact spare tire is not designed for driving at high speeds. Failure to observe this precaution may lead to an accident causing death or serious injury.

■ After using the tools and jack

Before driving, make sure all the tools and jack are securely in place in their storage location to reduce the possibility of personal injury during a collision or sudden braking.

■ Driving with tire chains and the compact spare tire

Do not fit tire chains to the compact spare tire.

Tire chains may damage the vehicle body and adversely affect driving performance.

■ When replacing the tires

When removing or fitting the wheels, tires or the tire pressure warning valve and transmitter, contact your Toyota dealer as the tire pressure warning valve and transmitter may be damaged if not handled correctly.

**NOTICE****■ Be careful when driving over bumps with the compact spare tire installed on the vehicle**

The vehicle height may become lower when driving with the compact spare tire compared to when driving with standard tires. Be careful when driving over uneven road surfaces.

If the hybrid system will not start

Reasons for the hybrid system not starting vary depending on the situation. Check the following and perform the appropriate procedure:

The hybrid system will not start even though the correct starting procedure is being followed (→P.180)

One of the following may be the cause of the problem:

- The electronic key may not be functioning properly. (→P.505)
- There may not be sufficient fuel in the vehicle's tank. Refuel the vehicle. (→P.210)
- There may be a malfunction in the immobilizer system. (→P.79)
- There may be a malfunction in the shift control system.* (→P.182)
- The hybrid system may be malfunctioning due to an electrical problem such as electronic key battery depletion or a blown fuse. However, depending on the type of malfunction, an interim measure is available to start the hybrid

system. (→P.504)

- There is a possibility that the temperature of the hybrid battery (traction battery) is extremely low (approximately below -22°F [-30°C]). (→P.75, 181)

*: It may not be possible to shift the shift position from P.

The interior lights and headlights are dim, or the horn does not sound or sounds at a low volume

One of the following may be the cause of the problem:

- The 12-volt battery may be discharged. (→P.507)
- The 12-volt battery terminal connections may be loose or corroded. (→P.424)

The interior lights and headlights do not turn on, or the horn does not sound

One of the following may be the cause of the problem:

- The 12-volt battery may be discharged. (→P.507)
- One or both of the 12-volt battery terminals may be disconnected. (→P.424)

Contact your Toyota dealer if the problem cannot be repaired, or if repair procedures are

unknown.

Starting the hybrid system in an emergency

When the hybrid system does not start, the following steps can be used as an interim measure to start the hybrid system if the power switch is functioning normally.

Do not use this starting procedure except in cases of emergency.

- 1 Pull the parking brake switch to check that the parking brake is set. (→P.193)

Parking brake indicator will come on.

- 2 Shift the shift position to P.
- 3 Turn the power switch to ACC*.
- 4 Press and hold the power switch for about 15 seconds while depressing the brake pedal firmly.

Even if the hybrid system can be started using the above steps, the system may be malfunctioning. Have the vehicle inspected by your Toyota dealer.

*: ACC mode can be enabled/disabled on the customize menu.

If you lose your keys

New genuine keys can be made by your Toyota dealer using the other key and the key number stamped on your key number plate. **Keep the plate in a safe place such as your wallet, not in the vehicle.**

NOTICE

■ When an electronic key is lost

If the electronic key remains lost, the risk of vehicle theft increases significantly. Visit your Toyota dealer immediately with all remaining electronic keys that were provided with your vehicle.

If the electronic key does not operate properly

If communication between the electronic key and vehicle is interrupted (→P.133) or the electronic key cannot be used because the battery is depleted, the smart key system and wireless remote control cannot be used. In such cases, the doors can be opened and the hybrid system can be started by following the procedure below.

■ When the electronic key does not work properly

- Make sure that the smart key system has not been deactivated in the customization setting. If it is off, turn the function on. (Customizable features: →P.542)
- Check if battery-saving mode is set. If it is set, cancel the function. (→P.133)
- The electronic key function may have stopped. (→P.133)



NOTICE

■ In case of a smart key system malfunction, or other key related problems

Take your vehicle with all the electronic keys provided with your vehicle to your Toyota dealer.

Locking and unlocking the doors

Use the mechanical key (→P.110) in order to perform the following operations.

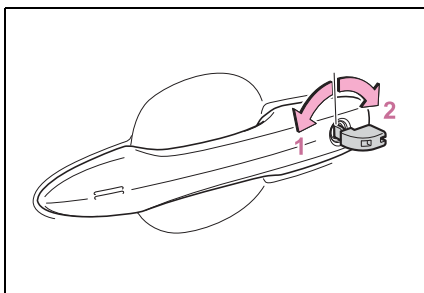

- 1 Locks all the doors
- 2 Unlocks the door

Turning the key rearward unlocks the driver's door. Turning the key once again within 5 seconds unlocks the other doors.

■ Key linked functions

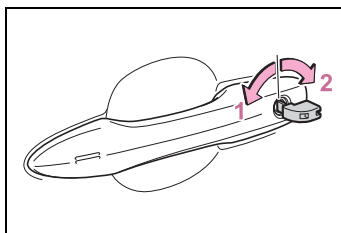

- 1 Closes the windows (turn and hold)*
- 2 Opens the windows (turn and hold)*

*: These settings must be customized at your Toyota dealer.

**WARNING**

When using the mechanical key and operating the power windows

Operate the power window after checking to make sure that there is no possibility of any passenger having any of their body parts caught in the window. Also, do not allow children to operate the mechanical key. It is possible for children and other passengers to get caught in the power window.

Starting the hybrid system

- 1 Ensure that the shift position is in P and depress the brake pedal.
- 2 Touch the area behind the buttons on the electronic key to the power switch.

When the electronic key is detected, a buzzer sounds and the power switch will turn to ON.

When the smart key system is deactivated in customization setting, the power switch will turn to ACC.

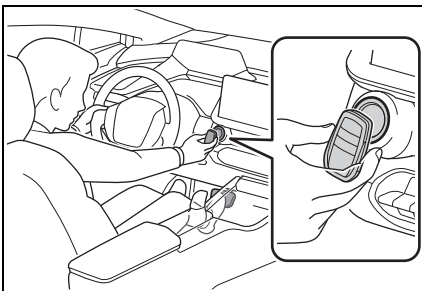

- 3 Firmly depress the brake pedal and check that  is displayed on the multi-information display.

- 4 Press the power switch shortly and firmly.

In the event that the hybrid system still cannot be started, contact your Toyota dealer.

Stopping the hybrid system

Shift the shift position to P, set the parking brake and press the power switch as you normally do when stopping the hybrid system.

Replacing the key battery

As the above procedure is a temporary measure, it is recommended that the electronic key battery be replaced immediately when the battery is depleted. (→P.446)

Changing power switch modes

Release the brake pedal and press the power switch in step 3 above. The hybrid system does not start and modes will be changed each time the switch is pressed. (→P.183)

If the 12-volt battery is discharged

The following procedures may be used to start the hybrid system if the vehicle's 12-volt battery is discharged.

You can also call your Toyota dealer or a qualified repair shop.

Restarting the hybrid system

If you have a set of jumper (or booster) cables and a second vehicle with a 12-volt battery, you can jump start your vehicle by following the steps below.

- 1 Open the hood (→P.412) and fuse box cover.
- 2 Open the exclusive jump starting terminal cover.
- 3 Connect a positive jumper cable clamp to **A** on your vehicle and connect the clamp on the other end of the positive cable to **B** on the second vehicle. Then, connect a negative cable clamp to **C** on the second vehicle and connect the clamp at the other end of the negative cable to **D**.

Use jumper cables that can reach the specified terminals and connecting

Push claw **A** and **B** to completely release the lock, and then lift up the cover.

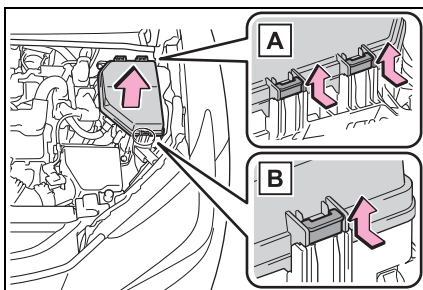

- 2 Open the exclusive jump starting terminal cover.

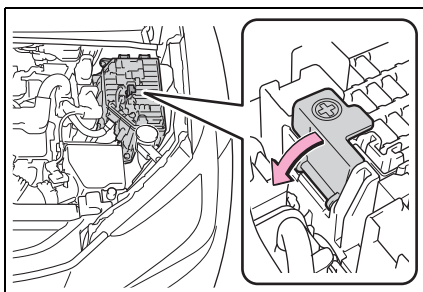

point.

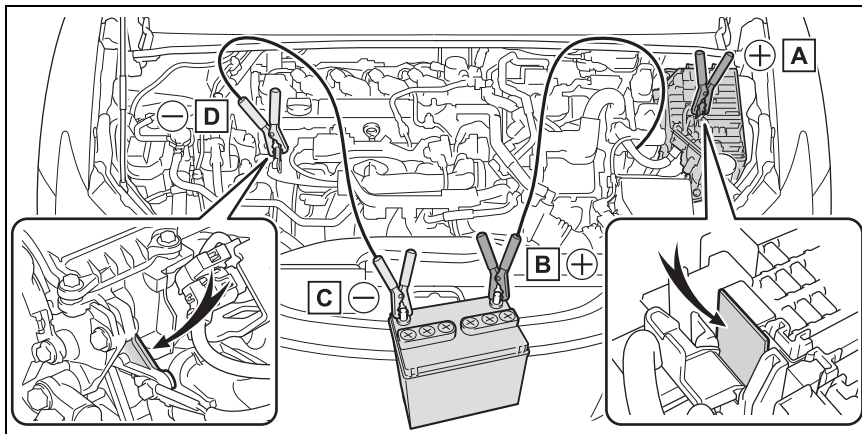

- A** Exclusive jump starting terminal (your vehicle)
- B** Positive (+) battery terminal (second vehicle)
- C** Negative (-) battery terminal (second vehicle)
- D** Metallic point shown in the illustration

- 4 Start the engine of the second vehicle. Increase the engine speed slightly and maintain at that level for approximately 5 minutes to recharge the 12-volt battery of your vehicle.
- 5 Maintain the engine speed of the second vehicle and start the hybrid system of your vehicle by turning the power switch to ON.
- 6 Make sure the “READY” indicator comes on. If the indicator light does not come on, contact your Toyota dealer.
- 7 Once the hybrid system has started, remove the jumper cables in the exact reverse

order from which they were connected.

- 8 Close the exclusive jump starting terminal cover, and reinstall the fuse box cover to its original position.

Once the hybrid system starts, have the vehicle inspected at your Toyota dealer as soon as possible.

■ Starting the hybrid system when the 12-volt battery is discharged

The hybrid system cannot be started by push-starting.

■ To prevent 12-volt battery discharge

- Turn off the headlights and the audio system while the hybrid system is off.
- Turn off any unnecessary electri-

cal components when the vehicle is running at a low speed for an extended period, such as in heavy traffic.

■ When the 12-volt battery is removed or discharged

- Information stored in the ECU is cleared. When the 12-volt battery is depleted, have the vehicle inspected at your Toyota dealer.
- Some systems may require initialization. (→P.553)

■ When removing the 12-volt battery terminals

When the 12-volt battery terminals are removed, the information stored in the ECU is cleared. Before removing the 12-volt battery terminals, contact your Toyota dealer.

■ Charging the 12-volt battery

The electricity stored in the 12-volt battery will discharge gradually even when the vehicle is not in use, due to natural discharge and the draining effects of certain electrical appliances. If the vehicle is left for a long time, the 12-volt battery may discharge, and the hybrid system may be unable to start. (The 12-volt battery recharges automatically while the hybrid system is operating.)

■ When recharging or replacing the 12-volt battery

- In some cases, it may not be possible to unlock the doors using the smart key system when the 12-volt battery is discharged. Use the wireless remote control or the mechanical key to lock or unlock the doors.
- The hybrid system may not start on the first attempt after reinstalling the 12-volt battery. In that case, start the hybrid system in the same manner as when the electronic key does not operate properly (→P.506). This is not a malfunction, as the hybrid system will start normally on the second attempt.

- The power switch mode is memorized by the vehicle. When the 12-volt battery is reconnected, the system will return to the mode it was in before the 12-volt battery was discharged. Before disconnecting the 12-volt battery, turn the power switch off. If you are unsure what mode the power switch was in before the 12-volt battery discharged, be especially careful when reconnecting the 12-volt battery.
- If the 12-volt battery discharges, it may not be possible to shift the shift position to other positions. In this case, the vehicle can not be towed without lifting both front wheels because the front wheels will be locked.
- Some systems may require initialization. (→P.553)
- **When replacing the 12-volt battery**
 - Use a 12-volt battery that conforms to European regulations.
 - Use a battery that the case size is same as the previous one (LN1), 20 hour rate capacity (20HR) is equivalent (45Ah) or greater, and performance rating (CCA) is equivalent (285A) or greater.
 - If the sizes differ, the 12-volt battery cannot be properly secured.
 - If the 20 hour rate capacity is low, even if the time period where the vehicle is not used is a short time, the 12-volt battery may discharge and hybrid system may not be able to start.
 - Use a ventilation type calcium battery
 - Use a 12-volt battery with a handle. If a 12-volt battery without a handle is used, removal is more difficult.
 - When removing the 12-volt battery: →P.423
 - After replacing, firmly attach the following items to the exhaust hole

- of the 12-volt battery.
- Use the exhaust hose that was attached to the 12-volt battery before replacing and confirm that it is firmly connected to the hole section of the vehicle.
- Use the exhaust hole plug included with the 12-volt battery replaced or the one installed on the battery prior to the replaced. (Depending on the 12-volt battery to be replaced, the exhaust hole may be plugged.)

For details, consult your Toyota dealer.

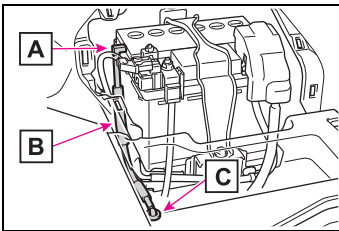

- A** Exhaust hole
- B** Exhaust hose
- C** Hole section of the vehicle



WARNING

■ When removing the battery terminals

Always remove the negative (-) terminal first. If the positive (+) terminal contacts any metal in the surrounding area when the positive (+) terminal is removed, a spark may occur, leading to a fire in addition to electrical shocks and death or serious injury.

■ Avoiding 12-volt battery fires or explosions

Observe the following precautions to prevent accidentally igniting the flammable gas that may be emitted from the 12-volt battery:

- Make sure each jumper cable is connected to the correct terminal and that it is not unintentionally in contact with any other than the intended terminal.
- Do not allow the other end of the jumper cable connected to the “+” terminal to come into contact with any other parts or metal surfaces in the area, such as brackets or unpainted metal.
- Do not allow the + and - clamps of the jumper cables to come into contact with each other.
- Do not smoke, use matches, cigarette lighters or allow open flame near the 12-volt battery.

■ 12-volt battery precautions

The 12-volt battery contains poisonous and corrosive acidic electrolyte, while related parts contain lead and lead compounds. Observe the following precautions when handling the 12-volt battery:

- When working with the 12-volt battery, always wear safety glasses and take care not to allow any battery fluids (acid) to come into contact with skin, clothing or the vehicle body.
- Do not lean over the 12-volt battery.
- In the event that battery fluid comes into contact with the skin or eyes, immediately wash the affected area with water and seek medical attention. Place a wet sponge or cloth over the affected area until medical attention can be received.

WARNING

- Always wash your hands after handling the 12-volt battery support, terminals, and other battery-related parts.
- Do not allow children near the 12-volt battery.
- **After recharging the 12-volt battery**
Have the 12-volt battery inspected at your Toyota dealer as soon as possible.
If the 12-volt battery is deteriorating, continued use may cause the 12-volt battery to emit a malodorous gas, which may be detrimental to the health of passengers.
- **When replacing the 12-volt battery**
- For information regarding 12-volt battery replacement, contact your Toyota dealer.
- After replacing, securely attach the exhaust hose and exhaust hole plug to the exhaust hole of the replaced 12-volt battery. If not properly installed, gases (hydrogen) may leak into the vehicle interior, and there is the possible danger of the gas igniting and exploding.

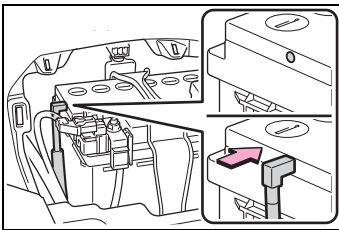

NOTICE

■ **When handling jumper cables**

When connecting the jumper cables, ensure that they do not become entangled in the cooling fan, etc.

■ **When connecting jumper cables**

Make sure to connect jumper cables to the specified terminals and connecting point. Failure to do so may adversely affect the electronic devices or damage to them.

■ **To prevent damaging the vehicle**

The exclusive jump starting terminal is to be used when charging the 12-volt battery from another vehicle in an emergency. It cannot be used to jump start another vehicle.

If your vehicle overheats

The following may indicate that your vehicle is overheating.

- The high coolant temperature warning light (→P.82, 463) comes on or flashes, or a loss of hybrid system power is experienced. (For example, the vehicle speed does not increase.)
- “Engine Coolant Temp High Stop in a Safe Place See Owner’s Manual” or “Hybrid System Overheated Output Power Reduced” is shown on the multi-information display.
- Steam comes out from under the hood.

Correction procedures

- **If the high coolant temperature warning light comes on or flashes or “Engine Coolant Temp High Stop in a Safe Place See Owner’s Manual” is shown on the multi-information display**

- 1 Stop the vehicle in a safe place and turn off the air conditioning system, and then stop the hybrid system.
- 2 If you see steam: Carefully lift the hood after

the steam subsides.

If you do not see steam: Carefully lift the hood.

- 3 After the hybrid system has cooled down sufficiently, inspect the hoses and radiator core (radiator) for any leaks.

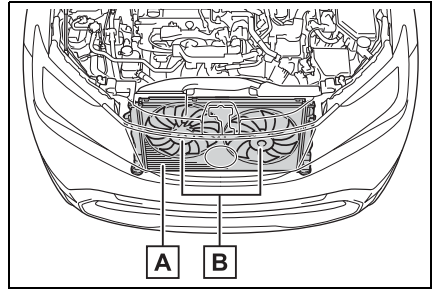

A Radiator

B Cooling fans

If a large amount of coolant leaks, immediately contact your Toyota dealer.

- 4 The coolant level is satisfactory if it is between the “MAX” and “MIN” lines on the reservoir.

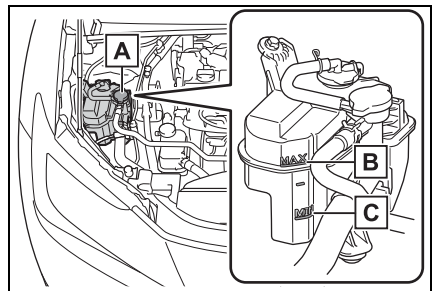

A Reservoir

B “MAX” line

C “MIN” line

5 Add coolant if necessary.

Water can be used in an emergency if engine coolant is unavailable.

If water was added in an emergency, have the vehicle inspected at your Toyota dealer as soon as possible.

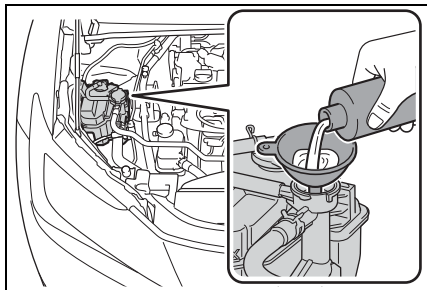

- 6 Start the hybrid system and turn the air conditioning system on to check that the radiator cooling fan operates and to check for coolant leaks from the radiator or hoses.

The fan operates when the air conditioning system is turned on immediately after a cold start. Confirm that the fan is operating by checking the fan sound and air flow. If it is difficult to check these, turn the air conditioning system on and off repeatedly. (The fan may not operate in freezing temperatures.)

- 7 If the fan is not operating:
Stop the hybrid system immediately and contact your Toyota dealer.
If the fan is operating:
Have the vehicle inspected at the nearest Toyota dealer.
- 8 Check if “Engine Coolant Temp High Stop in a Safe Place See Owner’s Manual”

is shown on the multi-information display.

If the message does not disappear: Stop the hybrid system and contact your Toyota dealer.

If the message is not displayed: Have the vehicle inspected at the nearest Toyota dealer.

■ If “Hybrid System Overheated Output Power Reduced” is shown on the multi-information display

- 1 Stop the vehicle in a safe place.
- 2 Stop the hybrid system and carefully lift the hood.
- 3 After the hybrid system has cooled down, inspect the hoses and radiator core (radiator) for any leaks.

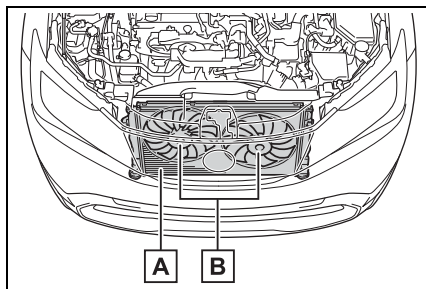

- A** Radiator
- B** Cooling fans

If a large amount of coolant leaks, immediately contact your Toyota dealer.

- 4 The coolant level is satisfactory if it is between the “F” and “L” lines on the reservoir.

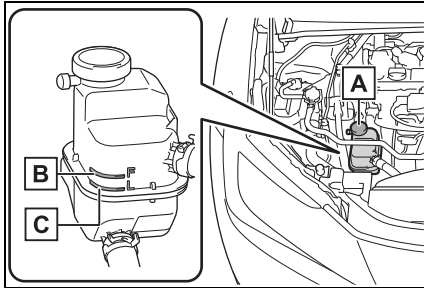

- A** Reservoir
- B** “F” line
- C** “L” line

- 5 Add coolant if necessary.

Water can be used in an emergency if power control unit coolant is unavailable.

If water was added in an emergency, have the vehicle inspected at your Toyota dealer as soon as possible.

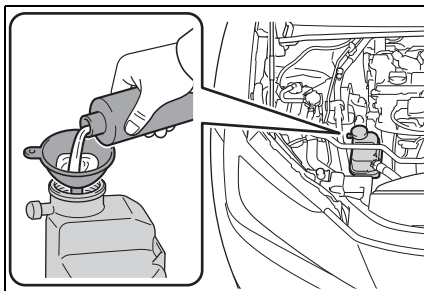

- 6 After stopping the hybrid system and waiting for 5 minutes or more, start the hybrid system again and check for the multi-information display.

If the message does not disappear: Stop the hybrid system and contact your Toyota dealer.

If the message is not displayed:

The hybrid system temperature has dropped and the vehicle may be driven normally.

However, if the message appears again frequently, contact your Toyota dealer.

! WARNING

■ When inspecting under the hood of your vehicle

Observe the following precautions.

Failure to do so may result in serious injury such as burns.

- If steam is seen coming from under the hood, do not open the hood until the steam has subsided. The engine compartment may be very hot.
- After the hybrid system has been turned off, check that the “READY” indicator is off. When the hybrid system is operating, the gasoline engine may automatically start, or the cooling fan may suddenly operate even if the gasoline engine stops. Do not touch or approach rotating parts such as the fan, which may lead to fingers or clothing (especially a tie, a scarf or a muffler) getting caught, resulting in serious injury.
- Do not loosen the coolant reservoir cap while the hybrid system and radiator are hot. High temperature steam or coolant could spray out.

! NOTICE

■ When adding engine/power control unit coolant

Add coolant slowly after the hybrid system has cooled down sufficiently. Adding cool coolant to a hot hybrid system too quickly can cause damage to the hybrid system.



NOTICE

■ To prevent damage to the cooling system

Observe the following precautions:

- Avoid contaminating the coolant with foreign matter (such as sand or dust, etc.).
- Do not use any coolant additive.

If the vehicle becomes stuck

Carry out the following procedures if the tires spin or the vehicle becomes stuck in mud, dirt or snow:

Recovering procedure

- 1 Stop the hybrid system. Set the parking brake and shift the shift position to P.
- 2 Remove the mud, snow or sand from around the front wheels.
- 3 Place wood, stones or some other material under the front wheels to help provide traction.
- 4 Restart the hybrid system
- 5 Shift the shift position to D or R and release the parking brake. Then, while exercising caution, depress the accelerator pedal.

■ When it is difficult to free the vehicle

Press  to turn off TRAC.
(→P.346)

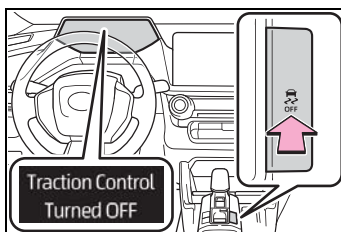

**WARNING****■ When attempting to free a stuck vehicle**

If you choose to push the vehicle back and forth to free it, make sure the surrounding area is clear to avoid striking other vehicles, objects or people. The vehicle may also lunge forward or lunge back suddenly as it becomes free. Use extreme caution.

■ When shifting the shift position

Be careful not to shift the shift position with the accelerator pedal depressed.

This may lead to unexpected rapid acceleration of the vehicle that may cause an accident resulting in death or serious injury.

**NOTICE****■ To avoid damaging the transmission and other components**

- Avoid spinning the wheels and depressing the accelerator pedal more than necessary.
- If the vehicle remains stuck even after these procedures are performed, the vehicle may require towing to be freed.

Vehicle specifications

8

8-1. Specifications

Maintenance data (fuel, oil level, etc.)..... 518

Fuel information 526

Tire information 528

8-2. Customization

Customizable features 538

8-3. Initialization

Items to initialize 553

Maintenance data (fuel, oil level, etc.)

Dimensions and weights

Overall length	181.1 in. (4599 mm)	
Overall width	70.2 in. (1782 mm)	
Overall height*	▶ Vehicles with 17-inch tires 55.9 in. (1420 mm) ▶ Vehicles with 19-inch tires 56.3 in. (1430 mm)	
Wheelbase	108.3 in. (2750 mm)	
Tread	Front	61.5 in. (1563 mm)
	Rear	▶ Vehicles with 17-inch tires 62.17 in. (1579 mm) ▶ Vehicles with 19-inch tires 62.20 in. (1580 mm)
Vehicle capacity weight (Occupants + luggage)	860 lb. (390 kg)	

*: Unladen vehicle

Seating capacity

Seating capacity	5 (Front 2, Rear 3)
------------------	---------------------

Vehicle identification

■ Vehicle identification number

The vehicle identification number (VIN) is the legal identifier for your vehicle. This is the primary identification number for your Toyota. It is used in registering the ownership of your vehicle.

This number is on the top left of

the instrument panel.

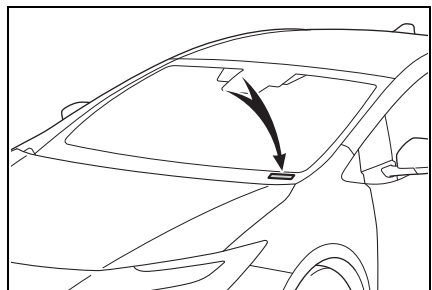

This number is also stamped

under the right-hand front seat.

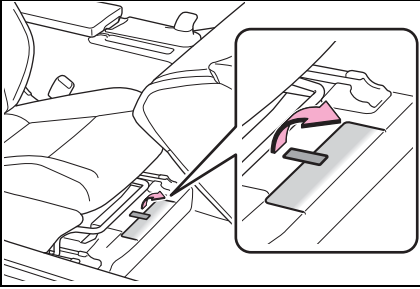

This number is also on the Certification Regulation Label.

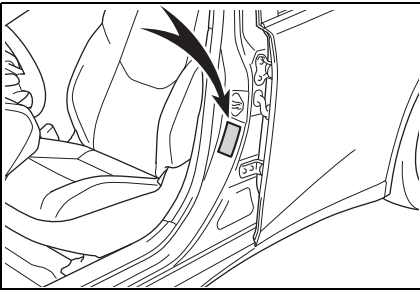

■ Engine number

The engine number is stamped on the engine block as shown.

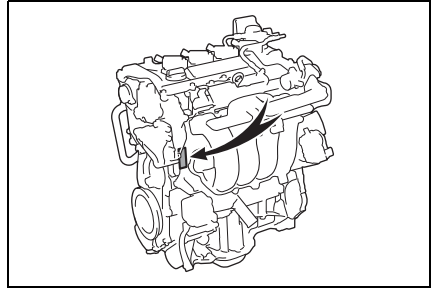

Engine

Model	2.0 L 4-cylinder (M20A-FXS)
Type	4-cylinder in line, 4-cycle, gasoline
Bore and stroke	3.17 × 3.84 in. (80.5 × 97.6 mm)
Displacement	121.3 cu.in. (1987 cm ³)
Valve clearance	Automatic adjustment

Fuel

Fuel type	Unleaded gasoline only
-----------	------------------------

Octane Rating	87 (Research Octane Number 91) or higher
Fuel tank capacity (Reference)	<ul style="list-style-type: none"> ▶ AWD models 10.6 gal. (40 L, 8.8 Imp.gal.) ▶ 2WD models 11.4 gal. (43 L, 9.5 Imp.gal.)

Electric motor (traction motor)

▶ Front

Type	Permanent magnet synchronous motor
Maximum output	83 kW
Maximum torque	151.9 ft•lbf (206 N•m, 21.0 kgf•m)

▶ Rear (AWD models)

Type	Permanent magnet synchronous motor
Maximum output	30 kW
Maximum torque	62.0 ft•lbf (84 N•m, 8.6 kgf•m)

Hybrid battery (traction battery)

Type	Lithium-ion battery
Voltage	3.7 V/cell
Capacity	4.08 Ah
Quantity	60 cells
Nominal voltage	222.0 V

Lubrication system

■ Oil capacity (Drain and refill — reference^{*})

With filter	4.4 qt. (4.2 L, 3.7 Imp. qt.)
Without filter	4.1 qt. (3.9 L, 3.4 Imp. qt.)

^{*}: The engine oil capacity is a reference quantity to be used when changing the engine oil. When actually adding the engine oil, make sure that the oil

level is between the low level mark and refill upper limit mark (→P.417). Warm up and turn off the hybrid system, wait about 5 minutes, and check the oil level on the dipstick.

■ Engine oil selection

“Toyota Genuine Motor Oil” is used in your Toyota vehicle. Use Toyota approved “Toyota Genuine Motor Oil” or equivalent to satisfy the following grade and viscosity.

Oil grade:

ILSAC GF-6B multigrade engine oil

Recommended viscosity:

SAE 0W-16

SAE 0W-16 is the best choice for good fuel economy and good starting in cold weather.

If SAE 0W-16 is not available, SAE 0W-20 oil may be used. However, it must be replaced with SAE 0W-16 at the next oil change.

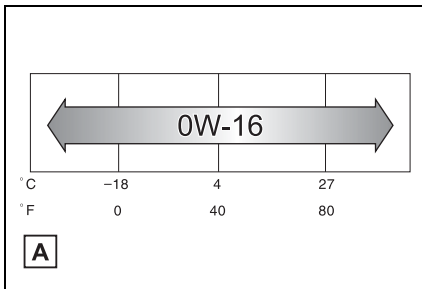

A Outside temperature

Oil viscosity (0W-16 is explained here as an example):

- The 0W in 0W-16 indicates the characteristic of the oil which allows cold startability.

Oils with a lower value before the W allow for easier starting of the engine in cold weather.

- The 16 in 0W-16 indicates the viscosity characteristic of the oil when the oil is at high temperature. An oil with a higher viscosity (one with a higher value) may be better suited if the vehicle is operated at high speeds, or under extreme load conditions.

How to read oil container label:

API registered mark is added to some oil containers to help you select the oil you should use.



Cooling system

Capacity *	Gasoline engine	6.4 qt. (6.1 L, 5.4 Imp. qt.)
	Power control unit	1.7 qt. (1.6 L, 1.4 Imp. qt.)
Coolant type		<p>Use either of the following:</p> <ul style="list-style-type: none"> • “Toyota Super Long Life Coolant” • Similar high-quality ethylene glycol-based non-silicate, non-amine, non-nitrite, and non-borate coolant with long-life hybrid organic acid technology <p>Do not use plain water alone.</p>

*: The coolant capacity is the quantity of reference.

If replacement is necessary, contact your Toyota dealer.

Ignition system (spark plug)

Make	DENSO FC16HR-Q8
Gap	0.031 in. (0.8 mm)



NOTICE

■ Iridium-tipped spark plugs

Use only iridium-tipped spark plugs. Do not adjust the spark plug gap.

Electrical system (12-volt Battery)

Open voltage at 68°F (20°C):	<p>12.0 V or higher</p> <p>(Turn the power switch to OFF and turn on the high beam headlights for 30 seconds.)</p> <p>If the voltage is lower than the standard value, charge the battery.</p>
Charging rates (Slow charge)	5 A max.

Hybrid transmission

Fluid capacity *	3.9 qt. (3.7 L, 3.2 Imp. qt.)
Fluid type	Toyota Genuine e-Transaxle fluid TE

*: The fluid capacity is the quantity of reference.
If replacement is necessary, contact your Toyota dealer.



NOTICE

Hybrid transmission fluid type

Using transmission fluid other than the above type may cause abnormal noise or vibration, or ultimately damage the transmission of your vehicle.

Rear differential (rear electric motor) (AWD models)

Fluid capacity*	1.47 qt. (1.39 L, 1.22 Imp. qt.)
Fluid type	Toyota Genuine e-Transaxle fluid TE

*: The fluid capacity is the quantity of reference.
If replacement is necessary, contact your Toyota dealer.



NOTICE

Rear differential fluid type

Using differential fluid other than the above type may cause abnormal noise or vibration, or ultimately damage the differential of your vehicle.

Brakes

Pedal clearance* ¹	5.2 in. (132 mm) Min.
Pedal free play	0.04 — 0.24 in. (1.0 — 6.0 mm)
Brake pad wear limit	<ul style="list-style-type: none"> ▶ Front 0.06 in. (1.5 mm) ▶ Rear 0.08 in. (2.0 mm)
Parking brake indicator* ²	<p>When pushing the parking brake switch for 1 to 2 seconds: turns off</p> <p>When pulling the parking brake switch for 1 to 2 seconds: comes on</p>
Fluid type	<p>FMVSS No.116 DOT 3 or SAE J1703</p> <p>FMVSS No.116 DOT 4 or SAE J1704</p>

*¹: Minimum pedal clearance when depressed with a force of 67.4 lbf (300 N, 30.6 kgf) while the hybrid system is operating.

When performing the brake pedal inspection, also be sure to check that the

brake system warning light is not illuminated when the hybrid system is operating. (If the brake system warning light is illuminated, refer to P.463.)

*2: Make sure to confirm that the brake system warning light (yellow) does not illuminate. (If the brake system warning light illuminates, refer to P.463.)

Steering

Free play	Less than 1.2 in. (30 mm)
-----------	---------------------------

Tires and wheels

► Vehicles with 17-inch tires

Tire size	195/60R17 90H, T145/90D16 106M (spare) (if equipped)
Tire inflation pressure (Recommended cold tire inflation pressure)	Front: 36 psi (250 kPa, 2.5 kgf/cm ² or bar) Rear: 35 psi (240 kPa, 2.4 kgf/cm ² or bar) Spare: 60 psi (420 kPa, 4.2 kgf/cm ² or bar)
Wheel size	17 × 6 1/2J, 16 × 4T (spare)
Wheel nut torque	76 ft•lbf (103 N•m, 10.5 kgf•m)

► Vehicles with 19-inch tires

Tire size	195/50R19 88H, T145/90D16 106M (spare) (if equipped)
Tire inflation pressure (Recommended cold tire inflation pressure)	<p>Front: 35 psi (240 kPa, 2.4 kgf/cm² or bar)</p> <p>Rear: 33 psi (230 kPa, 2.3 kgf/cm² or bar)</p> <p>Spare: 60 psi (420 kPa, 4.2 kgf/cm² or bar)</p> <p>Driving at high speeds (above 100 mph [160 km/h]) (in countries where such speeds are permitted by law): Add 3 psi (20 kPa, 0.2 kgf/cm² or bar) to the front tires and rear tires.</p> <p>Never exceed the maximum cold tire inflation pressure indicated on the tire sidewall.</p>
Wheel size	19 × 6 1/2J, 16 × 4T (spare)
Wheel nut torque	76 ft•lbf (103 N•m, 10.5 kgf•m)

Fuel information

You must only use unleaded gasoline in your vehicle.

Select octane rating 87 (Research Octane Number 91) or higher. Use of unleaded gasoline with an octane rating lower than 87 may result in engine knocking. Persistent knocking can lead to engine damage.

At minimum, the gasoline you use should meet the specifications of ASTM D4814 in the U.S.A..

■ Gasoline quality

In very few cases, driveability problems may be caused by the brand of gasoline you are using. If driveability problems persist, try changing the brand of gasoline. If this does not correct the problem, consult your Toyota dealer.

■ Recommendation of the use of gasoline containing detergent additives

- Toyota recommends the use of gasoline that contains detergent additives to avoid the build-up of engine deposits.
- All gasoline sold in the U.S.A. contains minimum detergent additives to clean and/or keep clean intake systems, per EPA's lowest additives concentration program.
- Toyota strongly recommends the use of Top Tier Detergent Gasoline. For more information on Top Tier Detergent Gasoline and a list of marketers, please go to the official website www.toptiergas.com.

■ Recommendation of the use of low emissions gasoline

Gasolines containing oxygenates such as ethers and ethanol, as well as reformulated gasolines, are available in some cities. These fuels are typically acceptable for use, providing they meet other fuel requirements.

Toyota recommends these fuels, since the formulations allow for reduced vehicle emissions.

■ Non-recommendation of the use of blended gasoline

- Use only gasoline containing up to 15% ethanol.

DO NOT use any flex-fuel or gasoline that could contain more than 15% ethanol, including from any pump labeled E30 (30% ethanol

A), E50 (50% ethanol **B**), E85

(85% ethanol **C**) (which are only some examples of fuel containing more than 15% ethanol).

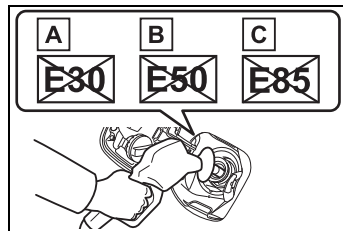

- If you use gasohol in your vehicle, be sure that it has an octane rating no lower than 87.
- Toyota does not recommend the use of gasoline containing methanol.

■ Non-recommendation of the use of gasoline containing MMT

Some gasoline contains an octane enhancing additive called MMT (Methylcyclopentadienyl Manganese Tricarbonyl).

Toyota does not recommend the use of gasoline that contains MMT.

If fuel containing MMT is used, your emission control system may be adversely affected.

The malfunction indicator lamp on the instrument cluster may come on. If this happens, contact your Toyota dealer for service.

■ If your engine knocks

- Consult your Toyota dealer.
- You may occasionally notice light knocking for a short time while accelerating or driving uphill. This is normal and there is no need for concern.

■ When refueling with gasohol

Take care not to spill gasohol. It can damage your vehicle's paint.



NOTICE

■ Notice on fuel quality

- Do not use improper fuels. If improper fuels are used, the engine will be damaged.
- Do not use leaded gasoline. Leaded gasoline can cause damage to your vehicle's three-way catalytic converters causing the emission control system to malfunction.
- Do not use gasohol other than the type previously stated. Other gasohol may cause fuel system damage or vehicle performance problems.
- Using unleaded gasoline with an octane number or rating lower than the level previously stated will cause persistent heavy knocking. At worst, this will lead to engine damage.

■ Fuel-related poor driveability

If poor driveability (poor hot starting, vaporization, engine knocking, etc.) is encountered after using a different type of fuel, discontinue the use of that type of fuel.

Tire information

Typical tire symbols

► Full-size tire

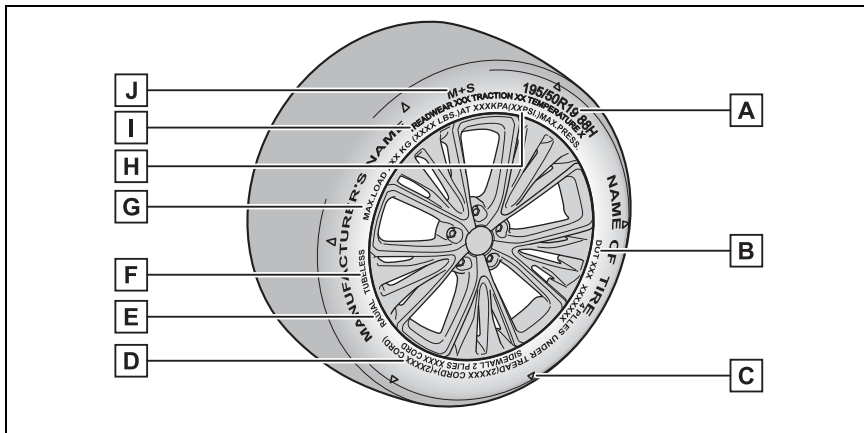

► Compact spare tire

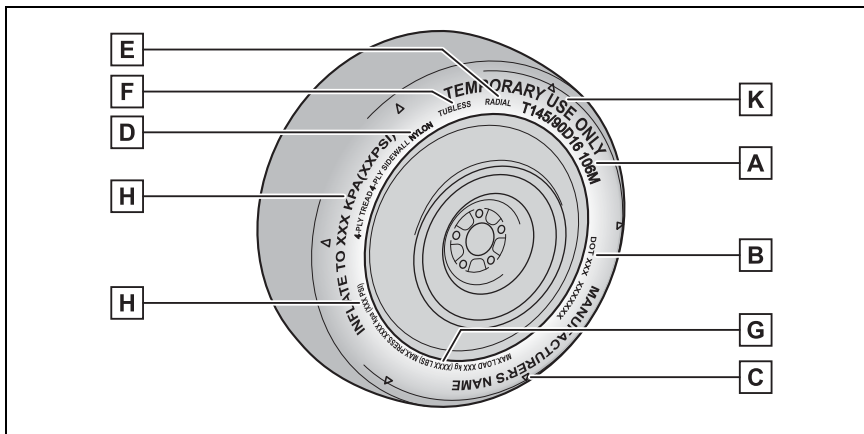

A Tire size (→P.530)

B DOT and Tire Identification Number (TIN) (→P.529)

C Location of treadwear indicators (→P.425)

D Tire ply composition and materials

Plies are layers of rubber-coated parallel cords. Cords are the strands which form the plies in a tire.

E Radial tires or bias-ply tires

A radial tire has “RADIAL” on the sidewall. A tire not marked “RADIAL” is a bias-ply tire.

F TUBELESS or TUBE TYPE

A tubeless tire does not have a tube and air is directly put into the tire. A tube type tire has a tube inside the tire and the tube maintains the air pressure.

G Load limit at maximum cold tire inflation pressure (→P.532)**H** Maximum cold tire inflation pressure (→P.532)

This means the pressure to which a tire may be inflated.

I Uniform tire quality grading

For details, see “Uniform Tire Quality Grading” that follows.

J Summer tires or all season tires (→P.426)

An all season tire has “M+S” on the sidewall. A tire not marked “M+S” is a summer tire.

K “TEMPORARY USE ONLY”

A compact spare tire is identified by the phrase “TEMPORARY USE ONLY” molded on its sidewall. This tire is designed for temporary emergency use only.

Typical DOT and Tire Identification Number (TIN)

► Type A

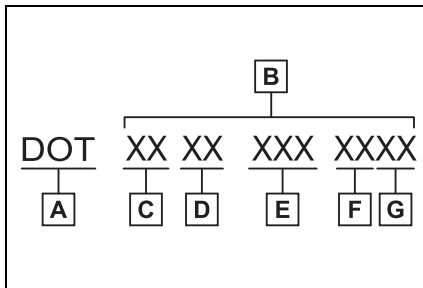

A DOT symbol*

B Tire Identification Number (TIN)

C Tire manufacturer's identification mark

D Tire size code

E Manufacturer's optional tire type code (3 or 4 letters)

F Manufacturing week

G Manufacturing year

*: The DOT symbol certifies that the tire conforms to applicable Federal Motor Vehicle Safety Standards.

► Type B

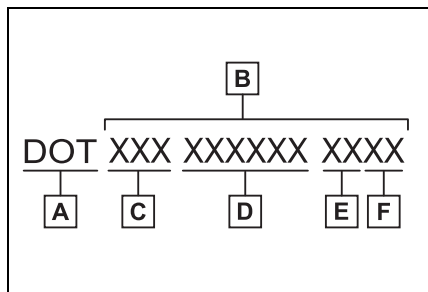

- A** DOT symbol*
- B** Tire Identification Number (TIN)
- C** Tire manufacturer's identification mark
- D** Manufacturer's code
- E** Manufacturing week
- F** Manufacturing year

*: The DOT symbol certifies that the tire conforms to applicable Federal Motor Vehicle Safety Standards.

Tire size

■ Typical tire size information

The illustration indicates typical tire size.

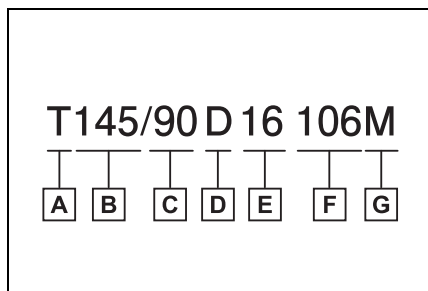

- A** Tire use

(P = Passenger car,
T = Temporary use)

- B** Section width (millimeters)
- C** Aspect ratio
(tire height to section width)
- D** Tire construction code
(R = Radial, D = Diagonal)
- E** Wheel diameter (inches)
- F** Load index (2 digits or 3 digits)
- G** Speed symbol (alphabet with one letter)

■ Tire dimensions

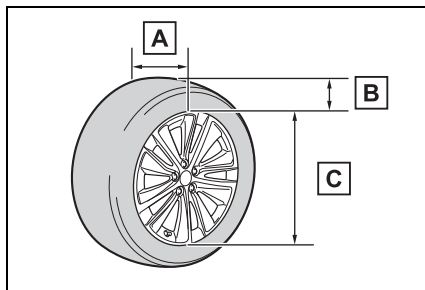

- A** Section width
- B** Tire height
- C** Wheel diameter

Tire section names

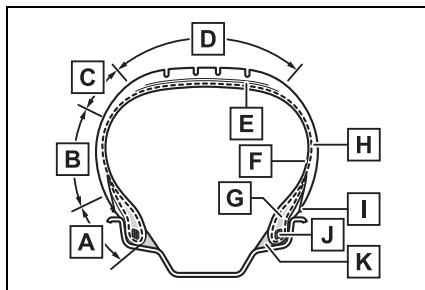

- A** Bead
- B** Sidewall
- C** Shoulder
- D** Tread
- E** Belt
- F** Inner liner
- G** Reinforcing rubber
- H** Carcass
- I** Rim lines
- J** Bead wires
- K** Chafer

Uniform Tire Quality Grading

This information has been prepared in accordance with regulations issued by the National Highway Traffic Safety Administration of the U.S. Department of Transportation.

It provides the purchasers and/or prospective purchasers of Toyota vehicles with information on uniform tire quality grading.

Your Toyota dealer will help answer any questions you may have as you read this information.

■ DOT quality grades

All passenger vehicle tires must conform to Federal Safety Requirements in addition to these grades. Quality grades can be found where applicable

on the tire sidewall between tread shoulder and maximum section width.

For example: Treadwear 200 Traction AA Temperature A

■ Treadwear

The treadwear grade is a comparative rating based on the wear rate of the tire when tested under controlled conditions on a specified government test course.

For example, a tire graded 150 would wear one and a half (1 - 1/2) times as well on the government course as a tire graded 100.

The relative performance of tires depends upon the actual conditions of their use. Performance may differ significantly from the norm due to variations in driving habits, service practices and differences in road characteristics and climate.

■ Traction AA, A, B, C

The traction grades, from highest to lowest, are AA, A, B and C, and they represent the tire's ability to stop on wet pavement as measured under controlled conditions on specified government test surfaces of asphalt and concrete.

A tire marked C may have poor traction performance.

Warning: The traction grade assigned to this tire is based on braking (straight ahead) traction tests and does not include cornering (turning) traction.

■ Temperature A, B, C

The temperature grades are A (the highest), B, and C, representing the tire's resistance to the generation of heat and its ability to dissipate heat when tested under controlled conditions on a specified indoor laboratory test wheel.

Sustained high temperature can cause the material of the tire to degenerate and reduce tire life, and excessive temperature can lead to sudden tire failure.

Grade C corresponds to a level of

performance which all passenger car tires must meet under the Federal Motor Vehicle Safety Standard No. 109.

Grades B and A represent higher levels of performance on the laboratory test wheel than the minimum required by law.

Warning: The temperature grades of a tire assume that it is properly inflated and not overloaded.

Excessive speed, underinflation, or excessive loading, either separately or in combination, can cause heat buildup and possible tire failure.

Glossary of tire terminology

Tire related term	Meaning
Cold tire inflation pressure	Tire pressure when the vehicle has been parked for three hours or more, or has not been driven more than 1 mile or 1.5 km under that condition
Maximum inflation pressure	The maximum cold inflated pressure to which a tire may be inflated, shown on the sidewall of the tire
Recommended inflation pressure	Cold tire inflation pressure recommended by a manufacturer
Accessory weight	The combined weight (in excess of those standard items which may be replaced) of hybrid transmission, power steering, power brakes, power windows, power seats, radio and heater, to the extent that these items are available as factory-installed equipment (whether installed or not)
Curb weight	The weight of a motor vehicle with standard equipment, including the maximum capacity of fuel, oil and coolant, and if so equipped, air conditioning and additional weight optional engine

Tire related term	Meaning
Maximum loaded vehicle weight	The sum of: (a) Curb weight (b) Accessory weight (c) Vehicle capacity weight (d) Production options weight
Normal occupant weight	150 lb. (68 kg) times the number of occupants specified in the second column of Table 1* that follows
Occupant distribution	Distribution of occupants in a vehicle as specified in the third column of Table 1* below
Production options weight	The combined weight of installed regular production options weighing over 5 lb. (2.3 kg) in excess of the standard items which they replace, not previously considered in curb weight or accessory weight, including heavy duty brakes, ride levelers, roof rack, heavy duty battery, and special trim
Rim	A metal support for a tire or a tire and tube assembly upon which the tire beads are seated
Rim diameter (Wheel diameter)	Nominal diameter of the bead seat
Rim size designation	Rim diameter and width
Rim type designation	The industry manufacturer's designation for a rim by style or code
Rim width	Nominal distance between rim flanges
Vehicle capacity weight (Total load capacity)	The rated cargo and luggage load plus 150 lb. (68 kg) times the vehicle's designated seating capacity
Vehicle maximum load on the tire	The load on an individual tire that is determined by distributing to each axle its share of the maximum loaded vehicle weight, and dividing by two
Vehicle normal load on the tire	The load on an individual tire that is determined by distributing to each axle its share of curb weight, accessory weight, and normal occupant weight (distributed in accordance with Table 1* below), and dividing by two

Tire related term	Meaning
Weather side	The surface area of the rim not covered by the inflated tire
Bead	The part of the tire that is made of steel wires, wrapped or reinforced by ply cords and that is shaped to fit the rim
Bead separation	A breakdown of the bond between components in the bead
Bias ply tire	A pneumatic tire in which the ply cords that extend to the beads are laid at alternate angles substantially less than 90 degrees to the center-line of the tread
Carcass	The tire structure, except tread and sidewall rubber which, when inflated, bears the load
Chunking	The breaking away of pieces of the tread or sidewall
Cord	The strands forming the plies in the tire
Cord separation	The parting of cords from adjacent rubber compounds
Cracking	Any parting within the tread, sidewall, or innerliner of the tire extending to cord material
CT	A pneumatic tire with an inverted flange tire and rim system in which the rim is designed with rim flanges pointed radially inward and the tire is designed to fit on the underside of the rim in a manner that encloses the rim flanges inside the air cavity of the tire
Extra load tire	A tire designed to operate at higher loads and at higher inflation pressures than the corresponding standard tire
Groove	The space between two adjacent tread ribs
Innerliner	The layer(s) forming the inside surface of a tubeless tire that contains the inflating medium within the tire
Innerliner separation	The parting of the innerliner from cord material in the carcass

Tire related term	Meaning
Intended outboard sidewall	(a)The sidewall that contains a whitewall, bears white lettering, or bears manufacturer, brand, and/or model name molding that is higher or deeper than the same molding on the other sidewall of the tire, or (b)The outward facing sidewall of an asymmetrical tire that has a particular side that must always face outward when mounted on a vehicle
Light truck (LT) tire	A tire designated by its manufacturer as primarily intended for use on lightweight trucks or multipurpose passenger vehicles
Load rating	The maximum load that a tire is rated to carry for a given inflation pressure
Maximum load rating	The load rating for a tire at the maximum permissible inflation pressure for that tire
Maximum permissible inflation pressure	The maximum cold inflation pressure to which a tire may be inflated
Measuring rim	The rim on which a tire is fitted for physical dimension requirements
Open splice	Any parting at any junction of tread, sidewall, or innerliner that extends to cord material
Outer diameter	The overall diameter of an inflated new tire
Overall width	The linear distance between the exteriors of the sidewalls of an inflated tire, including elevations due to labeling, decorations, or protective bands or ribs
Passenger car tire	A tire intended for use on passenger cars, multipurpose passenger vehicles, and trucks, that have a gross vehicle weight rating (GVWR) of 10,000 lb. or less.
Ply	A layer of rubber-coated parallel cords
Ply separation	A parting of rubber compound between adjacent plies

Tire related term	Meaning
Pneumatic tire	A mechanical device made of rubber, chemicals, fabric and steel or other materials, that, when mounted on an automotive wheel, provides the traction and contains the gas or fluid that sustains the load
Radial ply tire	A pneumatic tire in which the ply cords that extend to the beads are laid at substantially 90 degrees to the centerline of the tread
Reinforced tire	A tire designed to operate at higher loads and at higher inflation pressures than the corresponding standard tire
Section width	The linear distance between the exteriors of the sidewalls of an inflated tire, excluding elevations due to labeling, decoration, or protective bands
Sidewall	That portion of a tire between the tread and bead
Sidewall separation	The parting of the rubber compound from the cord material in the sidewall
Snow tire	A tire that attains a traction index equal to or greater than 110, compared to the ASTM E-1136 Standard Reference Test Tire, when using the snow traction test as described in ASTM F-1805-00, Standard Test Method for Single Wheel Driving Traction in a Straight Line on Snow-and Ice-Covered Surfaces, and which is marked with an Alpine Symbol () on at least one sidewall
Test rim	The rim on which a tire is fitted for testing, and may be any rim listed as appropriate for use with that tire
Tread	That portion of a tire that comes into contact with the road
Tread rib	A tread section running circumferentially around a tire
Tread separation	Pulling away of the tread from the tire carcass

Tire related term	Meaning
Treadwear indicators (TWI)	The projections within the principal grooves designed to give a visual indication of the degrees of wear of the tread
Wheel-holding fixture	The fixture used to hold the wheel and tire assembly securely during testing

*: Table 1 — Occupant loading and distribution for vehicle normal load for various designated seating capacities

Designated seating capacity, Number of occupants	Vehicle normal load, Number of occupants	Occupant distribution in a normally loaded vehicle
2 through 4	2	2 in front
5 through 10	3	2 in front, 1 in second seat
11 through 15	5	2 in front, 1 in second seat, 1 in third seat, 1 in fourth seat
16 through 20	7	2 in front, 2 in second seat, 2 in third seat, 1 in fourth seat

Customizable features

Your vehicle includes a variety of electronic features that can be personalized to your preferences. The settings of these features can be changed by using the multi-information display, the Multimedia Display or at your Toyota dealer.

Some of the customizable features are changed in conjunction with the settings of My Settings. (→P.162)



Customizing vehicle features

■ Changing by using the Multimedia Display

▶ Except for Advanced Park

- 1 Select  on the main menu.
- 2 Select “Vehicle customize” on the sub menu.
- 3 Select the item to change the settings of from the list.

Various setting can be changed. Refer to the list of settings that can be changed for details.

For functions that can be turned on/off, select  (ON)/  (OFF).

▶ For Advanced Park (if equipped)

- 1 Press the Advanced Park main switch.

- 2 Select  on the Multimedia Display, and then select “Advanced Park”.

■ Changing by using the multi-information display

Use the meter control switches to change settings. (→P.92)

- 1 Operate the meter control switch to select . (→P.96)
- 2 Operate the meter control switches to select the desired item to be customized.
- 3 According to the display, select the desired setting.

To go back to the previous screen or exit the customize mode, press



■ During customization

Stop the vehicle in a safe place, apply the parking brake, and shift the shift position to P. Also, to prevent 12-volt battery discharge, leave the hybrid system operating while customizing the features.

WARNING

■ During customization

As the hybrid system needs to be operating during customization, ensure that the vehicle is parked in a place with adequate ventilation. In a closed area such as a garage, exhaust gases including harmful carbon monoxide (CO) may collect and enter the vehicle. This may lead to death or a serious health hazard.

**NOTICE****During customization**

To prevent 12-volt battery discharge, ensure that the hybrid system is operating while customizing features.

Customizable features

Some function settings are changed simultaneously with other functions being customized. Contact your Toyota dealer for further details.

A Settings that can be changed using the Multimedia Display

B Settings that can be changed using the multi-information display

C Settings that can be changed by your Toyota dealer

Definition of symbols: O = Available, — = Not available

Gauges, meters and multi-information display (→P.87, 92)

Function* ¹	Default setting	Customized setting	A	B	C
Language* ²	English	Canadian French	O* ³	O	—
		Mexican Spanish			
Units* ⁴	miles (MPG US)	km (km/L)	O* ³	O	—
		km (L/100 km)			
Hybrid System Indicator	On	Off	—	O	—
EV indicator* ²	On	Off	—	O	—
Eco Guidance (ECO Accelerator Guidance)* ²	On	Off	—	O	—
Fuel Economy	Total Average	Trip Average	—	O	—
		Tank Average			
Audio system linked display* ²	On	Off	—	O	—
AWD system display* ^{2, 5}	On	Off	—	O	—

Function ^{*1}	Default setting	Customized setting	A	B	C
Drive information type ^{*2}	Trip	Total	—	O	—
Drive information items (first item) ^{*2}	Distance	Average Speed	—	O	—
		Total Time	—	O	—
Drive information items (second item) ^{*2}	Total Time	Average Speed	—	O	—
		Distance	—	O	—
Pop-up display ^{*2}	On	Off	—	O	—
Default settings	—	—	—	O	—
Convenience Services (Suggestion function) ^{*2}	On	On (when the vehicle is stopped)	O ^{*6}	—	O
		Off	—	—	—

^{*1}: For details about each function: →P.96

^{*2}: The default setting is changed in conjunction with the settings of My Settings.

^{*3}: The setting can be changed on “General” of .

^{*4}: The default setting varies according to country.

^{*5}: AWD models

^{*6}: The setting can be changed on “Notifications” of .

■ Door lock (→P.113, 505)

Function	Default setting	Customized setting	A	B	C
Unlocking using a mechanical key	Driver's door unlocked in one step, all doors unlocked in two step	All doors unlocked in one step	—	—	O
Automatic door locking function [*]	Shift position linked door locking operation	Off	—	—	—
		Speed linked door locking operation	O	—	O

Function	Default setting	Customized setting	A	B	C
Automatic door unlocking function*	Shift position linked door unlocking operation	Off	O	—	O
		Driver's door linked door unlocking operation			

*: The default setting is changed in conjunction with the settings of My Settings.

■ Rear seat reminder (→P.116)

Function	Default setting	Customized setting	A	B	C
Rear seat reminder function*	On	Off	—	O	O

*: The default setting is changed in conjunction with the settings of My Settings.

■ Smart key system and wireless remote control (→P.113, 119, 131)

Function	Default setting	Customized setting	A	B	C
Operating signal (Buzzers)*	Standard	Desired volume	O	—	O
Operation signal (Emergency flashers)*	On	Off	O	—	O
Time elapsed before automatic door lock function is activated if door is not opened after being unlocked*	60 seconds	Off	O	—	O
		30 seconds			
		120 seconds			
Open door warning buzzer (When locking the vehicle)	On	Off	—	—	O

*: The default setting is changed in conjunction with the settings of My Settings.

■ Smart key system (→P.113, 119, 131)

Function	Default setting	Customized setting	A	B	C
Smart door unlocking* ¹	Driver's door	All the doors	O	—	O
Smart key system	On	Off	—	—	O
Time elapsed before unlocking all the door when gripping and holding the driver's door handle* ²	2 seconds	Off			
		1.5 seconds	—	—	O
		2.5 seconds			
Number of consecutive door lock operations	2 times	As many as desired	—	—	O
Power switch illumination	On	Off	—	—	O

*¹: The default setting is changed in conjunction with the settings of My Settings.

*²: This setting can be changed when the smart door unlocking setting is set to Driver's door.

■ Wireless remote control (→P.108, 113, 119)

Function	Default setting	Customized setting	A	B	C
Unlocking operation*	Driver's door unlocked in one step, all doors unlocked in two step	All doors unlocked in one step	O	—	O
Locking operation when door opened*	On	Off	O	—	O
The function that activates the  switch of the wireless remote control when locking the door (→P.122)	On (Unlocking all the door)	Off			
		On (Unlocking back door only)	—	—	O
Theft deterrent panic mode	On	Off	—	—	O

*: The default setting is changed in conjunction with the settings of My Settings.

■ Power back door*1 (→P.122)

Function	Default setting	Customized setting	A	B	C
Power back door operations	On	Off	—	O	—
Operation buzzer volume	Loud	Soft	—	O	—
		Normal	—	O	—
Opening angle	5	1 to 4	—	O	—
		User setting*2	—	O	—
 switch of the wireless remote control operation	Press and hold	One short press	—	—	O
		Push twice	—	—	O
		Off	—	—	O
Power back door open operation when the back door opener switch is pressed	On	Off	—	—	O
Back door closing assist	On	Off	—	—	O
Close & lock (walk away) function	On	Off	—	—	O

*1: if equipped

*2: The open position is set by the power back door switch. (→P.130)

■ Enabling easier driver entry and exit (power easy access system)*1 (→P.158)

Function	Default setting	Customized setting	A	B	C
Driver's seat slide movement when exiting the vehicle*2	Full	Off	O	—	O
		Partial	O	—	O

*1: If equipped

*2: The default setting is changed in conjunction with the settings of My Settings.

■ Power windows (→P.155)

Function	Default setting	Customized setting	A	B	C
Mechanical key linked operation (open)	Off	On	—	—	O
Mechanical key linked operation (close)	Off	On	—	—	O
Wireless remote control linked operation (open)	Off	On	—	—	O
Wireless remote control linked operation signal (buzzer)	On	Off	—	—	O

■ Power switch (→P.183)

Function	Customized setting	A	B	C
ACC customization Enabling/Disabling ACC mode	On/Off	O	—	O

■ Reverse warning buzzer (→P.187)

Function	Default setting	Customized setting	A	B	C
Signal (buzzer) when the shift position is in R	Off	On	—	—	O

■ Automatic light control system (→P.199)

Function	Default setting	Customized setting	A	B	C
Daytime running lights ^{*1, 2}	On	Off	O	—	O
Light sensor sensitivity ^{*1}	Normal	Brighter	O	—	O
		Bright			
		Dark			
		Darker			

Function	Default setting	Customized setting	A	B	C
Time elapsed before headlights automatically turn off after doors are closed* ¹	30 seconds	Off	O	—	O
		60 seconds			
		90 seconds			
Windshield wiper linked headlight illumination	On	Off	—	—	O

*¹: The default setting is changed in conjunction with the settings of My Settings.

*²: Except for Canada

■ PCS (Pre-Collision System) (→P.222)

Function	Customized setting	A	B	C
Pre-Collision System* ¹	On/Off	—	O	—
Warning timing* ²	Later/Default/Earlier	—	O	—

*¹: The system is automatically enabled each time the power switch is turned to ON.

*²: The default setting is changed in conjunction with the settings of My Settings.

■ LCA (Lane Change Assist)*¹ (→P.239)

Function	Customized setting	A	B	C
Lane Change Assist* ²	On/Off	—	O	—

*¹: If equipped

*²: The default setting is changed in conjunction with the settings of My Settings.

■ LDA (Lane Departure Alert) system (→P.242)

Function	Customized setting	A	B	C
Lane Departure Alert system*	On/Off	—	O	—
Alert timing*	Default/Earlier	—	O	—
Alert options*	Vibration/Beep	—	O	—

*: The default setting is changed in conjunction with the settings of My Settings.

■ Driver break suggestion (→P.242)

Function	Customized setting	A	B	C
Driver break suggestion	On/Off	—	O	—

■ Proactive Driving Assist (→P.248)

Function	Customized setting	A	B	C
Proactive Driving Assist (PDA)*	On/Off	—	O	—
Support sensitivity*	Low/Mid/High	—	O	—
Steering Assist (SA)*	On/Off	—	O	—
Deceleration Assist (DA)*	On/Off	—	O	—
Obstacle Anticipation Assist (OAA)*	On/Off	—	O	—

*: The default setting is changed in conjunction with the settings of My Settings.

■ FCTA (Front Cross Traffic Alert)*¹ (→P.254)

Function	Customized setting	A	B	C
Front Cross Traffic Alert	On/Off	—	O	—
Alert timing* ²	Later/Default/Earlier	—	O	—

*¹: If equipped

*²: The default setting is changed in conjunction with the settings of My Settings.

■ RSA (Road Sign Assist)*¹ (→P.257)

Function	Customized setting	A	B	C
Road Sign Assist* ²	On/Off	—	O	—
Excess speed notification method* ²	None/Visual/Visual & Audible	—	O	—

Function	Customized setting	A	B	C
Other notifications method* ²	None/Visual/Visual & Audible	—	O	—
Excess speed notification level* ²	5 mph (10 km/h) / 3 mph (5 km/h) / 1 mph (2 km/h)	—	O	—

*1: If equipped

*2: The default setting is changed in conjunction with the settings of My Settings.

■ Dynamic Radar Cruise Control (→P.259)

Function	Customized setting	A	B	C
Acceleration setting*	Low/Mid/High	—	O	—
Guide message*	On/Off	—	O	—
Curve speed reduction*	Off/Low/Mid/High	—	O	—

*: The default setting is changed in conjunction with the settings of My Settings.

■ BSM (Blind Spot Monitor)* (→P.275)

Function	Default setting	Customized setting	A	B	C
BSM (Blind Spot Monitor)	On	Off	—	O	—
Outside rear view mirror indicator brightness	Bright	Dim	—	O	—
Alert timing for presence of approaching vehicle (sensitivity)	Intermediate	Early	—	O	—
		Late	—	O	—

*: If equipped

■ Safe Exit Assist* (→P.280)

Function	Default setting	Customized setting	A	B	C
Safe Exit Assist	On	Off	—	O	—
Outside rear view mirrors display	On	Off	—	O	—

Function	Default setting	Customized setting	A	B	C
Detection sensitivity	Middle	High	—	O	—
		Low	—	O	—

*: If equipped

■ Intuitive parking assist (→P.284)

Function	Default setting	Customized setting	A	B	C
Intuitive parking assist	On	Off	—	O	—
Buzzer volume of Intuitive parking assist when operating ^{*1}	Level2	Level1	—	O	O
		Level3	—	O	O
Distance from which the front center sensor starts detection	Standard	Near	O ^{*2}	—	O
Distance from which the rear center sensor starts detection	Standard	Near	O ^{*2}	—	O
Distance from which the corner sensors start detection	Standard	Near	—	—	O

^{*1}: The sound volume is linked among the intuitive parking assist, RCTA^{*3}, and RCD^{*3}.

^{*2}: For vehicles with panoramic view monitor, the setting can be changed on the panoramic view monitor settings screen. For details, refer to "MULTIMEDIA OWNER'S MANUAL". A setting changed at a Toyota dealer cannot be further changed on the panoramic view monitor settings screen.

^{*3}: If equipped

■ RCTA (Rear Cross Traffic Alert) function^{*3} (→P.294)

Function	Default setting	Customized setting	A	B	C
RCTA (Rear Cross Traffic Alert)	On	Off	—	O	—

Function	Default setting	Customized setting	A	B	C
Buzzer volume of RCTA when operating ^{*1, 2}	Level2	Level1	—	O	—
		Level3	—	O	—

^{*1}: This setting changes in accordance with My Settings

^{*2}: The sound volume is linked among the intuitive parking assist, RCTA^{*3}, and RCD^{*3}.

^{*3}: If equipped

■ RCD (Rear Camera Detection) function* (→P.299)

Function	Default setting	Customized setting	A	B	C
RCD (Rear Camera Detection) function	On	Off	—	O	—

*: If equipped

■ PKSB (Parking Support Brake)* (→P.303)

Function	Default setting	Customized setting	A	B	C
PKSB (Parking Support Brake) function	On	Off	—	O	O

*: If equipped

■ Toyota Teammate Advanced Park* (→P.316)

Function	Default setting	Customized setting	A	B	C
Remote Park	On	Off	O	—	—
Vehicle speed during operation	Normal	Slow	O	—	—
		Fast	O	—	—
Distance to objects	Normal	Far	O	—	—
Preferred parking method	Parallel	Perpendicular	O	—	—
Preferred parking direction	Forward	Reverse	O	—	—

Function	Default setting	Customized setting	A	B	C
Preferred exit direction (perpendicular)	Right	Left	O	—	—
Preferred exit direction (parallel)	Left	Right	O	—	—
Camera view when parking	Normal	Wide	O	—	—
Camera view when exiting	Wide	Normal	O	—	—
Parking path adjustment	0 (Centered)	-3 (Inward) to 3 (Outward)	O	—	—
Road width adjustment	Normal	Slightly narrow	O	—	—
		Narrow			
Park position adjustment (forward)	0 (Centered)	-3 (Rearward) to +3 (Frontward)	O	—	—
Park position adjustment (reverse)	0 (Centered)	-3 (Rearward) to +3 (Frontward)	O	—	—
Rear accessory setting	Off	3.9 in. (10 cm)	O	—	—
		7.9 in. (20 cm)			
		11.8 in. (30 cm)			
		15.7 in. (40 cm)			
Clear registered parking space	-	-	O	—	—

*: If equipped

■ Driving mode select switch (→P.343)

Function	Default setting	Customized setting	A	B	C
Powertrain control in custom mode	Normal	Sport	O	—	—
		Eco			

Function	Default setting	Customized setting	A	B	C
Steering wheel control in custom mode	Normal	Sport	0	—	—
Air conditioning operation in custom mode	Normal	Eco	0	—	—

■ Automatic air conditioning system (→P.358)

Function	Default setting	Customized setting	A	B	C
A/C auto switch operation*	On	Off	0	—	0

*: The default setting is changed in conjunction with the settings of My Settings.

■ Illumination (→P.368)

Function	Default setting	Customized setting	A	B	C
Time elapsed before the interior lights turn off* ¹	15 seconds	Off	0	—	0
		7.5 seconds			
		30 seconds			
Operation after the power switch is turned off	On	Off	—	—	0
Operation when the doors are unlocked	On	Off	—	—	0
Operation when you approach the vehicle with the electronic key on your person	On	Off	—	—	0
Footwell lights* ²	On	Off	—	—	0
Instrument panel ornament lights* ²	On	Off	—	—	0
Illumination notification* ^{2,3}	On	Off	—	—	0

*¹: The default setting is changed in conjunction with the settings of My Settings.

*2: If equipped

*3: If the instrument panel ornament lights is set to Off, this setting will also be set to Off.

■ Vehicle customization

- When the smart key system is off, the entry unlock function cannot be customized.
- When the doors remain closed after unlocking the doors and the timer activated automatic door lock function activates, signals will be generated in accordance with the operation buzzer volume and operational signal (Emergency flashers) function settings.
- Some settings can be changed using a switch or the Multimedia Display. If a setting is changed using a switch, the changed setting will not be reflected on the Multimedia Display until the power switch is turned off and then turned back to ON.

Items to initialize

The following items must be initialized for normal system operation after such cases as the battery being reconnected, or maintenance being performed on the vehicle:

List of the items to initialize

Item	When to initialize	Reference
Power back door*	<ul style="list-style-type: none"> • After reconnecting or changing the battery • After changing a fuse 	P.127
Power windows	When functioning abnormally	P.155
Maintenance required reminder message	<ul style="list-style-type: none"> • After the maintenance is performed 	P.406
Oil maintenance	After the maintenance is performed	P.417

*: If equipped

9-1. For owners

Reporting safety defects for
U.S. owners..... 556

Reporting safety defects for
Canadian owners 557

Seat belt instructions for
Canadian owners (in
French)..... 557

SRS airbag instructions for
Canadian owners (in
French)..... 559

Headlight aim instructions
for Canadian owners (in
French)..... 566

Reporting safety defects for U.S. owners

If you believe that your vehicle has a defect which could cause a crash or could cause injury or death, you should immediately inform the National Highway Traffic Safety Administration (NHTSA) in addition to notifying Toyota Motor Sales, U.S.A., Inc. (Toll-free: 1-800-331-4331).

If NHTSA receives similar complaints, it may open an investigation, and if it finds that a safety defect exists in a group of vehicles, it may order a recall and remedy campaign. However, NHTSA cannot become involved in individual problems between you, your dealer, or Toyota Motor Sales, U.S.A., Inc.

To contact NHTSA, you may call the Vehicle Safety Hotline toll-free at 1-888-327-4236 (TTY: 1-800-424-9153); go to <http://www.safercar.gov>; or write to: Administrator, NHTSA, 1200 New Jersey Ave. SE., Washington, DC 20590. You can also obtain other information about motor vehicle safety from <http://www.safercar.gov>.

Reporting safety defects for Canadian owners

Canadian customers who wish to report a safety-related defect to Transport Canada, Defects Investigations and Recalls, may telephone the toll-free hotline 1-800-333-0510, mail Transport Canada - ASFAD, 330 Sparks Street, Ottawa, ON, K1A 0N5, or complete the online form at <https://www.tc.gc.ca/recalls>.

Seat belt instructions for Canadian owners (in French)

The following is a French explanation of seat belt instructions extracted from the seat belt section in this manual.

See the seat belt section for more detailed seat belt instructions in English.

Utilisation adéquate des ceintures de sécurité

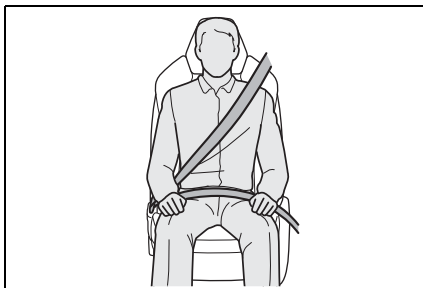

- Tirez sur la ceinture épaulière jusqu'à ce qu'elle recouvre entièrement l'épaule; elle ne doit cependant pas toucher le cou ni glisser de l'épaule.
- Placez la ceinture abdominale le plus bas possible sur les hanches.
- Réglez la position du dossier. Tenez-vous assis bien au fond du siège, le dos droit.
- Ne vrillez pas la ceinture de sécurité.

Entretien et soin

■ Manipulation des ceintures de sécurité

Avec un chiffon ou une éponge, nettoyez à l'aide d'un savon doux et de l'eau tiède. Vérifiez aussi les ceintures régulièrement pour vous assurer qu'elles ne présentent pas d'usure excessive, d'effilochage ou de coupures.



AVERTISSEMENT

■ Dommages et usure de la ceinture de sécurité

Vérifiez périodiquement le système de ceintures de sécurité. Vérifiez qu'il n'y a pas de coupures, d'effilochures ni de pièces desserrées. N'utilisez pas une ceinture de sécurité endommagée avant qu'elle ne soit remplacée. Les ceintures de sécurité endommagées ne peuvent pas protéger les occupants contre les blessures graves, voire mortelles.

SRS airbag instructions for Canadian owners (in French)

The following is a French explanation of SRS airbag instructions extracted from the SRS airbag section in this manual.

See the SRS airbag section for more detailed SRS airbag instructions in English.

Système de coussins gonflables SRS

■ Emplacement des coussins gonflables SRS

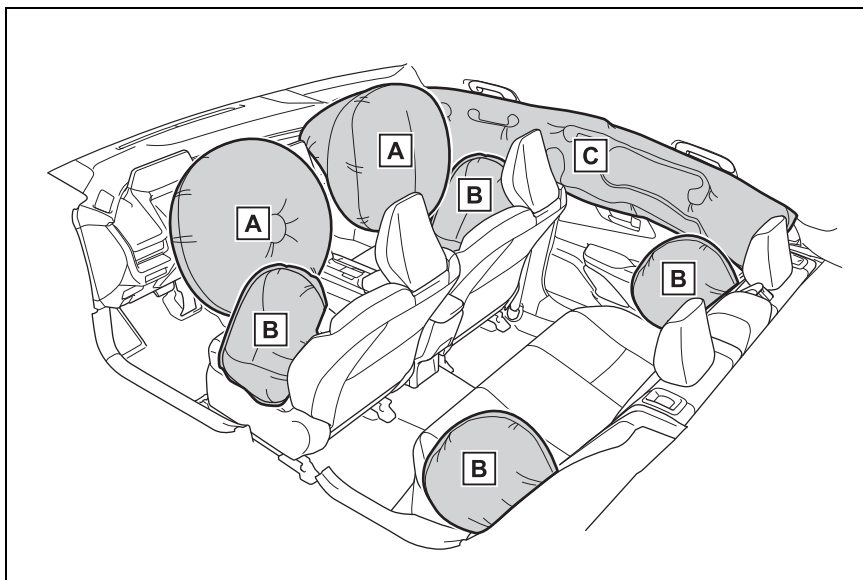

A Coussin gonflable SRS du conducteur/coussin gonflable SRS du passager avant

Permettent de réduire les blessures par choc à la tête et à la poitrine du conducteur et du passager avant

B Coussins gonflables SRS latéraux

- Permettent de réduire les blessures par choc à la poitrine des occupants des sièges avant
- Permettent de réduire les blessures par choc à la poitrine des occupants des sièges latéraux arrière

C Coussins gonflables SRS en rideau

- Permettent de réduire les blessures par choc à la tête des occupants des

sièges avant et latéraux arrière

- Peuvent permettre d'éviter que les occupants soient éjectés du véhicule en cas de tonneaux

■ Composants du système de coussins gonflables SRS

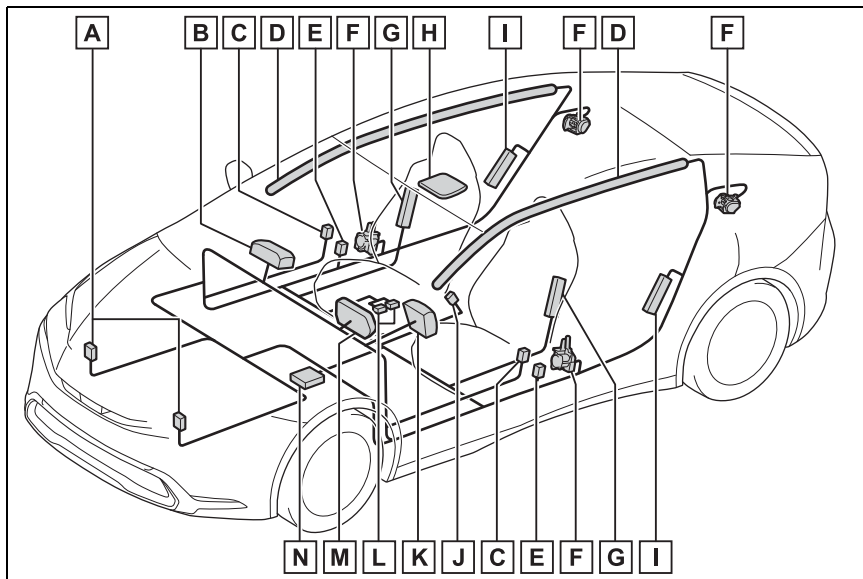

- A** Capteurs d'impact avant
- B** Coussin gonflable du passager avant
- C** Capteurs d'impact latéral (portière avant)
- D** Coussins gonflables en rideau
- E** Capteurs d'impact latéral (avant)
- F** Limiteurs de force et dispositifs de tension des ceintures de sécurité
- G** Coussins gonflables latéraux avant
- H** Voyants "AIR BAG ON" et "AIR BAG OFF"
- I** Coussins gonflables latéraux arrière
- J** Contacteur de boucle de ceinture de sécurité du passager avant
- K** Coussin gonflable du conducteur
- L** Capteurs du système de classification de l'occupant du siège du passager avant

M Lampe témoin SRS

N Module de capteur de coussin gonflable

Votre véhicule est doté de COUSSINS GONFLABLES ÉVOLUÉS dont la conception s'appuie sur les normes de sécurité des véhicules à moteur américains (FMVSS208). Le module de capteur de coussin gonflable (ECU) contrôle le déploiement des coussins gonflables en fonction des informations obtenues des capteurs et d'autres éléments affichés dans le diagramme des composants du système ci-dessus. Ces informations comprennent des données relatives à la gravité de l'accident et aux occupants. Au moment du déploiement des coussins gonflables, une réaction chimique se produit dans les gonfleurs de coussin gonflable et les coussins gonflables se remplissent rapidement d'un gaz non toxique pour aider à limiter le mouvement des occupants.



AVERTISSEMENT

■ Précautions relatives aux coussins gonflables SRS

Observez les précautions suivantes. Négliger de le faire pourrait occasionner des blessures graves, voire mortelles.

- Le conducteur et tous les passagers doivent porter leur ceinture de sécurité de la manière appropriée. Les coussins gonflables SRS sont des dispositifs supplémentaires qui doivent être utilisés avec les ceintures de sécurité.

- Le coussin gonflable SRS du conducteur se déploie avec une force considérable et peut occasionner des blessures graves, voire mortelles, notamment lorsque le conducteur se trouve très près du coussin gonflable. La National Highway Traffic Safety Administration (NHTSA), aux États-Unis, fait les recommandations suivantes :

La zone à risque du coussin gonflable du conducteur couvre 2 à 3 in. (50 à 75 mm) de la zone de déploiement du coussin gonflable. Pour assurer une marge de sécurité suffisante, restez à 10 in. (250 mm) du coussin gonflable. Cette distance est mesurée du centre du volant à votre sternum. Si votre position de conduite actuelle vous place à moins de 10 in. (250 mm) du coussin gonflable du conducteur, vous pouvez changer votre position de plusieurs manières :



AVERTISSEMENT

- Reculez votre siège à la position maximale vous permettant d'atteindre encore aisément les pédales.
- Inclinez légèrement le dossier du siège vers l'arrière. Bien que les véhicules soient conçus différemment, la plupart des conducteurs peuvent maintenir une distance de 10 in. (250 mm), même si leur siège est avancé au maximum, simplement en inclinant légèrement le dossier du siège vers l'arrière. Si la visibilité avant est compromise après avoir incliné le dossier du siège, utilisez un coussin ferme et non glissant pour être assis plus haut ou relevez le siège si cette option est disponible sur votre véhicule.
- Si votre volant est réglable en hauteur, inclinez-le vers le bas. Cela vous permet d'orienter le coussin gonflable vers votre buste plutôt que vers votre tête et vers votre cou. Le siège doit être réglé de la manière recommandée par la NHTSA, tout en vous permettant de conserver le contrôle des pédales et du volant du véhicule, ainsi que la vue sur les commandes du tableau de bord.

- Si la rallonge de ceinture de sécurité a été reliée à la boucle de la ceinture de sécurité du siège du passager, mais que la plaque de blocage de la ceinture de sécurité du siège du passager n'a pas été bloquée sur la rallonge de ceinture de sécurité, le système de coussins gonflables SRS considérera que l'occupant porte tout de même sa ceinture de sécurité même si la ceinture de sécurité n'est pas bouclée. Les coussins gonflables SRS du passager avant peuvent alors ne pas se déployer correctement lors d'une collision, ce qui pourrait occasionner des blessures graves, voire mortelles. Assurez-vous de toujours porter la ceinture de sécurité correctement lors de l'usage d'une rallonge de ceinture de sécurité.

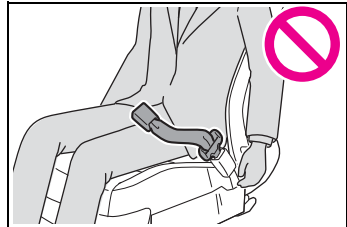

- Le coussin gonflable SRS du passager avant se déploie avec une force considérable et peut occasionner des blessures graves, voire mortelles, notamment lorsque le passager avant se trouve très près du coussin gonflable. Le siège du passager avant doit être positionné le plus loin possible du coussin gonflable avec le dossier de siège réglé de façon à ce que le passager soit assis bien droit sur son siège.

⚠ AVERTISSEMENT

- Le déploiement d'un coussin gonflable risque d'infliger des blessures graves, voire mortelles, aux bébés et aux enfants mal assis et/ou mal attachés. Un bébé ou un enfant trop petit pour utiliser une ceinture de sécurité doit être correctement retenu à l'aide d'un dispositif de retenue pour enfants. Toyota recommande vivement de placer et d'attacher correctement tous les bébés et tous les enfants sur les sièges arrière du véhicule à l'aide de dispositifs de retenue adaptés. Les sièges arrière sont plus sécuritaires pour les bébés et les enfants que le siège du passager avant.
- N'installez jamais un dispositif de retenue pour enfants de type dos à la route sur le siège du passager avant, même si le voyant "AIR BAG OFF" est allumé. En cas d'accident, la force et la vitesse de déploiement du coussin gonflable du passager avant pourraient infliger à l'enfant des blessures graves, voire mortelles, si le dispositif de retenue pour enfants de type dos à la route était installé sur le siège du passager avant.
- Ne vous asseyez pas sur le bord du siège et ne vous appuyez pas sur la planche de bord.

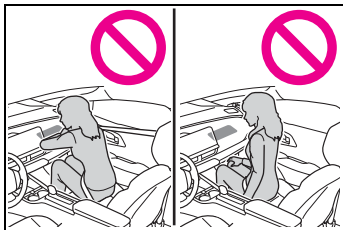

- Ne laissez pas un enfant se tenir face au coussin gonflable SRS du passager avant ni s'asseoir sur les genoux d'un passager avant.
- Les occupants des sièges avant ne doivent jamais placer d'objets sur leurs genoux.

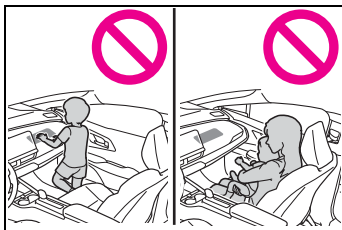

- Ne vous appuyez pas sur la portière ou sur un brancard de pavillon, ni sur un montant avant, latéral ou arrière.



- Ne laissez personne s'agenouiller face à la portière, ni sortir la tête ou les mains à l'extérieur du véhicule.

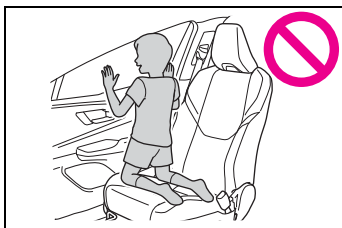



AVERTISSEMENT

- Ne fixez et n'appuyez rien sur des zones comme la planche de bord ou le tampon de volant.

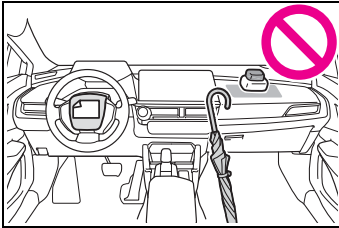

- Ne fixez rien sur des zones telles que les portières, le pare-brise, les glaces latérales, les montants avant ou arrière, les brancards de pavillon et les poignées de maintien.

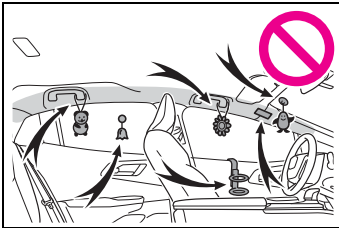

- N'utilisez pas d'accessoires de sièges recouvrant les parties d'où les coussins gonflables SRS se déploient, car ils pourraient entraver le gonflage des coussins gonflables SRS. De tels accessoires peuvent empêcher les coussins gonflables SRS de se déployer correctement, rendre le système inopérant ou provoquer accidentellement le déploiement des coussins gonflables SRS, ce qui serait susceptible d'occasionner des blessures graves, voire mortelles.

- Ne frappez jamais et n'exercez aucune pression excessive sur les composants du système de coussins gonflables SRS, les portières avant, ni au niveau des zones environnantes. Cela peut provoquer un mauvais fonctionnement des coussins gonflables SRS.

- Ne touchez à aucun composant des coussins gonflables SRS immédiatement après leur déploiement (gonflage), car ils pourraient être chauds.

- Si vous avez de la difficulté à respirer après le déploiement des coussins gonflables SRS, ouvrez une portière ou une glace pour laisser entrer l'air frais, ou quittez le véhicule si vous pouvez le faire en toute sécurité. Dès que possible, nettoyez tous les résidus afin d'éviter les irritations cutanées.

- Si une pièce abritant un coussin gonflable SRS est endommagée ou fissurée, faites-la remplacer par votre concessionnaire Toyota.

- Ne placez aucun objet, par exemple un coussin, sur le siège du passager avant. Cela disperserait le poids du passager, ce qui empêcherait le capteur de le détecter correctement. Ceci pourrait empêcher le déploiement des coussins gonflables SRS du siège du passager avant en cas de collision.

**AVERTISSEMENT****■ Modification et mise au rebut des composants du système de coussins gonflables SRS**

Ne mettez pas votre véhicule au rebut et n'effectuez aucune des modifications suivantes sans d'abord consulter votre concessionnaire Toyota. Les coussins gonflables SRS pourraient fonctionner de manière incorrecte ou se déployer accidentellement, ce qui serait susceptible d'occasionner des blessures graves, voire mortelles.

- Retrait, installation, démontage ou réparation des coussins gonflables SRS
- Réparation, retrait ou modification des pièces suivantes ou de leurs parties environnantes
 - Volant
 - Tableau de bord
 - Planche de bord
 - Sièges
 - Capitonnage des sièges
 - Montants avant
 - Montants latéraux
 - Montants arrière
 - Brancards de pavillon
 - Panneaux des portières avant
 - Garnitures des portières avant
 - Haut-parleurs des portières avant
- Modifications des panneaux des portières avant (comme les perforer)
- Réparation ou modification des pièces suivantes ou de leurs parties environnantes

- Aile avant
- Pare-chocs avant
- Parties latérales de l'intérieur du véhicule
- Installation des parties ou accessoires suivants
- Barres safari ou barres kangourou
- Lames de déneigement
- Treuils
- Porte-bagages de toit
- Modifications de la suspension du véhicule
- Installation d'appareils électroniques tels qu'un émetteur-récepteur radio (émetteur de fréquences radio) ou un lecteur de CD
- Modifications à votre véhicule pour une personne aux capacités physiques réduites

Headlight aim instructions for Canadian owners (in French)

The following is a French explanation of headlight aim instructions from the headlight aim section in this manual.

Boulons de réglage vertical

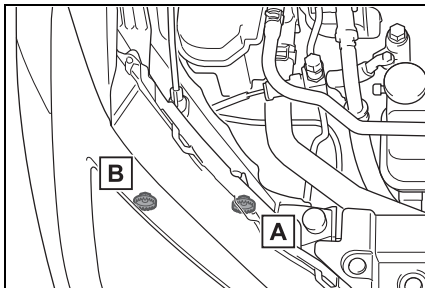

A Boulon de réglage A

B Boulon de réglage B

Avant de vérifier la portée des phares

- Assurez-vous que le réservoir de carburant du véhicule est plein et que la partie de carrosserie située autour des phares n'est pas déformée.
- Garez le véhicule sur un sol parfaitement horizontal.
- Assurez-vous que la pression de gonflage des pneus est au niveau prescrit.

- Demandez à quelqu'un de s'asseoir sur le siège du conducteur.
- Faites rebondir le véhicule à plusieurs reprises.

Réglage de la portée des phares

- 1 Tournez le boulon A vers la droite ou vers la gauche à l'aide d'un tournevis cruciforme.

Retenez le sens de rotation et le nombre de tours.

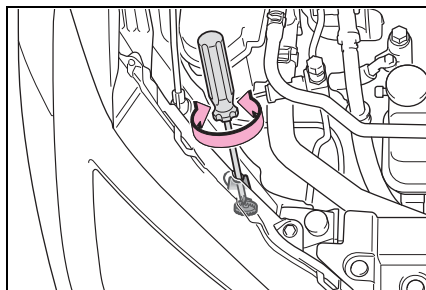

- 2 Tournez le boulon B du même nombre de tours et dans le même sens qu'à l'étape 1.

Si vous n'arrivez pas à régler vos phares en suivant cette procédure, apportez le véhicule chez votre concessionnaire Toyota afin qu'il règle la portée des phares.

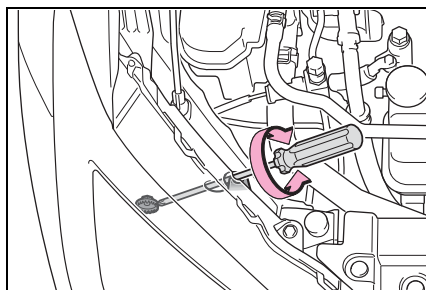

Index

- What to do if... (Trouble-
shooting) 568
- Alphabetical Index 570

What to do if... (Troubleshooting)

If you have a problem, check the following before contacting your Toyota dealer.

The doors cannot be locked, unlocked, opened or closed



You lose your keys

- If you lose your keys or mechanical keys, new genuine keys or mechanical keys can be made by your Toyota dealer. (→P.504)
- If you lose your electronic keys, the risk of vehicle theft increases significantly. Contact your Toyota dealer immediately. (→P.504)



The doors cannot be locked or unlocked

- Is the key battery weak or depleted? (→P.446)
- Is the power switch in ON? When locking the doors, turn the power switch off. (→P.183)
- Is the electronic key left inside the vehicle? When locking the doors, make sure that you have the

electronic key on your person.

- The function may not operate properly due to the condition of the radio wave. (→P.133)



The rear door cannot be opened

- Is the child-protector lock set? The rear door cannot be opened from inside the vehicle when the lock is set. Open the rear door from outside and then unlock the child-protector lock. (→P.117)

If you think something is wrong



The hybrid system does not start

- Did you press the power switch while firmly depressing the brake pedal? (→P.180)
- Is the shift position in P? (→P.180)
- Is the electronic key anywhere detectable inside the vehicle? (→P.132)
- Is the electronic key battery weak or depleted? In this case, the hybrid system can be started in a temporary way. (→P.506)

- Is the 12-volt battery discharged? (→P.507)



The windows do not open or close by operating the power window switches

- Is the window lock switch pressed?
The power window except for the one at the driver's seat cannot be operated if the window lock switch is pressed. (→P.157)



The power switch is turned off automatically

- The auto power off function will be operated if the vehicle is left in ACC or ON (the hybrid system is not operating) for a period of time. (→P.184)



A warning buzzer sounds during driving

- The seat belt reminder light is flashing
Are the driver and the passengers wearing the seat belts? (→P.470)
- The parking brake indicator is on

Is the parking brake released?
(→P.193)

Depending on the situation, other types of warning buzzer may also sound. (→P.463, 475)



A warning buzzer sounds when leaving the vehicle

- Is the message displayed on the multi-information display? Check the message on the multi-information display. (→P.475)



A warning light turns on or a warning message is displayed

- When a warning light turns on or a warning message is displayed, refer to P.463, 475.

When a problem has occurred



If you have a flat tire

- Stop the vehicle in a safe place and replace the flat tire with the spare tire. (→P.495)



The vehicle becomes stuck

- Try the procedure for when the vehicle becomes stuck in mud, dirt, or snow. (→P.515)

Alphabetical Index

A

A/C	358
Air conditioning eco mode	361
Air conditioning filter	441
Automatic air conditioning system	358
ABS (Anti-lock Brake System)	345
Function	345
Warning light	465
ACA (Active Cornering Assist)	345
Acoustic Vehicle Alerting System	72
Active Cornering Assist (ACA)	345
AHB (Automatic High Beam)	202
Airbags	35
Airbag operating conditions	37
Airbag precautions for your child	40
Airbag warning light	465
Correct driving posture	29
Curtain shield airbag operating conditions	38
Curtain shield airbag precautions	40
Front passenger occupant classification system	44
General airbag precautions	40
Location of the SRS airbags ..	35
Locations of airbags	35
Modification and disposal of airbags	42
Seat cushion airbag	35
Side airbag operating conditions	38
Side airbag precautions	40
Side and curtain shield airbags operating conditions	38
Side and curtain shield airbags	

precautions	40
SRS airbags	35
SRS warning light	465
Air conditioning filter	441
Air conditioning system	358
Air conditioning eco mode	361
Air conditioning filter	441
Automatic air conditioning system	358
Alarm	
Warning buzzer	463
Anchor brackets	53, 62
Antenna	
Smart key system	131
Anti-lock brake system (ABS)	345
Function	345
Warning light	465
Armrest	386
Assist grips	387
Automatic air conditioning system	358
Air conditioning eco mode	361
Air conditioning filter	441
Automatic door locking and unlocking systems	118
Automatic High Beam (AHB)	202
Automatic light control system	200
Average fuel economy	93
Average vehicle speed	93

B

Back door	119
Power back door	122
Wireless remote control	122
Back-up lights	
Replacing exterior lights	452
Battery (12-volt battery)	422
If the 12-volt battery is discharged	507
Preparing and checking before winter	353

Replacing 509
 Warning light 463
Battery (traction battery) 74
Blind Spot Monitor (BSM)..... 275
Bottle holders 373
Brake
 Brake Hold 196
 Fluid 420
 Parking brake 193
 Regenerative braking 71
 Warning light 463
Brake assist 345
Brake Hold 196
Brake Override System..... 168
Break-in tips 168
Brightness control
 Instrument panel light control . 91
BSM (Blind Spot Monitor)..... 275

C

Care
 Aluminum wheels 398
 Exterior 398
 Interior 402
 Seat belts 402
Cargo capacity 174, 177
Cargo hooks 375
Catch protection function
 Power windows 155
Chains 355
Child-protector lock 117
Child restraint system 51
 Fixed with a LATCH system... 60
 Fixed with a seat belt 55
 Front passenger occupant classification system 44
 Points to remember 51
 Riding with children 50
 Types of child restraint system installation method 53
 Using an anchor bracket 62
Child safety 50

12-volt battery precautions .422, 510
 Airbag precautions 40
 Back door precautions..... 119
 Child restraint system 53
 Heated steering wheel precautions 365
 How your child should wear the seat belt..... 32
 Power window precautions... 156
 Rear door child-protector lock 117
 Removed key battery precautions 447
 Seat belt extender precautions 32
 Seat belt precautions..... 31
 Seat heater precautions 365
 Window lock switch 157
Cleaning 398, 402
 Aluminum wheels 398
 Exterior 398
 Interior 402
 Radar sensor 276
 Seat belts 402
Condenser 419
Console box 372
Coolant
 Capacity 522
 Checking 418
 Preparing and checking before winter..... 353
 Warning light 464
Cooling system..... 418
 Hybrid system overheating ... 512
Coussins gonflables
 Emplacement des coussins gonflables SRS..... 559
 Modification et mise au rebut des coussins gonflables 565
 Précautions générales relatives aux coussins gonflables 561

Précautions relatives aux coussins gonflables en rideau	561
Précautions relatives aux coussins gonflables latéraux et en rideau	561
Précautions relatives aux coussins gonflables latéraux	561
Précautions relatives aux coussins gonflables pour vos enfants	561
Cruise control	
Cruise control	269
Dynamic radar cruise control	259
Cup holders	372
Current fuel economy	93
Curtain shield airbags	35
Customizable features	538
Custom mode	343

D

Daytime running light system	200
Replacing exterior lights	452
Deck board	375
Deck under tray	376
Defogger	
Outside rear view mirrors	360
Rear window	360
Windshield.....	359
Digital Rear-view Mirror	145
Dimensions	518
Dinghy towing	179
Display	
Cruise control	269
Driving information	93
Dynamic radar cruise control	262
Energy monitor	102
Intuitive parking assist.....	284
Multi-information display	92
Parking Support Brake function (rear pedestrians).....	315
RCD (Rear Camera Detection)	300
RCTA.....	294
Warning messages.....	475
Do-it-yourself maintenance .	406, 410
Door lock	
Back door	120
Side doors	113
Smart key system.....	131
Wireless remote control.....	110
Doors	
Automatic door locking and unlocking system.....	118
Back door	119
Door glasses	155
Door lock	113
Open door warning buzzer ...	117
Outside rear view mirrors	153
Rear door child-protector lock	117
Side doors	113
Driver's seat belt reminder light	470
Driver's seat position memory	159
Driving position memory.....	159
Memory recall function	160
Drive-Start Control (DSC)	173
Sudden start restraint control	173
Driving	167
Break-in tips	168
Correct posture.....	29
Driving in the rain	168
Driving mode select switch ...	343
Hybrid Electric Vehicle driving tips.....	351
Procedures	167
Winter drive tips.....	353
Driving information display	93
Driving mode select switch ...	343
Driving position memory	158
Memory recall function	160
Power easy access system ..	158

Seat position memory 159
Driving support system information display **95**
Dynamic radar cruise control
 Function 259
 Warning message 475

E

Eco drive mode **343**
EDR (Event data recorder)..... **10**
E-Four (Electronic On-Demand AWD system)..... **346**
Elapsed time **95**
Electric motor
 Location 70
 Specification 520
Electric Power Steering (EPS)
 Function 345
 Warning light 466
Electronic key
 Battery-saving function 132
 If the electronic key does not operate properly 505
 Replacing the battery 446
Emergency, in case of
 If a warning buzzer sounds .. 463
 If a warning light turns on 463
 If a warning message is displayed 475
 If the 12-volt battery is discharged 507
 If the electronic key does not operate properly 505
 If the hybrid system will not start 503
 If the vehicle is submerged or water on the road is rising .. 456
 If you have a flat tire 483, 495
 If you lose your keys 504
 If you think something is wrong 461
 If your vehicle becomes stuck

.....515
 If your vehicle has to be stopped in an emergency 455
 If your vehicle needs to be towed 457
 If your vehicle overheats 512
Emergency Driving Stop System **272**
Emergency flashers **454**
Emergency tire puncture repair kit **483**
Energy monitor **102**
Engine
 Compartment 415
 Hood 412
 Identification number 519
Engine coolant
 Capacity 522
 Checking 418
 Preparing and checking before winter 353
 Warning light 464
Engine coolant temperature gauge **87**
Engine oil
 Capacity 520
 Checking 415
 Preparing and checking before winter 353
 Warning light 464
Engine oil maintenance data **91, 417**
Enhanced Vehicle Stability Control (Enhanced VSC)..... **345**
Enhanced VSC (Enhanced Vehicle Stability Control)..... **345**
EPS (Electric Power Steering)
 Function 345
 Warning light 466
EV drive mode..... **185**
Event data recorder (EDR)..... **10**
EV indicator..... **71**

F

FCTA (Front Cross Traffic Alert)254

Flat tire483, 495
Tire pressure warning system
.....427

Floor mats28

Fluid

- Brake420, 523
- Hybrid transmission.....522
- Rear differential.....523
- Washer.....421

Footwell lights368

Front Cross Traffic Alert (FCTA)
.....254

Front doors113

**Front passenger's seat belt
reminder light**470

**Front passenger occupant clas-
sification system**44

Front seat heaters366

Front seats137

- Adjustment137
- Cleaning402
- Correct driving posture.....29
- Driving position memory.....158
- Head restraints.....140
- Memory recall function.....160
- Power easy access system..158
- Seat heaters.....366
- Seat position memory159
- Seat ventilators367

Front side marker lights199

- Replacing exterior lights.....452
- Switch.....199

Front turn signal lights192

- Replacing exterior lights.....452
- Turn signal lever.....192

Fuel

- Capacity519
- Fuel gauge87

- Information526
- Refueling210
- Type519, 526
- Warning light470

Fuel filler door.....211

- Opener switch211
- Refueling210

Fuel gauge.....87

Fuses448

G

Garage door opener389

Gauges87

Glove box372

H

Headlights199

- AHB (Automatic High Beam sys-
tem)202
- Indicator.....84
- Replacing exterior lights.....452
- Switch.....199

Headlights aim451

Head restraints140

Heated steering wheel.....366

Heaters

- Automatic air conditioning sys-
tem358
- Heated steering wheel.....366
- Outside rear view mirrors360
- Seat heaters366

High mounted stoplight

- Replacing exterior lights.....452

Hill-start assist control.....345

Hood412

Hooks

- Cargo hooks375
- Retaining hooks (floor mat)28

Horn143

Hybrid battery (traction battery)

- Location74

Specification 520

Hybrid battery air vent 77

Hybrid system 70

ACC 183

Brake Override System 168

Drive-Start Control (DSC) 173

Emergency shut off system 78

Energy monitor/consumption
screen 102

EV drive mode 185

High voltage components 74

How to start the hybrid system
..... 180

Hybrid Electric Vehicle driving
tips 351

Hybrid System Indicator 87

Hybrid system precautions 74

If the hybrid system will not start
..... 503

If your vehicle has to be stopped
in an emergency 455

Ignition switch (power switch)
..... 180

Overheating 512

Power (ignition) switch 180

Regenerative braking 71

Starting the hybrid system 180

Hybrid System Indicator 87

Hybrid transmission 187

I

I/M test 409

Identification

Engine 519

Vehicle 518

Ignition switch (power switch)
..... 180

Auto power off function 184

Changing the power switch
modes 183

If your vehicle has to be stopped
in an emergency 455

Starting the hybrid system 180

Illuminated entry system 368

Illumination notification 370

Immobilizer system 79

Indicators 82

Initialization 553

Items to initialize 553

Maintenance required reminder
message 406

Oil maintenance 417

Power back door 127

Power windows 155

Inside rear view mirror 144

Instrument panel light control . 91

**Instrument panel ornament
lights** 368

Interior lights 368

Intuitive parking assist

Function 284

Warning message 286

J

Jack

Positioning a floor jack 413

Vehicle-equipped jack . 484, 496

Jack handle 484, 496

Jam protection function

Driving position memory 159

Memory recall function 162

Power back door 125

Power easy access system .. 159

Power windows 155

K

Keyless entry

Smart key system 131

Wireless remote control 110

Keys 108

Battery-saving function 132

Electronic key 108

If the electronic key does not

operate properly	505
If you lose your keys	504
Key number plate	108
Keyless entry.....	110, 131
Mechanical key	110
Power switch	180
Replacing the battery	446
Warning buzzer	132
Wireless remote control key.	110
Knee airbags.....	35

L

Lane Change Assist (LCA)	239
Lane Departure Alert (LDA) ...	242
Lane Tracing Assist (LTA).....	234
Operation	234
LATCH anchors	60
LCA (Lane Change Assist)	239
LDA (Lane Departure Alert) ...	242
Lever	
Auxiliary catch lever	412
Hood lock release lever.....	412
Shift lever	187
Tilt and telescopic steering lock release lever.....	143
Turn signal lever.....	192
Wiper lever	205
License plate lights	199
Replacing exterior lights.....	452
Switch.....	199
Lights	
AHB (Automatic High Beam sys- tem).....	202
Footwell lights	368
Front personal lights.....	369
Headlight switch	199
Illuminated entry system	368
Illumination notification.....	370
Interior light list	368
Interior lights.....	369
Luggage compartment light 121, 125	

Personal lights.....	369
Rear personal lights	369
Replacing exterior lights	452
Shift lever light.....	368
Turn signal lever.....	192
Vanity lights	378
Load capacity.....	177
LTA (Lane Tracing Assist).....	234
Operation.....	234
Luggage compartment light 121, 125	
Luggage cover	377

M

Maintenance

Do-it-yourself maintenance ..	410
General maintenance	406
Maintenance data	518
Maintenance requirements ..	405
Malfunction indicator lamp....	464
Menu icons.....	93
Meter	
Indicators	84
Instrument panel light control	91
Meter control switches.....	92
Meters	87
Multi-information display.....	92
Settings	96
Warning lights.....	82, 463
Warning messages.....	101, 475

Meter control switches.....92

Mirrors

Digital Rear-view Mirror	145
Inside rear view mirror	144
Outside rear view mirror defog- gers	360
Outside rear view mirrors	153
Vanity mirrors	378

Multi-information display

Audio system-linked display ..	96
Changing the display	92
Cruise control	269

Display contents 92
 Driving information display 93
 Driving support system information display 95
 Dynamic radar cruise control 262
 Energy monitor 102
 Hybrid System Indicator 89
 Menu icons 93
 Meter control switches 92
 PCS (Pre-Collision System) 222
 Settings 96
 Suggestion function 101
 Tire pressure 427
 Vehicle information display 96
 Warning message display 101
 Warning messages 475
My Settings 162

N

Noise from under vehicle 6
 Normal mode 343

O

Odometer 87
 “ODO TRIP” switch 91
Odometer and trip meter display
 “ODO TRIP” switch 91
“ODO TRIP” switch 91
Oil
 Engine oil 520
Opener
 Back door 121, 123
 Fuel filler door 211
 Garage door 389
 Hood 412
 Rear door 116
Open tray 373
Outside rear view mirrors 153
 Adjustment 153
 BSM (Blind Spot Monitor) 275
 Folding 154

Outside rear view mirror defoggers 360
 RCTA function 294
 Safe Exit Assist 280
Outside temperature display ... 90
Overheating 512

P

Panic mode 110
Parking assist sensors (intuitive parking assist) 284
Parking brake
 Operation 193
 Parking brake engaged warning buzzer 195
 Warning light 469
 Warning message 195
Parking lights 199
 Replacing exterior lights 452
 Switch 199
Parking Support Brake (PKSB) 303
 Indicator 84
 Parking Support Brake function (rear-crossing vehicles) 313
 Parking Support Brake function (static objects to the front and rear/static objects around the vehicle) 309
Parking Support Brake function (rear pedestrians) 314
 Function 314
PCS (Pre-Collision System)
 Function 222
 Warning light 466
PDA (Proactive driving assist) 248
Personal lights 369
PKSB (Parking Support Brake) 303
 Indicator 84
 Parking Support Brake function

(rear-crossing vehicles).....	313
Parking Support Brake function (static objects to the front and rear/static objects around the vehicle).....	309
Power back door	122
Close & lock (Walk-Away) func- tion	123
Power back door switch	123
Power easy access system ...	158
Power outlets	378
Power steering (Electric Power Steering system)	345
Warning light	466
Power switch	180
Auto power off function	184
Changing the power switch modes	183
Starting the hybrid system....	180
Power windows	155
Catch protection function	155
Door lock linked window opera- tion	156
Jam protection function	155
Operation	155
Window lock switch	157
P position switch	188
Pre-Collision System (PCS) Function	222
Warning light	466
Proactive driving assist (PDA)	248

R

Radar cruise control Dynamic radar cruise control	259
Radiator	419
RCD (Rear Camera Detection)	299
Function	299
RCTA (Rear Cross Traffic Alert)	294

RCTA Function.....	294
Rear Cross Traffic Alert (RCTA)	294
Rear doors	113
Opener switch	116
Rear door child-protector lock	117
Rear seat reminder function .	116
Rear passengers' seat belt reminder light	470
Rear seats	138
Folding down the rear seatbacks	138
Head restraints	140
Rear seat reminder function .	116
Rear side marker lights	199
Replacing exterior lights	452
Switch	199
Rear turn signal lights	192
Replacing exterior lights	452
Turn signal lever.....	192
Rear view mirror Digital Rear-view Mirror.....	145
Inside rear view mirror.....	144
Outside rear view mirrors	153
Rear window defogger	360
Refueling	210
Capacity	519
Fuel types	519, 526
Opening the fuel tank cap	211
Regenerative braking	71
Replacing Electronic key battery	446
Fuses.....	448
Tires	495
Wireless remote control battery	446
Reporting safety defects for Canadian owners	557
Reporting safety defects for U.S. owners	556

Resetting the message indicating maintenance is required 406
Road accident cautions 75
Road Sign Assist..... 257
RSA (Road Sign Assist)..... 257

S

Safe Exit Assist 280
Seat belt reminder light 470
Seat belts 31
 Adjusting the seat belt shoulder anchor height 33
 Automatic Locking Retractor (ALR)..... 33
 Child restraint system installation 55
 Cleaning and maintaining the seat belt..... 402
 Emergency Locking Retractor (ELR)..... 33
 How to wear your seat belt.... 32
 How your child should wear the seat belt..... 32
 Pregnant women, proper seat belt use..... 31
 Reminder light and buzzer ... 470
 Seat belt extender 32
 Seat belt pretensioners 34
 SRS warning light..... 465
Seat heaters 366
Seating capacity 177
Seat position memory..... 159
Seats..... 137, 138
 Adjustment precautions..... 138
 Adjustment 137
 Armrest..... 386
 Child seats/child restraint system installation 51
 Cleaning 402
 Driving position memory..... 158
 Folding down the rear seatbacks 138

Front seats 137
 Head restraint..... 140
 Memory recall function 160
 Power easy access system .. 158
 Properly sitting in the seat 29
 Rear seats 138
 Seat heaters 366
 Seat position memory..... 159
 Seat ventilators..... 367
Seat ventilators..... 367
Secondary Collision Brake 346
Sécurité des enfants
 Précautions relatives aux coussins gonflables 561
Sensor
 AHB (Automatic High Beam system) 202
 Automatic headlight system . 200
 BSM (Blind Spot Monitor)..... 276
 Door handle 113
 Inside rear view mirror 144
 Intuitive parking assist 284
 LTA (Lane Tracing Assist).... 234
 Radar sensor 216, 276
 Rain-sensing windshield wipers 208
 RCTA..... 295
 Safe Exit Assist 281
Service plug 74
Service reminder message 406
Shift lever 187
 Shift lever light..... 368
 Transmission 187
Side airbags 35
Side doors 113
Side marker lights 199
 Replacing exterior lights 452
 Switch..... 199
Side mirrors 153
 Adjustment 153
 BSM (Blind Spot Monitor)..... 275
 Folding..... 154

- Heaters..... 360
- RCTA function..... 294
- Safe Exit Assist 280
- Side tray 374**
- Side windows 155**
- Smart key system..... 131**
 - Antenna location 131
 - Entry functions 113, 120
 - Starting the hybrid system.... 180
 - Warning message 475
- Snow tires 353**
- Spare tire**
 - Storage location 496
- Specifications 518**
- Speedometer 87**
- Sport mode 343**
- Steering wheel..... 143**
 - Adjustment 143
 - Heated steering wheel 366
 - Meter control switches 92
- Stop lights**
 - Replacing exterior lights 452
- Storage feature 371**
- Storage precautions 371**
- Stuck**
 - If the vehicle becomes stuck 515
- Suggestion function..... 101**
- Sunshades 387**
- Sun visors 378**
- Switches**
 - “ODO TRIP” switch 91
 - “SOS” button 65
 - Automatic High Beam switch 202
 - Brake hold switch 196
 - Camera washer switch 205
 - Cruise control switch 262, 269
 - Door lock switches 115
 - Driving mode select switch... 343
 - Driving position memory buttons
..... 159
 - Emergency flashers switch .. 454
 - EV drive mode switch..... 185
 - Fuel filler door opener switch 211
 - Garage door opener buttons 389
 - Headlight switch 199
 - Heated steering wheel..... 366
 - Ignition switch (power switch)
..... 180
 - LTA switch..... 236
 - Meter control switches..... 92
 - Outside rear view mirror
switches..... 153
 - P position switch..... 188
 - Parking brake switch 193
 - Power back door switch 123
 - Power door lock switch..... 115
 - Power switch 180
 - Power window switch 155
 - Rear door opener switch 116
 - Rear window and outside rear
view mirror defoggers switch
..... 360
 - Rear window defogger switch
..... 360
 - Seat adjustment 137
 - Seat heater switches 366
 - Seat ventilator switches..... 367
 - VSC OFF switch..... 346
 - Window lock switch 157
 - Windshield defogger switch.. 359
 - Windshield de-icer switch ... 363,
364
 - Windshield wipers and washer
switch 205
 - Wireless charger power supply
switch 381

T

- Tail lights..... 199**
 - Indicator..... 84
 - Replacing exterior lights 452
 - Switch..... 199
- Theft deterrent system**
 - Immobilizer system..... 79

Ticket holders	373	Warning light	469
Tire inflation pressure		Tonneau cover (luggage cover)	
Maintenance data.....	524	377
Tire inflation pressure display		Tools	484, 496
function.....	427	Top tether strap	62
Warning light	469	Total load capacity (vehicle	
Tire information	528	capacity weight)	174, 177
Glossary	532	Towing	
Size	530	Dinghy towing.....	179
Tire identification number	529	Emergency towing	459
Tire section names	530	Towing eyelet	460, 484, 496
Tire pressure warning system		Trailer towing.....	178
.....	427	Toyota Safety Sense 3.0	215
Function	427	Automatic High Beam.....	202
Installing tire pressure warning		Cruise control	269
valves and transmitters	429	Dynamic radar cruise control	259
Registering ID codes.....	434	Emergency Driving Stop System	
Registration of the position of		272
each wheel	430	FCTA (Front Cross Traffic Alert)	
Selecting wheel set	436	254
Setting the tire pressure	431	LCA (Lane Change Assist)...	239
Warning light	469	LDA (Lane Departure Alert)...	242
Tires	425	LTA (Lane Tracing Assist)...	234
Chains	355	PCS (Pre-Collision System)	222
Checking	425	PDA (Proactive driving assist)	
Emergency tire puncture repair		248
kit.....	483	RSA (Road Sign Assist)	257
Glossary	532	TRAC (Traction Control)	345
If you have a flat tire	483, 495	Traction battery (Hybrid battery)	
Inflation pressure.....	438	74
Information	528	Hybrid battery (traction battery)	
Replacing	483, 495	air intake and discharge vents	
Rotating tires	427	77
Size	524	Location	74
Snow tires	353	Specification	520
Spare tire.....	495	Warning messages.....	78
Tire identification number	529	Traction Control (TRAC)	345
Tire inflation pressure display		Traction motor (electric motor)	70
function.....	427	Trailer towing	178
Tire pressure warning system		Transmission	187
.....	427	Trip meters	87
Uniform Tire Quality Grading	531	Turn signal lights	192

- Replacing exterior lights 452
- Turn signal lever 192

U

USB Type-C charging ports .. 379

V

- Vanity lights 378**
- Vanity mirrors 378**
- Vehicle data recordings 7**
- Vehicle identification number 518**
- Vehicle Stability Control (VSC)**
..... 345
- Ventilators (seat ventilators) . 367**
- VSC (Vehicle Stability Control)**
..... 345

W

Warning buzzers

- Brake hold 469
- Brake Override System 468
- Brake system 463
- Drive-Start Control 468
- Electric power steering 466
- High coolant temperature 464
- Intuitive parking assist OFF indicator 468
- Intuitive parking assist 289
- Low engine oil pressure 464
- LTA (Lane Tracing Assist) .. 234, 466
- Open door 117
- Open hood 117
- PKSB 468
- Pre-collision warning 222
- Seat belt reminder 470

Warning lights

- ABS 465
- Brake hold operated indicator
..... 469

- Brake system 463
- Charging system 463
- Cruise control indicator 467
- Driving assist information indicator 467
- Dynamic radar cruise control indicator 467
- Electric power steering 466
- High coolant temperature 464
- Hybrid system overheat warning light 464
- Inappropriate pedal operation warning light 468
- Intuitive parking assist OFF indicator 468
- LDA indicator 466
- Low engine oil pressure 464
- Low fuel level 470
- LTA indicator 466
- Malfunction indicator lamp ... 464
- Parking brake indicator 469
- PCS 466
- PDA indicator 467
- Seat belt reminder light 470
- Slip indicator 468
- SRS 465
- Tire pressure 469

Warning messages 475

Warning reflector storage space

..... 376

Washer 205

- Camera washer 205
- Checking 421
- Low washer fluid warning message 421, 475
- Preparing and checking before winter 353
- Switch 205

Washing and waxing 398

Weight

- Cargo capacity 174, 177
- Load limits 177

Weight	518
Wheels.....	440
Replacing wheels	440
Size	524
Window glasses	155
Window lock switch	157
Windows	
Power windows	155
Rear window defogger	360
Washer	205
Windshield defogger.....	359
Windshield de-icer	363
Windshield wipers.....	205
Intermittent windshield wipers	205
Rain-sensing windshield wipers	205
Winter driving tips.....	353
Wireless charger	380
Wireless remote control	110
Battery-saving function.....	132
Locking/Unlocking	110
Panic mode	110
Replacing the battery	446

For information regarding the equipment listed below, refer to "MULTIMEDIA OWNER'S MANUAL".

- Voice control
- Navigation
- Audio
- Hands-free calls
- Connected Services
- Rear view monitor system
- Panoramic view monitor

Certifications

Safety Connect

► For vehicles sold in the U.S.A., Hawaii and Puerto Rico

FCC ID : BEJTL21BNN

This device complies with part 15 of the FCC Rules and RSS-Gen of IC Rules.

Operation is subject to the following two conditions:

- (1) This device may not cause harmful interference, and
- (2) this device must accept any interference received, including interference that may cause undesired operation.

Changes or modifications not expressly approved by the manufacturer (or party responsible) for compliance could void the user's authority to operate the equipment.

This equipment complies with FCC RF Radiation exposure limits set forth for an uncontrolled environment. This device and its antenna must not be co-located or operating in conjunction with any other antenna or transmitter. This equipment should be installed and operated with a minimum distance of 20 cm between the radiator and your body

► For vehicles sold in Canada

IC : 2703H-TL21BNN

IC Radiation Exposure Statement:

This equipment complies with IC radiation exposure limits set forth for an uncontrolled environment.

This equipment should be installed and operated with minimum distance 20 cm between the radiator & your body.

Operation is subject to the following two conditions:

- (1) This device may not cause interference.
- (2) This device must accept any interference, including interference that may cause undesired operation of the device.

NOTE: THE MANUFACTURER IS NOT RESPONSIBLE FOR ANY RADIO OR TV INTERFERENCE CAUSED BY UNAUTHORIZED MODIFICATIONS TO THIS EQUIPMENT. SUCH MODIFICATIONS COULD VOID THE USER'S AUTHORITY TO OPERATE THE EQUIPMENT.

IC : 2703H-TL21BNN

Avis d'Industrie Canada sur l'exposition aux rayonnements

Cet appareil est conforme aux limites d'exposition aux rayonnements d'Industrie Canada pour un environnement non contrôlé.

Il doit être installé de façon à garder une distance minimale de 20 centimètres entre la source de rayonnements et votre corps.

L'exploitation est autorisée aux deux conditions suivantes :

- 1.L'appareil ne doit pas produire de brouillage;
- 2.L'appareil doit accepter tout brouillage radioélectrique subi, même si le brouillage est susceptible d'en compromettre le fonctionnement.

REMARQUE: LE FABRICANT N'EST PAS RESPONSABLE DES INTERFÉRENCES RADIOÉLECTRIQUES CAUSÉES PAR DES MODIFICATIONS NON AUTORISÉES APPORTÉES À CET APPAREIL. DE TELLES MODIFICATIONS POURRAIT ANNULER L'AUTORISATION ACCORDÉE À L'UTILISATEUR DE FAIRE FONCTIONNER L'APPAREIL.

Digital key system

- For vehicles sold in the U.S.A. and Hawaii

US

FCC ID:HYQ17EAA

NOTE

This device complies with part 15 of the FCC Rules. Operation is subject to the following two conditions: (1) This device may not cause harmful interference, and (2) this device must accept any interference received, including interference that may cause undesired operation.

FCC WARNING

Changes or modifications not expressly approved by the party responsible for compliance could void the user's authority to operate the equipment.

CAUTION : Radio Frequency Radiation Exposure

This equipment complies with FCC radiation exposure limits set forth for an uncontrolled environment and meets the FCC radio frequency (RF) Exposure Guidelines. This equipment should be installed and operated keeping the radiator at least 20cm or more away from person's body.

Co-location: This transmitter must not be co-located or operated in conjunction with any other antenna or transmitter.

00

► For vehicles sold in Canada

CA

This device contains licence-exempt transmitter(s)/receiver(s) that comply with Innovation, Science and Economic Development Canada's licence-exempt RSS(s). Operation is subject to the following two conditions:

- (1) This device may not cause interference.
- (2) This device must accept any interference, including interference that may cause undesired operation of the device.

The antenna cannot be removed (and changed) by user.

Co-location: This transmitter must not be co-located or operated in conjunction with any other antenna or transmitter.

CAUTION: Radio Frequency Radiation Exposure

This equipment complies with ISED radiation exposure limits set forth for an uncontrolled environment and meets RSS-102 of the ISED radio frequency (RF) Exposure rules. This equipment should be installed and operated keeping the radiator at least 20 cm or more away from person's body.

02

L'émetteur/récepteur exempt de licence contenu dans le présent appareil est conforme aux CNR d'Innovation, Sciences et Développement économique Canada applicables aux appareils radio exempts de licence. L'exploitation est autorisée aux deux conditions suivantes :

- (1) L'appareil ne doit pas produire de brouillage;
- (2) L'appareil doit accepter tout brouillage radioélectrique subi, même si le brouillage est susceptible d'en compromettre le fonctionnement.

L'utilisateur n'est pas autorisé à retirer (ou modifier) l'antenne.

Emplacement : Cet émetteur ne doit pas être installé ou utilisé conjointement avec d'autres antennes ou émetteurs.

ATTENTION : exposition aux radiofréquences

Cet équipement est conforme aux limites d'exposition aux rayonnements d'ISDE établies pour un environnement non contrôlé ainsi que la norme CNR-102 de la réglementation d'ISDE relative à l'exposition aux radiofréquences (RF). Cet équipement doit être installé et utilisé avec un minimum de 20 cm de distance entre la source de rayonnement et le corps.

Smart key system and immobilizer system

- For vehicles sold in the U.S.A., Hawaii, Guam, Saipan and Puerto Rico

FCC ID: NI4TMLF19D-3

US

NOTE

This device complies with part 15 of the FCC Rules. Operation is subject to the following two conditions: (1) This device may not cause harmful interference, and (2) this device must accept any interference received, including interference that may cause undesired operation.

FCC WARNING

Changes or modifications not expressly approved by the party responsible for compliance could void the user's authority to operate the equipment.

► For vehicles sold in Canada

NOTE

CA

This device contains licence-exempt transmitter(s)/receiver(s) that comply with Innovation, Science and Economic Development Canada's licence-exempt RSS(s). Operation is subject to the following two conditions:

- (1) This device may not cause interference.
- (2) This device must accept any interference, including interference that may cause undesired operation of the device.

811

NOTE

CA

L'émetteur/récepteur exempt de licence contenu dans le présent appareil est conforme aux CNR d'Innovation, Sciences et Développement économique Canada applicables aux appareils radio exempts de licence. L'exploitation est autorisée aux deux conditions suivantes:

- (1) L'appareil ne doit pas produire de brouillage;
- (2) L'appareil doit accepter tout brouillage radioélectrique subi, même si le brouillage est susceptible d'en compromettre le fonctionnement.

811

Smart key system

- ▶ For vehicles sold in the U.S.A., Hawaii, Guam, Saipan and Puerto Rico

US

FCC ID:HYQ23ABN

FCC ID:HYQ14FBX

NOTE:

This device complies with part 15 of the FCC Rules. Operation is subject to the following two conditions: (1) This device may not cause harmful interference, and (2) this device must accept any interference received, including interference that may cause undesired operation.

FCC WARNING:

Changes or modifications not expressly approved by the party responsible for compliance could void the user's authority to operate the equipment.

<For 14FBX>

The FCC ID is affixed inside the equipment. You can find the ID when replacing the battery.

00

- ▶ For vehicles sold in Canada

CA

NOTE:

This device contains licence-exempt transmitter(s)/receiver(s) that comply with Innovation, Science and Economic Development Canada's licence-exempt RSS(s).

Operation is subject to the following two conditions:

- (1) This device may not cause interference.
- (2) This device must accept any interference, including interference that may cause undesired operation of the device.

<For 14FBX>

The IC Certification number is affixed inside the equipment. You can find the number when replacing the battery.

02

NOTE:

L'émetteur/récepteur exempt de licence contenu dans le présent appareil est conforme aux CNR d'Innovation, Sciences et Développement économique Canada applicables aux appareils radio exempts de licence.

L'exploitation est autorisée aux deux conditions suivantes :

- (1) L'appareil ne doit pas produire de brouillage;
- (2) L'appareil doit accepter tout brouillage radioélectrique subi, même si le brouillage est susceptible d'en compromettre le fonctionnement.

<Pour 14FBX>

Le numéro d'accréditation IC est apposé à l'intérieur de l'appareil. Ce numéro est visible au remplacement de la pile.

03

Millimeter wave radar sensor

- ▶ For vehicles sold in the U.S.A., Hawaii, Guam, Saipan and Puerto Rico

FCC ID: HYQDNMWR011

D11 US 01

NOTE:

This device complies with part 15 of the FCC Rules. Operation is subject to the following two conditions: (1) This device may not cause harmful interference, and (2) this device must accept any interference received, including interference that may cause undesired operation.

FCC WARNING:

Changes or modifications not expressly approved by the party responsible for compliance could void the user's authority to operate the equipment.

US 01

Radiofrequency radiation exposure Information:

This equipment complies with FCC radiation exposure limits set forth for an uncontrolled environment. This equipment should be installed and operated with minimum distance of 20 cm between the radiator (antenna) and your body. This transmitter must not be co-located or operating in conjunction with any other antenna or transmitter.

US 02

► For vehicles sold in Canada

NOTE:

This device contains licence-exempt transmitter(s)/receiver(s) that comply with Innovation, Science and Economic Development Canada's licence-exempt RSS(s). Operation is subject to the following two conditions:

- (1) This device may not cause interference.
- (2) This device must accept any interference, including interference that may cause undesired operation of the device.

This equipment complies with ISSED radiation exposure limits set forth for an uncontrolled environment and meets RSS-102 of the ISSED radio frequency (RF) Exposure rules. This equipment should be installed and operated keeping the radiator at least 20 cm or more away from person's body.

CA 01

NOTE:

L'émetteur/récepteur exempt de licence contenu dans le présent appareil est conforme aux CNR d'Innovation, Sciences et Développement économique Canada applicables aux appareils radio exempts de licence. L'exploitation est autorisée aux deux conditions suivantes :

- (1) L'appareil ne doit pas produire de brouillage;
- (2) L'appareil doit accepter tout brouillage radioélectrique subi, même si le brouillage est susceptible d'en compromettre le fonctionnement.

Cet équipement est conforme aux limites d'exposition aux rayonnements énoncées pour un environnement non contrôlé et respecte les règles d'exposition aux fréquences radioélectriques (RF) CNR-102 de l'ISDE. Cet équipement doit être installé et utilisé en gardant une distance de 20 cm ou plus entre le dispositif rayonnant et le corps.

CA 02

Blind Spot Monitor

- ▶ For vehicles sold in the U.S.A., Hawaii, Guam, Saipan and Puerto Rico

Radiofrequency radiation exposure Information:

This equipment complies with FCC and IC radiation exposure limits set forth for an uncontrolled environment. This equipment should be installed and operated with minimum distance of 20 cm between the radiator and your body.

This transmitter must not be co-located or operating in conjunction with any other antenna or transmitter.

FCC Notice:

Changes or modifications not expressly approved by the party responsible for compliance could void the user's authority to operate the equipment.

C5-002

- ▶ For vehicles sold in Canada

This device contains licence-exempt transmitter(s)/receiver(s) that comply with Innovation, Science and Economic Development Canada's licence-exempt RSS(s). Operation is subject to the following two conditions:

- (1) This device may not cause interference.
- (2) This device must accept any interference, including interference that may cause undesired operation of the device.

Radiofrequency radiation exposure information:

This equipment complies with radiation exposure limits set forth for an uncontrolled environment. This equipment should be installed and operated with minimum distance of 20 cm between the radiator and your body.

C5-003

L'émetteur/récepteur exempt de licence contenu dans le présent appareil est conforme aux CNR d'Innovation, Sciences et Développement économique Canada applicables aux appareils radio exempts de licence. L'exploitation est autorisée aux deux conditions suivantes :

- (1) L'appareil ne doit pas produire de brouillage;
- (2) L'appareil doit accepter tout brouillage radioélectrique subi, même si le brouillage est susceptible d'en compromettre le fonctionnement.

Informations sur l'exposition aux rayonnements radiofréquences:
Cet équipement est conforme aux limites d'exposition aux rayonnements définies pour un environnement non contrôlé. Cet équipement doit être installé et utilisé avec un minimum de 20 cm de distance entre la source de rayonnement et votre corps.

C5-004

Intuitive parking assist

- For vehicles sold in the U.S.A., Hawaii, Guam, Saipan and Puerto Rico

Product name : Intuitive parking assist

Compliance statement : This device complies with part 18 of the FCC Rules.

Responsible Party : DENSO International America, Inc.

24777 Denso Drive, P.O. Box 5047, Southfield, Michigan 48033-5244, U.S.A.

<https://www.denso.com/us-ca/en/about-us/company-information/diam/>

- For vehicles sold in Canada

This ISM device complies with Canadian ICES-001.

Cet appareil ISM est conforme à la norme NMB-001 du Canada.

Wireless charger (if equipped)

FCC Statement:

This device complies with Part 15 of the FCC Rules. Operation is subject to the following two conditions:

- (1) this device may not cause harmful interference, and
- (2) this device must accept any interference received, including interference that may cause undesired operation.

Changes or modifications not expressly approved by the party responsible for compliance could void the user's authority to operate the equipment

IC Statement:

This device complies with Industry Canada's licence-exempt RSSs. Operation is subject to the following two conditions:

- (1) This device may not cause interference; and
- (2) This device must accept any interference, including interference that may cause undesired operation of the device.

Le présent appareil est conforme aux CNR d'Industrie Canada applicables aux appareils radio exempts de licence.

L'exploitation est autorisée aux deux conditions suivantes:

- (1) l'appareil ne doit pas produire de brouillage, et
- (2) l'utilisateur de l'appareil doit accepter tout brouillage radioélectrique subi, même si le brouillage est susceptible d'en compromettre le fonctionnement

Garage door opener (if equipped)

- ▶ For vehicles sold in the U.S. mainland, Hawaii, Guam, Saipan and Puerto Rico

This device complies with FCC rules part 15 and Innovation, Science, and Economic Development Canada RSS-210. Operation is subject to the following two conditions: (1) This device may not cause harmful interference, and (2) This device must accept any interference that may be received including interference that may cause undesired operation. **WARNING:** The transmitter has been tested and complies with FCC and ISED rules. Changes or modifications not expressly approved by the party responsible for compliance could void the user's authority to operate the device.

This equipment complies with FCC and ISED radiation exposure limits set forth for an uncontrolled environment. End Users must follow the specific operating instructions for satisfying RF exposure compliance. This transmitter must be at least 20 cm from the user and must not be co-located or operating in conjunction with any other antenna or transmitter.

- ▶ For vehicles sold in Canada

This device complies with FCC rules part 15 and Innovation, Science, and Economic Development Canada RSS-210. Operation is subject to the following two conditions: (1) This device may not cause harmful interference, and (2) This device must accept any interference that may be received including interference that may cause undesired operation. **WARNING:** The transmitter has been tested and complies with FCC and ISED rules. Changes or modifications not expressly approved by the party responsible for compliance could void the user's authority to operate the device.

This equipment complies with FCC and ISED radiation exposure limits set forth for an uncontrolled environment. End Users must follow the specific operating instructions for satisfying RF exposure compliance. This transmitter must be at least 20 cm from the user and must not be co-located or operating in conjunction with any other antenna or transmitter.

Cet appareil est conforme aux règlements de la FCC, section 15, et au CNR-210 d'Innovation, Sciences et Développement économique Canada. Le fonctionnement est assujéti aux deux conditions suivantes : (1) cet appareil ne doit pas causer d'interférences nuisibles et (2) cet appareil doit accepter toute interférence reçue, y compris celle qui pourrait entraîner un dysfonctionnement. MISE EN GARDE : L'émetteur a subi des tests et est conforme aux règlements de la FCC et d'ISDE. Les changements ou modifications non approuvés explicitement par la partie responsable de la conformité pourraient rendre caduque l'autorisation de l'utilisateur de se servir du dispositif.

Cet appareil est conforme aux limites d'exposition aux radiations de la FCC et d'ISDE établies pour un environnement non contrôlé. Les utilisateurs finaux doivent respecter les instructions d'utilisation spécifiques pour satisfaire aux exigences de conformité aux expositions de RF. L'émetteur doit se trouver à 20 cm au minimum de l'utilisateur et ne doit pas être situé au même endroit que tout autre émetteur ou antenne ni fonctionner avec un autre émetteur ou antenne.

Tire pressure warning system

- ▶ For vehicles sold in the U.S.A., Hawaii, Guam, Saipan and Puerto Rico

FCC ID: PAXPMVG001

NOTE

This device complies with part 15 of the FCC Rules.

Operation is subject to the following two conditions:

- (1) This device may not cause harmful interference, and
- (2) this device must accept any interference received, including interference that may cause undesired operation.

FCC WARNING

Changes or modifications not expressly approved by the party responsible for compliance could void the user's authority to operate the equipment.

FCC ID: PAXPMVG101

NOTE

This device complies with part 15 of the FCC Rules.

Operation is subject to the following two conditions:

- (1) This device may not cause harmful interference, and
- (2) this device must accept any interference received, including interference that may cause undesired operation.

FCC WARNING

Changes or modifications not expressly approved by the party responsible for compliance could void the user's authority to operate the equipment.

“Perchlorate Material – special handling may apply, See www.dtsc.ca.gov/hazardouswaste/perchlorate.”

- For vehicles sold in Canada

NOTE

This device contains licence-exempt transmitter(s)/ receiver(s) that comply with Innovation, Science and Economic Development Canada's licence-exempt RSS(s).

Operation is subject to the following two conditions:

- (1) This device may not cause interference.
- (2) This device must accept any interference, including interference that may cause undesired operation of the device.

NOTE

L'émetteur/récepteur exempt de licence contenu dans le présent appareil est conforme aux CNR d'Innovation, Sciences et Développement économique Canada applicables aux appareils radio exempts de licence.

L'exploitation est autorisée aux deux conditions suivantes :

- (1) L'appareil ne doit pas produire de brouillage;
- (2) L'appareil doit accepter tout brouillage radioélectrique subi, même si le brouillage est susceptible d'en compromettre le fonctionnement.

GAS STATION INFORMATION

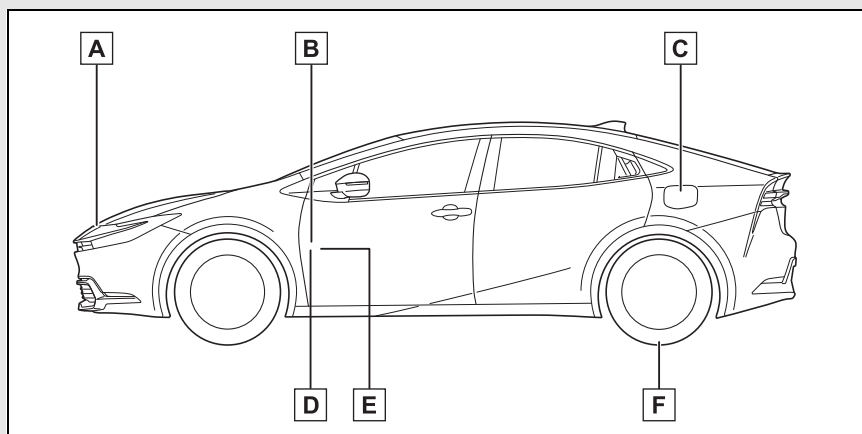

- A** Auxiliary catch lever (→P.412)
- B** Power back door switch (→P.122)
- C** Fuel filler door (→P.211)
- D** Fuel filler door opener switch (→P.211)
- E** Hood lock release lever (→P.412)
- F** Tire inflation pressure (→P.524)

Fuel tank capacity (Reference)	▶ AWD models 10.6 gal. (40 L, 8.8 Imp.gal.) ▶ 2WD models 11.4 gal. (43 L, 9.5 Imp.gal.)	
Fuel type	Unleaded gasoline only	P.519
Cold tire inflation pressure		P.524
Engine oil capacity (Drain and refill — reference)		P.520
Engine oil type		P.520