



Printing: November 2022 (01)
Publication No.: OM23EN-HJ12E0EUR
Printed in France
Nissan Automotive Europe SAS - France



HJ12-EN2

NISSAN QASHQAI

HJ12-EN2



QASHQAI

OWNER'S MANUAL

Foreword

This manual was prepared to help you understand the operation and maintenance of your vehicle so that you may enjoy many kilometres (miles) of driving pleasure. Please read through this manual before operating your vehicle.

A separate Warranty Information & Maintenance Booklet explains in detail the warranty coverage that applies to your vehicle.

Your NISSAN dealer knows your vehicle best. When you require any service or have any questions, your NISSAN dealer will be glad to assist you with the extensive resources available for you.

IMPORTANT SAFETY INFORMATION REMINDERS!

Follow these important driving rules to help ensure a safe and complete trip for you and your passengers!

- **NEVER drive under the influence of alcohol or drugs.**
- **ALWAYS observe posted speed limits and never drive too fast for conditions.**
- **ALWAYS give your full attention to driving and avoid using vehicle features or taking other actions that could distract you.**
- **ALWAYS use your seat belts and appropriate child restraint systems. Pre-teen children should be seated in the rear seat.**
- **ALWAYS provide information about the proper use of vehicle safety features to all occupants of the vehicle.**
- **ALWAYS review this Owner's Manual for important safety information.**

WHEN READING THE MANUAL

This manual includes information for all options available on this model. Therefore, you may find some information that does not apply to your vehicle.

Throughout this manual, some illustrations may only show the layout for Left-Hand Drive (LHD) models. For Right-Hand Drive (RHD) models, the illustrated shape and location of some components may differ.

All information, specifications and illustrations in this manual are those in effect at the time of printing. NISSAN reserves the right to change specifications or designs at any time without notice and without obligation.

MODIFICATION OF YOUR VEHICLE

This vehicle should not be modified. Modifications could affect its performance, safety or durability, and may even violate governmental regulations. In addition, damage or performance problems resulting from modifications may not be covered under NISSAN warranties.

READ FIRST — THEN DRIVE SAFELY

Before driving your vehicle, read this Owner's Manual carefully. This will ensure familiarity with controls and maintenance requirements, assisting you in the safe operation of your vehicle.

Throughout this manual the following symbols and words are used:

WARNING

Indicates the presence of a hazard that could cause death or serious personal injury. To avoid or reduce the risk, the procedures described must be followed precisely.

CAUTION

Indicates the presence of a hazard that could cause minor or moderate personal injury, or damage to your vehicle. To avoid or reduce the risk, the procedures described must be followed carefully.

NOTE

Indicates additional helpful information.



Blue Citizenship

The Blue Citizenship symbol indicates environmentally friendly information and best practices.

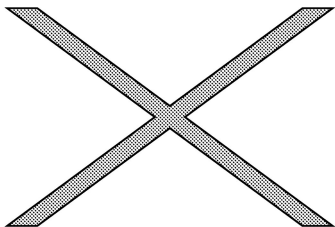

This symbol means **“Do not do this”** or **“Do not let this happen”**.



Arrows in an illustration that are similar to these point to the front of the vehicle.



Arrows in an illustration that are similar to these indicate movement or action.



Arrows in an illustration that are similar to these call attention to an item in the illustration.

[]:

Square brackets are used to indicate messages, keys, or items displayed on a screen.

< >:

Chevrons or angle brackets are used to indicate texts on controls like buttons or switches inside or on the vehicle.

Air bag warning labels (where fitted):



“NEVER use a rearward facing child restraint on a seat protected by an ACTIVE AIRBAG in front of it, DEATH or SERIOUS INJURY to the CHILD can occur.”

Be sure to read the “Airbag warning labels” description in the Safety section of this manual; and the “Airbag label” description at the end of this manual.

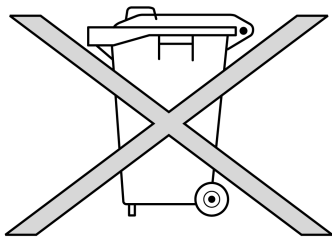

BATTERY DISPOSAL

CAUTION

An improperly disposed battery can harm the environment. Always confirm local regulations for battery disposal.

Examples of the batteries that the vehicle contains:

- Vehicle battery
- Remote controller battery (for Intelligent Key and/or Remote keyless entry system)
- Tyre Pressure Monitoring System (TPMS) sensor battery
- Remote controller battery (for Mobile Entertainment system)

If in doubt, contact your local authority, or a NISSAN dealer, or a qualified workshop for advice on disposal.



Bluetooth® is a trademark owned by Bluetooth SIG, Inc and licensed to Visteon Corporation and Robert Bosch GmbH.



iPod® is a trademark of Apple Inc.

Contents

Illustrated table of contents	0
e-POWER system overview	e-POWER
Safety – Seats, Seat belts and Supplemental Restraint System	1
Instruments and controls	2
Pre-driving checks and adjustments	3
Display screen, heater and air conditioner, and audio system	4
Starting and driving	5
In case of emergency	6
Appearance and care	7
Maintenance and do-it-yourself	8
Technical information	9
Regulatory information	10
Index	11



0 Illustrated table of contents

Seat belts and supplemental restraint system.....	2	Instrument panel	8
Exterior front	3	Left Hand Drive	8
Exterior rear	4	Right Hand Drive	9
Passenger compartment.....	5	Meters and gauges.....	10
Cockpit.....	6	Engine compartment	12
Left Hand Drive	6	KR15DDT engine.....	12
Right Hand Drive	7	Driving aids (where fitted)	14

SEAT BELTS AND SUPPLEMENTAL RESTRAINT SYSTEM

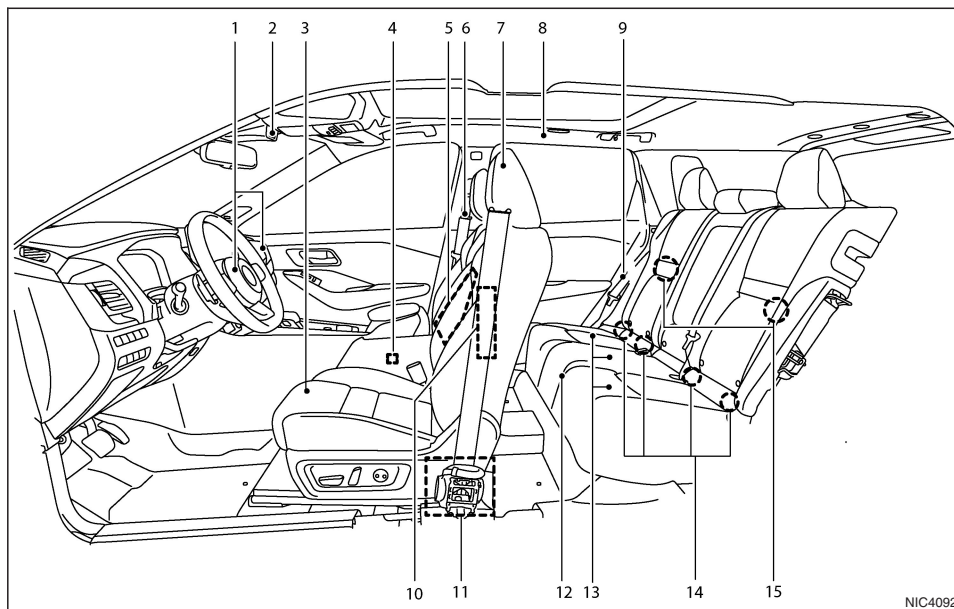

1. Supplemental front-impact air bags (P. 1-63)
2. Front passenger air bag status light (P. 1-67)
3. Front seats (P. 1-33)
4. Occupant classification sensor (OCS)* or Occupant detection sensor (ODS)* (front passenger seat) (P. 1-69)
5. Front central seat-mounted side-impact supplemental air bag* (P. 1-63)
6. Front seat belts (P. 1-39)
7. Head restraints (P. 1-37)
8. Supplemental curtain side-impact air bags (P. 1-63)
9. Rear seat belts (P. 1-39)
— Rear seat belt pre-tensioners (P. 1-45)

10. Front supplemental side-impact air bags (P. 1-63)
 11. Front seat belt pre-tensioners (P. 1-45)
 12. Rear seats (P. 1-35)
— Child restraints (P. 1-47)
 13. Rear Occupant Detection* (P. 1-42)
 14. ISOFIX child restraint system (P. 1-54)
 15. Child restraint anchor points (for top tether strap) (P. 1-55)
- * where fitted

2 Illustrated table of contents

EXTERIOR FRONT

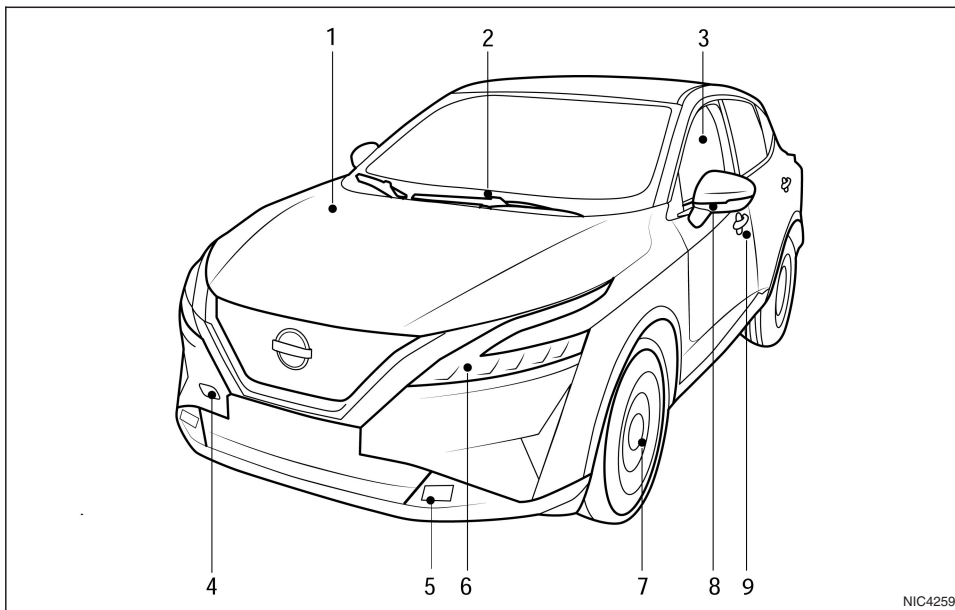

1. Bonnet (P. 3-170)
2. Windscreen wipers and washers
 - Switch operation (P. 2-127)
 - Blade replacement (P. 8-454)
 - Window washer fluid (P. 8-448)
 - Windscreen defogger (P. 2-130)
 - ThermaClear* (P. 2-129)
3. Power windows (P. 2-146)
4. Towing eye (P. 6-430)
5. Front fog lights*
 - Switch (P. 2-134)
6. Front lighting
 - Switch (P. 2-130)
 - Aiming control (P. 2-130)
 - Location and bulb replacement (P. 8-459)

7. Tyres
 - Tyres and wheels (P. 8-462, P. 9-471)
 - Flat tyre (P. 6-418)
 - Tyre Pressure Monitoring System (TPMS)* (P. 6-240)
8. Outside rear-view mirrors (P. 3-180)
 - Driving Position Memory System* (P. 3-177)
 - Side turn signal light (P. 2-130)
 - Location and bulb replacement (P. 8-459)
9. Doors
 - Keys (P. 3-152)
 - Door locks (P. 3-161)
 - Remote keyless entry system* (P. 3-154)

* where fitted

EXTERIOR REAR

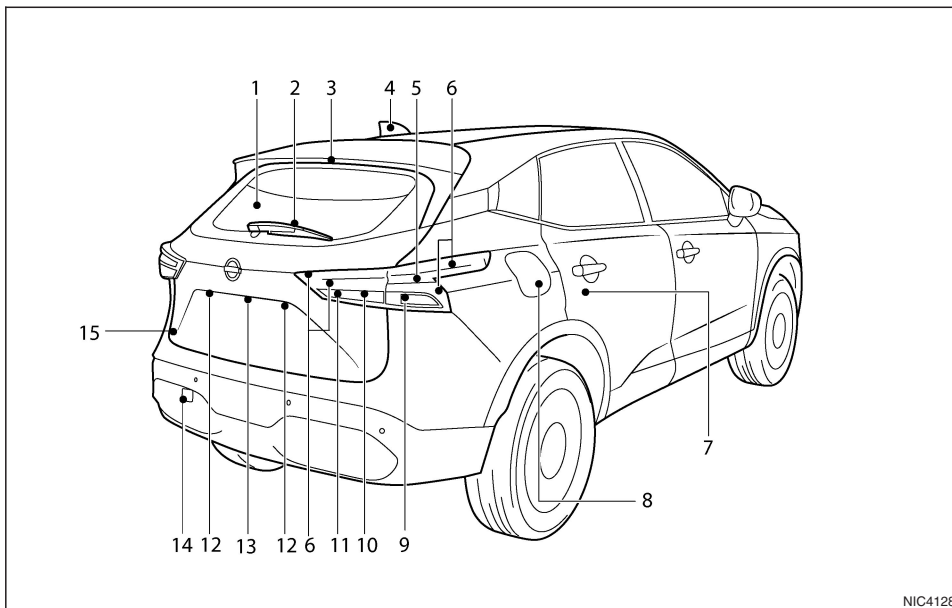

NIC4128

- | | |
|---|---|
| 1. Rear window (Defogger switch, P. 2-130) | 6. Tail light
– Switch location (P. 2-130) |
| 2. Rear wiper and washer
– Wiper and washer switch (P. 2-127)
– Wiper replacement (P. 8-454)
– Washer fluid (P. 8-448) | 7. Doors
– Keys (P. 3-152)
– Door locks (P. 3-161)
– Child safety lock (P. 3-163)
– Remote keyless entry system* (P. 3-154) |
| 3. High-mounted brake light (P. 8-459) | 8. Fuel filler lid (P. 3-170) |
| 4. Antenna (P. 4-211). | |
| 5. Brake light | |

9. Rear turn signal light
– Switch location (P. 2-130)
10. Reversing light (P. 8-459)
11. Rear fog light*
– Switch location (P. 2-134)
12. Number plate lights (P. 8-459)
13. Rear view camera*
– Rear-View Monitor* (P. 4-184)
– Intelligent Around View Monitor (IAVM)* (P. 4-190)
14. Towing eye (P. 6-430)
15. Tailgate (P. 3-164)
– Power tailgate (P. 3-164)
– Motion activated * (P. 3-166)

* where fitted

PASSENGER COMPARTMENT

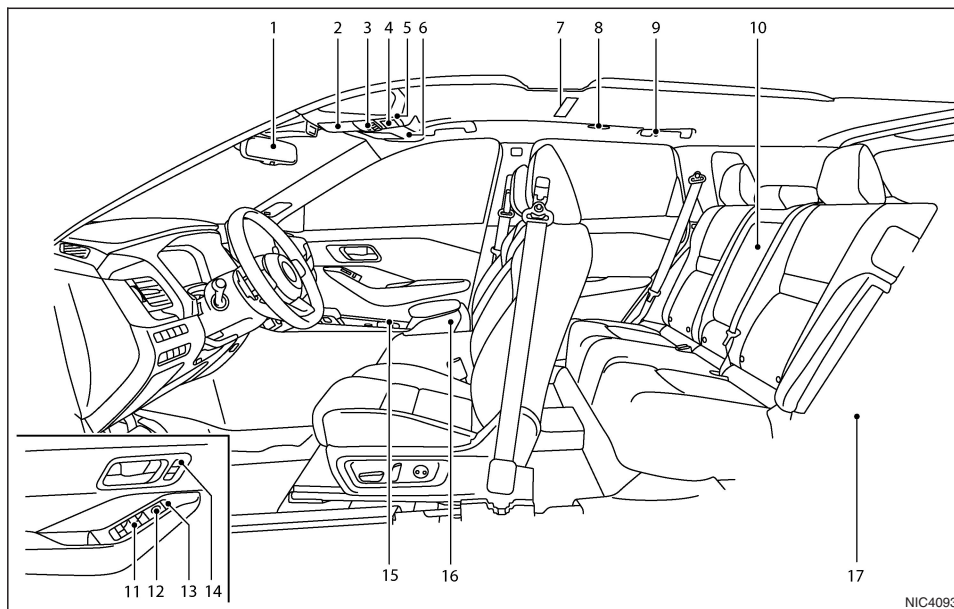

- | | |
|---|--|
| 1. Inside rear-view mirror (P. 2-179) | 7. Interior (room) light* (P. 2-149) |
| 2. Sunglasses holder* (P. 2-140) | 8. Rear personal lights* (P. 2-150) |
| 3. Map light (P. 2-149)
– Microphone** | 9. Coat hooks* (P. 2-141) |
| 4. Sunshade switch* (P. 2-148) | 10. Rear cup holders* (P. 2-141) |
| 5. eCall button* (P. 6-414) | 11. Power windows controls (P. 2-146) |
| 6. Sun visors (P. 3-179) | 12. Outside mirror remote control (P. 3-180) |
| | 13. Power door lock switch (P. 2-163) |

14. Driving Position Memory System switches (driver's side)* (P. 2-177)
15. Front cup holders (P. 2-141)
16. Console box (P. 2-140)
 - USB (Universal Serial Bus) power ports* (P. 2-138)
17. Cargo area
 - Adjustable luggage floor* (P. 2-145)
 - Luggage hooks* (P. 2-145)
 - Parcel shelf (P. 2-142)
 - Spare tyre* (P. 6-417)

*: where fitted

**: Refer to the separate NissanConnect Owner's Manual (where fitted).

COCKPIT

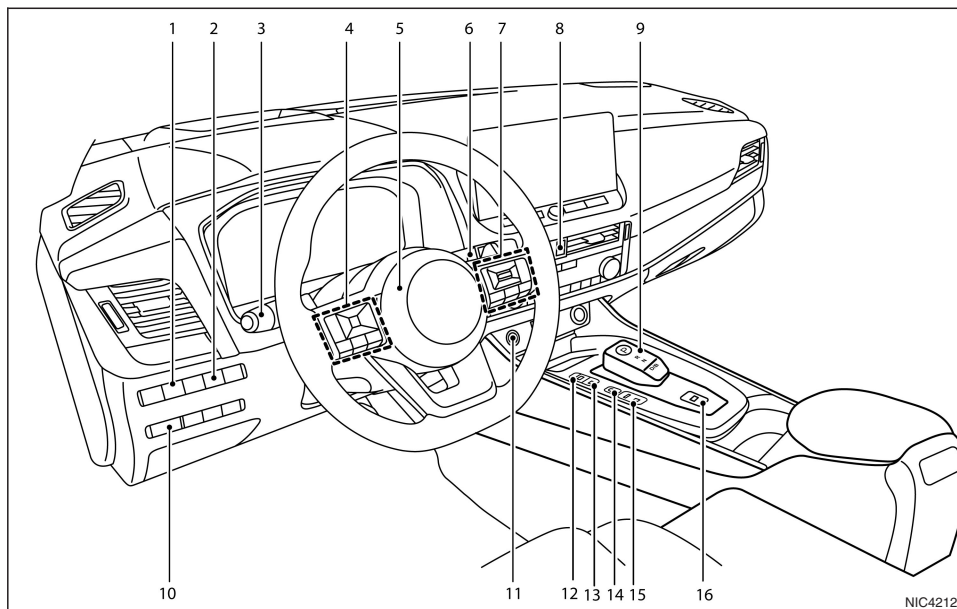

LEFT HAND DRIVE

1. Steering Assist switch* (models with ProPILOT Assist) (P. 5-315)
2. [Head-Up Display] (HUD) switch* (P. 2-125)
3. Headlight and turn signal switch (P. 2-130)

4. Steering wheel switches
 - Vehicle information display switches (P. 2-96)
 - Audio switches* (P. 4-230)
5. Steering wheel
 - Electric power steering system (P. 5-405)
 - Horn (P. 2-136)
 - Driver's supplemental front-impact air bag (P. 1-63)

6. Wiper and washer switch (P. 2-127)
 7. Steering wheel switches
 - ProPILOT Assist switch* (P. 5-315)
 - Cruise control* (P. 5-295)
 - Speed limiter* (P. 5-297)
 - Mobile phone integration for FM-AM radio without NissanConnect* (P. 4-230)
 - Mobile phone integration for NissanConnect* *1
 8. Hazard warning flasher switch (P. 6-414)
 9. Shift lever (P. 5-250)
 - P position switch (P. 5-252)
 10. Instrument brightness control (P. 2-82)
 11. Push button power switch (P. 3-247)
 12. Electric parking brake switch (P. 3-173)
 13. Automatic brake hold switch (P. 3-174)
 14. ProPILOT Park switch* (P. 5-377)
 15. EV mode switch* (P. e-POWER-26), e-Pedal Step switch* (P. e-POWER-27)
 16. Drive Mode Selector (P. e-POWER-24)
- * where fitted
- *1 See the separate NissanConnect Owner's Manual (where fitted).

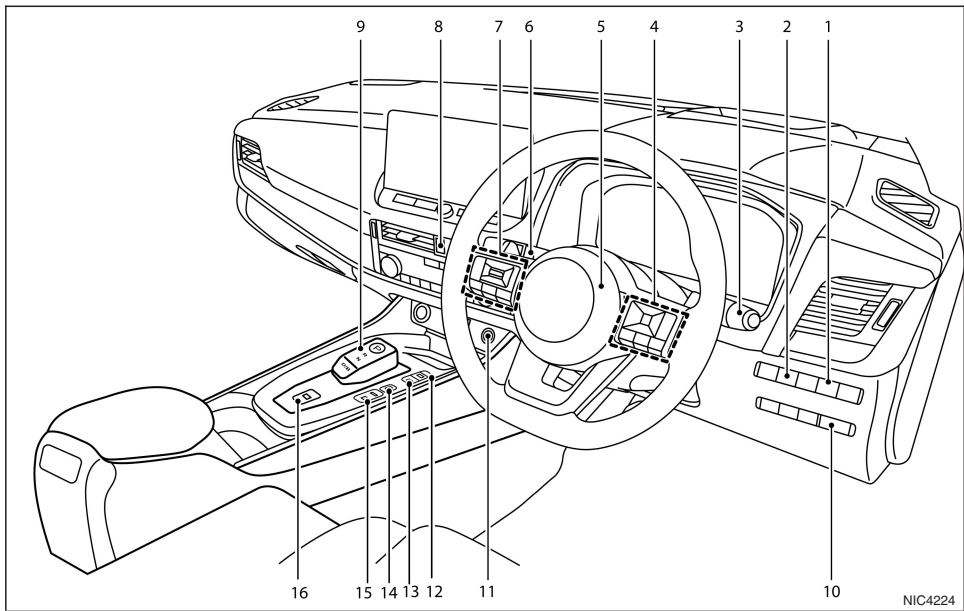

- Driver's supplemental front-impact air bag (P. 1-63)
 - 6. Headlight and turn signal switch (P. 2-130)
 - 7. Steering wheel switches
 - Vehicle information display switches (P. 2-96)
 - Audio switches* (P. 4-230)
 - 8. Hazard warning flasher switch (P. 6-414)
 - 9. Shift lever (P. 5-250)
 - P position switch (P. 5-252)
 - 10. Instrument brightness control (P. 2-82)
 - 11. Push button power switch (P. 3-247)
 - 12. Electric parking brake switch (P. 3-173)
 - 13. Automatic brake hold switch (P. 3-174)
 - 14. ProPILOT Park switch* (P. 5-377)
 - 15. EV mode switch* (P. e-POWER-26), e-Pedal Step switch* (P. e-POWER-27)
 - 16. Drive Mode Selector (P. e-POWER-24)
- * where fitted
- *¹ See the separate NissanConnect Owner's Manual (where fitted).

RIGHT HAND DRIVE

- 1. Steering Assist switch* (models with ProPILOT Assist) (P. 5-315)
- 2. [Head-Up Display] (HUD) switch* (P. 2-125)
- 3. Wiper and washer switch (P. 2-127)
- 4. Steering wheel switches
 - ProPILOT Assist switch* (P. 5-315)
 - Cruise control* (P. 5-295)
- 5. Steering wheel
 - Speed limiter* (P. 5-297)
 - Mobile phone integration for FM-AM radio without NissanConnect* (P. 4-230)
 - Mobile phone integration for NissanConnect* *¹
 - Electric power steering system (P. 5-405)
 - Horn (P. 2-136)

INSTRUMENT PANEL

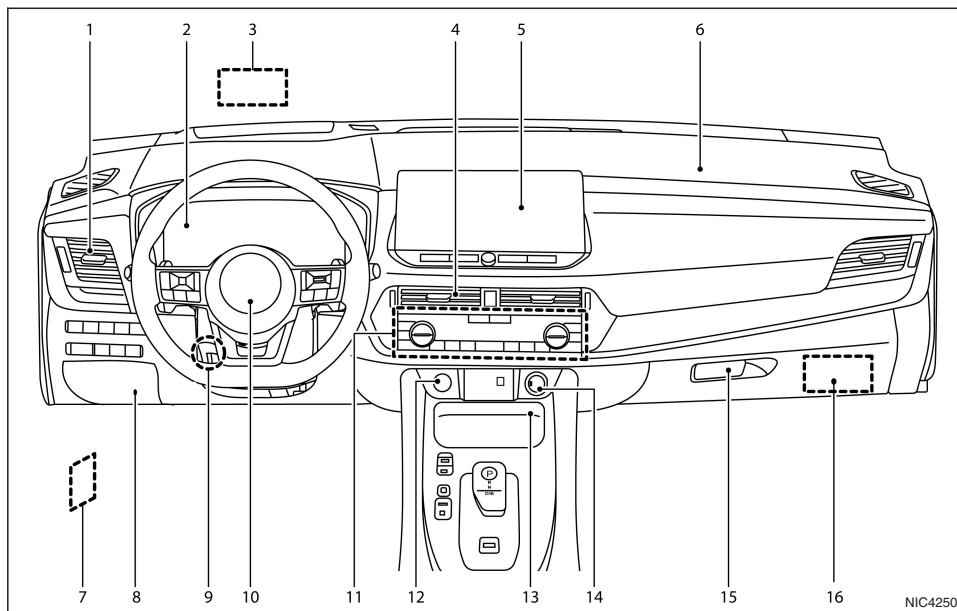

10. Driver supplemental front-impact air bag (P. 1-63)
11. Heater and air conditioner (P. 4-203)
 - Defogger switch (P. 2-130)
 - Heated seat switches* (P. 2-137)
 - Heated steering wheel switch* (P. 2-136)
12. Push button power switch (P. 5-247)
13. Wireless charger* (P. 2-138)
14. Power outlet (P. 2-137)
15. Glove box (P. 2-140)
16. Secondary fuse box (behind glove box) (P. 8-455)

*: where fitted

*1 See the separate NissanConnect Owner's Manual (where fitted).

LEFT HAND DRIVE

1. Side vent (P. 4-202)
2. Meters and gauges (P. 2-77)
3. Head Up Display (HUD)* (P. 2-125)
4. Centre vent (P. 4-202)
5. Audio system* (P. 4-208)
 - NissanConnect* *1
6. Front passenger's supplemental front-impact air bag (P. 1-63)
 - without NissanConnect* (P. 4-212)
7. Bonnet release handle (P. 3-170)
8. Fuse box cover (P. 8-455)
9. Tilt and telescopic steering lock lever (P. 3-179)

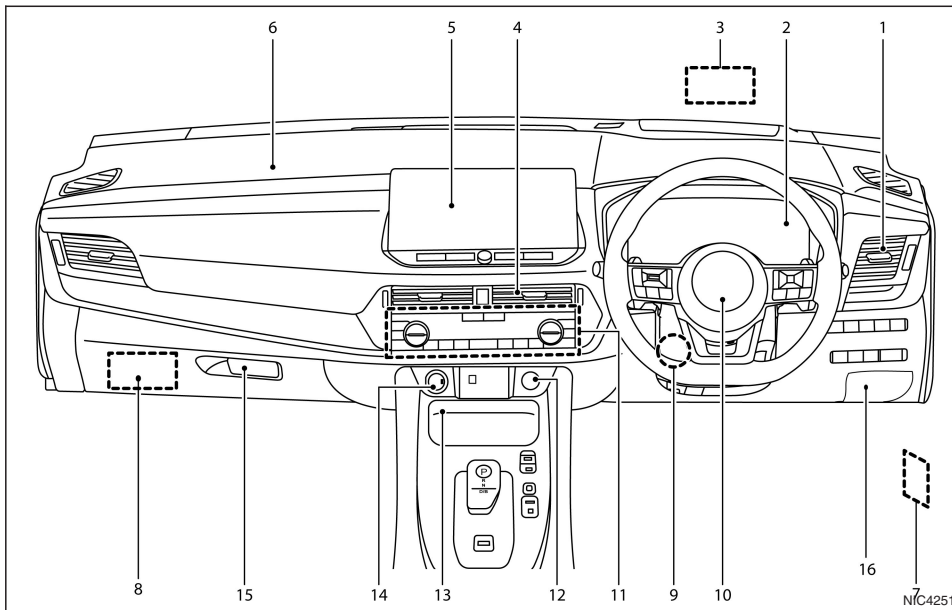

10. Driver supplemental front-impact air bag (P. 1-63)
11. Heater and air conditioner (P. 4-203)
 - Defogger switch (P. 2-130)
 - Heated seat switches* (P. 2-137)
 - Heated steering wheel switch* (P. 2-136)
12. Push button power switch (P. 5-247)
13. Wireless charger* (P. 2-138)
14. Power outlet (P. 2-137)
15. Glove box (P. 2-140)
16. Fuse box cover (P. 8-455)

*: where fitted

*1: See the separate NissanConnect Owner's Manual (where fitted).

RIGHT HAND DRIVE

1. Side vent (P. 4-202)
2. Meters and gauges (P. 2-77)
3. Head Up Display (HUD)* (P. 2-125)
4. Centre vent (P. 4-202)
5. Audio system* (P. 4-208)
 - NissanConnect* *1
 - without NissanConnect* (P. 4-212)
6. Front passenger's supplemental front-impact air bag (P. 1-63)
7. Bonnet release handle (P. 3-170)
8. Fuse box cover (inside glove box) (P. 8-455)
9. Tilt and telescopic steering lock lever (P. 3-179)

METERS AND GAUGES

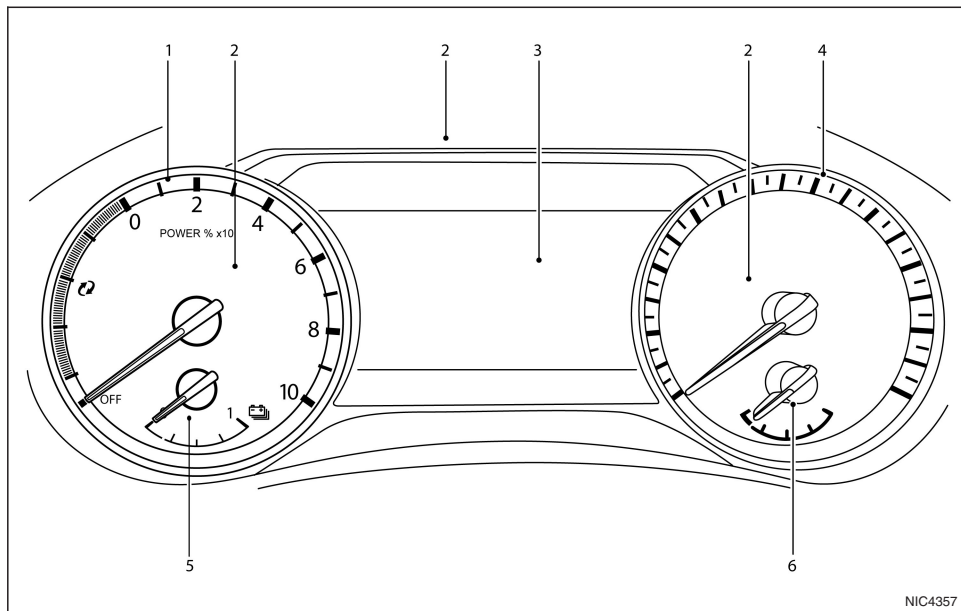

7 inch display

NIC4357

1. Power gauge (P. 2-80)
2. Warning and indicator lights (P. 2-84)
3. Vehicle information display (P. 2-96)
4. Speedometer (P. 2-80)
5. Li-ion battery gauge (P. 2-81)
6. Fuel gauge (P. 2-81)

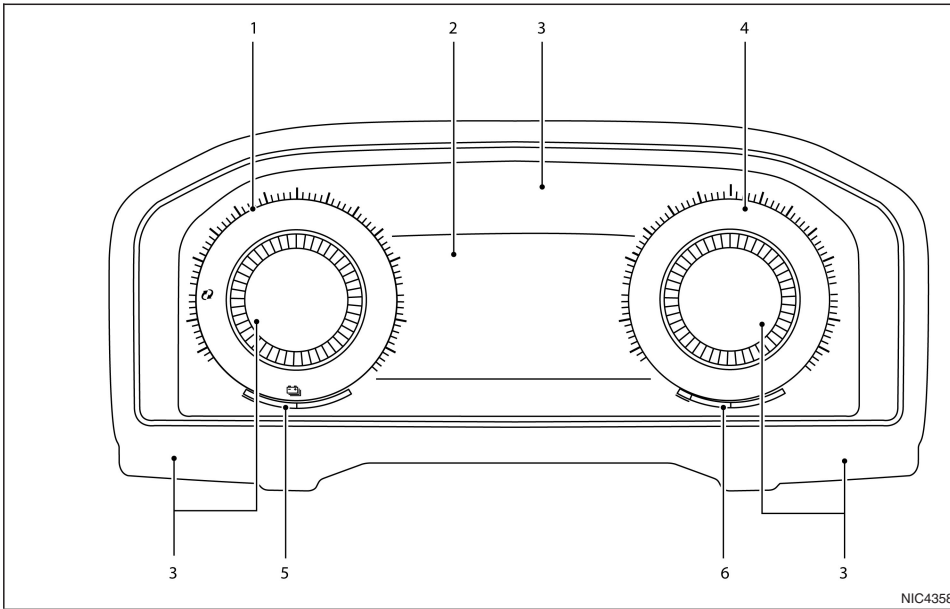

Full-screen display

1. Power gauge (P. 2-80)
2. Vehicle information display (P. 2-96)
3. Warning and indicator lights (P. 2-84)
4. Speedometer (P. 2-80)
5. Li-ion battery gauge (P. 2-81)
6. Fuel gauge (P. 2-81)

The view of the display can be changed from Classic View to Enhanced View to expand the vehicle information display area. (P. 2-79.)

ENGINE COMPARTMENT

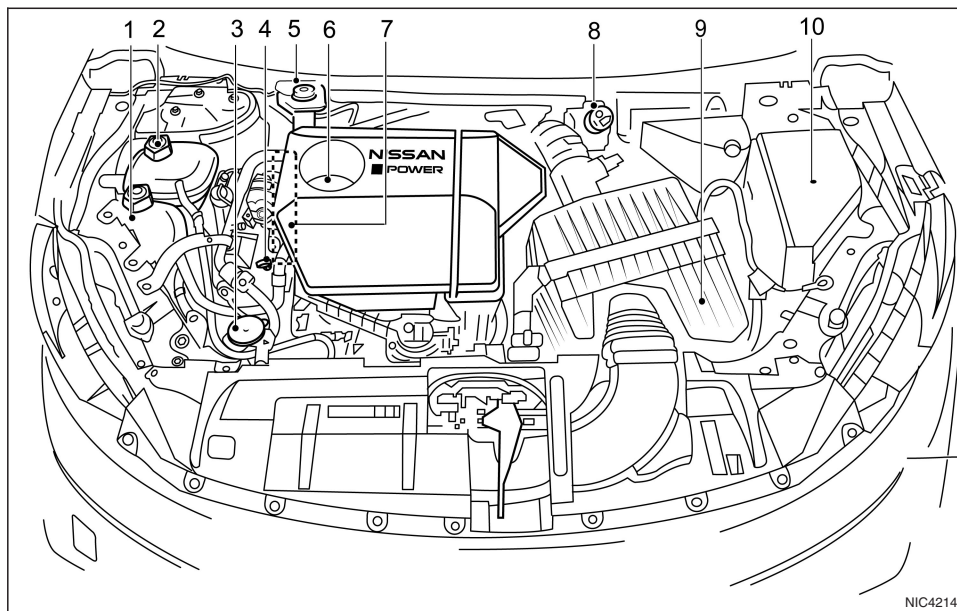









KR15DDT ENGINE









1. Inverter coolant reservoir (P. 8-443)
2. Engine coolant reservoir (P. 8-442)
3. Window washer/headlight cleaner (where fitted) fluid reservoir (P. 8-448)
4. Engine oil dipstick (P. 8-445)
5. Brake fluid reservoir (RHD) (P. 8-448)
6. Engine oil filler cap (P. 8-445)
7. Drive belt (P. 8-452)
8. Brake fluid reservoir (LHD) (P. 8-448)
9. Air cleaner (P. 8-453)
10. Fuses/fusible link box (P. 8-455)

NIC4214



DRIVING AIDS (where fitted)

System name	Abbreviation	Icon	Description	Page
Lane Departure Warning*	LDW		The LDW system warns the driver when the vehicle is beginning to leave the driving lane.	5-279
Intelligent Lane Intervention*	ILI		The ILI system warns the driver when the vehicle leaves the travelling lane and assists the driver in returning to the travelling lane.	5-284
Emergency Lane Assist*	ELA		The ELA system warns the driver when the vehicle approaches the road edge or solid white line and assists the driver to return the vehicle to the carriageway.	5-289
Steering Assist*	—		The Steering Assist system assists the driver in keeping the vehicle in the centre of the travelling lane. Steering Assist also incorporates ILI.	5-349
Cruise Control*	—		The Cruise Control system allows the driver to set and keep a constant vehicle speed.	5-295
Intelligent Cruise Control (without Steering Assist)*	ICC		The ICC system allows the driver to set and keep either a constant distance to the vehicle ahead or set vehicle speed.	5-299
ProPILOT Assist*	—		The ProPILOT Assist system combines the Intelligent Cruise Control, Steering Assist, Intelligent Lane Intervention and Blind Spot Intervention.	5-315
Speed limiter*	—		The speed limiter allows you to set the desired vehicle speed limit.	5-297

System name	Abbreviation	Icon	Description	Page
Blind Spot Warning*	BSW		While driving, the BSW system helps alert the driver to the presence of other vehicles in adjacent lanes.	5-257
Intelligent Blind Spot Intervention*	—		The Intelligent Blind Spot Intervention system helps alert the driver to the presence of other vehicles in adjacent lanes when changing lanes and helps assist the driver to return the vehicle to the centre of the travelling lane	5-257
Traffic Sign recognition*	TSR		The TSR system provides the driver with information about the most recently detected speed limit.	5-254
Intelligent Emergency Braking*	IEB		The IEB system can assist the driver when there is a risk of a forward collision with the vehicle ahead in the travelling lane or with a pedestrian or cyclist.	5-359
Rear Cross Traffic Alert*	RCTA		When the vehicle is in reverse, the RCTA system is designed to detect other vehicles approaching from the right or left of the vehicle.	5-269
Rear Automatic Braking*	RAB		When the vehicle is in reverse, The RAB system can assist the driver when there is a risk of a collision with an obstacle behind the vehicle.	5-274
Anti-lock Braking System	ABS		The ABS controls the brakes so the wheels do not lock during hard braking or when braking on slippery surfaces.	5-407
Electronic Stability Programme	ESP		The ESP system adjusts wheel brake pressure to assist in improving vehicle stability.	5-408
Hill Start Assist*	HSA		The Hill Start Assist system automatically keeps the brakes applied to help prevent the vehicle from rolling backwards when stopped on a hill.	5-410

*: Where fitted

NOTE

e-POWER system overview

NISSAN e-POWER system.....	18	When driving.....	23
Electric motors.....	18	Drive modes.....	24
Lithium ion (Li-ion) battery.....	19	How to change the drive mode.....	24
Regenerative brake.....	19	Customising [ECO] mode.....	25
When the vehicle starts the engine.....	19	ECO Pedal Guide function.....	25
e-POWER system precautions.....	20	EV mode.....	26
High voltage components.....	21	How to use the EV mode.....	26
e-POWER system characteristics.....	21	e-Pedal Step.....	27
Noise and vibration.....	21	e-Pedal Step System Operation.....	27
Road accident cautions.....	22	e-Pedal Step System Limitations.....	28
Emergency shut-off system.....	22	e-Pedal Step System Malfunction.....	28
Efficient use of your vehicle.....	23	Approaching Vehicle Sound for Pedestrians (VSP)	
Before driving.....	23	system.....	29

NISSAN E-POWER SYSTEM

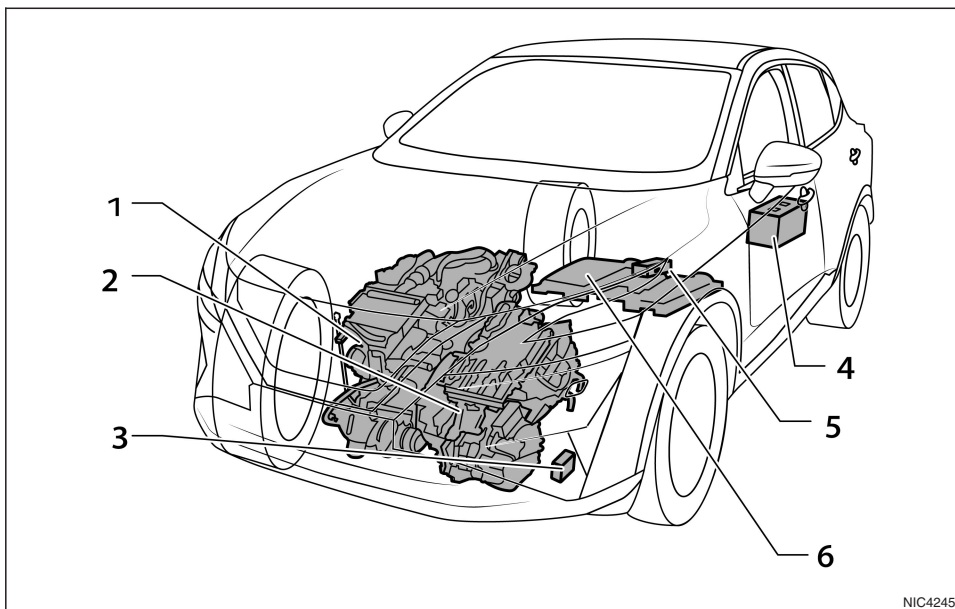

- 1 Petrol engine
- 2 Inverter, Electric motor for driving and power generator
- 3 Approaching Vehicle Sound for Pedestrians (VSP) system
- 4 12-volt battery
- 5 DC/DC converter

- 6 Lithium ion (Li-ion) battery

The NISSAN e-POWER system generates electric power by running the power generator with the petrol engine, and stores the generated electric power in the Lithium ion (Li-ion) battery or provides it to the electric motor (for driving) directly. This vehicle can be driven by running the electric motor (for driving) with the electric power, which is stored or generated.

ELECTRIC MOTORS

This vehicle has two types of electric motors.

- Electric motor for driving
- Power generator

The electric motor for driving generates traction power to drive the vehicle instead of the engine, using the electric power stored in the Lithium ion (Li-ion) battery or the generated electric power by the engine and power generator.

The power generator is powered by the petrol engine and generates electric power.

LITHIUM ION (LI-ION) BATTERY

The Lithium ion (Li-ion) battery is charged with the electric power generated by the power generator and/or the regenerative power from the electric motor for driving. While driving, the Li-ion battery provides the stored electric power to the electric motor for driving. Because the engine charges the Li-ion battery when the level of remaining charge in the Li-ion battery is low, the battery does not have to be charged from an outside source like an all-electric vehicle. If the vehicle is parked for a long period of time, the Li-ion battery discharges gradually. To avoid this occurrence, drive the vehicle for approximately 30 minutes at least once every two to three months. Otherwise, the Li-ion battery may be damaged. If the Li-ion battery is completely discharged and the e-POWER system cannot be activated, contact a NISSAN dealer.

REGENERATIVE BRAKE

The regenerative brake is a function that can reduce the vehicle speed by using the electric motor instead of the engine braking for the petrol engine vehicle. The Lithium ion (Li-ion) battery can be charged by the generated electric power when the vehicle decelerates, saving electric power consumption and improving fuel efficiency.

NOTE

- **The regenerative brake may provide less deceleration when the Li-ion battery is fully charged while driving on a long downhill road, when the outside temperature is low or when driving on a slippery road.**

WHEN THE VEHICLE STARTS THE ENGINE

In the e-POWER system, the engine may run under the following conditions:

- When the Lithium ion (Li-ion) battery charge is low (to generate electric power).
- When depressing the accelerator pedal strongly (to generate electric power).
- When driving on a long downhill (to generate deceleration without using fuel).
- When the engine is cold (to warm up the engine).
- When opening the bonnet with the e-POWER system running (to avoid an accident when performing maintenance).
- When turning on the front defogger switch.
- When engine start is required by maintenance mode.
- When the accelerator pedal is depressed while the vehicle is stationary and the vehicle is in P (Park) position.
- When the Li-ion battery is fully charged and regeneration is continued the electric motor may turn the engine to dissipate the excess electricity generated. In this mode the engine is not using fuel, this will maintain vehicle control.

E-POWER SYSTEM PRECAUTIONS

WARNING

- The e-POWER system uses high voltage up to approximately 420 volts. Obey the caution labels attached to the high voltage components.
- Never touch high voltage harnesses, their connectors or high voltage parts (electric motor for driving and Lithium ion (Li-ion) battery, etc.). Touching, disassembling, removing or replacing those parts and harnesses can cause severe burns or electric shock that may result in serious injury or death.

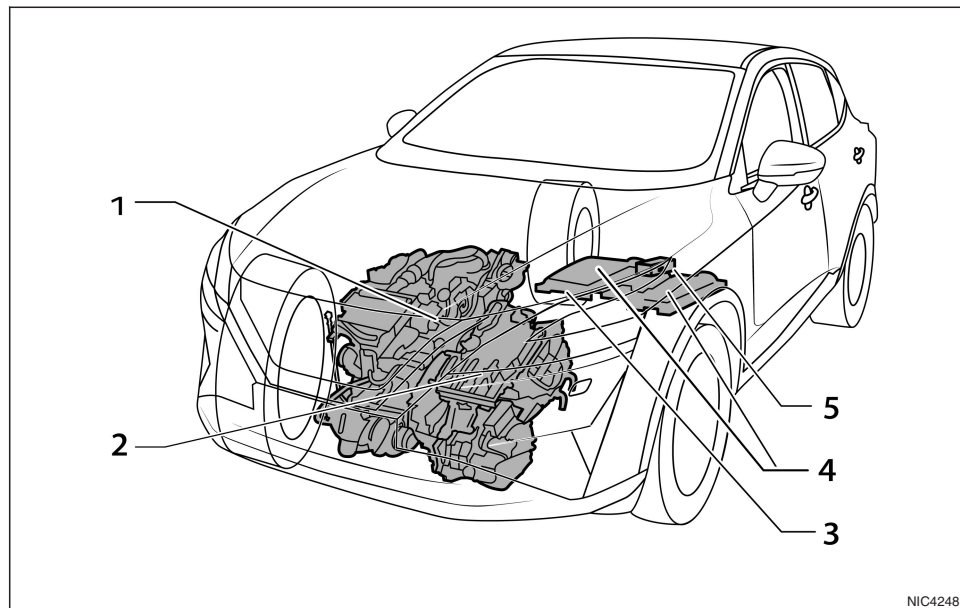

NIC4248

HIGH VOLTAGE COMPONENTS

The e-POWER system consists of the following high voltage parts.

- 1) High voltage harnesses (orange)
These harnesses are high voltage and orange-colored. Be sure not to touch the harnesses or remove the connector on the base of the cable.
- 2) Inverter, power generator and electric motor for driving
 - a. Inverter
This device controls various functions related to the e-POWER system. Be careful because it can be hot after driving.
 - b. Power generator
This motor is for generating electric power. Be careful because it can be hot after driving.
 - c. Electric motor for driving
This motor is for running the vehicle. Be careful because it can be hot after driving.
- 3) Service plug
This plug is used to cut-off the high voltage when performing maintenance. Never touch this plug.
- 4) Lithium ion (Li-ion) battery
This battery is charged from the electric power generated by the power generator and/or the regenerative power from the electric motor (driving). The Li-ion battery also supplies the electric power to the electric motor (driving) while driving.
- 5) DC/DC converter
This converter is for converting Li-ion battery power to 12-volt battery voltage.

E-POWER SYSTEM CHARACTERISTICS

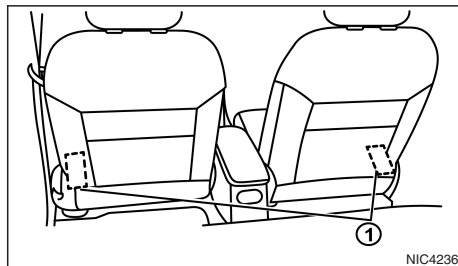

The air inlets ① for cooling the Lithium ion (Li-ion) battery are located under the front seats.

CAUTION

- **Do not cover the air inlets. Otherwise it will reduce output performance of the e- POWER system or cause vehicle damage. Additionally, do not allow any liquid or sand to get in the air inlet.**
- **Do not spill water onto the Li-ion battery or load large amounts of water in open containers (aquariums or buckets) into the vehicle. If the water spills onto the Li-ion battery, it may cause a short circuit and damage the Li-ion battery.**
- **Do not place any heavy objects under the front seats or stomp the floor around there, as the Li-ion battery is located under the front seats.**

- **If a large amount of liquid is spilled onto the Li-ion battery area, contact a NISSAN dealer as soon as possible.**

NOISE AND VIBRATION

After the e-POWER system is activated, the following noises and vibrations that are unique to the e-POWER system may occur. This does not indicate a malfunction.

- Electric motor noise from the engine compartment.
- Noise and vibration when the engine starts or stops running.
- Operating noise or electric motor noise when releasing the accelerator pedal or depressing the brake pedal.
- Engine noise due to rapid acceleration.
- Fan noise from under the front seat.
- Noise from the vehicle in order to alert pedestrians to the presence of an approaching vehicle. See "Approaching Vehicle Sound for Pedestrians (VSP) system" later in this section.

NOTE

Higher engine idling speed is set for this vehicle, compared to a conventional petrol engine model. This is to charge the Li-ion battery with the engine during idling, and it is not a malfunction.

ROAD ACCIDENT CAUTIONS

WARNING

In case of a collision or an accident, be sure to observe the following warnings.

- Pull your vehicle off the road, place the vehicle in the P (Park) position, apply the parking brake and turn the e-POWER system off.
- Never touch the high voltage parts or harnesses if they are exposed. For the locations of the high voltage parts and harnesses, "High voltage components" earlier in this section.
- Inspect the ground under the vehicle. If you noticed liquid spilled from the Lithium ion (Li-ion) battery, contact a NISSAN dealer or emergency services as soon as possible. Ignoring such conditions may lead to a fire.
- Never touch the liquid leaked on interior surfaces or outside the vehicle. If the liquid spilled from the Li-ion battery comes into contact with skin or clothes, immediately flush the area with plenty of clean water and see a doctor.
- If the vehicle receives a strong impact to the floor while driving, stop the vehicle in a safe location and check the floor. If the floor is damaged, never touch it and contact a NISSAN dealer as soon as possible.
- If a fire occurs in the Li-ion battery or high voltage parts, leave the vehicle as soon as possible. When extinguishing the fire, use a type ABC, BC or C fire extinguisher that is meant for use on electrical fires. Water can be used only when a large amount of water from a fire hy-

drant is available. Never attempt to extinguish a fire in an inappropriate way, as this can be dangerous.

- When towing your vehicle, lift the front wheels or all four wheels. If the vehicle is towed with front wheels on the ground, the electric motor for driving may generate electric power and cause damage to the vehicle.
- If you are not able to safely assess the vehicle due to vehicle damage, do not touch the vehicle. Leave the vehicle and contact a NISSAN dealer or emergency services. Advise 1st responders that this is a vehicle equipped with e-POWER system.
- In the event of an accident that requires body repair and painting, contact a NISSAN dealer. When the vehicle body is largely damaged or deformed, electrical leakage or shock depending on the damage condition could occur. Never touch the high voltage parts, such as Li-ion battery, and the orange-colored harnesses connected to them.
- Do not drive the vehicle with any exterior lights damaged. If water has leaked inside the light, it may lead to fumes or a fire.

NOTE

If the vehicle collides or a malfunction of the e-POWER system occurs, the READY to drive indicator light may be turned off since the high voltage system has been turned off. This is designed to minimize the risk of injury and accidents and is not a malfunction.

EMERGENCY SHUT-OFF SYSTEM

The emergency shut-off system is activated and the high-voltage system automatically turns off in the following conditions:

- Front and side collisions in which the supplemental air bags are deployed.
- Certain rear collisions.
- Certain e-POWER system malfunctions.

For the above collisions and the certain e-POWER system malfunctions, the READY to drive indicator light will turn off. See "Warning lights, indicator lights and audible reminders" in the "2. Instruments and controls" section

The emergency shut-off system activates for the above collisions to minimize risk of an event that could cause an injury or an accident. If the emergency shut-off system activates, the power switch may not switch to the READY to drive position. If this occurs, contact a NISSAN dealer or qualified workshop. Even if the power switch is switched to the READY to drive position, the system may shut-off suddenly. Therefore, drive cautiously to the nearest NISSAN dealer or qualified workshop or contact a NISSAN dealer or qualified workshop as soon as possible.

EFFICIENT USE OF YOUR VEHICLE

The fuel consumption varies considerably depending upon road conditions, weather, temperature, and number of occupants, etc. Keeping the following points in mind and reducing electric power consumption will help improve the fuel efficiency.

BEFORE DRIVING

- Plan for the route with less power consumption by the vehicle. Driving on uphill roads increases electric power consumption. If you choose the route where there are few uphill roads, the vehicle can reduce electric power consumption.
- Do not leave unnecessary cargo loaded. Removing unnecessary cargo from the vehicle to reduce vehicle weight can reduce electric power consumption.
- Keep the tyres inflated to the correct pressure. Low tyre pressure increases electric power consumption.

WHEN DRIVING

- Drive your vehicle with smooth start and acceleration.
 - Abrupt starting and acceleration will consume more electric power and decrease fuel economy.
 - You can accelerate the vehicle with less power consumption by checking the condition of the electric power consumption in the power meter.
- Keep a distance from the vehicle in front of you. Do not decelerate the vehicle more than necessary so that you can decrease the electric power consumption required to accelerate again.

- Do not drive at excessive speeds on a highway. Driving at excessive speeds consumes electric power more than necessary.
- Set the air conditioner at a moderate temperature and turn it off if unnecessary. Redundant power consumption can be reduced by the air conditioner.
- Do not use the defogger more than necessary. After removing fog from the windscreen, switching to the other air flow mode reduces the engine operation frequency and improve the fuel economy.
- Drive the vehicle in [ECO] mode for efficient use. Then the driving force response to accelerator operation is gentler than in [STANDARD]/[SPORT] mode; it suppresses unnecessary acceleration/deceleration and realizes energy saving.
- The fuel efficiency improves in the following order: [SPORT] mode → [STANDARD] mode → [ECO] mode. [ECO] mode is the most fuel-efficient mode. (See "Drive modes" later in this section.)
- When the [ECO] Mode Customize (Air Conditioning) is turned ON (fuel efficiency-oriented), the fuel efficiency is improved by reducing the performance of the air conditioner.

NOTE

The following are some conditions in which the fuel economy decreases significantly:

- **When driving on a route where there are many uphill roads.**
- **When continuing driving at a high speed on a highway.**

- **When starting, accelerating or braking abruptly.**

DRIVE MODES

There are three drive modes of the e-POWER system.

Drive Mode	Features
[STANDARD]	This is the standard mode that is most suitable for normal driving.
[ECO]	This mode assists the driver's economical driving. <ul style="list-style-type: none">• Acceleration profile is optimised for efficient driving.• Engine running logic is fully optimised for economy.• Optimum regenerative braking profile for cruising or city driving can be selected by shifting between D and B mode.• Air conditioning [ECO] mode is selected (this can be switched On/Off in the [Settings] menu of the vehicle information display).
[SPORT]	<ul style="list-style-type: none">• Adjusts electric motor torque response to improve driving agility.• The steering system adapts to give the driver a more engaging experience in sporty driving scenes (this can be switched On/Off in the Settings menu of the vehicle information display).

HOW TO CHANGE THE DRIVE MODE

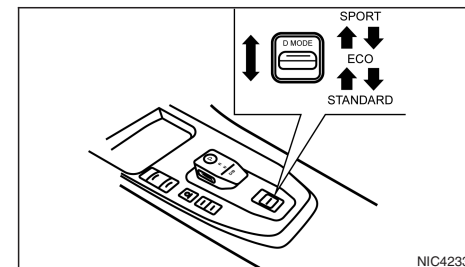

- The drive mode can be changed when the power switch is in the ON position. Push the drive mode switch up or down to change the mode as follows:
[SPORT] ⇄ [ECO] ⇄ [STANDARD].
- When the mode is switched, the selected mode is displayed in the vehicle information display.

NOTE

- If the system malfunction occurs when [SPORT] mode or [ECO] mode is selected, the deceleration force is weaker than usual. Apply the foot brake as necessary for the deceleration.
- The mode setting is changed to [STANDARD] mode every time the power switch is placed in the ON position.

CUSTOMISING [ECO] MODE

[ECO Drive Mode] is a function that can change the priority of the air conditioner function and the Cruise Control (where fitted) or the Intelligent Cruise Control (ICC) function to make fuel efficiency improvements.

[ECO Drive Mode] can be set when [ECO] mode is selected. Two menu options are available under [ECO Drive Mode]:

- [ECO Cruise Control]
- [ECO Climate Control]

[ECO Cruise Control]

This setting can be selected in [ECO Drive Mode] under the [ECO Settings] menu of the vehicle information display. When the setting is ON, the fuel efficiency while cruising will be improved by lowering the acceleration target from normal (setting OFF) mode. (See "[ECO Settings]" in the "2. Instruments and controls" section.)

NOTE

When the vehicle speed is reduced (for example, when the vehicle is driven on an uphill road from a flat road), it will take more time to return to the previously set speed than normal mode.

[ECO Climate Control]

This setting can be selected in [ECO Drive Mode] under the [ECO Settings] menu of the vehicle information display. Select the menu and turn [ECO Climate Control] to ON or OFF. (See "[ECO Settings]" in the "2. Instruments and controls" section.)

NOTE

- **When the [ECO Drive Mode] ([ECO Climate Control]) is turned ON (fuel efficiency-oriented), the fuel efficiency is improved by reducing the performance of the air conditioner.**
- **The [ECO Climate Control] setting maintains the status until the setting is changed, even if the power switch is placed in the OFF position.**
- **The air conditioner function will be prioritized even when the [ECO Climate Control] is turned ON under the following conditions.**
 - **When the A/C setting temperature is set at 28°C (82°F) or higher.**
(When the A/C setting temperature is set at 27.5°C (82°F) or lower, the fuel efficiency will be prioritized again.)
 - **When the A/C setting temperature is set at 18°C (64°F).**
(When the A/C setting temperature is set at 18.5°C (65°F) or higher, the fuel efficiency will be prioritized again.)
 - **When the front defogger is activated.**

ECO PEDAL GUIDE FUNCTION

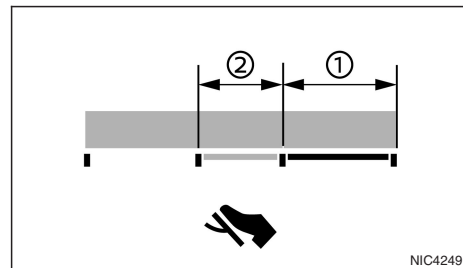

The ECO Pedal Guide can be displayed in the vehicle information display while driving in [ECO] mode. (See "5. [ECO Pedal Guide] function" in the "2. Instruments and controls" section.)

Use the ECO Pedal Guide function for improving fuel economy.

When the ECO Pedal Guide bar is in the range ①, it indicates that the vehicle is being driven within range of the super economy drive.

When the ECO Pedal Guide bar is in the range ②, it indicates that the vehicle is being driven within range of the economy drive.

If the ECO Pedal Guide bar is out of the range ① and ②, it indicates that the accelerator pedal is depressed over the range of economy drive.

The ECO Pedal Guide bar is not displayed when:

- The vehicle speed is less than approximately 4 km/h (2 MPH).
- The vehicle is in the P (Park), N (Neutral) or R (Reverse) position.

EV MODE

ECO indicator

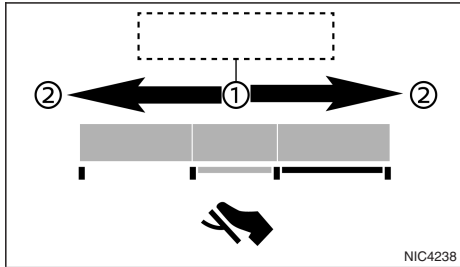

The ECO indicator ① will illuminate, flash partially or turn off according to the accelerator pedal operation while driving.

The ECO indicator will illuminate in the directions of ② as the driving pattern becomes more ECO friendly.

To activate or deactivate the ECO indicator, see [ECO Settings].

When EV mode is selected, you can drive the vehicle with the chance of engine starting reduced as much as possible. This mode is used when you wish to drive the vehicle quietly on a road such as a residential street in an early morning or a late at night, since the vehicle is powered by the Lithium ion (Li-ion) battery.

HOW TO USE THE EV MODE

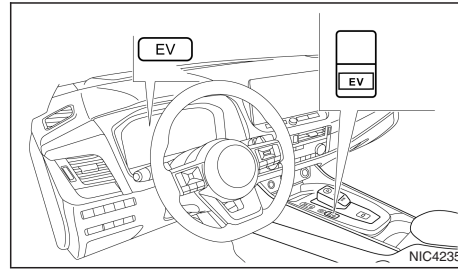

- When the READY to drive indicator light illuminates, EV mode is turned on every time the EV mode switch is pushed.
- When the outside temperature is low, the engine may start. However, when the EV mode is turned on before the engine starts, the vehicle can be driven by only the Li-ion battery due to reduction of the engine starting.

NOTE

- If the system malfunction occurs, EV mode is automatically turned off.
- If the accelerator pedal is depressed when the shift position is in the P (Park) position, the engine starts and EV mode is turned off.
- If the Li-ion battery is fully charged by the regenerative braking on a long downhill road, EV mode is turned off to protect the Li-ion battery.
- When the accelerator pedal is depressed to the floor on an uphill road or by abrupt acceleration, the engine starts and EV mode is turned off.
- If the bonnet is opened when the READY to drive indicator light illuminates, the engine starts automatically and EV mode is turned off.
- When the front defogger switch is turned on, the engine starts due to a warm-up operation, and EV mode cannot be used or it is turned off.
- If the system judges that the forced charging is necessary, EV mode is turned off and the engine starts.
- If the system judges that the warm-up operation is necessary, EV mode is turned off and the engine starts.
- When the outside temperature is low, EV mode may not be used.
- When the Li-ion battery charge is low, EV mode may not be used or is turned off.

E-PEDAL STEP

⚠ WARNING

Never rely solely on the e-Pedal Step system, as there is a performance limit to the system function. Always drive carefully and attentively. The brake pedal should be operated to slow or stop the vehicle, depending on traffic or road conditions.

The e-Pedal Step system enables the driver to slow the vehicle, by operating only the accelerator pedal. This assists the driver by reducing the number of times required to move their foot between the accelerator pedal and the brake pedal.

e-Pedal Step SYSTEM OPERATION

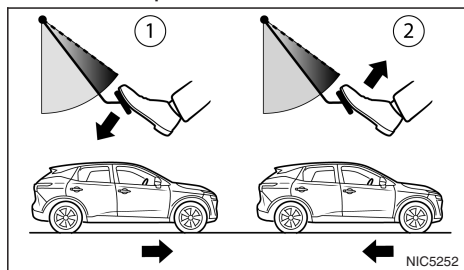

- ① Acceleration
- ② Deceleration (instead of brake pedal)

When the e-Pedal Step system is activated, the regenerative brake is enhanced and the driver can adjust the vehicle speed by only depressing or returning the accelerator pedal. When you release (take

your foot off) the accelerator pedal, the vehicle slows down smoothly without depressing the brake pedal.

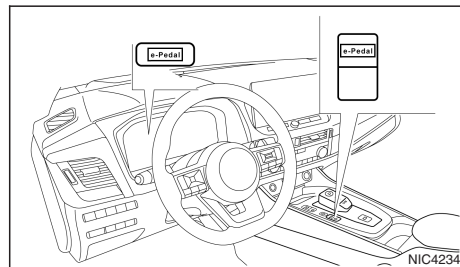

The e-Pedal Step system will be turned **ON** or **OFF** each time the e-Pedal switch is pressed. (The e-Pedal indicator in the Vehicle Information Display shows the status of the e-Pedal Step system.)

When the e-Pedal Step system is activated, the characteristics of the accelerator pedal change significantly and the accelerator pedal operates differently than a conventional one operates. Be sure to confirm the status of the e-Pedal Step system (**ON** or **OFF**) in the Vehicle Information Display before driving.

System Activation

To activate the e-Pedal Step system, place the power switch in the **ON** position and press the e-Pedal switch located on the centre console.

System Deactivation

To deactivate the e-Pedal Step system, with the power switch in the **ON** position, press the e-Pedal switch.

NOTE

- When the e-Pedal Step system is switched to **ON** or **OFF**, the degree of vehicle deceleration will change.
- The e-Pedal Step system is automatically turned **OFF** when the **E-POWER** system is re-started.

e-Pedal Step driving features

The e-Pedal Step system provides the following driving features:

When driving the vehicle:

- Depressing or returning the accelerator pedal will change the degree of acceleration and deceleration accordingly.
- Returning the accelerator pedal generates more deceleration than normal. (The maximum deceleration changes according to the vehicle speed.)
- Releasing (taking your foot off) the accelerator pedal reduces the vehicle speed.
- The vehicle's brake lights illuminate when the deceleration level reaches an ordinary braking operation.

If the deceleration is not sufficient when the accelerator pedal is returned or released, depress the brake pedal. The brake pedal can be operated to reduce the vehicle speed in the same way as normal even when the e-Pedal Step system is activated.

When reversing the vehicle:

With the shift position in **R** (Reverse), accelerator pedal operation returns to normal, operating in the same way in the same way as when e-Pedal Step is deactivated.

Other driving tips for the e-Pedal Step system:

- For smooth deceleration when the e-Pedal Step system is activated, it is recommended to adjust the accelerator pedal while driving with your foot on it (depressing or returning, but not releasing).
- Shifting the shift position from **D** (Drive) to **B** or from **B** to **D** will not affect the e-Pedal Step system feature.
- The e-Pedal Step system will not function under the following conditions:
 - When the vehicle is placed in the **P** (Park) or **N** (Neutral) position.
 - When cruise control (where fitted), ProPILOT Assist (where fitted), or Intelligent Emergency Braking operates. these Driver Assistance systems have priority over e-Pedal Step
- Brake pedal may move depending on deceleration, you might hear a noise when the e-Pedal Step is active. This is normal and does not indicate malfunction
- The characteristics of deceleration change according to the vehicle speed. At low speed, the motor continues to apply torque to move vehicle slowly forward (so-called "creep"), similar to a conventional vehicle with an automatic transmission. Remember to depress the brake pedal firmly to slow or stop the vehicle.

e-Pedal Step SYSTEM LIMITATIONS

WARNING

Listed below are the system limitations for the e-Pedal Step system. Failure to operate the vehicle in accordance with these system limitations could result in serious injury or death.

- If [Press brake pedal to prevent rolling] warning message appears in the Vehicle Information Display, depress the brake pedal. The vehicle may start moving.
- If the deceleration force provided by the e-Pedal Step system is not sufficient, depress the brake pedal.
- Under the following conditions, place the vehicle in the **P** (Park) position and make sure the parking brake is securely applied. The vehicle may start moving suddenly.
 - When getting in and out of the vehicle.
 - When loading and unloading the vehicle.
 - When stopping the vehicle for a long period of time.
- Under the following conditions the e-Pedal Step system may not decelerate or may not stop the vehicle sufficiently. Depress the brake pedal whenever necessary.
 - When excessively heavy baggage is loaded in the vehicle.
 - When driving on steep downhill roads.
 - When driving on icy roads.

- Frequent braking may result in overheating the brakes. This can be dangerous. Apply the regenerative brake when driving on steep downhill roads.

CAUTION

- Turn the e-Pedal Step system OFF and place the vehicle in the **N** (Neutral) position under the following conditions:
 - When the vehicle enters an automatic car wash.
 - When the vehicle is towed.
- Be careful not to operate the e-Pedal switch mistakenly or unintentionally.
- At low speed, the motor continues to apply torque to move vehicle slowly forward (so-called "creep"), similar to a conventional vehicle with an automatic transmission. Remember to depress the brake pedal firmly to slow or stop the vehicle.

e-Pedal Step SYSTEM MALFUNCTION

If the e-Pedal Step system malfunctions, [e-Pedal system failure! Press brake pedal to slow or stop] warning message appears in the Vehicle Information Display. When the warning message appears, the e-Pedal Step system will be turned off automatically. Have the system checked as soon as possible by a NISSAN dealer or qualified workshop.

APPROACHING VEHICLE SOUND FOR PEDESTRIANS (VSP) SYSTEM

The Approaching Vehicle Sound for Pedestrians (VSP) system is a function that uses sound to help alert pedestrians of the presence of the vehicle when it is being driven at a low speed.

The VSP sounds when the READY to drive indicator light is illuminated under the following conditions:

- When the vehicle speed is within 30 km/h (19 MPH) when starting.
- When the vehicle speed is less than 25 km/h (16 MPH) while decelerating.
- When the vehicle is in the R (Reverse) position.

The sound stops when the vehicle stops.

If the system malfunction occurs, the VSP warning light in the meter illuminates. If the VSP warning light illuminates, have the VSP system checked by a NISSAN dealer or qualified workshop immediately.

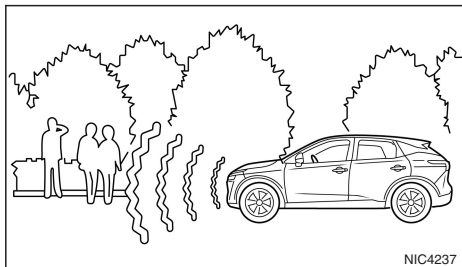

⚠ WARNING

If the sound from the VSP system is not heard while driving, stop the vehicle in a safe and quiet location. Open a window, and then place the ve-

hicle in the R (Reverse) position with the brake pedal firmly depressed. Check that the operating sound can be heard from the front side of the vehicle. If the sound from the VSP system is not heard, contact a NISSAN dealer or qualified workshop.

NOTE

- The VSP also sounds when all of the following conditions are met, in order to remind you to place the power switch in the OFF position.
 - When the shift position is in the P (Park) position.
 - When the READY to drive indicator light illuminates.
 - When the driver's seat belt is not fastened.
 - When any door (except the back door) is opened.
- If you wish to increase the volume of the VSP system, contact a NISSAN dealer. (It is not possible to lower the volume.)

NOTE

1 Safety — seats, seat belts and supplemental restraint system

Seats.....	32	Seat belt maintenance	45
Front seats.....	33	Pre-tensioner seat belt system.....	45
Driving Position Memory System (where fitted).....	35	Child safety.....	46
Seat heater (where fitted).....	35	Infants and small children.....	47
Massage seats (where fitted).....	35	Larger children.....	47
Rear seats.....	35	Legal requirements	47
Armrests (where fitted)	36	Child restraints.....	47
Head restraints	37	Precautions on child restraints.....	47
Adjustable head restraint components.....	37	Child restraint and ISOFIX information	49
Non-adjustable head restraint components.....	37	ISOFIX child restraint system	54
Remove	38	Child restraint anchorage	55
Install.....	38	Child restraint installation using ISOFIX	55
Adjust.....	38	Child restraint installation using three-point type seat belt	58
Seat belts	39	Supplemental Restraint System (SRS).....	63
Precautions on seat belt usage.....	39	Precautions on Supplemental Restraint System (SRS).....	63
Child safety.....	40	Front passenger air bag status light	67
Pregnant women.....	41	Repair and replacement procedure	73
Injured persons.....	41		
Seat belt reminders.....	41		
Three-point type seat belt.....	43		

SEATS

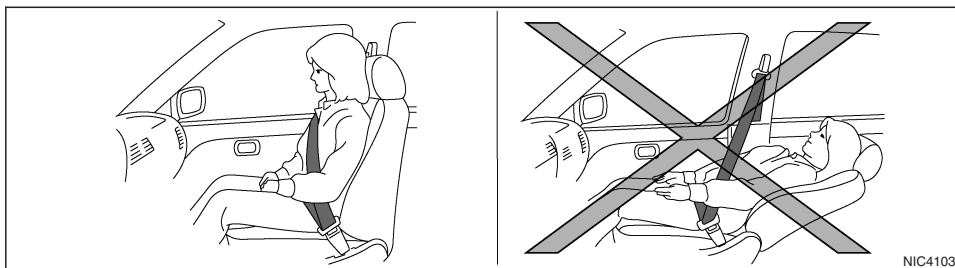

Sit upright and well back

⚠ WARNING

- Do not ride in a moving vehicle when the seatback is reclined. This can be dangerous. The shoulder belt will not be against your body. In an accident, you could be thrown into it and receive neck or other serious injuries. You could also slide under the lap belt and receive serious internal injuries.
- For the most effective protection when the vehicle is in motion, the seat should be upright. Always sit well back and upright in the seat with both feet on the floor and adjust the seat properly. See “Precautions on seat belt usage” later in this section.
- Do not adjust the driver’s seat while driving. The seat may move suddenly and could cause loss of control of the vehicle.
- After adjustment, gently rock in the seat to make sure it is securely locked.
- Do not leave children unattended inside the vehicle. They could unknowingly activate

switches or controls, or make the vehicle move. Unattended children could become involved in serious accidents.

- To help avoid risk of injury or death through unintended operation of the vehicle and/or its systems, do not leave children, people who require the assistance of others, or pets unattended in your vehicle. Additionally, the temperature inside a closed vehicle on a warm day can quickly become high enough to cause a significant risk of injury or death to people and pets.
- The seatback should not be reclined any more than needed for comfort. Seat belts are most effective when the passenger sits well back and upright in the seat. If the seatback is reclined, the risk of sliding under the lap belt and being injured is increased.
- When returning the seatbacks to the upright position, be certain that they are completely secured in the latched position. If they are not completely secured, passengers may be in-

jured in an accident or sudden stop. When operating the seatback release always rock the seatback afterwards to check that it is locked.

- When the vehicle is being used to carry cargo, properly secure all cargo to help prevent it from sliding or shifting. Do not place cargo higher than the seatbacks. In a sudden stop or collision, unsecured cargo could cause personal injury.
 - Never allow anyone to ride in the luggage area or on the rear seat when it is in the folded-down position. Use of these areas by passengers without proper restraints could result in serious injury or death in an accident or sudden stop.
 - Depending on vehicle specification, the front passenger seat may be equipped with occupant classification sensors that turn the front passenger air bag OFF under some conditions. These sensors are only used in this seat. Failure to be properly seated and wearing the seat belt can increase the risk or severity of injury in an accident. See “Supplemental Restraint System (SRS)” later in this section.
- Vehicles not fitted with occupant classification sensors have an Occupant Detection System on this seat which cannot turn the front airbag off automatically. For manual airbag control details see “Supplemental Restraint System (SRS)” later in this section.

CAUTION

- When adjusting the seat positions, be sure not to contact any moving parts to avoid possible injuries and/or damage.
- To avoid damage to the seats, seat heating (where fitted) and occupant detection, observe the following information:
 - Any liquid spilled on the seat should be removed immediately with a dry cloth.
 - If the seat covers are damp or wet, do not switch on the seat heating (where fitted) The seat heating must not be used to dry the seats.
 - Clean the seat covers as recommended, see “Cleaning interior” in the “7.Appearance and care” section.
 - Do not transport heavy loads on the seats. Do not place sharp objects on the seat cushions, for example knives, nails or tools.

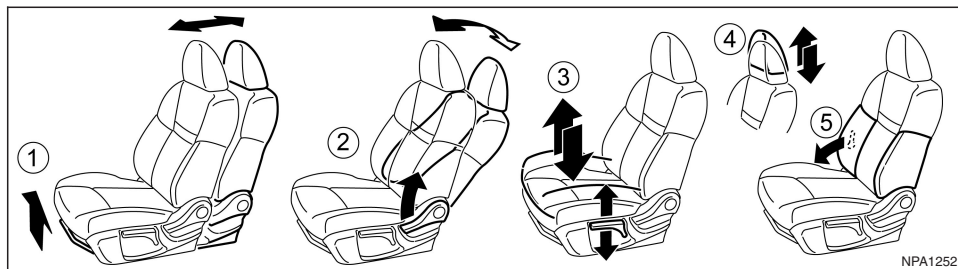

FRONT SEATS

Manual seat adjustment

Forward and backward:

Pull the lever ① up and hold it while sliding the seat forward or backward to the preferred position. Release the lever to lock the seat in position.

Reclining:

CAUTION

When moving the seats forward or backward, or returning a rear-reclined seatback to its upright position, make sure you hold onto the seatback while operating. If the seatback is not held, the seat or seatback will move suddenly and could cause injury.

To recline the seatback pull and hold the lever ② up, keeping the lever fully lifted, and lean back. To bring the seatback forward pull and hold the lever up, keeping the lever fully lifted, and lean forward. Keep

the lever fully lifted whilst adjusting the seatback. Release the lever when the seatback is stationary and in the desired recline position.

The reclining feature allows adjustment of the seatback for occupants of different sizes for added comfort and to help obtain proper seat belt fit, see “Precautions on seat belt usage” later in this section. Also, the seatback can be reclined to allow occupants to rest when the vehicle is stopped and the vehicle is in the P (Park) position or N (Neutral) position with the parking brake applied.

Seat lifter (where fitted):

Repeatedly pull up or push down the adjusting lever ③, to adjust the seat height to the desired position.

Head restraints:

Push and hold the lock knob ④ to remove, install, or (where possible) adjust the head restraints. For proper adjustment see “Head restraints” later in this section.

Lumbar support (where fitted):

The lumbar support feature provides lower back support to the driver.

Manual adjustment (where fitted): Move the adjusting lever ⑤ forward or backward to adjust the seat lumbar area until the desired position is achieved.

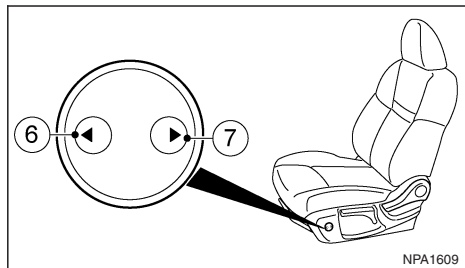

Power adjustment (where fitted): Push each side of the adjusting switch to adjust the seat lumbar area until the desired position is achieved

- ⑥ To harden the seatback contour
- ⑦ To soften the seatback contour

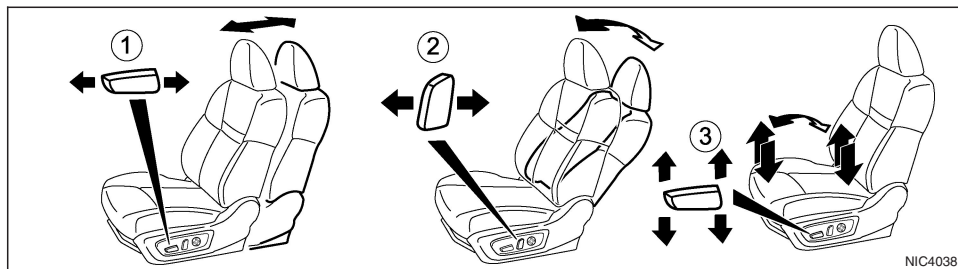

Power seat adjustment (where fitted)

⚠ WARNING

To help avoid risk of injury or death through unintended operation of the vehicle and/or its systems, do not leave children, people who require the assistance of others or pets unattended in your vehicle. Additionally, the temperature inside a closed vehicle on a warm day can quickly become high enough to cause a significant risk of injury or death to people and pets.

Operating tips:

- The power seat motor has an auto-reset overload protection circuit. If the motor stops during the seat adjustment, wait 30 seconds, then reactivate the switch.
- To avoid discharge of the battery, do not operate the power seats for a long period of time when the e-POWER system is not ON.

Forward and backward:

Move the adjusting switch ① forward or backward to the desired position.

Reclining:

Move the adjusting switch ② forward or backward to the desired position.

The reclining feature allows the adjustment of the seatback for occupants of different sizes to help obtain the proper seat belt fit. (See "Precautions on seat belt usage" later in this section.)

The seatback may be reclined to allow occupants to rest when the vehicle is parked.

Seat lifter/tilter (where fitted):

Move the adjusting switch ③ as shown to adjust the angle of the front portion or height of the seat. Pull the front or rear of the adjusting switch ③ up or push down to adjust the seat height and angle until the desired position is achieved.

Lumbar support (where fitted):

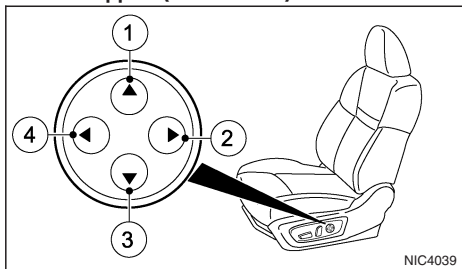

Type A (with height adjustment)

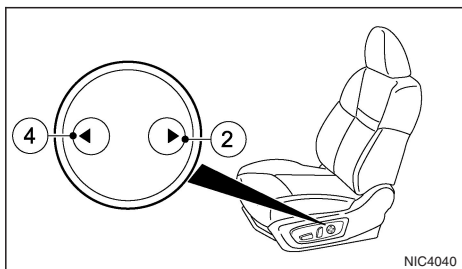

Type B (without height adjustment)

The lumbar support feature provides lower back support to the driver.

Push each side of the adjusting switch to adjust the seat lumbar area until the desired position is achieved.

- ① To raise the seatback contour
- ② To soften the seatback contour
- ③ To lower the seatback contour

- ④ To harden the seatback contour

DRIVING POSITION MEMORY SYSTEM (where fitted)

Two positions for the driver's seat can be stored in the Driving Position Memory System. For more information on the Driving Position Memory System, see "Driving Position Memory System (where fitted)" in the "3. Pre-driving checks and adjustments" section.

SEAT HEATER (where fitted)

The front seats can be warmed by built-in heaters. The switches are located on the instrument panel and can be operated independently of each other. For more information on the seat heater, see "Seat heating (where fitted)" in the "2. Instruments and controls" section.

MASSAGE SEATS (where fitted)

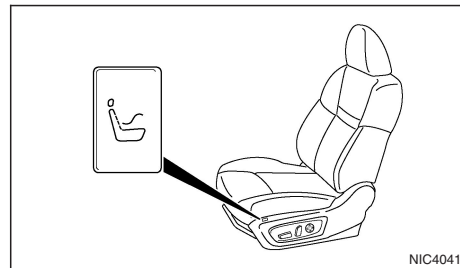

Massage seat switch

Use the massage seat switch on the side of the seat to turn the massage seat feature on or off.

NOTE

Before the massage seat can be operated, the door must be closed and the e-POWER system must be ON.

For details of how to control and adjust the massage seat functions, see your NissanConnect Owner's Manual.

REAR SEATS

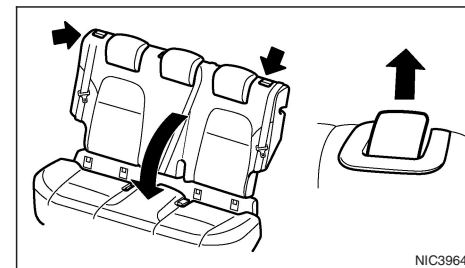

Folding

The luggage compartment loading capacity can be increased by folding the rear seats forward as shown.

To fold the seat:

1. Ensure head restraints are properly stowed, see "Head restraints" later in this section.

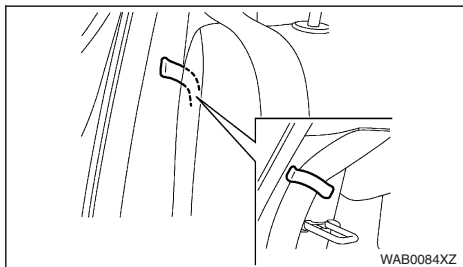

2. When folding the rear seat forward, the outer seat belts can be stored out of the way using the seat belt hooks as shown in the illustration.

CAUTION

- Take care when releasing the seatback lock, the seatback has a folding assist spring and the seat will spring forward.
- Do not fold down the rear seats when occupants are in the rear seat area or any luggage is on the rear seats.
 - Make sure that the seat path is clear before moving the seat.
 - Be careful not to allow hands or feet to get caught or pinched in the seat.

3. Release the seatback lock by lifting the latch.
4. Fold the seat forward as shown.

To return the seat to an upright position:

1. Make sure the seat belts are clear of the seat latch mechanism.
2. Lift the seatback up and push firmly to lock.

CAUTION

- If the seatback is not firmly locked, the seatback will spring forward.
 - Make sure that the seat path is clear before moving the seat.
 - Be careful not to allow hands or feet to get caught or pinched in the seat.

3. Ensure lock button has returned to the closed position and pull seatback firmly to check it is securely latched.

CAUTION

Always ensure that the seat belt is not trapped in the release lever or any other vehicle part.

ARMRESTS (where fitted)

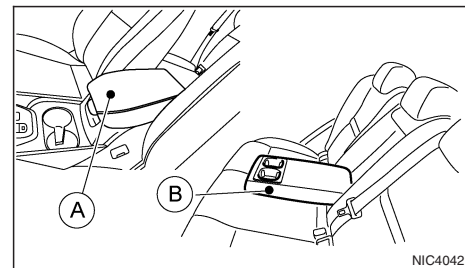

1. Front armrest (A)

The console box lid can be used as an armrest.

2. Rear armrest (B)

On the rear seat, pull the top of the armrest and lay it horizontally.

HEAD RESTRAINTS

⚠ WARNING

Head restraints supplement the other vehicle safety systems. They may provide additional protection against injury in certain rear end collisions. Adjust the head restraints properly, as specified in this section. Check the adjustment after someone else uses the seat. Do not attach anything to the head restraint stalks or remove the head restraint. Do not use the seat if the head restraint has been removed. If the head restraint was removed, reinstall and properly adjust the head restraint before an occupant uses the seating position. Failure to follow these instructions can reduce the effectiveness of the head restraints. This may increase the risk of serious injury or death in a collision.

- Your vehicle is equipped with head restraints. On the front seats they are adjustable. On the rear seats they are non-adjustable but have a lower storage position.
- Adjustable head restraints have multiple notches along the stalk to lock them in a desired adjustment position.
- The non-adjustable head restraints have a single locking notch to secure them to the seat frame.
- Proper Adjustment:
 - For the adjustable type, align the head restraint so the centre of your ear is approximately level with the centre of the head restraint.
 - If your ear position is still higher than the recommended alignment, place the head restraint at the highest position.

- For the non-adjustable type, raise into locking position before use. The seat should not be occupied with the head restraint in the lower storage position.

- If the head restraint has been removed, ensure that it is reinstalled and locked in place before riding in that designated seating position.

ADJUSTABLE HEAD RESTRAINT COMPONENTS

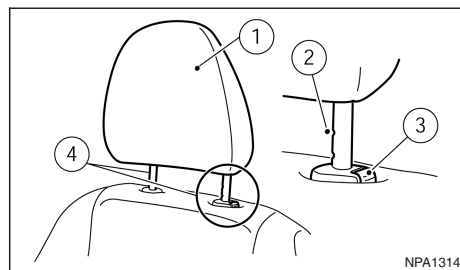

1. Removable head restraint
2. Multiple notches
3. Lock knob
4. Stalks

NON-ADJUSTABLE HEAD RESTRAINT COMPONENTS

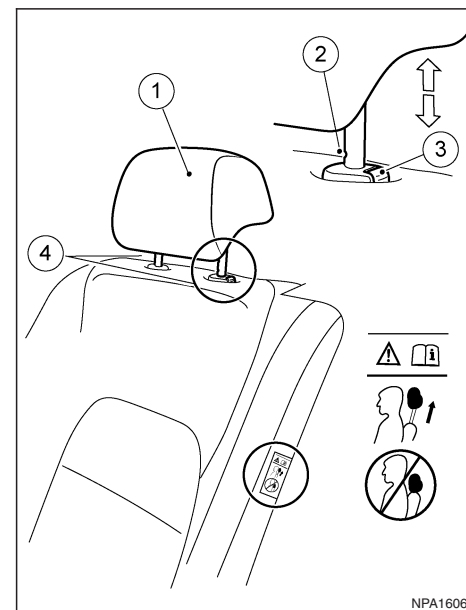

1. Removable head restraint
2. Single notch
3. Lock knob
4. Stalks

REMOVE

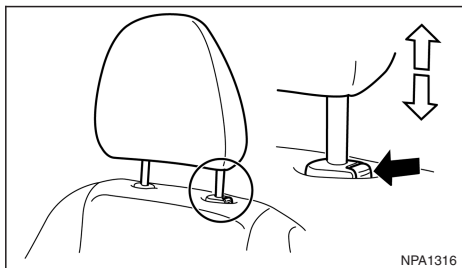

Use the following procedure to remove the head restraint.

1. Pull the head restraint up to the highest position.
2. Push and hold the lock knob.
3. Remove the head restraint from the seat.
4. Store the head restraint properly in a secure place so it is not loose in the vehicle.
5. Reinstall and properly adjust the head restraint before an occupant uses the seating position.

INSTALL

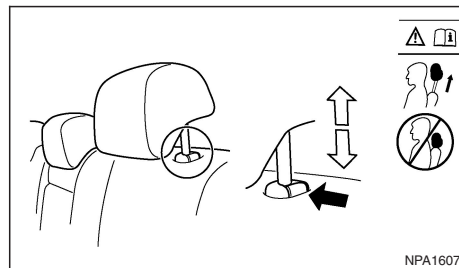

1. Align the head restraint stalks with the holes in the seat. Make sure that the head restraint is facing the correct direction. The stalk with the adjustment notch must be installed in the hole with the lock knob.
2. Push and hold the lock knob and push the head restraint down.
3. Properly adjust the head restraint before an occupant uses the seating position.

ADJUST

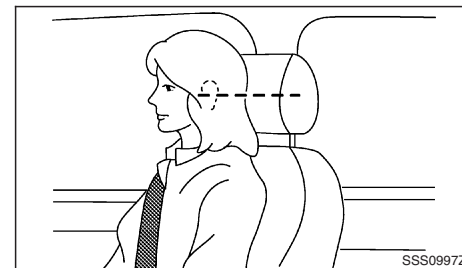

For adjustable front head restraint

Adjust the head restraint so the centre is level with the centre of your ears. If your ear position is still higher than the recommended alignment, place the head restraint at the highest position.

For non-adjustable head restraint

Make sure the head restraint is positioned so the lock knob is engaged in the notch before riding in that designated seating position.

SEAT BELTS

Raise

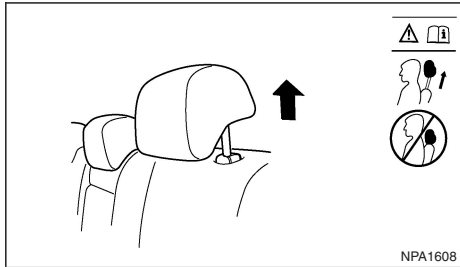

NPA1608

To raise the head restraint, pull it up as shown.

Lower

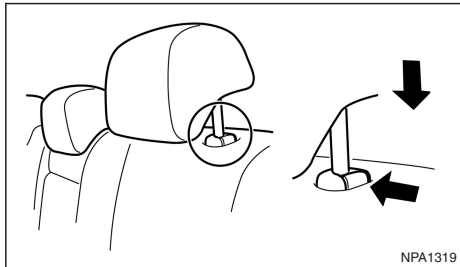

NPA1319

To lower, push and hold the lock knob and push the head restraint down as shown.

PRECAUTIONS ON SEAT BELT USAGE

If you are wearing your seat belt properly adjusted, and you are sitting upright and well back in your seat, your chances of being injured or killed in an accident and/or the severity of injury may be greatly reduced. NISSAN strongly encourages you and all of your passengers to buckle up every time you drive, regardless of whether or not your seating position includes a supplemental air bag.

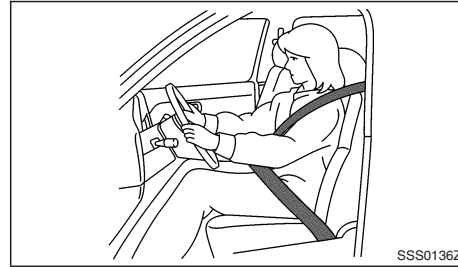

SSS0136Z

Sit upright and well back

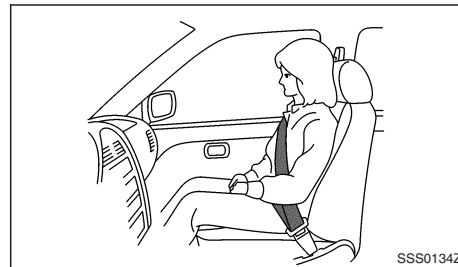

SSS0134Z

Sit upright and well back

WARNING

Be sure to observe the following warnings when using seat belts. Failure to do so could increase the chance and/or severity of injury in an accident.

- Every person who drives or rides in this vehicle should use a seat belt at all times. Children should be in the rear seats and in an appropriate restraint.
- The seat belt should be properly adjusted to a snug fit. Failure to do so may reduce the effectiveness of the entire restraint system and increase the chance or severity of injury in an accident. Serious injury or death can occur if the seat belt is not worn properly.
- Always route the shoulder belt over your shoulder and across your chest. Never put the belt behind your back, under your arm or across your neck. The belt should be away from your face and neck, but not falling off your shoulder.
- Seat belts are designed to bear upon the bony structure of the body, and should be worn low across the front of the pelvis or the pelvis, chest and shoulders, as applicable; wearing the lap section of the belt across the abdominal area must be avoided. Position the lap belt as low and snug as possible around THE HIPS, NOT THE WAIST. A lap belt worn too high could increase the risk of internal injuries in an accident.

- No modifications or additions should be made by the user which will either prevent the seat belt adjusting devices from operating to remove slack, or prevent the seat belt assembly from being adjusted to remove slack.
- Seat belts should be adjusted as firmly as possible, consistent with comfort, to provide the protection for which they have been designed. A slack belt will greatly reduce the protection afforded to the wearer.
- Be sure the seat belt tongue is securely fastened to the proper buckle.
- Do not wear the seat belt inside out or twisted. Doing so may reduce its effectiveness.
- Never carry more people in the vehicle than there are seat belts.
- Each belt assembly must only be used by one occupant; it is dangerous to put a belt around a child being carried on the occupant's lap.
- If the seat belt warning light illuminates continuously while the power switch is ON, with all doors closed, and all seat belts fastened, it may indicate a malfunction in the system. Have the system checked by a NISSAN dealer or qualified workshop.
- No changes should be made to the seat belt system. For example, do not modify the seat belt, add material, or install devices that may change the seat belt routing or tension. Doing so may affect the operation of the seat belt system. Modifying or tampering with the seat belt system may result in serious personal injury.

- Once a seat belt pre-tensioner has been activated, it cannot be reused and must be replaced together with the retractor. See a NISSAN dealer or qualified workshop.
- Removal and installation of the pre-tensioner seat belt system components should be done by a NISSAN dealer or qualified workshop.
- All seat belt assemblies, including retractors and attaching hardware, should be inspected by a NISSAN dealer or qualified workshop after any collision. NISSAN recommends that all seat belt assemblies in use during a collision be replaced unless the collision was minor and the belts show no damage and continue to operate properly. Seat belt assemblies not in use during a collision should also be inspected and replaced if either damage or improper operation is noted.
- All child restraints and attaching hardware should be inspected after any collision. Always follow the restraint manufacturer's inspection instructions and replacement recommendations. The child restraints should be replaced if they are damaged.
- It is essential to replace the entire assembly after it has been worn in a severe impact even if damage to the assembly is not obvious.
- Care should be taken to avoid contamination of the webbing with polishes, oils and chemicals, and particularly battery acid. It is possible to safely clean the seat belts, see "Seat belt maintenance" later in this section. The belt should be replaced if webbing becomes frayed, contaminated or damaged.

CHILD SAFETY

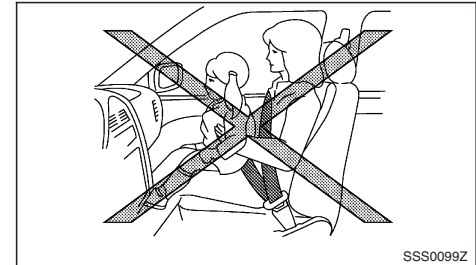

Infants or small children

NISSAN recommends that infants or small children should be seated in a child restraint on the rear seats. According to accident statistics, children are safer when properly restrained in the rear seat than in the front seat. See "Child restraints" later in this section. You should choose a child restraint system which fits your vehicle and always follow the manufacturer's instructions for installation and use.

Larger children

Children who are too large for child restraints should be seated and restrained by the seat belts that are provided.

The use of a booster seat (commercially available) may help to avoid the shoulder belt coming across a child's face or neck area. The booster seat should raise the child so that the shoulder belt is properly positioned across the top, middle portion of the shoulder and the lap belt is low on the hips. The booster seat should fit the vehicle's seat. Once the

child has grown so the shoulder belt is no longer on or near the face and neck, use the shoulder belt without the booster seat.

WARNING

Never let a child stand or kneel on any seat and do not allow a child in the cargo areas while the vehicle is moving.

PREGNANT WOMEN

NISSAN recommends that pregnant women use seat belts. The seat belt should be worn snug, and always position the lap belt as low as possible around the hips, not the waist. Place the shoulder belt over your shoulder and across your chest. Never put the lap/shoulder belt over your abdominal area. Contact your doctor for specific recommendations.

INJURED PERSONS

NISSAN recommends that injured persons use seat belts, depending on the injury. Check with your doctor for specific recommendations.

SEAT BELT REMINDERS

Dependent on the vehicle specification, the Seat Belt Reminder will either:

- Alert the driver if a front row occupant in the vehicle does not have their seat belt securely fastened or if any rear seatbelt changes from fastened to unfastened.
- For vehicles with Rear Occupant Detection, alert the driver if any occupant in the vehicle does not have their seat belt securely fastened

If your vehicle is NOT fitted with Rear Occupant Detection, the Rear Passenger Seat Belt Display will show when the power switch is switched ON while any rear seat belt is unfastened. See "Rear passenger seat belt display (where fitted)" later in this section.

WARNING

NISSAN strongly encourages you and all of your passengers to buckle up every time you drive. Failure to do so may reduce the effectiveness of the entire restraint system and greatly increase the chance or severity of being injured in an accident. Serious injury or death can occur if the seat belt is not worn.

Some infants and children may not require use of the vehicle's seat belt when using an appropriate ISOFIX Child Restraint System with integrated restraints. See "Child restraints" later in this section.



Seat belt warning light

The Seat Belt Warning Light located in the instrument panel will immediately illuminate whenever the power switch is switched ON and any front row occupant's seat belt is not fastened. It will also illuminate if any rear seat belt changes from fastened to unfastened, or in the case of vehicles fitted with Rear Occupant Detection if any rear occupant in the vehicle does not have their seat belt securely fastened. See "Warning lights, indicator lights and audible reminders" in the "2. Instruments and controls" section for further details.

If the vehicle speed exceeds 15 km/h (approximately 10 MPH) the light will flash and a chime will sound for at least 95 seconds or until all occupants are deemed to have their seat belts securely fastened.

All occupants are deemed fastened when all front row occupants have their seat belts securely fastened and the number of rear fastened seat belts matches the maximum number seen during the journey, or in the case of vehicles fitted with Rear Occupant Detection when all occupants have their seat belts securely fastened.

The journey is considered finished and the system will reset when either rear door is opened while the vehicle is stationary.

Rear passenger seat belt display (where fitted)

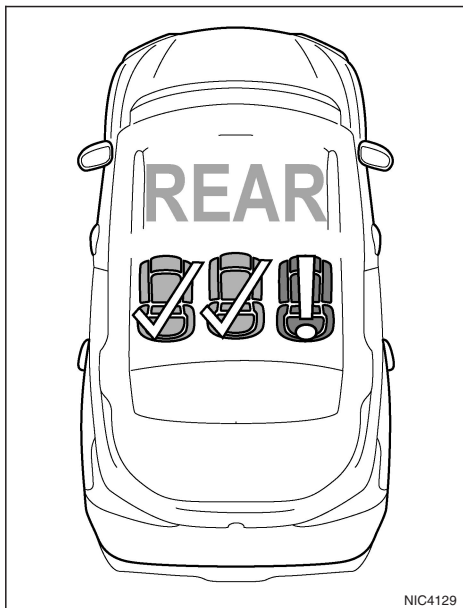

In vehicles not fitted with Rear Occupant Detection, the Rear Passenger Seat Belt Display will be shown in the Vehicle Information Display (See "Vehicle information display" in the "2. Instruments and controls" section) for approximately 65 seconds when the power switch is switched ON while any

rear seat belt is unfastened. The driver can acknowledge the display by pushing the <OK> steering wheel switch.

It will also display if any rear seat belt changes from fastened to unfastened. The display will remain until the number of rear fastened seat belts matches the maximum number seen during the journey or until acknowledged by the driver pushing the <OK> steering wheel switch.

The journey will reset when either rear door is opened while the vehicle is stationary.

If the vehicle speed exceeds 15 km/h (approximately 10 MPH) while the number of rear fastened seat belts remains less than the maximum number seen during the journey the Rear Passenger Seat Belt Display will reappear

It is not possible to acknowledge the display while the Seat Belt Reminder Chime is audible.



Red Seat with exclamation symbol: The corresponding seat belt is unfastened.



Green Seat with tick symbol: The corresponding seat belt is fastened.

Occupant status display (where fitted)

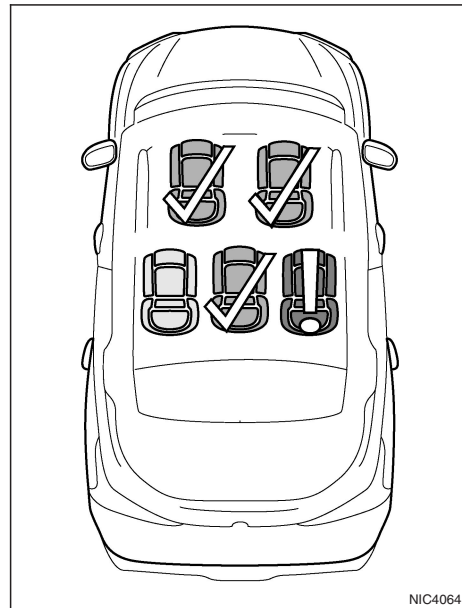

In vehicles fitted with Rear Occupant Detection, in addition to the Seat Belt Warning Light, the Occupant Status Display will be shown in the Vehicle Information Display (See "Vehicle information display" in the "2. Instruments and controls" section) when any vehicle occupant's seat belt is not fastened.

The display will remain until occupants have their seat belts securely fastened, or until acknowledged by the driver pushing the <OK> steering wheel switch.

If an occupant unfastens a seat belt or the vehicle speed exceeds 15 km/h (approximately 10 MPH) while a seat belt is not fastened, the Occupant Status Display will reappear. It is not possible to acknowledge the display while the Seat Belt Reminder Chime is audible.

The driver seat is always considered occupied.



Red Seat with exclamation symbol: The corresponding seat is occupied and seat belt is not fastened.



Green Seat with tick symbol: The corresponding seat belt is fastened.



Grey Seat: The corresponding seat is unoccupied.

⚠ WARNING

- **Lighter passengers, including children, may not be detected by the Seat Belt Reminder system.**
- **When heavy cargo is placed on the seat, the Seat Belt Reminder may be triggered. Such cargo should be secured in the boot. Only use the seat belts to restrain people or universal Child Restraint Systems (See “Child restraints” later in this section). Never use them to secure**

cargo, as this may cause damage, reducing their effectiveness during an accident when subsequently worn by people.

- **When an electrical devices like a smartphone or laptop is placed on front passenger seat, the Seat Belt Reminder may be triggered.**
- **If the Seat Belt Warning Light illuminates continuously while the power switch is ON, with all doors closed, and all seat belts fastened, it may indicate a malfunction in the system. Have the system checked by a NISSAN dealer or qualified workshop.**
- **No changes should be made to the Seat Belt Reminder system.**

THREE-POINT TYPE SEAT BELT

⚠ WARNING

- **Do not ride in a moving vehicle when the seat-back is reclined. This can be dangerous. The shoulder belt will not be against your body. In an accident, you could be thrown into it and receive neck or other serious injuries. You could also slide under the lap belt and receive serious internal injuries.**
- **For the most effective protection when the vehicle is in motion, the seat should be upright. Always sit well back and upright in the seat with both feet on the floor and adjust the seat belt properly.**

Fastening the seat belts

1. Adjust the seat. (See “Seats” earlier in this section.)
2. Slowly pull the seat belt out of the retractor and insert the tongue into the buckle until you hear and feel the latch engage.

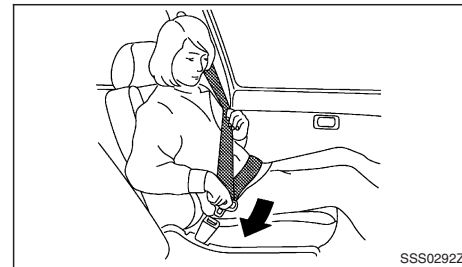

- **The retractor is designed to lock during a sudden stop or on impact. A slow pulling motion permits the belt to move and allows you some freedom of movement in the seat.**
3. Position the lap belt portion **low and snug on the hips** as shown.

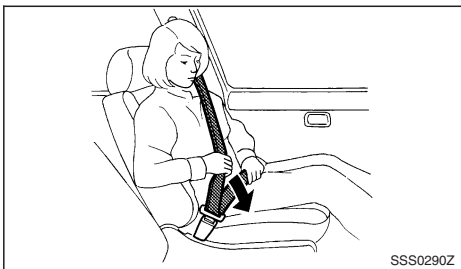

4. Pull the shoulder belt portion toward the retractor to take up extra slack. Be sure the shoulder belt is routed over your shoulder and across your chest.

Unfastening the seat belts

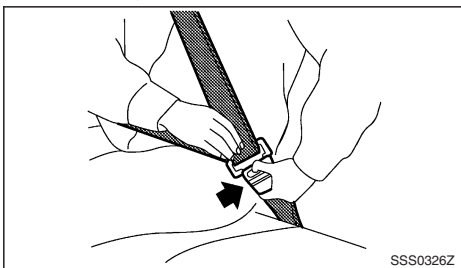

To unfasten the seat belt, push the button on the buckle. Then guide the seat belt as it automatically retracts.

Checking seat belt operation

Seat belt retractors are designed to lock seat belt movement by two separate methods:

- When the belt is pulled quickly from the retractor.
- When the vehicle slows down rapidly.

To increase your confidence in the seat belts, check the operation as follows:

- Grasp the shoulder belt and pull forward quickly. The retractor should lock and restrict further belt movement.

If the retractor does not lock during this check or if you have any questions about seat belt operation, see a NISSAN dealer or qualified workshop.

Shoulder belt height adjustment

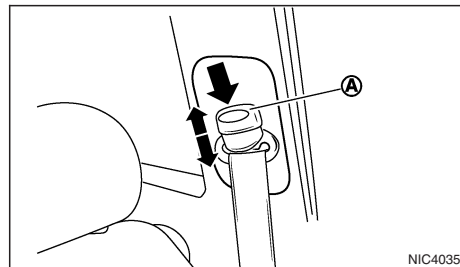

The shoulder belt anchor height should be adjusted to the position that is best for you. (See "Precautions on seat belt usage" earlier in this section.)

To adjust the shoulder belt anchor height upward, push up on the seat belt anchor, you will hear a click after it passes each available position. Once in the proper position, gently pull on the seat belt webbing to ensure the shoulder belt anchor is locked into position.

To adjust downward press down on the release button (A) and move the shoulder belt anchor down, then release the button and gently pull on the seat belt webbing to ensure the shoulder belt anchor is locked into position.

Always adjust the shoulder belt anchor to ensure that the seat belt passes over the centre of the shoulder so it is away from your face but not falling off of your shoulder.

⚠ WARNING

- After adjustment, release the adjustment button and then try to move the shoulder belt anchor up and down to make sure that it is securely fixed in position.
- The shoulder belt anchor height should be adjusted to the position that is best for you. Failure to do so may reduce the effectiveness of the entire restraint system and increase the chance or severity of injury in an accident.

PRE-TENSIONER SEAT BELT SYSTEM

Centre of rear seat

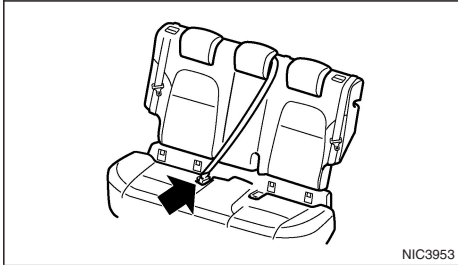

Rear seat belt storage

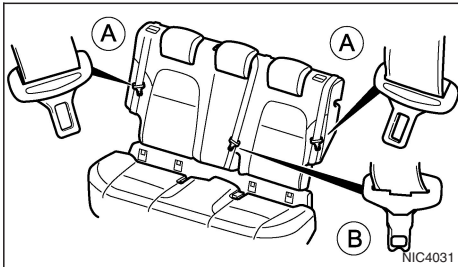
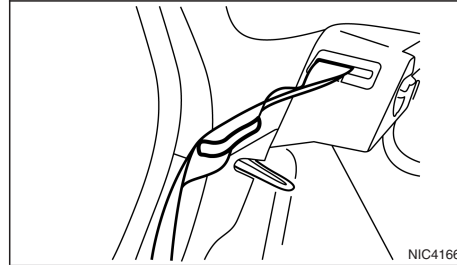

Selecting the correct seat buckle:

The centre seat belt tongue (B) has a different shape to the outer seat belt tongues, and can only be fastened into the centre seat belt buckle. The outer seat belt tongues (A) can only be fastened into the outer buckles.

When folding the rear seat forward, the outer seat belts can be stored out of the way using the seat belt hooks as shown in the illustration.

SEAT BELT MAINTENANCE

- To clean the seat belt webbing, apply a mild soap solution or any solution recommended for cleaning upholstery or carpets. Then wipe with a cloth and allow the seat belts to dry in the shade. Do not allow the seat belts to retract until they are completely dry.
- If dirt builds up in the shoulder belt guide of the seat belt anchors, the seat belts may retract slowly. Wipe the shoulder belt guide with a clean, dry cloth.
- Periodically check to see that the seat belt and the metal components, such as buckles, tongues, retractors, flexible wires and anchors, work properly. If loose parts, deterioration, cuts or other damage on the webbing is found, the entire seat belt assembly should be replaced.

⚠ WARNING

- The pre-tensioner seat belt cannot be reused after activation. It must be replaced together with the retractor as a unit.
- If the vehicle is involved in a frontal collision but the pre-tensioner is not activated, be sure to have the pre-tensioner system checked and, if necessary, replaced by a NISSAN dealer or qualified workshop.
- No unauthorised changes should be made to any components or wiring of the pre-tensioner seat belt system. This is to prevent accidental activation of the pre-tensioner seat belt or damage to the pre-tensioner seat belt operation. Tampering with the pre-tensioner seat belt system may result in serious personal injury.
- Work on and around the pre-tensioner system should be done by an authorised NISSAN dealer or qualified workshop. Installation of electrical equipment should also be done by a NISSAN dealer or qualified workshop. Unauthorised electrical test equipment and probing devices should not be used on the pre-tensioner seat belt system.
- If you need to dispose of the pre-tensioner or scrap the vehicle, contact a NISSAN dealer or qualified workshop. Correct pre-tensioner disposal procedures are set forth in the appropriate NISSAN Service Manual. Incorrect disposal procedures could cause personal injury.

CHILD SAFETY

The pre-tensioner seat belt system is activated in conjunction with the front air bag system. It helps tighten the seat belt when the vehicle is involved in certain types of collisions by restraining the seat occupants via the seat belt retractor.

The pre-tensioner is encased with the seat belt's retractor. These seat belts are used in the same way as conventional seat belts.

When the pre-tensioner seat belt system activates, smoke is released and a loud noise may be heard. The smoke is harmless, but care should be taken not to inhale it.

After pre-tensioner activation, load limiters allow the seat belt to release webbing (if necessary) to reduce forces against the chest. Load limiters are fitted to all seat belt retractors except the rear centre retractor.

When the power switch is switched ON, the Supplemental Restraint System (SRS) air bag warning light will illuminate. The SRS air bag warning light will turn off after approximately 7 seconds if the system is operational. If any of the following conditions occur, the air bag and/or pre-tensioner seat belt need servicing and your vehicle must be taken to the nearest NISSAN dealer or qualified workshop.

- The air bag warning light remains on after approximately 7 seconds.
- The air bag warning light flashes intermittently.
- The air bag warning light does not come on at all.

Unless checked and repaired, the Supplemental Restraint System (SRS) and/or pre-tensioner seat belt may not function properly. It must be checked and repaired.

When selling your vehicle, we request that you inform the buyer about the pre-tensioner seat belt system and guide the buyer to the appropriate sections in this Owner's Manual.

Children need adults to help protect them.

They need to be properly restrained.

In addition to the general information in this manual, child safety information is available from many other sources, including doctors, teachers, government traffic safety offices, and community organisations. Every child is different, so be sure to learn the best way to transport your child.

There are two basic types of child restraint system:

- Rear-facing child restraints
- Front-facing child restraints

Please refer to "Child restraint category, size and position" later in this section to check the recommended child restraint for your child.

WARNING

Infants and children need special protection. The vehicle's seat belts may not fit them properly. The shoulder belt may come too close to the face or neck. The lap belt may not fit over their small hip bones. In an accident, an improperly fitting seat belt could cause serious or fatal injury. Always use appropriate child restraints.

A child restraint may be secured in the vehicle by using either the ISOFIX child restraint system or with the vehicle seat belt, see "Child restraints" later in this section for more information.

CHILD RESTRAINTS

NISSAN recommends that all pre-teens and children be restrained in the rear seat. According to accident statistics, children are safer when properly restrained in the rear seat than in the front seat.

This is especially important because your vehicle has a supplemental restraint system (air bag system) for the front passenger. (See “Supplemental Restraint System (SRS)” later in this section.)

INFANTS AND SMALL CHILDREN

NISSAN recommends that infants and small children be seated in a child restraint system. You should choose a child restraint system that fits your vehicle and the child, and always follow the manufacturer’s instructions for installation and use.

LARGER CHILDREN

Children who are too large for a child restraint system should be seated and restrained by the seat belts that are provided. If the child’s seating position has a shoulder belt that fits close to the face or neck, the use of a booster seat (commercially available) may help overcome this. The booster seat should raise the child so that the shoulder belt is properly positioned across the top, middle portion of the shoulder and the lap belt is low on the hips. The booster seat should also fit the vehicle seat. Once the child has grown so that the shoulder belt is no longer on or near the face or neck of the child, use the shoulder belt without the booster seat. In addition, there are many types of child restraint system available for larger children that should be used for maximum protection.

LEGAL REQUIREMENTS

Check any legal requirements applicable in your location. For example, the U.K. has legal requirements to use child restraints based on height and age, see “Child restraints” later in this section for more information

PRECAUTIONS ON CHILD RESTRAINTS

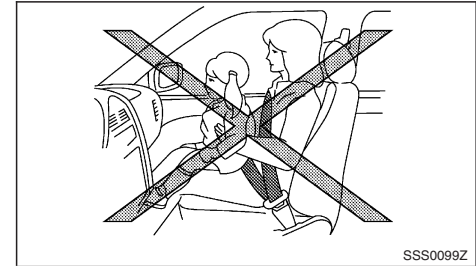

⚠ WARNING

- **Infants and small children should always be placed in an appropriate child restraint system while riding in the vehicle. Failure to use a child restraint system can result in serious injury or death.**
- **Infants and small children should never be carried on your lap. It is not possible for even the strongest adult to resist the forces of a severe accident. The child could be crushed between the adult and parts of the vehicle. Also, do not put the same seat belt around a child and yourself.**

- Infants and children need special protection. The vehicle's seat belts may not fit them properly. The shoulder belt may come too close to the face or neck. The lap belt may not fit over their small hip bones. In an accident, an improperly fitting seat belt could cause serious or fatal injury.
- NISSAN recommends that the child restraint system be installed in the rear seat. According to accident statistics, children are safer when properly restrained in the rear seat rather than in the front seat.
- Child restraint systems specially designed for infants and small children are available from several manufacturers. When selecting any child restraint systems, place your child in the child restraint system and check the various adjustments to be sure that the child restraint system is compatible with your child. Always follow the manufacturer's instructions for installation and use.
- Follow all of the child restraint manufacturer's instructions for installation and use. When purchasing a child restraint, be sure to select one which will fit your child and vehicle. It may not be possible to properly install some types of child restraint in your vehicle.
- Check the child restraint system in your vehicle to be sure that it is compatible with the vehicle's seat belt system.
- For a front-facing child restraint system, check to make sure the shoulder belt does not fit close to the child's face or neck.

- Never install a rear-facing child restraint system on the front passenger seat without ensuring that the front passenger air bag is deactivated. The vehicle may be equipped with a manual or an automatic front-passenger front air bag deactivation system. Where a manual front-passenger air bag deactivation system is equipped, the air bag switch must be used to deactivate the passenger air bag. (For details see "Automatic front-passenger air bag deactivation system (where fitted)" later in this section and "Manual front-passenger air bag deactivation system (where fitted)" later in this section). The <PASSENGER AIR BAG OFF> indicator  must be lit. In a frontal collision, supplemental front-impact air bags inflate with great force. An inflating supplemental front-impact air bag could seriously injure or kill your child.
- Adjustable seatbacks should be positioned to fit the child restraint system, but as upright as possible.
- If the seat belt in the position where a child restraint system is installed requires a locking device and if it is not used, injuries could result from a child restraint system tipping over during normal vehicle braking or cornering.
- After attaching a child restraint system, test it before you place the child in it. Push it from side to side and tug it forward to make sure that it is held securely in place. The child restraint system should not move more than 25 mm (1 in). If the restraint is not secure, tighten the belt as necessary, or install the restraint in another seat and test it again.

- If a child restraint system is not anchored properly, the risk of a child being injured in a collision or a sudden stop greatly increases.
- Improper use of a child restraint system can increase the risk or severity of injury for both the child and other occupants in the vehicle.
- When the child restraint system is not in use, keep it secured with the ISOFIX child restraint system or a seat belt to prevent it from being thrown around in case of a sudden stop or accident.

NISSAN recommends that infants and small children be seated in a child restraint system. You should choose a child restraint system that fits your vehicle and always follow the manufacturer's instructions for installation and use. In addition, there are many types of child restraint systems available for larger children that should be used for maximum protection.

CAUTION

Remember that a child restraint left in a closed vehicle can become very hot. Check the seating surface and buckles before placing your child in a child restraint.

CHILD RESTRAINT AND ISOFIX INFORMATION

When selecting any child restraint, keep the following points in mind:

- Choose a child restraint that complies with the latest European safety standard, ECE Regulation 44.04.
- Place your child in the child restraint and check the various adjustments to be sure the child restraint is compatible with your child. Always follow all of the recommended procedures.
- Check the child restraint in your vehicle to be sure it is compatible with the vehicle's seat belt system.
- Refer to the tables later in this section for a list of the recommended fitment positions and the approved child restraints for your vehicle.

NOTE

Child restraints approved to UN Regulation No. 44 (UN R44) or UN Regulation No.129 (UN R129) are clearly marked with the categories such as Universal, Semi-universal or ISOFIX.

Mass group of child restraint

Mass group	Child's weight
Group 0	up to 10 kg
Group 0+	up to 13 kg
Group I	9 to 18 kg
Group II	15 to 25 kg
Group III	22 to 36 kg

Examples of child restraint types:

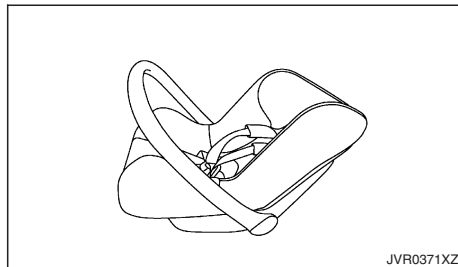

Child safety seat categories 0 and 0+

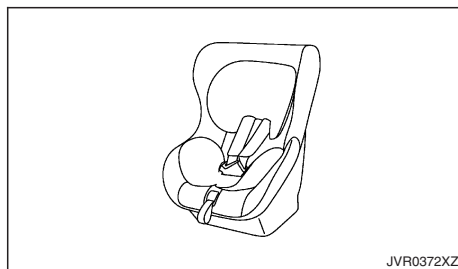

Child safety seat categories 0+ and I

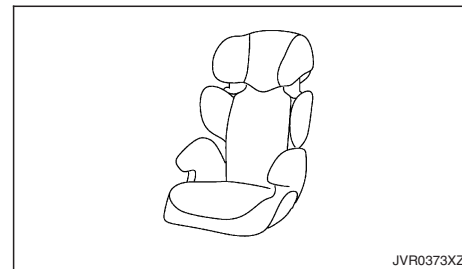

Child safety seat categories II and III

Selecting the child restraint system for each seating position



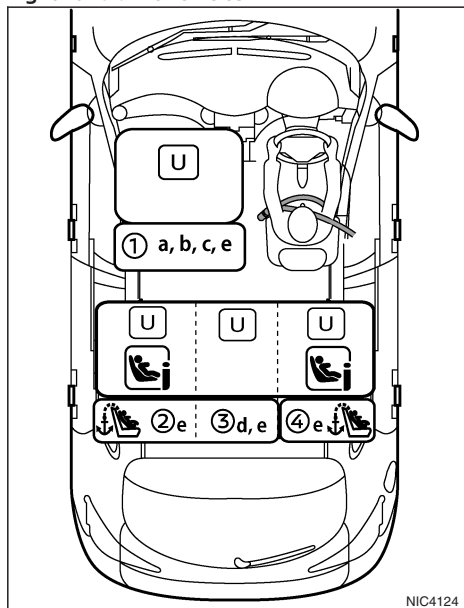

Right hand drive vehicles:

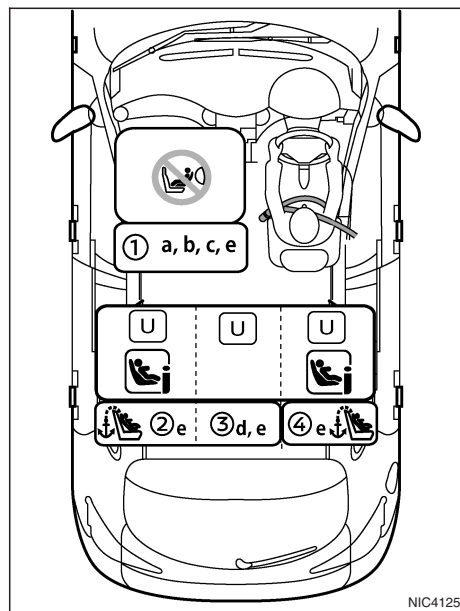

<PASSENGER AIR BAG OFF> indicator illuminated



<PASSENGER AIR BAG ON> indicator illuminated

①	Front passenger seat
②	Row 2: left hand outboard seat
③	Row 2: centre seat
④	Row 2: right hand outboard seat
	Suitable for a universal child restraint that is fastened with vehicle seat belt
	Suitable for i-Size and ISOFIX child restraint system
	Prohibit installation of rearward facing child restraint system
	Top tether anchorage equipment seats

- a: Adjust the seat backrest to the upright position.
- b: Adjust the seat lifter to the uppermost position.
- c: Adjust the seat slide to the rear most position.
- d: Do not install child restraints with a support leg.
- e: Move the head restraint to the uppermost position or remove it (and store securely) if there is any interference with the child restraint. Do not remove head restraint when using a booster cushion only.

Left hand drive vehicles:

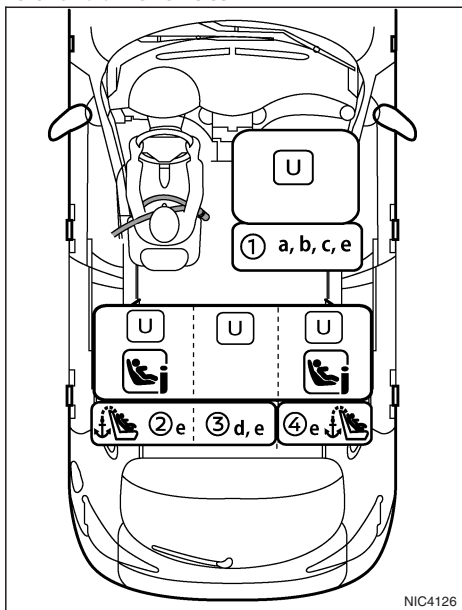

<PASSENGER AIR BAG OFF> indicator illuminated

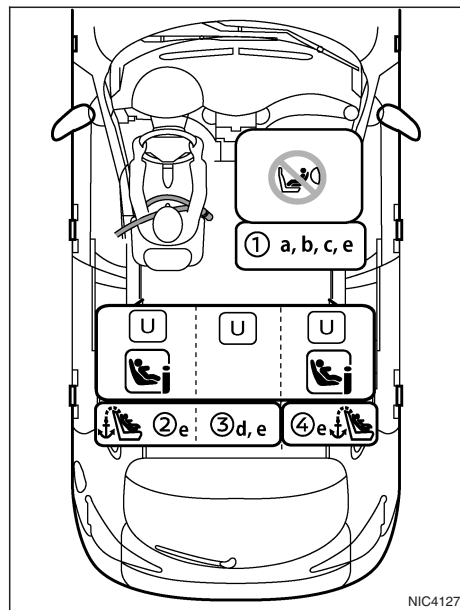

<PASSENGER AIR BAG ON> indicator illuminated

①	Front passenger seat
②	Row 2: left hand outboard seat
③	Row 2: centre seat
④	Row 2: right hand outboard seat
U	Suitable for a universal child restraint that is fastened with vehicle seat belt
i	Suitable for i-Size and ISOFIX child restraint system
	Prohibit installation of rearward facing child restraint system
	Top tether anchorage equipment seats

- a: Adjust the seat backrest to the upright position.
- b: Adjust the seat lifter to the uppermost position.
- c: Adjust the seat slide to the rear most position.
- d: Do not install child restraints with a support leg.
- e: Move the head restraint to the uppermost position or remove it (and store securely) if there is any interference with the child restraint. Do not remove head restraint when using a booster cushion only.

Child restraint category, size and position:

Age (approx.)	Weight (approx.)	Height (approx.)	CRS Mass Category	Recommended CRS	CRS suitable seat position				
					① Air bag Activation (ON)	① ** Air bag Deactivation (OFF)	② **	③ **	④ **
0 - 12 months	Up to 10kg	<75 cm	0	Britax Romer Babysafe Plus + ISOFIX Base Maxi Cosi Cabriofix + Isofix Base	No	No	Yes	No	Yes
0 - 18 months	Up to 13 kg	<85 cm	0+		No	No	Yes	No	Yes
9 months - 4 years old	9 - 18 kg	70 - 100 cm	I	Britax Romer Duo Plus	No	Yes (belt only)	Yes	Yes (belt only)	Yes
				Britax Trifix 2 i-Size	No	No	Yes	No	Yes
4 - 6 years old	15 - 25 kg	100 - 125 cm	II	Romer KidFix2 R *	No	Yes (belt only)	Yes	Yes (belt only)	Yes
6- 10 years old	22 - 36 kg	>125 cm	III	Romer KidFix2 R *	No	Yes (belt only)	Yes	Yes (belt only)	Yes

* It is recommended to use the backrest and lap belt Secure Guard. In the event that the back rest is removed the lap belt Secure Guard should not be used

** Move the head restraint to the uppermost position or remove it (and store securely) if there is any interference with the child restraint. Do not remove head restraint when using a booster cushion only.

Detailed information for child restraint system manufacturers:

Seat position	Front		2nd row		
	①		②	③	④
	Air bag Activation	Air bag Deactivation **	Left **	Centre ** ***	Right **
Seat position suitable for universal belted (yes/no)	No	Yes	Yes	Yes	Yes
i-Size seating position (yes/no)	No	No	Yes	No	Yes
Seating position suitable for lateral fixture (L1/L2)	—	—	—	—	—
Largest suitable rearward facing fixture (R1/R2X/R2/R3)	—	—	R3	—	R3
Largest suitable forward facing fixture (F2X/F2/F3)	—	—	F3	—	F3
Largest suitable booster fixture (B2/B3)	—	—	B3	—	B3

** Move the head restraint to the uppermost position or remove it (and store securely) if there is any interference with the child restraint. Do not remove head restraint when using a booster cushion only.

*** Not suitable for child restraint systems with a support leg

⚠ WARNING

- **Never install a rear-facing child restraint system on the front passenger seat without ensuring that the front passenger air bag is deactivated.** Depending on vehicle specification, the vehicle may be equipped with an automatic front-passenger front air bag deactivation system or a manual front-passenger front air bag deactivation system. (For details see "Automatic front-passenger air bag deactivation system (where fitted)" later in this section and "Manual front-passenger air bag deactivation system (where fitted)" later in this section. If this system is fitted, the **PASSENGER AIR BAG OFF** indicator  must be lit. In a frontal collision, supplemental front-impact air bags inflate with great force. An inflating supplemental front-impact air bag could seriously injure or kill your child.

Refer to the child restraint system tables earlier in this section.

NOTE

Child restraints approved to ECE Regulation NO. 44.04 or UN regulation No. 44 are clearly marked with the categories such as Universal, Semi-universal or ISOFIX.

ISOFIX CHILD RESTRAINT SYSTEM

Your vehicle is equipped with special anchor points that are used with ISOFIX child restraint systems.

ISOFIX lower anchor point locations

The ISOFIX anchor points are provided to install child restraints in the rear outer seating positions only. **Do not attempt to install a child restraint in the centre position using the ISOFIX anchors.**

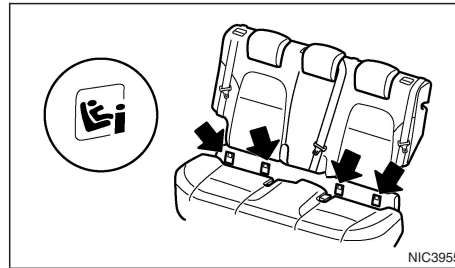

Rear ISOFIX anchor point locations

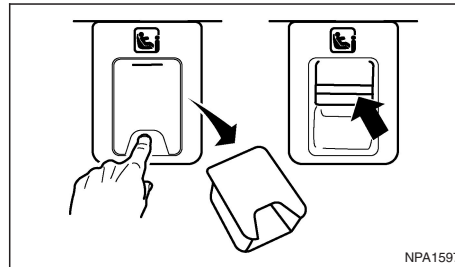

ISOFIX cover removal (rear seats)

The ISOFIX anchor points are located, under covers labelled ISOFIX, at the bottom of the rear seat cushions as shown. To access an ISOFIX anchor point insert your finger into the cover and pull the cover off as shown.

ISOFIX child restraint anchor attachments

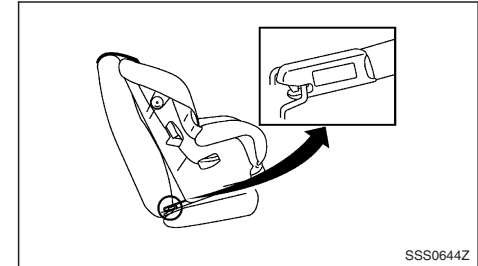

Anchor attachment

ISOFIX child restraints include two rigid attachments that can be connected to two anchors located in the seat. Check your child restraint for a label stating that it is compatible with the ISOFIX child restraints. This information may also be in the instructions provided by the child restraint manufacturer.

ISOFIX child restraints generally require the use of a top tether strap or other anti-rotation devices such as support legs. When installing ISOFIX child restraints, carefully read and follow the instructions in this manual and those supplied with the child restraints. See "ISOFIX child restraint system" later in this section.

CHILD RESTRAINT ANCHORAGE

Your vehicle is designed to accommodate a child restraint system on the rear seat. When installing a child restraint system, carefully read and follow the instructions in this manual and those supplied with the child restraint system.

⚠ WARNING

- Child restraint anchorages are designed to withstand only those loads imposed by correctly fitted child restraints. Under no circumstances are they to be used for adult seat belts, harnesses or for attaching other items or equipment to the vehicle. Doing so could damage the child restraint anchorages. The child restraint will not be properly installed using the damaged anchorage, and a child could be seriously injured or killed in a collision.
- The child restraint top tether strap may be damaged by contact with the parcel shelf or items in the luggage area. Remove the parcel shelf from the vehicle or secure it in the luggage area. See "Parcel shelf" in the "2. Instruments and controls" section. Also secure any items in the luggage area. Your child could be seriously injured or killed in a collision if the top tether strap is damaged.

Anchorage location

Rear passenger seat anchors:

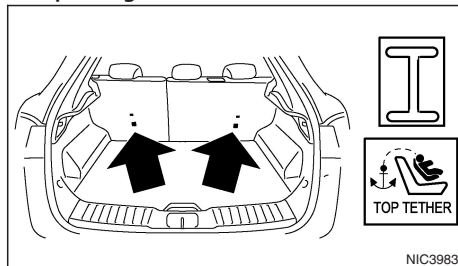

Anchor points are located on the seatback behind the rear outer seating positions and should only be used for child restraints in the rear outer positions.

CHILD RESTRAINT INSTALLATION USING ISOFIX

⚠ WARNING

- Attach ISOFIX child restraints only at the specified locations. For the ISOFIX lower anchor locations, see "ISOFIX lower anchor point locations" earlier in this section. If a child restraint is not secured properly, your child could be seriously injured or killed in an accident.
- Do not install child restraints that require the use of a top tether strap to seating positions that do not have a top tether anchor.

- Do not secure a child restraint in the centre rear seating position using the ISOFIX lower anchors. The child restraint will not be secured properly.
- Inspect the lower anchors by inserting your fingers into the lower anchor area and feeling to make sure there are no obstructions over the ISOFIX anchors, such as seat belt webbing or seat cushion material. The child restraint will not be secured properly if the ISOFIX anchors are obstructed.
- Child restraint anchorages are designed to withstand only those loads imposed by correctly fitted child restraints. Under no circumstance are they to be used for adult seat belts, harnesses or for attaching other items or equipment to the vehicle.

Installation on rear outer seats

Front-facing:

Be sure to follow the manufacturer's instructions for the proper use of your child restraint. Follow these steps to install a front-facing child restraint on rear outer seats using ISOFIX:

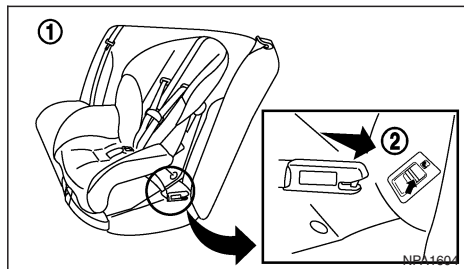

Steps 1 and 2

1. Position the child restraint on the seat ①.
2. Secure the child restraint anchor attachments to the ISOFIX lower anchors ②.
3. The back of the child restraint should be secured against the vehicle seat back. If necessary, adjust or remove the head restraint to obtain the correct child restraint fit. (See "Head restraints" earlier in this section.) If the head restraint is removed, store it in a secure place. Be sure to install the head restraint when the child restraint is removed. If the seating position does not have an adjustable head restraint and it is interfering with the proper child restraint fit, try another seating position or a different child restraint.

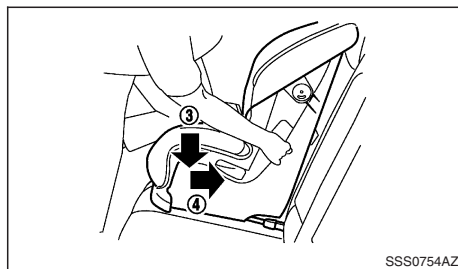

Step 4

4. Shorten the rigid attachment to have the child restraint firmly tightened; press downward ③ and rearward ④ firmly in the centre of the child restraint with your knee to compress the vehicle seat cushion and seatback.
5. If the child restraint is equipped with a top tether strap, route the top tether strap and secure the tether strap to the tether anchor point. (See "Child restraint anchorage" earlier in this section.)
6. If the child restraint is equipped with other anti-rotation devices such as support legs, use them instead of the top tether strap following the child restraint manufacturer's instructions.

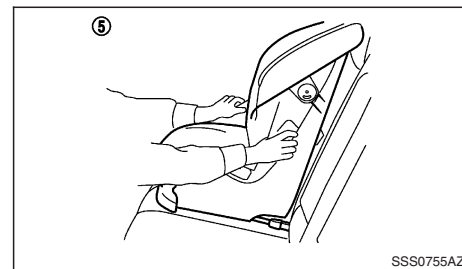

Step 7

7. Test the child restraint before you place the child in it ⑤. Push the child restraint from side to side and tug it forward to make sure that it is held securely in place.
8. Check to make sure that the child restraint is properly secured prior to each use. If the child restraint is loose, repeat steps 3 through 7.

Rear-facing:

Be sure to follow the manufacturer's instructions for the proper use of your child restraint. Follow these steps to install a rear-facing child restraint on the rear outer seats using ISOFIX:

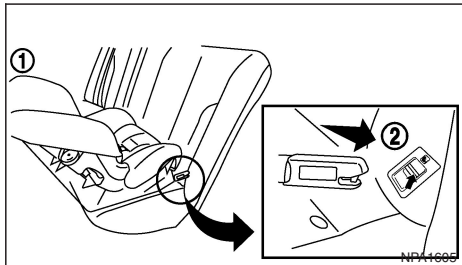

Steps 1 and 2

1. Position the child restraint on the seat ①.
2. Secure the child restraint anchor attachments to the ISOFIX lower anchors ②.

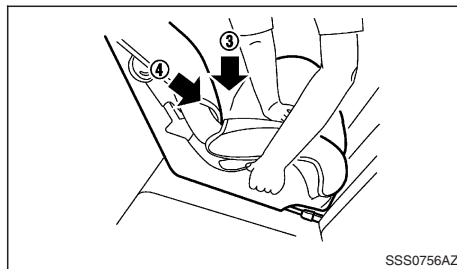

Step 3

3. Shorten the rigid attachment to have the child restraint firmly tightened; press downward ③ and rearward ④ firmly in the centre of the child restraint with your hand to compress the vehicle seat cushion and seatback. If any contact occurs between the child restraint and the front seat, slide the front seat forward until contact no longer occurs.
4. If the child restraint is equipped with a top tether strap, route the top tether strap and secure the tether strap to the tether anchor point. (See "Child restraint anchorage" earlier in this section.)
5. If the child restraint is equipped with other anti-rotation devices such as support legs, use them instead of the top tether strap following the child restraint manufacturer's instructions.

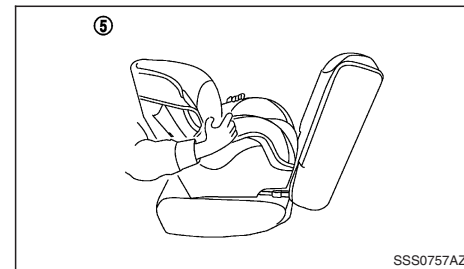

Step 6

6. Test the child restraint before you place the child in it ⑤. Push the child restraint from side to side and tug it forward to make sure that it is held securely in place.
7. Check to make sure that the child restraint is properly secured prior to each use. If the child restraint is loose, repeat steps 3 through 6.

CHILD RESTRAINT INSTALLATION USING THREE-POINT TYPE SEAT BELT

Installation on rear seats

Front-facing:

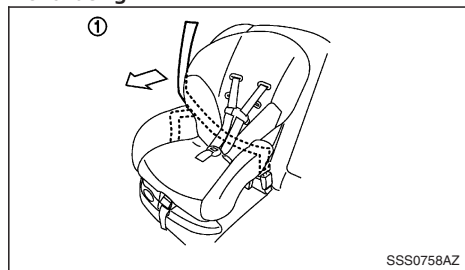

Step 1

Be sure to follow the manufacturer's instructions for the proper use of your child restraint. Follow these steps to install a front-facing child restraint on the rear seats using 3-point type seat belt:

1. Position the child restraint on the seat ①. If any contact occurs between the child restraint and the front seat, slide the front seat forward until contact no longer occurs.

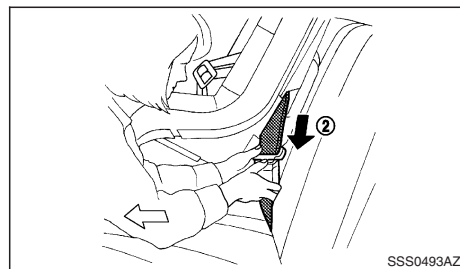

Step 2

2. Route the seat belt tongue through the child restraint and insert it into the buckle ② until you hear and feel the latch engage.
3. To prevent slack in the seat belt webbing, it is necessary to secure the seat belt in place with locking devices attached to the child restraint.

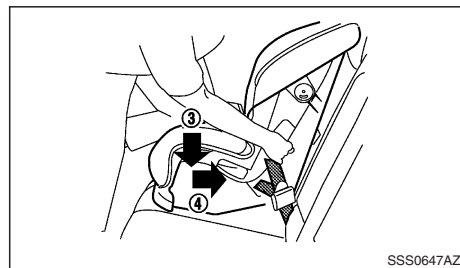

Step 4

4. Remove any additional slack from the seat belt; press downward ③ and rearward ④ firmly in the centre of the child restraint with your knee to compress the vehicle seat cushion and seatback while pulling up on the seat belt.

If the child restraint is equipped with a top tether strap, route the top tether strap and secure the tether strap to the tether anchor point. (See "Child restraint anchorage" earlier in this section.)

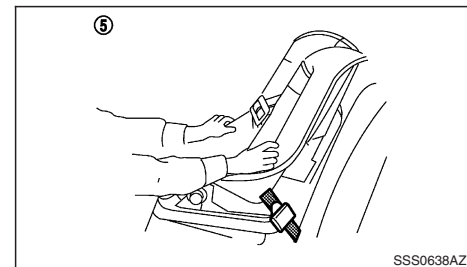

Step 5

5. Test the child restraint before you place the child in it ⑤. Push the child restraint from side to side and tug it forward to make sure that it is held securely in place.
6. Check to make sure that the child restraint is properly secured prior to each use. If the child restraint is loose, repeat steps 3 through 5.

Rear-facing:

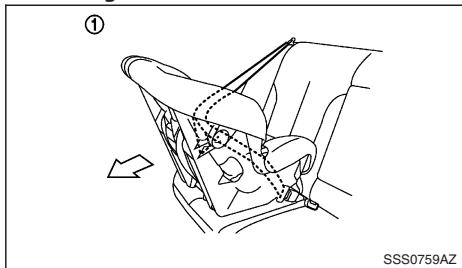

Step 1

Be sure to follow the manufacturer's instructions for the proper use of your child restraint. Follow these steps to install a rear-facing child restraint on the rear seats using 3-point type seat belt:

1. Position the child restraint on the seat ①.

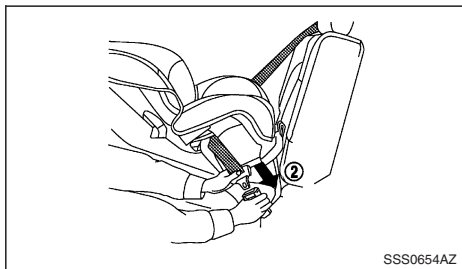

Step 2

2. Route the seat belt tongue through the child restraint and insert it into the buckle ② until you hear and feel the latch engage.

3. To prevent slack in the seat belt webbing, it is necessary to secure the seat belt in place with locking devices attached to the child restraint.

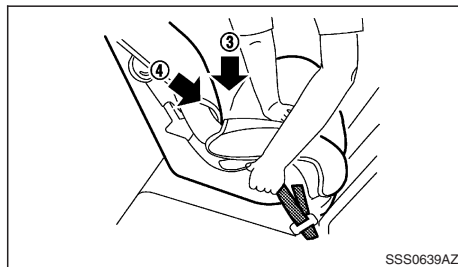

Step 4

4. Remove any additional slack from the seat belt; press downward ③ and rearward ④ firmly in the centre of the child restraint with your hand to compress the vehicle seat cushion and seatback while pulling up on the seat belt.

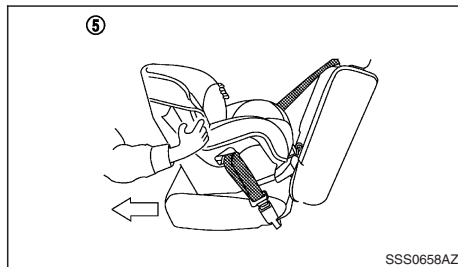

Step 5

5. Test the child restraint before you place the child in it ⑤. Push the child restraint from side to side and tug it forward to make sure that it is held securely in place.
6. Check to make sure that the child restraint is properly secured prior to each use. If the child restraint is loose, repeat steps 3 through 5.

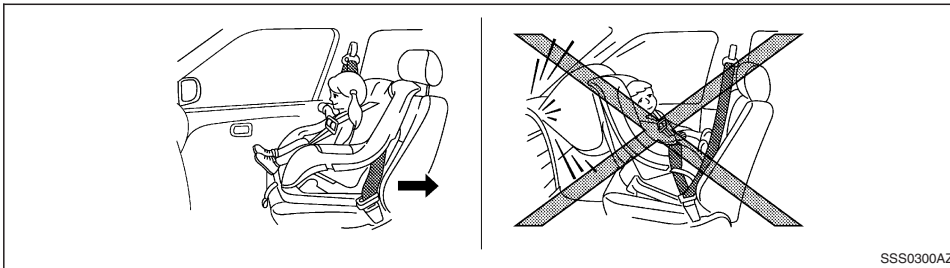

SSS0300AZ

Installation on front passenger's seat

⚠ WARNING

- Never install a rear-facing child restraint system on the front passenger seat without ensuring that the front passenger air bag is deactivated. Depending on vehicle specification, the vehicle may be equipped with an automatic front-passenger front air bag deactivation system or a manual front-passenger front air bag deactivation system. (For details see "Automatic front-passenger air bag deactivation system (where fitted)" later in this section and "Manual front-passenger air bag deactivation system (where fitted)" later in this section. If this system is fitted, the **PASSENGER AIR BAG OFF** indicator  located on the roof console must be lit. In a frontal collision, supplemental front-impact air bags inflate with great force. An inflating supplemental front-impact air bag could seriously injure or kill your child.

- NISSAN recommends that a child restraint be installed on the rear seat. However, if you must install a child restraint on the front passenger's seat, move the passenger's seat to the rearmost position.
- Child restraints for infants must be used in the rear-facing direction and therefore must not be used on the front passenger's seat when the front passenger's air bag has not been deactivated.

Front-facing:



Be sure to follow the manufacturer's instructions for the proper use of your child restraint. Follow these steps to install a front-facing child restraint on the front passenger's seat using a 3-point type seat belt:



NIC4034

NOTE

Depending on vehicle specification, the vehicle may be equipped with an automatic front-passenger front air bag deactivation system or a manual front-passenger front air bag deactivation system. (For details see "Automatic front-passenger air bag deactivation system (where fitted)" later in this section and "Manual front-passenger air bag deactivation system (where fitted)" later in this section

1. If the child restraint is installed on the front passenger seat, switch the power switch ON. The <PASSENGER AIR BAG OFF>  light, located on the roof console, should illuminate. If the <PASSENGER AIR BAG ON>  light is illuminated, see "Supplemental Restraint System (SRS)" later

in this section.) Move the child restraint to another seating position. Have the system checked by a NISSAN dealer or qualified workshop.

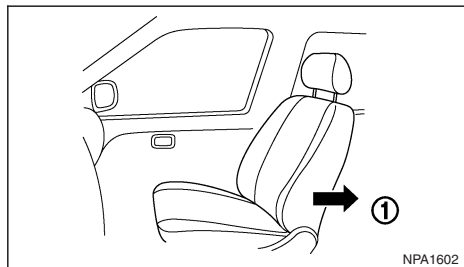

Step 2

2. Move the seat to the rearmost position ①.
3. Position the child restraint in the seat.

Always follow the child restraint system manufacturer's instructions for installation and use.

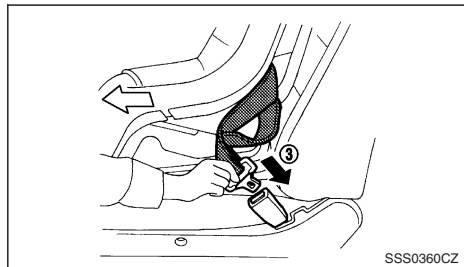

Steps 4 and 5

4. Route the seat belt tongue through the child restraint and insert it into the buckle ③ until you hear and feel the latch engage.

5. To prevent slack in the seat belt webbing, it is necessary to secure the seat belt in place with locking devices attached to the child restraint.

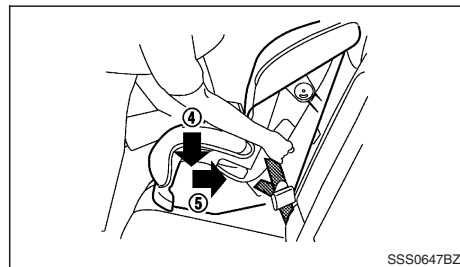

Step 6

6. Remove any additional slack from the seat belt; press downward ④ and rearward ⑤ firmly in the centre of the child restraint with your knee to compress the vehicle seat cushion and seatback while pulling up on the seat belt.

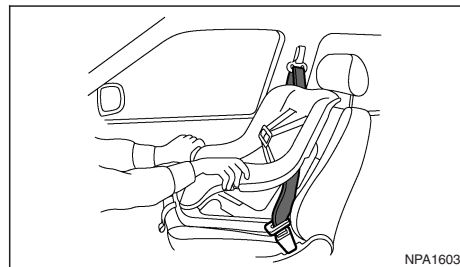

Steps 7 and 8

7. Test the child restraint before you place the child in it. Push the child restraint from side to side and tug it forward to make sure that it is held securely in place.

8. Check to make sure that the child restraint is properly secured prior to each use. If the child restraint is loose, repeat steps 5 through 8.

If the child restraint is still loose, do not use it. Please check the child restraint system manufacturer's instructions for installation and use. Seek advice from a NISSAN dealer or qualified workshop for correct child restraint installation.



Rear facing:

NOTE

Depending on vehicle specification, the vehicle may be equipped with an automatic front-passenger front air bag deactivation system or a manual front-passenger front air bag deactivation system. (For details see "Automatic front-passenger air bag deactivation system (where fitted)" later in this section and "Manual front-passenger air bag deactivation system (where fitted)" later in this section

If you must install a child restraint system in the front seat, follow these steps:



1. If the child restraint is installed on the front passenger seat, switch the power switch ON. The <PASSENGER AIR BAG OFF>  light, located on the roof console, should illuminate. If the <PASSENGER AIR BAG ON>  light is illuminated, see "Supplemental Restraint System (SRS)" later in this section.) Move the child restraint to another seating position. Have the system checked by a NISSAN dealer or qualified workshop.

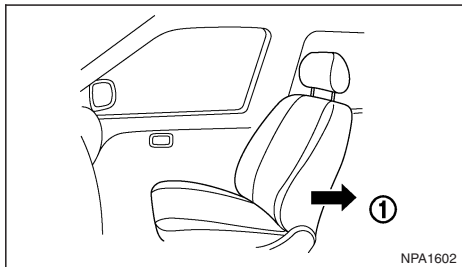

Steps 2 and 3

2. Move the seat to the rearmost position ①.
3. Position the child restraint system in the front passenger seat.

Always follow the child restraint system manufacturer's instructions for installation and use.

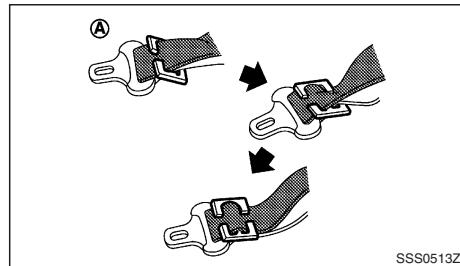

4. Route the seat belt tongue through the child restraint system and insert it into the buckle until you hear and feel the latch engage.
To prevent slack in the lap belt, secure the shoulder belt in place with a locking clip (A). Use a locking clip attached to the child restraint system, or one which is equivalent in dimensions and strength.
Be sure to follow the child restraint system manufacturer's instructions for belt routing.
5. Slide the seat forwards so that the seat belt fully tightens the child restraint system and the child restraint reaches the vehicle dashboard.
6. Test the child restraint system before you place the child in it. Check that it does not tilt too far from side to side. Try to tug it forwards and check if it is held securely in place.

If the child restraint is still not securely held in place, do not use it. Please check the child restraint system manufacturer's instructions for installation and use. Seek advice from a NISSAN dealer or qualified workshop for correct child restraint installation.

SUPPLEMENTAL RESTRAINT SYSTEM (SRS)

PRECAUTIONS ON SUPPLEMENTAL RESTRAINT SYSTEM (SRS)

This Supplemental Restraint System (SRS) section contains important information concerning the driver's and passenger's supplemental front impact air bags, front seat-mounted side-impact supplemental air bags, roof-mounted curtain side-impact air bags, and pre-tensioner seat belts.

Supplemental front-impact air bag system

The supplemental front-impact air bag consists of a Driver Air Bag located at the centre of the steering wheel and a Front Passenger Air Bag located in the instrument panel above the glove box.

The supplemental front-impact air bag system can help cushion the impact to the head and chest area or the driver and/or front passenger in certain higher severity frontal collisions, although it may inflate if the forces in another type of collision are similar to those of a higher severity frontal impact. It may not inflate in certain frontal collisions. Vehicle damage (or lack of it) is not always an indication of proper supplemental front impact air bag system operation.

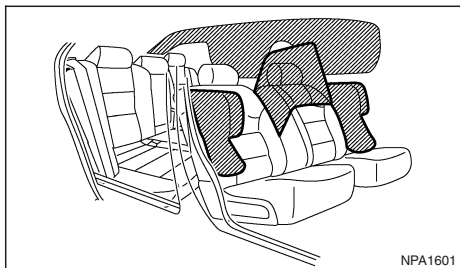

Supplemental side-impact air bag system (where fitted)

The Supplemental side-impact air bag system consist of two Front Side Air Bags located in the outside of the seatback of the front seats, two Curtain Air Bags located in the roof side trim and dependent on vehicle specification one Front Centre Air Bag (where fitted) located in the inside of the seatback of the driver seat.

The Curtain Airbags system can help cushion the head of the driver, front passenger and rear outer passengers. The Supplemental side-impact air bag system can help cushion the pelvis of the driver and front passenger in certain higher severity side collisions, although it may inflate if the forces in another type of collision are similar to those of a higher severity side impact. It may not inflate in certain side collisions. Vehicle damage (or lack of it) is not always an indication of proper supplemental side-impact air bag system operation.

Supplemental air bag systems

The SRS is designed to **supplement** the crash protection provided by the seat belts and is **not designed to substitute** them. Seat belts should always be correctly worn and the driver and front passenger seated a suitable distance away from the steering wheel, instrument panel and front door finishers. All occupants should always be seated a suitable distance away from the roof side trim. For additional information, see "Seat belts" earlier in this section.

When the air bags inflate, a fairly loud noise may be heard, followed by the release of smoke. This smoke is not harmful and does not indicate a fire. However, care should be taken not to inhale it, as it may cause irritation and choking. Occupants with a history of breathing difficulties, such as asthma, should get fresh air promptly.

Supplemental air bags, along with the use of seat belts, help to cushion the impact force on occupants. They can help save lives and reduce serious injuries. However, an inflating air bag may cause abrasions or other injuries. The supplemental air bags do not provide restraint to the lower body.

After switching the power switch ON, the air bag warning light will illuminate. The air bag warning light will turn off after approximately 7 seconds if the system is operational. For further details, see "Warning lights, indicator lights and audible reminders" in the "2. Instruments and controls" section.

The air bag will operate only when the power switch is ON.

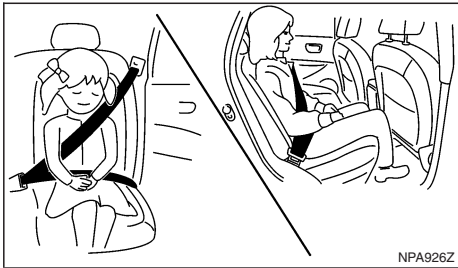

Correct (rear) seating positions

NPA926Z

⚠ WARNING

- The supplemental front-impact air bags ordinarily will not inflate in the event of a side impact, rear impact, rollover, or lower severity frontal collision. Always wear the seat belts to help reduce the risk or severity of injury in accidents.
- The seat belts and the supplemental front-impact air bags are most effective when you are sitting well back and upright in the seat. The front-impact air bags inflate with great force. If you are unrestrained, leaning forward, sitting sideways, or out of position in any way, you are at greater risk of injury or death in an accident. You may also receive serious or fatal injuries from the supplemental front-impact air bag if you are up against it when it inflates. Always sit back against the seatback and as far away as practical from the steering wheel. Always use the seat belts.

- The front seat-mounted side-impact supplemental air bags and roof-mounted curtain side-impact supplemental air bags ordinarily will not inflate in the event of a front impact, rear impact, rollover, or lower severity side collision. Always wear the seat belts to help reduce the risk or severity of injury in accidents.
- The seat belts, the front seat-mounted side-impact supplemental air bags and roof-mounted curtain side-impact supplemental air bags are most effective when you are sitting well back and upright in the seat. The front seat-mounted side-impact supplemental air bags and roof-mounted curtain side-impact supplemental air bags inflate with great force. If you and your passengers are unrestrained, leaning forward, sitting sideways, or out of position in any way, you and your passengers are at greater risk of injury or death in an accident.
- Do not allow anyone to place their hands, legs, or face near the front seat-mounted side-impact supplemental air bags and roof-mounted curtain side-impact supplemental air bags on the sides of the seatback of the front seats or near the side roof rails. Do not allow anyone sitting in the front seats or rear outer seats to extend their hands out of the windows or lean against the doors.
- When sitting in the rear seats, do not hold onto the seatback of the front seats. If the front seat-mounted side impact supplemental air bags and roof-mounted curtain side-impact supplemental air bags inflate, you may be se-

riously injured. Be especially careful with children, who should always be properly restrained.

- Do not use seat covers on the front seatbacks. They may interfere with the front seat-mounted side-impact supplemental air bag inflations.

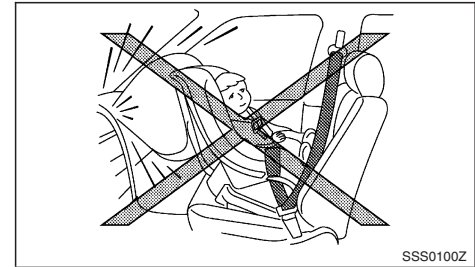

SSS0100Z

⚠ WARNING

- Children may be severely injured or killed when the air bags inflate if they are not properly restrained see "Child restraints" earlier in this section.
- Never let children ride unrestrained or extend their hands or face out of the window. Do not attempt to hold them in your lap or arms.

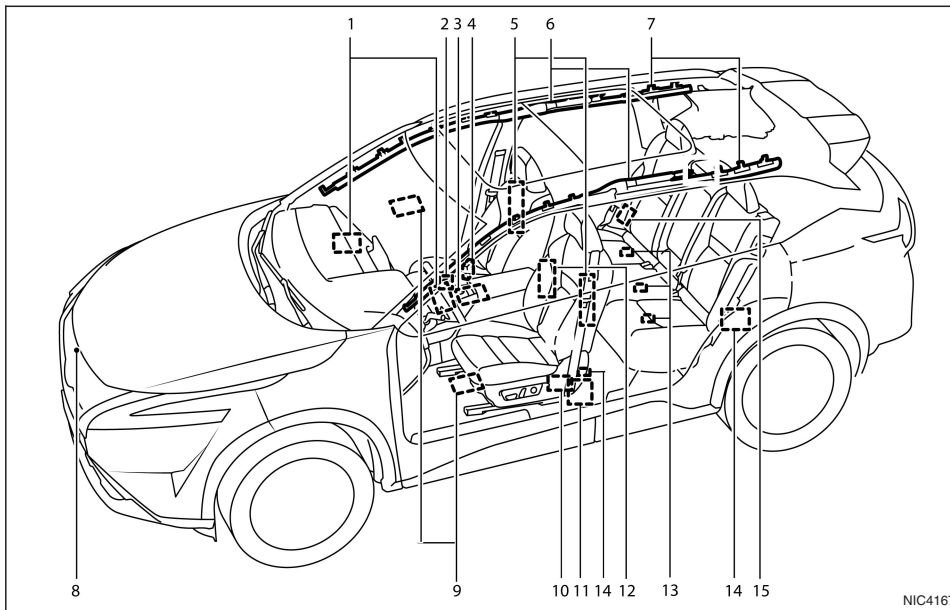

1. Supplemental front-impact air bag modules
2. Occupant classification system control unit (where fitted)
3. Air bag Control Unit (ACU)
4. Occupant classification sensor (where fitted) (front passenger seat)
5. Front seat-mounted side-impact supplemental air bag modules

6. Roof-mounted curtain side-impact supplemental air bag inflators
7. Roof-mounted curtain side-impact supplemental air bag modules
8. Crash zone sensor
9. Front door pressure sensors (where fitted)
10. Lap outer pre-tensioners (front seats)

11. Seat belt with pre-tensioners
12. Front central seat-mounted side-impact supplemental air bag (where fitted)
13. Rear seat Occupant Detection sensors (where fitted)
14. Satellite sensors (driver's side shown; front passenger side similar) (where fitted)
15. Seat belt with pre-tensioners (rear outboard seats)

⚠ WARNING

- Do not place any objects on the steering wheel pad. Do not place any objects between the driver and steering wheel pad. Such objects may become dangerous projectiles and cause injury if a supplemental air bag inflates.
- Immediately after inflation, several supplemental air bag system components will be hot. Do not touch them: you may severely burn yourself.
- No unauthorised changes should be made to any components or wiring of the supplemental air bag systems. This is to prevent accidental inflation of the supplemental air bags or damage to the supplemental air bag systems.
- Do not make unauthorised changes to your vehicle's electrical system, suspension system or front end structure. This could affect proper operation of the supplemental air bag systems.

- Tampering with the supplemental air bag systems may result in serious personal injury. Tampering includes changes to the steering wheel by placing materials over the steering wheel pad and above, and by installing additional trim materials around the supplemental air bag systems.
- Work around and on the supplemental air bag systems should be done by a NISSAN dealer or qualified workshop. The SRS wiring should not be modified or disconnected. Unauthorised electrical test equipment and probing devices should not be used on the supplemental air bag systems.
- The SRS wiring harness connectors are yellow and/or orange for easy identification.
- Never install a rear-facing child restraint system on the front passenger seat without ensuring that the front passenger air bag is deactivated. Depending on vehicle specification, the vehicle may be equipped with an automatic front-passenger front air bag deactivation system or a manual front-passenger front air bag deactivation system. (For details see "Automatic front-passenger air bag deactivation system (where fitted)" later in this section and "Manual front-passenger air bag deactivation system (where fitted)" later in this section. If this system is fitted, the PASSENGER AIR BAG OFF indicator  must be lit. In a frontal collision, supplemental front-impact air bags inflate with great force. An inflating supplemental front-impact air bag could seriously injure or kill your child.

Pre-tensioner seat belt system

The pre-tensioner seat belt system may activate with the supplemental air bag system in certain types of collisions.

Working with the seat belt retractor and anchor, it helps tighten the seat belt the instant the vehicle becomes involved in certain types of collisions, helping to restrain seat occupants. See "Pre-tensioner seat belt system" earlier in this section.

Air bag warning labels

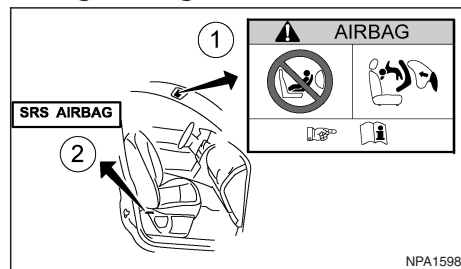

- ① **SRS air bag warning label:** The warning label is located on the surface of the front passenger sun visor.
- ② **SRS side air bag warning label:** The warning label is located on the side of the passenger side centre pillar, and on the base of the front seats.

When a front centre air bag is fitted there is also a label on the inside back of the driver's seat.

SRS front-impact passenger air bag:

The warning label ① is located on the sun visor.

"NEVER use a rearward facing child restraint on a seat protected by an ACTIVE AIRBAG in front of it, DEATH or SERIOUS INJURY to the CHILD can occur."

The BACK SEAT is the SAFEST place for children aged 12 and under according to accident statistics. Always use an appropriate Child Restraint System for your child, see "Child restraints" earlier in this section. Some infants and children may not require use of the vehicle's seat belt when using an appropriate ISOFIX Child Restraint System with integrated restraints, for all other children and adults ensure you always use the vehicle's seat belts. Do not sit or lean unnecessarily close to the air bag. Do not place any objects over the air bag or between the air bag and yourself. If the air bag warning light stays on or is flashing when the power switch is ON, go to a NISSAN dealer or qualified workshop. Air bags can only be removed or disposed of by a NISSAN dealer or qualified workshop.

Be sure to read the "AIRBAG LABEL" description at the end of this manual.

When installing a child restraint system in your vehicle, always follow the child restraint system manufacturer's instructions for installation. For information, see "Child restraints" earlier in this section.

SRS air bag warning light



The SRS air bag warning light, displaying  in the instrument panel, monitors the circuits of the supplemental restraint system. The circuits monitored are:

- Crash zone sensor
- Driver and Front Passenger Air Bags
- Front Side Air Bags
- Front Centre Air Bag (where fitted)
- Curtain Air Bags
- Pre-tensioner seat belt retractors
- Front Satellite Sensor (where fitted)
- Rear Satellite Sensor
- Front Door Pressure Sensor (where fitted)
- Supplemental air bag diagnosis sensor unit
- Occupant classification sensor (where fitted)
- Passenger air bag status indicator

Including all related wiring.

After switching the power switch ON, the supplemental air bag warning light illuminates. The air bag warning light will turn off after approximately 7 seconds if the system is operational.

Have the air bag systems and/or pre-tensioner seat belt systems serviced at the nearest NISSAN dealer or qualified workshop if any of the following conditions occur:

- The SRS air bag warning light remains on after approximately 7 seconds.
- The SRS air bag warning light flashes intermittently.
- The SRS air bag warning light does not illuminate at all.



Under these conditions, the air bag systems and/or pre-tensioner seat belt systems may not operate properly. They must be checked and repaired. Contact a NISSAN dealer or qualified workshop immediately.

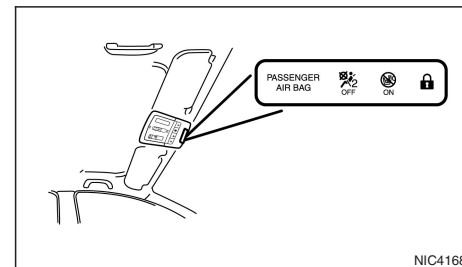

FRONT PASSENGER AIR BAG STATUS LIGHT



WARNING





Never install a rear-facing child restraint system on the front passenger seat without ensuring that the front passenger air bag is deactivated. The vehicle may be equipped with a manual or an automatic front-passenger front air bag deactivation system. Where a manual front-passenger air bag deactivation system is equipped, the air bag switch must be used to deactivate the passenger air bag. (For details see "Automatic front-passenger air bag deactivation system (where fitted)" later in this section and "Manual front-passenger air bag deactivation system (where fitted)" later in this section). The <PASSENGER AIR BAG OFF> indicator  must be lit. In a frontal collision, supplemental front-impact air bags inflate with great force. An inflating supplemental front-impact air bag could seriously injure or kill your child.

Depending on vehicle specification, the front passenger seat may be equipped with an occupant classification sensor that turns the front passenger air bag on or off depending on the type of occupant or object detected on the front passenger seat. The status of the front passenger air bag (ON or OFF) is indicated by the front passenger air bag status lights <PASSENGER AIR BAG OFF>  and <PASSENGER AIR BAG ON>  which are located on the roof console.

After the power switch is switched ON, the <PASSENGER AIR BAG OFF>  and <PASSENGER AIR BAG ON>  indicator lights must light up simultaneously for approximately 7 seconds.

The indicator lights display the status of the front-passenger front air bag:

- <PASSENGER AIR BAG ON> lights up: the front-passenger front air bag is enabled. If, in the event of an accident, all deployment criteria are met, the front-passenger front air bag is deployed.
- <PASSENGER AIR BAG OFF> lights up: the front-passenger front air bag is disabled. It will then not be deployed in the event of an accident.

CONDITION	DESCRIPTION	PASSENGER AIR BAG INDICATOR LIGHT ( OFF) or ( ON)	FRONT PASSENGER AIR BAG STATUS
Empty	Empty front passenger seat	 illuminated	INHIBITED
NISSAN recommended child restraint with child	Bag or Child Restraint in front passenger seat*	 illuminated	INHIBITED
Adult	Adult in the front passenger seat	 illuminated	ACTIVATED

* If an approved child restraint system is not being used, the passenger air bag may be active ( illuminated).

In addition to the above, certain objects placed on the front passenger seat may also cause the light to operate as described above.

For additional information related to the normal operation and troubleshooting of this occupant classification sensor system (where fitted), please refer to "Troubleshooting" later in this section.

Automatic front-passenger air bag deactivation system (where fitted)

WARNING

Depending on vehicle specification, the vehicle may be equipped with an automatic front-passenger front air bag deactivation system.

The front passenger air bag is designed to automatically turn OFF under some conditions. Read this section carefully to learn how it operates. Proper use of the seat, seat belt and child restraints is necessary for most effective protection. Failure to follow all instructions in this manual concerning the use of seats, seat belts and child restraints can increase the risk or severity of injury in an accident.

In order to recognise a child restraint system on the front-passenger seat, the automatic front-passenger front air bag deactivation system categorises the person in the front passenger seat using an occupant classification sensor. Depending on that result, the front-passenger front air bag is either enabled or disabled. If a NISSAN recommended child restraint system is fitted to the front passenger seat, the <PASSENGER AIR BAG OFF>  indicator light

must light up after the system self-test and remain lit. The front passenger front air bag is disabled.

The occupant classification sensor in this vehicle is designed to detect the type of occupant or objects on the seat. For example, if an approved child restraint on the seat, it can be detected together with the child and cause the air bag to turn OFF.

Front passenger seat adult occupants who are properly seated and using the seat belt as outlined in this manual should automatically cause the passenger air bag to be turned ON. However, if the occupant is not sitting correctly on the seat cushion (for example, by not sitting upright, by sitting on an edge of the seat, or by otherwise being out of position), this could cause the sensors to turn the air bag OFF. Always be sure to be seated and wearing the seat belt properly for the most effective protection by the seat belt and supplemental air bag.



NISSAN recommends that pre-teens and children be properly restrained in a rear seat. NISSAN also recommends that appropriate child restraints and booster seats be properly installed in a rear seat. If this is not possible, the occupant classification sensors are designed to operate as described above to turn the front passenger air bag OFF for NISSAN recommended child restraints. Failing to properly secure child restraints may allow the restraint to tip or move in an accident or sudden stop. This can also result in the passenger air bag inflating in a crash instead of being OFF. (See "Child restraints" later in this section for proper use and installation.)

If the front passenger seat is not occupied, the passenger air bag are designed not to inflate in a crash. However, heavy objects placed on the seat could result in air bag inflation, because of the way the

object is detected by the occupant classification sensors. Other conditions could also result in air bag inflation, such as if a child is standing on the seat, or if two or more children are on the seat, if the seat is wet, or if an electrical device is on the seat, contrary to the instructions in this manual. Always be sure that you and all vehicle occupants are seated and restrained properly.

Using the front passenger air bag status light, you can monitor when the front passenger air bag is automatically turned OFF.

If an adult occupant is in the seat but the <PASSENGER AIR BAG OFF>  light is illuminated (indicating that the front passenger air bag is OFF), it could be that the person is not sitting on the seat properly. If a seat cover or additional cushion is used, this may also prevent the occupant classification sensor from detecting an adult correctly.

If a child restraint must be used in the front seat, the <PASSENGER AIR BAG OFF>  indicator light may or may not be illuminated, depending on the size of the child and the type of child restraint being used. If the <PASSENGER AIR BAG OFF>  light is not illuminated (indicating that the air bag might inflate in a crash), it could be that the child restraint or seat belt is not being used properly. Make sure that the child restraint is installed properly, the seat belt is used properly and the occupant is positioned properly. If the <PASSENGER AIR BAG OFF>  light is not illuminated, reposition the occupant or child restraint in a rear seat.

If the <PASSENGER AIR BAG OFF>  light will not illuminate even though you believe that the child restraint, the seat belts and the occupant are properly positioned, it is recommended that you take your vehicle to a NISSAN dealer or qualified workshop. A NISSAN dealer or qualified workshop can check the system status by using a special tool. However, until you have confirmed with your dealer that your air bag is working properly, reposition the occupant or child restraint in a rear seat.

The air bag system and front passenger air bag status lights will take a few seconds to register a change in the passenger seat status. This is normal system operation and does not indicate a malfunction.

If a malfunction occurs in the front passenger air bag system, the supplemental air bag warning light , located in the meters and gauges area, will illuminate (blinking or steadily lit). Also, if the seat is wet and the system cannot work correctly, the system will deactivate the passenger air bag temporarily and illuminate the supplemental air bag warning light until seat is dry. Have the system checked. It is recommended you visit a NISSAN dealer or qualified workshop for this service.

Normal operation:

In order for the occupant classification sensor system to classify the front passenger, please follow the precautions and steps outlined below.

Precautions:

- Make sure that a child restraint or other object is not pressing against the rear of the seatback.

- Make sure that a rear passenger is not pushing or pulling on the back of the front passenger seat.
- Make sure that the front passenger seat or seat-back is not forced back against an object on the seat or floor behind it.
- Make sure that there is no object placed under the front passenger seat.
- Make sure that the front passenger seat head restraint does not contact the roof when adjusting the front passenger seat.
- Make sure the seat is dry.
- Make sure no electrical devices are placed on the seat.
- Make sure additional non-genuine seat covers or cushions are not used on the front passenger seat.
- Make sure the occupant of the seat is not wearing heavily padded clothing items.
- Make sure there are no sharp objects on the seat that could cut the cover and damage the sensor.

Steps:

1. Adjust the seat as outlined. (See “Seats” earlier in this section.) Sit upright, leaning against the seat-back, and centred on the seat cushion with your feet comfortably extended to the floor.
2. Make sure there are no objects on your lap.
3. Fasten the seat belt as outlined. (See “Seat belts” earlier in this section.) Front passenger seat belt buckle status is monitored by the occupant clas-

sification system, and is used as an input to determine occupancy status. So, it is highly recommended that the front passenger fastens their seat belt.

4. Remain in this position for several seconds allowing the system to classify the front passenger before the vehicle is put into motion.
5. Ensure proper classification by checking the front passenger air bag status light.

NOTE



This vehicle's occupant classification sensor system generally keeps the classification locked during driving, so it is important that you confirm that the front passenger is properly classified prior to driving. However, the occupant classification sensor system may recalculate the classification of the occupant under some conditions (both while driving and when stopped), so the front passenger seat occupant should continue to remain seated as outlined above.

WARNING

If the <PASSENGER AIR BAG OFF>  indicator light is lit, the front-passenger front air bag is disabled. It will not be deployed in the event of an accident and cannot perform its intended protective function. A person in the front passenger seat could then, for example, come into contact with the vehicle's interior, especially if the person is sitting too close to the dashboard. This poses an increased risk of injury or even fatal injury.

When the front-passenger seat is occupied, always make sure that:

- The classification of the person in the front passenger seat is correct and that the front passenger front air bag is enabled or disabled in accordance with the person in the front passenger seat.
- The front-passenger seat has been moved back as far back as possible.
- The person is seated correctly.

If you secure a child on the front passenger seat in a rearward-facing child restraint system and the <PASSENGER AIR BAG ON>  indicator lights up, the passenger's air bag could be deployed in the event of an accident. The child could be struck by the air bag. There is an increased risk of injury, possibly even fatal. In this case, always ensure that the passenger's air bag is disabled. The <PASSENGER AIR BAG OFF>  indicator must light up.

Troubleshooting:

If you think the front passenger air bag status light is incorrect:

1. If the <PASSENGER AIR BAG OFF>  light is lit with an adult occupying the front passenger seat:

This may be due to the following conditions that may be interfering with the occupant classification sensors:

- Occupant is not sitting upright, leaning against the seatback, and centred on the seat cushion with his/her feet comfortably extended to the floor.

- A child restraint or other object pressing against the rear of the seatback.
- The seat is wet or damp.
- An electrical device like a smartphone or tablet PC is placed on the seat.
- Non-genuine seat covers or cushions are used on the front passenger seat.
- The occupant of the seat is wearing heavily padded clothing items.
- A rear passenger pushing or pulling on the back of the front passenger seat.
- Forcing the front seat or seatback against an object on the seat or floor behind it.
- An object placed under the front passenger seat.
- An object placed between the seat cushion and centre console or between the seat cushion and the door.

If the vehicle is moving, please come to a stop when it is safe to do so. Check and correct any of the above conditions. Restart the vehicle.

NOTE

A system check will be performed during which the front passenger air bag status lights will remain lit for about 7 seconds initially.

If the <PASSENGER AIR BAG OFF>  light is still lit after this, the person should be advised not to ride in the front passenger seat and the vehicle should be checked as soon as possible. It is recommended you visit a NISSAN dealer or qualified workshop for this service.

2. If the <PASSENGER AIR BAG ON> light  is lit with a child restraint occupying the front passenger seat.

This may be due to the following conditions that may be interfering with the occupant classification sensors:

- The child restraint is not properly installed, as outlined. (See "Child restraints" earlier in this section.)
- A child restraint or other object pressing against the rear of the seatback.
- A rear passenger pushing or pulling on the back of the front passenger seat.
- The seat is wet or damp.
- An electrical device like a smartphone or tablet PC is placed on the seat.
- Forcing the front seat or seatback against an object on the seat or floor behind it.
- An object placed under the front passenger seat.
- An object placed between the seat cushion and centre console.
- The front passenger seat head restraint contacting the roof.

If the vehicle is moving, please come to a stop when it is safe to do so. Check and correct any of the above conditions. Restart the vehicle.

NOTE

A system check will be performed during which the front passenger air bag status light will remain lit for about 7 seconds initially.

If the <PASSENGER AIR BAG ON>  light is still lit after this, the child restraint should be repositioned in the rear seat and it is recommended that the vehicle should be checked by a NISSAN dealer or qualified workshop as soon as possible.

3. If the <PASSENGER AIR BAG ON>  light is lit with no front passenger and no objects on the front passenger seat, the vehicle should be checked as soon as possible. It is recommended you visit a NISSAN dealer or qualified workshop for this service.

Manual front-passenger air bag deactivation system (where fitted)

If the vehicle is not equipped with an automatic front-passenger air bag deactivation system, the vehicle may be equipped with a front passenger airbag switch which can be used to deactivate the front passenger airbag manually. (See "Automatic front-passenger air bag deactivation system (where fitted)" earlier in this section for details of the automatic system).

The front passenger air bag can be turned off with the front passenger air bag switch (A) located inside the glove box on right hand drive vehicles, or on the trim panel at the side of the dashboard on left hand drive vehicles.

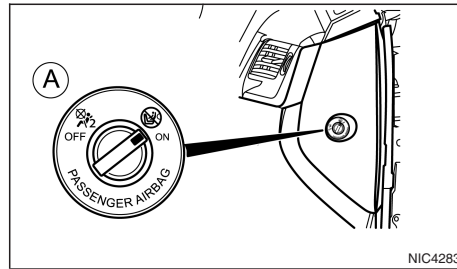

Left hand drive models

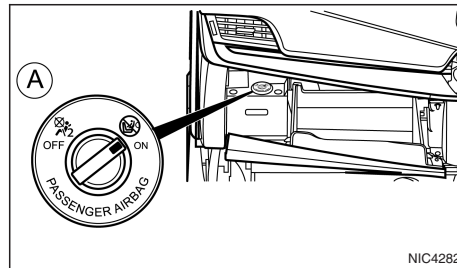

Right hand drive models

- (A) Air bag switch (where fitted)

To turn off the front passenger air bag:

1. Switch off the power switch.
2. Open the glove box (Right Hand Drive models) or open the front passenger door (Left Hand Drive models)
3. Push and turn the front passenger air bag switch to the OFF position.

4. Switch the power switch ON. The <PASSENGER AIR BAG OFF>  light will illuminate and remain lit.

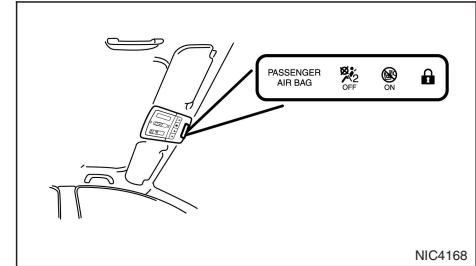

To turn on the front passenger air bag:

1. Switch off the power switch.
2. Open the glove box (Right Hand Drive models) or open the front passenger door (Left Hand Drive models)
3. Push and turn the front passenger air bag switch to the ON position.
4. Switch the power switch ON. The <PASSENGER AIR BAG ON>  will illuminate and after about 60 seconds turn off.

REPAIR AND REPLACEMENT PROCEDURE

WARNING

- **Once the air bags have been inflated, the air bag modules will not function and must be replaced. The air bag modules must be replaced by a NISSAN dealer or qualified workshop. The inflated air bag modules cannot be repaired.**
- **The air bag systems should be inspected by a NISSAN dealer or qualified workshop if there is any damage to the front end portion of the vehicle.**
- **When selling your vehicle, we request that you inform the buyer about the air bag system and guide the buyer to the appropriate sections in this Owner's Manual.**
- **If you need to dispose of the SRS or scrap the vehicle, contact a NISSAN dealer or qualified workshop. Correct disposal procedures are set forth in the appropriate NISSAN Service Manual. Incorrect disposal procedures could cause personal injury.**

The air bags and pre-tensioner seat belts are designed to activate on a one-time-only basis. As a reminder, unless the SRS air bag warning light is damaged, the SRS air bag warning light remains illuminated after inflation has occurred. The repair and replacement of the SRS should be done only by a NISSAN dealer or qualified workshop.

When maintenance work is required on the vehicle, information about the air bags, pre-tensioner seat belts and related parts should be pointed out to the person performing the maintenance. The power switch should always be switched OFF when working under the bonnet or inside the vehicle.

NOTE

2 Instruments and controls

Meters and gauges.....	77	Windscreen.....	127
Models with analogue meter and colour display.....	77	Rear window.....	128
Models with full-screen display.....	78	ThermaClear Heated Windscreen (where fitted).....	129
Speedometer and odometer.....	80	Defogger switch.....	130
Power gauge.....	80	Headlight and turn signal switch.....	130
Li-ion Battery gauge.....	81	Headlight switch.....	130
Fuel gauge.....	81	Turn signal switch.....	134
Instrument brightness control.....	82	Fog light switch.....	134
Shift position indicator.....	82	Front fog light (where fitted).....	134
[ECO Drive Report].....	82	Rear fog light (where fitted).....	135
Warning lights, indicator lights and audible reminders.....	84	Headlight aiming control.....	135
Checking lights.....	85	Headlight aiming control switch (where fitted).....	135
Warning lights.....	86	Horn.....	136
Indicator lights.....	91	Heated steering wheel (where fitted).....	136
Audible reminders.....	95	Seat heating (where fitted).....	137
Vehicle information display.....	96	Power outlets.....	137
Changing the meter screen view (models with full-screen display).....	96	USB (Universal Serial Bus) rear power ports (where fitted).....	138
How to use the vehicle information display.....	96	Wireless charger (where fitted).....	138
Vehicle information display.....	98	Storage.....	140
[Settings].....	102	Storage trays.....	140
General information and warnings.....	120	Glove box.....	140
Vehicle information display driving aids warnings and guidance messages.....	120	Sunglasses holder (where fitted).....	140
Clock and outside air temperature.....	124	Console box.....	140
[Head-up display] (where fitted).....	125	Cup holders.....	141
How to use the HUD.....	126	Bottle holder.....	141
Driving Aids/Navigation/Traffic Sign/Audio/Telephone linking.....	126	Coat hooks (where fitted).....	141
Wiper and washer switch.....	127	Map pocket (where fitted).....	141
		Seat pocket (where fitted).....	142
		Roof rail (where fitted).....	142
		Parcel shelf.....	142

Luggage compartment/boot floor (where fitted).....	145	Interior lights.....	149
Luggage hooks (where fitted).....	145	Interior light switch.....	149
Windows.....	146	Map lights.....	149
Power windows.....	146	Room lights (where fitted).....	150
Fixed glass roof (where fitted).....	148	Rear personal lights (where fitted).....	150
Sunshade operation.....	148	Vanity mirror light.....	150
		Luggage compartment light.....	150

METERS AND GAUGES

MODELS WITH ANALOGUE METER AND COLOUR DISPLAY

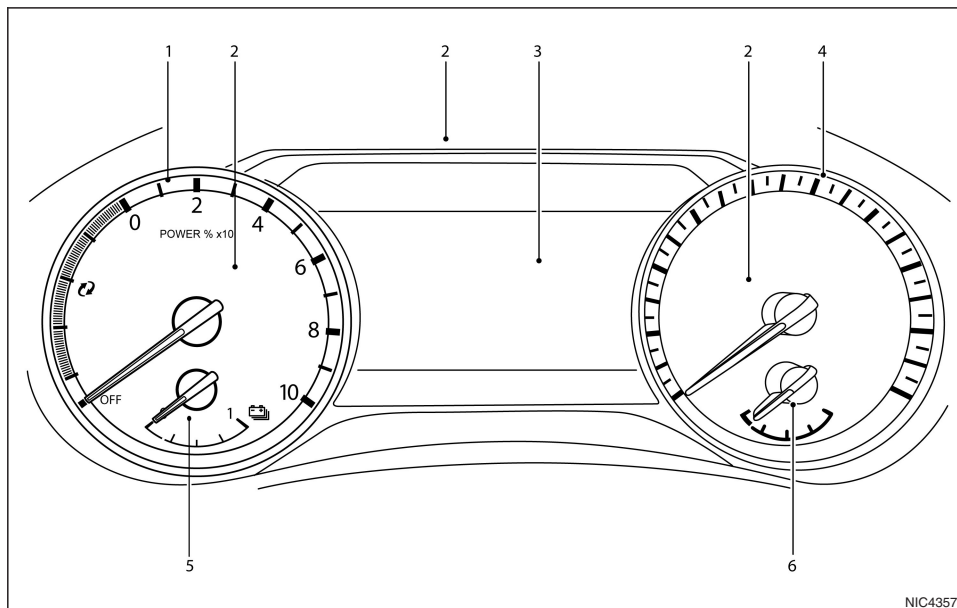

NIC4357

1. Power gauge
2. Warning and indicator lights
3. Vehicle information display
4. Speedometer
5. Battery gauge
6. Fuel gauge

CAUTION

- For cleaning, use a soft cloth, dampened with water. Never use a rough cloth, alcohol, benzene, thinner or any kind of solvent or paper towel with a chemical cleaning agent. They will scratch or cause discolouration to the lens.
- Do not spray any liquid such as water on the meter lens. Spraying liquid may cause the system to malfunction.

MODELS WITH FULL-SCREEN DISPLAY

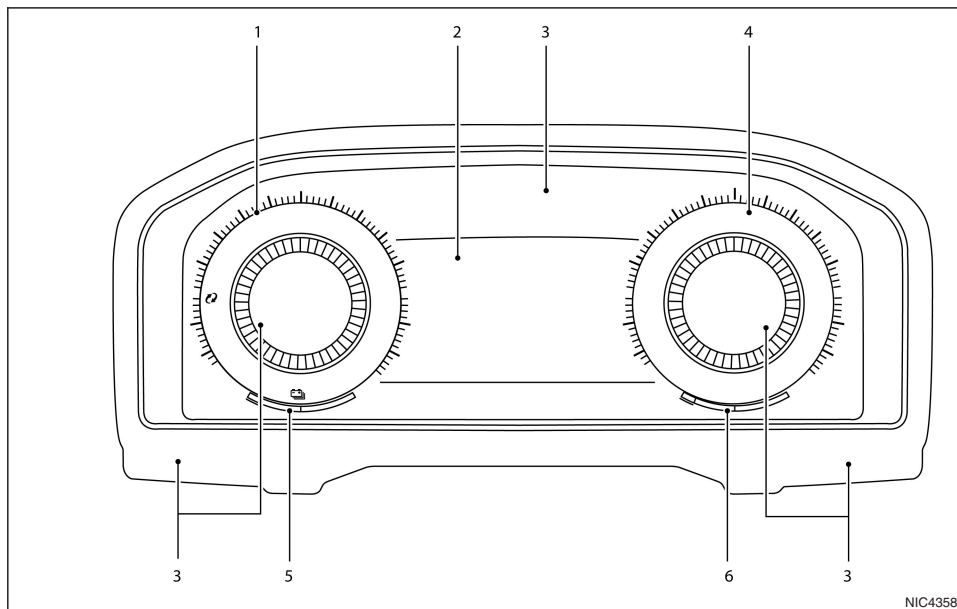

1. Power gauge
2. Vehicle information display
3. Warning and indicator lights
4. Speedometer
5. Battery gauge
6. Fuel gauge

CAUTION

- For cleaning, use a soft cloth, dampened with water. Never use a rough cloth, alcohol, benzine, thinner or any kind of solvent or paper towel with a chemical cleaning agent. They will scratch or cause discolouration to the lens.
- Do not spray any liquid such as water on the meter lens. Spraying liquid may cause the system to malfunction.

Changing the meter screen view (models with full-screen display)

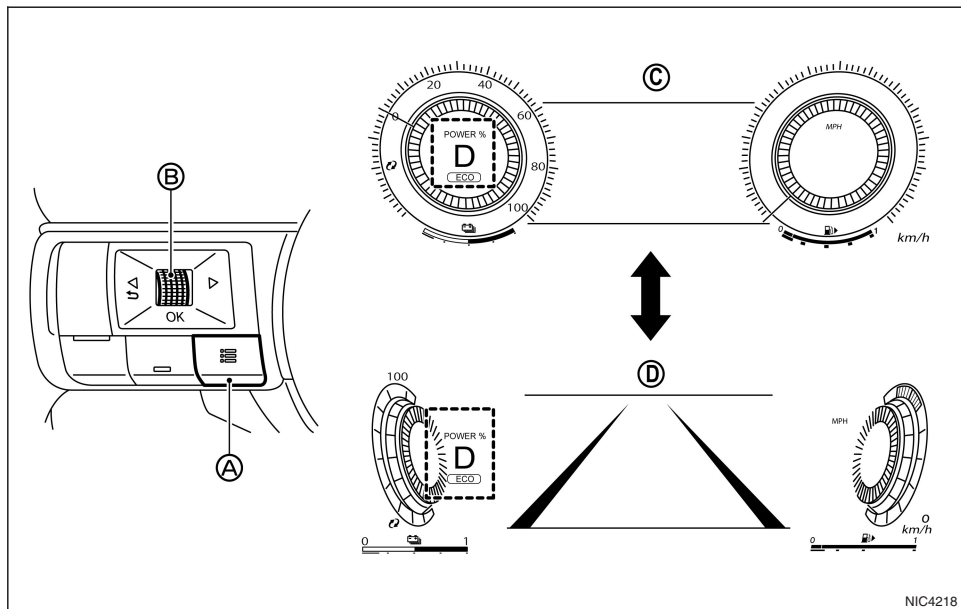

For models with full-screen display, the meter screen view can be changed from Classic View (C) to Enhanced View (D) to expand the vehicle information display area.

To change the meter screen view:

1. Push the control switch (A) on the left side of the steering wheel.
"Shortcut Menu" appears on the vehicle information display area.
2. Select "Change Meter View" by rotating the scroll dial (B) and push it to change the view.

SPEEDOMETER AND ODOMETER

Speedometer

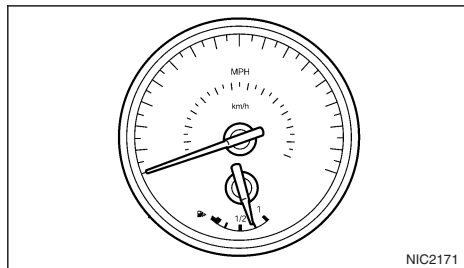

Example

The speedometer indicates the vehicle speed. Scale resolution on the meter varies with models.

Distance to empty (dte)/Odometer

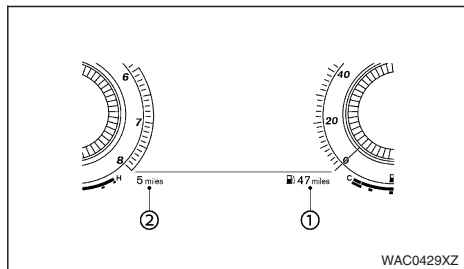

Example

Distance to empty (dte):

The distance to empty (dte) ① provides an estimation of the distance that can be driven before refuelling. The dte is constantly being calculated, based on the amount of fuel in the fuel tank and the actual fuel consumption.

The display is updated every 30 seconds.

The dte mode includes a low range warning feature. If the fuel level is low, the warning is displayed on the screen and the dte display will turn yellow.

When the fuel level drops even lower, the dte display will change to 0.

- If the amount of fuel added is small, the display just before the power switch is switched OFF may continue to be displayed.
- When driving uphill or rounding curves, the fuel in the tank shifts, which may momentarily change the display.

Odometer:

The odometer ② is displayed in the vehicle information display to display the total distance the vehicle has been driven.

POWER GAUGE

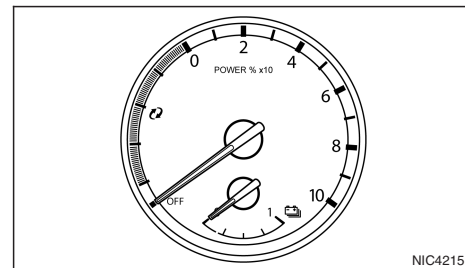

Example

The power meter displays the power level of the electric motor for driving when the accelerator pedal is depressed, as well as the level of power regeneration provided to the Lithium ion (Li-ion) battery by the regenerative brake.

LI-ION BATTERY GAUGE

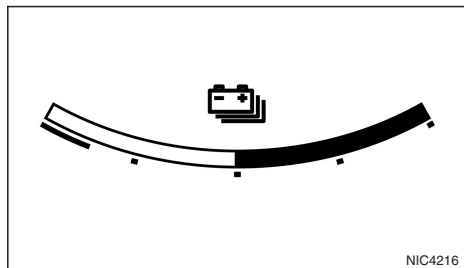

Full-screen model

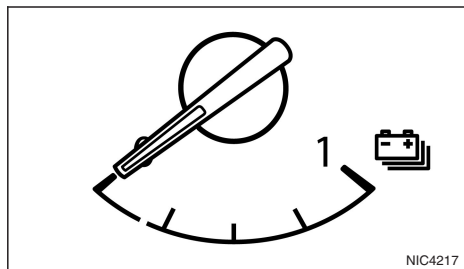

Analogue model

The gauge indicates the approximate remaining Lithium ion (Li-ion) battery charge available to drive the vehicle.

NOTE

- Li-ion battery temperature affects the amount of remaining Li-ion battery charge.

FUEL GAUGE

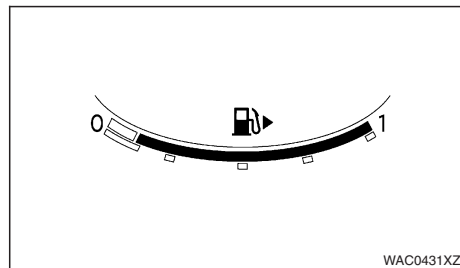

Full-screen model

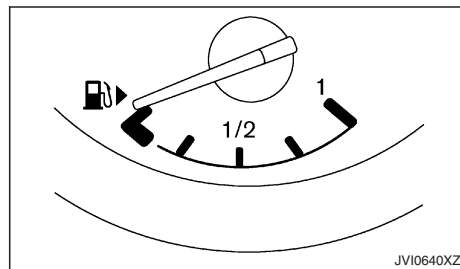

Analogue model

The fuel gauge is active when the power switch is **ON**.

The gauge may move slightly during braking, turning, acceleration, or when going uphill or downhill.

The  symbol indicates that the fuel filler lid is located on the right side of the vehicle.

NOTE

A low fuel warning comes on in the vehicle information display when the fuel level is getting low. Refuel as soon as it is convenient. There should be a small reserve of fuel in the tank when the fuel gauge needle reaches the empty level.

The available range or distance to empty is permanently shown at the bottom of the vehicle information display, see "Distance to empty (dte)/Odometer" earlier in this section.

CAUTION

Refill the fuel tank before the range displays [0], or [---], and the gauge registers empty.

INSTRUMENT BRIGHTNESS CONTROL

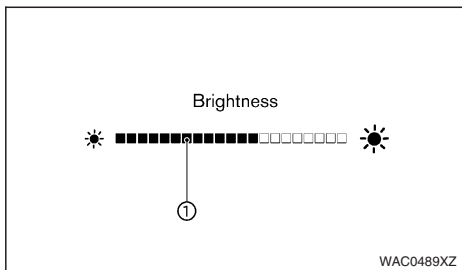
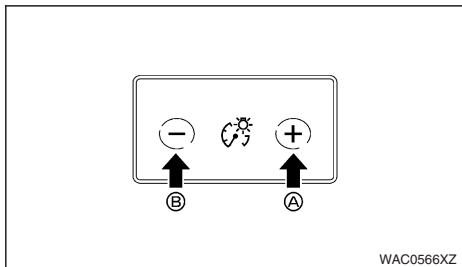

The instrument brightness control switch can be operated when the power switch is ON. When the switch is operated, the vehicle information display switches to the brightness adjustment mode.

Push the + side of the switch (A) to brighten the instrument panel lights. The bar ① moves to the right side.

Push the - side of the switch (B) to dim the lights. The bar ① moves to the left side.

The vehicle information display returns to the normal display when the instrument brightness control switch is not operated for more than 5 seconds.

SHIFT POSITION INDICATOR

The shift position indicator indicates the shift position when the power switch is in the ON or READY to drive position (See "Electric shift control system" in the "5. Starting and driving" section.)

CAUTION

Do not hold the shift lever in any position other than the centre position. Continued driving with the shift lever out of position could lead to damage to the vehicle. Additionally, if the shift lever is placed out of position, the position indicator blinks.

[ECO DRIVE REPORT]

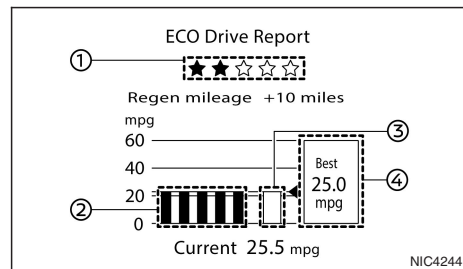

When the power switch is switched from ON to OFF and the current journey distance is greater than 5 km (3 miles), the [ECO Drive Report] is displayed.

Regen mileage is the total number of miles that accumulated due to regenerative braking. To increase the number of miles use B mode to capture more energy when braking.































- ① ECO evaluation
More ★ s will appear when you drive more economically.
- ② History of previous 5 journeys
The average fuel economy for the previous 5 journeys is displayed.
- ③ Current average fuel economy
The current average fuel economy since journey start will be displayed.















④ Best fuel economy

The best fuel economy of the past history will be displayed.

When the [Tyre Pressures] message appears in the [ECO Drive Report], the display can be switched to the [Tyre Pressures] display by pushing the scroll dial on the steering wheel to show an additional message.

WARNING LIGHTS, INDICATOR LIGHTS AND AUDIBLE REMINDERS

	Anti-lock Braking System (ABS) warning light		e-POWER system warning light		Supplemental Restraint System (SRS) air bag warning light
	Approaching Vehicle Sound for Pedestrians (VSP) OFF warning light		Hands OFF warning light*		Vehicle detected ahead warning light*
	Blind spot warning (BSW)*/Intelligent Blind Spot Intervention* warning light		Intelligent Emergency Braking (IEB) system* warning light*		Automatic brake hold indicator light (white)
	Brake warning light		Lane Departure Warning (LDW)*/Intelligent Lane Intervention (ILI)*/Emergency Lane Assist (ELA)* warning light		Automatic brake hold indicator light (green)
	Charge warning light		Low fuel warning light		Dipped beam indicator light*
	Brake system warning light (yellow)		Low tyre pressure warning light*		Door lock indicator light**
	Electric Power Steering warning light		Master warning light		Electric Parking brake indicator light
	Electric shift control system warning light		Rear Automatic Braking (RAB)* warning light		e-Pedal ON indicator
	Emergency Lane Assist (ELA)* OFF warning light		Rear Automatic Braking (RAB)* OFF warning light		e-Pedal OFF indicator
	Engine oil pressure warning light		Seat belt warning light		Electronic Stability Programme (ESP) OFF indicator light

	Front fog light indicator light*		Power limitation indicator light
	Front passenger air bag status lights*, **		ProPILOT Assist* indicator light Blue/white
	High beam assist indicator light*		READY to drive indicator light
	Adaptive driving beam indicator light*		Rear fog light indicator light*
	High beam indicator light		Side light indicator light
	Hill Start Assist (HSA) indicator light*		Slip indicator light*
	Malfunction indicator light (MIL)		Turn signal/hazard indicator lights

*: where fitted

** : located on the roof console

CHECKING LIGHTS

With all doors closed, apply the parking brake, fasten the seat belts and switch the power switch **ON** without starting the e-POWER system. The following lights (where fitted) will illuminate:

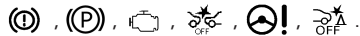





The following lights (where fitted) come on briefly and then go off:



If any light fails to come on, it may indicate a burned-out bulb or an open circuit in the electrical system. Have the system checked, and repaired promptly by a NISSAN dealer or qualified workshop.

Some indicators and warnings are also displayed in the vehicle information display between the speedometer and tachometer see "Vehicle information display" later in this section.

NOTE

The  or  light (where fitted), comes on and stays on depending on the status of the front passenger air bag. The front passenger air bag status light () will illuminate when the front passenger air bag is turned OFF. When the front passenger air bag is turned on, the front passenger air bag status light ON () will illuminate.

WARNING LIGHTS

Also see “Vehicle information display” later in this section.



Anti-lock Braking System (ABS) warning light

When the power switch is switched **ON**, the Anti-lock Braking System (ABS) warning light illuminates and then turns off. This indicates the ABS is operational.

If the ABS warning light illuminates while the e-POWER system is running, or while driving, it may indicate the ABS is not functioning properly. Have the system checked by a NISSAN dealer or qualified workshop.

If an ABS malfunction occurs, the anti-lock function is turned off. The brake system then operates normally, but without anti-lock assistance (see “Brake system” in the “5. Starting and driving” section).



Approaching Vehicle Sound for Pedestrians (VSP) OFF warning

The Approaching Vehicle Sound for Pedestrians (VSP) warning light illuminates when a malfunction occurs in the VSP system.

Have the VSP system checked by a NISSAN dealer or qualified workshop.



Blind spot warning (BSW) (where fitted)/Intelligent Blind Spot Intervention (where fitted) warning light

For details of the Blind spot warning (BSW) and Intelligent Blind Spot Intervention systems, see “Blind Spot Warning (BSW) system/Intelligent Blind Spot Intervention system (where fitted)” in the “5. Starting and driving” section.



Brake warning light (red)

WARNING

- **Your brake system may not be working properly if the warning light is on. Driving could be dangerous. Even if you judge the brake system to be safe, drive carefully to the nearest service station for repairs. Otherwise, have your vehicle towed because driving it could be dangerous.**
- **Pressing the brake pedal when the e-POWER system is not running and/or when the brake fluid level is low may increase the stopping distance, and braking will require greater pedal effort as well as pedal travel.**
- **If the brake fluid level is below the minimum or <MIN> mark on the brake fluid reservoir, do not drive until the brake system has been checked at a NISSAN dealer or qualified workshop.**

When the power switch is placed in the ON position or in the READY to drive position, the brake warning light remains illuminated for about a few seconds. If

the brake warning light illuminates at any other time, it may indicate that the hydraulic brake system is not functioning properly. If the brake warning light illuminates, stop the vehicle immediately and contact a NISSAN dealer or qualified workshop.

A buzzer sounds if a malfunction occurs in the brake system power supply.

Low brake fluid warning light:

When the power switch is placed in the ON or READY to drive position, the brake warning light illuminates, and then turns off. If the light illuminates while the power switch is in the READY to drive position with the parking brake not applied, stop the vehicle and perform the following:

1. Check the brake fluid level. If brake fluid level is low, add fluid and have the system checked by a NISSAN dealer or qualified workshop. See “Brake fluid” in the “8. Maintenance and do-it-yourself” section.
2. If the brake fluid level is correct, and the Brake warning light is still illuminated it may indicate that the brake system is not functioning properly. Have the brake system and the warning system checked by a NISSAN dealer or qualified workshop.

Anti-lock Braking System (ABS) warning indicator:

When the parking brake is released and the brake fluid level is sufficient, if both the brake warning light and the Anti-lock Braking System (ABS) warning light illuminate, it may indicate the ABS is not functioning properly. Have the brake system checked, and if necessary repaired by a NISSAN dealer or

qualified workshop. (See “Anti-lock Braking System (ABS) warning light” earlier in this section.)



Charge warning light

When the power switch is **ON**, the charge warning light illuminates. After starting the e-POWER system, the charge warning light turns off. This indicates that the charging system is operational.

If the charge warning light illuminates while the e-POWER system is running, or while driving, it may indicate that the charging system is not functioning properly and may need servicing.

If the charge warning light remains illuminated, have the charging system checked by a NISSAN dealer or qualified workshop promptly.

CAUTION

Do not continue driving if the charge warning light is on.



Brake system warning light (yellow)

WARNING

- **Depressing the brake pedal when the power switch position is not in the ON or READY to drive position and/or low brake fluid level may increase the stopping distance and braking will require greater pedal effort as well as pedal travel.**

- **If the brake fluid level is below the minimum or MIN mark on the brake fluid reservoir, do not drive until the brake system has been checked by a NISSAN dealer or qualified workshop.**
- **The cooperative regenerative brake system may not be working properly if the brake system warning light illuminates when the READY to drive indicator light is ON. If you judge it to be safe, drive carefully to the nearest service station for repairs. Otherwise, have your vehicle towed because driving could be dangerous.**

The brake system warning light functions for both the cooperative regenerative brake and the electronically driven intelligent brake systems. When the power switch is placed in the ON position or in the READY to drive position, the light remains illuminated for about a few seconds. If the light illuminates at any other time, it may indicate that the cooperative regenerative brake and/or the electronically driven intelligent brake systems are not functioning properly. Have the system checked by a NISSAN dealer or qualified workshop. If the brake warning light (red) also illuminates, stop the vehicle immediately and contact a NISSAN dealer or qualified workshop. For additional information, see “Brake system” in the “8. Starting and driving” section.



Electric Power Steering warning light

WARNING

- **If the e-POWER system is not running or is turned off while driving, the power assist for the steering will not work. Steering will be harder to operate.**
- **When the Electric Power Steering warning light illuminates with the e-POWER system, there will be no power assist for the steering. You will still have control of the vehicle but the steering will be harder to operate. Have the Electric Power Steering system checked by a NISSAN dealer or qualified workshop.**

When the power switch is **ON**, the Electric Power Steering warning light illuminates. After starting the e-POWER system, the Electric Power Steering warning light turns off. This indicates that the electric power steering system is operational.

If the Electric Power Steering warning light illuminates while the e-POWER system is running, it may indicate the Electric Power Steering system is not functioning properly and may need servicing. Have the Electric Power Steering system checked by a NISSAN dealer or qualified workshop. See “Power steering” in the “5. Starting and driving” section.



Electric shift control system warning light

When the power switch is switched to the ON position, the electric shift control system warning light illuminates, and then turns off. This indicates the electric shift control system is operational.

The electric shift control system warning light illuminates to warn when a malfunction occurs in the electric shift control system. Have the system checked by a NISSAN dealer or qualified workshop as soon as possible. When any warning message is displayed on the vehicle information display, follow the warning message displayed.



Emergency Lane Assist (ELA) (where fitted) OFF warning light

For details about the Emergency Lane Assist (ELA) system see "Emergency Lane Assist (ELA) system (where fitted)" in the "5. Starting and driving" section.



Engine oil pressure warning light

When the power switch is switched ON, the engine oil pressure warning light illuminates. After starting the e-POWER system, the engine oil pressure warning light turns off. This indicates that the oil pressure sensors in the engine are operational.

If the engine oil pressure warning light illuminates or blinks while the engine is running, it may indicate that the engine oil pressure is low.

Stop the vehicle safely as soon as possible. Stop the e-POWER system immediately and call a NISSAN dealer or qualified workshop.

CAUTION

- **Running the engine with the engine oil pressure warning light illuminated could cause serious damage to the engine.**
- **The engine oil pressure warning light is not designed to indicate a low oil level. The oil level should be checked using the dipstick. (See "Engine oil" in the "8. Maintenance and do-it-yourself" section.)**



e-POWER system warning light

When the power switch is in the ON position, the e-POWER system warning light illuminates and then turns off.

If the e-POWER system warning light illuminates while driving, it may indicate that there is a malfunction in the e-POWER system.

Stop the vehicle in a safe place immediately and contact a NISSAN dealer.



Hands OFF warning light (where fitted)

When the Steering Assist is activated, it monitors the driver's steering wheel operation.

Vehicles fitted with ProPILOT Assist: If the steering wheel is not operated or the driver takes his/her hands off the steering wheel for a period of time, the warning light illuminates. If the driver does not operate the steering wheel after the warning light has been illuminated, an audible alert sounds and the warning flashes in the vehicle information display, followed by a quick brake application to request the driver to take control of the vehicle again.

If the driver remains unresponsive, the vehicle will automatically turn on the hazard lights and slow to a complete stop. (See "Hands on detection" in the "5. Starting and driving" section.)



Intelligent Emergency Braking (IEB) system warning light (where fitted)

This light illuminates when the Intelligent Emergency Braking (IEB) system is set to OFF in the vehicle information display.

If the light illuminates when the IEB system is ON, it may indicate that the system is unavailable. See "Intelligent Emergency Braking (IEB) system (where fitted)" in the "5. Starting and driving" section for more details.

Disabling the ESP system with the vehicle information display causes the IEB system to become unavailable. This is not a malfunction.



Lane Departure Warning (LDW) (where fitted)/Intelligent Lane Intervention (ILI) (where fitted)/Emergency Lane Assist (ELA) (where fitted) warning light

For details about the Lane Departure Warning (LDW) and Intelligent Lane Intervention (ILI) systems see "Lane Departure Warning (LDW) system (where fitted)" in the "5. Starting and driving" section and "Intelligent Lane Intervention (ILI) system (where fitted)" in the "5. Starting and driving" section.

For details about the Emergency Lane Assist (ELA) system see "Emergency Lane Assist (ELA) system (where fitted)" in the "5. Starting and driving" section.



Low fuel warning light

If the yellow reserve fuel warning light is on while the e-POWER system is running, the fuel level has dropped into the reserve range.

Refuel at the nearest filling station.



Low tyre pressure warning light (where fitted)

Your vehicle is equipped with a Tyre Pressure Monitoring System (TPMS) (where fitted) that monitors the tyre pressure of all tyres except the spare.

The low tyre pressure warning light warns of low tyre pressure or indicates that the TPMS is not functioning properly.

After the power switch is switched **ON**, this light illuminates for about 1 second and turns off.

Low tyre pressure warning:

If the vehicle is being driven with low tyre pressure, the warning light will illuminate. A low tyre pressure warning (e.g., [Low tyre pressure]) also appears in the vehicle information display.

When the low tyre pressure warning light illuminates, you should stop and adjust the tyre pressure of all 4 tyres to the recommended COLD tyre pressure shown on the tyre placard located on the driver side centre pillar see "Tyre placard" in the "9. Technical information" section. The low tyre pressure warning light does not automatically turn off when the tyre pressure is adjusted. After the tyre is inflated to the recommended pressure, the vehicle must be driven at speeds above 25 km/h (16 MPH)

to activate the TPMS and turn off the low tyre pressure warning light. Use a tyre pressure gauge to check the tyre pressure.

The low tyre pressure (e.g., [Low tyre pressure]) warning appears each time the power switch is switched **ON** as long as the low tyre pressure warning light remains illuminated.

For additional information, see "Vehicle information display" later in this section and "Tyre Pressure Monitoring System (TPMS) (where fitted)" in the "5. Starting and driving" section.

TPMS resetting must also be performed after a tyre or a wheel is replaced, or the tyres are rotated.

For additional information, see "Tyre Pressure Monitoring System (TPMS) (where fitted)" in the "5. Starting and driving" section and "Vehicle information display" later in this section.

Depending on a change in the outside temperature, the low tyre pressure warning light may illuminate even if the tyre pressure has been adjusted properly. Adjust the tyre pressure to the recommended COLD tyre pressure again when the tyres are cold, and reset the TPMS.

If the low tyre pressure warning light still continues to illuminate after the resetting operation, it may indicate that the TPMS is not functioning properly. Have the system checked by a NISSAN dealer or qualified workshop.

For additional information, see "Tyre Pressure Monitoring System (TPMS) (where fitted)" in the "5. Starting and driving" section and "Vehicle information display" later in this section.

TPMS malfunction:

If the TPMS is not functioning properly, the low tyre pressure warning light will flash for approximately 1 minute when the power switch is switched **ON**. The light will remain on after 1 minute. Have the system checked by a NISSAN dealer or qualified workshop. The low tyre pressure warning does not appear if the low tyre pressure warning light illuminates to indicate a TPMS malfunction.

For additional information, see "Tyre Pressure Monitoring System (TPMS) (where fitted)" in the "5. Starting and driving" section.

WARNING

- **Radio waves could adversely affect electric medical equipment. Those who use a pacemaker should contact the electric medical equipment manufacturer for the possible influences before use.**
- **If the light does not illuminate with the power switch switched ON, have the vehicle checked by a NISSAN dealer or qualified workshop as soon as possible.**
- **If the low tyre pressure warning light illuminates while driving, avoid sudden steering manoeuvres or abrupt braking, reduce vehicle speed, pull off the road to a safe location and stop the vehicle as soon as possible. Driving with under-inflated tyres may permanently damage the tyres and increase the likelihood of tyre failure. Serious vehicle damage could occur and may lead to an accident and could result in serious personal injury. Check the tyre pressure for all four tyres. Adjust the tyre pressure to the recommended COLD tyre pressure**

shown on the tyre placard, located on the driver side centre pillar, to turn the low tyre pressure warning light off. If the light still illuminates while driving after adjusting the tyre pressure, a tyre may be flat. If you have a flat tyre, repair it with the emergency tyre puncture repair kit (where fitted) or replace it with a spare tyre (where fitted) as soon as possible.

- After adjusting the tyre pressure, be sure to reset the TPMS. Unless the resetting is performed, the TPMS will not warn of the low tyre pressure correctly.
- When a spare tyre is mounted or a wheel is replaced, the TPMS will not function and the low tyre pressure warning light will flash for approximately 1 minute. The light will remain on after 1 minute. Contact a NISSAN dealer or qualified workshop as soon as possible for tyre replacement and/or system resetting.
- Replacing tyres with those not originally specified by NISSAN could affect the proper operation of the TPMS.

CAUTION

- The TPMS is not a substitute for regular tyre pressure checking. Be sure to check the tyre pressure regularly.
- If the vehicle is being driven at speeds of less than 25 km/h (16 MPH), the TPMS may not operate correctly.
- Be sure to install the specified size of tyres to all four wheels correctly.



Master warning light

When the power switch is **ON**, the master warning light illuminates if any of the following are displayed in the vehicle information display (see "Vehicle information display" later in this section):

- Door/Boot Open Warning
- Parking Brake release warning
- Low tyre pressure warning (where fitted)
- System Fault Display
- No key warning (where fitted)
- Key ID incorrect warning (where fitted)
- Intelligent Key system warning (where fitted)
- Chassis Control System fault warning (where fitted)

If the Driving Aids system warnings (where fitted) appear in the vehicle information display, the master warning light also illuminates. See "Lane Departure Warning (LDW) system (where fitted)" in the "5. Starting and driving" section, and/or "Intelligent Emergency Braking (IEB) system (where fitted)" in the "5. Starting and driving" section.



Rear Automatic Braking (RAB) (where fitted) warning light

For details about the Rear Automatic Braking system see "Rear Automatic Braking (RAB) (where fitted)" in the "5. Starting and driving" section.



Rear Automatic Braking (RAB) OFF (where fitted) warning light

For details about the Rear Automatic Braking system see "Rear Automatic Braking (RAB) (where fitted)" in the "5. Starting and driving" section.



Seat belt warning light

The seat belt warning light reminds you to fasten your seat belts. See "Seat belts" in the "1. Safety – Seats, Seat belts and Supplemental Restraint System" section.



Supplemental Restraint System (SRS) air bag warning light

WARNING

If the supplemental air bag warning light is on, it could mean that the front air bag, side air bag (where fitted), curtain air bag (where fitted) and/or pre-tensioner systems will not operate in an accident. To help avoid injury to yourself or others, have your vehicle checked by a NISSAN dealer or qualified workshop as soon as possible.

When the power switch is switched **ON**, the Supplemental Restraint System (SRS) air bag warning light illuminates for approximately 7 seconds and then turns off this indicates the system is operational.

If any of the following conditions occur, the air bag systems and pre-tensioner systems need servicing and the vehicle must be taken to a NISSAN dealer or qualified workshop:

- The supplemental air bag warning light remains on after approximately 7 seconds.
- The supplemental air bag warning light flashes intermittently.
- The supplemental air bag warning light does not come on at all.

Unless checked and repaired, the SRS air bag system and/or the pre-tensioner seat belt system may not function properly.

For additional details see "SRS air bag warning light" in the "1. Safety – Seats, Seat belts and Supplemental Restraint System" section.



Vehicle Ahead Detected warning light (where fitted)

For details about the Vehicle Ahead detected warning light, see "Intelligent Emergency Braking (IEB) system (where fitted)" in the "5. Starting and driving" section.

INDICATOR LIGHTS



Automatic brake hold indicator light (white)

The Automatic brake hold indicator light (white) illuminates when the Automatic brake hold system is on standby.

For additional details see "Automatic brake hold" in the "3. Pre-driving checks and adjustments" section.



Automatic brake hold indicator light (green)

The Automatic brake hold indicator light (green) illuminates while the Automatic brake hold system is operating.

For additional details see "Automatic brake hold" in the "3. Pre-driving checks and adjustments" section.



Dipped beam indicator light (where fitted)

This light comes on when the switch is turned to the position:  The headlights will come on and front side, tail, number plate and instrument lights remain on. The light also comes on when the headlight switch is turned to AUTO and it is dark outside.



Door lock indicator light (where fitted)

The door lock indicator light located on the roof console illuminates when all the doors are locked while the power switch is **ON**.

- When the doors are locked with the power door lock switch, the door lock indicator light will illuminate for 30 minutes.
- When the doors are locked by pushing the LOCK button on the Intelligent Key or any request switch (where fitted), the door lock indicator light will illuminate for 1 minute.
- The door lock indicator light turns off when any door is unlocked.

For locking or unlocking doors, see "Doors" in the "3. Pre-driving checks and adjustments" section.

 Electric Parking brake indicator light







The electric parking brake indicator light indicates that the electric parking brake system is operating.

When the power switch is switched **ON**, the electric parking brake indicator light illuminates. When the e-POWER system is started and the parking brake is released, the warning light turns off.

If the parking brake is not fully released, the electric parking brake indicator light remains on. Be sure that the electric parking brake indicator light has turned off before driving.

If the electric parking brake indicator light illuminates or flashes while the brake system warning light (yellow)  illuminates, it may indicate that the electric parking brake system is not functioning properly. Have the brake system checked, and if necessary repaired, by a NISSAN dealer or qualified workshop promptly.

For further parking brake operation information see “Electric Parking Brake” in the “3. Pre-driving checks and adjustments” section.

	Meter				Switch	
	Indicator	Warning light	Master warning light	Display text	Buzzer	LED
Parking brake applied		–	–	–	–	LED
Dynamic parking brake		–		Release parking brake	Beep	LED
System failure	Depends on status	Warning light ON		–	–	Depends on status
Parking brake switch pressed without brake pedal pressed		–	–	Press brake pedal	–	LED
Parking brake cannot be released automatically		–	–	Release parking brake	–	LED
Parking brake malfunction	 Flashing	Warning light ON	–	–	–	LED Flashing



e-Pedal indicator lights

These indicators show the status of the e-Pedal Step system.



Electronic Stability Programme (ESP) OFF indicator light (where fitted)

⚠ WARNING

The ESP should remain on unless freeing a vehicle from mud or snow.

The light comes on when the Electronic Stability Programme (ESP) is turned OFF. This indicates that the ESP system and traction control system are not operating.

Turn the ESP on using the vehicle information display, or restart the e-POWER system and the system will operate normally. (See “Electronic Stability Programme (ESP) system” in the “5. Starting and driving” section.)

The light also comes on when switching the power switch ON. The light will turn off after about 2 seconds if the system is operational. If the light stays on or comes on along with the  indicator light while you are driving, have the ESP system checked by a NISSAN dealer or qualified workshop.

While the ESP system is operating, you might feel a slight vibration or hear the system working when starting the vehicle or accelerating, but this is not a malfunction.





Front fog light indicator light (where fitted)

The light comes on when the front fog lights are switched on (see “Fog light switch” later in this section).



Front passenger air bag status light (where fitted)

The front passenger air bag status light OFF () will illuminate when the front passenger air bag is turned OFF. When the front passenger air bag is turned on, the front passenger air bag status light ON () will illuminate.

For more details, see “SRS air bag warning light” in the “1. Safety — Seats, Seat belts and Supplemental Restraint System” section.



High beam assist indicator light (where fitted)/Adaptive driving beam indicator light (where fitted)

The indicator light illuminates when the headlights come on while the headlight switch is in the AUTO position with the High Beam Assist/Adaptive Driving Beam button pushed. This indicates that the high beam assist system and/or adaptive driving beam is operational. (See “Headlight and turn signal switch” later in this section)



High beam indicator light

This light comes on when the headlight high beam is on, or ADB system is active (where fitted), and goes out when the low beam is selected.



Hill Start Assist (HSA) on indicator light (where fitted)

The light illuminates when the conditions of the Hill Start Assist (HSA) system are satisfied when the vehicle is stopped on a hill.

Then, the light blinks when the brake pedal is released, which indicates that the Hill Start Assist (HSA) system is activated.

For additional information, see “Hill Start Assist (HSA) (where fitted)” in the “5. Starting and driving” section.



Malfunction indicator light (MIL)

When the power switch is switched **ON**, the orange Malfunction Indicator light illuminates. This means that the system is operational.

If the orange Malfunction Indicator light comes on while the e-POWER system is running, it may indicate an engine control system malfunction or misfire.

On steady and message [Engine malfunction Power reduced Service now]:

An engine malfunction has been detected. **STOP the e-POWER system.** Have the vehicle inspected by a NISSAN dealer or qualified workshop. **You need to have your vehicle towed to the dealer.**

On steady and message [Engine malfunction Service Now]:

An engine malfunction has been detected which may damage the engine control system.

To reduce or avoid engine control system damage:

- Do not drive at speeds above 70 km/h (43 MPH).
- Avoid hard acceleration or deceleration.
- Avoid steep uphill grades.
- If possible, reduce the load being carried or towed.

Have the vehicle inspected by a NISSAN dealer or qualified workshop. You do not need to have your vehicle towed to the dealer.

CAUTION

Continued vehicle operation without having the engine control system checked and repaired as necessary could lead to poor driveability, reduced fuel economy and possible damage to the engine control system, which may affect your warranty coverage.



Power limitation indicator light

⚠ WARNING

Power limitation mode can result in reduced power and vehicle speed. The reduced speed may be lower than other traffic, which could increase the chance of a collision. Be especially careful

when driving. If the vehicle cannot maintain a safe driving speed, pull to the side of the road in a safe area.

When the power switch is in the ON position, the power limitation indicator light illuminates and then turns off.

When the power limitation indicator light is illuminated with the power switch in the READY to drive position, the power provided to the electric motors (for driving and power generator) is reduced. Therefore the vehicle is not as responsive when the accelerator pedal is depressed while the power limitation indicator light is illuminated.

When this light illuminates and any message appears on the vehicle information display, follow the instructions.

This light illuminates in the following conditions.

- Li-ion battery charge is extremely low.
- Li-ion battery temperature is extremely low.
- When the temperature of e-POWER system is high (motor, coolant system, Li-ion battery, etc.).
- When the power generator output is limited.

Before the Li-ion battery is discharged and when the Low Fuel warning is also displayed in the vehicle information display, refuel as soon as possible.

If this light illuminates because the Li-ion battery is cold due to low outside temperatures, move the vehicle to a warmer location.

If the light illuminates because the Li-ion battery temperature is extremely high, stop the vehicle in a safe location and wait until the light turns off.

This light also illuminates in the following condition.

- If the accelerator pedal is depressed when the vehicle is stopped and the shift lever is placed in the N (Neutral) position.

In this case, even if the shift lever is shifted into the D (Drive) position, the acceleration will be reduced. While the accelerator pedal is depressed, the light illuminates and a message appears in the vehicle information display, and chime will sound. When the accelerator pedal is released, the indicator light and the message will turn off and chime will stop.

If the light illuminates in a situation other than those described above, or if it does not turn off, there may be a system malfunction. Contact a NISSAN dealer or qualified workshop.



ProPILOT Assist indicator light (where fitted)

For details of the ProPILOT Assist system see "ProPILOT Assist (where fitted)" in the "5. Starting and driving" section).



READY indicator light

The READY to drive indicator light illuminates when the e-POWER system is powered and the vehicle may be driven.

If the light is blinking, keep pushing the power switch with the brake pedal depressed until the light stops blinking (illuminates).



Rear fog light indicator light (where fitted)

The light comes on when the rear fog light is switched on (see "Rear fog light (where fitted)" later in this section).



Side light indicator light

This light comes on when the side light position is selected, see "Headlight and turn signal switch" later in this section for further details.



SLIP indicator light (where fitted)

When the power switch is switched ON, the SLIP indicator light illuminates and then turns off.

The light will blink when the Electronic Stability Program (ESP) system or the traction control system is operating, thus alerting the driver that the vehicle is nearing its traction limits. The road surface may be slippery.

You may feel or hear the system working, this is normal.

If the light illuminates when the ESP system is on, it alerts the driver to the fact that the system's fail-safe mode is operating, for example the ESP system may not be functioning properly. Have the system checked by your NISSAN dealer or qualified workshop. If an malfunction occurs in the system, the ESP system function will be cancelled, but the vehicle is still drivable.

For additional information, see "Electronic Stability Programme (ESP) system" in the "5. Starting and driving" section.



Turn signal/hazard indicator lights

The direction indicator lights will flash when the turn signal switch or hazard warning flasher switch is turned on. See "Headlight and turn signal switch" later in this section and see "Hazard warning flasher switch" in the "6. In case of emergency" section for further details.

AUDIBLE REMINDERS

In addition to the audible reminders described in this section, a number of other vehicle systems also provide audible warnings or reminders. These include:

- Moving Object Detection (MOD) (where fitted)
- Blind Spot Warning (BSW) (where fitted)
- Intelligent Blind Spot Intervention (where fitted)
- Rear Cross Traffic Alert (RCTA) (where fitted)
- Lane Departure Warning (LDW) (where fitted)
- Intelligent Lane Intervention (ILI) (where fitted)
- Intelligent Cruise Control (ICC) (where fitted)
- Intelligent Emergency Braking (IEB) (where fitted)
- Intelligent Forward Collision Warning (I-FCW) (where fitted)
- Rear Automatic Braking (RAB) (where fitted)
- Driver Attention Alert (DAA) (where fitted)

Door open reminder chime

The chime will sound if any door other than the driver's door is left open and the power door lock switch is held down.

Intelligent Key models: The external buzzer will sound if the vehicle is being locked remotely or using an outside door lock switch and any door is open.

Parking brake reminder buzzer

A buzzer will sound when driving away if the parking brake has not been released. Stop the vehicle and release the parking brake.

Light reminder chime

A chime will sound for 10 seconds if the driver's door is opened while the external lights are turned on and the power switch is **OFF**.

See "Headlight and turn signal switch" later in this section for further details on the headlight operation.

Fog light reminder chime

A chime will sound if the power switch is switched **OFF** and the headlight switch is in the <AUTO> position (where fitted) and the fog lights are left on.

See "Fog light switch" later in this section for further details.

Seat belt reminder chime

The seat belt reminder chime reminds you to fasten your seat belts. See "Seat belts" in the "1. Safety – Seats, Seat belts and Supplemental Restraint System" section.

VEHICLE INFORMATION DISPLAY

Key reminder buzzer (Intelligent Key models)

The external buzzer will beep 3 times if:

- The Intelligent Key is removed from the vehicle while the power switch is not switched to LOCK.
- The vehicle is being locked remotely or using an outside door lock switch and the Intelligent Key has been left inside the vehicle.

Park reminder chime

A chime will sound if the e-POWER system is switched **OFF** and the vehicle is not in the P (Park) position.

Electric shift control system reminder chime

If an improper shift operation is performed, for safety reasons a chime will sound and at the same time, depending on the conditions, the operation will be cancelled or the shift position will switch to the N (Neutral) position.

See "Driving the vehicle" in the "5. Starting and driving" section.

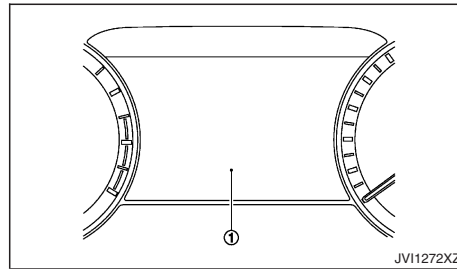

Example

The vehicle information display ① is located as shown above, and it displays warnings and information. The following items are also displayed if the vehicle is equipped with them:

- Drive computer
- Vehicle settings
- Trip computer information
- Driver Assistance
- Cruise control system information
- ProPILOT Assist
- Intelligent Key operation information
- Audio information
- Navigation - turn by turn
- Guidance and warnings
- Tyre pressure information
- Other information



CHANGING THE METER SCREEN VIEW (MODELS WITH FULL-SCREEN DISPLAY)

For the model with full-screen display, the meter screen view can be changed to expand the vehicle information display area. See "Changing the meter screen view (models with full-screen display)" earlier in this section for how to change the view.

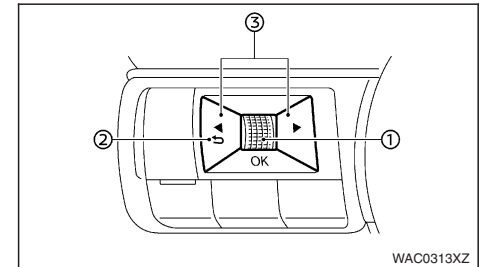
HOW TO USE THE VEHICLE INFORMATION DISPLAY



The vehicle information display can be changed using the scroll dial ①,  ②, and  ③ located on the steering wheel.

- ① Scroll dial - navigate through the items and change or select an item in vehicle information display. This scroll dial allows up/down navigation and push to select
- ②  - go back to the previous menu
- ③  - change from one display screen to the next (i.e. trip, Fuel economy)

VEHICLE INFORMATION DISPLAY

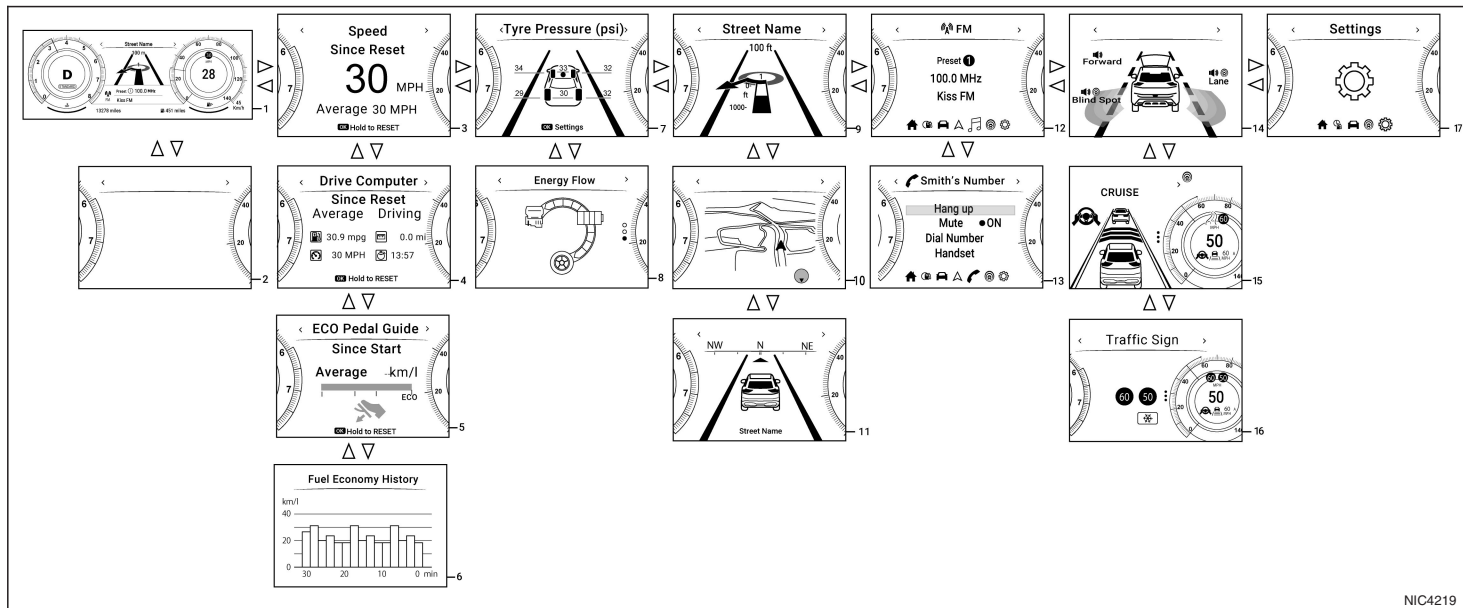

When the power switch is switched ON, the vehicle information display may display the following screens if the vehicle is equipped with them:

- 1. [Home]
- 2. [Blank]
- 3. [Speed] (where fitted)
- 4. [Drive Computer] – [Average Speed] (Distance & Time)
- 5. [ECO Pedal Guide]
- 6. [Fuel Economy History]
- 7. [Tyre Pressures]
- 8. [Energy Flow]
- 9. [Navigation] (where fitted)
- 10. [Navigation] (where fitted)
- 11. [Compass] (where fitted)
- 12. [Audio]
- 13. Telephone screen (displays when there is an incoming call)
- 14. [Driving Aids] (where fitted)
- 15. ProPILOT Assist (where fitted)
- 16. [Traffic sign] (where fitted)
- Warnings. Warnings will only display if there are any present. For more information on warnings and indicators, see “Warning lights, indicator lights and audible reminders” earlier in this section.
- 17. [Settings]

To control what items display in the vehicle information display, see “[Personal Display] (where fitted)” later in this section.

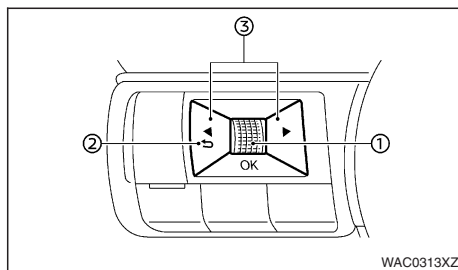

Switches for the vehicle information display are located on the left side of the steering wheel.

- ① Scroll dial - navigate through the items and change or select an item in vehicle information display. This scroll dial allows up/down navigation and push to select
- ② ↶ - go back to the previous menu
- ③ ◀ ▶ - change from one display screen to the next (i.e. trip, Fuel economy)

The displayed images may differ depending on the model.

1. Home

The Home mode shows the following information.

- Vehicle speed
- Navigation (where fitted)
- Audio

2. Blank

Blank display.

3. Speed (where fitted)

The Speed mode shows the following information.

- Vehicle speed
- Average Speed

4. Drive Computer

The Drive computer shows the average fuel economy, average vehicle speed, driving time and driving distance. You can switch between [Since Reset], [Since Start] and [Since Refuel] by pushing the <OK> button.

[Since Reset] can be reset manually by pressing the <OK> button for more than 2 secs or until reset page appears.

[Since Start] will reset after 30 minutes from last power OFF. It can be also reset manually by pressing the <OK> button for more than 2 secs or until reset page appears.

[Since Refuel] will be reset automatically each time when refuelling and when vehicle speed is greater than 10 km/h (6 MPH) or if vehicle travelled 500m or more. It can be also reset manually by pressing the <OK> button for more than 2 secs or until reset page appears

Average fuel consumption:

The average fuel consumption shows the average fuel consumption since the last reset.

Average speed:

The average speed shows the average vehicle speed since the last reset.

Trip odometer:

The trip odometer shows the total distance the vehicle has been driven since the last reset.

Elapsed time:

The elapsed time shows the time since the last reset.

5. [ECO Pedal Guide] function

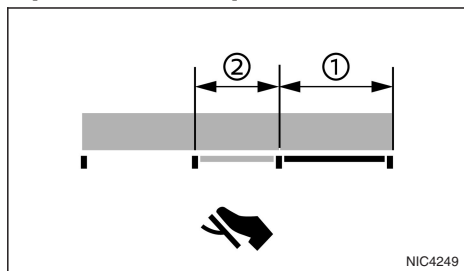

The [ECO Pedal Guide] display can be selected in the vehicle information display in the [ECO] mode. Use the [ECO Pedal Guide] function for improving fuel economy.

When the [ECO Pedal Guide] bar is in the green range ①, it indicates that the vehicle is being driven within range of the super economy drive.

When the [ECO Pedal Guide] bar is in the light green range ②, it indicates that the vehicle is being driven within range of the economy drive.

If the [ECO Pedal Guide] bar is out of the green range (① and ②), it indicates that the accelerator pedal is depressed over the range of economy drive.

The [ECO Pedal Guide] bar is not displayed when:

- The vehicle speed is less than approximately 4 km/h (2 MPH).
- The shift is in the P (Park), N (Neutral) or R (Reverse) position.

6. Fuel Economy History

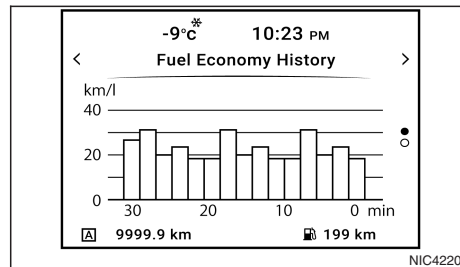

The Fuel Economy History display shows recent fuel economy data recorded at 2 minute intervals.

7. Tyre Pressures

The tyre pressure mode shows the pressure of all four tyres while the vehicle is driven.

With the [Tyre ECO advice] function ON, when the tyre pressure is getting low, [Check Tyre Pressures for Best Energy Economy]] appears.

When the [Low Tyre Pressure] warning appears, the display can be switched to the tyre pressure mode by pushing the scroll dial to reveal additional details on the displayed warning.

8. Energy Flow

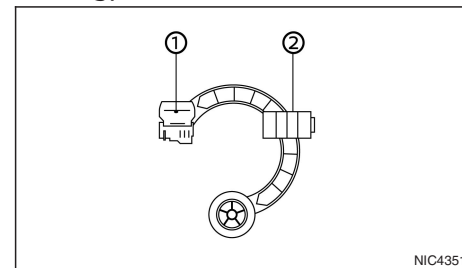

Classic view

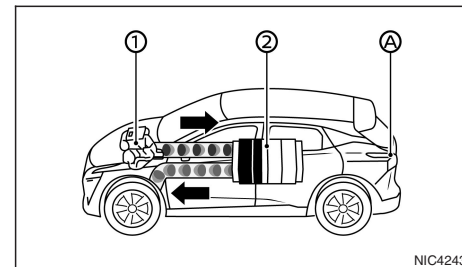

Enhanced view

The Energy Flow shows the current energy flow between engine, Lithium ion (Li-ion) battery and front wheels.

- ① Engine
- ② Li-ion battery

The current energy status of the engine, Li-ion battery and Li-ion battery charge is shown by color or illumination pattern as follows:

① **Engine display colour:**

- **Grey:** When fuel is NOT being consumed
- **Orange:** When fuel is being consumed

② **Lithium ion (Li-ion) battery display colour:**

- **Blue:** The remaining battery level is normal.
- **Yellow:** The remaining battery level is low. (When the remaining battery level is low, less power may be provided to drive than usual.)

NOTE

- **For the e-POWER system, the engine may also start when the electric motor is not generating power. The energy flow is not displayed when the electrical power is not generated.**
- **When the vehicle's brake lights come on, the brake lights  in the Energy Flow also come on.**

The charge level display will continuously change as the Li-ion battery charge level increases or decreases during normal vehicle operation.

9 and 10. Navigation (where fitted)

When the route guidance is set in the navigation system, this item shows the navigation route information.

11. Compass (where fitted)

This display indicates the heading direction of the vehicle.

12. Audio

The audio mode shows the status of audio information.

13. Telephone

The telephone mode shows the status of telephone information.

14. Driver Assistance

The Driver Assistance mode shows the operating condition for the following systems.

- **Forward:**
 - Intelligent Emergency Braking (IEB) (where fitted)
 - Intelligent Forward Collision Warning (I-FCW) (where fitted)
- **Lane:**
 - Lane Departure Warning (LDW) (where fitted)
 - Intelligent Lane Intervention (ILI) (where fitted)
- **Blind Spot:**
 - Blind Spot Warning (BSW) (where fitted)
 - Intelligent Blind Spot Intervention (where fitted)

For more details, see "Intelligent Lane Intervention (ILI) system (where fitted)" in the "5. Starting and driving" section, and/or "Intelligent Emergency Braking (IEB) system (where fitted)" in the "5. Starting and driving" section.

15. ProPILOT Assist (where fitted)

The ProPILOT Assist mode shows the operating conditions for the following systems:

- Intelligent Cruise Control (ICC)
- Steering Assist

The display will also be shown when the ProPILOT Assist is turned on. For additional information, see "ProPILOT Assist (where fitted)" in the "5. Starting and driving" section.

16. Traffic Sign Recognition (where fitted)

The Traffic Sign Recognition (TSR) system provides the driver with information about the most recently detected speed limit. See "Traffic sign recognition (where fitted)" later in this section for more details.

17. [Settings]

The setting mode allows user to change the information displayed in the vehicle information display and some settings. See the next section.

[SETTINGS]

The setting mode allows user to change the information displayed in the vehicle information display and some settings:

- [ESP Setting]
- [Driver Assistance]
- [Personal Display] (where fitted)
- [Head-Up Display] (where fitted)
- [ECO Settings]
- [Tyre Pressures]
- [Clock]
- [Vehicle Settings]
- [Maintenance]
- [Display Settings]
- [Unit/Language]
- [I-key Link] (where fitted)
- [Factory Reset]

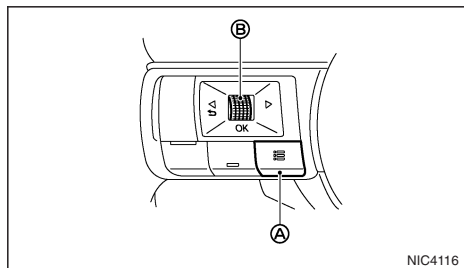

[Shortcut Menu]

A [Shortcut Menu] is available to quickly access certain items. The menu can be accessed by pressing the shortcut switch (A) on the steering wheel and using the scroll dial (B) to select the required item.

The following items are available:

- [Emergency Lane] (where fitted)
- [Change Display View]
- [Audio Source]
- [Driver Assistance]
- [Personal Display]

[ESP Setting]

To change the setting, use the scroll dial to select and push it.

- [System]

Allows user to turn the Electronic Stability Programme (ESP) system ON or OFF. By default the ESP system will be turned ON. If the ESP system is turned off, the ESP OFF indicator light will illuminate.

(For more information, see "Electronic Stability Programme (ESP) system" in the "5. Starting and driving" section)

NOTE

The vehicle should be driven with the Electronic Stability Program (ESP) system ON for most driving conditions.

[Driver Assistance]

To change the status, warnings or turn on or off any of the systems/warnings displayed in the [Driver Assistance] menu, use the scroll dial to select and change a menu item:

- [Steering Assist] (where fitted)
- [Lane]
- [Blind Spot] (where fitted)
- [Emergency Brake]
- [Traffic Sign] (where fitted)
- [CRUISE Navi Link] (where fitted)
- [Speed Limit Link] (where fitted)
- [Speed Link Offset] (where fitted)
- [Parking Aids]
- [Rear Cross Traffic Alert] (where fitted)
- [Driver Attention Alert] (where fitted)
- [Timer Alert]
- [Low Temp. Alert]
- [Steering Effort] (where fitted)
- [Chassis Control]

[Steering Assist] (where fitted):

- Allows user to turn the [Steering Assist] ON/OFF.

[Lane]:

- [Warning]

Allows user to turn the Lane Departure Warning (LDW) system ON/OFF. See "Lane Departure Warning (LDW) system (where fitted)" in the "5. Starting and driving" section.

- [Intervention]

Allows user to turn the Intelligent Lane Intervention (ILI) system ON/OFF. See "Intelligent Lane Intervention (ILI) system (where fitted)" in the "5. Starting and driving" section.

- [Vibration Level] (where fitted)

Allows user to adjust the level of steering wheel vibration for the LDW system. It can be set to [High], [Medium] or [Low]. See "Lane Departure Warning (LDW) system (where fitted)" in the "5. Starting and driving" section.

- [Emergency Lane] (where fitted)

Allows user to turn the Emergency Lane Assist (ELA) system ON/OFF. See "Emergency Lane Assist (ELA) system (where fitted)" in the "5. Starting and driving" section.

- [Lane Sensitivity] (where fitted)

Allows user to adjust the sensitivity of the ELA system (where fitted). It can be set to [Normal], [Strong] or [Mild]. See "Emergency Lane Assist (ELA) system (where fitted)" in the "5. Starting and driving" section.

[Blind Spot] (where fitted):

- [Warning]

Allows user to turn the Blind Spot Warning (BSW) system ON/OFF.

- [Intervention] (where fitted)

Allows user to turn the Intelligent Blind Spot Intervention system ON/OFF.

See "Blind Spot Warning (BSW) system/Intelligent Blind Spot Intervention system (where fitted)" in the "5. Starting and driving" section.

[Emergency Brake]:

- [Front]

Allows user to turn the Intelligent Emergency Braking (IEB) with pedestrian detection system (where fitted) ON/OFF. See "Intelligent Emergency Braking (IEB) system (where fitted)" in the "5. Starting and driving" section.

- [Rear]

Allows user to turn the Rear Automatic Braking (RAB) system (where fitted) ON/OFF. See "Rear Automatic Braking (RAB) (where fitted)" in the "5. Starting and driving" section.

[Traffic Sign] (where fitted):

Allows user to turn the Traffic Sign Recognition (TSR) ON/OFF.

[CRUISE Navi Link] (where fitted):

Allows user to turn the [CRUISE Navi Link] (ProPILOT Assist with Navi-link) function ON/OFF. (See "Cruise Navi Link - ProPILOT Assist with Navi Link (where fitted)" in the "5. Starting and driving" section.)

[Speed Limit Link] (ProPILOT Assist with Navi-link) (where fitted):

Allows user to customise the [Speed Limit Link] (ProPILOT Assist with Navi-link) options.

- [OFF]

- [Prompt]

- [Auto]

(See "Speed Limit Link - ProPILOT Assist (where fitted)" in the "5. Starting and driving" section.)

[Speed Limit Link] (Without Navi-link) (where fitted):

Allows user to customise the [Speed Limit Link] (without Navi-link) options.

- [ON]/[OFF]

(See "Speed Limit Link - ProPILOT Assist (where fitted)" in the "5. Starting and driving" section.)

[Speed Link Offset] (where fitted):

Allows user to set whether the speed limit used by [Speed Limit Link] should be accepted exactly, or with a tolerance of -10 km/h (-5 MPH) to +10 km/h (+5 MPH) adjust. (See "Speed Limit Link - ProPILOT Assist (where fitted)" in the "5. Starting and driving" section.)

[Parking Aids]:

To change the status or turn on or off any of the systems displayed in the [Parking Aids] menu, use the scroll dial to select and change a menu item:

- [Moving Object] (where fitted)

Allows user to turn the Moving Object Detection (MOD) ON/OFF.

- [Display] (where fitted)

Allows user to turn the sonar system or the Rear Sonar System (RSS) display ON/OFF.

- [Front] (where fitted)

Allows user to turn the front sonar sensors ON/OFF.

- [Rear]

Allows user to turn the rear sonar sensors ON/OFF.

- [Distance] (where fitted)

Allows user to select the sonar sensor's detection distance ([Far], [Medium] or [Near]).

- [Volume]

Allows user to select the volume of the sonar tone ([High], [Medium] or [Low]).

[Rear Cross Traffic Alert]:

Allows user to turn the Rear Cross Traffic Alert (RCTA) system ON/OFF. (See "Rear Cross Traffic Alert (RCTA) system (where fitted)" in the "5. Starting and driving" section.)

[Driver Attention Alert]:

Allows user to turn the Intelligent Driver Alertness on or off. (See "Intelligent Driver Alertness (where fitted)" in the "5. Starting and driving" section.)

[Timer Alert]:

Allows user to adjust the [Timer Alert] or reset.

[Low Temp. Alert]:

Allows user to turn the Low Temperature Alert function ON/OFF.

[Steering Effort] (where fitted):

Allows user to adjust the power steering to reduce or increase steering effort.

- [Drive Mode]
- [Standard]
- [Sport]

[Chassis Control]:

- [Trace Control]

Allows the user to turn the [Trace Control] function ON/OFF. (See "Intelligent Trace Control" in the "5. Starting and driving" section.)

[Personal Display] (where fitted)

To change the display in the [Personal Display] menu, use the scroll dial to select and change a menu item:

- [Blank]
- [Navigation]
- [Time to Destination]
- [Trip]
 - [Since Reset]
 - [Since Start]
 - [Since Refuel]
- [Gear position]
- [Average speed]
 - [Since Reset]
 - [Since Start]
 - [Since Refuel]
- [Brake Lamp]

[Head-Up Display] (where fitted)

To change the status or turn on or off any of the systems displayed in the [Head-Up Display] (HUD), use the scroll dial to select and change a menu item:

- [Brightness]
- [Height]

- [Rotation]

- [Contents selection]

- [Navigation] (where fitted)
- [Driving Aids] (where fitted)
- [Traffic Sign] (where fitted)
- [Audio] (where fitted)
- [Telephone] (where fitted)

- [Reset]

(See "[Head-up display] (where fitted)" later in this section.)

[ECO Settings]

This setting allows user to change the [ECO] mode system settings.

To change the status or turn on or off any of the systems displayed in the [ECO Settings] menu, use the scroll dial to select and change a menu item:

- [ECO Drive Mode]
 - [ECO Cruise Control]
 - [ECO Climate Control]
- [ECO Info Settings]
 - [ECO Indicator]
 - [ECO Drive Report]

- [View History]

To reset the [View History]:

- 1) Select [View History] using the scroll dial.
- 2) Push the scroll dial.
- 3) Select [Yes] by pushing the scroll dial.

- [Tyre ECO advice]

Push the scroll dial to turn the [Tyre ECO advice] ON/OFF.

[Tyre Pressures]

The settings in the [Tyre Pressures] menu are all related to the Tyre Pressure Monitoring System TPMS (see "Tyre Pressure Monitoring System (TPMS) (where fitted)" in the "5. Starting and driving" section).

- [Target Front]
- [Target Rear]
- [Tyre Pressure Unit]
- [Calibrate]

[Target Front]:

The [Target Front] tyre pressure is the pressure specified for the front tyres on the tyre placard (see "Tyre placard" in the "9. Technical information" section and "Tyre Pressure Monitoring System (TPMS) (where fitted)" in the "5. Starting and driving" section).

Use the scroll dial to select and change the value for the [Target Front] tyre pressure.

[Target Rear]:

The [Target Rear] tyre pressure is the pressure specified for the rear tyres on the tyre placard (see "Tyre placard" in the "9. Technical information" section and "Tyre Pressure Monitoring System (TPMS) (where fitted)" in the "5. Starting and driving" section).

Use the scroll dial to select and change the value for the [Target Rear] tyre pressure.

[Tyre Pressure Unit]:

The unit for tyre pressure that displays in the Vehicle Information Display can be changed to:

- [psi]
- [bar]
- [kPa]
- [kgf/cm²]

Use the scroll dial to select and change the unit.

Pressure units conversion table

kPa	psi	bar	kgf/cm ²
200	29	2.0	2.0
210	30	2.1	2.1
220	32	2.2	2.2
230	33	2.3	2.3
240	35	2.4	2.4
250	36	2.5	2.5
250	36	2.5	2.5
260	38	2.6	2.6
270	39	2.7	2.7
280	41	2.8	2.8
290	42	2.9	2.9
300	44	3.0	3.0
310	45	3.1	3.1
320	46	3.2	3.2
330	48	3.3	3.3
340	49	3.4	3.4

[Calibrate]:

The tyre pressure is affected by the temperature of the tyre; the tyre temperature increases when the vehicle is driven. The TPMS system uses temperature sensors in the tyres to compensate for changes in temperature in order to prevent false TPMS warnings.

The [Calibrate] function resets the previously stored temperature value. It is recommended that this function is performed after the tyre pressures are adjusted.

See "Tyre Pressure Monitoring System (TPMS) (where fitted)" in the "5. Starting and driving" section.

Use the scroll dial to start or cancel the calibration process. While the calibration process is active, the message: [Calibrate] will be displayed.

[Clock]

Allows user to adjust the clock settings and time within the vehicle information display.

- [Display] (where fitted)
- [Clock Mode] (where fitted)
- [Clock Format]
- [Summer Time] (where fitted)
- [Time Zone] (where fitted)
- Set Clock Manually

The clock may also be set in the centre display. For additional information, refer to the separate Nissan-Connect Owner's Manual.

[Vehicle Settings]

The vehicle settings allows user to change settings for the following menus.

- [Power Back Door] (where fitted)
- [Lighting]
- [Locking]
- [Wipers]
- [Alarm System] (where fitted)
- [Driving Position] (where fitted)
- [Rear Door Alert]
- [Mirror Fold]

The vehicle settings can be changed using the scroll dial.

[Power Back Door] (where fitted):

This allows user to turn the power tailgate ON or OFF.

When [Power Back Door] is turned off, the power tailgate can still be opened and closed by pressing the open button and moving the tailgate by hand. Note that the effort required to open/close the power tailgate will be higher than for a non-power tailgate model

[Lighting]:

The [Lighting] menu has the following options:

- [Welcome Light]
The welcome lighting causes the lights to be turned on when the doors are unlocked using the Intelligent Key. Use the scroll dial to turn this feature ON or OFF.
- [Mood Lighting] (where fitted)
The brightness of the [Mood Lighting] can be adjusted. Use the scroll dial to select the brightness.

[Locking]:

The [Locking] menu has the following options:

- [I-Key Door Lock] (where fitted)
When this item is turned on, the request switch on the door is activated. Use the scroll dial to activate or deactivate this function.
- [Selective Unlock] (where fitted)
When this item is turned on, and the driver's side door handle request switch is pushed, only the driver's side door is unlocked. All the doors can be unlocked if the door handle request switch is pushed again within 1 minute. When this item is turned to off, all the doors will be unlocked when the door handle request switch is pushed once. Use the scroll dial to activate or deactivate this function.

- [Auto Door Unlock] (where fitted)

The [Auto Door Unlock] feature allows user to customise the auto door unlock options. Use the scroll dial to change the mode.

- [Shift to Park]
- [Power OFF]
- [OFF]

- [Horn Beeps on Lock] (where fitted)

When this item is turned on, the horn will beep and the hazard indicators will flash twice when locking the vehicle with the Intelligent Key. Use the scroll dial to activate or deactivate this function.

- [Auto Door Lock] (where fitted)

The [Auto Door Lock] feature allows user to customise the auto door lock options. Use the scroll dial to change the mode.

- [Vehicle Speed] (where fitted)
- [Shift out of Park] (where fitted)
- [OFF]

[Wipers]:

The [Wipers] menu has the following options:

- [Speed Dependent]
The [Speed Dependent] feature can be activated or deactivated. Use the scroll dial to turn this feature ON or OFF.

- [Auto Wipe]

The [Auto Wipe] wiper feature can be set to be ON or OFF. Use the scroll dial to turn this feature ON or OFF.

- [Reverse Link] (where fitted)

The Reverse Link wiper feature can be set to be ON or OFF. From the [Wipers] menu, select [Reverse Link]. Use the scroll dial to turn this feature ON or OFF. If set to ON, the rear wiper will operate if the front wipers are switched on and the shift position is in the R (Reverse) position.

- [Drip Wipe]

The [Drip Wipe] feature can be set to be ON or OFF. From the [Wipers] menu, select [Drip Wipe]. Use the Scroll dial to turn this feature ON or OFF. If set to ON, the wiper will operate once about 3 seconds after using the washer. This operation is to wipe washer fluid that has dripped on the windscreen.

[Alarm System] (where fitted):

The [Alarm System] menu has the following options:

- [Always ON]

When this option (where fitted) is selected, the alarm system will provide the choice to disable the interior movement sensors (where fitted) after the e-POWER system is switched **OFF**. Use the scroll dial to select the preferred function.

- [Disable Once]

When this option (where fitted) is selected, the interior movement sensors (where fitted) will be disabled until the next time the alarm system is disarmed.

[Driving Position] (where fitted):

- [Exit Seat Slide]

This allows user to turn the entry/exit function ON or OFF. Use the scroll dial to turn this function ON or OFF. (See "Driving Position Memory System (where fitted)" in the "3. Pre-driving checks and adjustments" section.)

[Rear Door Alert] (where fitted):

The [Rear Door Alert] feature allows user to customise the Rear Door Alert options. Use the scroll dial to change the mode.

- [Horn & Alert]

When selected, the alert is displayed and the horn sounds.

- [Alert Only]

When selected, only the alert is displayed.

- [OFF]

When selected, no alert or horn will be active.

[Mirror Fold]:

There are three options (where fitted) in the [Mirror Fold] menu:

- [Auto Fold Off] (where fitted)

When this item is turned on, the auto fold feature for the outside rear-view mirrors is disabled. Use the scroll dial to select this function.

- [Unfold at Power on] (where fitted)

When this item is turned on, the outside rear-view mirrors automatically fold when the power switch is switched OFF, and unfold when the power switch is switched ON. Use the scroll dial to select this function.

- [Unfold at Unlock] (where fitted)

When this item is turned on, the outside rear-view mirrors automatically fold when the vehicle doors are locked, and unfold when the vehicle doors are unlocked. Use the scroll dial to select this function.

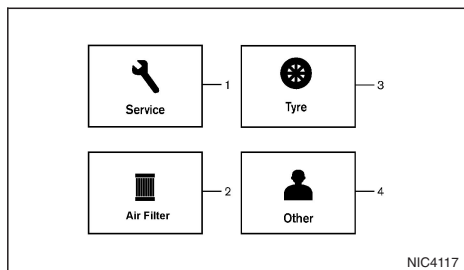

[Maintenance]

The maintenance mode allows user to set alerts for the reminding of maintenance intervals. To change an item:

Select [Maintenance] using the scroll dial and push the scroll dial.

1. [Service]
2. [Air Filter]
3. [Tyre]
4. [Other]

[Service]:

The [Service] indicator (Oil Control System) displays the remaining distance to the next oil change. Never exceed one year or 10,000 km (6,250 miles) between oil change intervals.

Display when power is ON	Display timing	Action Required
Engine Oil Service due in xxx km (miles)	Remaining oil life is less than 1,500 km (940 miles), 1,000 km (625 miles), 500 km (312.5 miles), 400 km (250 miles), 300 km (187.5 miles), 200 km (125 miles), 100 km (62.5 miles).	Plan to have your vehicle serviced.
Engine Oil Service due	Remaining oil life is 0 km (0 miles).	Have your vehicle serviced within two weeks or less than 800 km (500 miles).

The oil change interval cannot be adjusted manually.

The distance to oil change interval is calculated depending on the driving conditions and set automatically by the oil control system. A reminder will be displayed when approaching the end of the service interval.

When the Factory Reset option is selected in the vehicle information display, the oil control system

will also be reset to initial value. Please change the engine oil when Factory Reset is selected.

CAUTION

If the oil replacement indicator is displayed, change the engine oil within two weeks or less than 800 km (500 miles).

Operating the vehicle with deteriorated oil can damage the engine.

To reset oil control system:

1. Place the power switch in the ON position.
2. Push the ◀ and ▶ buttons on the steering wheel until [Settings] appears in the vehicle information display. Use the scroll dial to select [Maintenance]. Then push the scroll dial.
3. Select the [Service] option and push the scroll dial.
4. Push the scroll dial according to the reset instructions displayed at the bottom of the [Service] maintenance screen.

For scheduled maintenance items and intervals, see your NISSAN Service and Maintenance Guide.

[Air Filter] (where fitted):

This indicator appears when the customer set distance comes for changing the air filter. You can set or reset the distance for checking or replacing these items.

For scheduled maintenance items and intervals, see your NISSAN Service and Maintenance Guide.

[Tyre]:

This indicator appears when the customer set distance comes for replacing tyres. You can set or reset the distance for replacing tyres.

WARNING

The tyre replacement indicator is not a substitute for regular tyre checks, including tyre pressure checks. See “Wheels and tyres” in the “8. Maintenance and do-it-yourself” section. Many factors including tyre inflation, alignment, driving habits and road conditions affect tyre wear and when tyres should be replaced. Setting the tyre replacement indicator for a certain driving distance does not mean your tyres will last that long. Use the tyre replacement indicator as a guide only and always perform regular tyre checks. Failure to perform regular tyre checks, including tyre pressure checks could result in tyre failure. Serious vehicle damage could occur and may lead to a collision, which could result in serious personal injury or death.

[Other]:

This indicator appears when the customer set distance comes for checking or replacing maintenance items other than the engine oil, oil filter and tyres. Other maintenance items can include such things as air filter or tyre rotation. You can set or reset the distance for checking or replacing the items.

[Display Settings]

The display settings allows user to choose from the various meter selections.

The display settings can be changed using the scroll dial.

[Contents Selection]:

Displays available screens that can be shown in the vehicle information display.

[Route Guidance] (where fitted):

To change the setting, use the scroll dial to select and push it.

- [Alert(s)]

The [Alert(s)] setting allows user to turn the Navigation Settings alerts on or off.

[AUTO Cruise Display] (where fitted):

The [AUTO Cruise Display] item allows user to turn the cruise screen transition on or off.

[Welcome Effect]:

The [Welcome Effect] displays the available welcome effect settings.

- [Gauges] (where fitted)
- [Animation]
- [Sound]

[Operation guidance]:

The [Operation guidance] displays the available operation guidance settings.

- [Lights]
- [Wiper]
- [Front]

- [Rear]

- [High Beam Assist] (where fitted)
- [Adaptive Headlight] (where fitted)
- [Seat Memory] (where fitted)
- [Speed limiter] (where fitted)

[Unit/Language]

The units that are shown in the vehicle information display can be changed:

- [Distance/Fuel]
- [Tyre Pressure]
- [Temperature]
- [Language]

Use the scroll dial to select and change the units of the vehicle information display.

[Distance/Fuel]:

The unit for the fuel consumption that is shown in the vehicle information display can be changed.

- [miles, MPG]
- [km, km/l]
- [km, l/100km]

Use the scroll dial to select and change the unit.

[Tyre Pressures]:

The unit for tyre pressures that is shown in the vehicle information display can be changed to:

- [psi]
- [bar]
- [kPa]
- [kgf/cm²]

[Temperature]:

The temperature that is shown in the vehicle information display can be changed from:

- [°C]
- [°F]

Use the scroll dial to toggle choices.

[Language]:

The language of the vehicle information display can be changed.

Use the scroll dial to select and change the language of the vehicle information display.

[I-Key Link] (where fitted)











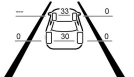





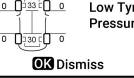

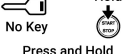



The [I-Key Link] can be turned ON/OFF using the scroll dial. It will display the key synchronised and in use for this vehicle.

[Factory Reset]



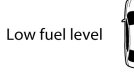





















































The settings in the vehicle information display can be reset back to the factory default. To reset the vehicle information display:

1. Select [Factory Reset] using the scroll dial and push it.
2. Select [Yes] to return all settings back to default by pushing the scroll dial.

GENERAL INFORMATION AND WARNINGS

 <p>BRAKE START STOP</p> <p>Push Brake and Start Button to Drive</p>	<p>Tyre Pressure (psi)</p> 	 <p>Reminder Turn OFF Headlights</p> <p>OK Dismiss</p>	<p>Driver Attention Alert</p>  <p>Take a break?</p> <p>OK Dismiss</p>	<p>Warning</p> <p>Release Parking Brake</p>
 <p>Rotate the Steering Wheel and Push Start Button</p>	<p>Tyre Pressure (psi)</p>  <p>OK Dismiss</p>	<p>Warning</p> <p>Headlight system fault See Owner's Manual</p> <p>OK Dismiss</p>	<p>Warning</p>  <p>Driver Attention Alert System fault</p> <p>OK Dismiss</p>	<p>Driving Position</p> <p>1 2</p> <p>Push Memory Switch to Save Driving Position</p> <p>OK Dismiss</p>
<p>Warning</p>  <p>No key detected</p> <p>OK Dismiss</p>	<p>Warning</p>  <p>Low Tyre Pressure</p> <p>OK Dismiss</p>	 <p>Not Available Requires AUTO lights</p>		<p>Driving Position</p> <p>1</p> <p>Driving Position Saved</p> <p>OK Dismiss</p>
 <p>No Key Hold</p> <p>Press and Hold to Stop Engine</p>		<p>Front Wipers</p>  <p>OK Dismiss</p>		
 <p>Key Battery Low</p> <p>OK Dismiss</p>		<p>Front Wipers</p>  <p>OK Dismiss</p>	 <p>Forward Blind Spot Lane</p>	<p>Alarm System</p> <p>Interior Movement Sensors</p> <p>ON OFF</p>
 <p>Place the Key near the Start Button</p>	 <p>Low fuel level</p>	<p>Parking Aids</p>  <p>OK To Disable</p>	<p>Power will turn off to save the battery</p> <p>OK Dismiss</p>	<p>Alarm System</p> <p>Interior Movement Sensors Enabled</p>
<p>Warning</p>  <p>Key System Fault See Owner's Manual</p> <p>OK Dismiss</p>	<p>Headlights</p>  <p>OK Dismiss</p>	<p>P</p> <p>Parking sensor system fault See Owner's Manual</p>	<p>Power turned off to save the battery</p>	<p>Alarm System</p> <p>Interior Movement Sensors Disabled</p>

NIC4240

<p> Warning</p> <p>Check position of gear lever</p> <p> Dismiss</p>	36	<p>Exhaust Filter</p> <p></p> <p>Exhaust filter maintenance See owner's manual</p> <p> Dismiss</p>	43	<p> Warning</p> <p>Engine Malfunction Service now</p> <p> Dismiss</p>	50	<p> Warning</p> <p>e-POWER System Failure Power reduced</p> <p> Dismiss</p>	57	<p> Warning</p> <p>e-POWER system off</p> <p> Dismiss</p>	64
<p>Warning</p> <p>Press brake pedal</p>	37	<p> Warning</p> <p> Shift to Park</p> <p> Dismiss</p>	44	<p> Warning</p> <p>Stop the vehicle safely</p> <p> Dismiss</p>	51	<p> Warning</p> <p>e-POWER System off Stop safely</p> <p> Dismiss</p>	58	<p>EV Mode Unavailable Acceleration Demand Too High</p> <p> Dismiss</p>	65
<p>Press brake pedal</p>	38	<p>Shipping Mode On Push Storage Fuse</p>	45	<p> Warning</p> <p> Apply parking brake</p> <p> Dismiss</p>	52	<p> Warning</p> <p>e-POWER System Fault Unable to Restart after power off</p> <p> Dismiss</p>	59	<p>EV Mode Unavailable Engine Too Cold</p> <p> Dismiss</p>	66
<p> Warning</p> <p>Press brake pedal to prevent rolling</p> <p> Dismiss</p>	39	<p> Warning</p> <p>Battery Management Fault Service Now</p> <p> Dismiss</p>	46	<p> Warning</p> <p>Chassis control system fault See Owner's Manual</p> <p> Dismiss</p>	53	<p> Warning</p> <p>e-POWER System Error Power reduced Stop Safely</p> <p> Dismiss</p>	60	<p>EV Mode Unavailable Front Defrost On</p> <p> Dismiss</p>	67
<p>Autohold</p> <p>Caution Steep slope</p> <p> Dismiss</p>	40	<p> Warning</p> <p>Engine Malfunction Power reduced Service now</p> <p> Dismiss</p>	47	<p> Warning</p> <p>T/M system malfunction Service now</p> <p> Dismiss</p>	54	<p> Warning</p> <p>Service e-POWER System Apply Parking Brake</p> <p> Dismiss</p>	61	<p>EV Mode Unavailable</p> <p> Dismiss</p>	68
<p>Autohold</p> <p>Steep Slope Apply foot brake</p> <p> Dismiss</p>	41	<p> Warning</p> <p>Engine Stalled Stop Safely</p> <p> Dismiss</p>	48	<p>Temporary Power Control Activated</p> <p> Dismiss</p>	55	<p> Warning</p> <p>e-POWER System Fault Stop Safely</p> <p> Dismiss</p>	62	<p>EV Mode Unavailable Vehicle Speed Too High</p> <p> Dismiss</p>	69
<p>Autohold</p> <p>Press brake to operate switch</p> <p> Dismiss</p>	42	<p> Warning</p> <p>Engine hot Power reduced</p> <p> Dismiss</p>	49	<p> Warning</p> <p>Engine Malfunction Power reduced Service now</p> <p> Dismiss</p>	56	<p> Warning</p> <p>Service e-POWER System</p> <p> Dismiss</p>	63	<p>EV Mode Unavailable Battery Too Low</p> <p> Dismiss</p>	70

NIC2464

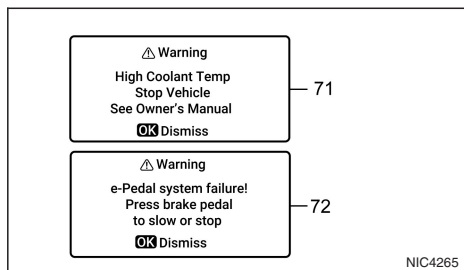

The displayed images may differ depending on the model.

1. Start operation guidance

This message appears when the shift position is in the P (Park) position.

This message means that the e-POWER system will start by pushing the power switch with the brake pedal depressed.

2. Start operation guidance

This message indicates that the power switch is unable to unlock the steering lock. Turn the steering wheel slightly while pushing the power switch.

3. [No Key Detected] warning

This warning appears when the door is closed with the Intelligent Key left outside the vehicle and the e-POWER system is ON. Make sure that the Intelligent Key is inside the vehicle.

If the Intelligent Key has not moved for more than 2 minutes, move the key and check if the warning message is still displayed.

See "Intelligent Key system (where fitted)" in the "3. Pre-driving checks and adjustments" section for more details.

4. [No Key] [Press and Hold to Stop Engine] warning

This warning appears you try to turn off the e-POWER system when the door is closed with the Intelligent Key left outside the vehicle and the e-POWER system is ON. Press and hold the start button to turn off the e-POWER system.

See "Intelligent Key system (where fitted)" in the "3. Pre-driving checks and adjustments" section for more details.

5. [Key Battery Low] warning

This warning appears when the Intelligent Key battery is running out of power.

If this warning appears, replace the battery with a new one. See "Intelligent Key battery replacement" in the "8. Maintenance and do-it-yourself" section.

6. Start operation for Intelligent Key system guidance

This message appears when the Intelligent Key battery is running out of power and when the Intelligent Key system and vehicle are not communicating normally.

If this message appears, touch the start button with the Intelligent Key while depressing the brake pedal. (See "Push-button power switch" in the "5. Starting and driving" section.)

7. [Key System Fault See Owner's Manual] warning

This warning appears if there is a malfunction in the Intelligent Key system.

If this warning appears while the e-POWER is stopped, the e-POWER system cannot be started. If this warning appears while the e-POWER system is running, the vehicle can be driven. However, it is recommended that you visit a NISSAN dealer or qualified workshop for repair as soon as possible.

8-9. [Tyre Pressure] guidance messages

The tyre pressure mode shows the pressure of all four tyres while the vehicle is driven.

With the [Tyre ECO advice] function ON, when the tyre pressure is getting low, [Check Tyre Pressures for Best Energy Economy] or appears.

10. [Low Tyre Pressure] warning

This warning appears when the low tyre pressure warning light in the meter illuminates and low tyre pressure is detected. The warning appears each time the power switch is switched ON as long as the low tyre pressure warning light remains illuminated. If this warning appears, stop the vehicle and adjust the pressure to the recommended COLD tyre pressure shown on the tyre placard. (See "Low tyre pressure warning light (where fitted)" earlier in this section and "Tyre Pressure Monitoring System (TPMS) (where fitted)" in the "5. Starting and driving" section.)

11. Occupant Status Display (where fitted)

In vehicles fitted with Rear Occupant Detection, in addition to the Seat Belt Warning Light, the Occupant Status Display will be shown in the Vehicle Information Display when any vehicle occupant's seat belt is not fastened. The display will remain until occupants have their seat belts securely fastened, or until acknowledged by the driver

For precautions on seat belt usage, see "Seat belts" in the "2. Safety — Seats, Seat belts and Supplemental Restraint System" section.

12. Rear Passenger Seat Belt Display (Where Fitted)

Dependent on vehicle specification, this warning will appear for 65 seconds after the e-POWER system is switched ON. It will also display if the total number of rear buckled seat belt is less than the maximum seem during the journey.

For precautions on seat belt usage, see "Seat belts" in the "2. Safety — Seats, Seat belts and Supplemental Restraint System" section.

13. [Low fuel level] warning

This warning appears when the fuel level in the tank is getting low. Refuel as soon as it is convenient, preferably before the fuel gauge reaches the empty (0) position.

There is a small reserve of fuel remaining in the tank when the fuel gauge reaches the empty (0) position.

14. [Headlights] guidance

This message is displayed when a change is made to the position of the headlight switch. See "Headlight and turn signal switch" later in this section.

15. [Reminder Turn OFF Headlights] warning

This warning appears when the driver side door is opened with the headlight switch is left ON and the e-POWER system is switched OFF. Place the headlight switch in OFF (where fitted) or AUTO position. For additional information, (See "Headlight and turn signal switch" later in this section.)

16. [Headlight System Fault See Owner's Manual] warning

This warning appears if the LED headlights are malfunctioning. Have the system checked. It is recommended that you visit a NISSAN dealer or qualified workshop for this service.

17. [Not Available Requires AUTO lights] warning

This warning is displayed of you try to turn on the dynamic high beam assistant and/or adaptive driving beam but the Headlight switch is not in the AUTO position. (See "Dynamic high beam assistant (where fitted)" in the "5. Instruments and controls" section.)

18-19. [Front Wipers] guidance

This message is displayed when a change is made to the position of the wiper switch. See "Wiper and washer switch" later in this section.

20. [Parking Aids] Parking Sensor System guidance

This message appears to indicate the status of the Parking Sensor system (where fitted) or the Rear Parking sensor System (where fitted).

Press **<OK>** on the steering wheel to disable parking sensors and associated systems, such as Rear Automatic Braking (RAB).

See "Front and Rear Ultrasonic Parking Sensors (where fitted)" in the "5. Starting and driving" section.

21. [Parking sensor system fault See Owner's Manual] warning

This warning appears when there is a malfunction with the Parking Sensor system (where fitted) or the Rear Parking sensor System (where fitted). (See "Front and Rear Ultrasonic Parking Sensors (where fitted)" in the "5. Starting and driving" section.)

22. [Driver Attention Alert] [Take a Break?] guidance

This message appears when the Intelligent Driver Alertness (IDA) system detect that the driver attention is decreasing. (See "Intelligent Driver Alertness (where fitted)" in the "5. Starting and driving" section.)

23. [Driver Attention Alert] [System fault] (IDA) warning

This warning appears when the Intelligent Driver Alertness (IDA) system malfunctions. (See "Intelligent Driver Alertness (where fitted)" in the "5. Starting and driving" section.)

24. Door/tailgate open warning

This warning appears if any of the doors and/or the tailgate are open or not closed securely. The vehicle icon indicates which door or the tailgate is open on the display.

25. Shift position indicator

This indicator shows the shift position when the power switch is ON.

See "Electric shift control system" in the "5. Starting and driving" section for further details.

26. Lane Departure Warning (LDW)/Intelligent Lane Intervention (ILI)/Blind Spot Warning (BSW)/Intelligent Blind Spot Intervention/Intelligent Emergency Braking (IEB)/Intelligent Forward Collision Warning (I-FCW) guidance

This appears when one or more of the following systems are engaged:

- Lane Departure Warning (LDW)
- Intelligent Lane Intervention (ILI)
- Blind Spot Warning (BSW)
- Intelligent Blind Spot Intervention (where fitted)
- Intelligent Emergency Braking (IEB (where fitted))
- Intelligent Forward Collision Warning (I-FCW) (where fitted)

See "Intelligent Lane Intervention (ILI) system (where fitted)" in the "5. Starting and driving" section, "Blind Spot Warning (BSW) system/Intelligent Blind Spot Intervention system (where fitted)" in the "5. Starting and driving" section, "Intelligent Emergency

Braking (IEB) system (where fitted)" in the "5. Starting and driving" section, "Intelligent Forward Collision Warning (I-FCW) system (where fitted)" in the "5. Starting and driving" section.

27. [Power will turn off to save the battery] warning

Under the specific conditions, this warning may appear after the power switch is ON for a certain period of time.

28. [Power turned off to save the battery] warning

Under the specific conditions, this warning may appear after the power is automatically turned OFF to save the battery.

29. [Release parking brake] warning

This warning appears when the accelerator pedal is depressed when the electric parking brake automatic release function cannot be used. Release the electric parking brake manually.

30–31. [Driving Position] guidance (where fitted)

These messages are displayed when a change is made to the Driving Position Memory System settings. (See "Driving Position Memory System (where fitted)" in the "3. Pre-driving checks and adjustments" section.)

32. [Drive Mode Selector] indicator

When a driving mode is selected using the [Drive Mode Selector], the selected mode indicator is displayed.

- [SPORT]
- [STANDARD]
- [ECO]

33. [Interior Movement Sensors] status

This screen allows you to turn the [Interior Movement Sensors] on or off. Use the scroll dial to select the required option.

(See "[Alarm System] (where fitted)" in the "5. Instruments and controls" section.)

34. [Interior Movement Sensors Enabled] guidance

This message is displayed when the interior movement sensors for the system have been enabled in the Settings menu.

(See "[Alarm System] (where fitted)" in the "5. Instruments and controls" section.)

35. [Interior Movement Sensors Disabled] guidance

This message is displayed when the interior movement sensors for the system have been disabled in the Settings menu.

(See "[Alarm System] (where fitted)" in the "5. Instruments and controls" section.)

36. [Check position of gear lever] warning

This warning is displayed when the shift lever is held in a position other than the centre position.

Make sure that the shift lever is placed in the centre position.

If the warning appears when the shift lever is placed in the centre position, contact a NISSAN dealer or qualified workshop immediately.

37. [Press Brake Pedal] warning (where fitted)

The vehicle is stopped on a steep hill and there is a possibility of moving backward, even if the electric parking brake is applied. Depress the brake pedal to stop the vehicle moving. (See "Electric Parking Brake" in the "3. Pre-driving checks and adjustments" section).

38. [Press Brake Pedal] guidance (where fitted)

This message appears if an attempt is made to release the electric parking brake manually without depressing the brake pedal. (See "Electric Parking Brake" in the "3. Pre-driving checks and adjustments" section).

39. [Press Brake Pedal to prevent rolling] warning

This warning appears and a chime sounds if the vehicle moves while the Automatic brake hold function is activated. Apply the foot brake to stop the vehicle moving. (See "Automatic brake hold" in the "3. Pre-driving checks and adjustments" section).

40. [Autohold] [Caution Steep slope] guidance

This message appears and a chime sounds when the Automatic brake hold function is activated while the vehicle is on a steep hill. Apply the foot brake to stop the vehicle moving. (See "Automatic brake hold" in the "3. Pre-driving checks and adjustments" section)

41. [Autohold] [Steep Slope Apply foot brake] guidance

This message appears and a chime sounds if the [Caution Steep slope] guidance has appeared for over about 3 minutes. Then, the parking brake will automatically be applied and the braking force of Automatic brake hold will be released, and vehicle may move or roll away unexpectedly. Apply the foot brake to stop the vehicle moving. (See "Automatic brake hold" in the "3. Pre-driving checks and adjustments" section).

42. [Autohold] [Press brake to operate switch] guidance

This message appears if the Automatic brake hold switch is pushed without depressing the brake pedal while the Automatic brake hold function is activated. Apply the foot brake and push the switch to deactivate Automatic brake hold. (See "Automatic brake hold" in the "3. Pre-driving checks and adjustments" section)

43. [Exhaust filter maintenance See owner's manual] warning (where fitted)

Your vehicle may also be fitted with a Gasoline Particulate Filter (GPF). Under certain less-favourable driving conditions, the GPF may become saturated or clogged because these driving conditions prevent automatic regeneration of the filter. In this case, a warning message (where fitted) will be displayed in the vehicle information display. For additional details, see "Gasoline particulate filter (GPF) (where fitted)" in the "5. Starting and driving" section.

44. [Shift to Park] warning

This warning appears when the driver's door is opened while the shift is in any position other than P (Park).

If this warning appears, push the P position switch to engage the P (Park) position.

An inside warning chime will also sound. (See "Push-button power switch" in the "5. Starting and driving" section.)

45. [Shipping Mode On Push Storage Fuse] warning (where fitted)

This warning may appear if the extended storage switch is not pushed in. When this warning appears, push in the extended storage switch to turn off the warning. (See "Fuses" in the "8. Maintenance and do-it-yourself" section.)

46. [Battery Management Fault Service Now] warning

This warning appears if a fault is detected with the battery management system. Have the system checked. It is recommended you contact a NISSAN dealer or qualified workshop for this service.

47–50. Engine warning (where fitted)

Malfunctions or high engine temperature will result in one of these warning messages being displayed. For additional details, see “If your vehicle overheats” in the “6. In case of emergency” section.

51. [Stop the vehicle safely] warning

This warning appears when the system detects that the vehicle is moving backwards on an uphill road with the shift position in D (Drive), or moving forward on a downhill road with the shift position in R (Reverse). The e-POWER system may stall, so stop vehicle movement by depressing the brake pedal.

52. [When parked apply parking brake] warning

This warning appears if a malfunction occurs in the electric shift control system. Contact a NISSAN dealer or qualified workshop as soon as possible. When parking the vehicle, make sure that the parking brake is applied during power switch on. If the parking brake is not applied, the power switch may not be turned off.

53. [Chassis Control System Fault See Owner’s Manual] warning

This warning appears if the chassis control module detects a malfunction in the chassis control system. Have the system checked. It is recommended that you visit a NISSAN dealer or qualified workshop for this service. (See “Chassis control” in the “5. Starting and driving” section.)

54. [T/M system malfunction Service now] warning

This warning appears if a malfunction occurs in the electric shift control system.

Contact a NISSAN dealer or qualified workshop as soon as possible.

Since the shift position may not be switched immediately, hold the shift lever in that position and confirm that the shift position has been switched, and then release the shift lever.

If the vehicle does not automatically apply the P (Park) position when the power switch is placed in the OFF position, push the P position switch when parking the vehicle, and then confirm that the shift position indicator is P in the vehicle information display.

55. [Temporary Power Control Activated] warning

This warning appears when the power limitation indicator light illuminates. If this warning appears, acceleration performance will be temporarily reduced in certain circumstances.

This warning will also appear if the accelerator pedal is depressed when the vehicle is stopped and the shift lever is placed in the N (Neutral) position.

56. [Engine Malfunction Power reduced Service now] warning

This warning appears if an engine malfunction occurs. The engine power will be reduced to protect the engine from further damage. Contact a NISSAN dealer or qualified workshop as soon as possible.

57. [e-POWER System Failure Power reduced] warning

This warning appears if there is a malfunction in the e-POWER system and the power provided to the electric motor is reduced. The displayed message will vary depending on the condition of the system malfunction. Be sure to follow the displayed instruction.

58. [e-POWER System off Stop safely] warning

This warning is displayed when the e-POWER system is off due to an error while driving.

Contact a NISSAN dealer or qualified workshop.

59. [e-POWER System Fault Unable to Restart after power off] warning

This warning is displayed if the e-POWER system cannot be restarted due to an error. Contact a NISSAN dealer or qualified workshop immediately.

60. [e-POWER System Error Power reduced Stop Safely] warning

This warning appears if there is a malfunction in the e-POWER system and the power provided to the electric motor is reduced. The displayed message will vary depending on the condition of the system malfunction. Be sure to follow the displayed instruction.

61. [Service e-POWER System Apply Parking Brake] warning

This message is displayed when the e-POWER system is stopped because an error has occurred in the e-POWER system while the vehicle is stopped. Contact a NISSAN dealer or qualified workshop immediately.

62. [e-POWER System Fault Stop Safely] warning

This warning appears if there is a malfunction in the e-POWER system and the power provided to the electric motor is reduced. The displayed message will vary depending on the condition of the system malfunction. Be sure to follow the displayed instruction.

63. [Service e-POWER system] warning

This warning appears if there is a malfunction in the e-POWER system. Contact a NISSAN dealer or qualified workshop immediately.

64. [e-POWER system off] warning

This warning is displayed when the e-POWER system is off due to an error while the vehicle is stopped.

Contact a NISSAN dealer or qualified workshop.

65-70. EV Mode warnings

These warnings appear when the EV mode is not under operating conditions. The displayed message will vary depending on the condition of the system. To use the EV mode, correct the condition or wait until the warning disappears, and then push the EV mode switch. If the warning persists, have the system checked by a NISSAN dealer or qualified workshop as soon as possible.

71. [High Coolant Temp Stop Vehicle See Owner's manual] warning

This warning appears when the engine coolant temperature is extremely high.







































































CAUTION

- **If this warning appears when the power switch is ON, stop the vehicle safely as soon as possible.**
- **If the vehicle is overheated, continuing vehicle operation may seriously damage the engine. See "If your vehicle overheats" in the "6. In case of emergency" section for the immediate action required.**

72. e-Pedal system failure warning

This warning appears when the e-Pedal Step system is malfunctioning. Have the system checked by a NISSAN dealer or qualified workshop as soon as possible.

VEHICLE INFORMATION DISPLAY DRIVING AIDS WARNINGS AND GUIDANCE MESSAGES

 Not available System Fault  Dismiss	1	 System fault See Owner's Manual  Dismiss	8	 Temporarily Disabled Front Radar Blocked  Dismiss	15	 Unavailable Slippery Road  Dismiss	22	 Not Available Front Camera obstructed  Dismiss	29
 Not available System Fault  Dismiss	2	 System fault See Owner's Manual  Dismiss	9	 Temporarily Disabled Front Radar Blocked  Dismiss	16	 Unavailable Slippery Road  Dismiss	23	 Not Available Front Camera obstructed  Dismiss	30
 Not available System Fault  Dismiss	3	 Unavailable Camera Temperature High  Dismiss	10	 Steering Assist Not Available Cannot Detect Lane  Dismiss	17	 Unavailable Slippery Road  Dismiss	24	 Not Available Visibility is impaired  Dismiss	31
 Not available System Fault  Dismiss	4	 Unavailable Camera Temperature High  Dismiss	11	 Currently Not Available  Dismiss	18	 Unavailable Slippery Road  Dismiss	25	 Not Available, Parking Brake On  Dismiss	32
 Not available System Fault  Dismiss	5	 Unavailable Camera Temperature High  Dismiss	12	 Currently Not Available  Dismiss	19	 Not Available Side radar obstructed  Dismiss	26	 Not Available, Seat Belt Not Fastened  Dismiss	33
 System fault  Dismiss	6	 Temporarily Disabled Front Radar Blocked  Dismiss	13	 Currently Not Available  Dismiss	20	 Not Available Side radar obstructed  Dismiss	27	 Press brake pedal  Dismiss	34
 System fault  Dismiss	7	 Temporarily Disabled Front Radar Blocked  Dismiss	14	 Currently Not Available  Dismiss	21	 Not Available Side radar obstructed  Dismiss	28	 System OFF  Dismiss	35

NIC4368

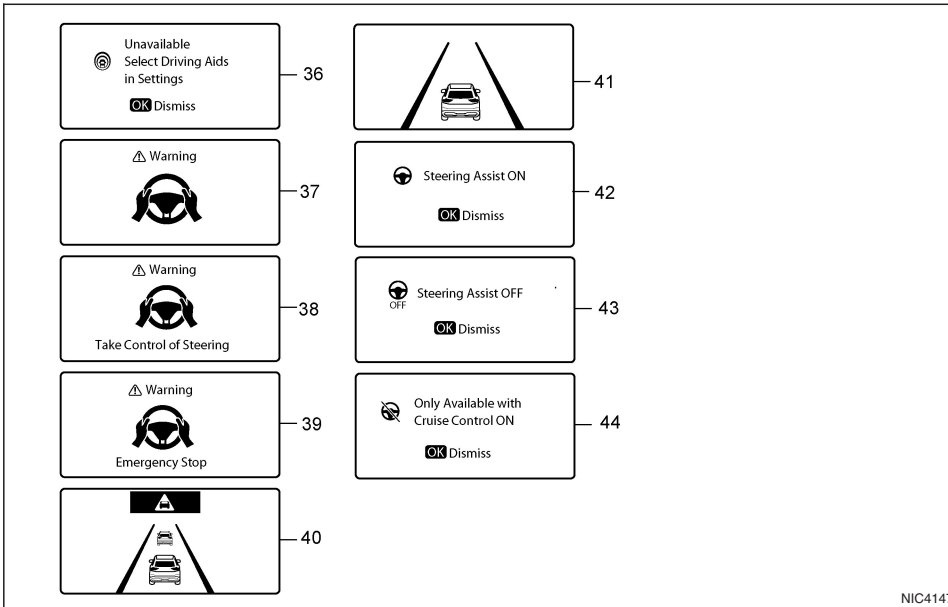

1-5. [Not Available] [System Fault] warning

This warning appears is one or more of the following systems malfunction.

- Lane Departure Warning (LDW) (where fitted)
- Intelligent Lane Intervention (ILI) (where fitted)
- Blind Spot Warning (BSW) (where fitted)
- Intelligent Blind Spot Intervention (where fitted)
- ProPILOT Assist (where fitted)
- Intelligent Cruise Control (ICC) (where fitted)
- Emergency Lane Assist (ELA) (where fitted)

If the warning continues to display, have the system checked. It is recommended that you visit a NISSAN dealer or qualified workshop for this service.

6-7. [System fault] warning

This warning appears when the following systems malfunction.

- Rear Cross Traffic Alert (RCTA) (where fitted)
- Intelligent Emergency Braking (IEB) (where fitted)

If the warning continues to display, have the system checked. It is recommended that you visit a NISSAN dealer or qualified workshop for this service.

8–9. [System fault See Owner’s Manual] warning (where fitted)

This warning appears when the following systems malfunction.

- Traffic Sign Recognition (TSR) (where fitted)
- Rear Automatic Braking (RAB) (where fitted)

If the warning continues to display, have the system checked. It is recommended that you visit a NISSAN dealer or qualified workshop for this service.

10–12. [Unavailable Camera Temperature High] warning

This warning appears if the interior temperature of the vehicle has reached such a high temperature that the sensors for the following systems can no longer function reliably.

- Lane Departure Warning (LDW) (where fitted)
- Intelligent Lane Intervention (ILI) (where fitted)
- Intelligent Blind Spot Intervention (where fitted)
- Steering Assist (where fitted)

Once the interior temperature has reached normal levels, the warning should disappear.

If the warning continues to display, have the system checked. It is recommended that you visit a NISSAN dealer or qualified workshop for this service.

13–16. [Temporarily Disabled Front Radar Blocked] warning

If the front radar sensor area on the front of the vehicle is covered with dirt or obstructed, making it impossible to detect a vehicle ahead, the following system is automatically turned off.

- Intelligent Cruise Control (ICC) (ProPILOT Assist system) (where fitted)
- Intelligent Emergency Braking (IEB) (where fitted)
- Emergency Lane Assist (ELA) (where fitted)
- Intelligent Cruise Control (ICC) (where fitted)

If the warning message appears, park the vehicle in a safe location and turn the e-POWER system off.

Check to see if the sensor area is blocked. If the sensor area is blocked, remove the blocking material. Restart the e-POWER system. If the warning message continues to appear, have the system checked. It is recommended that you visit a NISSAN dealer or qualified workshop for this service.

17. [Steering Assist Not Available Cannot Detect Lane] guidance (where fitted)

This message may appear when the Steering Assist system is engaged. The Steering Assist system is automatically cancelled when the lane markers in the travelling lane cannot be correctly detected for a period of time due to such items as a snow rut, reflection of light on a rainy day or several unclear lane markers are present.

If you want to use the Steering Assist system again, cancel the ProPILOT Assist system and set it again when lane markers are clearly visible.

18–21. [Currently not available] warning

This warning appears when the Intelligent Lane Intervention (ILI), Intelligent Blind Spot Intervention (where fitted) or the Intelligent Cruise Control (ICC) system (where fitted) becomes unavailable in the following conditions:

- The Electronic Stability Programme (ESP) system is turned off

22–25. [Unavailable Slippery Road] warning (where fitted)

This warning appears when the following systems become unavailable because the road is slippery.

- Intelligent Lane Intervention (ILI) (where fitted)
- Intelligent Blind Spot Intervention (where fitted)
- Intelligent Cruise Control (ICC) (where fitted)
- ProPILOT Assist (where fitted)

26–28. [Not available Side Radar Obstructed] warning (where fitted)

This warning appears when the following systems become unavailable because a radar blockage is detected.

- Blind Spot Warning (BSW) (where fitted)
- Intelligent Blind Spot Intervention (where fitted)
- Rear Cross Traffic Alert (RCTA) (where fitted)
- Emergency Lane Assist (ELA) (where fitted)

29–30. [Not Available Front Camera Obstructed] guidance (where fitted)

This message may appear when the Steering Assist and/or Emergency Lane Assist (ELA) system is activated.

Under the following conditions, the Steering Assist and/or Emergency Lane Assist (ELA) system is automatically cancelled:

- The camera area of the windscreen is fogged up or covered with dirt, water, drops, ice, snow, etc.
- Strong light, such as sunlight or high beams from oncoming vehicles, enter the front camera

31. [Not Available Visibility is impaired] guidance (where fitted)

This message may appear when the Steering Assist system is engaged.

Under the following conditions, the Steering Assist system is automatically cancelled:

- When the wiper (HI) operates.
- When lane markers in the travelling lane cannot be correctly detected for a period of time due to such items as a snow rut, reflection of light on a rainy day or several unclear lane markers are present.

If you want to use the Steering Assist system again, cancel the ProPILOT Assist system and set it again when lane markers are clearly visible.

32. [Not Available, Parking Brake On] guidance (where fitted)

This message may appear when the Intelligent Cruise Control (ICC) system is engaged.

Under the following condition, the ICC system is automatically cancelled:

- The Electric Parking Brake is applied.

The above system cannot be used when the Electric Parking Brake is activated.

33. [Not Available Seat Belt Not Fastened] guidance (where fitted)

This message may appear when the Intelligent Cruise Control (ICC) system is engaged.

Under the following condition, the ICC system is automatically cancelled:

- When the driver's seat belt is not fastened.

The ICC system cannot be used when the driver's seat belt is not fastened.

34. [Press Brake Pedal] guidance (where fitted)

This message may appear when the ProPILOT Assist Intelligent Cruise Control (ICC) system is engaged and the following condition occurs:

- While the vehicle is stopped by ProPILOT Assist, the driver's door is opened but the Electric Parking Brake was not activated.

Step on the brake pedal immediately.

35. [System OFF] warning

This warning is displayed if the RCTA is switched off. See "Rear Cross Traffic Alert (RCTA) system (where fitted)" in the "5. Starting and driving" section.

36. [Unavailable Select Driving Aids in Settings] warning

This warning is displayed if no Driver Assistance features are enabled.

37–39. Hands on detection warning (where fitted)

This warning may appear when the Steering Assist system is engaged and the following condition(s) occur:

- When not holding the steering wheel
- When there is no steering wheel operation

Hold on the steering wheel immediately. When the steering operation is detected, the warning turns off. For additional information, refer to "ProPILOT Assist (where fitted)" in the "5. Starting and driving" section.

40. Intelligent Emergency Braking (IEB) emergency warning (where fitted)

This warning appears along with an audible warning, when the Intelligent Emergency Braking (IEB) system detects the possibility of a forward collision.

See "Intelligent Emergency Braking (IEB) system (where fitted)" in the "5. Starting and driving" section.

41. Intelligent Emergency Braking (IEB) system guidance (where fitted)

This screen appears to indicate the status of the Intelligent Emergency Braking (IEB) system.

See "Intelligent Emergency Braking (IEB) system (where fitted)" in the "5. Starting and driving" section

42-43. Steering Assist guidance (where fitted)

This message appears when the Steering Assist system is turned on or off.

See "ProPILOT Assist (where fitted)" in the "5. Starting and driving" section.

44. [Only Available with Cruise Control ON] guidance (where fitted)

This message appears when the Steering Assist switch has been pressed while the Cruise Control is not switched on.

See "ProPILOT Assist (where fitted)" in the "5. Starting and driving" section.

CLOCK AND OUTSIDE AIR TEMPERATURE

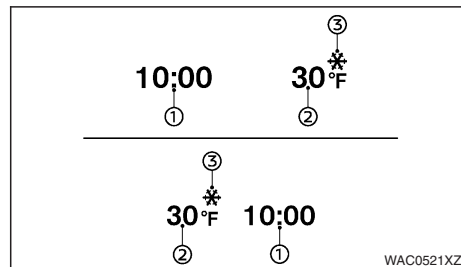

The clock ① and outside air temperature ② are displayed on the upper side of the vehicle information display.

Clock

For clock adjustment, see "FM/AM radio (with DAB) (where fitted)" in the "4. Display screen, heater and air conditioner, and audio system" section or the separate NissanConnect Owner's Manual (where fitted).

Outside air temperature (°C or °F)

The outside air temperature is displayed in °C or °F in the range of -40 to 60°C (-40 to 140°F).

The outside air temperature mode includes a low temperature warning feature. If the outside air temperature is below 3°C (37°F), the indicator ③ is displayed.

The outside temperature sensor is located in front of the radiator. The sensor may be affected by road or engine heat, wind directions and other driving conditions. The display may differ from the actual outside temperature or the temperature displayed on various signs or billboards.

[HEAD-UP DISPLAY] (where fitted)

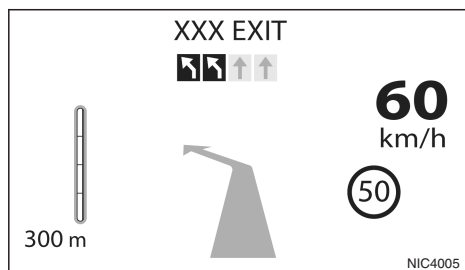
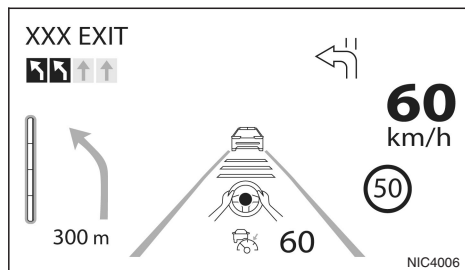

⚠ WARNING

- Failure to properly adjust the brightness and position of the displayed image may interfere with the driver's ability to see through the windscreen, which could cause an accident leading to severe injury or death.
- Do not use the [Head-Up Display] (HUD) for extended periods of time as that can cause you to not see other vehicles, pedestrians or ob-

jects, which could cause an accident leading to severe injury or death.

The [Head-Up Display] (HUD) can display one or more of the following features (where fitted):

- Vehicle speed
- [Navigation]
- [Driving Aids]
- [Traffic Sign]
- [Audio]
- [Telephone]

NOTE

- Do not place any type of liquid on or near the projector. Doing so may cause malfunction of the equipment.

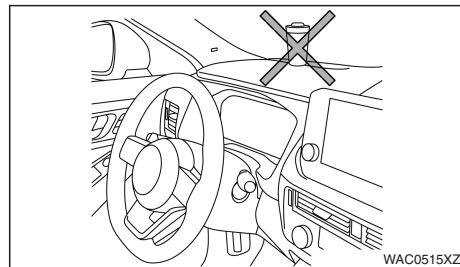

- Do not touch any internal parts of the projector. Doing so may cause malfunction of the equipment.

- To prevent scratches to the projector glass, do not place any sharp objects on or near the projector opening.
- Do not place any objects on the instrument panel which may obstruct the display of the HUD.
- If you wear polarised sunglasses, the display may be difficult to see. Increase the brightness of the HUD in the vehicle information display or remove your sunglasses.
- Depending on weather conditions (rain, snow, sunlight, etc.), the display may be difficult to see.
- For cleaning, use a soft clean dry cloth. If this is not sufficient, use a soft clean dry cloth dampened with water, after that use a soft clean dry cloth. Never use a rough cloth, alcohol, benzine, thinner or any kind of solvent or paper towel with a chemical cleaning agent. They will scratch or cause discolouration of the projector lens. Do not spray any liquid such as water on the projector lens. Spraying liquid may cause the system to malfunction.
- If the displayed image appears distorted, it is recommended you have the system checked by a NISSAN dealer or qualified workshop.
- The HUD has a special windscreen to allow the image to be displayed clearly. If your windscreen needs replacing, this should be completed by a NISSAN dealer.

HOW TO USE THE HUD

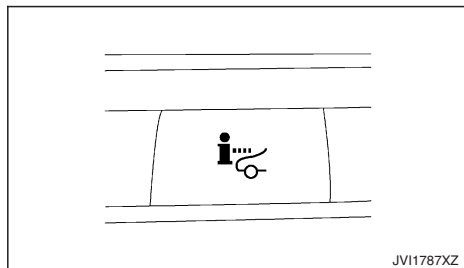

To turn the HUD on, push the HUD switch. To turn the HUD off, push the switch again.

If the HUD is turned off, it will remain off even if the vehicle is restarted.

The following settings can be changed in the vehicle information display:

- [Brightness]
- [Height]
- [Rotation]
- [Contents selection]
 - [Navigation] (where fitted)
 - [Driving Aids]
 - [Traffic Sign]
 - [Audio]
 - [Telephone]
- Reset

For more information see "[Settings]" earlier in this section.

NOTE

Emergency information may display even if the HUD is turned off. For more information see "Driving Aids/Navigation/Traffic Sign/Audio/Telephone linking" later in this section.

This product includes the following software.

- (1) Panasonic Corporation or software developed for Panasonic Corporation
- (2) Third-party software licensed to Panasonic Corporation
- (3) Open source software

Regarding (3) Open source software, it includes open source software (OSS), including various software to which license information applies.

Refer to the license web site at: <http://car.panasonic.jp/oss/i02lln39>

Display brightness

The brightness of the display may be controlled in the vehicle information display. The brightness will also be adjusted automatically according to the exterior ambient lighting brightness.

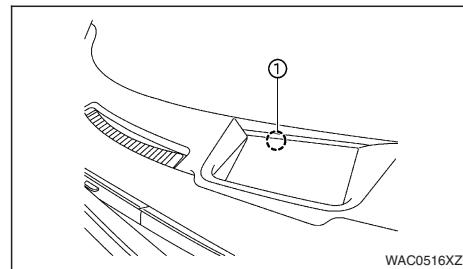

NOTE

- **The HUD has a built-in sensor ① that controls the brightness of the displayed image. If you block the sensor with an object, the display will darken, making it difficult to see.**
- **Do not apply strong light to the sensor of the HUD. Doing so may cause a malfunction.**

DRIVING AIDS/NAVIGATION/TRAFFIC SIGN/AUDIO/TELEPHONE LINKING

The HUD will display Driving Aids and navigation information.

The Driving Aids display will show warning situations for the following systems:

- Intelligent Emergency Braking (IEB)
- Intelligent Forward Collision Warning (I-FCW)
- Lane Departure Warning (LDW)
- Intelligent Lane Intervention (ILI)

WIPER AND WASHER SWITCH

- Hands-on warning (for vehicles with ProPILOT Assist) (where fitted)

- Emergency Lane Assist (ELA)

The Navigation System linking display will show the following items:

- Junction names
- Arrows indicating turning direction
- Distance to the next junction
- Recommended lane indicator

The Traffic Signs Recognition (TSR) system linking display will show the following item:

- Speed Limit Sign

The Audio System linking display will show the following items:

- Songs
- Radio stations

The Telephone linking display will show the following item:

- Caller's name or phone number

WINDSCREEN

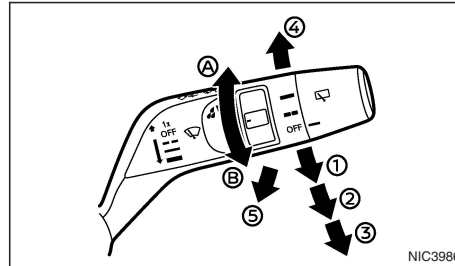

Type A (without <AUTO> mode)

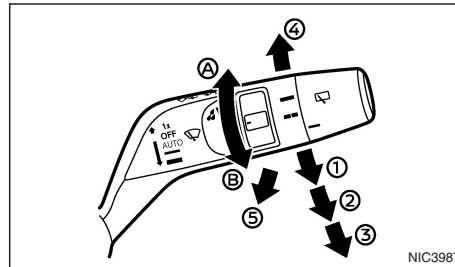

Type B (with <AUTO> mode)

⚠ WARNING

In freezing temperatures the washer fluid may freeze on the windscreen and obscure your vision. Warm the windscreen with the defogger before you wash it.

CAUTION

- Do not open/release the bonnet when the front wiper arms are raised from their original position.
- Do not operate the washer continuously for more than 15 seconds.
- Do not operate the washer if the reservoir tank is empty or frozen.

The windscreen wiper and washer can be operated when the power switch is ON.

Wiper operation

Move the lever up or down to operate the wiper at the following speeds:

- ①: **Intermittent** (▬ ▬) – Type A or **<AUTO>** – Type B (where fitted) operates the rain-sensing auto wiper system. (See “Rain sensor (where fitted)” later in this section).
 - The intermittent operation speed can be adjusted by rotating the ring forward Ⓐ (slower) or backward Ⓑ (faster).
 - The wiper operation speed will vary in accordance with the vehicle speed in the <AUTO> position. For example, when the vehicle speed is high, the intermittent operation speed will be faster.
- ②: **Low** (▬) – for continuous low speed operation.
- ③: **High** (▬) – for continuous high speed operation.
- ④: – for a single sweep operation of the wiper.

Washer operation

Pull the lever towards you ⑤ to operate the washer.

Wiper drip wipe system (where fitted):

The wiper will also operate once about 3 seconds after using the washer. This operation is to wipe washer fluid that has dripped on the windscreen.

Rain sensor (where fitted)

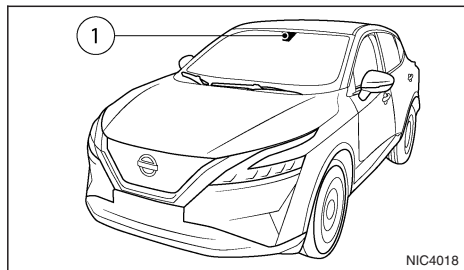

The sensor ① of the rain-sensing auto wiper system located on the upper part of the windscreen, in front of the rear view mirror, can automatically turn on the wipers and adjust the wiper speed depending on the rainfall intensity and the vehicle speed when the lever in the <AUTO> position.

The sensitivity can be adjusted by rotating the ring of the wiper switch forward ④ – less sensitive, or backward ⑤ – more sensitive.

NOTE

- Be sure to turn off the rain-sensing auto wiper system when the car is in the car wash.

- Leaving the lever in <AUTO> position will not harm the rain sensor system, although occasional unexpected activation of the wipers may occur.
- If the switch is left in the <AUTO> position, the wipers may operate unexpectedly when dirt, fingerprints, oil film or insects are covering the windscreen of the rain sensor location. The wipers may also operate when exhaust gas or moisture affects the rain sensor.
- Do not touch or cover the windscreen where the rain sensor is located. The wipers may operate unexpectedly when the wiper switch is in the <AUTO> position and the power switch is ON. This can cause an injury or may damage a wiper.

REAR WINDOW

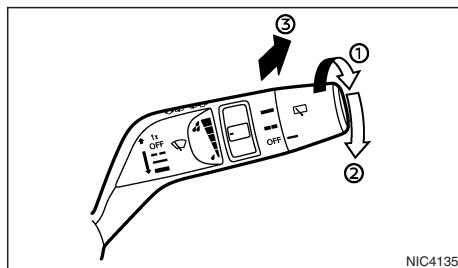

⚠ WARNING

In freezing temperatures the washer solution may freeze on the rear window and obscure your vision. Warm the rear window with the rear window defogger before using the rear wipers.

CAUTION

- Do not operate the washer continuously for more than 15 seconds.
- Do not operate the washer if the reservoir tank is empty or frozen.

The rear window wiper and washer operates when the power switch is ON.

Wiper operation

Turn the switch clockwise to the intermittent (■, ①) position or continuous (■, ②) position for wiper operation.

To stop the wiper operation, turn the switch back to the OFF position.

Washer operation:

To operate the washer, push the lever towards the front of the vehicle ③ until the desired amount of washer fluid is spread on the rear window. The wiper will automatically operate several times.

Wiper drip wipe system (where fitted):

The wiper will also operate once about 3 seconds after using the washer. This operation is to wipe washer fluid that has dripped on the windscreen.

The mode can be turned off. For details, see "Vehicle information display" earlier in this section.

THERMACLEAR HEATED WINDSCREEN (where fitted)

Reverse synchronisation function (where fitted)

When the windscreen wiper switch is in either the intermittent or <AUTO> (where fitted), low or high speed position, shifting to the R (Reverse) position will operate the rear window wiper.

The mode can be turned off. For details, see "Vehicle information display" earlier in this section.

NOTE

In the <AUTO> position (where fitted), the rear wiper will not begin to sweep when the vehicle is shifted to the R (Reverse) position. It waits until the front wipers have made the first sweep.

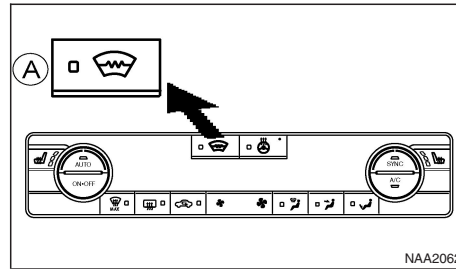

Automatic air conditioning system

A ThermoClear Heated Windscreen On/Off

To defog/defrost the windscreen glass, start the e-POWER system and push the ThermoClear button A. The indicator light will come on. Push the button again to turn the ThermoClear system off.

If the ambient temperature is lower than +5°C, the ThermoClear system will turn off automatically after approximately 8 minutes. If the ambient temperature is higher than +5°C, it will turn off after approximately 4 minutes. If the windscreen clears before this time, push the button again to turn the ThermoClear system off.

NOTE

- Switch position (where fitted) may vary slightly from the illustrations above depending on vehicle specification.
- The ThermoClear system can only be activated while the e-POWER system is running.

- Before activating the ThermoClear system make sure to remove excess snow/ice from the windscreen
- Electrical conductors embedded in the windscreen provide the heating of the windscreen. If damage occurs to the windscreen have the ThermoClear system checked by a NISSAN dealer or qualified workshop.
- Reduced performance or deactivation of the ThermoClear Heated Windscreen may be noticed to preserve the battery. This is not a malfunction.
- NISSAN recommends using the ThermoClear system to support defogging of the windscreen. For more information, see "Heater and air conditioner" in the "4. Display screen, heater and air conditioner, and audio system" section.

DEFOGGER SWITCH

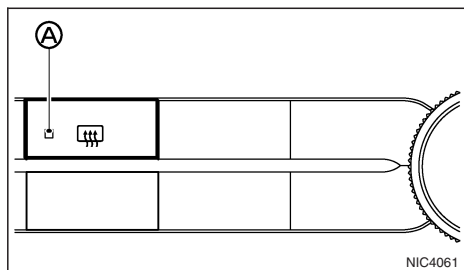

Type A

NIC4061

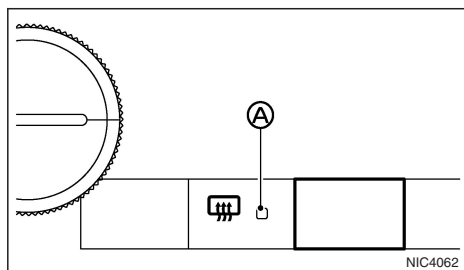

Type B

NIC4062

The rear window defogger switch will only operate when the e-POWER system is running.

The defogger is used to reduce the moisture, fog or frost on the rear window surface and outside door mirror surface (where fitted) to improve the rear view.

When the defogger switch is pushed, the indicator light **A** illuminates and the defogger operates for approximately 20 minutes. After the preset time has passed, the defogger will turn off automatically.

To turn off the defogger manually, push the defogger switch again.

CAUTION

When cleaning the inner side of the window, be careful not to scratch or damage the electrical conductors on the surface of the window.

HEADLIGHT AND TURN SIGNAL SWITCH

NISSAN recommends you to consult the local regulations concerning the use of lights.

HEADLIGHT SWITCH

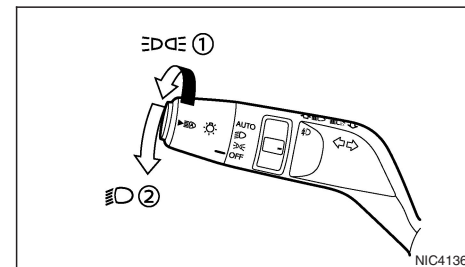

Type A

NIC4136

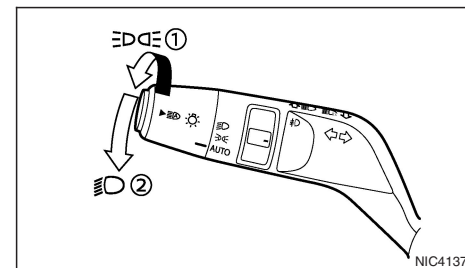

Type B

NIC4137

Lighting

Turn the switch to the  position ①:

The front side, tail, number plate and instrument lights will come on. The indicator light  in the instrument panel will come on. The daytime running lights will turn off.

Turn the switch to the  position ②:



The headlights will come on and all the other lights remain on. The daytime running lights will turn off.

CAUTION

Never leave the light switch on for extended periods of time while the e-POWER system is not running.

Daytime light system (where fitted)

The front daytime running lights will come on when the e-POWER system is running.

When the light switch is turned to the  or  position, the daytime running lights will turn off.

Autolight system (<AUTO> – where fitted)

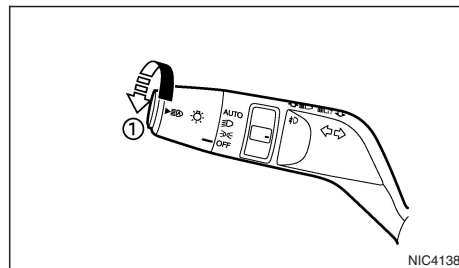

Type A

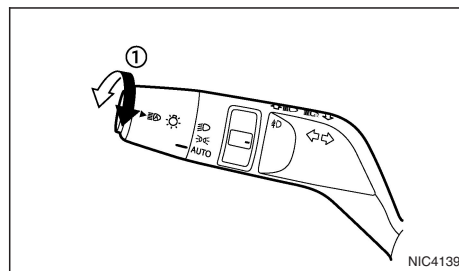

Type B

The autolight system allows the headlights to be set so they turn on and off automatically. When active, the autolight system will:

- Turn on the headlights, front side, tail, number plate and instrument panel lights automatically when it gets dark.
- Turn off all the lights when it gets light.

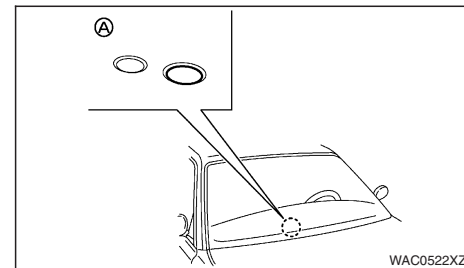



NOTE

Be sure not to put anything on top of the photo sensor **A** located on the top of the instrument panel. The photo sensor controls the autolight system; if it is covered, the photo sensor reacts as if it is dark and the headlights will illuminate.

To activate the autolight system:



1. Turn the headlight switch to the <AUTO> position ①
2. Switch the power switch **ON**.

To disable the autolight system:

Turn the switch to the , or  position.

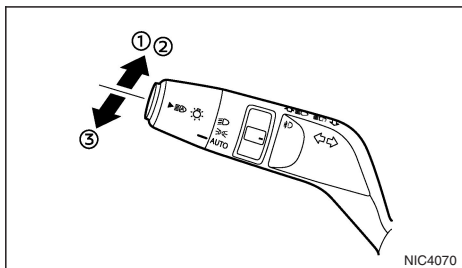
High beam select



- 1 To select the high beam when in the  position, push the lever forward. The high beam lights come on and the  indicator light illuminates.
- 2 Push the lever forwards again to select the low beam ( position).
- 3 Pulling the lever towards you will flash the headlight high beam.

DYNAMIC HIGH BEAM ASSISTANT (where fitted)

A camera-controlled high beam assistant which changes from low beam to high beam automatically.

Precautions:

WARNING

The dynamic high beam assistant cannot compensate for road and weather circumstances while driving. The system saves the driver from having to operate the switch. The driver always remains responsible for choosing the correct light setting.

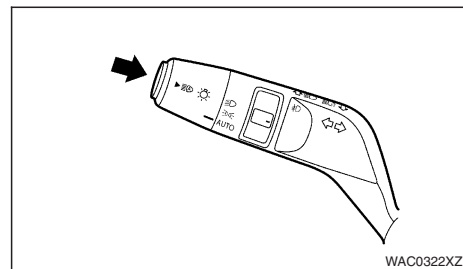

Specific situations in which to operate the headlight switch manually:

- In heavy rain, snowy conditions. (general poor visibility and bad weather conditions).
- When the vehicle sensors are dirty, covered or broken.
- When oncoming or preceding vehicle lights are obscured, for example by a solid barrier.





Dynamic high beam assistant activation:

To activate the high beam assist system, push the switch as illustrated when it is in the AUTO position. The high beam assist indicator light  in the instrument panel will illuminate. The system operates as follows:



- High beam comes on automatically in dark conditions:
If the vehicle speed is over 40 km/h (25 MPH) and no other road users are recognised. The  high beam light (blue) comes on additionally.
- High beam turns off automatically:
If the vehicle speed drops below 30 km/h (18 MPH) or other road users are detected. The  High beam light (blue) turns off.

NOTE

If the dynamic high beam assistant cannot function (for example: up to 15 seconds after start up, snow covering front camera or similar) the headlights will operate at night in low beam until the

system can activate. At all times, the status of the dynamic high beam assistant status system is shown by the indicator lights in the instrument panel. Full dynamic high beam assistant operation is shown by the  indicator light. If the system cannot function, only the  dipped beam indicator light is illuminated.

To disable the dynamic high beam assistant:

To turn the dynamic high beam assistant off, push the switch again, or turn the headlight switch to the , or  position.

ADAPTIVE DRIVING BEAM (where fitted)

A camera-controlled system which automatically maximises night time forward visibility, while preventing bright light from shining directly at oncoming traffic and blinding drivers of oncoming vehicles.

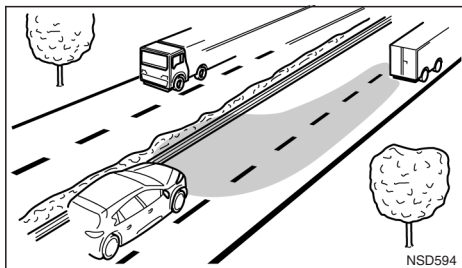

Adaptive Driving Beam

Precautions:

WARNING

The Adaptive Driving Beam cannot compensate for road and weather circumstances while driving. The system. The driver always remains responsible for choosing the correct light setting. Specific situations in which to switch off the Adaptive Driving Beam:

- In heavy rain, snowy conditions. (general poor visibility and bad weather conditions).
- When the vehicle sensors are dirty, covered or broken.
- When oncoming or preceding vehicle lights are obscured, for example by a solid barrier.

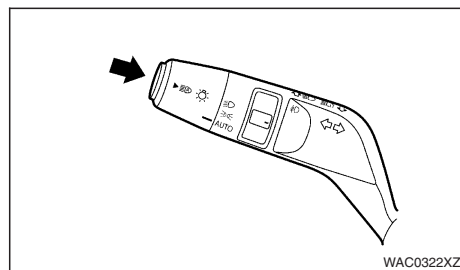

Adaptive Driving Beam activation:



To switch on the Adaptive Driving Beam system, push the switch as illustrated when it is in the AUTO position. The Adaptive Driving Beam indicator light  in the instrument panel will illuminate.

The system will now detect oncoming traffic and automatically adjust the beam of the headlights to avoid blinding drivers of oncoming vehicles. At the same time it will provide maximum illumination of the road ahead.



- Adaptive Driving Beam comes on automatically in dark conditions if the vehicle speed is over 40 km/h (25 MPH).
- Adaptive Driving Beam turns off automatically if the vehicle speed drops below 30 km/h (18 MPH).

The  light indicates that the Adaptive Driving Beam system is active.

NOTE

If the Adaptive Driving Beam is not active (for example: up to 15 seconds after start up, camera view blocked, speed below activation threshold, or in an area well lit by street lighting) the headlights will operate in low beam until the system can activate. The  indicator light remains illuminated to show that the system is switched on, but the  light remains off until the activation criteria are met.

To disable the Adaptive Driving Beam:

To turn the Adaptive Driving Beam off, push the switch again, or turn the headlight switch to the , or  position.

“Friendly Lighting”

The “Friendly Lighting” function is a convenience facility. It allows you to provide lighting from the vehicle after the power switch has been switched to OFF and the headlight switch is in the <AUTO> (where fitted) position. Pulling the headlight switch toward you once when the power switch is OFF will activate the headlight for approximately 30 seconds. After that period of time, it will automatically switch off.

It is possible to pull the headlight switch up to four times to increase the lighting period up to 2 minutes.

NOTE

The “Friendly Lighting” function can be cancelled by switching the power switch ON again.

Battery save function

The battery save feature prevents your vehicle from discharging the battery after you have left the external lights, map lights or room lights on when exiting the vehicle. This occurs when the power switch is switched to OFF after the e-POWER system has been running.

NOTE

The next time the e-POWER system is started the external lights, map lights or room light will come on again

Battery save function for external lights:

If the power switch is switched OFF after driving but the external lights are accidentally left on, the external lights will automatically be switched off as soon as the driver's door is opened.

It is possible to leave the external lights on permanently by switching them back on using the headlight switch while the power switch is still switched OFF. In this case, the light reminder chime will sound when the driver's door is opened.

Battery save function for interior light:

The interior light will automatically be switched off after a period of time if it has been accidentally left on.

TURN SIGNAL SWITCH

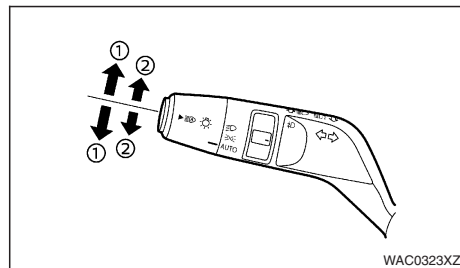

Direction indicator

Move the lever up or down ① to indicate right or left. When the turn is completed, the turn signal is automatically cancelled.

Lane change signal

Move the lever only part of the way up or down ② to signal a lane change (right or left). The indicator lights will flash three times before cancelling automatically.

FOG LIGHT SWITCH

FRONT FOG LIGHT (where fitted)

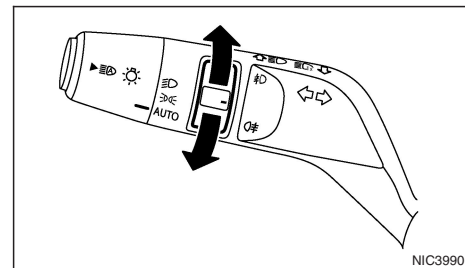

The front fog lights should only be used when visibility is seriously reduced – generally, to less than 100 m (328 ft).

The front fog lights can be operated in any headlight switch position (☀ or ☾ or <AUTO>), but will not operate if the headlight switch is in the <AUTO> position and low beam is not activated.

To turn the front fog lights on, turn the fog light switch to the ☾ position. The front fog lights and indicator light will come on. The fog light switch will return to the neutral position (—). For additional information, see “Warning lights, indicator lights and audible reminders” earlier in this section.

To turn the front fog lights off, turn the fog light switch to the ☾ position again. The front fog lights and indicator light will turn off. The fog light switch will return to the neutral position.

HEADLIGHT AIMING CONTROL

REAR FOG LIGHT (where fitted)

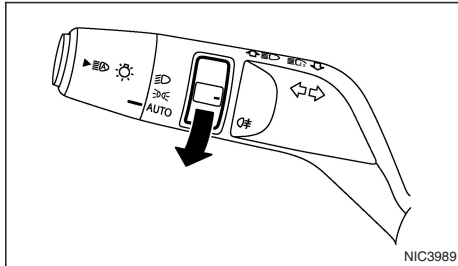

Type A: Rear fog light only

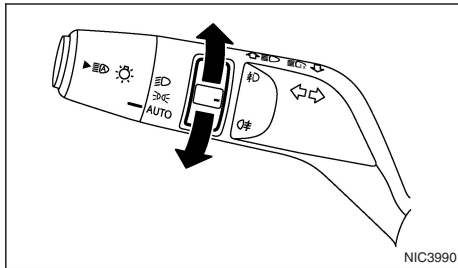

Type B: Front and rear fog lights

The rear fog light should only be used when visibility is seriously reduced – generally, to less than 100 m (328 ft).

The rear fog lights can be operated in any headlight switch position (☀️ or ☞ or <AUTO>), but will not operate if the headlight switch is in the <AUTO> position and low beam is not activated.

To turn the rear fog light on, turn the fog light switch to the ☞ position. The rear fog light and indicator light will come on. The fog light switch will return to the neutral position (—). For additional information, see “Warning lights, indicator lights and audible reminders” earlier in this section.

To turn the rear fog light off, turn the fog light switch to the ☞ position again.

HEADLIGHT AIMING CONTROL SWITCH (where fitted)

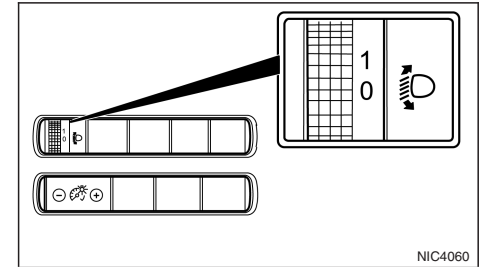

Left hand drive models

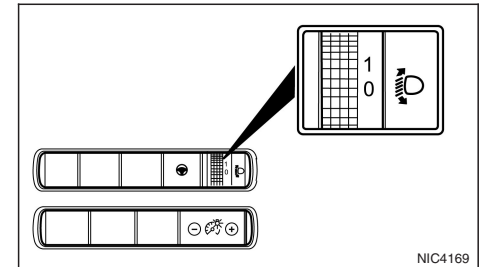

Right hand drive models

Depending on the number of occupants in the vehicle and the load it is carrying, the headlight aiming may be higher than desired. If the vehicle is travelling on a hilly road, the headlights may directly hit the rear-view mirror of the vehicle ahead or the windscreen of an oncoming vehicle. The headlight

HORN

aiming can be lowered using the switch located on the driver's side of the instrument panel, next to the steering wheel.

The higher the number designated on the switch, the lower the headlight aiming.

When travelling with no heavy load on a flat road, select position 0.

NISSAN recommends consulting local regulations on the use of lights.

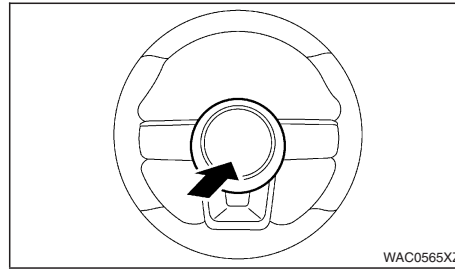

To sound the horn, push the centre pad area of the steering wheel.

HEATED STEERING WHEEL (where fitted)

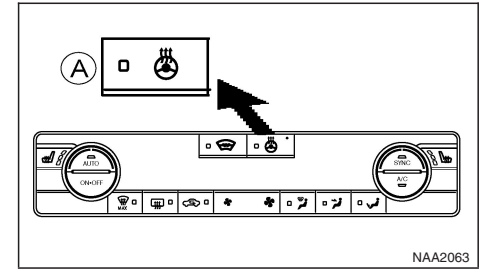

Front (where fitted)

Push the heated steering wheel switch **A** to warm the steering wheel after the e-POWER system starts. The indicator light on the switch will illuminate.

If the surface temperature of the steering wheel is below 30°C (86°F), the system will heat the steering wheel and cycle off and on to maintain a temperature between 25 and 45°C (77 to 113°F) dependent on cabin temperature. The indicator light will remain on as long as the system is on.

The heated steering wheel system is automatically turned off after 30 minutes. Push the switch again to turn the heated steering wheel system off manually. The indicator light will turn off.

SEAT HEATING (where fitted)

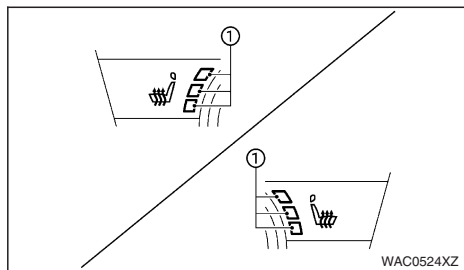

Front (where fitted)

The front seats can be warmed by built-in heaters. The switches are located on the heater and air conditioning unit and can be operated independently of each other.

1. Start the e-POWER system.
2. Select heat range.
 - For high heat, push the button once (three indicator lights ① will illuminate).
 - For medium heat, push the switch twice (two indicator lights ① will illuminate).
 - For low heat, push the button again (one indicator light ① will illuminate).
3. To turn off the heater, push the button again. Make sure the indicator lights turn off.

The heater is controlled by a thermostat, automatically turning the heater on and off. The indicator light will remain on as long as the switch is on.

NOTE

Switching the e-POWER system off resets the seat heater to the off position.

CAUTION

- The battery could run down if the seat heater is operated while the e-POWER system is not running.
- Do not use the seat heater for extended periods or when no one is using the seat.
- Do not put anything on the seat which insulates heat, such as a blanket, cushion, non-genuine seat cover, etc. Otherwise, the seat may become overheated.
- Do not place anything hard or heavy on the seat or pierce it with a pin or similar object. This may result in damage to the seat heater.
- Any liquid spilled on the heated seat should be removed immediately with a dry cloth.
- When cleaning the seat, never use petrol, thinner, or any similar materials.
- If any malfunctions are found or the heated seat does not operate, turn the switch off and have the system checked by a NISSAN dealer or qualified workshop.

POWER OUTLETS

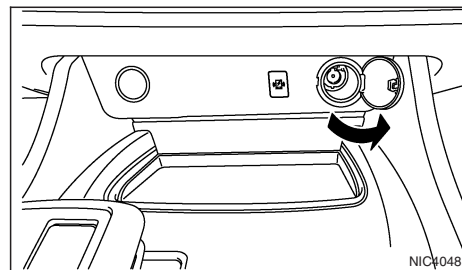

Instrument Panel

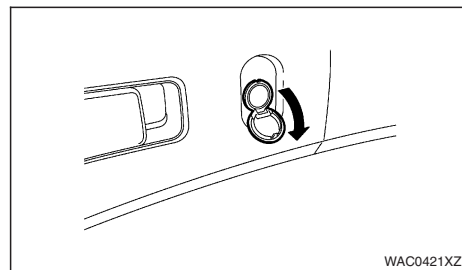

Luggage area

12V power outlets are located in the lower part of the instrument panel and in the luggage area.

⚠ WARNING

Take care as the power outlet and plug may be hot during or immediately after use.

CAUTION

- This power outlet is not designed for use with a cigarette lighter unit.
- Do not use with accessories that exceed a 12 volt, 120 W (10 A) power draw. Do not use double adaptors or more than one electrical accessory.
- Use this power outlet with the e-POWER system running (do not use for extended periods of time with the e-POWER system stopped).
- When not in use, be sure that the cap is closed. Do not allow water to come into contact with the outlet.
- Before inserting or disconnecting a plug, be sure to turn off the power switch of the electrical accessory being used or switch the e-POWER system power switch OFF to turn the power of the vehicle off.
- Fully push the plug in sufficiently. If sufficient contact is not made, the plug may overheat or the internal temperature fuse may blow.

USB (UNIVERSAL SERIAL BUS) REAR POWER PORTS (WHERE FITTED)

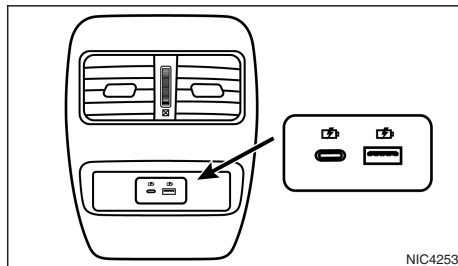

Two USB power ports (where fitted) are provided on the rear of the console box/armrest unit.

These ports are for power supply only. They do not support data transfer.

The maximum output current for each port is 2.4A. Please note that actual output current will depend on the device connected to the port(s). The charger will provide the appropriate current value to the device connected based on the protocol used by the mobile device.

The external device will be charged continuously while the vehicle power switch is ON.

Some mobile devices cannot be charged depending on their specifications.

NOTE

There are two USB data connection ports (where fitted) in the console box. See “USB (Universal Serial Bus) connection ports” in the “4. Display

screen, heater and air conditioner, and audio system” section.

CAUTION

- Do not force a USB device into the connector. Inserting the USB device tilted or upside-down into the connector may damage the connector. Make sure that the USB device is connected correctly into the connector.
- Do not use a reversible USB cable. Using the reversible USB cable may damage the connector.

WIRELESS CHARGER (WHERE FITTED)

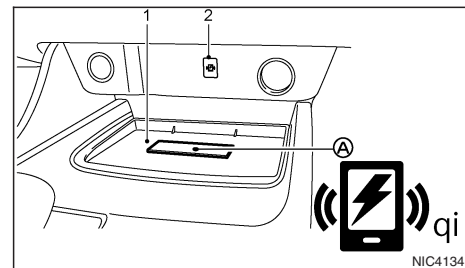

1 Charging pad

2 Indicator

Ⓐ <QI> logo

The wireless charger is located on the front of the centre console. Lay the smartphone on the <QI> logo Ⓐ on the charging pad of the wireless charger.

Charging will start automatically. The smartphone will be charged continuously while the vehicle power switch is ON.

WARNING

- **Never put metallic materials between the wireless charger and a smartphone.**
- **Those who use a pacemaker or other medical equipment should contact the electric medical equipment manufacturer for the possible influences before use.**
- **Never put cloth over the smartphone during charging process.**
- **Never charge a smartphone when it is wet.**
- **Never put metallic materials or small goods such as a cigarette lighter, Intelligent Key or memory drive on the charging pad.**

CAUTION

- **Do not put an RFID/NFC/credit card between the wireless charger and a smartphone. This could cause data corruption in the card.**
- **Do not use the wireless charger with dust accumulated or dirt on the pad.**
- **Do not hit the surface of the wireless charger.**
- **Do not spill liquid (water, drinks, etc.) on the charging pad.**
- **Do not use grease, oil or alcohol for cleaning charging pad.**
- **Do not remove rubber mat (including non wireless charger mat).**

Wireless charger Indicator

The indicator  will illuminate in orange when the charging process is started.

When the charging has completed, the indicator illuminates in green (not applicable to all wireless charge devices).

If a malfunction occurs or the charging process has stopped, the indicator will blink in orange for 8 seconds then turn off.

Operation of the wireless charger

To use the wireless charger, it is necessary to seat the smartphone well within the charging pad. To maximise charging performance, ensure the smartphone is fully seated on the centre of the charging pad over the <Qi> logo . Because the location of the power receiver may vary depending on the smartphone, you will need to try and find the area that suits your smartphone.

Because some smartphone cases or accessories may adversely affect charging, remove them before wireless charging.

Turn off the vibration function of the smartphone before wireless charging.

NOTE

- **Only a <Qi> certified smartphone can be used.**
- **The smartphone may become warm during the charging process and the charging may be stopped by the protection function of the wireless charger. The indicator will blink in orange then turn off. This is not a malfunction. If**

this occurs, remove the smartphone from the wireless charging pad and let it cool down before putting it back on the charging pad.

- **The wireless charging process may be stopped by the status of the smartphone (battery temperature, etc.).**
- **If a radio noise interference occurs during charging process, put the smartphone onto the centre (<Qi> logo) position of the wireless charger.**
- **The wireless charging process will stop during process of searching the Intelligent Key.**
- **The wireless charging process will not be started when a USB (Universal Serial Bus) cable is connected to the smartphone. The indicator may illuminate in orange or blink if the smartphone is put on the wireless charger with a USB cable connected. However, charging is not performed.**
- **Depending on the type of the smartphone, the indicator may remain illuminated in orange even when the charging process has been completed.**

STORAGE

STORAGE TRAYS

⚠ WARNING

To help prevent injury in an accident or sudden stop, do not place sharp objects in the trays.

GLOVE BOX

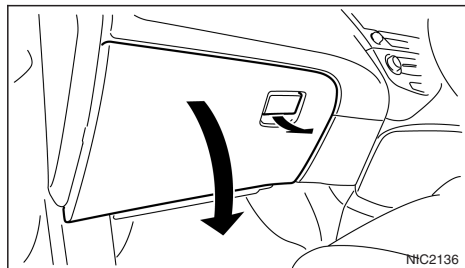

⚠ WARNING

Keep the glove box lid closed while driving to help prevent injury in an accident or a sudden stop.

To open the glove box, lift the latch and lower the lid.

SUNGLASSES HOLDER (where fitted)

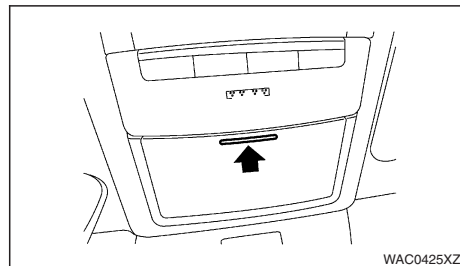

⚠ WARNING

Keep the sunglasses holder closed while driving to avoid obstructing the driver's view and to help prevent an accident.

CAUTION

Do not use for anything other than sunglasses.

To open the sunglasses holder, push and release. Only store one pair of sunglasses in the holder.

CONSOLE BOX

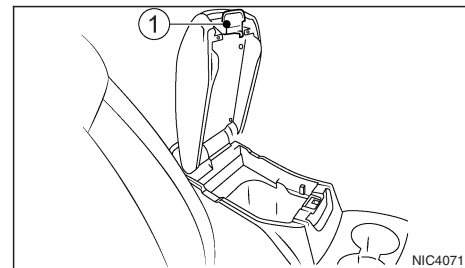

Type A

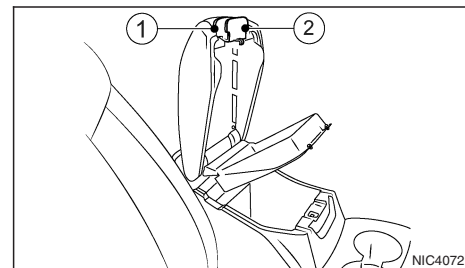

Type B

⚠ WARNING

The centre console box should not be used while driving so that full attention may be given to vehicle operation.

Type A:

To open the console box lid, pull the lever ① and pull up the lid.

To close, push the lid down until the lock latches.

Type B:

To open the console box lid, lift the lever ① or ② and pull up the lid.

When the upper lever ① is lifted, the upper case is available for storing small items. When the lower lever ② is lifted, the bottom case is available for storing larger items.

To close, push the lid down until the lock latches.

CUP HOLDERS

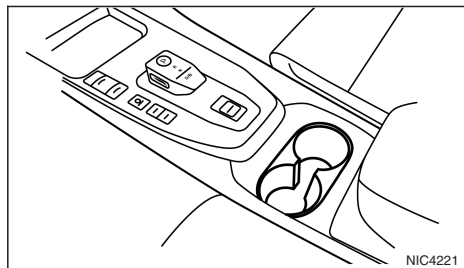

⚠ WARNING

Cup holders should not be used while driving so that full attention may be given to vehicle operation.

To access the rear cup holders (where fitted), lower the centre armrest.

CAUTION

- Avoid abrupt starting and braking when the cup holder is being used to prevent spillage. If the liquid is hot, it can scald you or your passenger.
- Use only soft cups in the cup holder. Hard objects can injure you in an accident.

BOTTLE HOLDER

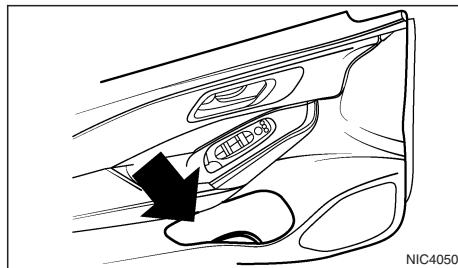

Front door

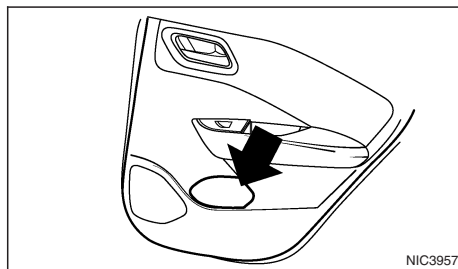

Rear door

CAUTION

- Do not use the bottle holder for any other objects that could be thrown about in the vehicle and possibly injure people during sudden braking or an accident.
- Do not use the bottle holder for open liquid containers.

COAT HOOKS (where fitted)

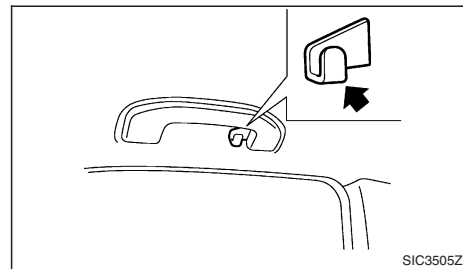

CAUTION

Do not apply a load of more than 1 kg (2 lb) to the hook.

The coat hooks are fitted at the rear assist grips.

MAP POCKET (where fitted)

Map pockets are located in the doors.

SEAT POCKET (where fitted)

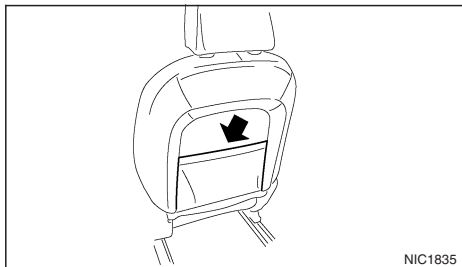

NIC1835

Seat pocket (where fitted)

A seat pocket (where fitted) is located on the back of the driver and/or passenger seat.

ROOF RAIL (where fitted)

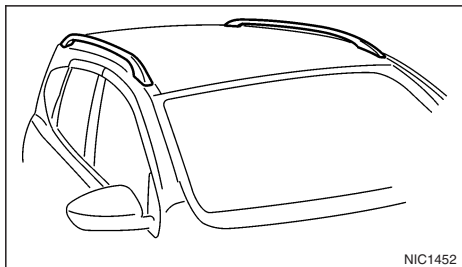

NIC1452

Luggage can be carried on the roof by securing crossbars to the roof rail. Follow all crossbar manufacturer's instructions for installing and use of the crossbars. The roof rail is designed to carry loads (luggage plus crossbars) below 75 kg (165 lb). Overloading may cause damage to the vehicle.

WARNING

- Always install the cross bars onto the roof side rails before loading cargo of any kind. Loading cargo directly onto the roof side rails or the vehicle's roof may cause vehicle damage.
- Drive extra carefully when the vehicle is loaded at or near the cargo carrying capacity, especially if the significant portion of that load is carried on the cross bars/roof rack.
- Do not exceed the maximum gross vehicle weight. This is the combined weight of the vehicle, driver, passengers, cargo, and load on the towing coupling device (where fitted). You can find the maximum gross vehicle weight on the vehicle identification label (see "Vehicle identification label" in the "9. Technical information" section).
- Heavy loading of the cross bars/roof rack has the potential to affect the vehicle stability and handling during sudden or unusual handling manoeuvres.
- Roof rack load should be evenly distributed.
- Do not exceed maximum roof rack cross bar load capacity.
- Properly secure all cargo with ropes or straps to help prevent it from sliding or shifting. In a sudden stop or collision, unsecured cargo could cause personal injury.

CAUTION

Use care when placing or removing items from the roof rack. If you cannot comfortably lift the items onto the roof rack from the ground, use a ladder or stool.

PARCEL SHELF

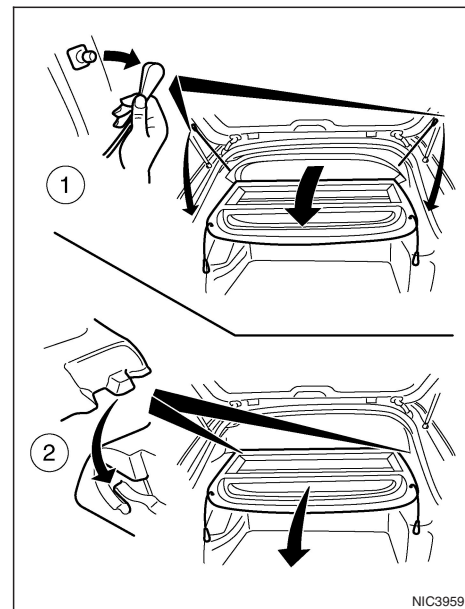

NIC3959

⚠ WARNING

- Never put anything on the parcel shelf, no matter how small. Any object on it could cause an injury in case of an accident or if the brakes are applied suddenly.
- Do not leave the parcel shelf in position when it is disengaged from the grooves.
- Properly secure all cargo to help prevent it from sliding or shifting. Do not place cargo higher than the seatbacks. In a sudden stop or collision, unsecured cargo could cause personal injury.
- Properly secure cargo and do not allow it to contact the top tether strap when it is attached to the top tether anchor. Cargo that is not properly secured or cargo that contacts the top tether strap may damage the top tether strap during a collision. If the cargo cover contacts the top tether strap when it is attached to the top tether anchor, remove the cargo cover from the vehicle or store it in its storage space. If the cargo cover is not removed, it may damage the top tether strap during a collision. Your child could be seriously injured or killed in a collision if the child restraint top tether strap is damaged.

Removal

1. Open the tailgate (see "Tailgate" in the "3. Pre-driving checks and adjustments" section).
2. Detach both of the ropes (left and right) ① from the inside of the tailgate.

3. Detach the parcel shelf by simply pulling it rearwards ② through the tailgate opening.

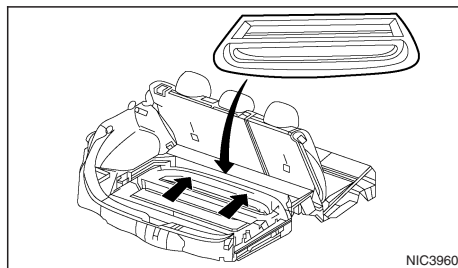

CAUTION

Make sure the parcel shelf is carefully stored when not in use in order to prevent any damage.

NOTE

The parcel shelf can be securely stored under the luggage compartment floor boards (for vehicles without a full size spare wheel).

Installation

1. Open the tailgate.
2. Insert the parcel shelf by pushing it forwards as far as possible through the tailgate opening.
3. Attach the corresponding ropes to each side ① of the tailgate.
4. Close the tailgate (see "Tailgate" in the "3. Pre-driving checks and adjustments" section).

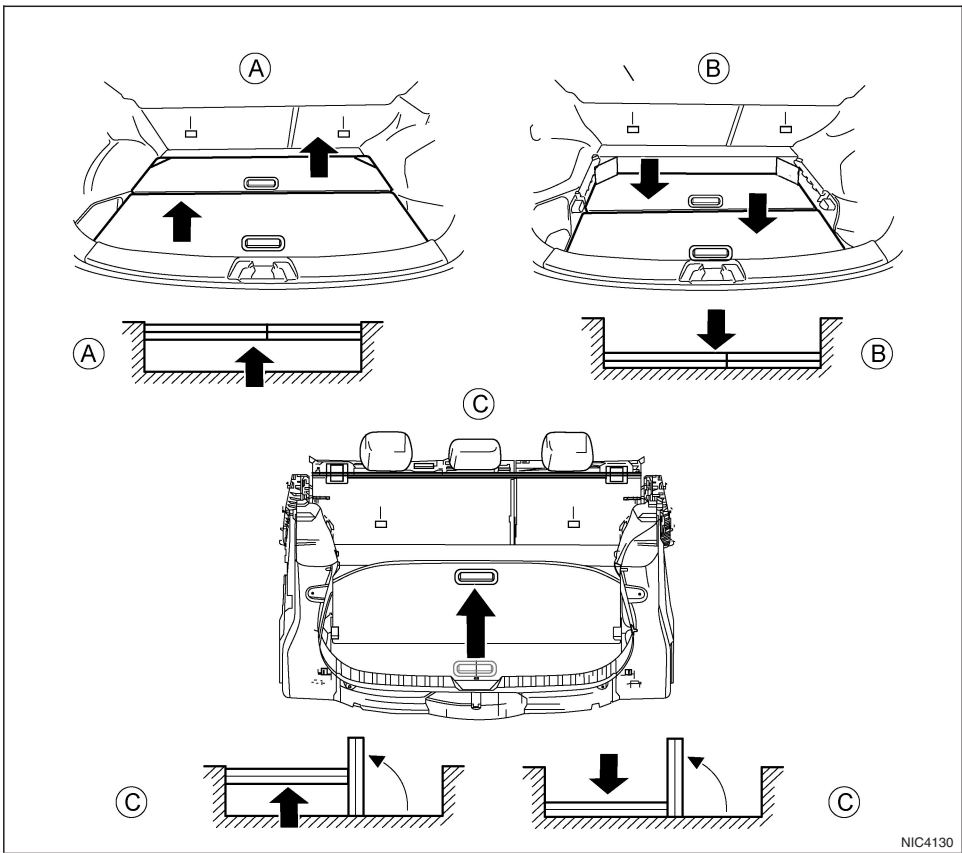

LUGGAGE COMPARTMENT/BOOT FLOOR (where fitted)

⚠ WARNING

- Properly secure all cargo with ropes or straps to help prevent it from sliding or shifting. Do not place cargo higher than the seatbacks. In a sudden stop or collision, unsecured cargo could cause personal injury.
- Do not put objects heavier than 50 kg (110 lb) on the load floor.
- Never allow anyone to ride in the luggage area. It is extremely dangerous to ride in a luggage area inside of a vehicle. In a collision, people riding in these areas are more likely to be seriously injured or killed.
- Only two anchorage points identified by the top tether labels can be used for top tether strap anchorage. Under no circumstances should the luggage hooks be used for top tether strap anchorage.

The luggage (cargo) compartment or boot floor has a dual surface (wet and dry), or dual position system with loose floorboards that allow different luggage compartment arrangements.

CAUTION

- The carpet finish should face up for all dry use applications.
- The smooth surface should be used only when loading wet objects.

NIC4130

- The load should be distributed evenly and should not exceed 50 kg (110 lb) on any of the boards/panels.
- To avoid any damage, the panels/boards should be placed in the lower position (B) for heavy loads and securely held with ropes or straps to prevent any load shift.

Upper position (A)

This position provides a flat load floor when the rear seat backs are folded forward. It also serves as a concealed load area for objects placed below the boards.

NOTE

The parcel shelf can be securely stored under the luggage compartment floor boards.

Move the boards as illustrated by lifting and sliding each board into the upper position (A).

- 1) Remove the larger floorboard as illustrated by lifting and sliding it into the upper position (A).
- 2) Repeat the operation with the smaller board.

Lower position (B)

This position maximises the load space in the luggage compartment.

Move both boards as illustrated by lifting and sliding each board into the lower position (B).

Vertical positions (C)

These positions provide further subdivisions of the luggage space by standing either one of the boards vertically in the midway slots provided in the side trim.

Moving the rear board

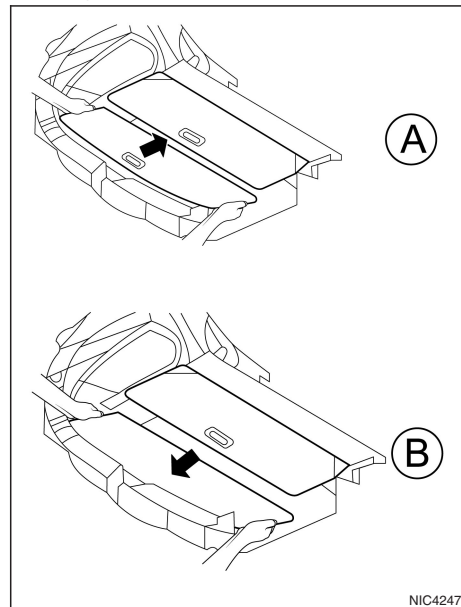

Before the rear board can be moved to the upper or lower position, it must first be slid forward towards the lower front area while holding the sides of the board (A).

Then slide it backwards to the lower or upper position (B).

LUGGAGE HOOKS (where fitted)

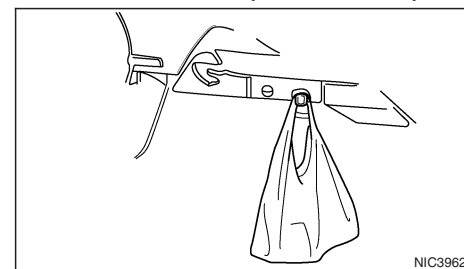

The luggage hooks are for shopping bags, etc.

⚠ WARNING

- Do not apply a total load of more than 3 kg (7 lb) to the hook.

WINDOWS

POWER WINDOWS

The power window switches are located on the door panels.

⚠ WARNING

- Make sure that all passengers have their hands, etc. inside the vehicle before operating the power windows. Use the window lock switch to prevent unexpected use of the power windows.
- To help avoid risk of injury or death through unintended operation of the vehicle and/or its systems, do not leave children, people who require the assistance of others or pets unattended in your vehicle. Additionally, the temperature inside a closed vehicle on a warm day can quickly become high enough to cause a significant risk of injury or death to people and pets.
- It is recommended to instruct all occupants in the safe operation of power windows with particular emphasis given to the safety and supervision of children.

The power windows operate when the e-POWER system power switch is **ON** or for approximately 45 seconds after the e-POWER system power switch is switched **OFF**. If the driver's or front passenger's door is opened during this period of approximately 45 seconds, power to the windows is cancelled.

To open a window, push down the power window switch.

To close a window, pull up the power window switch.

Driver's side main window switch

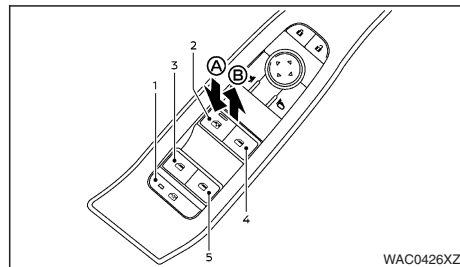

1. Window lock button
2. Driver side window
3. Rear left passenger side window
4. Front passenger side window
5. Rear right passenger side window

To open or close the window, push down Ⓐ or pull up Ⓑ the switch and hold it. The main switch (driver side switches) will open or close all the windows.

Locking rear passenger windows:

When the window lock button is pushed (the indicator illuminates), the rear passenger windows cannot be operated with the rear passenger power window switches. The rear passenger windows can only be operated with the main switch (driver side switches). To cancel the rear passenger windows lock, push the window lock button again.

Passenger's window switch

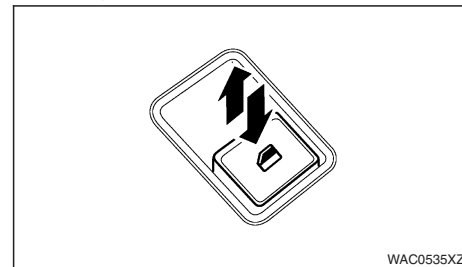

The passenger's switch can control its corresponding window. When the window lock button on the driver's switch is pushed, rear passenger's switches cannot be operated, but the front passenger's switch can still be operated.

Automatic function

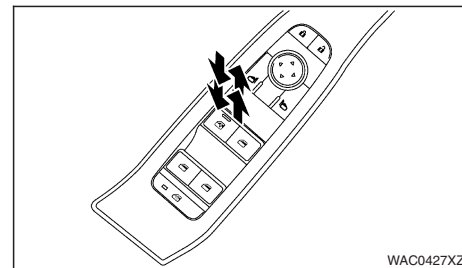

The automatic function enables a window to fully open or close without holding the switch down or up.

To fully open the window, push the power window switch down to the second detent and release the switch. To fully close the window, pull the power window switch up to the second detent and release the switch. The switch does not have to be held during window operation.

To stop the window open/close operation during the automatic function, push down or pull up the switch in opposite direction.

Window timer:

The window timer allows the window switch to be operated for approximately 45 seconds even if the e-POWER system power switch is switched **OFF**. The window timer will be cancelled when the driver's or front passenger's door is opened or the preset time has expired.

Auto-reverse function:

WARNING

There is a small distance just before the closed position which cannot be detected. Make sure that all passengers have their hands, etc. inside the vehicle before closing the windows.

The auto-reverse function enables a window to automatically reverse when something is caught in the window as it is closing. When the control unit detects an obstacle, the window will be lowered immediately.

Depending on the environment or driving conditions, the auto-reverse function may activate if an impact or load similar to something being caught in the window occurs.

Operating windows with Intelligent Key

The windows can be opened or closed (where fitted) by pushing the LOCK or UNLOCK button on the key. This function will not operate while the window timer is activated or when the windows need to be initialised. For details about the key button usage, see "Remote keyless entry system (where fitted)" in the "3. Pre-driving checks and adjustments" section.

Opening:

To open the windows, push the UNLOCK  button on the key for about 3 seconds after the door is unlocked.

To stop opening, release the UNLOCK  button.

If the window open operation is stopped on the way while pushing the UNLOCK  button, release and push the button again until the windows open completely.

Closing:

To close the windows, push the LOCK  button on the Intelligent Key for about 3 seconds after the door is locked.

To stop closing, release the LOCK  button.

If the window close operation is stopped on the way while pushing the LOCK  button, release and push the button again until the windows close completely.

If the windows do not close automatically

If the power window automatic function (closing only) does not operate properly, perform the following procedure to initialise the power window system.

1. Switch the e-POWER system power switch **ON**.
2. Close the door.
3. Open the window completely by operating the power window switch.
4. Pull the power window switch and hold it to close the window, and then hold the switch more than 3 seconds after the window is closed completely.
5. Release the power window switch. Push the power window switch down and hold it until the window is fully open.
6. Operate the window by the automatic function to confirm the initialisation is complete.
7. Perform steps 2 through 6 above for other windows.

If the power window automatic function does not operate properly after performing the procedure above, have your vehicle checked by a NISSAN dealer or qualified workshop.

FIXED GLASS ROOF (where fitted)

CAUTION

- Do not place heavy objects on the glass roof or surrounding area.
- Do not hang from the sunshade or hang any objects from it. It may cause damage or deformation to the sunshade.
- Close the sunshade when you leave the vehicle for extended periods of time to prevent the inside of the vehicle from reaching high temperatures.

SUNSHADE OPERATION

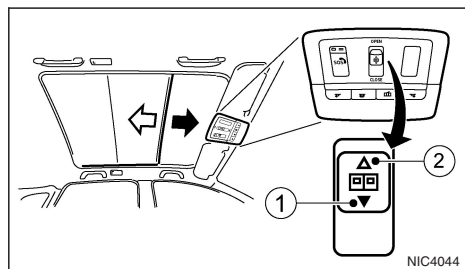

- ① Close sunshade
- ② Open sunshade

The sunshade operates only when the e-POWER power switch is **ON**.

⚠ WARNING

Never allow hands or fingers, or any part of your body within operating range of the sunshade. You could be injured.

Opening and closing

Manual control:

To close the sunshade, press and hold the CLOSE side of the switch ①. To stop the sunshade from closing fully, release the switch.

To open the sunshade press and hold the OPEN side of the switch ②. To stop the sunshade from opening fully, release the switch.

Automatic operation:

To fully open or close the sunshade automatically, press briefly on the open or close side of the switch and then release. To stop the sunshade from opening or closing, press either side of the switch.

Auto-reverse function:

When the control unit detects something caught in the sunshade, the sunshade will open automatically.

NOTE

The auto-reverse function remains active whether the sunshade is being closed manually or automatically.

If the sunshade does not operate

Due to electrical or mechanical issues, the sunshade could require initialisation to return it to normal working order.

Initialisation of the sunshade:

If the sunshade is not functional at all (no movement is possible) implement the following initialisation procedure:

1. Switch power switch ON.
2. Irrespective of sunshade position, press and hold the CLOSE side of the switch ①. After 5 seconds a step-by-step closing movement starts until the front of the sunshade makes contact with the frame.
3. Release the button when the movement has stopped.

At this point the sunshade should be fully functional.

Re-initialisation of the sunshade:

If the sunshade is partially closed, but movement is still possible, implement the following re-initialisation procedure:

1. Switch power switch ON.
2. Press and hold the CLOSE side of the switch ① and close the sunshade as far as possible.
3. Release the button when the movement has stopped.

INTERIOR LIGHTS

4. Press and hold the CLOSE side of the switch ① again. After 5 seconds a step-by-step closing movement starts until the front of the sunshade makes contact with the frame.
5. Release the button when the movement has stopped.

At this point the sunshade should be fully functional.

Anti-pinch (auto-reverse) learning of the sunshade:

After the initialisation or re-initialisation procedure, it is recommended to perform the anti-pinch learning procedure.

Within 5 seconds of completing the initialisation or re-initialisation procedure described above:

1. Press and hold the CLOSE side of the switch ①. A complete continuous opening movement followed by a complete continuous closing movement will occur.
2. Release the button when the movement has stopped.

CAUTION

- To prevent the battery from being discharged, do not leave the light switch on when the e-POWER system is not running for extended periods of time.
- Turn off the lights when you leave the vehicle.

INTERIOR LIGHT SWITCH

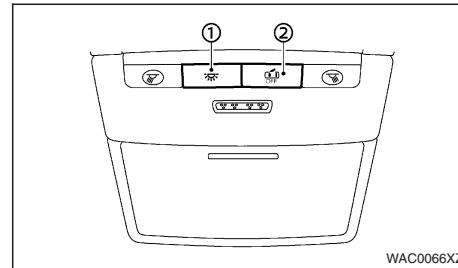

- ① The interior light can be turned ON regardless of door position. The light will go off after a period of time unless the power switch is ON when any door is opened.
- ② The interior lights can be set to operate when the doors are opened. To turn off the interior lights when a door is open, push the switch, the interior lights will not illuminate, regardless of door position. The lights will go off when the power switch is switched ON, or the driver's door is closed and locked.

MAP LIGHTS

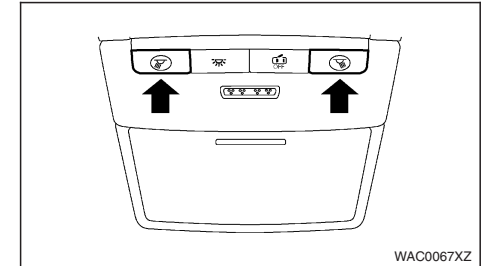

Push the button to turn the map lights on. To turn them off, push the button again.

The lights will also turn off after a period of time when the lights remain illuminated to prevent the battery from becoming discharged.

ROOM LIGHTS (WHERE FITTED)

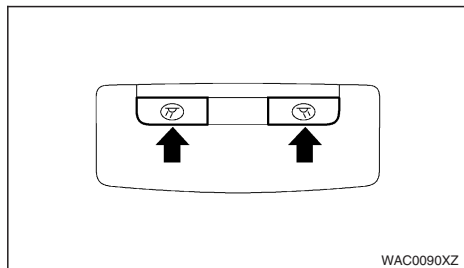

Push the button to turn the room lights on. To turn them off, push the button again.

The lights will also turn off after a period of time when the lights remain illuminated to prevent the battery from becoming discharged.

REAR PERSONAL LIGHTS (WHERE FITTED)

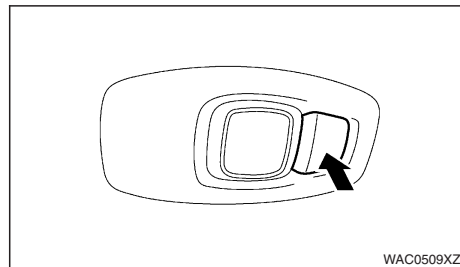

To turn the rear personal lights on, push the button. To turn them off, push the button again.

The lights will also turn off after a period of time when the lights remain illuminated to prevent the battery from becoming discharged.

VANITY MIRROR LIGHT

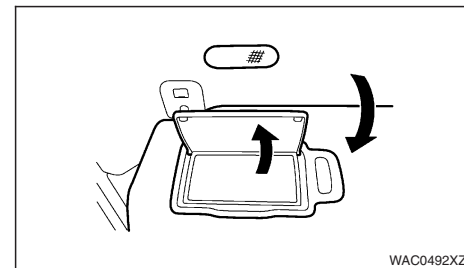

The light over the vanity mirror will turn on when the cover on the vanity mirror is opened.

When the cover is closed, the light will turn off.

The lights will also turn off after a period of time when the lights remain illuminated to prevent the battery from becoming discharged.

LUGGAGE COMPARTMENT LIGHT

The light comes on automatically when the tailgate is opened. When the tailgate is closed, the light goes off.

3 Pre-driving checks and adjustments

Keys	152	Garage mode system (where fitted).....	167
NISSAN Anti-Theft System (NATS)* key.....	152	Auto closure (where fitted).....	168
Intelligent Key (where fitted).....	152	Tailgate release lever	168
Key number.....	153	Security system.....	168
New keys.....	153	Alarm system (where fitted).....	168
Emergency/mechanical key	153	NISSAN Anti-Theft System (NATS) (where fitted).....	169
Remote opening or closing windows	153	Bonnet.....	170
Remote keyless entry system (where fitted).....	154	Fuel-filler lid	170
Using the remote keyless entry system.....	155	Opening the fuel-filler lid.....	171
Key operation failure	155	How to refuel.....	171
Intelligent Key system (where fitted).....	156	When refuelling from a portable fuel container	172
Intelligent Key operating range	157	Electric Parking Brake.....	173
Using Intelligent Key system.....	157	Driving away when towing a trailer.....	174
Door locks/unlocks precaution	157	Automatic brake hold.....	174
Doors locking/unlocking	158	How to activate/deactivate Automatic brake	
Starting the vehicle with the Intelligent Key.....	159	hold.....	175
Intelligent Key sleep function (where fitted).....	159	How to use the Automatic Brake Hold function	176
Troubleshooting guide	160	Driving Position Memory System (where fitted).....	177
Doors.....	161	Memory Storage.....	177
Super Lock system (RHD models).....	161	Entry/Exit function	178
Locking/unlocking with the key (vehicle		Steering wheel.....	179
battery discharged).....	162	Tilt and telescopic operation	179
Inside door handle.....	162	Sun visors.....	179
Power door lock switch	163	Mirrors	179
Child safety lock – rear doors.....	163	Inside rear-view mirror	179
Tailgate	164	Automatic anti-dazzling inside mirror (where	
Operating manual tailgate (where fitted)	164	fitted).....	180
Operating power tailgate (where fitted).....	164	Outside rear-view mirrors.....	180
Motion-activated tailgate (where fitted).....	166	Vanity mirror.....	181

KEYS

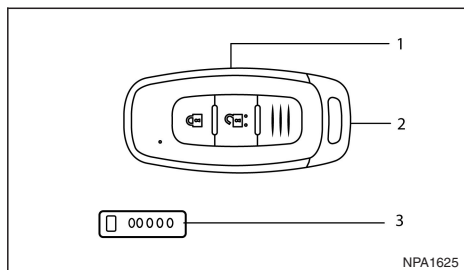

Type A

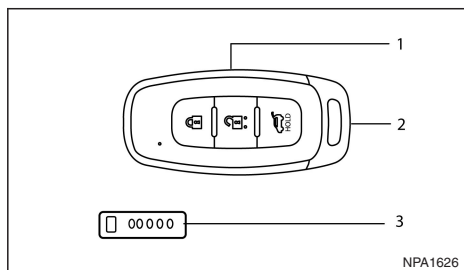

Type B

1. Intelligent Key
2. Emergency/Mechanical key (inside the Intelligent Key), see "Emergency/mechanical key" later in this section
3. Key number plate

NISSAN ANTI-THEFT SYSTEM (NATS)* KEY

Your vehicle can only be driven with the keys specific to your vehicle. Only NISSAN Anti-Theft System (NATS)* keys can be used with your vehicle (see "Security system" later in this section).

INTELLIGENT KEY (where fitted)

Your vehicle can only be driven with the Intelligent Keys, which are registered to your vehicle's Intelligent Key system components and NISSAN Anti-Theft System (NATS*) components. As many as 4 Intelligent Keys can be registered and used with one vehicle. The new keys must be registered by a NISSAN dealer or qualified workshop prior to use with the Intelligent Key system and NATS of your vehicle. Since the registration process requires erasing all memory in the Intelligent Key components when registering new keys, be sure to take all Intelligent Keys that you have to the NISSAN dealer or qualified workshop.

*: Immobiliser

CAUTION

- **Be sure to carry the Intelligent Key with you. Do not leave the vehicle with the Intelligent Key inside.**
- **Be sure to carry the Intelligent Key with you when driving. The Intelligent Key is a precision device with a built-in transmitter. To avoid damaging it, please note the following.**
 - **The Intelligent Key is water resistant; however, wetting may damage the Intelligent**

Key. If the Intelligent Key gets wet, immediately wipe until it is completely dry.

- **Do not allow the Intelligent Key to come into contact with water or salt water this could affect the system function.**
- **Do not bend, drop or strike it against another object.**
- **Do not place the Intelligent Key for an extended period in a place where temperatures exceed 60°C (140°F).**
- **Do not change or modify the Intelligent Key.**
- **Do not use a magnetic key holder.**
- **Do not place the Intelligent Key near equipment that produces a magnetic field such as a TV, audio equipment and personal computers.**
- **If an Intelligent Key is lost or stolen, NISSAN recommends erasing the ID code of that Intelligent Key. This will prevent the Intelligent Key from unauthorised use to unlock the vehicle. For information regarding the erasing procedure, please contact a NISSAN dealer or qualified workshop.**

KEY NUMBER

A key number plate ③ is supplied with your key

Record the key number on the “Security Information” page at the end of this manual and keep it in a safe place, but **not in the vehicle**. The key can only be duplicated using an original key or the original key number. The key number is required when you have lost all of the keys and do not have the original key to duplicate from. If the key is lost, or you need extra keys, provide an original key or the key number to a NISSAN dealer or qualified workshop.

NISSAN does not record key numbers, so it is very important that you keep a record of your key number.

NEW KEYS

As many as four NATS keys can be registered to one vehicle at any one time. New keys must be registered to the NATS components of your vehicle by a NISSAN dealer.

When registering a new key at a NISSAN dealer, you are requested to bring all of your NATS keys with you. This is necessary because the registration process will erase and reprogram the memory of your vehicle's NATS components.

NOTE

A key number is only required if you have lost all of your keys and do not have one to duplicate from. If you still have a key, this key can be duplicated by a NISSAN dealer.

EMERGENCY/MECHANICAL KEY

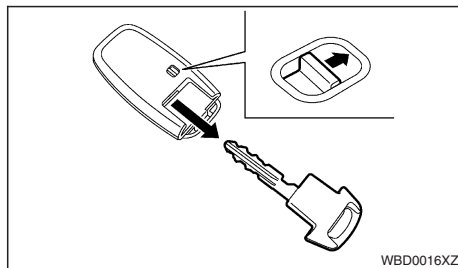

Intelligent Key and emergency/mechanical key:

The emergency key can be used to unlock the driver's door in emergency situations (e.g. Intelligent Key dead battery).

- To remove the mechanical key, release the lock knob at the back of the Intelligent Key.
- To install the mechanical key, firmly insert it into the Intelligent Key until the lock knob returns to the lock position.

Use the mechanical key to lock or unlock the doors. (See “Doors” later in this section.)

NOTE

For the driver's side door, it is normal for the key not to go all the way into the key cylinder.

REMOTE OPENING OR CLOSING WINDOWS

The windows can be opened or closed with the key. This function will not operate while the window timer is activated or the windows need to be initialised. See, “Windows” in the “2. Instruments and controls” section.

Opening

To open the windows, push and hold the UNLOCK  button on the key for **about 3 seconds** after the door is unlocked.

To stop opening, release the UNLOCK  button.

If the window open operation is stopped mid-operation while pushing the UNLOCK  button, release and push the button again until all the windows are opened completely.

Closing

To close the windows, push and hold the LOCK  button on the key for **about 3 seconds** after the door is locked.

To stop closing, release the LOCK  button.

If the window closing operation is stopped mid-operation while pushing the LOCK  button, release and push the button again until all the windows are closed completely.

CAUTION

Always ensure that all windows are fully closed after remote operation.

REMOTE KEYLESS ENTRY SYSTEM (where fitted)

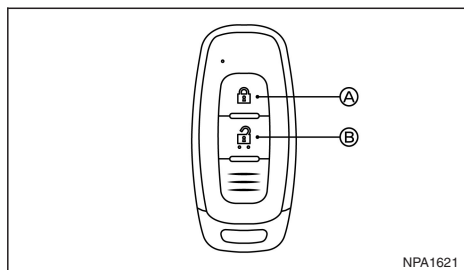

Type A

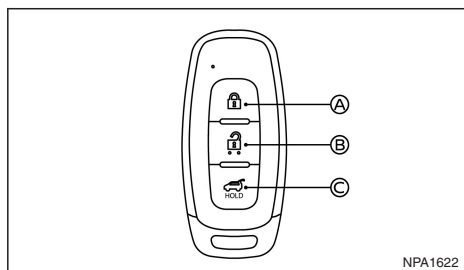

Type B

- A LOCK button
- B UNLOCK button
- C Power tailgate button (where fitted)

The remote keyless entry system can operate all door locks (including the tailgate) using the Intelligent Key). The Intelligent Key can operate at a distance of approximately 5 m (15 ft) from the vehicle (the effective distance depends upon the conditions around the vehicle and the state of the key battery).

As many as 4 remote controllers can be used with one vehicle. For information about the purchase and use of additional remote controllers, contact a NISSAN dealer or qualified workshop.

The Intelligent Key will not function under the following conditions:

- When the distance between the Intelligent Key and the vehicle is more than approximately 5 m (15 ft).
- When the Intelligent Key battery is discharged.

All doors can be locked or unlocked from the outside by pressing the (LOCK) or (UNLOCK) button on the Intelligent Key.

WARNING

Super Lock system equipped models:

Failure to follow the precautions below may lead to hazardous situations. Make sure the Super Lock system activation is always conducted safely.

- **When the vehicle is occupied, never super lock the doors. Doing so will trap the occupants, since the Super Lock system prevents the doors from being opened from the inside of the vehicle.**
- **Only super lock by double-pressing the Intelligent Key "LOCK" button when there is a clear view of the vehicle. This is to prevent anybody from being trapped inside the vehicle through the Super Lock system activation.**

For further details on the Super Lock system see "Doors" later in this section.

CAUTION

- **When locking the doors using the Intelligent Key, be sure not to leave the key in the vehicle.**
- **Always remove the Intelligent Key, close all windows before operating the Intelligent Key door lock system.**
- **Ensure that the driver's door is securely closed before operating the Intelligent Key door lock system for correct operation of the system.**
- **Do not allow the Intelligent Key, which contains electrical components, to come into contact with water or salt water. This could affect the system function.**
- **Do not drop the Intelligent Key.**
- **Do not strike the Intelligent Key sharply against another object.**
- **Do not place the Intelligent Key for an extended period in an area where temperatures exceed 60°C (140°F).**

If an Intelligent Key is lost or stolen, NISSAN recommends erasing the ID code of that Intelligent Key from the vehicle. This may prevent the unauthorised use of the Intelligent Key to unlock the vehicle. For information regarding the erasing procedure, contact a NISSAN dealer or qualified workshop. For information regarding the replacement of a battery, see "Intelligent Key battery replacement" in the "8. Maintenance and do-it-yourself" section.

USING THE REMOTE KEYLESS ENTRY SYSTEM

Locking the doors

1. Switch the power switch OFF and make sure you have the Intelligent Key with you when exiting the vehicle.
2. Close all doors (including the tailgate) and windows.
3. Push the  button.
 - All the doors and the tailgate will lock.
 - Hazard indicator lights flash once for confirmation.
4. Operate the door handles to confirm that the doors have been securely locked.

If the  button is pushed with all the doors locked, the direction indicators will flash once to remind you that the doors are already locked.

Unlocking the doors

Convenience door unlock mode:



As default, the door unlock (convenience) mode is set to unlock all the doors and the tailgate with one push on the  button.

Push the  button:

- All doors and the tailgate will be unlocked.
- Hazard indicator lights flash twice.

Selective door unlock mode:

Selective door unlock mode allows the remote unlocking of only the driver's door to prevent an attacker from entering the vehicle via an unlocked passenger door.

1. Push the  button.
 - The driver's door unlocks.
 - Hazard indicator lights flash twice quickly.
2. Push the  button again (if necessary):
 - All doors and the tailgate will be unlocked.
 - Hazard indicator lights flash twice slowly.

NOTE

Pushing twice on the  button all doors will be unlocked.

Switching between convenience and selective door lock mode:

For details, see "Vehicle information display" in the "2. Instruments and controls" section.

Auto-relock (where fitted):

An auto-relock function will operate a short period after a full or partial unlock, if no further user action is taken. The auto-relock will be cancelled if any door is opened.

KEY OPERATION FAILURE

The Intelligent Key may not work properly if:

- **The Intelligent Key battery is low.**
See "Intelligent Key battery replacement" in the "8. Maintenance and do-it-yourself" section for key battery replacement instructions and the required battery type.
- **The locking/unlocking system has been used continuously.**
An anti lock-abuse system prevents the lock motors from overheating and disables the key locking operation for a short period of time if the system is used continuously.
- **The door handle is being pulled while the key is being operated.**
- **The vehicle's battery is discharged.**

NOTE

See [No key Detected] warning, [Key battery low] indicator, [Key ID Incorrect] warning or Intelligent Key system warning in "Vehicle information display" in the "2. Instruments and controls" section for more information.

INTELLIGENT KEY SYSTEM (where fitted)

WARNING

- **Radio waves could adversely affect electric medical equipment. Those who use a pacemaker should contact the electric medical equipment manufacturer for the possible influences before use.**
- **The Intelligent Key transmits radio waves when the buttons are pushed. The radio waves may affect aircraft navigation and communication systems. Do not operate the Intelligent Key while on an aeroplane. Make sure the buttons are not operated unintentionally when the unit is stored during a flight.**

The Intelligent Key system can operate all the door locks and the tailgate by using the Intelligent Key or pushing a request button on the vehicle without taking the key out from a pocket or purse. The operating environment and/or conditions may affect the Intelligent Key system operation.

Be sure to read the following items before using the Intelligent Key system.

CAUTION

- **Be sure to carry the Intelligent Key with you when operating the vehicle.**
- **Never leave the Intelligent Key in the vehicle when you leave the vehicle.**

In such cases, correct the operating conditions before using the Intelligent Key function or use the mechanical key.

Although the life of the Intelligent Key battery varies depending on the operating conditions, the battery's life is approximately 2 years. If the battery is discharged, replace it with a new one.

For information regarding replacement of a battery, see "Intelligent Key battery replacement" in the "8. Maintenance and do-it-yourself" section.

When the Intelligent Key battery is almost discharged, firmly apply the footbrake and touch the power switch with the Intelligent key. Then push the power switch while depressing the brake pedal within 10 seconds after the chime sounds. For details, see "Push-button power switch" in the "5. Starting and driving" section.

Pay special attention that the vehicle battery is not completely discharged.

CAUTION

- **Do not allow the Intelligent Key, which contains electrical components, to come into contact with water or salt water. This could affect the functioning of the system.**
- **Do not drop the Intelligent Key.**
- **Do not strike the Intelligent Key sharply against another object.**
- **Do not change or modify the Intelligent Key.**
- **The Intelligent Key may be damaged if it gets wet. If the Intelligent Key gets wet, immediately wipe until it is completely dry.**

- **Do not place the Intelligent Key for an extended period in an area where temperatures exceed 60°C (140°F).**

- **If the outside temperature is below -10°C (14°F), the Intelligent Key may not function properly.**

- **Do not attach the Intelligent Key to a key holder that contains a magnet.**

- **Do not place the Intelligent Key near equipment that produces a magnetic field, such as a TV, audio equipment, personal computer or mobile phone.**

- **Make sure the Intelligent Key battery is in good condition. Note that battery life may vary depending on condition, amount of use, ambient temperature, etc.**

INTELLIGENT KEY OPERATING RANGE

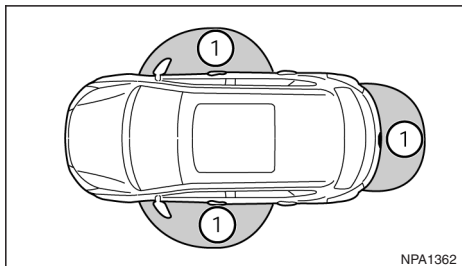

The Intelligent Key functions can only be used when the Intelligent Key is within the specified operating range from the request (lock/unlock) button ①. When the Intelligent Key battery is discharged or strong radio waves are present near the operating location, the Intelligent Key system's operating range becomes narrower, and the Intelligent Key may not function properly. The operating range is within 80 cm (31.50 in) from each request button ①.

If the Intelligent Key is too close to the door glass, door handle or rear bumper, the request button may not function.

When the Intelligent Key is within the operating range, it is possible for anyone, even someone who does not carry the Intelligent Key, to push the request button to lock/unlock the doors including the tailgate.

USING INTELLIGENT KEY SYSTEM

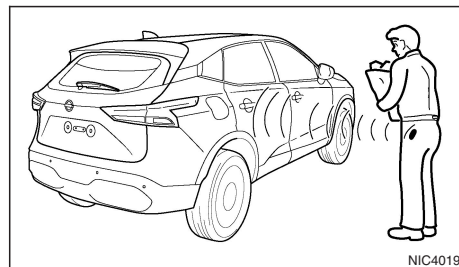

The request button will not function under the following conditions:

- When the Intelligent Key is left inside the vehicle. If another intelligent key is outside the vehicle, it can be locked/unlocked.
- When the Intelligent Key is not within the operational range
- When any door is open or not closed securely
- When the Intelligent Key battery is discharged

DOOR LOCKS/UNLOCKS PRECAUTION

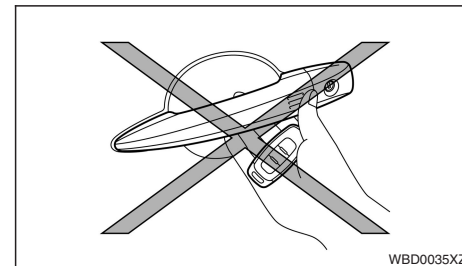

- Do not push the door handle request button with the Intelligent Key held in your hand as illustrated. The close distance to the door handle will cause the Intelligent Key system to have difficulty recognising that the Intelligent Key is outside the vehicle.
- After locking with the door handle request button, verify the doors are securely locked by operating the door handles.
- To prevent the Intelligent Key from being left inside the vehicle, make sure you carry the key with you and then lock the doors.
- Do not pull the door handle before pushing the door handle request button. The door will be unlocked but will not open. Release the door handle once and pull it again to open the door.

DOORS LOCKING/UNLOCKING

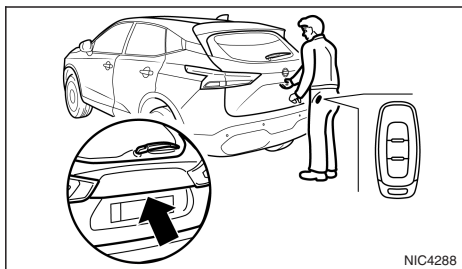
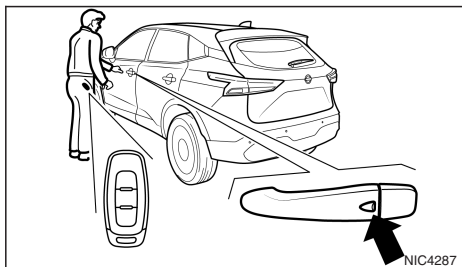

Request button (where fitted)

When the Intelligent Key is within the range of operation, the door locks can be locked or unlocked by pushing the door handle request button on the driver's or front passenger's door or the tailgate request button (where fitted).

The request button will not function under the following conditions:

- When the Intelligent Key is left inside the vehicle. If another intelligent key is outside the vehicle, it can be locked/unlocked.
- When the Intelligent Key is not within the operational range.
- When the Intelligent Key battery is discharged.
- When the doors are open or not closed securely.
- e-POWER system is running.

Locking the doors

1. Make sure you have the Intelligent Key when exiting the vehicle.
2. Close all doors.
3. Press any of the request button (front doors or tailgate).
 - All doors and the tailgate will be locked.
 - Hazard indicator lights flash once for confirmation.
 - **Super Lock system equipped models:** The Super Lock system will be activated if the request button or the Intelligent Key lock button is double-pressed. Hazard indicator lights flash longer to indicate Super Lock activation.
4. Pull the door handles to confirm that the doors have been securely locked.

CAUTION

Do not leave the duplicate Intelligent Key inside the vehicle as the locking procedure logic will not work.

NOTE

If the Intelligent Key is left in the vehicle and the door/tailgate request button is pressed, a buzzer will sound to indicate that the Intelligent Key is still inside the vehicle. If another intelligent key is outside the vehicle, it can be locked/unlocked.

Unlocking the doors

For details about the selective or convenience door unlock mode settings, see "Vehicle information display" in the "2. Instruments and controls" section.

Convenience door unlock mode:

As default, the door unlock (convenience) mode is set to unlock all the doors and the tailgate with one push on the door/tailgate request button.

- All doors and the tailgate will be unlocked.
- Hazard indicator lights flash twice quickly.

Selective door unlock mode:

Selective door unlock mode allows the remote unlocking of only the driver's door to prevent an attacker from entering the vehicle via an unlocked passenger door.

1. Push the door/tailgate request button.
 - If the driver's door request button was pressed, only the driver's door unlocks.
 - If the passenger door request button was pressed, only the passenger door unlocks.

- If the tailgate request button was pressed, only the tailgate unlocks.
 - Hazard indicator lights flash twice quickly.
2. Push the request button again within 5 seconds.
- All the doors and the tailgate will be unlocked.
 - Hazard indicator lights flash twice slowly.

NOTE

- **External interference may impair the Intelligent Key's operation. In this case, use the emergency key located in the Intelligent Key. See "Doors" later in this section for further details.**
- **If the vehicle is unlocked and no doors are opened for a period of time, the doors will automatically be locked.**

STARTING THE VEHICLE WITH THE INTELLIGENT KEY

See "Push-button power switch" in the "5. Starting and driving" section.

CAUTION

- **Make sure you carry the Intelligent Key with you when starting and driving the vehicle.**
- **If the Intelligent Key is too far away from the passenger compartment, the vehicle may not start. See "Intelligent Key operating range" in the "3. Pre-driving checks and adjustments" section.**

INTELLIGENT KEY SLEEP FUNCTION (where fitted)

The Intelligent Key has a sleep function where if the key is physically not moved for 2 or more minutes, it will stop transmitting.

If the Intelligent Key has not been physically moved for 2 or more minutes, the message [No Key Detected] may appear on the Vehicle Information Display. Should this occur, physically move the intelligent key to stop the sleep function.

TROUBLESHOOTING GUIDE

	Symptom	Possible cause	Action to take
When pushing the power switch to start the e-POWER system	The [Key battery low] warning appears in the vehicle information display.	The Intelligent Key battery charge is low.	Replace the battery with a new one. See "Battery" in the "8. Maintenance and do-it-yourself" section.
	The [Hold key near start button] message appears in the vehicle information display.	The Intelligent Key is not in the vehicle.	Carry the Intelligent Key with you.
When pushing the power switch to stop the e-POWER system	The [Shift to Park] warning appears in the vehicle information display and the inside warning chime sounds continuously.	The shift system is not in the P (Park) position.	Press the P position switch to shift to the P (Park) position.
	The [No Key Detected] warning appears in the vehicle information display, the outside chime sounds 3 times and the inside warning chime sounds for a few seconds.	The e-POWER system is running and the Intelligent Key is not in the vehicle.	Carry the Intelligent Key with you. If you cannot carry the Intelligent Key, push the power switch 3 consecutive times or push and hold the power switch for more than 2 seconds.
		Intelligent Key sleep function activated.	Physically move the intelligent key.
When closing the door after getting out of the vehicle	The [Shift to Park] warning appears in the vehicle information display and the outside warning chime sounds continuously.	The power switch is OFF and the shift system is not in the P (Park) position.	Press the P position switch to shift to the P (Park) position.
When closing the door with the inside lock button (where fitted) in the LOCK position	The outside chime sounds for a few seconds and all the doors unlock.	The Intelligent Key is inside the vehicle or cargo area.	Carry the Intelligent Key with you.
When pushing the request switch or the  button on the Intelligent Key to lock the door	The outside chime sounds for a few seconds and all the doors unlock.	A door is not closed securely.	Close the door securely.

DOORS

SUPER LOCK SYSTEM (RHD models)

WARNING

Super Lock system equipped models:

Failure to follow the precautions below may lead to hazardous situations. Make sure the Super Lock system activation is always conducted safely.

- When the vehicle is occupied, never super lock the doors. Doing so will trap the occupants, since the Super Lock system prevents the doors from being opened from the inside of the vehicle.
- Only super lock by double-pressing the Intelligent Key "LOCK" button when there is a clear view of the vehicle. This is to prevent anybody from being trapped inside the vehicle through the Super Lock system activation.

Double-pressing the "LOCK" button () on the Intelligent Key, or locking the doors by double-pressing one of the request buttons (Intelligent Key models) will activate the Super Lock system. Hazard warning lights flash longer to indicate Super Lock activation.

When the Super Lock system is active, none of the doors can be opened from inside the vehicle. This provides additional security in case of theft or break-in.

The Super Lock system will be released when all the doors are unlocked using the Intelligent Key or a request button.

Emergency situations

If the Super Lock system is activated while you are inside the vehicle, for example by a traffic accident or other unexpected circumstances, follow the instructions below.

To release the Super Lock system:

- Switch the power switch ON.
All doors can now be unlocked and opened from inside the vehicle.
- Unlock the doors using the Intelligent Key "UN-LOCK" button ().
All doors can now be opened from inside the vehicle.

To unlock and open the driver's door from inside the vehicle while the Super Lock system is active:

1. Open or break the driver's door window.
2. Insert the key into the outside door key cylinder and turn it towards the rear of the vehicle.
3. The driver's door will unlock and can now be opened from inside the vehicle.

Locking without activating the Super Lock system

WARNING

Do not leave the key inside the vehicle when leaving the vehicle.

Locking the doors using the door key cylinder, or by a single press of the "LOCK" button on the Intelligent Key, or by a single press of one of the request buttons will not activate the Super Lock system. See "Locking/unlocking with the key (vehicle battery discharged)" later in this section for further information.

LOCKING/UNLOCKING WITH THE KEY (vehicle battery discharged)

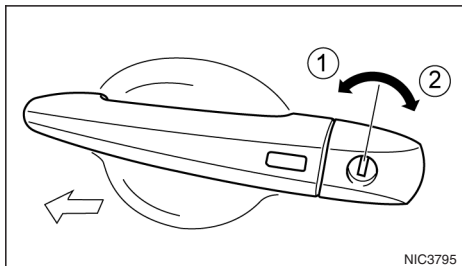

⚠ WARNING

- When leaving the vehicle, do not leave the key inside the vehicle.
- To help avoid risk of injury or death through unintended operation of the vehicle and/or its systems, do not leave children, people who require the assistance of others or pets unattended in your vehicle. Additionally, the temperature inside a closed vehicle on a warm day can quickly become high enough to cause a significant risk of injury or death to people and pets.

The driver's door can be locked/unlocked from outside using the key/emergency key if the vehicle's battery is discharged.

To lock the door, insert the key into the driver's door key cylinder and turn it towards the rear of the vehicle ②.

To unlock the door, turn the key towards the front of the vehicle ①.

See "Emergency/mechanical key" in the "5. Pre-driving checks and adjustments" section for instructions on accessing the Intelligent Key system Emergency key.

CAUTION

The alarm system will be triggered when the door is opened using the key (NISSAN alarm equipped models). To stop the alarm, turn the power switch ON or press the unlock button () on the Intelligent Key.

Initialising the system after vehicle battery loading or replacement

After recharging or replacing the battery, you should release (initialise) the system by:

- Switch the power switch ON.
- Unlocking the vehicle using the Intelligent Key.

INSIDE DOOR HANDLE

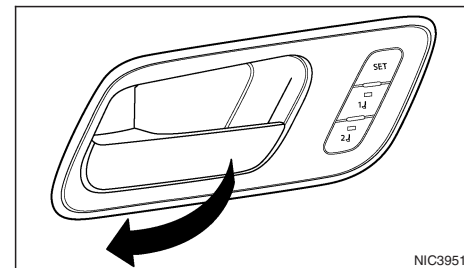

To unlock and open the door, pull the inside door handle as illustrated.

Models with Super Lock system (where fitted)

The door cannot be opened when the Super Lock system is activated.

POWER DOOR LOCK SWITCH

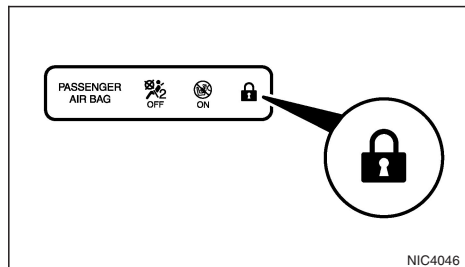

Power door lock light

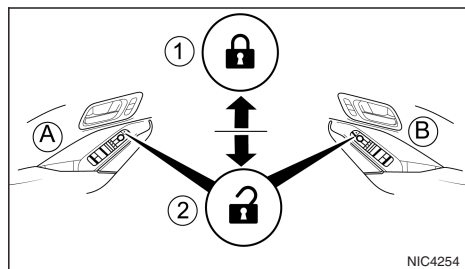



- ① Press to lock
- ② Press to unlock
- Ⓐ LHD vehicles
- Ⓑ RHD vehicles

⚠ WARNING



When leaving the vehicle, do not leave the key inside the vehicle.

The power door lock switch, located on the door trimming, can be used to lock ① or unlock ② all doors simultaneously from inside the vehicle. The door lock indicator light () on the roof console comes on when the doors are locked.

NOTE

Models without the Super Lock system: If a door is manually opened from inside after having pressed the Intelligent Key "LOCK" button (), the door will unlock and the power door lock indicator light () goes out.

Super Lock equipped models (RHD models)

If the doors are locked by double-pressing the Intelligent Key lock button () or by double-pressing a request button (Intelligent Key models), the Super Lock system will be activated. The  indicator light on the roof console comes on to indicate that all doors are locked, but it will not be possible to use the  button of the power door lock switch to unlock the doors.

Locking the doors with the power door lock switch will not activate the Super Lock system.

CHILD SAFETY LOCK — REAR DOORS

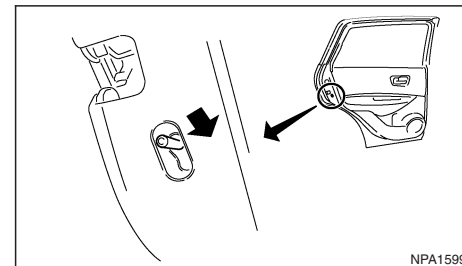

The child safety lock helps prevent doors from being opened accidentally, especially when small children are in the vehicle.

When the switch is in the LOCK position, the rear door can only be opened from the outside by the outside door handle.

Make sure the child safety lock is working properly.

TAILGATE

⚠ WARNING

- Always be sure the tailgate has been closed securely to prevent it from opening while driving.
- Do not drive with the tailgate open. This could allow dangerous exhaust gases to be drawn into the vehicle.
- To help avoid risk of injury or death through unintended operation of the vehicle and or its systems, including entrapment in windows or inadvertent door lock activation, do not leave children, people who require the assistance of others or pets unattended in your vehicle. Additionally, the temperature inside a closed vehicle on a warm day can quickly become high enough to cause a significant risk of injury or death to people and pets.
- Always be sure that hands and feet are clear of the door frame to avoid injury while closing the tailgate.

CAUTION

Do not use accessory carriers that attach to the tailgate. Doing so will cause damage to the vehicle.

OPERATING MANUAL TAILGATE (where fitted)

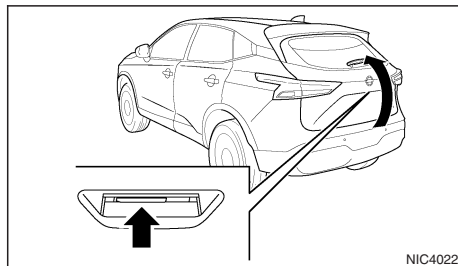

To open the tailgate, unlock it. Pull up the tailgate to open.

The tailgate can be unlocked by:

- Pushing the UNLOCK  button on the Intelligent Key.
- Pushing the tailgate request switch (where fitted).
- Pushing the door handle request switch (where fitted).

To close the tailgate, pull down until it securely locks.

OPERATING POWER TAILGATE (where fitted)

To operate the power tailgate, the vehicle must be in the P (Park) position.

The power tailgate will not operate if the battery voltage is low.

The power tailgate operation can be activated or deactivated in the vehicle information display. (See “Vehicle information display” in the “2. Instruments and controls” section.)

NOTE

- For models with motion-activated tailgate: **When washing, waxing or maintaining your vehicle, placing or replacing the body cover, or splashing water to the area around the kick motion sensor, turn off the power tailgate.**
- **If the power open or close operation is performed consecutively, the safety mode activates and the operation cannot be performed for a certain period of time. In this case, wait for a while and then perform the operation.**

Power open (using switches)

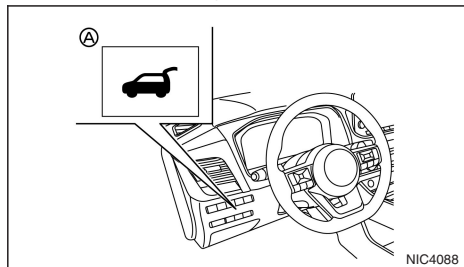

Power tailgate switch — Instrument panel

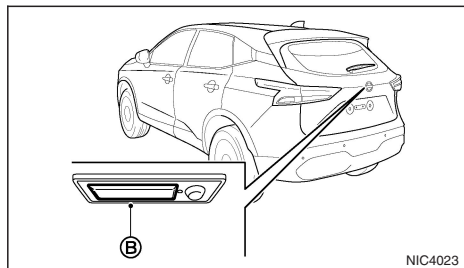

Tailgate opener switch

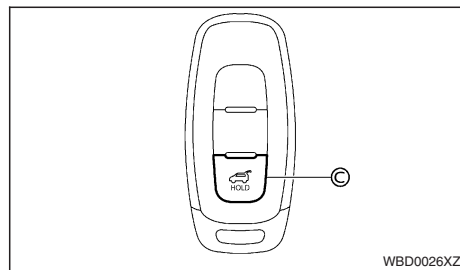

Power tailgate button - Key (example)

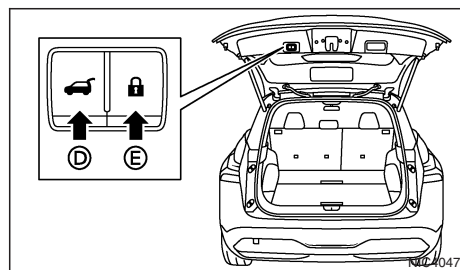

Power tailgate close and lock switches — Tailgate

When the tailgate is fully closed, the tailgate will fully open automatically by:

- Pushing the power tailgate switch (A) on the instrument panel for more than 1 second.
- Pushing the tailgate opener switch (B).
- Pushing the power tailgate button (C) on the key for more than 1 second.

The outside chime sounds when the tailgate starts opening.

NOTE

The tailgate can be opened by the power tailgate switch (A) or the power tailgate button (C) even if the tailgate is locked. The tailgate can be unlocked and opened independently of the other doors, even when they are locked. The tailgate must be unlocked (or the Intelligent Key must be within range) to open with the tailgate opener switch (B).

Power close (using switches)

When the tailgate is fully opened, the tailgate will fully close automatically by:

- Pushing the power tailgate switch (A) on the instrument panel for more than 1 second.
- Pushing the power tailgate button (C) on the key for more than 1 second.
- Pushing the power tailgate close switch (D) on the lower part of the tailgate for 1 second.

The outside chime sounds when the tailgate starts closing.

Power close and lock

When the tailgate is fully opened and the Intelligent Key is carried with you near the tailgate, the tailgate will fully close and lock automatically by pushing the power tailgate lock switch (E) on the lower part of the tailgate.

The outside chime sounds when the tailgate starts closing.

Stop and reverse function (where fitted)

The power tailgate will stop immediately if one of the following actions is performed during power open or close.

- Pushing the power tailgate switch (A).
- Pushing the tailgate opener switch (B).
- Pushing the power tailgate close switch (D) on the lower part of the tailgate.
- Pushing the power tailgate button (C) on the key.

And then the power tailgate will move in the reverse direction if one of the above actions is performed again.

The outside chime sounds when the tailgate starts to reverse.

Auto reverse function

The auto-reverse function enables the tailgate to automatically reverse when something is caught in the tailgate as it is opening or closing. When the control unit detects an obstacle, the tailgate will reverse 5% and stop.

When the switch is operated again the tailgate will travel in the opposite direction.

A pinch sensor is mounted on each side of the tailgate. If an obstacle is detected by the pinch sensor during power close, the tailgate will reverse and return to the full open position immediately.

NOTE

If the pinch sensor is damaged or removed, the power close function will not operate.

WARNING

There is a small distance immediately before the closed position that cannot be detected. Make sure that all passengers keep their hands, etc., clear from the tailgate opening before closing the tailgate.

Manual mode

If power operation is not available, the tailgate can be operated manually. Power operation may not be available if multiple obstacles have been detected in a single power cycle or if the battery voltage is low. When the power tailgate is turned off, the tailgate can be opened manually by pushing the tailgate opener switch. If the power tailgate opener switch is pushed during power open or close, the power operation will be cancelled and the tailgate can be operated manually. This will allow normal power operation functions to resume.

MOTION-ACTIVATED TAILGATE (where fitted)

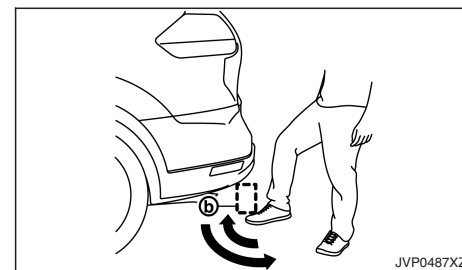
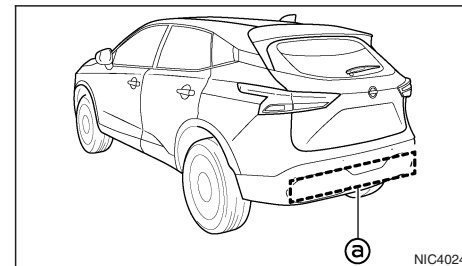

The tailgate can be operated using a quick kicking motion under the centre of the rear bumper.

The kick motion sensor (a) is located on the back of the rear bumper. when you move your foot under and then away from the operating range (b) similar to a kicking motion, while carrying the Intelligent Key with you, the tailgate will open or close automatically.

Proper operation technique

- While at the rear of the vehicle, begin making a quick forward kicking motion.
- Raise your foot straight under the centre of the rear bumper then immediately return your foot to the ground in a continuous motion.
- You do not need to hold your foot under the bumper or move it side to side. Immediately return your foot to the ground.
- The kicking motion should be straight, smooth and consistent.
- After your kick motion is complete, step back and allow the tailgate to open/close.
- Three beeps will sound and the tailgate will begin moving within 2 seconds after the kick.

WARNING

Prevent unintentional tailgate opening/closing. There may be conditions when opening/closing the tailgate is not desired. Keep the Intelligent Key out of range of the tailgate, (2 m (7 ft) or more) or inside the vehicle, when washing or working around the back of the vehicle.

NOTE

- The kick motion sensor may not function under the following conditions:
 - When operating near a location where strong radio waves are transmitted, such as a TV tower, power station or broadcasting station.

- When the vehicle is parked near a parking meter.

- The power tailgate may not operate when your foot remains in the operating range .

CAUTION

- When the Intelligent Key is carried with you near the tailgate, even someone, who does not carry the Intelligent Key, may be able to open or close the tailgate with a kick motion.
- Do not perform a kick motion near the exhaust system components while they are hot. You may severely burn yourself.
- Do not perform a kick motion on an unstable place (for example, on a slope or a muddy ground, etc.).

Power open or close function

The tailgate will fully open automatically using the kick motion sensor.

1. Carry the Intelligent Key.
2. Move your foot under and away from the rear bumper similarly to a kicking motion within the operation range of the kick motion sensor.
3. The tailgate will automatically open or close.

Stop and reverse function

The power tailgate will stop immediately if a kick motion is performed during power open or close. The tailgate can be stopped even if you do not carry the Intelligent Key.

And then the power tailgate will move in the reverse direction if a kick motion is performed again.

The power tailgate can be reversed when you carry the Intelligent Key.

Do not apply excessive force when manually operating the power tailgate. Excessive force applied may cause damage to the vehicle.

GARAGE MODE SYSTEM (where fitted)

The tailgate can be set to open to a specific height by performing the following:

1. Open the tailgate.
2. Pull the tailgate down to the desired position and hold the tailgate (the tailgate will have some resistance when being manually adjusted).
3. While holding the tailgate in position, press and hold the power tailgate close and lock switch  located on the tailgate for approximately 3 seconds or until 2 beeps are heard.

The tailgate will open to the selected position setting. To change the position of the tailgate, repeat steps 1-3 for setting the position of the tailgate.

Do not apply excessive force when the auto closure is operating. Excessive force applied may cause the mechanism to malfunction.

CAUTION

Do not set the height of the tailgate below approximately 1/3 of the way to the floor using garage mode. Even if you set the height below approximately 1/3 of the way to the floor, the height will automatically be set to approximately 1/3 of the way to the floor.

SECURITY SYSTEM

AUTO CLOSURE (where fitted)

When the tailgate reaches the secondary position, the closure motor engages and pulls the tailgate to its primary latch position.

Do not apply excessive force when the auto closure is operating. Excessive force applied may cause the mechanism to malfunction.

CAUTION

- The tailgate will automatically close from the secondary position. To avoid pinching, keep hands and fingers away from tailgate opening.
- Do not let children operate the tailgate.

TAILGATE RELEASE LEVER

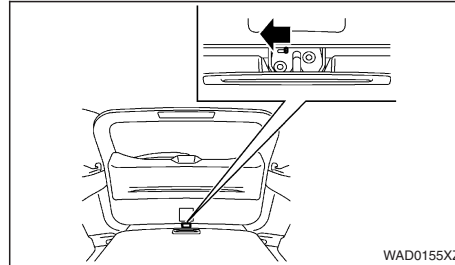

If the tailgate cannot be opened with the power door lock switch due to a discharged battery, follow these steps.

1. Fold the rear seats down. (See "Rear seats" in the "1. Safety — Seats, Seat belts and Supplemental Restraint System" section.)
2. Insert a suitable tool in the access opening. Move the release lever to the left. The tailgate will be unlatched.
3. Push the tailgate up to open.

Contact a NISSAN dealer or qualified workshop as soon as possible for repair.

ALARM SYSTEM (where fitted)

The alarm system provides visual and audible alarm signals if parts of the vehicle are disturbed.

How to arm the alarm system

1. Close all doors, windows, tailgate and bonnet.
2. Lock the vehicle using the Intelligent Key (lock button), for additional information, see "Remote keyless entry system (where fitted)" in the "3. Pre-driving checks and adjustments" section.
3. The Alarm system will arm 20 seconds after the vehicle has been locked.

Alarm system operation

The system will give the following alarm:

- The siren sounds intermittently and all direction indicators will flash.
- The alarm automatically turns off after 28 seconds.

The alarm is activated when:

- The volumetric sensing system (interior movement sensors, where fitted) is triggered.
- Any door/the tailgate is opened.
- The bonnet is opened.
- The power switch is turned on without the owner's key being used.

The alarm system will stop when:

- The vehicle is unlocked using the intelligent key unlock button.
- The power switch is switched **ON** with a registered NATS key.

If the system does not operate as described above, have it checked by your NISSAN dealer or qualified workshop.

Interior Movement Sensors (where fitted)

The interior movement sensors (volumetric sensing) detect movements in the passenger's compartment. When the alarm system is set to the armed position, it will automatically switch on the interior movement sensors.

To disable the interior movement sensors:

1. Press the ◀ or ▶ buttons on the steering wheel until the [Settings] menu is displayed in the Vehicle Information Display and press the <OK> button.
2. Use the ▲ and ▼ buttons on the steering wheel to highlight [Vehicle Settings] and press the <OK> button.
3. Use the ▲ and ▼ buttons on the steering wheel to highlight [Alarm System] and press the <OK> button.
4. Three options are available:
 - [Always ON]

- [Ask on Exit]

When this option (where fitted) is selected, the alarm system will provide the choice to disable the interior movement sensors (where fitted) after the power switch is switched OFF. Use the scroll dial to select the preferred function.

- [Disable Once]

When this option (where fitted) is selected, The interior movement sensors (where fitted) will be disabled until the next time the alarm system is disarmed.

Use the ▲ and ▼ buttons on the steering wheel to highlight the desired option and press the <OK> button.

NOTE

When the windows are opened by a long press of the Intelligent Key unlock button  and the vehicle automatically re-locks, see "Auto-relock (where fitted)" earlier in this section, the interior movement sensors are disabled to avoid any nuisance alarm.

WARNING

To help avoid risk of injury or death through unintended operation of the vehicle and/or its systems, do not leave children, people who require the assistance of others or pets unattended in your vehicle. Additionally, the temperature inside a closed vehicle on a warm day can quickly become high enough to cause a significant risk of injury or death to people and pets.

NISSAN ANTI-THEFT SYSTEM (NATS) (where fitted)

The NISSAN Anti-Theft System (NATS)* will not allow the e-POWER system to start without the use of the registered NATS key.

* Immobiliser

If the e-POWER system fails to start using the registered NATS key, it may be due to interference from another NATS key, an automated toll road device or an automated payment device on the key ring. Restart the e-POWER system using the following procedure:

1. Leave the power switch **ON** for approximately 5 seconds.
2. Switch the power switch **OFF** and wait approximately 5 seconds.
3. Repeat steps 1 and 2.
4. Restart the e-POWER system while holding the device (which may have caused the interference) separated from the registered NATS key or NATS Intelligent Key (where fitted).

If this procedure allows the e-POWER system to start, NISSAN recommends placing the registered NATS key or NATS Intelligent Key (where fitted) on a separate key-ring to avoid interference from other devices.

BONNET

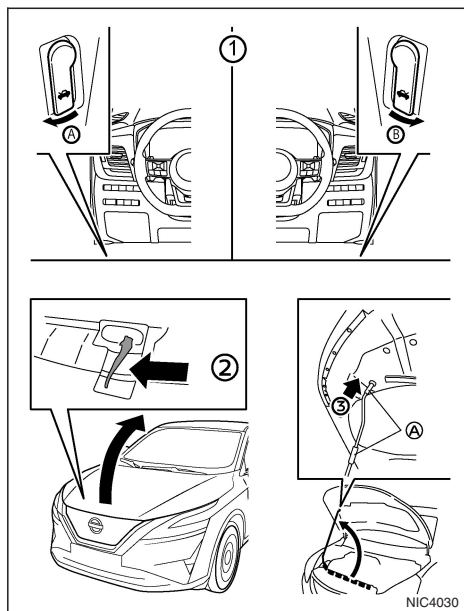

A LHD models

B RHD models

⚠ WARNING

- **Make sure the bonnet is completely closed and latched before driving. Failure to do so could cause the bonnet to fly open and result in an accident.**

- **Never open the bonnet if steam or smoke is coming from the engine compartment to avoid injury.**

CAUTION

The engine will start if the bonnet is opened when e-POWER system is running (to avoid accidents when performing maintenance).

1. Pull the bonnet lock release handle ① located below the driver's side instrument panel; the bonnet springs up slightly.
2. Push the lever ② underneath the front of the bonnet sideways as illustrated with your fingertips.
3. Raise the bonnet.
4. Remove the support rod and insert it into the slot ③.

Hold the coated parts A when removing or resetting the support rod. Avoid direct contact with the metal parts, as they may be hot immediately after the engine has been stopped.

When closing the bonnet:

1. While supporting the bonnet, return the support rod to its original position.
2. Slowly lower the bonnet to about 8 to 12 in (20 to 30 cm) above the bonnet lock, then let it drop.
3. Make sure it is securely latched.

FUEL-FILLER LID

CAUTION

- **Avoid applying direct water pressure, such as high-pressure sprayer, on or around the fuel-filler lid.**
- **Be sure to close the fuel-filler lid and lock it by locking the vehicle doors before using an automatic car wash or a high-pressure car wash.**

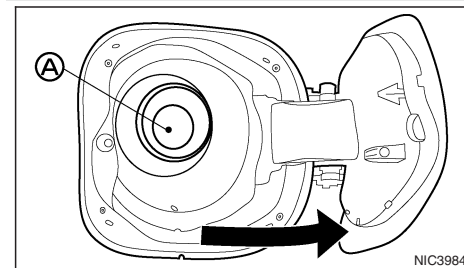

- **Do not spray high-pressure water onto the capless unit A when fuel-filler door is open. Failure to observe this caution may cause the capless unit to malfunction or cause damage to fuel system or engine.**

OPENING THE FUEL-FILLER LID

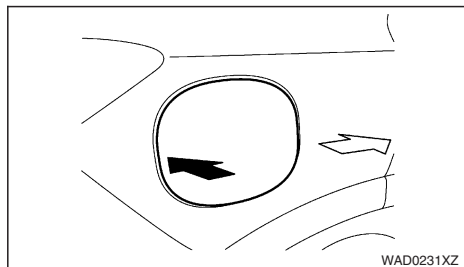

To open the fuel-filler lid, push the middle left side of the lid.

NOTE

If the fuel filler lid is locked, it should unlock automatically together with the driver's door during normal use. If selective unlock is selected and only the driver's door is unlocked, the unlock button on the key or the power door lock switch inside the vehicle must be pressed to unlock the fuel filler lid.

HOW TO REFUEL

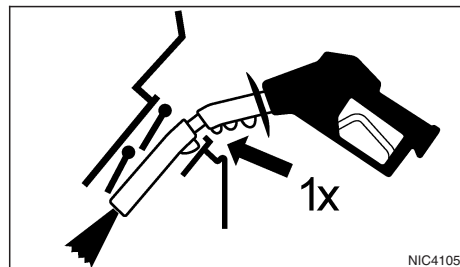

The fuel tank is not equipped with a fuel-filler cap. After opening the fuel-filler lid, insert the fuel pump nozzle directly into the fuel-filler opening and only to the first notch on the bottom of the nozzle. When the fuel pump nozzle is pulled out, the fuel-filler opening will be sealed.

To refuel:

Be sure to insert the fuel pump nozzle slowly into the fuel-filler opening and only to the first notch on the bottom of the nozzle, before fuelling. Inserting further may cause the fuel pump to stop filling prematurely.

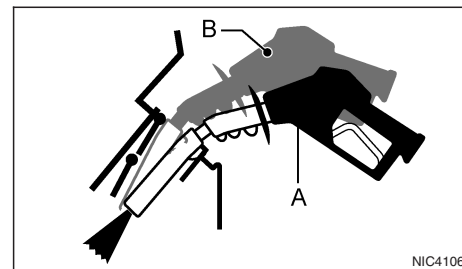

Hold the fuel pump nozzle in position A (shown). Holding the fuel pump nozzle in position B may cause fuel pump nozzle to shut off before the tank is full.

Never move the nozzle during refuelling.

Pull out the nozzle approximately 5 seconds after the fuel pump nozzle shuts off automatically (initial shut-off).

Close the fuel-filler lid after refuelling.

If you need to refuel from a portable fuel container, use the funnel supplied with your vehicle. (See "When refuelling from a portable fuel container" later in this section.)

CAUTION

- Do not attempt to open the flaps on the fuel-filler opening using any tool other than the fuel pump nozzle.
- This fuel-filler opening is only conformable to normal fuel pump nozzles at gas stations. Using a nozzle with a small diameter may damage the opening and the fuel system.

- If fuel is spilled on the vehicle body, flush it away with water to avoid paint damage.

⚠ WARNING

- Petrol is extremely flammable and highly explosive under certain conditions. You could be burned or seriously injured if it is misused or mishandled. Always stop the e-POWER system and do not smoke or allow open flames or sparks near the vehicle when refuelling.
- Do not attempt to top off the fuel tank after the fuel pump nozzle shuts off automatically. Continued refuelling may cause fuel overflow, resulting in fuel spray and possibly a fire.
- Never pour fuel into the throttle body to attempt to start your vehicle.
- Do not fill a portable fuel container in the vehicle or trailer. Static electricity can cause an explosion of flammable liquid, vapour or gas in any vehicle or trailer. To reduce the risk of serious injury or death when filling portable fuel containers:
 - Always place the container on the ground when filling.
 - Do not use electronic devices when filling.
 - Keep the pump nozzle in contact with the container while you are filling it.
 - Use only approved portable fuel containers for flammable liquid.

WHEN REFUELLING FROM A PORTABLE FUEL CONTAINER

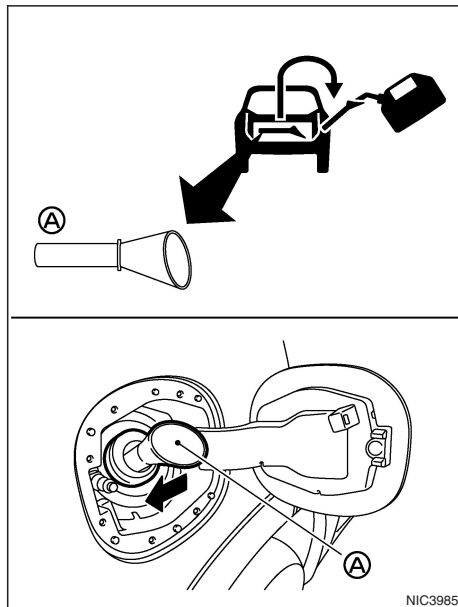

If you need to refuel from a portable fuel container, use the funnel **A** stored in the tool storage area (located under the luggage board).

Be sure to insert the funnel into the fuel-filler opening slowly and fully. Insert the nozzle of the portable fuel container into the opening along the funnel and fill the fuel tank.

After refuelling, remove the funnel from the fuel-filler opening. Wipe the funnel clean and return it to the tool storage area.

CAUTION

- Do not insert the nozzle of the portable fuel container directly into the fuel-filler opening. Doing so may damage the opening and the fuel system.
- Use only the funnel provided with your vehicle. Otherwise, the fuel-filler opening and the fuel system may be damaged.
- Make sure you remove the funnel before closing the fuel filler lid and driving the vehicle. Do not drive with funnel still inserted in fuel-filler opening.

ELECTRIC PARKING BRAKE

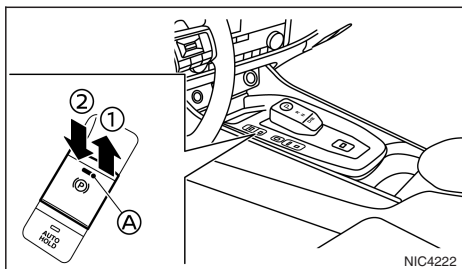

The Electric Parking Brake can be applied or released by operating the parking brake switch (A).

To apply: Pull the switch (A) up ① the indicator light will illuminate.

To release: With the power switch **ON**, depress the brake pedal and push the switch (A) down ②. The indicator light will turn off.

Before driving, check that the brake indicator light (P) goes out. For additional information, see "Warning lights, indicator lights and audible reminders" in the "2. Instruments and controls" section.

The Electric Parking Brake also has an auto release function.

The parking brake will automatically release when you drive away using the accelerator with the shift system in D (Drive) or R (Reverse). For safety reasons, parking brake will not release automatically when the driver's door is open.

NOTE

When the Automatic brake hold function is active (Auto Hold indicator is green), under the following conditions, the Electric Parking Brake will automatically be applied and the braking force of Automatic brake hold will be released:

- The braking force is applied by the Automatic brake hold function for 3 minutes or longer.
- The shift system is in the P (Park) position.
- The Electric Parking Brake is applied manually.
- The driver's seat belt is unfastened.
- The driver's door is opened.
- The power switch is switched OFF.
- A malfunction occurs in the Automatic brake hold function.

To keep the Electric Parking Brake released after switching off the power switch: While the power switch is ON, press the brake pedal, deactivate Automatic brake hold if activated and push the parking brake switch (A) before switching the power switch **OFF**.

⚠ WARNING

- **Be sure the Electric Parking Brake is released before driving. Failure to do so could cause brake failure and lead to an accident.**
- **Do not release the parking brake from outside the vehicle.**
- **To help avoid risk of injury or death through unintended operation of the vehicle and/or its systems, do not leave children, people who require the assistance of others or pets unat-**

tended in your vehicle. Additionally, the temperature inside a closed vehicle on a warm day can quickly become high enough to cause a significant risk of injury or death to people and pets.

- Before leaving the vehicle, confirm that the vehicle is held by the parking brake.

NOTE

- **Do not start driving while the parking brake is applied this may cause the parking brake to overheat or reduce its effectiveness, which could result in an accident.**
- **A buzzer will sound if the vehicle is driven without releasing the parking brake. See "Audible reminders" in the "2. Instruments and controls" section.**
- **While the Electric Parking Brake is applied or released, an operating sound is heard from the lower side of the rear seat. This is normal and does not indicate a malfunction.**
- **When the Electric Parking Brake is frequently applied and released in a short period of time, the parking brake may not operate in order to prevent the parking brake system from overheating. If this occurs, operate the Electric Parking Brake switch again after waiting approximately 1 minute.**
- The Electric Parking Brake can only be released with the power switch **ON**.

- If the Electric Parking Brake must be applied while driving in an emergency, pull up and hold the parking brake switch. When you release the parking brake switch, the parking brake will be released.
- While pulling up the Electric Parking Brake switch while driving, the parking brake is applied and a chime sounds. The parking brake indicator light in the meter and in the parking brake switch illuminate. This does not indicate a malfunction. The Electric Parking Brake indicator lights in the meter and in the parking brake switch turn off when the parking brake is released.
- When pulling the Electric Parking Brake switch up with the power switch OFF, the parking brake switch indicator light will continue to illuminate for a short period of time.

CAUTION

To park the vehicle in cold climates press the Park (P) button, and place suitable chocks at both the front and back of a wheel with the Electric Parking Brake released. If the Electric Parking Brake is applied in cold climates, the brake may become frozen and cannot be released.

DRIVING AWAY WHEN TOWING A TRAILER

Please note the following points to prevent the vehicle from rolling back unintentionally on a gradient.

- Pull and hold the parking brake switch and press the accelerator. The parking brake will remain engaged and prevent any tendency to roll back down the slope.
- You can release the parking brake switch as soon as the e-POWER system is delivering enough power to the wheels.

Depending on the weight of the vehicle and trailer and the steepness of the slope, there may be a tendency to roll back downhill when driving away from a standstill. You can prevent this by pulling up the parking brake switch as you press the accelerator (in the same way as with a conventional handbrake).

AUTOMATIC BRAKE HOLD

The Automatic brake hold function maintains the braking force without the driver having to depress the brake pedal when the vehicle is stopped at a traffic light or an intersection.

As soon as the driver depresses the accelerator pedal again, the Automatic brake hold function is deactivated and the braking force is released. The operating status of Automatic brake hold can be displayed.

WARNING

- The Automatic brake hold function is not designed to hold the vehicle on a steep hill or slippery road. Never use the Automatic brake hold function when the vehicle is stopped on a steep hill or a slippery road. Failure to do so may cause the vehicle to move.
- Warnings may appear to request that the driver retake control by depressing the brake pedal.
- When the Automatic brake hold function is activated, but fails to maintain the vehicle at a standstill, depress the brake pedal to stop the vehicle. If the vehicle unexpectedly moves due to the outside conditions, the chime may sound and warnings may appear.
- Be sure to deactivate the Automatic brake hold function when using a drive-through car wash or towing your vehicle.
- Make sure the shift is in the P (Park) position and apply the Electric Parking Brake when parking your vehicle, exiting the vehicle, or loading or unloading luggage. Failure to do so

could cause the vehicle to move or roll away unexpectedly and result in serious personal injury or property damage.

- If any of the following conditions occur, the Automatic brake hold function may not function. Have the system checked promptly by a NISSAN dealer or qualified workshop. Failure to operate the vehicle in accordance with these conditions could cause the vehicle to move or roll away unexpectedly and result in serious personal injury or property damage

- A warning message appears.
- The indicator light on the Automatic brake hold switch does not illuminate when the switch is pushed.

- When the vehicle stops on a slope, depress the brake pedal firmly until the Automatic brake hold indicator light (green) illuminates.

- The Automatic brake hold function will not be activated if the slip indicator light, Electric Parking Brake indicator light, Brake system warning light (yellow), or master warning light illuminates and the [Chassis Control System Fault See Owner's Manual] warning message appears.

The Automatic brake hold function is operated by applying sufficient braking force to hold the vehicle in its place, so there are cases when this hold function is maintained even if the accelerator pedal is depressed. In this situation, it is advised to depress the brake pedal first, then to turn off the Automatic brake hold switch. This will cancel the hold function

NOTE

To maintain the braking force to keep the vehicle to a standstill, a noise may be heard. This is not a malfunction.

HOW TO ACTIVATE/DEACTIVATE AUTOMATIC BRAKE HOLD

Activation of the Automatic brake hold function

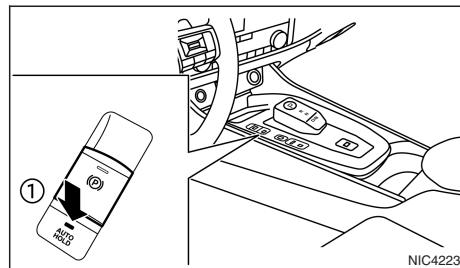

1. With the power switch switched **ON**, press the Automatic brake hold switch (1). The indicator light on the Automatic brake hold switch illuminates.
2. When the Automatic brake hold function goes into standby, the Automatic brake hold indicator light (white) illuminates.

To use the Automatic brake hold function, the following conditions need to be met:

- The driver's seat belt is fastened.
- The Electric Parking Brake is released.
- The vehicle is not in the **P** (Park) position.

- The vehicle is not parked on a steep hill.

NOTE

The Automatic brake hold function retains the last state until the driver changes the option even if the power switch is switched off.

How to deactivate the Automatic brake hold function

While the Automatic brake hold function is activated, push the Automatic brake hold switch to turn off the Automatic brake hold indicator light and deactivate the Automatic brake hold function. To deactivate the Automatic brake hold function while the braking force has been maintained by the Automatic brake hold function, depress the brake pedal and push the Automatic brake hold switch.

CAUTION

Make sure to firmly depress and hold the brake pedal when turning off the Automatic brake hold function while the braking force is applied. When the Automatic brake hold function is deactivated, the braking force will be released. This could cause the vehicle to move or roll away unexpectedly.

Failure to prevent the vehicle from rolling may result in serious personal injury or property damage.

HOW TO USE THE AUTOMATIC BRAKE HOLD FUNCTION

For additional information on using Automatic brake hold, refer to the instructions outlined in this section.

To maintain braking force automatically

With the Automatic brake hold function activated and the Automatic brake hold indicator light (white) illuminated, depress the brake pedal to stop the vehicle and the Automatic brake hold indicator light (green) illuminates.

The braking force is automatically applied without your foot pressing on the brake pedal. While the braking force is maintained, the Automatic brake hold indicator light (green) illuminates. See "Warning lights, indicator lights and audible reminders" in the "2. Instruments and controls" section.

NOTE

The Automatic brake hold indicator light (green) will not illuminate if the brake pedal is not depressed with sufficient force to hold the vehicle or is released too quickly when the vehicle is stopped.

CAUTION

Confirm the Automatic brake hold indicator light (green) is illuminated before removing your foot from the brake pedal.

To start the vehicle from standstill

With the vehicle **not** in the **P** (Park) or **N** (Neutral) position, depress the accelerator pedal while the braking force is maintained. The braking force will automatically be released to restart the vehicle. Automatic brake hold indicator light (white) illuminates and Automatic brake hold will return to standby.

Parking

When the vehicle is in the **P** (Park) position with the braking force maintained by the Automatic brake hold function, the Electric Parking Brake will automatically be applied and the braking force of Automatic brake hold will be released. The Automatic brake hold indicator light turns off. When the Electric Parking Brake is applied with the braking force maintained by the Automatic brake hold function, the braking force of Automatic brake hold will be released. The Automatic brake hold indicator light turns off.

NOTE

- **Under the following conditions, the Electric Parking Brake will automatically be applied and the braking force of Automatic brake hold will be released and the Automatic brake hold indicator light turns off.**
 - The braking force is applied by the Automatic brake hold function for 3 minutes or longer.
 - The vehicle is in the **P** (Park) position.
 - The Electric Parking Brake is applied manually.

- The driver's seat belt is unfastened.
- The driver's door is opened.
- The power switch is switched OFF.
- A malfunction occurs in the Automatic brake hold function.
- **When the vehicle stops, but the braking force is not automatically applied, depress the brake pedal firmly until the Automatic brake hold indicator light (green) illuminates.**

DRIVING POSITION MEMORY SYSTEM (where fitted)

The Driving Position Memory System features two functions:

- Memory Storage
- Entry/exit function

MEMORY STORAGE

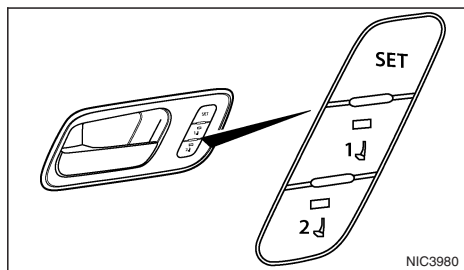

Two positions for the driver's seat and outside mirrors can be stored in the Driving Position Memory System memory. Follow these procedures to use the memory system.

1. Adjust the driver's seat and outside mirrors to the desired position by manually operating each adjustment switch.
2. Push the **<SET>** switch and, within 5 seconds, push the desired memory switch (1 or 2).

The indicator light for the pushed memory switch will stay on for approximately 5 seconds after pushing the switch.

When the memory is stored in the memory, a buzzer will sound.

If a new position is stored in the same memory switch, the previous memory will be deleted.

Confirming memory storage

Push the **<SET>** switch. If the main memory has not been stored, the indicator light will come on for approximately 0.5 seconds. When the memory has a position stored, the indicator light will stay on for approximately 5 seconds.

Selecting memorised position

1. Stop the vehicle in a safe location and apply the parking brake.
2. Push the memory switch (1 or 2) fully for at least 1 second.

The driver's seat will move to the memorised position with the indicator light flashing, and then the light will stay on for approximately 5 seconds.

System operation

The Driving Position Memory System will not work or will stop operating under the following conditions:

- When the vehicle is moving.
- When the adjusting switch for the driver's seat is operated while the Driving Position Memory System is operating.
- When the memory switch 1 or 2 is pushed for less than 1 second.
- When the seat has already been moved to the memorised position.
- When no position is stored in the memory switch.

- When the shift system is shifted from P (Park) to any other position.

Linking user profile to a stored memory position (models with navigation system)

The user profile can be linked to a stored memory position with the following procedure.

1. Switch the power switch ON while carrying the Intelligent Key that was registered to the vehicle with a user profile function.

NOTE



Make sure the other Intelligent Key is far apart. Otherwise, the vehicle may detect the wrong Intelligent Key.

2. Adjust the position of the driver's seat and outside mirrors.
3. Switch the power switch OFF.

The next time you log in (selecting the user on the display) after switching the power switch ON while carrying the Intelligent Key, the system will automatically adjust to the memorised driving position. (See the separate NissanConnect Owner's Manual.)

Linking an Intelligent Key to a stored memory position (models without navigation system)

Each Intelligent Key can be linked to a stored memory position (memory switch 1 or 2) with the following procedure.

1. Follow steps 1-3 in "Memory Storage" earlier in this section for storing the memory position.
2. The indicator light for the pushed memory switch will come on. While the indicator light is on for 5 seconds, press the  button and the  button on the Intelligent Key in succession. The hazard warning light will blink and the indicator light of the linked memory switch will blink twice. After the indicator light goes off, the Intelligent Key is linked to that memory setting.

Once it is linked, when the power switch is OFF, pressing the  button on the Intelligent Key will move the driver's seat and outside mirrors to the linked memory switch position.

NOTE

- If a new memory position is stored in the linked memory switch, then the Intelligent Key will link the new position and overwrites the previous position.
- The linked memory feature can be turned ON or OFF using the [I-Key Link] setting in the vehicle information display. See "[Settings]" in the "3. Instruments and controls" section.

ENTRY/EXIT FUNCTION

This system is designed so that the driver's seat will automatically move. This allows the driver to get into and out of the driver's seat more easily.

Operation

The driver's seat will slide backward:

- When the driver's door is opened and the power switch is **OFF**.
- When the power switch is switched **OFF** with the driver's door open.







The driver's seat will return to the previous position:



- When the power switch is switched **ON**.

NOTE

The driver's seat will not return to the previous position if the seat switch is operated when the seat is at the exit position.

The entry/exit function can be adjusted or cancelled through the [Vehicle settings] the vehicle information display by performing the following:

1. Press the  or  buttons on the steering wheel until the [Settings] menu is displayed in the Vehicle Information Display and press the **<OK>** button.
2. Use the  and  buttons on the steering wheel to highlight [Vehicle Settings] and press the **<OK>** button.
3. Use the  and  buttons on the steering wheel to highlight [Driving Position] and press the **<OK>** button.

4. Use the  and  buttons on the steering wheel to highlight [Exit Seat Slide] and press the **<OK>** button.

Use the scroll dial to turn the [Exit Seat Slide] function **ON** or **OFF**.

STEERING WHEEL

⚠ WARNING

- Do not adjust the steering wheel while driving. You could lose control of your vehicle and cause an accident.
- Do not adjust the steering wheel any closer to you than is necessary for proper steering operation and comfort. The driver's air bag inflates with great force. If you are unrestrained, leaning forward, sitting sideways or out of position in any way, you are at greater risk of injury or death in a crash. You may also receive serious or fatal injuries from the air bag if you are up against it when it inflates. Always sit back against the seatback and as far away as practical from the steering wheel. Always use the seat belts.

TILT AND TELESCOPIC OPERATION

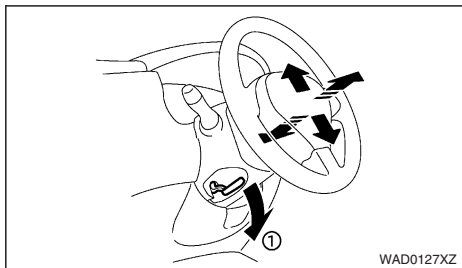

Pull the lock lever ① down and adjust the steering wheel up, down, forward or rearward to the desired position. Push the lock lever up securely to lock the steering wheel in place.

SUN VISORS

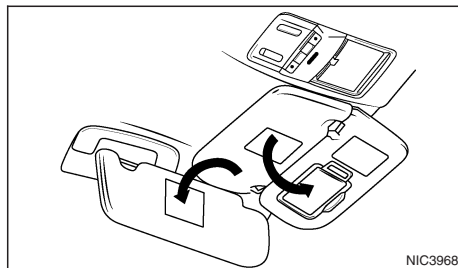

CAUTION

Do not store the sun visor before returning it to its original position.

1. To block out glare from the front, move the main sun visor downwards.
2. To block glare from the side, remove the main sun visor from the centre mount and move it to the side.

MIRRORS

INSIDE REAR-VIEW MIRROR

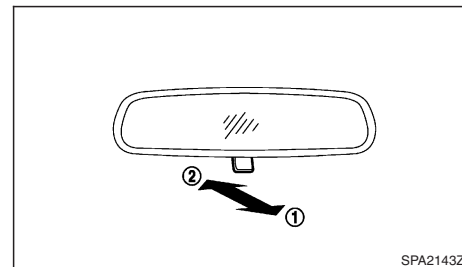

- ① Day position
- ② Night position

The night position ② will reduce glare from the headlights of vehicles behind you at night.

⚠ WARNING

Only use the night position ② when necessary, as it reduces rear-view clarity.

AUTOMATIC ANTI-DAZZLING INSIDE MIRROR (where fitted)

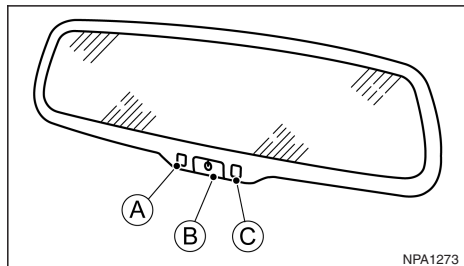

The inside mirror is designed so that it automatically adjusts the reflection according to the intensity of the following vehicle's headlights on the sensor **C**.

The automatic anti-dazzling inside mirror will operate when the power switch is ON. The light **A** shows the system is activated.

The automatic anti-dazzling inside mirror can be deactivated by pressing the power button **B**. The light **A** will turn off to show system deactivation.

CAUTION

Do not cover the sensor, hang any object on the mirror or spray glass cleaner directly on the mirror. Doing so will reduce the sensitivity of the sensor, resulting in improper operation.

OUTSIDE REAR-VIEW MIRRORS

⚠ WARNING

- Check the position of all mirrors before driving. Altering their position while driving could distract your attention from the driving operation.
- Objects viewed in the outside mirrors are closer than they appear.
- Never touch the outside rear-view mirrors while they are in motion. Doing so may pinch your fingers or damage the mirror.
- Never drive the vehicle with the outside rear-view mirrors folded. This reduces rear-view visibility and may lead to an accident.

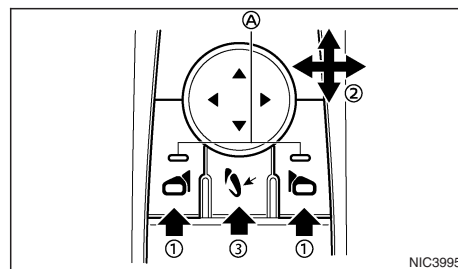

Adjusting — Remote control (where fitted)

Select the left or right outside rear-view mirror using the appropriate selection switch **1** (the indicator light **A** on the selected mirror switch illuminates), then adjust the mirror to the desired position by pushing the control as illustrated **2**.

Folding — Manual control

Fold the outside rear-view mirror by pushing it towards the rear of the vehicle.

Folding — Remote control (where fitted)

The outside rear-view mirrors fold when the outside rear-view mirror folding button **3** is pressed. To unfold, push the button again.

NOTE

If the mirror becomes displaced from its adjusted position, use the following procedure to return it to the correct geared position:

1. Fold the mirrors electronically using the outside rear-view mirror folding button.
2. Wait until the mirror emits a strong noise, this confirms that the mirror has correctly engaged.
3. Fold out the mirrors electronically using the outside rear-view mirror folding button.
4. Adjust the mirror to the correct driving angle using the remote control, see "Adjusting — Remote control (where fitted)" earlier in this section.

Mirror Fold

Auto Fold Off
Unfold at Ignition
Unfold at Unlock

NIC4119

Folding — Auto Fold (where fitted)

The outside rear-view mirrors automatically unfold when the power switch is switched on or when the vehicle doors are unlocked. Use the [Mirror Fold] menu of the Vehicle Information Display to select the moment that the mirrors are to be automatically folded and unfolded. The Auto Fold feature can also be switched off. See "[Mirror Fold]" in the "2. Instruments and controls" section.

NOTE

The outside rear view mirror folding button can be used to override the Auto Fold feature.

Reverse tilt-down feature (where fitted)

When reversing the vehicle, the right or left outside mirror will turn downward automatically to provide better rear visibility.

1. Switch the power switch to the ON position.
2. Shift to the R (Reverse) position.
3. Choose the right or left outside mirror by operating the outside mirror control switch.
4. The selected outside mirror surface tilts downward

When one of the following conditions has occurred, the outside mirror surface will return to its original position.

- The vehicle is shifted out of the R (Reverse) position.
- The vehicle speed exceeds 8 km/h (5 MPH).
- The selected outside mirror is deselected using the outside mirror control switch.
- The power switch is switched to the OFF position.
- The e-POWER system is stopped.

VANITY MIRROR

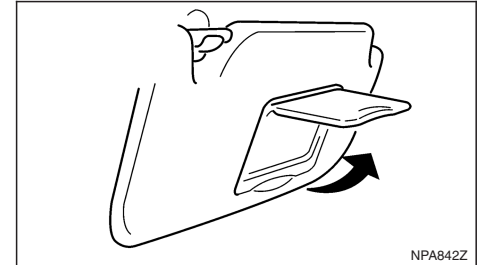

Left hand drive

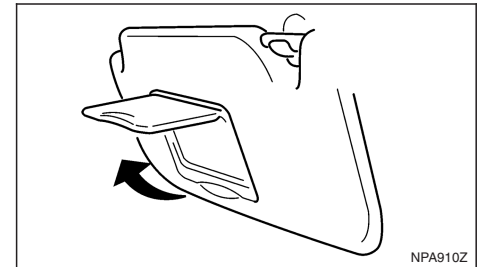

Right hand drive

To use the front vanity mirror, pull down the sun visor and lift up the cover.

The light over the vanity mirror will turn on when the cover on the vanity mirror is opened.

When the cover is closed, the light will turn off.

The lights will also turn off after a period of time when the lights remain illuminated to prevent the battery from becoming discharged.

NOTE

4 Display screen, heater and air conditioner, and audio system

Safety precautions.....	184	Heater and air conditioner.....	203
Rear-view Monitor (where fitted).....	184	Operating tips (for automatic air conditioner).....	203
Rear-view Monitor system operation.....	185	Automatic air conditioner.....	204
How to read the displayed lines.....	185	Servicing air conditioner.....	207
Difference between predictive and actual		Audio system.....	208
distances.....	185	Audio operation precautions.....	208
How to park with predictive course lines.....	187	Antenna.....	211
Adjusting the display.....	188	FM/AM radio (with DAB) (where fitted).....	212
How to turn on and off predictive course lines.....	188	Audio main operation.....	213
Rear-view Monitor system limitations.....	188	Radio operation.....	215
System maintenance.....	189	USB (Universal Serial Bus) Connection Port.....	217
Intelligent Around View Monitor (IAVM).....	190	iPod® player operation (where fitted).....	218
Intelligent Around View Monitor system		Bluetooth® operation.....	219
operation.....	191	Apple CarPlay and Android Auto (where fitted).....	223
Difference between predictive and actual		NissanConnect (where fitted).....	224
distances.....	194	Safety information.....	224
How to park with predictive course lines.....	195	Navigation (where fitted).....	226
How to switch the display.....	196	Audio operation precautions.....	226
How to adjust the screen view.....	197	How to update map data (where fitted).....	226
Intelligent Around View Monitor system		Updating system software (where fitted).....	226
limitations.....	197	Regulatory information.....	227
System maintenance.....	198	Trademarks.....	229
Moving Object Detection (MOD).....	199	Licences.....	229
MOD system operation.....	199	Steering wheel switches for audio control (where	
Turning MOD on and off.....	201	fitted).....	230
MOD system limitations.....	201	Control buttons.....	230
System maintenance.....	201	Mobile phone integration for FM AM radio (where	
Vents.....	202	fitted).....	230
Centre vents.....	202	Bluetooth® mobile phone feature.....	230
Side vents.....	202	Hands-free telephone control.....	233
Rear vents.....	202		

SAFETY PRECAUTIONS

⚠ WARNING

- Do not adjust the heater and air conditioner controls or audio controls while driving so that full attention may be given to vehicle operation.
- If you notice any sparks, smoke, fumes, or fire, immediately stop the vehicle and contact your nearest NISSAN dealer or qualified workshop. Ignoring such conditions may lead to an accident, fire or electric shock.

CAUTION

To prevent battery discharge, do not use the system for extended periods of time when the e-POWER system is not running.

REAR-VIEW MONITOR (where fitted)

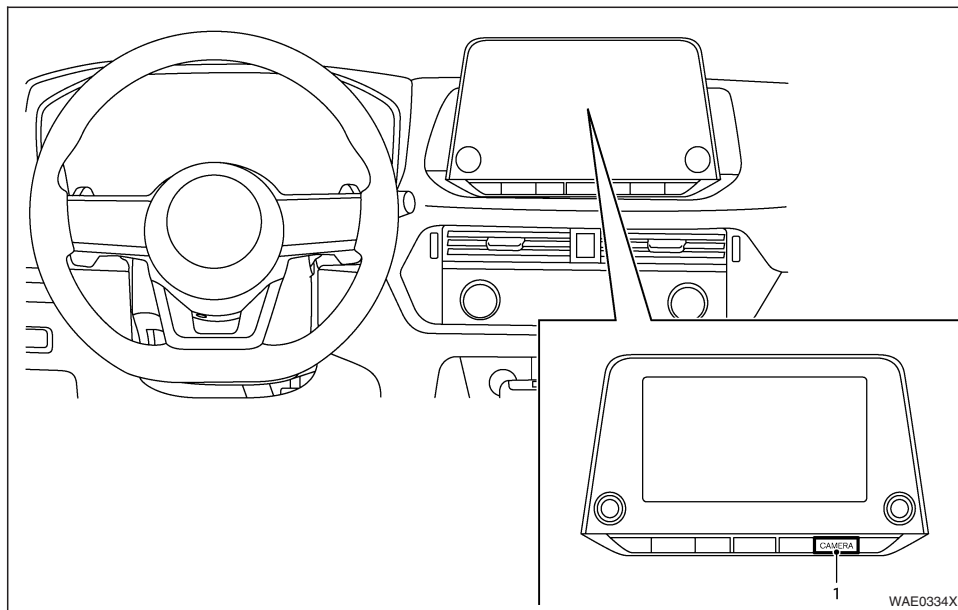

1. <CAMERA> button

⚠ WARNING

Failure to follow the warnings and instructions for proper use of the Rear-view Monitor could result in serious injury or death.

- Rear view Monitor is a convenience feature and is not a substitute for proper reversing.

Always turn and look out the windows, and check mirrors to be sure that it is safe to move before operating the vehicle. Always reverse slowly.

- The system is designed as an aid to the driver in showing large stationary objects directly behind the vehicle, to help avoid damaging the vehicle.

- The distance guide line and the vehicle width line should be used as a reference only when the vehicle is on a level paved surface. The distance viewed on the monitor is for reference only and may be different than the actual distance between the vehicle and displayed objects.

CAUTION

There is a transparent cover over the camera lens. Do not scratch the cover when cleaning dirt or snow from it.

The Rear-view Monitor system automatically shows a view from the rear of the vehicle when the vehicle is shifted into the R (Reverse) position.

The radio can still be heard while the Rear-view Monitor is active.

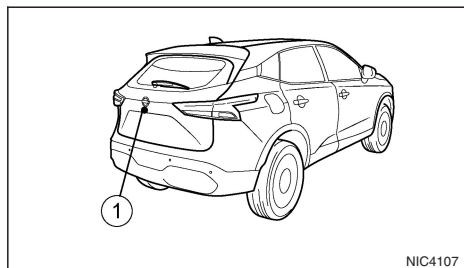

To display the rear view, the Rear-view Monitor system uses a camera ① located just above the vehicle's number plate.

REAR-VIEW MONITOR SYSTEM OPERATION

When the power switch is switched ON, shift to the R (Reverse) position to operate the Rear-view Monitor.

HOW TO READ THE DISPLAYED LINES

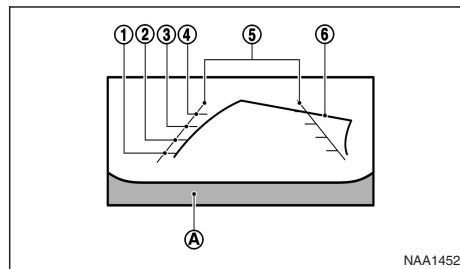

Guiding lines which indicate the vehicle width and distances to objects with reference to the bumper line A are displayed on the monitor.

Distance guide lines:

Indicate distances from the vehicle body.

- ① approximately 0.5 m (1.5 ft) – red
- ② approximately 1 m (3 ft) – yellow
- ③ approximately 2 m (7 ft) – green
- ④ approximately 3 m (10 ft) – green

Vehicle width guide lines ⑤:

Indicate the vehicle width when reversing.

Predictive course lines ⑥:

Indicate the predictive course when reversing. The predictive course lines will be displayed on the monitor when the vehicle is in the R (Reverse) position and if the steering wheel is turned. The predictive course lines will move depending on how much the steering wheel is turned and will not be displayed while the steering wheel is in the straight ahead position.

The vehicle width guide lines and the width of the predictive course lines are wider than the actual width and course.

DIFFERENCE BETWEEN PREDICTIVE AND ACTUAL DISTANCES

The displayed guidelines and their locations on the ground are for approximate reference only. Objects on uphill or downhill surfaces or projecting objects will be actually located at distances different from those displayed in the monitor relative to the guidelines (refer to illustrations). When in doubt, turn around and view the objects as you are reversing, or park and exit the vehicle to view the positioning of objects behind the vehicle.

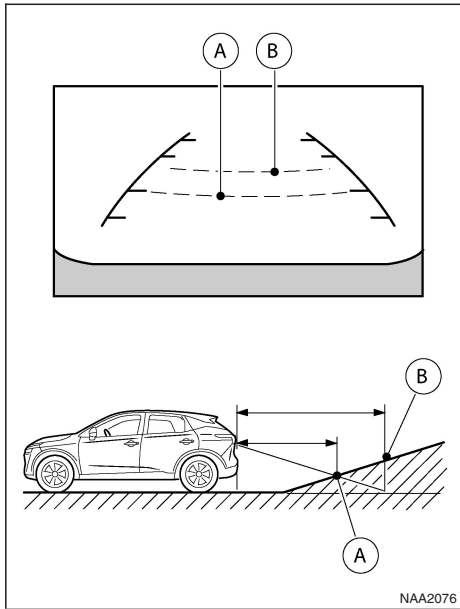

Reversing up a steep hill

When reversing a vehicle up a hill, the distance guide lines and the vehicle width guide lines are shown closer than the actual distance. For example, the display shows 1 m (3 ft) to the place ①, but the actual 1 m (3 ft) distance on the hill is the place ②. Note that any object on the hill is viewed in the monitor further than it appears.

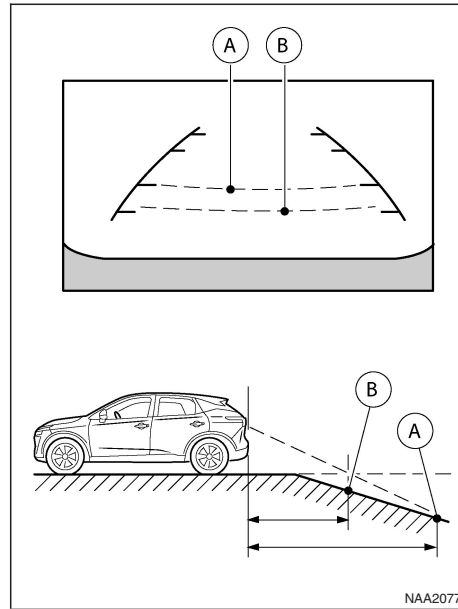

Reversing down a steep hill

When reversing the vehicle down a hill, the distance guide lines and the vehicle width guide lines are shown further than the actual distance. For example, the display shows 1 m (3 ft) to the place ①, but the actual 1 m (3 ft) distance on the hill is the place ②. Note that any object on the hill is viewed in the monitor closer than it appears.

Reversing near a projecting object

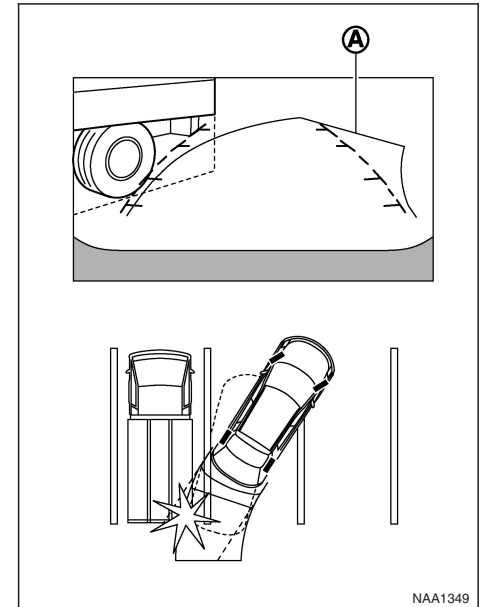

The predictive course lines ① do not touch the object in the display. However, the vehicle may hit the object if it projects over the actual moving course.

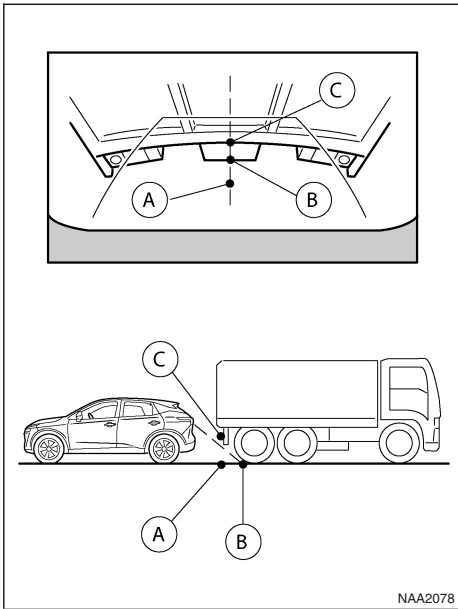

Reversing closer to a projecting object

The position ③ is shown further than the position ② in the display. However, the position ③ is actually at the same distance as the position ①. The vehicle may hit the object when moving toward the position ① if the object projects over the actual moving course.

HOW TO PARK WITH PREDICTIVE COURSE LINES

⚠ WARNING

- If the tyres are replaced with different sized tyres, the predictive course lines may be displayed incorrectly.
- On a snow-covered or slippery road, there may be a difference between the predictive course line and the actual course line.
- If the battery is disconnected or becomes discharged, the predictive course lines may be displayed incorrectly. If this occurs, please perform the following procedures:
 - Turn the steering wheel from lock to lock while the e-POWER system is running.
 - Drive the vehicle on a straight road for more than 5 minutes.
- When the steering wheel is turned with the power switch switched ON, the predictive course lines may be displayed incorrectly.

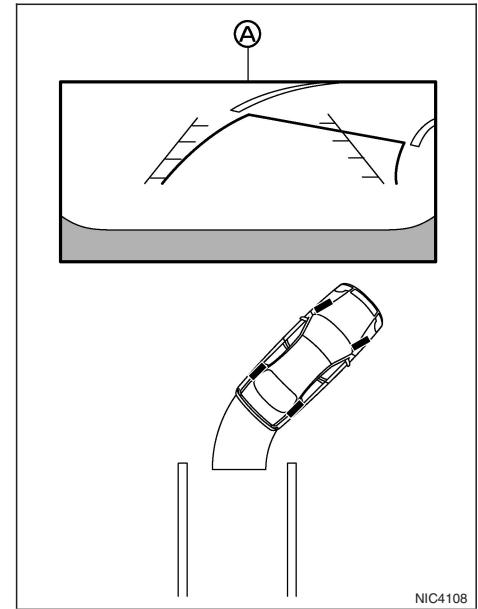

1. Visually check that the parking space is safe before parking your vehicle.
2. The rear view of the vehicle is displayed on the screen ① when the vehicle is shifted to the R (Reverse) position.

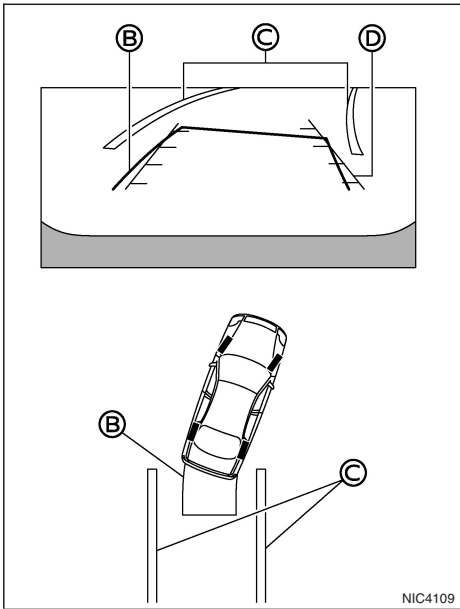

3. Slowly reverse the vehicle adjusting the steering wheel so that the predictive course lines (B) enter the parking space (C).
4. Manoeuvre the steering wheel to make the vehicle width guide lines (D) parallel to the parking space (C) while referring to the predictive course lines.

5. When the vehicle is parked in the space completely, push the P position switch and apply the parking brake.

ADJUSTING THE DISPLAY

To adjust the display brightness of the Rear-view Monitor, use the settings described in the separately provided NissanConnect owner's manual.

NOTE

Do not adjust any of the display settings while the vehicle is moving. Make sure the parking brake is firmly applied.

HOW TO TURN ON AND OFF PREDICTIVE COURSE LINES

Pushing the <CAMERA> button while the vehicle is in the R (Reverse) position can turn on and off the predictive course lines.

REAR-VIEW MONITOR SYSTEM LIMITATIONS

⚠ WARNING

Listed below are the system limitations for Rear-view Monitor. Failure to operate the vehicle in accordance with these system limitations could result in serious injury or death.

- **The system cannot completely eliminate blind spots and may not show every object.**
- **Underneath the bumper and the corner areas of the bumper cannot be viewed on the Rear-view Monitor because of its monitoring range limitation. The system will not show small ob-**

jects below the bumper, and may not show objects close to the bumper or on the ground.

- **Objects viewed in the Rear-view Monitor differ from actual distance because a wide-angle lens is used.**
- **Objects in the Rear-view Monitor will appear visually opposite compared to when viewed in the rear view and outside mirrors.**
- **Use the displayed lines as a reference. The lines are highly affected by the number of occupants, fuel level, vehicle position, road conditions and road grade.**
- **Make sure that the tailgate is securely closed when reversing.**
- **Do not put anything on the rear view camera. The rear view camera is installed above the number plate.**
- **When washing the vehicle with high-pressure water, be sure not to spray it around the camera. Otherwise, water may enter the camera unit causing water condensation on the lens, a malfunction, fire or an electric shock.**
- **Do not strike the camera. It is a precision instrument. Otherwise, it may malfunction or cause damage resulting in a fire or an electric shock.**

The following are operating limitations and do not represent a system malfunction:

- When the temperature is extremely high or low, the screen may not clearly display objects.
- When strong light directly shines on the camera, objects may not be displayed clearly.

- Vertical lines may be seen in objects on the screen. This is due to strong reflected light from the bumper.
- The screen may flicker under fluorescent light.
- The colours of objects on the Rear view Monitor may differ somewhat from the actual colour of objects.
- Objects on the monitor may not be clear in a dark environment.
- There may be a delay when switching between views.
- If dirt, rain or snow accumulates on the camera, the Rear view Monitor may not display objects clearly. Clean the camera.
- Do not use wax on the camera lens. Wipe off any wax with a clean cloth dampened with a diluted mild cleaning agent, then wipe with a dry cloth.

SYSTEM MAINTENANCE

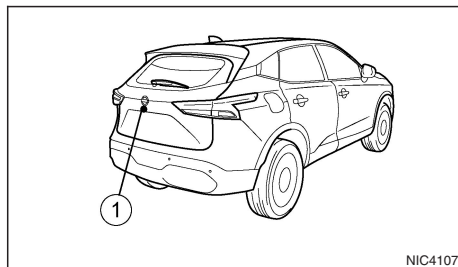

CAUTION

- **Do not use alcohol, benzine or thinner to clean the camera. This will cause discolouration.**
- **Do not damage the camera as the monitor screen may be adversely affected.**

If dirt, rain or snow accumulates on the camera ①, Rear-view Monitor may not display objects clearly. Clean the camera by wiping it with a cloth dampened with a diluted mild cleaning agent and then wiping it with a dry cloth.

INTELLIGENT AROUND VIEW MONITOR (IAVM)

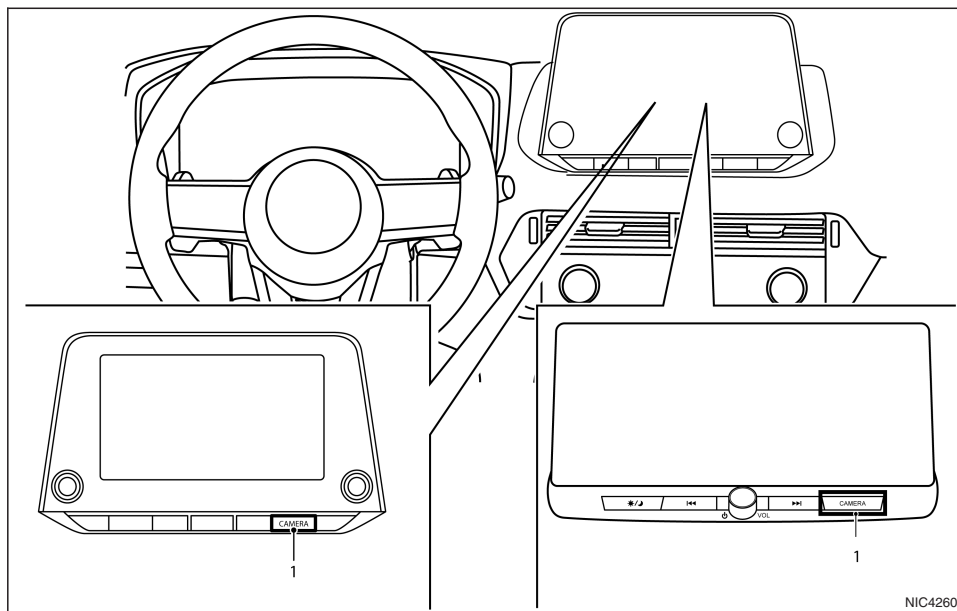

1. <CAMERA> button

⚠ WARNING

- Failure to follow the warnings and instructions for the proper use of the Intelligent Around View Monitor system could result in serious injury or death.

- The Intelligent Around View Monitor is a convenience feature and is not a substitute for proper vehicle operation because it has areas where objects cannot be viewed. The four corners of the vehicle in particular, are areas where objects do not always appear in the bird's-eye, front, or rear views. Always check

your surroundings to be sure that it is safe to move before operating the vehicle. Always operate the vehicle slowly.

- The driver is always responsible for safety during parking and other manoeuvres.

CAUTION

Do not scratch the lens when cleaning dirt or snow from the front of the camera.

The Intelligent Around View Monitor system is designed as an aid to the driver in situations such as slot parking or parallel parking.

The monitor displays various views of the position of the vehicle in a split screen format. Not all views are available at all times.

Available views:

- Front view
A view of the front of the vehicle
- Rear view
A view of the rear of the vehicle
- Bird's-eye view
The surrounding view of the vehicle from above
- Front-side view
The view around and ahead of the front passenger's side wheel
- Front-wide view
A wider area view of the front view
- Rear-wide view
A wider area view of the rear view

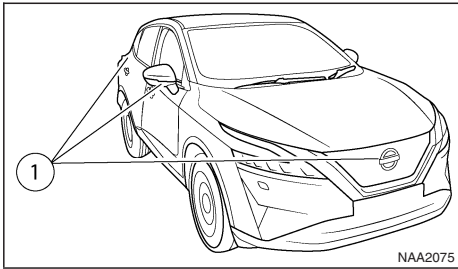

To display the multiple views, the Intelligent Around View Monitor system uses cameras ① located on the front grille, on the vehicle's outside mirrors and one just above the vehicle's rear number plate.

INTELLIGENT AROUND VIEW MONITOR SYSTEM OPERATION

When the power switch switched ON, push the **<CAMERA>** button on the instrument panel or shift to the R (Reverse) position to operate the Intelligent Around View Monitor.

The screen displayed on the Intelligent Around View Monitor will automatically return to the previous screen 3 minutes after the **<CAMERA>** button has been pushed with the shift system in a position other than the R (Reverse) position.

Available views

⚠ WARNING

- The distance guide lines and the vehicle width guide lines should be used as a reference only when the vehicle is on a paved, level surface. The apparent distance viewed on the monitor may be different than the actual distance between the vehicle and displayed objects.
 - Use the displayed lines and the bird's-eye view as a reference. The lines and the bird's-eye view are greatly affected by the number of occupants, fuel level, vehicle position, road condition and road grade.
 - If the tyres are replaced with different sized tyres, the predictive course lines and the bird's-eye view may be displayed incorrectly.
 - When driving the vehicle up a hill, objects viewed in the monitor are farther than they appear. When driving the vehicle down a hill, objects viewed in the monitor are closer than they appear.
 - Objects in the rear view will appear visually opposite compared to when viewed in the rearview and outside mirrors.
 - Use the mirrors or actually look to properly judge distances to other objects.
- The distance between objects viewed in the rear view differs from actual distance because a wide-angle lens is used.
 - On a snow-covered or slippery road, there may be a difference between the predictive course line and the actual course line.
 - The vehicle width and predictive course lines are wider than the actual width and course.

Front and rear view:

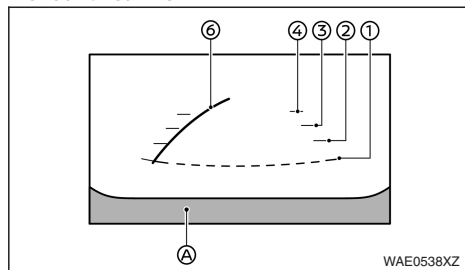

Front view

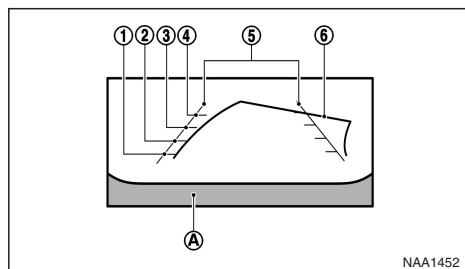

Rear view (example)

Guiding lines that indicate the approximate vehicle width and distances to objects with reference to the vehicle body line (A), are displayed on the monitor.

Distance guide lines:

Indicate distances from the vehicle body.

- Red line ①: approx. 0.5 m (1.5 ft)
- Yellow line ②: approx. 1 m (3 ft)
- Green line ③: approx. 2 m (7 ft)
- Green line ④: approx. 3 m (10 ft)

Vehicle width guide lines ⑤:

Indicate the vehicle width.

Predictive course lines ⑥:

Indicate the predictive course when operating the vehicle. The predictive course lines will move depending on how much the steering wheel is turned. The predictive course lines in the rear view will not be displayed while the steering wheel is in the straight ahead position.

The front view will not be displayed when the vehicle speed is above 10 km/h (6 MPH).

NOTE

- **When the monitor displays the front view and the steering wheel turns about 90 degrees or less from the straight ahead position, both the right and left predictive course lines ⑥ are displayed. When the steering wheel turns about 90 degrees or more, the predictive course line is displayed only on the opposite side of the turn.**

Bird's-eye view:

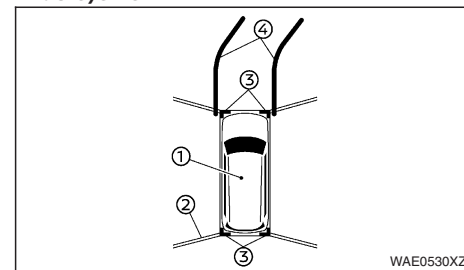

The bird's-eye view shows the overhead view of the vehicle which helps confirm the vehicle position and the predictive course to a parking space.

The vehicle icon ① shows the position of the vehicle. Note that the distance between objects viewed in the bird's-eye view differs from the actual distance.

The areas between the camera views ② (where fitted) are indicated in black.

After the power switch is switched ON, the non-viewable area ② (where fitted) is highlighted in yellow for a few seconds after the bird's-eye view is displayed.

The amber markers ③ are displayed when the sonar is turned off or the sonar is not available at the corner.

The predictive course lines ④ indicate the predicted course when operating the vehicle.

⚠ WARNING

- Objects in the bird's-eye view will appear farther than the actual distance.
- Tall objects, such as a kerb or vehicle, may be misaligned or not displayed at the seam of the views.
- Objects that are above the camera cannot be displayed.
- The view for the bird's-eye view may be misaligned when the camera position alters.
- A line on the ground may be misaligned and is not seen as being straight at the seam of the views. The misalignment will increase as the line proceeds away from the vehicle.

Front-side view:

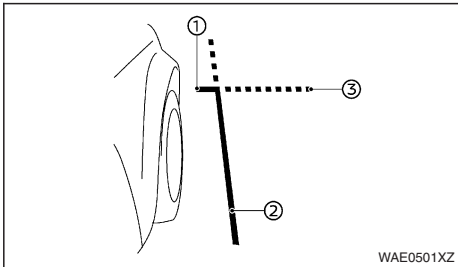

Guiding lines:

Guiding lines that indicate the approximate width and the front end of the vehicle are displayed on the monitor.

The front-of-vehicle line ① shows the front part of the vehicle.

The side-of-vehicle line ② shows the vehicle width including the outside mirrors.

The extensions ③ of both the front ① and side ② lines are shown with a green dotted line.

CAUTION

The turn signal light may look like the side-of-vehicle line. This is not a malfunction.

Front-wide/rear-wide view:

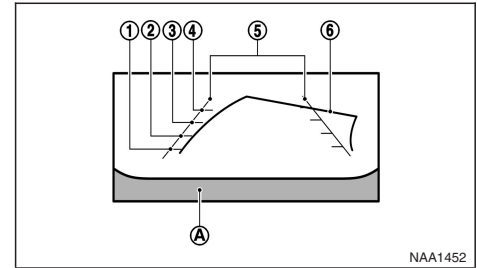
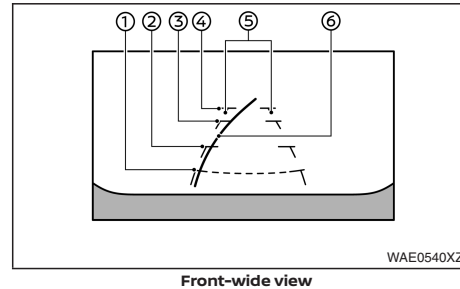

Rear-wide view

While the front view/rear view shows a normal view on the split screens, the front-wide view/rear-wide view shows a wider area on the entire screen and allows checking of the blind corners on the right and left sides.

Distance guide lines ① - ④:

Indicate distances from the vehicle body.

- Red line ①: approx. 0.5 m (1.5 ft)
- Yellow line ②: approx. 1 m (3 ft)
- Green line ③: approx. 2 m (7 ft)
- Green line ④: approx. 3 m (10 ft)

Vehicle width guide lines ⑤:

Indicate the approximate vehicle width.

Predictive course lines ⑥:

Indicate the predictive course when operating the vehicle. The predictive course lines will move depending on how much the steering wheel is turned. The predictive course lines in the rear-wide view will not be displayed while the steering wheel is in the straight ahead position.

The front-wide view will not be displayed when the vehicle speed is above 10 km/h (6 MPH).

NOTE

- When the monitor displays the front-wide view and the steering wheel turns about 90 degrees or less from the straight ahead position, both the right and left predictive course lines ⑥ are displayed. When the steering wheel turns about 90 degrees or more, the predictive course line is displayed only on the opposite side of the turn.

DIFFERENCE BETWEEN PREDICTIVE AND ACTUAL DISTANCES

The displayed guide lines and their locations on the ground are for approximate reference only. Objects on uphill or downhill surfaces or projecting objects will be actually located at distances different from those displayed in the monitor relative to the guide lines (refer to illustrations). When in doubt, turn around and view the objects as you are reversing, or park and exit the vehicle to view the positioning of objects behind the vehicle.

Reversing up a steep hill

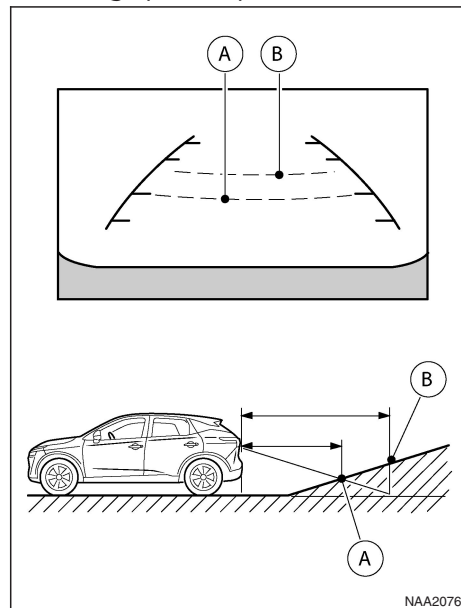

When reversing a vehicle up a hill, the distance guide lines and the vehicle width guide lines are shown closer than the actual distance. For example, the display shows 1 m (3 ft) to the place ①, but the actual 1 m (3 ft) distance on the hill is the place ②. Note that any object on the hill is viewed in the monitor further than it appears.

Reversing down a steep hill

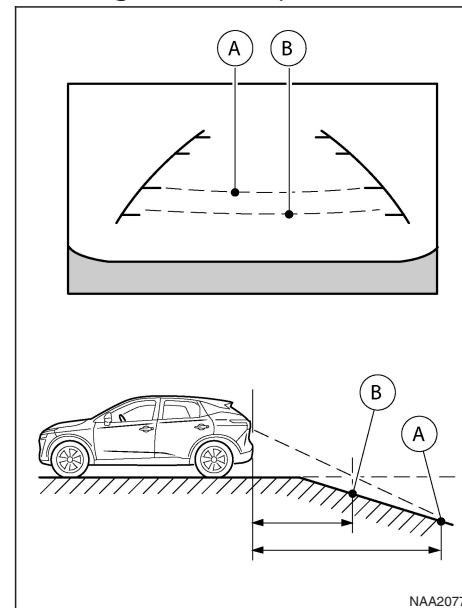

When reversing the vehicle down a hill, the distance guide lines and the vehicle width guide lines are shown further than the actual distance. For example, the display shows 1 m (3 ft) to the place ①, but the actual 1 m (3 ft) distance on the hill is the place ②. Note that any object on the hill is viewed in the monitor closer than it appears.

Reversing near a projecting object

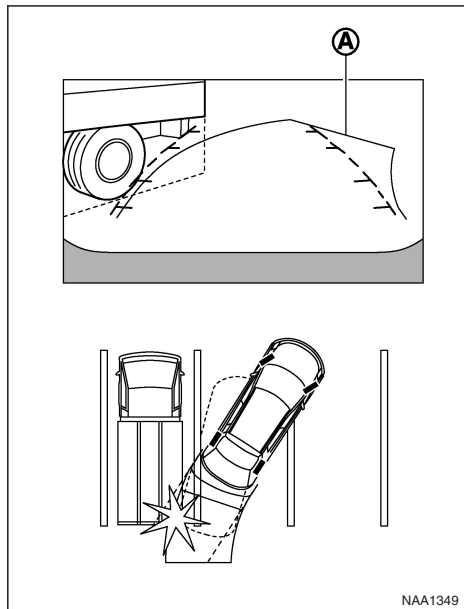

The predictive course lines (A) do not touch the object in the display. However, the vehicle may hit the object if it projects over the actual reversing course.

Reversing closer to a projecting object

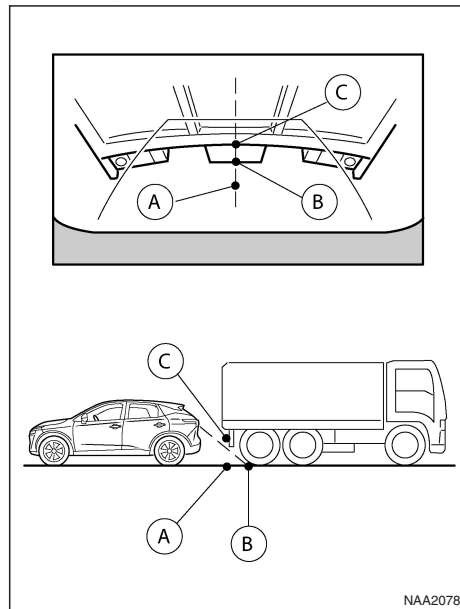

The position (C) is shown farther than the position (B) in the display. However, the position (C) is actually at the same distance as the position (A). The vehicle may hit the object when reversing to the position (A) if the object projects over the actual moving course.

HOW TO PARK WITH PREDICTIVE COURSE LINES

⚠ WARNING

- If the tyres are replaced with different sized tyres, the predictive course lines may be displayed incorrectly.
- On a snow-covered or slippery road, there may be a difference between the predictive course line and the actual course line.
- If the battery is disconnected or becomes discharged, the predictive course lines may be displayed incorrectly. If this occurs, please perform the following procedures:
 - Turn the steering wheel from lock to lock while the e-POWER system is running.
 - Drive the vehicle on a straight road for more than 5 minutes.
- When the steering wheel is turned with the power switch switched ON, the predictive course lines may be displayed incorrectly.

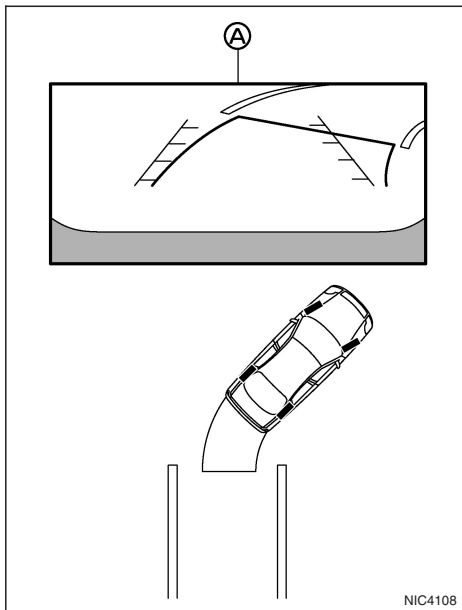

1. Visually check that the parking space is safe before parking your vehicle.
2. The rear view of the vehicle is displayed on the screen **A** when the vehicle is shifted to the R (Reverse) position.

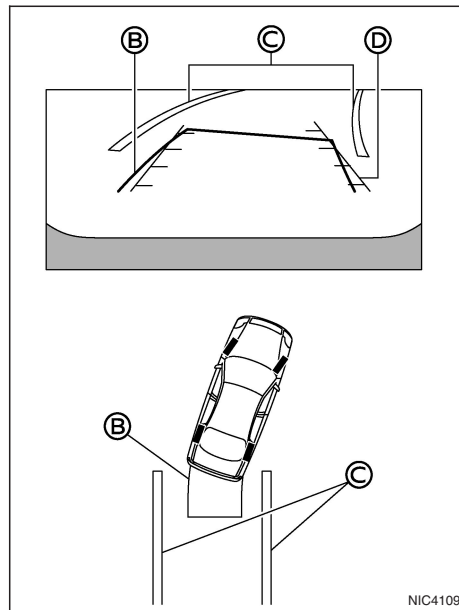

3. Slowly reverse the vehicle adjusting the steering wheel so that the predictive course lines **B** enter the parking space **C**.
4. Manoeuvre the steering wheel to make the vehicle width guide lines **D** parallel to the parking space **C** while referring to the predictive course lines.

5. When the vehicle is parked in the space completely, push the P position switch and apply the parking brake.

HOW TO SWITCH THE DISPLAY

With the power switch switched ON, push the **<CAMERA>** button or shift to the R (Reverse) position to operate the Intelligent Around View Monitor.

The Intelligent Around View Monitor displays different split screen views depending on the selected shift position. Push the **<CAMERA>** button to switch between the available views.

If the shift system is in the R (Reverse) position, the available views are:

- Rear view/bird's-eye view split screen
- Rear view/front-side view split screen
- Rear-wide view

If the shift system is out of the R (Reverse) position, the available views are:

- Front view/bird's-eye view split screen
- Front view/front-side view split screen
- Front-wide view

The display will switch from the Intelligent Around View Monitor screen when:

- The shift system is in a forward drive position and the vehicle speed increases above approximately 10 km/h (6 MPH).
- A different screen is selected.

HOW TO ADJUST THE SCREEN VIEW

To adjust the display brightness of the Around View Monitor, use the settings described in the separately provided NissanConnect owner's manual.

NOTE

Do not adjust any of the display settings of the IAVM while the vehicle is moving. Make sure the parking brake is firmly applied.

INTELLIGENT AROUND VIEW MONITOR SYSTEM LIMITATIONS

⚠ WARNING

Listed below are the system limitations for Intelligent Around View Monitor. Failure to operate the vehicle in accordance with these system limitations could result in serious injury or death.

- Do not use the Intelligent Around View Monitor with the outside mirrors in the stored position, and make sure that the tailgate is securely closed when operating the vehicle using the Intelligent Around View Monitor.
- The apparent distance between objects viewed on the Intelligent Around View Monitor differs from the actual distance.
- The cameras are installed on the front grille, the outside mirrors and above the rear number plate. Do not put anything on the cameras.
- When washing the vehicle with high pressure water, be sure not to spray it around the cameras. Otherwise, water may enter the camera unit causing water condensation on the lens, a malfunction, fire or an electric shock.

- Do not strike the cameras. They are precision instruments. Doing so could cause a malfunction or cause damage resulting in a fire or an electric shock.

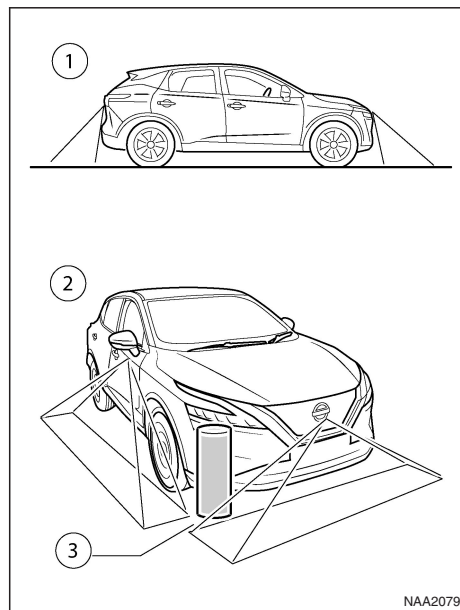

There are some areas where the system will not show objects and the system does not warn of moving objects.

- ① When in the front or the rear view display, an object below the bumper or on the ground may not be viewed.
- ② When in the bird's-eye view, a tall object near the seam ③ of the camera viewing areas will not appear in the monitor.

The following are operating limitations and do not represent a system malfunction:

- There may be a delay when switching between views.
- When the temperature is extremely high or low, the screen may not display objects clearly.
- When strong light directly shines on the camera, objects may not be displayed clearly.
- The screen may flicker under fluorescent light.
- The colours of objects on the Intelligent Around View Monitor may differ somewhat from the actual colour of objects.
- Objects on the Intelligent Around View Monitor may not be clear and the colour of the object may differ in a dark environment.
- There may be differences in sharpness between each camera view of the bird's-eye view.
- Do not use wax on the camera lens. Wipe off any wax with a clean cloth that has been dampened with a diluted mild cleaning agent, then wipe with a dry cloth.

System temporarily unavailable

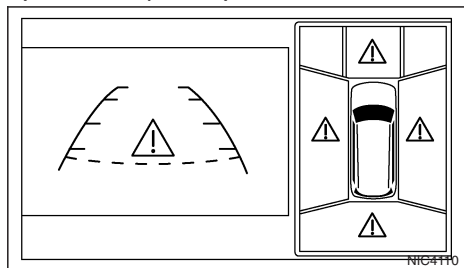

When the "⚠" icon is displayed on the screen, there will be abnormal conditions in the Intelligent Around View Monitor. This will not hinder normal driving operation but the system should be inspected. It is recommended you visit a NISSAN dealer or qualified workshop.

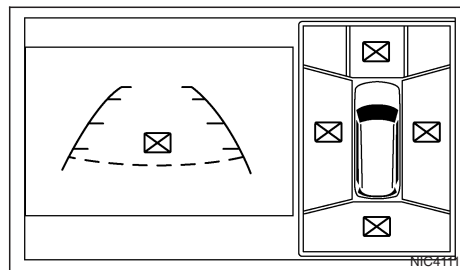

When the "⊗" icon is displayed on the screen, the camera image may be receiving temporary electronic disturbances from surrounding devices. This will not hinder normal driving operation but the system should be inspected. It is recommended you visit a NISSAN dealer or qualified workshop.

SYSTEM MAINTENANCE

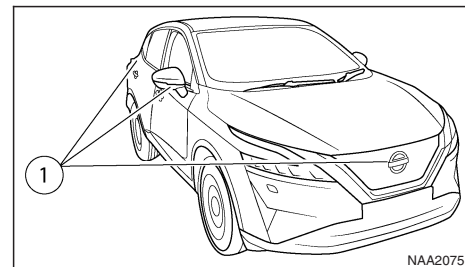

CAUTION

- Do not use alcohol, benzine or thinner to clean the camera. This will cause discolouration.
- Do not damage the camera as the monitor screen may be adversely affected.

If dirt, rain or snow accumulates on any of the cameras ①, the Intelligent Around View Monitor may not display objects clearly. Clean the camera by wiping with a cloth dampened with a diluted mild cleaning agent and then wiping with a dry cloth.

MOVING OBJECT DETECTION (MOD)

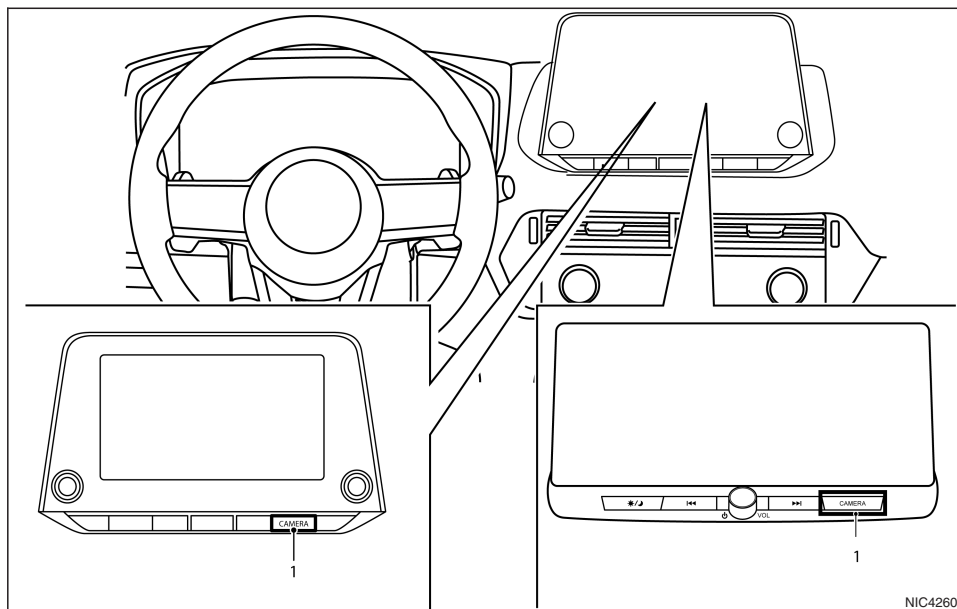

1. <CAMERA> button

⚠ WARNING

- Failure to follow the warnings and instructions for proper use of the Moving Object Detection system could result in serious injury or death.
- The MOD system is not a substitute for proper vehicle operation and is not designed to pre-

vent contact with objects surrounding the vehicle. When manoeuvring, always use the outside mirror and rearview mirror and turn and check the surroundings to ensure it is safe to manoeuvre.

- The system is deactivated at speeds above 8 km/h (5 MPH). It is reactivated at lower speeds.

- The MOD system is not designed to detect the surrounding stationary objects.

The MOD system can inform the driver of moving objects near the vehicle when driving out of garages, manoeuvring in parking lots and in other such instances.

The MOD system detects moving objects by using image processing technology on the image shown in the display.

CAUTION

Do not scratch the lens when cleaning dirt or snow from the front of the camera.

MOD SYSTEM OPERATION

The MOD system will turn on automatically under the following conditions:

- When the shift system is in the R (Reverse) position.
- When the <CAMERA> button is pushed to activate the Intelligent Around View Monitor system on the display.
- When vehicle speed decreases below approximately 8 km/h (5 MPH).

The MOD system operates in the following conditions when the camera view is displayed:

- When the shift system is in the P (Park) or N (Neutral) position and the vehicle is stopped, the MOD system detects the moving objects in the bird's-eye view. The MOD system will not operate if either door is opened. If outside mirrors are folded, MOD may not operate properly.

- When the shift system is in a forward drive position, and the vehicle speed is below approximately 8 km/h (5 MPH), the MOD system detects moving objects in the front view or front-wide view.
- When the shift system is in the R (Reverse) position and the vehicle speed is below approximately 8 km/h (5 MPH), the MOD system detects moving objects in the rear view or rear-wide view. The MOD system will not operate if the tail-gate is open.

The MOD system does not detect moving objects in the front-side view. The MOD icon is not displayed on the screen when in this view.

When the MOD system detects a moving object near the vehicle, the yellow frame will be displayed on the view where the object is detected and a chime will sound once. While the MOD system continues to detect moving objects, the yellow frame continues to be displayed.

NOTE

While the RCTA chime (where fitted) is beeping, the MOD system does not chime.

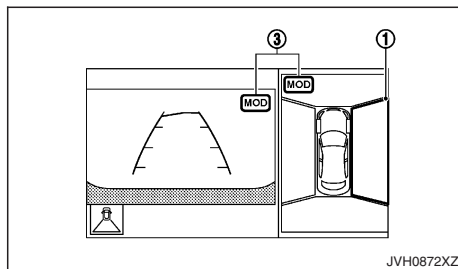

Front and bird's-eye views

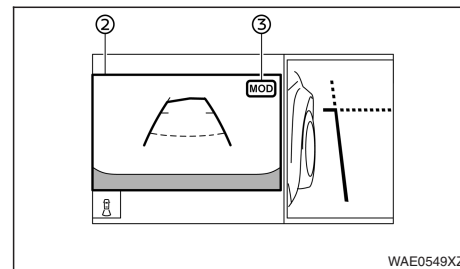

Rear and front-side views

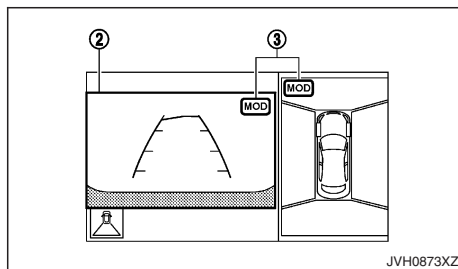

Rear and bird's-eye views

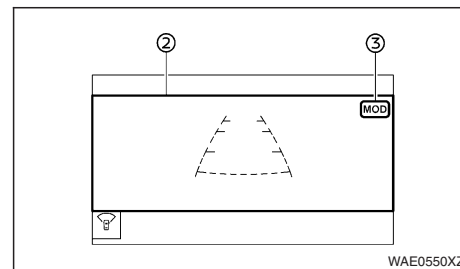

Front-wide view/rear-wide view

In the bird's-eye view, the yellow frame ① is displayed on each camera image (front, rear, right, left) depending on where moving objects are detected.

The yellow frame ② is displayed on the front view, rear view, front-wide view and rear-wide view.

A green MOD icon ③ is displayed in the view where the MOD system is operative. A grey MOD icon ③ is displayed in the view where the MOD system is not operative.

If the MOD system is turned off, the MOD icon ③ is not displayed.

TURNING MOD ON AND OFF

The MOD system can be turned on and off using the vehicle information display. (See “Vehicle information display” in the “2. Instruments and controls” section.)

MOD SYSTEM LIMITATIONS

⚠ WARNING

Listed below are the system limitations for MOD. Failure to operate the vehicle in accordance with these system limitations could result in serious injury or death.

- Do not use the MOD system when towing a trailer. The system may not function properly.
- Excessive noise (for example, audio system volume or open vehicle window) will interfere with the chime sound, and it may not be heard.
- The MOD system performance will be limited according to environmental conditions and surrounding objects such as:
 - When there is low contrast between background and the moving objects.
 - When there is blinking source of light.
 - When strong light such as another vehicle's headlight or sunlight is present.
 - When camera orientation is not in its usual position, such as when the outside mirror is folded.

- When there is dirt, water drops or snow on the camera lens.
- When the position of the moving objects in the display is not changed.

- The MOD system might detect flowing water droplets on the camera lens, white smoke from the muffler, moving shadows, etc.
- The MOD system may not function properly depending on the speed, direction, distance or shape of the moving objects.
- If your vehicle sustains damage to the parts where the camera is installed, leaving it misaligned or bent, the sensing zone may be altered and the MOD system may not detect objects properly.
- When the temperature is extremely high or low, the screen may not display objects clearly. This is not a malfunction.

NOTE

The green MOD icon will change to orange if one of the following has occurred.

- When the system is malfunctioning.
- When the component temperature reaches a high level.
- When the rear view camera has detected a blockage.

If the icon light continues to illuminate in orange, have the MOD system checked. It is recommended that you visit a NISSAN dealer or qualified workshop for this service.

SYSTEM MAINTENANCE

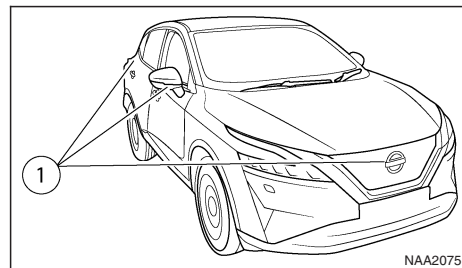

CAUTION

- Do not use alcohol, benzene or thinner to clean the camera. This will cause discoloration.
- Do not damage the camera as the monitor screen may be adversely affected.

If dirt, rain or snow accumulates on any of the cameras ①, the MOD system may not operate properly. Clean the camera by wiping with a cloth dampened with a diluted mild cleaning agent and then wiping with a dry cloth.

VENTS

CENTRE VENTS

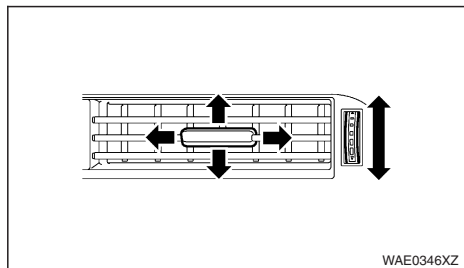

Right side

Open/close the vents by moving the control to either direction.

Adjust the air flow direction of the vents by moving the centre knob (up/down, left/right) until the desired position is achieved.

SIDE VENTS

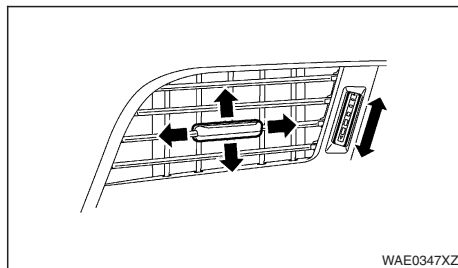

Right side

Open/close the vents by moving the control to either direction.

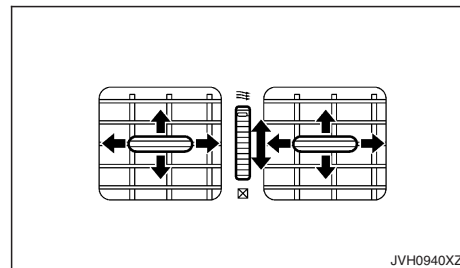

Adjust the air flow direction of the vents by moving the centre knob (up/down, left/right) until the desired position is achieved.

REAR VENTS



JVH0940XZ

Open/close the vents by moving the control to either direction.

	This symbol indicates that the vents are open. Moving the side control to this direction will open the vents.
	This symbol indicates that the vents are closed. Moving the side control to this direction will close the vents.

Adjust the air flow direction of the vents by moving the centre knob (up/down, left/right) until the desired position is achieved.

HEATER AND AIR CONDITIONER

WARNING

- The heater and air conditioner operate only when the e-POWER system is running.
- Never leave children or adults who would normally require the support of others alone in the vehicle. Pets should not be left alone either. They could unknowingly activate switches or controls and inadvertently become involved in a serious accident and injure themselves. On hot, sunny days, temperatures in a closed vehicle could quickly become high enough to cause severe or possibly fatal injuries to people or animals.
- Do not use the recirculation mode for long periods as it may cause the interior air to become stale and the windows to fog up.
- Do not adjust the heating and air conditioning controls while driving so that full attention may be given to vehicle operation.

The heater and air conditioner operate when the e-POWER system is running. The air blower will operate when the power switch is ON even if the e-POWER system is not running.

NOTE

- Condensation forms inside the air conditioning unit when the air conditioner is running, and is safely discharged underneath your vehicle. Traces of water on the ground are therefore normal.
- Odours from inside and outside the vehicle can build up in the air conditioner unit. Odour can enter the passenger compartment through the vents.
- When parking, set the heater and air conditioner controls to turn off air recirculation to allow fresh air into the passenger compartment. This should help reduce odours inside the vehicle.

OPERATING TIPS (for automatic air conditioner)

The sensors, located on the instrument panel and beneath the steering wheel, help maintain a constant temperature. Do not put anything on or around the sensors.

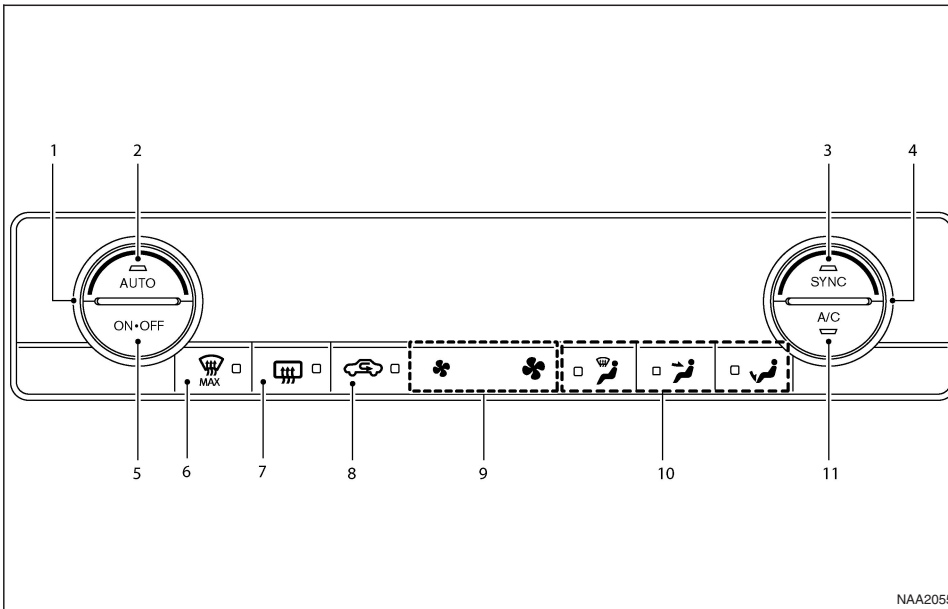





11. **<A/C>** (Air Conditioner) button

Type A

AUTOMATIC AIR CONDITIONER

Type A

1. Temperature control dial (left side)
2. **<AUTO>** button
3. SYNC (synchronise) button
4. Temperature control dial (right side)
5. **<ON OFF>** button
6. Front defogger  MAX button
7. Rear window defogger  button (see "Defogger switch" in the "2. Instruments and controls" section)
8. Air recirculation  button
9. Fan speed control () buttons
10. Air flow control buttons

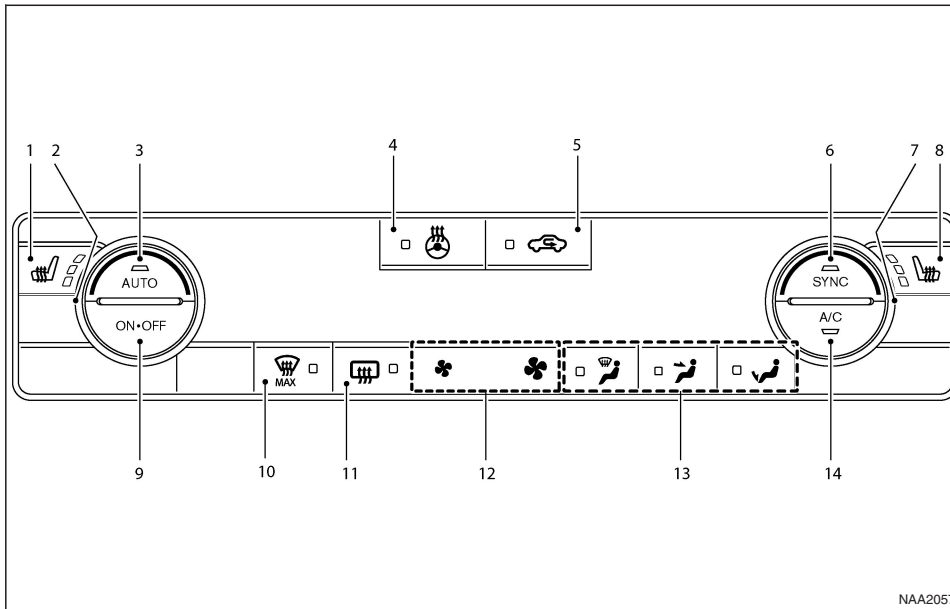



Type B (with seat heater and steering wheel heater, without Thermaclear heated windscreen)

Type B (with seat heater and steering wheel heater, without Thermaclear heated windscreen)

1. Front left seat heater button (see "Seat heating (where fitted)" in the "2. Instruments and controls" section)
2. Temperature control dial (left side)

3. <AUTO> button
4. Steering wheel heater button (see "Heated steering wheel (where fitted)" in the "2. Instruments and controls" section)
5. Air recirculation  button
6. SYNC (synchronise) button
7. Temperature control dial (right side)

8. Front right seat heater button (see "Seat heating (where fitted)" in the "2. Instruments and controls" section.)
9. <ON OFF> button
10. Front defogger  MAX button
11. Rear window defogger  button (see "Defogger switch" in the "2. Instruments and controls" section)
12. Fan speed control () buttons
13. Air flow control buttons
14. <A/C> (Air Conditioner) button

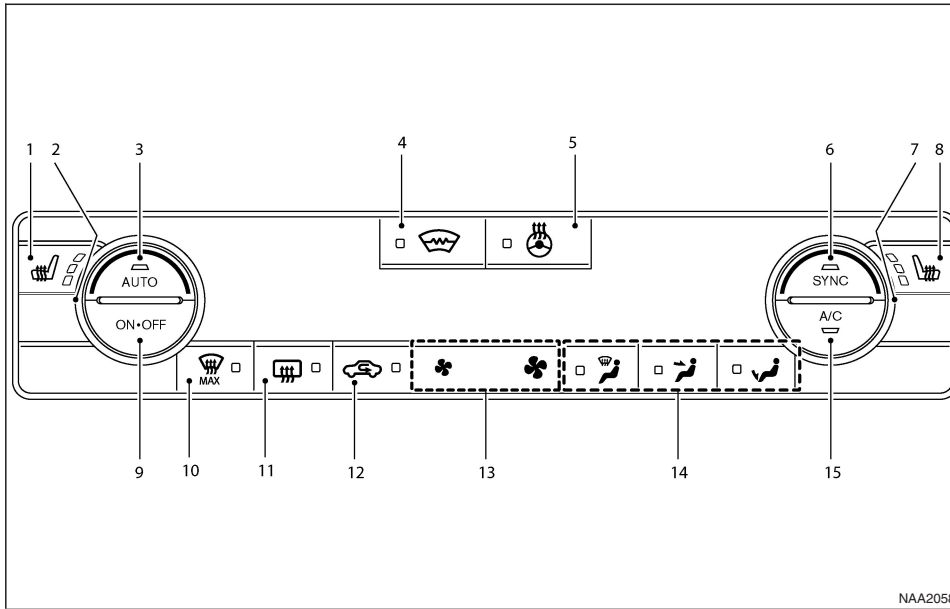

Type C (with seat heater, steering wheel heater and ThermoClear heated windscreen)

Type C (with seat heater, steering wheel heater and ThermoClear heated windscreen)

1. Front left seat heater button (see "Seat heating (where fitted)" in the "2. Instruments and controls" section)
2. Temperature control dial (left side)
3. **<AUTO>** button

4. ThermoClear heated windscreen heater button (see "ThermoClear Heated Windscreen (where fitted)" in the "2. Instruments and controls" section)
5. Steering wheel heater button (see "Heated steering wheel (where fitted)" in the "2. Instruments and controls" section)
6. SYNC (synchronise) button

7. Temperature control dial (right side)
8. Front right seat heater button (see "Seat heating (where fitted)" in the "2. Instruments and controls" section.)
9. **<ON OFF>** button
10. Front defogger MAX button
11. Rear window defogger button (see "Defogger switch" in the "2. Instruments and controls" section)
12. Air recirculation button
13. Fan speed control () buttons
14. Air flow control buttons
15. **<A/C>** (Air Conditioner) button

Automatic operation (AUTO)

The AUTO mode may be used year-round as the system automatically controls constant temperature, air flow distribution and fan speed after the desired temperature is set manually.

Turning off the heater and air conditioner:

To turn off the heater and air conditioner, push the **<ON OFF>** button.

Cooling and dehumidified heating:

1. Push the **<AUTO>** button.
2. If the A/C indicator light does not illuminate, push the **<A/C>** button. (The A/C indicator light will illuminate.)
3. Turn the temperature control dial to set the desired temperature.



4. If the indicator light on the air recirculation  button is illuminated, push the button with the light illuminated to switch the air recirculation mode OFF.



A visible mist may be seen coming from the vents in hot, humid conditions as the air is cooled rapidly. This does not indicate a malfunction.

Heating (A/C off):

1. Push the <AUTO> button.
 2. If the A/C indicator light illuminates, push the <A/C> button. (The A/C indicator light will turn off.)
 3. Turn the temperature control dial to set the desired temperature.
- Do not set the temperature lower than the outside air temperature. Doing so may cause the temperature to not be controlled properly.
 - If the windows fog up, use dehumidified heating instead of the A/C off heating.

Dehumidified defrosting/defogging:

1. Push the front defogger  MAX button. (The  MAX indicator light will illuminate.)
 2. Turn the temperature control dial to set the desired temperature.
- To remove frost from the outside surface of the windscreen quickly, set the temperature to a high temperature.
 - The system will set the fan speed to maximum automatically.
 - The air recirculation mode will automatically turned off and the air conditioner will be activated automatically.
 - Air flows mainly from the defogger outlets.

3. Push the front defogger  MAX button again to return to the previous mode or the <AUTO> button for auto climate control mode. (The  MAX indicator light will turn off.)

Manual operation

The manual mode can be used to control the heater and air conditioner to your desired settings.

To turn off the heater and air conditioner, push the <ON OFF> button.

Fan speed control:

Turn the fan speed control dial. Turn the dial clockwise to increase the fan speed. Turn the dial counter clockwise to decrease the fan speed.

Push the <AUTO> button to change the fan speed to the automatic mode.

Air flow control:

Push air flow control button to select/change the air flow outlet. More than one air flow control button can be selected.



Air flows from the centre and side vents.



Air flows mainly from the foot outlets.







Air flows mainly from the defogger outlets.

Temperature control:

Turn the temperature control dial to set the desired temperature. Turn the dial clockwise to increase the temperature. Turn the dial counter clockwise to decrease the temperature.

Air recirculation:

Push the air recirculation  button to circulate the air flow inside the vehicle. (The  indicator light will illuminate.)

Push the air recirculation  button again to draw the air flow from outside the vehicle. (The  indicator light goes off.)

Automatic air intake control (where fitted):

If the indicator light on the air recirculation  button is illuminated, push and hold the button with the light illuminated (the indicator light will blink twice). The automatic air intake control mode is set.

SERVICING AIR CONDITIONER

WARNING

The air conditioner system contains refrigerant under high pressure. To avoid personal injury, any air conditioner service should be done only by an experienced technician with the proper equipment.

The air conditioner system in your vehicle is charged with a refrigerant designed with the environment in mind.

This refrigerant will not harm the earth's ozone layer. However, it may contribute in a small part to global warming.

Special charging equipment and lubricant are required when servicing your vehicle's air conditioner. Using improper refrigerants or lubricants will cause severe damage to the air conditioner system. (See "Recommended fluids/lubricants and capacities" in the "9. Technical information" section.)

AUDIO SYSTEM

A NISSAN dealer or qualified workshop will be able to service your environmentally friendly air conditioner system.

Air conditioner filter

The air conditioner system is equipped with an air conditioner filter which collects pollen. To make sure the air conditioner heats, defogs, and ventilates efficiently, replace the filter according the specified maintenance intervals listed in a separate maintenance booklet. To replace the filter, contact a NISSAN dealer or qualified workshop.

The filter should be replaced if the air flow decreases significantly or if windows fog up easily when operating the heater or air conditioner.

⚠ WARNING

Do not adjust the audio system while driving.

The audio system operates when the power switch is **ON**. **Do not use for an extended period of time with the e-POWER system stopped.**

AUDIO OPERATION PRECAUTIONS

NOTE

Models with navigation system, see the audio operation precautions in the separately provided navigation system owner's manual.

Radio

- Radio reception is affected by station signal strength, distance from radio transmitter, buildings, bridges, mountains and other external influences. Intermittent changes in reception quality are normally caused by these external influences.
- Using a mobile phone in or near the vehicle may influence radio reception quality.
- Use the antenna for the best reception.

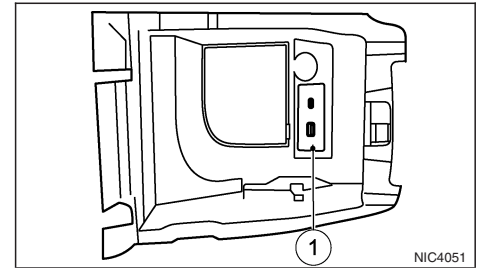

USB (Universal Serial Bus) connection ports

⚠ WARNING

Do not connect, disconnect or operate the USB device while driving. Doing so can be a distraction. If distracted you could lose control of your vehicle and cause an accident or serious injury.

CAUTION

- **Do not force the USB device into the USB connection port. Inserting the USB device tilted or up-side-down into the USB connection port may damage the USB connection port. Make sure that the USB device is connected correctly into the USB connection port (some USB devices come with a  mark as a guide, make sure that the mark is facing the correct direction before inserting the device).**

- **Do not grab the USB connection port cover (where fitted) when pulling the USB device out of the USB connection port. This could damage the USB connection port and USB connection port cover (where fitted).**
- **Do not leave the USB cable in a place where it can be pulled unintentionally. Pulling the cable may damage the USB connection port.**

The USB sockets ① are located in the centre console underneath the armrest.

The vehicle is not equipped with a USB device. USB devices should be purchased separately as necessary.

This system cannot be used to format USB devices. To format a USB device, use a personal computer.

In some areas, the USB device for the front seats plays only sound without images for regulatory reasons, even when the vehicle is parked.

This system supports various USB connection port devices, USB hard drives and iPod players. Some USB devices may not be supported by this system.

- Partitioned USB devices may not play correctly.
- Some characters used in other languages (Chinese, Japanese, etc.) may not appear properly in the display. Using English language characters with a USB device is recommended.

General notes for USB use:

Refer to your device manufacturer's owner information regarding the proper use and care of the device.

Notes for iPod use:

"Made for iPod", "Made for iPhone", and "Made for iPad" mean that an electronic accessory has been designed to connect specifically to iPod, iPhone, or iPad, respectively, and has been certified by the developer to meet Apple performance standards.

Apple is not responsible for the operation of this device or its compliance with safety and regulatory standards.

Please note that the use of this accessory with iPod, iPhone, or iPad may affect wireless performance.

iPad, iPhone, iPod, iPod classic, iPod nano, iPod shuffle, and iPod touch are trademarks of Apple Inc., registered in the U.S. and other countries. Lightning is a trademark of Apple Inc.

- NISSAN audio system supports only accessories that Apple has certified and that come with the "Made for iPod/iPhone/iPad" logo.
- Improperly plugging in the iPod may cause a checkmark to be displayed on and off (flickering). Always make sure that the iPod is connected properly.
- An iPod nano (1st Generation) may remain in fast forward or rewind mode if it is connected during a seek operation. In this case, please manually reset the iPod.
- An iPod nano (2nd Generation) will continue to fast-forward or rewind if it is disconnected during a seek operation.
- An incorrect song title may appear when the Play Mode is changed while using an iPod nano (2nd Generation)

- Audiobooks may not play in the same order as they appear on an iPod.
- Large video files cause slow responses in an iPod. The vehicle centre display may momentarily black out, but will soon recover.
- If an iPod automatically selects large video files while in the shuffle mode, the vehicle centre display may momentarily black out, but will soon recover.

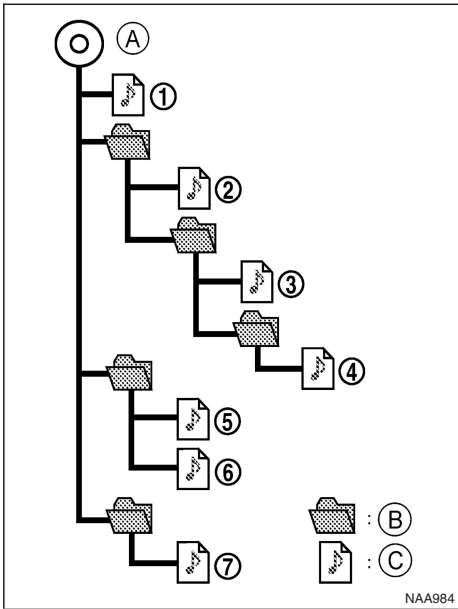

- Ⓐ Root folder
- Ⓑ Folder
- Ⓒ MP3/WMA (where fitted)

Playback order:

Music playback order of the USB device with MP3/WMA (where fitted) is as illustrated above.

- The names of folders not containing MP3/WMA (where fitted) files are not shown in the display.
- If there is a file in the top level of the device, FOLDER is displayed.
- The playback order is the order in which the files were written by the writing software, so the files might not be played in the desired order.

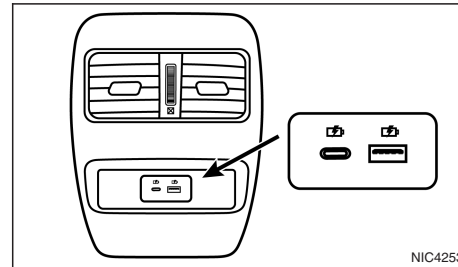

Rear USB power ports (where fitted)

USB (Universal Serial Bus) rear power ports (where fitted)

⚠ WARNING

Do not connect, disconnect or operate the USB device while driving. Doing so can be a distraction. If distracted you could lose control of your vehicle and cause an accident or serious injury.

CAUTION

- **Do not force the USB device into the USB connection port. Inserting the USB device tilted or up-side-down into the USB connection port may damage the USB connection port. Make sure that the USB device is connected correctly into the USB connection port (some USB devices come with a ⚡ mark as a guide, make sure that the mark is facing the correct direction before inserting the device).**
- **Do not grab the USB connection port cover (where fitted) when pulling the USB device out of the USB connection port. This could damage the USB connection port and USB connection port cover (where fitted).**
- **Do not leave the USB cable in a place where it can be pulled unintentionally. Pulling the cable may damage the USB connection port.**

Two USB power ports (where fitted) are provided on the rear of the console box/armrest unit.

These ports are for power supply only. They do not support data transfer.

The maximum output current for each port is 2.4A. Please note that actual output current will depend on the device connected to the port(s). The charger will provide the appropriate current value to the device connected based on the protocol used by the mobile device.

Bluetooth® Audio player (where fitted)

- Some Bluetooth® audio devices may not be used with this system. For detailed information about Bluetooth® audio devices that are available for use with this system, contact a NISSAN dealer or qualified workshop.
- Before using a Bluetooth® audio system, the initial registration process for the audio device is necessary.
- Operation of the Bluetooth® audio system may vary depending on the audio device that is connected. Confirm the operation procedure before use.
- The playback of Bluetooth® audio will be paused under the following conditions. The playback will be resumed after the following conditions are completed.
 - while using a hands-free phone
 - while checking a connection with a mobile phone
- The in-vehicle antenna for Bluetooth® communication is built in the system. Do not place the Bluetooth® audio device in an area surrounded by metal, far away from the system or in a narrow space where the device closely contacts the body or the seat. Otherwise, sound degradation or connection interference may occur.
- While a Bluetooth® audio device is connected through the Bluetooth® wireless connection, the battery power of the device may discharge quicker than usual.
- This system is compatible with the Bluetooth® AV profile (A2DP and AVRCP).

ANTENNA

The shark fin antenna is located on the rear part of the vehicle roof.

The radio performance may be affected if cargo carried on the roof blocks the radio signal. If possible, do not put cargo near the shark fin antenna.

A buildup of ice on the antenna can affect radio performance. Remove the ice to restore radio reception.

CAUTION

- **When washing the vehicle, do not apply high pressure water directly to the seal of the antenna. It may damage the seal of the antenna.**
- **When removing snow from the roof, do not apply excessive force to the shark fin antenna. This may cause damage to the shark fin antenna and the roof panel.**

FM/AM RADIO (with DAB) (where fitted)

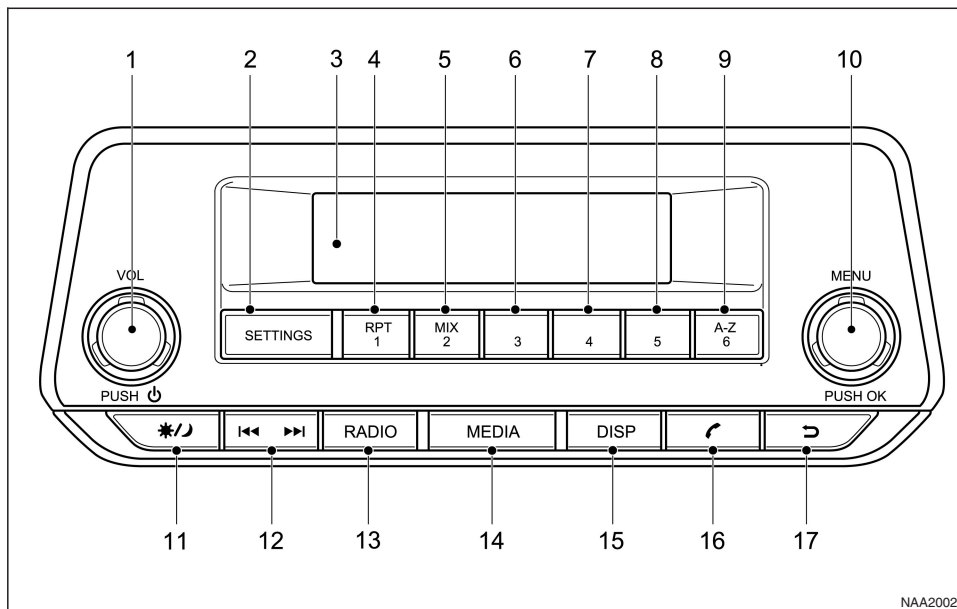

1. Power button/Volume control **<VOL>** dial
2. **<SETTINGS>** button
3. Display
4. Radio mode: Preset button
iPod/USB/Bluetooth audio mode: Repeat **<RPT>** button

5. Radio mode: Preset button **<MIX>** button
6. Radio mode: Preset button
7. Radio mode: Preset button
8. Radio mode: Preset button
9. Radio mode: Preset button
USB or Phone mode: Quick search button

10. Confirmation **<OK>** button/**<MENU>** dial
11. Display brightness (Day/Night mode) button
Turn the **<MENU>** dial to set the display brightness.

The illumination brightness level is linked to the headlight switch. When the headlights are switched ON the brightness is dimmed automatically. Press the button to toggle illumination brightness levels between daytime setting and night time setting independent of headlight status.

12. Fast Forward (Cue)/Forward Track and Rewind/Previous Track buttons
13. **<RADIO>** button
14. **<MEDIA>** button
Switch between the audio sources (USB, BT Audio) (if connected)
15. **<DISP>** button
Provides on screen information when available (music tags, RDS, etc.)
16. (Telephone) button
17. Back button

AUDIO MAIN OPERATION

The audio unit operates when the e-POWER system power switch is **ON**.



Power ON/OFF button

Press the  button to switch on the audio unit. If the audio unit was switched off using the e-POWER system power switch, it can also be switched on with the e-POWER system power switch. The source that was playing immediately before the unit was switched off will resume playing and the volume will be set to the previous volume level.

The audio unit can be switched off by pressing , or by switching the e-POWER system power switch **OFF**.



Volume (VOL) level control

Turn the **<VOL>** dial clockwise or anticlockwise to adjust the volume level.

The audio unit is equipped with a speed control volume function, this means that the audio system automatically adjusts the volume level in relation to vehicle speed. For details, see "[Speed Vol.] menu" later in this section.

<SETTINGS> button

To configure [Audio], [Clock], [Radio], and [Language] settings, perform the following procedure:

1. Press the **<SETTINGS>** button.
2. Turn the **<MENU>** dial clockwise or anticlockwise, the display will appear in the following order:

[Audio] ⇄ [Clock] ⇄ [Radio] ⇄ [Language]

After the desired levels have been set, press either the  (Back) button repeatedly, or the **<SETTINGS>** button.

Audio adjustments

1. Press the **<SETTINGS>** button to enter the settings menu screen, then select [Audio].
2. Turn the **<MENU>** dial clockwise or anticlockwise, the display will appear in the following order:

[Sound] → [Speed Vol.] → [Bass Boost] → [Audio Reset]

[Sound] menu:

Submenus in the sound menu:

[Bass]	Use this control to enhance or attenuate bass response sound. Turn the <MENU> dial clockwise or anticlockwise to adjust the bass settings then press <OK> to confirm.
[Treble]	Use this control to enhance or attenuate the treble. Turn the <MENU> dial clockwise or anticlockwise to adjust the treble settings then press <OK> to confirm.
[Bal.]	Use this control to adjust the balance of the volume between the left and right speakers. Turn the <MENU> dial anticlockwise or clockwise to adjust the left/right balance then press <OK> to confirm.
[Fade]	Use this control to adjust the balance of the volume between the front and rear speakers. Turn the <MENU> dial anticlockwise or clockwise to adjust the front/rear balance then press <OK> to confirm.

[Speed Vol.] menu:

Set the audio system to automatically adjust the volume level in relation to vehicle speed.

This mode controls the volume output from the speakers automatically in relation to vehicle speed. When [Speed Vol.] is displayed, turn the <MENU> dial clockwise or anticlockwise to adjust the volume level.

Adjusting the setting to 0 (zero) turns off the speed volume feature. Increasing the speed volume setting results in the audio volume increasing more rapidly with vehicle speed. Once chosen, press <OK> to save the setting.

[Bass Boost] menu:

Switch [Bass Boost] [ON] or [OFF]

[Audio Reset] menu:

The audio unit has a saved preset settings as a factory default. Select [YES] to change all settings back to the factory preset settings. Select [NO] to exit the menu keeping the current settings.

Setting the clock

The clock menu screen set up screen will appear when selecting the [Clock] item from the set up menu.

[Set Time]:

Select [Set Time] then adjust the clock as follows:

1. The hour display will start flashing. Turn the <MENU> dial to adjust the hour.
2. Press the <OK> button. The minute display will start flashing.
3. Turn the <MENU> dial to adjust the minute.
4. Press <OK> to finish the clock adjustment.

[ON/OFF]:

Set the clock display between on or off when the audio unit is turned off.

If set in the [ON] position, the clock will be displayed when the audio unit is turned off either by pressing the  button or when the e-POWER system power switch is switched **OFF**.

[Format]:

Set the clock display between 24-hour mode and 12-hour clock mode.

[Radio] menu

For activation or deactivation details, see “<SETTINGS> button” earlier in this section.

[TA] Use this control to switch Traffic Announcements on or off when the unit starts. Turn the <MENU> dial clockwise or anticlockwise to select then press <OK> to confirm.

[DAB. Interrupt] (where fitted) For models fitted with DAB functionality only. Switch on or off specific listed Digital Interruptions. When selected the DAB radio stations will be interrupted if a specific message is available. Turn the <MENU> dial clockwise or anticlockwise to adjust then press <OK> to select.

[Ref. FM List] Manually update the FM station list. Press <OK> to start the search of the stations. A confirmation message appears. In a short period of time the stations are updated and the last station (if possible) starts playing.

[Ref. DAB List] (where fitted) Manually update the DAB station list. Press <OK> to start the search of the stations. A confirmation message appears. In a short period of time the stations are updated and the last station (if possible) starts playing.

[EPG] (where fitted) Electronic Program Guide (EPG) for DAB is designed to offer similar features for the user as television EPG, but for radio and associated data services, for example:

- display of schedules with programs and events
- searching through current and future programs lists

[Intellitext] (where fitted) Intellitext messages are a special format of DL (Dynamic Label) messages that provide data like sport or news.

Language settings

Select the appropriate language and press the **<OK>** button. Upon completion, the screen will automatically adapt the language setting.

- [English (UK)]
- [Français]
- [Deutsch]
- [Italiano]
- [Português]
- [Nederlands]
- [Español]
- [Türkçe]
- [русский]

RADIO OPERATION

When the  (power ON/OFF) button is pressed, the audio unit will switch on with the last received radio station, if the audio unit was previously switched off in radio mode.

The radio is able to receive multiple kinds of audio transmissions:

- FM
- DAB (Digital Audio Broadcasting) (where fitted)
- AM

Radio band select button

Press the **<RADIO>** button to change the audio transmission source as follows:

For models with DAB:

FM1 → FM2 → DAB1 → DAB2 → AM → FM1

Pushing and holding the **<RADIO>** button will update the station lists.

For models without DAB:

FM1 → FM2 → AM → FM1

When the **<RADIO>** button is pressed, the radio will come on at the last received radio station. If audio is already playing using one of the other input sources (iPod, Bluetooth, USB) pressing the **<RADIO>** button will switch off the playing source mode and the last received radio station will be selected.

When the **<RADIO>** button is pressed for more than 1.5 seconds while in FM/DAB modes the current stations list will automatically be updated.



Manual tuning

When adjusting the broadcasting station frequency manually access the FM list and turn the **<MENU>** dial to select the desired station and press **<OK>** to select it.

The frequency increases or decreases in steps of 100 kHz on the FM band, and 9 kHz on the AM band.



WARNING

The radio should not be tuned while driving in order for full attention to be given to the driving operation.





SEEK tuning buttons

FM mode:

Pressing the  or  button starts the tuning mode. A short press of the button will increase or decrease the frequency a single step. Pressing the button longer will activate the seek mode. The radio tuner seeks from low to high or high to low frequencies and stops at the next broadcasting station. During seek mode, the audio output is muted. If no broadcasting station can be found within the complete band cycle, it will return to the initial frequency.

DAB mode:

Press  or  to select the next or previous station. A long press triggers seek by ensemble.

Preset station buttons ①②③④⑤⑥

Pressing a preset button for less than 2 seconds will select the stored radio station.

Pressing a preset button for more than 2 seconds while in the FM list or radio main screen will cause the station currently being received to be stored against that preset button.

- Twelve stations (if available) can be stored in the FM bands. (Six each for FM1 and FM2)
- Twelve stations (if available) can be stored in the DAB bands. (Six each for DAB1 and DAB2) (where fitted)
- Six stations (if available) can be set for the AM band.

If the battery is disconnected, or if the fuse blows, the radio memory will be erased. In that case, reset the desired stations after battery connection or fuse replacement.

DAB and Radio Data System (RDS) operation (where fitted)

The RDS is a system through which encoded digital information is transmitted by FM radio stations in addition to the normal FM radio broadcasting. The RDS provides information services such as station name, traffic information, or news.

DAB (Digital Audio Broadcast):

DAB (Digital Audio Broadcasting) is a standard for digital radio broadcast.

Various information selected by the driver (Travel, Warning, News, Weather, Sport, etc.) can be received and will be provided to the driver.

Occasionally, in areas of poor DAB signal strength, the full station name in the DAB List and DAB main screen might be distorted. In this situation it may still be possible to listen to the particular radio station, at a reduced level of sound quality, but this is not always possible.

NOTE

- **When in DAB mode, operation is similar to FM mode but may slightly differ.**
- **In some countries or regions, some of these services may not be available.**

Alternative Frequency (AF) mode:

The AF mode operates in the FM (radio) mode.

- The AF mode operates in the FM (radio), and will continue to operate in the background if any media source is selected.
- The AF function compares signal strengths and selects the station with the optimum reception conditions for the currently tuned-in station.

DAB and RDS functions

Programme Service (PS) function (station name display function):

- FM:
When an RDS station is tuned in with seek or manual tuning, the RDS data is received and the PS name is displayed.
- DAB:
When a station is tuned in with seek or manual tuning, the data is received and the PS name is displayed.

TA Traffic announcement

This function operates in FM/DAB (Radio) mode. This function will still operate in the background if any media source is selected.

- Pressing the <TA> button selects the TA mode. The TA indicator is displayed while TA mode is on.
- When <TA> or <BACK> is pressed again. The mode will be switched off and the TA indicator will disappear from the display.

Traffic announcement interrupt function:

When a traffic announcement is received, the announcement is tuned in and the display shows a notification message with the radio station name.

Once the traffic announcement has finished, the unit returns to the source that was active before the traffic announcement started.

If the <BACK> button is pressed during a traffic announcement, the traffic announcement interrupt mode is cancelled. The TA mode returns to the standby mode and the audio unit returns to the previous source.

USB (Universal Serial Bus) CONNECTION PORT

⚠ WARNING

Do not connect, disconnect or operate the USB device while driving. Doing so can be a distraction. If distracted you could lose control of your vehicle and cause an accident or serious injury.

CAUTION

- Do not force the USB device into the USB port. Inserting the USB device tilted or up-side-down into the port may damage the port. Make sure that the USB device is connected correctly into the USB port.
- Do not grab the USB port cover (where fitted) when pulling the USB device out of the port. This could damage the port and the cover.
- Do not leave the USB cable in a place where it can be pulled unintentionally. Pulling the cable may damage the port.

Connecting a device to the USB

Refer to your device manufacturer's owner information regarding the proper use and care of the device.

The USB connection port is located on the lower part of the instrument panel. Connect a USB memory device into the USB connection port. The USB memory device will be activated automatically. The display will show the notification message [USB Detected Please Wait...] for a few seconds, while it is reading the data.

If the audio system has been turned off while the USB memory was playing, pressing  will start the USB device operation.

MEDIA button

To operate the USB device press **<MEDIA>** once or repeatedly until USB is available.

Audio main operation

- List view
- Quick search
- 
- MIX (Random play)
- RPT (Repeat track)
- Folder browsing

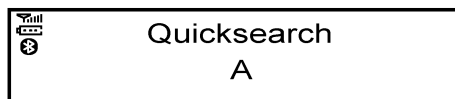



List view:

While the track is being played, either press the **<ENTER>** button or turn the **MENU** dial to display the available tracks in a listed view mode. To select a track from the list, or a track to start listening from, turn the **<MENU>** dial then press **<ENTER>**.

Press the  button to enter the Folder screen.







Fast Forward (Cue), Fast Reverse (Review) buttons:



When the  (Cue) or  (Review) button is pressed continuously, the track will be played at high speed. When the button is released, the track will be played at normal playing speed.



Track up/down buttons:

Pressing the  or  button once, the track will be skipped forward to the next track or backward to the beginning of the current played track. Press the  or  button more than once to skip through the tracks.

Folder browsing:

If the recorded media contains folders with music files, pressing the  or  button will play in sequence the tracks of each folder.

To select a preferred folder:

1. Press the **<ENTER>** button or turn the **<MENU>** dial and a list of tracks in the current folder is displayed.
2. Press the  button to enter the Folder screen.
3. Press **<ENTER>** to access the folder. Press **<ENTER>** again to start playing the first track or turn the **<MENU>** dial, and press **<ENTER>** to select another track.

If the current selected folder contains sub folders, press **<ENTER>**, a new screen with a list of sub folders will be displayed. Turn the **<MENU>** dial for the sub folder then press **<ENTER>** to select. Select the Root folder item when songs are recorded additionally in the root folder.

To return to the previous folder screen, press .

<RPT> Repeat button:

Push the **<RPT>** button and the current track will be played continuously.

<MIX> button:

Push the <MIX> button and all the tracks in the current folder (MP3/USB) or playlist (iPod) will be played in a random order.

When the entire folder/playlist has been played the system will start playing the next folder/playlist.

<DISP> button:

While a USB device with recorded music information tags (ID3-text tags) is being played, the title of the played track is displayed. If the title information is not provided then [Songs] is displayed.

When the <DISP> button is pressed repeatedly, further information about the track can be displayed along with the track title as follows:

Track time → Artist name → Album title → Track time

The track name is always displayed.

Track details:

A long press on the <DISP> button will turn the display into a detailed overview. Press the  button briefly to return to the main display.

Quick search:

When a USB device with recorded music information tags (ID3-text tags) is being played from list view mode, a quick search can be performed to find a track from the list.

Push the <A-Z> button then turn the <MENU> dial for the first alphabetic/numerical letter of the track title then press <OK>. When found, a list of the available tracks will be displayed. When there is no match (the display shows [No match] the next item will be shown. Select, and press <OK> to play the preferred track.

iPod® PLAYER OPERATION (where fitted)

Connecting iPod®

WARNING

Do not connect, disconnect or operate the USB device while driving. Doing so can be a distraction. If distracted you could lose control of your vehicle and cause an accident or serious injury.

CAUTION

- **Do not force the USB device into the USB port. Inserting the USB device tilted or up-side-down into the port may damage the port. Make sure that the USB device is connected correctly into the USB port.**
- **Do not grab the USB port cover (where fitted) when pulling the USB device out of the port. This could damage the port and the cover.**
- **Do not leave the USB cable in a place where it can be pulled unintentionally. Pulling the cable may damage the port.**

Refer to your device manufacturer's owner information regarding the proper use and care of the device.

Open the console lid and connect the iPod® cable to the USB connector. The battery of the iPod® will be charged during the connection to the vehicle. The display will show the notification message [iPod <Name> Detected...] for a few seconds, while it is reading the data.

If the audio system has been turned off while the iPod® was playing, pressing  will start the iPod® operation. During the connection, the iPod® can only be operated with the audio controls.

Notes for iPod use:

"Made for iPod", "Made for iPhone", and "Made for iPad" mean that an electronic accessory has been designed to connect specifically to iPod, iPhone, or iPad, respectively, and has been certified by the developer to meet Apple performance standards.

Apple is not responsible for the operation of this device or its compliance with safety and regulatory standards.

Please note that the use of this accessory with iPod, iPhone, or iPad may affect wireless performance.

iPad, iPhone, iPod, iPod classic, iPod nano, iPod shuffle, and iPod touch are trademarks of Apple Inc., registered in the U.S. and other countries. Lightning is a trademark of Apple Inc.

NISSAN audio system supports only accessories that Apple has certified and that come with the "Made for iPod/iPhone/iPad" logo.

Compatibility:

The system unit shall be compatible with all devices (past and future) supporting Apple Accessory Protocol on USB link.

It includes (and not limited to):

- iPod touch 5th (iOS 9.3.5)
- iPhone 7 Plus (iOS 10.1.1, 11.0.3, 11.1.2)
- iPhone 8 (iOS 11.2)
- iPhone 8 Plus (iOS 11.2.5)

- iPhone X (iOS 11.2, 12.0.1)

NOTE

This audio system does not support iPad charging.

MEDIA button

To operate the iPod press **<MEDIA>** once or repeatedly until [iPod <Name>] is shown.



Audio main operation

Interface:

The interface for iPod® operation shown on the audio system display is similar to the iPod® interface. Use the **<MENU>** dial and the **<OK>** button to play a track on the iPod®.

The following items can be chosen from the menu list screen.

- [Playlists]
- [Artists]
- [Albums]
- [Songs]
- [More...] (Which provides access to the following)
- [Composers]
- [Genre]
- [Podcasts]
- [Audiobooks]

For further information about each item, see the iPod® owner's manual.

The following operations are identical to the audio main operation of the USB device operation. For details, see "USB (Universal Serial Bus) Connection Port" earlier in this section.

- List view
- 
- MIX (Random play)
- RPT (Repeat track)
- Folder browsing

<DISP> button

While a track with recorded music information tags (ID3-tags) is being played, the title of the played track is displayed. If the tags are not provided then a notification message is displayed.

When the **<DISP>** button is pressed repeatedly, further information about the track can be displayed along with the track title as follows:

Track time → Artist name → Album title → Track time

Track details:

A long press on the **<DISP>** button, the screen displays the song title, artist name, and album title. Press the  button briefly to return to the main display.

BLUETOOTH® OPERATION

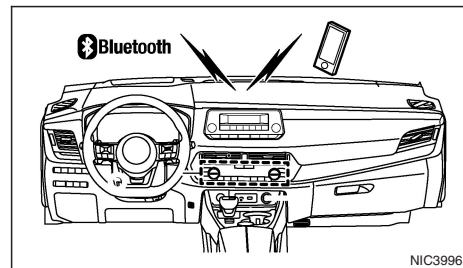

*: a device with Bluetooth capabilities

Bluetooth® settings

To pair a device, make sure the Bluetooth is switched on and use the [Scan devices] key or the [Pair device] key. For details, see "[Scan devices]" later in this section.

When an Apple device is connected via the USB connection port and Bluetooth, the device will be recognised as a USB device. The battery of the Apple device is charged while the cable is connected to the USB connection port.

Up to 5 different Bluetooth devices can be connected. However, only one device can be used at a time. If 5 different Bluetooth registered devices are registered, a new device can only replace one of the 5 existing paired devices. Use [Del. device] key to delete one of the existing paired devices. For details, see "[Del. device]" later in this section.

When successfully paired a notification message will be displayed, then the audio system display will return to the current audio source display. During connection the following status icons will be displayed (top left of the display): Signal strength (📶), Battery status* (🔋) and Bluetooth ON (📶).

*: If the low battery message comes on, the Bluetooth® device must be recharged soon.

The pairing procedure and operation may vary according to device type and compatibility. See the Bluetooth® owner's manual for further details.

NOTE

- For device details, see your audio/mobile phone Owner's Manual.
- For assistance with the Bluetooth® audio/mobile phone integration, please visit your local NISSAN dealer or qualified workshop.

To set up the Bluetooth system with a device the following items are available:



- [Scan devices]
Shows all available visible BT devices and initialises BT connection.
- [Pair device]
Bluetooth devices can be paired with the system. A maximum of 5 Bluetooth devices can be registered.

- [Sel. device]
Paired Bluetooth devices are listed and can be selected for connection.
- [Del. device]
A registered Bluetooth device can be deleted.
- [Bluetooth]
If this setting is turned off, the connection between the Bluetooth devices and the in-vehicle Bluetooth module will be cancelled.

[Scan devices]:

- 1) Press the button. Select [Scan devices]
The audio unit searches Bluetooth devices and shows all visible devices. Pressing the <BACK> button cancels the search.

Make sure your Bluetooth device is visible at this time. The audio unit will wait for a connection request from the Bluetooth device.

- 2) Select the device to be paired.
Use the <MENU> dial and press <OK> to select.
- 3) The pairing procedure may depend on the device to be connected:

- 1) Device without PIN code:
The Bluetooth connection will be automatically connected without any further input.

- 2) Device with PIN code:
Two different ways of pairing are possible depending on the device:

- Type A:
The message [To pair] [Enter Pin] 0000 will be displayed.

Confirm the PIN code on the device and the audio unit.

The Bluetooth connection will be made. If the countdown timer reaches 0, the attempt to pair the device will be cancelled.

- Type B:
The message [Pairing request] [Confirm password] together with a 6 digit code will be displayed. The unique and identical code should be displayed on the device. If the code is identical confirm on the device and on the audio unit.
The Bluetooth connection will be made.

[Pair device]:

Turn on the Bluetooth® on the audio unit. See "[Bluetooth]" later in this section.



- Use the Bluetooth® audio device/mobile phone to pair:
 - 1) Switch on the search mode for Bluetooth® devices. If the search mode finds the audio unit, it will be shown on the device display.
 - 2) Select the unit device shown as [My Car].
 - 3) Two different ways of pairing are possible depending on the device. For the correct procedure details, see "[Scan devices]" earlier in this section.

When an Apple device is connected via the USB connection port and Bluetooth®, the device will be recognised as a USB device. The battery of the Apple device is charged while the cable is connected to the USB connection port.

[Sel. device]:

The paired device list shows which Bluetooth® audio or mobile phone devices have been paired or registered with the Bluetooth® audio system. If the list contains devices then select the appropriate device to connect to the Bluetooth® audio system.

The following symbols (where fitted) indicate the capability of the registered device:

-  : Mobile phone integration
-  : Audio streaming (A2DP – Advanced Audio Distribution Profile)

[Del. device]:

A registered device can be removed from the Bluetooth audio system. Select a registered device then press **<OK>** to confirm to deletion.

[Bluetooth]:

If Bluetooth® has been switched off a notification message [ON/OFF] appears when you select [Bluetooth] from the phone menu (press ). To switch the Bluetooth® signal on, press **<OK>** and a follow up screen will appear. Then select [ON] and press **<OK>** to display the Bluetooth® settings menu screen.

Bluetooth® audio streaming main operation

Switch the e-POWER system power switch **ON**. If the audio system was turned off while the Bluetooth® audio was playing, pressing the **< ⏪ >** button will start the Bluetooth® audio streaming.

<MEDIA> button:



To operate the Bluetooth® audio streaming use the following method:

- Press **<MEDIA>** repeatedly until [BT Audio] is shown.

The type of display shown on the audio system can vary depending on the Bluetooth® version of the device.







Fast Forward (Cue), Fast Reverse (Review) buttons:

When the  (Cue) or  (Review) button is pressed continuously, the track will be played at high speed. When the button is released, the track will be played at normal playing speed.



Track up/down buttons:

Pressing the  or  button once, the track will be skipped forward to the next track or backward to the beginning of the current played track. Press the  or  button more than once to skip through the tracks.

<DISP> button

If the song contains music information tags (ID3-tags), the title of the played song will be displayed. If tags are not provided then the display will not show any messages.

When the **<DISP>** button is pressed repeatedly further information about the song can be displayed along with the song title.

A long press on **<DISP>** will turn the display into a detailed overview. Press the  button briefly to return to the main display.

Bluetooth® mobile phone feature

This system offers a hands-free facility for your mobile telephone with Bluetooth® to enhance driving safety, and comfort.

For details, see "Mobile phone integration for FM AM radio (where fitted)" later in this section.

Specification chart

Supported media		USB 2.0	
Supported file systems		ISO9660 LEVEL1, ISO9660 LEVEL2, Romeo, Joliet * ISO9660 Level 3 (packet writing) is not supported. * Files saved using the Live File System Component (on a Windows Vista-based computer) are not supported.	
Supported versions *1	MP3	Version	MPEG1, MPEG2
		Sampling frequency	8 kHz - 48 kHz
		Bit rate	32 kbps - 448 kbps, VBR*4
	WMA *3	Version	WMA7, WMA8, WMA9, WMA9 Pro (except WMA9 Lossless, WMA9 Voice)
		Sampling frequency	8 kHz - 48 kHz
		Bit rate	5 kbps - 320 kbps, VBR*4
	AAC	Version	MPEG-4, AAC
		Sampling frequency	8 kHz - 48 kHz
		Bit rate	32 kbps - 192 kbps, VBR*4
Tag information (Song title and Artist and Album name)		MP3	ID3 tag ver. 1.0, 1.1, 2.2, 2.3, 2.4 (MP3 only)
		WMA (where fitted)	WMA tag (WMA only)
Folder levels		Folder levels: 8, Folders: 2500 (including root folder), Files: 32000	
Displayable character codes *2		01: ASCII, 02: ISO-8859-1, 03: UNICODE (UTF-16 BOM Big Endian), 04: UNICODE (UTF-16 Non-BOM Big Endian), 05: UNICODE (UTF-8), 06: UNICODE (Non-UTF-16 BOM Little Endian)	

*1 Files created with a combination of 48 kHz sampling frequency and 64 Kbps bit rate cannot be played.

*2 Available codes depend on what kind of media, versions and information are going to be displayed.

*3 Where fitted. Protected WMA files (DRM) cannot be played.

*4 When VBR files are played, the playback time may not be displayed correctly. WMA7 and WMA8 are not applied to VBR.

APPLE CARPLAY AND ANDROID AUTO (where fitted)

WARNING

- **Stop your vehicle in a safe location and apply the parking brake before connecting your mobile device to the vehicle or operating your connected mobile device for setup.**
- **Laws in some jurisdictions may restrict the use of some of the applications and features, such as social networking and texting. Check local regulations for any requirements.**
- **If you are unable to devote full attention to vehicle operation while using your mobile device, pull off the road to a safe location and stop your vehicle.**

Apple CarPlay:

With Apple CarPlay, your in-vehicle system can be used as a display and a controller for some of the iPhone functions. Apple CarPlay features Siri which enables operations via voice controls. Wireless Apple CarPlay (where fitted) is also available for certain iPhone models. Refer to the NissanConnect Owner's Manual and visit the Apple website for information about the functions that are available and other details.

NOTE

To ensure efficient wireless charging (where fitted), do not use wireless Apple CarPlay and wireless charging simultaneously for long periods. Use a USB connection in these circumstances.

Android Auto:

With Android Auto, your in-vehicle system can be used as a display and a controller for some of your Android phone functions. Android Auto supports Talk to Google which enables operations via voice controls. Refer to the NissanConnect Owner's Manual and visit the Android Auto website for information about the functions that are available and other details.

NISSANCONNECT (where fitted)

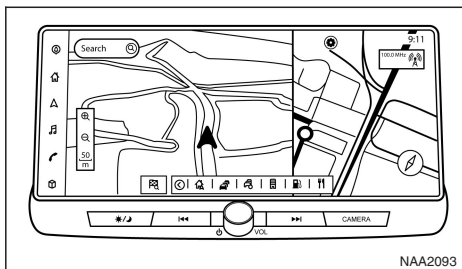

Type A

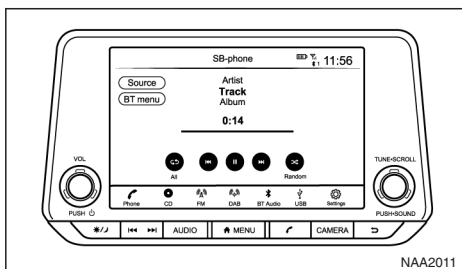

Type B

For details, see the separately provided NissanConnect Owner's Manual.

- Online:
 - **Type A**
Go to: <https://uqr.to/16959>
Or scan the QR code



- **Type B**
Go to: <https://uqr.to/16959>
Or scan the QR code



- Printed version: Please contact your NISSAN dealer or qualified workshop.

SAFETY INFORMATION

This system is primarily designed to help you support pleasant driving as outlined in this manual. However, you, the driver, must use the system safely and properly. Information and the availability of services may not always be up to date. The system is not a substitute for safe, proper and legal driving.

Before using the system, please read the following safety information. Always use the system as outlined in this manual.

⚠ WARNING

- **To operate the system, first park the vehicle in a safe location and set the parking brake. Operating the system while driving can distract the driver and may result in a serious accident.**
- **Exercise extreme caution at all times so full attention may be given to vehicle operation. If the system does not respond immediately, please be patient and keep your eyes on the road. Inattentive driving may lead to a crash resulting in serious injuries or death.**
- **Do not rely on route guidance (where fitted) alone. Always be sure that all driving manoeuvres are legal and safe in order to avoid accidents.**
- **Do not disassemble or modify this system. If you do, it may result in accidents, fire or electrical shock.**

- If you notice any foreign objects in the system hardware, spill liquid on the system or notice smoke or a smell coming from it, stop using the system immediately and it is recommended you contact a NISSAN dealer or qualified workshop. Ignoring such conditions may lead to accidents, fire or electrical shock.

CAUTION

- Some jurisdictions may have laws limiting the use of video screens while driving. Use this system only where it is legal to do so.
- Extreme temperature conditions (below -20°C (-4°F) and above 70°C (158°F)) could affect the performance of the system.
- The display screen may break if it is hit with a hard or sharp object. If the display screen breaks, do not touch it. Doing so could result in an injury.

NOTE

Do not keep the system running with the e-POWER system stopped. Doing so may discharge the vehicle battery (12V battery). When you use the system, always keep the e-POWER system running.

Models with NissanConnect Services: NissanConnect Services may not be available in some regions. Completing the NissanConnect Services registration is necessary to use NissanConnect Services related functions.

Hands-free telephone control

WARNING

- Use a phone after stopping your vehicle in a safe location. If you have to use a phone while driving, exercise extreme caution at all times so full attention may be given to vehicle operation.
- If you find yourself unable to devote full attention to vehicle operation while talking on the phone, pull off the road to a safe location and stop your vehicle before doing so.

CAUTION

To avoid draining the vehicle battery (12V battery), use a phone only after starting the e-POWER system.

Hands-free text messaging assistant

WARNING

- Use the text messaging feature after parking your vehicle in a safe location. If you have to use the feature while driving, exercise extreme caution at all times so full attention may be given to vehicle operation.
- Laws in some jurisdictions may restrict the use of "Text-to-Speech." Check local regulations before using this feature.
- Laws in some jurisdictions may restrict the use of some of the applications and features, such as social networking and texting. Check local regulations for any requirements.

- If you are unable to devote full attention to vehicle operation while using the text messaging feature, pull off the road to a safe location and stop your vehicle.

CAUTION

This feature is disabled if the connected device does not support it. See the phone's Owner's Manual for details and instructions.

Liquid crystal display

The display on this unit is a liquid crystal display and should be handled with care.

WARNING

Never disassemble the display. Some parts utilise extremely high voltage. Touching them may result in serious personal injury.

Maintenance of display:

To clean the display screen, use a dry, soft cloth. If additional cleaning is necessary, use a small amount of neutral detergent with a soft cloth. Never spray the screen with water or detergent. Dampen the cloth first, then wipe the screen.

CAUTION

- To clean the display, never use a rough cloth, alcohol, benzene, thinner or any kind of solvent or paper towel with a chemical cleaning agent. They will scratch or deteriorate the panel.

- **Do not splash any liquid, such as water or car fragrance, on the display. Contact with liquid will cause the system to malfunction.**

NAVIGATION (where fitted)

The navigation system is primarily designed to help you reach your destination. However, you, the driver, must use the system safely and properly. Information concerning road conditions, traffic signs and the availability of services may not always be up to date. The system is not a substitute for safe, proper, and legal driving.

WARNING

- **Do not rely on route guidance alone. Always be sure that all driving manoeuvres are legal and safe in order to avoid accidents.**
- **Always stop the vehicle in a safe location before modifying the route conditions. Modifying the route conditions while driving may cause an accident.**
- **The navigation system's visual and voice guidance is for reference purposes only. The contents of the guidance may be inappropriate depending on the situation.**
- **Follow all traffic regulations when driving along the suggested route (e.g. one-way traffic).**

AUDIO OPERATION PRECAUTIONS

CAUTION

- **Operate the audio system only when the e-POWER system is running. Operating the audio system for extended periods of time with the e-POWER system turned off can discharge the vehicle battery (12V battery).**
- **Do not allow the system to get wet. Excessive moisture such as spilled liquids may cause the system to malfunction.**

HOW TO UPDATE MAP DATA (where fitted)

WARNING

TO AVOID RISK OF DEATH OR SERIOUS PERSONAL INJURY WHEN UPDATING THE MAP SOFTWARE:

If you choose to park the vehicle within range of a Wi-Fi connection (where fitted) or a TCU (Telematics Control Unit) (where fitted), park the vehicle in a secure, safe, well-ventilated location that is open to the air. During the update process, if you choose to park your vehicle, it should be kept in a well ventilated area to avoid exposure to carbon monoxide. Do not breathe exhaust gases; they contain colourless and odourless carbon monoxide. Carbon monoxide is dangerous. It can cause unconsciousness or death.

UPDATING SYSTEM SOFTWARE (where fitted)

WARNING

TO AVOID RISK OF DEATH OR SERIOUS PERSONAL INJURY WHEN UPDATING THE SYSTEM SOFTWARE:

If you choose to park the vehicle within range of a Wi-Fi connection (where fitted), park the vehicle in a secure, safe, well-ventilated location that is open to the air. During the update process, if you choose to park your vehicle, it should be kept in a well ventilated area to avoid exposure to carbon monoxide. Do not breathe exhaust gases; they contain colourless and odourless carbon monoxide. Carbon monoxide is dangerous. It can cause unconsciousness or death.

How to update from the system menu

WARNING

To operate the system for software update, first park the vehicle in a safe location.

REGULATORY INFORMATION

Radio approval number and information

For Europe:

Type A:

Hereby, Robert Bosch GmbH declares that the radio equipment type AIVI2SBXM is in compliance with Directive 2014/53/EU.

The full text of the EU declaration of conformity is available at the following internet address:

<https://eu-doc.bosch.com>



Hereby, Robert Bosch GmbH declares that the radio equipment type AIVI2SBXM is in compliance with of Radio Equipment Regulations 2017.



Frequency Band

2400 MHz - 2480 MHz

5490 MHz - 5600 MHz

5650 MHz - 5710 MHz ≤ 100 mW

5735 MHz - 5835 MHz ≤ 25 mW

Radiated Power [EIRP]

Bluetooth < 10 mW

WLAN < 100 mW

Hints/Restrictions

Internal Antenna

Internal antenna not accessible by user. Any change by the user will violate the legal approval of this product.

Type B:

Hereby, Robert Bosch GmbH declares that the radio equipment type AIVIP33A0 is in compliance with Directive 2014/53/EU.

The full text of the EU declaration of conformity is available at the following internet address:

<https://eu-doc.bosch.com>



Hereby, Robert Bosch GmbH declares that the radio equipment type AIVIP33A0 is in compliance with of Radio Equipment Regulations 2017.



Frequency Band

2400 MHz - 2480 MHz

Radiated Power [EIRP]

Bluetooth < 10 mW

WLAN < 100 mW

Hints/Restrictions

Internal Antenna

Internal antenna not accessible by user. Any change by the user will violate the legal approval of this product.

For Ukraine:

Type A:

Декларація про відповідність
Справжнім «Robert Bosch GmbH» заявляє, що Automotive Infotainment System моделі AVI2SVMX відповідає основним вимогам та іншим відповідним положенням директиви 2014/53/ЄС, а також суттєвим вимогам Технічного регламенту радіоблагодання, затвердженого постановою Кабінету Міністрів України від 24 травня 2017 року № 355. З повним текстом української Декларації про відповідність можна ознайомитись, відвідавши сторінку на <https://eu-doc.bosch.com>
Виробник: «Robert Bosch GmbH» «Роберт Бош ГмбХ» (Роберт-Босх-Плаца 1, 70839 Герлінген, Німеччина).

PHB0263XZ

Діапазон частот:
Bluetooth (IEEE 802.15.1), WLAN 802.11 b/g/n:
2400.0 - 2483.5 МГц
WLAN 802.11 a/n/ac:
5150 – 5250 МГц/ 5725-5875 МГц
(Glonass/GPS): 1559 - 1610 МГц
AM/FM/DAB:
526.5 – 1606.5 кГц
87.5-108 МГц
174 - 230 МГц

Максимальна вихідна потужність
ЕІВП не більше, дБм (мВт) :
1.4 (1.38) Bluetooth (IEEE 802.15.1)
17.4 (54.95) WLAN 802.11 b/g/n
16.7 (46.77) WLAN 802.11 a/n/ac
13.7 (23.44) (SRD)

NAVI0008



PBH0015X

Type B:

Декларація про відповідність
Справжнім «Robert Bosch GmbH» заявляє, що Automotive Infotainment System моделі AVI/PS340 відповідає основним вимогам та іншим відповідним положенням директиви 2014/53/ЄС, а також суттєвим вимогам Технічного регламенту радіоблагодання, затвердженого постановою Кабінету Міністрів України від 24 травня 2017 року № 355. З повним текстом української Декларації про відповідність можна ознайомитись, відвідавши сторінку на: <https://eu-doc.bosch.com>
Виробник: «Robert Bosch GmbH» «Роберт Бош ГмбХ» (Роберт-Босх-Плаца 1, 70839 Герлінген, Німеччина).

NAVI0007



PBH0015X

Діапазон частот:
Bluetooth (IEEE 802.15.1), WLAN 802.11 b/g/n:
2400.0 - 2483.5 МГц
WLAN 802.11 a/n/ac:
5150 – 5250 МГц/ 5725-5875 МГц
(Glonass/GPS): 1559 - 1610 МГц
AM/FM/DAB:
526.5 – 1606.5 кГц
87.5-108 МГц
174 - 230 МГц

Максимальна вихідна потужність
ЕІВП не більше, дБм (мВт) :
1.4 (1.38) Bluetooth (IEEE 802.15.1)
17.4 (54.95) WLAN 802.11 b/g/n
16.7 (46.77) WLAN 802.11 a/n/ac
13.7 (23.44) (SRD)

NAVI0008

TRADEMARKS



Apple, iPhone, iPod, and iPod touch are trademarks of Apple Inc., registered in the U.S. and other countries. Apple CarPlay is a trademark of Apple Inc. Use of the Apple CarPlay logo means that a vehicle user interface meets Apple performance standards. Apple is not responsible for the operation of this vehicle or its compliance with safety and regulatory standards. Please note that the use of this product with iPhone or iPod may affect wireless performance.



Bluetooth® is a trademark owned by Bluetooth SIG, Inc. and licensed to Robert Bosch GmbH.



Music recognition technology and related data are provided by Gracenote®. Gracenote is the industry standard in music recognition technology and related content delivery. For more information, visit www.gracenote.com. Music related data from Gracenote, Inc., copyright © 2000 to present Gracenote. Gracenote Software, copyright © 2000 to present Gracenote.

One or more patents owned by Gracenote apply to this product and service. See the Gracenote website for a nonexhaustive list of applicable Gracenote patents. Gracenote, the Gracenote logo and logotype are either a registered trademark or a trademark of Gracenote, Inc. in the United States and/or other countries.

App Store

Apple and the Apple logo are trademarks of Apple Inc., registered in the U.S. and other countries. App Store is a service mark of Apple Inc.

Siri

Siri is a trademark of Apple Inc., registered in the U.S. and other countries.

Google/Android/Google Play/Android Auto

Google, Android, Google Play, Android Auto, and other marks are trademarks of Google LLC.

LICENCES

SOFTWARE LICENCES

Open Source Software Licences

<http://oss.bosch-cm.com/nissan.html>

Telematics Control unit (TCU)
(where fitted)

<http://opensourceautomotive.com/IC/tZ7T3eE6AIV4>

or

<https://www.oss-valeo.com/nissan/default.html>

STEERING WHEEL SWITCHES FOR AUDIO CONTROL (where fitted)

CONTROL BUTTONS

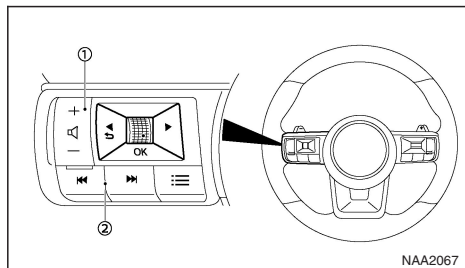

- ① Volume buttons
- ② Tuning switch

Play Control (Tuning switch)

Push the tuning switch left or right to select a channel, track, CD or folder when they are listed on the display.

RADIO:

- Pushing Left/Right longer Next or previous preset channel
- Pushing Left/Right shorter Next or previous station/channel

iPod (where fitted), USB device (where fitted) or Bluetooth® Audio (where fitted):

- Pushing Left/Right shorter
Next track or the beginning of the current track (the previous track if the button is pushed immediately after the current track starts playing)
- Pushing Left/Right longer
Forward or rewind.

Volume control switches

Push the volume control switch to increase or decrease the volume.

MOBILE PHONE INTEGRATION FOR FM AM RADIO (where fitted)

Not for models with NissanConnect system, see the separately provided Owner's Manual.

BLUETOOTH® MOBILE PHONE FEATURE

⚠ WARNING

While driving, using the mobile phone is extremely dangerous because it significantly impairs your concentration and diminishes your reaction capabilities to sudden changes on the road, and it may lead to a fatal accident. This applies to all phone call situations such as when receiving an incoming call, during a phone conversation, when calling through the phone book search, etc.

CAUTION

Certain country jurisdictions prohibit the use of the mobile phone in the car without hands-free support.

This chapter provides information about the NISSAN hands-free phone system using a Bluetooth® connection.

Bluetooth® is a wireless radio communication standard. This system offers a hands-free facility for your mobile telephone to enhance driving comfort.

In order to use your mobile phone with the Bluetooth® of the audio system, the mobile phone must first be setup. For details, see "Bluetooth® settings" later in this section. Once it has been setup, the

hands-free mode is automatically activated on the registered mobile phone (via Bluetooth®) when it comes into range.

A notification message appears on the audio display when the phone is connected, when an incoming call is being received, as well as when a call is initiated.

When a call is active, the audio system, microphone (located in the ceiling in front of the rear view mirror), and steering wheel switches enable hands-free communication.

If the audio system is in use at the time, the radio, CD, iPod, USB audio, Bluetooth® audio or AUX source mode will be muted and will stay muted until the active call has ended.

The Bluetooth® system may not be able to connect with your mobile phone for the following reasons:

- The mobile phone is too far away from the vehicle.
- The Bluetooth® mode on your mobile phone has not been activated.
- Your mobile phone has not been paired with the Bluetooth® system of the audio unit.
- The mobile phone does not support Bluetooth® technology (BT Core v2.0).

NOTE

- For models with NissanConnect (Audio with Navigation system) see the separately provided Owner's Manual.
- For details, see your mobile phone's Owner's Manual.

- For assistance with your mobile phone integration, please visit your local NISSAN dealer or qualified workshop.

Control buttons and microphone

Instrument panel:

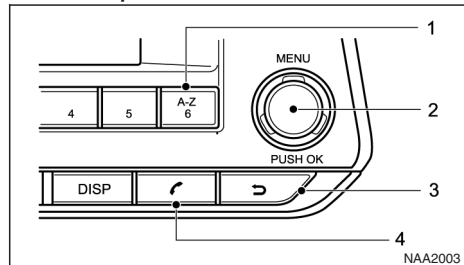

- ① Phone book quick search button **A-Z**
- ② <MENU> or <OK> button (rotate and push to select)
- ③ ↶ (Back) button
- ④ ↷ Phone button

Steering wheel mounted control:

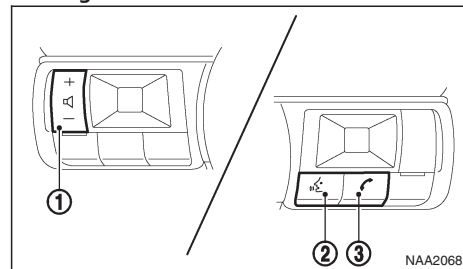

- ① Volume up/down buttons
- ② Phone send/answer button
- ③ Phone call end button

The hands-free mode can be operated using the steering wheel switches.

Microphone:

The microphone is located near the map light.



Bluetooth® settings

Enter the phone setup menu via the  (phone) button, select the [Bluetooth] key, and then check if the Bluetooth® is set to on (default setting is on, push the <OK> button if not).

To setup the Bluetooth® system to pair (connect or register) your preferred mobile phone, follow the following procedure.

To pair a device, use the [Scan devices] key or the [Pair device] key.

Up to 5 different Bluetooth® devices can be connected. However, only one device can be used at a time. If 5 different Bluetooth® registered devices are registered, a new device can only replace one of the 5 existing paired devices. Use [Del. device] key to delete one of the existing paired devices. For details, see "[Del. device]" later in this section.

When successfully paired a notification message will be displayed, then the audio system display will return to the current audio source display. During connection the following status icons will be displayed (top left of the display): Signal strength () , Battery status* () and Bluetooth® "ON" () .

*: If the low battery message comes on, the Bluetooth® device must be recharged soon.

The pairing procedure and operation may vary according to device type and compatibility. See the Bluetooth® owner's manual for further details.

NOTE

- For device details, see your audio/mobile phone Owner's Manual.
- For assistance with the Bluetooth® audio/mobile phone integration, please visit your local NISSAN dealer or qualified workshop.



- A maximum of 5 Bluetooth® devices can be paired with the system.

To set up the Bluetooth® system with a device the following items are available:



- [Scan devices]
Shows all available visible Bluetooth® devices and initialises Bluetooth® connection from the audio unit.
- [Pair device]
Initialises Bluetooth® connection from the mobile device.
- [Sel. device]
Paired Bluetooth® devices are listed and can be selected for connection.
- [Del. device]
A registered Bluetooth® device can be deleted.
- [Bluetooth]
If this setting is turned off, the connection between the Bluetooth® devices and the in-vehicle Bluetooth® module will be cancelled.

[Scan devices]:

- 1) Press the  button. Select [Scan devices]
The audio unit searches Bluetooth® devices and shows all visible devices.
Pressing the  button cancels the search.
- 2) Select the device to be paired.
Use the <MENU> dial and press to select.
- 3) The pairing procedure depends on the device to be connected:
 - 1) Device without PIN code:
The Bluetooth® connection will be automatically connected without any further input.
 - 2) Device with PIN code:
Two different ways of pairing are possible depending on the device:
 - Type A:
The message [To pair] [Enter Pin] 0000 and a countdown timer will be displayed. Confirm the PIN code on the device. The Bluetooth® connection will be made. If the countdown timer reaches 0 the attempt to pair the devices will be cancelled.
 - Type B:
The message [Pairing request] [Confirm password] together with a 6 digit code will be displayed. The unique and identical code should be displayed on the device. If the code is identical confirm on the device. The Bluetooth® connection will be made.

[Pair device]:

Turn on the Bluetooth® on the audio unit. See "[Bluetooth]" later in this section.

- Use the audio unit to pair:

Push the  button on the instrument panel. Select the [Pair Device] key.

The pairing procedure depends on the Bluetooth® device to be connected:

- 1) Device without PIN code:

The Bluetooth® connection will be automatically connected without any further input.

- 2) Device with PIN code:

Two different ways of pairing are possible depending on the device. For the correct procedure details, see "[Scan devices]" earlier in this section.

- Use the Bluetooth® audio/cellular phone device to pair:

- 1) Switch on the search mode for Bluetooth® devices. If the search mode finds the audio unit, it will be shown on the device display.
- 2) Select the unit device shown as [My Car].
- 3) Enter the number code shown on the relevant Bluetooth® device with the device's own keypad, and push the confirmation key on the device and the <MENU>/<OK> dial on the audio unit.



When an Apple device is connected via the USB connection port and Bluetooth®, the device will be recognised as a USB device. The battery of the Apple device is charged while the cable is connected to the USB connection port.

Refer to the relevant Bluetooth® device Owner's Manual for further details.

[Sel. device]:

The paired device list shows which Bluetooth® audio or mobile phone devices have been paired or registered with the Bluetooth® audio system. If the list contains devices then select the appropriate device to connect to the Bluetooth® audio system.



The following symbols (where fitted) indicate the capability of the registered device:

-  : Mobile phone integration
-  : Audio streaming (A2DP – Advanced Audio Distribution Profile)



[Del. device]:

A registered device can be removed from the Bluetooth® audio system. Select a registered device then press <OK> to confirm the deletion.

[Bluetooth]:

If Bluetooth® has been switched on a notification message [ON/OFF] appears when you select [Bluetooth] from the phone menu (press ). To switch the Bluetooth® signal on, press <OK> and a follow up screen will appear. Then select [ON] and press  to display the Bluetooth® settings menu screen.

HANDS-FREE TELEPHONE CONTROL

The hands-free mode can be operated using the telephone  button on the audio system, or the  button (where fitted) on the steering wheel.

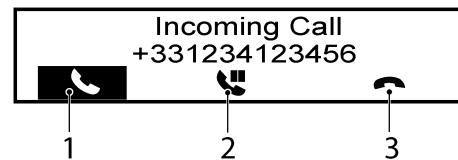





Receiving a call

When receiving an incoming call, the display will show the caller's phone number (or a notification message that the caller's phone number cannot be shown) and three operation icons.

1. Answering and during a call:

Answer the call by pressing <OK> (the  is highlighted).

By pressing <OK>, you can select the following options:

- Ending the call by selecting  and press <OK>.
- Put the call on hold by selecting  and press <OK>.
- [] Use this item (the transfer handset command) to transfer the call from the audio system to your mobile phone.
To transfer the call back to hands-free via the audio system select [].

2. Put a call on hold:

Rotate the <MENU> dial until  is highlighted, press <OK>. The call is on hold. Pressing <OK> accepts the call, rotate the <MENU> dial clockwise and press <OK> to reject.

3. Rejecting a call:

Rotate the <MENU> dial until  is highlighted, press <OK>. The call is rejected.



Initiating a call

A call can be initiated using one of the following methods:

- Making a call from the phone book
- Manually dialling a phone number
- Redialling
- Using call history (Call List menu)
 - Outgoing
 - Incoming
 - Missed

Making a call from the phone book:

Once the Bluetooth® connection has been made, between the registered mobile phone and the audio system, phone book data will be transferred automatically to the audio system. The transfer may take a while before completion.

NOTE

Phone book data will be erased when:

- Switching to another registered mobile phone.
- Mobile phone is disconnected.

● The registered mobile phone is deleted from the audio system.

1. Press <←>.
2. Turn the <MENU> dial and scroll down to [Phonebook] then press <OK>.
3. Scroll down through the list, select the appropriate contact name (highlighted), and press <OK>.
4. A following screen will show the number to be dialled. If correct, press <OK> again to dial the number.

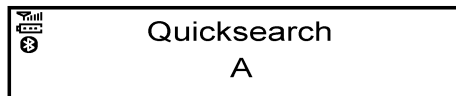

Alternatively, the quick search mode can be used as follows:

1. While in the phonebook screen press <A-Z/ⓐ>.
2. Turn the <MENU> dial for the first alphabetic or numerical letter of the contact name. Once highlighted, press <OK> to select the letter.
3. The display will show the corresponding contact name(s). Where necessary, use the <MENU> dial again to scroll further for the appropriate contact name to call.
4. A following screen will show the number to be dialled. If correct, press <OK> again to dial the number.

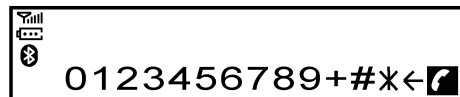



Manually dialling a phone number:

⚠ WARNING

Park the vehicle in a safe location, and apply the parking brake before making a call.

To dial a phone number manually use the audio system display (virtual keyboard pad) as follows:

1. Press , and turn the <MENU> dial to highlight [Dial Number].
2. Press <OK> to select [Dial Number].
3. Turn the <MENU> dial to scroll along, and select each number of the phone number. Once highlighted, press <OK> after each number selection.

To delete the last number entered scroll to the [←] (Backspace) symbol, and once highlighted press <OK>. The last number will be deleted. Pressing <OK> repeatedly will delete each subsequent number.
4. After entering the last number, scroll to the  symbol, and press <OK> to dial the number.



Redial:

To redial or call the last number dialled, press  for more than 2 seconds.





Using call history (Call List menu):

A number from the dialled, received, or missed call lists can also be used to make a call.

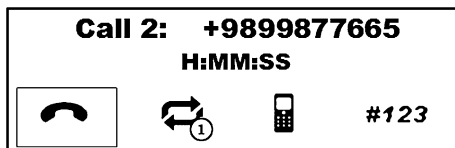
- [Outgoing]
Use the dialled call mode to make a call which is based on the list of outgoing (dialled) calls.
 - [Incoming]
Use the received call mode to make a call which is based on the list of received calls.
 - [Missed]
Use the missed call mode to make a call which is based on the list of missed calls.
1. Press , and select [Call History].
 2. Turn the <MENU> dial to scroll to an item, and press <OK> to select it.
 3. Scroll to the preferred phone number then press <OK>, or press  to dial the number.



Second incoming call

Whenever there is a second incoming call is shown in the display. By selecting the  icon the call is accepted and the current call is put on hold. Selecting  by rotating <MENU> and pressing <OK> rejects the second incoming call. When this is done during the conversation it ends the call. Selecting the  key using the <MENU> dial and pressing <OK> switches between the phone conversations. (For the other selections, see Making a call from the phone book earlier)



General settings

From the phone menu select [Settings]
Volume settings and manually downloading the phonebook can be done using this menu.
Menu operation:
Press <OK> to select, rotate the <MENU> dial to increase or decrease the volume.

Press <OK> to confirm.

Menu items:

- [Volume]
 - [Ring]
Set the phone ringing volume
 - [Call]
Set the volume of the conversation during a call.
- [Ring]
 - [Vehicle]
Choose the in car ringtone.
 - [Phone]
Choose the phone ringtone.
- [PB download]
Download the phonebook of the mobile device to the audio unit manually.

Standby mode operation

The audio system is in standby mode when the audio system is inactive but the clock is displayed on the screen.

When a mobile device is connected to the in-vehicle audio system via Bluetooth with the audio system in the standby mode, the audio system will turn on automatically under the following instances:

- The connected mobile device receives an incoming call.
- An outgoing call is made with the connected phone.

The Bluetooth Hands-Free Phone System operation will become possible on the audio system once it is turned on. The audio system will automatically return to standby mode after the call is disconnected.

5 Starting and driving

Before starting the e-POWER system.....	239	Electric shift control system.....	250
Precautions when starting and driving.....	239	Traffic sign recognition (where fitted).....	254
Exhaust gas (Carbon Monoxide).....	240	System Operation.....	256
Tyre Pressure Monitoring System (TPMS) (where fitted).....	240	Turning the TSR system on and off.....	256
Meter information.....	243	System temporarily unavailable.....	256
Activation.....	243	System Malfunction.....	257
New and repositioned TPMS sensors (including fitment of alternative wheels).....	243	Maintenance.....	257
Adjusting TPMS target pressure (where possible).....	244	Blind Spot Warning (BSW) system/Intelligent Blind Spot Intervention system (where fitted).....	257
Tyre pressure units.....	244	The BSW and Intelligent Blind Spot Intervention systems.....	258
[Check Cold Tyre] message.....	244	BSW system operation.....	259
TPMS temperature calibration (where possible).....	244	Intelligent Blind Spot Intervention system operation.....	262
Three-way catalyst.....	245	BSW/Intelligent Blind Spot Intervention system precautions.....	264
To help prevent damage.....	245	BSW/Intelligent Blind Spot Intervention driving situations.....	265
Gasoline particulate filter (GPF) (where fitted).....	245	System maintenance.....	268
Turbocharger system.....	246	Rear Cross Traffic Alert (RCTA) system (where fitted).....	269
Care when driving.....	246	RCTA system operation.....	270
Loading luggage.....	246	How to enable/disable the RCTA system.....	271
Driving on wet roads.....	246	RCTA system limitations.....	272
Driving under winter conditions.....	246	System temporarily unavailable.....	273
Push-button power switch.....	247	System malfunction.....	273
Precautions on push-button power switch operation.....	247	System maintenance.....	273
Intelligent Key system.....	247	Rear Automatic Braking (RAB) (where fitted).....	274
Power switch positions.....	248	RAB system operation.....	275
Emergency system shut off.....	248	Turning the RAB system ON/OFF.....	276
Steering lock.....	249	RAB system limitations.....	277
Intelligent Key battery discharge.....	249	System malfunction.....	278
Starting the e-POWER system.....	250		
Driving the vehicle.....	250		

System maintenance.....	278	Conventional (fixed speed) cruise control mode.....	312
Lane Departure Warning (LDW) system (where fitted).....	279	ProPILOT Assist (where fitted).....	315
LDW system operation.....	280	ProPILOT Assist system operation.....	316
LDW temporary disabled status.....	282	ProPILOT Assist switches.....	336
LDW malfunction.....	283	ProPILOT Assist System Display and Indicators.....	318
Multi-sensing camera unit maintenance.....	283	Turning the ProPILOT Assist Conventional (fixed speed) Cruise Control mode on.....	319
Intelligent Lane Intervention (ILI) system (where fitted).....	284	Operating the ProPILOT Assist system.....	320
Intelligent Lane Intervention System Operation.....	285	ProPILOT Assist Intelligent Cruise Control (ICC) system.....	322
Intelligent Lane Intervention Activation/Deactivation.....	286	ProPILOT Assist Steering Assist.....	335
Intelligent Lane Intervention Limitations.....	287	ProPILOT Assist Conventional (fixed speed) Cruise Control Mode.....	340
Intelligent Lane Intervention temporarily unavailable.....	288	ProPILOT Assist Speed limiter (where fitted).....	342
System malfunction.....	288	ProPILOT Assist Lane Departure Warning (LDW) system.....	345
Multi-sensing camera unit maintenance.....	288	ProPILOT Assist Intelligent Lane Intervention system.....	349
Emergency Lane Assist (ELA) system (where fitted).....	289	Intelligent Forward Collision Warning (I-FCW) system (where fitted).....	354
ELA System Operation.....	290	I-FCW system operation.....	355
ELA Activation/Deactivation.....	291	Turning the I-FCW system ON/OFF.....	356
ELA Limitations.....	292	I-FCW system limitations.....	357
System temporarily unavailable.....	294	System temporarily unavailable.....	358
System malfunction.....	294	System malfunction.....	359
System maintenance.....	295	System maintenance.....	359
Cruise control (where fitted).....	295	Intelligent Emergency Braking (IEB) system (where fitted).....	359
Precautions on cruise control.....	296	IEB system operation.....	361
Cruise control system operations.....	296	System maintenance.....	367
Speed limiter (where fitted).....	297	Intelligent Driver Alertness (where fitted).....	368
Speed limiter operations.....	298	System operation.....	368
Intelligent Cruise Control (ICC) (where fitted).....	299	Parking.....	370
Cruise control operations.....	300	Intelligent Parking Assist (IPA) (where fitted).....	371
How to select Cruise Control modes.....	300	Deactivation of the IPA system.....	372
Vehicle-to-vehicle distance control mode.....	301		

Parking procedure using the IPA system.....	373	Rear Ultrasonic Parking Sensors (where fitted)	399
Operating tips	377	System operation	399
ProPILOT Park (where fitted)	377	How to enable/disable the parking sensor	
ProPILOT Park switch.....	378	(sonar) system	400
ProPILOT Park screen	378	Parking sensor (sonar) system limitations.....	401
Selecting the parking method.....	379	System temporarily unavailable.....	402
ProPILOT Park operation.....	380	System maintenance.....	402
ProPILOT Park pause.....	383	Trailer towing	403
ProPILOT Park deactivation.....	383	Operating precautions	403
About the ProPILOT Park parking methods	384	Tyre pressure.....	403
Adjusting the parking position.....	386	Safety chains.....	403
Changing the direction of parking control		Trailer brakes.....	403
travel.....	387	Installation of coupling device.....	404
Parking position detection function	387	Vehicle security	405
Cameras and parking sensors (sonar) used for		Power steering.....	405
ProPILOT Park.....	389	Brake system.....	406
ProPILOT Park precautions.....	389	Braking precautions.....	406
ProPILOT Park malfunction.....	390	Anti-lock Braking System (ABS)	407
ProPILOT Park settings.....	390	Using system.....	407
Parking sensor (sonar) detection conditions		Self-test feature	407
and limitations.....	391	Normal operation	407
Intelligent Around View Monitor detection		Electronic Stability Programme (ESP) system.....	408
conditions and limitations.....	391	Brake force distribution	409
ProPILOT Park detection conditions and		How to turn off the ESP system.....	409
limitations.....	392	Chassis control.....	409
Front and Rear Ultrasonic Parking Sensors (where		Intelligent Trace Control	409
fitted).....	394	Hill Start Assist (HSA) (where fitted).....	410
System operation	395	Cold weather driving.....	411
How to enable/disable the parking sensor		Battery.....	411
(sonar) system	396	Engine coolant.....	411
Parking sensor (Sonar) system limitations	397	Tyre equipment.....	411
System temporarily unavailable.....	398	Special winter equipment.....	411
System maintenance.....	398	Corrosion protection	412

BEFORE STARTING THE E-POWER SYSTEM

WARNING

The driving characteristics of your vehicle can be changed remarkably by any additional load and its distribution as well as by adding optional equipment (trailer couplings, roof racks, etc.). Your driving style and speed have to be adjusted accordingly. Especially when carrying heavy loads, your speed must be reduced adequately.

- Make sure the area around the vehicle is free of obstacles.
- Check fluid levels such as engine oil, coolant, brake fluid, and window washer fluid as frequently as possible, at least whenever you refuel.
- Visually inspect tyres for their appearance and condition. Also check the tyre pressure for proper inflation.
- Maintenance items in the “8. Maintenance and do-it-yourself” section should be checked periodically.
- Check that all windows and light lenses are clean.
- Check that all doors are closed.
- Position the seat and adjust the head restraints.
- Adjust the inside and outside mirrors.
- Fasten your seat belt and ask all passengers to do likewise.
- Check the operation of the warning/indicator lights when the power switch is switched ON.

- Do not place hard or heavy objects on the dashboard or rear parcel shelf in order to prevent injury in the event of a sudden stop.

PRECAUTIONS WHEN STARTING AND DRIVING

WARNING

- Do not leave children or adults who would normally require the support of others alone in your vehicle. Pets should also not be left alone. They could accidentally injure themselves or others through inadvertent operation of the vehicle. Also, on hot, sunny days, temperatures in a closed vehicle could quickly become high enough to cause severe or possibly fatal injuries to people or animals.
- To prevent luggage or packages from sliding forward during braking, do not stack anything in the cargo area higher than the seatbacks.
- Secure all cargo with ropes or straps to prevent it from sliding or shifting.
- Failure to follow proper seating instructions see “Seats” in the “1. Safety – Seats, Seat belts and Supplemental Restraint System” section, could result in serious personal injury in an accident or sudden stop.

NOTE

During the first few months after purchasing a new vehicle, if you smell strong odours of Volatile Organic Compounds (VOCs) inside the vehicle, ventilate the passenger compartment thoroughly. Open all the windows before entering or while in the vehicle. In addition, when the temperature in the passenger compartment rises, or when the vehicle is parked in direct sunlight for a period of time, turn off the air recirculation mode of the air conditioner and/or open the windows to allow sufficient fresh air into the passenger compartment.

EXHAUST GAS (Carbon Monoxide)

⚠ WARNING

- Do not breathe exhaust gases; they contain colourless and odourless carbon monoxide. Carbon monoxide is a dangerous gas and can cause unconsciousness or death.
- If you suspect that exhaust fumes are entering the vehicle, drive with all windows fully open and have the vehicle inspected immediately.
- Do not run the engine in closed spaces, such as a garage, for any longer than is absolutely necessary.
- Do not park the vehicle with the engine running for any extended length of time.
- Keep the tailgate closed while driving, otherwise exhaust gases could be drawn into the passenger compartment. If you must drive in this way for some reason, take the following steps:
 - 1) Open all the windows.
 - 2) Set the air recirculation mode () to the "OFF" position.
 - 3) Set the fan speed control to the maximum position to circulate the air.
- If electrical wiring or other cable connections must pass to a trailer through the seal of the body, follow the manufacturer's recommendations to prevent carbon monoxide entry into the vehicle.

- If a special body or other equipment is added for recreational or other usage, follow the manufacturer's recommendation to prevent carbon monoxide entry into the vehicle. (Some recreational vehicle appliances such as stoves, refrigerators, heaters, etc. may also generate carbon monoxide.)
- The exhaust system and body should be inspected by a NISSAN dealer or qualified workshop whenever:
 - The vehicle is raised for service.
 - You suspect that exhaust fumes are entering into the passenger compartment.
 - You notice a change in the sound of the exhaust system.
 - You have had an accident involving damage to the exhaust system, underbody, or rear of the vehicle.

TYRE PRESSURE MONITORING SYSTEM (TPMS) (where fitted)

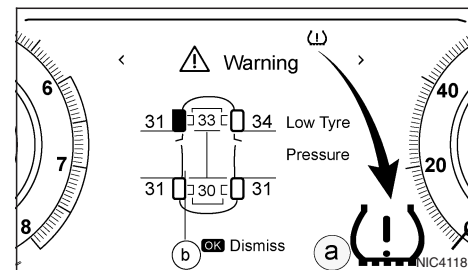

- (a) TPMS indicator light
- (b) TPMS tyre location indicator

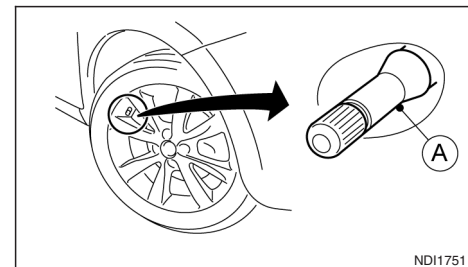

- (A) Tyre valve with sensor

The tyre pressure monitoring system monitors the tyre pressure of the four wheels while the vehicle is in motion. Following a loss in pressure, the system will warn the driver using a visual warning. Each

TPMS sensor ④ has a registered wheel location and sends pressure and temperature data via radio to a receiver inside the vehicle.

Each tyre, including the spare (where fitted), should be checked monthly when cold and inflated to the inflation pressure recommended by the vehicle manufacturer on the vehicle placard or tyre inflation pressure label. (If your vehicle has tyres of a different size than the size indicated on the vehicle placard or tyre inflation pressure label, you should determine the proper tyre inflation pressure for those tyres.)

The Tyre Pressure Monitoring System (TPMS) controls the TPMS indicator light ⑤, which will illuminate when one or more tyres are significantly under-inflated. A warning and tyre location indicator ⑥ will also appear in the vehicle information display to identify the tyre or tyres with low pressure.

Accordingly, when the TPMS indicator light illuminates, safely stop the vehicle to check the tyres as soon as possible and inflate the tyres to the proper pressure. Driving on a significantly under-inflated tyre causes the tyre to overheat and can lead to tyre failure. Under-inflation also reduces fuel efficiency and tyre tread life which may affect the vehicle's handling and stopping ability.

NOTE

The TPMS is not a substitute for proper tyre maintenance. It is the driver's responsibility to maintain correct tyre pressure, even if under-inflation has not reached the level to trigger the illumination of the TPMS indicator light ⑤.

The TPMS indicator light flashes for a short period and then turns on continuously if the system is not operating properly. This sequence will continue upon subsequent vehicle start-ups as long as the malfunction exists (missing or faulty TPMS sensor or TPMS system malfunction). When the malfunction warning light is illuminated, the system may not be able to detect or signal low tyre pressure as intended. TPMS malfunctions may occur for a variety of reasons including the installation of replacement or alternate tyres or wheels on the vehicle that prevent the TPMS from functioning properly. Always check the TPMS indicator light after replacing one or more tyres or wheels on your vehicle to ensure that the replacement or alternate tyres and wheels allow the TPMS to continue to function properly.

- The TPMS does not monitor the tyre pressure of the spare tyre.
- The TPMS will activate only when the vehicle is driven at speeds above 25 km/h (16 MPH). Also, this system may not detect a sudden drop in tyre pressure (for example a flat tyre while driving).
- The TPMS indicator light may not automatically turn off when the tyre pressure is adjusted. **After the tyre is inflated to the recommended COLD tyre pressure**, drive the vehicle at speeds above 25 km/h (16 MPH) to activate the TPMS. See "New and repositioned TPMS sensors (including fitment of alternative wheels)" later in this section

- Following a change in the outside temperature, the TPMS indicator light may illuminate even if the tyre pressure has been adjusted properly. Adjust the tyre pressure to the recommended COLD tyre pressure again when the tyres are cold, and reset the TPMS. For additional information, see "[Check Cold Tyre] message" later in this section.

WARNING

- If the TPMS indicator light illuminates while driving:
 - avoid sudden steering manoeuvres
 - avoid abrupt braking
 - reduce vehicle speed
 - pull off the road to a safe location
 - stop the vehicle as soon as possible
- Driving with under-inflated tyres may permanently damage the tyres and increase the likelihood of tyre failure. Serious vehicle damage could occur which may lead to an accident and could result in serious personal injury.
- Check the tyre pressure for all four tyres. Adjust the tyre pressure to the recommended COLD tyre pressure shown on the tyre placard to turn the TPMS indicator light "OFF". In case of a flat tyre, replace it with a spare tyre as soon as possible. (See "Flat tyre" in the "6. In case of emergency" section for changing a flat tyre.)
- When a spare tyre is mounted or a wheel is replaced, the TPMS will not function and the TPMS indicator light will flash for approximately 1 minute. The light will remain on after 1 minute. Be sure to follow all instructions for wheel replacement and mount the TPMS system correctly.
- Replacing tyres with those not originally specified by NISSAN could affect the proper operation of the TPMS.

- The Genuine NISSAN Emergency Tyre Repair Sealant or equivalent can be used for temporarily repairing a tyre. Do not inject any other tyre liquid or aerosol tyre sealant into the tyres, as this may cause a malfunction of the tyre pressure sensors.
- NISSAN recommends using only Genuine NISSAN Emergency Tyre Sealant provided with your vehicle. Other tyre sealants may damage the valve stem seal which can cause the tyre to lose air pressure. Visit a NISSAN dealer or qualified workshop as soon as possible after using tyre repair sealant (for models equipped with the emergency tyre puncture repair kit).

CAUTION

- The TPMS may not function properly when the wheels are equipped with tyre chains or the wheels are buried in snow.
- Do not place metallised film or any metal parts (antenna, etc.) on the windows. This may cause poor reception of the signals from the tyre pressure sensors, and the TPMS will not function properly.

Some devices and transmitters may temporarily interfere with the operation of the TPMS and cause the TPMS indicator light to illuminate. Some examples are:

 - Facilities or electric devices using similar radio frequencies are near the vehicle.
 - If a transmitter set to similar frequencies is being used in or near the vehicle.

- If a computer (or similar equipment) or a DC/AC converter is being used in or near the vehicle.
- If devices which transmit electrical noise are connected to the vehicle's 12V power supply.
- When inflating the tyres and checking the tyre pressure, never bend the valves.
- Use Genuine NISSAN valve caps that comply with the factory-fitted valve cap specifications.
- Do not use metal valve caps.
- Fit the valve caps properly. Without the valve caps the valve and tyre pressure monitor sensors could be damaged.
- Do not damage the valves and sensors when storing the wheels or fitting different tyres.
- Replace the TPMS sensor valve stem (including valve core and cap) and screw (where fitted) when the tyres are replaced due to wear or age. The screw (where fitted) must be fitted correctly with a torque setting of 1.4 ± 0.1 N.m. The TPMS sensors can be used again.
- Use caution when using tyre inflation equipment with a rigid air supply tube, as leverage applied by the long nozzle can damage the valve stem.

METER INFORMATION

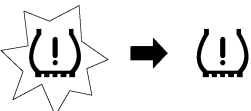
TPMS indicator light(s)	Possible cause	Recommended action
	Low tyre pressure	Inflate tyre(s) to the correct pressure
	Genuine NISSAN TPMS sensor is not detected at one or more wheels	Check if the TPMS sensors are present. If no sensor is present add a genuine NISSAN TPMS sensor
	TPMS radio communication interference between TPMS wheel sensor and TPMS receiver due to external sources.	Drive away from the area of interference
	TPMS parts malfunction	If the problem persists contact a NISSAN dealer or qualified workshop

ACTIVATION

When the e-POWER system is started. Once the vehicle starts moving the tyre pressure is monitored.

NEW AND REPOSITIONED TPMS SENSORS (including fitment of alternative wheels)

It is recommended that a NISSAN dealer performs the registration of a new TPMS sensor or sensor location.

It is also possible to register the sensor yourself following the procedure below:

Procedure:

1. Change tyre position or have a new TPMS sensor fitted.
2. Confirm pressure of COLD tyre and perform Temperature Calibration. See "TPMS temperature calibration (where possible)" later in this section.
3. Drive the vehicle for several minutes between 25 km/h (16 MPH) and 100 km/h (64 MPH). The TPMS sensor ID and position will automatically be detected.

NOTE

The TPMS might not synchronise if one or more of the following conditions apply:

- Bad road conditions
- The TPMS unit does not receive correct data from tyre pressure sensors
- Driving below 25 km/h (16 MPH)
- Driving above 100 km/h (64 MPH)
- High acceleration

- High deceleration
- In stop and go traffic or traffic waves

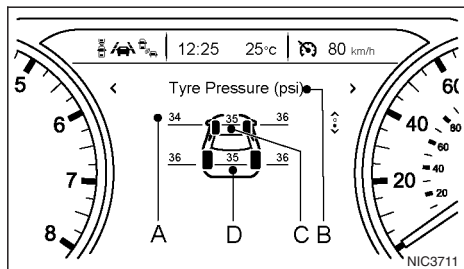

7 inch display

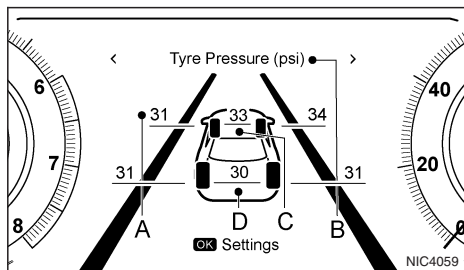

Full screen display

- (A) Tyre pressure
- (B) Tyre pressure units
- (C) Front target pressure
- (D) Rear target pressure

ADJUSTING TPMS TARGET PRESSURE (where possible)

If you are using your vehicle in a heavily laden condition, the tyre pressures should be inflated to the 'Laden Pressure' shown on the tyre placard.

The TPMS system can be adjusted in the vehicle information display to set the target pressure to the 'Laden Pressure' shown on the tyre placard. See "Vehicle information display" in the "2. Instruments and controls" section. To adjust the target pressure use the steering wheel switches to select the [Settings] menu, followed by [Tyre Pressures]. Select [Target front] and [Target rear] and set the desired tyre pressure.

The TPMS target pressures will be displayed in the centre of the front and rear axle on the TPMS screen of the vehicle information display.

TYRE PRESSURE UNITS

The units displayed by the TPMS system can be selected using the vehicle information display. Select the [Settings] menu, followed by [Tyre Pressures]. Select [Tyre pressure unit] and choose the desired unit.

[CHECK COLD TYRE] MESSAGE

If the tyre pressure becomes higher than the target pressure during a low tyre pressure condition, the [Check Cold Tyre] message will be displayed in the vehicle information display.

See "Vehicle information display" in the "2. Instruments and controls" section.

NOTE

Even if the pressure is above the preset target pressure, the yellow colour in the tyre pressure warning means that the tyre pressure is actually too low. Tyre pressure is increasing during driving. Check the tyre pressure when the tyre is cold.

TPMS TEMPERATURE CALIBRATION (where possible)

The tyre pressure is affected by the temperature of the tyre; the tyre temperature increases when the car is driven. To be able to accurately monitor the tyre air leakage and to prevent false TPMS warnings due to reductions in temperature, the TPMS system uses temperature sensors in the tyres to perform temperature compensation calculations.

On rare occasions it may be necessary to recalibrate the TPMS system reference temperature using the vehicle information display. See "Vehicle information display" in the "2. Instruments and controls" section. This operation should only be performed when the actual tyre pressure has been adjusted, whilst the current ambient temperature is significantly different to the current calibration temperature.

To initiate TPMS temperature calibration use the steering wheel switches to select the [Settings] menu, followed by [Tyre Pressures]. Select [Calibrate]. While the calibration process is active, the message: [Calibrate] will be displayed in the vehicle information display.

THREE-WAY CATALYST



The three-way catalyst is an emission control device installed in the exhaust system or the engine. In the converter, exhaust gases are burned at high temperatures to help reduce pollutants.

CAUTION

- **The exhaust gas and the exhaust system are very hot. While the engine is running, keep people or flammable materials away from the exhaust pipe.**
- **Do not stop or park the vehicle over flammable materials such as dry grass, waste paper or rags, as they may burn easily.**
- **When parking, ensure that people or flammable materials are kept away from the exhaust pipe.**

TO HELP PREVENT DAMAGE

CAUTION

- **Use UNLEADED PETROL ONLY, specifically the recommended type. For details, see "Recommended fluids/lubricants and capacities" in the "9. Technical information" section.**
- **Do not use leaded petrol. Leaded petrol will seriously damage three-way catalyst.**
Deposits from leaded petrol will seriously reduce the three-way catalyst's ability to help reduce exhaust pollutants.

- **Keep your engine tuned up. Malfunctions in the ignition, fuel injection, or electrical systems can cause over-rich fuel flow into the converter, causing it to overheat.**
- **Avoid driving with an extremely low fuel level. Running out of fuel could cause the engine to misfire, damaging the three-way catalyst.**
- **Do not keep driving if the engine misfires, or if noticeable loss of performance or other unusual operating conditions are detected. Have the vehicle inspected promptly by a NISSAN dealer or qualified workshop.**
- **Do not push or tow your vehicle to start the engine.**

GASOLINE PARTICULATE FILTER (GPF) (where fitted)



Your vehicle is fitted with a Gasoline Particulate Filter (GPF) (or Petrol Particulate Filter) as part of the emission control system.

The GPF filters carbon particles from the exhaust gas, thus reducing the emission of soot to the environment.

Under normal driving conditions, the accumulated carbon particles in the GPF are burned-off regularly, thus emptying the filter from carbon particles. In this way, the GPF is "regenerated" and again fully operational to filter out the carbon particles from the exhaust gas as intended.



**Exhaust filter
maintenance
See owner's manual**

NSD1135

CAUTION

- **Under certain driving conditions, the GPF may become saturated/clogged because these driving conditions prevent automatic regeneration of the filter. In this case, a message is displayed in the vehicle information display.**

TURBOCHARGER SYSTEM

- When the [Exhaust filter maintenance See owner's manual] message is displayed, the engine speed increases automatically to burn carbon particles. When this message is displayed, continue to drive appropriately, provided that legal and safety conditions allow, until the message is no longer displayed.
- Should the MIL come on for any reason, or if the [Exhaust filter maintenance See owner's manual] warning message continues to be displayed in the vehicle information display and will not clear, always visit a NISSAN dealer or qualified workshop as soon as possible. Extended driving with the MIL illuminated may lead to damage to the exhaust filter system.
- When the [Exhaust filter maintenance See owner's manual] message is displayed, the ProPILOT Assist system (where fitted) will be deactivated.

The turbocharger system uses engine oil for lubrication and cooling of its rotating components. The turbocharger turbine turns at extremely high speeds and it can reach an extremely high temperature. It is essential to maintain a flow of clean oil through the turbocharger system. A sudden interruption to the oil supply may cause a malfunction in the turbocharger.

To ensure prolonged life and performance of the turbocharger, it is essential to comply with the following recommendations:

CAUTION

- Change the engine oil of the turbo-charged engine as prescribed. See the separately provided Warranty Information & Maintenance Booklet for additional information.
- Use only the recommended engine oil. See "Recommended fluids/lubricants and capacities" in the "9. Technical information" section.
- If the engine has been operating at high rpm for an extended period of time, let it idle for a few minutes prior to shutdown.
- Do not accelerate the engine to high rpm immediately after starting it.

CARE WHEN DRIVING

Driving your vehicle to fit the circumstances is essential for your safety and comfort. As a driver, you should be the one who knows best how to drive in the given circumstances.

LOADING LUGGAGE

Loads, their distribution and the attachment of equipment (coupling devices, roof luggage carriers, etc.) will change the driving characteristics of the vehicle considerably. Driving style and speed must be adjusted accordingly.

DRIVING ON WET ROADS

- Avoid starting off, accelerating and stopping suddenly.
- Avoid sharp turns or lane changes.
- Extra distance should be kept from the vehicle in front.
- When water covers the road surface in puddles, small streams, etc. REDUCE SPEED to prevent aquaplaning which will cause skidding and loss of control. Worn tyres increase this risk.

DRIVING UNDER WINTER CONDITIONS

- Drive safely.
- Avoid starting off, accelerating or stopping suddenly.
- Avoid sharp turns or lane changes.
- Avoid sudden steering actions.
- Extra distance should be kept from the vehicle in front.

PUSH-BUTTON POWER SWITCH

PRECAUTIONS ON PUSH-BUTTON POWER SWITCH OPERATION

⚠ WARNING

Do not operate the push-button power switch while driving the vehicle except in an emergency. (The e-POWER system will stop when the power switch is pushed 3 consecutive times or the power switch is pushed and held for more than 2 seconds.) The steering wheel will lock and could cause the driver to lose control of the vehicle. This could result in serious vehicle damage or personal injury.

Before operating the push-button power switch, be sure to push the P position switch to engage the P (Park) position.

INTELLIGENT KEY SYSTEM

The Intelligent Key system can operate the power switch without taking the key out from your pocket or bag. The operating environment and/or conditions may affect the Intelligent Key system operation.

CAUTION

- Be sure to carry the Intelligent Key with you when operating the vehicle.
- Never leave the Intelligent Key inside the vehicle when you leave the vehicle.
- If the Intelligent Key is too far away from the driver, the vehicle may not start.

Operating range

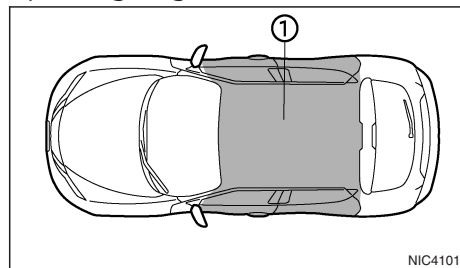

The Intelligent Key can only be used for starting the e-POWER system when the Intelligent Key is within the specified operating range ① as illustrated.

When the Intelligent Key battery is almost discharged or strong radio waves are present near the operating location, the Intelligent Key system's operating range becomes narrower and may not function properly.

If the Intelligent Key is within the operating range, it is possible for anyone, even someone who does not carry the Intelligent Key, to push the power switch to start the e-POWER system.

- The luggage room area is not included in the operating range, but the Intelligent Key may function.
- If the Intelligent Key is placed on the instrument panel, inside the glove box, door pocket or the corner of the interior compartment, the Intelligent Key may not function.

- If the Intelligent Key is placed near the door or window outside the vehicle, the Intelligent Key may function.

POWER SWITCH POSITIONS

WARNING

Never place the power switch in the OFF position while driving. The steering wheel may lock and cause the driver to lose control of the vehicle, resulting in serious vehicle damage or personal injury

CAUTION

- Do not leave the vehicle for extended periods of time when the power switch is in the ON position and the e-POWER system is not running. This can discharge the 12-volt battery.
- Use electrical accessories with the e- POWER system running to avoid discharging the 12-volt battery. If you must use accessories while the e-POWER system is not running, do not use them for extended periods of time and do not use multiple electrical accessories at the same time.

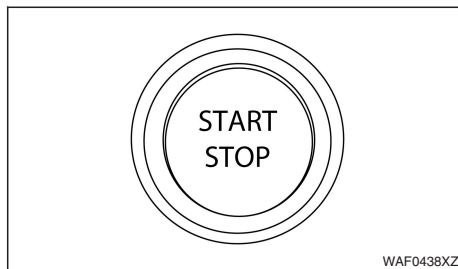

When the power switch is pushed without depressing the brake pedal, the power switch will illuminate:

Push the centre of the power switch:

- Once to switch the system ON.
- Two times to switch the system OFF.

When the READY to drive indicator light illuminates in the meter, the vehicle can be driven.

ON (normal operating position)

The electrical accessory power activates at this position without the e-POWER system turned on.

The ON position has a battery saver feature that will place the power switch in the OFF position, if the vehicle is not running, after some time under the following conditions:

- Power switch is in the ON position.
- e-POWER system is stopped.

The battery saver feature will be cancelled if any of the following occur:

- Power switch is in the "OFF" position.
- e-POWER system is running.
- Vehicle is driven.

The power switch will automatically be placed in the OFF position when the following conditions have been met and 10 minutes have passed.

- When the power switch is placed in the ON position.
- When the vehicle is parked.
- When the hazard indicator and turn signal light are turned off.

OFF

The e-POWER system is turned off at this position.

Auto ACC

With the vehicle in the P (Park) position, the Intelligent Key with you and the power switch placed from ON to OFF, the outside rearview mirror remote control, etc. can still be used for a period of time.

EMERGENCY SYSTEM SHUT OFF

To shut off the system in an emergency situation while driving, perform the following procedure:

- Rapidly push the push-button power switch 3 consecutive times in less than 1.5 seconds, or
- Push and hold the push-button power switch for more than 2 seconds.

STEERING LOCK

The power switch is equipped with an anti-theft steering lock device.

To lock steering wheel

1. Switch the power OFF where the power switch position indicator will not illuminate.
2. Open or close the door.
3. Turn the steering wheel 1/6 of a turn to the right or left from the straight up position.

To unlock steering wheel

Push the power switch to ON, and the steering wheel will be automatically unlocked.

CAUTION

- **If the battery of the vehicle is discharged, the push-button power switch cannot be switched ON.**
- **If the system does not turn ON, push the power switch again while rotating the steering wheel slightly to the right and left.**

INTELLIGENT KEY BATTERY DISCHARGE

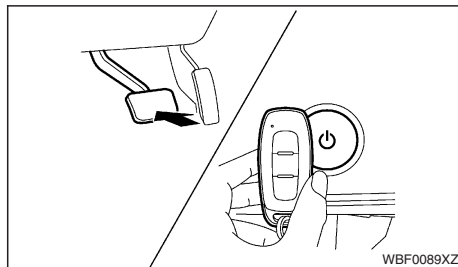

If the battery of the Intelligent Key is discharged, or environmental conditions interfere with the Intelligent Key operation, start the e-POWER system according to the following procedure:

1. Firmly apply the footbrake.
2. Push the power switch.
3. Touch the power switch with the Intelligent Key as illustrated. (A chime will sound.)
4. Push the power switch while depressing the brake pedal within 10 seconds after the chime sounds. The e-POWER system will start.

After step 3 is performed, when the power switch is pushed without depressing the brake pedal, the power switch will switch ON.

NOTE

- When the power switch is placed in the ON position or the e-POWER system is started by the above procedures, the [Key Battery Low] warning appears on the vehicle information display even if the Intelligent Key is inside the vehicle. This is not a malfunction. To turn off the warning, touch the power switch with the Intelligent Key again.
- If the Intelligent Key system warning message [Key Battery Low] appears in the vehicle information display, replace the battery as soon as possible. (See "Intelligent Key battery replacement" in the "8. Maintenance and do-it-yourself" section.)

STARTING THE E-POWER SYSTEM

1. Before starting the e-POWER system ensure parking brake is applied and vehicle is secure. For additional information, see "Electric Parking Brake" in the "3. Pre-driving checks and adjustments" section.
2. Confirm that the vehicle is in the P (Park) position.

The e-POWER system is designed not to operate unless the vehicle is in the P (Park) position or the shift position is in the N (Neutral) position.

The Intelligent Key (where fitted) must be carried while inside the vehicle when operating the power switch.

3. Firmly depress the brake pedal and push the power switch to place the vehicle in the READY to drive position.

To place the vehicle in the READY to drive position immediately, push and release the power switch while depressing the brake pedal with the power switch in any position. The READY to drive indicator light in the meter illuminates.

To stop the e-POWER system, push the P position switch, and push the power switch to the OFF position.

NOTE

- **After placing the power switch in the ON position, the engine may start before the READY to drive indicator light stops blinking and then illuminates.**
- **When the remaining Lithium ion (Li-ion) battery level is low, it may take a period of time until the READY to drive indicator light stops blinking and then illuminates after pushing the power switch. In the meantime, the Energy Flow, etc. will not appear.**
- **The brake pedal may be firm since the pedal is operated before the e-POWER system starts. In this case, depress the brake pedal more firmly than usual.**
- **You may hear a sound when the brake pedal is depressed with the e-POWER system off. This does not indicate a malfunction.**
- **If the e-POWER system cannot be started, place the power switch in the OFF position and wait for 5 seconds or more and then restart the e-POWER system.**

DRIVING THE VEHICLE

ELECTRIC SHIFT CONTROL SYSTEM

This vehicle is electronically controlled to produce maximum available power and smooth operation.

The recommended operating procedures for this shift control system are shown on the following pages. Follow these procedures for maximum vehicle performance and driving enjoyment.

WARNING

- **Do not depress the accelerator pedal while shifting from P (Park) or N (Neutral) to R (Reverse), D (Drive) mode. Always depress the brake pedal until shifting is completed. Failure to do so could cause you to lose control and have an accident.**
- **Never shift to either the P (Park) or R (Reverse) position while the vehicle is moving forward and P (Park) or D (Drive) mode position while the vehicle is reversing. This could cause an accident or damage the shift control system.**
- **Except in an emergency, do not shift to the N (Neutral) position while driving. Coasting with the shift control system in the N (Neutral) position may cause serious damage to the shift control system.**

CAUTION

- To avoid possible damage to your vehicle, when stopping the vehicle on an uphill grade, do not hold the vehicle by depressing the accelerator pedal. The footbrake should be used for this purpose.
- Do not hang items on the shift lever. This may cause an accident due to a sudden start.

Starting the vehicle

1. After placing the vehicle in the READY to drive position, fully depress the foot brake pedal before moving the shift lever to the D (Drive) position. **The shift lever of this vehicle is designed so that the foot brake pedal must be depressed before shifting from P (Park) to any driving position while the e-POWER system is running. The shift position cannot be placed out of the P (Park) position and into any of the other positions if the power switch is switched OFF.**
2. Keep the footbrake pedal depressed and move the shift lever to select a driving position.
3. Release the foot brake and gradually apply the accelerator pedal. If the parking brake is on it will automatically release provided the driver has their seat belt fastened.

CAUTION

- **DEPRESS THE FOOTBRAKE PEDAL - Shifting to D (Drive) or R (Reverse) without depressing the footbrake pedal causes the vehicle to move suddenly while the e-POWER system is running.**

Make sure the footbrake pedal is depressed fully and the vehicle is stopped before shifting the shift control system.

- **MAKE SURE OF THE SHIFT CONTROL SYSTEM POSITION - Make sure the shift control system position is in the desired position on the vehicle information display. D (Drive) is used to move forward and R (Reverse) to reverse.**

Shifting

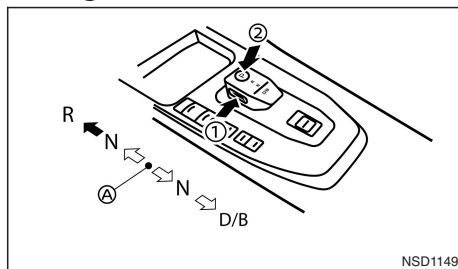

- Ⓐ Home position (central position)

To shift gear move the lever to the desired position as indicated then release it. To shift to reverse you need to first depress button ①.

	Push the button ① to shift.
	Shift without pushing the button ①.

Push the P position switch ② to shift to P (Park).

When in the "D" (Drive) position, slide along the gate to select "B" position

To place the vehicle into the "D" (Drive) position from the "B" position, move the shift lever into the "D" (Drive) position again.

After placing the power switch in the READY to drive position, fully depress the brake pedal, and move the shift lever to any of the preferred shift positions as indicated then release it. To shift to reverse you need to first depress button ①.

Confirm that the shift control system is in the desired shift position by checking the shift indicator located on the shift lever or on the vehicle information display.

NOTE

- The vehicle automatically applies the P (Park) position when the power switch is switched OFF.
- When the READY to drive indicator light does not illuminate, the shift position cannot be changed to the D (Drive), B or R (Reverse) position even if the power switch is switched ON.
- If the following conditions have been met, the shift position may be changed to the P (Park) position automatically.
 - When the driver's seat belt is not fastened.
 - When the driver's door is opened.

⚠ WARNING

- The shift lever is always in the centre position when released. When the power switch is placed in the READY to drive position, the driver needs to confirm that the shift control system is in the P (Park) position.

The indicator light above the P on the shift lever is illuminated and the P is displayed on the vehicle information display. If the vehicle is in the D (Drive) or R (Reverse) position when the power switch is placed in the READY to drive position, this may cause a sudden start which could result in an accident.

- On a hilly road, do not allow the vehicle to roll backwards while in the D (Drive) position or B position, or allow the vehicle to roll forward while in the R (Reverse) position. This may cause an accident.
- Do not shift to the N (Neutral) position while driving. The regenerative brake is not operated, which could result in an accident.
- If the regenerative brake does not work sufficiently, depress the brake pedal to decrease the vehicle speed.
- When stopping or parking on an uphill or downhill road, depress the brake pedal and stop the vehicle. If the vehicle continues to be stopped with only the accelerator pedal depressed and the brake pedal released, the electric motor for driving could cause overheating. When stopping the vehicle, release the accelerator pedal and depress the brake pedal.

CAUTION

- Do not slide the shift lever while pushing the P position switch. This may damage the electric motor.
- When switching to the desired shift position by operating the shift lever, check that the shift lever returns to the central position by releasing your hand from the lever. Holding the shift lever in a mid-way position may also damage the shift control system.
- Do not operate the shift lever while the accelerator pedal is depressed, except when switching to the B position. This may cause a sudden start which could result in an accident.
- The following operations are not allowed because excessive force would be applied to the electric motor for driving and this may result in damage to the vehicle: If these operations are attempted, a chime sounds and the vehicle shifts to the N (Neutral) position.
 - Shifting to the R (Reverse) position when driving forward
 - Shifting to the D (Drive) or B position when reversing

NOTE

- Do not intentionally reverse with the shift control system in the D (Drive) or B position on an incline or move your vehicle forward with the shift control system in the R (Reverse) position on a downhill slope.
- When the Lithium ion (Li-ion) battery is fully charged, regenerated electric power is con-

sumed by the engine started with the power generator. In that case, the engine sound may be loud, no fuel is used in this situation, this is not a malfunction.

- When the P position switch is pushed while driving, the operation is canceled. (The buzzer sounds and the shift position before being operated is maintained.)
- If the accelerator pedal is depressed when the vehicle is stopped and the shift control system is in the N (Neutral) position, the power limitation indicator light will illuminate. In this case, even if the shift lever is shifted to D (Drive), the acceleration will be reduced. (See "Power limitation indicator light" in the "2. Instruments and controls" section.)

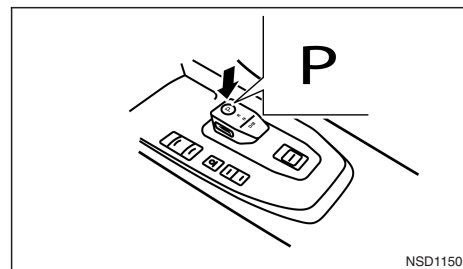

P (Park):

Use this position when the vehicle is parked or when placing the vehicle in the READY to drive position. Always make sure that the vehicle is completely stopped before pushing the P position switch to engage the P (Park) position. push the P position

switch as shown in the illustration once the vehicle has come to a complete stop. If the P position switch is pushed while the vehicle is in motion, a chime sounds and the current shift position is maintained. After switching to the P (Park) position, apply the parking brake. When parking on a hill, apply the parking brake first while keeping the foot brake pedal depressed then push the P position switch and place the vehicle in the P (Park) position. For the parking brake operation, see "Electric Parking Brake" in the "3. Pre-driving checks and adjustments" section).

NOTE

- While the vehicle is stationary, if the shift position is other than P (Park), when the power switch is placed in the "OFF" position, the shift position will automatically switch to the P (Park) position.
- If the P switch is pushed while sliding the shift lever, the shift position will not switch to the P (Park) position. When pushing the P switch, be sure to first allow the shift lever to return to its centre position.

R (Reverse):

Use the R (Reverse) position to reverse. Make sure the vehicle is completely stopped before selecting the R (Reverse) position. **The brake pedal must be depressed and the shift lever button pushed to move the shift lever from the home position to engage R (Reverse). If the vehicle is placed in the R (Reverse) position while the vehicle is moving forward, the chime will sound and the vehicle will switch into the N (Neutral) position.**

N (Neutral):

Neither the forward nor reverse gear is engaged. The vehicle can be placed in the READY to drive position in this position.

Do not shift to the N (Neutral) position while driving. The regenerative brake system does not operate in the N (Neutral) position. However, the vehicle brakes will still stop the vehicle.

To shift to the N (Neutral) position:

- When the vehicle is in the P (Park) position, slide the shift lever forward or backward by one notch with the brake pedal depressed, and hold the shift lever at the position for longer than 1 second.
- When the vehicle is in the D (Drive) or B position, slide the shift lever forward by one notch with the brake pedal depressed, and hold the shift lever at the position for longer than 1 second.
- When the vehicle is in the R (Reverse) position, slide the shift lever backward by one notch with the brake pedal depressed, and hold the shift lever at the position for longer than 1 second.

D (Drive):

Use this position for all normal forward driving. **If the shift control system is placed in the D (Drive) position while the vehicle is reversing, the chime will sound and the vehicle will switch into the N (Neutral) position.**

B:

Use the B position when more regenerative brake is required such as driving downhill. When the B position is used, more regenerative brake is applied when the accelerator pedal is released in comparison to the D (Drive) position.

Regenerative brake:

- The effectiveness of the regenerative brake is increased when the vehicle is placed in the "B" position. If the vehicle speed is too fast, depress the brake pedal accordingly.
- The effectiveness of the brake of the regenerative brake may be decreased on a slippery road, when the Li-ion battery is fully charged or the Li-ion battery temperature is low.

TRAFFIC SIGN RECOGNITION (where fitted)

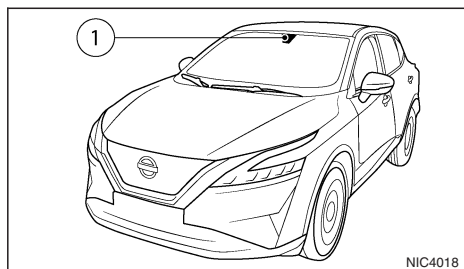

The Traffic Sign Recognition (TSR) system provides the driver with information about the most recently detected speed limit. The system captures the road sign information with the front camera unit ① located in front of the interior rear-view mirror and displays the detected signs in the Vehicle Information Display. For vehicles equipped with NissanConnect, the speed limit displayed is based on a combination of navigation system data and live camera recognition. TSR information is always displayed at the top of the Vehicle Information Display, and optionally in the main central area of the display screen. See "Vehicle information display" in the "2. Instruments and controls" section for details of how to adapt the display of TSR information.

⚠ WARNING

The TSR system is only intended to be a support device to provide the driver with information. It is not a replacement for the driver's attention to traffic conditions or responsibility to drive safely.

It cannot prevent accidents due to carelessness. It is the driver's responsibility to stay alert and drive safely at all times.

SYSTEM OPERATION

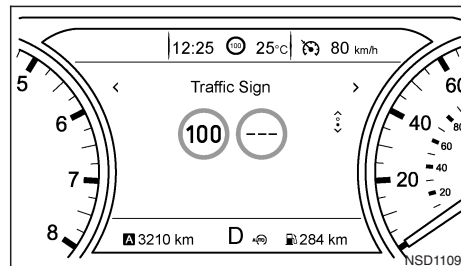

7 inch display

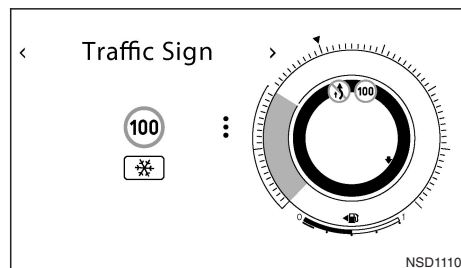

Full screen display

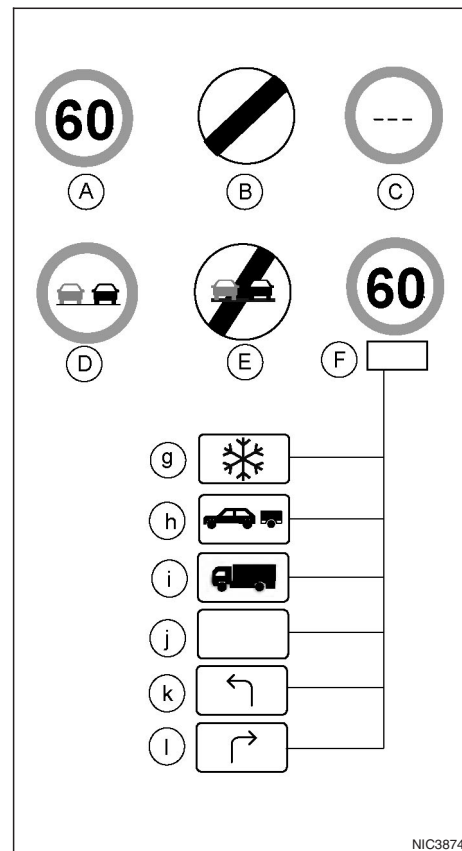

TSR: available road signs

The traffic recognition system displays the following types of road sign:

- Ⓐ Latest detected speed limit.
- Ⓑ National speed limit.
- Ⓒ No speed limit information.
- Ⓓ No-overtaking zone.
- Ⓔ End of no-overtaking zone.
- Ⓕ Conditional speed limit, with the following available conditions:
 - Ⓖ Snow
 - Ⓗ Towing
 - Ⓘ Goods vehicles
 - Ⓢ Generic
 - Ⓚ Left turn allowed
 - Ⓛ Right turn allowed

CAUTION

- The Traffic Sign Recognition (TSR) system is intended as an aid to careful driving. It is the driver's responsibility to stay alert, drive safely, and observe all road regulations that currently apply, including looking out for road signs.
- The Traffic Sign Recognition (TSR) system may not function properly under the following conditions:
 - When rain, snow, fogging up or dirt adheres to the windscreen in front of the TSR camera unit.

- When the headlights are not bright due to dirt on the lens or if the aiming is not adjusted properly.
- When strong light enters the camera unit. (For example, the light directly shines on the front of the vehicle at sunrise or sunset.)
- When a sudden change in brightness occurs. (For example, when the vehicle enters or exits a tunnel or under a bridge.)
- When there is poor visibility. (For example, insufficient illumination of the road, bad weather conditions in rain, snow or fog or heavy spray.)
- When the traffic signs are damaged or not standard. (For example, incorrect size, height, direction or brightness, or broken or bent).
- When the traffic signs are hard to detect. (For example, they are covered by dirt or snow, or insufficient lighting.)
- When the signs are ambiguous. (For example, traffic signs on construction sites, in adjacent lanes or exit lane.)
- When there is a object similar to traffic signs. (For example, similar signs, board or structure.)
- When passing traffic signs outside the camera's field of vision. (For example, after a sharp turn or located too far away.)
- When electric traffic signs are hard to detect. (For example, low contrast, located too far away, 3 digits.)

- In areas not covered by the navigation system.
- When the data of the navigation system is incorrect or out-of-date.
- If there are deviations in relation to the navigation, for example due to changes in the road routing.
- When overtaking buses or trucks with speed stickers.
- The TSR system may display a traffic sign even though there is no traffic sign in front of the vehicle. It may display a different speed limit from that for a passenger vehicle. The maximum speed limit sign may show a higher or lower number than the actual maximum speed, for example, when detecting a speed limit sign for trucks, different speed limit with the time of day or day of the week, or speed limit sign using different units (MPH or km/h) near a border, when detecting an electric traffic sign with or without speed limit indication, when detecting an irrelevant speed limit passing by a highway exit or junction, etc.

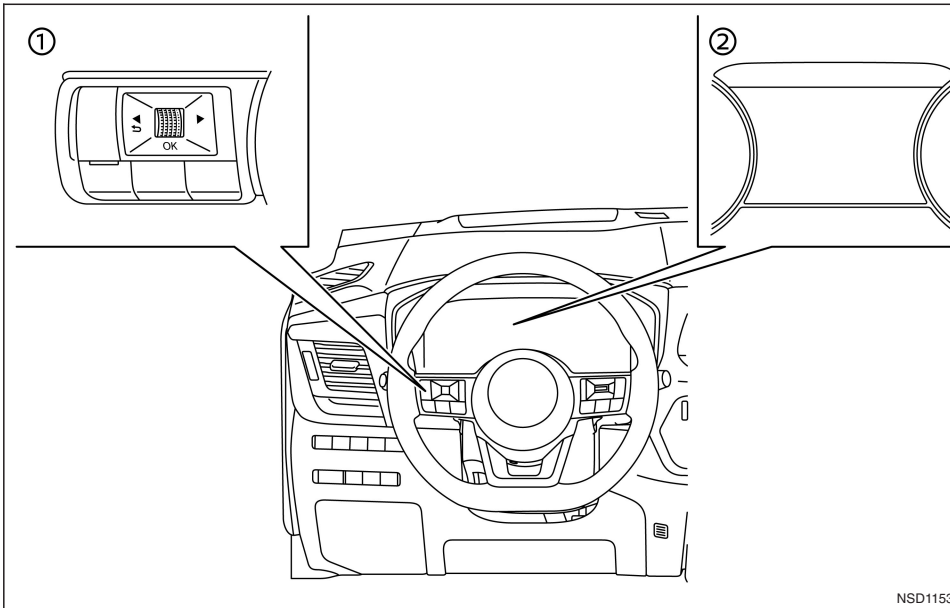

- ① Steering wheel-mounted controls (left side)
- ② Vehicle information display

TURNING THE TSR SYSTEM ON AND OFF

Turning the TSR system on or off is done using the [Settings] menu in the Vehicle Information Display. For details, see “Vehicle information display” in the “2. Instruments and controls” section.

Perform the following steps to enable or disable the TSR system:

1. Press the ◀ or ▶ button until [Settings] displays in the Vehicle Information Display and then press the scroll dial. Use the scroll dial buttons to select [Driver Assistance]. Then press the scroll dial.
2. Use the scroll dial buttons to select [Traffic Sign]. Then press the scroll dial to turn the system ON/OFF.

SYSTEM TEMPORARILY UNAVAILABLE

If the vehicle is parked in direct sunlight under high temperature conditions (over approximately 40°C (104°F)) and then started, the TSR system may be deactivated automatically.

Action to take:

When the interior temperature is reduced, the TSR system will resume operating automatically.

SYSTEM MALFUNCTION

If the TSR system malfunctions it will be turned off automatically and the [System fault] warning message will appear in the Vehicle Information Display.

Action to take:

If the [System fault] message appears, pull off the road at a safe location and stop the vehicle. Turn the e-POWER system off and restart the e-POWER system. If the [System fault] message continues to appear, have the TSR system checked by a NISSAN dealer or qualified workshop.

MAINTENANCE

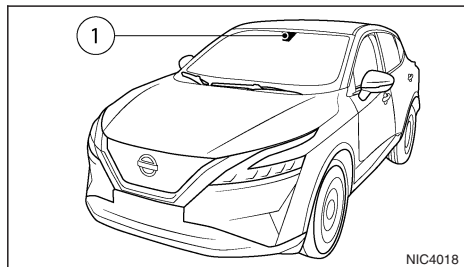

The lane camera unit ① for the Traffic Sign Recognition (TSR) system is located above the interior rear view mirror. To maintain the proper operation of the Traffic Sign Recognition (TSR) system and prevent a system malfunction, be sure to observe the following:

- Always keep the windscreen clean.

- Do not attach a sticker (including transparent material) or install an accessory near the camera unit.
- Do not place reflective materials, such as white paper or a mirror, on the instrument panel. The reflection of sunlight may adversely affect the camera unit's detection capability.
- Do not strike or damage the areas around the camera unit. Do not touch the camera lens or remove the screw located on the camera unit. If the camera unit is damaged due to an accident, contact a NISSAN dealer or qualified workshop.

BLIND SPOT WARNING (BSW) SYSTEM/INTELLIGENT BLIND SPOT INTERVENTION SYSTEM (where fitted)

This section contains the information about the following systems:

- Blind Spot Warning (BSW) system
- Intelligent Blind Spot Intervention system

WARNING

Listed below are the system limitations for the BSW/Intelligent Blind Spot Intervention system. Failure to operate the vehicle in accordance with these system limitations could result in serious injury or death.

- The BSW/Intelligent Blind Spot Intervention system is not a replacement for proper driving procedure and is not designed to prevent contact with vehicles or objects. When driving, always use the side and rear mirrors and always turn your head and look in the direction you will move to ensure it is safe to change lanes. Never rely solely on the BSW system.
- There is a limitation to the detection capability of the radar. Using the BSW and Intelligent Blind Spot Intervention systems under some road, lane marker or weather conditions could lead to improper system operation. Always rely on your own operation to avoid accidents.
- The BSW system operates at speeds above approximately 32 km/h (20 MPH).
- The Intelligent Blind Spot Intervention system operates at speeds above approximately 60 km/h (37 MPH).

THE BSW AND INTELLIGENT BLIND SPOT INTERVENTION SYSTEMS

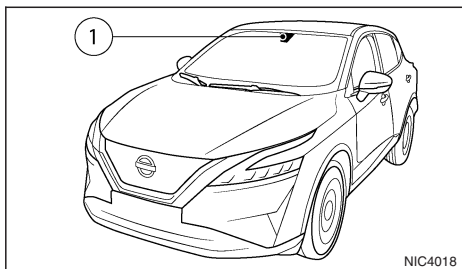
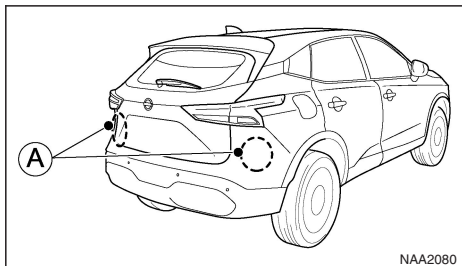

The Blind Spot Warning (BSW) and Intelligent Blind Spot Intervention systems can help alert the driver of other vehicles in adjacent lanes when changing lanes.

The BSW system uses radar sensors (A) installed near the rear bumper to detect other vehicles beside your vehicle in an adjacent lane. In addition to the radar sensors, the Intelligent Blind Spot Intervention system uses a camera (1) installed behind the windscreen to monitor the lane markers of your travelling lane.

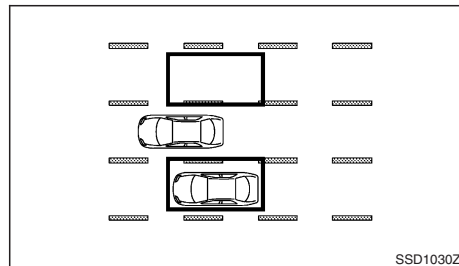

Detection zone

The radar sensors can detect vehicles on either side of your vehicle within the detection zone shown as illustrated. This detection zone starts from the outside mirror of your vehicle and extends approximately 3.0 m (10 ft) behind the rear bumper, and approximately 3.0 m (10 ft) sideways.

The BSW system operates above approximately 32 km/h (20 MPH). If the radar sensors detect vehicles in the detection zone, the BSW LED indicator light illuminates. If the driver then activates the turn signal, the system chimes a sound (twice) and the BSW LED indicator light and the BSW indicator will flash.

The Intelligent Blind Spot Intervention system operates above approximately 60 km/h (37 MPH). If the radar detects a vehicle in the detection zone and your vehicle is approaching the lane marker, the systems chime a sound (three times), flashes the BSW LED indicator light and the BSW indicator, and slightly applies the brakes on one side for a short period of time to help return the vehicle back to the travelling lane.

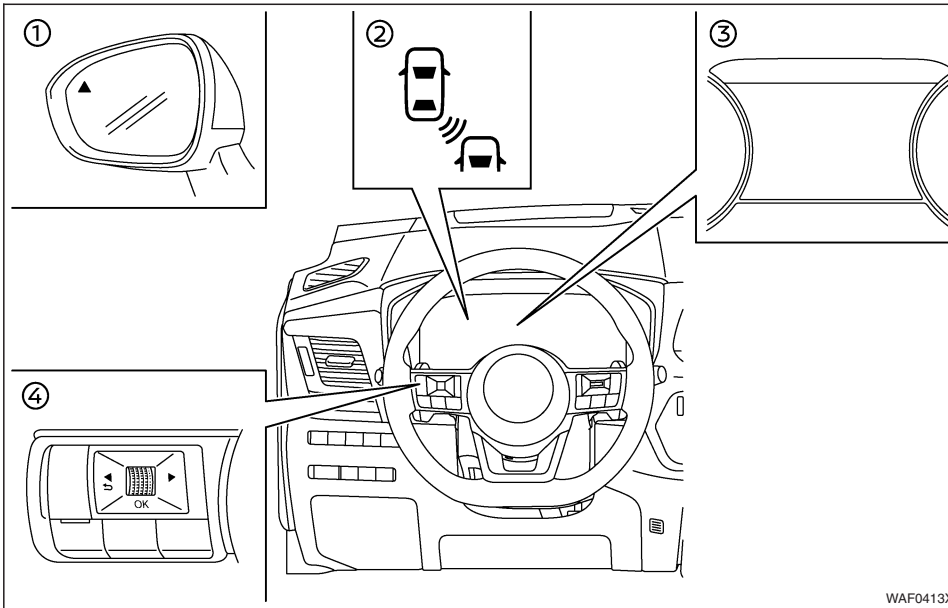

WAF0413X

- ① BSW LED indicator light
- ② BSW indicator (on the vehicle information display)
- ③ Vehicle information display
- ④ Steering-wheel-mounted controls (left side)

BSW SYSTEM OPERATION

The BSW system operates above approximately 32 km/h (20 MPH).

If the radar sensors detect a vehicle in the detection zone, the BSW LED indicator light illuminates.

If the turn signal is then activated, the system chimes (twice) and the BSW LED indicator light and the BSW indicator will flash. The BSW LED indicator light and the BSW indicator continue to flash until the detected vehicle leaves the detection zone.

The BSW LED indicator light illuminates for a few seconds when the power switch is switched **ON**. The brightness of the side indicator light is adjusted automatically depending on the brightness of ambient light.

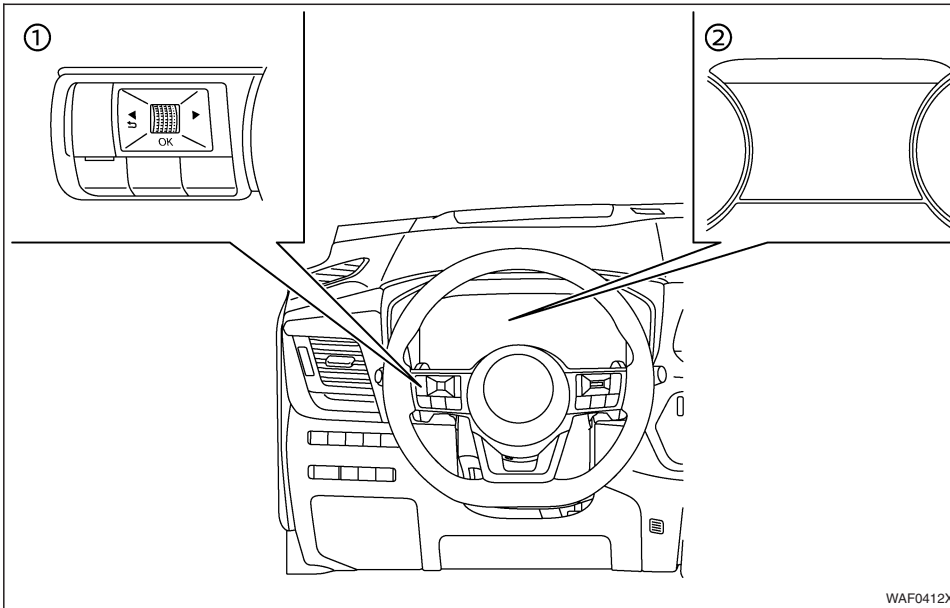

WAF0412X

- ① Steering-wheel-mounted controls (left side)
- ② Vehicle information display

Turning the BSW system on or off

Perform the following steps to enable or disable the BSW system.

1. Push the ◀ ▶ button until [Settings] appears in the vehicle information display and then push the scroll dial. Use the scroll dial to select [Driver Assistance]. Then push the scroll dial.
2. Select [Blind Spot] and push the scroll dial.
3. Select [Warning] and push the scroll dial.

For details, see "Vehicle information display" in the "2. Instruments and controls" section.

NOTE

When enabling/disabling the system, the system will retain the current settings even if the e-POWER system is restarted.

BSW temporary disabled status

When radar blockage is detected, the BSW system will be turned off automatically. The [Not available Side radar obstructed] warning message will appear in the vehicle information display.

The system is not available until the conditions no longer exist.

The radar sensors may be blocked by temporary ambient conditions such as splashing water, mist, or fog. The blocked condition may also be caused by objects such as ice, frost or dirt obstructing the radar sensors.

NOTE

If the BSW system stops working, the Intelligent Blind Spot Intervention (where fitted) and the Rear Cross Traffic Alert (RCTA) systems will also stop working.

Action to take:

When the above conditions no longer exist, the system will resume automatically.

System malfunction

If the BSW system malfunctions, it will be turned off automatically. The [System Fault] warning message will appear in the vehicle information display.

NOTE

If the BSW system stops working, the Intelligent Blind Spot Intervention (where fitted) and the Rear Cross Traffic Alert (RCTA) systems will also stop working.

Action to take:

Stop the vehicle in a safe location, turn off and restart the e-POWER system. If the message continues to appear, have the BSW system checked by a NISSAN dealer or qualified workshop.

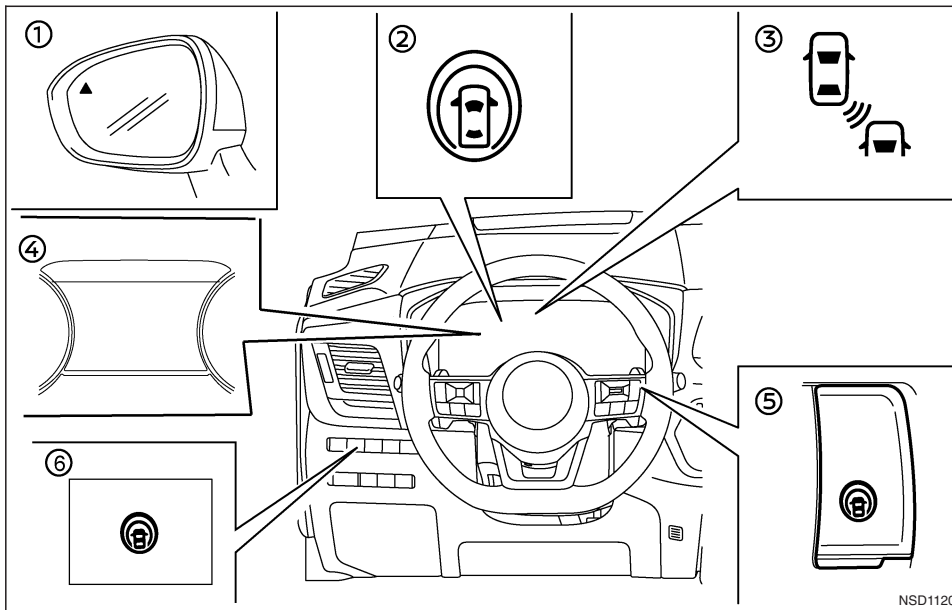

INTELLIGENT BLIND SPOT INTERVENTION SYSTEM OPERATION

- ① BSW LED indicator on the door mirror glass (where fitted)
- ② ProPILOT Assist status indicator light (where fitted) or Safety Shield indicator light (where fitted) in the vehicle information display
- ③ BSW indicator

- ④ Vehicle Information Display
- ⑤ ProPILOT Assist switch (for models with ProPILOT Assist)
- ⑥ Safety Shield switch (for models without ProPILOT Assist)

If the radar sensors detect vehicles in the detection zone, the BSW LED indicator light located on the outside mirrors illuminates. If your vehicle is ap-

proaching a lane marker, the system chimes a sound (three times) and the BSW LED indicator light and the BSW indicator will flash. Then the system applies the brakes on one side of the vehicle for a moment to help return the vehicle back to the centre of the lane. Intelligent Blind Spot Intervention operates regardless of turn signal usage.

NOTE

Warning and brake control will only be activated if the BSW LED indicator light is already illuminated when your vehicle approaches a lane marker. If another vehicle comes into the detection zone after your vehicle has crossed a lane marker, no warning or brake control will be activated. For additional information, see "BSW/Intelligent Blind Spot Intervention driving situations" later in this section. The Intelligent Blind Spot Intervention system is typically activated earlier than the Intelligent Lane Intervention (ILI) system when your vehicle is approaching a lane marker.

The Intelligent Blind Spot Intervention system turns on when either the ProPILOT Assist switch (for models with ProPILOT Assist), the Safety Shield switch (for models without ProPILOT Assist), or the speed limiter switch on the steering wheel is pushed when the Blind Spot Intervention is enabled in the [Driver Assistance] menu in the vehicle information display.

The ProPILOT Assist status indicator light (for models with ProPILOT Assist) or Safety Shield indicator (for models without ProPILOT Assist) on the vehicle information display illuminates.

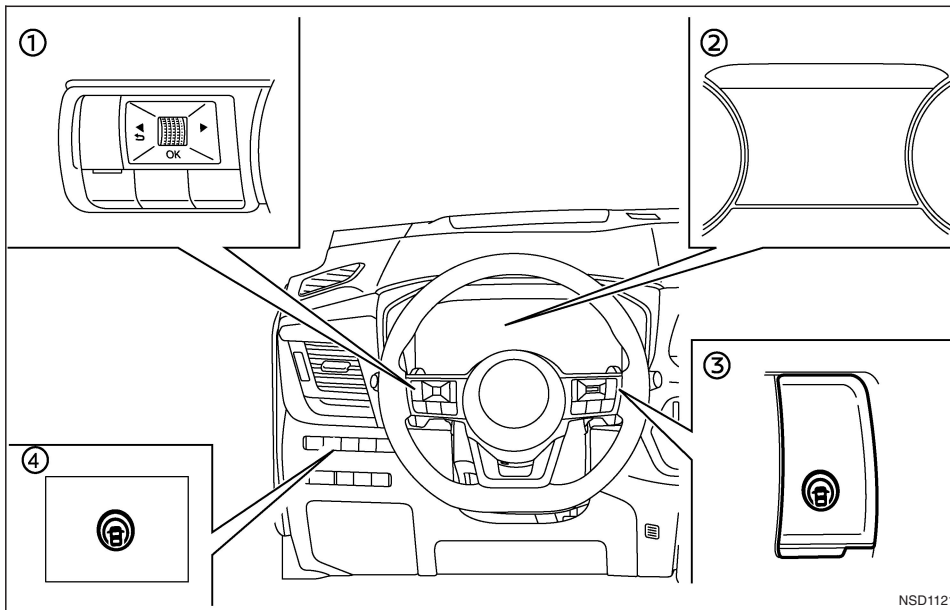

Intelligent Blind Spot Intervention system activation and deactivation

- ① Steering wheel mounted control (left side)
- ② Vehicle Information Display
- ③ ProPILOT Assist switch (for models with ProPILOT Assist)

- ④ Safety Shield switch (for models without ProPILOT Assist)

Intelligent Blind Spot Intervention is activated when pushing either the ProPILOT Assist switch (for models with ProPILOT Assist) on the steering wheel, or the Safety Shield switch (for models without ProPILOT Assist) when the Blind Spot Intervention setting is enabled in the [Driver Assistance] menu in the vehicle information display.

To deactivate the Intelligent Blind Spot Intervention, push the same switch again or disable the Blind Spot Intervention setting in the [Driver Assistance] menu. The system will be automatically deactivated when the power switch is switched OFF.

To enable or disable the Blind Spot Intervention setting:

1. Push the ◀ ▶ button until [Settings] appears in the vehicle information display and then push the scroll dial. Use the scroll dial to select [Driver Assistance]. Then push the scroll dial.
2. Select [Blind Spot] and push the scroll dial.
3. Select [Intervention] and push the scroll dial.
4. Push either the ProPILOT Assist switch (for models with ProPILOT Assist) or the Safety Shield switch (for models without ProPILOT Assist) to turn the system on or off.

For details, see "Vehicle information display" in the "2. Instruments and controls" section.

NOTE

- **For models with ProPILOT Assist system: When the Intelligent Blind Spot Intervention is enabled in the settings menu, the Intelligent Blind Spot Intervention system can be turned on or off by pushing the speed limiter MAIN switch (where fitted) on the steering wheel.**

- **Before Intelligent Blind Spot Intervention can be activated, Blind Spot Warning must be activated. To enable or disable the Blind Spot Warning setting:**

1. Push the ◀ ▶ button until [Settings] appears in the vehicle information display and then push the scroll dial. Use the scroll dial to select [Driver Assistance]. Then push the scroll dial.
2. Select [Blind Spot] and push the scroll dial.
3. Select [Warning] and push the scroll dial.

Turning the Blind Spot Warning system off will deactivate the Intelligent Blind Spot Intervention at the same time.

Intelligent Blind Spot Intervention temporarily not available

When any of the following messages appear on the vehicle information display, a chime will sound and the Intelligent Blind Spot Intervention system will be turned off automatically.

- [Unavailable Slippery Road]: When the ESP system (except traction control system function) or ABS operates.
- [Currently Not Available]:
 - When the ESP system is turned **OFF**.
- [Unavailable Camera Temperature High]: When the camera detects that the interior temperature is high (over approximately 40°C (104°F)).
- [Not Available Side Radar Obstructed]: When side radar blockage is detected.

Turn off the Intelligent Blind Spot Intervention system and turn it on again when the above conditions no longer exist.

Intelligent Blind Spot Intervention malfunction

If the Intelligent Blind Spot Intervention system malfunctions, it will be turned off automatically. The [System Fault] warning message will appear and BSW indicator (yellow) on in the vehicle information display will illuminate and a chime will sound.

Action to take:

Stop the vehicle in a safe location, turn off and restart the e-POWER system. If the message continues to appear, have the Intelligent Blind Spot Intervention system checked by a NISSAN dealer or qualified workshop.

BSW/INTELLIGENT BLIND SPOT INTERVENTION SYSTEM PRECAUTIONS

WARNING

- **The radar sensors may not be able to detect and activate BSW/Intelligent Blind Spot Intervention when certain objects are present such as:**
 - **Pedestrians, bicycles, animals.**
 - **Vehicles such as motorcycles, low height vehicles, or high ground clearance vehicles.**
 - **Oncoming vehicles.**
 - **Vehicles remaining in the detection zone when you accelerate from a stop.**
 - **A vehicle merging into an adjacent lane at a speed approximately the same as your vehicle.**

- **A vehicle approaching rapidly from behind.**
- **A vehicle which your vehicle overtakes rapidly.**
- **See "BSW/Intelligent Blind Spot Intervention driving situations" later in this section for the situations in which the radar sensors may not be able to detect vehicle(s).**

- **The BSW and Intelligent Blind Spot Intervention systems may not provide a warning or brake control for vehicles that pass the detection zone quickly.**
- **The radar sensors detection zone is designed based on a standard lane width. When driving in a wider lane, the radar sensors may not detect vehicles in an adjacent lane. When driving in a narrow lane, the radar sensors may detect vehicles driving two lanes away.**
- **The radar sensors are designed to ignore most stationary objects, however objects such as guardrails, walls, foliage and parked vehicles may occasionally be detected. This is a normal operating condition.**
- **Severe weather or road spray conditions may reduce the ability of the radar to detect other vehicles.**
- **The camera may not detect lane markers in the following situations and the Blind Spot Intervention system may not operate properly.**
 - **On roads where there are multiple parallel lane markers; lane markers that are faded or not painted clearly; yellow painted lane markers; non-standard lane markers; lane markers covered with water, dirt, snow, etc.**

- On roads where discontinued lane markers are still detectable.
- On roads where there are sharp curves.
- On roads where there are sharply contrasting objects, such as shadows, snow, water, wheel ruts, seams or lines remaining after road repairs.
- On roads where the travelling lane merges or separates.
- When the vehicle's travelling direction does not align with the lane markers.
- When travelling close to the vehicle in front of you, which obstructs the lane camera unit detection range.
- When rain, snow or dirt adheres to the windscreen in front of a lane camera unit.
- When the headlights are not bright due to dirt on the lens or if aiming is not adjusted properly.
- When strong light enters a lane camera unit. (For example: light directly shines on the front of the vehicle at sunrise or sunset.)
- When a sudden change in brightness occurs. (For example: when the vehicle enters or exits a tunnel or under a bridge.)
- Do not use the Intelligent Blind Spot Intervention system under the following conditions because the system may not function properly.
 - During bad weather (For example: rain, fog, snow, etc.)

- When driving on slippery roads, such as on ice or snow, etc.
- When driving on winding or uneven roads.
- When there is a lane closure due to road repairs.
- When driving in a makeshift or temporary lane.
- When driving on roads where the lane width is too narrow.
- When driving with a tyre that is not within normal tyre conditions (for example, tyre wear, low tyre pressure, installation of spare tyre, tyre chains, non-standard wheels).
- When the vehicle is equipped with non-original brake parts or suspension parts.
- When towing a trailer or other vehicle.
- Excessive noise (for example, audio system volume, open vehicle window) will interfere with the chime sound, and it may not be heard.

BSW/INTELLIGENT BLIND SPOT INTERVENTION DRIVING SITUATIONS

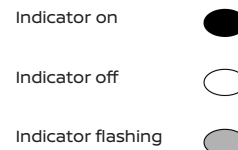

Another vehicle approaching from behind

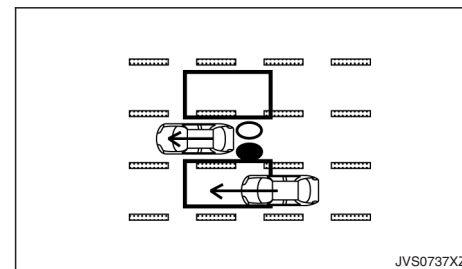

Illustration 1 Approaching from behind

Illustration 1: The BSW LED indicator light illuminates if a vehicle enters the detection zone from behind in an adjacent lane. However, if the overtaking vehicle is travelling much faster than your vehicle, the BSW LED indicator light may not illuminate before the detected vehicle is beside your vehicle. Always use the side and rear mirrors and turn and look in the direction your vehicle will move to ensure it is safe to change lanes.

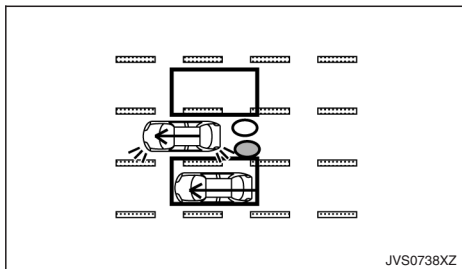

Illustration 2 Approaching from behind

Illustration 2: If the driver activates the turn signal, then the system chimes (twice) and the BSW LED indicator light and the BSW indicator will flash.

NOTE

If the driver activates the turn signal before a vehicle enters the detection zone, the BSW LED indicator light and the BSW indicator will flash but no chime will sound when the other vehicle is detected.

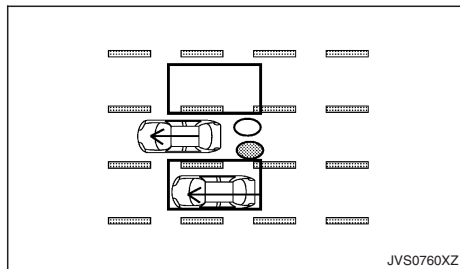

Illustration 3 Approaching from behind

Illustration 3: If the Intelligent Blind Spot Intervention system is on and your vehicle is approaching a lane marker and a vehicle is in the detection zone, the system chimes (three times) and the BSW LED indicator light and the BSW indicator will flash. Then the Intelligent Blind Spot Intervention system slightly applies the brakes on one side to help return the vehicle back to the centre of the driving lane.

Overtaking another vehicle

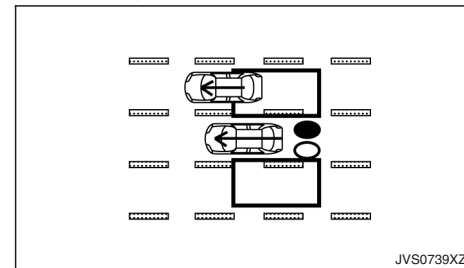

Illustration 4 Overtaking another vehicle

Illustration 4: BSW LED indicator light illuminates if you overtake a vehicle and that vehicle stays in the detection zone for approximately 3 seconds.

The radar sensors may not detect slower moving vehicles if they are passed quickly.

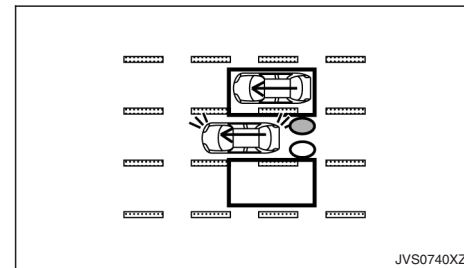
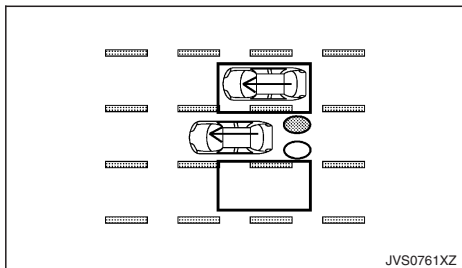

Illustration 5 Overtaking another vehicle

Illustration 5: If the driver activates the turn signal while another vehicle is in the detection zone, then the system chimes (twice) and the BSW LED indicator light and the BSW indicator will flash.



JVS0761XZ

Illustration 6 Overtaking another vehicle

Illustration 6: If the Intelligent Blind Spot Intervention system is on and your vehicle approaches a lane marker while another vehicle is in the detection zone, the system chimes (three times) and the BSW LED indicator light and the BSW indicator will flash. Then, the Intelligent Blind Spot Intervention system slightly applies the brakes on the appropriate side to help return the vehicle back to the centre of the driving lane.

NOTE

- When overtaking several vehicles in a row, the vehicles after the first vehicle may not be detected if they are travelling close together.
- The radar sensors may not detect slower moving vehicles if they are passed quickly.

Entering from the side

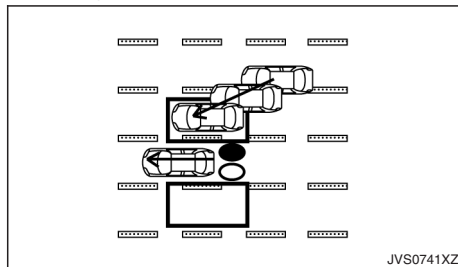

JVS0741XZ

Illustration 7 Entering from the side

Illustration 7: The BSW LED indicator light illuminates if a vehicle enters the detection zone from either side.

NOTE

The radar sensors may not detect a vehicle which is travelling at about the same speed as your vehicle when it enters the detection zone.

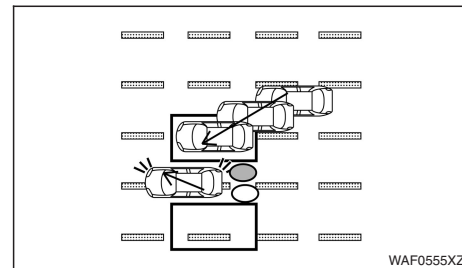

WAF0555XZ

Illustration 8 Entering from the side

Illustration 8: If the driver activates the turn signal while another vehicle is in the detection zone, then the BSW LED indicator light and the BSW indicator will flash and a chime will sound twice.

NOTE

If the driver activates the turn signal before a vehicle enters the detection zone, the BSW LED indicator light and the BSW indicator will flash but no chime will sound when the other vehicle is detected.

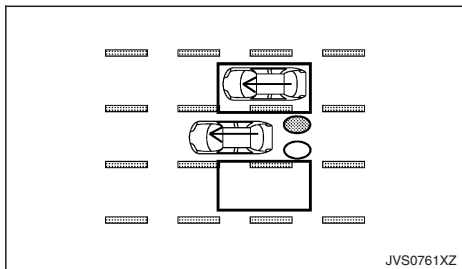

Illustration 9 Entering from the side

Illustration 9: If the Intelligent Blind Spot Intervention system is on and your vehicle approaches the lane marker while another vehicle is in the detection zone, the BSW LED indicator light and the BSW indicator will flash and a chime will sound three times. Then, the Intelligent Blind Spot Intervention system slightly applies the brakes on the appropriate side to help return the vehicle back to the centre of the driving lane.

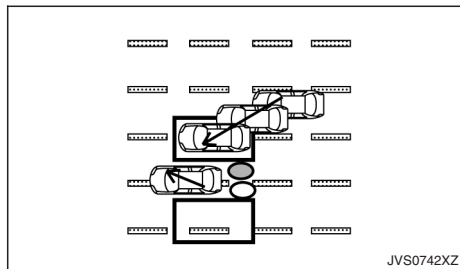

Illustration 10 Entering from the side

Illustration 10: The Intelligent Blind Spot Intervention system will not operate if your vehicle is on a lane marker when another vehicle enters the detection zone. In this case only the BSW system operates.

NOTE

Intelligent Blind Spot Intervention braking will not operate or will stop operating and only a warning chime will sound under the following conditions:

- When the brake pedal is depressed or if the vehicle decelerates strongly.
- When the vehicle is accelerated during Intelligent Blind Spot Intervention system operation.
- When steering quickly.
- When the ICC or Intelligent Emergency Braking warnings sound.
- When the hazard warning flashers are operated
- When driving on a curve at a high speed.

SYSTEM MAINTENANCE

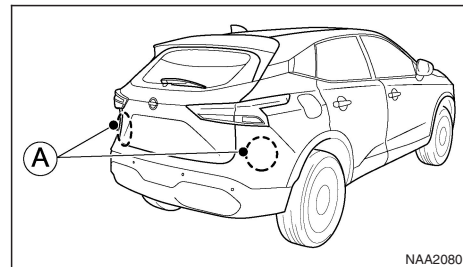

The two radar sensors (A) for the BSW/Intelligent Blind Spot Intervention system are located near the rear bumper.

To keep the BSW/Intelligent Blind Spot Intervention system operating properly, be sure to observe the following:

- Always keep the area near the radar sensors clean.
- The radar sensors may be blocked by temporary ambient conditions such as splashing water, mist, or fog.
- The blocked condition may also be caused by objects such as ice, frost, or dirt obstructing the radar sensors. Check for and remove objects obstructing the area around the radar sensors.
- Do not attach stickers (including transparent material), install accessories, or apply additional paint near the radar sensors

REAR CROSS TRAFFIC ALERT (RCTA) SYSTEM (where fitted)

- Do not attach metallic objects near the sensor area (brush guard, etc.). This could cause failure or malfunction.
- Do not strike or damage the area around the radar sensors. If the area around the radar sensors is damaged due to an accident, it is recommended that you visit a NISSAN dealer or qualified workshop.
- Do not strike or damage the areas around the camera unit. Do not touch the camera lens or remove the screw located on the camera unit. If the camera unit is damaged due to an accident, contact a NISSAN dealer or qualified workshop.

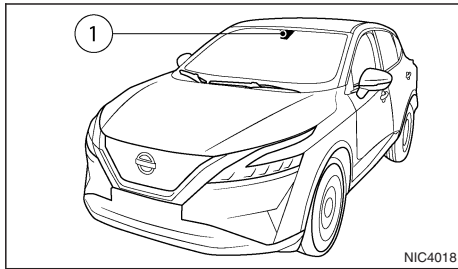

The lane camera unit ① for the Intelligent Blind Spot Intervention system is located above the interior rear view mirror. To maintain the proper operation of the Intelligent Blind Spot Intervention system and prevent a system malfunction, be sure to observe the following:

- Always keep the windscreen clean.
- Do not attach a sticker (including transparent material) or install an accessory near the camera unit.
- Do not place reflective materials, such as white paper or a mirror, on the instrument panel. The reflection of sunlight may adversely affect the camera unit's detection capability.

WARNING

Failure to follow the warnings and instructions for proper use of the RCTA system could result in serious injury or death.

- **The RCTA system is not a replacement for proper driving procedures and is not designed to prevent contact with vehicles or objects. When reversing out of a parking space, always use the side and rear mirrors and turn and look in the direction your vehicle will move. Never rely solely on the RCTA system.**

The RCTA system will assist you when reversing out of a parking space. When the vehicle is in reverse, the system is designed to detect other vehicles approaching from the right or left of the vehicle. If the system detects cross traffic, it will alert you.

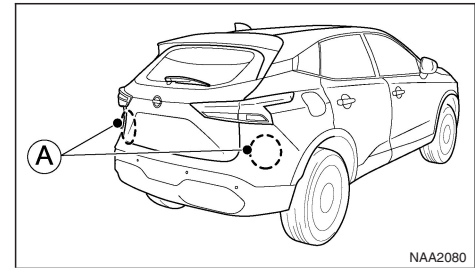
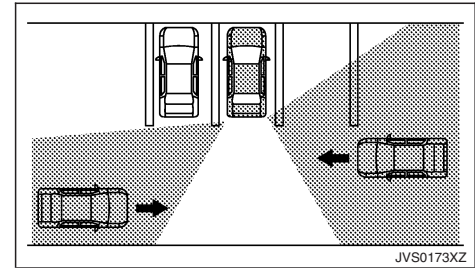
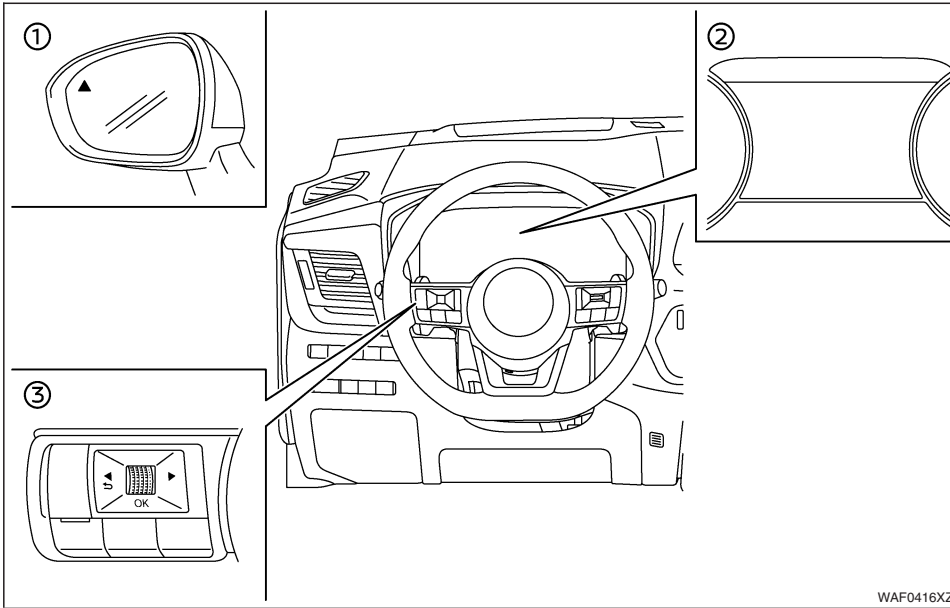

- ① BSW LED indicator light
- ② Vehicle Information Display
- ③ Steering-wheel-mounted controls (left side)

RCTA SYSTEM OPERATION

The RCTA system can help alert the driver of an approaching vehicle when the driver is reversing out of a parking space.

When the shift position is in R (Reverse) and the vehicle speed is less than approximately 8 km/h (5 MPH), the RCTA system is operational.

If the radar detects an approaching vehicle from either side, the system chimes (once) and the BSW LED indicator light flashes on the side the vehicle is approaching from.

The RCTA system uses radar sensors (A) installed on both sides near the rear bumper to detect an approaching vehicle.

The radar sensors (A) can detect an approaching vehicle from up to approximately 20 m (66 ft) away.

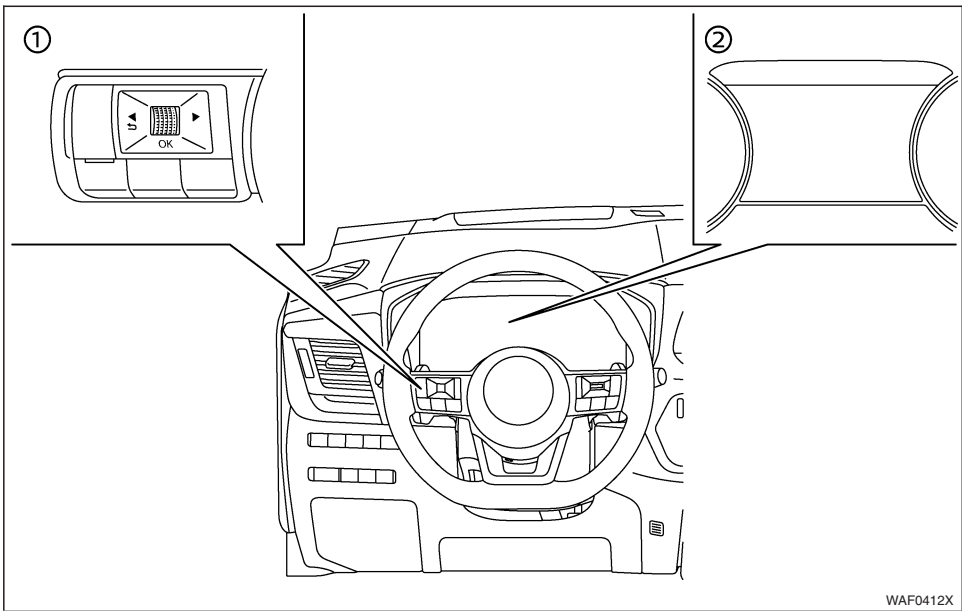

WAF0412X

- ① Steering-wheel-mounted controls (left side)
- ② Vehicle Information Display

HOW TO ENABLE/DISABLE THE RCTA SYSTEM

Perform the following steps to enable or disable the RCTA system.

1. Press the ◀ or ▶ button until [Settings] displays in the Vehicle Information Display and then press the scroll dial. Use the scroll dial buttons to select [Driver Assistance]. Then press the scroll dial.
2. Use the scroll dial buttons to select [Rear Cross Traffic Alert]. Then press the scroll dial.
3. To set the RCTA system to on or off, use the scroll dial to navigate the menu and press the scroll dial to select or change an item.

NOTE

When enabling/disabling the system, the system setting will be retained even if the e-POWER system is restarted.

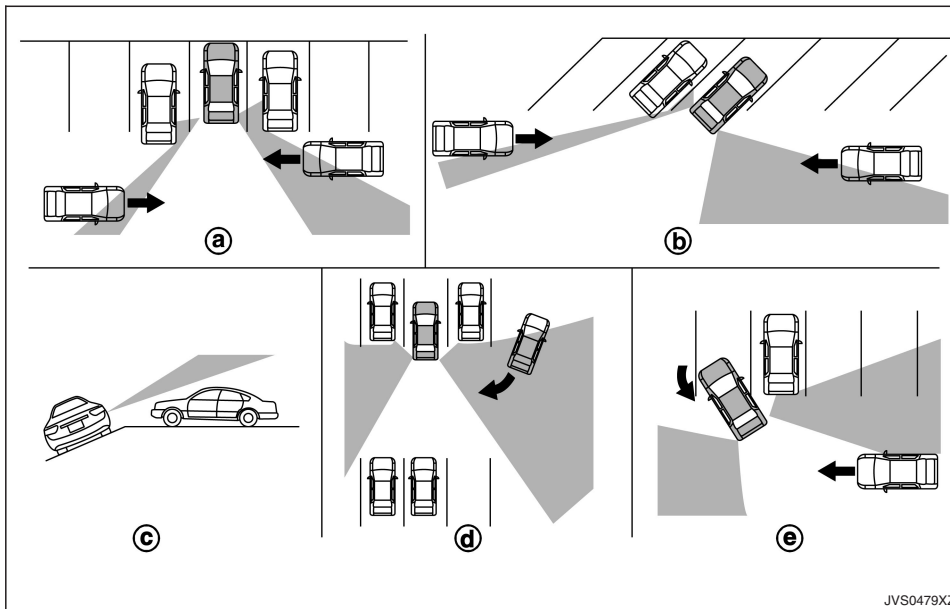

RCTA SYSTEM LIMITATIONS

⚠ WARNING

Listed below are the system limitations for the RCTA system. Failure to operate the vehicle in accordance with these system limitations could result in serious injury or death.

- Always check surroundings and turn to check what is behind you before reversing. The radar sensors detect approaching (moving) vehicles. The radar sensors cannot detect every object such as:
 - Pedestrians, bicycles, motorcycles, animals or child-operated toy vehicles.

- A vehicle that is passing at speeds greater than approximately 30 km/h (19 MPH).
- A vehicle that is passing at speeds lower than approximately 8 km/h (5 MPH).
- The radar sensors may not detect approaching vehicles in certain situations:
 - Illustration (a): When a vehicle parked next to you obstructs the beam of the radar sensor.
 - Illustration (b): When the vehicle is parked in an angled parking space.
 - Illustration (c): When the vehicle is parked on inclined ground.
 - Illustration (d): When an approaching vehicle turns into your vehicle's parking lot aisle.
 - Illustration (e): When the angle formed by your vehicle and the approaching vehicle is small
- The following conditions may reduce the ability of the radar to detect other vehicles:
 - Severe weather
 - Road spray
 - Ice/frost/dirt build-up on the vehicle
- Do not attach stickers (including transparent material), install accessories or apply additional paint near the radar sensors. These conditions may reduce the ability of the radar to detect other vehicles.

- Excessive noise (e.g. audio system volume, open vehicle window) will interfere with the chime sound, and it may not be heard.

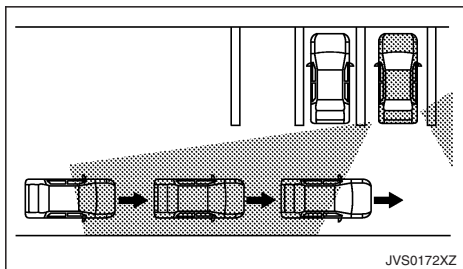

Illustration 1

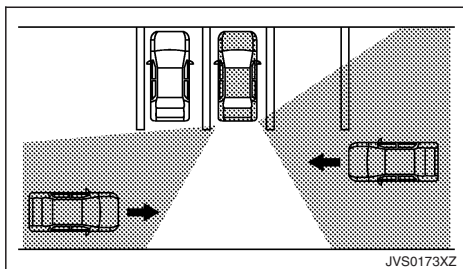

Illustration 2

NOTE

In the case of several vehicles approaching in a row (Illustration 1) or in the opposite direction (Illustration 2), a chime may not be sounded by the RCTA system after the first vehicle passes the sensors.

SYSTEM TEMPORARILY UNAVAILABLE

When radar blockage is detected, the system will be deactivated automatically. The [Not available Side Radar Obstructed] warning message will appear in the Vehicle Information Display.

The systems are not available until the conditions no longer exist.

The radar sensors may be blocked by temporary ambient conditions such as splashing water, mist or fog.

The blocked condition may also be caused by objects such as ice, frost or dirt obstructing the radar sensors.

NOTE

If the BSW system stops working, the RCTA system will also stop working.

Action to take:

When the above conditions no longer exist, the system will resume automatically.

SYSTEM MALFUNCTION

If the RCTA system malfunctions, it will turn off automatically. The [System fault] warning message will appear in the Vehicle Information Display.

NOTE

If the BSW system stops working, the RCTA system will also stop working.

Action to take:

Stop the vehicle in a safe location, turn the e-POWER system off and restart the e-POWER system. If the

message continues to appear, have the RCTA system checked by a NISSAN dealer or qualified workshop.

SYSTEM MAINTENANCE

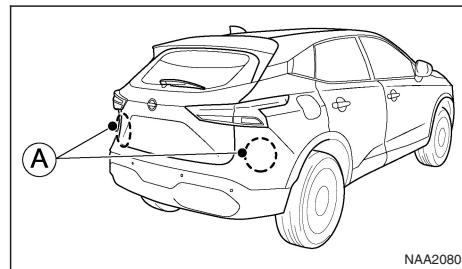

The two radar sensors (A) for the RCTA systems are located near the rear bumper. Always keep the area near the radar sensors clean.

The radar sensors may be blocked by temporary ambient conditions such as splashing water, mist or fog.

The blocked condition may also be caused by objects such as ice, frost or dirt obstructing the radar sensors.

Check for and remove objects obstructing the area around the radar sensors.

Do not attach stickers (including transparent material), install accessories or apply additional paint near the radar sensors.

Do not attach metallic objects near the sensor area (brush guard, etc.). This could cause failure or malfunction.

REAR AUTOMATIC BRAKING (RAB) (where fitted)

Do not strike or damage the area around the radar sensors. It is recommended that you visit a NISSAN dealer or qualified workshop if the area around the radar sensors is damaged due to a collision.

For the radio approval numbers and information, see "Radio frequency approval" in the "9. Technical information" section.

WARNING

Failure to follow the warnings and instructions for proper use of the RAB system could result in serious injury or death.

- **The RAB system is a supplemental aid to the driver. It is not a replacement for proper driving procedures. Always use the side and rear mirrors and turn and look in the direction you will move before and while reversing. Never rely solely on the RAB system. It is the driver's responsibility to stay alert, drive safely, and be in control of the vehicle at all times.**
- **There are limitations to the RAB system capability. The RAB system is not effective in all situations.**

The RAB system can assist the driver when the vehicle is reversing and approaching objects directly behind the vehicle.

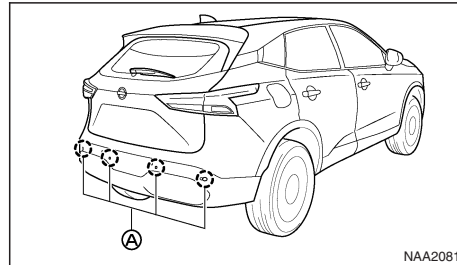

Models with 4 parking (sonar) sensors

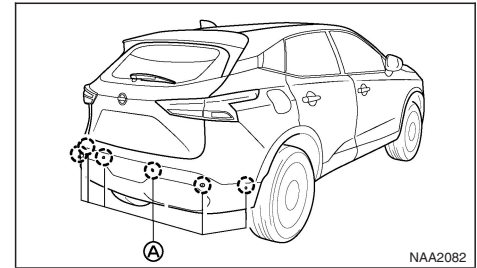

Models with 6 parking (sonar) sensors

The RAB system detects obstacles behind the vehicle using the parking sensors  located on the rear bumper.

NOTE

You can temporarily cancel the sonar function in the vehicle, this will also temporarily cancel the RAB system. For additional information, see "Front and Rear Ultrasonic Parking Sensors (where fitted)" later in this section.

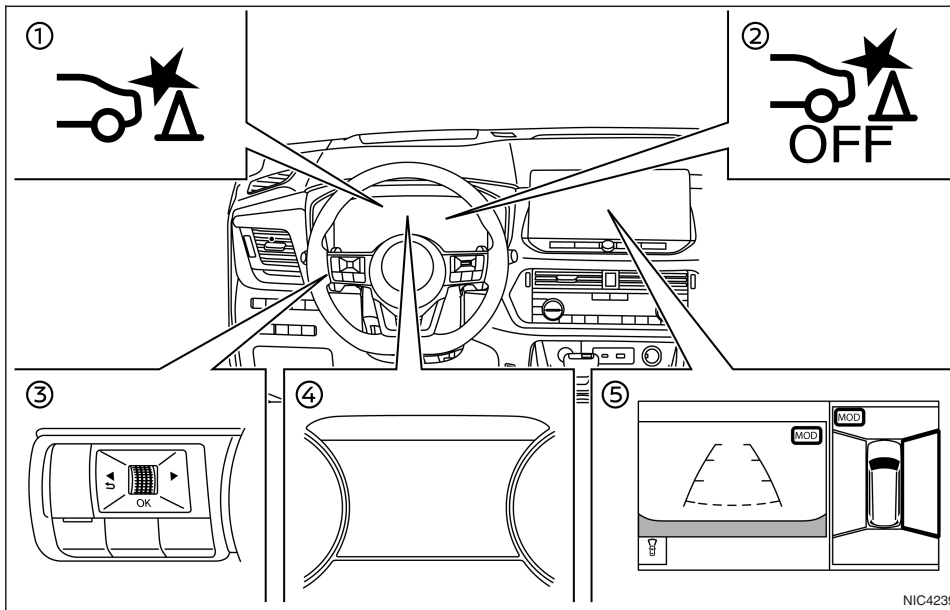

- ① RAB system warning indicator (on the vehicle information display)
- ② RAB system OFF warning light (on the meter panel)
- ③ Steering-wheel-mounted controls (left side)
- ④ Vehicle information display
- ⑤ Centre display (where fitted)

RAB SYSTEM OPERATION

When the vehicle is in the R (Reverse) position and the vehicle speed is between approximately 3 km/h (2 MPH) and 15 km/h (9 MPH), the RAB system is active.

If a risk of a collision with an obstacle is detected when your vehicle is reversing, the RAB system warning indicator will flash in the vehicle information display, a red frame will appear in the centre display (models with the Intelligent Around View Monitor system), and the system will chime three times. The system will then automatically apply the brakes. After the automatic brake application, the driver must depress the brake pedal to maintain brake pressure.

NOTE

- The brake lights of the vehicle come on when braking is performed by the RAB system.
- When the brakes operate, a noise may be heard. This is not a malfunction.

NIC4239

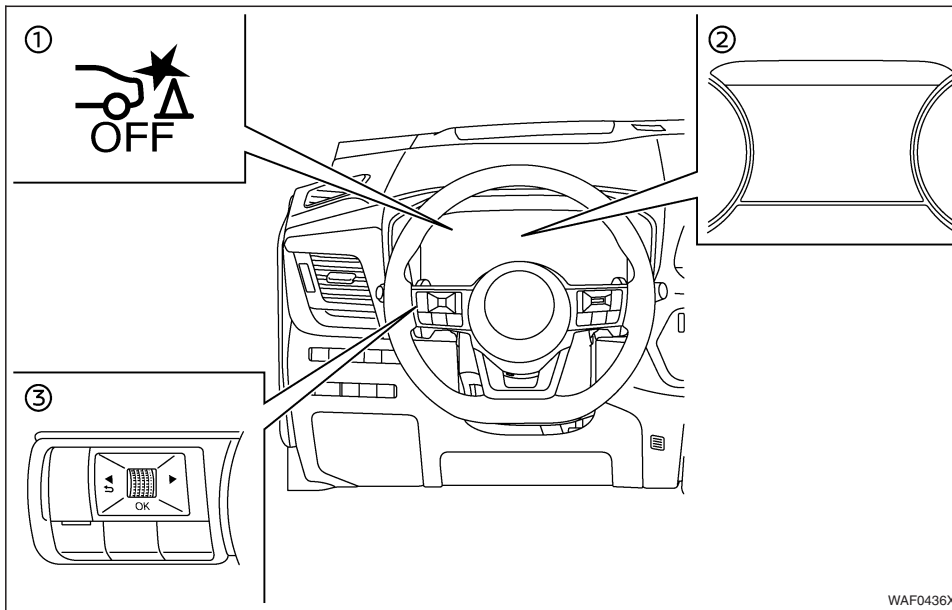

WAF0436X

TURNING THE RAB SYSTEM ON/OFF

- ① RAB system OFF warning light
- ② Vehicle information display
- ③ Steering-wheel-mounted control (left side)

Perform the following steps to turn the RAB system ON or OFF.

1. Push the ◀ ▶ button until [Settings] appears in the vehicle information display and then push the scroll dial. Use the scroll dial to select [Driver Assistance]. Then push the scroll dial.
2. Select [Emergency Brake] and push the scroll dial.

3. Select [Rear] and use the scroll dial to turn the system on or off.

When the RAB system is turned off, the RAB system OFF warning light illuminates when the vehicle is in R (Reverse).

The RAB system OFF warning light will also illuminate when the vehicle is in R (Reverse) and the RAB system is ON if the parking sensors have been temporarily disabled using the [Parking Aids] setting.

NOTE

The RAB system will be automatically turned on when the e-POWER system is restarted.

NOTE



NSD1071

When the vehicle is in R (Reverse) and the [Parking Aids] screen is displayed in the vehicle information display the RAB system can be disabled temporarily by pushing the <OK> switch on the steering wheel.

RAB SYSTEM LIMITATIONS

WARNING

Listed below are the system limitations for the RAB system. Failure to follow the warnings and instructions for proper use of the RAB system could result in serious injury or death.

- When the vehicle approaches an obstacle while the accelerator or brake pedal is depressed, the function may not operate or the start of the operation may be delayed. The RAB system may not operate or may not perform sufficiently due to vehicle conditions, driving conditions, the traffic environment, the weather, road surface conditions, etc. Do not wait for the system to operate. Operate the brake pedal by yourself as soon as necessary.
- If it is necessary to override RAB operation, strongly press the accelerator pedal.
- Always check your surroundings and turn to check what is behind you before and while reversing. The RAB system detects stationary objects behind the vehicle. The RAB system does not detect the following objects:
 - Moving objects
 - Low objects
 - Narrow objects
 - Wedge-shaped objects
 - Complex-shaped objects
 - Multiple object in close
 - Objects close to the bumper (less than approximately 30 cm (1 ft))

- Objects that suddenly appear
- Thin objects such as rope, wire, chain, etc.
- The RAB system may not operate for pedestrians or animals.
- The RAB system may not operate for the following obstacles:
 - Obstacles located high off the ground
 - Obstacles in a position offset from your vehicle
 - Obstacles, such as spongy materials or snow, that have soft outer surfaces and can easily absorb a sound wave
- The RAB system may not operate in the following conditions:
 - There is rain, snow, ice, dirt, etc., attached to the parking sensors.
 - A loud sound is heard in the area around the vehicle.
 - The surface of the obstacle is diagonal to the rear of the vehicle.
 - The parking sensors or the area around them are extremely hot or cold.
- The RAB system may unintentionally operate in the following conditions:
 - There is overgrown grass in the area around the vehicle.
 - There is a structure (e.g., a wall, toll gate equipment, a narrow tunnel, a parking lot gate) near the side of the vehicle.
 - There are bumps, protrusions, or manhole covers on the road surface.

- The vehicle is driving through a draped flag or a curtain.
- The vehicle is driving on a steep slope.
- There is an accumulation of snow or ice behind the vehicle.
- An ultrasonic wave source, such as another vehicle's sonar, is near the vehicle.
- Once the automatic brake control operates, it does not operate again if the vehicle approaches the same obstacle.
- The automatic brake control can only operate for a short period of time. Therefore, the driver must depress the brake pedal.
- In the following situations, the RAB system may not operate properly or may not function sufficiently:
 - The vehicle is driven in bad weather (rain, fog, snow, etc.).
 - The vehicle is driven on a steep slope.
 - The vehicle's posture is changed (e.g., when driving over a bump).
 - The vehicle is driven on a slippery road.
 - The vehicle is turned sharply by turning the steering wheel fully.
 - Snow chains are used.
 - Wheels or tyres other than NISSAN recommended are used.
 - The brakes are cold at low ambient temperatures or immediately after driving has started.

- The braking force becomes poor due to wet brakes after driving through a puddle or washing the vehicle.
- Turn the RAB system off in the following conditions to prevent the occurrence of an unexpected accident resulting from sudden system operation:
 - The vehicle is towed.
 - The vehicle is carried on a flatbed truck.
 - The vehicle is on the chassis dynamometer.
 - The vehicle drives on an uneven road surface.
 - Suspension parts other than those designated as genuine parts are used. (If the vehicle height or the vehicle body inclination is changed, the system may not detect an obstacle correctly.)
 - If the vehicle is using an accessory like a bike rack, or cargo carrier that blocks the sensors.
- When towing a trailer or other vehicle, turn the RAB system off to prevent the occurrence of an unexpected accident resulting from sudden system operation.
- Excessive noise (e.g., audio system volume, an open vehicle window) will interfere with the chime sound, and it may not be heard.

SYSTEM MALFUNCTION

If the RAB system malfunctions, it will be turned off automatically, the RAB system OFF warning light will illuminate, a chime will sound, and the [System fault] warning message will appear in the vehicle information display.

Action to take

If the warning light illuminates, park the vehicle in a safe location, turn the e-POWER system off, and restart the e-POWER system. If the warning light continues to illuminate, have the RAB system checked. It is recommended that you visit a NISSAN dealer or qualified workshop for this service.

NOTE

If the RAB system cannot be operated temporarily, the RAB system OFF warning light blinks.

SYSTEM MAINTENANCE

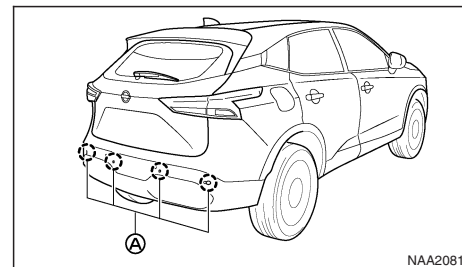

NAA2081

Models with 4 parking (sonar) sensors

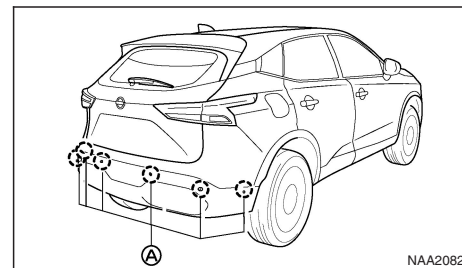

NAA2082

Models with 6 parking (sonar) sensors

The parking sensors (A) are located on the rear bumper. Observe the following items to ensure proper operation of the system:

- Always keep the sensors clean.
- If the sensors are dirty, wipe them off with a soft cloth while being careful to not damage them.

LANE DEPARTURE WARNING (LDW) SYSTEM (where fitted)

- The sensors may be blocked by temporary ambient conditions such as splashing water, mist or fog. The blocked condition may also be caused by objects such as ice, frost or dirt obstructing the sensors. Check for and remove objects obstructing the area around the sensors.
- Do not subject the area around the sensors to strong impact. Also, do not remove or disassemble the sensors. If the sensors and peripheral areas are deformed in an accident, etc., have the sensors checked. It is recommended that you visit a NISSAN dealer or qualified workshop for this service.
- Do not attach stickers (including transparent material), install accessories or apply additional paint on the sensors and their surrounding areas. This may cause a malfunction or improper operation.
- When washing the vehicle using a high-pressure washer, do not apply direct washer pressure on the sensors. This may cause a malfunction of the sensors.

NOTE

If your vehicle is fitted with ProPILOT Assist, refer to the dedicated section later in this manual for information on the Lane Departure Warning System.

- **ProPILOT Assist:** See "ProPILOT Assist (where fitted)" later in this section.

The LDW system will operate when the vehicle is driven at the following speeds and above, and only when the lane markings are clearly visible on the road:

- For Europe:
approximately 60 km/h (37 MPH)
- Except for Europe:
approximately 70 km/h (45 MPH)

The LDW system monitors the lane markers on the travelling lane using the camera unit ① located above the inside mirror.

The LDW system warns the driver with a LDW indicator on the Vehicle Information Display and steering wheel vibration that the vehicle is beginning to leave the driving lane.

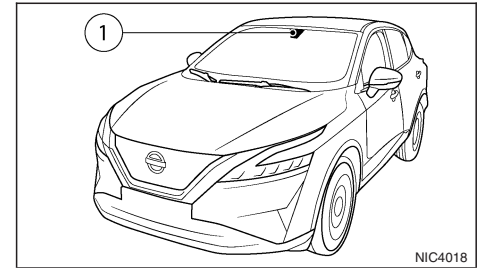

WARNING

Listed below are the system limitations for the Lane Departure Warning system. Failure to operate the vehicle in accordance with these system limitations could result in serious injury or death.

- The LDW system is only a warning device to help inform the driver of a potential unintended lane departure. It will not steer the vehicle or prevent loss of control. It is the driver's responsibility to stay alert, drive safely, keep the vehicle in the travelling lane, and be in control of the vehicle at all times.

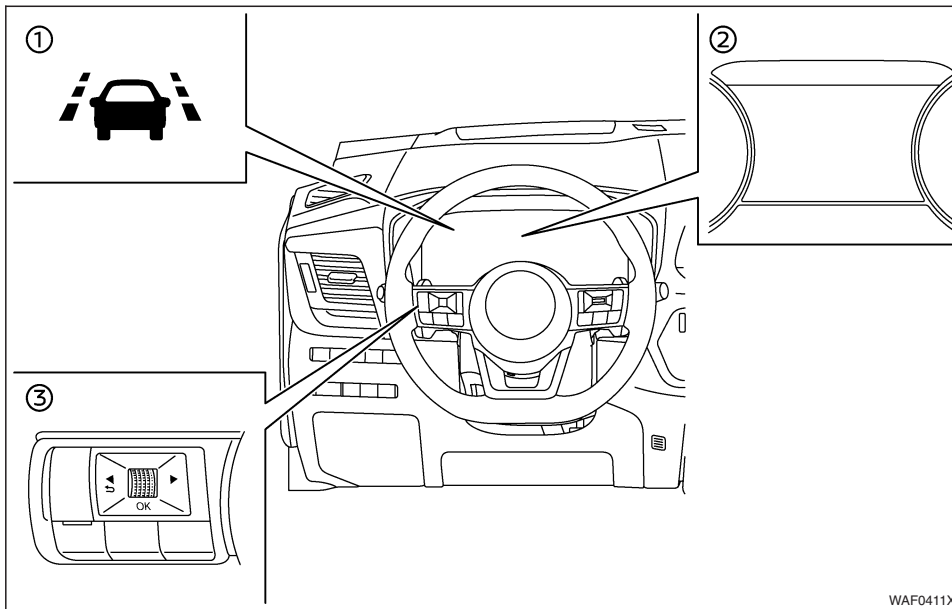

WAF0411X

- ① LDW indicator (on the vehicle information display)
- ② Vehicle information display
- ③ Steering wheel-mounted controls (left side)

LDW SYSTEM OPERATION

The LDW system provides a lane departure warning function when the vehicle is driven at the following speeds and above, and only when the lane markings are clearly visible on the road:

- For Europe:
approximately 60 km/h (37 MPH)
- Except for Europe:
approximately 70 km/h (45 MPH)

When the vehicle approaches either the left or the right side of the travelling lane, the steering wheel will vibrate, and the LDW indicator on the vehicle information display will blink to alert the driver.

The warning function will stop when the vehicle returns inside of the lane markers.

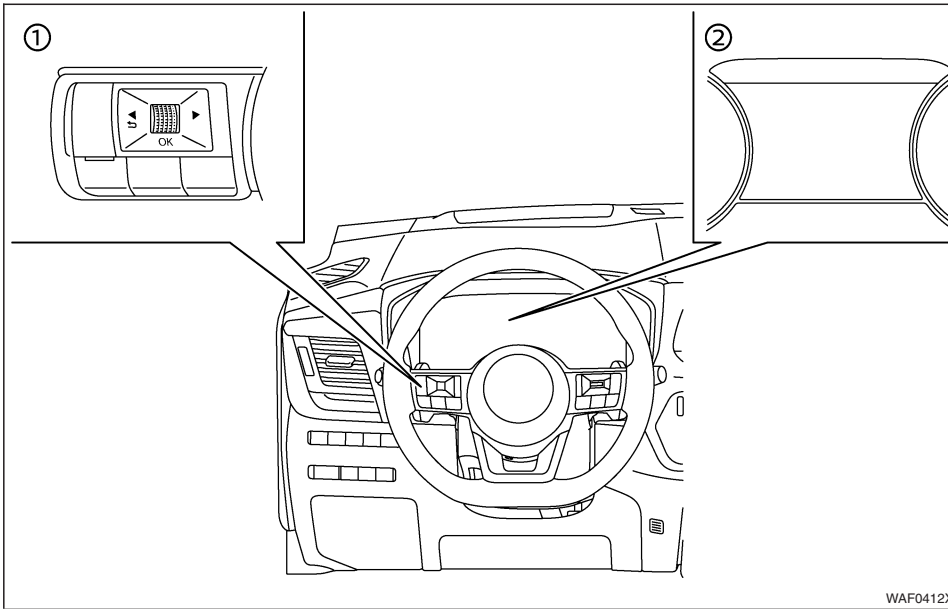

WAF0412X

- ① Steering wheel-mounted controls (left side)
- ② Vehicle information display

Turning the LDW system on or off

You can turn the LDW system on and off using the [Settings] menu in the vehicle information display.

For details, see "Vehicle information display" in the "2. Instruments and controls" section.

1. Push the ◀ ▶ button until [Settings] appears in the vehicle information display and then push the scroll dial. Use the scroll dial to select [Driver Assistance]. Then push the scroll dial.
2. Select [Lane] and push the scroll dial.
3. Select [Warning] and push the scroll dial.

NOTE

If you turn the LDW system off using the [Settings] menu, the system will remain turned off the next time you start the e-POWER system.

NOTE

You can adjust the intensity of the steering wheel vibration using the [Vibration Level] setting (where fitted) in the [Lane] menu of the vehicle information display. It can be set to [High], [Medium] or [Low]. See "[Lane]" in the "2. Instruments and controls" section.

WARNING

Listed below are the system limitations for the Lane Departure Warning system. Failure to operate the vehicle in accordance with these system limitations could result in serious injury or death.

- The system will not operate at speeds below approximately 60 km/h (37 MPH) (for Europe) or 70 km/h (45 MPH) (except for Europe), or if it cannot detect lane markers
- Do not use the LDW system under the following conditions as it may not function properly:
 - During bad weather (rain, fog, snow, etc.).
 - When driving on slippery roads, such as on ice or snow.
 - When driving on winding or uneven roads.
 - When there is a lane closure due to road repairs.
 - When driving in a makeshift or temporary lane.
 - When driving on roads where the lane width is too narrow.
 - When driving without normal tyre conditions (for example, tyre wear, low tyre pressure, installation of spare tyre, tyre chains, non-standard wheels).
 - When the vehicle is equipped with non-original brake parts or suspension parts.
 - When you are towing a trailer or other vehicle.

- The system may not function properly under the following conditions:
 - On roads where there are multiple parallel lane markers; lane markers that are faded or not painted clearly; yellow painted lane markers; non-standard lane markers; or lane markers covered with water, dirt, snow, etc.
 - On roads where discontinued lane markers are still detectable.
 - On roads where there are sharp curves.
 - On roads where there are sharply contrasting objects, such as shadows, snow, water, wheel ruts, seams or lines remaining after road repairs. (The LDW system could detect these items as lane markers.)
 - On roads where the travelling lane merges or separates.
 - When the vehicle's travelling direction does not align with the lane marker.
 - When travelling close to the vehicle in front of you, which obstructs the lane camera unit detection range.
 - When rain, snow, dirt or object adheres to the windscreen in front of the lane camera unit.
 - When the headlights are not bright due to dirt on the lens or if the aiming is not adjusted properly.
 - When strong light enters the lane camera unit. (For example, the light directly shines on the front of the vehicle at sunrise or sunset.)

- When a sudden change in brightness occurs. (For example, when the vehicle enters or exits a tunnel or under a bridge.)

LDW TEMPORARY DISABLED STATUS

If the vehicle is parked in direct sunlight under high temperature conditions (over approximately 40 °C (104 °F)) and then started, the LDW system may be deactivated automatically and the [Unavailable Camera Temperature High] message will appear in the Vehicle Information Display.

When the interior temperature is reduced, the LDW system will resume operating automatically.

The LDW system is not designed to warn under the following conditions:

- When you operate the lane change signal and change travelling lanes in the direction of the signal. (The LDW system will become operational again approximately two seconds after the lane change signal is turned off.)
- When the vehicle speed lowers to less than approximately 60 km/h (37 MPH) (for Europe) or 70 km/h (45 MPH) (except for Europe).
- When rain, snow, dirt or object adheres to the windscreen in front of the lane camera unit.

After the above conditions have finished and the necessary operating conditions are satisfied, the LDW system will resume.

LDW MALFUNCTION

If the LDW system malfunctions, it will cancel automatically and the [System Fault] message will appear in the Vehicle Information Display. If the [System Fault] message appears in the Vehicle Information Display pull off the road in a safe location, turn off and restart the e-POWER system. If the [System Fault] message continues to appear in the Vehicle Information Display, have the LDW system checked by a NISSAN dealer or qualified workshop.

MULTI-SENSING CAMERA UNIT MAINTENANCE

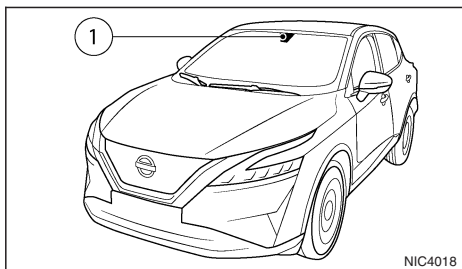

The lane camera unit ① for the LDW system is located above the interior rear view mirror. To maintain the proper operation of the LDW system and prevent a system malfunction, be sure to observe the following:

- Always keep the windscreen clean.
- Do not attach a sticker (including transparent material) or install an accessory near the camera unit.

- Do not place reflective materials, such as white paper or a mirror, on the instrument panel. The reflection of sunlight may adversely affect the camera unit's detection capability.
- Do not strike or damage the areas around the camera unit. Do not touch the camera lens or remove the screw located on the camera unit. If the camera unit is damaged due to an accident, contact a NISSAN dealer or qualified workshop.

INTELLIGENT LANE INTERVENTION (ILI) SYSTEM (where fitted)

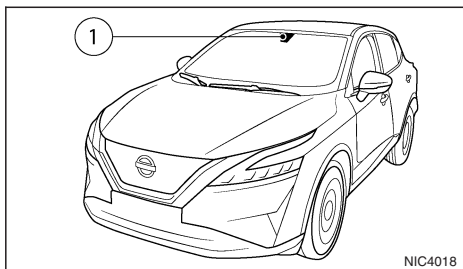

NOTE

If your vehicle is fitted with ProPILOT Assist, refer to the dedicated section later in this manual for information on the Lane Departure Warning (LDW) System. See "ProPILOT Assist (where fitted)" later in this section

WARNING

Failure to follow the warnings and instructions for proper use of the Intelligent Lane Intervention system could result in serious injury or death.

- The Intelligent Lane Intervention system will not steer the vehicle or prevent loss of control. It is the driver's responsibility to stay alert, drive safely, keep the vehicle in the travelling lane, and be in control of the vehicle at all times.

- The Intelligent Lane Intervention system is primarily intended for use on well-developed motorways or highways. It may not detect the lane markers in certain road, weather, or driving conditions.

The Intelligent Lane Intervention system must be turned on with the ILI switch (where fitted) or the Safety Shield switch (where fitted) every time the power switch is switched **ON**.

The Intelligent Lane Intervention system will operate when the vehicle is driven at the following speeds and above, and only when the lane markings are clearly visible on the road:

- For Europe:
approximately 60 km/h (37 MPH)
- Except for Europe:
approximately 70 km/h (45 MPH)

The Intelligent Lane Intervention system warns the driver when the vehicle has left the centre of the travelling lane with an Intelligent Lane Intervention indicator on the vehicle information display and steering wheel vibration. The system helps assist the driver to return the vehicle to the centre of the travelling lane by applying the brakes to the left or right wheels individually (for a short period of time).

The Intelligent Lane Intervention system monitors the lane markers on the travelling lane using the camera unit ① located above the inside mirror.

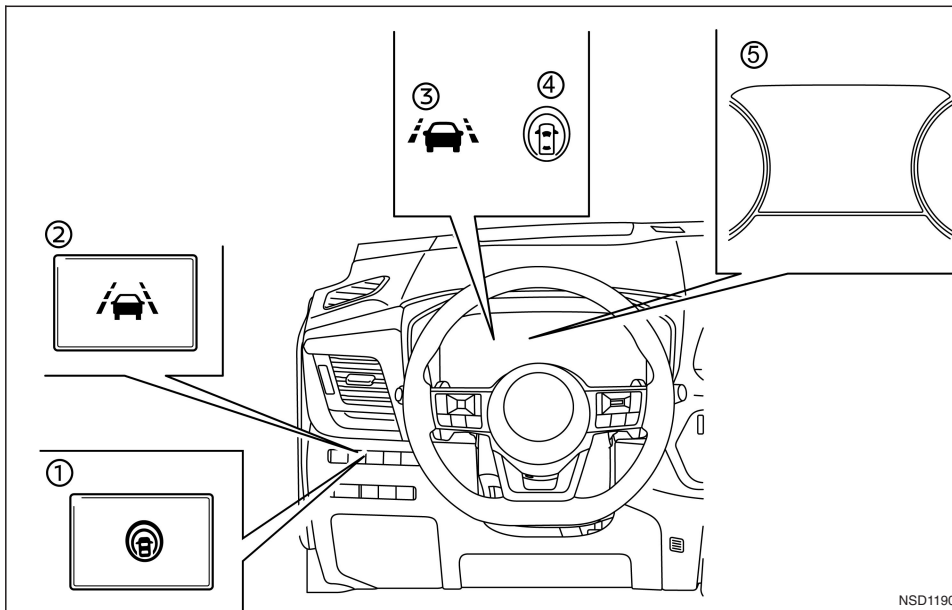

- ① Safety Shield switch (where fitted)
- ② ILI switch (where fitted)
- ③ ILI indicator (on the vehicle information display)
- ④ Safety Shield indicator (on the vehicle information display)
- ⑤ Vehicle information display

INTELLIGENT LANE INTERVENTION SYSTEM OPERATION

The Intelligent Lane Intervention (ILI) system operates at speeds above:

- For Europe:
approximately 60 km/h (37 MPH)
- Except for Europe:
approximately 70 km/h (45 MPH)

When the vehicle approaches either the left or the right side of the travelling lane, the steering wheel will vibrate and the ILI indicator (yellow) on the vehicle information display will blink to alert the driver. Then, the Intelligent Lane Intervention system will automatically apply the brakes for a short period of time to help assist the driver to return the vehicle to the centre of the travelling lane.

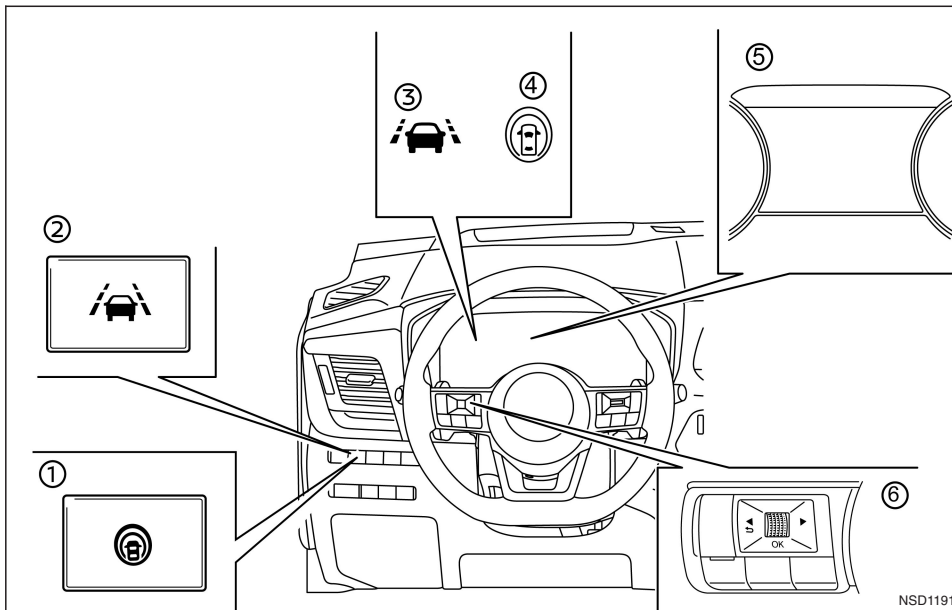

INTELLIGENT LANE INTERVENTION ACTIVATION/DEACTIVATION

- ① Safety Shield switch (where fitted)
- ② ILI switch (where fitted)
- ③ ILI indicator (on the vehicle information display)

- ④ Safety Shield indicator (on the vehicle information display)
- ⑤ Vehicle information display
- ⑥ Steering wheel mounted controls (left side)

For models fitted with a ILI switch: To turn on the Intelligent Lane Intervention system, push the ILI switch (on the instrument panel after starting the e-POWER system.

For models fitted with a Safety Shield switch: To turn on the Intelligent Lane Intervention system when the ILI setting is enabled in the [Driver Assistance] menu in the vehicle information display, push the Safety Shield switch on the instrument panel after starting the e-POWER system.

NOTE

For models fitted with a Safety Shield switch: The ILI setting must be enabled in the [Driver Assistance] menu in the vehicle information display before the Intelligent Lane Intervention system can be switched on.

For models fitted with a ILI switch, the ILI indicator on the vehicle information display will appear. Push the ILI switch again to turn off the Intelligent Lane Intervention system. The ILI indicator on the vehicle information display will turn off.

For models fitted with a Safety Shield switch, when the ILI setting is enabled in the [Driver Assistance] menu in the vehicle information display the Safety Shield indicator on the vehicle information display will appear. Push the Safety Shield switch again to turn off the Intelligent Lane Intervention system or disable the ILI setting in the [Driver Assistance] menu. The Safety Shield indicator on the vehicle information display will turn off.

For models fitted with a Safety Shield switch, to enable or disable the ILI system:

1. Push the ◀ ▶ button on the steering wheel until [Settings] appears in the vehicle information display and then push the scroll dial. Use the scroll dial to select [Driver Assistance]. Then push the scroll dial.

2. Select [Lane] and push the scroll dial.
3. Select [Intervention] and push the scroll dial.
4. Push the Safety Shield switch to turn the system on or off.

INTELLIGENT LANE INTERVENTION LIMITATIONS

WARNING

Listed below are the system limitations for the Intelligent Lane Intervention system. Failure to operate the vehicle in accordance with these system limitations could result in serious injury or death.

- The Intelligent Lane Intervention system may activate if you change lanes without first activating your turn signal or, for example, if a construction zone directs traffic to cross an existing lane marker. If this occurs you may need to apply corrective steering to complete your lane change.
- Because the Intelligent Lane Intervention may not activate under the road, weather and lane marker conditions described in this section, it may not activate every time your vehicle begins to leave the travelling lane and you will need to apply corrective steering.
- The ILI system will not operate if it cannot detect lane markers, or at speeds below approximately 60 km/h (37 MPH) (for Europe) or 70 km/h (45 MPH) (except for Europe).

- **Do not use the Intelligent Lane Intervention system under the following conditions as it may not function properly:**
 - During bad weather (rain, fog, snow, etc.).
 - When driving on slippery roads, such as on ice or snow.
 - When driving on winding or uneven roads.
 - When there is a lane closure due to road repairs.
 - When driving in a makeshift or temporary lane.
 - When driving on roads where the lane width is too narrow.
 - When driving without normal tyre conditions (for example, tyre wear, low tyre pressure, installation of spare tyre, tyre chains, non-standard wheels).
 - When the vehicle is equipped with non-original brake parts or suspension parts.
 - On roads where there are multiple parallel lane markers; lane markers that are faded or not painted clearly; yellow painted lane markers; non-standard lane markers; or lane markers covered with water, dirt, snow, etc.
 - On roads where discontinued lane markers are still detectable.
 - On roads where there are sharp curves.
 - On roads where there are sharply contrasting objects, such as shadows, snow, water, wheel ruts, seams or lines remaining after

road repairs. (The Intelligent Lane Intervention system could detect these items as lane markers.)

- On roads where the travelling lane merges or separates.
- When the vehicle's travelling direction does not align with the lane marker.
- When travelling close to the vehicle in front of you, which obstructs the lane camera unit detection range.
- When rain, snow, dirt or object adheres to the windscreen in front of the lane camera unit.
- When the headlights are not bright due to dirt on the lens or if the aiming is not adjusted properly.
- When strong light enters the lane camera unit. (For example, the light directly shines on the front of the vehicle at sunrise or sunset.)
- When a sudden change in brightness occurs. (For example, when the vehicle enters or exits a tunnel or under a bridge.)
- When towing a trailer or another vehicle.

NOTE

While the Intelligent Lane Intervention system is operating, you may hear a sound of brake operation. This is normal and indicates that the Intelligent Lane Intervention system is operating properly.

INTELLIGENT LANE INTERVENTION TEMPORARILY UNAVAILABLE

Condition A:

The warning and assist functions of the Intelligent Lane Intervention system are not designed to work under the following conditions:

- When you operate the lane change signal and change the travelling lanes in the direction of the signal. (The Intelligent Lane Intervention system will be deactivated for approximately 2 seconds after the lane change signal is turned off.)
- When the vehicle speed lowers to less than approximately 60 km/h (37 MPH) (for Europe) or 70 km/h (45 MPH) (except for Europe).

After the above conditions have finished and the necessary operating conditions are satisfied, the warning and assist functions will resume.

Condition B:

The assist function of the Intelligent Lane Intervention system is not designed to work under the following conditions (warning is still functional):

- When the brake pedal is depressed or if the vehicle decelerates strongly.
- When the steering wheel is turned as far as necessary for the vehicle to change lanes.
- When the vehicle is accelerated during the Intelligent Lane Intervention system operation.
- When the hazard warning flashers are operated.
- When driving on a curve at high speed.

After the above conditions have finished and the necessary operating conditions are satisfied, the Intelligent Lane Intervention system application of the brakes will resume.

Condition C:

If the following messages appear in the vehicle information display, a chime will sound and the Intelligent Lane Intervention system will be turned off automatically.

- [Unavailable Slippery Road]:
When the ESP system (except Traction Control System (TCS) function) or ABS operates.
- [Currently not available]:
 - When the ESP system is turned **OFF**.

When the above conditions no longer exist, turn off the Intelligent Lane Intervention system. Push the ILI switch again to turn the Intelligent Lane Intervention system back on.

Temporary disabled status at high temperature:

If the vehicle is parked in direct sunlight under high temperature conditions (over approximately 40°C (104°F)) and then the Intelligent Lane Intervention system is turned on, the Intelligent Lane Intervention system may be deactivated automatically and the following message will appear on the vehicle information display: [Unavailable Camera Temperature High] and a chime will sound.

SYSTEM MALFUNCTION

If the ILI system malfunctions, it will cancel automatically. The ILI indicator (orange) will illuminate, a chime will sound and the [System Fault] message will appear in the Vehicle Information Display. If the [System Fault] message appears in the Vehicle Information Display pull off the road in a safe location, turn off and restart the e-POWER system. If the [System Fault] message continues to appear in the Vehicle Information Display, have the ILI system checked by a NISSAN dealer or qualified workshop.

MULTI-SENSING CAMERA UNIT MAINTENANCE

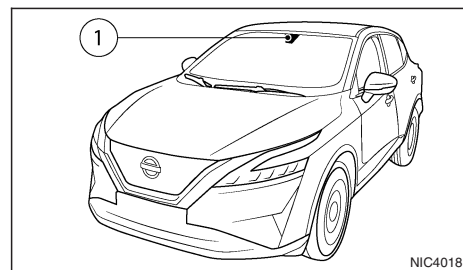

The lane camera unit ① for the Intelligent Lane Intervention system is located above the interior rear view mirror. To maintain the proper operation of the Intelligent Lane Intervention system and prevent a system malfunction, be sure to observe the following:

- Always keep the windscreen clean.

EMERGENCY LANE ASSIST (ELA) SYSTEM (where fitted)

- Do not attach a sticker (including transparent material) or install an accessory near the camera unit.
- Do not place reflective materials, such as white paper or a mirror, on the instrument panel. The reflection of sunlight may adversely affect the camera unit's detection capability of detecting lane markers.
- Do not strike or damage the areas around the camera unit. Do not touch the camera lens or remove the screw located on the camera unit. If the camera unit is damaged due to an accident, contact a NISSAN dealer or qualified workshop.

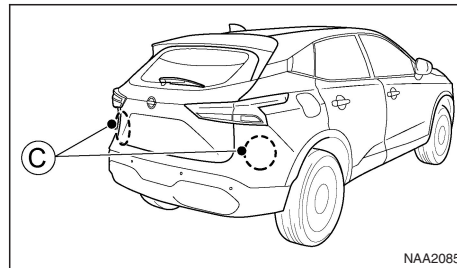
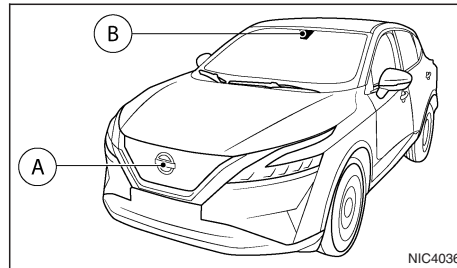

- The ELA system is intended to work on all roads with well defined markings or road edges, but it may not detect the road edge or lane markers in certain road, weather or driving conditions.
- There is a limitation to the detection capability of the radars and camera. Not every moving object or vehicle will be detected. Always rely on your own operation to avoid accidents.

The ELA system will be automatically turned on each time the e-POWER system is restarted.

The sensitivity of the ELA system, can be adjusted and this setting is kept until changed again by the driver

The ELA uses a multisensing camera (B) located above the inside mirror to monitors the lane markers on the travelling lane and to detect other vehicles. The ELA system also uses radar sensors (A) located at the front of the vehicle and (C) located near the rear bumpers to detect other vehicles.

⚠ WARNING

Failure to follow the warnings and instructions for proper use of the ELA system could result in serious injury or death.

- The ELA system will not steer the vehicle or prevent loss of control. It is the driver's responsibility to stay alert, drive safely, keep the vehicle in the travelling lane, and be in control of the vehicle at all times.

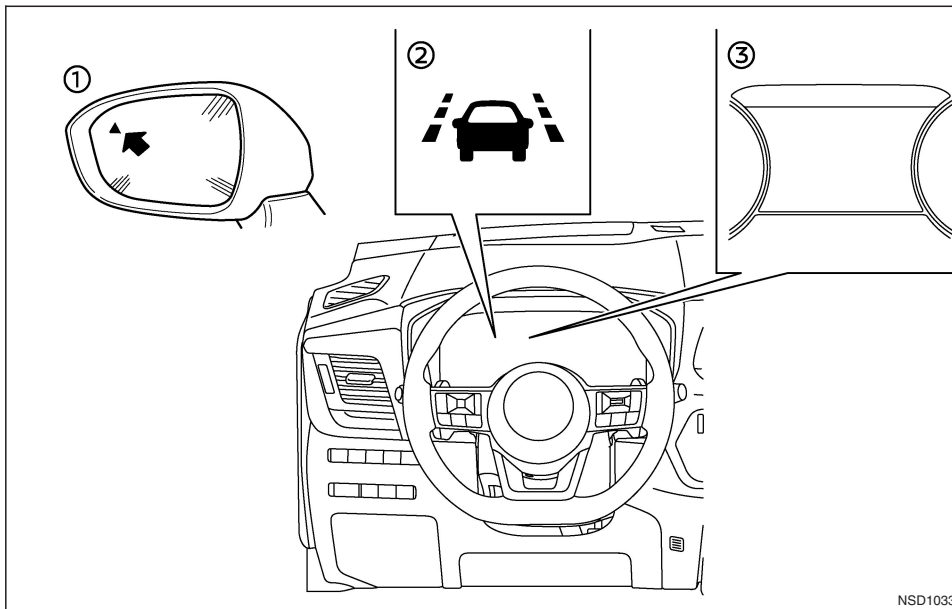

- ① Side indicator light
- ② ELA indicator (on the vehicle information display)
- ③ Vehicle information display

ELA SYSTEM OPERATION

The ELA system will operate when the vehicle is driven at the following speeds and above, and only when the lane markings or road edge are clearly visible on the road:

- For Europe:
approximately 60 km/h (37 MPH)
- Except for Europe:
approximately 70 km/h (45 MPH)

The ELA system warns the driver when the vehicle approaches the road edge or solid white line with an indicator on the vehicle information display and steering wheel vibration. The system helps assist the driver to return the vehicle to the carriageway by applying the brakes to the left or right wheels individually (for a short period of time) in the following circumstances:

- The vehicle is approaching the edge of the road, towards grass or gravel or a kerb, for example.
- The vehicle is approaching a solid line on a single lane marking.
- Oncoming vehicles in adjacent lanes.
- Overtaking vehicles in adjacent lanes. The side indicator light will also flash.
- Intelligent Lane intervention can be turned on to provide assistance in lanes on motorway/dual carriageways.

NSD1033

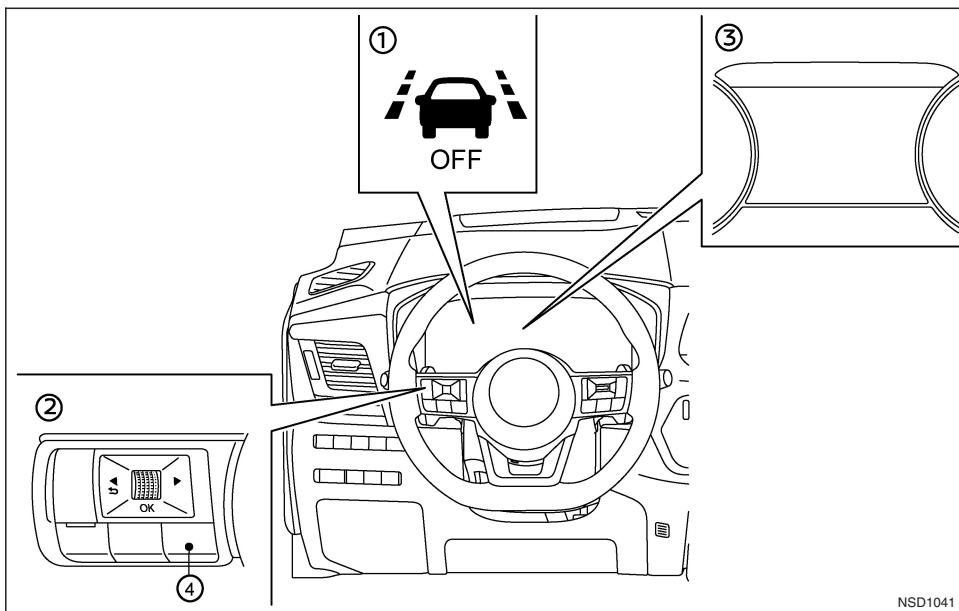

ELA ACTIVATION/DEACTIVATION

- ① ELA system OFF warning light (on the instrument panel)
 - ② Steering wheel mounted controls (left side)
 - ③ Vehicle information display
 - ④ Shortcut button
1. Press short cut button ④ on steering switch.

2. Push the scroll dial to turn ELA on or off.

Or

1. Push the ◀ ▶ button until [Settings] appears in the vehicle information display and then push the scroll dial. Use the scroll dial to select [Driver Assistance]. Then push the scroll dial.
2. Select [Lane] and push the scroll dial.

3. Select [Emergency Lane] and push the scroll dial to turn the system on or off.

When the ELA system is turned off, the ELA system OFF warning light illuminates.

For details, see "Vehicle information display" in the "2. Instruments and controls" section and "Warning lights, indicator lights and audible reminders" in the "2. Instruments and controls" section.

NOTE

- The ELA system will be automatically turned on each time the e-POWER system is restarted.
- Intelligent Lane Intervention (ILI) is an additional aid that can be turned on in addition to ELA if required. For details, see "Vehicle information display" in the "2. Instruments and controls" section.

Setting lane sensitivity

You can set lane sensitivity using the [Settings] menu in the vehicle information display.

For details, see "Vehicle information display" in the "2. Instruments and controls" section.

1. Push the ◀ ▶ button until [Settings] appears in the vehicle information display and then push the scroll dial.
In the [Settings] menu, select the [Driver Assistance] key using the scroll dial then push the scroll dial.
2. Select the [Lane] submenu by pressing the scroll dial.

3. Select [Lane Sensitivity]
 - Strong
 - Normal
 - Mild

NOTE

- The sensitivity setting will be retained even if the e-POWER system is restarted. This setting is also applied to ILI and LDW (where ELA is fitted).
- Even if the ELA system is disabled in the [Settings] menu, ELA will automatically be turned on when ILI or the Steering Assist system (where fitted) is active.

ELA LIMITATIONS

WARNING

Listed below are the system limitations for the ELA system. Failure to operate the vehicle in accordance with these system limitations could result in serious injury or death.

- The ELA system may activate if you cross a solid lane marker without first activating your turn signal or, for example, if a construction zone directs traffic to cross an existing lane marker. If this occurs you may need to apply corrective steering to complete your lane change.
- Because the ELA may not activate under the road, weather and lane marker conditions described in this section, it may not activate every time your vehicle begins to leave the travelling lane and you will need to apply corrective steering.

- The ELA system will not operate at speeds below the following speeds, or if it cannot detect lane markers.
- Below approximately 60 km/h (37 MPH) (for Europe) or 70 km/h (45 MPH) (except for Europe).
- When the ELA system detects oncoming vehicles in adjacent lanes, the ELA system will not operate at speeds above approximately 120 km/h (74 MPH).
- DO NOT use the ELA system under the following conditions, there could be serious affect on vehicle safety with risk of an accident and injury or death.
 - When driving without normal tyre conditions (for example, tyre wear, low tyre pressure, installation of spare tyre, tyre chains, non-standard wheels). See "Wheels and tyres" in the "8. Maintenance and do-it-yourself" section.
 - When the vehicle is equipped with non-original brake parts or suspension parts.
 - When towing a trailer or another vehicle.
- The ELA system may not function properly in the following conditions:
 - During bad weather (rain, fog, snow, etc.).
 - When driving on slippery roads, such as on ice or snow.
 - When driving on winding or uneven roads.
 - When there is a lane closure due to road repairs.

- When driving in a makeshift or temporary lane.
- When driving on roads where the lane width is too narrow.
- On roads where there are multiple parallel lane markers; lane markers that are faded or not painted clearly; yellow painted lane markers; non-standard lane markers; or lane markers covered with water, dirt, snow, etc.
- On roads where the edge of the road is not clearly visible.
- On roads where discontinued lane markers are still detectable.
- On roads where there are sharp curves.
- On roads where there are sharply contrasting objects, such as shadows, snow, water, wheel ruts, seams or lines remaining after road repairs. (The ELA system could detect these items as lane markers.)
- On roads where the travelling lane merges or separates.
- When the vehicle's travelling direction does not align with the lane marker.
- When travelling close to the vehicle in front of you, which obstructs the lane camera unit detection range.
- When rain, snow, dirt or object adheres to the windscreen in front of the lane camera unit.
- When the headlights are not bright due to dirt on the lens or if the aiming is not adjusted properly.

- When strong light enters the lane camera unit. (For example, the light directly shines on the front of the vehicle at sunrise or sunset.)
- When a sudden change in brightness occurs. (For example, when the vehicle enters or exits a tunnel or under a bridge.)

Listed below are the system limitations for the overtaking detection feature of the ELA system. Failure to operate the vehicle in accordance with these system limitations could result in serious injury or death.

- The ELA system cannot detect all overtaking vehicles under all conditions.
- The radar sensors may not be able to detect and activate ELA when certain objects are present such as:
 - Pedestrians, bicycles, animals.
 - Vehicles such as motorcycles, low height vehicles, or vehicles with high ground clearance.
 - Vehicles remaining in the detection zone when you accelerate from a stop.
 - A vehicle merging into an adjacent lane at a speed approximately the same as your vehicle.
 - A vehicle approaching rapidly from behind.
 - A vehicle which your vehicle overtakes rapidly.
 - A vehicle that passes through the detection zone quickly.

- The radar sensor's detection zone is designed based on a standard lane width. When driving in a wider lane, the radar sensors may not detect vehicles in an adjacent lane. When driving in a narrow lane, the radar sensors may detect vehicles driving two lanes away.
- The radar sensors are designed to ignore most stationary objects, however objects such as guardrails, walls, foliage and parked vehicles may occasionally be detected. This is a normal operation condition.
- The following conditions may reduce the ability of the radar to detect other vehicles:
 - Severe weather
 - Road spray
 - Ice/frost/dirt build-up on the vehicle
- Do not attach stickers (including transparent material), install accessories or apply additional paint near the radar sensors. These conditions may reduce the ability of the radar to detect other vehicles.

Listed below are the system limitations for the Oncoming detection feature of the ELA system. Failure to operate the vehicle in accordance with these system limitations could result in serious injury or death.

- The ELA system cannot detect all oncoming vehicles under all conditions.
- The following are not detected as oncoming vehicles:
 - Pedestrians, bicycles, animals.

- Vehicles such as motorcycles, low height vehicles, or vehicles with high ground clearance.
- Parked Vehicles or Low speed Vehicles.
- Oncoming Vehicles on same lane.
- The ELA system may not function properly or detect an oncoming vehicle in the following conditions:
 - In poor visibility conditions (such as rain, snow, fog, dust storms, sand storms, smoke and road spray from other vehicles).
 - If dirt, ice, snow, fog or other material is covering the radar sensor area or camera area of the windscreen.
 - If strong light (for example, sunlight or high beams) enters the front camera or a sudden change in brightness occurs (for example, entering a tunnel or driving in lightning).
 - In dark or dimly lit conditions, such as at night or in tunnels, including cases where your vehicle's headlights are off or dim, or the tail lights of the vehicle ahead are off.
 - When the direction of the camera is misaligned.
 - When driving on a steep downhill slope, on roads with sharp curves, and/or bumpy or dirt roads.
 - If there is interference from other radar sources.

- When your vehicle's position or movement is changed quickly or significantly (for example, lane change, turning vehicle, abrupt steering, sudden acceleration or deceleration).
- If the vehicle ahead has a unique or unusual shape, extremely low or high clearance heights, or unusual cargo loading or is narrow (for example, a motorcycle).

NOTE

While the ELA system is operating, you may hear a sound of brake operation. This is normal and indicates that the ELA system is operating properly.

SYSTEM TEMPORARILY UNAVAILABLE

Condition A:

The warning and assist functions of the ELA system are not designed to work under the following conditions:

- When you operate the lane change signal and change the travelling lanes in the direction of the signal. (The ELA system will be deactivated for approximately 2 seconds after the lane change signal is turned off). This does not apply if an overtaking vehicle is detected.
- When the vehicle speed lowers to less than approximately 60 km/h (37 MPH) (for Europe) or 70 km/h (45 MPH) (except for Europe).

- When an oncoming vehicle is detected and the vehicle speed is over approximately 120 km/h (74 MPH)

After the above conditions have finished and the necessary operating conditions are satisfied, the warning and assist functions will resume.

Condition B:

The assist function of the ELA system is not designed to work under the following conditions (warning is still functional):

- When the brake pedal is depressed.
- When the steering wheel is turned as far as necessary for the vehicle to change lanes.
- When the vehicle is accelerated during the ELA system operation.
- When the Intelligent Cruise Control (ICC) approach warning occurs (where fitted)
- When the hazard warning flashers are operated.
- When driving on a curve at high speed.

After the above conditions have finished and the necessary operating conditions are satisfied, the ELA system application of the brakes will resume.

Condition C:

If the ESP system is turned OFF, the ELA system OFF warning light illuminates and the ELA system will be turned off automatically.

When the ESP system turns ON again and the necessary operating conditions are satisfied, the ELA system application of the brakes will resume.

Condition D:

If one of the following messages appears in the vehicle information display and the ELA system warning light blinks in the vehicle information display, the ELA system will be turned off automatically:

- [Not available Side radar obstructed]: When the rear radar is blocked. Always keep the area near the radar sensors clean.
- [Temporarily Disabled Front Radar Blocked]: When the front radar is blocked. Always keep the area near the radar sensors clean.
- [Not Available Front Camera Obstructed]: When the front camera is blocked. Always keep the area near the front camera clean.
- If the vehicle is parked in direct sunlight under high temperature conditions (over approximately 40°C (104°F)) and then the ELA system is turned on, the ELA system may be deactivated automatically and the ELA system warning light blinks.

SYSTEM MALFUNCTION

If the ELA system malfunctions, it will cancel automatically. The ELA indicator (orange) will illuminate, the [System Fault] message will appear in the Vehicle Information Display and a chime will sound. If the [System Fault] message appears in the Vehicle Information Display pull off the road in a safe location, turn off and restart the e-POWER system. If the [System Fault] message continues to appear in the Vehicle Information Display, have the ELA system checked by a NISSAN dealer or qualified workshop.

SYSTEM MAINTENANCE

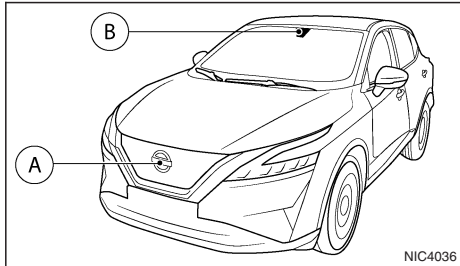

NIC4036

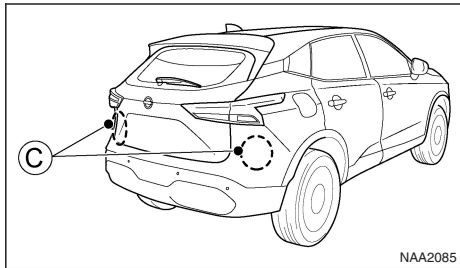

NAA2085

The front radar sensor (A) is located on the front of the vehicle. The camera (B) is located on the upper side of the windscreen. To keep the ELA system operating properly, be sure to observe the following:

- Always keep the sensor area on the front of the vehicle and windscreen clean.
- Do not strike or damage the areas around the sensors (bumper, windscreen).

- Do not cover or attach stickers or similar objects on the front of the vehicle near the sensor area. This could cause failure or malfunction.
- Do not attach metallic objects near the radar sensor area (brush guard, etc.). This could cause failure or malfunction.
- Do not place reflective materials, such as white paper or a mirror, on the instrument panel. The reflection of sunlight may adversely affect the camera unit's detection capability.
- Do not alter, remove or paint the front of the vehicle near the sensor area. Before customising or restoring the sensor area, it is recommended that you visit a NISSAN dealer or qualified workshop.

The two rear radar sensors (C) for the ELA system are located near the rear bumper. Always keep the area near the radar sensors clean.

The radar sensors may be blocked by temporary ambient conditions such as splashing water, mist or fog. The blocked condition may also be caused by objects such as ice, frost or dirt obstructing the radar sensors.

Check for and remove objects obstructing the area around the radar sensors.

Do not attach stickers (including transparent material), install accessories or apply additional paint near the radar sensors.

Do not strike or damage the area around the radar sensors.

It is recommended you visit a NISSAN dealer or qualified workshop if the area around the radar sensors is damaged due to a collision.

NOTE

If your vehicle is fitted with ProPILOT Assist, refer to the dedicated section later in this manual for information on Cruise Control.

- **ProPILOT Assist:** See "ProPILOT Assist (where fitted)" later in this section.

The cruise control system allows driving at constant speeds without keeping your foot on the accelerator pedal.

WARNING

- **The cruise control system ONLY maintains a constant vehicle speed, it does not replace the driver.**
- **Always observe the posted speed limits and do not set the speed above them.**
- **Do not use the cruise control system when driving under the following conditions. Doing so could cause a loss of vehicle control and result in an accident.**
 - **When it is not possible to keep the vehicle at a constant speed**
 - **When driving in heavy traffic**
 - **When driving in traffic that varies speed**
 - **When driving in windy areas**
 - **When driving on winding or hilly roads**
 - **When driving on slippery (rain, snow, ice, etc.) roads**

When the cruise control system is on the speed limiter cannot be operated.

The cruise control system operation switches are located on the steering wheel (right side).

The cruise control system operating condition is shown in the vehicle information display.

PRECAUTIONS ON CRUISE CONTROL

- The cruise control system will be automatically cancelled when there is a malfunction. Have the system checked by a NISSAN dealer or qualified workshop.
- To properly set the cruise control system, perform the steps as described in "Setting a cruising speed" later in this section.

CRUISE CONTROL SYSTEM OPERATIONS

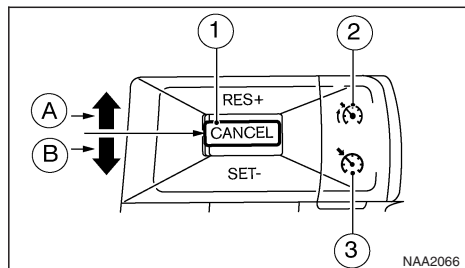

- ① <CANCEL> switch
- Ⓐ <RES+> (Resume) switch
- Ⓑ <SET-> switch

- ② Speed limiter main "ON/OFF" switch (For details, see "Speed limiter (where fitted)" later in this section) (where fitted)
- ③ Cruise control main "ON/OFF" switch

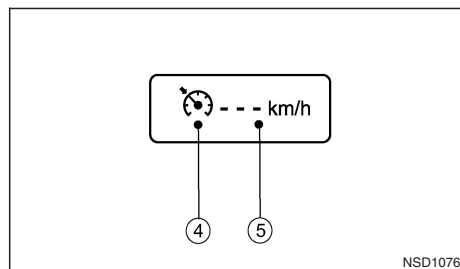

Before setting speed

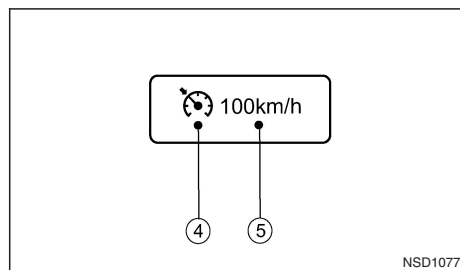

After setting speed

- ④ Cruise control symbol
- ⑤ Set speed value

Turning the cruise control system on

Push the cruise control main switch ③. The cruise control symbol ④ appears together with a blank set speed value [— —] ⑤ at the top of the vehicle information display.

Setting a cruising speed

1. Accelerate to the desired cruising speed.
2. Push the <SET-> switch ③ down and release it.
3. The cruise control symbol ④ changes to green with the set speed value (desired cruising speed) ⑤ in the top of the vehicle information display.
4. Take your foot off the accelerator pedal.

The vehicle will maintain the set speed.

If the vehicle speed is less than the minimum set speed, it will not be possible to set the cruise control system.

Changing a cruising speed

Use any one of the following methods to change the cruising speed.

- Slow the vehicle as normal using the footbrake pedal. When the vehicle reaches the desired cruising speed, push down and release the <SET-> switch ③. The new set speed value will be displayed in the top of the vehicle information display.
- Press the accelerator pedal. When the vehicle reaches the desired cruising speed, push up and release the <SET-> switch ③.

SPEED LIMITER (where fitted)

The new set speed value will be displayed in the top of the vehicle information display.

- Push up and release the <RES+> (resume) (A) switch to increase or push down and release the <SET-> switch (B) to decrease the set speed in steps of 1 km/h (1 MPH).

The new set speed value will be displayed in the top of the vehicle information display.

- Push up and hold the <RES+> (resume) (A) switch or push down and hold or the <SET-> switch (B). The vehicle speed will increase or decrease to the new set speed.

The new set speed value will be displayed in the top of the vehicle information display.

Passing another vehicle

Depress the accelerator pedal to accelerate. After releasing the accelerator pedal, the vehicle will return to the previously set speed.

The set speed value (5) will flash until the vehicle returns to the previously set speed.

Cancelling the cruise control system

To cancel a set speed limit, push the <CANCEL> switch (1).

The cruise control symbol (4) and the set speed value (5) at the top of the vehicle information display turn grey.

The cruise control system will also be cancelled automatically by any of the following:

- Pressing the footbrake pedal.
- Shifting to the N (Neutral) position.
- If the vehicle slows down more than approximately 12 km/h (8 MPH) below the set speed.

Resuming a previous cruising speed

If the cruising speed has been cancelled, the last set speed value will be stored in the cruise control system memory and displayed in grey at the top of the vehicle information display. This cruising speed can be reactivated by pressing the <RES+> (Resume) switch (A).

If the vehicle speed is less than a minimum set speed, it will not be possible to resume to the cruising speed.

Turn the cruise control system off

The cruise control system will be turned off when one of the following operations is performed:

- Push the cruise control main "ON/OFF" switch (3). The cruise control symbol (4) and the set speed value (5) will turn off in the combination meter display.
- Push the speed limiter main "ON/OFF" switch (2). The cruise control system information in the combination meter will be replaced with the speed limiter information. For details see "Speed limiter (where fitted)" later in this section.
- When the vehicle is stopped and the power switch is switched OFF.

Turning off the cruise control system will erase the cruise control system memory.

NOTE

If your vehicle is fitted with ProPILOT Assist, refer to the dedicated ProPILOT Assist Speed Limiter section later in this manual.

The speed limiter allows you to set the desired vehicle speed limit. While the speed limiter is activated, you can perform normal braking and acceleration, but the vehicle will not exceed the set speed.

When the vehicle reaches the set speed limit or if the set speed limit is lower than the actual vehicle speed, the accelerator pedal will not work (unless fully depressed) until the vehicle speed drops below the set speed limit.

When the actual vehicle speed exceeds the set speed, an audible warning will be heard a short time after the set speed is exceeded and driver intervention is not detected.

When the speed limiter is on the cruise control system cannot be operated.

WARNING

- **The speed limiter will not automatically brake the vehicle to the set speed limit.**
- **Always observe posted speed limits. Do not set the speed above them.**
- **Always confirm the setting status of the speed limiter in the Vehicle Information Display.**
- **When the speed limiter is set, avoid hard acceleration to reach the set limit to ensure that the system can limit the speed of the vehicle correctly.**

- When additional floor mats are used, be sure that they are correctly secured and that they cannot interfere with the accelerator pedal. Mats not adapted to the vehicle may prevent proper operation of the speed limiter.

The speed limiter operation switches are located on the steering wheel (right hand side).

The speed limiter operating condition is shown on the top of Vehicle Information Display. For details, see "Vehicle information display" in the "2. Instruments and controls" section.

SPEED LIMITER OPERATIONS

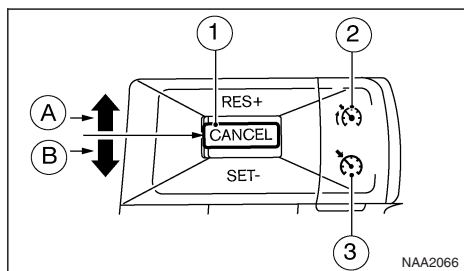

- ① <CANCEL> switch
- Ⓐ <RES+> (Resume) switch
- Ⓑ <SET-> (Set) switch
- ② Speed limiter main "ON/OFF" switch
- ③ Cruise control main "ON/OFF" switch. (For details, see "Cruise control (where fitted)" earlier in this section)

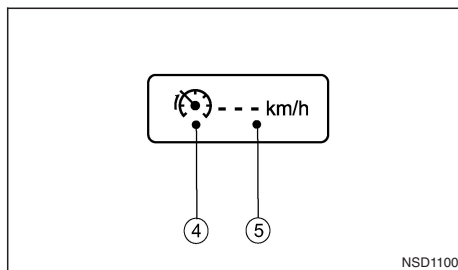

Before setting speed

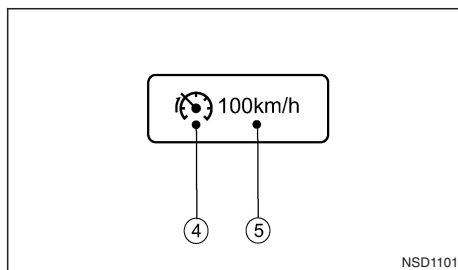

After setting speed

- ④ Speed limiter symbol
- ⑤ Set speed value

Turning the speed limiter on

The speed limiter can be switched on after the e-POWER system is started or when driving.

Push the speed limiter main ON/OFF switch ②.

The speed limiter symbol ④ and the set speed value ⑤ will illuminate in the Vehicle Information Display.

Setting speed limit

Push the <SET-> switch ⑦ down.

The speed limit will be set at the current speed.

When driving less than 30 km/h (20 MPH), the speed limiter will be set to the minimum possible set speed of 30 km/h (20 MPH).

When the speed limit is set, the speed limiter symbol ④ and the set speed value ⑤ will turn green.

Changing a speed limit

Use either of the following operations to change an active speed limit:

- Push up and release the <RES+> (Resume) switch Ⓐ or push down and release <SET-> switch Ⓑ. Each time you do this, the set speed will increase or decrease by 1 km/h (1 MPH).
- Push up and hold the <RES+> (Resume) switch Ⓐ or push down and hold <SET-> switch Ⓑ. The set speed will increase or decrease to the next multiple of 5 km/h (5 MPH) and then in steps of 5 km/h (5 MPH).

The new set speed limit value ⑤ will be displayed in the Vehicle Information Display.

When the actual vehicle speed exceeds the set speed, an audible warning will be heard a short time after the set speed is exceeded and driver intervention is not detected.

Cancelling a speed limit

To cancel a set speed limit, push the <CANCEL> switch ①. The speed limiter symbol ④ and the set speed value ⑤ in the Vehicle Information Display will turn grey.

It is also possible to override the speed limiter by fully depressing the accelerator pedal beyond the resistance point.

WARNING

- **The vehicle may accelerate when the speed limiter cancels.**
- **When additional floor mats are used, be sure that they are correctly secured and that they cannot interfere with the accelerator pedal. Mats not adapted to the vehicle may prevent proper operation of the speed limiter.**

Fully depress the accelerator pedal beyond the resistance point. The speed limiter will be suspended to allow driving above the set speed. The set speed value ⑤ will flash and an audible warning will sound. The speed limiter will automatically resume when the vehicle speed drops below the set speed limit.

Resuming a previous set speed

If a set speed limit has been cancelled, the set speed will be stored in the speed limiter memory and displayed in grey at the top of the vehicle information display.

This speed limit can be reactivated by pressing the **<RES+>** (Resume) switch .

If the current vehicle speed is higher than the previous set speed, the accelerator pedal will not work and the set speed value ⑤ will flash until the vehicle speed drops below the set speed limit.

When the actual vehicle speed exceeds the set speed, an audible warning will be heard a short time after the set speed is exceeded and driver intervention is not detected.

Turning the speed limiter off

The speed limiter system will be turned off when one of the following operations is performed:

- Push the speed limiter main ON/OFF switch ②. The speed limiter symbol ④ and the set speed value ⑤ in the Vehicle Information Display will be turned off.
- Push the cruise control main ON/OFF switch ③. The speed limiter information in the Vehicle Information Display will be replaced with the cruise control information. For details see "Cruise control (where fitted)" earlier in this section, or "ProPILOT Assist (where fitted)" later in this section.
- When the vehicle is stopped and the power switch is switched **OFF**.

Turning off the speed limiter will erase the set speed limit memory.

Speed limiter malfunction

If the speed limiter malfunctions, the speed limiter symbol ④ in the Vehicle Information Display will flash.

Turn the speed limiter off by pushing the speed limiter main "ON/OFF" switch ② and have the system checked by a NISSAN dealer or qualified workshop.

INTELLIGENT CRUISE CONTROL (ICC) (where fitted)

NOTE

If your vehicle is fitted with ProPILOT Assist, refer to the dedicated section later in this manual for information on the Intelligent Cruise Control (ICC) System.

- **ProPILOT Assist: See "ProPILOT Assist (where fitted)" later in this section.**

WARNING

Failure to follow the warnings and instructions for proper use of the ICC system could result in serious injury or death.

- **ICC is not a collision avoidance or warning device. It is intended for motorway use only and it is not intended for congested areas or city driving. Failure to apply the brakes could result in an accident.**
- **The ICC system is only an aid to assist the driver and is not a collision warning or avoidance device. It is the driver's responsibility to stay alert, drive safely, and be in control of the vehicle at all times.**
- **Always observe the posted speed limits and do not set the speed over them.**
- **Always drive carefully and attentively when using either cruise control mode. Read and understand the Owner's Manual thoroughly before using the cruise control. To avoid serious injury or death, do not rely on the system to prevent accidents or to control the vehicle's speed in emergency situations. Do not use cruise control except in appropriate road and traffic conditions.**

- In the conventional (fixed speed) cruise control mode, a warning chime will not sound to warn you if you are too close to the vehicle ahead. Pay special attention to the distance between your vehicle and the vehicle ahead of you or a collision could occur.

The ICC system will maintain a constant set speed or keep a set distance from the vehicle in front of you up to the preset speed.

The vehicle travels at the set speed when the road ahead is clear.

The ICC system can be set to one of two cruise control modes.

- Vehicle-to-vehicle distance control mode:

For maintaining a selected distance between your vehicle and the vehicle in front of you up to the preset speed.

- Conventional (fixed speed) cruise control mode:

For cruising at a preset speed.

The ICC system cannot be operated when the speed limiter is on, see "Speed limiter (where fitted)" earlier in this section for additional information.

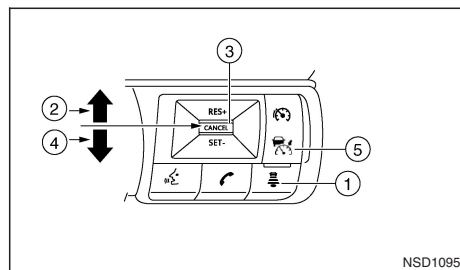

- ① Distance switch:
Changes the vehicle's following distance:
Long → Middle → Short → Long
- ② <RES+> switch:
Resumes set speed or increases speed incrementally.
- ③ <CANCEL> switch:
Deactivates the system without erasing the set speed.
- ④ <SET-> switch:
Sets desired cruise speed, reduces speed incrementally.
- ⑤ ICC ON/OFF switch
Master switch to activate the system.

CRUISE CONTROL OPERATIONS

Push the ICC ON/OFF switch ⑤ shortly to choose the vehicle-to-vehicle distance control cruise control mode.

Push and hold the ICC ON/OFF switch ⑤ to choose the conventional (fixed speed) cruise control mode.

Once a control mode is activated, it cannot be changed to the other cruise control mode. To change the mode, push the ICC ON/OFF switch ⑤ once to turn the system **OFF**. Then push the ICC ON/OFF switch ⑤ again to turn the system back on and select the desired cruise control mode.

Always confirm the setting of the ICC system in the vehicle information display.

HOW TO SELECT CRUISE CONTROL MODES

Selecting the vehicle-to-vehicle distance control mode

To choose the vehicle-to-vehicle distance control mode, quickly push and release the ICC ON/ OFF switch.

Selecting the conventional (fixed speed) cruise control mode

To choose the conventional (fixed speed) cruise control mode, push and hold the ICC ON/ OFF switch for longer than approximately 1.5 seconds.

For the conventional (fixed speed) cruise control mode, see "Conventional (fixed speed) cruise control mode" later in this section.

VEHICLE-TO-VEHICLE DISTANCE CONTROL MODE

In the vehicle-to-vehicle distance control mode, the ICC system automatically maintains a selected distance from the vehicle travelling in front of you according to that vehicle's speed (up to the set speed), or at the set speed when the road ahead is clear.

The system is intended to enhance the operation of the vehicle when following a vehicle travelling in the same lane and direction.

If the radar sensor detects a slower moving vehicle ahead, the system will reduce the vehicle speed so that your vehicle follows the vehicle in front at the selected distance.

The system automatically controls the throttle and applies the brakes (up to approximately 40% of vehicle braking power) if necessary.

Vehicle-to-vehicle distance control mode operation

The vehicle-to-vehicle distance control mode is designed to maintain a selected distance and reduce the speed to match the slower vehicle ahead; the system will decelerate the vehicle as necessary. However, the ICC system can only apply up to approximately 40% of the vehicle's total braking power. This system should only be used when traffic conditions allow vehicle speeds to remain fairly constant or when vehicle speeds change gradually. If a vehicle moves into the travelling lane ahead or if a vehicle travelling ahead rapidly decelerates, the distance between vehicles may become closer because the ICC system cannot decelerate the vehicle quickly enough. If this occurs, the ICC system will

sound a warning chime and blink the system display to notify the driver to take necessary action.

NOTE

The system will cancel and a warning chime will sound if the speed falls below approximately 30 km/h (20 MPH) and no vehicle is detected ahead.

The following items are controlled in the vehicle-to-vehicle distance control mode:

- The vehicle-to-vehicle distance control mode maintains the speed set by the driver. The set speed range is between approximately 30 and 170 km/h (20 and 105 MPH).
- When there is a vehicle travelling ahead, the vehicle-to-vehicle distance control mode adjusts the speed to maintain the distance, selected by driver, from the vehicle ahead. The adjusting speed range is up to the set speed. If the vehicle ahead comes to a stop, the vehicle decelerates to a standstill within the limitations of the system. The system will cancel once it judges a standstill, with a warning chime. Apply the foot-brake to hold the vehicle stationary if required.
- When the vehicle travelling ahead has moved out from its lane of travel, the vehicle-to-vehicle distance control mode accelerates and maintains vehicle speed up to the set speed.

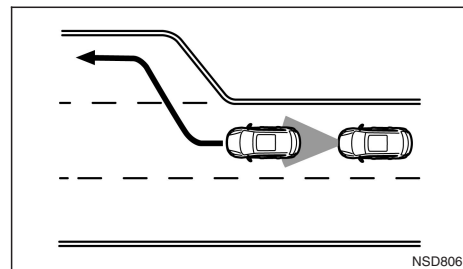

Pay attention to the driving operation to maintain control of the vehicle as it accelerates to the set speed.

The ICC system does not control vehicle speed or warn you when you approach stationary and slow moving vehicles. You must pay attention to vehicle operation to maintain proper distance from vehicles ahead when approaching toll gates or traffic congestion.

The vehicle may not maintain the set speed on winding or hilly roads. If this occurs, you will have to manually control the vehicle speed.

Normally when controlling the distance to a vehicle ahead, this system automatically accelerates or decelerates your vehicle according to the speed of the vehicle ahead. Depress the accelerator to properly accelerate your vehicle when acceleration is required for a lane change. Depress the brake pedal when deceleration is required to maintain a safe distance to the vehicle ahead due to its sudden braking or if a vehicle cuts in. Always stay alert when using the ICC system.

Vehicle-to-vehicle distance control mode switches

The system is operated by a ICC ON/OFF switch and four control switches, all mounted on the steering wheel.

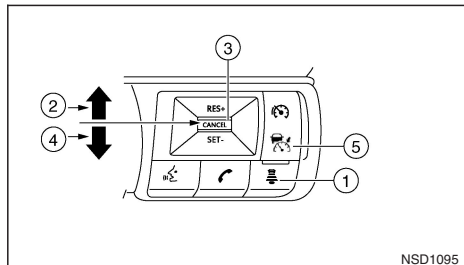

- ① Distance switch:
Changes the vehicle's following distance:
Long → Middle → Short → Long
- ② <RES+> switch:
Resumes set speed or increases speed incrementally.
- ③ <CANCEL> switch:
Deactivates the system without erasing the set speed.
- ④ <SET-> switch:
Sets desired cruise speed, reduces speed incrementally.
- ⑤ ICC ON/OFF switch:
Master switch to activate the system.

Vehicle-to-vehicle distance control mode display and indicators

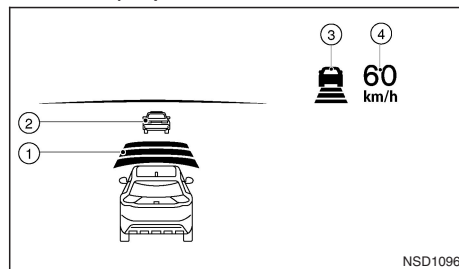

The display is located in the vehicle information display.

- 1) Set distance indicator:
Displays the selected distance between vehicles set with the DISTANCE switch.
- 2) Vehicle ahead detection indicator:
Indicates whether it detects a vehicle in front of you (only when ICC is active).
- 3) This indicator indicates the ICC system status using colour.
 - ICC system **ON** indicator (grey):
ICC standby.
 - ICC system **ON** indicator (green):
Indicates that the ICC system is **ON** and active.
 - Green vehicle icon displayed: Vehicle detected ahead.

- No vehicle icon shown: No vehicle detected ahead (Your vehicle maintains the driver-selected set speed.)

- ICC system **ON** indicator (yellow):
Indicates that there is a malfunction in the ICC system.

- 4) Set vehicle speed indicator:
Indicates the set vehicle speed.
 - Green: ICC active
 - Grey: ICC standby

Vehicle-to-vehicle distance control mode operation

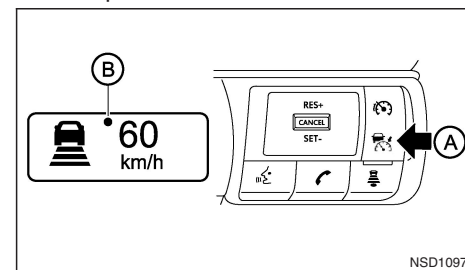

To turn the cruise control on, quickly push and release the ICC switch (A). The ICC system **ON** indicator (grey), and set vehicle speed indicator --- (B) come on.

To set cruising speed, accelerate your vehicle to the desired speed, push the <SET-> switch and release it. (The ICC system indicator and set vehicle speed indicator change to green.) Take your foot off the

accelerator pedal. Your vehicle will maintain the set speed or the desired distance to the vehicle in front.

When the **<SET->** switch is pushed under the following conditions, the system cannot be set and the set vehicle speed indicator will blink for approximately 2 seconds:

- When travelling below 30 km/h (20 MPH).
- When the vehicle is shifted to the N (Neutral) position.
- When the brakes are operated by the driver.
- When the parking brake is applied.

When the **<SET->** switch is pushed under the following conditions, the system cannot be set.

A message will pop up:

- When the ESP system is off (To use the ICC system, turn the ESP system on. Push the ICC ON/OFF switch to turn off the ICC system and reset the ICC system by pushing the ICC ON/OFF switch again.) For additional information about the ESP system, see "Electronic Stability Programme (ESP) system" later in this section.
- When ESP (including the traction control system) is operating.
- When a wheel is slipping (To use the ICC system, make sure the wheels are no longer slipping.)
- When the front radar is impaired due to dirt or another obstruction blocking the radar sensor.

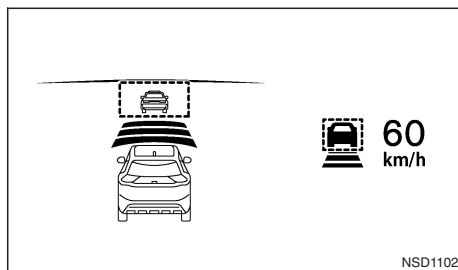

System set display with vehicle ahead

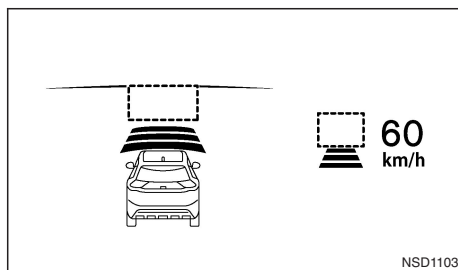

System set display without vehicle ahead

The driver sets the desired vehicle speed based on the road conditions. The ICC system maintains the set vehicle speed, similar to standard cruise control, as long as no vehicle is detected in the lane ahead. The ICC system displays the set speed.

Vehicle detected ahead:

When a vehicle is detected in the lane ahead, the ICC system decelerates the vehicle by controlling the throttle and applying the brakes to match the speed of a slower vehicle ahead. The system then

controls the vehicle speed based on the speed of the vehicle ahead to maintain the driver selected distance.

NOTE

- **The brake lights of the vehicle come on when braking is performed by the ICC system.**
- **When the brake operates, a noise may be heard. This is not a malfunction.**

When the ICC system detects a vehicle ahead, the vehicle ahead detection indicator is displayed and the speed control status indicator (vehicle icon) illuminates in green.

No vehicle detected ahead:

When a vehicle is no longer detected ahead, the ICC system gradually accelerates your vehicle to resume the previously set vehicle speed. The ICC system then maintains the set speed.

When a vehicle is no longer detected the vehicle ahead detection indicator turns off.

If a vehicle ahead appears during acceleration to the set vehicle speed or any time the ICC system is in operation, the system controls the distance to that vehicle.

If a vehicle is detected ahead, the system will continue to work until vehicle has stopped.

When the vehicle speed is under approximately 30 km/h (20 MPH), the system will be cancelled.

When overtaking another vehicle:

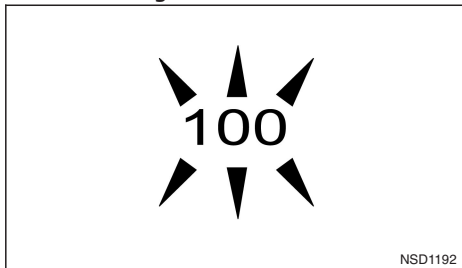

NSD1192

The driver can override ICC by pressing the accelerator. The set speed indicator will flash when the vehicle speed exceeds the set speed. The vehicle detect indicator will turn off when the area ahead of the vehicle is clear. When the pedal is released, the vehicle will return to the previously set speed.

Even though your vehicle speed is set in the ICC system, you can depress the accelerator pedal when it is necessary to accelerate your vehicle rapidly.

How to switch the ICC system off

Switch off ICC completely by turning the ICC ON/OFF switch off. The ICC indicators will go out.

How to change the set vehicle speed

To cancel the preset speed, use any of these methods:

- Push the **<CANCEL>** switch. The cruise indicator and set vehicle speed indicators will turn grey.
- Tap the brake pedal. The cruise indicator and set vehicle speed indicators will turn grey.

To reset at a faster cruising speed, use one of the following methods:

- Depress the accelerator pedal. When the vehicle attains the desired speed, push and release the **<SET->** switch.
- Push and hold the **<RES+>** switch. The set vehicle speed will increase by 10 km/h (5 MPH) increments.
- Push, then quickly release the **<RES+>** switch. Each time you do this, the set speed will increase by 1 km/h (1 MPH).

To reset at a slower cruising speed, use one of the following methods:

- Lightly tap the brake pedal. When the vehicle attains the desired speed, push the **<SET->** switch and release it.
- Push and hold the **<SET->** switch. The set vehicle speed will decrease by 10 km/h (5 MPH) increments.
- Push, then quickly release the **<SET->** switch. Each time you do this, the set speed will decrease by 1 km/h (1 MPH).

To resume the preset speed after ICC cancel, push and release the **<RES+>** switch. The vehicle will resume the last set cruising speed when the vehicle speed is over 30 km/h (20 MPH).

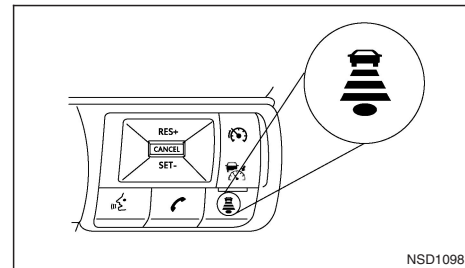

How to change the set distance to the vehicle ahead



NSD1098

The distance to the vehicle ahead can be selected when the ICC is in standby mode or the ICC is active, depending on the traffic conditions.

Each time the DISTANCE switch () is pushed, the set distance will change to long, middle, short and back to long again in that sequence.

Distance	Display	Approximate distance at 100 km/h (60 MPH) (m (ft))
Long		60 (200)
Middle		45 (150)
Short		30 (100)

- The distance to the vehicle ahead will change according to the vehicle speed. The higher the vehicle speed, the longer the distance.

- The distance setting will remain at the current setting even if the e-POWER system is restarted.

Approach warning

If your vehicle comes closer to the vehicle ahead due to rapid deceleration of that vehicle or if another vehicle cuts in, the system warns the driver with the chime and ICC system display. Decelerate by depressing the brake pedal to maintain a safe vehicle distance if:

- The chime sounds.
- The vehicle ahead detection indicator blinks.

The warning chime may not sound in some cases when there is a short distance between vehicles. Some examples are:

- When the vehicles are travelling at the same speed and the distance between vehicles is not changing.
- When the vehicle ahead is travelling faster and the distance between vehicles is increasing.
- When a vehicle cuts in near your vehicle.

The warning chime will not sound when:

- Your vehicle approaches other vehicles that are parked or moving slowly.
- The accelerator pedal is depressed, overriding the system.

NOTE

The approach warning chime may sound and the system display may blink when the radar sensor detects objects on the side of the vehicle or on the side of the road. This may cause the ICC system to decelerate or accelerate the vehicle. The

radar sensor may detect these objects when the vehicle is driven on winding roads, narrow roads, hilly roads or when entering or exiting a curve. In these cases you will have to manually control the proper distance ahead of your vehicle.

Also, the sensor sensitivity can be affected by vehicle operation (steering manoeuvre or driving position in the lane) or traffic or vehicle condition (for example, if a vehicle is being driven with some damage).

Acceleration when overtaking (where fitted)

NOTE

The acceleration when overtaking feature is only available for certain countries and for certain vehicle grades.

Overtaking on the left-hand side (for countries where traffic travels on the right hand side of the road):

When the ICC system is engaged above 70 km/h (44 MPH) and following a slower vehicle (below ICC set speed), and the turn signal is activated to the left, the ICC system will automatically start to accelerate the vehicle to help initiate overtaking on the left and will begin to reduce the distance to vehicle directly ahead. **Only the left side turn signal operates this feature.** As the driver steers the vehicle and moves into the overtaking lane, if no vehicle is detected ahead the ICC system will continue to accelerate to the ICC system set speed.

If another vehicle is detected ahead, then the vehicle will accelerate up to the following speed of that vehicle. If the vehicle is not steered into the left lane

to overtake, the acceleration will stop after a short time and regain the set following distance.

Acceleration can be stopped at any point by depressing the brake pedal or the **<CANCEL>** switch on the steering wheel.

Overtaking on the right-hand side (for countries where traffic travels on the left hand side of the road):

When the ICC system is engaged above 70 km/h (44 MPH) and following a slower vehicle (below ICC set speed), and the turn signal is activated to the right, the ICC system will automatically start to accelerate the vehicle to help initiate overtaking on the right and will begin to reduce the distance to vehicle directly ahead. **Only the right side turn signal operates this feature.** As the driver steers the vehicle and moves into the overtaking lane, if no vehicle is detected ahead the ICC system will continue to accelerate to the ICC system set speed.

If another vehicle is detected ahead, then the vehicle will accelerate up to the following speed of that vehicle. If the vehicle is not steered into the right lane to overtake, the acceleration will stop after a short time and regain the set following distance.

Acceleration can be stopped at any point by depressing the brake pedal or the **<CANCEL>** switch on the steering wheel

WARNING

In order to reduce the risk of a collision that may result in serious injury or death, please be aware of the following:

- This function is only activated with the left or right turn signal and will briefly accelerate the vehicle even if a lane change is not initiated. This can include non-overtaking situations such as left or right side exits.
- Ensure that when overtaking another vehicle, the adjacent lane is clear before initiating the overtaking manoeuvre. Sudden changes in traffic may occur while overtaking. Always manually steer or brake as needed never solely rely on the system.

Automatic cancellation

A chime sounds under the following conditions and the control is automatically cancelled.

- The vehicle ahead is not detected and your vehicle is travelling below the speed of 25 km/h (15 MPH).
- When the system judges the vehicle is at standstill.
- When the parking brake is applied.
- When the ESP system is turned off.
- When ESP (including the traction control system) operates.
- When distance measurement becomes impaired due to adhesion of dirt or obstruction to the sensor.
- When a wheel slips.

- When the radar signal is temporarily interrupted.
- When the shift control system is not in the D (Drive) position.

Vehicle-to-vehicle distance control mode limitations

WARNING

Listed below are the system limitations for the ICC system. Failure to operate the vehicle in accordance with these system limitations could result in serious injury or death.

- The system is primarily intended for use on straight, dry, open roads with light traffic. It is not advisable to use the system in city traffic or congested areas.
- This system will not adapt automatically to road conditions. This system should be used in evenly flowing traffic. Do not use the system on roads with sharp curves, or on icy roads, in heavy rain or in fog.
- As there is a performance limit to the distance control function, never rely solely on the ICC system. This system does not correct careless, inattentive or absent minded driving, or overcome poor visibility in rain, fog, or other bad weather. Decelerate the vehicle speed by depressing the brake pedal, depending on the distance to the vehicle ahead and the surrounding circumstances in order to maintain a safe distance between vehicles.
- Always pay attention to the operation of the vehicle and be ready to manually control the proper following distance. The vehicle-to-vehicle distance control mode of the ICC system

may not be able to maintain the selected distance between vehicles (following distance) or selected vehicle speed under some circumstances.

- The system may not detect the vehicle in front of you in certain road or weather conditions. To avoid accidents, never use the ICC system under the following conditions:
 - On roads where the traffic is heavy or there are sharp curves
 - On slippery road surfaces such as on ice or snow, etc.
 - During bad weather (rain, fog, snow, etc.)
 - When rain, snow or dirt adhere to the system sensor
 - On steep downhill roads (the vehicle may go beyond the set vehicle speed and frequent braking may result in overheating the brakes)
 - On repeated uphill and downhill roads
 - When traffic conditions make it difficult to keep a proper distance between vehicles because of frequent acceleration or deceleration
 - Interference by other radar sources
- In some road or traffic conditions, a vehicle or object can unexpectedly come into the sensor detection zone and cause automatic braking. You may need to control the distance from other vehicles using the accelerator pedal. Always stay alert and avoid using the ICC system when it is not recommended in this section.

- **Do not use the ICC system if you are towing a trailer. The system may not detect a vehicle ahead.**

The radar sensor will not detect the following objects:

- Stationary and slow moving vehicles
- Pedestrians or objects in the roadway
- Oncoming vehicles in the same lane
- Motorcycles and other vehicles travelling offset in the travel lane

The sensor generally detects the signals returned from the vehicle ahead. Therefore, if the sensor cannot detect the reflection from the vehicle ahead, the ICC system may not maintain the selected distance.

The following are some conditions in which the sensor cannot detect the signals:

- When snow or road spray from travelling vehicles reduces the sensor's visibility
- When excessively heavy baggage is loaded in the rear seat or the luggage compartment of your vehicle
- When your vehicle is towing a trailer, etc.

The ICC system is designed to automatically check the sensor's operation within the limitation of the system. When the sensor is covered with dirt or is obstructed, the system will automatically be cancelled. If the sensor is covered with ice, a transparent or translucent vinyl bag, etc., the ICC system may not detect them. In these instances, the vehicle-to-vehicle distance control mode may not cancel and may not be able to maintain the selected following distance from the vehicle ahead. Be sure to check and clean the sensor regularly.

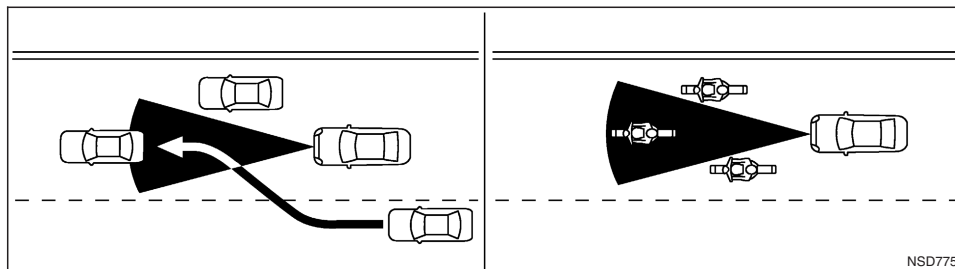

The detection zone of the radar sensor is limited. A vehicle ahead must be in the detection zone for the vehicle-to-vehicle distance detection mode to maintain the selected distance from the vehicle ahead.

A vehicle ahead may move outside of the detection zone due to its position within the same lane of travel. Motorcycles may not be detected in the same lane ahead.

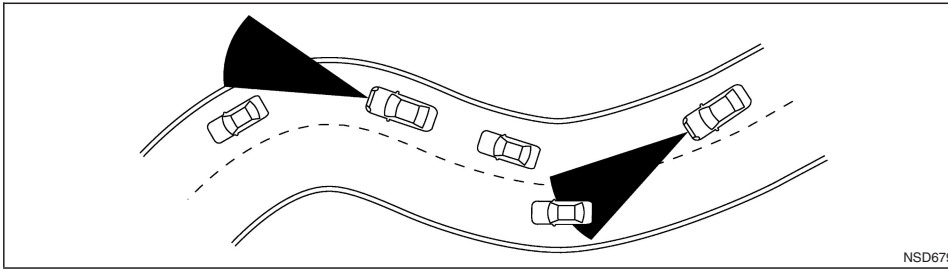

When driving on some roads, such as winding, hilly, curved, narrow roads, or roads which are under construction, the radar sensor may detect vehicles in a different lane, or may temporarily not detect a vehicle travelling ahead. This may cause the ICC system to decelerate or accelerate the vehicle.

The detection of vehicles may also be affected by vehicle operation (steering manoeuvre or travelling position in the lane, etc.) or vehicle condition.

System temporarily unavailable

The following are conditions in which the ICC system may be temporarily unavailable. In these instances, the ICC system may not cancel and may not be able to maintain the selected following distance from the vehicle ahead.

Condition A:

Under the following conditions, the ICC system is automatically cancelled. A chime will sound and the system will not be able to be set:

- When the ESP is turned off

- When the ESP (including the traction control system) operates
- When the vehicle speed falls below approximately 30 km/h (20 MPH)
- When the parking brake is applied
- When a tyre slips
- When the radar signal is temporarily interrupted
- When the shift control system is not in the D (Drive) position.
- When any door is open.
- When the front radar is impaired due to dirt or another obstruction blocking the radar sensor.

Action to take:

When the conditions listed above are no longer present, press the <RES+> switch to resume using the ICC system.

Condition B:

The chime will sound and the [Temporarily Disabled Front Radar Blocked] warning message will appear in the vehicle information display.

- When the radar sensor area is covered with dirt or is obstructed, making it impossible to detect a vehicle ahead, the ICC system is automatically cancelled.

Action to take:

If the warning message appears, park the vehicle in a safe place and turn the e-POWER system off. When the radar signal is temporarily interrupted, clean the sensor area and restart the e-POWER system. The system will need some time to detect that the sensor area is now clean. If the warning message continues to be displayed, have the ICC system checked by a NISSAN dealer or qualified workshop.

- When driving on roads with limited road structures or buildings (for example, long bridges, deserts, snow fields, driving next to long walls), the system may display the [Temporarily Disabled Front Radar Blocked] message.

Action to take:

When the conditions listed above are no longer present, turn the ICC system back on to use the system.

ICC system malfunction

If the ICC system malfunctions, it will be turned off automatically, a chime will sound, a warning will be displayed in the vehicle information display, and the speed control status warning (yellow) will illuminate.

Action to take:

If the warning light comes on, stop the vehicle in a safe place. Turn the e-POWER system off, restart the e-POWER system and set the ICC system again. If it is not possible to set the ICC system or the indicator stays on, it may be a malfunction. Although the normal driving can be continued, the ICC system should be checked by a NISSAN dealer or qualified workshop.

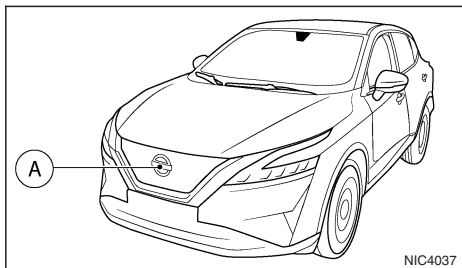

System maintenance

The sensor for the ICC system is located on the front of the vehicle (A).

To keep the ICC system operating properly, be sure to observe the following:

- Always keep the sensor area clean.

- Do not strike or damage the areas around the sensor.
- Do not cover or attach stickers or similar objects near the sensor area. This could cause failure or malfunction.
- Do not attach metallic objects near the sensor area (brush guard, etc.). This could cause failure or malfunction.

Speed Limit Link - ICC (where fitted)

⚠ WARNING

Listed below are the system limitations for the Speed Limit Link. Failure to operate the vehicle in accordance with these system limitations could result in serious injury or death:

- It is the driver's responsibility to select the proper speed, follow all traffic regulations and observe other road users.
- The Speed Limit Link may not operate properly and the actual speed limit may not be applied to the vehicle set speed in all conditions. The driver must manually control the vehicle speed.

Below are some examples:

- When the Traffic Sign Recognition (TSR) system is not functioning properly or turned off. (See "Traffic sign recognition (where fitted)" earlier in this section.)
- When driving in an area with nearby parallel roads (for example, motorway with a parallel service drive).
- When driving in an area where each lane has a different speed limit sign.

- When driving on a road under construction or in a construction zone.
- When End of speed limit sign is indicated.
- When speed unit selected in [Display Settings] is different to the unit of the speed limit sign.

When ICC is active and it detects a change of the speed limit, the new speed limit is indicated and it can be applied to the vehicle set speed manually.

The Speed Limit Link operates:

- When the detected speed limit is 30 km/h (20 MPH) and above.
- The [Speed Limit Link] is enabled in the settings menu of the vehicle information display.

NOTE

- In the following situations, the Speed Limit Link will not operate:
 - When an increase in the posted speed limit is detected, but the vehicle set speed is already faster than the new speed limit.
 - When a decrease in the posted speed limit is detected, but the vehicle set speed is already lower than the new speed limit.

System display and indicators:

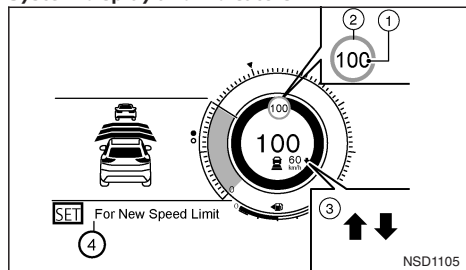

Example

1. Detected speed limit indicator

Displays the currently detected speed limit. For additional information, see "Traffic sign recognition (where fitted)" earlier in this section.

2. Applied speed limit indicator (green frame)

Indicates the detected speed limit can be applied to the vehicle set speed.

3. Speed Limit Link indicator

Indicates the system activation mode or system operation.

↑ Manual mode is activated and a new speed limit (faster speed value) is indicated.

↓ Manual mode is activated and a new speed limit (lower speed value) is indicated.

4. Guidance message, instruction on how to set new speed.

Operating the system:

When the system detects a different speed limit, the new speed value is indicated. The vehicle set speed can be changed to the indicated speed limit manually.

- To accept the newly indicated speed limit, operate the <RES+> switch (in case of speed limit up) or <SET-> switch (in case of speed limit down).
- The Speed Limit Link indicator (↑ or ↓) will turn off after approximately 15 seconds if the <RES+> or <SET-> switch is not operated. (The Speed Limit Link indicator can be turned off immediately by operating the opposite switch from the direction indicated by the Speed Limit Link indicator.)

The system will not activate if a speed limit change is not detected.

[Speed Link Offset]:

It is possible to set whether the speed limit should be accepted exactly, or with a tolerance of -10 km/h (-5 MPH) to +10 km/h (+5 MPH).

How to activate or deactivate the system:

1. Push the ◀ ▶ button on the steering wheel until [Settings] appears in the vehicle information display, and push the scroll dial.
2. Use the scroll dial to select [Driver Assistance]. Then push the scroll dial.
3. Select [Speed Limit Link], and push the scroll dial to turn the system on or off.

To deactivate the system, select [OFF].

NOTE

The system will retain current settings in the vehicle information display even if the e-POWER system is restarted.

How to set tolerance for [Speed Link Offset]:

1. Push the ◀ ▶ button on the steering wheel until [Settings] appears in the vehicle information display, and push the scroll dial.
2. Use the scroll dial to select [Driver Assistance]. Then push the scroll dial.
3. Select [Speed Link Offset], and push the scroll dial to select tolerance value.

NOTE

The system will retain current settings in the vehicle information display even if the e-POWER system is restarted.

Speed Limit Link - ICC with Navigation system (where fitted)

⚠ WARNING

Listed below are the system limitations for the Speed Limit Link. Failure to operate the vehicle in accordance with these system limitations could result in serious injury or death:

- It is the driver's responsibility to select the proper speed, follow all traffic regulations and observe other road users.
- The Speed Limit Link may not operate properly and the actual speed limit may not be applied to the vehicle set speed in all conditions. The driver must manually control the vehicle speed.

Below are some examples:

- When the Traffic Sign Recognition (TSR) system is not functioning properly or turned off. (See "Traffic sign recognition (where fitted)" earlier in this section.)
- When driving in countries or areas not covered by the navigation system.
- When crossing national boundaries.
- When driving on the exit of the limited access motorway as identified in the navigation map data.
- When driving in an area with nearby parallel roads (for example, motorway with a parallel service drive).
- When driving in an area where each lane has a different speed limit sign.

- When driving on a road under construction or in a construction zone.
- When the data from the navigation system is not up-to-date or is unavailable.

When the ICC Speed Limit Link is active and it detects a change of the speed limit, the new speed limit is indicated and it can be applied to the vehicle set speed manually.

The Speed Limit Link operates:

- When the detected speed limit is 30 km/h (20 MPH) and above.
- The [Speed Limit Link] is enabled in the settings menu of the vehicle information display.

NOTE

- In the following situations, the Speed Limit Link will not operate:

- When an increase in the posted speed limit is detected, but the vehicle set speed is already faster than the new speed limit.
- When a decrease in the posted speed limit is detected, but the vehicle set speed is already lower than the new speed limit.

For Germany: No Limit speed setting:

When you switch on the e-POWER system and subsequently enter a motorway with no speed limit, the system initially regulates the speed to 130 km/h. After this, the last speed stored by the driver on a motorway with no speed limit is applied.

NOTE

This feature only works in Germany.

System display and indicators:

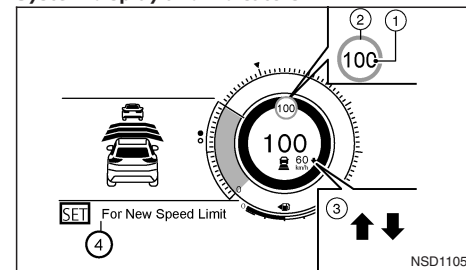



Example

1. Detected speed limit indicator
Displays the currently detected speed limit. For additional information, see "Traffic sign recognition (where fitted)" earlier in this section.
2. Applied speed limit indicator (green frame)
Indicates the detected speed limit can be applied to the vehicle set speed.
3. Speed Limit Link indicator
Indicates the system activation mode or system operation.
 - ↑ Manual mode is activated and a new speed limit (faster speed value) is indicated.
 - ↓ Manual mode is activated and a new speed limit (lower speed value) is indicated.
4. Guidance message, instruction on how to set new speed.

Operating the system:

When the system detects a different speed limit, the new speed value is indicated. The vehicle set speed can be changed to the indicated speed limit manually.



- To accept the newly indicated speed limit, operate the <RES+> switch (in case of speed limit up) or <SET-> switch (in case of speed limit down).
- The Speed Limit Link indicator ( or ) will turn off after approximately 15 seconds if the <RES+> or <SET-> switch is not operated. (The Speed Limit Link indicator can be turned off immediately by operating the opposite switch from the direction indicated by the Speed Limit Link indicator.)

The system will not activate if a speed limit change is not detected.

[Speed Link Offset]:

It is possible to set whether the speed limit should be accepted exactly, or with a tolerance of -10 km/h (-5 MPH) to +10 km/h (+5 MPH)

How to activate or deactivate the system:



1. Push the   button on the steering wheel until [Settings] appears in the vehicle information display, and push the scroll dial.
2. Use the scroll dial to select [Driver Assistance]. Then push the scroll dial.
3. Select [Speed Limit Link], and push the scroll dial to turn the system on or off.

To deactivate the system, select [OFF].

NOTE

The system will retain current settings in the vehicle information display even if the e-POWER system is restarted.

How to set tolerance for [Speed Link Offset]:

1. Push the   button on the steering wheel until [Settings] appears in the vehicle information display, and push the scroll dial.
2. Use the scroll dial to select [Driver Assistance]. Then push the scroll dial.
3. Select [Speed Link Offset], and push the scroll dial to select tolerance value.

NOTE

The system will retain current settings in the vehicle information display even if the e-POWER system is restarted.

CONVENTIONAL (fixed speed) CRUISE CONTROL MODE

This mode allows driving at speeds between approximately 30 and 170 km/h (20 and 105 MPH) without keeping your foot on the accelerator pedal.

WARNING

- In the conventional (fixed speed) cruise control mode, a warning chime does not sound to warn you if you are too close to the vehicle ahead, as neither the presence of the vehicle ahead nor the vehicle-to-vehicle distance is detected.
- Pay special attention to the distance between your vehicle and the vehicle ahead of you or a collision could occur.
- Always confirm the setting in the Vehicle Information Display.
- Do not use the conventional (fixed speed) cruise control mode when driving under the following conditions:
 - when it is not possible to keep the vehicle at a set speed
 - in heavy traffic or in traffic that varies in speed
 - on winding or hilly roads
 - on slippery roads (rain, snow, ice, etc.)
 - in very windy areas
- Doing so could cause a loss of vehicle control and result in an accident.

CONVENTIONAL (FIXED SPEED) CRUISE CONTROL SWITCHES

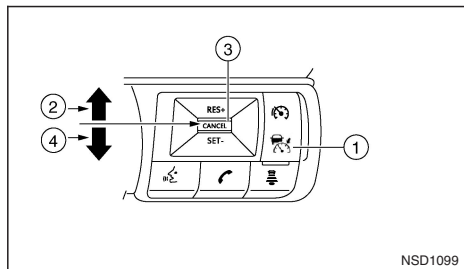

① ICC ON/OFF switch:

Main switch to activate/deactivate the system.

② <RES+> switch:

Resumes set speed or increases speed incrementally.

③ <CANCEL> switch:

Deactivates the system without erasing the set speed.

④ <SET-> switch:

Sets desired cruise speed, reduces speed incrementally.

Conventional (fixed speed) cruise control mode display and indicators

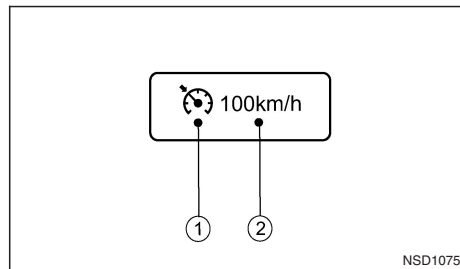

The display is located in the vehicle information display.

1. Cruise indicator:

This indicator indicates the condition of the Conventional (fixed speed) cruise control mode of the ICC system depending on a colour.

- Cruise control ON indicator (grey): Indicates that the ICC ON/OFF switch is on.
- Cruise control SET indicator (green): Indicates that the cruising speed is set.
- Cruise control warning (yellow): Indicates that there is a malfunction in the Conventional (fixed speed) cruise control mode of the ICC system.

2. Set vehicle speed indicator:

This indicator indicates the set vehicle speed.

- Grey: cruise control standby
- Green: cruise control active

Operating conventional (fixed speed) cruise control mode

To turn the conventional (fixed speed) cruise control mode on, push and hold the ICC ON/OFF switch for longer than about 1.5 seconds.

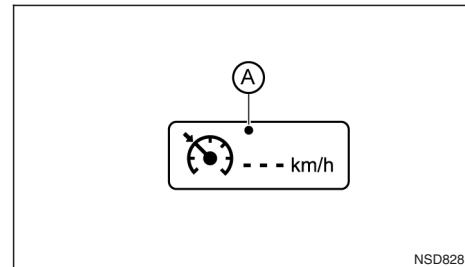

When pushing the ICC ON/OFF switch on, the conventional (fixed speed) cruise control mode display and indicators are displayed in the vehicle information display. After you hold the ICC ON/OFF switch for longer than about 1.5 seconds, the ICC system display goes out. The cruise indicator appears. You can now set your desired cruising speed. Pushing the ICC ON/OFF switch again will turn the system completely off.

When the power switch is placed in the **OFF** position, the system is also automatically turned off.

To use the ICC system again, quickly push and release the ICC ON/OFF switch (vehicle-to-vehicle distance control mode) or push and hold it (conventional cruise control mode) again to turn it on.

CAUTION

To avoid accidentally engaging cruise control, make sure to turn the ICC ON/OFF switch off when not using the ICC system.

To set cruising speed, accelerate your vehicle to the desired speed, push the <SET-> switch and release it. (The colour of the cruise indicator changes to green and the set vehicle speed indicator comes on.) Take your foot off the accelerator pedal. Your vehicle will maintain the set speed.

- **To overtake another vehicle**, depress the accelerator pedal. When you release the pedal, the vehicle will return to the previously set speed.
- The vehicle may not maintain the set speed when going up or down steep hills. If this happens, manually maintain vehicle speed.

To cancel the preset speed, use any of the following methods:

- Push the <CANCEL> switch. The vehicle speed indicator and the cruise indicator will turn grey.
- Tap the brake pedal. The vehicle speed indicator and the cruise indicator will turn grey.

To reset at a faster cruising speed, use one of the following three methods:

- Depress the accelerator pedal. When the vehicle attains the desired speed, push and release the <SET-> switch.
- Push and hold the <RES+> switch. When the vehicle displays the desired set speed, release the switch.
- Push, then quickly release the <RES+> switch. Each time you do this, the set speed will increase by about 1 km/h (1 MPH).

To reset at a slower cruising speed, use one of the following three methods:

- Lightly tap the brake pedal. When the vehicle attains the desired speed, push the <SET-> switch and release it.
- Push and hold the <SET-> switch. Release the switch when the vehicle slows down to the desired speed.
- Push, then quickly release the <SET-> switch. Each time you do this, the set speed will decrease by about 1 km/h (1 MPH).

To resume the preset speed, push and release the <RES+> switch. The vehicle will resume the last set cruising speed when the vehicle speed is over 30 km/h (20 MPH).

System temporarily unavailable

A chime sounds and the control is automatically cancelled under the following conditions:

- When the parking brake is applied.
- When the ESP (including the traction control system) operates.
- When a wheel slips.
- When the ESP system is off.

When the system is not operating properly, the chime sounds and the colour of the cruise indicator will change to yellow.

Action to take:

If the colour of the cruise indicator changes to yellow, park the vehicle in a safe place. Turn the e-POWER system off, restart the e-POWER system, resume driving and then perform the setting again.

If it is not possible to set or the indicator stays on, it may indicate that the system is malfunctioning. Although the vehicle is still driveable under normal conditions, have the vehicle checked by a NISSAN dealer or qualified workshop.

PROPILOT ASSIST (where fitted)

⚠ WARNING

Failure to follow the warnings and instructions for proper use of the ProPILOT Assist system could result in serious injury or death.

- ProPILOT Assist is not a self-driving system. Within the limits of its capabilities, as described in this manual, it helps the driver with certain driving activities.
- The ProPILOT Assist system is not a replacement for proper driving procedure and is not designed to correct careless, inattentive or absent-minded-driving. ProPILOT Assist will not always steer the vehicle to keep it in the lane. The ProPILOT Assist system is not designed to prevent loss of control. It is the driver's responsibility to stay alert, drive safely, keep the vehicle in the travelling lane, and be in control of the vehicle at all times.
- There are limitations to the ProPILOT Assist system capability. The ProPILOT Assist system does not function in all driving, traffic, weather, and road conditions. It is the driver's responsibility to stay alert, drive safely, keep the vehicle in the travelling lane, and be in control of the vehicle at all times.
- The ProPILOT Assist system is only an aid to assist the driver and is not a collision warning or avoidance device.
- The ProPILOT Assist system is for use on motorways with opposing traffic separated by a barrier only, and is not intended for city driving.

- Always observe the posted speed limits and do not set the speed over them.
- Never take your hands off the steering wheel when driving. Always keep your hands on the steering wheel and drive your vehicle safely.
- The ProPILOT Assist system does not react to stationary or slow moving vehicles.
- Always drive carefully and attentively when using the ProPILOT Assist system. Read and understand the Owner's Manual thoroughly before using the ProPILOT Assist system. To avoid serious injury or death, do not rely on the system to prevent accidents or to control the vehicle's speed in emergency situations. Do not use the ProPILOT Assist system except in appropriate road and traffic conditions.

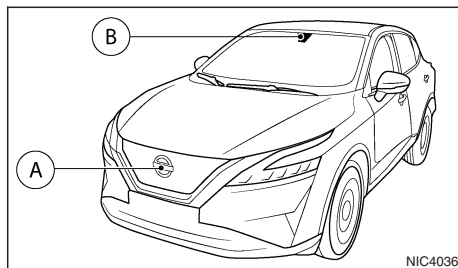

- Ⓐ Radar sensor
- Ⓑ Multi-sensing front camera

The ProPILOT Assist system is intended to enhance the operation of the vehicle when following a vehicle travelling in the same lane and direction.

The ProPILOT Assist system uses a multi-sensing front camera (B) installed behind the windscreen and a radar sensor located on the front of the vehicle (A) to measure the distance to the vehicle ahead in the same lane and to monitor the lane markers. If the vehicle detects a slower moving vehicle ahead, the system will reduce the vehicle speed so that your vehicle follows the vehicle in front at the selected distance. The system will also help keep the vehicle centred in the travelling lane when clear lane markings are detected.

PROPILOT ASSIST SYSTEM OPERATION

The ProPILOT Assist system has the following functions:

- **Intelligent Cruise Control (ICC)**
- **Steering Assist**

Intelligent Cruise Control (ICC) (vehicles with ProPILOT Assist)

The ICC system can be set to one of two cruise control modes:

- **Conventional (fixed speed) cruise control mode:**

Used for cruising at a preset speed.

NOTE

Steering assist is not available in the conventional (fixed speed) cruise control mode.

- **Vehicle-to-vehicle distance control mode:**

The ICC system maintains a selected distance from the vehicle in front of you within the speed range of 0 km/h (0 MPH) up to the set speed. The set speed can be selected by the driver above approximately 30 km/h (20 MPH). When the vehicle ahead slows to a stop, your vehicle gradually decelerates to a standstill. When the vehicle is stopped, the ICC system maintains braking force to keep your vehicle stationary.

NOTE

When your vehicle is stopped for less than approximately 3 seconds and the vehicle ahead begins to move, your vehicle will start moving again automatically. If your vehicle is stationary for more than approximately 3 minutes, the ICC system will be switched off and the electronic parking brake will be applied.

- When the vehicle ahead begins to move forward, push the <RES+> button on the steering wheel or lightly depress the accelerator pedal to release the brake. The ICC system will restart to maintain a selected distance from the vehicle in front of you.
- When stationary and no vehicle is detected ahead the ICC will not function. The accelerator should be used to control the vehicle speed.

NOTE

Even if the Intelligent Emergency Braking (IEB) setting is turned off by the driver using the [Settings] menu in the Vehicle Information Display, IEB will be turned on automatically when the ProPILOT Assist is used.

Steering Assist (vehicles with ProPILOT Assist)

The Steering Assist function controls the steering system to help keep your vehicle within the traveling lane.

Steering Assist is not available at speeds under 60 km/h (37 MPH) unless a vehicle is detected ahead.

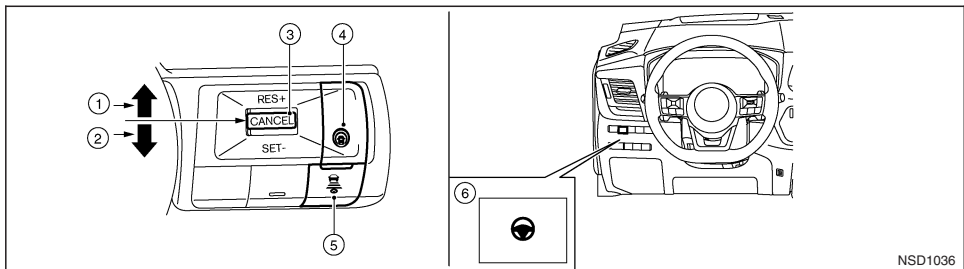

PROPILOT ASSIST SWITCHES

- 1) **<RES+>** switch
Resumes set speed or increases speed incrementally.
- 2) **<SET->** switch
Sets desired cruise speed or reduces speed incrementally
- 3) **<CANCEL>** switch
Deactivates the ICC system without erasing the set speed
- 4) ProPILOT Assist switch:
Turns ProPILOT Assist on or off
- 5) Distance switch
 - Long
 - Middle
 - Short
- 6) Steering Assist Switch
Turns the Steering Assist function on or off.

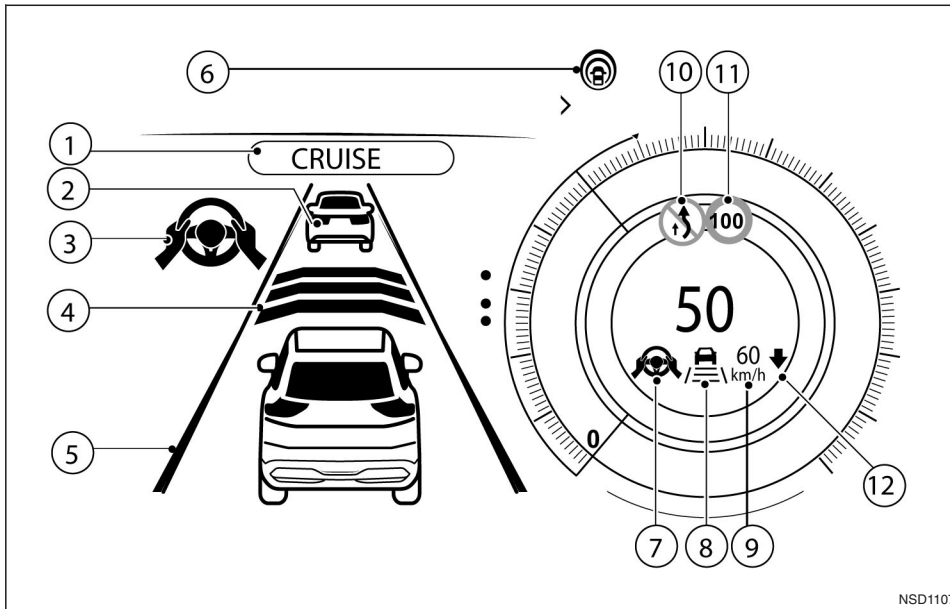

Example

PROPILOT ASSIST SYSTEM DISPLAY AND INDICATORS

1) ProPILOT Assist [CRUISE] indicator

Displays when ProPILOT Assist is activated.

2) Vehicle ahead detection indicator

When the ICC is ON and active this indicates whether the system detects a vehicle in front of you.

3) Steering Assist status indicator

Displays the status of the Steering Assist by the colour of the indicator

- Grey: Steering Assist standby.

- Green: Steering Assist active.

4) Set distance indicator

Displays the selected distance.

5) Lane marker indicator

Indicates whether the system detects lane markers

- No lane markers displayed: Steering Assist is turned off
- Lane marker indicator (grey): No lane markers detected
- Lane marker indicator (green): Lane markers detected
- Lane marker indicator (yellow): Lane departure is detected

6) ProPILOT Assist indicator

Displays the status of Intelligent Blind Spot Intervention, Intelligent Lane Intervention, Steering Assist and ICC systems.

- White: systems are on (only if they are turned on in the [Settings] menu), ICC is in standby mode.
- Blue: ICC is active

7) Steering Assist status indicator/warning

Displays the status of the Steering Assist by the colour of the indicator/warning

- No Steering Assist status indicator displayed: Steering Assist is turned off.
- Grey: Steering Assist standby.
- Green: Steering Assist active.
- Yellow: Steering Assist malfunction.

NSD1107

- Red: Hands off detected.

8) Lane marker indicator/speed control status indicator/set distance indicator

Displays the status of speed control by the colour and shape of the indicator/warning

- Speed control status indicator (white): ICC standby
- Speed control status indicator (green): ICC (distance control mode) is active
 - Green vehicle icon displayed: Vehicle detected ahead
 - No vehicle icon shown: No vehicle detected ahead (Your vehicle maintains the driver-selected set speed.)
- Speed control status indicator (orange): Indicates an ICC malfunction
- Lane marker indicator: Indicates whether the system detects lane markers
 - No lane markers displayed: Steering Assist is turned off
 - Lane marker indicator (grey): No lane markers detected
 - Lane marker indicator (green): Lane markers detected

9) Set vehicle speed indicator

Indicates the set vehicle speed.

- Grey: ICC standby.
- Green numbers: ICC active.

10) Road information indicator (where fitted)

11) Detected road sign (speed limit) indicator (where fitted)

12) Speed limit link indicator (where fitted)

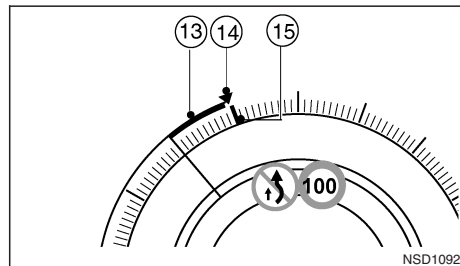

13) Green line: Intelligent Cruise Control (ICC) (where fitted): gap between current speed and ICC target speed.

14) Target speed:

- White triangle: Cruise Control or Speed Limiter target speed (where fitted).
- Green triangle: Intelligent Cruise Control (ICC) target speed (where fitted).

15) Red line: Traffic Sign Recognition (TSR) speed limit marker (where fitted)

NOTE

Some of the items listed above are only available in Classic View. See "Changing the meter screen view (models with full-screen display)" in the "2. Instruments and controls" section for additional information.

TURNING THE PROPILOT ASSIST CONVENTIONAL (FIXED SPEED) CRUISE CONTROL MODE ON

NOTE

ProPILOT Assist provides no approach warnings, automatic braking, or steering assist in the conventional (fixed speed) cruise control mode.

To select the conventional (fixed speed) cruise control mode, push and hold the ProPILOT Assist switch for longer than approximately 1.5 seconds. For additional information, refer to "ProPILOT Assist Conventional (fixed speed) Cruise Control Mode" later in this section.

OPERATING THE PROPILOT ASSIST SYSTEM

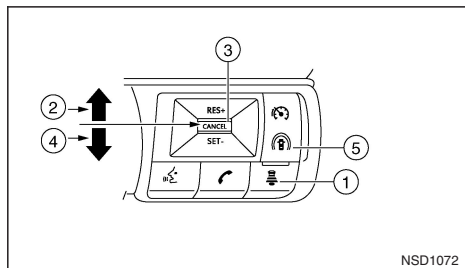

- 1) Distance switch:
Changes the vehicle's following distance:
Long → Middle → Short → Long
- 2) <RES+> switch:
Resumes set speed or increases speed incrementally.
- 3) <CANCEL> switch:
Deactivates the system without erasing the set speed.
- 4) <SET-> switch:
Sets desired cruise speed, reduces speed incrementally.
- 5) ProPILOT Assist switch:
Master switch to activate the system.

1. Push the ProPILOT Assist switch (5). This turns on the ProPILOT Assist system and displays the status of the ProPILOT Assist system on the Vehicle Information Display.
2. Accelerate or decelerate your vehicle to the desired speed.
3. Push the <SET-> switch. The ProPILOT Assist system begins to automatically maintain the set speed. The ProPILOT Assist activation indicator and ProPILOT Assist status indicators illuminate (blue), speed control status indicator and set speed illuminate green.
4. When a vehicle ahead is travelling at a speed of 30 km/h (20 MPH) or below and the <SET-> switch is pushed, the set speed of your vehicle is 30 km/h (20 MPH).

NOTE

Turning the ProPILOT Assist system on will turn on the Intelligent Lane Intervention (ILI) system and Intelligent Blind Spot Intervention system at the same time, providing those systems are enabled in the [Driver Assistance] menu in the vehicle information display. For additional information, refer to "ProPILOT Assist Intelligent Lane Intervention system" later in this section and "Blind Spot Warning (BSW) system/Intelligent Blind Spot Intervention system (where fitted)" earlier in this section.

When the <SET-> switch is pushed under the following conditions, the ProPILOT Assist system cannot be set and the set vehicle speed indicators blink for approximately 2 seconds:

- When travelling below 30 km/h (20 MPH) and the vehicle ahead is not detected

- When the shift control system is not in the D (Drive) position
- When the parking brake is applied
- When the brakes are operated by the driver
- When the ESP system is off. For additional information about the ESP system, see "Electronic Stability Programme (ESP) system" later in this section.
- When ESP (including the traction control system) is operating.
- When a wheel is slipping
- When any door is open
- When the driver's seat belt is not fastened
- When Intelligent Parking Assist (IPA) (where fitted) is activated.

How to change the set vehicle speed

The set vehicle speed can be adjusted.

To change to a faster cruising speed:

- Push and hold the <RES+> switch. The set vehicle speed increases by 10 km/h (5 MPH) increments.
- Push, then quickly release, the <RES+> switch. Each time you do this, the set speed increases by 1 km/h (1 MPH).

To change to a slower cruising speed:

- Push and hold the <SET-> switch. The set vehicle speed decreases by 10 km/h (5 MPH) increments.
- Push, then quickly release, the <SET-> switch. Each time you do this, the set speed decreases by 1 km/h (1 MPH).

How to momentarily accelerate or decelerate

- Depress the accelerator pedal when acceleration is required. Release the accelerator pedal to resume the previously set vehicle speed.
- Depress the brake pedal when deceleration is required. Control by the ProPILOT Assist system is cancelled. Push the <RES+> switch to resume the previously set vehicle speed.

⚠ WARNING

When the accelerator pedal is depressed and you are approaching the vehicle ahead, the ICC system will neither control the brake nor warn the driver with the chime and display. The driver must manually control the vehicle speed to maintain a safe distance to the vehicle ahead. Failure to do so could result in severe personal injury or death.



NOTE

When you accelerate by depressing the accelerator pedal or decelerate by pushing the <SET-> switch and the vehicle travels faster than the speed set by the driver, the set speed vehicle indicator will blink.

How to change the set distance to the vehicle ahead

The distance to the vehicle ahead can be selected when the ICC is in standby mode or the ICC is active, depending on the traffic conditions.

Each time the DISTANCE switch () is pushed, the set distance will change from long to middle, short and back to long again in that sequence.

Distance	Display	Approximate distance at 100 km/h (60 MPH) (m (ft))
Long		60 (200)
Middle		45 (150)
Short		30 (100)

The distance to the vehicle ahead changes automatically according to the vehicle speed. As the vehicle speed increases so does the distance.

The distance setting will remain at the current setting even if the e-POWER system is restarted.

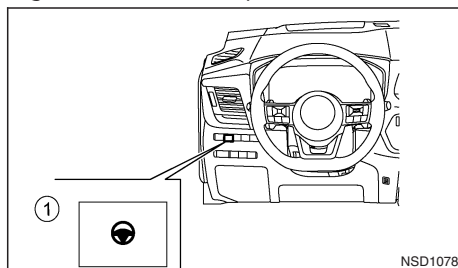

Steering Assist Activation/Deactivation

Use the following methods to enable or disable the Steering Assist.

Steering Assist switch:

To turn the Steering Assist ON or OFF, push the Steering Assist switch ① on the instrument panel.

NOTE

- **When the Steering Assist switch is used to turn the system ON or OFF, the system remembers the setting between power cycles. The switch must be pushed again to change the setting to ON or OFF.**
- **The Steering Assist switch changes the status of the [Steering Assist] selection made in the [Settings] screen in the Vehicle Information Display.**

Setting in the Vehicle Information Display:

1. Press the ◀ or ▶ buttons on the steering wheel until the [Settings] menu is displayed in the Vehicle Information Display and press the scroll dial.
2. Use the scroll dial to highlight [Driver Assistance] and then push the scroll dial.
3. Select [Steering Assist] and push the scroll dial to turn Steering Assist system on or off.
If the indicator is displayed, the system is ON.

NOTE

- **When the ProPILOT Assist screen is displayed on the Vehicle Information Display, press the <OK> button on the steering wheel to show the [Driver Assistance] setting menu.**
- **When enabling/disabling the system through the Vehicle Information Display or when pressing the Steering Assist switch, the system retains the current settings even if the system is restarted.**

Cancelling the ProPILOT Assist system

To cancel the ProPILOT Assist system, use one of the following methods:

- Press the **<CANCEL>** switch on the steering wheel.
- Tap or depress the brake pedal (except when the vehicle is stationary).
- To turn the ProPILOT Assist system off completely, press the ProPILOT Assist switch on the steering wheel, the ProPILOT Assist indicator will turn OFF.

When the ProPILOT Assist system is switched off while the vehicle is stopped, the electronic parking brake is automatically activated.

WARNING

When you leave the vehicle, make sure to push the ProPILOT Assist switch to turn the system OFF, Press the P position switch to shift to the P (Park) position, and turn the e-POWER system OFF.

PROPILOT ASSIST INTELLIGENT CRUISE CONTROL (ICC) SYSTEM

WARNING

Failure to follow the warnings and instructions for proper use of the ICC system could result in serious injury or death.

- The ICC system is only an aid to assist the driver and is not a collision warning or avoidance device. It is for highway use only and it is not intended for congested areas or city driv-

ing. It is the driver's responsibility to stay alert, drive safely, and be in control of the vehicle at all times.

- **There are limitations to the ICC system capability. The ICC system does not function in all driving, traffic, weather, and road conditions. It is the driver's responsibility to stay alert, drive safely, keep the vehicle in the travelling lane, and be in control of the vehicle at all times.**
- **Always observe posted speed limits and do not set the speed over them.**
- **The ICC system does not react to stationary or slow moving vehicles.**
- **Always drive carefully and attentively when using the ICC system. Read and understand the Owner's Manual thoroughly before using the ICC system. To avoid serious injury or death, do not rely on the system to prevent accidents or to control the vehicle's speed in emergency situations. Do not use the ICC system except in appropriate road and traffic conditions.**
- **In the conventional (fixed speed) cruise control mode, a warning chime will not sound to warn you if you are too close to the vehicle ahead. Pay special attention to the distance between your vehicle and the vehicle ahead of you or a collision could occur.**

ProPILOT Assist ICC system operation

The vehicle-to-vehicle distance control mode is designed to maintain a selected distance and reduce the speed to match the slower vehicle ahead; the system will decelerate the vehicle as necessary and

if the vehicle ahead comes to a stop, the vehicle decelerates to a standstill. However, the ICC system can only apply up to approximately 40% of the vehicle's total braking power. This system should only be used when traffic conditions allow vehicle speeds to remain fairly constant or when vehicle speeds change gradually. If a vehicle moves into the travelling lane ahead or if a vehicle travelling ahead rapidly decelerates, the distance between vehicles may become closer because the ICC system cannot decelerate the vehicle quickly enough. If this occurs, the ICC system will sound a warning chime and blink the system display to notify the driver to take necessary action.

The ICC system cancels and a warning chime sounds if the speed is below approximately 30 km/h (20 MPH) and a vehicle is not detected ahead. The ICC system cancels and a warning chime sounds if your vehicle is at a standstill for more than approximately 3 seconds and a vehicle is not detected ahead.

The ICC system operates as follows:

- When there are no vehicles travelling ahead, the ICC system maintains the speed set by the driver. The set speed range is above approximately 30 km/h (20 MPH).
- When there is a vehicle travelling ahead, the ICC system adjusts the speed to maintain the distance, selected by the driver, from the vehicle ahead. If the vehicle ahead comes to a stop, the vehicle decelerates to a standstill. Once your vehicle stops, the ICC system keeps the vehicle stopped.

- When your vehicle is at a standstill for more than 3 seconds and the vehicle ahead begins to accelerate, push the <RES+> switch or lightly depress the accelerator pedal. The ICC system starts to follow the vehicle ahead. If your vehicle is stationary for more than approximately 3 minutes, the ICC system will be switched off and the electronic parking brake will be applied.
- When the vehicle travelling ahead moves to a different travelling lane, while the vehicle speed is above 30 km/h (20 MPH), the ICC system accelerates and maintains vehicle speed up to the set speed.
- When the vehicle travelling ahead moves to a different travelling lane, while the vehicle speed is below 30 km/h (20 MPH), the ICC system cancels and a warning chime sounds.

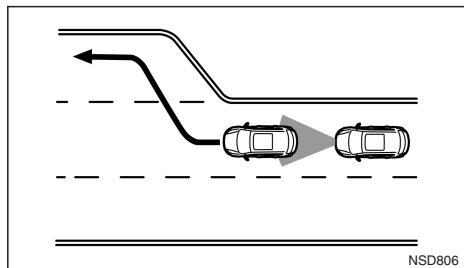

NOTE

The ICC system does not control vehicle speed or warn you when you approach stationary and slow

moving vehicles. You must pay attention to vehicle operation to maintain proper distance from vehicles ahead when approaching toll gates or traffic congestion.

When driving on the motorway at a set speed and approaching a slower travelling vehicle ahead, the ICC system adjusts the speed to maintain the distance, selected by the driver, from the vehicle ahead. If the vehicle ahead changes lanes or exits the motorway, the ICC system accelerates and maintains the speed up to the set speed. Pay attention to the driving operation to maintain control of the vehicle as it accelerates to the set speed.

The vehicle may not maintain the set speed on winding or hilly roads. If this occurs, you will have to manually control the vehicle speed.

Normally when controlling the distance to a vehicle ahead, the system automatically accelerates or decelerates your vehicle according to the speed of the vehicle ahead.

Depress the accelerator to properly accelerate your vehicle when acceleration is required for a lane change. Depress the brake pedal when deceleration is required to maintain a safe distance to the vehicle ahead due to sudden braking or if a vehicle cuts in. Always stay alert when using the ICC system.

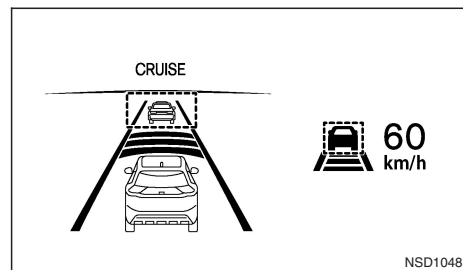

System set display with vehicle ahead

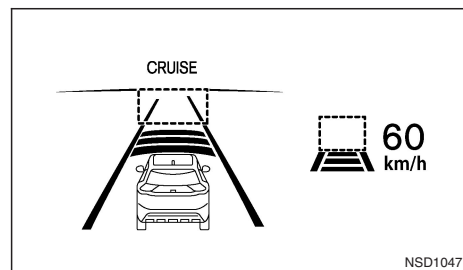

System set display without vehicle ahead

No vehicle detected ahead

The driver sets the desired vehicle speed based on the road conditions. The ICC system maintains the set vehicle speed, similar to standard cruise control, as long as no vehicle is detected in the lane ahead. The ICC system displays the set speed.

Vehicle detected ahead

When a vehicle is detected in the lane ahead, the ICC system decelerates the vehicle by controlling the throttle and applying the brakes to match the speed of a slower vehicle ahead. The ICC system then controls the vehicle speed based on the speed of the vehicle ahead to maintain the driver selected distance.

NOTE

- **The brake lights of the vehicle come on when braking is performed by the ICC system.**
- **When the brake is applied by the system, a noise may be heard. This is not a malfunction.**

When the ICC system detects a vehicle ahead, the vehicle ahead detection indicator is displayed and the speed control status indicator (vehicle icon) illuminates in green.

Vehicle ahead stops

When the vehicle ahead decelerates to stop, your vehicle decelerates to a standstill. Once your vehicle stops, the ICC system automatically applies the brakes to keep the vehicle stopped. When your vehicle is at a standstill, the [Press to Restart] message is displayed on the Vehicle Information Display.

NOTE

When your vehicle stops for less than 3 seconds, your vehicle will automatically follow the vehicle ahead as it accelerates from a stop. If your vehicle is stationary for more than approximately 3 minutes, the ICC system will be switched off and the electronic parking brake will be applied.

Vehicle ahead accelerates

When your vehicle is stopped and the vehicle ahead begins to accelerate, push the <RES+> switch or lightly depress the accelerator pedal. The ICC system starts to follow the vehicle ahead.

Vehicle ahead not detected

When a vehicle is no longer detected ahead, the ICC system gradually accelerates your vehicle to resume the previously set vehicle speed. The ICC system then maintains the set speed.

When a vehicle is no longer detected, the vehicle ahead detection indicator turns off and speed control status indicator (maintain speed control mode) turn off.

The ICC system gradually accelerates to the set speed, but you can depress the accelerator pedal to quickly accelerate. When a vehicle is no longer detected and your vehicle is travelling under approximately 30 km/h (20 MPH), the ICC system automatically cancels.

The ICC system cancels and a warning chime sounds if your vehicle is at a standstill for more than approximately 3 seconds and a vehicle is not detected ahead.

When overtaking another vehicle

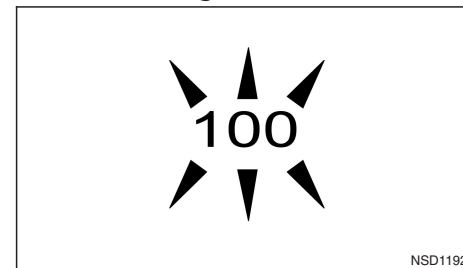

The driver can override ICC by pressing the accelerator. The set speed indicator will flash when the vehicle speed exceeds the set speed. The vehicle detection indicator will turn off when the area ahead of the vehicle is clear. When the pedal is released, the vehicle will return to the previously set speed.

Even though your vehicle speed is set in the ICC system, you can depress the accelerator pedal when it is necessary to accelerate your vehicle rapidly.

Approach warning

If your vehicle comes closer to the vehicle ahead due to rapid deceleration of that vehicle, the system warns the driver with the chime and ICC system display. Decelerate by depressing the brake pedal to maintain a safe vehicle distance if:

- The chime sounds.
- The vehicle ahead detection indicator blinks.

- You judge it necessary to maintain a safe distance.

The warning chime may not sound in some cases when there is a short distance between vehicles. Some examples are:

- When the vehicles are travelling at the same speed and the distance between vehicles is not changing.
- When the vehicle ahead is travelling faster and the distance between vehicles is increasing.
- When a vehicle cuts in near your vehicle.

The warning chime will not sound when:

- Your vehicle approaches other vehicles that are parked or moving slowly.
- The accelerator pedal is depressed, overriding the system.

NOTE

The approach warning chime may sound and the system display may flash when the radar sensor detects objects on the side of the vehicle or on the side of the road. This may cause the ICC system to decelerate or accelerate the vehicle. The radar sensor may detect these objects when the vehicle is driven on winding, narrow, or hilly roads or when the vehicle is entering or exiting a curve. In these cases, you will have to manually control the proper distance ahead of your vehicle.

Also, the sensor sensitivity can be affected by vehicle operation (steering manoeuvre or driving position in the lane) or traffic or vehicle conditions (for example, if a vehicle is being driven with some damage).

Acceleration when overtaking (where fitted)

NOTE

The acceleration when overtaking feature is only available for certain countries and for certain vehicle grades.

Overtaking on the left-hand side (for countries where traffic travels on the right hand side of the road):

When the ICC system is engaged above 70 km/h (44 MPH) and following a slower vehicle (below ICC set speed), and the turn signal is activated to the left, the ICC system will automatically start to accelerate the vehicle to help initiate overtaking on the left and will begin to reduce the distance to vehicle directly ahead. **Only the left side turn signal operates this feature.** As the driver steers the vehicle and moves into the overtaking lane, if no vehicle is detected ahead the ICC system will continue to accelerate to the ICC system set speed.

If another vehicle is detected ahead, then the vehicle will accelerate up to the following speed of that vehicle. If the vehicle is not steered into the left lane to overtake, the acceleration will stop after a short time and regain the set following distance.

Acceleration can be stopped at any point by depressing the brake pedal or the <CANCEL> switch on the steering wheel.

Overtaking on the right-hand side (for countries where traffic travels on the left hand side of the road):

When the ICC system is engaged above 70 km/h (44 MPH) and following a slower vehicle (below ICC

set speed), and the turn signal is activated to the right, the ICC system will automatically start to accelerate the vehicle to help initiate overtaking on the right and will begin to reduce the distance to vehicle directly ahead. **Only the right side turn signal operates this feature.** As the driver steers the vehicle and moves into the overtaking lane, if no vehicle is detected ahead the ICC system will continue to accelerate to the ICC system set speed.

If another vehicle is detected ahead, then the vehicle will accelerate up to the following speed of that vehicle. If the vehicle is not steered into the right lane to overtake, the acceleration will stop after a short time and regain the set following distance.

Acceleration can be stopped at any point by depressing the brake pedal or the <CANCEL> switch on the steering wheel



WARNING

In order to reduce the risk of a collision that may result in serious injury or death, please be aware of the following:

- **This function is only activated with the left or right turn signal and will briefly accelerate the vehicle even if a lane change is not initiated. This can include non-overtaking situations such as left or right side exits.**
- **Ensure that when overtaking another vehicle, the adjacent lane is clear before initiating the overtaking manoeuvre. Sudden changes in traffic may occur while overtaking. Always manually steer or brake as needed never solely rely on the system.**

Operating the system:

When the system detects a different speed limit, the new speed value is indicated. The vehicle set speed can be changed to the indicated speed limit manually.



- To accept the newly indicated speed limit, operate the <RES+> switch (in case of speed limit up) or <SET-> switch (in case of speed limit down).
- The Speed Limit Link indicator ( or ) will turn off after approximately 15 seconds if the <RES+> or <SET-> switch is not operated. (The Speed Limit Link indicator can be turned off immediately by operating the opposite switch from the direction indicated by the Speed Limit Link indicator.)

The system will not activate if a speed limit change is not detected.

[Speed Link Offset]:

It is possible to set whether the speed limit should be accepted exactly, or with a tolerance of -10 km/h (-5 MPH) to +10 km/h (+5 MPH).



How to activate or deactivate the system:

1. Push the   button on the steering wheel until [Settings] appears in the vehicle information display, and push the scroll dial.
2. Use the scroll dial to select [Driver Assistance]. Then push the scroll dial.
3. Select [Speed Limit Link], and push the scroll dial to turn the system on or off.

NOTE

The system will retain current settings in the vehicle information display even if the e-POWER system is restarted.

How to set tolerance for [Speed Link Offset]:

1. Push the   button on the steering wheel until [Settings] appears in the vehicle information display, and push the scroll dial.
2. Use the scroll dial to select [Driver Assistance]. Then push the scroll dial.
3. Select [Speed Link Offset], and push the scroll dial to select tolerance value.

NOTE

The system will retain current settings in the vehicle information display even if the e-POWER system is restarted.

Speed Limit Link - ProPILOT Assist with Navi Link (where fitted)

WARNING

Listed below are the system limitations for the Speed Limit Link. Failure to operate the vehicle in accordance with these system limitations could result in serious injury or death:

- It is the driver's responsibility to select the proper speed, follow all traffic regulations and observe other road users.

- The Speed Limit Link may not operate properly and the actual speed limit may not be applied to the vehicle set speed in all conditions. The driver must manually control the vehicle speed.

Below are some examples:

- When the Traffic Sign Recognition (TSR) system is not functioning properly or turned off. (See "Traffic sign recognition (where fitted)" earlier in this section.)
- When driving in countries or areas not covered by the navigation system.
- When crossing national boundaries.
- When driving on the exit of the limited access motorway as identified in the navigation map data.
- When driving in an area with nearby parallel roads (for example, motorway with a parallel service drive).
- When driving in an area where each lane has a different speed limit sign.
- When driving on a road under construction or in a construction zone.
- When the data from the navigation system is not up-to-date or is unavailable.

When the ProPILOT Assist with Navi Link is active and it detects a change of the speed limit, the new speed limit is indicated and it can be applied to the vehicle set speed automatically or manually.

The Speed Limit Link operates:

- When the detected speed limit is 30 km/h (20 MPH) and above.
- The [Speed Limit Link] is enabled in the settings menu of the vehicle information display.

NOTE

- **While the accelerator pedal is operated with AUTO mode selected, the Speed Limit Link will function (automatically adjust the vehicle set speed) only when the detected speed limit is faster than the vehicle set speed.**
- **In the following situations, the Speed Limit Link will not operate:**
 - **When an increase in the posted speed limit is detected, but the vehicle set speed is already faster than the new speed limit.**
 - **When a decrease in the posted speed limit is detected, but the vehicle set speed is already lower than the new speed limit.**

For Germany: No Limit speed setting:

When you switch on the e-POWER system and subsequently enter a motorway with no speed limit, the system initially regulates the speed to 130 km/h. After this, the last speed stored by the driver on a motorway with no speed limit is applied.

NOTE

This feature only works in Germany.

System display and indicators:

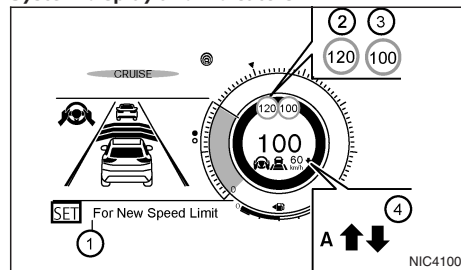

Example

1. Guidance message, instruction on how to set new speed.
2. Detected speed limit indicator (left side)
Displays detected impending or anticipated speed limit. The impending or anticipated speed limit will only be indicated when a new speed limit (lower speed value) is detected in manual mode.
Detected speed limit indicator (right side)
Displays the currently detected speed limit. For additional information, see "Traffic sign recognition (where fitted)" earlier in this section.
3. Applied speed limit indicator (green frame)
Indicates the detected speed limit can be applied to the vehicle set speed.
4. Speed Limit Link indicator
Indicates the system activation mode or system operation.
 - ↑ Manual mode is activated and a new speed limit (faster speed value) is indicated.
 - ↓ Manual mode is activated and a new speed limit (lower speed value) is indicated.
 - "A": Auto mode is activated.

↓ Manual mode is activated and a new speed limit (lower speed value) is indicated.

"A": Auto mode is activated.

Operating the system:

When the system detects a different speed limit, the new speed value is indicated. The vehicle set speed can be changed to the indicated speed limit automatically or manually.

When Manual mode is selected on settings menu (factory default setting):

- To accept the newly indicated speed limit, operate the <RES+> switch (in case of speed limit up) or <SET-> switch (in case of speed limit down).
- The Speed Limit Link indicator (↑ or ↓) will turn off after approximately 15 seconds if the <RES+> or <SET-> switch is not operated. (The Speed Limit Link indicator can be turned off immediately by operating the opposite switch from the direction indicated by the Speed Limit Link indicator.)

The system will not activate if a speed limit change is not detected.

When Auto mode is selected on the settings menu:

- The indicated speed limit is applied to the vehicle set speed automatically when on a limited access motorway as identified in the navigation map data. Also, if the ProPILOT Assist with Navi Link system is ON, but not set (active), and a new speed limit is detected, the vehicle set speed is automatically updated.

- The Auto mode may not be available in some regions or on roads other than limited access motorways. In this case, the system operates as the Manual mode.

[Speed Link Offset]:

It is possible to set whether the speed limit should be accepted exactly, or with a tolerance of -10 km/h (-5 MPH) to +10 km/h (+5 MPH).

How to activate or deactivate the system:

1. Push the ◀ ▶ button on the steering wheel until [Settings] appears in the vehicle information display, and push the scroll dial.
2. Use the scroll dial to select [Driver Assistance]. Then push the scroll dial.
3. Select [Speed Limit Link], and push the scroll dial to select [Auto] or [Prompt] to enable (not activate) the system.

NOTE

The system will retain current settings in the vehicle information display even if the e-POWER system is restarted.

How to set tolerance for [Speed Link Offset]:

1. Push the ◀ ▶ button on the steering wheel until [Settings] appears in the vehicle information display, and push the scroll dial.
2. Use the scroll dial to select [Driver Assistance]. Then push the scroll dial.
3. Select [Speed Link Offset], and push the scroll dial to select tolerance value.

NOTE

The system will retain current settings in the vehicle information display even if the e-POWER system is restarted.

Cruise Navi Link - ProPILOT Assist with Navi Link (where fitted)

WARNING

Listed below are the system limitations for the Cruise Navi Link. Failure to operate the vehicle in accordance with these system limitations could result in serious injury or death:

- There are limitations to the Cruise Navi Link system capability. The system does not function in all driving, traffic, weather and road conditions. It is the driver's responsibility to stay alert, drive safely, and be in control of the vehicle at all times.
- The Cruise Navi Link system does not brake the vehicle to a stop. Whenever necessary, the driver must apply appropriate braking.
- It is the driver's responsibility to select the proper speed, follow all traffic regulations and observe other road users.
- The availability of the Cruise Navi Link function is country-dependent. In some countries, for example, Iceland, Malta, Cyprus, this function is not available. The map data quality does not satisfy the system requirements. If the system detects that the vehicle is located in these countries on the basis of GPS information, the system prohibits activation of the Cruise Navi Link function.

- The Cruise Navi Link may not operate properly in some road and traffic conditions, the system may unexpectedly change the speed. The driver must manually control the vehicle speed.

Below are some examples:

- When driving in countries or areas not covered by the navigation system.
- When the data from the navigation system is not up-to-date or is unavailable.
- When not driving along the route suggested by the navigation system.
- When the navigation system is recalculating the route.
- When driving in countries or areas not covered by the navigation system.
- When driving on a road under construction or newly constructed road.
- When driving near a road split or junction.
- When driving in bad weather or poor road conditions.

When the ProPILOT Assist with Navi Link is active on a limited access motorway (as identified in the navigation map data), the Cruise Navi Link uses road information provided by the navigation system and can adjust the vehicle speed depending on curves, junctions and exits.

The Cruise Navi Link uses road information provided by the navigation system and can adjust the vehicle speed depending on roundabouts (as identified in the navigation map data).

The system may not always reduce speed for all curves, junctions, roundabouts or exits and the driver may need to apply additional braking at any time.

When the vehicle is through the curve, roundabout or junction, the vehicle will accelerate again to the set speed. When exiting the limited access motorway, the driver will need to apply braking at the end of the exit.

NOTE

- The system does not operate when the accelerator pedal is depressed.
- The system may not operate depending on the set distance to the vehicle ahead and vehicles detected ahead.

System display and indicators:

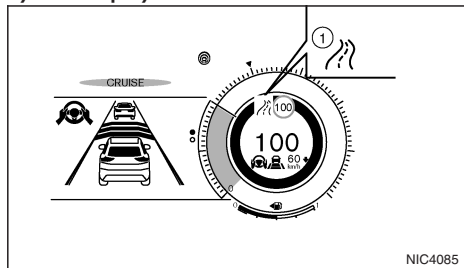

Example

1. Road information indicator

Appears when the system adjusts the speed depending on turns or exits.

	Curves and junctions
	Right exit
	Left exit
	Roundabout

How to activate or deactivate the system:

1. Push the ◀ ▶ button on the steering wheel until [Settings] appears in the vehicle information display, and push the scroll dial.
2. Use the scroll dial to select [Driver Assistance]. Then push the scroll dial.
3. Select [CRUISE Navi Link] and push the scroll dial to turn the system on or off.

NOTE

The system will retain current settings in the vehicle information display even if the e-POWER system is restarted.

Automatic cancellation

A chime sounds under the following conditions and the control is automatically cancelled.

- Any door is open
- The driver's seat belt is not fastened.
- The vehicle ahead is not detected and your vehicle is travelling below the speed of 25 km/h (15 MPH). The ICC system cancels and a warning chime sounds if your vehicle is at a standstill for more than approximately 3 seconds and a vehicle is not detected ahead.
- Your vehicle has been stopped by the ICC system for approximately 3 minutes or longer.
- When the shift control system is not in the D (Drive) mode.
- The electric parking brake is applied.
- When the ESP system is turned off.
- The IEB applies harder braking
- When ESP (including the traction control system) operates.
- A wheel slips.
- When distance measurement becomes impaired due to adhesion of dirt or obstruction to the sensor.
- When the radar signal is temporarily interrupted.
- When Intelligent Parking Assist (IPA) (where fitted) is activated.

ICC system limitations

WARNING

Listed below are the system limitations for the ICC system. Failure to operate the vehicle in accordance with these system limitations could result in serious injury or death:

- The ICC system is primarily intended for use on straight, dry, open roads with light traffic. It is not advisable to use the ICC system in city traffic or congested areas.
- The ICC system will not adapt automatically to road conditions. This system should be used in evenly flowing traffic. Do not use the system on roads with sharp curves or on icy roads, in heavy rain or in fog.
- As there is a performance limit to the distance control function, never rely solely on the ICC system. This system does not correct careless, inattentive or absent minded driving or overcome poor visibility in rain, fog, or other bad weather. Decelerate the vehicle speed by depressing the brake pedal, depending on the distance to the vehicle ahead and the surrounding circumstances in order to maintain a safe distance between vehicles.
- When the ICC system automatically brings the car to a stop, your vehicle can automatically accelerate if the vehicle is stopped for less than approximately 3 seconds and a vehicle ahead is detected moving away. Be prepared to stop your vehicle if necessary.
- Always pay attention to the operation of the vehicle and be ready to manually control the

proper following distance. The ICC system may not be able to maintain the selected distance between vehicles (following distance) or selected vehicle speed under some circumstances.

- The system may not detect the vehicle in front of you in certain road or weather conditions. To avoid accidents, never use the ICC system under the following conditions:
 - On roads with heavy, high-speed traffic or sharp curves
 - On slippery road surfaces such as on ice or snow, etc.
 - During bad weather (rain, fog, snow, etc.)
 - When rain, snow or dirt adhere to the front of the vehicle around the distance sensor
 - On steep downhill roads (the vehicle may go beyond the set vehicle speed and frequent braking may result in overheating the brakes)
 - On repeated uphill and downhill roads
 - When traffic conditions make it difficult to keep a proper distance between vehicles because of frequent acceleration or deceleration
 - Interference by other radar sources.
- Do not use the ICC system if you are towing a trailer or another vehicle.
- In some road or traffic conditions, a vehicle or object can unexpectedly come into the sensor detection zone and cause automatic braking. Always stay alert and avoid using the ICC sys-

tem where not recommended in this warning section.

The ICC system will not detect the following objects:

- Stationary or slow moving vehicles
- Pedestrians or objects in the roadway
- Oncoming vehicles in the same lane
- Motorcycles travelling offset in the travel lane

The following are some conditions in which the radar sensor cannot properly detect a vehicle ahead and the system may not operate properly:

- When the sensor detection is reduced (conditions such as rain, snow, fog, dust storms, sandstorms, and road spray from other vehicles).
- Driving on a steep downhill slope or roads with sharp curves.
- Driving on a bumpy road surface, such as an uneven dirt road.
- If dirt, ice, snow or other material is covering the radar sensor area.
- A complicated-shaped vehicle such as a car carrier trailer or flatbed truck/trailer is near the vehicle ahead.
- Interference by other radar sources.
- When your vehicle is towing a trailer, etc.
- When excessively heavy baggage is loaded in the rear seat or cargo area of your vehicle.

The ICC system is designed to automatically check the radar sensor's operation within the limitations of the system.

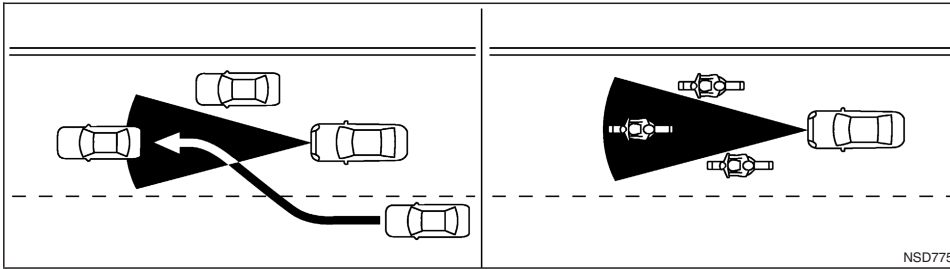

The detection zone of the radar sensor is limited. A vehicle ahead must be in the detection zone for the ICC system to maintain the selected distance from the vehicle ahead. A vehicle ahead may move outside of the detection zone due to its position within the same lane of travel. Motorcycles may not be detected in the same lane ahead.

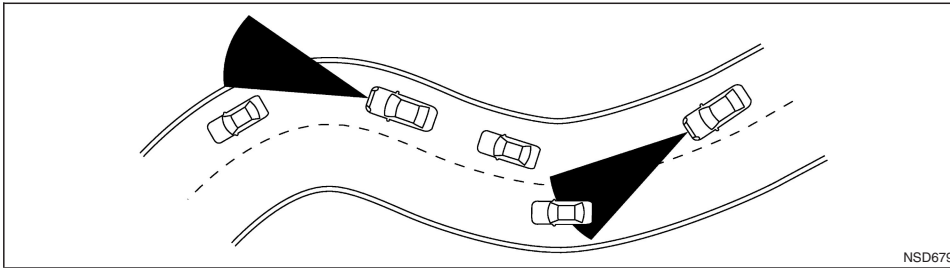

When driving on some roads, such as winding, hilly, curved, narrow roads, or roads which are under construction, the radar sensor may detect vehicles in a different lane, or may temporarily not detect a vehicle travelling ahead. This may cause the radar system to decelerate or accelerate the vehicle.

The detection of vehicles may also be affected by vehicle operation (steering manoeuvre or travelling position in the lane, etc.) or vehicle condition.

The ICC system (with ProPILOT Assist) uses a multi-sensing front camera. The following are some conditions in which the camera may not properly detect a vehicle and detection of a vehicle ahead may be delayed:

- Poor visibility (conditions such as rain, snow, fog, dust storms, sandstorms, and road spray from other vehicles).
- The camera area of the windscreen is fogged up or covered with dirt, water drops, ice, snow, etc.

- Strong light (for example, sunlight or high beams from oncoming vehicles) enters the front camera.
- Strong light causes the area around the pedestrian to be cast in a shadow, making it difficult to see.
- A sudden change in brightness occurs (for example, when the vehicle enters or exits a tunnel or shaded area or lightning flashes).

System temporarily unavailable

The following are conditions in which the ICC system may be temporarily unavailable. In these instances, the ICC system may not cancel and may not be able to maintain the selected following distance from the vehicle ahead.

Condition A:

Under the following conditions, the ICC system is automatically cancelled. A chime will sound and the system will not be able to be set:

- Any door is open

- The driver's seat belt is not fastened.
- The vehicle ahead is not detected and your vehicle is travelling below the speed of 25 km/h (15 MPH). The ICC system cancels and a warning chime sounds if your vehicle is at a standstill for more than approximately 3 seconds and a vehicle is not detected ahead.
- Your vehicle has been stopped by the ICC system for approximately 3 minutes or longer.
- When the shift control system is not in the D (Drive) mode.
- The electronic parking brake is applied.
- When the ESP system is turned off.
- The IEB applies harder braking
- When ESP (including the traction control system) operates.
- A wheel slips.
- When distance measurement becomes impaired due to adhesion of dirt or obstruction to the sensor.
- When the radar signal is temporarily interrupted.
- When Intelligent Parking Assist (IPA) (where fitted) is activated.

Action to take:

When the conditions listed above are no longer present, turn the system off using the ProPILOT Assist switch. Turn the ProPILOT Assist system back on to use the system.

NOTE

When the ICC system is cancelled under the following conditions at a standstill, the electronic parking brake is automatically activated:

- Any door is opened.
- The driver's seat belt is not fastened.
- Your vehicle has been stopped by the ICC system for approximately 3 minutes or longer.
- When the shift control system is not in the D (Drive) mode.
- When the ESP system is turned off.
- When distance measurement becomes impaired due to adhesion of dirt or obstruction to the sensor.
- When the radar signal is temporarily interrupted.

Condition B:

The Radar sensor is positioned at the front of the vehicle. When this area is covered with dirt or is obstructed, the ICC system will automatically be cancelled.

The chime will sound and the [Temporarily Disabled Front Radar Blocked] warning message will appear in the Vehicle Information Display.

Action to take:

If the warning message appears, stop the vehicle in a safe place, press the P position switch to shift to the P (Park) position, and turn the e-POWER system off. When the radar signal is temporarily interrupted, clean the sensor area and restart the e-POWER system. Note that the system will require some time to detect that the area is now clean and to reset itself. If the [Temporarily Disabled Front Radar Blocked]

warning message continues to be displayed, have the system checked by a NISSAN dealer or qualified workshop.

Condition C:

When driving on roads with limited road structures or buildings (for example, long bridges, deserts, snow fields, driving next to long walls), the system may display the [Temporarily Disabled Front Radar Blocked] message.

Action to take:

When the above driving conditions no longer exist, turn the system back on.

ICC system malfunction

If the ICC system malfunctions, it will be turned off automatically, a warning will be displayed in the vehicle information display, a chime will sound, and the speed control status warning (yellow) will illuminate.

Action to take:

If the warning light comes on, stop the vehicle in a safe place. Turn the e-POWER system off, restart the e-POWER system and set the ICC system again. If it is not possible to set the ICC system or the indicator stays on, it may be a malfunction. Although the normal driving can be continued, the ICC system should be checked by a NISSAN dealer or qualified workshop.

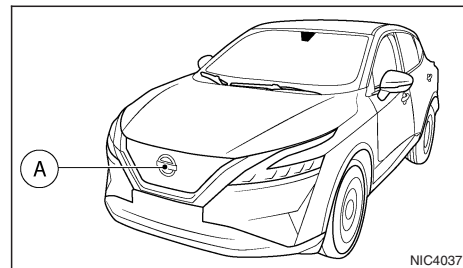

ICC sensor maintenance

The radar sensor is located on the front of the vehicle (A).

To keep the ICC system operating properly, be sure to observe the following:

- Always keep the sensor area clean.
- Do not strike or damage the areas around the sensor.
- Do not cover or attach stickers or similar objects near the sensor area. This could cause failure or malfunction.
- Do not attach metallic objects near the sensor area (brush guard, etc.) This could cause failure or malfunction.

For the radio approval numbers and information, see "Radio frequency approval" in the "9. Technical information" section.

The camera sensor is located above the inside mirror.

To keep the proper operation of the systems and prevent a system malfunction, be sure to observe the following:

- Always keep the windscreen clean.
- Do not attach a sticker (including transparent material) or install an accessory near the camera unit.
- Do not place reflective materials, such as white paper or a mirror, on the instrument panel. The reflection of sunlight may adversely affect the camera unit's capability of detecting the lane markers.
- Do not strike or damage the areas around the camera unit. Do not touch the camera lens or remove the screw located on the camera unit.

If the camera unit is damaged due to an accident, have it checked by a NISSAN dealer or qualified workshop.

PROPILOT ASSIST STEERING ASSIST

WARNING

Failure to follow the warnings and instructions for proper use of the Steering Assist could result in serious injury or death.

- **The Steering Assist is not a replacement for proper driving procedures and is not designed to correct careless, inattentive or absent-minded driving. The Steering Assist will not always steer the vehicle to keep it in the lane. It is not designed to prevent loss of control. It is the driver's responsibility to stay alert, drive safely, keep the vehicle in the travelling lane, and be in control of the vehicle at all times.**

- **As there is a performance limit to the Steering Assist's capability, never rely solely on the system. The Steering Assist does not function in all driving, traffic, weather, and road conditions. Always drive safely, pay attention to the operation of the vehicle, and manually control your vehicle appropriately.**
- **The Steering Assist is intended for use on well-developed motorways or highways with gentle (moderate) curves, where traffic travelling in opposing directions is separated with a barrier. To avoid risk of an accident, do not use this system on local or non-highway roads.**
- **The Steering Assist only steers the vehicle to maintain its position in the centre of a lane. The vehicle will not steer to avoid objects in the road in front of the vehicle or to avoid a vehicle moving into your lane.**
- **It is the driver's responsibility to stay alert, drive safely, keep the vehicle in the travelling lane, and be in control of the vehicle at all times. Never take your hands off the steering wheel when driving. Always keep your hands on the steering wheel and drive your vehicle safely.**
- **Always drive carefully and attentively when using the Steering Assist. Read and understand the Owner's Manual thoroughly before using the Steering Assist. To avoid serious injury or death, do not rely on the system to prevent accidents or to control the vehicle's speed in emergency situations. Do not use the Steering Assist except in appropriate road and traffic conditions.**

ProPILOT Assist Steering Assist operation

The Steering Assist controls the steering system to help keep your vehicle near the centre of the lane when driving. The Steering Assist is combined with the Intelligent Cruise Control (ICC) system. For additional information, refer to "Intelligent Cruise Control (ICC) (vehicles with ProPILOT Assist)" earlier in this section.

The Steering Assist can be activated when the following conditions are met:

- The ICC system is activated and the speed set.
- Lane markers on both sides are clearly detected.
- Your vehicle is travelling at a speed over 60 km/h (37 MPH), OR a vehicle is detected in front of you when travelling under 60 km/h (37MPH).
- The driver grips the steering wheel.
- The vehicle is driven at the centre of the lane.
- The turn signals are not operated.
- The windscreen wiper is not operated in the high (HI) speed operation (the steering assist function is disabled after the wiper operates for approximately 10 seconds).

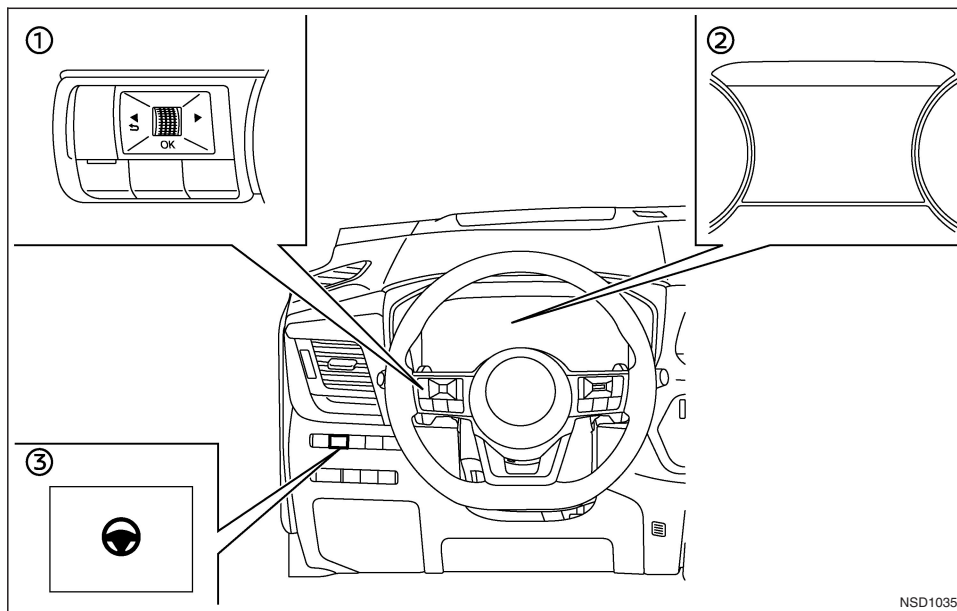

ProPILOT Assist Steering Assist switches

- ① Steering wheel mounted controls (left)
- ② Vehicle Information Display
- ③ Steering Assist switch

To turn the Steering Assist ON or OFF, push the Steering Assist switch on the instrument panel.

When the Steering Assist switch is used to turn the system ON or OFF, the system remembers the setting when the e-POWER system is restarted. The switch must be pushed again to change the setting to ON or OFF.

The Steering Assist switch changes the status of the [Steering Assist] selection made in the [Settings] screen in the Vehicle Information Display.

ProPILOT Assist Steering Assist display and indicators

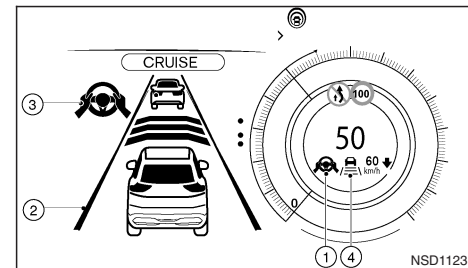

1. Steering Assist status indicator/warning

Displays the status of the Steering Assist by the colour of the indicator/warning

- No indicator: Steering Assist off
- Grey: Steering Assist standby
- Green: Steering Assist active
- Yellow: Steering Assist malfunction
- Red: Hands off detected.

2. Lane marker indicator

Indicates whether the system detects the lane marker

- Grey: Lane markers not detected
- Green: Lane markers detected
- Yellow: Lane departure is detected

3. Steering Assist status indicator

Displays the status of the Steering Assist by the colour of the indicator/warning

- Grey: Steering Assist standby
- Green: Steering Assist active

4. Lane marker indicator/speed control status indicator/set distance indicator

Displays the status of the Steering Assist by the colour of the lane marker indicator.

- Lane marker indicator (no lane): Steering Assist turned off
- Lane marker indicator (green): Steering Assist active
- Lane marker indicator (grey): Steering Assist standby

When the Steering Assist is in operation, the Steering Assist status indicators ① and ③, and the lane marker indicators ② and ④ on the Vehicle Information Display turn green. A chime sounds when the Steering Assist initially activates.

When the Steering Assist enters standby mode, the Steering Assist status indicators ① and ③, and the lane marker indicators ② and ④ on the Vehicle Information Display turn grey. If Steering Assist has been deactivated automatically as the conditions for activation are no longer met, a double chime will sound.

ProPILOT Assist Intelligent Lane Intervention (ILI)

When a curve or strong cross wind exceeds the capabilities of the Steering Assist and your vehicle approaches either the left or the right side of the travelling lane, the steering wheel vibrates, a warning chime sounds and the ILI indicator light (yellow) on the instrument panel flashes to alert the driver. Then, the ILI system automatically applies the brakes for a short period of time to help assist the driver to avoid departing the lane and to return the vehicle to the centre of the travelling lane. This action is in addition to any Steering Assist actions. For additional information, refer to "ProPILOT Assist Intelligent Lane Intervention system" later in this section.

Hands on detection

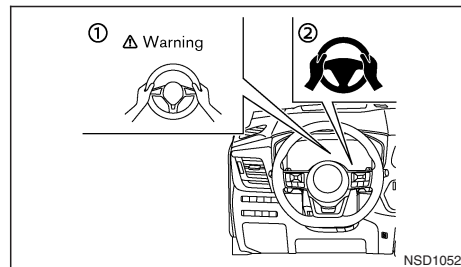

When the Steering Assist is activated, it monitors the driver's steering wheel operation.

If the driver takes his/her hands off the steering wheel for a period of time, the warning ① appears in the Vehicle Information Display and the warning light ② illuminates.

If the driver does not operate the steering wheel after the warning has been displayed, an audible alert sounds and the warning flashes in the Vehicle Information Display. If the driver still does not operate the steering wheel, the system applies Emergency Assist, followed by a momentary brake application to request the driver to take control of the vehicle again.

If the driver still does not respond, the ProPILOT Assist turns on the hazard flasher and slows the vehicle to a complete stop.

The driver can cancel the deceleration at any time by steering, braking, accelerating, or operating the ProPILOT Assist switch.

WARNING

Steering Assist is not a system for hands-free driving. Always keep your hands on the steering wheel and drive your vehicle safely. Failure to do so could cause a collision resulting in serious personal injury or death.

NOTE

The sensors may not detect the driver's hand(s) on the steering wheel in the following situations and a sequence of warnings may occur:

- Driving with gloves.
- Protective covers on the steering wheel.
- Gripping the part of the steering wheel without sensors, including leather joints and spokes.

Steering Assist Activation/Deactivation

Use the following methods to enable or disable the Steering Assist.

ProPILOT Assist switch on steering wheel:

Press the ProPILOT Assist switch. This will turn ICC on. Note that Steering Assist may already be switched on, depending on the settings in the [Settings] menu. These settings are retained if the e-POWER system is restarted.

Then press <SET-> on the right-hand steering wheel switch to set cruise control speed. When the system detects clear lane markings the Steering Assist icons will turn green and the Steering Assist system will become active. For Turkey, a chime will sound when Steering Assist restarts.

The Steering Assist icon will remain grey if the vehicle is driven at speeds under 60 km/h (37 MPH) and no vehicle ahead is detected

Steering Assist switch:

To turn the Steering Assist ON or OFF, push the Steering Assist switch on the instrument panel.

NOTE

- When the Steering Assist switch is used to turn the system ON or OFF, the system remembers the setting when the e-POWER system is restarted. The switch must be pushed again to change the setting to ON or OFF.
- The Steering Assist switch changes the status of the [Steering Assist] selection made in the [Settings] screen in the Vehicle Information Display.

Setting in the Vehicle Information Display:

1. Push the ◀ ▶ button on the steering wheel ① until [Settings] appears in the vehicle information display ② and then push the scroll dial.
2. Use the scroll dial to select [Driver Assistance]. Then push the scroll dial.
3. Select [Steering Assist] and push the scroll dial to turn the Steering Assist on or off.

NOTE

- When the Steering Assist screen is displayed on the Vehicle Information Display, press the <OK> button on the steering wheel to show the [Driver Assistance] setting menu.
- When enabling/disabling the system through the Vehicle Information Display or when pressing the Steering Assist switch, the system retains the current settings even if the e-POWER system is restarted.

Steering Assist limitations

WARNING

- In the following situations, the camera may not detect lane markers correctly or may detect lane markers incorrectly and the Steering Assist may not operate properly:
 - When driving on roads where there are multiple parallel lane markers, lane markers that are faded or not painted clearly, nonstandard lane markers, or lane markers covered with water, dirt, snow, etc.
 - When driving on roads with discontinued lane markers

- When driving on roads with a widening or narrowing lane width
- When driving on roads where there are multiple lanes or unclear lane markers due to road construction
- When driving on roads where there are sharply contrasting objects, such as shadows, snow, water, wheel ruts, seams, or lines remaining after road repairs (the Steering Assist could detect these items as lane markers)
- When driving on roads where the travelling lane merges or separates
- Where the lanes are too narrow or too wide
- Do not use the Steering Assist under the following conditions because the system may not properly detect lane markers. Doing so could cause a loss of vehicle control and result in an accident.
 - During bad weather (rain, fog, snow, dust, etc.)
 - When rain, snow, sand, etc., is thrown up by the wheels of other vehicles
 - When dirt, oil, ice, snow, water, or another object adheres to the camera unit
 - When the glass in front of the camera is foggy
 - When strong light (for example, sunlight or high beams from oncoming vehicles) shines on the camera

- When the headlights are not bright due to dirt on the lens or the headlights are off in tunnels or darkness
- When a sudden change in brightness occurs (for example, when the vehicle enters or exits a tunnel or is under a bridge)
- When driving on roads where the travelling lane merges or separates or where there are temporary lane markers because of road construction
- When there is a lane closure due to road repairs
- When driving on a bumpy road surface, such as an uneven dirt road
- When driving on sharp curves or winding roads
- When driving on repeated uphill and downhill roads
- Do not use the Steering Assist under the following conditions because the system will not operate properly:
 - When driving with a tyre that is not within normal tyre conditions (for example, tyre wear, abnormal tyre pressure, installation of a spare tyre, tyre chains, nonstandard wheels)
 - When the vehicle is equipped with non-original brake or suspension parts
 - When an object such as a sticker or cargo obstructs the camera

- When excessively heavy baggage is loaded in the rear seat or luggage area of your vehicle
- When the vehicle load capacity is exceeded
- When towing a trailer or other vehicle
- Excessive noise will interfere with the warning chime sound, and the beep may not be heard.
- For the ProPILOT Assist system to operate properly, the windscreen in front of the camera must be clean. Replace worn wiper blades. The correct size wiper blades must be used to help make sure the windscreen is kept clean. Only use Genuine NISSAN wiper blades, or equivalent wiper blades, that are specifically designed for use on your vehicle model and model year. It is recommended that you visit a NISSAN dealer or qualified workshop for the correct parts for your vehicle.

Steering Assist temporary standby

Automatic standby due to driving operation:

When the driver activates the turn signal, the Steering Assist is temporarily placed in a standby mode. (The Steering Assist restarts automatically when the operating conditions are met again. For Turkey, a chime will sound when Steering Assist restarts.)

Automatic standby:

In the following cases, a double chime sounds, and the Steering Assist is placed in a temporary standby mode. (The Steering Assist restarts automatically when the operating conditions are met again. For Turkey, a chime will sound when Steering Assist restarts.)

- When the current travelling lane is too narrow to operate.
- When a corner is too tight and the vehicle cannot stay in the travelling lane.
- When lane markers on both sides are no longer detected.
- When a vehicle ahead is no longer detected under approximately 60 km/h (37 MPH).
- When strong light enters the camera unit. (For example, the light directly shines on the front of the vehicle at sunrise or sunset.)
- When the temperature of the camera is too high.

NOTE

For vehicles fitted with ProPILOT Assist with Navi Link on a limited access motorway as identified in the navigation map data, the Steering Assist may continue to operate with visible lane markers on both sides even when the vehicle speed is below approximately 60 km/h (37 MPH) and a vehicle is not detected ahead.

Steering Assist cancel

Under the following conditions, the Steering Assist cancels a warning message is displayed, a double-chime sounds, and the Steering Assist indicators turn off:

- When unusual lane markers appear in the travelling lane or when the lane marker cannot be correctly detected for some time due to certain conditions (for example, a snow rut, the reflection of light on a rainy day, the presence of several unclear lane markers).
- When the windscreen wiper operates in the high (HI) speed operation (the Steering Assist is disabled when the wiper operates for more than approximately 10 seconds).

Action to take:

When the conditions listed above are no longer present, turn the Steering Assist system on again using the Steering Assist button on the instrument panel.

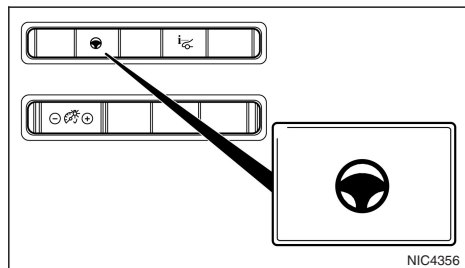

Steering Assist malfunction

When the system malfunctions, it turns off automatically. The Steering Assist status warning illuminates (yellow) and a warning message is displayed in the vehicle information display. A chime may sound depending on the situation.

Action to take:

Stop the vehicle in a safe location, place the vehicle in the P (Park) position, turn the e-POWER system off, restart the e-POWER system, resume driving, ensure that the Steering Assist is switched on using the Steering Assist button on the instrument panel or the [Settings] menu and set the Intelligent Cruise Control system again. If the warning (yellow) continues to illuminate, the Steering Assist may be malfunctioning. Although the vehicle is still drivable under normal conditions, have the system checked by a NISSAN dealer or qualified workshop.

Steering Assist maintenance

The camera sensor is located above the inside mirror.

To keep the proper operation of the system and prevent a system malfunction, be sure to observe the following:

- Always keep the windscreen clean.
- Do not attach a sticker (including transparent material) or install an accessory near the camera unit.
- Do not place reflective materials, such as white paper or a mirror, on the instrument panel. The reflection of sunlight may adversely affect the camera unit's capability of detecting the lane markers.

- Do not strike or damage the areas around the camera unit. Do not touch the camera lens or remove the screw located on the camera unit.

If the camera unit is damaged due to an accident, it is recommended that you visit a NISSAN dealer or qualified workshop.

PROPILOT ASSIST CONVENTIONAL (FIXED SPEED) CRUISE CONTROL MODE

NOTE

ProPILOT Assist provides no approach warnings, automatic braking, or steering assist in the conventional (fixed speed) cruise control mode.

This mode allows driving at a speed above approximately 30 km/h (20 MPH) without keeping your foot on the accelerator pedal.

WARNING

- **In the conventional (fixed speed) cruise control mode, a warning chime does not sound to warn you if you are too close to the vehicle ahead, as neither the presence of the vehicle ahead nor the vehicle-to-vehicle distance is detected.**
- **Pay special attention to the distance between your vehicle and the vehicle ahead of you or a collision could occur.**
- **Always confirm the setting in the ICC system display.**

● Do not use the conventional (fixed speed) cruise control mode when driving under the following conditions:

- When it is not possible to keep the vehicle at a set speed
- In heavy traffic or in traffic that varies in speed
- On winding or hilly roads
- On slippery roads (rain, snow, ice, etc.)
- In very windy areas

● Doing so could cause a loss of vehicle control and result in an accident.

ProPILOT Assist Conventional (fixed speed) cruise control switches

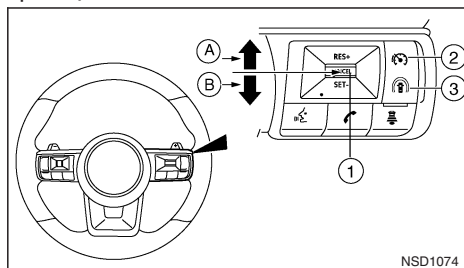

- ① <CANCEL> switch
- Ⓐ <RES+> (Resume) switch
- Ⓑ <SET-> (Set) switch
- ② Speed limiter main "ON/OFF" switch (where fitted)

③ ProPILOT Assist switch.

ProPILOT Assist Conventional (fixed speed) cruise control mode display and indicators

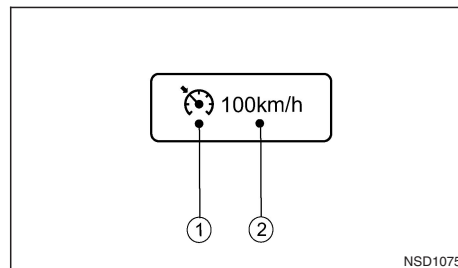

The display is located in the vehicle information display.

1. Cruise indicator:

This indicator indicates the condition of the Conventional (fixed speed) cruise control mode of the ICC system depending on a colour.

- Cruise control ON indicator (grey): Indicates that the ICC switch is on.
- Cruise control SET indicator (green): Indicates that the cruising speed is set.
- Cruise control warning (yellow): Indicates that there is a malfunction in the Conventional (fixed speed) cruise control mode of the ICC system.

2. Set vehicle speed indicator:

This indicator indicates the set vehicle speed.

- Grey: cruise control standby
- Green: cruise control active

Operating ProPILOT Assist conventional (fixed speed) cruise control mode

To turn on the conventional (fixed speed) cruise control mode, push and hold the blue ProPILOT Assist switch for longer than about 1.5 seconds.

When pushing the blue ProPILOT Assist switch on, the ICC system display and indicators are displayed in the Vehicle Information Display. After you hold ProPILOT Assist switch on for longer than about 1.5 seconds, the ProPILOT Assist system display turns off. The cruise indicator appears. You can now set your desired cruising speed. Pushing the ProPILOT Assist switch again will turn the system completely off. When the power switch is switched OFF, the system is also automatically turned off.

To use the ICC system again, quickly push and release the ProPILOT Assist switch (vehicle-to-vehicle distance control mode) or push and hold it (conventional cruise control mode) again to turn it on.

CAUTION

To avoid accidentally engaging cruise control, make sure to turn the ProPILOT Assist switch off when not using the cruise control system.

To set cruising speed, accelerate your vehicle to the desired speed, push the <SET-> switch and release it. (The colour of the cruise indicator changes to green and set vehicle speed indicator comes on.) Take your foot off the accelerator pedal. Your vehicle will maintain the set speed.

- To pass another vehicle, depress the accelerator pedal. When you release the pedal, the vehicle will return to the previously set speed.
- The vehicle may not maintain the set speed when going up or down steep hills. If this happens, manually maintain vehicle speed.

To cancel the preset speed, use any of the following methods:

- Push the <CANCEL> switch. The vehicle set speed indicator and the cruise indicator will turn grey.
- Tap the brake pedal. The vehicle set speed indicator and the cruise indicator will turn grey.
- You can also Turn ProPILOT Assist off completely. Turn the blue ProPILOT Assist switch off. Both the cruise indicator and vehicle set speed indicator will turn off.

To reset at a faster cruising speed, use one of the following three methods:

- Depress the accelerator pedal. When the vehicle attains the desired speed, push and release the <SET-> switch.
- Push and hold the <RES+> switch. When the vehicle attains the desired speed, release the switch.

- Push, then quickly release the <RES+> switch. Each time you do this, the set speed will increase by about 1 km/h (1 MPH).

To reset at a slower cruising speed, use one of the following three methods:

- Lightly tap the brake pedal. When the vehicle attains the desired speed, push the <SET-> switch and release it.
- Push and hold the <SET-> switch. Release the switch when the vehicle slows down to the desired speed.
- Push, then quickly release the <SET-> switch. Each time you do this, the set speed will decrease by about 1 km/h (1 MPH).

To resume the preset speed after ICC cancel, push and release the <RES+> switch. The vehicle will resume the last set cruising speed when the vehicle speed is over 30 km/h (20 MPH).

System temporarily unavailable

A chime sounds and the control is automatically cancelled under the following conditions:

- When the parking brake is applied.
- When ESP (including the traction control system) operates.
- When a wheel slips.
- When the ESP system is off.

When the system is not operating properly, the chime sounds and the colour of the cruise indicator will change to yellow.

Action to take:

If the colour of the cruise indicator changes to yellow, park the vehicle in a safe place. Turn the e-POWER system off, restart the e-POWER system, resume driving and then perform the setting again.

If it is not possible to set or the indicator stays on, it may indicate that the system is malfunctioning. Although the vehicle is still driveable under normal conditions, have the vehicle checked by a NISSAN dealer or qualified workshop.

PROPILOT ASSIST SPEED LIMITER (where fitted)

The speed limiter allows you to set the desired vehicle speed limit. While the speed limiter is activated, you can perform normal braking and acceleration, but the vehicle will not exceed the set speed.

When the vehicle reaches the set speed limit or if the set speed limit is lower than the actual vehicle speed, the accelerator pedal will not work until the vehicle speed drops below the set speed limit.

When the actual vehicle speed exceeds the set speed, an audible warning will be heard a short time after the set speed is exceeded and driver intervention is not detected.

When the speed limiter is on the cruise control system cannot be operated.

⚠ WARNING

- The speed limiter will not automatically brake the vehicle to the set speed limit.
- Always observe posted speed limits. Do not set the speed above them.
- Always confirm the setting status of the speed limiter in the Vehicle Information Display.
- When the speed limiter is set, avoid hard acceleration to reach the set limit to ensure that the system can limit the speed of the vehicle correctly.
- When additional floor mats are used, be sure that they are correctly secured and that they cannot interfere with the accelerator pedal. Mats not adapted to the vehicle may prevent proper operation of the speed limiter.

The speed limiter operation switches are located on the steering wheel (right hand side).

The speed limiter operating condition is shown on the top of Vehicle Information Display. For details, see "Vehicle information display" in the "2. Instruments and controls" section.

ProPILOT Assist Speed limiter operations

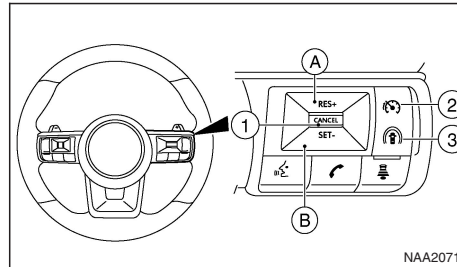

- ① <CANCEL> switch
- A <RES+> (Resume) switch
- B <SET-> (Set) switch
- ② Speed limiter main "ON/OFF" switch (where fitted)
- ③ ProPILOT Assist switch.

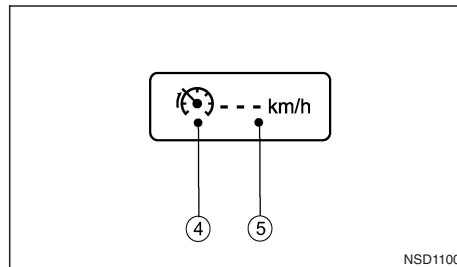

Before setting speed

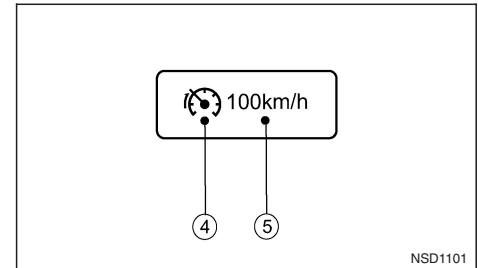

NSD1101

After setting speed

- ④ Speed limiter symbol
- ⑤ Set speed value

Turning the speed limiter on:

The speed limiter can be switched on after the e-POWER system is started or when driving.

Push the speed limiter main "ON/OFF" switch ②.

The speed limiter symbol ④ and the set speed value ⑤ will illuminate in the Vehicle Information Display.

NOTE

Turning the Speed limiter system on will turn on the Intelligent Lane Intervention (ILI) and Intelligent Blind Spot Intervention systems at the same time, providing those systems are enabled in the [Driver Assistance] menu in the vehicle information display. For additional information, see "ProPILOT Assist Intelligent Lane Intervention system" later in this section and "Blind Spot Warning (BSW) system/Intelligent Blind Spot Intervention system (where fitted)" earlier in this section.

Setting speed limit:

Push the <SET-> switch.

The speed limit will be set at the current speed.

When driving less than 30 km/h (20 MPH), the speed limiter will be set to the minimum possible set speed of 30 km/h (20 MPH).

When the speed limit is set, the speed limiter symbol ④ and the set speed value ⑤ will turn green.

Changing a speed limit:

Use either of the following operations to change an active speed limit:

- Push and release the <RES+> (Resume) switch or <SET-> switch. Each time you do this, the set speed will increase or decrease by 1 km/h (1 MPH).
- Push and hold the <RES+> (Resume) switch or <SET-> switch. The set speed will increase or decrease to the next multiple of 5 km/h (5 MPH) and then in steps of 5 km/h (5 MPH).

The new set speed limit value ⑤ will be displayed in the Vehicle Information Display.

When the actual vehicle speed exceeds the set speed, an audible warning will be heard a short time after the set speed is exceeded and driver intervention is not detected.

Cancelling a speed limit:

To cancel a set speed limit, push the <CANCEL> switch. The speed limiter symbol ④ and the set speed value ⑤ in the Vehicle Information Display will turn grey.

It is also possible to override the speed limiter by fully depressing the accelerator pedal beyond the resistance point.

WARNING

- **The vehicle may accelerate when the speed limiter cancels.**
- **When additional floor mats are used, be sure that they are correctly secured and that they cannot interfere with the accelerator pedal. Mats not adapted to the vehicle may prevent proper operation of the speed limiter.**

Fully depress the accelerator pedal beyond the resistance point. The speed limiter will be suspended to allow driving above the set speed. The set speed value ⑤ will flash and an audible warning will sound. The speed limiter will automatically resume when the vehicle speed drops below the set speed limit.

Resuming a previous set speed:

If a set speed limit has been cancelled, the set speed will be stored in the speed limiter memory.

This speed limit can be reactivated by pressing the <RES+> (Resume) switch A.

If the current vehicle speed is higher than the previous set speed, the accelerator pedal will not work and the set speed value ⑤ will flash until the vehicle speed drops below the set speed limit.

When the actual vehicle speed exceeds the set speed, an audible warning will be heard a short time after the set speed is exceeded and driver intervention is not detected.

Turning the speed limiter off:

The speed limiter system will be turned off when one of the following operations is performed:

- Push the speed limiter main "ON/OFF" switch. The speed limiter symbol ④ and the set speed value ⑤ in the Vehicle Information Display will be turned off.
- Push the blue ProPILOT Assist "ON/OFF" switch. The speed limiter information in the vehicle information will be replaced with the ProPILOT Assist display. For details see "ProPILOT Assist (where fitted)" earlier in this section
- When the vehicle is stopped and the power switch is switched **OFF**.

Turning off the speed limiter will erase the set speed limit memory.

Speed limiter malfunction:

If the speed limiter malfunctions, the speed limiter symbol ④ in the Vehicle Information Display will flash.

Turn the speed limiter off by pushing the speed limiter main "ON/OFF" switch ③ and have the system checked by a NISSAN dealer or qualified workshop.

PROPILOT ASSIST LANE DEPARTURE WARNING (LDW) SYSTEM

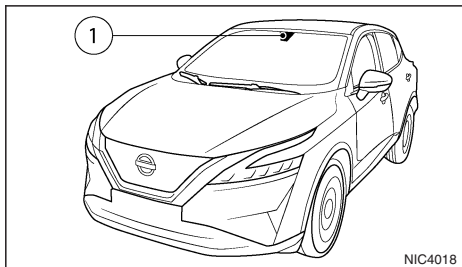

The LDW system will operate when the vehicle is driven at the following speeds and above, and only when the lane markings are clearly visible on the road:

- For Europe:
approximately 60 km/h (37 MPH)
- Except for Europe:
approximately 70 km/h (45 MPH)

The LDW system monitors the lane markers on the travelling lane using the camera unit ① located above the inside mirror.

The LDW system warns the driver with a LDW indicator on the Vehicle Information Display, steering wheel vibration and a chime that the vehicle is beginning to leave the driving lane.

WARNING

The LDW system is only a warning device to help inform the driver of a potential unintended lane departure. It will not steer the vehicle or prevent loss of control. It is the driver's responsibility to stay alert, drive safely, keep the vehicle in the travelling lane, and be in control of the vehicle at all times. Failure to operate the vehicle in accordance with these limitations could result in serious injury or death.

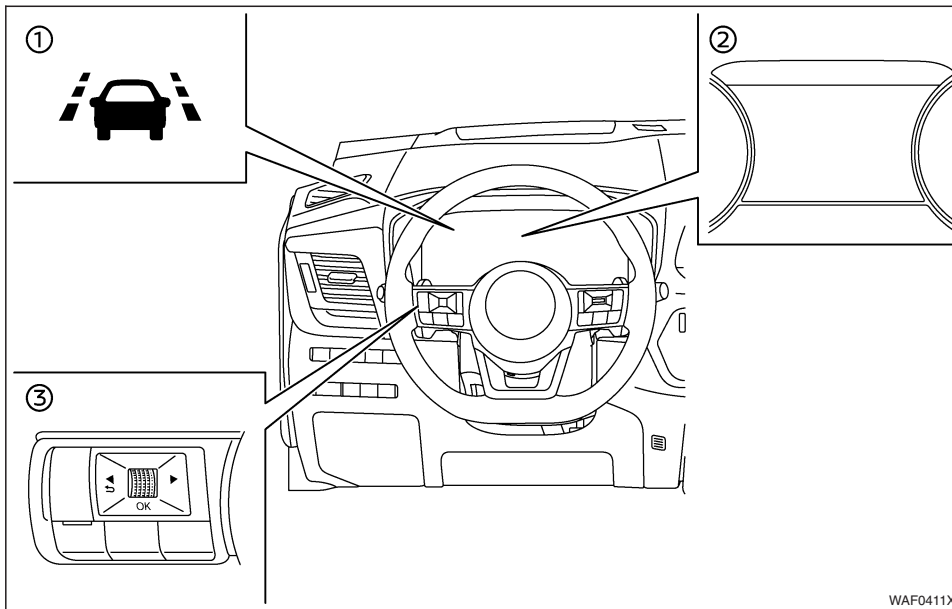

ProPILOT Assist LDW system operation

The LDW system provides a lane departure warning function when the vehicle is driven at the following speeds and above, and only when the lane markings are clearly visible on the road:

- For Europe:
approximately 60 km/h (37 MPH)
- Except for Europe:
approximately 70 km/h (45 MPH)

When the vehicle approaches either the left or the right side of the travelling lane, the steering wheel will vibrate, a chime will sound (only when Steering Assist is active) and the LDW indicator on the vehicle information display will blink to alert the driver.

The warning function will stop when the vehicle returns inside of the lane markers.

- ① LDW indicator (on the vehicle information display)
- ② Vehicle information display
- ③ Steering-wheel-mounted controls (left side)

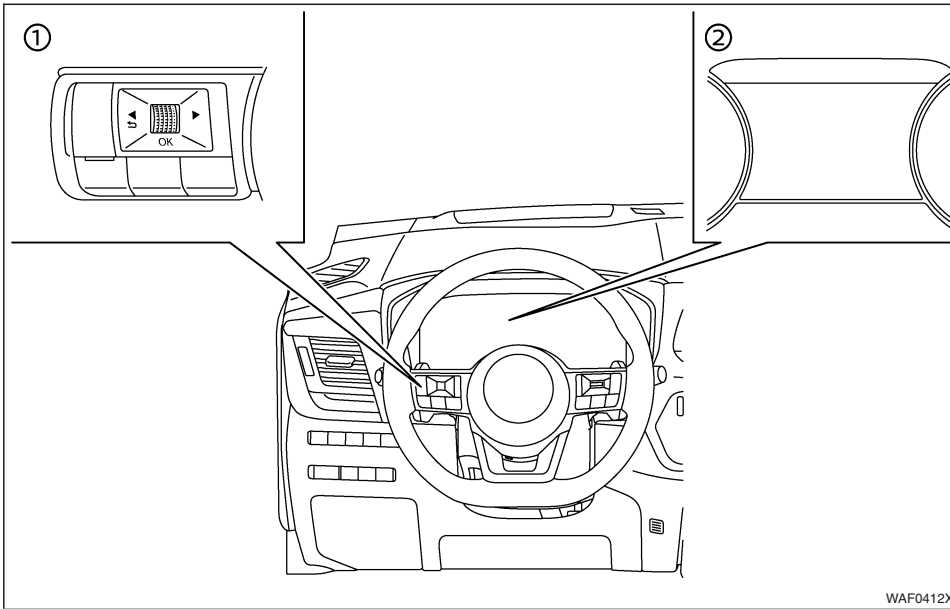

- ① Steering-wheel-mounted controls (left side)
- ② Vehicle information display

Turning the LDW system on or off:

To turn the LDW system on and off use the [Settings] menu in the vehicle information display.

For details, see "Vehicle information display" in the "2. Instruments and controls" section.

1. Push the ◀ ▶ button until [Settings] appears in the vehicle information display and then push the scroll dial. Use the scroll dial to select [Driver Assistance]. Then push the scroll dial.
2. Select [Lane] and push the scroll dial.
3. Select [Warning] and push the scroll dial.

NOTE

- If you turn the LDW system off using the [Settings] menu, the system will remain turned off the next time you start the e-POWER system.

⚠ WARNING

Listed below are the system limitations for the Lane Departure Warning system. Failure to operate the vehicle in accordance with these system limitations could result in serious injury or death.

- The system will not operate at speeds below approximately 60 km/h (37 MPH) (for Europe) or 70 km/h (45 MPH) (except for Europe), or if it cannot detect lane markers
- Excessive noise will interfere with the warning chime sound, and the chime may not be heard.
- Do not use the LDW system under the following conditions as it may not function properly:
 - During bad weather (rain, fog, snow, etc.).
 - When driving on slippery roads, such as on ice or snow.
 - When driving on winding or uneven roads.
 - When there is a lane closure due to road repairs.
 - When driving in a makeshift or temporary lane.
 - When driving on roads where the lane width is too narrow.
 - When driving without normal tyre conditions (for example, tyre wear, low tyre pressure, installation of spare tyre, tyre chains, non-standard wheels).

- When the vehicle is equipped with non-original brake parts or suspension parts.
- When you are towing a trailer or other vehicle.
- **The system may not function properly under the following conditions:**
 - On roads where there are multiple parallel lane markers; lane markers that are faded or not painted clearly; yellow painted lane markers; non-standard lane markers; or lane markers covered with water, dirt, snow, etc.
 - On roads where discontinued lane markers are still detectable.
 - On roads where there are sharp curves.
 - On roads where there are sharply contrasting objects, such as shadows, snow, water, wheel ruts, seams or lines remaining after road repairs. (The LDW system could detect these items as lane markers.)
 - On roads where the travelling lane merges or separates.
 - When the vehicle's travelling direction does not align with the lane marker.
 - When travelling close to the vehicle in front of you, which obstructs the lane camera unit detection range.
 - When rain, snow, dirt or object adheres to the windscreen in front of the lane camera unit.

- When the headlights are not bright due to dirt on the lens or if the aiming is not adjusted properly.
- When strong light enters the lane camera unit. (For example, the light directly shines on the front of the vehicle at sunrise or sunset.)
- When a sudden change in brightness occurs. (For example, when the vehicle enters or exits a tunnel or under a bridge.)

LDW temporary disabled status

If the vehicle is parked in direct sunlight under high temperature conditions (over approximately 40°C (104°F)) and then started, the LDW system may be deactivated automatically and the [Unavailable Camera Temperature High] message will appear in the Vehicle Information Display.

The LDW system is not designed to warn under the following conditions:

- When you operate the lane change signal and change travelling lanes in the direction of the signal. (The LDW system will become operational again approximately two seconds after the lane change signal is turned off.)
- When the vehicle speed lowers to less than approximately 60 km/h (37 MPH) (for Europe) or 70 km/h (45 MPH) (except for Europe).
- When rain, snow, dirt or object adheres to the windscreen in front of the lane camera unit.

After the above conditions have finished and the necessary operating conditions are satisfied, the LDW system will resume.

LDW malfunction

If the LDW system malfunctions, it will cancel automatically and the [System Fault] message will appear in the Vehicle Information Display. If the [System Fault] message appears in the Vehicle Information Display pull off the road in a safe location, turn off and restart the e-POWER system. If the [System Fault] message continues to appear in the Vehicle Information Display, have the LDW system checked by a NISSAN dealer or qualified workshop.

Multi-sensing camera unit maintenance

The lane camera unit ① for the LDW system is located above the interior rear view mirror. To maintain the proper operation of the LDW system and prevent a system malfunction, be sure to observe the following:

- Always keep the windscreen clean.
- Do not attach a sticker (including transparent material) or install an accessory near the camera unit.
- Do not place reflective materials, such as white paper or a mirror, on the instrument panel. The reflection of sunlight may adversely affect the camera unit's detection capability.
- Do not strike or damage the areas around the camera unit. Do not touch the camera lens or remove the screw located on the camera unit. If the camera unit is damaged due to an accident, contact a NISSAN dealer or qualified workshop.

PROPILOT ASSIST INTELLIGENT LANE INTERVENTION SYSTEM

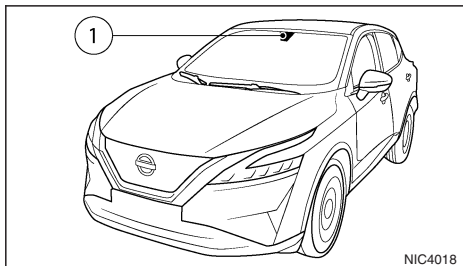

⚠ WARNING

Failure to follow the warnings and instructions for proper use of the Intelligent Lane Intervention (ILI) system could result in serious injury or death.

- **The ILI system will not steer the vehicle or prevent loss of control. It is the driver's responsibility to stay alert, drive safely, keep the vehicle in the travelling lane, and be in control of the vehicle at all times.**
- **The ILI system is primarily intended for use on well-developed motorways or highways. It may not detect the lane markers in certain road, weather, or driving conditions.**

The ILI system must be turned on with the ProPILOT Assist switch every time the power switch is switched ON.

The ILI system will operate when the vehicle is driven at the following speeds and above, and only when the lane markings are clearly visible on the road:

- For Europe:
approximately 60 km/h (37 MPH)
- Except for Europe:
approximately 70 km/h (45 MPH)

The ILI system warns the driver when the vehicle has left the centre of the travelling lane with a ILI indicator on the Vehicle Information Display, a chime (only when Steering Assist is active) and steering wheel vibration. The system helps assist the driver to avoid departing the lane and to return the vehicle to the centre of the travelling lane by applying the brakes to the left or right wheels individually (for a short period of time).

The ILI system monitors the lane markers on the travelling lane using the camera unit ① located above the inside mirror

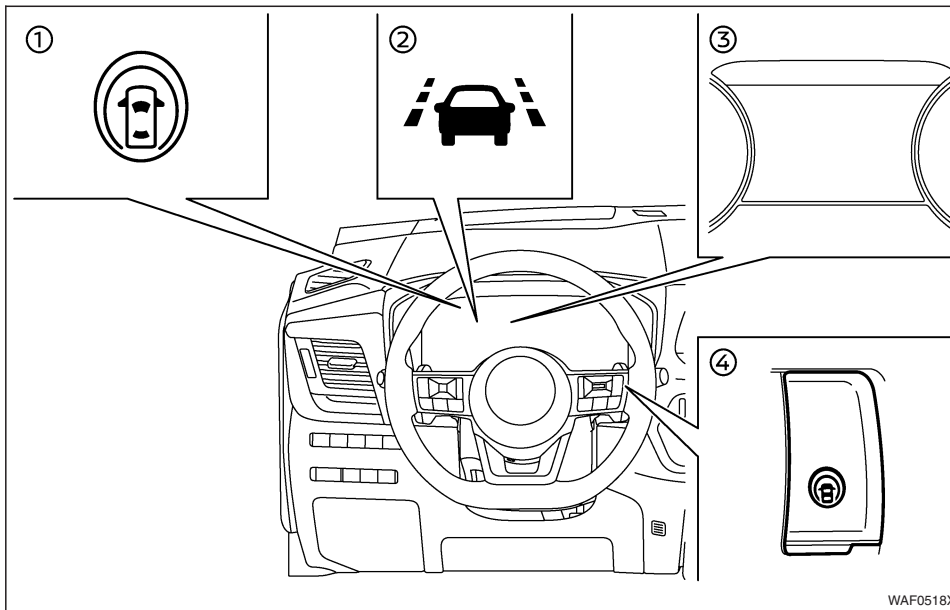

WAF0518X

- ① ProPILOT Assist indicator
- ② ILI indicator (on the Vehicle Information Display). Appears only when system activates (blinks yellow).
- ③ Vehicle Information Display
- ④ ProPILOT Assist switch

ProPILOT Assist Intelligent Lane Intervention System Operation

The Intelligent Lane Intervention (ILI) system operates at speeds above:

- For Europe:
approximately 60 km/h (37 MPH)
- Except for Europe:
approximately 70 km/h (45 MPH)

When the vehicle approaches either the left or the right side of the travelling lane, the steering wheel will vibrate, a chime will sound (only when Steering Assist is active) and the ILI indicator (yellow) on the Vehicle Information Display will blink to alert the driver. Then, the ILI system will automatically apply the brakes for a short period of time to help assist the driver to return the vehicle to the centre of the travelling lane.

The ILI system turns on when the ProPILOT Assist or Speed limiter (where fitted) switch on the steering wheel is pushed when the ILI setting is enabled in the [Driver Assistance] menu in the vehicle information display. The ProPILOT Assist indicator illuminates on the vehicle information display.

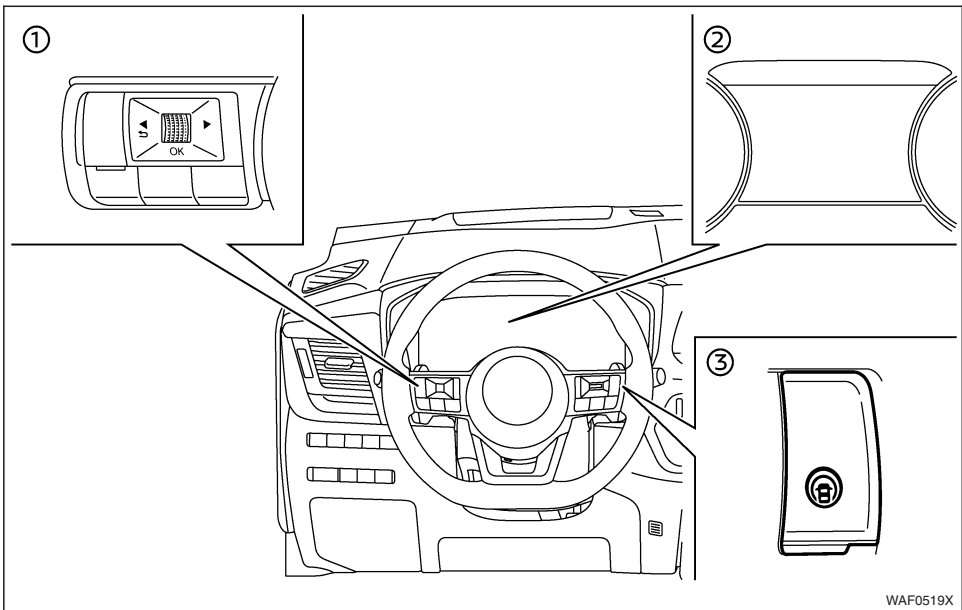

- ① Steering-wheel-mounted control (left side)
- ② Vehicle information display
- ③ ProPILOT Assist switch

ProPILOT Assist Intelligent Lane Intervention Activation/Deactivation

The ILI system is activated when pushing the ProPILOT Assist or the Speed Limiter (where fitted) switch on the steering wheel when the ILI setting is enabled in the [Driver Assistance] menu in the vehicle information display. To deactivate the ILI system, push the same switch again or disable the ILI setting in the [Driver Assistance] menu. The ILI system will be automatically deactivated when the power switch is switched OFF.

To enable or disable the ILI system:

1. Push the ◀ ▶ button until [Settings] appears in the vehicle information display and then push the scroll dial. Use the scroll dial to select [Driver Assistance]. Then push the scroll dial.
2. Select [Lane] and push the scroll dial.
3. Select [Intervention] and push the scroll dial.
4. Push the ProPILOT Assist switch to turn the system on or off.

NOTE

- **Turning on ProPILOT Assist will turn on the ILI system at the same time. If the ILI system is disabled in the [Settings] menu, the ILI will automatically be turned on when ProPILOT Assist is active.**
- **When the ILI system is enabled in the [Settings] menu, the ILI system can be turned on or off by pushing the speed limiter MAIN switch (where fitted).**
- **When the engine is restarted, the system will retain current settings in the vehicle information display.**

Limitations

WARNING

Listed below are the system limitations for the Intelligent Lane Intervention system. Failure to operate the vehicle in accordance with these system limitations could result in serious injury or death.

- The ILI system may activate if you change lanes without first activating your turn signal or, for example, if a construction zone directs traffic to cross an existing lane marker. If this occurs you may need to apply corrective steering to complete your lane change.
- Because the ILI may not activate under the road, weather and lane marker conditions described in this section, it may not activate every time your vehicle begins to leave the travelling lane and you will need to apply corrective steering.
- When the ILI system is operating, avoid excessive or sudden steering manoeuvres, otherwise you could lose control of the vehicle.
- The ILI system will not operate if it cannot detect lane markers, or at speeds below approximately 60 km/h (37 MPH) (for Europe) or 70 km/h (45 MPH) (except for Europe).
- Do not use the ILI system under the following conditions as it may not function properly:
 - During bad weather (rain, fog, snow, etc.).
 - When driving on slippery roads, such as on ice or snow.
 - When driving on winding or uneven roads.

- When there is a lane closure due to road repairs.
- When driving in a makeshift or temporary lane.
- When driving on roads where the lane width is too narrow.
- When driving without normal tyre conditions (for example, tyre wear, low tyre pressure, installation of spare tyre, tyre chains, non-standard wheels).
- When the vehicle is equipped with non-original brake parts or suspension parts.
- On roads where there are multiple parallel lane markers; lane markers that are faded or not painted clearly; yellow painted lane markers; non-standard lane markers; or lane markers covered with water, dirt, snow, etc.
- On roads where discontinued lane markers are still detectable.
- On roads where there are sharp curves.
- On roads where there are sharply contrasting objects, such as shadows, snow, water, wheel ruts, seams or lines remaining after road repairs. (The ILI system could detect these items as lane markers.)
- On roads where the travelling lane merges or separates.
- When the vehicle's travelling direction does not align with the lane marker.

- When travelling close to the vehicle in front of you, which obstructs the lane camera unit detection range.
- When rain, snow, dirt or object adheres to the windscreen in front of the lane camera unit.
- When the headlights are not bright due to dirt on the lens or if the aiming is not adjusted properly.
- When strong light enters the lane camera unit. (For example, the light directly shines on the front of the vehicle at sunrise or sunset.)
- When a sudden change in brightness occurs. (For example, when the vehicle enters or exits a tunnel or under a bridge.)
- Excessive noise will interfere with the warning chime sound, and the chime may not be heard.
- When the vehicle load capacity is exceeded.
- When towing a trailer or another vehicle.

NOTE

While the ILI system is operating, you may hear a sound of brake operation. This is normal and indicates that the ILI system is operating properly.

ILI temporarily unavailable

Condition A:

The warning and assist functions of the ILI system are not designed to work under the following conditions:

- When you operate the lane change signal and change the travelling lanes in the direction of the signal. (The ILI system will be deactivated for approximately 2 seconds after the lane change signal is turned off.)
- When the vehicle speed lowers to less than approximately 60 km/h (37 MPH) (for Europe) or 70 km/h (45 MPH) (except for Europe).

After the above conditions have finished and the necessary operating conditions are satisfied, the warning and assist functions will resume.

Condition B:

The assist function of the ILI system is not designed to work under the following conditions (warning is still functional):

- When the brake pedal is depressed or the vehicle decelerates strongly.
- When the steering wheel is turned as far as necessary for the vehicle to change lanes.
- When the vehicle is accelerated during the ILI system operation.
- When the Intelligent Cruise Control (ICC) approach warning occurs.
- When the hazard warning flashers are operated.
- When driving on a curve at high speed.

After the above conditions have finished and the necessary operating conditions are satisfied, the ILI system application of the brakes will resume.

Condition C:

If the following messages appear in the Vehicle Information Display, a chime will sound and the ILI system will be turned off automatically.

- [Unavailable Slippery Road]:
When the ESP system (except Traction Control System (TCS) function) or ABS operates.
- [Currently not available]:
 - When the ESP system is turned **OFF**.

When the above conditions no longer exist, turn on the ILI system. Push the ProPILOT Assist switch again to turn the ILI system back on.

Temporary disabled status at high temperature:

If the vehicle is parked in direct sunlight under high temperature conditions (over approximately 40°C (104°F)) and then the ILI system is turned on, the ILI system may be deactivated automatically and the following message will appear on the Vehicle Information Display: [Unavailable Camera Temperature High] and a chime will sound.

System malfunction

When the ILI system malfunctions, it will cancel automatically. The ILI indicator (orange) will illuminate, a chime will sound and the [System Fault] message will appear in the Vehicle Information Display. If the [System Fault] message appears in the Vehicle Information Display pull off the road in a safe location, turn off and restart the e-POWER system. If the [System Fault] message continues to appear in the Vehicle Information Display, have the ILI system checked by a NISSAN dealer or qualified workshop.

Multi-sensing camera unit maintenance

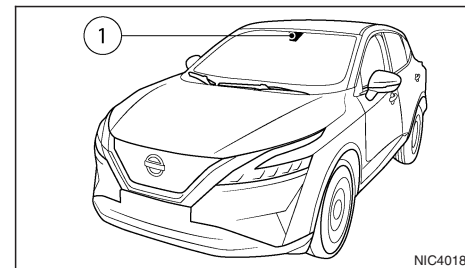

The lane camera unit ① for the ILI system is located above the interior rear view mirror. To maintain the proper operation of the ILI system and prevent a system malfunction, be sure to observe the following:

- Always keep the windscreen clean.
- Do not attach a sticker (including transparent material) or install an accessory near the camera unit.
- Do not place reflective materials, such as white paper or a mirror, on the instrument panel. The reflection of sunlight may adversely affect the camera unit's detection capability of detecting lane markers.
- Do not strike or damage the areas around the camera unit. Do not touch the camera lens or remove the screw located on the camera unit. If the camera unit is damaged due to an accident, contact a NISSAN dealer or qualified workshop.

INTELLIGENT FORWARD COLLISION WARNING (I-FCW) SYSTEM (where fitted)

WARNING

Failure to follow the warnings and instructions for proper use of the I-FCW system could result in serious injury or death.

- The I-FCW system helps warn the driver before a collision but will not avoid a collision. It is the driver's responsibility to stay alert, drive safely and be in control of the vehicle at all times.

The I-FCW system can help alert the driver when there is a sudden braking of a second vehicle travelling in front of the vehicle ahead in the same lane.

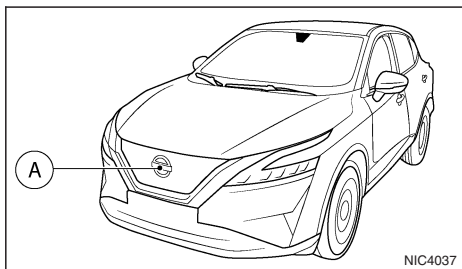

The I-FCW system uses a radar sensor (A) located on the front of the vehicle to measure the distance to a second vehicle ahead in the same lane.

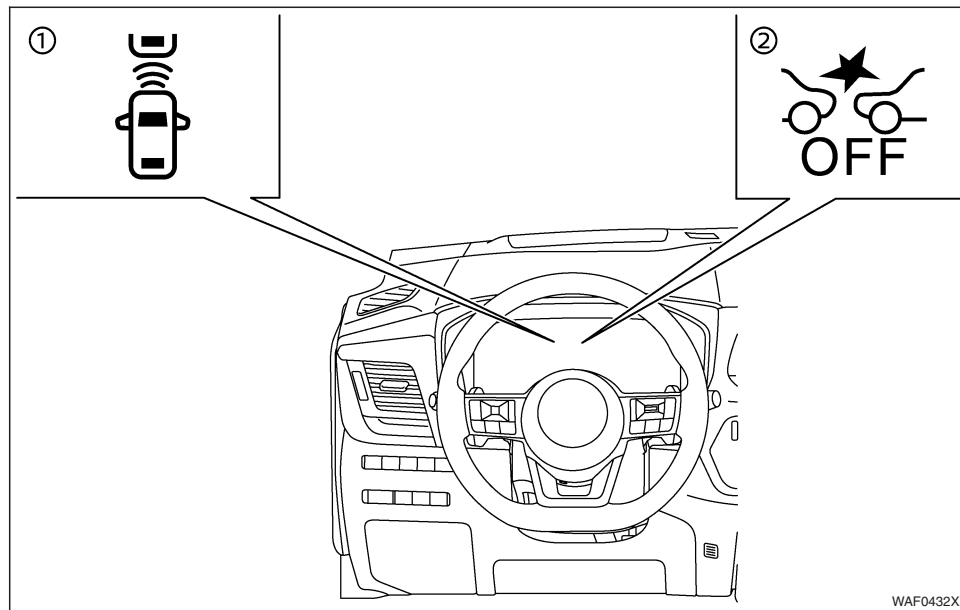

- ① Vehicle ahead detection indicator (on the vehicle information display)
- ② Intelligent Emergency Braking (IEB) system OFF warning light (on the meter panel)

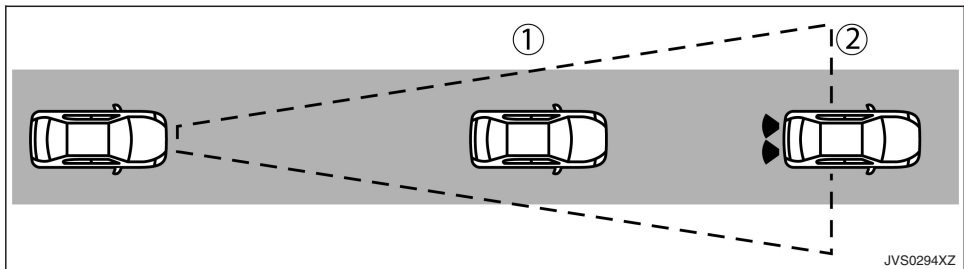

I-FCW SYSTEM OPERATION

The I-FCW system operates at speeds above approximately 5 km/h (3 MPH).

If there is a potential risk of a forward collision, the I-FCW system will warn the driver by blinking the vehicle ahead detection indicator, and sounding an audible alert.

TURNING THE I-FCW SYSTEM ON/OFF

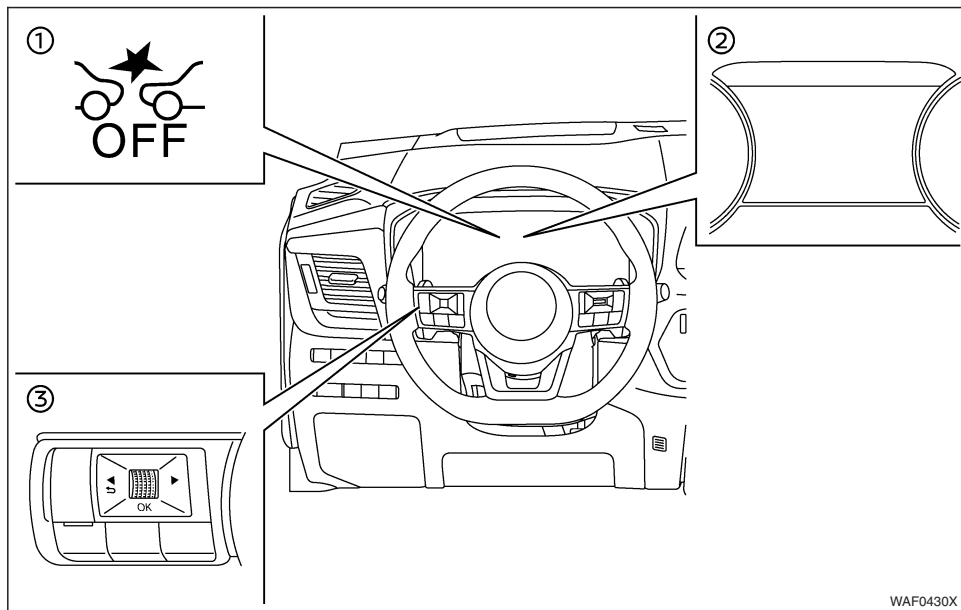

- ① IEB system OFF warning light (on the meter panel)
- ② Vehicle information display
- ③ Steering-wheel-mounted controls (left side)

Perform the following steps to turn the I-FCW system on or off.

1. Push the ◀ ▶ button until [Settings] appears in the vehicle information display and then push the scroll dial. Use the scroll dial to select [Driver Assistance]. Then push the scroll dial.
2. In the [Driver Assistance] menu, highlight the [Emergency Brake] item and push the scroll dial. This will turn the IEB system and I-FCW system on or off, if Rear Automatic Braking (RAB) is NOT fitted
3. (Only if Rear Automatic Braking (RAB) is fitted): Select [Front] and use the scroll dial to turn the system on or off.

When the I-FCW system is turned off, the IEB system OFF warning light (orange) illuminates.

NOTE

- The I-FCW system will be automatically turned on when the e-POWER system is restarted.
- The I-FCW system is integrated into the IEB system. There is not a separate selection for the I-FCW system. When the IEB system is turned off, the I-FCW system is also turned off.

I-FCW SYSTEM LIMITATIONS

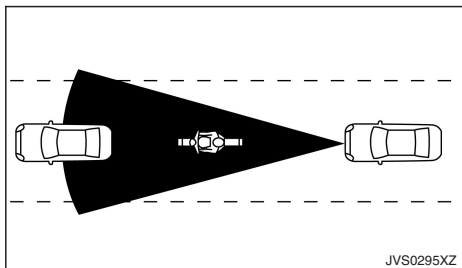

Illustration A

JVS0295XZ

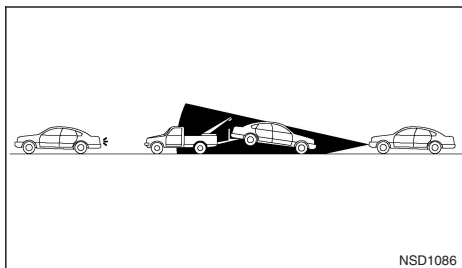

Illustration B

NSD1086

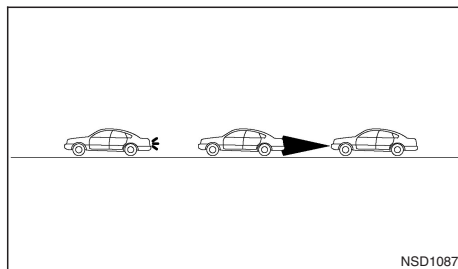

Illustration C

NSD1087

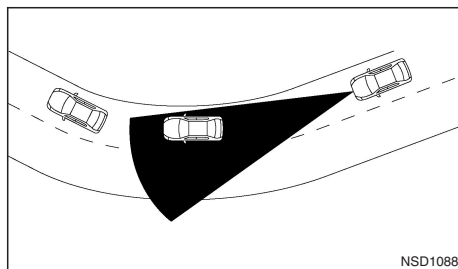

Illustration D

NSD1088

⚠ WARNING

Listed below are the system limitations for the I-FCW system. Failure to operate the vehicle in accordance with these system limitations could result in serious injury or death.

- The I-FCW system cannot detect all vehicles under all conditions.

- The radar sensor does not detect the following objects:

- Pedestrians, animals or obstacles in the roadway
- Oncoming vehicles
- Crossing vehicles

- (Illustration A) The I-FCW system does not function when a vehicle ahead is a narrow vehicle, such as a motorcycle.

- (Illustration B) When the vehicle ahead is being towed.

- The radar sensor may not detect a vehicle ahead in the following conditions:

- Snow or heavy rain
- Dirt, ice, snow or other material covering the radar sensor
- Interference by other radar sources
- Snow or road spray from travelling vehicles.
- Driving in a tunnel
- Towing a trailer

- (Illustration C) When the distance to the vehicle ahead is too close, the beam of the radar sensor is obstructed.

- (Illustration D) When driving on a steep downhill slope or roads with sharp curves.

- The system is designed to automatically check the sensor's functionality, within certain limitations. The system may not detect some forms of obstruction of the sensor area such as ice, snow, stickers, for example. In these cases, the system may not be able to warn the driver properly. Be sure that you check, clean and clear the sensor area regularly.
- Excessive noise will interfere with the warning chime sound, and the chime may not be heard.

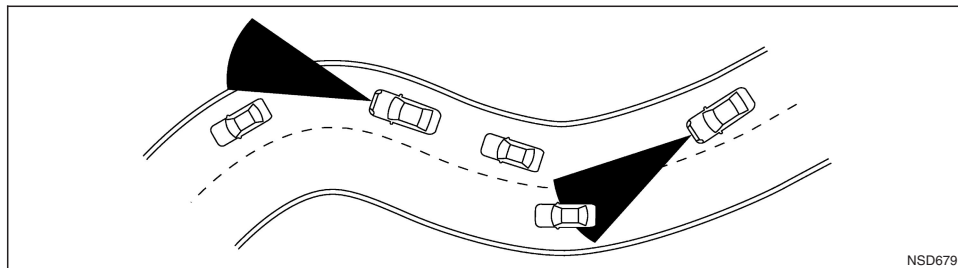

NSD679

When driving on some roads, such as winding, hilly, curved, narrow roads, or roads which are under construction, the radar sensor may detect vehicles in a different lane, or may temporarily not detect a vehicle travelling ahead. This may cause the I-FCW system to work inappropriately.

The detection of vehicles may also be affected by vehicle operation (steering manoeuvre or travelling position in the lane, etc.) or vehicle condition. **If this occurs, the system may warn you by blinking the vehicle ahead detection indicator and sounding the chime unexpectedly. You will have to manually control the proper distance away from the vehicle travelling ahead.**

SYSTEM TEMPORARILY UNAVAILABLE

Condition A

When the radar sensor picks up interference from another radar source, making it impossible to detect a vehicle ahead, the I-FCW system is automatically turned off. The IEB system OFF warning light (orange) will flash.

Action to take:

When the above conditions no longer exist, the I-FCW system will resume automatically.

Condition B

Under the following conditions, making it impossible to detect a vehicle ahead, the I-FCW system is automatically turned off.

The IEB system OFF warning light (orange) will flash and the [Temporarily Disabled Front Radar Blocked] warning message will appear in the vehicle information display.

- When the sensor area of the front of the vehicle is covered with dirt or is obstructed

Action to take:

If the warning light (orange) flashes, stop the vehicle in a safe place, push the P position switch to engage the P (Park) position and turn the e-POWER system off. Clean the radar cover on the front of the vehicle with a soft cloth, and restart the e-POWER system. If the warning light continues to illuminate, have the I-FCW system checked. It is recommended you visit a NISSAN dealer or qualified workshop for this service.

- When driving on roads with limited road structures or buildings (for example, long bridges, deserts, snow fields, driving next to long walls)

Action to take:

When the above conditions no longer exist, the I-FCW system will resume automatically.

SYSTEM MALFUNCTION

If the I-FCW system malfunctions, it will be turned off automatically, a chime will sound, the IEB system OFF warning light (orange) will illuminate and the [System Fault] warning message will appear in the vehicle information display.

Action to take:

If the warning light (orange) illuminates, stop the vehicle in a safe location. Turn the e-POWER system off and restart the e-POWER system. If the warning

light continues to illuminate, have the I-FCW system checked. It is recommended you visit a NISSAN dealer or qualified workshop for this service.

SYSTEM MAINTENANCE

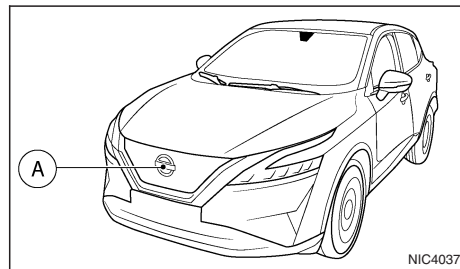

The sensor (A) is located at the front of the vehicle.

To keep the system operating properly, be sure to observe the following:

- Always keep the sensor area clean.
- Do not strike or damage the areas around the sensor.
- Do not cover or attach stickers or similar objects near the sensor area. This could cause failure or malfunction.
- Do not attach metallic objects near the sensor area (brush guard, etc.) This could cause failure or malfunction.
- Do not alter, remove or paint the front of the vehicle near the sensor area. Before customising or restoring the sensor area, it is recommended that you visit a NISSAN dealer or qualified workshop.

INTELLIGENT EMERGENCY BRAKING (IEB) SYSTEM (where fitted)

WARNING

Failure to follow the warnings and instructions for proper use of the IEB system could result in serious injury or death.

- The IEB system is a supplemental aid to the driver. It is not a replacement for the driver's attention to traffic conditions or responsibility to drive safely. It cannot prevent accidents due to carelessness or dangerous driving techniques.
- The IEB system does not function in all driving, traffic, weather and road conditions.

There are three types of IEB available, the type fitted to your vehicle depends on the vehicle specification:

- Intelligent Emergency Braking (IEB).
- Intelligent Emergency Braking (IEB) with Pedestrian Detection.
- Intelligent Emergency Braking (IEB) with Pedestrian and Cyclist Detection and Junction Support.

Depending on the specification of the IEB system fitted to your vehicle, IEB can assist the driver when there is a risk of a forward collision with:

- A vehicle ahead in the travelling lane.
- A pedestrian ahead in the travelling lane (where Pedestrian Detection is fitted).
- A cyclist ahead in the travelling lane (where Cyclist Detection is fitted).

Junction assist (where fitted) can assist the driver when there is a risk of a forward collision

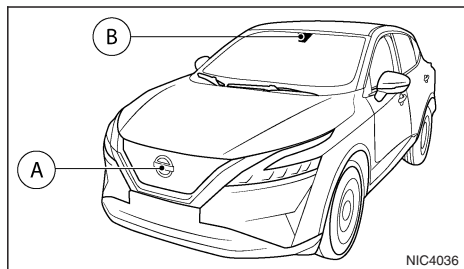

- When you turn right or left and cross the path of an oncoming vehicle.
- When you turn right or left, a pedestrian is detected in the forward direction and is expected to enter your vehicle's path.

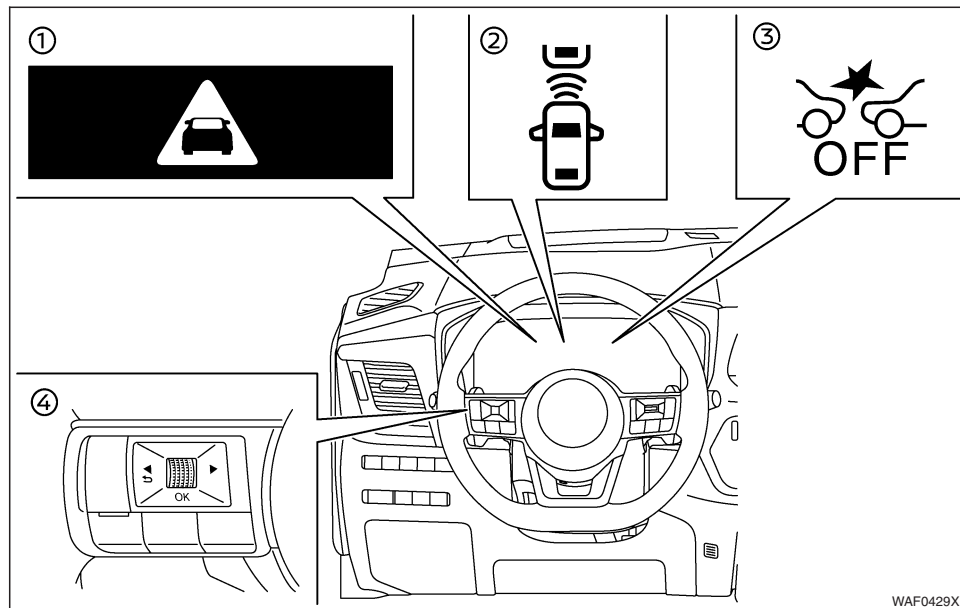

The IEB system uses a radar sensor (A) located on the front of the vehicle and camera (B) installed behind the windscreen in to measure the distance to the vehicle, pedestrians and cyclists ahead in the same lane (where pedestrian or pedestrian and cyclist detection is fitted).



- ① IEB emergency warning indicator
- ② Vehicle ahead detection indicator (on the vehicle information display)
- ③ IEB system OFF warning light (on the meter panel)
- ④ Steering-wheel-mounted controls (left side)

Warning	Visual	Audible
First		Chime
Second		High pitched chime

Overview of warnings

IEB SYSTEM OPERATION

If a risk of a forward collision is detected, the IEB system will first provide a warning to the driver by flashing the warning (yellow) in the vehicle information display and providing an audible alert, and causing the brake system to pulse (quickly partially apply). In addition, the IEB system applies partial braking. If the driver applies the brakes quickly and forcefully, but the IEB system detects that there is still the possibility of a forward collision, the system will automatically increase the braking force.

If the driver does not take action, the IEB system issues the second visual warning (flashing red and white) and audible warning, then the system applies partial braking when the condition to do so is satisfied. If the risk of a collision becomes imminent, the IEB system applies harder braking automatically.

The IEB system will function when your vehicle is driven at speeds above approximately 5 km/h (3 MPH). For the pedestrian and cyclist detection func-

tion (where fitted), the IEB system operates at speeds between 10 and 80 km/h (6 and 50 MPH).

Junction assist (where fitted) operates at your vehicle speeds between 10 - 25 km/h (6 - 16 MPH).

When turning left or right, the turn signal must be activated to ensure that oncoming vehicles can be detected by Junction assist.

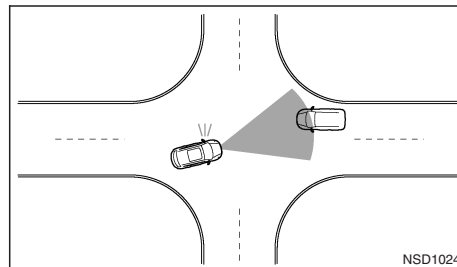

Junction assist (where fitted) for oncoming vehicle

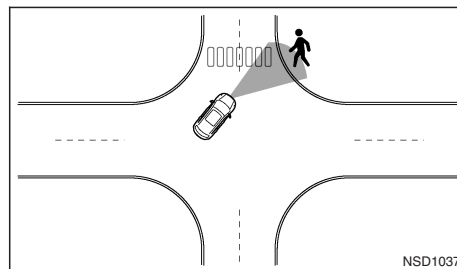

Junction assist (where fitted) for pedestrian

NOTE

- The vehicle's brake lights come on when braking is performed by the IEB system.
- When the IEB system detects an obstacle in the path of the vehicle and displays the IEB warning, a noise may be heard from the engine bay as the vehicle primes the brakes to improve response time.

Depending on vehicle speed and distance to the vehicle or pedestrian or cyclist ahead, as well as driving and roadway conditions, the system may help the driver avoid a forward collision or may help mitigate the consequences of a collision, should one be unavoidable. If the driver is handling the steering wheel, accelerating or braking, the IEB system will function later or will not function.

If the IEB system has stopped the vehicle, the vehicle will remain at a standstill for approximately 2 seconds before the brakes are released.

If the brake pedal is depressed while the brakes are being applied by the system, you may feel the pedal effort has changed and may hear a sound and feel vibration. This is normal and does not indicate a malfunction. In addition, the braking force can be increased by increasing the pedal effort.

The automatic braking will cease under the following conditions:

- When the steering wheel is turned as far as necessary to avoid a collision.
- When there is no longer a vehicle or pedestrian or cyclist detected ahead.
- When the accelerator pedal is depressed.

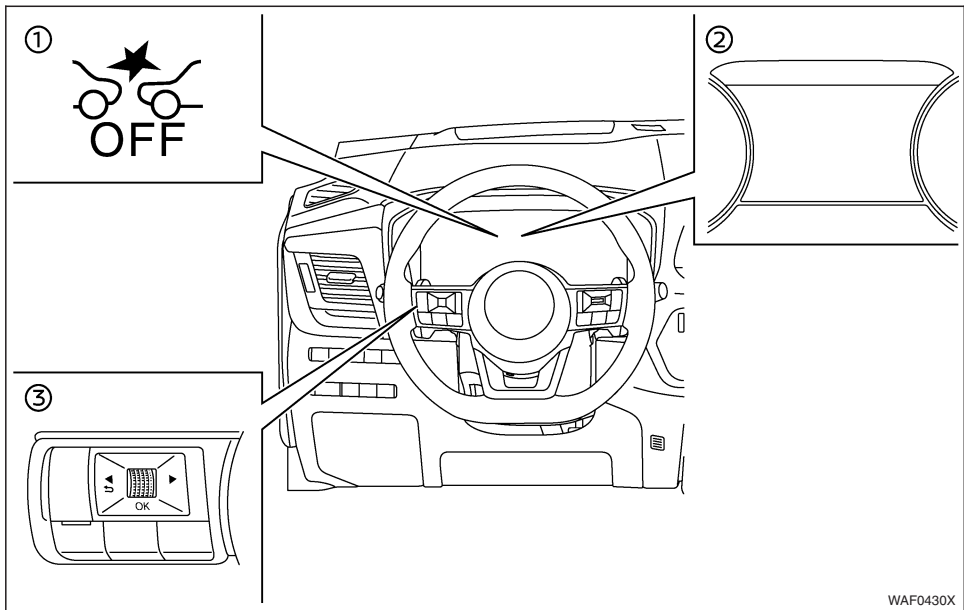

- ① IEB system OFF warning light (on the meter panel)
- ② Vehicle information display
- ③ Steering-wheel-mounted controls (left side)

Turning the Intelligent Emergency Braking (IEB) system ON/OFF

Perform the following steps to turn the IEB system ON or OFF.

1. Push the ◀ ▶ button on the left side of the steering wheel until the [Settings] menu appears in the Vehicle Information Display, then push the scroll dial.

For details, see "Vehicle information display" in the "2. Instruments and controls" section.
2. Use scroll dial to select the [Driver Assistance] menu then push the scroll dial.
3. In the [Driver Assistance] menu, highlight the [Emergency Brake] item and push the scroll dial. This will turn the IEB system on or off, if Rear Automatic Braking (RAB) is NOT fitted
4. (Only if Rear Automatic Braking (RAB) is fitted): Select [Front] and use the scroll dial to turn the system on or off.

When the IEB system is turned off, the IEB system OFF warning light will illuminate.

NOTE

- **Disabling the ESP system causes the Intelligent Emergency Braking system to become unavailable regardless of settings selected in the Vehicle Information Display.**
- **The IEB system will be automatically turned ON when the e-POWER system is restarted.**

- The Intelligent Forward Collision Warning (I-FCW) system is integrated into the IEB system. There is not a separate selection for the I-FCW system. When the IEB system is disabled, the I-FCW system is also turned off.

IEB system limitations

WARNING

Listed below are the system limitations for the IEB system. Failure to operate the vehicle in accordance with these system limitations could result in serious injury or death.

- The IEB system cannot detect all vehicles, pedestrians or cyclists under all conditions.
- The IEB system does not detect the following objects:
 - Small pedestrians (including small children) and animals.
 - Pedestrians in wheelchairs or using mobile transport such as scooters, child-operated toys, or skateboards.
 - Pedestrians who are seated or otherwise not in a full upright standing or walking position.
 - Crossing vehicles.
 - Obstacles on the roadside.
 - Parked vehicles

- Junction Assist (where fitted) does not detect the following:

- Oncoming vehicle in front of your vehicle.

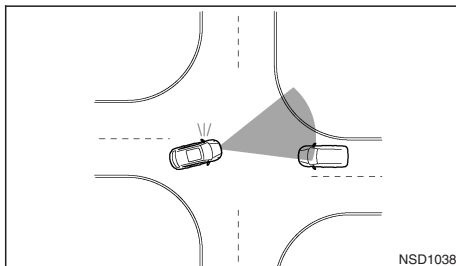

- The IEB system has some performance limitations.
 - If a stationary vehicle is in the vehicle's path, the IEB system will not function when the vehicle is driven at speeds over approximately 100 km/h (62 MPH).
- The IEB system with pedestrian and cyclist detection (where fitted) may not function for pedestrians and cyclists in darkness or in tunnels, even if there is street lighting in the area.
- The IEB system may not function if the vehicle ahead is narrow (e.g. a motorcycle).
- The IEB system may not function if the speed difference between the two vehicles is too small.
- The IEB system may not apply braking when the vehicle speed is high in the operation range.

- For pedestrians, the IEB with pedestrian detection system (where fitted) will not issue the first warning.
- The IEB system may not function properly or detect a vehicle, pedestrian or cyclist ahead in the following conditions:
 - In dark or dimly lit conditions, such as at night or in tunnels, including cases where your vehicle's headlights are off or dim, or the tail lights of the vehicle ahead are off.
 - When the direction of the camera is misaligned.
 - Poor visibility (conditions such as rain, snow, fog, dust storms, sand storms, and road spray from other vehicles).
 - Driving on a steep downhill slope or roads with sharp curves.
 - Driving on a bumpy road surface, such as an uneven dirt road.
 - If dirt, ice, snow or other material is covering the radar sensor area.
 - Interference by other radar sources.
 - The camera area of the windscreen is fogged up, covered with dirt, water drops, ice, snow, etc.
 - Strong light (e.g. sunlight or high beams from oncoming vehicles) enters the front camera. Strong light causes the area around the pedestrian or cyclist to be cast in shadow, making it difficult to see.

- A sudden change in brightness occurs. For example, when the vehicle enters or exits a tunnel or a shaded area or lightning flashes.
- The poor contrast of a person to the background, such as having clothing coloured or patterned similar to the background.
- The pedestrian's profile is partially obscured or unidentifiable due to the pedestrian transporting luggage, wearing bulky or very loose-fitting clothing or accessories.
- When your vehicle's position or movement is changed quickly or significantly (for example, lane change, turning vehicle, abrupt steering, sudden acceleration or deceleration).
- When your vehicle or the vehicle, pedestrian or cyclist ahead moves quickly or significantly such that the system cannot detect and react in time (for example, pedestrian moving quickly toward the vehicle at close range, vehicle cutting in, changing lanes, making a turn, steering abruptly, sudden acceleration or deceleration).
- When the vehicle, pedestrian or cyclist is offset from the vehicle's forward path.
- If the speed difference between the two vehicles is small.
- For approximately 15 seconds after starting the e-POWER system.
- If the vehicle ahead or oncoming vehicle has a unique or unusual shape, extremely

low or high clearance heights, or unusual cargo loading or is narrow (for example, a motorcycle).

- When the vehicle, pedestrian or cyclist is located near a traffic sign, a reflective area (for example, water on road), or is in a shadow.
- When multiple pedestrians or cyclists are grouped together.
- When the view of the pedestrian or cyclist is obscured by a vehicle or other object.
- While towing a trailer or other vehicle.
- Junction Assist (where fitted) may not operate properly or detect an oncoming vehicle or pedestrian in the following conditions:
 - When driving in a traffic lane separated by more than 2 lanes from oncoming vehicles while making a right/left turn
 - When not heading directly towards an oncoming vehicle during a right/left turn.
 - When crossing an oncoming vehicle lane and an oncoming vehicle approaches.

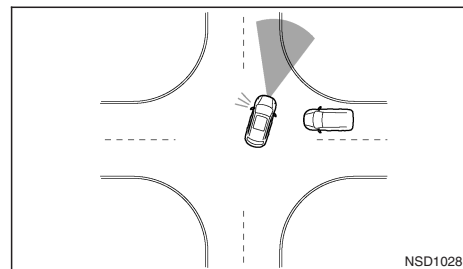

- When turning sharply or on a very wide curve.
- When the centre line is not recognised by the system.
- When there are a number of oncoming vehicles following each other in a row.

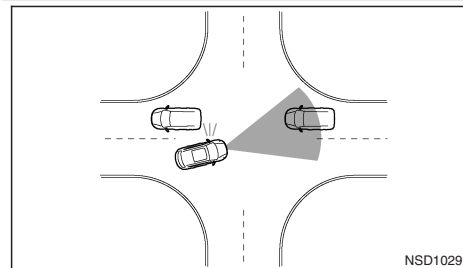

- When the lane is wider or narrower than normal.

- When the centre line is located close to a road marker.
- The system performance may degrade in the following conditions:
 - The vehicle is driven on a slippery road.
 - The vehicle is driven on a slope.
 - Excessively heavy luggage is loaded in the rear seat or the luggage area of your vehicle.
 - When the coast stop system is active.
- The system is designed to automatically check the sensor (radar and camera) functionality, within certain limitations. The system may not detect some forms of obstruction of the sensor area such as ice, snow, stickers, etc. In these cases, the system may not be able to warn the driver properly. Be sure that you check, clean and clear sensor areas regularly.
- In some road or traffic conditions, the IEB system may unexpectedly apply partial braking. When acceleration is necessary, continue to depress the accelerator pedal to override the system.
- Excessive noise will interfere with the warning chime sound, and the chime may not be heard.
- Braking distances increase on slippery surfaces.

- The Intelligent Emergency Braking system may operate when the following are similar to the outlines of pedestrians or cyclists, or if they are the same size and position as a vehicle's and motorcycle's tail lights.
 - Paint, a shadow or a pattern on the road, roadside or wall (including faded and unusual road markings).
 - A shape formed by road structures ahead (such as tunnels, viaducts, traffic sign, reflection sheets, and guardrails), road side objects (trees, buildings) and light sources.
 - A shape formed by road side objects, such as trees, lighting, shadows, or buildings.
- The IEB system may keep operating when the vehicle ahead is turning right or left.
- The IEB system may operate when your vehicle is approaching and passing a vehicle ahead.
- Depending on the road shape (curved road, entrance and exit of the curve, winding road, lane regulation, under construction, etc.), the function may operate temporarily for the oncoming vehicle in front of your vehicle.

- The Intelligent Emergency Braking with pedestrian detection system (where fitted) may react to:

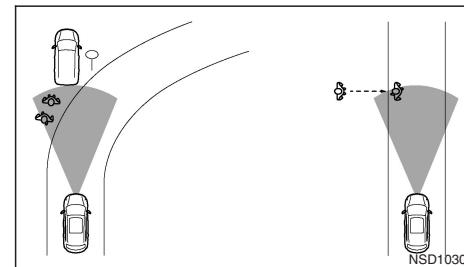

- Objects on the roadside (traffic sign, guard rail, pedestrian, cyclist, motorcycle, vehicle, etc.).
- Objects above the road (low bridge, traffic sign, etc.).
- Objects on the road surface (railroad track, grate, steel plate, etc.).
- Objects in a parking garage (beam, pillar, etc.).
- Pedestrians or cyclists or motorcycles approaching the travelling lane.
- Pedestrians and cyclists when driving down narrow alleys, for example.
- Pedestrians and cyclists who temporarily move into or approach the driving lane to avoid obstacles at the side of the road.
- Objects on the road such as trees.

- Vehicles, pedestrians, cyclists, motorcycles or objects in adjacent lane or close to the vehicle.
- Oncoming pedestrians, cyclists.
- **Junction Assist (where fitted) may react to the following while making a right/left turn:**
 - When an oncoming vehicle or a crossing pedestrian has already exited the path of your vehicle.
 - If you are closely in front of an oncoming vehicle or a crossing pedestrian.
 - When an oncoming vehicle or a crossing pedestrian stops before entering the path of your vehicle.
 - When an oncoming vehicle turns right or left in front of your vehicle.
- **Junction Assist (where fitted) may also react to the following:**
 - When oncoming vehicle movement cannot be predicted due to sudden left/right turns or deceleration of the oncoming vehicles.
- **Braking distances increase on slippery surfaces.**
- **Excessive noise will interfere with the warning chime and the chime may not be heard.**

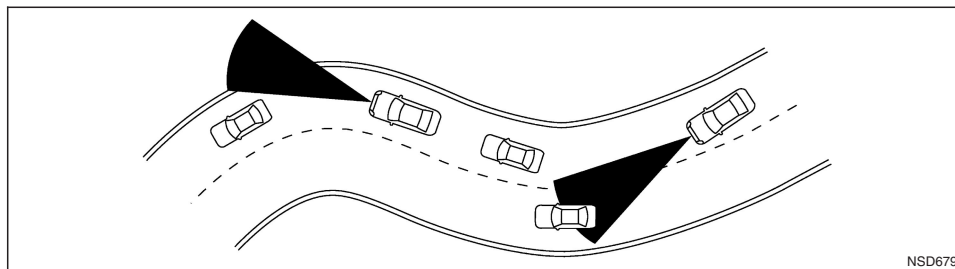

NSD679

When driving on some roads, such as winding, hilly, curved, narrow roads, or roads which are under construction or on a slope, the sensor may detect vehicles in a different lane, or may temporarily not detect a vehicle travelling ahead. This may cause the system to work inappropriately.

The detection of vehicles may also be affected by vehicle operation (steering manoeuvre or travelling position in the lane, etc.) or vehicle condition. **If this occurs, the system may warn you by blinking the system indicator and sounding the chime unexpectedly. You will have to manually control the proper distance to the vehicle travelling ahead.**

System temporarily unavailable

Condition A:

In the following conditions, the IEB system warning light blinks and the system will be turned off automatically.

- The camera area of the windscreen is misted or frozen.
- The camera area of the windscreen is continuously covered with dirt, etc.

Action to take:

Check that the windscreen is clean and free from ice/mist in front of the camera. If necessary, operate the Max Demist function or heated front screen to clear. This may take several minutes.

When the above condition no longer exists, the IEB system will resume automatically.

Condition B:

In the following conditions, the Intelligent Emergency Braking warning light will blink, with no accompanying message in the vehicle information display.

- Strong light is shining onto the front of the vehicle.
- The cabin temperature is over approximately 40 °C (104 °F) in direct sunlight.
- The radar sensor can receive interference from other radar sources, and excessive reflection from other vehicles (for example, when travelling past vehicles in a traffic jam).
- The camera unit detects that it is not correctly aligned.

Action to take:

None. When the above condition no longer exists, the IEB system will resume automatically.

NOTE

If the inside of the windscreen in front of the camera is misted or frozen, it will take a period of time to for it to clear after the air conditioner turns on. If dirt appears in this area, it is recommended you visit a NISSAN dealer.

Condition C:

In the following condition, the Intelligent Emergency Braking warning light (yellow) will blink and the [Temporarily Disabled Front Radar Blocked] warning message will appear in the Vehicle Information Display.

- The sensor area on the front of the vehicle is covered with dirt or is obstructed.

Action to take:

If the warning light (yellow) blinks, stop the vehicle in a safe place and turn the e-POWER system off. Check if the sensor area around the NISSAN emblem at the centre of the front grille is clean, and if necessary, clean this area on the front of the vehicle with a soft cloth. Restart the e-POWER system. If the warning light continues to blink after driving for a few minutes, have the Intelligent Emergency Braking system checked by a NISSAN dealer or qualified workshop.

Condition D:

In the following condition, the Intelligent Emergency Braking warning light (yellow) will blink and the

[Temporarily Disabled Front Radar Blocked] warning message will appear in the Vehicle Information Display.

- When driving on roads with limited road structures or buildings (for example, long bridges, deserts, snow fields, driving next to long walls).

Action to take:

When the above conditions no longer exist, the Intelligent Emergency Braking system will resume automatically.

Condition E:

When the Electronic Stability Program (ESP) system is turned OFF, the IEB system braking will not operate. In this case only the visible and audible warning operates. The IEB system warning light (yellow) will illuminate.

Action to take:

When the ESP system is ON, the Intelligent Emergency Braking system will resume automatically.

System malfunction

If the IEB system malfunctions, it will be turned off automatically, a chime will sound, the IEB system warning light (yellow) will illuminate and the warning message [System Fault] will appear in the Vehicle Information Display.

Action to take:

If the warning light (yellow) comes on, park the vehicle in a safe location, turn the e-POWER system off and restart the e-POWER system. If the warning light continues to illuminate, have the IEB system checked by a NISSAN dealer or qualified workshop.

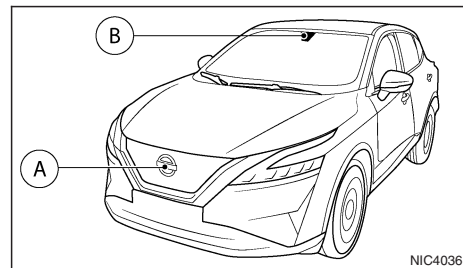
SYSTEM MAINTENANCE

The sensor (A) is located at the front of the vehicle.

The camera (B) is located on the upper side of the windscreen.

The sensor for the Intelligent Emergency Braking system (A) is located at the front of the vehicle.

To keep the Intelligent Emergency Braking system operating properly, be sure to observe the following:

- Always keep the sensor area clean.
- Do not strike or damage the areas around the sensor.
- Do not cover or attach stickers or similar objects near the sensor area. This could cause failure or malfunction.
- Do not attach metallic objects near the sensor area (brush guard, etc.) This could cause failure or malfunction.

INTELLIGENT DRIVER ALERTNESS (where fitted)

- Do not place reflective materials, such as white paper or a mirror, on the instrument panel. The reflection of sunlight may adversely affect the camera unit's detection capability.
- Do not alter, remove or paint the front of the vehicle near the sensor area. Before customising or restoring the sensor area, it is recommended that you visit a NISSAN dealer or qualified workshop.

For the radio approval numbers and information, see "Radio frequency approval" in the "9. Technical information" section.

WARNING

Failure to follow the warnings and instructions for proper use of the Intelligent Driver Alertness system could result in serious injury or death.

- **The Intelligent Driver Alertness system is only a warning to inform the driver of a potential lack of driver attention or drowsiness. It will not steer the vehicle or prevent loss of control.**
- **The Intelligent Driver Alertness system does not detect and provide an alert of the driver's lack of attention or fatigue in every situation.**
- **It is the driver's responsibility to:**
 - stay alert,
 - drive safely,
 - keep the vehicle in the travelling lane,
 - be in control of the vehicle at all times,
 - avoid driving when tired,
 - avoid distractions (texting, etc.).

The Intelligent Driver Alertness system helps alert the driver if the system detects a lack of attention or driving fatigue.

The system monitors driving style and steering behaviour over a period of time, and it detects changes from the normal pattern. If the system detects that driver attention is decreasing over a period of time, the system uses an audible and visual warning to suggest that the driver take a break.

SYSTEM OPERATION



If the system detects that driver fatigue increases or that driver attention is decreasing, the message [Take a break?] appears in the Vehicle Information Display and a chime sounds when the vehicle is driven at speeds above 60 km/h (37 MPH).

The system continuously monitors driver attention and can provide multiple warnings per trip.

The system resets and starts reassessing driving style and steering behaviour when the power switch is cycled from the **ON** to **OFF** and back to **ON**.

The system will not operate when Steering Assist system is activated.

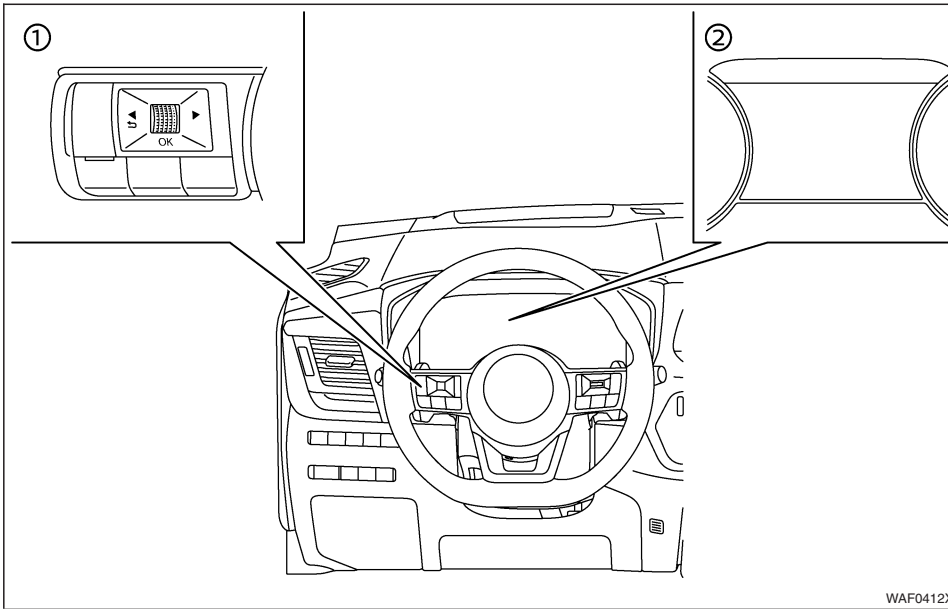

WAF0412X

System Activation/Deactivation

Perform the following steps to enable or disable the Intelligent Driver Alertness system.

1. Use the ◀ or ▶ button on the steering wheel until [Settings] is shown on the Vehicle Information Display and push the scroll dial.
2. Use the scroll dial to select [Driver Assistance]. Then push the scroll dial.

3. Use the scroll dial to select [Driver Attention Alert]. Then push the scroll dial.

NOTE

- **The Intelligent Driver Alertness system will automatically be turned on when the e-POWER system is restarted.**
- **As long as Steering Assist (where fitted) is activated the Intelligent Driver Alertness system**

will be deactivated. Turning off Steering Assist reactivates the Intelligent Driver Alertness system.

Intelligent Driver Alertness Limitations

⚠ WARNING

Listed below are the system limitations for the Intelligent Driver Alertness system. Failure to operate the vehicle in accordance with these system limitations could result in serious injury or death.

- **The Intelligent Driver Alertness system may not operate properly and may not provide an alert in the following conditions:**
 - Poor road conditions such as an uneven road surface or pot holes.
 - Strong side wind.
 - If you have adopted a sporty driving style with higher cornering speeds or higher rates of acceleration.
 - Frequent lane changes or changes to vehicle speed.
- **The Intelligent Driver Alertness system may not provide an alert in the following conditions:**
 - Vehicle speeds lower than 60 km/h (37 MPH).
 - Short lapses of attention.
 - Instantaneous distractions such as dropping an object.
 - Instantaneous distractions such as dropping an object.

PARKING

- While Steering Assist is activated.

System Malfunction

If the Intelligent Driver Alertness system malfunctions, the [Driver Attention Alert] [System Fault] warning message will appear in the Vehicle Information Display and the function will be stopped automatically.

Action to take:

Stop the vehicle in a safe location, and then turn off and restart the e-POWER system. If the warning message continues to appear, have the Intelligent Driver Alertness system checked by a NISSAN dealer or qualified workshop.

WARNING

- Do not park the vehicle over flammable materials, such as dry grass, waste paper, or rags. They may ignite and cause a fire.
 - Safe parking procedures require that:
 - The parking brake is applied.
 - The shift control system is placed in the P (Park) position.
- Failure to follow the above recommendations could cause the vehicle to move unexpectedly or roll away and result in an accident.
- Never leave the e-POWER system running while the vehicle is unattended.
 - Do not leave children unattended inside the vehicle. They could unknowingly activate switches or controls, or move the vehicle. Unattended children could become involved in serious accidents.
 - To help avoid risk of injury or death through unintended operation of the vehicle and/or its systems, do not leave children, people who require the assistance of others or pets unattended in your vehicle. Additionally, the temperature inside a closed vehicle on a warm day can quickly become high enough to cause a significant risk of injury or death to people and pets.

Fully depress the brake pedal and press the P position switch to shift to the P (Park) position.

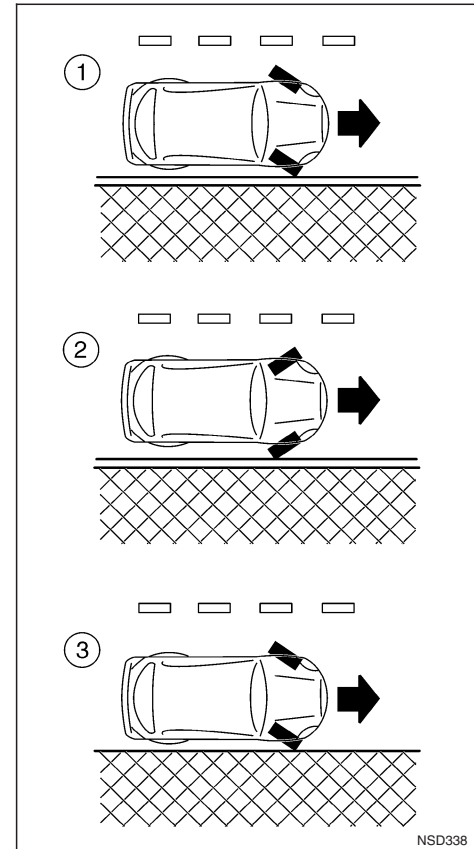

NSD338

LHD models

INTELLIGENT PARKING ASSIST (IPA) (where fitted)

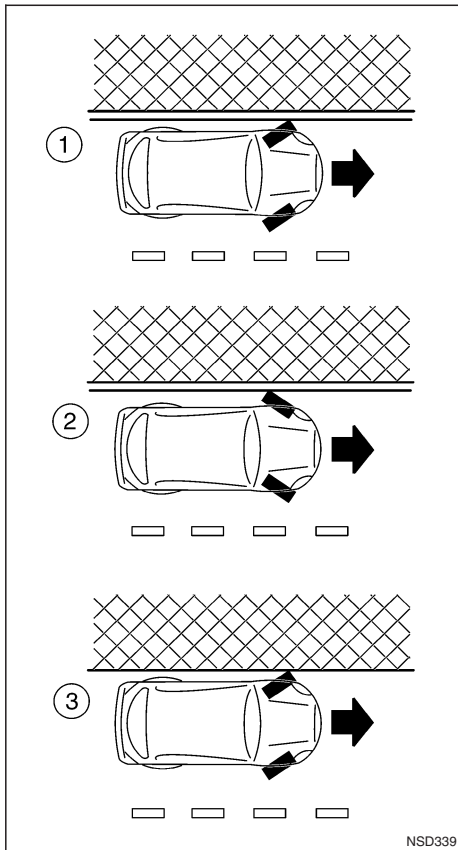

When parked on a sloping driveway, turn the wheels so the vehicle will not roll into the street in case it moves.

FACING DOWNHILL: ①

Turn the wheels into the kerb, allow the vehicle to move forward until the kerb side wheel gently touches the kerb. Then set the parking brake.

FACING UPHILL: ②

Turn the wheels away from the kerb and allow the vehicle to move back until the kerb side wheel gently touches the kerb. Then set the parking brake.

NO KERB — FACING DOWNHILL OR UPHILL: ③

Turn the wheels toward the side of the road so the vehicle will move away from the centre of the road if it moves. Then set the parking brake.

Switch the power switch OFF.

WARNING

- The Intelligent Parking Assist (IPA) system is a guidance system to support the driver when parking the vehicle. However, it does not automatically adjust speed or avoid obstacles. Just as for normal parking, always check the surroundings of the vehicle and the condition of the road surface in the mirror or directly. Move the vehicle slowly while the system is operating and brake if necessary (for example, when the vehicle is likely to come in contact with other vehicles, obstacles, people, etc.).
- During IPA system operation, do not touch the spoke part of the steering wheel. Your hands and fingers might get injured. In addition, be careful with ties, scarves, etc. that can also get caught, which may lead to injuries.
- Never look only at the screen while driving. The vehicle may come into contact with obstacles or cause unexpected accidents.
- When the guidance of the IPA system is no longer required, select [Cancel] on the screen to end the function. If the IPA system remains in operation, the steering wheel might operate automatically, which could lead to unexpected accidents.
- Before using the IPA system, make sure that there is enough space around the vehicle to manoeuvre.

The IPA system controls steering, guiding the vehicle when parking:

- In a bay
- Parallel to the road

NOTE

The IPA system instructs you to stop, drive forwards or drive backwards. Follow the instructions given by the system.

The IPA system is not able to support parking when the vehicle speed during the parking manoeuvre is more than 7 km/h (4 MPH).

CAUTION

Do not use the IPA system under the following conditions:

- On unpaved roads.
- On snow-covered or frozen roads.
- On uneven roads with slants, bumps, kerbstones, wheel tracks, etc.
- At mechanical parking facilities.
- When tyre chains or a spare tyre are installed.
- When the vehicle is being towed.
- When the doors (including the tailgate) are not closed.

The following conditions may reduce the ability of the system to detect other vehicles:

- Severe weather.
- Road spray.
- Ice build up on the vehicle.
- Frost on the vehicle.

- **Dirt on the vehicle.**

Do not attach stickers (including transparent material), install accessories or apply additional paint near the sonar sensors. These conditions may reduce the ability of the system to detect other vehicles.

The sonar sensors detect stationary objects behind the vehicle. The sonar sensors may not detect:

- Small or moving objects.
- Wedge-shaped objects.
- Objects close to the bumper.
- Thin objects such as rope, wire, or chain.

NOTE

Under the following conditions, the IPA may not be able to predict precise courses and function properly. There may be instances where surrounding objects and vehicles are displayed inside the clearance guidelines (red), or where the vehicle cannot be parked in the correct spot following the IPA operation.

- When the shift lever is operated while driving.
- When sudden start, sudden stop or sudden operation of the shift lever occurs.
- When tyre pressure is too low or a tyre is worn out.
- When tyres are installed that are of a different size from the tyres that were equipped at the time of factory shipment.
- When the vehicle is heavily laden.

DEACTIVATION OF THE IPA SYSTEM

The IPA will deactivate under the following conditions:

- When the steering wheel is operated manually.
- When 5 seconds have passed since the shift control system was placed and kept in the N (Neutral) position.
- When reversing operations are conducted more than 15 times for steering corrections.
- When the system judges that conditions (such as worn out or low pressure tyres, road conditions for example) are not suitable for correct course predictions.
- When the vehicle reverses to a position behind the position where the IPA operation started.
- When the vehicle speed exceeds approximately 7 km/h (4 MPH).
- When the driver does not follow the IPA guidance.

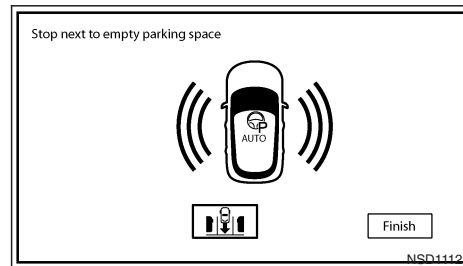



Camera interruption screen

Automatic cancellation

When the shift control system is not in the R (Reverse) position and the vehicle speed increases above approximately 10 km/h (6 MPH), the camera view from the Intelligent Parking Assist system will be suspended to prohibit the display of video images to the driver during driving. This is not a malfunction.

When the vehicle speed increases above approximately 30 km/h (18 MPH), the camera view from the Intelligent Parking Assist system will be cancelled and the system returns to the previously selected source.

NOTE

When the wipers are operating or when water or other substances on the camera lens is detected, the  sign is displayed. When the  sign is displayed, the detectable parking positions are restricted.

PARKING PROCEDURE USING THE IPA SYSTEM

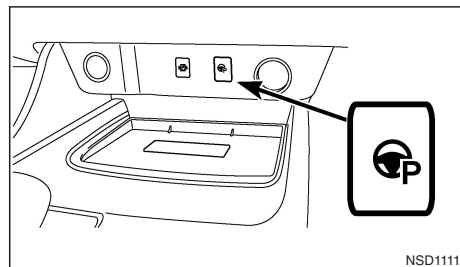

IPA switch (where fitted)

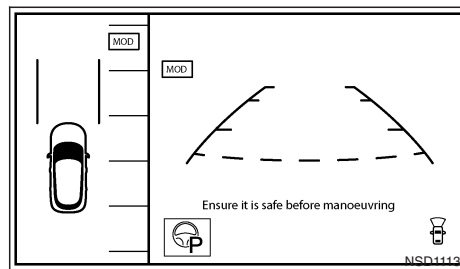

Using text guidance, the system provides step-by-step instructions for parking. The IPA buttons are located in the lower centre of the screen.

Parallel parking

The system detects parking slots and shows the status by displayed text messages.

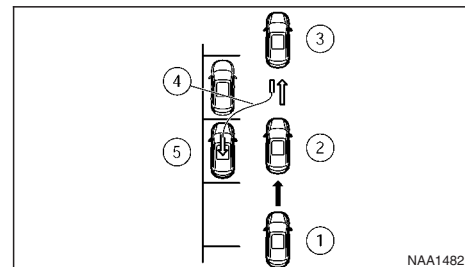

Parallel parking procedure

1. Press the **<CAMERA>** button to display the Intelligent Around View Monitor (IAVM) on the centre display.

Press the IPA button  on the screen or the IPA switch (where fitted) on the lower instrument panel.

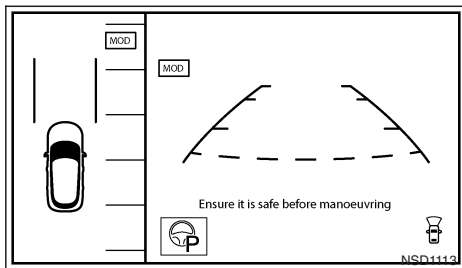

2. Press Parking Mode button  and check the parallel parking mode is displayed.

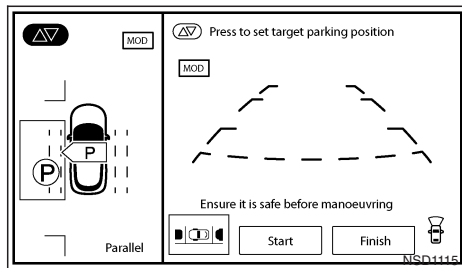
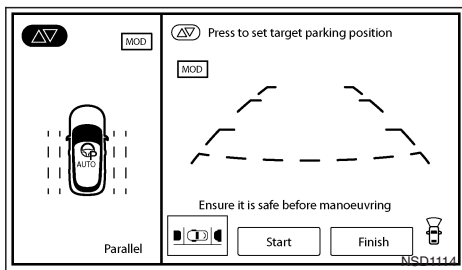

NOTE

Use the turn signal switch to select the side of the vehicle the IPA system should use to find a parking space. The scanning area will change sides, depending upon the position of the turn signal switch.

Drive the vehicle forward at a steady pace along side the row of parked vehicles. The system will search for a parking space. The IPA system will inform you when it finds a suitable parking space. When parking slots cannot be detected, a target parking rectangle is displayed at a default position by pressing the  button. Then you can press [Start].

3. Slowly move the vehicle forward to the correct position until the IPA system instructs you to stop and select reverse gear.

WARNING

If there is any doubt that the surroundings in the path of the parking area and/or the parking area itself are not free from obstacles immediately stop the vehicle and check.

NOTE

Make sure the vehicle is stopped completely before shifting to the R (Reverse) position.

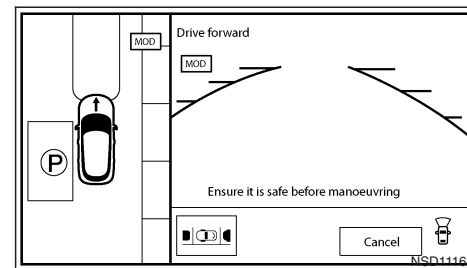

4. Follow the instructions given by the system. Shift to the R (Reverse) position.

Gently place your hands on the steering wheel and slowly reverse towards the parking space.

The steering will be operated automatically. Carefully and slowly accelerate while checking the surroundings.

Do not turn the steering wheel.

The system indicates when the parking procedure has ended.

NOTE

- Only the steering operates automatically.

- Follow the instructions given by the system.
- Carefully and slowly accelerate while checking the surroundings.
- Use of the steering wheel will cancel the IPA operation.

5. When the vehicle is in the target parking position, check, then depress the brake pedal to stop the vehicle.

When the vehicle reaches the approximate area of the target parking space, a chime will sound, [Park assist finished] will appear on the centre display and the IPA operation will automatically terminate.

Make any final adjustments that may be necessary manually, after confirming the vehicle's surroundings.

NOTE

The system can be cancelled at any time:

- By engaging the P (Park) position.
- By shifting to the N (Neutral) position.
- By overriding the steering manoeuvre.
- By pressing the [Cancel] button on the centre display.



Parking in a bay

The system detects lines on the ground for parking slots by processing images from the camera, and displays a rectangle in the centre of the parking lines to set a target for parking.

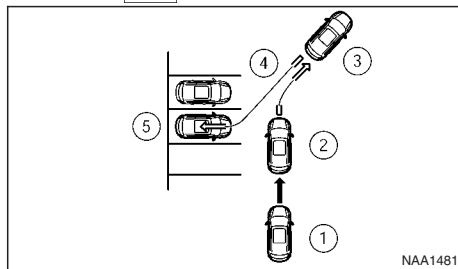
When there are no parking lines for parking spots and parking slots cannot be detected, a target parking rectangle is displayed at a default position by pressing the  button.



Bay parking procedure

1. Stop the vehicle near to the space where you wish to park.
2. Press the **<CAMERA>** button, followed by the IPA button  on the screen or the IPA switch (where fitted) on the lower instrument panel. Press Parking Mode button  and check the bay parking mode is displayed.

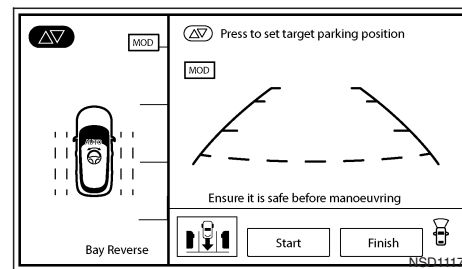

NOTE

If the bird's-eye view is not displayed on the front passenger side of the screen, press the **<CAMERA>** button until the bird's-eye view is displayed.

NOTE

Use the turn signal switch to select the side of the vehicle where the parking bay is situated.

3. The bay parking mode is displayed. Use the turn signal switch to select the side of the vehicle where the parking bay is situated.

Stop vehicle alongside, and approximately 1 m (3 ft) from the parking place. The system will search for a parking space. The IPA system will inform you when it finds a suitable parking space. When there are no parking lines for parking spots and parking slots cannot be detected, a target parking rectangle is displayed at a default position by pressing the  button. Then you can press [Start].

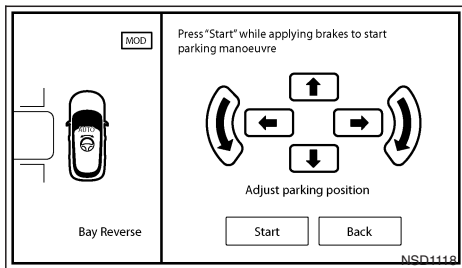

Adjust the target parking rectangle using the arrow keys on the screen so that the clearance guidelines do not overlap any obstacles around the vehicle.

CAUTION

After pressing [Start] the vehicle will park within the blue area. Make sure this area is free of obstacles.

4. Press [Start].

The vehicle starts the parking procedure. The IPA operation can be started when the following conditions are met:

- The vehicle is completely stopped by depressing the brake pedal.
- The steering wheel is in the straight-ahead position.
- The shift control system is in the D (Drive) position.

NOTE

If the vehicle deviates from the parking rectangle while following the parking procedure, stop and adjust the position.

WARNING

If there is any doubt that the surroundings in the path of the parking area and/or the parking area itself are not free from obstacles immediately stop the vehicle and check.

5. Gently place hands on the steering wheel and slowly move the vehicle forward to the correct position indicated in green in preparation for reversing.

Bring the vehicle to a standstill.

The steering wheel will turn itself towards the reverse starting position rectangle (green).

Depress the brake and stop the vehicle when it approaches another vehicle or object, or when the vehicle reaches the reverse starting position.

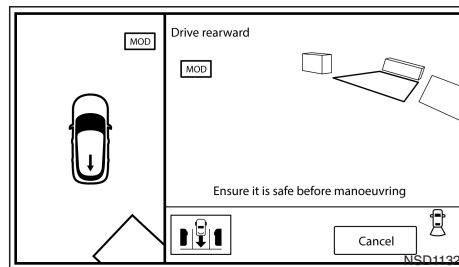

6. Shift to the R (Reverse) position.

Gently place hands on the steering wheel and slowly reverse to the parking space.

Steering will be operated automatically.

NOTE

- Only the steering operates automatically.
- Follow the instructions given by the system.
- Carefully and slowly accelerate while checking the surroundings.
- Use of the steering wheel will cancel the IPA operation.

7. When the vehicle is in the target parking position, check, then depress the brake pedal to stop the vehicle.

When the vehicle reaches the approximate area of the target parking space, a chime will sound, [Park assist finished] will appear on the centre display and the IPA operation will automatically terminate.

Make any final adjustments that may be necessary manually, after confirming the vehicle's surroundings.

NOTE

The system can be cancelled at any time:

- By engaging the P (Park) position.
- By shifting to the N (Neutral) position.
- By overriding the steering manoeuvre.
- By pressing the [Cancel] button on the centre display.

OPERATING TIPS

- The screen displayed on the IAVM will automatically return to the previous screen three minutes after the <CAMERA> button has been pressed while the shift control system is in a position other than the R (Reverse) position.
- When the view is switched, the display of images on the screen may be displayed with some delay.
- When the temperature is extremely high or low, the screen may not display objects clearly. This is not a malfunction.
- When strong light directly shines on the camera, objects may not be displayed clearly. This is not a malfunction.
- The screen may flicker under fluorescent light. This is not a malfunction.
- The colour of objects on the IAVM may differ somewhat from the actual colour of objects. This is not a malfunction.
- Objects on the monitor may not be clear and the colour of the object may differ in a dark environment. This is not a malfunction.
- There may be differences in sharpness between each camera view of the bird's-eye view.
- If dirt, rain or snow accumulates on the camera, the IAVM may not display objects clearly. Clean the camera.
- Do not use alcohol, benzine or thinner to clean the camera. This will cause discoloration. To clean the camera, wipe with a cloth that has been dampened with a diluted mild cleaning agent and then wipe with a dry cloth.

- Do not damage the camera because the monitor screen may be adversely affected.
- Do not use wax on the camera lens. Wipe off any wax with a clean cloth that has been dampened with a mild detergent diluted with water.
- A click sound is made when the vehicle comes to the target position in each step. Stop the vehicle when the click sounds and follow the next guidance.
- Depending on the situation, multiple parking manoeuvres may be required.

IPA malfunction

A warning message will be displayed and the system will terminate operation if a malfunction is detected in the IPA.

If the warning message is displayed during the IPA operation, park the vehicle in a safe place and restart the e-POWER system.

If the warning message is shown on the display repeatedly or if the IPA cannot be operated after restarting the e-POWER system, this may indicate a system malfunction. It should not hinder normal driving, but the vehicle should be inspected by a NISSAN dealer or qualified workshop.

ProPILOT Park is a function that supports parallel parking, reverse bay parking, and forward bay parking.

It uses the camera system and parking sensor (sonar) to detect the parking position, and controls the accelerator, brake, steering wheel, and shifting operations in order to support the series of parking operations.

WARNING

- **There is a limit to ProPILOT Park performance. The responsibility for safe driving is borne by the driver. Therefore, in the same way as with ordinary driving, check the surrounding conditions directly by visual confirmation or using the mirrors. Apply the brakes to stop the vehicle if it appears that the vehicle will hit a surrounding vehicle, person, or object.**
- **There are limitations to the parking sensor (sonar) and cameras. The parking positions or steering cut backs may not be adjusted correctly because the system cannot detect the obstacles.**
- **Do not touch the spokes of the steering wheel during steering control.**
There is the possibility that hands or fingers may become caught, causing injury. Also, exercise sufficient caution so that neckties, scarves, and other items do not become caught. There is the possibility of an unexpected accident.

PROPILOT PARK SWITCH

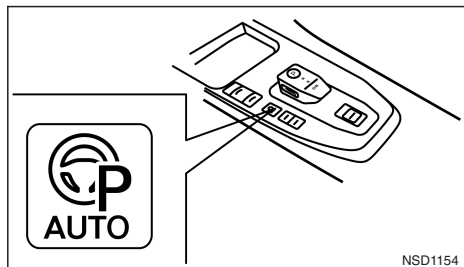

Push this switch to activate ProPILOT Park.

ProPILOT Park is displayed on the navigation system screen.

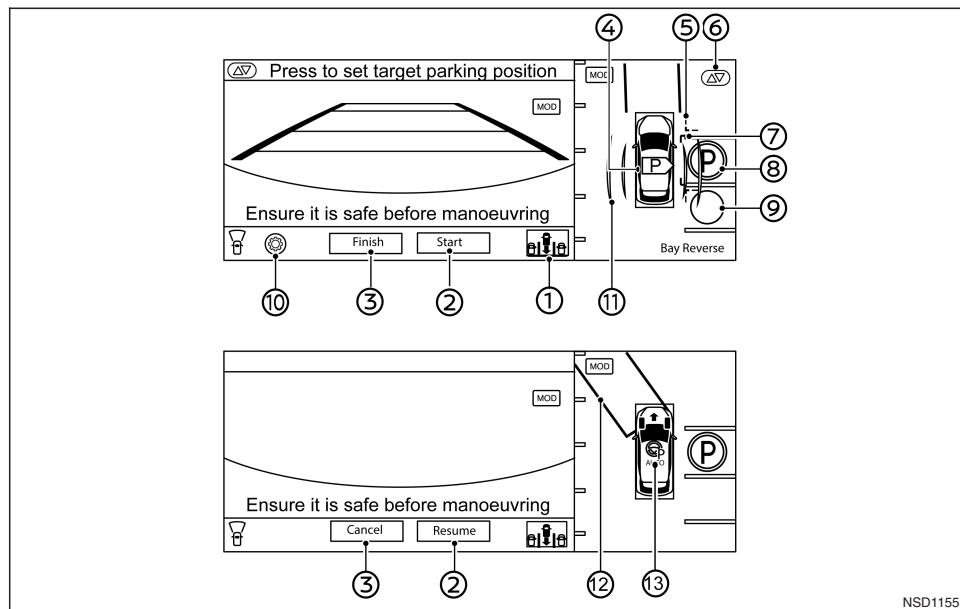

PROPILOT PARK SCREEN

1. **Parking method selection icon:**

Indicates the parking method that is currently selected. Touch to change the parking method.

2. **[Start]/[Resume]:**

Touch this key to start the ProPILOT Park control.

3. **[Finish]/[Cancel]:**

Touch this key to deactivate ProPILOT Park.

4. **Parking space detection icon:**

Indicates which side of parking space is detected during parking space search.

: A parking space is detected on the right side.

: A parking space is detected on the left side.

5. **Clearance Guidelines (Red):**

Indicates the approximate area that the vehicle will pass through when parking control is active.

6. **Parking guide box adjustment icon ():**

Touch this key to adjust the location of the parking guide box.

7. **Parking guide box (Green):**

This indicates the approximate position where the vehicle will be parked. The box turns light blue when parking control is active.

8. **P sign (Blue):**

Indicates the position where the vehicle will be parked.

9. **○ sign (Colourless):**

Indicates a selectable parking position besides the selected parking position. When touched, the icon will change to blue.

10. **Settings icon ():**

Touch this icon to change the ProPILOT Park settings.

11. **ProPILOT Park control icon ():**

The ProPILOT Park control status is indicated by colors.

Green: The parking control is active.

Gray: The parking control is not active.



12. **Parking space search area guidelines (Light green):**

Indicates that the system is currently searching for a parking space. Lines are also used as a guide for vehicle positioning during space searching.

13. **Direction change position rectangle (Green):**

Indicates the position at which to make the next shift change.

NOTE

When the wipers are operating or when water or other substances on the camera lens is detected, the  sign is displayed. When the  sign is displayed, the detectable parking positions are restricted.

When vehicle speed becomes 10 km/h or higher

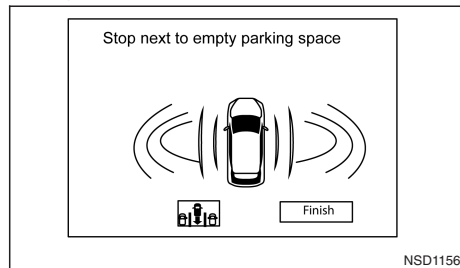

When the vehicle speed becomes approximately 10 km/h or higher while parking position detection is in progress, the screen changes. When the vehicle



speed drops to approximately 10 km/h or less, the screen returns to the regular ProPILOT Park screen.

SELECTING THE PARKING METHOD

The parking method can be changed by touching the parking method selection icon before touching [Start].

The parking method changes each time the parking method selection icon is touched. The vehicle will only scan for the type of parking method that has been selected

Available methods

Parallel parking 	Supports reversing into a parking space where vehicles are parked in line with one another.
Bay reverse parking 	Supports reversing into a Bay parking space defined by lines.
Bay forward parking 	Supports parking forward into a bay parking space defined by lines.

PROPILOT PARK OPERATION

Parallel parking

1. **Drive forward at reduced speed.**
2. **Push the ProPILOT Park switch.**

ProPILOT Park activates.

3. **Drive slowly forward and the system will search for a parking space.**

The system will provide a chime and indicates  when a parking spot is detected and when the vehicle has reached the correct position ready to start the parking process. Depress the brake pedal to stop the vehicle.

4. **Keep the brake pedal depressed and touch [Start] on the screen.**

The ProPILOT Park control icon turns green and the brakes are applied automatically to keep the vehicle stopped. Parking control cannot be started if the system determines that movement to the parking position is not possible due to an obstacle detected by the parking sensors (sonar) and cameras.

In that case, park the vehicle manually.

5. **Release the brake pedal and the vehicle moves toward the direction change position rectangle (in the direction of the arrow on the vehicle icon).**

Depress the brake pedal and adjust the vehicle speed depending on the surrounding conditions.

6. **When the vehicle enters the next direction change position rectangle (green), the shift lever automatically changes.**

If it is not possible to proceed until the vehicle reaches the direction change position rectangle (green) because of an obstacle, depress the brake pedal and stop the vehicle near the obstacle. Change the shift lever position to change the direction.

7. **When the vehicle is in the parking guide box (light blue), the vehicle stops and parking control ends.**

A sound and the display notify the driver when parking control ends.

At this time, the shift position changes to P (Park) and the electric parking brake is activated.

Parking control may end automatically before the vehicle is in the parking guide box (light blue).

If it is not possible to reach the parking guide box due to an obstacle or some other reason, depress the brake pedal to stop the vehicle, then touch [Cancel] on the screen to deactivate ProPILOT Park. Park the vehicle manually or move the vehicle to a more suitable position.

Bay parking

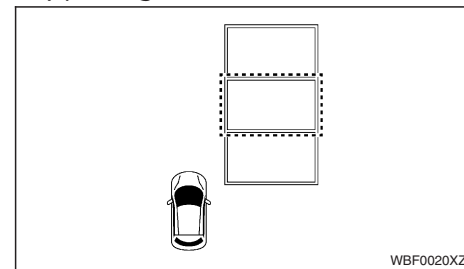

1. **Stop the vehicle near the place you wish to park.**
2. **Push the ProPILOT Park switch.**

ProPILOT Park activates.

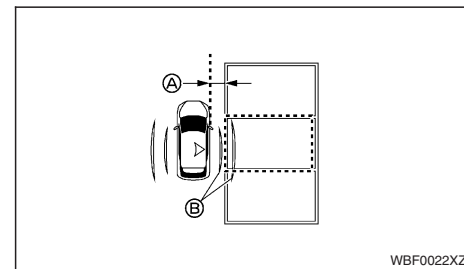

- (A) Approximately 1m (3 ft)
- (B) Parking space search area guidelines (Light blue)

3. Drive slowly forward and stop next to the desired parking space (at a distance of approximately 1m (3 ft)).

Stop the vehicle so that the parking space detection icon  is pointing near the center of the desired parking space.

Position the vehicle so that the end line of the parking space is in between the parking space search area guidelines (Light blue) for easier detection.

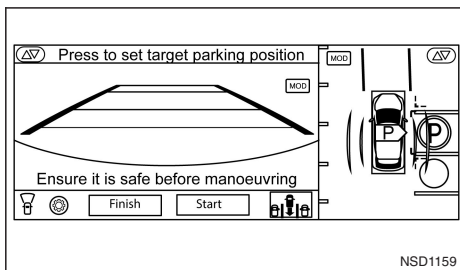

4. While the vehicle is stopped, check that  is displayed in the desired parking space.

Check that it is possible to park in the space indicated by . Check that there are no obstacles in the parking space and the surrounding area, and check that the space is large enough to park in.

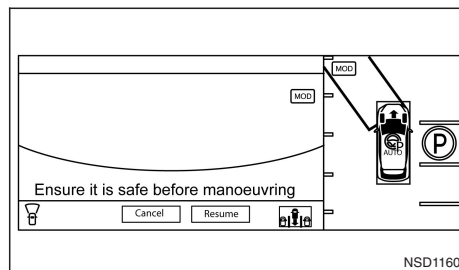

5. Keep the brake pedal depressed and touch **[Start]** on the screen.

The ProPILOT Park control icon  turns green and the brakes are applied automatically to keep the vehicle stopped. Parking control cannot be started if the system determines that movement to the parking position is not possible due to an obstacle detected by the parking sensors (sonar) and cameras.

In that case, park the vehicle manually.

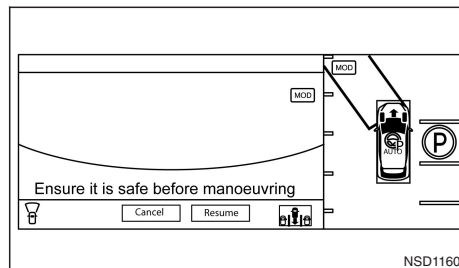

6. Release the brake pedal and the vehicle moves toward the direction change position rectangle (in the direction of the arrow on the vehicle icon).

Depress the brake pedal and adjust the vehicle speed depending on the surrounding conditions.

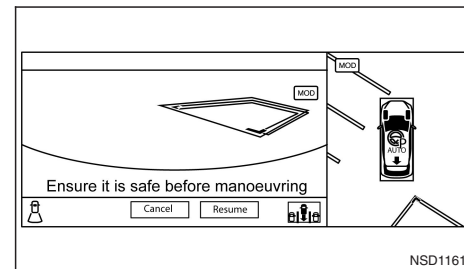

7. When the vehicle enters the direction change position rectangle (green), the shift position automatically changes and the vehicle moves backwards.

If it is not possible to proceed until the vehicle reaches the direction change position rectangle (green) because of an obstacle, depress the brake pedal, and stop the vehicle near the obstacle. Change the shift lever position to change the direction.

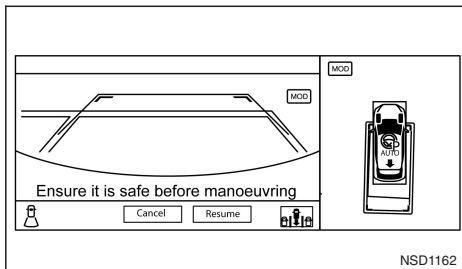

8. When the vehicle is in the parking guide box (light blue), the vehicle stops and parking control ends.

A sound and the display notify the driver when parking control ends.

At this time, the shift position changes to P (Park) and the electric parking brake is activated.

Parking control may end automatically before the vehicle is in the parking guide box (light blue).

If it is not possible to reach the parking guide box due to an obstacle or some other reason, depress the brake pedal to stop the vehicle, then touch [Cancel] on the screen to deactivate ProPILOT Park. Park the vehicle manually or move the vehicle to a more suitable position.

NOTE

- ProPILOT Park can also be activated by touching <CAMERA> on the navigation system and then touching  on the Intelligent Around View Monitor screen.
- While ProPILOT Park is activated, the volume of the audio system and other sounds are reduced.
- If the parking guide box does not display a position where parking is actually possible (due to the presence of an obstacle or a street gutter), manually set a suitable parking position.
- If the [Detect parallel spaces on either side] setting is activated and parking spaces are detected on both sides. The turn signal switch can be used to select the desired side if parking spaces on both sides are detected.
- Even if the system detects the parking space once, the detected parking space may disappear or parking may not be started depending on the circumstances of obstacles such as the width of the aisle.
- When parking control is started, the parking sensor (sonar) function automatically turns on. When ProPILOT Park deactivates, the parking sensor (sonar) returns to the condition that it was set to on the vehicle information display.
- While parking control is active, the screen will not change even if <MAP>, <MENU>, or <AUDIO> is touched.

- Touching <CAMERA> deactivates ProPILOT Park.
- Parking control cannot be started in the following cases. After the conditions are corrected, parking control can be started.
 - The driver's seat belt is not fastened.
 - The shift position is in P (Park).
 - The shift position is in R (Reverse).
 - The electric parking brake is activated.
 - The ESP system is turned off.
- Parking control cannot be started when the vehicle is on a steep slope. Park the vehicle manually.
- When the ProPILOT Park system changes the driving direction of the vehicle there is a slight pause.
- Parking control may automatically end when the system determines that movement to the parking position is not possible due to an obstacle detected by the parking sensors (sonar) or cameras. Move the vehicle to a more suitable position.
- If the Clearance Guidelines contact a parked vehicle or another obstacle, the parking sensor (sonar) may detect an obstacle and stops the vehicle, hindering the system from completing the parking procedure.
- The turn signal is activated automatically, in the direction of the parking space when touching [Start] on the screen.

- The route to the parking position and the number of steering cut backs vary depending on the set parking position and the position of the obstacles detected by the parking sensors (sonar) and cameras.
- The [Unavailable. Mirrors in folded position] message may be displayed even though the mirror is open. In that case, close and open the mirror again.

PROPILOT PARK PAUSE

Automatic stop of parking control

In the following cases, the brakes are applied automatically and the vehicle stops.

- An obstacle in the direction of travel was detected.
- The driver's seat belt was unfastened.

Parking control can be resumed by touching [Resume] on the screen while depressing the brake pedal after confirming that the conditions have been corrected.

NOTE

- When parking control is resumed, the shift position automatically changes to D (Drive) or R (Reverse).
- When parking control is resumed after the vehicle was stopped due to detection of an obstacle, the direction of travel changes and steering cut backs are used to continue parking control.
- Parking control cannot be resumed when the system determines that movement to the

parking position is not possible due to an obstacle detected by the parking sensors (sonar) and cameras.

- Parking control cannot be resumed if the driver's seat belt is not fastened.

PROPILOT PARK DEACTIVATION

Touch [Finish] or [Cancel] on the screen to deactivate ProPILOT Park.

If ProPILOT Park is deactivated while parking control is in progress, the brakes are applied automatically, the vehicle stops, and the electric parking brake is activated. At this time, the shift position changes to P (Park).

Automatic deactivation during parking position detection

WARNING

Depress the brake pedal if ProPILOT Park automatically deactivates during parking position detection. The brakes are not automatically applied and it may cause an unexpected accident.

In the following cases, ProPILOT Park automatically deactivates.

- The door of the driver seat, passenger seat, either rear seat or the tailgate was opened.
- The vehicle drove 500 m or more after ProPILOT Park was activated.
- Vehicle speed exceeded approximately 30 km/h.
- The outside mirrors were folded.

- The screen was switched by touching the <MAP> or <CAMERA> key.
- A system malfunction was detected.

Automatic deactivation while parking control in progress (while vehicle is in motion)

In the following cases, ProPILOT Park deactivates automatically.

If ProPILOT Park is deactivated automatically while parking control is in progress, the brakes are applied automatically, the vehicle stops, and the electric parking brake is activated. At this time, the shift position changes to P (Park).

- The driver operates the steering wheel.
- The driver operates the accelerator pedal.
- The driver's door, front passenger's door, either of the rear doors or the tailgate was opened.
- The electric parking brake was activated.
- The shift position was changed to P (Park), N (Neutral), D (Drive) or R (Reverse).
- The <CAMERA> key was touched.
- The outside mirrors were folded.
- The ProPILOT Park switch was pushed.
- The system determined that movement to the parking position is not possible due to an obstacle or some other reason.
- The system decided that there was a large deviation in the parking position used for parking control.
- The ESP system was turned off.

- The ESP/TCS/ABS was activated.
- The vehicle speed exceeded approximately 8 km/h.
- A system malfunction was detected.
- Any of the following conditions are met in a location close to the parking position.
 - An obstacle in the parking path was detected.
 - The driver's seat belt was unfastened.

Automatic deactivation while parking control in progress (while vehicle is not in motion)

In the following cases, the user is notified by sound and the display and ProPILOT Park automatically deactivates.

At this time, the electric parking brake is activated and the shift position changes to P (Park).

- The driver's door, front passenger's door, either of the rear doors or the tailgate was opened.
- The driver operates the accelerator pedal.
- The electric parking brake was activated.
- The shift position was changed to N (Neutral) or P (Park).
- 1 minute or more passed after ProPILOT Park is in pausing status.
- The <CAMERA> key was touched.
- The outside mirrors were folded.
- The ESP system was turned off.
- The ESP/TCS/ABS was activated.
- A system malfunction was detected.

- The ProPILOT Park switch was pushed.

ABOUT THE PROPILOT PARK PARKING METHODS

Parallel parking (Sonar detection)

Pass the parking position at a distance of less than approximately 1m (3 ft) (A) next to the desired parking place.

If the distance from the parking position is too large, it may not be possible to detect obstacles.

Parking position accuracy depends on object position and angle.

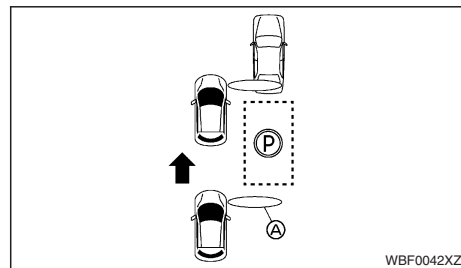

Example with parking space before obstacle

(A) Sensor detection range

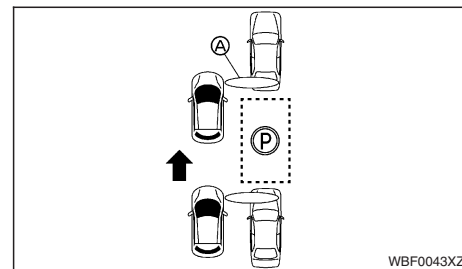

Example with parking space between obstacles

(A) Sensor detection range

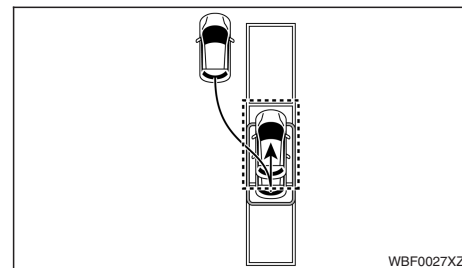

Parking is performed using a route such as that shown in the illustration.

The parking route and number of switch-backs vary depending on the parking position and the positions of the surrounding obstacles.

Parallel parking (Line detection)

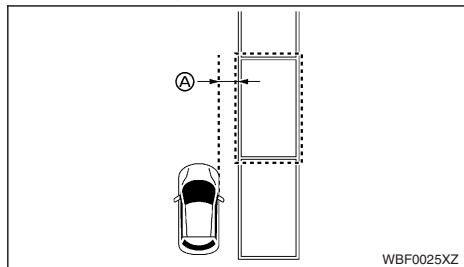

Approach the parking position at a distance of approximately 1 m (3 ft) (A) next to the desired parking place.

If the distance from the parking position is too large, it may not be possible to detect obstacles or the parking space lines.

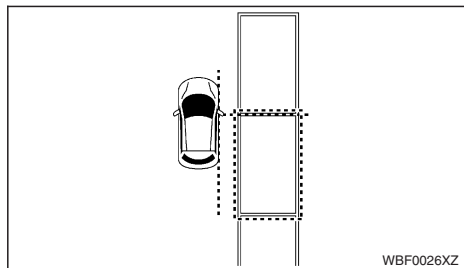

Drive slowly forward and depress the brake pedal to stop the vehicle when parallel to the parking position.

Stop the vehicle so that the front doors are positioned at the forward edge of the desired parking space.

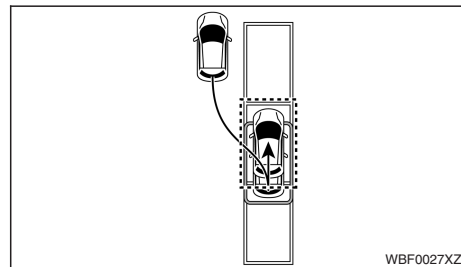

Example: route starting backwards

Parking is performed using a route as shown in the illustration. Depending on the obstacles and distance to the parking position, parking operation may start by reversing.

The parking route and number of switch-backs vary depending on the parking position and the positions of the surrounding obstacles.

Bay parking

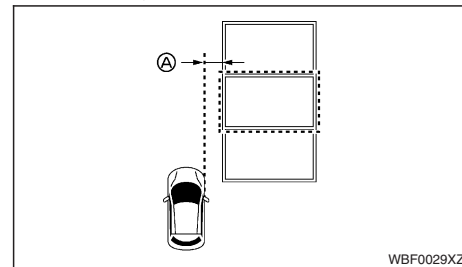

Approach the parking position at a distance of approximately 1 m (3 ft) (A) next to the desired parking place.

If the distance from the parking position is too large, it may not be possible to detect obstacles, or it may not be possible to detect the parking space lines.

Drive slowly and stop the vehicle so that the vehicle is perpendicular to the parking space. Stop the vehicle to position the front doors are at the center of the desired parking space.

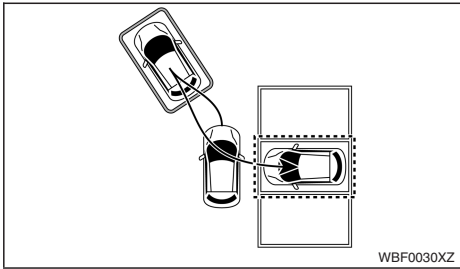

Parking control is performed using a route as shown in the illustration.

The parking route and number of switch-backs vary depending on the parking position and the positions of the surrounding obstacles.

Forward parking

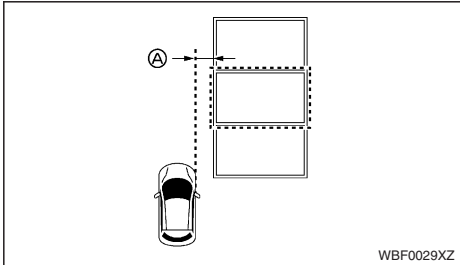

Approach the parking position at a distance of approximately 1 m (3 ft) (A) next to the desired parking place.

If the distance from the parking position is too large, it may not be possible to detect obstacles or the parking space lines.

Drive slowly and stop the vehicle so that the vehicle is perpendicular to the parking space. Stop the vehicle to position the front doors at the center of the desired parking space.

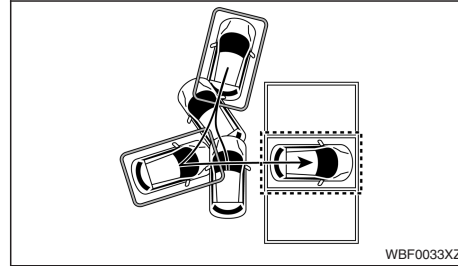



Parking control is performed using a route as shown in the illustration.

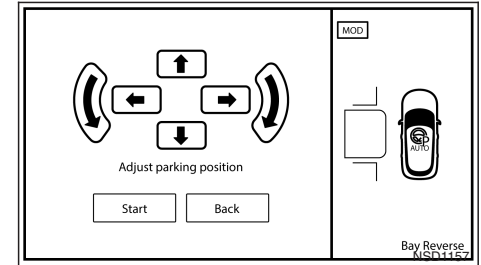

The parking route and number of switch-backs vary depending on the parking position and the positions of surrounding obstacles.

ADJUSTING THE PARKING POSITION

The parking position can be adjusted manually when parallel parking or bay parking is selected as a parking method.



1. Depress the brake pedal and stop the vehicle, then touch the parking guide box adjustment icon  on the screen.

When  is displayed, the parking guide box is displayed in the  position.

If no parking position is detected or parking position is off the screen, the parking guide box is displayed in the default position.

2. Touch the arrow on the screen for fine adjustments.

NOTE

- The displayed Clearance Guidelines indicate the guides of the area where a part of the vehicle may enter when moving to the parking position. Smooth parking is possible when vehicles, poles, and other obstacles are on the outside of the Clearance Guidelines.

- Touch the left side of the screen to move the parking guide box.
- The parking guide box direction can be changed by operating the turn signal switch.

CHANGING THE DIRECTION OF PARKING CONTROL TRAVEL

If there is an obstacle (such as a pole) or a location lower than ground level (such as a ditch or cliff) in the vehicle's direction of travel, depress the brake pedal to stop the vehicle.

Use the shift lever to change the direction of travel to resume parking control.

NOTE

Parking control cannot be resumed if the system determines that movement to the parking space is not possible due to an obstacle detected by the parking sensors (sonar) or cameras.

(Example) When there is a parked vehicle

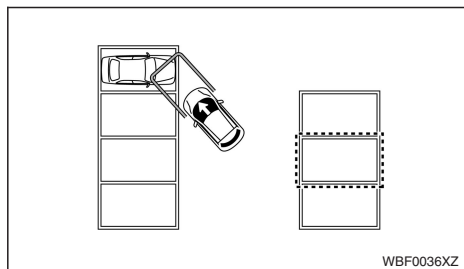

1. Depress the brake pedal to stop the vehicle.

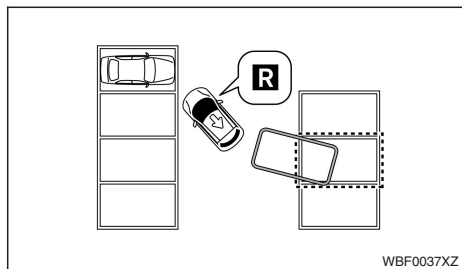

2. Use the shift lever and change the direction of travel.

When [Resume] is touched, parking control is resumed.

PARKING POSITION DETECTION FUNCTION

The cameras and parking sensors (sonar) are used to detect the parking position. Multiple parking positions can be detected.

The parking space lines are recognised using the cameras, and the parking positions are displayed.

A parking position is not displayed if the parking sensors (sonar) detect an obstacle inside the detected parking space.

NOTE

If the lens of the front view, side view, or rear view camera is dirty or there are water drops or some other substance adhering to it, the detectable parking positions may be restricted.

When bay parking or forward parking is selected

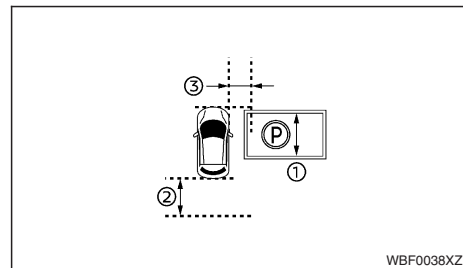

- ① Approximately 2.3 m (8 ft).
- ② Approximately 2 m (6 ft).
- ③ Approximately 1 m (3 ft).

A parking position is detected under the following conditions:

- Parking spaces of approximately 2.3 to 2.5m (6.5 to 8 ft) width ① are recognised.
- Parking space lines composed of single lines or U-shaped space lines are recognised.
- Parking space lines with a width of approximately 15 cm (6 inches) are recognised.
- Recognition occurs when there are parking space lines located within the range from the front edge of the vehicle to approximately 2 m (6 ft) from the rear edge of the vehicle ②.
- Recognition occurs when a parking space is located approximately 1 m (3 ft) from the vehicle ③.

- If [Detect parallel spaces on either side] is turned on, parking positions on both sides of the vehicle are detected.

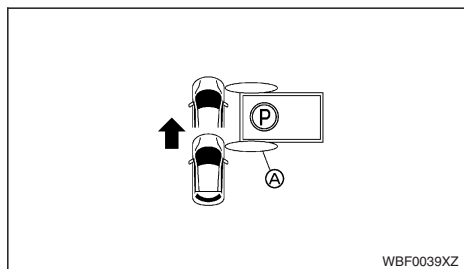

(A) Sensor detection range

A parking position is not displayed when the detection range of the front sensors (sonar) passes through the parking space detected by cameras and an obstacle is detected.

Obstacles in parking spaces located beyond the sensor detection range cannot be detected.

When parallel parking is selected

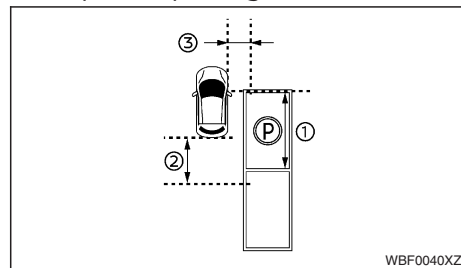

- ① Approximately 5 m (15 ft).
- ② Approximately 3 m (10 ft).
- ③ Approximately 1 m (3 ft).

A parking position is detected under the following conditions.

- Parking spaces of approximately 5 to 6 m (15 to 18 ft) length ① are recognised.
- Parking space lines composed of single lines are recognised.
- Parking space lines with a width of approximately 15 cm (6 inches) are recognised.
- Recognition occurs when there are parking space lines located within the range from the driver's door to approximately 3 m (10 ft) from the rear edge of the vehicle ②.
- Recognition occurs when a parking space is located approximately 1 m (3 ft) from the vehicle ③.

- If [Detect parallel spaces on either side] is turned on, parking positions on both sides of the vehicle are detected.

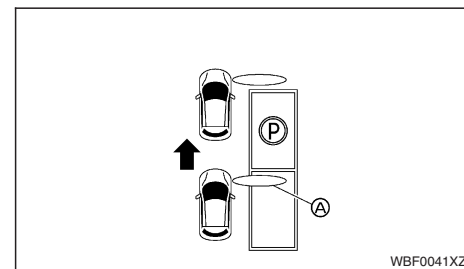

(A) Sensor detection range

A parking position is not displayed when the detection range of the front sensors (sonar) passes through the parking space detected by cameras and an obstacle is detected.

Obstacles in parking spaces located beyond the sensor detection range cannot be detected.

If the parking space lines are not recognised, the parking sensors (sonar) are used to detect the parking space based on the surrounding obstacles.

Depending on the positions and angles of the surrounding obstacles, the parking guidance box may deviate.

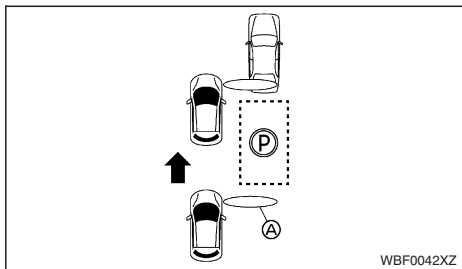

Example with parking space before obstacle

(A) Sensor detection range

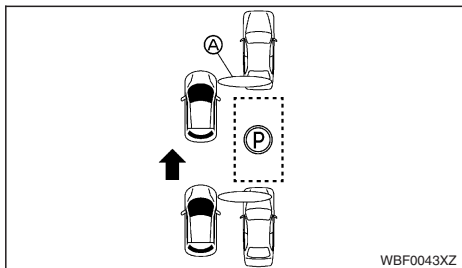

Example with parking space between obstacles

(A) Sensor detection range

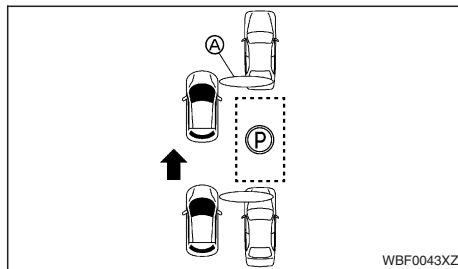

CAMERAS AND PARKING SENSORS (SONAR) USED FOR PROPILOT PARK

Cameras

The Intelligent Around View Monitor cameras are used.

For maintenance, see "Intelligent Around View Monitor (IAVM)" in the "4. Display screen, heater and air conditioner, and audio system" section.

Parking sensors (sonar)

12 parking sensors (sonar) located on the front, rear, left, and right are used.

For maintenance, see "Front and Rear Ultrasonic Parking Sensors (where fitted)" in the "5. Starting and driving" section.

PROPILOT PARK PRECAUTIONS

⚠ WARNING

- Never attempt to drive while looking only at the screen. There is the risk of hitting an obstacle or causing an unexpected accident.
- Pay attention to the movement of vehicles and persons in the surrounding area. Parking support is provided by making effective use of the detected path. Pay attention to the movements of oncoming vehicles, following vehicles, and pedestrians when operating parking control.
- When parking support by ProPILOT Park is no longer necessary, deactivate ProPILOT Park. If ProPILOT Park remains activated, there is the risk of an unexpected accident.
- Before exiting the vehicle, check that the electric parking brake is activated and that the shift position is in P (Park).
- Before using ProPILOT Park, check directly to confirm that there is sufficient space around the vehicle for the steering cut backs and other parking operations to be performed.
- Depending on the circumstances, noise from inside or outside the vehicle may prevent the driver from hearing the warning sound.
- Operate the turn signal switch during parking control to inform the surroundings of the vehicle moving direction.

● **Do not use ProPILOT Park in the following circumstances:**

- In a location where the traffic is heavy with persons and vehicles
- In a location where stopping or parking is prohibited
- In a location that is too narrow for the vehicle to fit
- In a location where parking is not possible due to a hole, ditch, etc.
- In a location where the street width is narrow
- On a steep slope
- On a gravel, dirt, or unpaved road
- On a slippery surface, such as snow or ice
- On a road that is not flat due to inclination, steps, kerbs, wheel ruts, or other reasons
- On a road where the asphalt has melted due to exposure to excessive heat
- In a location where a road heater (heater for preventing the road surface from freezing) is installed in the parking area
- In a mechanical parking area or location where there are obstacles in the parking spaces
- When the vehicle is overloaded
- When worn tyres, an emergency tyre or tyre chains are being used
- When the tyre air pressure is not correct
- When a towing hook or similar item is installed

- When an object is attached that interferes with the camera's field of view
- When the camera images are difficult to see due to dirt, sunlight, shadows, or other reasons
- When the outside mirror is not all the way open
- When the cameras are not properly installed
- When an item is installed on the bumper that interferes with the parking sensors' (sonar) performance
- When there is a dent or other irregularity in the bumper
- When there is rain, snow, mud, or some other substance adhering to the parking sensors (sonar)
- When the loaded vehicle is tilted due to carrying an extremely heavy load or carrying a load only on one side

CAUTION

Car stops cannot be detected and there is some possibility that kerbs cannot be detected. Depress the brake pedal to stop the vehicle if the wheels appear to hit a kerb or the vehicle appears to pass over a car stop. There is the risk of damage to the vehicle.

PROPILOT PARK MALFUNCTION

If there is an abnormality in the system, a warning message is displayed on the screen, the color of the ProPILOT Park control icon  changes to orange, and ProPILOT Park is automatically deactivated. If a warning is displayed while the system is in use, stop the vehicle in a safe location and place the power switch in the OFF position and then place it back in the ON position.

If it is not possible to activate ProPILOT Park after performing the above, there may be a malfunction in the system. This does not interfere with ordinary driving. However, the system should be inspected by a knowledgeable repairer such as a NISSAN certified electric vehicle dealer.

PROPILOT PARK SETTINGS

1. Touch [Settings] on the launch bar.
2. Touch [Parking].
3. Select the setting item.

Available items:

- [Use the last selected parking mode]
When this item is turned on, the parking method that was most recently used will be selected.
When the item is turned off, parallel parking will be selected.

- [Detect parallel spaces on either side]

When this item is turned on, parking positions on the both sides of the vehicle will be detected.

When the item is turned off, only parking positions on the side last time ProPILOT Park used will be detected.

If the turn signal switch is operated in this state, parking spaces on that side of the vehicle will be detected.

- [Parking mode]

The parking methods which can be selected on the ProPILOT Park screen can be set.

The parking methods that are turned on can be selected each time the parking method selection icon is touched.

The parking methods that are turned off cannot be selected by touching the parking method selection icon.

PARKING SENSOR (SONAR) DETECTION CONDITIONS AND LIMITATIONS

WARNING

The parking sensor (sonar) system has some limitations. For details, see “Front and Rear Ultrasonic Parking Sensors (where fitted)” later in this section.

- Under conditions such as the following, the brakes may be applied or correct parking control may not be possible.
 - When there is rain, snow, ice, dirt, or some other substance adhering to the parking sensors (sonar)
 - When there is a loud noise in the surrounding area
 - When there is a device generating ultrasound (including vehicles equipped with sensors (sonar)) in the surrounding area
 - When there is thick grass in the surrounding area
 - When passing near a structure with bumps or depressions
 - When there is a structure (such as a wall, toll collection equipment, or parking area gate) located nearby to the side of the vehicle
 - When there is a step, projecting object, or drain cover on the road
 - When passing under a hanging flag, plastic curtain, or similar object

- When there are clumps of snow around the vehicle

INTELLIGENT AROUND VIEW MONITOR DETECTION CONDITIONS AND LIMITATIONS

WARNING

The Intelligent Around View Monitor has some limitations. For details, see “Intelligent Around View Monitor (IAVM)” in the “4. Display screen, heater and air conditioner, and audio system” section.

- Under conditions such as the following, the Intelligent Around View Monitor cameras may be unable to detect an obstacle and/or the parking position correctly.
 - When the vehicle gets wet with rain or water
 - When the surroundings are dark, such as at night, when in underground locations or in an above-ground parking garage
 - When parking space lines are not clearly visible due to bad weather (rain, snow, fog, dust, sand or snowstorms)
 - When the camera lens is clouded due to contact with water
 - When strong light from the sun or streetlights shines on the road
 - When the road surface is wet and shining, such as during or after rain, or when there are puddles on the road

- When sunlight shines into the camera, such as in the morning or in the evening
- When the camera lens is dirty or there are water drops adhering to it
- When an object is attached that interferes with the camera field of view
- When strong light (for example, sunlight or high beams from oncoming vehicles) enters the front camera
- When vehicle's driving posture changed significantly due to sudden braking or loads
- A sudden change in brightness occurs (for example, when the vehicle enters or exits a tunnel or shaded area or lightning flashes)
- When driving on a steep downhill or slope or roads with sharp curves
- People with postures other than upright standing or walking, such as leaning forward, etc.
- People in a vehicle
- People pushing shopping carts, strollers, etc.
- People in clothes such as raincoats or dresses whose outlines are obscured
- People who have an umbrella or a large bag and have a part of their body hidden
- A pedestrian's profile is not recognised because he or she has a large luggage or wearing a cloth of the same color as the background.

PROPILOT PARK DETECTION CONDITIONS AND LIMITATIONS

- Under conditions such as the following, the brakes may be applied or correct parking control may not be possible.
 - When there is rain, snow, ice, dirt, or some other substance adhering to the parking sensors (sonar)
 - When there is a loud noise in the surrounding area
 - When there is a device generating ultrasound (including vehicles equipped with sensors (sonar)) in the surrounding area
 - When there is thick grass in the surrounding area
 - When passing near a structure with bumps or depressions
 - When there is a structure (such as a wall, toll collection equipment, or parking area gate) located nearby to the side of the vehicle
 - When there is a step, projecting object, or drain cover on the road
 - When passing under a hanging flag, plastic curtain, or similar object
 - When there are clumps of snow around the vehicle
- The system may not work properly under the following condition.
 - When the vehicle is equipped with non-original tyres

- Under conditions such as the following, correct parking control to the set position may not be possible. As necessary, move the vehicle to a more suitable position.
 - When the road surface is not flat
 - When the vehicle is tilted due to carrying an extremely heavy load or carrying a load only on one side
- Under conditions such as the following, it may be impossible or difficult to detect a parking position.
 - When the vehicle is too close to the parking space
 - In a parking area without parking space lines where the spaces are created with rope, blocks, or other means
 - When the parking space lines are not clearly visible due to fading or dirt
 - When the contrast between the road and parking space lines is low
 - When the parking space lines on the road are yellow or some other color besides white
 - When the parking space is extremely narrow or wide
 - When the parking space lines are extremely short
 - When the parking space lines are extremely narrow or wide
 - When the parking space lines are not parallel in the camera image due to inclination of the parking area or some other reason

- When the parking space lines are connected to diagonal lines or other markings
- When the shadow of the vehicle, shade from trees, or other shadows are on the parking space lines
- When there is a neighbouring vehicle or some other obstacle on the parking space lines
- When there is an obstacle in the parking space
- When the surroundings are dark, such as at night, when in underground locations or in an above-ground parking garage
- When parking space lines are not clearly visible due to bad weather (rain, snow, fog, dust, sand or snowstorms)
- When the camera lens is clouded due to contact with water
- When the sun or streetlights are reflecting on the road
- When strong light from the sun or streetlights shines on the road
- When the road surface is wet and shining, such as during or after rain, or when there are puddles on the road
- When sunlight shines into the camera, such as in the morning or in the evening
- When the camera lens is dirty or there are water drops adhering to it
- When an object is attached that interferes with the camera field of view
- When there is a step, gutter, road painting, repainted line, or similar item
- When there is accumulated snow or snow-melting agents
- When the parking area is paved with stones or greenery
- When there is a noise pattern image in the parking space on the screen
- When letters or other characters are painted in the parking space
- When the road color and brightness are not even
- When the vehicle is stopped inclined relative to the parking space
- When the street width is narrow
- When there is an obstacle in front of the vehicle
- When there is rain, snow, ice, dirt, or some other substance adhering to the parking sensors (sonar)
- When there is a loud noise in the surrounding area
- When there is a device generating ultrasound (including vehicles equipped with sensor (sonar)) in the surrounding area
- When there is thick grass in the surrounding area
- When there is a step, projecting object, or drain cover on the road
- When there are clumps of snow around the vehicle
- Under conditions such as the following, the parking position may not be detected in the correct location.
 - When there is light that looks like parking space lines, the reflection of a building or other object, a step, gutter, road painting, repainted line, or similar items
 - When there are marks from road repairs, letters printed on the road, poles, or other obstacles
 - When the road surface is wet and shining, such as during or after rain, or when there are puddles on the road
 - When the road color and brightness are not even
 - When the parking area is on a slope
 - When a side step of the vehicle or a shadow is on the parking space line
 - When the parking space lines are not clearly visible due to fading or dirt
 - When the system is affected by the shadows of the vehicle or shades of the trees
- When the vehicle is equipped with non-original tyres, correct parking control to the set position may not be possible. It is recommended that you visit a NISSAN certified electric vehicle dealer when changing to winter tyres.

FRONT AND REAR ULTRASONIC PARKING SENSORS (where fitted)

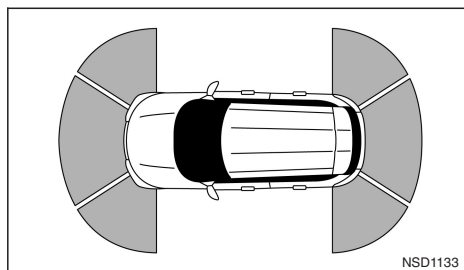

Where fitted

The parking sensor (sonar) system sounds a tone to inform the driver of obstacles around the vehicle using the Parking (sonar) sensors located in the front and rear bumpers.

When the parking sensor (sonar) system is turned on, the parking sensor view will automatically appear in the vehicle information display.

⚠ WARNING

- If there is any doubt the surroundings in the path of the parking area and/or the parking area itself are not free from obstacles immediately stop the vehicle and check.
- The parking sensor system is a convenience but it is not a substitute for proper parking. The driver is always responsible for safety during parking and other manoeuvres. Always look around and check that it is safe to do so before parking.
- Read and understand the limitations of the parking sensor system as contained in this section. The colours of the corner sensor indi-

cator and the distance guide lines in the front (where fitted)/rear view indicate different distances to the object. Inclement weather or ultrasonic sources such as an automatic car wash, a truck's compressed-air brakes, horn sound, or a pneumatic drill may affect the function of the system; this may include reduced performance or a false activation.

- Some types of kerb may also be detected.
- This function is designed as an aid to the driver in detecting large stationary objects to help avoid damaging the vehicle. The system is not designed to prevent contact with small or moving objects. Always move slowly.
- The system will not detect small objects below the bumper, and may not detect objects close to the bumper or on the ground.
- The system is deactivated at speeds above 12 km/h (7.5 MPH). It is reactivated below 10 km/h (6 MPH).
- This system is intended as an aid to parking, to be used in conjunction with your rear view mirrors.
- The system may not detect the following objects.
 - Fluffy objects such as snow, cloth, cotton, glass-wool, etc.
 - Thin objects such as rope, wire and chain, etc.
 - Wedge-shaped objects.

CAUTION

- If your vehicle sustains damage to the bumper fascia, leaving it misaligned or bent, the sensing zone may be altered causing inaccurate measurement of obstacles or false alarms.
- Excessive noise (such as audio system volume or an open vehicle window) will interfere with the tone and it may not be heard.
- In some conditions (i.e. after car wash, or rain) water can accumulate around the parking sensor (sonar) sensors reducing performance or cause false activation of the system. This water will drain away automatically while driving, bringing system performance back to normal.
- Keep the surface of the parking sensor (sonar) sensors (located on the front and rear bumper fascia) free from accumulations of snow, ice and dirt. Do not scratch the surface of the sensors when cleaning. If the sensors are covered, the accuracy of the parking sensor (sonar) function will be diminished.

SYSTEM OPERATION

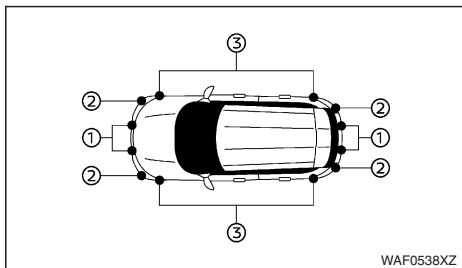

- ① Centre parking sensors
- ② Corner parking sensors
- ③ Side parking sensors (where fitted)

The system informs with a visual and audible alert of:

- Front obstacles when the shift control system is in the D (Drive) position
- Front and rear obstacles when the shift control system is in the R (Reverse) position

How the system alerts for obstacles:

The system is deactivated at speeds above 12 km/h (7.5 MPH). It is reactivated below 10 km/h (6 MPH).

The intermittent tone will stop after several seconds when the obstacle is identified only with the corner sensor. The tone will stop when the obstacle gets away from the vehicle.

When the object is detected, the indicator (green) appears and blinks and the tone sounds intermittently. When the vehicle moves closer to the object, the colour of the indicator turns yellow and the rate of the blinking increases. When the vehicle is very close to the object, the indicator stops blinking and turns red, and the tone sounds continuously.

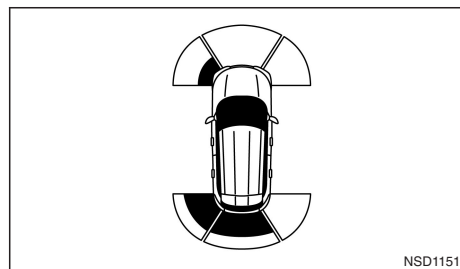

Example

When the vehicle moves closer to an obstacle, the parking sensor (sonar) indicator (detected area) appears in the vehicle information display.

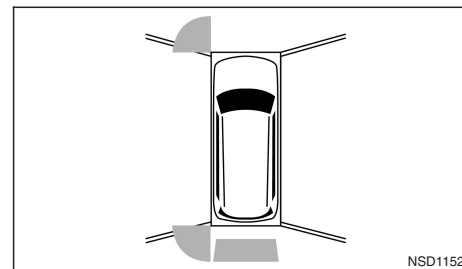

Example

The parking sensor (sonar) indicator also appears on the camera view of the centre display.

HOW TO ENABLE/DISABLE THE PARKING SENSOR (SONAR) SYSTEM/BA

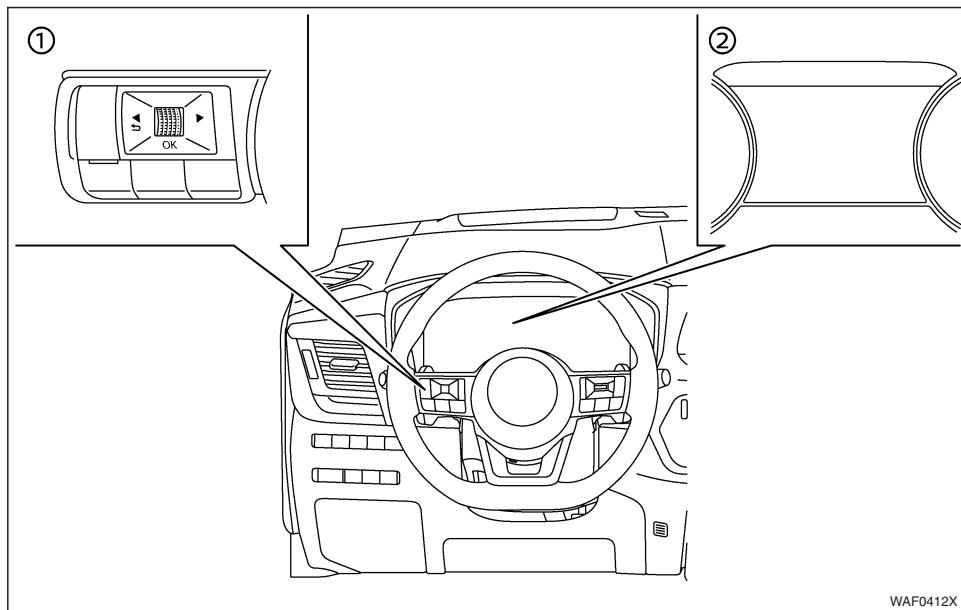

- ① Steering-wheel-mounted control (left side)
- ② Vehicle information display

The system is automatically activated when the power switch is switched ON and the shift control system is in the D (Drive) or R (Reverse) position.



NOTE

When the shift control system is in R (Reverse) and the [Parking Aids] screen is displayed in the vehicle information display the parking sensor (sonar) system can be disabled temporarily by pushing the <OK> switch on the steering wheel.

The system will remain disabled until the shift control system is shifted to N (Neutral) or P (Park) or vehicle speed exceeds 12 km/h (7.5 MPH).

Perform the following steps to set up the parking sensor (sonar) system function.

1. Push the ◀ ▶ button until [Settings] appears in the vehicle information display and then push the scroll dial. Use the scroll dial to select [Driver Assistance]. Then push the scroll dial.
2. Select [Parking Aids] and push the scroll dial.

3. Use the scroll dial to navigate in the menu and select or change an item:

- [Moving Object]
 - Turns ON/OFF the Moving Object Detection (MOD) (See “Moving Object Detection (MOD)” in the “4. Display screen, heater and air conditioner, and audio system” section.)
- [Display]
 - Shows the parking sensor (sonar) display in the vehicle information display when the system activates
- [Front] (where fitted)
 - Turns ON/OFF the front parking sensors
- [Rear]
 - Turns ON/OFF the rear parking sensors
- [Side] (where fitted)
 - Turns ON/OFF the side parking sensors
- [Distance]
 - Changes the parking sensor’s detection distance to [Far], [Medium] or [Near]
- [Volume]
 - Changes the volume of the tone sound to [High], [Medium] or [Low]

PARKING SENSOR (SONAR) SYSTEM LIMITATIONS

WARNING

Listed below are the system limitations for the parking sensor (sonar) system. Failure to operate the vehicle in accordance with these system limitations could result in serious injury or death.

- Read and understand the limitations of the parking sensor (sonar) system as contained in this section. Inclement weather may affect the function of the system; this may include reduced performance or a false activation.
- The parking sensor (sonar) system is deactivated at speeds above 12 km/h (7.5 MPH). It is reactivated below 10 km/h (6 MPH).
- Inclement weather or ultrasonic sources such as an automatic car wash, a truck’s compressed-air brakes or a pneumatic drill may affect the function of the parking sensor (sonar) system; this may include reduced performance or a false activation.
- The parking sensor (sonar) system is not designed to prevent contact with small or moving objects. Always move slowly. The system will not detect small objects below the bumper or on the ground.
- The parking sensor (sonar) system may not detect the following objects: fluffy objects such as snow, cloth, cotton, glass-wool, etc.; thin objects such as rope, wire and chain, etc.; or wedge-shaped objects; complex-shaped objects or multiple objects in close.

- The parking sensor (sonar) system may not detect objects at speed above 5 Km/h (3 MPH) and may not detect certain angular or moving objects.
- The parking sensor (sonar) system may not detect the following objects:
 - Pedestrians who approach the vehicle from the side
 - Objects placed next to the vehicle
- The parking sensor (sonar) system may not operate in the following conditions:
 - When rain, snow, ice, dirt, etc. adheres to the parking sensor.
 - When a loud sound is heard in the area around the vehicle.
 - When the surface of the obstacle is diagonal to the front or rear of the vehicle.
 - When a parking sensor or the area around the sensor is extremely hot or cold.
- The parking sensor (sonar) system may unintentionally operate in the following conditions:
 - When there is overgrown grass in the area around the vehicle.
 - When there is a structure (for example, a wall, a toll gate equipment, a narrow tunnel or a parking lot gate) near the side of the vehicle.
 - When there are bumps, protrusions or manhole covers on the road surface.
 - When the vehicle drives through a draped flag or a curtain.

- When there is an accumulation of snow or ice behind the vehicle.
- When driving on a steep hill.

SYSTEM TEMPORARILY UNAVAILABLE

When parking sensor blockage is detected, the system will be deactivated automatically.

The system is not available until the conditions no longer exist.

The parking sensors may be blocked by temporary ambient conditions such as splashing water, mist or fog. The blocked condition may also be caused by objects such as ice, frost or dirt obstructing the sensors.

Action to take:

When the above conditions no longer exist, the system will resume automatically.

SYSTEM MAINTENANCE

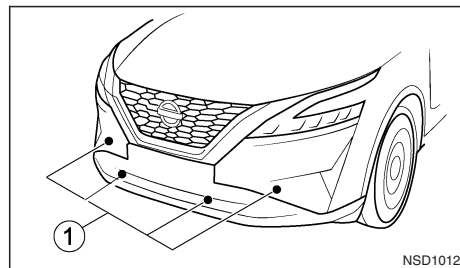

Where fitted

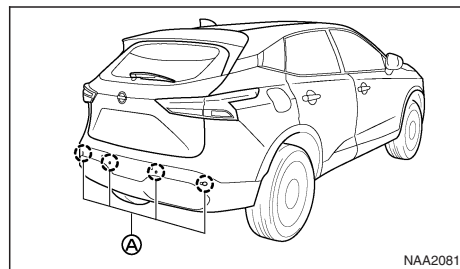

Where fitted

The parking sensors (A) and (B) are located on the front and rear bumpers.

- Always keep the area near the sonar sensors clean.
- If the parking sensors are dirty, wipe them off with a soft cloth while being careful to not damage them.

- The parking sensors may be blocked by temporary ambient conditions such as splashing water, mist or fog. The blocked condition may also be caused by objects such as ice, frost or dirt obstructing the sonar sensors. Check for and remove objects obstructing the area around the sensors.
- Do not subject the area around the parking sensors to strong impact. Also, do not remove or disassemble the sensors. If the parking sensors and peripheral areas are deformed in an accident, etc., have the sensors checked. It is recommended that you visit a NISSAN dealer or qualified workshop for this service.
- Do not attach stickers (including transparent material), install accessories or apply additional paint on the parking sensors and their surrounding areas. This may cause a malfunction or improper operation.
- When washing the vehicle using a high-pressure washer, do not apply direct washer pressure on the parking sensors. This may cause a malfunction of the sensors.

REAR ULTRASONIC PARKING SENSORS (where fitted)

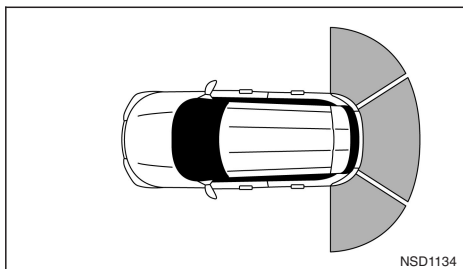

The parking sensor (sonar) system sounds a tone to inform the driver of obstacles near the rear bumper.

When the parking sensor (sonar) system is turned on, the sonar view will automatically appear in the vehicle information display.

WARNING

- The parking sensor (sonar) system is a convenience but it is not a substitute for proper parking.
- The driver is always responsible for safety during parking and other manoeuvres. Always look around and check that it is safe to do so before parking.
- Read and understand the limitations of the parking sensor (sonar) system as contained in this section. The colours of the sonar indicator indicates different distances to the object.

- Inclement weather or ultrasonic sources such as an automatic car wash, a truck's compressed-air brakes or a pneumatic drill may affect the function of the system; this may include reduced performance or a false activation.
- The parking sensor (sonar) system is designed as an aid to the driver in detecting large stationary objects to help avoid damaging the vehicle.
- The parking sensor (sonar) system is not designed to prevent contact with small or moving objects. Always move slowly. The system will not detect small objects below the bumper, and may not detect objects close to the bumper or on the ground.
- The parking sensor (sonar) system may not detect the following objects: fluffy objects such as snow, cloth, cotton, glass, wool, etc.; thin objects such as rope, wire and chain, etc.; or wedge-shaped objects.

CAUTION

- Excessive noise (such as audio system volume or an open vehicle window) will interfere with the tone and it may not be heard.
- Keep the parking sensor (sonar) sensors (located on the rear bumper fascia) free from snow, ice and large accumulations of dirt. Do not clean the sensors with sharp objects. If the sensors are covered, the accuracy of the sonar function will be diminished.

- If your vehicle sustains damage to the bumper fascia, leaving it misaligned or bent, the sensing zone may be altered causing inaccurate measurement of obstacles or false alarms.

SYSTEM OPERATION

The system informs with a visual and audible alert of rear obstacles when the shift control system is in the R (Reverse) position.

The parking sensor (sonar) system is deactivated at speeds above 12 km/h (7.5 MPH). It is reactivated below 10 km/h (6 MPH).

The intermittent tone will stop after several seconds when an obstacle is identified only with the corner sensor. The tone will stop when the obstacle gets away from the vehicle.

When the object is detected, the indicator (green) appears and blinks and the tone sounds intermittently. When the vehicle moves closer to the object, the colour of the indicator turns yellow and the rate of the blinking increases. When the vehicle is very close to the object, the indicator stops blinking and turns red, and the tone sounds continuously.

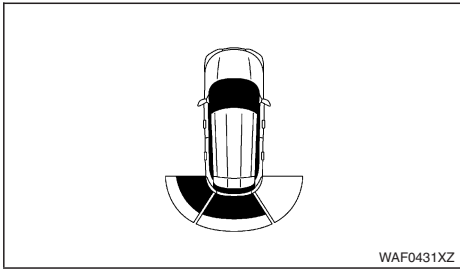

WAF0431XZ

Example

When the rear of the vehicle moves closer to an obstacle, the parking sensor (sonar) indicator appears in the vehicle information display.

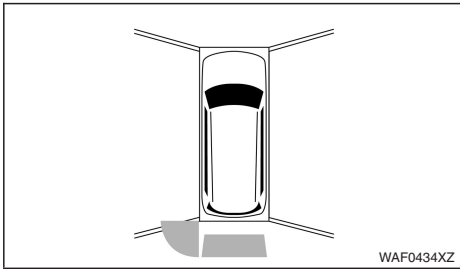

WAF0434XZ

Example

The parking sensor (sonar) indicator also appears on the camera view of the centre display.

HOW TO ENABLE/DISABLE THE PARKING SENSOR (SONAR) SYSTEM

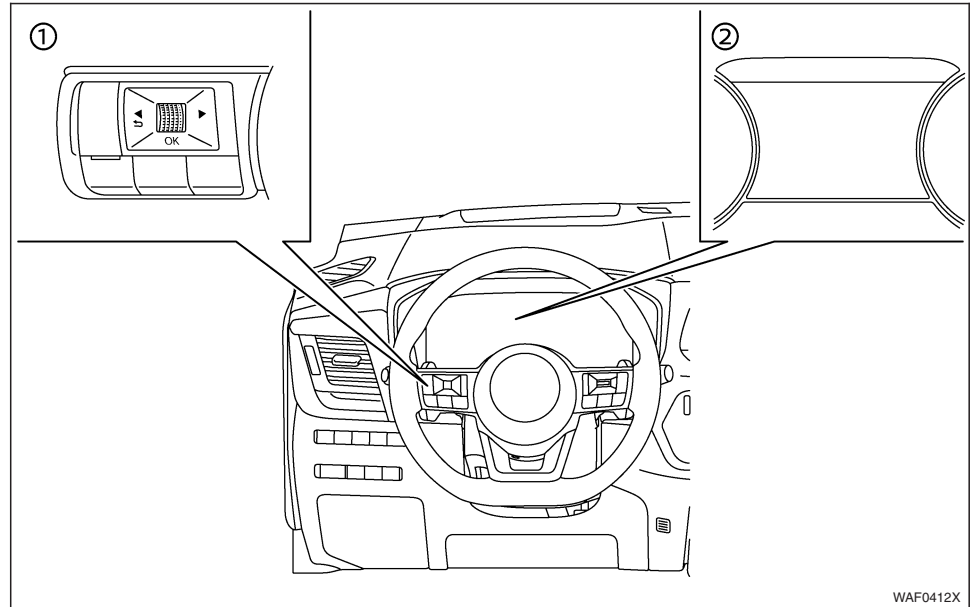

WAF0412X

- ① Steering-wheel-mounted control (left side)
- ② Vehicle information display

The system is automatically activated when the power switch is switched ON and the shift control system is in the R (Reverse) position.



NOTE

When the shift control system is in R (Reverse) and the [Parking Aids] screen is displayed in the vehicle information display the parking sensor (sonar) system can be disabled temporarily by pushing the <OK> switch on the steering wheel.

The system will remain disabled until the shift control system is shifted to N (Neutral) or P (Park) or vehicle speed exceeds 12 km/h (7.5 MPH).

Perform the following steps to set up the parking sensor (sonar) system function:

1. Push the ◀ ▶ button until [Settings] appears in the vehicle information display and then push the scroll dial. Use the scroll dial to select [Driver Assistance]. Then push the scroll dial.
2. Select [Parking Aids] and push the scroll dial.

3. Use the scroll dial to navigate in the menu and select or change an item:

- [Moving Object] (where fitted)
 - Turns ON/OFF the Moving Object Detection (MOD) (See “Moving Object Detection (MOD)” in the “4. Display screen, heater and air conditioner, and audio system” section.)
- [Rear]
 - Turns ON/OFF the parking sensor (sonar) system
- [Distance]
 - Changes the parking sensor (sonar) system sensor’s detection distance to [Far], [Medium] or [Near]
- [Volume]
 - Changes the volume of the tone sound to [High], [Medium] or [Low]

PARKING SENSOR (SONAR) SYSTEM LIMITATIONS

WARNING

Listed below are the system limitations for the parking sensor (sonar) system. Failure to operate the vehicle in accordance with these system limitations could result in serious injury or death.

- Read and understand the limitations of the parking sensor (sonar) system as contained in this section. Inclement weather may affect the function of the parking sensor (sonar) system; this may include reduced performance or a false activation.

- The parking sensor (sonar) system is deactivated at speeds above 12 km/h (7.5 MPH). It is reactivated below 10 km/h (6 MPH).
- Inclement weather or ultrasonic sources such as an automatic car wash, a truck’s compressed-air brakes or a pneumatic drill may affect the function of the parking sensor (sonar) system; this may include reduced performance or a false activation.
- The parking sensor (sonar) system is not designed to prevent contact with small or moving objects. Always move slowly. The system will not detect small objects below the bumper or on the ground.
- The parking sensor (sonar) system may not detect the following objects: fluffy objects such as snow, cloth, cotton, glass-wool, etc.; thin objects such as rope, wire and chain, etc.; or wedge-shaped objects; complex-shaped objects or multiple objects in close.
- The parking sensor (sonar) system may not detect objects at speed above 5 km/h (3 MPH) and may not detect certain angular or moving objects.
- The parking sensor (sonar) system may not operate in the following conditions:
 - When rain, snow, ice, dirt, etc. adheres to the sonar sensor.
 - When a loud sound is heard in the area around the vehicle.
 - When the surface of the obstacle is diagonal to the rear of the vehicle.

- When a sonar sensor or the area around the sensor is extremely hot or cold.
- The parking sensor (sonar) system may unintentionally operate in the following conditions:
 - When there is overgrown grass in the area around the vehicle.
 - When there are bumps, protrusions or manhole covers on the road surface.
 - When the vehicle drives through a draped flag or a curtain.
 - When there is an accumulation of snow or ice behind the vehicle.
 - When driving on a steep hill.

SYSTEM TEMPORARILY UNAVAILABLE

When sensor blockage is detected, the system will be deactivated automatically.

The system is not available until the conditions no longer exist.

The parking sensor (sonar) sensors may be blocked by temporary ambient conditions such as splashing water, mist or fog. The blocked condition may also be caused by objects such as ice, frost or dirt obstructing the sensors.

Action to take:

When the above conditions no longer exist, the system will resume automatically.

SYSTEM MAINTENANCE

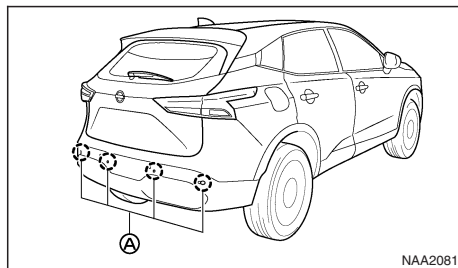

Where fitted

The parking sensor (sonar) sensors (A) are located on the rear bumper.

- Always keep the area near the sonar sensors clean.
- If the sensors are dirty, wipe them off with a soft cloth while being careful to not damage them.
- The sensors may be blocked by temporary ambient conditions such as splashing water, mist or fog. The blocked condition may also be caused by objects such as ice, frost or dirt obstructing the sonar sensors. Check for and remove objects obstructing the area around the sensors.
- Do not subject the area around the sensors to strong impact. Also, do not remove or disassemble the sensors. If the sensors and peripheral areas are deformed in an accident, etc., have the sensors checked. It is recommended that you visit a NISSAN dealer or qualified workshop for this service.

- Do not attach stickers (including transparent material), install accessories or apply additional paint on the sensors and their surrounding areas. This may cause a malfunction or improper operation.
- When washing the vehicle using a high-pressure washer, do not apply direct washer pressure on the sensors. This may cause a malfunction of the sensors.

TRAILER TOWING

Your new vehicle was designed to be used primarily to carry passengers and luggage.

Remember that towing a trailer will place additional loads on your vehicle's engine, drive-train, steering, braking and other systems. Towing a trailer will also exaggerate other conditions, such as sway caused by crosswinds, rough road surfaces or passing trucks. Driving style and speed must be adjusted according to the circumstances. Before towing a trailer, see a NISSAN dealer or qualified workshop for an explanation of towing equipment and its proper use.

OPERATING PRECAUTIONS

- Choose proper coupling devices (trailer hitch, safety chain, roof carrier, etc.) for your vehicle and trailer. These devices are available from a NISSAN dealer or qualified workshop where you can also obtain more detailed information about trailer towing.
- It is advisable to contact a NISSAN dealer or qualified workshop for towing details, before towing a trailer up steep slopes for long distances.
- Never allow the total trailer load (trailer weight plus its cargo weight) to exceed the maximum set for the coupling device.

Contact a NISSAN dealer or qualified workshop for more information on this matter.

- The trailer must be loaded so that heavy goods are distributed over the axle and as low in the trailer as possible. Poor load distribution can seriously affect the stability of the trailer and tow vehicle.

- Do not exceed the maximum permitted vertical load on the trailer hitch.
- Do not exceed the maximum gross vehicle weight. This is the combined weight of the vehicle, driver, passengers, cargo, and load on the towing coupling device (where fitted). You can find the maximum gross vehicle weight on the vehicle identification label (see "Vehicle identification label" in the "9. Technical information" section).
- Before driving, make sure that the lighting system of the trailer works properly.
- Avoid abrupt starts, acceleration and stops.
- Avoid sharp turns and lane changes.
- Always drive your vehicle at a moderate speed.
- Always block the wheels on both vehicle and trailer when parking. Apply the handbrake (where fitted) on the trailer. Parking on a steep slope is not recommended.

If parking on a steep slope is unavoidable it is also advisable to select P (Park), and turn the front wheels into the kerb (in addition to the other precautions described). Before parking on a steep slope consider the incline (the towing weights quoted are for a 12% slope).

- Follow the trailer manufacturer's instructions.
- Have your vehicle serviced more often than at the intervals specified in the separately provided Warranty Information and Maintenance booklet.
- Trailer towing requires more fuel than under normal circumstances because of a considerable increase in traction power required and resistance.

- When towing a trailer, observe the following restricted towing speed:

Speed: below 100 km/h (62 MPH)

CAUTION

While towing a trailer, check the engine coolant temperature gauge regularly to prevent engine overheating.

TYRE PRESSURE

When towing a trailer, inflate the vehicle tyres to the maximum recommended COLD tyre pressure, as indicated on the tyre placard (for full loading). Make sure the trailer tyre pressures are correct.

CAUTION

Do not tow a trailer when the vehicle is installed with a temporary-use spare tyre.

SAFETY CHAINS

Always use a suitable chain between the vehicle and trailer. The chain should be attached to the hitch and not to the vehicle bumper or axle. Be sure to leave enough slack in the chain to permit turning corners. The chain should not drag on the ground: passing the chain across the trailer hitch may be the best practice depending on your trailer.

TRAILER BRAKES

Ensure that trailer brakes are installed as required by local regulations. Also check that all other trailer equipment conforms to local regulations.

INSTALLATION OF COUPLING DEVICE

NISSAN recommends that the coupling device for trailer towing be installed under the following conditions:

- Maximum permissible vertical load on the coupling device: 981 N (100 kg, 220 lb)
- The coupling device, mounting points and installation parts on your vehicle: as shown as an example in the illustration.

Follow all of the coupling device manufacturer's instructions for installation and use.

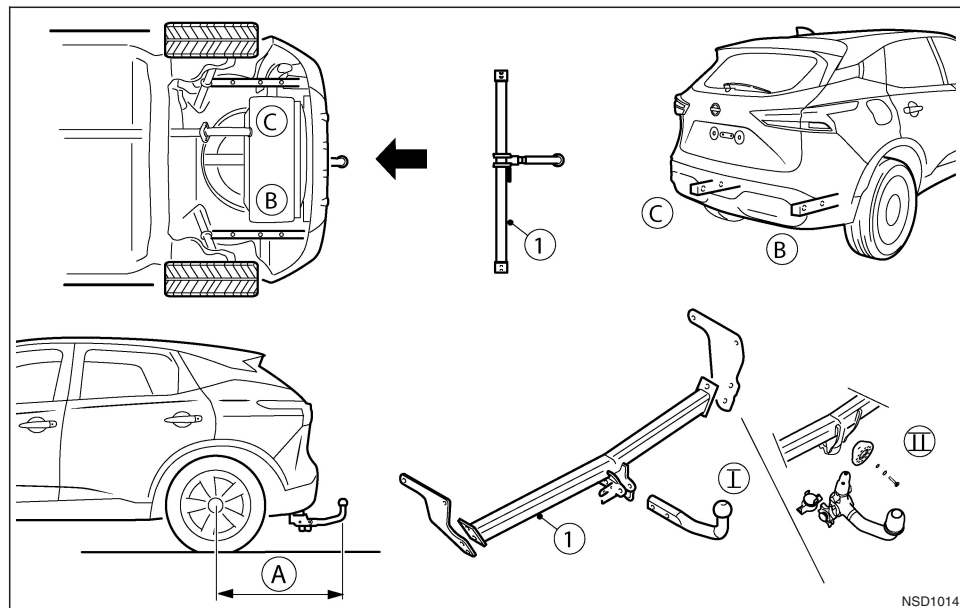

NSD1014

Rear overhang of coupling device:

- Ⓐ 744 mm (29.3 in)
- Ⓘ Fixed towbar
- Ⓚ Detachable towbar

VEHICLE SECURITY

When leaving your vehicle unoccupied:

- Always remove the Intelligent Key (where fitted) and take it with you – even in your own garage.
- Close all windows completely and lock all doors.
- Always park your vehicle where it can be seen. At night, park in a well lit area.
- If the vehicle is equipped with an alarm or immobilisation device, use it – even for short periods.
- Do not leave children and pets in the vehicle unattended.
- Do not leave valuables on view to tempt a thief. Always take your valuables with you. If you must leave something in your vehicle, lock it in the luggage compartment or hide it out of sight.
- Do not leave the vehicle documents in your vehicle. In the unfortunate event of your vehicle being stolen, the documents will only help a thief to sell the vehicle.
- Do not leave articles on a roof rack as they are particularly vulnerable. If possible, remove them from the rack and lock them inside the vehicle.
- Do not leave the Intelligent Key or spare key in the vehicle – keep it in a safe place at home.
- Do not leave a note of your vehicle's key number in the vehicle. A thief may break into the vehicle, note the key number and return with a new key and drive the vehicle.

POWER STEERING

WARNING

- **If the e-POWER system is not running or is turned off while driving, the power assistance for the steering will not work. The steering will be harder to operate.**
- **When the electric power steering warning light illuminates with the e-POWER system running, the power assistance for the steering will cease operation. You will still have control of the vehicle but the steering will be harder to operate.**

The electric power steering system is designed to provide power assistance while driving to allow you to operate the steering wheel with light force.

NOTE

When the steering wheel is operated repeatedly or continuously while parking or driving at a very low speed, the power assistance for the steering wheel will be reduced. This is to prevent overheating of the electric power steering system and protect it from becoming damaged. While the power assistance is reduced, steering wheel operation will become heavy. When the temperature of the electric power steering system decreases, the power assistance level will return to normal. Avoid repeating such steering wheel operations that could cause the electric power steering system to overheat.

You may hear a noise when the steering wheel is operated quickly. However, this is not a malfunction.

If the electric power steering warning light  illuminates while the e-POWER system is running, it may indicate the electric power steering system is not functioning properly and may need servicing. Have the electric power steering system checked by a NISSAN dealer or qualified workshop. (See “Electric Power Steering warning light” in the “2. Instruments and controls” section.)

When the electric power steering warning light illuminates with the e-POWER system running, the power assistance for the steering will cease operation. You will still have control of the vehicle. However, greater steering effort is needed, especially in sharp turns and at low speeds.

BRAKE SYSTEM

BRAKING PRECAUTIONS

This vehicle is equipped with two braking systems:

- 1) Hydraulic brake system
- 2) Regenerative brake system

Hydraulic brake system

The hydraulic brake system is similar to the brakes used on conventional vehicles.

The brake system has two separate hydraulic circuits. If one circuit malfunctions, you will still have braking at two wheels.

Regenerative brake system

The primary purpose of regenerative brake system is to provide some power to help recharge the Li-ion battery and extend driving range. A secondary benefit is “engine braking” that operates based on battery conditions.

In the D (Drive) position, when the accelerator is released, the regenerative brake system provides some deceleration and generates power for the Li-ion battery. Power is also generated when the brake pedal is applied.

When you put the shift lever in the B position and take your foot off the accelerator pedal, more regenerative brake is applied than in the D (Drive) position. However, during high-speed driving you may feel that regenerative brake provides less deceleration than the engine braking in an ordinary vehicle. This is normal.

Less deceleration is provided by the regenerative brake system when the Li-ion battery is fully charged. Regenerative brake is automatically reduced when the Li-ion battery is fully charged to

prevent the Li-ion battery from becoming overcharged. Regenerative brake is also automatically reduced when the battery temperature is high/low to prevent Li-ion battery damage.

The brake pedal should be used to slow or stop the vehicle depending on traffic or road conditions. The vehicle brakes are not affected by regenerative brake system operation.

NOTE

- **When applying the regenerative brakes, you may hear a sound coming from the regenerative brake system. This is a normal operating characteristic of an e-POWER vehicle.**
- **If the power switch position is in a position other than ON or READY to drive, you can stop the vehicle by depressing the brake pedal. However, greater foot pressure on the brake pedal will be required to stop the vehicle, and the stopping distance will be longer.**
- **When depressing the brake pedal, the braking pedal feel may change when the cooperative regenerative brake system activates. However, the electronically controlled brake system is operating normally and this does not indicate a malfunction.**

Using the brakes

Avoid resting your foot on the brake pedal while driving. This will cause overheating of the brakes, wearing out the brake pads faster and will reduce driving range.

To help reduce brake wear and to prevent the brakes from overheating, reduce speed and select the B position before going down a slope or long

grade. Overheated brakes may reduce braking performance and could result in loss of vehicle control.

WARNING

- **While driving on a slippery surface, be careful when braking or accelerating. Abrupt braking or accelerating could cause the wheels to skid, which could result in an accident.**
- **If the brake pedal is depressed with the e-POWER system OFF, you may feel an increased brake pedal effort and a decreased pedal stroke. If the brake warning light (red) does not illuminate and the brake pedal feels like it has returned to its normal state after the e-POWER system is started, this indicates that there is no malfunction and the vehicle can be operated normally.**

Wet brakes

When the vehicle is washed or driven through water, the brakes may get wet. As a result, your braking distance will be longer and the vehicle may pull to one side during braking.

To dry brakes, drive the vehicle at a safe speed while lightly pressing the brake pedal to heat up the brakes. Do this until the brakes return to normal. Avoid driving the vehicle at high speeds until the brakes function correctly.

ANTI-LOCK BRAKING SYSTEM (ABS)

WARNING

- **The Anti-lock Braking System (ABS) is a sophisticated device, but it cannot prevent accidents resulting from careless or dangerous driving techniques. It can help maintain vehicle control during braking on slippery surfaces. Remember that stopping distances on slippery surfaces will be longer than on normal surfaces even with ABS. Stopping distances may also be longer on rough, gravel or snow covered roads, or if you are using snow chains. Always maintain a safe distance from the vehicle in front of you. Ultimately, the driver is responsible for safety.**
- **Tyre type and condition may also affect braking effectiveness.**
 - **When replacing tyres, install the specified size of tyres on all four wheels.**
 - **When installing a spare tyre, make sure that it is the proper size and type as specified on the tyre placard. (See “Vehicle identification” in the “9. Technical information” section.)**
 - **For detailed information, see “Wheels and tyres” in the “8. Maintenance and do-it-yourself” section.**

The Anti-lock Braking System (ABS) controls the brakes so the wheels do not lock during hard braking or when braking on slippery surfaces. The system detects the rotation speed at each wheel and varies the brake fluid pressure to prevent each

wheel from locking and sliding. By preventing each wheel from locking, the system helps the driver maintain steering control and helps to minimise swerving and spinning on slippery surfaces.

USING SYSTEM

Depress the brake pedal and hold it down. Depress the brake pedal with firm steady pressure, but do not pump the brakes. The ABS will operate to prevent the wheels from locking up. Steer the vehicle to avoid obstacles.

WARNING

Do not pump the brake pedal. Doing so may result in increased stopping distances.

SELF-TEST FEATURE

The ABS includes electronic sensors, electric pumps, hydraulic solenoids and a computer. The computer has a built-in diagnostic feature that tests the system each time you start the e-POWER system and move the vehicle at a low speed in forward or reverse. When the self-test occurs, you may hear a “clunk” noise and/or feel a pulsation in the brake pedal. This is normal and does not indicate a malfunction. If the computer senses a malfunction, it switches the ABS off and illuminates the ABS warning light on the instrument panel. The brake system then operates normally, but without anti-lock assistance.

If the ABS warning light illuminates during the self-test or while driving, have the vehicle checked by a NISSAN dealer or qualified workshop.

NORMAL OPERATION

The ABS operates at speeds above 5 to 10 km/h (3 to 6 MPH). The speed varies according to road conditions.

When the ABS senses that one or more wheels are close to locking up, the actuator rapidly applies and releases hydraulic pressure. This action is similar to pumping the brakes very quickly. You may feel a pulsation in the brake pedal and hear a noise from under the bonnet or feel a vibration from the actuator when it is operating. This is normal and indicates that the ABS is operating properly. However, the pulsation may indicate that road conditions are hazardous and extra care is required while driving.

ELECTRONIC STABILITY PROGRAMME (ESP) SYSTEM

The Electronic Stability Program (ESP) system uses various sensors to monitor driver inputs and vehicle motion. Under certain driving conditions, the ESP system helps to perform the following functions.

- Controls brake pressure to reduce wheel slip on one slipping drive wheel so power is transferred to a non slipping drive wheel on the same axle.
- Controls brake pressure and EV system output to reduce drive wheel slip based on vehicle speed (traction control function).
- Controls brake pressure at individual wheels and EV system output to help the driver maintain control of the vehicle in the following conditions:
 - Understeer (vehicle tends to not follow the steered path despite increased steering input).
 - Oversteer (vehicle tends to spin due to certain road or driving conditions).



The ESP system can help the driver to maintain control of the vehicle, but it cannot prevent loss of vehicle control in all driving situations.

When the ESP system operates, the slip indicator light  in the instrument panel flashes so note the following:

- The road may be slippery or the system may determine some action is required to help keep the vehicle on the steered path.
- You may feel a pulsation in the brake pedal and hear a noise or vibration from under the bonnet. This is normal and indicates that the ESP system is working properly.

- Adjust your speed and driving to the road conditions.

If a malfunction occurs in the system, the slip indicator light  illuminates in the instrument panel. The ESP system automatically turns off.

The vehicle information display is used to turn off the ESP system. The ESP off indicator  illuminates to indicate the ESP system is off. When the ESP system is turned off, the ESP system still operates to prevent one drive wheel from slipping by transferring power to a non slipping drive wheel. The slip indicator light  flashes if this occurs. All other ESP functions are off, and the slip indicator light  will not flash. The ESP system is automatically reset to on when the power switch is placed in the off position then back to the on position.





See "Warning lights, indicator lights and audible reminders" in the "2. Instruments and controls" section.

The computer has a built-in diagnostic feature that tests the system each time you start the EV system and move the vehicle forward or in reverse at a slow speed. When the self-test occurs, you may hear a "clunk" noise and/or feel a pulsation in the brake pedal. This is normal and is not an indication of a malfunction.

WARNING

- **The ESP system is designed to help improve driving stability but does not prevent accidents due to abrupt steering operation at high speeds or by careless or dangerous driving techniques. Reduce vehicle speed and be**

especially careful when driving and cornering on slippery surfaces and always drive carefully.

- **Do not modify the vehicle's suspension. If suspension parts such as shock absorbers, struts, springs, stabilizer bars, bushings and wheels are not NISSAN recommended for your vehicle or are extremely deteriorated, the ESP system may not operate properly. This could adversely affect vehicle handling performance, and the slip indicator light  may illuminate.**
- **If brake related parts such as brake pads, rotors and calipers are not NISSAN recommended or are extremely deteriorated, the ESP system may not operate properly and the slip indicator light  may illuminate.**
- **If e-POWER system control related parts are not NISSAN recommended or are extremely deteriorated, the slip indicator light  may illuminate.**
- **When driving on extremely inclined surfaces such as higher banked corners, the ESP system may not operate properly and the slip indicator light  may illuminate. Do not drive on these types of roads.**
- **When driving on an unstable surface such as a turntable, ferry, elevator or ramp, the slip indicator light  may illuminate. This is not a malfunction. Restart the EV system after driving onto a stable surface.**

- If wheels or tyres other than the NISSAN recommended ones are used, the ESP system may not operate properly and the slip indicator light  may illuminate.
- The ESP system is not a substitute for winter tyres or tyre chains on a snow covered road.

BRAKE FORCE DISTRIBUTION

During braking while driving through turns, the system optimizes the distribution of force to each of the four wheels depending on the radius of the turn.

HOW TO TURN OFF THE ESP SYSTEM

The vehicle should be driven with the Electronic Stability Programme (ESP) system ON for most driving conditions.

If the vehicle is stuck in mud or snow, the ESP system reduces the e-POWER system output to decrease wheel spin. The e-POWER system speed will be reduced even if the accelerator is depressed to the floor. If maximum e-POWER system power is needed to free a stuck vehicle, turn the ESP system off.

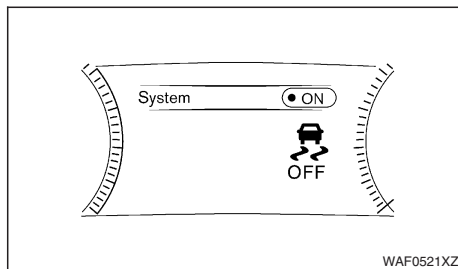

Example

To turn off the ESP system, perform the following steps in the vehicle information display, see "Vehicle information display" in the "2. Instruments and controls" section for operational details.

1. Use the steering wheel switches to select the [Settings] menu.
2. Use the scroll dial to select [ESP Setting] and then push the scroll dial.
3. Select [System] and push the scroll dial. The ESP OFF indicator light () will illuminate.

Turn [ESP Setting] back on in the vehicle information display or restart the e-POWER system to turn on the ESP system.

CHASSIS CONTROL

The chassis control is an electric control module that includes the following functions:

- Intelligent Trace Control

INTELLIGENT TRACE CONTROL

WARNING

The Intelligent Trace Control may not be effective depending on the driving condition. Always drive carefully and attentively.

This system senses driving based on the driver's steering and acceleration/braking patterns, and controls brake pressure at individual wheels to aid tracing at corners and help smooth vehicle response.

The Intelligent Trace Control can be set to ON (enabled) or OFF (disabled) using the [Driver Assistance] settings in the vehicle information display. (See "[Settings]" in the "2. Instruments and controls" section.)

When the ESP system is turned off, the Intelligent Trace Control is also turned off.

When the Intelligent Trace Control is not functioning properly, the master warning light illuminates, and warning message [Chassis Control System Fault See Owner's Manual] will also appear in the vehicle information display.

If the chassis control warning message appears in the vehicle information display, it may indicate that the Intelligent Trace Control is not functioning properly. Have the system checked as soon as possible.

HILL START ASSIST (HSA) (where fitted)

It is recommended that you visit a NISSAN dealer or qualified workshop for this service. (See "Vehicle information display" in the "2. Instruments and controls" section.)

When the Intelligent Trace Control is operating, you may feel a pulsation in the brake pedal and hear a noise. This is normal and indicates that the Intelligent Trace Control is operating properly. You may also feel deceleration when the Intelligent Trace Control is operating. However, this is not a malfunction.

WARNING

- **Never rely solely on the Hill Start Assist (HSA) system to prevent the vehicle from moving backward on a hill. Always drive carefully and attentively. Depress the brake pedal when the vehicle is stopped on a steep hill. Be especially careful when stopped on a hill on frozen or muddy roads. Failure to prevent the vehicle from rolling backwards may result in a loss of control of the vehicle and possible serious injury or death.**
- **The Hill Start Assist system is not designed to hold the vehicle at a standstill on a hill. Depress the brake pedal when the vehicle is stopped on a steep hill. Failure to do so may cause the vehicle to roll backwards and may result in a collision or serious personal injury.**
- **The Hill Start Assist system may not prevent the vehicle from rolling backwards on a hill under all load or road conditions. Always be prepared to depress the brake pedal to prevent the vehicle from rolling backwards. Failure to do so may result in a collision or serious personal injury.**

The Hill Start Assist system automatically keeps the brakes applied to help prevent the vehicle from rolling backwards in the time it takes the driver to release the brake pedal and apply the accelerator when the vehicle is stopped on a hill.

The Hill Start Assist system will operate automatically under the following conditions:

- The shift control system shifted into D (Drive) (vehicle facing uphill) or R (Reverse) (vehicle facing downhill).
- The vehicle is stopped completely on a hill by applying the footbrake.

The maximum holding time is 2 seconds. After 2 seconds the vehicle will begin to roll back and the Hill Start Assist system will stop operating completely.

The Hill Start Assist system will not operate when the shift control system is shifted to the N (Neutral) or P (Park) position or on a flat and level road.

When the Electronic Stability Programme (ESP) OFF indicator light illuminates in the meter, the Hill Start Assist system will not operate. (See "Electronic Stability Programme (ESP) OFF indicator light (where fitted)" in the "2. Instruments and controls" section.)

COLD WEATHER DRIVING

WARNING

- **Whatever the conditions, drive with caution. Accelerate and decelerate with great care. If accelerating or decelerating too fast, the drive wheels will lose even more traction.**
- **Allow more stopping distance in cold weather driving. Braking should be started sooner than on dry surfaces.**
- **Keep at a greater distance from the vehicle in front of you on slippery roads.**
- **Wet ice (0°C, 32°F and freezing rain), very cold snow and ice can be slick and very difficult to drive on. The vehicle will have a lot less traction or grip under these conditions. Try to avoid driving on wet ice until the road is salted or sanded.**
- **Watch for slippery spots (black ice). These may appear on an otherwise clear road in shaded areas. If a patch of ice is seen ahead, brake before driving on it. Try not to brake while actually on the ice and avoid any sudden steering manoeuvres.**
- **Do not use cruise control (where fitted) on slippery roads.**
- **Snow can trap dangerous exhaust gas under your vehicle. Keep snow clear of the exhaust pipe and from around your vehicle.**

BATTERY

If the battery is not fully charged during extremely cold weather conditions, the battery fluid may freeze and damage the battery. To maintain maximum efficiency, the battery should be checked regularly. For details, see "Battery" in the "8. Maintenance and do-it-yourself" section.

ENGINE COOLANT

If the vehicle is to be left outside without anti-freeze, drain the cooling system. Refill before operating the vehicle. For details, see "Engine cooling system" in the "8. Maintenance and do-it-yourself" section.

TYRE EQUIPMENT

- 1) The SUMMER tyres are of a tread design to provide superior performance on dry surfaces. However, the performance of these tyres will be substantially reduced in snowy and icy conditions. If you operate your vehicle on snowy or icy roads, NISSAN recommends the use of MUD & SNOW or ALL SEASON tyres on all four wheels. Please consult a NISSAN dealer or qualified workshop for tyre type, size, speed rating and availability information.
- 2) For additional traction on icy roads, studded tyres may be used. However, some countries, provinces and states prohibit their use. Check applicable laws before installing studded tyres.

CAUTION

Skid and traction capabilities of studded snow tyres on wet or dry surfaces may be poorer than that of non-studded snow tyres.

- 3) Snow chains may be used, if desired. But the use of snow chains may be prohibited in some areas. Therefore, check the local laws before installing snow chains. When installing snow chains, make sure they are of proper size for the tyres on your vehicle and are installed according to the snow chain manufacturer's instructions. Use chain tensioners when recommended by the snow chain manufacturer to ensure a tight fit. Loose end links of the snow chain must be secured or removed to prevent the possibility of whipping action damage to the wings or undercarriage. In addition, drive at a reduced speed, otherwise, your vehicle may be damaged and/or vehicle handling and performance may be adversely affected.

SPECIAL WINTER EQUIPMENT

It is recommended to carry the following items in the vehicle during winter:

- A scraper and stiff-bristled brush to remove ice and snow from the windows.
- A sturdy, flat board to be placed under the jack to give it firm support.
- A shovel to dig the vehicle out of snowdrifts.
- Extra windscreen washer fluid to refill the reservoir tank.

CORROSION PROTECTION

Chemicals used for road surface de-icing are extremely corrosive and will accelerate corrosion and the deterioration of underbody components such as the exhaust system, fuel and brake lines, brake cables, floor pan, and wings.

In the winter, the underbody must be cleaned periodically. For additional information, see "Corrosion protection" in the "7. Appearance and care" section.

For additional protection against rust and corrosion, which may be required in some areas, consult a NISSAN dealer or qualified workshop.

6 In case of emergency

Hazard warning flasher switch	414	Tyre Pressure Monitoring System (TPMS)	
Emergency services call eCall/SOS system (where fitted).....	414	(where fitted).....	421
Automatic eCall.....	414	Repairing flat tyre (Models with emergency tyre puncture repair kit).....	423
Manual eCall (SOS button).....	415	Jump starting	426
System status indicator.....	416	Push starting.....	427
Modalities for exercising data subject's rights.....	416	If your vehicle overheats	428
Spare tyre.....	417	Towing your vehicle.....	429
Temporary-use spare tyre (where fitted).....	417	Towing precautions.....	429
Conventional spare tyre (where fitted)	417	Recommendations for towing e-POWER models	429
Flat tyre.....	418	Towing eye.....	430
Stopping the vehicle.....	418	Freeing the vehicle from sand, snow or mud.....	430
Changing flat tyre (Models with spare wheel, where fitted)	418		

HAZARD WARNING FLASHER SWITCH

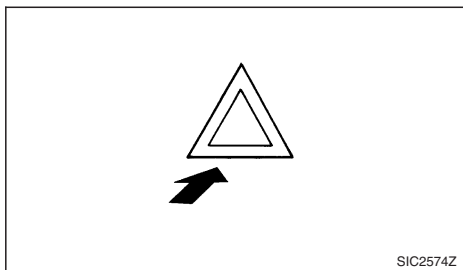

The hazard warning flasher switch operates regardless of the e-POWER power switch position except when the battery is discharged.

The hazard warning flasher is used to warn other drivers when you have to stop or park under emergency conditions.

When the hazard warning flasher switch is pushed, all turn signal lights will flash. To turn off the hazard warning flasher, push the hazard warning flasher switch again.

When an impact that could activate the supplemental air bags is detected, the hazard warning flasher lights blink automatically. If the hazard warning flasher switch is pushed, the hazard warning flashers will turn off.

WARNING

Do not turn the hazard warning flasher switch off until you can make sure that it is safe to do so. Also, the hazard warning flasher may not blink automatically depending on the force of impact.

EMERGENCY SERVICES CALL eCall/SOS SYSTEM (where fitted)

Your vehicle is equipped with the 112-based in-vehicle emergency services call system (eCall). In the event of a serious road accident emergency an automatic call can be made to the emergency services operator. The system can also be used manually to call the emergency services operator.

The 112-based eCall service is a public service of general interest and is accessible free of charge.

NISSAN is responsible only for the emergency communication system technical performance in the event of an accident within the warranty period.

AUTOMATIC eCall

If the air bag control unit detects a frontal collision, side collision or rear collision (where fitted) the system automatically places an emergency call to the emergency call centre. At the same time, the vehicle information is also transferred. Once an emergency call is received by the emergency call centre, the operator tries to talk to the vehicle's occupant.

NOTE

- **During the emergency call, the volume of the voice of the operator cannot be adjusted.**
- **During the emergency call, the volume of the vehicle audio will be muted.**

The eCall system is always enabled by default. It is activated automatically by means of in-vehicle sensors in the event of a severe accident.

The eCall system is not traceable and is not subject to any constant tracking in its normal operational status. Data in the internal memory of the system is not available outside the in-vehicle system to any entities before the eCall is triggered.

Any processing of personal data through the 112-based eCall in-vehicle system shall comply with the personal data protection rules provided for in Directives 95/46/EC and 2002/58/EC of the European Parliament and of the Council, and in particular, shall be based on the necessity to protect the vital interests of the individuals in accordance with Article 7(d) of Directive 95/46/EC.

Processing of such data is strictly limited to the purpose of handling the emergency eCall to the single European emergency number 112.

Recipients of data processed by the 112-based eCall in-vehicle system are the relevant public safety answering points designated by the respective public authorities of the country on which territory they are located, to first receive and handle eCalls to the single European emergency number 112.

The following information will be sent to the emergency call centre by the vehicle emergency call system if a collision occurs:

- Vehicle Identification Number (VIN)
- Vehicle type
- Fuel type
- Activation type (Automatic/Manual)
- Call type (Test/Emergency)
- Position (Trusted/Low confidence)
- Time stamp (when the collision or event occurred)
- Last three vehicle locations, and vehicle direction
- Vehicle speed
- (where fitted) Number of passengers

The 112-based eCall in-vehicle system is designed in such a way as to ensure that data in the system internal memory is automatically and continuously removed.

The vehicle location data is constantly overwritten in the internal memory of the system so as always to keep maximum of the last three up-to-date locations of the vehicle necessary for the normal functioning of the system.

The log of activity data in the 112-based eCall in-vehicle system is kept for no longer than necessary for attaining the purpose of handling the emergency eCall and in any case not beyond 13 hours from the moment an emergency eCall was initiated.

CAUTION

- **The automatic emergency call will only be triggered if the vehicle air bag system is activated during the collision.**
- **If the automatic emergency call has been triggered, please bring your vehicle to a NISSAN dealer or qualified workshop. This is necessary because the automatic emergency call system needs to be reset to avoid any unintended eCall being made.**
- **The mobile network provider that manages the connection from the vehicle to the emergency call centre is specified and controlled outside of the vehicle emergency call system.**
- **Within the first minute of any emergency call the operator will determine if the call is genuine. Should the operator determine it is a non-genuine call they will stop the call, making no further attempts to call the vehicle back. This**

action does not prevent the occupant(s) of the vehicle from making a further manual emergency call.

The emergency call function cannot be used in the following conditions:

- **The vehicle is outside the area where mobile network service is receivable.**
- **The vehicle is in a location with poor signal reception such as tunnels, underground parking garages, between buildings or in mountainous areas.**
- **The TCU (Telematics Control Unit) or other systems of your vehicle are not working properly.**
- **The available mobile network provider at the location of the vehicle is not specified for emergency call usage.**
- **The communication line of the emergency call centre is busy.**

MANUAL eCall (SOS BUTTON)

The manual eCall can be performed with the power switched **ON**, by pushing the **<SOS>** call button ③ located on the overhead control panel.

After the power switch is switched **OFF**, if an emergency call was not made, the eCall system is turned off.

CAUTION

- **Park the vehicle in a safe location and apply the parking brake before operating the <SOS> button.**

- **Use this service only in case of an emergency. There may be a penalty for inappropriate use of the service.**

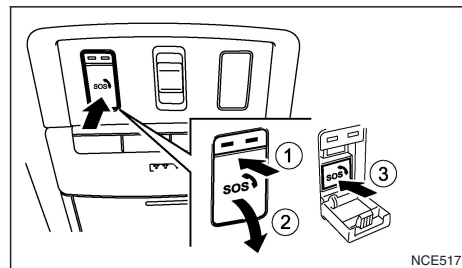

1. Switch the power switch **ON**.
2. Push ① to open the **<SOS>** cover ②.
3. Push the **<SOS>** button ③. An emergency call is sent to the emergency call centre. At the same time, the vehicle information is also transferred.
4. When the call is connected, you can speak to the emergency support staff.

If you want to cancel the emergency call, push and hold the **<SOS>** button for a few seconds. The call cannot be cancelled after connection.

NOTE

- During the emergency call, the volume of the voice of the operator cannot be adjusted.
- During the emergency call, the volume of the vehicle audio will be muted.
- After the <SOS> button is pushed, it may take some time until the system initiates connection, depending on the technical environment and whether the TCU is being used by other services.
- To avoid disconnecting the call, do not turn the e-POWER system power switch off.
- During the emergency call Bluetooth® Hands-Free Phone connection will be disabled and phone operation will only be available by mobile phone.
- If the emergency call is disconnected for some reason the emergency call centre may call back. This action does not prevent the occupant(s) of the vehicle from making another manual emergency call.

SYSTEM STATUS INDICATOR

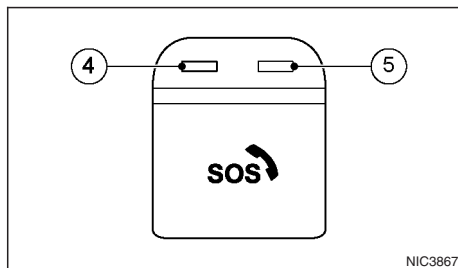

The indicator lights ④ and ⑤ above the <SOS> button indicate the status of the vehicle emergency call system. If the indicator light is illuminated red or no indicator light is illuminated the emergency call may not connect to the emergency call centre when the <SOS> button is pressed. Also an automatic emergency call may not be sent when a collision occurs.

- During vehicle start up the system operates self diagnostics and the red indicator light is illuminated for up to 15 seconds.
- At any other time if the red indicator light is illuminated contact a NISSAN dealer or qualified workshop for assistance. In the event of a critical system failure that would disable the 112-based eCall in-vehicle system, the red indicator light is illuminated as a warning.

NOTE

If the indicator light is illuminated red or no indicator light is illuminated, emergency services (such as the police or other agencies) should be contacted using other normal communication devices (for example a phone) in the event of an accident.

MODALITIES FOR EXERCISING DATA SUBJECT'S RIGHTS

The data subject (the vehicle's owner) has a right of access to data and as appropriate to request the rectification, erasure or blocking of data, concerning him or her, the processing of which does not comply with the provisions of Directive 95/46/EC. Any third parties to whom the data have been disclosed have to be notified of such rectification, erasure or blocking carried out in compliance with this Directive, unless it proves impossible or involves a disproportionate effort.

The data subject has a right to complain to the competent data protection authority if he or she considers that his or her rights have been infringed as a result of the processing of his or her personal data.

SPARE TYRE

TEMPORARY-USE SPARE TYRE (where fitted)

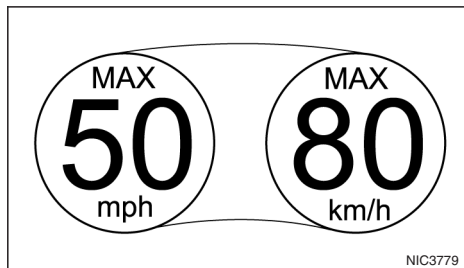

Temporary use spare tyre label

The temporary-use spare tyre is designed for emergency use only. This spare tyre should be used **ONLY** for very short periods and **NEVER** be used for long drives or extended periods.

Observe the following precautions if the temporary-use spare tyre must be used, otherwise your vehicle could be damaged or involved in an accident.

WARNING

Any continuous road use of this tyre could result in tyre failure, loss of vehicle control, and possible personal injury.

CAUTION

- The temporary-use spare tyre should be used only in emergencies. It should be replaced by the standard tyre at the first opportunity.
- Drive carefully and do not drive your vehicle faster than 80 km/h (50 MPH).
- Avoid driving over obstacles. Also, do not take the vehicle through an automatic car wash.
- Avoid driving sharp turns and abrupt braking.
- Do not exceed the vehicle's maximum load rating or the load-carrying capacity molded on the sidewall of the temporary-use spare tyre.
- Do not use a snow chain on this tyre because it will not fit properly. This could cause damage to the vehicle and result in loss of the chain.
- Do not use the temporary-use spare tyre on any other vehicle because this tyre has been designed specifically for your vehicle.
- The vehicle must not be driven with more than one temporary-use spare tyre at the same time.
- Do not tow a trailer.
- As with all tyres, the temporary-use spare tyre must be checked regularly to ensure pressure is maintained.

For pressure details, see the tyre placard located on the driver's side centre pillar.

CONVENTIONAL SPARE TYRE (where fitted)

A standard wheel and tyre is supplied with your vehicle.

FLAT TYRE

In case of a flat tyre, follow the instructions as described below:

STOPPING THE VEHICLE

⚠ WARNING

- Make sure that the parking brake is securely applied.
- Make sure that the shift control system is in the P (Park) position.
- Never change tyres when the vehicle is on a slope, ice or a slippery area. This is hazardous.
- Never change tyres if oncoming traffic is close to your vehicle. Wait for professional road assistance.

1. Safely move the vehicle off the road, away from traffic.
2. Switch on the hazard warning flashers.
3. Park on a level surface.
4. Apply the parking brake.
5. Press the P position switch to shift to the P (Park) position.
6. Turn off the e-POWER system.
7. Open the bonnet (for details, see "Bonnet" in the "3. Pre-driving checks and adjustments" section) in order to:
 - Warn other traffic.
 - Signal to professional road assistance that you require assistance.

8. Have all passengers exit the vehicle and stand in a safe place, away from traffic and clear of the vehicle.

CHANGING FLAT TYRE (Models with spare wheel, where fitted)

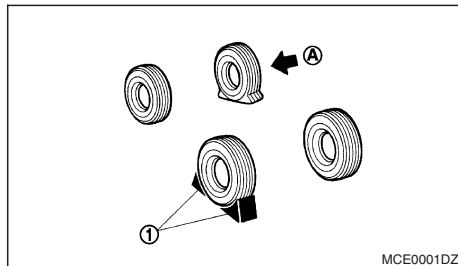

Blocking the wheels

⚠ WARNING

Make sure to block the appropriate wheel to prevent the vehicle from moving, which may cause personal injury.

Place suitable blocks ① in front of and behind the wheel diagonally opposite the flat tyre (A) to prevent the vehicle from moving when it is on the jack.

Getting the tools and spare wheel

The spare wheel, jack and tools are located inside the luggage compartment.

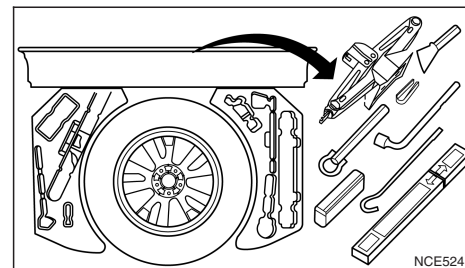
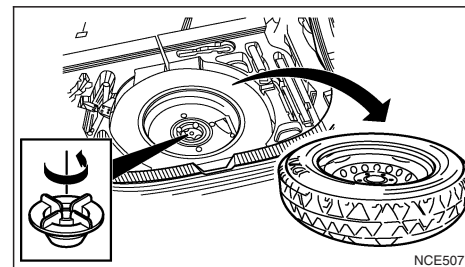

1. Open the tailgate.
2. Remove the luggage boards and luggage compartment floor cover.
3. Remove the retainer by turning it anticlockwise.

4. If you have a subwoofer speaker fitted, lift it out carefully and place it in a safe position away from the spare wheel. **Do not strain the cable attached to the subwoofer.**
5. Remove the jack, tools and spare wheel.

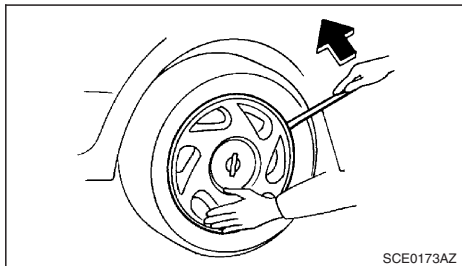

Removing wheel cover (where fitted)

⚠ WARNING

Take care when removing the wheel cover as the cover may detach suddenly.

Remove the wheel cover as illustrated with a suitable tool or carefully remove the wheel cover with both hands.

Removing the wheel

⚠ WARNING

- **Make sure to read the caution label attached to the jack body before use.**
- **DO NOT GET UNDER A VEHICLE THAT IS SUPPORTED BY A JACK.**
- **Never use a jack which was not provided with your vehicle.**
- **The jack, which is provided with your vehicle is designed only to lift your vehicle during a tyre change.**
- **Use the correct jacking points. Never use any other part of the vehicle for jack support.**
- **Never lift the vehicle more than necessary.**
- **Never use blocks on or under the jack.**
- **Do not start or run the e-POWER system while the vehicle is on the jack. The vehicle may move suddenly, and this may cause an accident.**
- **Never allow passengers to stay in the vehicle while the tyre is off the ground.**
- **Remove all loads before lifting the vehicle with the jack.**

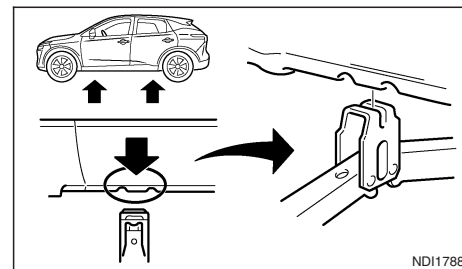

Jacking points

1. Place the jack directly under the jacking point as illustrated so that the top of the jack contacts the vehicle at the jacking point.

CAUTION

The jack should be placed on firm level ground.

2. Align the centre of both the jack head and the notches at the jacking point as shown.
3. Fit the groove of the jack head between the two notches as shown.

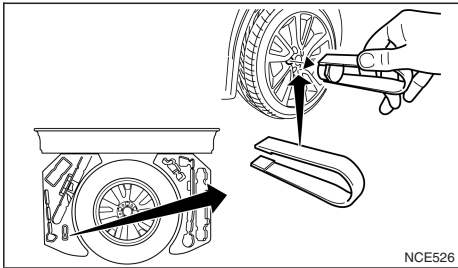

NCE526

4. **Alloy wheels (where fitted):** Alloy wheel bolts have a plastic cap that can be removed using tweezers (where fitted) from the tool kit.

Loosen each wheel bolt by one or two turns anticlockwise with the wheel wrench.

Do not remove the wheel bolts until the tyre is off the ground.

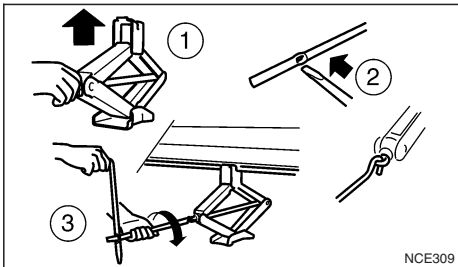

NCE309

5. To lift the vehicle, securely hold and turn the handle clockwise as shown.

6. Carefully raise the vehicle until the tyre clears the ground.
7. Remove the wheel bolts, then remove the wheel with the flat tyre.

CAUTION

The wheel is heavy. Be sure that your feet are clear of the wheel and use gloves as necessary to avoid injury.

Installing the wheel

⚠ WARNING

- **The temporary use spare tyre (where fitted) is designed for emergency use. See "Spare tyre" earlier in this section.**
- **Never use wheel bolts other than those provided with your vehicle. Incorrect wheel bolts or improperly tightened wheel bolts may cause the wheel to become loose or come off. This could cause an accident.**
- **Never use oil or grease on the wheel bolts. This may cause the wheel bolts to become loose.**

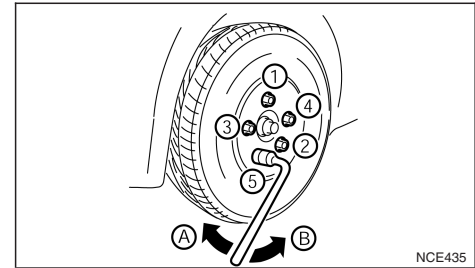

NCE435

- (A) Tighten
(B) Loosen

1. Clean any mud or dirt from the surface between the wheel and the hub.
2. Carefully fit the wheel and tighten the wheel bolts with your fingers. Check that all the wheel bolts contact the wheel surface horizontally and on the bevelled side.
3. With the wheel wrench, tighten the wheel bolts alternately and evenly in the sequence as illustrated (① - ⑤) until they are tight.
4. Lower the vehicle slowly until the tyre touches the ground.
5. Tighten the wheel bolts securely using the wheel wrench in the sequence as illustrated.
6. Lower the vehicle completely.

7. Install the wheel cover (where fitted).

NOTE

Before installation, align **NISSAN logo (centre cap) with the wheel bolts/or perpendicular to valve hole (where fitted), to correctly align to the centre.**

Wheel bolt tightening torque:
113 N•m (12 kg-m, 83 ft-lb)

As soon as possible, tighten the wheel bolts to the specified torque with a torque wrench.

⚠ WARNING

Retighten the wheel bolts after the vehicle has been driven for 1,000 km (600 miles) (also in cases of a flat tyre, etc.).

The wheel bolts must be kept tightened to specification at all times. It is recommended that the wheel bolts be tightened to specification at each maintenance interval.

Adjust the tyre pressure to the COLD pressure.

COLD pressure is the tyre pressure as measured after the vehicle has been parked for three hours or more or driven for less than 1.6 km (1 mile).

COLD tyre pressures are shown on the tyre placard affixed to the driver's side centre pillar.

Stowing the wheel and tools

Securely store the wheel with the flat tyre, the jack and the tools in the specified storage areas.

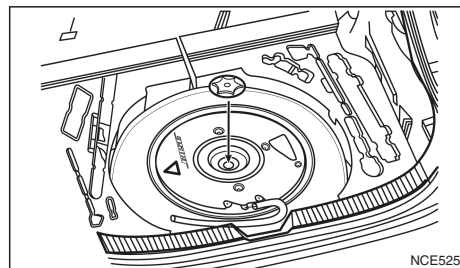

Subwoofer speaker

CAUTION

Take care when refitting the subwoofer in the spare wheel. It is important to align the speaker as shown to ensure that the cable is not stretched. Check that the cable attached to the speaker is not under strain.

TYRE PRESSURE MONITORING SYSTEM (TPMS) (where fitted)

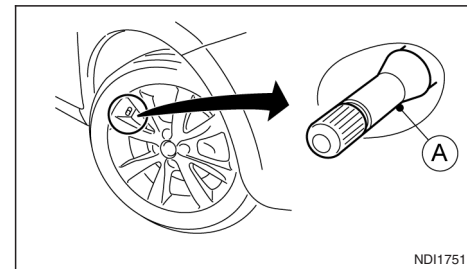

A Tyre valve with sensor

⚠ WARNING

- If the TPMS indicator light illuminates while driving:
 - avoid sudden steering manoeuvres
 - avoid abrupt braking
 - reduce vehicle speed
 - pull off the road to a safe location
 - stop the vehicle as soon as possible
- Driving with under-inflated tyres may permanently damage the tyres and increase the likelihood of tyre failure. Serious vehicle damage could occur which may lead to an accident and could result in serious personal injury.

- Check the tyre pressure for all four tyres. Adjust the tyre pressure to the recommended COLD tyre pressure shown on the tyre placard to turn the TPMS indicator light "OFF". In case of a flat tyre, replace it with a spare tyre as soon as possible.
- When a spare tyre is mounted or a wheel is replaced, the TPMS will not function and the TPMS indicator light will flash for approximately 1 minute. The light will remain on after 1 minute. Be sure to follow all instructions for wheel replacement and make sure the TPMS system is mounted correctly.
- Replacing tyres with those not originally specified by NISSAN could affect the proper operation of the TPMS.
- The Genuine NISSAN Emergency Tyre Repair Sealant can be used for temporarily repairing a tyre. Do not inject any other tyre liquid or aerosol tyre sealant into the tyres, as this may cause a malfunction of the tyre pressure sensors.
- NISSAN recommends using only Genuine NISSAN Emergency Tyre Sealant provided with your vehicle. Other tyre sealants may damage the valve stem seal which can cause the tyre to lose air pressure. Visit a NISSAN dealer or qualified workshop as soon as possible after using tyre repair sealant (for models equipped with the emergency tyre puncture repair kit).

CAUTION

- The TPMS may not function properly when the wheels are equipped with tyre chains or the wheels are buried in snow.
- Do not place metalised film or any metal parts (antenna, etc.) on the windows. This may cause poor reception of the signals from the tyre pressure sensors, and the TPMS will not function properly.
Some devices and transmitters may temporarily interfere with the operation of the TPMS and cause the TPMS indicator light to illuminate. Some examples are:
 - Facilities or electric devices using similar radio frequencies are near the vehicle.
 - If a transmitter set to similar frequencies is being used in or near the vehicle.
 - If a computer (or similar equipment) or a DC/AC converter is being used in or near the vehicle.
- When inflating the tyres and checking the tyre pressure, never bend the valves.
- Use Genuine NISSAN valve caps that comply with the factory-fitted valve cap specifications.
- Do not use metal valve caps.
- Fit the valve caps properly. Without the valve caps the valve and tyre pressure monitor sensors could be damaged.

- Do not damage the valves and sensors when storing the wheels or fitting different tyres.
- Replace the TPMS sensor valve stem (including valve core and cap) and screw (where fitted) when the tyres are replaced due to wear or age. The screw (where fitted) must be fitted correctly with a torque setting of 1.4 ± 0.1 N.m. The TPMS sensors can be used again.

The Tyre Pressure Monitoring System (TPMS) monitors the tyre pressure of the four wheels except the spare wheel. When the TPMS indicator light comes on together with the TPMS tyre location indicator light (in the meter panel), one or more of the tyres is significantly under-inflated. If the vehicle is being driven with low tyre pressure, the TPMS will activate and TPMS indicator light together with the TPMS tyre location indicator light remains on. This system will deactivate only when tyre pressure is corrected and the vehicle is driven at speeds above 25 km/h (16 MPH).

For more details about the TPMS, see "Tyre Pressure Monitoring System (TPMS) (where fitted)" in the "5. Starting and driving" section.

REPAIRING FLAT TYRE (Models with emergency tyre puncture repair kit)

The emergency tyre puncture repair kit is supplied with the vehicle instead of a spare tyre. This repair kit must be used for temporarily fixing a minor tyre puncture. After using the repair kit, see a NISSAN dealer or qualified workshop as soon as possible for tyre inspection and repair/replacement.

CAUTION

Do not use the emergency tyre puncture repair kit under the following conditions. Contact a NISSAN dealer or qualified workshop or professional road assistance.

- when the sealant has passed its expiration date (shown on the label attached to the bottle)
- when the cut or the puncture is approximately 4 mm (0.16 in) or longer
- when the side of the tyre is damaged
- when the vehicle has been driven with a considerable loss of air from the tyre
- when the tyre is completely displaced inside or outside the rim
- when the tyre rim is damaged
- when two or more tyres are flat

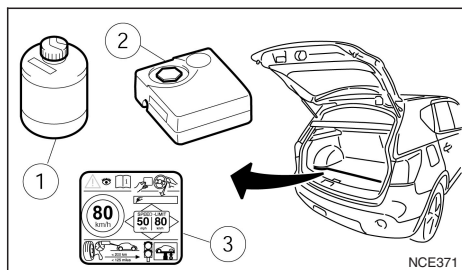

Getting emergency tyre puncture repair kit

Take the emergency tyre puncture repair kit out of the boot. The repair kit consists of the following items:

- ① Tyre sealant bottle
- ② Air compressor
- ③ Speed restriction sticker

NOTE

For models with the emergency tyre puncture repair kit, a spare tyre, jack and rod are not equipped as standard. These parts are dealer options. Contact a NISSAN dealer or qualified workshop about obtaining these parts. See "Removing the wheel" earlier in this section for usage of jacking tools and tyre replacement.

Before using emergency tyre puncture repair kit

- If any foreign object (for example, a screw or nail) is embedded in the tyre, **do not remove it**.
- Check the expiration date of the sealant (shown on the label attached to the bottle). Never use a sealant which has passed its expiration date.

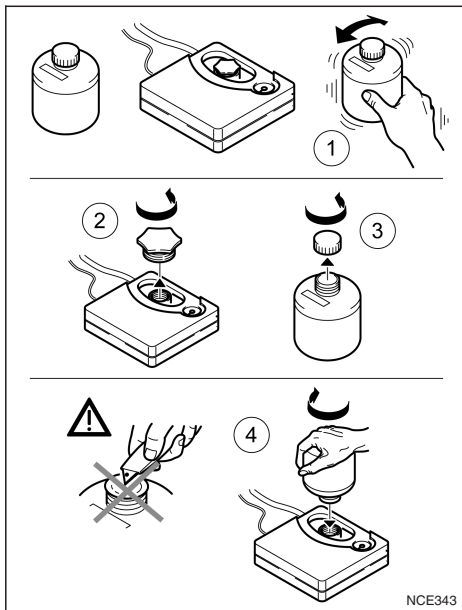

Repairing tyre

1. Shake the sealant bottle well ①.
2. Remove the bottle cap ③ and the orange plug ② from the top of the compressor.
3. Screw the bottle ④ into the opening of the compressor (where the orange plug was).

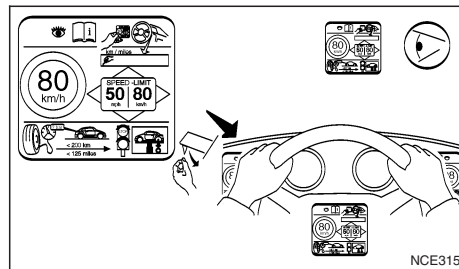

4. Remove the speed restriction sticker from the compressor, then place it in a location where the driver can see it while driving.

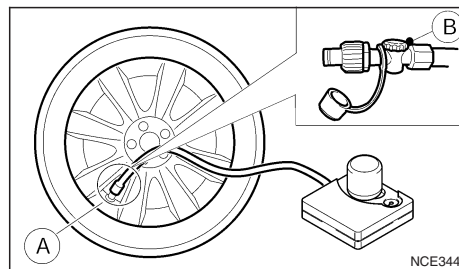

5. Screw the air tube ① of the compressor securely onto the tyre valve. Make sure that the air compressor switch is in the "OFF" (O) position and the pressure release valve ② is securely closed.

6. Insert its power plug into the power outlet in the vehicle. Make sure no other accessories are fitted to the power outlet. For details, see "Power outlets" in the "2. Instruments and controls" section.
7. Switch the e-POWER system power switch ON.
8. Switch on the compressor, and inflate the tyre to the pressure that is specified on the tyre placard affixed to the driver's side centre pillar.

CAUTION

Do not operate the compressor for more than 10 minutes.

If the tyre pressure does not increase to the specified pressure **within 10 minutes**, the tyre may be seriously damaged and **the tyre cannot be repaired with this tyre repair kit**. Contact a NISSAN dealer or qualified workshop.

9. Remove the air compressor from the tyre valve. Immediately drive the vehicle at a speed of 80 km/h (50 MPH) or less.
10. After 10 minute or 10 km (6 miles) drive, check the tyre pressure. The temporary repair is completed if the tyre pressure does not drop.

If the tyre pressure is lower than specified, repeat the steps from step 5.

If the pressure drops again or under 130 kPa (1,3 bar, 19 psi), **the tyre cannot be repaired with this tyre repair kit**. Contact a NISSAN dealer or qualified workshop.

After repairing tyre

See a NISSAN dealer or qualified workshop for tyre repair/replacement, inspection/replacement of the TPMS sensor and for a new tyre sealant bottle and hose, as soon as possible.

JUMP STARTING

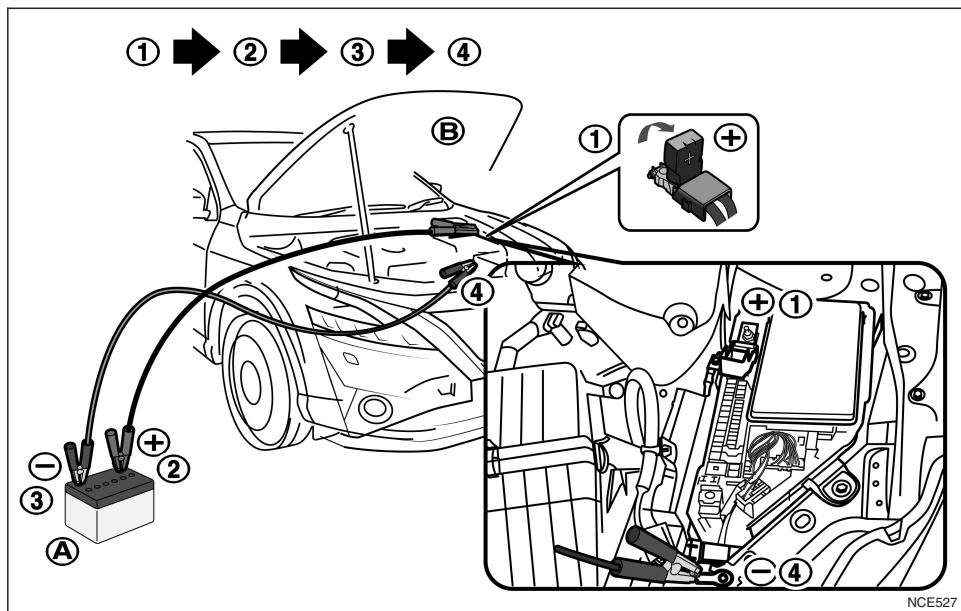

⚠ WARNING

- Incorrect jump-starting can lead to a battery explosion. The battery explosion may result in severe injury or death. It may also result in damage to the vehicle. Be sure to follow the instructions in this section.

- Explosive hydrogen gas is always present in the vicinity of the battery. Keep all sparks and flames away from the battery.
- Always wear suitable eye protection glasses and remove rings, bracelets, and any other jewellery whenever working on or near a battery.

- Never lean over the battery while jump-starting.
- Never allow battery fluid to come into contact with eyes, skin, clothes or the vehicle's painted surfaces. Battery fluid is a corrosive sulphuric acid which can cause severe burns. If the fluid comes into contact with anything, immediately flush the contacted area with plenty of water.
- Keep the battery out of the reach of children.
- The booster battery must be rated at 12 volts. Use of an incorrectly rated battery will damage your vehicle.
- Never attempt to jump-start a frozen battery. It could explode and cause serious injury.

1. Check if the parking brake is applied. If not, after connecting the vehicle with the booster battery (after step 8), apply the parking brake. The vehicle has an electric parking brake, for more information see, "Electric Parking Brake" in the "3. Pre-driving checks and adjustments" section.
2. Prepare vehicle (A) with the booster battery for the vehicle (B) being jump-started.

CAUTION

Do not allow the two vehicles to touch.

3. Press the P position switch to shift to the P (Park) position).
4. Switch off all unnecessary electrical systems (headlights, hazard lights, etc.).

5. Ensure that the power switch of the vehicle being jump-started is OFF.
6. Open the bonnet. For details, see “Bonnet” in the “3. Pre-driving checks and adjustments” section.
7. Using a trim tool or other appropriate tool if necessary, release the three locking tabs and remove the engine compartment fuse box cover on the vehicle (B) being jump-started to allow access to the positive (+) terminal inside the fuse box.
8. Open the red positive (+) terminal cover.
9. Connect the jump leads in the sequence (1) → (2) → (3) → (4) as illustrated.

CAUTION

- Always connect positive (+) (1) to positive (+) (2) and negative (-) (3) to body earth (4) NOT to the 12-volt battery's negative (-) terminal, engine or motor.
- An incorrect connection could damage the charging system.
- Be sure that the jumper cables do not touch moving parts in the engine compartment.
- Be careful not to allow contact between the positive jump lead connector and the vehicle or the negative lead during connection and disconnection.

10. Start the engine of the other vehicle (A) and let it run for a few minutes. Keep the engine speed at about 2,000 rpm.
11. Start the e-POWER system of your vehicle (B) in the normal way.

CAUTION

Never keep the starter motor engaged for more than 10 seconds. If the e-POWER system does not start immediately, switch the power switch OFF and wait 10 seconds before trying again.

12. After starting the e-POWER system of your vehicle, carefully disconnect the negative lead and then the positive lead (4) → (3) → (2) → (1).
13. Close the red positive (+) terminal cover inside the fuse box and replace the fuse box cover.
14. Close the bonnet.

NOTE

- Do not use this vehicle as a booster vehicle.
- If the e-POWER system cannot be started, place the power switch in the OFF position with the driver's door open. Get out of the vehicle, close the driver's door and wait for more than 3 minutes. Then restart the e-POWER system.
- If the 12-volt battery is discharged, the power switch cannot be placed in the ON or OFF position. Charge the 12-volt battery immediately.

PUSH STARTING

Do not attempt to start the engine by pushing the vehicle.

CAUTION

- Starting the engine by pushing the vehicle may damage the three-way catalyst.
- The e-POWER vehicles cannot be push-started or tow-started. Attempting to do so may cause electric motor damage.
- Never try to start the vehicle by towing it; when the engine starts, the forward surge could cause the vehicle to collide with the tow vehicle.

IF YOUR VEHICLE OVERHEATS

WARNING

- **Never continue driving if the engine of your vehicle overheats. Doing so could cause a vehicle fire.**
- **Never open the bonnet if steam is coming out.**
- **Never remove the engine coolant reservoir cap while the engine is hot. If the engine coolant reservoir cap is removed when the engine is hot, pressurized hot water will spurt out and possibly cause burning, scalding or serious injury.**
- **If steam or coolant is coming out of the engine, stand clear of the vehicle to prevent getting injured.**
- **The engine cooling fan or engine will start whenever the coolant temperature exceeds preset degrees.**
- **Be careful not to allow your hands, hair, jewelry or clothing to come into contact with, or get caught in, the cooling fan or drive belts.**

If your vehicle is overheating (indicated by the high temperature indicator), or if you feel a lack of traction motor power, detect an unusual noise, etc., take the following steps:

1. Move and park the vehicle safely off the road and away from traffic.
2. Turn on the hazard warning flasher lights.
3. Apply the parking brake.
4. Push the P position switch to engage the P (Park) position.

DO NOT STOP THE e-POWER system.

5. Open all windows.
6. Switch off the air conditioner system (where fitted).
7. Set the heater or air conditioner temperature control to maximum "HOT" and fan speed control to maximum speed.
8. Exit the vehicle.
9. Visually inspect and listen for steam or coolant escaping from the radiator before opening the bonnet. Wait until no steam or coolant can be seen before proceeding.
10. Open the bonnet. For details, see "Bonnet" in the "3. Pre-driving checks and adjustments" section.
11. Visually check if the cooling fan is running.
12. Visually check the radiator and radiator hoses for leakage.

WARNING

If coolant is leaking, or the cooling fan is not running, stop the engine.

After the engine cools down, check the coolant level in the reservoir with the engine running. Do not open the engine coolant reservoir cap.

13. If the level is low, remove the engine coolant reservoir cap and add coolant slowly into the reservoir. After refilling the reservoir to the MAX level, install the reservoir cap.

WARNING

Before removing the engine coolant reservoir cap and to avoid the danger of being scalded, cover the reservoir cap with a rag and loosen the reservoir cap to the first notch to allow the steam to escape.

14. Close the bonnet.

Have your vehicle inspected or repaired by a NISSAN dealer or qualified workshop.

TOWING YOUR VEHICLE

When towing your vehicle, local regulations for towing must be followed. Incorrect towing equipment could damage your vehicle. To assure proper towing and to prevent accidental damage to your vehicle, NISSAN recommends that you have a service operator tow your vehicle. It is advisable to have the service operator carefully read the following precautions.

If you have subscribed to NissanConnect Services you will receive a notification on your connected device via the NissanConnect Services App notifying you on the tow.

WARNING

- Do not allow any occupants in the vehicle that is being towed.
- Never get under your vehicle after it has been lifted by a tow truck.

TOWING PRECAUTIONS

- **When towing:** Make sure that the axles, steering system and power train are in working condition before towing. If any units are damaged, the vehicle must be towed using a dolly or be placed on a flat bed lorry.
- NISSAN recommends that your vehicle be towed with the driving (front) wheels off the ground.
- Always attach safety chains before towing.

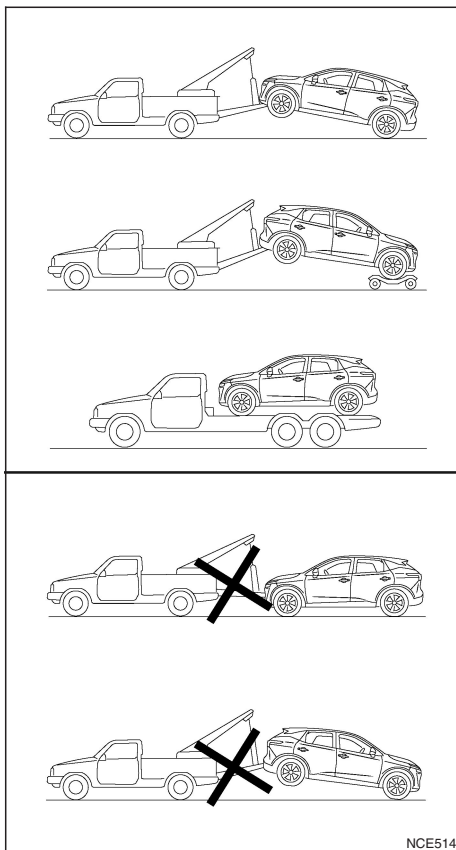

RECOMMENDATIONS FOR TOWING E-POWER MODELS

CAUTION

NEVER tow e-POWER models with the front wheels on the ground or with all four wheels on the ground (forwards or backwards), this may cause serious and expensive damage to the vehicle. If it is necessary to tow the vehicle, always use a dolly under the front wheels or use a flatbed tow truck as illustrated.

Towing with rear wheels on the ground:

1. Place the power switch in the OFF position.
2. Secure the steering wheel in a straight-ahead position with rope or a similar device.
3. Move the shift lever to the N (Neutral) position.
4. Release the parking brake.
5. Attach safety chains for all towing.

TOWING EYE

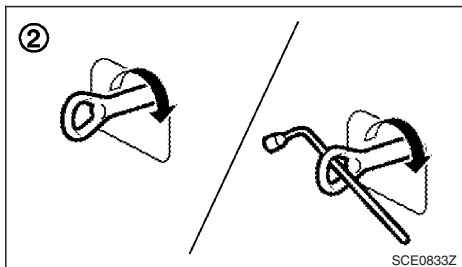

The towing eye is stored with the vehicle tools and located in the spare wheel recess (luggage compartment area).

- 1) Remove the cover from the bumper.
- 2) Securely install the towing eye, as illustrated.

Make sure that the towing eye is properly stored in its designated location after use.

NOTE

- **Ensure that the towing eye is securely fitted to the vehicle.**
- **Your vehicle may be supplied with two towing eyes. In this case, use the longer eye on the front of the vehicle, and the shorter eye on the rear of the vehicle.**

FREEING THE VEHICLE FROM SAND, SNOW OR MUD

⚠ WARNING

- **Never allow anyone to stand near the towing line during the pulling operation.**
- **Never spin the tyres at high speed. This could cause serious damage to the tyres and result in serious injury. Parts of the vehicle could also overheat and be damaged.**

Towing eye usage

The towing eye should be used in the event that your vehicle becomes trapped in sand, snow or mud, and is unable to drive away without being pulled, use the towing eye.

- Use the towing eye **only**, not other parts of the vehicle. Otherwise, the vehicle body will be damaged.
- **Only** use the towing eye to free a vehicle stuck in sand, snow, mud, etc.
- Never tow the vehicle for a long distance using only the towing eye.
- The towing eye is under tremendous force when used to free a stuck vehicle. Always pull the cable straight out from the front of the vehicle. Never pull on the towing eye at a sideways angle.

CAUTION

In order not to break the towing line, tension it slowly.

7 Appearance and care

Cleaning exterior.....	432	Air fresheners.....	434
Washing.....	432	Floor mats.....	434
Removing spots.....	432	Cleaning Glass.....	435
Waxing.....	432	Plastic parts.....	435
Cleaning glass.....	433	Seat belts.....	435
Cleaning rear-view camera (where fitted).....	433	Corrosion protection.....	435
Underbody.....	433	Most common factors contributing to vehicle	
Care of wheels.....	433	corrosion.....	435
Cleaning aluminium alloy wheels.....	433	Environmental factors influence the rate of	
Chrome parts.....	433	corrosion.....	435
Cleaning interior.....	434	To protect your vehicle from corrosion.....	436

CLEANING EXTERIOR

In order to maintain the appearance of your vehicle, it is important to take proper care of it.

Whenever possible, park your vehicle inside a garage or in a covered area to minimise the chances of damaging the paint surface of your vehicle.

When it is necessary to park outside, park in a shady area or protect the vehicle with a body cover. **Be careful not to scratch the paint surface when putting on or removing the body cover.**

WASHING

In the following instances, wash your vehicle as soon as possible to protect the paint surface:

- After a rainfall, to prevent possible damage from acid rain.
 - After driving on coastal roads.
 - When contaminants such as soot, bird droppings, tree sap, metal particles or insects get on the paint surface.
 - When dust or mud builds up on the paint surface.
1. Wash the vehicle surface with a wet sponge and plenty of water.
 2. Clean the vehicle surface gently and thoroughly using a mild soap or a special vehicle wash shampoo mixed with clean, lukewarm (never hot) water.

CAUTION

- **Do not wash the vehicle with strong household soap, strong chemical detergents, petrol or solvents.**

- **Do not wash the vehicle in direct sunlight or while the vehicle body is hot, as the paint surface may become water-spotted.**

- **Avoid using tight-napped or rough cloths, such as washing mitts. Care must be taken when removing caked-on dirt or other foreign substances so the paint surface is not scratched or damaged.**

3. Rinse the vehicle thoroughly with plenty of clean water.
4. Use a damp chamois to dry the paint surface to avoid leaving water spots.

When washing the vehicle, take care of the following:

- Inside flanges, joints and folds on the doors, tailgate and bonnet are particularly vulnerable to the effects of road salt. Therefore, these areas must be cleaned regularly.
- Be sure that the drain holes in the lower edge of the doors are not clogged.
- Spray water on the underbody and in the wheel wells to loosen the dirt and/or wash away road salt.
- If using a high pressure washer always follow the recommendations on the equipment (pressure and spraying distance).
- If there are damaged areas on the vehicle (e.g. painted bumpers or headlight assembly), it is not recommended to direct the high pressure jet onto them. Carefully wash these areas by hand.
- Avoid the entry of water into the locks.

REMOVING SPOTS

Remove tar and oil spots, industrial dust, insects, and tree sap as quickly as possible from the paint surface to avoid lasting damage or staining. Special cleaning products are available at a NISSAN dealer or any automotive accessory store.

WAXING

Regular waxing protects the paint surface and helps to retain a new vehicle appearance.

After waxing, polishing is recommended to remove built-up residue.

A NISSAN dealer or qualified workshop can assist you in choosing the appropriate waxing products.

CAUTION

- **Wash your vehicle thoroughly and completely before applying wax to the paint surface.**
- **Always follow the manufacturer's instructions supplied with the wax.**
- **Do not use a wax containing any abrasives, cutting compounds or cleaners that may damage the vehicle finish.**
- **If the vehicle surface cannot polish easily, apply a road tar remover prior to waxing the vehicle.**
- **Machine compounding or aggressive polishing on a base coat/clear coat paint finish may dull the finish or leave swirl marks.**

CLEANING GLASS

Use glass cleaner to remove smoke and dust film from the glass surfaces. It is normal for glass to become coated with a film after the vehicle is parked in the hot sun. Glass cleaner and a soft cloth will easily remove this film.

CLEANING REAR-VIEW CAMERA (where fitted)

Clean the transparent camera cover regularly. If dirt, rain or snow attaches to the cover, the monitor may not display objects clearly.

CAUTION

- **Do not use alcohol, benzene or thinner to clean the transparent camera cover. This will cause discolouration. To clean the cover, first use a cloth dampened with diluted mild cleaning agent and then wipe with a dry cloth.**
- **Do not use body wax on the transparent camera cover.**
- **When washing the vehicle with a high pressure water spray, make sure not to spray it around the transparent camera cover. Otherwise, water may enter the camera unit causing water condensation on the lens and it may result in a malfunction or an electric shock.**

UNDERBODY

In areas where road salt is used in the winter, the vehicle's underbody must be cleaned regularly. This will prevent dirt and salt from building up and causing underbody and suspension corrosion.

Before the winter period and again in the spring, the underseal must be checked and, if necessary, re-treated.

CARE OF WHEELS

- Wash the wheels when washing the vehicle to maintain their appearance.
- Clean the inner side of the wheels when the wheel is changed or the underside of the vehicle is washed.
- Do not use abrasive cleaners when washing the wheels.
- Inspect wheel rims regularly for dents or corrosion. This may cause loss of pressure or damage the tyre bead.
- NISSAN recommends that the road wheels be waxed to protect against road salt in areas where it is used during winter.

CLEANING ALUMINIUM ALLOY WHEELS

Wash the wheels regularly with a sponge dampened in a mild soap solution, especially during winter in areas where road salt is used. The salt residue from road salt could discolour the wheels if it is not washed off regularly.

CAUTION

Follow the directions as described below in order to avoid staining or discolouring of the wheels.

- **Do not use a cleaner that contains strong contents of acid or alkali to clean the wheels.**
- **Do not apply wheel cleaner when the wheels are hot. The wheel temperature should be the same as ambient temperature.**
- **Rinse the wheel to completely remove the cleaner within 15 minutes after the cleaner has been applied.**

CHROME PARTS

Clean all chrome parts regularly with a nonabrasive chrome polish to maintain the finish.

CLEANING INTERIOR

Occasionally remove loose dust from the interior trim, plastic parts and seats using a vacuum cleaner or soft bristled brush. Wipe the vinyl and leather surfaces with a clean, soft cloth dampened in mild soap solution, then wipe clean with a dry, soft cloth.

Regular care and cleaning is required in order to maintain the appearance of the leather.

Before using any fabric protector, read the manufacturer's recommendations. Some fabric protectors contain chemicals that may stain or bleach the seat material.

Use a soft cloth dampened only with water to clean the meter and gauge lens covers.

CAUTION

- **Never use benzene, thinner or any similar material.**
- **Small dirt particles can be abrasive and damaging to leather surfaces and should be removed promptly. Do not use saddle soap, car waxes, polishes, oils cleaning fluids, solvents, detergents or ammonia based cleaners as they may damage the leather's natural finish.**
- **Never use fabric protectors unless recommended by the manufacturer.**
- **Do not use glass or plastic cleaner on meter or gauge lens covers. It may damage the lens covers.**

AIR FRESHENERS

Most air fresheners use a solvent that could affect the vehicle interior. If you use an air freshener, take the following precautions:

- Hanging-type air fresheners can cause permanent discolouration when they contact vehicle interior surfaces. Place the air freshener in a location that allows it to hang free and not contact an interior surface.
- Liquid-type air fresheners typically clip on the vents. These products can cause immediate damage and discolouration when spilled on interior surfaces.

Carefully read and follow the manufacturer's instructions before using air fresheners.

FLOOR MATS

NISSAN recommends the use of Genuine NISSAN floor mats.

The use of Genuine NISSAN floor mats (where fitted) can extend the life of your vehicle carpet and make it easier to clean the interior. Regardless of what mats are used, be sure they are fitted for your vehicle and are properly positioned in the foot well to prevent interference with pedal operation at all times. Mats should be maintained with regular cleaning and replaced if they become excessively worn.

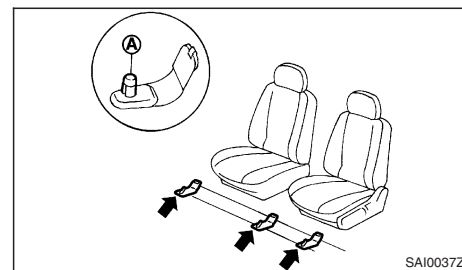

Floor mat positioning aid

Note that the above illustration is for LHD models.

This vehicle includes front floor mat brackets (A) to act as a floor mat positioning aid. Genuine NISSAN floor mats have been specially designed for your vehicle.

Position the mat by placing the floor mat bracket hook through the floor mat grommet hole while centring the mat in the foot area.

Periodically check that the mats are properly positioned.

CLEANING GLASS

Use glass cleaner to remove smoke and dust film from the glass surfaces. It is normal for glass to become coated with a film after the vehicle is parked in the hot sun. Glass cleaner and a soft cloth will easily remove this film.

CAUTION

When cleaning the inside of the windows, do not use sharp-edged tools, abrasive cleaners or chlorine based disinfectant cleaners. They could damage electrical conductors such as the rear window defogger.

Do not stick labels on the inside surface of the glass. Removing stickers and its residue could damage electrical conductors such as the rear window defogger.

Take care that any objects stored in the luggage room, do not come in contact with the inside surface of the rear window. This is to avoid damage to electrical conductors such as the rear window defogger.

Automatic anti-dazzling inside rear-view mirror (where fitted)

Use a soft cloth dampened only with water to clean the automatic anti-dazzling inside rear view mirror (where fitted).

CAUTION

Do not use glass cleaner. Doing so will reduce the sensitivity of the sensor, resulting in improper operation.

PLASTIC PARTS

Plastic parts can be cleaned with a mild soap solution. If the dirt cannot be easily removed, use a plastic cleaner. Do not use any solvents.

SEAT BELTS

WARNING

- **Do not allow wet seat belts to roll up in the retractor.**
- **Never use bleach, dye or chemical solvents to clean the seat belts, since these materials may severely weaken the seat belt webbing.**

The seat belts can be cleaned by wiping them with a sponge dampened in a mild soap solution.

Allow the belts to dry completely in the shade before using them.

CORROSION PROTECTION

MOST COMMON FACTORS CONTRIBUTING TO VEHICLE CORROSION

- The accumulation of moisture-retaining dirt and debris in body panel sections, cavities, and other areas.
- Damage to the paint surface and other protective coatings caused by gravel and stone chips or minor traffic accidents.

ENVIRONMENTAL FACTORS INFLUENCE THE RATE OF CORROSION

Moisture

Accumulation of sand, dirt and water on the vehicle body underside can accelerate corrosion. Wet floor coverings will not dry completely inside the vehicle, and should be removed for drying to avoid floor panels corrosion.

Relative humidity

Corrosion will be accelerated in areas of high relative humidity, especially those areas where the temperatures stay above freezing, where atmospheric pollution exists and road salt is used.

Temperature

A temperature increase will accelerate the rate of corrosion to those parts which are not well ventilated.

Corrosion will also accelerate in areas where the temperatures stay above freezing.

Air pollution

Industrial pollution, the presence of salt in the air in coastal areas, or heavy road salt use will accelerate the corrosion process. Road salt will also accelerate the disintegration of paint surfaces.

TO PROTECT YOUR VEHICLE FROM CORROSION

- Wash and wax your vehicle often to keep the vehicle clean.
- Always check for minor damage to the paint surface and if any exists, repair it as soon as possible.
- Keep the drain holes at the bottom of the doors and back door opened to avoid water accumulation.
- Check the vehicle underbody for accumulation of sand, dirt or salt. If present, wash with water as soon as possible.

CAUTION

- **Never remove dirt, sand or other debris from the passenger compartment by washing it out with a hose. Remove dirt with a vacuum cleaner or broom.**
- **Never allow water or other liquids to come in contact with electronic components inside the vehicle as this may damage them.**

Chemicals used for road surface de-icing are extremely corrosive. They accelerate corrosion and deterioration of underbody components such as the exhaust system, fuel and brake lines, brake cables, floor pan and fenders.

In the winter, the underbody must be cleaned periodically.

For additional protection against rust and corrosion, which may be required in some areas, consult a NISSAN dealer or qualified workshop.

8 Maintenance and do-it-yourself

Maintenance requirements.....	438	Spark plugs.....	452
Scheduled maintenance.....	438	Replacing Spark plugs.....	452
General maintenance.....	438	Air cleaner.....	453
Where to go for service.....	438	Dry paper filter element.....	453
General maintenance.....	438	Wiper blades.....	454
Explanation of general maintenance items.....	438	Cleaning.....	454
Maintenance precautions.....	440	Front window wiper replacement.....	454
Engine compartment.....	441	Rear window wiper replacement.....	454
Engine cooling system.....	442	Windscreen washer nozzle.....	454
Checking engine coolant level.....	442	Fuses.....	455
Changing engine coolant.....	442	Passenger compartment.....	455
Inverter cooling system.....	443	Engine compartment.....	458
Checking inverter coolant level.....	444	Lights.....	459
Changing inverter coolant.....	444	Headlights.....	459
Engine oil.....	445	Exterior lights.....	459
Checking engine oil level.....	445	Interior lights.....	459
Changing engine oil and oil filter.....	445	Light locations.....	460
Protect the environment.....	447	Wheels and tyres.....	462
Gear fluid.....	447	Tyre inflation pressure.....	462
Brakes.....	447	Types of tyres.....	463
Checking parking brake.....	447	Snow chains.....	463
Checking brake pedal.....	447	Tyre rotation.....	464
Brake fluid.....	448	Tyre wear and damage.....	464
Window washer fluid.....	448	Tyre age.....	464
Battery.....	449	Changing tyres and wheels.....	464
Vehicle 12V battery.....	450	Wheel balance.....	465
Intelligent Key battery replacement.....	450	Spare tyre.....	465
Drive belt.....	452	Care of wheels.....	465

MAINTENANCE REQUIREMENTS

Some day-to-day and regular maintenance is essential to maintain your vehicle's good mechanical condition, as well as its emission and engine performance.

It is the owner's responsibility to make sure that the specified maintenance, as well as general maintenance, is performed.

As the vehicle owner, you are the only one who can ensure that your vehicle receives the proper maintenance care.

SCHEDULED MAINTENANCE

For your convenience, the required scheduled maintenance items are described and listed in the separate Warranty Information and Maintenance booklet. You must refer to that booklet to ensure that necessary maintenance is performed on your vehicle at regular intervals.

GENERAL MAINTENANCE

General maintenance includes those items which should be checked during normal day-to-day operation of the vehicle. They are essential if your vehicle is to continue to operate properly. It is your responsibility to perform these procedures regularly as prescribed.

Performing general maintenance checks requires minimal mechanical skill and a few general automotive tools.

These checks or inspections can be done by yourself, a qualified technician or, if you prefer, your NISSAN dealer or qualified workshop.

WHERE TO GO FOR SERVICE

If maintenance service is required or your vehicle appears to malfunction, have the systems checked and tuned by an authorised NISSAN dealer or qualified workshop.

GENERAL MAINTENANCE

During the normal day-to-day operation of the vehicle, general maintenance should be performed regularly as prescribed in this section. If you detect any unusual sounds, vibrations or smell, be sure to check for the cause or have a NISSAN dealer or qualified workshop do it promptly. In addition, you should notify a NISSAN dealer or qualified workshop if repairs are required.

When performing any checks or maintenance work, closely observe the "Maintenance precautions" later in this section.

EXPLANATION OF GENERAL MAINTENANCE ITEMS

Additional information on the following items with an asterisk (*) is found later in this section.

The maintenance items listed here should be performed from time to time, unless otherwise specified.

Outside the vehicle

Tailgate, doors and bonnet:

Check that the tailgate, all doors and the bonnet operate properly. Also ensure that all latches lock securely. Lubricate hinges and latches if necessary. Make sure that the secondary latch keeps the bonnet from opening when the primary latch is released.

When driving in areas using road salt or other corrosive materials, check for lubrication frequently.

Lights*:

Clean the headlights on a regular basis. Make sure that the headlights, brake lights, tail lights, turn signal lights, and other lights are all operating properly and installed securely. Also check headlight aim.

Tyres*:

Check the pressure with a gauge periodically when at a service station (including the spare) and adjust to the specified pressure if necessary. Check carefully for damage, cuts or excessive wear.

Tyre rotation*:

In the case of Two-Wheel Drive (2WD), and front and rear tyres are the same size; tyres should be rotated every 10,000 km (6,000 miles). Tyres marked with directional indicators can only be rotated between front and rear. Make sure that the directional indicators point in the direction of wheel rotation after the tyre rotation is completed.

In the case of Four-Wheel Drive (4WD), and front and rear tyres are the same size; tyres should be rotated every 5,000 km (3,000 miles). Tyres marked with directional indicators can only be rotated between front and rear. Make sure that the directional indicators point in the direction of wheel rotation after the tyre rotation is completed.

In the case that front tyres are different size from rear tyres; tyres cannot be rotated.

The timing for tyre rotation may vary according to your driving habits and the road surface conditions.

Tyre Pressure Monitoring System (TPMS) transmitter components (where fitted):

Replace the TPMS sensor valve stem (including valve core and cap) and screw (where fitted) when the tyre are replaced due to wear or age. The screw (where fitted) must be fitted correctly with a torque setting of 1.4 ± 0.1 N.m. The TPMS sensors can be used again.

Wheel alignment and balance:

If the vehicle pulls to either side while driving on a straight and level road, or if you detect uneven or abnormal tyre wear, alignment should be checked and tyre replacement may be necessary. If the steering wheel or seat vibrates at normal highway speeds, wheel balancing may be needed.

Wheel bolts:

When checking the tyres, make sure no wheel bolts are missing, and check for any loose wheel bolts. Tighten if necessary.

Windscreen:

Clean the windscreen on a regular basis. Check the windscreen at least every six months for cracks or other damage. Have a damaged windscreen repaired by a qualified repair facility.

Wiper blades*:

Check for cracks or wear if they do not wipe properly.

Under the bonnet and vehicle

The maintenance items listed here should be checked periodically, e.g. each time you check the engine oil or refuel.

12V Battery (except for maintenance free batteries)*:

The 12V battery is located at the bottom of the luggage compartment

Check the fluid level in each cell. It should be between the <UPPER> and <LOWER> lines. Vehicles operated in high temperatures or under severe conditions require frequent checks of the battery fluid level.

Brake fluid level*:

Make sure that the brake fluid level is between the <MAX> and <MIN> lines on the reservoir.

See "Brake fluid" later in this section.

Engine coolant level*:

Check the coolant level when the engine is cold. Make sure that the coolant level is between the <MAX> and <MIN> lines on the reservoir.

See "Engine cooling system" later in this section.

Inverter coolant level*:

Check the coolant level when the engine and inverter are cold. Make sure that the coolant level is between the <MAX> and <MIN> lines on the reservoir.

See "Inverter cooling system" later in this section.

Engine drive belt*:

Make sure that the drive belt is not frayed, worn, cracked or oily.

MAINTENANCE PRECAUTIONS

Engine oil level*:

Check the level after parking the vehicle on a level surface and turning off the engine.

See "Engine oil" later in this section.

Fluid leaks:

Check under the vehicle for fuel, oil, water or other fluid leaks after the vehicle has been parked for a while. Water dripping from the air conditioner after use is normal. If you should notice any leaks or if petrol fumes are evident, check for the cause and have it corrected immediately.

Window washer fluid*:

Check that there is adequate fluid in the tank.

See "Window washer fluid" later in this section.

Inside the vehicle

The maintenance items listed here should be checked on a regular basis, such as when performing periodic maintenance, cleaning the vehicle, etc.

Accelerator pedal:

Check the pedal for smooth operation and make sure that the pedal does not catch or require uneven effort. Keep the floor mats away from the pedal.

Brake pedal*:

Check the pedal for smooth operation. If the brake pedal suddenly goes down further than normal, the pedal feels spongy or the vehicle seems to take longer to stop, contact a NISSAN dealer or qualified workshop immediately. Keep the floor mat away from the pedal.

Parking brake*:

Confirm your vehicle can be held securely on a fairly steep hill with only the parking brake applied.

Seats:

Check seat position controls such as seat adjusters, seatback recliner, etc. to ensure they operate smoothly and all latches lock securely in every position. Check that the head restraints move up and down smoothly and the locks hold securely in all latched positions.

Seat belts:

Check that all parts of the seat belt system (e.g. buckles, anchors, adjusters and retractors) operate properly and smoothly, and are installed securely. Check the belt webbing for cuts, fraying, wear or damage. See "Seat belts" in the "1. Safety — Seats, Seat belts and Supplemental Restraint System" section for further details.

Steering wheel:

Check for any change in the steering conditions, such as excessive free play, hard steering or strange noises.

Warning lights and audible reminders:

Make sure that all warning/indicator lights and audible reminders are operating properly.

Windscreen defogger:

Check that the air comes out of the defogger outlets properly when operating the heater or air conditioner.

Windscreen wiper and washer*:

Check that the wipers and washer operate properly and that the wipers do not streak.

When performing any inspection or maintenance work on your vehicle, always take care to prevent serious accidental injury to yourself or damage to the vehicle. The following are general precautions which should be closely observed.

WARNING

- **Never touch, disassemble, remove or replace the high voltage parts, harnesses and their connectors. High voltage harnesses are orange. Touching, disassembling, removing or replacing those parts and harnesses can cause severe burns or electric shock that may result in serious injury or death.**
- **Never try to remove the service plug located under the console box. The service plug is used only when the vehicle is serviced by trained technicians wearing personal protection equipment and is part of the high voltage system. Touching the service plug can cause severe burns or electric shock that may result in serious injury or death.**
- **The e-POWER system uses high voltage up to approximately 420 volts. The system can be hot while and after starting. Be careful of both the high voltage and the high temperature. Obey the caution labels attached to the vehicle.**
- **The engine can start at any time without warning when the e-POWER system is in the READY to drive mode. If you must work with the e-POWER system in the READY to drive mode, keep your hands, clothing, hair and tools away from moving fans, belts and any other moving parts.**

- Park the vehicle on a level surface, apply the parking brake securely and block the wheels to prevent the vehicle from moving. Push the P position switch to engage the P (Park) position.
- Be sure the power switch is switched OFF when performing any parts replacement or repairs.
- Do not work under the bonnet while the engine is hot. Always turn off the e- POWER system and wait until it cools down.
- If you must work with the engine running, keep your hands, clothing, hair and tools away from moving fans, belts and any other moving parts.
- It is advisable to secure or remove any loose clothing and any jewelry, such as rings, watches, etc. before working on your vehicle.
- If you must run the engine in an enclosed space such as a garage, be sure there is proper ventilation for exhaust gases to escape.
- Never get under the vehicle while it is supported by a jack.
- Keep smoking materials, flame and sparks away from fuel and the battery.
- Never connect or disconnect either the battery or any transistorized component connector while the power switch is switched ON.
- The fuel filter and fuel lines should be serviced by a NISSAN dealer or qualified workshop because the fuel lines are under high pressure even when the engine is turned off.

- Your vehicle is equipped with an automatic engine cooling fan. It may come on at any time without warning, even if the power switch is in switched OFF and the e-POWER system is not running. To avoid injury, always disconnect the negative battery cable before working near the fan.
- Always wear eye protection whenever you work on your vehicle.
- Never leave the e-POWER system or associated harness connectors disconnected while the power switch is switched ON.
-  **Blue Citizenship**
Avoid direct contact with used engine oil and coolant. Improperly disposed engine oil, engine coolant, and/or other vehicle fluids can hurt the environment. Always conform to local regulations for disposal of vehicle fluids.

This section gives instructions regarding only those items which are relatively easy for an owner to perform.

You should be aware that incomplete or improper servicing may result in operating difficulties or excessive emissions, and could affect your warranty coverage. **If in doubt about any servicing, have it done by your NISSAN dealer or qualified workshop.**

For an overview of the engine compartment, see. "Engine compartment" in the "0. Illustrated table of contents" section

ENGINE COOLING SYSTEM

⚠ WARNING

- Never remove the engine coolant reservoir cap when the engine is hot. Serious burns could be caused by high pressure fluid escaping from the engine coolant reservoir. Wait until the engine and radiator have cooled down.
- Engine coolant is poisonous and should be stored carefully in marked containers out of the reach of children.

The engine cooling system is filled at the factory with a high-quality, year-round and extended life engine coolant. The high quality engine coolant contains the specific solutions effective for the anti-corrosion and the anti-freeze function. Therefore, additional cooling system additives are not necessary.

CAUTION

- Never use any cooling system additives such as radiator sealer. Additives may clog the cooling system and cause damage to the engine and/or cooling system.
- When adding or replacing engine coolant, be sure to use Genuine NISSAN engine coolant or equivalent in its quality with the proper mixture ratio. The use of other types of coolant solutions may damage the engine cooling system.

Outside temperature down to		Composition	
°C	°F	Engine coolant (concentrated)	Demineralised or distilled water
-15	5	30%	70%
-35	-30	50%	50%

CHECKING ENGINE COOLANT LEVEL

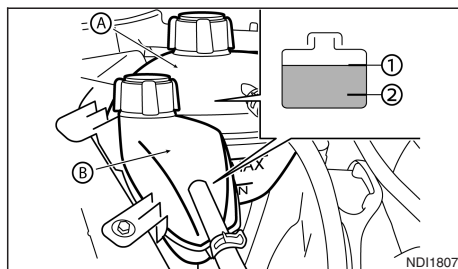

- (A) Engine coolant reservoir
- (B) Inverter coolant reservoir

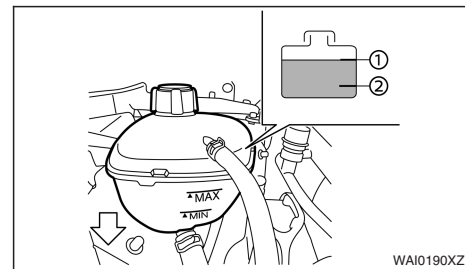

Check the coolant level in the reservoirs (A) and (B) when the engine is cold. If the coolant level is below MIN level (2), add coolant up to the MAX level (1).

CAUTION

If the cooling system frequently requires coolant, have it checked by a NISSAN dealer or qualified workshop.

CHANGING ENGINE COOLANT

Major cooling system repairs should be performed by a NISSAN dealer or qualified workshop. The service procedures can be found in the appropriate NISSAN Service Manual.

When checking or replacement is required, NISSAN recommends contacting a NISSAN dealer or qualified workshop for servicing.

Improper servicing or engine coolant change can result in reduced heater performance and engine overheating.

INVERTER COOLING SYSTEM

WARNING

- Never remove the engine coolant reservoir cap when the engine is hot. Serious burns could be caused by high pressure fluid escaping from the engine coolant reservoir. Wait until the engine and radiator have cooled down.
- To avoid the danger of being scalded, never change the coolant when the engine is hot.
- Avoid direct skin contact with used coolant. If skin contact is made, wash thoroughly with soap or hand cleaner and plenty of water as soon as possible.
- Keep coolant out of reach of children and pets.



NISSAN Blue Citizenship

Engine coolant must be disposed of properly. Check your local regulations.

WARNING

- Never remove the inverter coolant reservoir cap when the engine and/or inverter is hot. Serious burns could be caused by high pressure fluid escaping from the inverter coolant reservoir. Wait until the engine and inverter have cooled down.
- Coolant is poisonous and should be stored carefully in marked containers out of the reach of children.

The inverter cooling system is filled at the factory with a high-quality, year-round and extended life engine coolant. The high quality coolant contains the specific solutions effective for the anti-corrosion and the anti-freeze function. Therefore, additional cooling system additives are not necessary.

CAUTION

- Never use any cooling system additives such as radiator sealer. Additives may clog the cooling system and cause damage to the engine, inverter and/or cooling system.
- When adding or replacing coolant, be sure to use Genuine NISSAN engine coolant or equivalent in its quality with the proper mixture ratio. The use of other types of coolant solutions may damage the inverter cooling system.

Outside temperature down to		Composition	
°C	°F	Engine coolant (concentrated)	Demineralised or distilled water
-15	5	30%	70%
-35	-30	50%	50%

CHECKING INVERTER COOLANT LEVEL

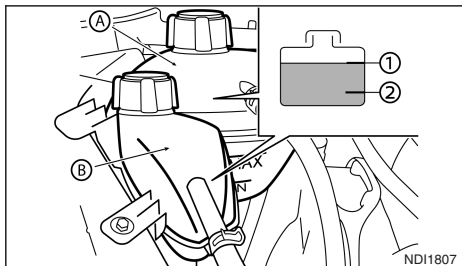

- Ⓐ Engine coolant reservoir
- Ⓑ Inverter coolant reservoir

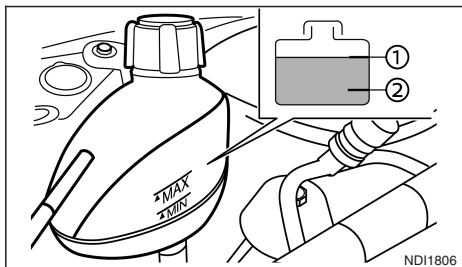

Check the coolant level in the reservoirs Ⓐ and Ⓑ when the engine and inverter are cold. If the coolant level is below MIN level ②, add coolant up to the MAX level ①.

CAUTION

If the cooling system frequently requires coolant, have it checked by a NISSAN dealer or qualified workshop.

CHANGING INVERTER COOLANT

Major cooling system repairs should be performed by a NISSAN dealer or qualified workshop. The service procedures can be found in the appropriate NISSAN Service Manual.

When checking or replacement is required, NISSAN recommends contacting a NISSAN dealer or qualified workshop for servicing.

Improper servicing or coolant change can result in reduced heater performance and engine or inverter overheating.

⚠ WARNING

- Never remove the inverter coolant reservoir cap when the engine is hot. Serious burns could be caused by high pressure fluid escaping from the inverter coolant reservoir. Wait until the engine and inverter have cooled down.
- To avoid the danger of being scalded, never change the coolant when the engine is hot.
- Avoid direct skin contact with used coolant. If skin contact is made, wash thoroughly with soap or hand cleaner and plenty of water as soon as possible.

- Keep coolant out of reach of children and pets.



NISSAN Blue Citizenship

Coolant must be disposed of properly. Check your local regulations.

ENGINE OIL

CHECKING ENGINE OIL LEVEL

CAUTION

The oil level should be checked regularly. Operating with an insufficient amount of oil can damage the engine, and such damage is not covered by warranty.

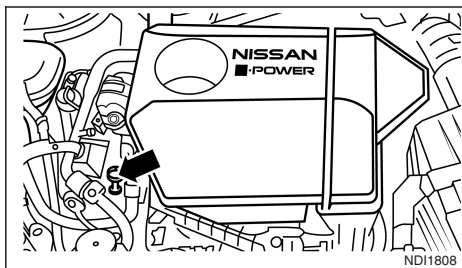

KR15DDT engine

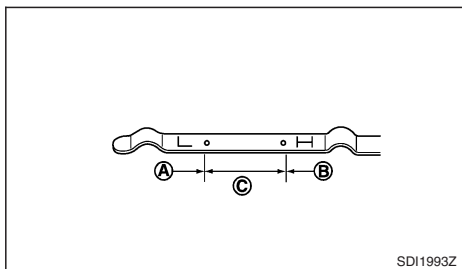

(A) MIN level

(B) MAX level

(C) Normal range

1. Park the vehicle on a level surface and apply the parking brake.
2. Start the engine. If the engine is cold, start and let the engine idle until it reaches the operational temperature (approximately 5 minutes).
3. Turn the engine off.
4. Wait at least 15 minutes for the engine oil to drain back into the oil pan.
5. Remove the dipstick and wipe it clean.
6. Re-insert it all the way.
7. Remove the dipstick again and check the oil level. It should be in the normal range (C).
8. If the oil level is below the minimum mark (A), remove the engine oil filler cap and pour the recommended oil through the opening. **Do not overfill (B).**
9. Recheck the oil level with the dipstick.

It is normal to add some oil between oil maintenance intervals, depending on the severity of operating conditions.

CHANGING ENGINE OIL AND OIL FILTER

WARNING



NISSAN Blue Citizenship

Used oil must not be poured into the ground, canals, rivers, etc. It should be disposed of at a rubbish tip having proper facilities.

- NISSAN recommends contacting a NISSAN dealer or qualified workshop for engine oil servicing.
- Be careful not to burn yourself, as the engine oil is hot.
- Prolonged and repeated contact with used engine oil may cause skin cancer.
- Avoid direct skin contact with used oil. If skin contact is made, wash thoroughly with soap or hand cleaner and plenty of water as soon as possible.
- Store used engine oil in marked containers out of the reach of children.

CAUTION

Waste oil must be disposed of properly. Check your local regulations.

Engine oil replacement

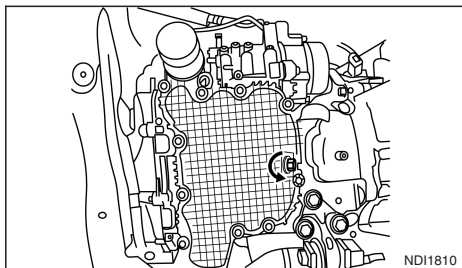
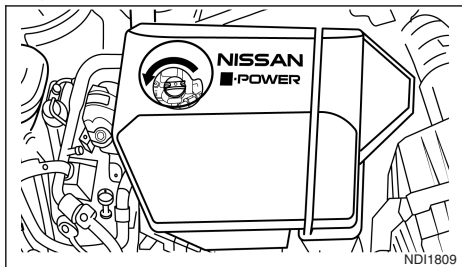

1. Park the vehicle on a level surface and apply the parking brake.
2. Start the engine. If the engine is cold, start and let the engine idle until the engine temperature reaches the operational temperature (approximately 5 minutes).
3. Turn the engine off.

4. Wait at least 15 minutes to let the engine oil drain back into the oil pan.
5. Remove the underbody cover (where fitted).
6. Place a large drain pan under the drain plug.
7. Remove the drain plug with a wrench.
8. Remove the oil filler cap and completely drain the oil.

If the engine oil filter needs to be changed, remove and replace it at this time. See "Changing engine oil filter" later in this section.

9. Clean and re-install the drain plug along with a new washer. Securely tighten the drain plug with a wrench. **Do not use excessive force.**

Drain plug tightening torque:

30.0 to 37.0 N•m (3.1 to 3.8 kg-m, 22 to 27 ft-lb)

10. Refill the engine with recommended engine oil and quantity. (See "Recommended fluids/lubricants and capacities" in the "9. Technical information" section.)

When filling the engine oil, do not remove the dipstick.

11. Install the engine oil filler cap securely.
12. Start the engine.
13. Check for any leakage around the drain plug. Correct as required.
14. Check the oil level with the dipstick. For details, see "Checking engine oil level" earlier in this section.

Changing engine oil filter

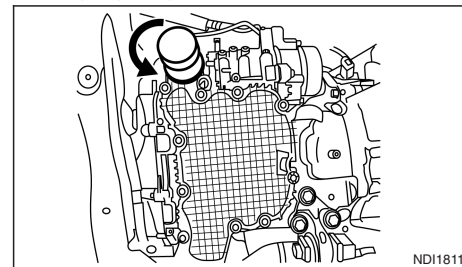

1. Park the vehicle on a level surface and apply the parking brake.
2. Turn the engine off.
3. Drain the engine oil according to the proper procedure. (See "Engine oil replacement" earlier in this section.)
4. Loosen the engine oil filter with an oil filter wrench.

Depending on the engine model, a special cap type wrench may be required. See a NISSAN dealer or qualified workshop for more information.

5. Remove the engine oil filter by turning it by hand.
6. Wipe the engine oil filter mounting surface with a clean cloth.

Be sure to remove any old gasket remaining on the mounting surface.

7. Apply the new engine oil to the gasket of the new oil filter.

- Screw in the oil filter until a slight resistance is felt, and then tighten an additional 2/3 of turn to secure the oil filter.

Oil filter tightening torque:

15.0 to 21.0 N•m (1.5 to 2.1 kg-m, 11 to 15 ft-lb)

- Refill the engine oil. (See "Engine oil replacement" earlier in this section.)
- Start the engine and check for leakage around the oil filter. Correct as required.
- Turn the engine off and wait several minutes.
- Check the engine oil level according to the proper procedure. (See "Checking engine oil level" earlier in this section.)

PROTECT THE ENVIRONMENT



NISSAN Blue Citizenship

It is illegal to pollute drains, water courses and soil. Use authorised waste collection facilities, including civic amenity sites and garages providing facilities for the disposal of used oil and used oil filters. If in doubt, contact your local authority for advice on disposal.

The regulations concerning the pollution of the environment will vary from country to country.

GEAR FLUID

When checking or replacement is required, NISSAN recommends contacting a NISSAN dealer or qualified workshop for servicing.

CAUTION

- **Genuine NISSAN Matic S ATF*. Do not mix with other fluids.**
- **Using gear fluid other than Genuine NISSAN Matic S ATF will cause deterioration in drivability and gearbox durability, and may damage the gearbox; such damage is not covered by the warranty.**

***: For details, contact a NISSAN dealer or qualified workshop.**

BRAKES

CHECKING PARKING BRAKE

Periodically check the holding ability of the parking brake by parking on a steep hill and restraining the vehicle by using only the parking brake. If it does not hold satisfactorily, see a NISSAN dealer or qualified workshop.

CHECKING BRAKE PEDAL

If the brake pedal suddenly goes down further than normal, the pedal feels "spongy" or the vehicle seems to take longer to stop, see a NISSAN dealer or qualified workshop.

Self-adjusting brakes

Your vehicle is equipped with self-adjusting brakes. The disc-type brakes self-adjust every time the brake pedal is applied.

BRAKE FLUID

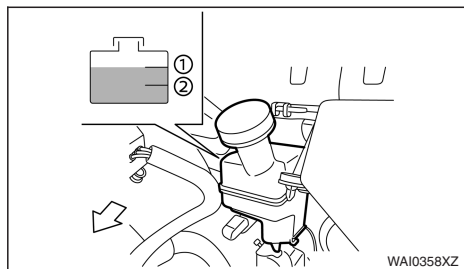

⚠ WARNING

- Use only new fluid. Old, inferior, or contaminated fluid may damage the brake system. The use of improper fluids can damage the brake system and affect the vehicle's stopping ability.
- Clean the filler cap before removing.
- Brake fluids are poisonous and should be stored carefully in marked containers out of the reach of children.

Check the fluid level in the reservoir. If the fluid level is between the MIN ② and MAX ① lines or the brake warning light comes on, add fluid up to the MAX line.

See "Recommended fluids/lubricants and capacities" in the "9. Technical information" section for the recommended brake fluid type.

If fluid must be added frequently, the system should be thoroughly checked by a NISSAN dealer or qualified workshop.

CAUTION

- NISSAN recommends that refilling and checking the brake systems should be left to a NISSAN dealer or qualified workshop who will have the necessary fluids and technical knowledge.
- Do not spill the fluid on painted surfaces. This will damage the paint. If fluid is spilled, wash with water.

WINDOW WASHER FLUID

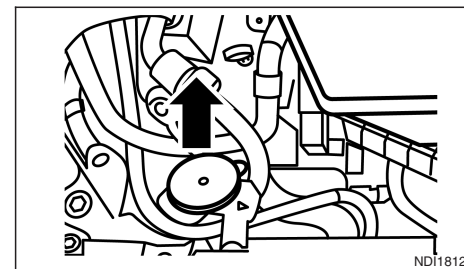

⚠ WARNING







Anti-freeze window washer fluid is poisonous and should be stored carefully in marked containers out of the reach of children.

- Check the fluid level in the window washer reservoir. If the fluid level is low or when the low washer fluid warning light (where fitted) comes on, add window washer fluid up to the MAX level.
- Refill the reservoir more frequently when driving conditions require an increased amount of window washer fluid.
- Add a washer solvent to the water for better cleaning. In the winter season, add a window washer anti-freeze. Follow the manufacturer's instructions for the mixture ratio.

BATTERY

CAUTION

- Do not substitute anti-freeze engine coolant for window washer solution. This may result in damage to the paint.
- Always use window washer fluid recommended by NISSAN.

Caution symbols for battery			 WARNING
①		No smoking No exposed flames No sparks	Never smoke around the battery. Never expose the battery to open flames or electrical sparks.
②		Shield eyes	Handle the battery cautiously. Always wear eye protection glasses to protect against explosion or battery acid.
③		Keep away from children	Never allow children to handle the battery. Keep the battery out of reach of children.
④		Battery acid	Do not allow battery fluid to contact your skin, eyes, fabrics, or painted surfaces. After handling the battery or battery cap, immediately wash your hands thoroughly. If the battery fluid gets into your eyes, or onto your skin or clothing, flush with water immediately for at least 15 minutes and seek medical attention. Battery fluid is acid. If the battery fluid gets into your eyes or onto your skin, it could cause eyesight loss or burns.
⑤		Note operating instructions	Before handling the battery, read this instruction carefully to ensure correct and safe handling.
⑥		Explosive gas	Hydrogen gas, generated by battery fluid, is explosive.

VEHICLE 12V BATTERY

⚠ WARNING

Do not operate the vehicle if the fluid in the battery is low. Low battery fluid can cause a higher load on the battery which can generate heat, reduce battery life, and in some cases lead to an explosion.

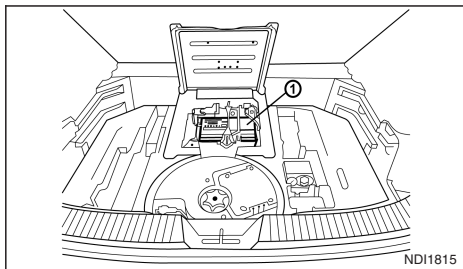

Example of 12V battery location

The 12-volt battery ① is located in the luggage area. The exact location depends on whether or not a spare wheel/tyre is fitted. To access the 12-volt battery, raise the luggage floor board and remove the tool holder (s), or if an access panel is fitted, raise the access panel as illustrated.

For a maintenance free battery it is not required to check the fluid level. However, NISSAN recommends to have the battery checked periodically at a NISSAN dealer or qualified workshop.

Reinitialisation procedure after battery reconnection

If the battery has been reconnected, check the following items:

- Clock setting (where fitted).
- Reset the desired radio stations to the preset station buttons.

For details, see "Vehicle information display" in the "2. Instruments and controls" section, or the separately provided NissanConnect Owner's Manual, or the audio device descriptions in "FM/AM radio (with DAB) (where fitted)" in the "4. Display screen, heater and air conditioner, and audio system" section.

Avoid battery discharge

The vehicle battery will slowly discharge during prolonged periods of inactivity. There are a number of ways to prevent the battery becoming discharged to such a low level that the vehicle cannot be started:

- Top up the battery charge using a trickle/smart charger. Do not use rapid charge as this can cause damage to the battery. Follow the instructions provided with the battery charger.
- It is recommended that the vehicle is driven for at least 15 minutes every 2 weeks.
- If driving the vehicle is not possible, start the engine and run the engine at idle speed for 25–30 minutes every 4 weeks.

Jump-starting

If jump-starting is necessary, see "Jump starting" in the "6. In case of emergency" section. If the engine does not start by jump starting, the battery may have to be replaced. Contact a NISSAN dealer or qualified workshop.

INTELLIGENT KEY BATTERY REPLACEMENT

CAUTION

- The **⚠** symbol noted on the Intelligent key is intended to alert the user to the presence of important operating and maintenance (servicing) instructions in the literature accompanying the appliance.
- Be careful not to allow children to swallow the battery and removed parts.
- There is danger of explosion if the lithium battery is incorrectly replaced. Replace only with the same or equivalent type.
- Do not expose the battery to excessive heat such as concentrated sunshine, fire or the like.
- Do not crush or cut the battery.
- Do not subject the battery to extremely low air pressure at high altitude.
- When changing batteries, do not let dust or oil get on the components.

- Be careful not to touch a circuit board or a battery terminal.



An improperly disposed battery can harm the environment. Always conform to local regulations for battery disposal.

- The Intelligent Key is water-resistant; however, if it does get wet, immediately wipe it until it gets completely dry. To replace the battery, open the Intelligent Key carefully in the sequence shown in the illustration.
- When changing the battery, do not let dust or oil get on the Intelligent Key.

⚠ WARNING

- Do not ingest the battery, Chemical Burn Hazard (The remote control supplied with) This product contains a coin button cell battery. If the coin/button cell battery is swallowed, it can cause severe internal burns in just 2 hours and can lead to death.
- Keep new and used batteries away from children. If the battery compartment does not close securely, stop using the product and keep it away from children.
- If you think batteries might have been swallowed or placed inside any part of the body, seek immediate medical attention.

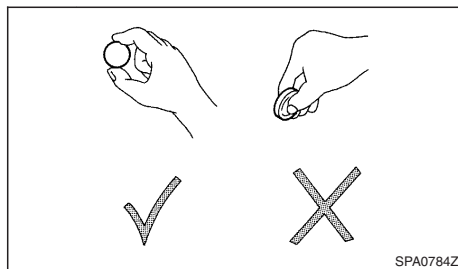

CAUTION

Always hold the battery by the edges, as shown. Holding the battery across the contact points will seriously deplete the storage capacity.

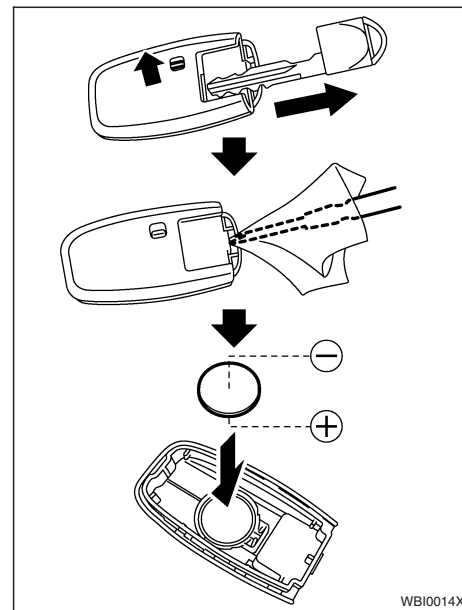

Intelligent Key

Replacement

1. Slide the locking pin to the unlock position.
2. Remove the key.
3. Insert a flat blade screwdriver or a suitable tool into the slot and twist it to open the lid.

4. Replace the battery with a new one with the same specifications.

Use the following battery type:

CR2032

- Do not touch the internal circuit and electric terminals as doing so could cause a malfunction.
- Make sure that the + side faces the bottom of the case, as illustrated.

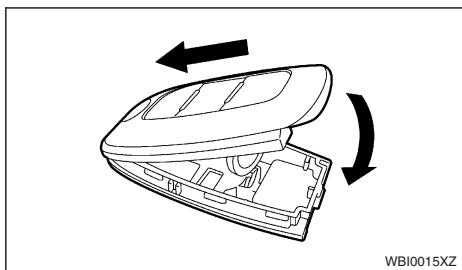

5. Align the tips of the upper and lower parts, and then push them together until it is securely closed.
6. Operate the buttons to check that the key works correctly.
- Contact a NISSAN dealer or qualified workshop if you need assistance for battery replacement.

DRIVE BELT

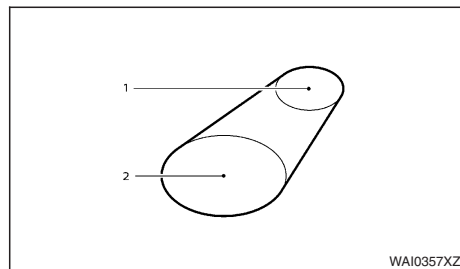

- 1 Water pump
- 2 Crankshaft pulley

⚠ WARNING

Be sure the power switch is OFF. Otherwise the cooling fan or the engine may start to operate suddenly.

1. Visually inspect the belt for signs of unusual wear, cuts, fraying or looseness. If the belt is in poor condition or loose, have it replaced or adjusted by a NISSAN dealer or qualified workshop.
2. Have the belt checked regularly for condition and tension in accordance with the maintenance schedule as shown in a separately provided Warranty Information and Maintenance booklet.

SPARK PLUGS

⚠ WARNING

Be sure the e-POWER system and power switch is switched OFF and that the parking brake is engaged securely.

CAUTION

- Be sure to use the correct socket to remove the spark plugs. An incorrect socket can cause damage to the spark plugs.
- Always replace spark plugs with recommended or equivalent ones.

REPLACING SPARK PLUGS

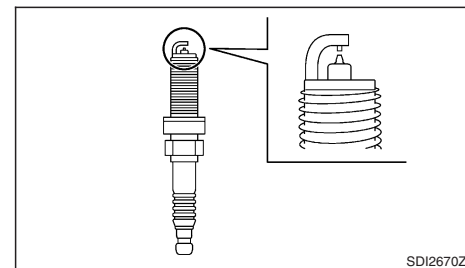

If replacement is required, see a NISSAN dealer or qualified workshop for servicing.

AIR CLEANER

Iridium platinum-tipped spark plugs

It is not necessary to replace the iridium platinum-tipped spark plugs as frequently as the conventional type spark plugs since they will last much longer. Follow the maintenance schedule shown in the separate maintenance booklet. Do not reuse the iridium platinum-tipped spark plugs by cleaning or regapping.

WARNING

- **Operating the engine without the air cleaner filter, can cause you or others to be burned. The air cleaner filter not only cleans the intake air, it also stops flame if the engine backfires. If the air cleaner filter is not installed and the engine backfires, you could be burned.**
- **Do not drive without the air cleaner filter.**
- **Be careful when working on the engine without the air cleaner filter.**

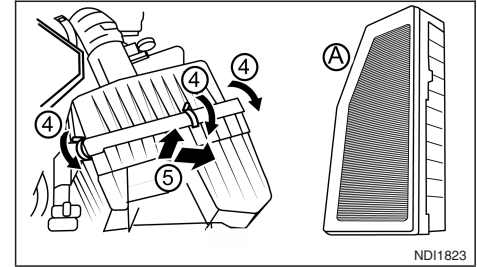

DRY PAPER FILTER ELEMENT

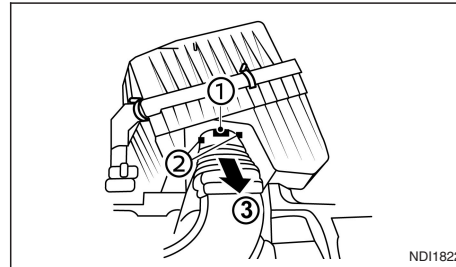

Before opening the air filter cover, disconnect the air intake duct from the air cleaner assembly. Use a finger to press down on ①, disconnect the two lock tabs ②, and pull the rubber duct forward (towards you) to disconnect it from the air cleaner assembly. Move the duct away from the air cleaner assembly.

To remove the filter, release the locking clips ④ and pull the filter cover forward and sideways ⑤.

The filter can now be removed from the cover.

Check the filter element A to see if it is dirty. If it is dirty, shake the element to remove dust.

Clean or replace it according to the maintenance schedule shown in the separately provided Warranty Information & Maintenance Booklet. When cleaning or replacing the filter, wipe the inside of the air cleaner housing and the cover with a damp cloth.

Reassemble the filter, cover and duct in the reverse order of disassembly.

WIPER BLADES

CLEANING

If the windscreen or tailgate window is not clear after using the window washer or if a wiper blade chatters when running, wax or other material may be on the blade or windscreen.

Clean the outside of the windscreen or tailgate window with a washer solution or a mild detergent. The windscreen or tailgate window is clean if beads do not form when rinsing with clear water.

Clean the blade by wiping it with a cloth soaked in a washer solution or a mild detergent. Then rinse the blade with clear water. If the windscreen or tailgate window is still not clear after cleaning the blades and using the wiper, replace the blades.

CAUTION

- **After wiper blade replacement, return the wiper arm to its original position. Otherwise it may be damaged when the bonnet is opened.**
- **Make sure the wiper blade contacts the glass. Otherwise, the arm may be damaged by wind pressure.**

FRONT WINDOW WIPER REPLACEMENT

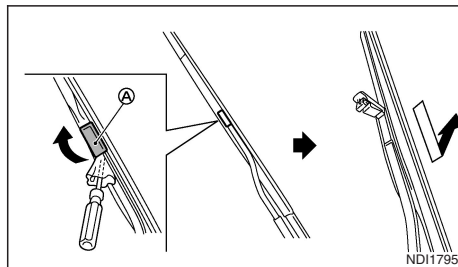

1. Lift the wiper arm away from the windscreen.
2. Open (A), using a suitable tool, and then move the wiper blade down as shown to remove.
3. Install the new wiper blade in the reverse order of removal.
4. Slide the new wiper blade onto the wiper arm until a click sounds.
5. Close (A).

REAR WINDOW WIPER REPLACEMENT

It is recommended you contact a NISSAN dealer or qualified workshop if checking or replacement are required.

WINDSCREEN WASHER NOZZLE

The windscreen washer nozzles are integrated into the wiper arms.

It is recommended you contact a NISSAN dealer or qualified workshop if a washer nozzle is clogged or any malfunction occurs. Do not attempt to clean the nozzle using a needle or a pin. Doing so may damage the nozzle.

FUSES

PASSENGER COMPARTMENT

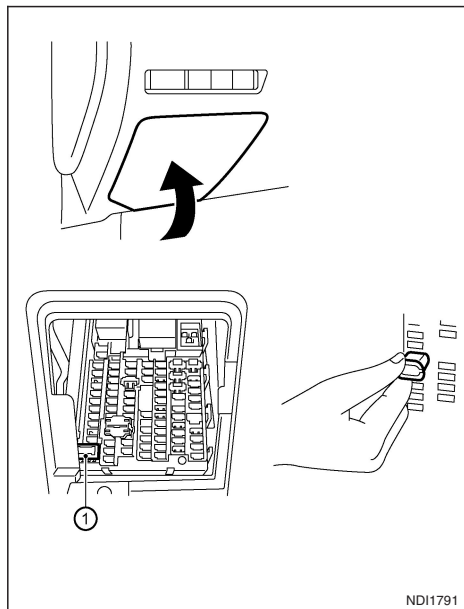

Primary fuse box LHD models

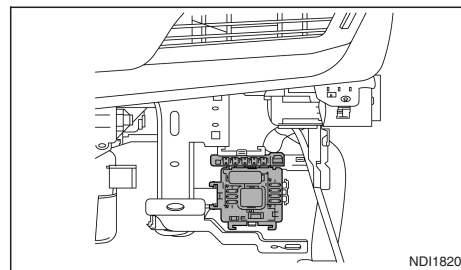

Secondary fuse box LHD models

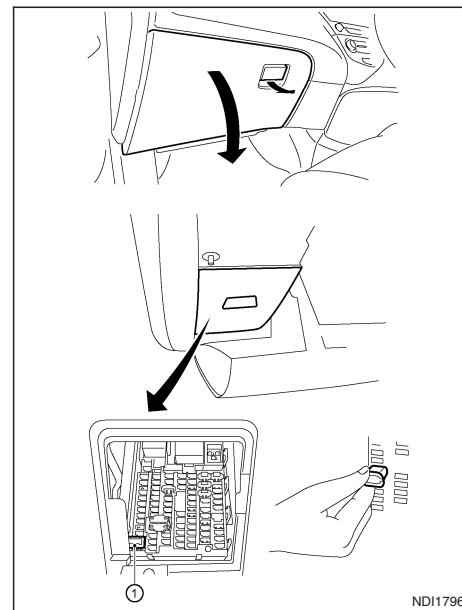

Primary fuse box RHD models

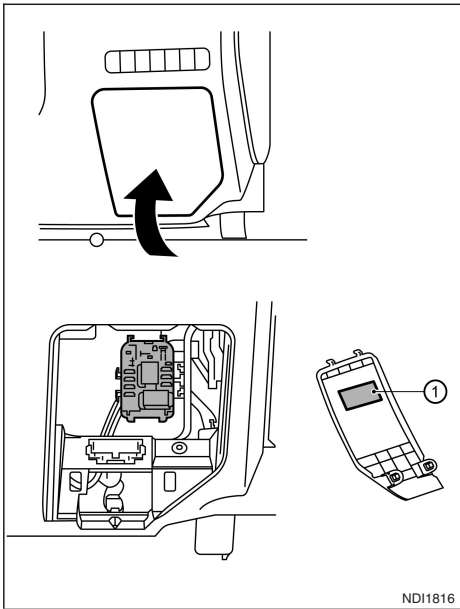

Secondary fuse box RHD models

ND11816

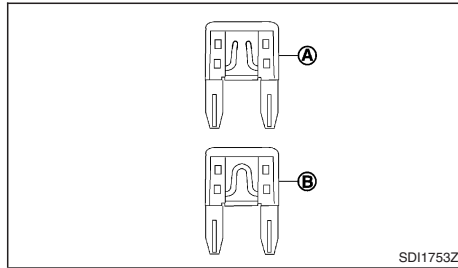

CAUTION

- **Never use a fuse of higher or lower amperage rating than that specified on the fuse box cover.**
- **Never pull the harness or wires when disconnecting the connector.**
- **Be careful not to damage the connector support bracket when disconnecting the connector.**

If any electrical equipment does not operate, check for an open fuse.

LHD models: The primary fuse box is located in the lower part of the left hand side of the instrument panel. The secondary fuse box is located behind the glove box.

RHD models: The primary fuse box is located in the glove box. The secondary fuse box is located in the lower part of the right hand side of the instrument panel

The affected circuits are shown on the inside of the fuse box lid, and on the back of the glove compartment for LHD models.

1. Make sure the power switch is OFF and the headlight switch is in the OFF position.
2. Open the fuse box lid or for the LHD secondary fuse box, remove the glove compartment and side panel (see "Removing the glove compartment" later in this section).
3. Locate and remove the fuse with the fuse puller ① (where fitted).

NOTE

The fuse puller is stored in the fuse box.

4. If the fuse is open ①, replace it with a new fuse ②.
5. Close the fuse box lid, or for the LHD secondary fuse box, refit the glove compartment and side panel (see "Removing the glove compartment" later in this section).

NOTE

If the new fuse opens again, after installing, have the electrical system checked and repaired by a NISSAN dealer or qualified workshop.

Removing the glove compartment

To access the secondary fuse box on LHD models, it is necessary to remove the glove compartment and side panel.

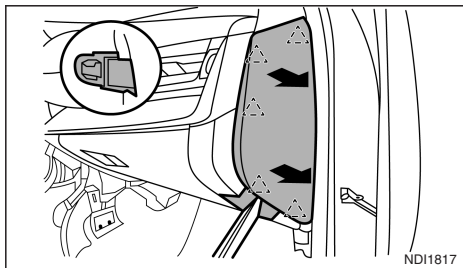

1. Using a suitable tool, remove the side panel.

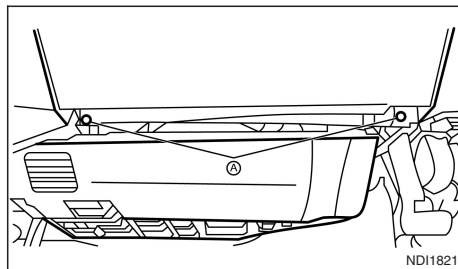
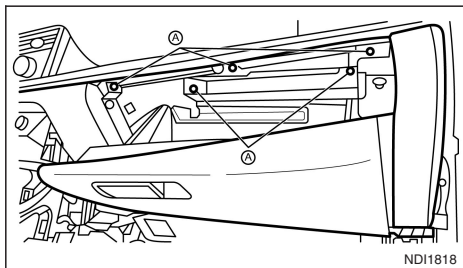

2. Remove the 7 fixing screws (A).

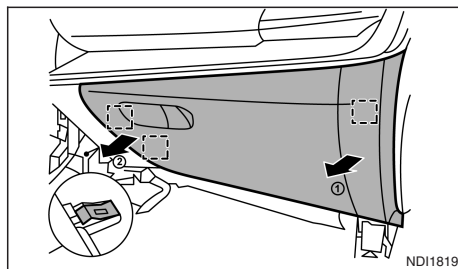

3. Disengage the metal fixing clips in the order shown, then remove the glove box.

Disconnect the harness connector from the glove box light.

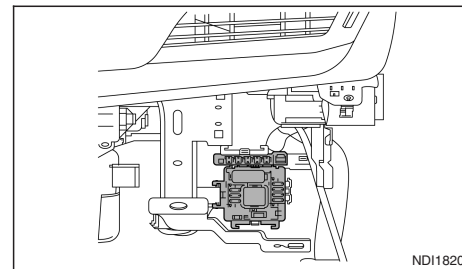

4. The secondary fuse box fuse box can now be accessed. A list of the fuses and their locations is provided on the back of the glove box.

5. Refit the glove box in the reverse order of removal.

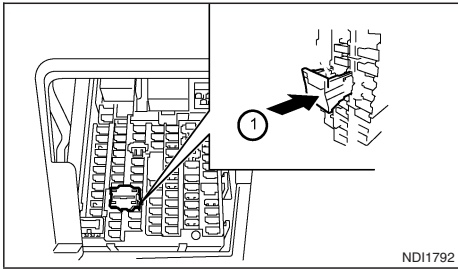

Extended storage fuse switch

To reduce battery drain, the extended storage fuse switch ① comes from the factory switched off. Prior to delivery of your vehicle, the switch is pushed in (switched on) and should always remain on.

If any electrical equipment does not operate, remove the extended storage fuse switch and check for an open fuse.

NOTE

If the extended storage fuse switch malfunctions or if the fuse is open, it is not necessary to replace the switch. In this case, remove the extended storage fuse switch and replace it with a new fuse of the same rating.

How to remove the extended storage fuse switch:

1. To remove the extended storage fuse switch, be sure the power switch is OFF.
2. Be sure the headlight switch is in the OFF position.

3. Remove the fuse box cover.
4. Pinch the locking tabs found on each side of the extended storage fuse switch ③.
5. Pull the extended storage fuse switch straight out from the fuse box.

ENGINE COMPARTMENT

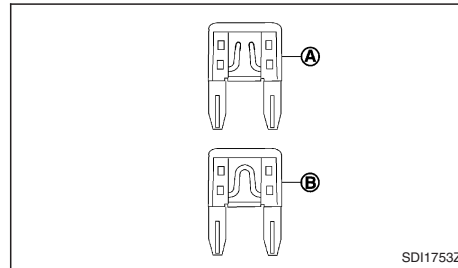
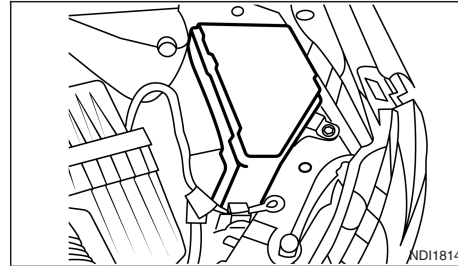

CAUTION
Never use a fuse of higher or lower amperage rating than that specified on the fuse box cover.

If any electrical equipment does not operate, check for an open fuse.

1. Make sure the power switch is OFF and the headlight switch is in the OFF position.
2. Open the bonnet. For details, see "Bonnet" in the "3. Pre-driving checks and adjustments" section.
3. Using a trim tool or other appropriate tool if necessary, release the three locking tabs and remove the engine compartment fuse box cover.
4. Locate the fuse that needs to be replaced.
5. Remove the fuse with the fuse puller (where fitted). The fuse puller is located in the fuse box of the passenger compartment.
6. If the fuse is open (A), replace it with a new fuse (B).
7. Install the fuse box cover.
8. Close the bonnet.

NOTE

If the new fuse opens again, after installing, have the electrical system checked and repaired by a NISSAN dealer or qualified workshop.

LIGHTS

HEADLIGHTS

LED headlight

The LED headlight uses an LED module without serviceable parts.

CAUTION

- To prevent an electric shock, never attempt to modify or disassemble the LED headlights assembly.
- If replacement is required, contact a NISSAN dealer or qualified workshop.

Fog may temporarily form inside the lens of the exterior lights in the rain or in a car wash. A temperature difference between the inside and the outside of the lens causes the fog. This is not a malfunction. If large drops of water collect inside the lens, contact a NISSAN dealer or qualified workshop.

EXTERIOR LIGHTS

Item	Wattage (W)
Front combination light	
Daytime running light*1	LED
Headlight (High beam) *1	LED
Headlight (Low beam) *1	LED
Front turn signal light *1	21 or LED
Front side light *1	LED
Front fog light *1	LED
Side turn signal light *1	LED
Rear combination light *1	
Turn signal light *1	21 or LED
Brake/Tail light *1	LED
Reverse light *1	16
High-mounted brake light *1	LED
Number plate light	5 or LED
Rear fog light *1	LED

*1: If replacement is required, contact a NISSAN dealer or qualified workshop.

INTERIOR LIGHTS

Item	Wattage (W)
Room light/Map lights (where fitted)	5
Reading lights – rear (where fitted) *1	5
Rear room light (where fitted)	5
Luggage compartment light	5

*1: If replacement is required, contact a NISSAN dealer or qualified workshop.

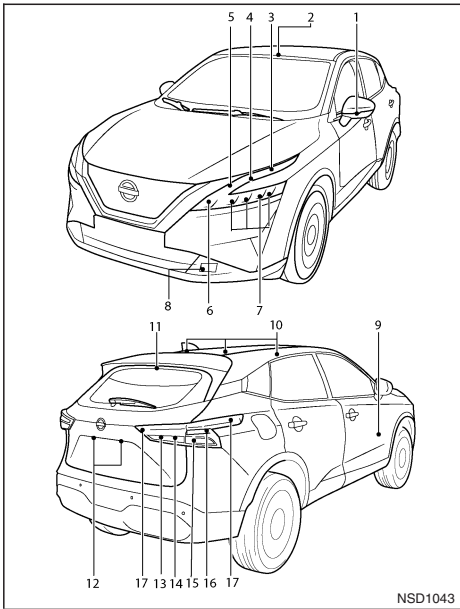

Light locations (Type A)

NSD1043

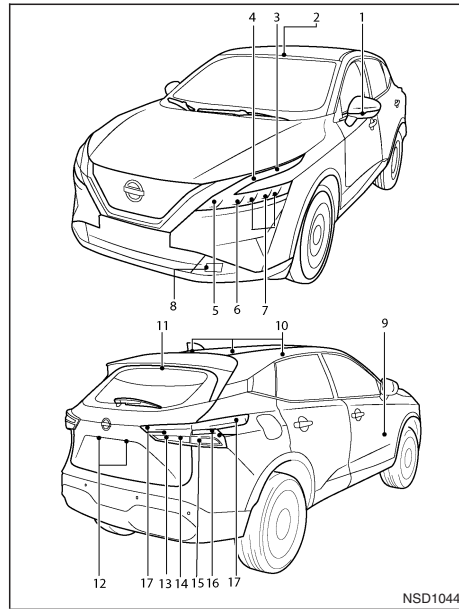

Light locations (Type B)

NSD1044

LIGHT LOCATIONS

- ① Side turn signal light
- ② Room light/Map lights (where fitted)
- ③ Daytime Running Light (DRL)
- ④ Front side light
- ⑤ Front turn signal light
- ⑥ High beam headlight/Adaptive Driving Beam (Type A only)
- ⑦ Low beam headlight
- ⑧ Front fog light (where fitted)
- ⑨ Footwell light (where fitted)
- ⑩ Room light/Reading lights – rear (where fitted)
- ⑪ High mounted brake light
- ⑫ Number plate light
- ⑬ Rear fog light (where fitted)
- ⑭ Reverse light
- ⑮ Rear turn signal light
- ⑯ Brake light
- ⑰ Tail light

Replacing procedures

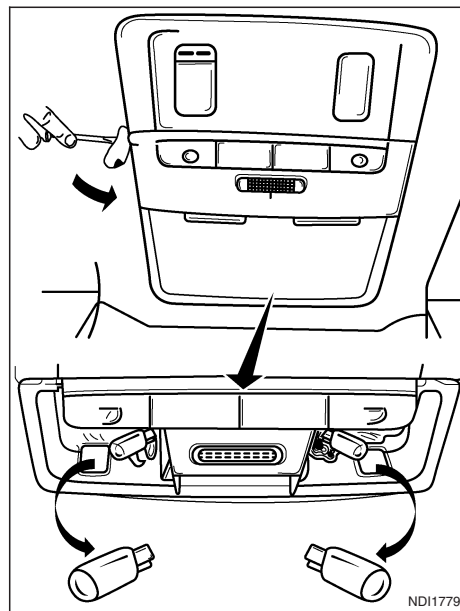
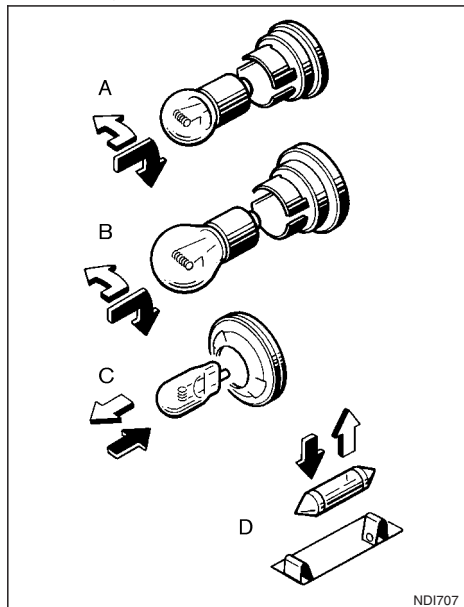

Room light/Map lights (where fitted)

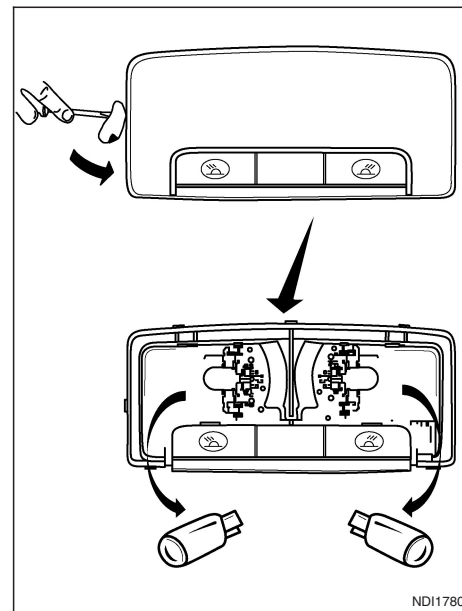

Room light – rear (where fitted)

All other lights are either type A, B, C or D or LED.

⇐ REMOVE

➔ INSTALL

WHEELS AND TYRES

In case of a flat tyre, see "Flat tyre" in the "6. In case of emergency" section.

TYRE INFLATION PRESSURE

Periodically check the tyre pressure (including the spare tyre). An incorrect tyre pressure may adversely affect tyre life and vehicle handling. After adjusting the tyre pressure, perform a TPMS temperature calibration (see "TPMS temperature calibration (where possible)" in the "5. Starting and driving" section).

NOTE

Incorrectly inflated tyres can also lead to poor steering ability and make the driver suspect a steering problem: keep the vehicle's tyres inflated to the correct pressure at all times.

The tyre pressure should be checked when tyres are COLD. Tyres are considered COLD after the vehicle has been parked for three or more hours, or driven less than 1.6 km (1 mile). COLD tyre pressures are shown on the tyre placard affixed to the driver's side centre pillar.

Insufficient pressure can lead to an overheating of the tyre and subsequent internal damage. At high speeds, this could result in tread separation and even bursting of the tyre.

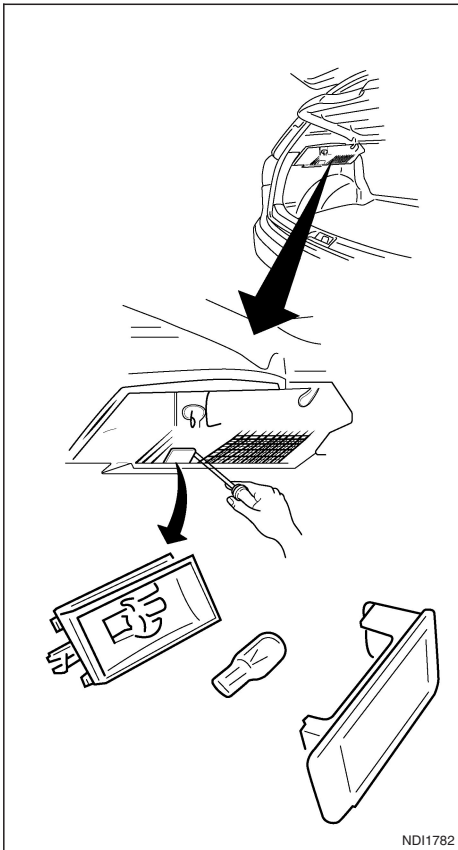

Luggage compartment light

NDI1782

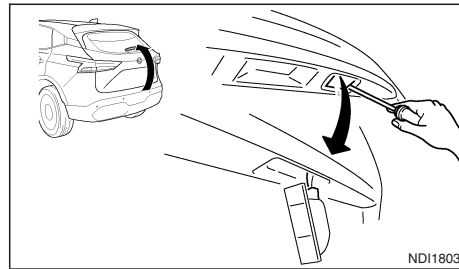

Number plate light

NDI1803

TYPES OF TYRES

CAUTION

- **When changing or replacing tyres, be sure all four tyres are of the same type (i.e., summer, all season or snow) and construction.**
- **A NISSAN dealer or qualified workshop may be able to help you with information about tyre type, size, speed rating and availability.**
- **Replacement tyres may have a lower speed rating than the factory equipped tyres, and may not match the potential maximum vehicle speed. Never exceed the maximum speed rating of the tyre.**
- **Speedometer calibration may be affected if wheels and/or tyres of a different size to factory equipped wheels and/or tyres are fitted to the vehicle (for example, winter wheels). Consult a NISSAN dealer or qualified workshop before fitting alternative size wheels and/or tyres.**

All season tyres

NISSAN specifies all season tyres on some models to provide good performance for use all year around, including snowy and icy road conditions. All season tyres are identified by ALL SEASON and/or M&S on the tyre sidewall. Snow tyres have better snow traction than all season tyres and may be more appropriate in some areas.

Summer tyres

NISSAN specifies summer tyres as standard fit. These tyres provide superior performance under typical mild weather conditions.

If you plan to operate your vehicle in snowy or icy conditions, NISSAN recommends the use of SNOW or ALL SEASON tyres on all four wheels.

Snow tyres

If snow tyres are needed, it is necessary to select tyres equivalent in size and load rating to the original equipment tyres. If you do not, it can adversely affect the safety and handling of your vehicle.

Generally, snow tyres will have lower speed ratings than factory equipped tyres and may not match the potential maximum vehicle speed. Never exceed the maximum speed rating of the tyre.

For additional traction on icy roads, studded tyres may be used. However, some provinces and states prohibit their use. Check local, state and provincial laws before installing studded tyres. Skid and traction capabilities of studded snow tyres, on wet or dry surfaces, may be poorer than that of non-studded snow tyres.

SNOW CHAINS

Use of snow chains may be prohibited in some areas. Check the local laws before installing snow chains. When installing snow chains, make sure they are of proper size for the tyres on your vehicle and are installed according to the chain manufacturer's suggestions. Use chain tensioners when recommended by the snow chain manufacturer to ensure a tight fit. Loose end links of the snow chain must be secured or removed to prevent the possibility of whipping action damage to the fenders or undercarriage.

In addition, drive at a reduced speed. Otherwise, your vehicle can be damaged and/or vehicle handling and performance may be adversely affected.

Snow chains must be installed only on the front wheels and not on the rear wheels.

CAUTION

- **Never install snow chains on a temporary-use or small size spare tyre.**
- **Do not drive with snow chains on paved roads which are clear of snow. Driving with chains in such conditions can cause damage to the various mechanisms of the vehicle due to some overstress.**

TYRE ROTATION

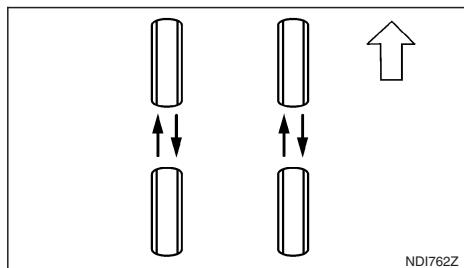

NISSAN recommends that tyres be rotated every 10,000 km (6,000 miles).

However, the timing for tyre rotation may vary according to your driving habits and the road surface conditions. See "Flat tyre" in the "6. In case of emergency" section for tyre replacing procedures.

⚠ WARNING

- **After rotating the tyres, adjust the tyre pressure.**
- **Retighten the wheel bolts when the vehicle has been driven for the first 1,000 km (600 miles) (also in cases of a flat tyre, etc.).**
- **Do not include the temporary-use spare tyre in the tyre rotation.**
- **Incorrect tyre selection, fitting, care or maintenance can affect vehicle safety with risk of accident and injury. If in doubt, consult a NISSAN dealer or the tyre manufacturer.**

NOTE

Models with Tyre Pressure Monitoring System (TPMS).

After rotating the tyres, the TPMS must be reinitialised. For details, see "Activation" in the "5. Starting and driving" section.

TYRE WEAR AND DAMAGE

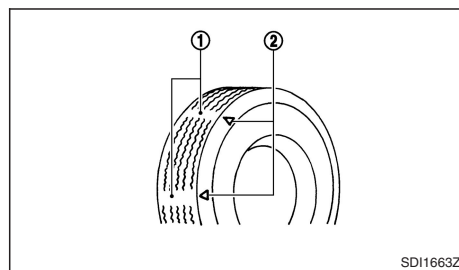

Tyres should be periodically inspected for wear, cracking, bulging or objects caught in the tread. If excessive wear, cracks, bulging or deep cuts are found, the tyre should be replaced.

The original tyres have a built-in tread wear indicator ①. When the wear indicator is visible, the tyre should be replaced.

The wear indicator locations are indicated by the location marks ②.

TYRE AGE

Remember tyre age. Never use a tyre over six years old, regardless of whether they have been used or not.

Tyres degrade with age as well as the use they are subjected to. Have the tyres checked and balanced frequently by a NISSAN dealer or qualified workshop. Report all accidents where the tyre is knocked even if it is minor.

CHANGING TYRES AND WHEELS

⚠ WARNING

Do not install a deformed wheel or tyre even if it has been repaired. Such wheels or tyres could have structural damage and could fail without warning.

When replacing a tyre, use the same size, speed rating and load carrying capacity as originally equipped. Recommended types and sizes are mentioned in "Wheels and Tyres" in the "9. Technical information" section.

The use of tyres other than those recommended or the mixed use of tyres of different brands, construction (bias, bias-belted or radial), or tread patterns can adversely affect the ride, braking, handling, ground clearance, body-to-tyre clearance, snow chain clearance, speedometer calibration, headlight aim and bumper height.

WARNING

Some of these effects may lead to accidents and could result in serious personal injury.

WHEEL BALANCE

Unbalanced wheels may affect vehicle handling and tyre life. Even with regular use, wheels can get out of balance. Therefore, they should be balanced as required.

Wheel balance service should be performed with the wheels off the vehicle. Spin balancing the front wheels on the vehicle could lead to vehicle damage.

SPARE TYRE

Conventional spare wheel/tyre
(where fitted)

A standard wheel/tyre is supplied with your vehicle.

Temporary-use spare wheel/tyre
(where fitted)

The temporary-use spare wheel/tyre can be identified by the temporary-use spare tyre label which contrasts to the standard road wheels. If in doubt, contact a NISSAN dealer, qualified workshop or see "Spare tyre" in the "6. In case of emergency" section.

Emergency tyre puncture repair kit
(where fitted)

The emergency tyre puncture repair kit is supplied to the vehicle instead of a spare tyre. The repair kit must be used for temporarily fixing a minor tyre puncture. After using the repair kit, see a NISSAN dealer or qualified workshop as soon as possible for tyre inspection and repair/replacement.

CAUTION

Do not use the emergency tyre puncture repair kit under the following conditions. Contact a NISSAN dealer or qualified workshop or professional road assistance.

- **when the sealant has passed its expiration date (shown on the label attached to the sealant bottle)**
- **when the cut or the puncture is approximately 4 mm (0.16 in) or longer**
- **when the side of the tyre is damaged**
- **when the vehicle has been driven with a considerable loss of air from the tyre**
- **when the tyre is completely displaced inside or outside the rim**
- **when the tyre rim is damaged**
- **when two or more tyres are flat**

See "Spare tyre" in the "6. In case of emergency" section for more details.

CARE OF WHEELS

For details, see "Care of wheels" in the "7. Appearance and care" section.

NOTE

9 Technical information

Recommended fluids/lubricants and capacities	468	Air conditioner specification label (where fitted).....	473
Fuel information	470	Additional data recording (where fitted).....	473
Recommended SAE viscosity number.....	470	Installation of an RF transmitter	474
Air conditioner system refrigerant and lubricant.....	470	Approval numbers.....	474
Engine.....	471	Intelligent Key system.....	474
Wheels and Tyres	471	Tyre Pressure Monitoring System (TPMS) (Transmitter).....	476
Dimensions.....	472	Radar systems.....	478
When travelling or registering in another country.....	472	Audio systems.....	479
Vehicle identification.....	472	Telematics Control Unit (where fitted).....	480
Vehicle identification label.....	472	Radio frequency approval.....	481
Vehicle identification number (VIN) (chassis number)	473	CE approval details.....	482
Engine serial number.....	473	UKCA approval details.....	485
Tyre placard	473		

RECOMMENDED FLUIDS/LUBRICANTS AND CAPACITIES

The following values are approximate capacities. The actual refill capacities may be slightly different from them. When refilling, follow the procedure instructed in the "8. Maintenance and do-it-yourself" section to determine the proper refill capacity.

Fluid type			Metric measure	US measure	Imperial measure	Recommended Fluids/Lubricants
Fuel			55 L	14-1/2 gal	12-1/8 gal	<ul style="list-style-type: none"> See "Fuel information" later in this section.
Engine oil	KR15DDT	With oil filter change	5.1 L	5-3/8 qt	4-1/2qt	<ul style="list-style-type: none"> Genuine "NISSAN Motor Oil 0W-20 SP" or "NISSAN Motor Oil 0W-20 SN" is recommended. If the above motor oil is not available, use "NISSAN Motor Oil" or equivalent that matches the following grade and viscosity. <ul style="list-style-type: none"> Oil grade: - API: SN or SP, ILSAC GF-5 or GF-6 SAE Viscosity: See "Recommended SAE viscosity number" later in this section
		Without oil filter change	5 L	5-1/4 qt	4-3/8 qt	
Engine coolant with reservoir		Total system capacity	8.15 L	8-5/8 qt	7-1/4 qt	<ul style="list-style-type: none"> "NISSAN Genuine Engine Coolant L255N" or equivalent Use "NISSAN Genuine Engine Coolant L255N" or equivalent in its quality, in order to avoid possible aluminium corrosion within the engine cooling system caused by the use of non-genuine engine coolant. Note that any repairs for the incidents within the engine cooling system while using non-genuine engine coolant may not be covered by the warranty, even if such incidents occurred during the warranty period. Contact a NISSAN dealer or qualified workshop for more information regarding the coolant type and capacity. If dilution of new coolant is necessary to achieve the correct concentration, only use demineralised or distilled water for dilution.
		Reservoir max level	0.83 L	7/8 qt	3/4 qt	
Inverter coolant with reservoir		Total system capacity	5.37 L	5-3/4 qt	4-3/4 qt	<ul style="list-style-type: none"> If dilution of new coolant is necessary to achieve the correct concentration, only use demineralised or distilled water for dilution.
		Reservoir max level	0.55 L	5/8 qt	1/2 qt	

Fluid type	Capacity (approximate)			Recommended Fluids/Lubricants
	Metric measure	US measure	Imperial measure	
Gear oil	1.54 L	1-5/8 qt	1-1/2 qt	<ul style="list-style-type: none"> Genuine NISSAN Matic S ATF. Using gear fluid other than Genuine NISSAN Matic S ATF will cause deterioration in drivability and gear box durability, and may damage the gear box; such damage is not covered by the warranty.
Brake fluid	Refill to the correct level according to the instructions in the "8. Maintenance and do-it-yourself" section.			<ul style="list-style-type: none"> Genuine "NISSAN Brake Fluid" or equivalent DOT 4 (US FMVSS No. 116)
Multi-purpose grease	-	-	-	<ul style="list-style-type: none"> NLGI No. 2 (Lithium soap base)
Air conditioning system refrigerant	550 g			<ul style="list-style-type: none"> For Europe: HFO-1234yf
	500 g			<ul style="list-style-type: none"> Except for Europe: HFC-134a (R-134a)
Air conditioning system lubricants	-	-	-	<ul style="list-style-type: none"> SP-A2 oil or equivalent

FUEL INFORMATION

Petrol engine

CAUTION

Do not use leaded petrol. Using leaded petrol will damage the catalytic converter.

Compatible Fuels for Petrol Engines

The petrol engines are compatible with current and future European standards for bio-fuel.

E5

Petrol conforming to EN228 and mixed with a bio-fuel conforming to EN15376. (Only applicable to Europe, Turkey, Chile, New Caledonia, Tahiti, Hong Kong, Singapore.

E10

Not applicable to Morocco, Algeria, Tunisia, Mongolia, Ukraine.)

For Europe, Turkey, Chile, New Caledonia, Tahiti, Hong Kong, Singapore:

Use UNLEADED PREMIUM petrol with an octane rating of at least 95 (RON).

For Morocco, Algeria, Tunisia, Mongolia, Ukraine, Australia, New Zealand, South Africa and other destinations:

If UNLEADED PREMIUM petrol is not available, UNLEADED REGULAR petrol with an octane rating of at least 91 (RON) may be used at slightly reduced performance. However, for maximum vehicle performance and the best driveability, the use of unleaded premium petrol with an octane rating of at least 95 (RON) is recommended.

RECOMMENDED SAE VISCOSITY NUMBER

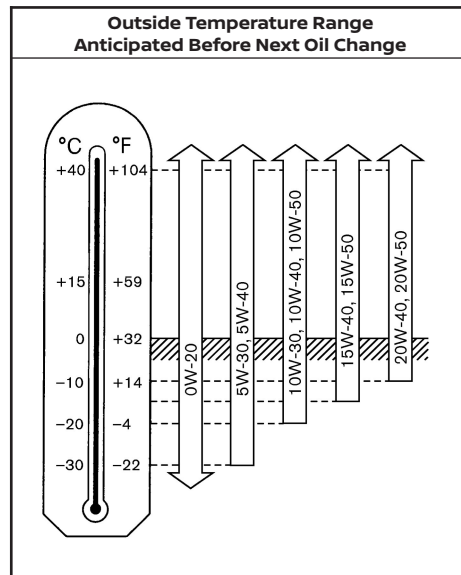

Engine oil

● KR15DDT engine:

0W-20 is preferable. If 0W-20 is not available, select the viscosity from the chart, that is suitable for the outside temperature range.

AIR CONDITIONER SYSTEM REFRIGERANT AND LUBRICANT

For Europe: The air conditioner system of your vehicle must be charged with the refrigerant HFO1234yf (R1234yf) and the lubricant NISSAN A/C System Oil Type SP-A2 or equivalents.

Except for Europe: The air conditioner system of your vehicle must be charged with the refrigerant HFC-134a and the lubricant NISSAN A/C System Oil Type SP-A2 or equivalents.

CAUTION

Use of any other refrigerants or lubricants will cause severe damage, and you may need to replace your vehicle's entire air conditioner system.

The release of refrigerants into the atmosphere is prohibited in many countries and regions. The refrigerant in your vehicle will not harm the Earth's ozone layer. However, it may contribute in a small part to the global warming effect. NISSAN recommends that the refrigerant be appropriately recovered and recycled. Air conditioner system should only be serviced by trained and certified technicians to ensure proper and safe operation. Contact a NISSAN dealer or qualified workshop when servicing the air conditioner system.

ENGINE

Model	KR15DDT	
Type	Petrol, 4-cycle, DOHC	
Cylinder arrangement	3-cylinder in-line	
Bore x Stroke		
when compression ratio = 8	mm (in)	84.0 × 90.1 (3.307 × 3.547)
when compression ratio = 14	mm (in)	84.0 × 88.9 (3.307 × 3.500)
Displacement		
when compression ratio = 8	cm ³ (cu in)	1,497 (91.4)
when compression ratio = 14	cm ³ (cu in)	1,477 (90.1)
Idling speed	rpm	1500+/-125
Spark plug	Standard	ILMAR8G8GS
Spark plug gap	mm (in)	0.8 (0.031)
Camshaft operation	Timing chain	

WHEELS AND TYRES

			Unit: mm (in)
	Item	Size	Offset
Road wheel	Steel *1	18 X 4T*1	30 (1.18)
	Aluminium*	18 x 75J	45 (1.77)
		20 x 8.0J	40 (1.57)
Tyre size	Conventional	235/55R18 100V*	
		235/50R19 99V*	
	Spare	215/55R18 99V *1	145/80R18 109M *1

*: where fitted

*1: Temporary-use spare tyre (where fitted)

DIMENSIONS

		Unit: mm (in.)
		mm (in.)
Overall length		4,425 (174.2)
Overall width	excl. mirrors	1,835 (72.2)
	incl. mirrors	2084 (82.1)
Overall height	incl. antenna	1,625 (64.0)
	excl. antenna	1,610 (63.4)
Front track	18" and 19" wheels	1,580 (62.2)
	20" wheels	1,590 (62.6)
Rear track (beam suspension)	18" and 19" wheels	1,580 (62.2)
	18" and 19" wheels	1586 (62.4)
Rear track (multi-link suspension)	18" and 19" wheels	1,596 (62.8)
	20" wheels	1,596 (62.8)
Wheelbase		2,665 (104.9)

WHEN TRAVELLING OR REGISTERING IN ANOTHER COUNTRY

When planning to travel in another country, you should first find out if the fuel available is suitable for your vehicle's engine.

Using fuel with too low octane rating may cause engine damage. Therefore, avoid taking your vehicle to areas where appropriate fuel is not available.

When transferring your vehicle registration to another country, check with the appropriate authorities that the vehicle complies with the requirements as it may not be possible to adapt it. In some cases, a vehicle cannot meet the legal requirements and in other cases, it may be necessary to modify the vehicle to meet specific laws and regulations.

The laws and regulations for motor vehicle emission control and safety standards vary according to the country; therefore, vehicle specifications may differ.

NISSAN is not responsible for any inconvenience when the vehicle is taken and registered into another country. The necessary modifications, transportation and registration are the owner's responsibility.

VEHICLE IDENTIFICATION

VEHICLE IDENTIFICATION LABEL

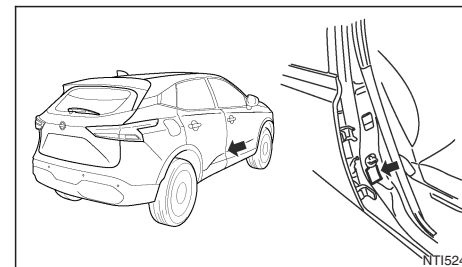

The label is affixed on the B pillar as shown.

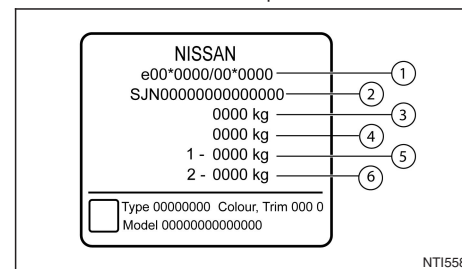

- ① Type approval number
- ② Vehicle Identification Number (VIN)
- ③ Maximum Gross Vehicle Weight
- ④ Maximum Laden Mass of the Combination
- ⑤ Maximum mass on the axle front
- ⑥ Maximum mass on the axle rear

VEHICLE IDENTIFICATION NUMBER (VIN) (chassis number)

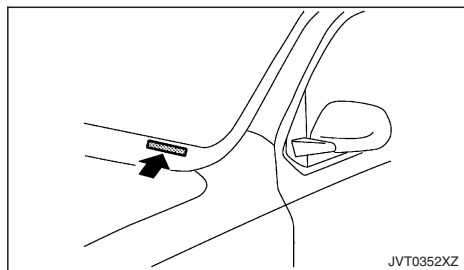
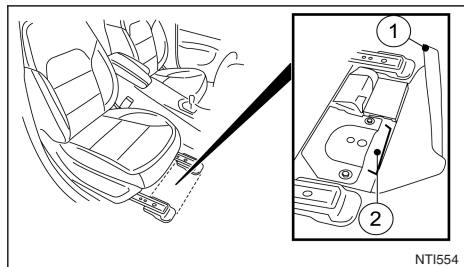

The Vehicle identification number (VIN) is located as shown.

To access the VIN stamped on the floor cross member, pull back the carpet ① to expose the VIN ②.

ENGINE SERIAL NUMBER

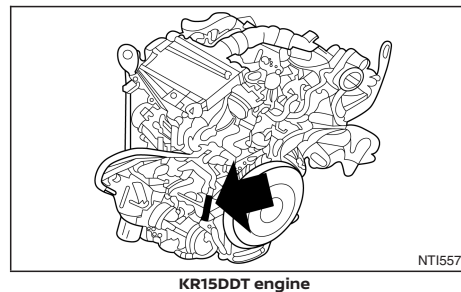

The number is stamped on the engine as shown.

TYRE PLACARD

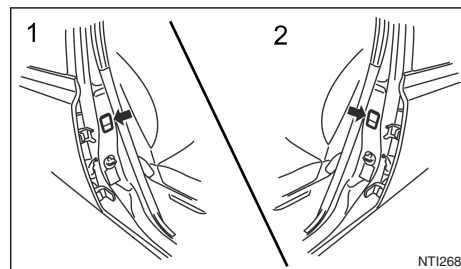

- 1 Right Hand Drive models
- 2 Left Hand Drive models

The cold tyre pressure is shown on the tyre placard fixed to the side of the driver's side centre pillar.

AIR CONDITIONER SPECIFICATION LABEL (where fitted)

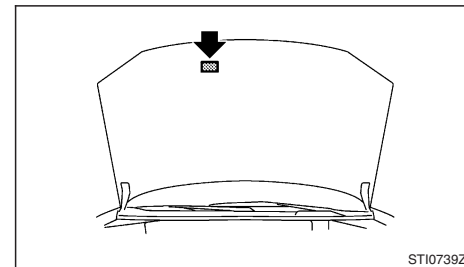

Open the bonnet. The label is affixed at the front section of the bonnet.

ADDITIONAL DATA RECORDING (where fitted)

If your vehicle is fitted with the ProPILOT Assist system, it will also be fitted with supplemental data recording function intended to assist in understanding how the ProPILOT Assist system performs in certain non-trivial crash or near-crash scenarios. Specifically, supplemental recording is designed to capture the following:

- Driver operational status of the accelerator, brakes, steering, etc.
- Detection status of a vehicle ahead and lane markers.
- Vehicle information including distance to vehicle ahead and lateral position.

INSTALLATION OF AN RF TRANSMITTER

- Information on the operation of the ProPILOT Assist system and other crash avoidance features.
- ProPILOT Assist system malfunction diagnosis information.
- External images from the multi-sensing front camera (Available only when the SRS air bag or IEB system is activated).

The ProPILOT Assist system does not record conversations, sounds or images of the inside of the vehicle.

To read this supplemental data, special equipment is required and access to the vehicle or the recording unit is needed. This supplemental data will only be accessed with the consent of the vehicle owner or lessee or as otherwise required or permitted by law.

If downloaded, NISSAN and third parties entrusted by NISSAN may use the data recorded for the purpose of improving NISSAN's vehicle safety performance.

NISSAN and third parties entrusted by NISSAN will not disclose/provide the recorded data to a third party except:

- With the consent of the vehicle owner or with the consent of the lessee.
- In response to an official request from law enforcement, court order, governmental agency, or other legally enforceable request.
- For research purposes after the data is modified such that it is no longer tied to a specific vehicle or vehicle owner (anonymously)

For countries conforming to UN regulation No.10 or equivalent:

The installation of an RF transmitter in your vehicle could affect electric equipment systems. Be sure to check with your NISSAN dealer or qualified workshop for precautionary measures or special instructions regarding installation. Upon request, your NISSAN dealer or qualified workshop will provide the detailed information (frequency band, power, antenna position, installation guide, etc.) regarding installation.

APPROVAL NUMBERS

All radio frequency or audio frequency products fitted to the NISSAN range during production conform to the requirements of the R&TTE Directive.

INTELLIGENT KEY SYSTEM

Intelligent Key hand unit (where fitted)

Model TXPZ1, Passive entry system (hand unit):

Hereby, Continental Automotive GmbH., declares that the radio equipment type TXPZ1 is in compliance with Directive 2014/53/EU.

The full text of the EU declaration of conformity is available at the following internet address:

<https://continental-homologation.com/nissan>

- Manufacturer name:
Continental Automotive GmbH
- Importer name, address:
Nissan International SA
Zone d'activités La Pièce 12
1180 Rolle, Switzerland
- Operating frequency band: 433.92 MHz.
- Maximum radio-frequency power: ≤10 dBm



Справжнім Continental заявляє, що тип радіобладнання TXP21 відповідає Технічному регламенту радіотехнічного обладнання; Повний текст декларації про відповідність доступний на веб-сайті за такою адресою:

<http://continental-homologation.com/nissan>
Частотний діапазон: [433,92MHz]
Максимальна потужність передавача: [-15dBm]
Continental Automotive GmbH
Siemensstrasse 12
93055 Regensburg Germany

NT1573

For Ukraine

AGREE PAR L'ANRT MAROC

Numéro d'agrément :MR 11511
ANRT 2016
Date d'agrément :03/03/2016

NT1548

For Morocco

Intelligent Key system control unit (where fitted)

Hereby, Continental declares that the radio equipment type HFM401 is in compliance with Directive 2014/53/EU.

The full text of the EU declaration of conformity is available at the following internet address:

<https://continental-homologation.com/nissan>

- Manufacturer name, address:
Continental Automotive GmbH
Siemensstraße 12, D-93055
Regensburg, Germany
- Importer name, address:
Nissan International SA
Zone d'activités La Pièce 12
1180 Rolle, Switzerland
- Operating frequency band: 433.92 MHz.
- Maximum radio-frequency power: ≤10 dBm



Справжнім Continental заявляє, що тип радіобладнання HFM401 відповідає Технічному регламенту радіотехнічного обладнання; Повний текст декларації про відповідність доступний на веб-сайті за такою адресою:

<http://continental-homologation.com/nissan>
Частотний діапазон: [433,92MHz]
Максимальна потужність передавача: [-15dBm]
Continental Automotive GmbH
Siemensstrasse 12
93055 Regensburg Germany

NT1546

For Ukraine

TYRE PRESSURE MONITORING SYSTEM (TPMS) (Transmitter)

This device complies with Part 15 of the FCC Rules. Operation is subject to the following two conditions:

- 1) this device may not cause harmful interference, and
- 2) this device must accept any interference received, including interference that may cause undesired operation.

CAUTION TO USERS: Changes or modifications not expressly approved by the party responsible for compliance could void the user's authority to operate the equipment.

Date: 19.10.2018	Das Zeichen mit Datum	Unter Zeichen TIS-09DL	Im Zeichen Zeichen
EU Declaration of Conformity in accordance with Directive 2014/53/EU			
Manufacturer: Address:	Continental Automotive GmbH Siemensstrasse 12 D-93055 Regensburg Germany		
Product type designation:	TIS-09DL		
Intended use:	Tire pressure monitoring sensor		
The product mentioned above complies with the essential requirements and other relevant provisions of Directive 2014/53/EU, when used for its intended purpose:			
Health and safety pursuant to Art. 3(1)(a):	Applied standard(s): EN 60950-1:2006 + A11:2009 + A1:2010 + A12:2011 + A2:2013		
Electromagnetic compatibility pursuant to Art. 3(1)(b):	Applied standard(s): DRAFT EN 301 489-1 V2.2.0:2017-03 DRAFT EN 301 489-3 V2.1.1		
Efficient use of spectrum pursuant to Art. 3(2):	Applied standard(s): EN 300 220-1 V3.1.1 EN 300 220-2 V3.2.1		
The following marking applies to the above mentioned product:			
Continental Automotive GmbH Regensburg, 19.10.2018			
 Klaus Birger Head of Controlling Body & Security		 Norbert Müller Director Research & Development Body & Security	
NT1454			

Hereby, Continental declares that the radio equipment type TIS-09DL is in compliance with Directive 2014/53/EU.

The full text of the EU declaration of conformity is available at the following internet address:

<https://continental-homologation.com/nissan>

- Frequency band: 433.92 MHz.
- Maximum transmitter power: -17 dBm

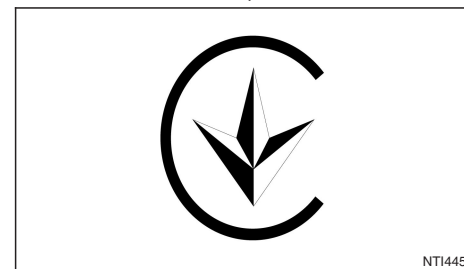

For Ukraine

Справжнім Continental Automotive GmbH заявляє, що тип радіообладнання TIS-09DL відповідає Технічному регламенту радіотехнічного обладнання; Повний текст декларації про відповідність доступний на веб-сайті за такою адресою: <http://continental-homologation.com/>

Частотний діапазон: 433.92 MHz)
Максимальна потужність передавача: <10mW)

Continental Automotive GmbH
Siemensstrasse 12
93055 Regensburg
Germany

NT1450

For Ukraine

א. השימוש במכשיר הוא על בסיס "משגן" ופטור מרישיון הפעלה אלחוטי.
 ב. כלומר - לא מוגן מהפרעות. וללא הפד למערכות אחרות.
 ג. רק "בפעולות בזק" לשימוש עצמי של הלקוח בלבד. היצוד פטור מרישיון הפעלה אלחוטי.
 ד. מתן "שרות בזק" לצד ג' מחייב רישיון מיוחד ממשרד התקשורת
 ה. אסור להחליף את האנטנה המקורית של המכשיר, ולא לעשות בו כל שינוי טכני אחר.

NTI451

For Israel

הספר אישור אלחוטי של משרד התקשורת הוא 51-68322
 השימוש במכשיר הוא על בסיס משגי ופטור מרישיון הפעלה אלחוטי, כלומר – לא מוגן מהפרעות ולא הפרעה
 למערכות אחרות הפועלות כדין.
 רק "בפעולות בזק" לשימוש עצמי של הלקוח בלבד. היצוד פטור מרישיון הפעלה אלחוטי.
 מתן "שרות בזק" לצד ג' מחייב רישיון מיוחד ממשרד התקשורת.
 אסור להחליף את האנטנה של המכשיר ולא לעשות בו כל שינוי טכני אחר.
 האישור הרלי תקף אך ורק עבור יצוד אלחוטי הפועל בתחום תדרים של 433.05-434.79MHz ואשר הספק השידור
 שלו אינו עולה על 10mW.

NTI453

For Israel



الهيئة العامة للتكنولوجيا والمعلومات
 Ministry of Telecom & Information Technology

Type Approval Reg. No.
 2019/61

NTI485

For Palestine

TIS-09DL : **שם הדגם**
 Continental Automotive GmbH : **שם היצרן וכתובתו**
 Siemensstrasse 12
 93055 Regensburg
 Germany

NTI452

For Israel

AGREE PAR L'ANRT MAROC
 Numéro d'agrément: MR 18411 ANRT 2018
 Date d'agrément :28/12/2018

NTI462

For Morocco

RADAR SYSTEMS

Front radar sensor (where fitted)

Simplified EU declaration of conformity	Hereby, Robert Bosch GmbH declares that the radio equipment type FR5CPEC is in compliance with Directive 2014/53/EU. The full text of the EU declaration of conformity is available at the following internet address: http://eu-doc.bosch.com
--	--



UA RF: 1BOSC0001

NTI560

For Ukraine

2.4.1.2.24 Ukraine

справжнім (Robert Bosch GmbH) заявляє, що тип радіообладнання (FR5CPEC) відповідає технічному регламенту радіообладнання; повний текст декларації про відповідність доступний на веб-сайті за такою адресою: <http://ita.bosch.com/radar>

English translation of the above Ukrainian text:
The present (Robert Bosch GmbH) states that the type of radio equipment (FR5CPEC) corresponds to the Technical regulations of the radio equipment.
The full text of the declaration of conformity is available on the website at the following address: <http://ita.bosch.com/radar>

NTI482

For Ukraine

אישור התאמה ליבואן מסחרי (אישור התאמה מאת המנהל) פסי 51-73294

תנאים מיוחדים הוגדרו המסדד
לכלי השינוע ידואג היבואן שעל אריות היענות של המוצר יודבק מודבקה, בה יהיה רשום כי:
א. השימוש במכשיר דוגו על בסיס יימשיני ופסור מרשיון המעלה אחרות.
ב. לא מונן מתפרשות וללא הכרעה למטרות אחרות המעלות כדון.
ב רק יבפעולת בוקי לשימוש עמבי של הקלוח בלבד, הבידוד עבור מרשיון המעלה אחרות.
מתן ישרות בוקי לגד גי מתחייב רשיון מיוחד ממשדר התקשורת.
ג. אסור להחליף את האנטנה המקורית של המכשיר, ולא לעשות בו כל שינוי טכני אחר.

NTI562

For Israel

AGREE PAR L'ANRT MAROC

Numéro d'agrément : MR 17528 ANRT 2018

Date d'agrément : 20/09/2018

NTI564

For Morocco

Side radar sensor (where fitted)

Simplified EU declaration of conformity	Hereby, APTIV, 42367 Wuppertal declares that this RN5TR is in compliance with the essential requirements and other relevant provisions of Directive 2014/53/EU (RED). The original declaration of conformity can be accessed at the following internet address: www.aptiv.com/automotive-homologation
	Frequency band(s) in which the radio equipment operates: 76-77 GHz
	Maximum radio-frequency power transmitted in the frequency band(s) in which the radio equipment operates: 30 dBm (1 W)

UA RF: 1APTIV RN5TR
справжнім (найменування виробника APTIV, 42367 Wuppertal) заявляє, що тип радіообладнання (позначення типу радіообладнання RN5TR) відповідає технічному регламенту радіообладнання; зареєстровано в протоколі ООБ за № UA.TR.109 повний текст декларації про відповідність доступний на веб-сайті за такою адресою: www.aptiv.com/automotive-homologation

RED:
СПРОШЕНА ДЕКЛАРАЦІЯ ЄС ПРО ВІДПОВІДНІСТЬ
Цим APTIV, 42367 Wuppertal заявляє, що радіообладнання типу RN5TR відповідає вимогам Директиви 2014/53/ЄУ. Повний текст декларації ЄС про відповідність доступний за наступною адресою в мережі Інтернет: www.aptiv.com/automotive-homologation
Частотний діапазон(-и), в якому працює радіообладнання: 76-77 ГГц
Максимальна потужність радіочастотного сигналу, що передається у частотному діапазоні(-ах), в якому працює радіообладнання: 1 Вт (30 дБм середньоквадратична ефективна потужність випромінювання)*

NTI566

For Ukraine



For Ukraine





For Morocco

AUDIO SYSTEMS

FM AM radio (where fitted)

Simplified EU declaration of conformity	Hereby Visteon Automotive Electronics Co., Ltd. declares that this system is in compliance with Directive 2014/53/EU.
	Frequency band(s) in which the radio equipment operates: 2400-2483.5 MHz
	Maximum radio-frequency power transmitted in the frequency band(s) in which the radio equipment operates: Bluetooth <10 mW (EIRP)

Notified Body TÜV Rheinland LGA Products GmbH Tillystraße 2 90431 Nürnberg notified by the Bundesnetzagentur für Elektrizität, Gas, Telekommunikation, Post und Eisenbahnen under No. 0197 hereby issued as an EU-Type Examination Certificate within the meaning of Annex III Module B of the 2014/53/EU Radio Equipment Directive (RED) for compliance with the essential requirements of this directive		
Registration Number: RT 6012909 0001 Evaluation Report Nr.: 60151596 001		
Manufacturer:	Yanfeng Visteon Automotive Electronics Co., Ltd. No. 300, Minolta Road, Songjiang District 201600 Shanghai China	
Product:	Radio Equipment (Car Radio with Bluetooth)	
Type Identification:	N18 W DAB N19 W/D DAB (VISTEON)	
Essential requirements:	2014/53/EU (RED) Article 3.1a Health Article 3.1b Electrical Safety Article 3.1c EMC Article 3.2 Radio spectrum	
The technical design of the assessed type has been verified based on the technical documentation presented by the manufacturer according to Annex III Module B of the Directive. As far as the essential requirements indicated, the Notified Body of TÜV Rheinland LGA Products GmbH confirms, that the technical design of the apparatus meets the essential requirements of the Directive 2014/53/EU Article 3. This certificate consists of this page and Annex I. Validity of the certificate is specified in the Annex I.		
Date	06.06.2018	 S. Peng Notified Body
		NTI480

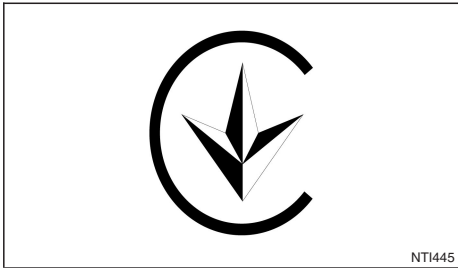

For Ukraine



For Morocco

TELEMATICS CONTROL UNIT (where fitted)

Hereby, Valeo declares that the radio equipment type A-IVC-EU-01 is in compliance with Directive 2014/53/EU. The full text of the EU declaration of conformity is available at the following internet address:

[https://www.valeo.com/
declaration-of-conformity/](https://www.valeo.com/declaration-of-conformity/)

Hereby, Continental declares that the radio equipment type IVC Telematic Control Unit is in compliance with Directive 2014/53/EU. The full text of the EU declaration of conformity is available at the following internet address:

[http://www.continental-homologation.com/
nissan](http://www.continental-homologation.com/nissan)



For Israel

RADIO FREQUENCY APPROVAL

All radio frequency products fitted to the vehicle range during production conform to the requirements of the Radio Equipment Directive (RED) 2014/53/EU.

The countries covered by this directive, or those which accept it, are: Albania, Austria, Belgium, Bosnia & Herzegovina, Bulgaria, Croatia, Cyprus, Czech Republic, Denmark, Estonia, Finland, France, French Guiana, Georgia, Germany, Greece, Guadeloupe, Hungary, Iceland, Ireland, Italy, Kosovo, Latvia, Liechtenstein, Lithuania, Luxembourg, Macedonia, Malta, Martinique, Mayotte, Monaco, Montenegro, Netherlands, Norway, Poland, Portugal, Reunion, Romania, Saint Pierre & Miquelon, San Marino, Slovakia, Slovenia, Spain, Sweden, Switzerland, Turkey, Tuvalu, United Kingdom.

VEHICLE RADIO FUNCTIONS		
Frequency Range	Technology	Power/Magnetic Field
125 kHz (119 - 135 kHz)	Remote Keyless Entry Transponder Ring	≤ 42 dBμA/m at 10m
433 MHz (433.05 - 434.79 MHz)	Tyre Pressure Monitoring	≤ 10 mW e.i.r.p.
433.92 MHz (433.05 - 434.79 MHz)	Remote Keyless Entry	≤ 10 mW e.i.r.p.
20 kHz (9 - 90 kHz)	Keyless Go system	≤ 72 dBμA/m at 10m
2.4 GHz (2400 - 2483.5 MHz)	Bluetooth®, Wi-Fi	≤ 100 mW e.i.r.p.
824 - 894 MHz	GSM 850 (2G)	≤ 39 dBm e.i.r.p.
880 - 960 MHz	GSM 900 (2G)	≤ 39 dBm e.i.r.p.
1710 - 1880 MHz	GSM 1800 (2G)	≤ 36 dBm e.i.r.p.
1850 - 1890 MHz	GSM 1900 (2G)	≤ 33 dBm e.i.r.p.
1922 - 2168 MHz	W-CDMA Band I (3G)	≤ 24 dBm e.i.r.p.
24.05 - 24.25 GHz	24 GHz ISM Radar	≤ 100 mW e.i.r.p.
24.25 - 26.65 GHz	24 GHz UWB Radar	≤ -41,3 dBm/MHz e.i.r.p. mean ≤ 0 dBm/50 MHz e.i.r.p. peak
76 - 77 GHz	77 GHz Radar	≤ 55 dBm e.i.r.p.

CE APPROVAL DETAILS

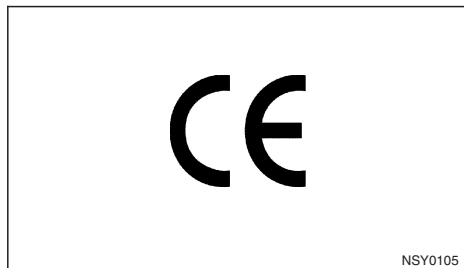

Description	Supplier	Supplier Address	CE Certificate #	Link to Certificate	Importer	Importer Address
Telematics Control Unit (TCU)	Continental	Continental Automotive Singapore Pte Ltd Continental Building 80 Boon Keng Road Singapore 339780	Refer to Link	https://www.continental-homologation.com/en-gl/Nissan	Nissan Automobile Europe (NAE)	Trappes, Paris
Telematics Control Unit (TCU) Model A-IVC-EU-01	Valeo	VALEO Telematik und Akustik GmbH Max-Planck-Straße 32, 61381 Friedrichsdorf, Germany	Refer to Link	https://www.valeo.com/declaration-of-conformity/		
Tyre Pressure Monitoring System (TPMS) Model TIS-09DL	Continental Automotive GmbH.	Siemensstrasse 12 D-93055 Regensburg Germany	Refer to Link	https://www.continental-homologation.com/en-gl/Nissan		
Front Radar Sensor Model FR5CPEC	Robert Bosch GmbH	Postfach 166 71226, Leonberg Germany	T.2021.04.0014	https://ita.bosch.com		
Side Radar Sensor Model RN5TR	Aptiv Services Deutschland GmbH	Am Technologiepark 1 D-42119 Wuppertal Germany	Refer to Link	https://www.aptiv.com/en/automotive-homologation		
AIVI Model AIVIP33A0	Robert Bosch GmbH	Robert Bosch GmbH Postfach 31132 Hildesheim Germany	Refer to Link	https://doc-ita.bosch.com/		
Intelligent Key system control unit Model HFM401	Continental Automotive GmbH	Continental Automotive GmbH Siemensstrasse 12 D-93055 Regensburg Germany	Refer to Link	https://www.continental-homologation.com/en-gl/Nissan		
Passive Entry System Model TXPZ1 (Hand Unit)	Continental Automotive GmbH	Continental Automotive GmbH Siemensstrasse 12 D-93055 Regensburg Germany	Refer to Link	https://www.continental-homologation.com/en-gl/Nissan		
Intelligent Key System (iKey)	Continental Automotive GmbH	Continental Automotive GmbH Siemensstrasse 12 D-93055 Regensburg Germany	Refer to Link	https://www.continental-homologation.com/en-gl/Nissan		

CE1J12

Description	Supplier	Supplier Address	CE Certificate #	Certificate	Importer	Importer Address
Body Control Module (BCM) Model 40406557	Continental Automotive GmbH	Continental Automotive GmbH Siemensstrasse 12 D-93055 Regensburg Germany	Refer to Link	https://continental-homologation.com/en-gl/Nissan	Nissan Automobile Europe (NAE)	Trappes, Paris
Audio Head Unit Model N18	Visteon corporation (China)	Yanfeng Visteon automotive electric Co.,Ltd. No.300,Minolta Road, Songjiang District, Shanghai 201600, P.R.China.	Refer to certificate	Simplified EU declaration of conformity Hereby Visteon Automotive Electronics Co., Ltd. declares that this system is in compliance with Directive 2014/53/EU.		
				Frequency band(s) in which the radio equipment operates: 2400–2483.5 MHz Maximum radio-frequency power transmitted in the frequency band(s) in which the radio equipment operates: Bluetooth <10 mW (EIRP)		

CE2J12

UKCA APPROVAL DETAILS



Description	Supplier	Supplier Address	UKCA Certificate #	Link to Certificate	Importer	Importer Address
Telematics Control Unit (TCU)	Continental	Continental Automotive Singapore Pte Ltd Continental Building 80 Boon Keng Road Singapore 339780	Refer to Link	https://www.continental-homologation.com/en-gl/Nissan	Nissan Motors Great Britain (NMGB)	Rivers Office Park Denham Way Rickmansworth WD3 9YS
Telematics Control Unit (TCU) Model A-IVC-EU-01	Valeo	VALEO Telematik und Akustik GmbH Max-Planck-Straße 32, 61381 Friedrichsdorf, Germany	Refer to Link	https://www.valeo.com/declaration-of-conformity/		
Tyre Pressure Monitoring System (TPMS) Model TIS-09DL	Continental Automotive GmbH.	Siemensstrasse 12 D-93055 Regensburg Germany	Refer to Link	https://www.continental-homologation.com/en-gl/Nissan		
Front Radar Sensor Model FR5CPEC	Robert Bosch GmbH	Postfach 166 71226, Leonberg Germany	10385	https://ita.bosch.com		
Side Radar Sensor Model RN5TR	Aptiv Services Deutschland GmbH	Am Technologiepark 1 D-42119 Wuppertal Germany	Refer to Link	https://www.aptiv.com/en/automotive-homologation		
AIVI Model AIVIP33A0	Robert Bosch GmbH	Robert Bosch GmbH Postfach 31132 Hildesheim Germany	Refer to Link	https://doc-ita.bosch.com/		
Intelligent Key system control unit Model HFM401	Continental Automotive GmbH	Continental Automotive GmbH Siemensstrasse 12 D-93055 Regensburg Germany	Refer to Link	https://www.continental-homologation.com/en-gl/Nissan		
Passive Entry System Model TXPZ1 (Hand Unit)	Continental Automotive GmbH	Continental Automotive GmbH Siemensstrasse 12 D-93055 Regensburg Germany	Refer to Link	https://www.continental-homologation.com/en-gl/Nissan		
Intelligent Key System (iKey)	Continental Automotive GmbH	Continental Automotive GmbH Siemensstrasse 12 D-93055 Regensburg Germany	Refer to Link	https://www.continental-homologation.com/en-gl/Nissan		

UKCA1J12

Description	Supplier	Supplier Address	UKCA Certificate #	Certificate	Importer	Importer Address
Body Control Module (BCM) Model 40406557	Continental Automotive GmbH	Continental Automotive GmbH Siemensstrasse 12 D-93055 Regensburg Germany	Refer to Link	https://continental-homologation.com/en-gl/Nissan	Nissan Motors Great Britain (NMGB)	Rivers Office Park Denham Way Rickmansworth WD3 9YS
Audio Head Unit Model N18	Visteon corporation (China)	Yanfeng Visteon automotive electric Co.,Ltd. No.300,Minolta Road, Songjiang District, shanghai 201600, P.R.China.	TUVS19-UK/17 SEP 2021/Rev A	Certification ID:TUVS19-UK/17 SEP 2021/Rev A		
				Satisfies all the technical regulations applicable to the product within the scope of UK Radio Equipment Regulations (SI 2017/1206); UK Electrical Equipment (Safety) Regulations (SI 2016/1101); and UK electromagnetic Compatibility Regulations (SI 2016/1091) and declare that the same application has not been lodged with any other UK Approved Body.		
				Bluetooth frequency band(s) in which the radio equipment operates: 2402-2480 MHz		
				Maximum radio-frequency power transmitted in the frequency band(s) in which the radio equipment operates: Bluetooth < 5.86 dBm(EIRP)		

UKCA2J12

NOTE

10 Regulatory information

Environmental information.....	490	Consumer and user safety information	
Environmental concern	490	(REACH).....	490
Compliance at every step	490	Protect the environment when driving	490
We build our vehicles with recycling in mind.....	490	AIRBAG LABEL (where fitted).....	492

ENVIRONMENTAL INFORMATION

ENVIRONMENTAL CONCERN



Today, the efforts made by NISSAN to fulfil our responsibilities to protect and sustain the environment are far-reaching. Within NISSAN, we promote the highest levels of practice in every region and in every area of operations.

COMPLIANCE AT EVERY STEP

NISSAN focuses on ensuring that end of life vehicle components are reused, recycled or recovered, and guarantees compliance with EU legislation (the End of Life Vehicle Directive).

WE BUILD OUR VEHICLES WITH RECYCLING IN MIND

Reducing landfill waste, emissions, conserving natural resources, and enhancing recycling activities are emphasised daily in our manufacturing, sales and service operations and in the disposal of end of life vehicles (ELV).

Design phase

To reduce environmental impact we have developed your NISSAN vehicle to be 95% recoverable. We mark the components to facilitate dismantling, recycling and to reduce hazardous substances. We carefully verify and control substances of concern. We have already reduced to a minimum the cadmium, mercury and lead in your NISSAN vehicle. NISSAN includes recycled material in your vehicle and looks for opportunities to increase the percentage of recycled materials used.

Manufacturing phase

NISSAN plants based in the UK already achieve a recycling rate of over 90% and are looking for further improvements. The UK plant installed 10 wind turbines to cut carbon dioxide emissions at power plants by more than 3,000 tonnes per year.

Production and distribution phase

Using resources efficiently to reduce the amount of waste generated during the production and distribution stage. NISSAN promotes activities based on Reducing, Reusing, and Recycling materials whenever possible. NISSAN's goal is to achieve a 100% recycling rate for operations in Japan and globally.

Use and service phase

NISSAN dealers are our window to you, our customer. In order to meet your expectations they provide not only high quality services but are also environmentally responsible. NISSAN promotes activities to recycle the waste generated as a result of service centre activities.

Disposal phase

Recycle your end of life vehicle or its components. When your NISSAN reaches the end of its life, and is no longer suitable for daily use, it still has value. You can help prevent waste affecting the environment by bringing your NISSAN to be recycled at our collection networks in your area. Our collection networks guarantee no cost for the treatment of your ELV. For further information on how and where to dispose of your ELV refer to your local NISSAN dealer or consult: www.nissan-europe.com.

CONSUMER AND USER SAFETY INFORMATION (REACH)

REACH is the chemical regulation in the EU, focusing on Registration, Evaluation, Authorisation and Restriction of Chemicals manufactured in or imported into the European Economic Area. Nissan complies with REACH obligations, and fully supports its underlying goals: to protect human health and reduce the environment from risks posed by chemicals. For more information, visit:

www.nissan-safetysheets.com

This website provides information on substances present in the Nissan product(s) that you buy, and recommendations for their safe use.

PROTECT THE ENVIRONMENT WHEN DRIVING

Your driving behaviour has significant impact on fuel economy and the environment. Follow the tips below for better fuel-efficiency, better driving habits, and to be environmentally friendly by reducing emissions:

Fuel efficient driving

Anticipating traffic conditions and acting accordingly reduces fuel consumption, helping to protect of our natural environment. Take your foot off the accelerator while approaching traffic lights and avoid last minute braking when the light turns red. Avoid speeding, harsh acceleration, and strong braking. The gain in time does not offset pollution of the environment. Try to maintain speed when driving uphill to reduce fuel consumption and pollution. Maintain speed or allow the vehicle to go slower where traffic allows.

Close windows when driving

Driving with a window open at 100 km/h (62 MPH) increases fuel consumption by up to 4%. Driving with the windows closed allows for better fuel economy.

Use the roof rack only when necessary

Only install the roof luggage system when you really need it, otherwise put it inside the vehicle or store it in your garage. Do not drive around with an empty roof rack, kayak holder, or ski rack, this will reduce your aerodynamic drag significantly.

Optimise the use of air conditioning

The air conditioning system has a positive effect on driving and vehicle safety through comfort cooling and dehumidifying, drivers are more alert and have better visibility when window demisting/defogging becomes necessary. However, use of the air conditioning system will increase fuel consumption substantially in an urban environment. Optimise the use of air conditioning by using the vents as much as possible.

Use the parking brake on slopes

Use the parking brake when holding your vehicle on a slope. Avoid using the accelerator to hold your vehicle as this leads to unnecessary fuel consumption and wear.

Maintain a safe distance

Anticipate traffic conditions for a smoother drive and to assure comfort and safety during your trip. Drive and maintain a safe distance from other vehicles while in traffic. This will help reduce fuel consumption as you will not be constantly tapping your brakes.

Check your tyre pressure

Low tyre pressure increases fuel consumption as well as the use of non-recommended tyres. Correct tyre pressure will maximise the grip of your vehicle and optimise fuel consumption.

Have your car serviced regularly

Regular service allows you to run your vehicle in optimal condition and with the best fuel efficiency. Have your vehicle serviced by your NISSAN dealer or a qualified workshop to ensure that it is maintained to its original standard.

AIRBAG LABEL (where fitted)



NEVER use a rearward facing child restraint on a seat protected by an ACTIVE AIRBAG in front of it, DEATH or SERIOUS INJURY to the CHILD can occur.

NE JAMAIS utiliser un dispositif de retenue pour enfant de type dos à la route sur un siège protégé par un AIRBAG ACTIVÉ placé devant lui. Cela peut entraîner la MORT de l'ENFANT ou des BLESSURES GRAVES.

Installieren Sie niemals ein entgegen der Fahrtrichtung angeordnetes Kinderrückhaltesystem auf einem Sitz mit aktiviertem Frontairbag. Es könnte zum Tod oder schweren Verletzungen des Kindes führen.

No instalar nunca los sistemas de retención para niños (sillitas de niño) de espaldas al sentido de la marcha en el asiento del pasajero protegido por un AIRBAG frontal ACTIVO. Esto puede provocar la MUERTE del niño o DAÑARLE SERIAMENTE.

«NON INSTALLARE MAI un seggiolino per bambini rivolto con verso opposto al senso di marcia su un sedile protetto da un AIRBAG frontale ATTIVO. In caso di incidente questo potrebbe risultare molto pericoloso per l'incolumità del bambino.»

Plaats nooit een kinderzitje achterstevoren op de passagiersstoel voorin als de airbags van de voorpassagier niet zijn uitgeschakeld. Dit kan ernstige of zelfs dodelijke verwondingen van het kind veroorzaken.

NUNCA utilize um sistema de retenção de criança virado para a traseira num banco protegido por um AIRBAG ACTIVO à sua frente, porque pode ocorrer MORTE ou FERIMENTOS GRAVES na CRIANÇA.

W żadnym przypadku NIE NALEŻY stosować fotelików dla dzieci skierowanych twarzą do tyłu przed siedzeniami chronionymi AKTYWNA PODUSZKA POWIETRZNA. Może to doprowadzić do POWAŻNYCH OBRAZEŃ lub nawet ŚMIERCI DZIECKA.

NIKDY nepoužívejte dětskou sedačku směřující dozadu na sedadle s AKTIVNÍM čelním AIRBAGEM, mohlo by dojít k USMRCENÍ nebo VÁŽNĚMU ZRANĚNÍ DÍTĚTE.

Önünde AKTİF BİR HAVA YASTIĞI ile korununan bir koltuğa hiç bir zaman yüzü geriye bakan bir çocuk koltuğu KOYMAYIN, bu ÇOCUĞUN ÖLÜMÜNE veya CİDDİ ŞEKİLDE YARALANMASINA neden olabilir.

Nu folosiți NICIODATĂ un scaun pentru copil cu spatele la direcția de deplasare pe un scaun protejat de un AIRBAG ACTIV amplasat în fața sa, deoarece există riscul de DECES sau RĂNIRE GRAVĂ a copilului.

SOHA ne használnjon hátrafelé néző gyermekülést olyan ülésen, amelyet előlről AKTÍV LÉGZSÁK véd, mert az a GYERMEK HALÁLÁT vagy SÜLYÖS SÉRÜLÉSÉT okozhatja.

“ΑΠΑΓΟΡΕΥΕΤΑΙ η τοποθέτηση παιδικού καθίσματος, με την πλάτη προς το εμπρόσθιο μέρος του αυτοκινήτου, στο κάθισμα του συνοδηγού, επειδή μπροστά του υπάρχει ΕΝΕΡΓΟΣ ΜΕΤΩΠΙΚΟΣ ΑΕΡΟΣΑΚΟΣ. Μπορεί να επέλθει, ΘΑΝΑΤΟΣ ή ΣΟΒΑΡΟΣ ΤΡΑΥΜΑΤΙΣΜΟΣ του ΠΑΙΔΙΟΥ”.

Använd ALDRIG en bakåtvänd barnstol på ett säte som skyddas av en AKTIVERAD AIRBAG framför det; LIVSFARA eller risk för ALLVARLIGA SKADOR.

ÄLÄ KOSKAAN käyttää kasvot taaksepäin suunnattua lastenistuinta istuimella, jossa on KÄYTÖSSÄ OLEVA TURVATYYNY. Seurauksena voi olla KUOLEMA tai LAPSEN VAKAVA LOUKKAANTUMINEN.

Brug ALDRIG et bagudvendt barnesæde på et sæde, der er beskyttet af en AKTIV AIRBAG foran det. Det kan resultere i DØD eller ALVORLIG PERSONSKADE på BARNET.



NEMOJTE upotrebljavati sjedalico za djecu okrenutu prema natrag na sjedalu ispred kojega se nalazi zaštićeni AKTIVNI ZRAČNI JASTUK, može doći do SMRTONOSNIH ili OZBILJNIH OZLJEDA za DIJETE.

NIKOLI ne namestite otroškega sedeža, obrnjenega v nasprotni smeri smeri vožnje, v primeru VKLOPLJENE varnostne blazine. To lahko povzroči OTROKOVO SMRT ali HUDE TELESNE POŠKODBE.

Никога не устанавливайте обращенное назад детское удерживающее сиденье на переднем пассажирском сиденье при неотключенной подушке безопасности. Это может привести к смерти ребенка или к тяжелым повреждениям.

NIKDY nepoužívajte detskú sedačku smerujúcu dozadu na sedadle s AKTÍVNYM čelným AIRBAGOM, mohlo by prísť k USMRTENIU alebo VÁŽNEMU ZRANENIU DIEŤAŤA.

ÄRGE kasutage seljaga sõidusuunas laste turvatooli istmel, mille ees on AKTIIVNE TURVAPADI. LAPS võib saada TÕSISE KEHAVIGASTUSE või HUKKUDA.

NEIEVIETOJIET ar skatu pretēji braukšanas virzienam vērstu bērnu sēdekļiti šajā sēdekļi, ja tā priekšā uzstādītais GAISA SPILVENS ir AKTIVIZĒTS, – tas BĒRNAM var radīt NOPIETNAS TRAUMAS vai pat izraisīt BĒRNA NĀVI.

NU NCA utilize uma cadeirinha protetora para crianças voltada para a traseira em um assento que seja protegido por um AIR BAG ATIVO na frente do assento. Podem ocorrer MORTE ou FERIMENTOS GRAVES para a CRIANÇA.

NIEKADA nevežkite vaiku prie automobīlio sēdynēs atvirkščiā judējimo kryptīāi prītvirtintoje specialioje kėdūtėje, jeigu ši sėdynė apsaugota VEIKIANČIA SAUGOS PAGALVE, nes VAIKUI kyla MIRTINAS ar SUNKAUS SUŽEIDIMO pavojus.

Ніколи не встановлюйте дитяче крісло спинкою вперед на сидінні, передня ПОДУШКА БЕЗПЕКИ якого не заблокована. Ризик ЗАГИБЕЛІ або ТЯЖКИХ ТРАВМ дитини.

„Никога на използвайте детско столче за автомобил, монтирано с гръб към движението, на седалка оборудвана с предпазна въздушна възглавница пред нея. Съществува риск за живота или сериозно нараняване на детето!“

يحذر نهائيًا تثبيت مقعد الطفل بشكل عكسي على القعد المحمي بوسادة هوائية نشطة أمام مقعد الطفل، فمن الممكن أن يتسبب ذلك في وفاة الطفل أو إصابته بجروح خطيرة

ALDREI má nota festingar sem snúa afturábak á sæti sem varið er með ACTIVE AIRBAG að framan. Það getur valdið DAUÐA eða ALVARLEGUM MEIÐSLUM á BARNINU.

Na sedež, ki je spredaj zaščiten z ZRAČNO BLAZINO, NIKOLI ne namestite otroškega sedeža tako, da otrok gleda nazaj; nevarnost SMRTI ali RESNE TELESNE POŠKODBE OTROKA

هرگز از کمربند کودک رو به پشت در روبروی صندلی حفاظت شده توسط ACTIVE AIRBAG (کیسه هوای فعال) استفاده نکنید. این کار ممکن است باعث مرگ یا جراحت شدید در کودک شود.

절대로 능동형 에어백이 전면에 설치된 좌석에 후향식 어린이 보호시트를 사용하지 마십시오. 어린이에게 심각한 상해를 입히거나 사망에 이르게 할 수 있습니다.

前部に作動可能なエアバッグが装着されているシートに、後ろ向きのチャイルドシートを絶対に使用しないでください。お子様に死や大けがを招く恐れがあります。

禁止在座椅前部安全气囊激活的情况下，在该座椅上使用后向儿童安全座椅，可能造成儿童严重受伤甚至死亡。

NOTE

11 Index

A

ABS (Anti-lock Braking System)	407
- Warning light	86
Accident	
- Emergency Response System	414
Aids	
- Blind Spot Warning (BSW)	257
- Chassis control	409
- Emergency Lane Assist system	289
- Hill Start Assist (HSA)	410
- Intelligent Around View Monitor (IAVM)	190
- Intelligent Blind Spot Intervention	257
- Intelligent Emergency Braking (IEB)	359
- Intelligent Forward Collision Warning (I-FCW)	354
- Intelligent Lane Intervention system	284, 349
- Intelligent Parking Assist (IPA)	371
- Lane Departure Warning (LDW)	279, 345
- Moving Object Detection (MOD)	199
- Overview	14
- Rear Cross Traffic Alert (RCTA) system	269
- Rear Ultrasonic Parking Sensor System	399
- Ultrasonic parking sensors	394, 398
Air bags	
- Repair and replacement	73
- Supplemental restraint System	63
Air cleaner filter	453
Air conditioner	
- Automatic	204
- Heater and air conditioner	203
- Servicing	207

- Specification label	473
Antenna	211
Anti-Theft System (NISSAN)	168
Approaching Vehicle Sound for Pedestrians (VSP) system	29
Approval numbers	474
Armrests	36
- Storage	140
Audible reminders	95
Audio	208
- Bluetooth® audio streaming	221
- FM AM radio	213
- FM AM radio with USB	212
- iPod® player operation	218
- NissanConnect	224
- Precautions	208
- Settings	213
- Steering-wheel switches	230
- USB Connection Port	217
Audio system	
- Precautions	226
Automatic brake hold	174

B

Battery	449
- Caution label	449
- Gauge	81
- Information	450
- Intelligent Key battery discharge	249
- Jump starting	426

- Key battery replacement	450
- Lithium ion (Li-ion) battery	19
- Saver system	248
- Warning light	87
Blind Spot Intervention	
- Driving situations	265
Blind Spot Warning (BSW)	257
- Driving situations	265
- Warning light	86
Bluetooth®	225
- Audio streaming	221
- Hands-Free Phone System	230
- Operation	219
- Phone settings	230
- Precautions	211
- Settings	219
- Texting	225
Bonnet	
- Release	170
Boot	144
Brakes	406, 447
- Adjustment	447
- Anti-lock Braking System (ABS)	407
- Automatic brake hold	174
- Checking	447
- Electric Parking Brake	173
- Fluid	448
- Intelligent Emergency Braking (IEB)	359
- Precautions	406
- Rear Automatic Braking (RAB)	274
- Regenerative brake	19
- Trailer	403
- Warning light	86
Brightness	
- Intelligent Around View Monitor (IAVM)	197

C

Capacities and recommendations	468
- Brake and clutch fluid	468
- Coolant	468
- Fuel	470
- Oil	468
- Refrigerant	468
Cargo compartment	
- Cargo floor	144
Changing	
- Engine coolant	442
- Engine oil	445
- Inverter coolant	444
- Tyres and wheels	464
Chassis control	409
- Intelligent Trace Control	409
Checking	
- Brake pedal	447
- Coolant level	442, 444
- Engine oil level	445
- Parking brake	447
Child restraints	47
- Anchorage	55
- ISOFIX	54
- ISOFIX installation	55
- Precautions	47
- Seat belt installation	58
Child safety	40, 46
Cleaning	
- Alloy wheels	433
- Automatic anti-dazzling inside mirror	435
- Chrome parts	433
- Exterior	432
- Glass	433, 435
- Interior	434

- Plastic parts	435
- Rear-view camera lens	433
- Removing spots	432
- Underbody	433
- Washing	432
- Waxing	432
- Wheels	433
Coat hooks	141
Cold weather	411
- Battery	411
- Corrosion protection	412
- Engine coolant	411
- Equipment	411
- Winter equipment	411
Console box	140
Coolant	
- Changing engine coolant	442
- Changing inverter coolant	444
- Checking coolant level	442, 444
- Cold weather	411
- Engine cooling system	442
- Inverter cooling system	443
Corrosion protection	435
- Environmental factors	435
Cruise control	295
- Operation	296, 300
- Precautions	296
Cup holders	141
- Bottle holder	141

D

Defogger	
- Switch	130

Dimensions	472
- Engine	471
Display	
- Head up display	125
- Rear-view Monitor	184
- Vehicle information	96
Doors	
- Child safety	163
- Locks	161
- Map pocket	141
- Power door lock switch	163
- Precautions	157
- Remote keyless entry system	154
Drive belt	452
Drive modes	24
Driving	250
- Care	246
- Cold weather	411
- Intelligent Emergency Braking (IEB)	359
- Intelligent Forward Collision Warning (I-FCW)	354
- Precautions	239
- Wet road	246
- Winter conditions	246
Driving Position Memory System	
- Memory storage	177
- System operation	177

E

e-Pedal Step	27
e-POWER system	18
- Before starting	239
- Precautions	20
eCall	414
Efficient use of your vehicle	23

Electric motors	18
Electric power steering	405
Electric shift control system	250
- Driving	250
Electronic Stability Programme (ESP) system	408
- Deactivation	409
Emergency	
- Response System	414
Emergency Lane Assist system	289
Emergency shut-off system	22
Emergency tyre puncture repair kit	465
- Location	423
Engine	
- Air cleaner filter	453
- Changing engine coolant	442
- Changing engine oil	445
- Checking coolant level	442
- Checking engine oil level	445
- Cooling system	442
- Data	471
- Engine overheat	428
- Oil	445
- Serial number	473
- Spark plugs	452
- Starting	250
- Three-way catalyst	245
- Turbocharger	246
EV mode	26
Exhaust gas (Carbon Monoxide)	240
Exterior	
- Cleaning	432
- Lights	459

F

Filter	
- Air cleaner	453
- Engine oil	445
Flat tyre	418
Floor	144
Floor mats	434
Fluids	
- Brake	448
- Gear	447
- Window washer	448
Fog lights	459
- Front – Location	460
- Front – Operation	134
- Rear – Location	460
- Rear – Operation	135
- Rear – Replacement	461
Frequency approval numbers	227,481
Fuel	
- Capacities	468
- Gauge	81
- Information	470
Fuses	455
- Engine compartment	458
- Extended storage	458
- Passenger compartment	455

G

Gasoline particulate filter	245
Gauges	
- Battery	81
- Fuel	81
- Meters and gauges	77

- Power gauge	80
- Speedometer	80
Gear	
- Fluid	447
Glass cleaning	433
Glass roof	148
- Sunshade operation	148
Glove box	140

H

Hands-Free Phone System	230
Hazard warning flasher switch	414
Head restraints	37
- Adjustment	38
- Installation	38
- Removal	38
Head up display	125
Headlights	
- Adaptive Driving Beam	133
- Aiming control	135
- Dynamic high beam assistant	132
- Operation	130
- Replacement (bulb)	459
- Switch	131
Heated seats	
- Operation	137
- Precautions	137
Heated steering wheel	
- Operation	136
- Precautions	136
Heated windscreen	129
Heater and air conditioner	203
- Automatic air conditioner	204
- Servicing	207

- Vents	202
Hill Start Assist (HSA)	410
- Indicator light	93
Horn	136

I

Immobiliser	
- NISSAN Anti-Theft System (NATS)	168
Indicator lights	84
Injured persons	41
Inside rear-view mirror	179
Intelligent Around View Monitor (IAVM)	190
Intelligent Blind Spot Intervention	257
- Warning light	86
Intelligent Cruise Control (ICC)	299
Intelligent Emergency Braking (IEB)	359
- Activation	362
- Operation	361
- Warning light	88, 362
Intelligent Key	156, 247
- Battery discharge	249
- Battery replacement	450
- Locking	155, 158
- Operating range	157
- Operation	157
- Operation failure	155
- Remote keyless entry system	154
- Starting	159
- Unlocking	155, 158
Intelligent Lane Intervention system	284, 349
Intelligent Parking Assist (IPA)	371
- Bay parking	375
- Deactivation	372
- Interruption	373

- Malfunction	377
- Operation	373
- Parallel parking	373
- Precautions	371
- Tips	377
Intelligent Trace Control	409
Interior	
- Lights – Information	459
- Lights – operation	149
Inverter	
- Changing inverter coolant	444
- Checking coolant level	444
- Cooling system	443
iPod®	
- Operation	218
ISOFIX	
- Anchor locations	54
- Child restraints	54
- Installation	55

J

Jump starting	426
---------------------	-----

K

Keys	152
- Battery replacement	450
- Emergency key	153
- Immobiliser	152
- Intelligent Key	156, 247
- Intelligent Key battery discharge	249
- Mechanical key	153
- NISSAN Anti-Theft System (NATS)	152
- Operating range (Intelligent Key)	157

- Operation (Intelligent Key)	157
- Operation failure	155
- Radio approval number and information	474
- Remote keyless entry system	154
- Troubleshooting	160

L

Lane Departure Warning (LDW)	279, 345
- Operation	280, 346
Legal requirements	47
Licences	229
Lights	
- Exterior	459
- Fog light switch	134
- Hazard warning flasher switch	414
- Headlight aiming	135
- Headlight and turn signal switch	130
- Headlight switch	131
- Headlights	459
- Indicator lights	84
- Interior	149, 459
- LED headlight	459
- Locations	460
- Replacement	461
- Turn signal switch	134
- Warning lights	84
Lithium ion (Li-ion) battery	19
Locks	
- Child safety	163
- Door	161
- Inside door handle	162
- Power door lock switch	163
- Steering	249
- Super Lock system	161

- Vehicle battery discharged	162
Luggage compartment	144

M

Maintenance	
- Camera unit	283, 288, 348, 353
- ELA	295
- General maintenance	438
- Precautions	440
- Requirements	438
- Seat belts	45
Map data	226
Meters and gauges	
- Battery	81
- Fuel	81
- Odometer/trip/twin trip odometer	80
- Power gauge	80
- Speedometer	80
Mirrors	
- Adjustment (Power)	180
- Automatic anti-dazzling	180
- Folding	180
- Rear-view (Inside)	179
- Rear-view (Outside)	180
- Vanity mirror	181
Mobile phone integration for FM AM radio with CD player	230
Moving Object Detection (MOD)	199

N

NISSAN Anti-Theft System (NATS)	
- NATS key	152
- Radio approval number and information	474

O

Odometer/trip/twin trip odometer	80
Oil	
- Capacities and recommendations	468
- Changing engine oil	445
- Checking engine oil level	445
- Disposal	447
- Engine oil	445
- SAE viscosity number	470
- Warning light	88
Overheat	
- Engine overheat	428

P

Parcel shelf	143
- Installation	143
- Removal	143
Parking	370
- Brake	173
- Intelligent Around View Monitor (IAVM)	190
- Rear Ultrasonic Parking Sensor System	399
- Ultrasonic parking sensors	394
Petrol	
- Engine oil	470
- Gauge	81
- Information	470
Phone	
- Bluetooth®	225
- Bluetooth® Hands-Free	230
- Hands-Free Phone System	225
- Mobile phone integration	230
- Texting	225

Power	
- Door lock switch	163
- Electric power steering	405
- Outlet	137
- Switch	247
- Switch – positions	248
- Windows	146
Power gauge	80
Precautions	
- Audio	208
- Brakes	406
- Child restraints	47
- Cruise control	296
- Door locks	157
- e-POWER system	20
- Exhaust gas	240
- Intelligent Emergency Braking (IEB)	359
- Intelligent Forward Collision Warning (I-FCW)	354
- Intelligent Parking Assist (IPA)	371
- Maintenance	440
- Predictive guide lines	185
- Push-button power switch	247
- Safety	184
- Seat belts	39
- Starting and driving	239
- Supplemental Restraint System	63
- Towing	429
- Trailer	403
Pregnant women	41
ProPILOT Assist	315
- Operation	316
ProPILOT Park	377
Protection	
- Corrosion	412
- Environment	447
Push starting	427

Push-button power	247
-------------------	-----

R

Radio	
- Approval number and information	474
- FM AM radio	213
- FM AM radio with USB	212
- NissanConnect	224
Radio transmitter	474
Rear Automatic Braking (RAB)	274
Rear Cross Traffic Alert (RCTA)	
- Operation	270
Rear Cross Traffic Alert (RCTA) system	269
Rear seats	
- Folding	35
Rear-view Monitor	184
- Settings	188
Rear-view Monitor	
- Guide lines	185
Regenerative brake	19
Remote keyless entry system	154
- Operation	155
Repairing	
- Flat tyre	423
- Headlights	459
Replacement	
- Air bags	73
- Air cleaner filter	453
- Engine coolant	442
- Engine oil	445
- Engine oil filter	445
- Inverter coolant	444
- Spark plugs	452
- Wiper blades	454

Road accident cautions	22
Roof	
- Glass	148
- Sunshade operation	148
Roof rail	142

S

SAE viscosity number	470
Safety	
- Chains (Trailer)	403
- Child safety rear door locks	163
- Children	40, 46
- Head restraints	37
- Injured persons	41
- Precautions	184
- Pregnant women	41
- Road Accident Emergency Response System	414
Safety information	224
Seat belts	39, 43
- Adjustment	44
- Child restraint installation	58
- Child safety	40, 46
- Children - Infants	47
- Children - Larger	47
- Cleaning	435
- Legal requirements	47
- Maintenance	45
- Precautions	39
- Rear centre position	45
- Reminder	41
- Warning light	84, 90
- Warnings	41
Seats	32
- Adjustment (Manual)	33

- Adjustment (Power)	34
- Head restraints	37
- Heating	137
- ISOFIX child restraints	49
- Rear	35
Security system	
- Alarm system	168
- Interior movement sensors	169
- NISSAN Anti-Theft System (NATS)	152, 168
Servicing	
- Air conditioner	207
Settings	
- Intelligent Around View Monitor (IAVM)	190
- Moving Object Detection (MOD)	199
Shift control system	250
Shifting	
- Electric shift control system	250
Snow chains	463
SOS Switch	414
Spare tyre	417
Spark plugs	452
Speed limiter	297, 342
- Operation	298, 343
Speedometer	80
Starting	
- Before starting	239
- e-POWER system	250
- Jump starting	426
- Precautions	239
- Push starting	427
Steering wheel	
- Adjustment	179
- Electric power steering	405
- Heating	136
- Lock	249
- Switches – Audio control	230

- Switches – Hands-free telephone control	230
- Warning light	87
Storage	140
- Boot	144
- Bottle holder	141
- Coat hooks	141
- Console box	140
- Cup holders	141
- Glove box	140
- Luggage hooks	145
- Map pocket	141
- Roof rail	142
- Seat pocket	142
- Trays	140
Sun visors	179
Sunshade	
- Operation	148
Super Lock system	161
- Emergency release	161
Supplemental Restraint System	63
Switches	
- Automatic brake hold	174
- Defogger	130
- e-Pedal Step	27
- eCall	414
- Electric Parking Brake	173
- EV mode	26
- Fog light	134
- Front passenger air bag	69
- Hazard warning	414
- Headlight aiming	135
- Headlight and turn signal	130
- Power door lock	163
- Push-button power	247
- SOS	414
- Steering-wheel – Audio	230

- Steering-wheel – Phone	231
- ThermoClear	129
- Wiper and washer	127

T

Texting	225
ThermoClear Heated Windscreen	
- Operation	129
Three-way catalyst	
- Care	245
- Information	245
Tilting steering wheel	179
Tools	418
Towing	
- Eye	430
- Precautions	429
- Tow bar installation	404
- Tow truck towing	429
- Towing e-POWER models	429
- Trailer	403
Trademarks	229
Traffic sign recognition (TSR)	254
Trailer	
- Brakes	403
- Precautions	403
- Tow bar Installation	404
- Towing	403
Transferring registration to another country	472
Travelling	472
Troubleshooting	
- Keys	160
TSR	254
Turbocharger	246

Turn signal	
- Operation	134
Tyre Pressure Monitoring System (TPMS)	240
- Meter information	243
- Settings	244
Tyres	
- Age	464
- Changing tyres and wheels	464
- Emergency tyre puncture repair kit	423, 465
- Equipment	411
- Flat tyre	418
- Inflation pressure	462
- Placard	473
- Repairing flat tyre	423
- Rotation	464
- Sizes	471
- Snow chains	463
- Spare	417
- Spare tyre	465
- Temporary-use spare tyre	417
- Trailer tyre pressure	403
- Types	463
- Tyre Pressure Monitoring System (TPMS)	421
- Wear and damage	464
- Wheels and tyres	462

U

USB (Universal Serial Bus)	
- Connection Port	217
- Operation	217
- Precautions	208

V

Vehicle identification	472
- Air conditioner label	473
- Engine serial number	473
- Label	472
- Number (VIN) (chassis number)	473
- Tyre placard	473
Vehicle information display	96
Vehicle security	168, 405
- Alarm system	168
- Interior movement sensors	169
Vents	202

W

Warning labels	
- Air bag	66
Warning lights	
- Air bag - Passenger	67
Warning/indicator lights and audible reminders	84
Washing	432
Waxing	432
Wheels	
- Balance	465
- Blocking	418
- Care	433
- Changing tyres and wheels	464
- Cover	419
- Installation	420
- Removal	419
- Sizes	471
- Stowing	421
- Tools and spare wheel	418
- Wheels and tyres	462

Windows	146
- Automatic function	146
- Locking	146
- Power	146
Wipers	127
- Blade replacement	454
- Operation (Rear window)	128
- Operation (Windscreen)	127
- Rain-sensing auto wiper	128
- Reverse synchronisation	129
- Washer nozzle	454
- Window washer cleaner fluid	448

QUICK REFERENCE

- In case of emergency ... 6-414
(Flat tyre, engine will not start, overheating, towing)
- How to start the e-POWER system ... 5-250
- How to read the meters and gauges ... 2-77
- Maintenance and do-it-yourself ... 8-438
- Technical information ... 9-438

SECURITY INFORMATION

As owner of this vehicle important codes have been supplied to you that may be required by your NISSAN dealer to duplicate keys or repair the radio.

Please fill in the allocated areas or attach sticker(s) if available. Remove this page and keep it in a safe place, **not in the vehicle**.

When selling your vehicle, we kindly request you to hand over this page to the buyer.

SECURITY INFORMATION

Radio security code
(where fitted)

--	--	--	--

Key number

--	--	--	--	--

Wheel lock key code
(where fitted)

--	--	--	--	--	--	--	--

Remove this page from the manual and keep it in a safe place, **not in the vehicle**.

When selling your vehicle, we kindly request you to hand over this page to the buyer.

