

[Content](#)

[A-Z](#)



# OWNER'S MANUAL.

## BMW X3.







# WELCOME TO BMW.

## Owner's Manual.

Thank you for choosing a BMW.

The more familiar you are with your vehicle, the better control you will have on the road. We therefore strongly suggest the following:

Read this Owner's Manual before starting off in your new BMW. Also use the Integrated Owner's Manual in your vehicle. It contains important notes on vehicle operation that will help you make full use of the technical features available in your BMW. The manual also contains information designed to enhance operating reliability and traffic safety, and to contribute to maintaining the value of your BMW.

At the time of production at the plant, the printed Owner's Manual is the most current resource. After a vehicle software update – such as a Remote Software Upgrade – the Integrated Owner's Manual for the vehicle will contain the latest information.

You can find supplementary information in the additional brochures in the onboard literature.

We wish you a safe and enjoyable ride.

# TABLE OF CONTENTS

After a vehicle software update – such as a Remote Software Upgrade – the Integrated Owner's Manual for the vehicle will contain the latest information.

## ! NOTES

Information .....	6
-------------------	---

## 🔧 QUICK REFERENCE

Getting in .....	16
Set-up and use .....	20
On the road .....	24

## 👉 CONTROLS

Dashboard .....	30
Sensors of the vehicle .....	35
Operating condition of the vehicle .....	39
iDrive .....	42
BMW Remote Software Upgrade .....	57
General settings .....	61
Personal settings .....	66
Connections .....	72
Opening and closing .....	81
Seats, mirrors and steering wheel .....	114
Transporting children safely .....	128
Driving .....	134
Displays .....	153
Lights .....	175
Safety .....	182
Driving stability control systems .....	213
Driver assistance systems .....	219
Driving comfort .....	271
Climate control .....	273

Interior equipment .....	289
Storage compartments .....	297
Cargo area .....	301

## DRIVING TIPS

Things to remember when driving .....	310
Trailer towing .....	315
Saving fuel .....	320

## MOBILITY

Refueling .....	326
Wheels and tires .....	328
Engine compartment .....	360
Operating materials .....	363
Maintenance .....	370
Replacing components .....	372
Breakdown Assistance .....	377
Vehicle Care .....	384

## REFERENCE

Technical data .....	390
Appendix .....	393
Everything from A to Z .....	394

---

© 2022 Bayerische Motoren Werke

Aktiengesellschaft

Munich, Germany

Reprinting, including excerpts, only with the written consent of BMW AG, Munich.

US English ID7 VI/22, -

Printed on environmentally friendly paper, bleached without chlorine, suitable for recycling.

# Information

## Using this Owner's Manual

### Orientation

The fastest way to find information on a particular topic is by using the index.

For an overview of the vehicle, we recommend reading the quick reference guide in the owner's manual.

### Validity of the Owner's Manual

#### Production of the vehicle

At the time of production at the plant, the printed Owner's Manual is the most current resource. Due to updates after the editorial deadline, differences may exist between the printed Owner's Manual and the Integrated Owner's Manual in the vehicle.

Notes on updates can be found in the appendix of the printed Owner's Manual for the vehicle.

#### After a software update in the vehicle

After a vehicle software update, such as via Remote Software Upgrade, the Integrated Owner's Manual for the vehicle will contain the latest information.

### Owner's Manual for Navigation, Entertainment, Communication

The Owner's Manual for Navigation, Entertainment, and Communication can be obtained as a printed book from the service center.

The topics are also discussed in the Integrated Owner's Manual in the vehicle.

## Media at a glance

### General information

The contents of the Owner's Manual are available in various media formats. The following Owner's Manual media formats are available:

- ▶ Printed Owner's Manual.
- ▶ Integrated Owner's Manual in the vehicle.

### Printed Owner's Manual

The printed Owner's Manual describes all standard, country-specific, and optional equipment offered with the series.

### Integrated Owner's Manual in the vehicle

#### Principle

The Integrated Owner's Manual specifically describes features and functions found in the vehicle.

The Integrated Owner's Manual can be displayed on the Control Display.

### Selecting the Owner's Manual

1.  Press the button.
2. "CAR"
3. "Owner's Manual"
4. Select the desired method of accessing the contents.

### Scrolling through the Owner's Manual

Turn the Controller, until the next or previous contents are displayed.

## Context help

### General information

The Integrated Owner's Manual can be accessed from any menu. Depending on the selected function, either the associated description or the main menu of the Integrated Owner's Manual will be displayed.

### Opening via iDrive

Change directly to the Options menu from the function on the Control Display:

-  Press the button.
- "Help"

### Opening when a Check Control message is displayed

Directly from the Check Control message on the control display:

 "Owner's Manual"

## Supplementary Owner's Manuals

Also follow the Supplementary Owner's Manuals, which are included in addition to the on-board literature.

## Additional sources of information

### Service center

An authorized service center will be glad to answer questions at any time.

### Internet

Vehicle information and general information on BMW, such as on technology, are available on the Internet: [www.bmwusa.com](http://www.bmwusa.com).

## BMW Driver's Guide app



The BMW Driver's Guide app specifically describes features and functions found in the vehicle. The app can be displayed on smartphones and tablets.

## BMW Driver's Guide Web

The BMW Driver's Guide Web shows the most suitable information for the selected vehicle. If possible, only equipment and functions that are actually installed in the vehicle will be explained. The BMW Driver's Guide Web can be displayed in any current browser.

## Icons and displays

### Icons in the Owner's Manual

Icon	Meaning
	Precautions that must be followed in order to avoid the possibility of injury to yourself and to others as well as serious damage to the vehicle.
	Measures that can be taken to help protect the environment.
"..."	Texts in vehicle used to select individual functions.
>...<	Verbal instructions to use with the voice activation system.
>>...<<	Responses generated by the voice activation system.

### Action steps

Action steps to be carried out are presented as a numbered list. These steps must be carried out in the order shown.

- First action step.
- Second action step.

## Bulletpoint lists

Items or actions without strict order or alternative options are shown as a bulletpoint list.

- ▷ First possibility.
- ▷ Second possibility.

## Icons on vehicle parts

 This symbol on a vehicle component indicates that further information on the component is available in the Owner's Manual.

## Vehicle features and options

This Owner's Manual describes all models and all standard, country-specific and optional equipment that is offered in the model series. That is why this Owner's Manual also describes and illustrates features and functions that are not available in a vehicle, for instance, because of the selected optional equipment or the national-market version.

This also applies to safety-related functions and systems.

When using these functions and systems, the applicable laws and regulations must be observed.

For any options and equipment not described in this Owner's Manual, refer to the Supplementary Owner's Manuals.

Your BMW service center is happy to answer any questions that you may have about the features and options applicable to your vehicle.

## Status of the Owner's Manual

### Basic information

The manufacturer of your vehicle pursues a policy of constant development to ensure that our vehicles continue to embody the highest quality and safety standards. In rare cases,

therefore, the features described in this Owner's Manual may deviate from those in your vehicle.

## Validity of the Owner's Manual

### Production of the vehicle

At the time of production at the plant, the printed Owner's Manual is the most current resource. Due to updates after the editorial deadline, differences may exist between the printed Owner's Manual and the Integrated Owner's Manual in the vehicle.

Notes on updates can be found in the appendix of the printed Owner's Manual for the vehicle.

### After a software update in the vehicle

After a vehicle software update, such as via Remote Software Upgrade, the Integrated Owner's Manual for the vehicle will contain the latest information.

## For Your Own Safety

### Intended use

Heed the following when using the vehicle:

- ▷ Owner's Manual.
- ▷ Information on the vehicle. Do not remove stickers.
- ▷ Technical vehicle data.
- ▷ The traffic, speed, and safety laws where the vehicle is driven.
- ▷ Vehicle documents and statutory documents.

### Warranty

Your vehicle is technically configured for the operating conditions and registration requirements applicable in the country of first delivery, also known as homologation. If your vehicle is to be operated in a different country it might



be necessary to adapt your vehicle to potentially differing operating conditions and registration requirements. Noncompliance with homologation requirements in a certain country may affect warranty coverage. Please consult the New Vehicle Limited Warranty Booklet for further information on warranty matters.

## Maintenance and repairs

Advanced technology, for instance the use of modern materials and high-performance electronics, requires suitable maintenance and repair work.

The manufacturer of the vehicle recommends that you entrust corresponding procedures to a BMW center. If you choose to use another service facility, BMW recommends use of a facility that performs work, e.g., maintenance and repair, according to BMW specifications with properly trained personnel, referred to in the Owner's Manual as "another qualified service center or repair shop".

If work is performed improperly, for instance maintenance and repair, there is a risk of subsequent damage and related safety risks.

Improperly performed work on the vehicle paintwork can lead to a failure or fault of components, e.g., the radar sensors, and thereby result in a safety hazard.

## Parts and accessories

BMW recommends the use of parts and accessories products approved by BMW.

Approved parts and accessories and advice on their use and installation are available from a BMW center.

BMW parts and accessories have been tested by BMW for their safety and suitability in BMW vehicles.

BMW warrants genuine BMW parts and accessories.

BMW does not evaluate whether each individual product from another manufacturer can be used with BMW vehicles without presenting a

safety hazard, even if a country-specific official approval was issued. BMW does not evaluate whether these products are suitable for BMW vehicles under all usage conditions.

## California Proposition 65 Warning

For vehicles sold in California, the law requires vehicle manufacturers to provide the following warning:

### **Warning**

Engine exhaust and a wide variety of Automobile components and parts, including components found in the interior furnishings in a vehicle, contain or emit chemicals known to the State of California to cause cancer and birth defects and reproductive harm. In addition, certain fluids contained in vehicles and certain products of component wear contain or emit chemicals known to the State of California to cause cancer and birth defects or other reproductive harm. Battery posts, terminals and related accessories contain lead and lead compounds. Batteries also contain other chemicals known to the State of California to cause cancer. Wash your hands after handling. Used engine oil contains chemicals that have caused cancer in laboratory animals. Always protect your skin by washing thoroughly with soap and water. For more information go to [www.P65Warnings.ca.gov/passenger-vehicle](http://www.P65Warnings.ca.gov/passenger-vehicle).

### **Warning**

Operating, servicing and maintaining a passenger vehicle or off-highway motor vehicle can expose you to chemicals including engine exhaust, carbon monoxide, phthalates, and lead, which are known to the State of California to cause cancer and birth defects or other reproductive harm. To minimize exposure, avoid breathing exhaust, do not idle the engine except as necessary, service your

vehicle in a well-ventilated area and wear gloves or wash your hands frequently when servicing your vehicle. For more information go to [www.P65Warnings.ca.gov/passenger-vehicle](http://www.P65Warnings.ca.gov/passenger-vehicle).

## Service and warranty

We recommend that you read this publication thoroughly. Your vehicle is covered by the following warranties:

- ▶ New Vehicle Limited Warranty.
- ▶ Rust Perforation Limited Warranty.
- ▶ Federal Emissions System Defect Warranty.
- ▶ Federal Emissions Performance Warranty.
- ▶ California Emission Control System Limited Warranty.

Detailed information about these warranties is listed in the New Vehicle Limited Warranty Booklet.

Your vehicle has been specifically adapted and designed to meet the particular operating conditions and homologation requirements in your country and continental region in order to deliver the full driving pleasure while the vehicle is operated under those conditions. If you wish to operate your vehicle in another country or region, you may be required to adapt your vehicle to meet different prevailing operating conditions and homologation requirements. You should also be aware of any applicable warranty limitations or exclusions for such country or region. In such case, please contact Customer Relations for further information.

## Maintenance

Maintain the vehicle regularly to sustain the road safety, operational reliability and the New Vehicle Limited Warranty.

Specifications for maintenance measures:

- ▶ BMW maintenance system.

Maintenance, refer to page [370](#).

- ▶ Maintenance Booklet, available online and accessible via a QR code in the New Vehicle Limited Warranty Booklet.
- ▶ Warranty and Service Guide Booklet for Canadian models.

If the vehicle is not maintained or is improperly maintained, this could result in serious damage to the vehicle.

A failure to maintain your vehicle or improper maintenance may affect your warranty coverage. Please consult the New Vehicle Limited Warranty Booklet for further information on warranty matters.

Refer to section on engine oil change regarding recommended service intervals for oil changes.

## Data memory

### General information

Electronic control devices are installed in the vehicle. Electronic control units process data they receive from vehicle sensors, self-generate or exchange with each other. Some control units are necessary for the vehicle to function safely or provide assistance during driving, for instance driver assistance systems. Furthermore, control units facilitate comfort or infotainment functions.

Information about stored or exchanged data can be requested from the manufacturer of the vehicle, in a separate booklet, for example.

### Personal reference

Each vehicle is marked with a unique vehicle identification number. Depending on the country, the vehicle owner can be identified with the vehicle identification number, license plate and corresponding authorities. In addition, there are other options to track data collected in the vehicle to the driver or vehicle owner, such as via the ConnectedDrive account that is used.

## Operating data in the vehicle

Control units process data to operate the vehicle.

For example, this includes:

- ▶ Status messages for the vehicle and its individual components, e.g., wheel RPM, wheel speed, deceleration, lateral acceleration, engaged seat belt indicator.
- ▶ Ambient conditions, e.g., temperature, rain sensor signals.

The processed data is only processed in the vehicle itself and is generally volatile. The data is not stored beyond the operating period.

Electronic components, e.g. control units and vehicle keys, contain components for storing technical information. Information about the vehicle condition, component usage, maintenance recommendations, events or faults can be stored temporarily or permanently.

This information generally documents the state of a component, a module, a system, or the surrounding area, for instance:

- ▶ Operating states of system components, such as fill levels, tire pressure, battery status.
- ▶ Malfunctions and faults in important system components, for instance lights and brakes.
- ▶ Responses by the vehicle to special driving situations such as airbag deployment or engagement of the driving stability control systems.
- ▶ Information on vehicle-damaging events.

The data is required to perform the control unit functions. Furthermore, it also serves to detect and correct malfunctions, and helps the vehicle manufacturer to optimize vehicle functions.

The majority of this data is stored temporarily and is only processed within the vehicle itself. In some circumstances the vehicle may store some data for an additional but limited period of time.

When servicing, for instance during repairs, service processes, warranty cases, and quality assurance measures, this technical information can be read out from the vehicle together with the vehicle identification number.

An authorized service center or another qualified service center or repair shop can read out the information. The diagnostic socket required by law in the vehicle is used to read out data.

The data is collected, processed, and used by the relevant organizations in the service network. The data documents technical conditions of the vehicle, which can be used to determine vehicle maintenance status, and facilitate quality improvement.

Fault and event memories in the vehicle can be reset when an authorized service center or another qualified service center or repair shop performs repair or servicing work.

## Data entry and data transfer into the vehicle

### General information

Depending on the vehicle equipment, comfort and individual settings can be stored in the vehicle and modified or reset at any time.

For example, this includes:

- ▶ Settings for the seat and steering wheel positions.
- ▶ Chassis and climate control settings.

If necessary, data can be transferred to the entertainment and communication system of the vehicle, for instance via smartphone.

This includes the following depending on the respective equipment:

- ▶ Multimedia data such as music, films or photos for playback in an integrated multimedia system.
- ▶ Address book data for use in conjunction with an integrated hands-free system or an integrated navigation system.

- ▶ Entered navigation destinations.
- ▶ Data on the use of Internet services.

This data can be stored locally in the vehicle or is found on a device that has been connected to the vehicle, e.g., a smartphone, USB stick or MP3 player. If this data is stored in the vehicle, it can be deleted at any time.

This data is only transmitted to third parties upon personal request as part of the use of online services. The transmission depends on the selected settings for the use of the services.

## Incorporation of mobile devices

Depending on the vehicle equipment, mobile devices connected to the vehicle, for instance smartphones, can be controlled via the vehicle control elements.

The sound and picture from the mobile devices can be played back and displayed through the multimedia system. Certain information is transferred to the mobile devices at the same time. Depending on the type of incorporation, this includes, for instance, position data and other general vehicle information. This optimizes the way in which selected apps, for instance navigation or music playback, work.

There is no further interaction between the mobile device and the vehicle, such as active access to vehicle data.

How the data will be processed further is determined by the provider of the particular app being used. The extent of the possible settings depends on the respective app and the operating system of the mobile device.

## Services

### General information

If the vehicle has a wireless network connection, it will enable data to be exchanged between the vehicle and other systems. The wireless network connection is realized via an in-vehicle transmitter and receiver unit or via personal mobile devices brought into the ve-

hicle, for instance smartphones. This wireless network connection enables 'online functions' to be used. These include online services and apps supplied by the vehicle manufacturer or by other providers.

### Services from the vehicle manufacturer

Where online services from the vehicle manufacturer are concerned, the corresponding functions are described in the appropriate place, for instance the Owner's Manual or manufacturer's web page. The relevant legal information pertaining to data protection may also be found on the manufacturer's website. Personal data may be used to perform online services. Data is exchanged over a secure connection, for instance with the IT systems of the vehicle manufacturer intended for this purpose.

Any collection, processing, and use of personal data above and beyond that needed to provide the services must always be based on a legal permission, contractual arrangement or consent. It is also possible to activate or deactivate the data connection as a whole. This excludes functions and services required by law such as Assist systems.

### Services from other providers

When using online services from other providers, these services are the responsibility of the relevant provider and subject to their data privacy conditions and terms of use. The vehicle manufacturer has no influence on the content exchanged during this process. Information on the way in which personal data is collected and used in relation to services from third parties, the scope of such data, and its purpose, can be obtained from the relevant service provider.

## Event Data Recorder (EDR)

This vehicle is equipped with an event data recorder (EDR). The main purpose of an EDR is to record, in certain crash or near crash-

like situations, such as an air bag deployment or hitting a road obstacle, data that will assist in understanding how a vehicle's systems performed. The EDR is designed to record data related to vehicle dynamics and safety systems for a short period of time, typically 30 seconds or less.

The EDR in this vehicle is designed to record such data as:

- ▶ How various systems in your vehicle were operating.
- ▶ Whether or not the driver and passenger seat belts were fastened.
- ▶ How far, if at all, the driver was depressing the accelerator and/or brake pedal.
- ▶ How fast the vehicle was traveling.

This data can help provide a better understanding of the circumstances in which crashes and injuries occur.

EDR data is recorded by your vehicle only if a nontrivial crash situation occurs; no data is recorded by the EDR under normal driving conditions and no personal data, for instance name, gender, age, and crash location, are recorded.

However, other parties, such as law enforcement, could combine the EDR data with the type of personally identifying data routinely acquired during a crash investigation.

To read data recorded by an EDR, special equipment is required, and access to the vehicle or the EDR is needed. In addition to the vehicle manufacturer, other parties, such as law enforcement, that have the special equipment, can read the information if they have access to the vehicle or the EDR.

## Vehicle identification number

### General information

Depending on the national-market equipment, the vehicle identification number is located in

different positions in the vehicle. This chapter describes all possible positions for the series.

### Engine compartment



The engraved vehicle identification number can be found in the engine compartment, on the right-hand side of the vehicle.

### Right nameplate



The vehicle identification number can be found on the nameplate, on the right-hand side of the vehicle.

## Left nameplate



The vehicle identification number can be found on the nameplate, on the left-hand side of the vehicle.

## Windshield



The vehicle identification number can also be found behind the windshield.

## iDrive

It is also possible to display the vehicle identification number via iDrive.

Additional information:

Displaying the vehicle identification number and software part number, refer to page 73.

## Reporting safety defects

### For US customers

The following only applies to vehicles owned and operated in the US.

If you believe that your vehicle has a defect which could cause a crash or could cause injury or death, you should immediately inform the National Highway Traffic Safety Administration (NHTSA), in addition to notifying BMW of North America, LLC, P.O. Box 1227, Westwood, New Jersey 07675-1227, Telephone 1-800-831-1117.

If NHTSA receives similar complaints, it may open an investigation, and if it finds that a safety defect exists in a group of vehicles, it may order a recall and remedy campaign.

However, NHTSA cannot become involved in individual problems between you, your dealer, or BMW of North America, LLC.

To contact NHTSA, you may call the Vehicle Safety Hotline toll-free at 1-888-327-4236 (TTY: 1-800-424-9153); go to <http://www.safercar.gov>; or write to: Administrator, NHTSA, 1200 New Jersey Avenue, SE., Washington, DC 20590. You can also obtain other information about motor vehicle safety from <http://www.safercar.gov>.

### For Canadian customers

Canadian customers who wish to report a safety-related defect to Transport Canada, Defect Investigations and Recalls, may call the toll-free hotline 1-800-333-0510. You can also obtain other information about motor vehicle safety from <http://www.tc.gc.ca/roadsafety>.



# Getting in

## Opening and closing

### Buttons on the vehicle key

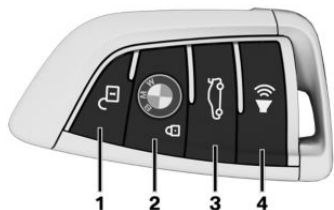

- 1 Unlocking
- 2 Locking
- 3 To open the tailgate
- 4 Panic mode, pathway lighting

### Unlocking the vehicle

 Press the button on the vehicle key.

Depending on the settings, either only the driver's door or all vehicle access points are unlocked.

If only the driver's door is unlocked, press the button on the vehicle key again to unlock the other vehicle access points.

 Press and hold the button on the vehicle key after unlocking.

The windows and the glass sunroof are opened, as long as the button on the vehicle key is pressed.

### Locking the vehicle

1. Close the driver's door.
2.  Press the button on the vehicle key.  
All vehicle access points are locked.

## Buttons for the central locking system

### Overview



Buttons for the central locking system.

### Locking

 Press the button with the front doors closed.

The fuel filler flap remains unlocked.

### Unlocking

 Press the button.

### Panic mode

You can trigger the alarm system if you find yourself in a dangerous situation.

 ▶ Press the button on the vehicle key and hold for at least 3 seconds.

▶ Briefly press the button on the vehicle key three times in succession.

To switch off the alarm: press any button.



## Comfort Access

### Principle

The vehicle can be accessed without operating the vehicle key.

Carrying the vehicle key with you, e.g., in your pants pocket, is sufficient.

The vehicle automatically detects the vehicle key when it is in close proximity or in the interior.

### Unlocking the vehicle

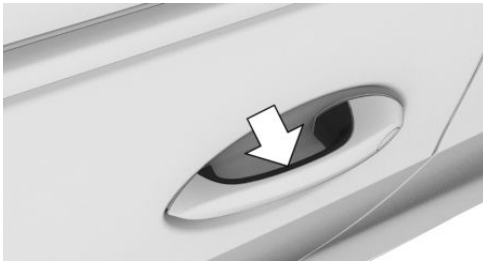

Grasp the handle of a vehicle door completely.

### Locking the vehicle

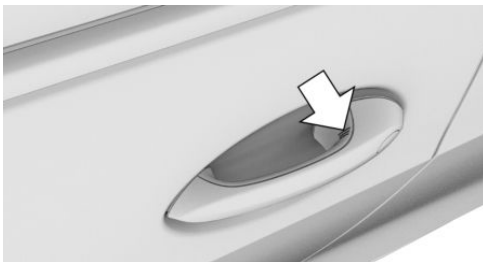

Touch the grooved surface on the handle of a closed vehicle door with your finger for approx. 1 second without grasping the door handle.

## Contactless trunk opening and closing

### Principle

The trunk can be opened and closed contactless using the vehicle key you are carrying.

### Performing the foot movement

1. Stand in the middle behind the vehicle at approx. one arm's length away from the rear of the vehicle.
2. Wave a foot under the vehicle in the driving direction and immediately pull it back. With this movement, the leg must pass through the ranges of both sensors.

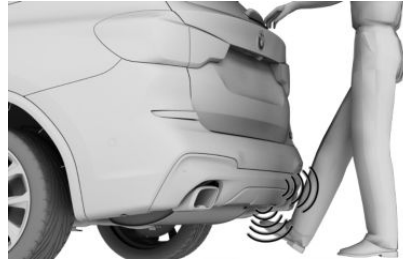

## Tailgate

### Opening

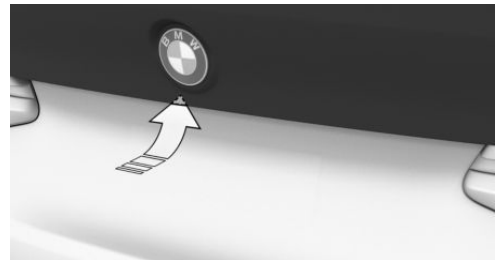

- ▶ Unlock the vehicle and then press the button on the outer side of the tailgate.
- ▶  Press the button on the vehicle key for approx. 1 second.

Depending on the setting, the doors may be unlocked.

Selector lever position P must be engaged to open the tailgate with the vehicle key.

### Closing

- ▶  Press the button on the inside of the upper tailgate.

## Displays, control elements

### In the vicinity of the steering wheel

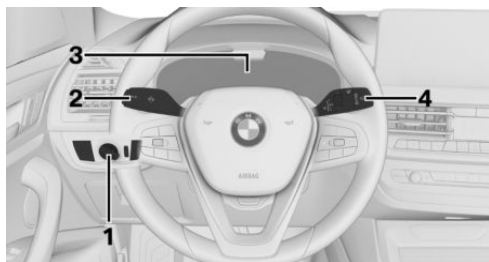

- 1 Light switch element
- 2 Turn signal indicator, high beams
- 3 Instrument cluster
- 4 Wipers

### Indicator/warning lights

The indicator/warning lights can light up in a variety of combinations and colors.

Several of the lights are checked for proper functioning and light up temporarily when drive-ready state is turned on.

### Driver's door

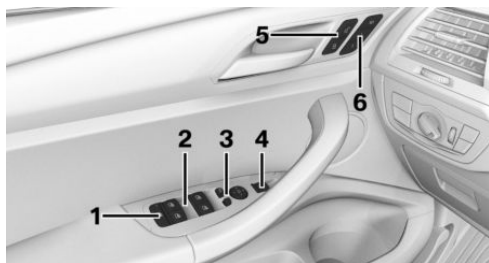

- 1 Safety switch
- 2 Power windows
- 3 Exterior mirrors
- 4 Opening/closing the tailgate
- 5 Central locking system
- 6 Seats, comfort features

## Switch console

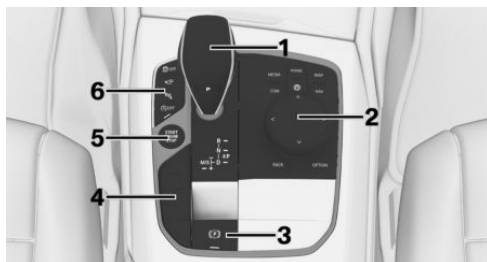

- 1 Selector lever
- 2 Controller
- 3 Parking brake, Automatic Hold
- 4 Driving Dynamics Control
- 5 Start/Stop button
- 6 Assistance systems

## iDrive

### Principle

iDrive is the operating concept of the infotainment system and includes a large number of functions.

### Buttons on the Controller

Button	Function
HOME	Call up the main menu.
	Go to Apps menu.
MEDIA	Call up the Media/Radio menu.
COM	Call up the Communication menu.
MAP	Call up the navigation map.
NAV	Call up the destination input menu for navigation.

**Button Function** Call up the previous display. Call up the Options menu.

## Voice control

### Activating the voice control system

 Press the button on the steering wheel.

Say the command.

### Canceling voice control

 Press the button on the steering wheel or >Cancel.

# Set-up and use

## Seats, mirrors and steering wheel

### Electrically adjustable seats

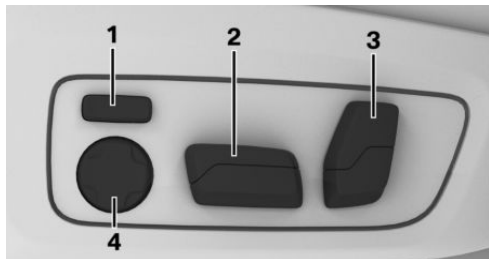

- 1 Backrest width
- 2 Forward/backward, height, seat tilt
- 3 Backrest tilt, head restraint
- 4 Lumbar support

### Adjusting the head restraint

#### Adjusting the height: manual head restraints

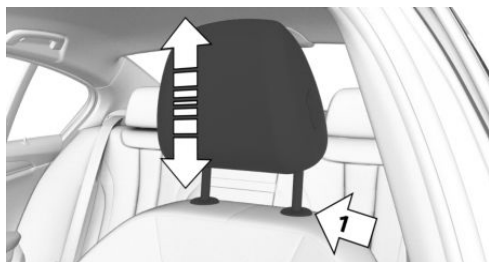

- ▶ To lower: press the button, arrow 1, and push the head restraint down.
- ▶ To raise: push the head restraint up.

After setting the height, make sure that the head restraint engages correctly.

### Adjusting distance



- ▶ Back: press the button and push the head restraint toward the rear.
- ▶ Forward: pull the head restraint toward the front.

After setting the distance, make sure that the head restraint engages correctly.

### Adjusting the exterior mirrors



- 1 Adjusting
- 2 Selecting a mirror, Automatic Curb Monitor
- 3 Folding in and out

## Adjusting the steering wheel

### Manual steering wheel adjustment

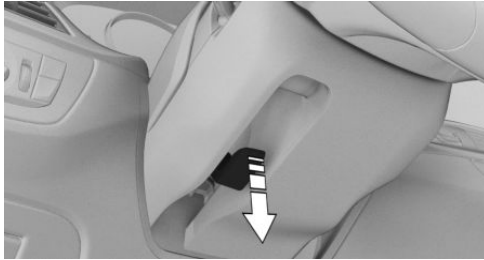

1. Fold the lever down.
2. Move the steering wheel to the preferred height and angle to suit your seat position.
3. Fold the lever back up.

## Memory function

### Principle

The following settings can be stored and, if necessary, retrieved using the memory function:

- ▶ Seat position.
- ▶ Exterior mirror position.
- ▶ Height of the Head-up Display.

### Storing

1. Set the desired position.
2.  Press the button. The lettering on the button is illuminated.
3. Press the desired button 1 or 2 at the door while the lettering is illuminated. A signal sounds.

### Calling up settings









Press the desired button 1 or 2.

## Infotainment

### Radio



#### Buttons and functions

Depending on the country and equipment version, the radio has the following buttons.

Button	Function
	Press: turns sound output on/off. Turn: adjusts the volume.
	Change the entertainment source.
	Press once: changes the station/track.
/	Press and hold: fast forward/rewind the track.
	
	Programmable memory buttons.
/	
	
	Changeover of wave range/satellite radio. Changing the wave range.
	Menu Apps.

### Navigation destination input

#### Entering a destination via the search

1.  Press the button on the Controller.
2.  "Where to?"
3. Enter at least two letters or characters.

Select point of interest categories from the points of interest menu as needed.

The search term may be completed automatically in orange lettering.

Tilt the Controller up to accept the suggested search term.

4. **OK** Select the icon, if needed.  
A list of the results is displayed.
5. If necessary, "Filter"
6. "Show results"
7. Select the desired entry.
8. If necessary, "Start guidance"

## Using the mobile phone

### General information

After the mobile phone is connected once to the vehicle, the mobile phone can be operated using iDrive and the steering wheel buttons.

### Connecting via Bluetooth®

1. "COM"
2. "Mobile devices"
3. Tilt the Controller to the right.
4. "New device"
5. "Phone calls and audio"

The vehicle's Bluetooth name is displayed on the Control Display.

6. Compare the control number displayed on the Control Display with the control number on the display of the mobile device, and confirm that the two match.
7. A Bluetooth connection is established.

The mobile device is connected to the vehicle and displayed in the device list.

### Accepting a call

Depending on the equipment, incoming calls can be answered in several ways.

- ▶ Via iDrive:

 "Accept"



- ▶ Press the corresponding button on the steering wheel.
- ▶ Use the thumbwheel on the steering wheel to select from the list in the instrument cluster: "Accept"
- ▶ Via touchscreen: tap on the corresponding entry on the Control Display.

### Dialing a number

1. "COM"
2. If necessary, "Telephone"
3. "Dial number:"
4. Enter the numbers.
5.  Select the icon. The connection is established via the mobile phone to which this function has been assigned.

Establish the connection via the additional telephone:

1.  Press the button.
2. "Call via"

### Apple CarPlay® preparation

#### Principle

CarPlay allows operation of select functions of a compatible Apple iPhone via Siri voice control and iDrive.

#### Functional requirements

- ▶ Compatible iPhone, iPhone 5 or later with iOS 7.1 or later.
- ▶ Corresponding mobile contract.
- ▶ If necessary, the setting for mobile data must be activated on the iPhone.

- ▷ Bluetooth®, Wi-Fi, and Siri voice control are turned on the iPhone.
- ▷ Wi-Fi and Bluetooth are enabled in the vehicle.

## Pairing the iPhone with CarPlay

1. "COM"
2. "Mobile devices"
3. "New device"
4. "Phone calls and audio"  
The vehicle's Bluetooth name is displayed on the Control Display.
5. On the mobile device, search for Bluetooth devices in the vicinity and select the vehicle.  
A control number is displayed.
6. Compare the control number displayed on the Control Display with the control number on the display of the mobile device, and confirm that the two match.
7. "Use Apple CarPlay"

The iPhone is connected to the vehicle and displayed in the device list.

# On the road

## Driving

### Drive-ready state

#### Turning on the drive-ready state



1. Depress the brake pedal.
2. Press the Start/Stop button.

#### Turning off drive-ready state

Steptronic transmission:

1. Engage selector lever position P with the vehicle stopped.
2. Set the parking brake.
3. Press the Start/Stop button.  
The engine is switched off.

### Auto Start/Stop function

The Auto Start/Stop function switches the engine off automatically while stationary to save fuel. The engine starts automatically under the following preconditions:

Steptronic transmission:

- ▷ By releasing the brake pedal.
- ▷ When Automatic Hold is activated: step on the accelerator pedal.

### Parking brake

#### Setting



Pull the switch.

The LED on the switch and the indicator light in the instrument cluster are illuminated.

### Releasing



With drive-ready state switched on:

Steptronic transmission: press the switch while the brake is pressed or selector lever position P is set.

The LED and the indicator light go out.

The parking brake is released.

### Parking

Make sure the parking brake is engaged.

### Steptronic transmission

#### Engaging selector lever position D, N, R



- ▷ Gear position D.
- ▷ Neutral N.
- ▷ Reverse R.

To prevent the vehicle from creeping after you select a gear position or reverse, maintain pressure on the brake pedal until you are ready to drive off.

Engage selector lever position R only when the vehicle is stationary.



## Releasing the selector lever lock

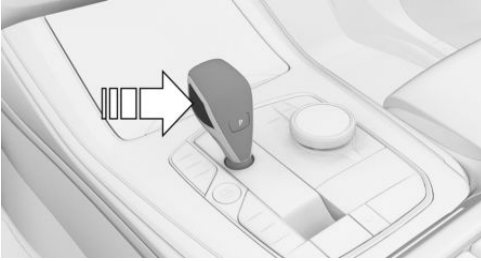

Press the button.

## Engaging selector lever position P

Engage selector lever position P only when the vehicle is stationary.

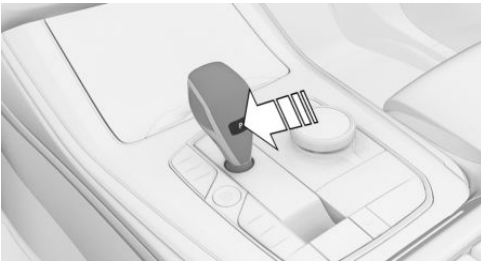

Press button P.

## Light and view

### Turn signal, high beams, headlight flasher

#### Turn signal

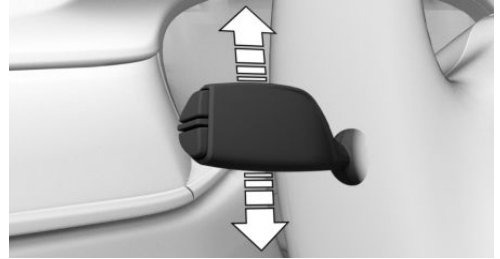

- ▶ Blinking: press the lever past the resistance point.
- ▶ Triple turn signal activation: lightly tap the lever up or down.
- ▶ Brief blinking: press the lever to the resistance point and hold it there for as long as you want the turn signal to blink.

#### High beams, headlight flasher

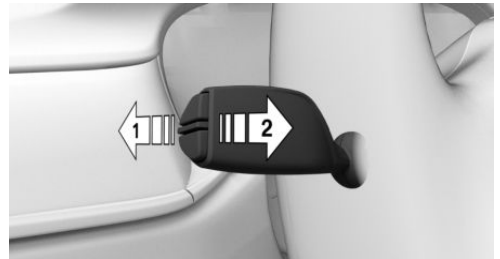







Press the lever forward or pull it backward.

- ▶ High beams on, arrow 1.  
The high beams light up when the low beams are switched on.
- ▶ High beams off/headlight flasher, arrow 2.

## Lights and lighting

### Lighting functions

Icon	Function
	Lights off. Daytime driving lights.
	Parking lights.
	Automatic headlight control. Adaptive lighting functions.
	Low beams.
	Instrument lighting.
	Right roadside parking light.
	Left roadside parking light.

## Window wiper system

### Turning on window wiper system



Press the lever up until the desired position is reached.

- ▷ Resting position of the wipers: position 0.
- ▷ Rain sensor: position 1.

- ▷ Normal wiper speed: position 2.
- ▷ Fast wiper speed: position 3.

### Turning off the window wiper system and flick wipe

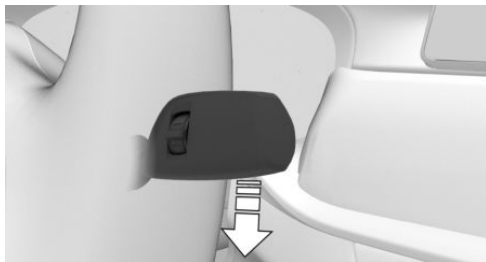

Press the lever down.

- ▷ Turn off: press the lever down until it reaches the 0 position.
- ▷ Flick wipe: press the lever down from the 0 position.

### Activating/deactivating rain sensor



Activate: press the lever up once from its 0 position, arrow 1.

Deactivate: press the lever back into the 0 position.

## Adjusting the rain sensor sensitivity

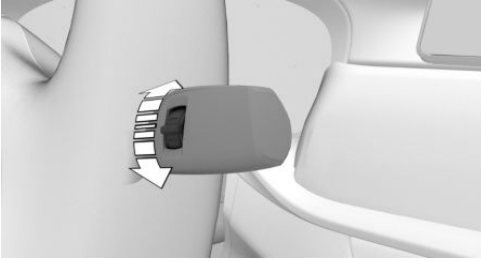

Turn the thumbwheel on the wiper lever.

## Cleaning the windshield



Pull the lever.

## Switching on the rear wiper

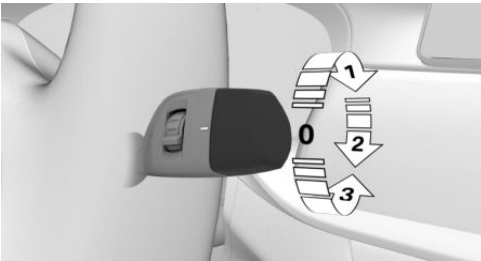

Turn the outer switch upward.

- ▶ Resting position of the wiper, position 0.
- ▶ Intermittent operation, arrow 1. When reverse gear is engaged, the system switches to continuous operation.









## Clean the rear window



Turn the outer switch in the desired direction.

- ▶ In resting position: turn the switch downward, arrow 3. The switch automatically returns to its idle position when released.
- ▶ In intermittent operation: turn the switch further, arrow 2. The switch automatically returns to its interval position when released.

## Climate control

### Automatic climate control

Button	Function
	Temperature.
	Air recirculation mode.
	Maximum cooling.
	AUTO program.
	Air flow, manual. Switching off. Intensity AUTO program.
	Air distribution, manual.
	Defrost function.
	Rear window defroster.

Button	Function
	Seat heating.
	Air conditioning. Opening the Climate menu. For example, for the following settings: upper body temperature adjustment, pre-ventilation.

## Intermediate stop

### Refueling

#### Fuel cap

1. To open the fuel filler flap, press on the rear edge, arrow. The fuel filler flap opens.



2. Turn the fuel cap counterclockwise.
3. Place the fuel cap in the bracket attached to the fuel filler flap.

#### Gasoline

For the best fuel efficiency, the gasoline should be sulfur-free or very low in sulfur content.

Fuels that are marked on the gas pump as containing metal must not be used.

## Wheels and tires

### Tire pressure specifications

The tire inflation pressure specifications can be found in the tire inflation pressure table in the printed Owner's Manual.

### After correcting the tire pressure

For the flat tire monitor:

Reinitialize the Flat Tire Monitor.

With Tire Pressure Monitor:

The corrected tire inflation pressures are applied automatically. Make sure that the correct tire settings have been made.

With tires that cannot be found in the tire pressure values on the control display, reset the Tire Pressure Monitor (TPM).

### Checking the tire pressure

Regularly check the tire inflation pressure and correct it as needed:

- ▷ At least twice a month.
- ▷ Before embarking on an extended trip.

### Cleaning the wheels

The friction during hard braking may produce brake dust and make the rims dirty. Brake dust can be removed by cleaning the rims. BMW recommends using vehicle care and cleaning agents from BMW.

## Electronic oil measurement

### Functional requirements

A current measured value is available after approx. 30 minutes of normal driving.

### Displaying the engine oil level

1. "CAR"
2. "Vehicle status"
3.  "Engine oil level"

Different messages appear on the Control Display depending on the engine oil level. Pay attention to these messages.

## Adding engine oil

### General information

Safely park the vehicle and switch off drive-ready state before adding engine oil.

### Adding engine oil



Only add engine oil when the message is displayed in the instrument cluster.

Observe the top-up quantity in the message.  
Take care not to add too much engine oil.  
Observe recommended engine oil types.

## Providing assistance

### Hazard warning flashers



The button is located in the center console.

## BMW Roadside Assistance

In many non-ConnectedDrive countries, BMW Roadside Assistance can be reached by phone around the clock. You can obtain support there in the event of a vehicle breakdown.

In ConnectedDrive countries, proceed as follows:

1. "APPS"
2. "Installed apps"
3. "BMW Assist"
4. If necessary, "BMW Roadside Assistance"  
A voice connection is established.

## ConnectedDrive

### BMW Assistance

BMW Assist includes various services having to do with the vehicle, e.g., customer support. The services help maintain mobility.

1. "COM"
2. "BMW Assist"
3. "BMW Assist"

Follow the instructions on the Control Display.

### Teleservices

Teleservices are services that help to maintain vehicle mobility.

Teleservices can comprise the following services:

- ▷ BMW Roadside Assistance.
- ▷ BMW Accident Assistance.
- ▷ Teleservice Call.
- ▷ Your service center.

# Dashboard

## Vehicle features and options

This chapter describes all standard, country-specific and optional features offered with the series. It also describes features and functions that are not necessarily available in your vehi-

cle, e.g., due to the selected options or country versions. This also applies to safety-related functions and systems. When using these functions and systems, the applicable laws and regulations must be observed.

## In the vicinity of the steering wheel

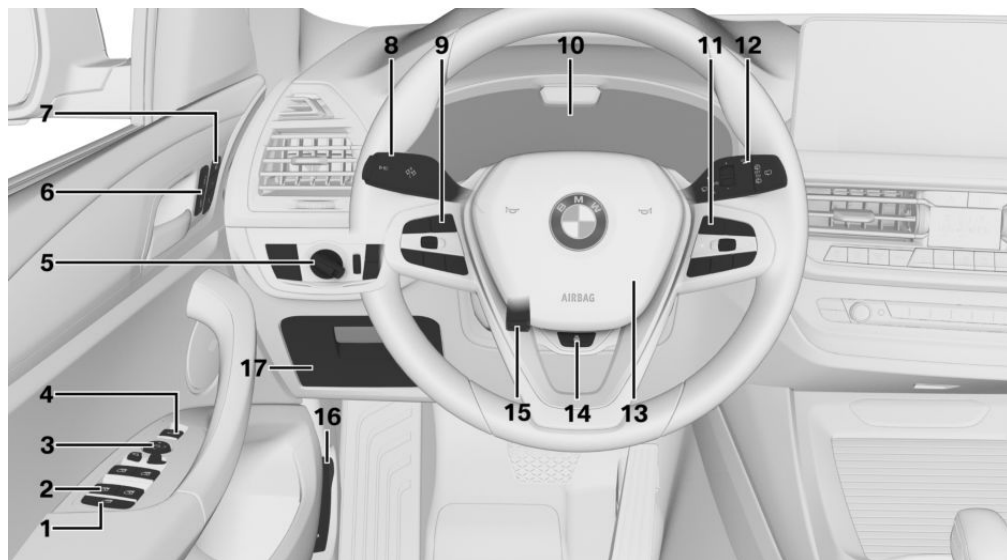

1  Safety switch [111](#)

2  Power windows [109](#)

3 Exterior mirror adjustment button [122](#)

4  Opening and closing the tailgate [102](#)





























5 Lights

 Light switch [175](#)

 Lights off  
Daytime driving lights [177](#)

 Parking lights [176](#)

 Automatic headlight control [175](#)  
Adaptive lighting functions [177](#)  
Automatic High Beam Assistant [178](#)

-  Low beams [176](#)
-  Instrument lighting [180](#)
-  Right roadside parking light [176](#)
-  Left roadside parking light [176](#)
- 6** Central locking system [97](#)
-  Unlocking
-  Locking
- 7** Seating comfort features
-  Memory function [124](#)
- 8** Pitman arm, left
-  Turn signal [142](#)
-  High beams, headlight flasher [143](#)
-  Automatic High Beam Assistant [178](#)
-  Widgets [156](#)
-  Trip data [170](#)
- 9** Steering wheel buttons, left
-  Manual Speed Limiter [221](#)
-  Depending on the equipment:  
Cruise Control on/off [223](#)
- 
-  Depending on the equipment:  
Active Cruise Control on/off [226](#)
-  With Steering Assistant [236](#):  
Cruise Control, Distance Control  
and lane guidance on/off
- 
-  Cruise Control: store the speed  
Speed Limit Assistant: accept  
suggested speed [234](#)
-  Interrupt or continue cruise control
-  Active Cruise Control: increase  
distance
-  Active Cruise Control: reduce dis-  
tance
- Cruise Control rocker switch
- 10** Instrument cluster [153](#)
- 11** Steering wheel buttons, right
-  Selection lists [169](#)
-  Volume, see Owner's Manual for  
Navigation, Entertainment and  
Communication [6](#)
-  Voice activation system [50](#)
-  Telephone, see Owner's Manual  
for Navigation, Entertainment and  
Communication [6](#)
- Thumbwheel for selection lists [169](#)
- 12** Pitman arm, right
-  Wipers [143](#)
-  Rain sensor [144](#)



Cleaning the windshield [145](#)



Rear wiper in Canadian models [145](#)



Rear wiper [145](#)



Clean the rear window [145](#)



**13** Horn, entire surface



**14** Steering wheel heating [124](#)

**15** Adjusting the steering wheel [124](#)

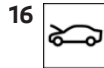

**16** Unlocking the hood [361](#)

**17** Fold-out compartment [298](#)

## In the vicinity of the center console

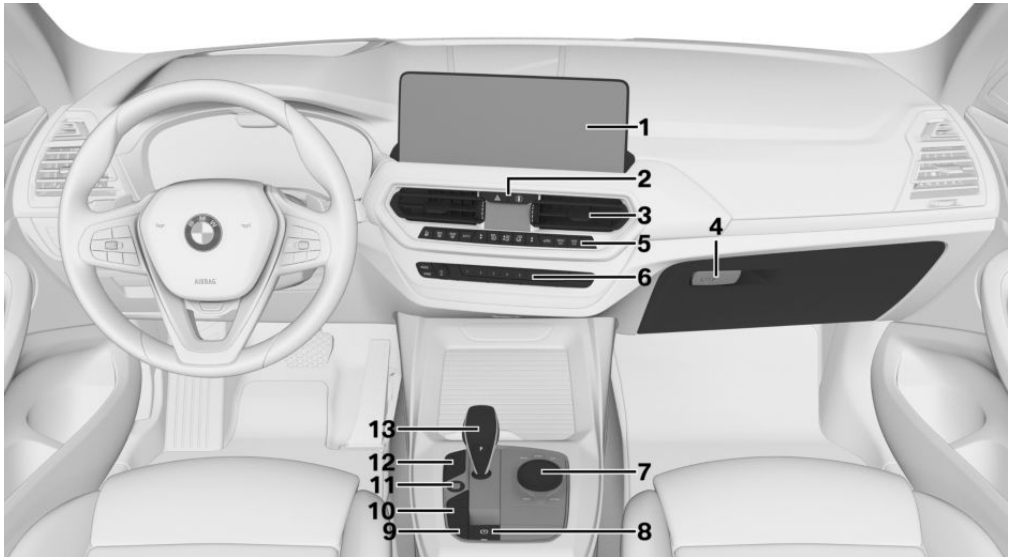

**1** Control Display [45](#)

**2**  Hazard warning system [377](#)



Intelligent Safety [185](#)

**3** Ventilation [278](#)

**4** Glove compartment [297](#)











**5** Automatic climate control [273](#)

**6** Radio/multimedia, see Owner's Manual for Navigation, Entertainment, and Communication [6](#)

**7** Controller with buttons [46](#)

**8**  Parking brake [139](#)



- 9**  Automatic Hold [140](#)
- 10**  Driving Dynamics Control [137](#)  
SPORT drive mode
-  COMFORT drive mode
-  ECO PRO drive mode
-  HDC Hill Descent Control [216](#)
- 11**  Turning the drive-ready state on/off [134](#)
- 12**  Auto Start/Stop function [134](#)
-  Parking assistance systems [244](#)
-  Panorama View [265](#)
-  DSC Dynamic Stability Control [213](#)
- 13**  Steptronic transmission selector lever [146](#)

## In the vicinity of the headliner



- 1**  Emergency Call, SOS [379](#)
- 2**  Glass sunroof [111](#)

**3**  Indicator light, front passenger  
airbag [185](#)

**5**  Interior lights [180](#)

**4**  Reading lights [181](#)

# Sensors of the vehicle

## Vehicle features and options

This chapter describes all standard, country-specific and optional features offered with the series. It also describes features and functions that are not necessarily available in your vehicle, e.g., due to the selected options or country versions. This also applies to safety-related functions and systems. When using these functions and systems, the applicable laws and regulations must be observed.

## Overview

Depending on the equipment, the following cameras and sensors are installed in the vehicle:

- ▶ Front camera.
- ▶ Cameras behind the windshield.
- ▶ Top view cameras.
- ▶ Rearview camera.
- ▶ Front radar sensor.
- ▶ Radar sensors, side, front.
- ▶ Radar sensors, side, rear.
- ▶ Ultrasonic sensors in the front/rear bumpers.
- ▶ Ultrasonic sensors, side.

Keep the vehicle cameras and sensors, as well as surrounding areas, clean and unobstructed.

## Cameras

### Front camera

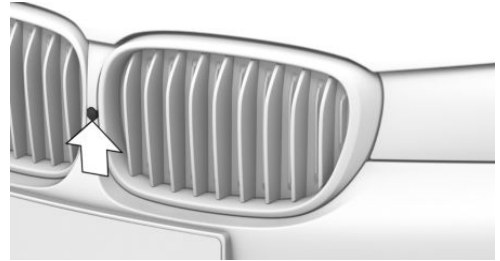

The front camera is located in the radiator grille.

### Cameras behind the windshield

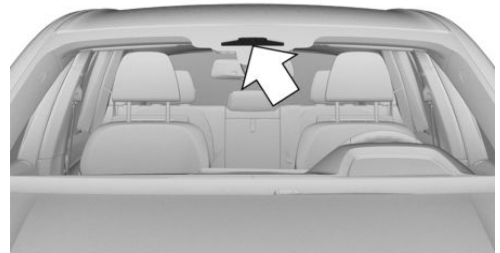

The cameras behind the windshield are located near the interior mirror.

## Top view cameras

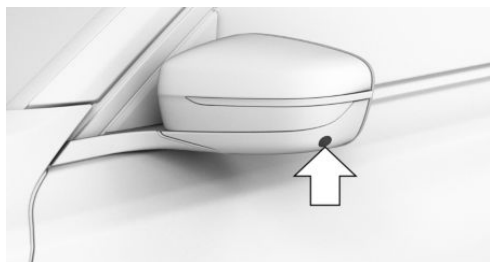

One exterior mirror camera is located at the bottom of each exterior mirror housing.

## Rearview camera

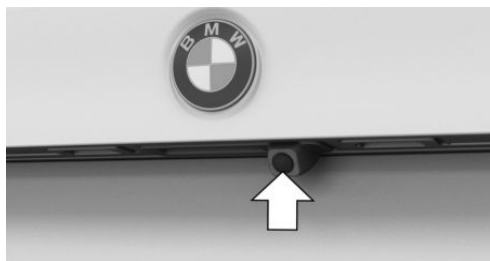

The rearview camera is located in the tailgate handle.

## System limits of the cameras

The cameras may not be fully functional and may provide incorrect information in the following situations:

- ▷ In heavy fog, wet conditions, or snowfall.
- ▷ On steep hills, in steep depressions or in tight curves.
- ▷ When the camera field of view is covered, for instance by a fogged up windshield or labels.
- ▷ If the camera lens is dirty or damaged.
- ▷ With exterior mirrors folded in.
- ▷ When driving toward bright lights or strong reflections, e.g., because of a setting sun.
- ▷ When it is dark outside.

- ▷ Camera behind the windshield: if the camera has overheated and been temporarily switched off due to excessively high temperatures.
- ▷ Camera behind the windshield: during calibration of the camera immediately after vehicle delivery.

If applicable, a Check Control message will be displayed when the system limits are reached.

## Radar sensors

### Safety information

#### Warning

The vehicle radar sensors and thus also the driver assistance systems can be impaired by external influences, e.g., interference. There is a risk of accident. Watch the surrounding traffic situation closely, be ready to take over steering and braking at any time, and actively intervene where appropriate.

## Front radar sensor

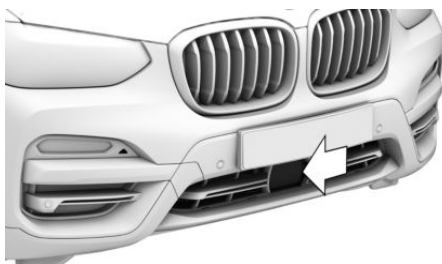

The front radar sensor is located in the front bumper.

## Radar sensors, side, front



The radar sensors are located to the side in the front bumper.

## Radar sensors, side, rear



The radar sensors are located to the side behind the rear bumper.

## System limits of the radar sensors

The radar sensors may not be fully functional or may not be available in the following situations:

- ▷ If sensors are dirty, such as due to icing.
- ▷ If sensors are covered, such as by labels, films or a number plate baseplate.
- ▷ If the sensor is not aligned correctly, for instance due to parking damage.
- ▷ If the radiation range of the sensors is covered, e.g., by protruding cargo.
- ▷ When the field of view of the sensors is covered, e.g., by garage walls, hedges, snow hills, vehicles or trailers.

- ▷ After improper paint work on the vehicle in the area of the sensors.
- ▷ On steep hilltops or in sharp dips in the road.

If applicable, a Check Control message will be displayed when the system limits are reached.

## Ultrasonic sensors

### Ultrasound sensors in the front/rear bumpers



The ultrasonic sensors for Park Distance Control are located in the front and rear bumpers.

### Ultrasonic sensors, side

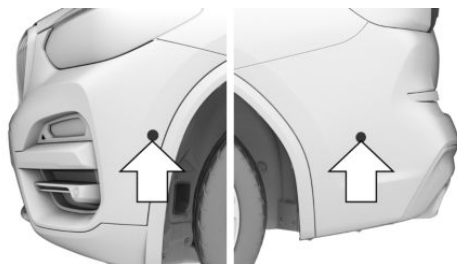

The ultrasonic sensors for Parking Assistant are located to the side in the front and rear bumpers.

## System limits of the ultrasonic sensors

The detection of objects with ultrasonic measurements can run into physical limits, e.g., in the following situations:

- ▷ If the sensors are dirty or covered, e.g., by stickers.
- ▷ If the sensor is not aligned correctly, for instance due to parking damage.



- ▷ After improper paint work on the vehicle in the area of the sensors.
- ▷ For small children and animals.
- ▷ For persons with certain clothing, for instance jacket.
- ▷ In case of external interference with the ultrasonics, for instance from passing vehicles, loud machines or other ultrasonic sources.
- ▷ Under certain weather conditions, e.g., high moisture, wet conditions, snowfall, cold, extreme heat, or strong wind.
- ▷ With tow bars and trailer couplings of other vehicles.
- ▷ With thin or wedge-shaped objects.
- ▷ With moving objects.
- ▷ With elevated, protruding objects such as ledges.
- ▷ With objects with corners, edges, and smooth surfaces.
- ▷ For objects with fine surfaces or objects like fences, plants, or bushes.
- ▷ For objects with porous surfaces.
- ▷ With small and low objects, for instance boxes.
- ▷ With soft obstacles or obstacles covered in foam material.
- ▷ In automatic car washes.
- ▷ On uneven surfaces, such as speed bumps.
- ▷ Due to heavy exhaust.
- ▷ Cargo that extends beyond the perimeter of the vehicle is not taken into account by the ultrasonic sensors.
- ▷ When the trailer hitch cover is not on straight.

If applicable, a Check Control message will be displayed when the system limits are reached.

# Operating condition of the vehicle

## Vehicle features and options

This chapter describes all standard, country-specific and optional features offered with the series. It also describes features and functions that are not necessarily available in your vehicle, e.g., due to the selected options or country versions. This also applies to safety-related functions and systems. When using these functions and systems, the applicable laws and regulations must be observed.

## General information

Depending on the situation, the vehicle is in one of the three states:

- ▷ Idle state.
- ▷ Standby state.
- ▷ Drive-ready state.

## Idle state

### Principle

When the vehicle is in idle state, it is switched off.

### General information

The vehicle is in idle state prior to opening from the outside and after exiting and locking.

### Safety information

#### **Warning**

An unsecured vehicle can begin to move and possibly roll away. There is a risk of accident. Before leaving the vehicle, secure the vehicle against rolling away.

In order to ensure that the vehicle is secured against rolling away, follow the following:

- ▷ Set the parking brake.
- ▷ On uphill grades or on downhill slopes, turn the front wheels in the direction of the curb.
- ▷ On uphill grades or on downhill slopes, also secure the vehicle, for instance with a wheel chock.

#### **Warning**

Unattended children or animals in the vehicle can cause the vehicle to move and endanger themselves and traffic, for instance due to the following actions:

- ▷ Pressing the Start/Stop button.
- ▷ Releasing the parking brake.
- ▷ Opening and closing the doors or windows.
- ▷ Engaging selector lever position N.
- ▷ Using vehicle equipment.

There is a risk of accidents or injuries. Do not leave children or animals unattended in the vehicle. Take the vehicle key with you when exiting and lock the vehicle.

## Automatic idle state

For instance, the idle state is automatically established under the following conditions:

- ▷ After several minutes, if no operation takes place on the vehicle.
- ▷ If the charge state of the vehicle battery is low.
- ▷ Depending on the configuration via iDrive: one or both front doors will be opened after driving when exiting the vehicle.

In some situations, the idle state is not set automatically, for instance during a phone call or when the low beams are switched on.

## Establishing idle state when opening the front doors

After a trip, the sleep mode can be established by opening the front doors. For this purpose, the driver and front passenger must exit the vehicle.

1. "CAR"
2. "Settings"
3. "Doors/ vehicle access"
4. "Turn off vehicle after opening door"

## Manual idle state

To establish idle state in the vehicle after completion of trip:



Press and hold the button on the radio until the OFF indicator on the instrument cluster goes out.

## Standby state

### Principle

When standby state is switched on, most functions can be used while the vehicle is stationary. Desired settings can be adjusted.

### General information

The vehicle is in the standby state after the front doors are opened from the outside.

### Standby, manual

#### General information

Standby can be switched back on after the vehicle is automatically set to idle state.

## Via button on the radio



Press the button on the radio. The control display and the instrument cluster illuminate.

## Via start/stop button



Press the Start/Stop button. The control display and the instrument cluster illuminate.

## Display in the instrument cluster



OFF is displayed in the instrument cluster. The drivetrain is switched off and standby state switched on.

## Drive-ready state

### Principle

Turning on drive-ready state corresponds to starting the engine.

### General information

Some functions, such as the Dynamic Stability Control, can only be used with the drive readiness turned on.

### Safety information

#### **⚠ DANGER**

If the exhaust pipe is blocked or ventilation is insufficient, harmful exhaust gases can penetrate the vehicle. The exhaust gases contain pollutants which are colorless and odorless. In enclosed areas, exhaust gases can also accumulate outside of the vehicle. There is a



danger to life. Keep the exhaust pipe free and ensure sufficient ventilation.

### **Warning**

An unsecured vehicle can begin to move and possibly roll away. There is a risk of accident. Before leaving the vehicle, secure the vehicle against rolling away.

In order to ensure that the vehicle is secured against rolling away, follow the following:

- ▷ Set the parking brake.
- ▷ On uphill grades or on downhill slopes, turn the front wheels in the direction of the curb.
- ▷ On uphill grades or on downhill slopes, also secure the vehicle, for instance with a wheel chock.

### **NOTICE**

Repeated attempts to start the vehicle or repeated starting of the vehicle in rapid succession can cause the starter to overheat. This also results in unburned or inadequately burned fuel, and can cause the catalytic converter to overheat. There is a risk of damage to property, among other potential damage. Avoid repeated starting of the vehicle, particularly repeated starting in rapid succession.

## Turning on the drive-ready state

### Principle



Drive-ready state is switched on via the Start/Stop button.

## Steptronic transmission

1. Depress the brake pedal.
2. Press the Start/Stop button.

The ignition is activated automatically for a brief time and is stopped as soon as the engine starts.

Most of the indicator/warning lights in the instrument cluster light up for a varied length of time.

## Gasoline engine

Depending on the motorization, full drive power and the entire speed range may not be available for approx. 30 seconds after starting the engine. In this case, the vehicle will not accelerate as usual.

Additional information:

- ▷ Tachometer, refer to page 166.
- ▷ Instrument cluster with enhanced features: Power gauge, refer to page 166.

## Display in the instrument cluster

The activated drive readiness is indicated in the instrument cluster, depending on the equipment, by the display of information required for driving or the READY display.

## Turning off drive-ready state

### Steptronic transmission

1. Engage selector lever position P with the vehicle stopped.
2. Set the parking brake.
3. Press the Start/Stop button.

The engine is switched off. The vehicle switches into standby state.

# iDrive

## Vehicle features and options

This chapter describes all standard, country-specific and optional features offered with the series. It also describes features and functions that are not necessarily available in your vehicle, e.g., due to the selected options or country versions. This also applies to safety-related functions and systems. When using these functions and systems, the applicable laws and regulations must be observed.

## Operating concept

### Principle

iDrive is the operating concept of the infotainment system and includes a large number of functions.

### General information

Depending on vehicle equipment, the functions can be operated as follows:

- ▶ Via the Controller.
- ▶ Via the Control Display.
- ▶ Via the touchpad.
- ▶ Via the BMW Intelligent Personal Assistant.
- ▶ Via the gesture control.

### Safety information

#### **Warning**

Operating the integrated information systems and communication devices while driving can distract from surrounding traffic. It is possible to lose control of the vehicle. There is a risk of accident. Only use the systems or devices when the traffic situation allows. As

warranted, stop and use the systems and devices while the vehicle is stationary.

## Input and display

### Main menu

#### General information

The main menu is divided into two areas. The left area contains menu items that can be used to call up all the iDrive functions. The right area contains widgets that provide quick access to certain functions.

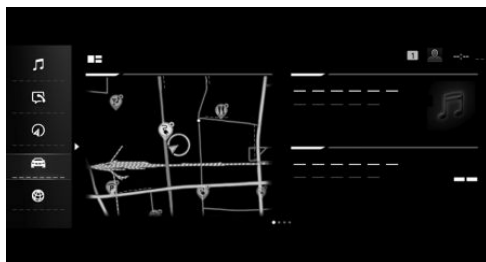

#### Media/Radio

 All functions of the entertainment system, e.g., radio stations or connection with external devices.

#### Communication

 Phone and message functions, e-mail and calendar, and also the connection and management of mobile devices, such as smartphones.

#### Navigation

 Access to the navigation system, destination input and traffic bulletins. Configurable map views and other functions, such as points of interest and areas to be avoided.

## My Car

 Information about vehicle status and trips. Access to the Integrated Owner's Manual and also administration of driver profiles and range of adjustments for vehicle and iDrive.

## Apps

 Management of apps, access to apps and vehicle functions. Additional apps and vehicle functions can be purchased from the BMW Store.





## Widgets

 Widgets provide quick access to frequently used functions. The configured widgets display dynamic contents such as the navigation map, and serve as interfaces at the same time.

## Letters and numbers

Letters and numbers can be selected when making the destination input, for example.

Letters and numbers can be entered using the controller, touchpad, control display, or voice control, depending on vehicle equipment. The keyboard's display changes automatically.

Icon	Function
abc ABC	Change between capital and lower-case letters.
	Enter a blank space.
EN	Switching between languages.
	Use voice control.
OK	Confirm entry.
 	Shift the input area to the left or right.

## Entry comparison

When entering names and addresses, the selection is gradually narrowed down for ev-

ery character entered, with characters being added as necessary.

Entries are continuously compared with data stored in the vehicle.

- ▷ Only those letters and numbers are offered during entry for which data is available.
- ▷ Destination search: place names can be entered in all languages that are available in iDrive.

## Activating/deactivating the functions

Several menu items are preceded by a checkbox. The checkbox indicates whether the function is activated or deactivated. Selecting the menu item activates or deactivates the function.









- Function is activated.
- Function is deactivated.

## Status information





### General information

The status field can be found in the upper area of the Control Display. Status information is displayed in the form of icons.

### Telephone icons







Icon	Meaning
	Incoming or outgoing call.
	Missed call.
	Signal strength of mobile phone network.
	Network search.
	Mobile phone network is not available.
	The critical charge state of the mobile phone has been reached.
	Roaming is active.
	Locating is active.

**Icon Meaning**

	SMS text message received.
	Message received.
	Reminder.
	Sending not possible.













Entertainment icons

**Icon Meaning**

	Bluetooth audio.
	USB device.
	Connected Music.
	Wi-Fi.
	Apple CarPlay.
	Android Auto.
	Satellite radio is switched on.

Other icons

**Icon Meaning**

	Check Control message.
	Sound output active.
	Sound output deactivated.
	Voice activation system active.
	Request for the current vehicle position.
	Checking the current vehicle position.
	Driver profile.
	Notifications.
	Data protection.
	Destination guidance active.
	Passengers on board.
	Do not disturb.

## Programmable memory buttons

### General information

The iDrive functions can be stored on the programmable memory buttons and called up directly, for instance radio stations, navigation destinations, phone numbers and menu entries.

### Overview



**1...8** Programmable memory buttons

### Storing a function

A function can be stored on a programmable memory button. A button with a stored function can be overwritten with another function.

1. Select function via iDrive, for instance radio station.
2. **1...8** Press and hold the desired button until the displayed bar on the control display has loaded completely.

### Executing a function

**1...8** Press the button.

The function will work immediately. This means for instance that the connection is established when a phone number is selected.

### Displaying the key assignment

Touch buttons with finger. Do not wear gloves or use objects.

The assignment of the buttons is displayed in the upper area of the Control Display.

## Deleting all button assignments

All button assignments can be deleted.

1. Press and hold buttons 1 and 8 at the same time.
2. "OK"

# Control Display and Controller

## Principle

The iDrive functions are displayed on the Control Display.

## Overview

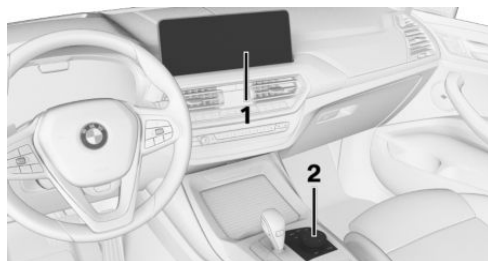

- 1 Control Display
- 2 Controller

## Control Display

## Safety information

### NOTICE

Objects in the area in the front of the Control Display can slip and damage the Control Display. There is a risk of damage to property, among other potential damage. Do not place

objects in the area in front of the Control Display.

## Switching on/off automatically

The Control Display is turned on automatically when the vehicle is unlocked or as soon as the control display is needed for operation.

In certain situations, the Control Display is switched off automatically, for instance if no operation is performed on the vehicle for several minutes.

## Switching on/off manually

The Control Display can also be switched off manually.

1. Tip the Controller up.
2. "Screen off"

Press the Controller or any button on the Controller to switch it back on again.

## System limits

In the case of very high temperatures on the Control Display, for instance due to intense solar radiation, the brightness may be reduced down to complete deactivation. Once the temperature is reduced, for instance through shade or air conditioning system, the normal functions are restored.

## Controller

## General information

The buttons can be used to open the menus directly. The Controller can be used to select menu items and enter the settings.

## Operation

- ▶ Turn to switch between menu items, for example.

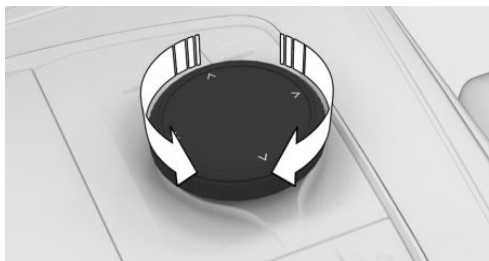



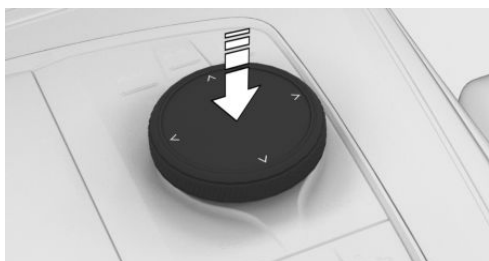

▶ Press to select a menu item, for example.

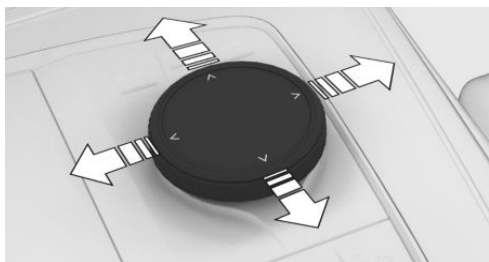





▶ Tilt in four directions to switch between displays, for example.



### Buttons on the Controller

Button	Function
	Call up the main menu.
	Go to Apps menu.
	Call up the Media/Radio menu.
	Call up the Communication menu.

Button	Function
	Call up the navigation map.
	Call up the destination input menu for navigation.
	Call up the previous display.
	Call up the Options menu.

## Operating via the Controller

### Opening the main menu

 Press the button.

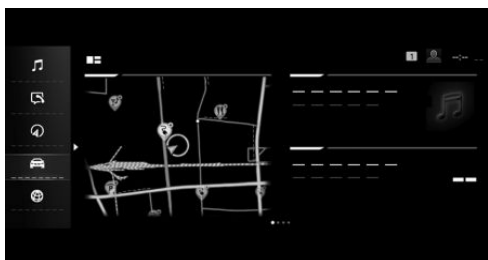

The main menu is displayed.

### Selecting a menu

#### Selecting menu items

1. Turn the Controller until the desired menu item is highlighted.
2. Press the Controller.

#### Selecting a widget



1. Move the Controller in the main menu to the right.
2. Turn the Controller until the desired widget is selected.
3. Press the Controller.

It is also possible to select widgets in the instrument cluster.

## Adjusting the menu

### Adjusting widgets

The widgets can be adjusted in the main menu. It is possible to create multiple pages with widgets and switch between pages. The adjustments can only be performed when the vehicle is stationary.

1. Select the desired page in the main menu. Only the currently selected page can be adjusted.
2. Tip the Controller up.
3. "Adjust main menu"
4. Select the desired adjustment:
  - ▶  Icon and select desired widget: add new widget.  
The requested widget will be inserted in the relevant position. A maximum of four widgets can be displayed per page.
  - ▶  Select icon: delete selected widget.
  - ▶ Add new page: "Add page".
  - ▶ Delete selected page: "Delete page".
  - ▶ Adjust the content of the widget: select widget.
5. "Done"

### Adjusting contents

Depending on vehicle equipment, the contents of the menus "MEDIA" and "COM" can be adjusted, for instance to remove the entries of unused functions from the menu

1. Select the menu.
2. "Personalize menu"
3. Select the desired setting.

## Changing between displays

After a menu item is selected, for instance "Settings", a new display appears.

- ▶ Tilt the Controller to the left.  
The current display closes and the previous display is shown.
- ▶  Press the button.  
The previous display re-opens.
- ▶ Tilt the Controller to the right.  
The new display opens.

An arrow indicates that additional displays can be opened.

## Going to the Options menu

The menu items can be used to access additional options.

Various options are available depending on the menu item selected.

- ▶  Press the button.

Available options are displayed.

## Entering letters and numbers

### Input

1. Turn the Controller: select letters or numbers.
2. **OK** : confirm entry.

### Deleting

Icon	Function
	Press the Controller: delete letters or number.
	Hold the Controller down: delete all letters or numbers.

## Using alphabetical lists

For alphabetical lists with more than 30 entries, the letters for which an entry exists can be displayed in a text box.

1. Turn the Controller to the left or right quickly.
2. Select the first letter of the desired entry.  
The first entry of the selected letter is displayed in the list.

## Operation via touchpad

### General information

Depending on vehicle equipment, some iDrive functions can be operated with the controller touchpad.

### Selecting functions

1. "CAR"
2. "Settings"
3. "General settings"
4. "Touchpad"
5. Select the desired setting.

### Entering letters and numbers

- ▶ Enter characters as they are displayed on the Control Display.
- ▶ Always enter associated characters, such as accents or periods, so that the letter can be clearly recognized.
- ▶ The set language determines what input is possible. Where necessary, enter special characters via the Controller.  
Setting the system language, refer to page 62.

## Entering special characters

Input	Operation
Delete a character.	Swipe to the left on the touchpad.
Enter a blank space.	Swipe to the right in the center of the touchpad.
Enter a hyphen.	Swipe to the right in the upper area of the touchpad.
Enter an underscore.	Swipe to the right in the lower area of the touchpad.

### Using the map

The map in the navigation system can be moved via the touchpad. Tap the map on the control display and then continue the operation using the touchpad.

Function	Operation
Move map.	Swipe in the appropriate direction.
Display menu.	Tap once.

### Using alphabetical lists

Alphabetical lists with more than 30 entries permit a direct jump to letters for which an entry exists.

Enter the first letter on the touchpad.

The first entry of the entered letter is displayed in the list.

## Operation via Control Display

### General information

Depending on the equipment version, the Control Display is equipped with a touchscreen.



You can tap on menu items and widgets. Touch the Control Display with your fingers. Do not use any objects.

## Opening the main menu



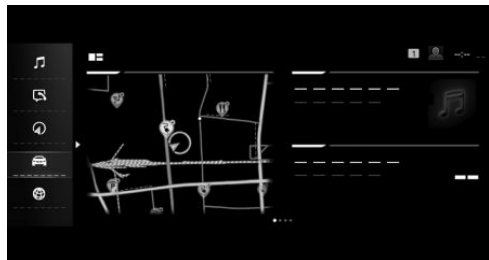

 Tap on the icon.



The main menu is displayed.

## Adjusting widgets

The widgets can be adjusted in the main menu. It is possible to create multiple pages with widgets and switch between pages. The adjustments can only be performed when the vehicle is stationary.

1. Select the desired page in the main menu. Only the currently selected page can be adjusted.
2.  Tap the icon in the main menu.
3. Select the desired adjustment:
  - ▶  Tap icon and select desired widget: add new widget.  
The requested widget will be inserted in the relevant position. A maximum of four widgets can be displayed per page.
  - ▶  Tap on the icon.  
The widget is made larger.
  - ▶  Tap on the icon.  
The widget is made smaller.
  - ▶  Tap on the icon.  
The widget is deleted.
  - ▶ Add new page: tap "Add page".

- ▶ Delete selected page: tap "Delete page".
- ▶ Adjust content of the widget: tap center of widget.

4. Tap "Done".

## Showing/hiding the display bar

In the upper area of the Control Display, it is possible to show or hide a display bar with additional functions.

- ▶ To show the display bar, pull down the display bar at the top edge of the screen.
- ▶ To hide the display bar, pull up the display bar at the top edge of the screen.

## Changing between displays

After a menu item is selected, a new display opens.

An arrow indicates that additional displays can be opened.

- ▶ Swipe to the left.
- ▶ Tap arrow.

The new display opens.

## Entering letters and numbers

### Input

1. Depending on vehicle equipment, either tap the  icon on the Control Display, or a keyboard is displayed on the Control Display when approached.
2. Enter desired letters and numbers.

### Deleting

#### Icon Function

 Tapping the icon: deletes the letter or number.

 Tapping and holding the icon all letters: deletes all letters or numbers.

## Using the map

The navigation map can be moved on the Control Display.

Function	Operation
Move map.	Swipe in the appropriate direction.
Enlarge/shrink map.	Drag in or out with the fingers.
Display menu.	Tap once.

## Using alphabetical lists

For alphabetical lists with more than 30 entries, the letters for which an entry exists can be displayed in a text box.

1. Tap the letter in front of the list.  
A letter box is displayed.
2. Tap the first letter of the desired entry.

# BMW Intelligent Personal Assistant

## Principle

The BMW Intelligent Personal Assistant is a personal assistant that enables natural voice operation of various vehicle functions. The Personal Assistant simplifies the operation of the vehicle with the automation of processes and habits.

## General information

- ▶ BMW Intelligent Personal Assistant is available depending on national-market version.
- ▶ The system includes special microphones on the driver side and the front passenger side.
- ▶ Say commands at a normal volume. Speaking directly into the microphone does not improve the speech recognition.

- ▶ Say the commands and numbers fluently as well as with normal volume, emphasis, and speed.
- ▶ >...< identifies commands that can be spoken.

## Functional requirements

- ▶ A language that is supported by the Personal Assistant must be set via iDrive. Setting the system language, refer to page 62.
- ▶ Always say commands in the configured system language.

For the full range of functions, the following functions should be activated, set or booked:

- ▶ Online speech processing, refer to page 53.
- ▶ For all settings under BMW ConnectedDrive, see Owner's Manual on navigation, entertainment, and communication.
- ▶ Activation word, refer to page 51.
- ▶ A driver profile.
- ▶ Synchronize driver profile, refer to page 70.
- ▶ Relevant ConnectedDrive services from the ConnectedDrive Store.

## Activating the voice control system

### General information

There are various methods for activating the voice control feature:

- ▶  Press the button on the steering wheel.  
The microphone on the driver's side is active.
- ▶ Say the activation word >Hello BMW< or a personal activation word.  
The microphones on the driver's or front passenger's side are active with the follow-

ing voice control, depending on where the activation word was spoken.

Then say the command. The activation word and the command can be spoken without pause in one sentence. No other commands may be available. In this case, operate the function via iDrive.

## Button on the steering wheel

1.  Press the button on the steering wheel briefly.
2. Say the command.

## Activation word

### General information

Speaking the activation word ›Hello BMW‹ or the personal activation word will start the system.

### Preset activation word

The preset activation word ›Hello BMW‹ can be activated and deactivated.

1. "CAR"
2. "Settings"
3. "General settings"
4. If necessary, "Personal assistant"
5. "Voice control"
6. "Wake word"
7. "Wake word"

### Personal activation word

In addition to a preset activation word ›Hello BMW‹, a personal activation word can be set up in the active driver profile. The personal activation word can also be changed or deleted.

The activation word should consist of multiple syllables to ensure good recognition. An addition such as ›Hello‹ is not necessary.

1. "CAR"
2. "Settings"
3. "General settings"
4. If necessary, "Personal assistant"
5. "Voice control"
6. "Wake word"
7. "Personal wake word"
8. "Set wake word"
9. Select the desired setting.

### Activation word from third-party providers

Depending on the national-market version, some third-party providers provide digital voice assistants, e.g. Amazon Alexa.

Supported voice assistants can be used with a connected smartphone in the vehicle. In addition to the preset or personal activation word, the activation word from connected third-party providers can be used.

1. "CAR"
2. "Settings"
3. "General settings"
4. If necessary, "Personal assistant"
5. "Voice control"
6. "Third-party providers"
7. Select the desired setting.

## Canceling voice control

- ▷  Press the button on the steering wheel again.
- ▷ ›Cancel‹
- ▷ Tilt the Controller to the right or left.
- ▷ Press the Controller.



## Possible commands

### General information

Most contents on the Control Display can be spoken as commands, e.g. menu items or list entries. Say list entries as shown.

Instructions can be issued or questions can be asked where the Personal Assistant provides support.

### Function examples

#### Vehicle status and vehicle information

- ▷ ›Is my tire pressure still OK?‹
- ▷ ›Show me the sport displays.‹
- ▷ ›Open Owner's Manual.‹

#### Navigation

- ▷ ›Drive me to 300 Chestnut Ridge Road, Woodcliff Lake in New Jersey.‹
- ▷ ›Take me home.‹
- ▷ ›Are there any traffic messages?‹

#### Communication

For example, when a mobile phone is connected, calls can be started or SMS can be sent.

- ▷ ›Call John Doe on cell phone.‹
- ▷ ›Dial the number 1 8 0 0 8 3 11117.‹
- ▷ ›New text message to John Doe: I'll be right there.‹

#### Entertainment

- ▷ ›What song is this?‹
- ▷ ›Play Blue Suede Shoes by Elvis Presley‹
- ▷ ›Next title.‹

#### Climate control

- ▷ ›Turn off the air conditioning.‹
- ▷ ›Activate fresh air.‹
- ▷ ›I'm cold.‹

#### Windows and light

- ▷ ›Open the windows automatically.‹
- ▷ ›Delete activation point for automatic power window.‹
- ▷ ›Ambient lighting.‹

#### Owner's Manual via voice operation

You can ask simple questions about vehicle functions and the operation of the vehicle.

The voice activation system and the feedback it provides do not replace the printed or Integrated Owner's Manual. The speech recognition and quality of the feedback may vary.

›How can the passenger airbag be deactivated‹

The Personal Assistant returns feedback. When stationary, the section of the integrated Owner's Manual is displayed on the Control Display.

#### Menu items

The commands of the menu items are spoken just as they are selected via the Controller.

1. Activate the voice control system.
2. ›MEDIA‹
3. ›Presets‹

The stored stations are displayed on the Control Display.

#### Help for voice control

- ▷ ›Voice commands: to have the available spoken commands announced.
- ▷ ›General information on voice control: have information on the operating principle of the voice control announced.
- ▷ ›Help: have help for the current menu read out loud.

## Settings

### Setting the voice control

You can set the system to use standard dialog or a short version.

The short version of the voice control plays back short messages in abbreviated form.

1. "CAR"
2. "Settings"
3. "General settings"
4. If necessary, "Personal assistant"
5. "Voice control"
6. "Response length"
7. Select the desired setting.

### Speaking during voice output

It is possible to answer during inquiries of the voice activation system. The function can be deactivated if inquiries are often undesirably canceled, for instance due to background noise or conversations in the vehicle.

1. "CAR"
2. "Settings"
3. "General settings"
4. If necessary, "Personal assistant"
5. "Voice control"
6. "Speaking during voice output"

### Online speech processing

Online speech processing improves the quality of the speech recognition and search results for points of interest. To use the functions, data is transmitted to a service provider via an encrypted connection and stored locally there.

1. "CAR"
2. "Settings"
3. "General settings"
4. If necessary, "Personal assistant"

5. "Voice control"
6. "Online speech processing"

### Adjusting the volume



Turn the volume button during the voice guidance until the desired volume is set.

The volume remains constant even if the volume of other audio sources is changed.

### Using the voice activation of the smartphone

Depending on the device, a smartphone connected to the vehicle can be used via voice control.

The device must be connected via Apple CarPlay or Android Auto.

1.  Press and hold the button on the steering wheel for approx. 3 seconds.  
The voice activation of the smartphone is activated.
2.  Release the button.  
If activation is successful, a confirmation appears on the Control Display.

## Automating routines

### General information

The Personal Assistant can automate routines, for instance the automatic activation of the seat heating from a specific outside temperature. Rules are created for this purpose, which can be activated and deactivated at any time.

### Activate/deactivate

1. "APPS"
2. "Installed apps"
3. "Personal assistant"
4. "Automate habits"
5. Select the desired setting.

## Caring Car

### Principle

Different vehicle functions in the car's interior are harmonized for the driver in a short-term program.

### General information

By selecting a program, the interior lighting, climate control and music selection will be adjusted. A program takes 3 minutes.

### Activate/deactivate

1. "CAR"
2. "Caring Car"
3. Select the desired program.

The program can be stopped prematurely:  
"End program"

### Adjusting a program

1. "CAR"
2. "Caring Car"
3. Select the desired program.
4. "Music settings"
5. Select the desired setting.

### System limits

- ▶ The Personal Assistant provides information about vehicle functions that may not be installed in the vehicle.  
This also applies to safety-related functions and systems.
- ▶ Certain noises can be detected and may lead to problems. Keep the doors, windows, and glass sunroof closed.
- ▶ Noises from the front passenger or occupants can impair the system. Avoid making other noise in the vehicle while speaking.

- ▶ Major language dialects can cause problems with the speech recognition feature.
- ▶ A poor data connection influences the response time of the Personal Assistant and the Search.

## BMW Gesture Control

### Principle

Several iDrive functions can be operated by hand motion using BMW Gesture Control.

### Overview



The camera in the headliner detects gestures that are carried out in the area of the center console at the height of the Control Display.

### Activate/deactivate

1. "CAR"
2. "Settings"
3. "General settings"
4. "Gesture control"
5. "Gesture control"





### Settings

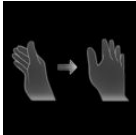

1. "CAR"
2. "Settings"
3. "General settings"
4. "Gesture control"
5. Select the desired setting.

## Carrying out gestures

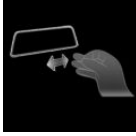
- ▷ Perform gestures underneath the interior mirror and next to the steering wheel.
- ▷ Execute gestures clearly.
- ▷ The gestures can also be executed from the front-passenger side.

## Possible gestures

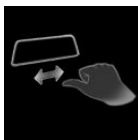
Gesture	Operation	Function
	Move index finger forward and backward in the direction of the screen.	Accept call. Select a highlighted entry in a list during voice control. Confirm pop-up.
	Move hand across the width of the Control Display in the direction of the front-passenger side.	Reject call. Close pop-up. End voice control.
	Slowly move hand clockwise in a circular pattern with the index finger stretched out forward. Gesture is detected after one circular movement.	Increase the volume.
	Slowly move forearm counterclockwise in a circular pattern with the index finger stretched out forward. Gesture is detected after one circular movement.	Reduce the volume.
	Pinch with thumb and index finger and move hand horizontally to the right or left.	Surround View: turn camera view. This gesture can only be executed while the vehicle is stationary.
	Move stretched out index and middle finger forward.	Individually assignable gesture.

Gesture	Operation	Function
	Move fist with thumb extended to the left back and forth.	Reverse Skip function. The previous title is played.
	Move fist with thumb extended to right left back and forth.	Forward Skip function. The next title is played.
	Stretch out five fingers, form a fist and stretch five fingers out again.	Individually assignable gesture.

## Assigning gesture individually

### General information

Two gestures can be assigned individually and can be configured for certain functions, such as:

- ▶ Destination guidance to home address.
- ▶ Mute/Playback
- ▶ Control Display on/off

### Select function

1. "CAR"
2. "Settings"
3. "General settings"
4. "Gesture control"
5. "Function assignment gesture 1" or "Function assignment gesture 2"
6. Select the desired setting.

## System limits

Gesture recognition by the camera in the headliner can be disturbed by the following circumstances:

- ▶ The camera lens is covered.
- ▶ Objects are located on the interior mirror.
- ▶ The camera lens is dirty, clean camera lens.  
Sensors and camera lenses, refer to page [388](#).
- ▶ The gesture is executed outside of the detection range.
- ▶ Wearing of gloves or jewelry.
- ▶ Smoking in the car's interior.



# BMW Remote Software Upgrade

## Vehicle features and options

This chapter describes all standard, country-specific and optional features offered with the series. It also describes features and functions that are not necessarily available in your vehicle, e.g., due to the selected options or country versions. This also applies to safety-related functions and systems. When using these functions and systems, the applicable laws and regulations must be observed.

## BMW Remote Software Upgrade

### Principle

Remote Software Upgrade can be used to update the entire software of the vehicle. This makes new functions, functional enhancements or quality improvements available.

### General information

BMW recommends performing the Remote Software Upgrade as soon as it becomes available.

### Safety information

#### **Warning**

Unattended children or animals in the vehicle can cause the vehicle to move and endanger themselves and traffic, for instance due to the following actions:

- ▷ Pressing the Start/Stop button.
- ▷ Releasing the parking brake.
- ▷ Opening and closing the doors or windows.

- ▷ Engaging selector lever position N.
- ▷ Using vehicle equipment.

There is a risk of accidents or injuries. Do not leave children or animals unattended in the vehicle. Take the vehicle key with you when exiting and lock the vehicle.

### Functional requirement

- ▷ Active ConnectedDrive contract.
- ▷ The integrated SIM card in the vehicle has been activated.
- ▷ Cellular network reception.
- ▷ Consent to transmit the corresponding data was given in the Data Protection menu.

Additional information:

Data protection, refer to page [66](#).

### Search for an upgrade

#### Functional requirement

Standby must be turned on to search for a software upgrade.

#### Automatic search

The vehicle regularly searches for updates in the background.

#### Manual search

1. "CAR"
2. "Settings"
3. "General settings"
4. "Remote Software Upgrade"
5. "Search for upgrades"
6. Follow the instructions on the Control Display.

## Download of an upgrade

### Automatic download

The available data for Remote Software Upgrade is automatically loaded into the vehicle. No download consent is required.

### Via BMW app

If an upgrade is available, information about the new software version is displayed in the BMW app.

The data for the upgrade can then be downloaded to a mobile device, for instance via an existing WLAN connection.

The data can then be transmitted from the mobile device to the vehicle.

This transmission method accelerates the download of the data, for instance in areas with limited mobile network availability.

1. Download the upgrade in the BMW app to the smartphone.
2. Follow the instructions in the BMW app.
3. Establish connection to the vehicle.
  - ▷ iOS: connect Bluetooth audio and WLAN.
  - ▷ Android: connect WLAN.

The data transfer of the upgrade from the mobile device to the vehicle occurs in the background only while driving.

4. Follow the instructions on the Control Display.

Additional information:

Connecting mobile devices to the vehicle, refer to page 72.

## Information about the version

### General information

The information about the version contains a description of the updates included in the Remote Software Upgrade. During the download

and after the installation has been successfully completed, the information about the version can be displayed on the Control Display.

This information is also available in the ConnectedDrive customer portal.

### Displaying information

Display in the vehicle:

1. "CAR"
2. "Settings"
3. "General settings"
4. "Remote Software Upgrade"
5. "Info about version"

Display in the ConnectedDrive customer portal: [www.bmw-connecteddrive.com](http://www.bmw-connecteddrive.com).

## Installing the upgrade

### General information

- ▷ The installation of the upgrade may result in a deletion of software changes, e.g., increases in performance that have been made by parties other than the manufacturer of the vehicle.
- ▷ Modifications to the electrical system of the vehicle, for instance to control units, that have not been made by the vehicle manufacturer can lead to an interruption of the installation.
- ▷ The installation may take approx. 20 minutes.
- ▷ The installation cannot be terminated.
- ▷ The vehicle cannot be used during the installation.
- ▷ The vehicle can be exited during the installation.
- ▷ The installation does not occur until the consent was given.

## Prerequisites for the installation

- ▷ The battery is sufficiently charged.
- ▷ The outside temperature is above 14 °F/-10 °C.
- ▷ The vehicle is parked in a horizontal position.
- ▷ The hazard warning system is turned off.
- ▷ The selector lever position P is engaged.
- ▷ The engine is turned off and sufficiently cooled down.
- ▷ Automatic engine start for pre-conditioning is not activated via iDrive.

If applicable, follow the notes for further prerequisites on the control display.

If the prerequisites are not met, such as a sufficient vehicle battery charge state, the upgrade will not be offered for installation.

Pay attention to an offer for installation, e.g., after longer trips.

## Preparing the vehicle

- ▷ Park the vehicle safely away from the public road.
- ▷ Cellular network reception must be ensured so that a fault message can be sent, for instance if the installation is terminated.
- ▷ Close the windows.
- ▷ Close the glass sunroof.
- ▷ Close the trunk.
- ▷ Remove energy consuming devices, such as a mobile phone.
- ▷ Disconnect any trailer or load carrier.
- ▷ The vehicle key must be located in the vehicle for the consent for installation.
- ▷ Switch off the exterior lighting.
- ▷ Remove the devices connected to the diagnostic socket.

## Starting installation

The upgrade can be installed when all prerequisites have been met.

1. "CAR"
2. "Settings"
3. "General settings"
4. "Remote Software Upgrade"
5. "Start upgrade now"

Follow the instructions on the Control Display.

## Functional limitations

During the upgrade, the majority of functions is temporarily unavailable, for instance:

- ▷ Hazard warning system.
- ▷ Central locking system and, if necessary, Comfort Access.
- ▷ Parking lights.
- ▷ Horn.
- ▷ Alarm system.
- ▷ Emergency call.
- ▷ Power windows.
- ▷ Operation of the tailgate.
- ▷ Glass sunroof.
- ▷ Checking the fuel filler flap lock.

The driver's door can be locked and unlocked from the outside using the integrated key.

## After successful upgrade

The vehicle can be used again immediately.

Booked services such as Advanced Real Time Traffic Information or Remote Services are automatically reactivated during the next trip.

After an extended stationary period, charge the vehicle battery with an extended drive.



## Malfunction

In the event of a malfunction, follow the instructions on the control display or in the BMW app.

If the malfunction cannot be remedied, contact an authorized service center or another qualified service center or a repair shop.

## Validity of the Owner's Manual

### Production of the vehicle

At the time of production at the plant, the printed Owner's Manual is the most current resource.

### After a software update in the vehicle

After a vehicle software update, such as via Remote Software Upgrade, the Integrated Owner's Manual for the vehicle will contain the latest information.

# General settings

## Vehicle features and options

---

This chapter describes all standard, country-specific and optional features offered with the series. It also describes features and functions that are not necessarily available in your vehicle, e.g., due to the selected options or country versions. This also applies to safety-related functions and systems. When using these functions and systems, the applicable laws and regulations must be observed.

## Time

---

### Setting the time zone

1. "CAR"
2. "Settings"
3. "General settings"
4. "Date and time"
5. "Time zone:"
6. Select the desired setting.

### Setting the time

1. "CAR"
2. "Settings"
3. "General settings"
4. "Date and time"
5. "Time:"
6. Turn the Controller until the desired hours are displayed.
7. Press the Controller.
8. Turn the Controller until the desired minutes are displayed.
9. "OK"

### Setting the time format

1. "CAR"
2. "Settings"
3. "General settings"
4. "Date and time"
5. "Time format:"
6. Select the desired setting.

## Automatic time setting

---

Depending on your vehicle's optional features, the time, date and, if needed, the time zone are updated automatically.

1. "CAR"
2. "Settings"
3. "General settings"
4. "Date and time"
5. "Automatic time setting"

## Date

---

### Setting the date

1. "CAR"
2. "Settings"
3. "General settings"
4. "Date and time"
5. "Date:"
6. Turn the Controller until the desired day is displayed.
7. Press the Controller.
8. Make the settings for the month and year.
9. "OK"

## Setting the date format

1. "CAR"
2. "Settings"
3. "General settings"
4. "Date and time"
5. "Date format:"
6. Select the desired setting.

## Language

---

### Setting the system language

1. "CAR"
2. "Settings"
3. "General settings"
4. "Language"
5. Select the desired setting.

## Setting the units of measurement

---

Depending on the national-market version, you can set the units of measurement for some values, for instance consumption, distances, and temperature.

1. "CAR"
2. "Settings"
3. "General settings"
4. "Units"
5. Select the desired setting.

## Driver Attention Camera

---

### Principle

A camera that monitors driver activity is located in the instrument cluster. The camera evaluates the head position and eye opening and uses the data to analyze the attention of

the driver. This system supports various vehicle assistance systems, e.g.:

- ▷ Fatigue alert.
- ▷ Steering Assistant with Assisted Driving Plus.

### Activating/deactivating

1. "CAR"
2. "Settings"
3. "General settings"
4. "Driver Attention Camera"
5. Select the desired setting.

### System limits

The Driver Attention Camera may not be fully functional in the following situations:

- ▷ When the Driver Attention Camera is covered by the steering wheel rim.
- ▷ When the driver is wearing infrared impermeable sunglasses.

## Trip data settings

---

### Principle

The intervals in which the trip data will be reset can be configured.

### Resetting trip data

1. "CAR"
2. "Settings"
3. "General settings"
4. "Reset trip data"
5. Select the desired setting.

## Speed warning

---

### Principle

The speed warning can be used to set a speed limit. A warning will be issued when this speed limit is exceeded.

### General information

The warning is repeated if the vehicle speed exceeds the set speed limit again after dropping below it by 3 mph/5 km/h.

### Adjusting

1. "CAR"
2. "Settings"
3. "General settings"
4. "Speed warning"
5. "Warning at:"
6. Turn the Controller until the desired speed is displayed.
7. Press the Controller.

### Activate/deactivate

1. "CAR"
2. "Settings"
3. "General settings"
4. "Speed warning"
5. "Speed warning"

### Applying current speed as the speed warning

1. "CAR"
2. "Settings"
3. "General settings"
4. "Speed warning"
5. "Select current speed"

## Activating/deactivating pop-ups

---

For some functions, pop-ups are displayed automatically on the Control Display. Some of these pop-ups can be activated or deactivated.

1. "CAR"
2. "Settings"
3. "General settings"
4. "Pop-ups"
5. Select the desired setting.

## Control Display

---

### Brightness

1. "CAR"
2. "Settings"
3. "Displays"
4. "Control display"
5. "Brightness at night"
6. Press the Controller.
7. Turn the Controller until the desired brightness is set.
8. Press the Controller.

Depending on the light conditions, the brightness control may not be clearly visible.

## Reset vehicle data

---

All individual settings can be reset to the factory settings when the drive-ready state is switched off.

1. "CAR"
2. "Settings"
3. "General settings"
4. "Reset vehicle data"
5. "Reset vehicle data"

When the saved settings in a driver profile are synchronized with the ConnectedDrive account, these settings will remain in the ConnectedDrive account.

## Notifications

### Principle

The menu centrally displays all notifications arriving in the vehicle in form of a list.

### General information

The following notifications can be displayed:

- ▷ Traffic messages.
- ▷ Check Control messages.
- ▷ Messages on service notifications.
- ▷ Communication messages, for example e-mails, SMS text messages or reminders.
- ▷ Messages, for instance from the BMW app.
- ▷ Messages from the manufacturer of the vehicle, for instance technical information or important customer information.

The number of notifications is additionally displayed in the status field.

### Go to notifications

1. Tip the Controller up.
2. "Notifications"
3. Select desired notification.

### Delete notifications

Notifications can be deleted from the list.

Sustained Check Control messages or messages from the vehicle manufacturer with important customer information are displayed as long as they are relevant.

1. Tip the Controller up.
2. "Notifications"
3. Select desired notifications.

4.  Press the button.
5. Select the desired setting.

## Settings



It is possible to set which notifications are permitted and which notifications will be displayed at the start of the trip or upon completion of the trip.

1. Tip the Controller up.
2. "Notifications"
3. Tilt the Controller to the right.
4. "Settings"
5. Select the desired setting.

## Display, notifications

### General information

The BMW Intelligent Personal Assistants allows the configuration of the range of messages that will be displayed. Depending on the situation, the desired condition can be activated.

Condition	Description
"Do not disturb"	Incoming calls and non-critical notifications are not displayed.  Icon is shown in the status information with the number of messages.
"Passenger on board"	Private contents, such as messages, will not be displayed directly.  Icon is shown in the status information with the number of messages.

### Activate/deactivate

1. Tip the Controller up.
2. "Notifications"



3. Tilt the Controller to the right.
4. "Notification display"
5. Select the desired setting.

# Personal settings

## Vehicle features and options

This chapter describes all standard, country-specific and optional features offered with the series. It also describes features and functions that are not necessarily available in your vehicle, e.g., due to the selected options or country versions. This also applies to safety-related functions and systems. When using these functions and systems, the applicable laws and regulations must be observed.

## Data protection

### Data transfer

#### Principle

The vehicle offers different services, whose use requires a data transfer to BMW or a service provider.

#### General information

The data transfer can be deactivated for some services. When the data transfer is deactivated, the respective service cannot be used.

#### Settings

The data transfer can be configured in different stages or individually for separate services.

1. "CAR"
2. "Settings"
3. "General settings"
4. "Data privacy"
5. Select the desired setting.

## Deleting personal data in the vehicle

### Principle

Depending on the usage, the vehicle stores personal data, such as stored radio stations. This personal data can be permanently deleted using iDrive.

### General information

Depending on the equipment, the following data is deleted:

- ▶ Driver profile settings.
- ▶ Stored radio stations.
- ▶ Stored programmable memory buttons.
- ▶ Trip computer and on-board computer information.
- ▶ Navigation, for instance stored destinations.
- ▶ Phone book.
- ▶ Online data, for instance Favorites, cookies.
- ▶ Office data, for instance voice memos.
- ▶ Login accounts.
- ▶ Linking vehicle and ConnectedDrive account.

Altogether, the deletion of the data can take up to 15 minutes.

### Functional requirement

Data can only be deleted while stationary.

### Deleting data

The personal data in the vehicle will be deleted when the vehicle is reset to the factory settings.

Additional information:

Resetting vehicle data, refer to page [63](#).

## Driver profiles

### Principle

Driver profiles can be created to store personal vehicle settings. If the vehicle is used by multiple drivers, each driver can create his personal driver profile. When a driver profile is selected, the vehicle will automatically apply the stored settings in the driver profile.

### General information

Three personal driver profiles can be created.

In addition, a guest profile is available that can be selected by any driver. The guest profile is active when a personal driver profile has not been selected.

Changes to the vehicle settings are automatically stored in the active driver profile or in the guest profile.

The vehicle can already adjust to the driver when it is unlocked. For this purpose, the recognition via a vehicle key or a digital key must be assigned to a driver profile.

**ConnectedDrive countries:** The settings stored in the driver's profile can be synchronized with the personal BMW ConnectedDrive account. It is thereby possible to use these settings in other BMW vehicles as well.

### Functional requirements

When a driver profile is created, switched or deleted, the vehicle must move at a maximum of walking speed.

### Welcome screen

After the Control Display is switched on, the Welcome screen will be displayed.

The following actions can be carried out on the Welcome screen:

- ▶ Switch the driver profile.
- ▶ Starting the set-up assistant.

This option is offered in new vehicle for a limited period of time.

As soon as the engine is started or any button is pressed, the Welcome screen will be hidden.

### Setup assistant

The setup assistant is offered in new vehicles for a limited period of time on the Welcome screen to configure the most important settings for the vehicle.

"Getting started" Select to start the set-up assistant.

The set-up assistant can be started via iDrive at any time.

1. "CAR"
2. "Settings"
3. "General settings"
4. "Getting started"

The driver is guided step by step through the following functions:

- ▶ Setting the system language.
- ▶ ConnectedDrive countries:
  - If the set-up assistant was opened in the guest profile: create driver profile.
- ▶ Pairing mobile devices with the vehicle.
- ▶ If the set-up assistant was opened from an already defined driver profile: set up personal assistant.
  - ▶ Depending on whether the set-up assistant was opened from an already defined driver profile or a guest profile: set up services or confirm the explanation for the transmission of vehicle related data.
- ▶ Set up other methods for use.

The selected settings are stored in the active driver's profile.

### Guest profile

The guest profile can be activated by any driver. Vehicle settings that are entered when

the guest profile is active will be stored in the guest profile.

In the following cases the guest profile is automatically active:

- ▷ A driver profile has not been created yet.
- ▷ No driver profile has been assigned to the vehicle key that was used to unlock the vehicle.
- ▷ No driver profile has been assigned to the digital key that was used to unlock the vehicle.

The following limitations apply:

- ▷ The guest profile cannot be renamed.
- ▷ It is not possible to assign the recognition to the guest profile.
- ▷ It is not possible to assign a PIN to the guest profile.
- ▷ ConnectedDrive countries: It is not possible to synchronize with a ConnectedDrive account.

The guest profile is selected on the Welcome screen or via iDrive:

1. "CAR"
2. "Driver profiles"

As an alternative for Steps 1 and 2, the profile image can be tapped in the top status bar.

3. "Guest"
4. "OK"

## Creating a driver profile

1. "CAR"
2. "Driver profiles"
3. Tilt the Controller to the right.

As an alternative for Steps 1 to 3, the profile image can be tapped in the top status bar.

4. "Add driver profile"
- Non-ConnectedDrive countries: A name must be entered for the driver profile.

ConnectedDrive countries: An existing ConnectedDrive account must be assigned to a driver profile. The following options are available for this purpose:

- ▷ "Via My BMW app"
  - Scanning the displayed QR code will accept the access data for the ConnectedDrive account from the BMW app.
- ▷ "Log in"
  - The access data must be entered via iDrive.
- ▷ "New registration"
  - Scan the displayed QR code and follow the instructions on the smartphone.

5. If the vehicle is in the guest profile: "Transfer current settings"
  - The settings of the guest profile are applied.
6. ConnectedDrive countries: "Synchronize driver profile"
  - Future changes to the settings are synchronized with the BMW Cloud.

## Selecting recognition

1. "CAR"
2. "Driver profiles"
3. Tilt the Controller to the right.
  - As an alternative for Steps 1 to 3, the profile image can be tapped in the top status bar.
4. "Driver recognition"
5. Select the desired setting:
  - ▷ "with vehicle key"
    - The vehicle key that is recognized in the vehicle interior is assigned to the driver profile. If multiple vehicle keys are detected, the unintended vehicle keys must be removed from the vehicle interior.
  - ▷ "With Digital Key"

The digital key that is recognized in the vehicle interior is assigned to the driver profile. If multiple digital keys are detected, the unintended digital keys must be removed from the vehicle interior.

#### 6. "Activate linkage"

If the vehicle key or the smartphone with the digital key is not carried with you or not recognized, the driver profile can only be selected on the Welcome screen when a PIN has been set up.

## Automatic recognition

If recognition has been defined, automatic activation of the driver profile is triggered by the following activities:

- ▷ By unlocking the vehicle using the button on the assigned vehicle key.
- ▷ By unlocking the vehicle using an external door handle. The assigned vehicle key or the assigned Digital Key must be carried with you.
- ▷ By automatic unlocking when approaching the vehicle. The assigned vehicle key or the assigned Digital Key must be carried with you. Depending on the country, it may not be possible to recognize the Digital Key.

If there are several vehicle keys or Digital Keys in the vicinity of the vehicle, activation of the driver profile is done according to the following priority:

- ▷ The key that unlocks the vehicle triggers activation of the assigned driver profile.  
If the vehicle is unlocked using an unassigned key, the guest profile is activated.
- ▷ If a vehicle key and a Digital Key are detected at the same time, the Digital Key triggers the activation of the assigned driver profile.
- ▷ If another key is detected on the driver's door after activation of the driver profile, the driver profile of the last key detected is activated.

If no driver profile is assigned to this key, the guest profile is activated.

## Setting up a PIN

A driver profile with recognition cannot be activated without vehicle key and without digital key. In this case, a PIN can be set up to activate the driver profile.

Countries in which ConnectedDrive is not available: If a PIN was not set up or the PIN is not known, the driver profile cannot be activated.

Countries in which ConnectedDrive is available: If a PIN was not set up or the PIN is not known, the driver's profile can be activated with the access data of the corresponding ConnectedDrive account.

1. "CAR"
2. "Driver profiles"
3. Tilt the Controller to the right.  
As an alternative for Steps 1 to 3, the profile image can be tapped in the top status bar.
4. "Driver recognition"
5. "using PIN"

## Changing/canceling the recognition function

When another vehicle key or another digital key is assigned to a driver profile, the current assignment must be canceled first.

1. "CAR"
2. "Driver profiles"
3. Tilt the Controller to the right.  
As an alternative for Steps 1 to 3, the profile image can be tapped in the top status bar.
4. "Driver recognition"
5. Select the desired setting:
  - ▷ "with vehicle key"
  - ▷ "With Digital Key"
6. "Activate linkage"

When the vehicle and vehicle key will be handed over, such as for maintenance, carry out the following steps first:

- ▷ Setting up PIN.
- ▷ Canceling recognition using the vehicle key.
- ▷ Switching to the guest profile.

The handed over vehicle key can then no longer be used to access the personal driver profile.

## Selecting a driver profile

Depending on the recognition setting, the driver profile will be selected automatically.

If the guest profile is active, the driver profile will be selected on the Welcome screen or via iDrive. A PIN may have to be entered.

1. "CAR"
2. "Driver profiles"

As an alternative for Steps 1 and 2, the profile image can be tapped in the top status bar.

3. Select driver profile.
4. "OK"

All settings stored in the selected driver profile are automatically applied.

## Switching synchronization with the ConnectedDrive account on/off

The settings stored in the driver's profile are synchronized with the personal ConnectedDrive account. This means that it is possible to use the personal settings in other BMW vehicles with ConnectedDrive access as well, if this function is supported.

The synchronization with the ConnectedDrive account is enabled when a driver profile is created or via iDrive:

1. "CAR"
2. "Driver profiles"
3. Tilt the Controller to the right.

As an alternative for Steps 1 to 3, the profile image can be tapped in the top status bar.

4. "Settings"
5. "Synchronize driver profile"
6. "Synchronize driver profile"

## Renaming a driver profile

Non-ConnectedDrive countries:

1. "CAR"
2. "Driver profiles"

As an alternative for Steps 1 and 2, the profile image can be tapped in the top status bar.

3. Select driver profile.
4. "Settings"
5. Enter a profile name.
6. **OK** Select the icon.

ConnectedDrive countries:

The name of the driver profile is transferred from the ConnectedDrive account. Changes for the profile name must be made in the ConnectedDrive account.

## Selecting a profile picture

1. "CAR"
2. "Driver profiles"
3. Tilt the Controller to the right.

As an alternative for Steps 1 to 3, the profile image can be tapped in the top status bar.

4. "Avatar"
5. Select the desired profile picture.

ConnectedDrive countries:

The profile image is transferred from the ConnectedDrive customer portal or the BMW app.

## Deleting the driver profile

1. "CAR"
2. "Driver profiles"
3. Tilt the Controller to the right.

As an alternative for Steps 1 to 3, the profile image can be tapped in the top status bar.

4. "Settings"
5. "Remove driver profile"
6. Select the desired driver profile.
7. "Delete now"

ConnectedDrive countries: If the driver profile was synchronized with a ConnectedDrive account, the stored data in the ConnectedDrive account will be retained.

## System limits

A clear detection of the desired vehicle key may not be possible in the following cases, e.g.:

- ▶ The driver changes, but the vehicle is not locked and unlocked.
- ▶ When multiple vehicle keys or multiple digital keys with an assigned driver profile are located in the outer area on the driver's side of the vehicle.
- ▶ When the vehicle was unlocked from the BMW app.

ConnectedDrive countries:

A driver profile can only be created and synchronized with the ConnectedDrive account when the vehicle has cellular network reception.

The use of personal settings that are stored in the ConnectedDrive account in other vehicles is subject to technical limitations. For example, settings may be stored for a system that is not available, or available in a non-compatible version, in other vehicles.

# Connections

## Vehicle features and options

This chapter describes all standard, country-specific and optional features offered with the series. It also describes features and functions that are not necessarily available in your vehi-

cle, e.g., due to the selected options or country versions. This also applies to safety-related functions and systems. When using these functions and systems, the applicable laws and regulations must be observed.





## Connecting mobile devices to the vehicle

### Principle



Various connection types are available for using mobile devices in the vehicle. The connection type to select depends on the mobile device and the desired function.

### General information

The following overview shows possible functions and the suitable connection types for them. The range of functions depends on the mobile device.

Function	Connection type	Icon in the device list
Making calls via the hands-free system. Using phone functions via iDrive or touchscreen. Other functions, e.g. Contacts or SMS.	Bluetooth.	
Playing music from the smartphone or the audio system.	Bluetooth audio.	
WLAN in the vehicle: Using apps in the vehicle.	Wi-Fi.	
Wi-Fi hotspot: Using the vehicle Internet access.	Wi-Fi.	
USB port: Playing music or videos from a USB device.	USB.	



Function	Connection type	Icon in the device list
Apple CarPlay: Using apps via iDrive and via voice operation.	Bluetooth and Wi-Fi.	
Android Auto: Using apps via iDrive and via voice operation.	Bluetooth and Wi-Fi.	

The following connection types require one-time pairing with the vehicle:

- ▷ Bluetooth.
- ▷ Wi-Fi.

Paired devices are automatically recognized later on and connected to the vehicle.

## Safety information

### **Warning**

Operating the integrated information systems and communication devices while driving can distract from surrounding traffic. It is possible to lose control of the vehicle. There is a risk of accident. Only use the systems or devices when the traffic situation allows. As warranted, stop and use the systems and devices while the vehicle is stationary.

## Compatible devices

### General information

Information on compatible mobile devices is available as follows:

- ▷ On the BMW homepage.
- ▷ Via Hotline/Customer Support
- ▷ At an authorized service center or another qualified service center or repair shop.

## Displaying the vehicle identification number and software part number

With a search for compatible devices, you may have to state the vehicle identification number and the software part number. These numbers can be displayed in the vehicle.

1. "COM"
2. "Mobile devices"
3. Tilt the Controller to the right.
4. "Settings"
5. "Bluetooth@ info"
6. "System information"

## Managing mobile devices

### General information

- ▷ After one-time pairing, the devices are automatically recognized and reconnected when standby state is switched on.
- ▷ After stored content on the SIM card or the mobile phone, such as contacts, has been detected, the data is transmitted to the vehicle and can be used via iDrive.
- ▷ For some devices, certain settings are necessary, for instance authorization; see the operating instructions of the device.

### Displaying the device list







All devices paired with or connected to the vehicle are displayed in the device list.

A maximum of four devices can be connected to the vehicle via Bluetooth®, and a maximum of ten devices can be connected to the vehicle via Wi-Fi.

1. "COM"
2. "Mobile devices"

An icon to the right of the device name indicates, for which function the device is used.

When the icon is displayed in white, this function is actively connected to the vehicle. The icon is displayed in gray when the function of the device is inactive.

Icon	Meaning
	Telephone.
	Bluetooth audio.
	WLAN in the vehicle, Wi-Fi hotspot.
	Apps.
	Apple CarPlay.
	Android Auto.

## Configuring the device

Functions can be activated or deactivated for paired and connected devices.

The range of functions depends on the mobile device.

Follow the information on the Control Display.

1. "COM"
2. "Mobile devices"
3. Select the desired device.
4. Select the desired setting:

- ▷ "Connect device"

The functions that were assigned to the device before disconnecting are assigned to the device when it is reconnected. The functions may be deactivated on a device already connected.

- ▷ "Disconnect device"

The device remains paired and can be connected again.

- ▷ "Delete device"

The device is disconnected and removed from the device list.

- ▷ "Connection mode"

Select a connection mode, for instance Apple CarPlay.

- ▷ "Telephone"

Set telephone.

- ▷ "Bluetooth® audio"

Playback of music files on external devices such as audio devices or mobile phones via Bluetooth®.

- ▷ "Apps"

With the installed BMW app, apps from the smartphone can be displayed in the vehicle.

- ▷ "Wi-Fi®"

Connects the device with the WLAN in the vehicle.

## Priority of the phones

When multiple mobile phones are connected to the vehicle, you can specify the priority of the mobile phones. The mobile phone with the highest priority is preferred, for instance for outgoing calls and messages.

1. "COM"
2. "Mobile devices"
3. Tilt the Controller to the right.
4. "Settings"
5. "Priorities for telephones"
6. Select the desired device.
7. Select the desired priority by sliding.

## Bluetooth connection

### Functional requirements

- ▷ Compatible device with Bluetooth interface. Compatible devices, refer to page 73.
- ▷ The vehicle key or BMW display key is in the vehicle.
- ▷ The device is ready for operation.
- ▷ Bluetooth is switched on in the vehicle and on the device.
- ▷ The pairing readiness is displayed on the Control Display.
- ▷ Bluetooth presettings, such as visibility, may be required on the device; refer to the operating instructions of the device.

### Activate Bluetooth

1. "COM"
2. "Mobile devices"
3. Tilt the Controller to the right.
4. "Settings"
5. "Bluetooth®"
6. Select setting.

### Connecting the device

1. "COM"
2. "Mobile devices"
3. Tilt the Controller to the right.
4. "New device"
5. "Phone calls and audio"
 

The vehicle's Bluetooth name is displayed on the Control Display.
6. Compare the control number displayed on the Control Display with the control number on the display of the mobile device, and confirm that the two match.
7. A Bluetooth connection is established.

The mobile device is connected to the vehicle and displayed in the device list.

## Frequently Asked Questions

All prerequisites are met and all required steps were completed in the specified order. Despite that, the mobile device does not function as expected.

In this case, the following explanations can help:

Why could the mobile phone not be paired or connected?

- ▷ There are too many Bluetooth devices connected to the mobile phone or vehicle.

In the vehicle, delete Bluetooth connections with other devices.

Delete the Bluetooth connection from the device list on the mobile phone and start a new device search.

Too many Bluetooth devices with the same function are paired. Adapt the functions in the device list on the control display.

- ▷ The mobile phone is in power-save mode or has only a limited remaining battery life. Charge the mobile phone and deactivate the power-save mode where required.

Why does the mobile phone no longer react?

- ▷ The applications on the mobile phone do not function anymore.

Switch the mobile phone off and on again.

- ▷ Too high or too low ambient temperature for mobile phone operation.

Do not subject the mobile phone to extreme ambient temperatures.

Why can telephone functions not be used via iDrive?

- ▷ Phone functions are not configured for the mobile phone.

Connect the mobile phone with the telephone function.

Why are no or not all telephone book entries displayed or why are they incomplete?

- ▶ Transmission of the telephone book entries is not yet complete.
- ▶ It is possible that only the telephone book entries of the mobile phone or the SIM card are transmitted.
- ▶ It may not be possible to display telephone book entries with special characters.
- ▶ It may not be possible to transmit contacts from social networks.
- ▶ The number of phone book entries to be transmitted is too high.
- ▶ Data volume of the contact too large, for instance due to stored information such as memos.

Reduce the data volume of the contact.

- ▶ The mobile phone has only been connected as an audio source.

Configure the mobile phone and connect it with the telephone function.

- ▶ Contact was created in the contact list of the phone after the last synchronization.

Synchronize contacts again: "Reload contacts"

How can the telephone connection quality be improved?

- ▶ Adjust the strength of the Bluetooth signal on the mobile phone, depending on the mobile phone.
- ▶ Insert the mobile phone into the wireless charging tray.
- ▶ Adjust the volume of the microphone separately in the sound settings.

If all points in this list have been checked and the required function is still not available, contact Customer Relations, an authorized service center or another qualified service center or repair shop.

## WLAN connection

---

### General information

For certain applications, such as apps, the data exchange between smartphone and vehicle occurs via WLAN.

### Functional requirements

- ▶ Standby state is switched on.
- ▶ Compatible device with activated WLAN interface.

### Activate WLAN in the vehicle

1. "COM"
2. "Mobile devices"
3. Tilt the Controller to the right.
4. "Settings"
5. "Wi-Fi®"

## Wi-Fi hotspot

---

### Principle

Compatible devices with WLAN interface can use the Internet connection of the vehicle via the Wi-Fi hotspot.

### General information

Up to ten devices can be connected to the Wi-Fi hotspot simultaneously.

### Functional requirements

- ▶ Compatible device with activated WLAN interface.  
Compatible devices, refer to page 73.
- ▶ WLAN is activated on the vehicle.
- ▶ Internet use is activated for the vehicle.
- ▶ Registration and data contract with a service provider where required.
- ▶ Standby state is switched on.

## Connecting a device to the Internet via the Wi-Fi hotspot

Using the Internet for the first time via the Wi-Fi hotspot requires registration and possibly a data volume purchase from a service provider.

Depending on the national-market version, data volume can be purchased via the connected mobile communication device or from the ConnectedDrive Store.

1. "COM"
2. "Mobile devices"
3. Tilt the Controller to the right.
4. "New device"
5. "Internet, apps"  
Hotspot name and hotspot code are displayed on the Control Display.
6. Activate Internet usage via WLAN if necessary.  
"Open settings"
7. Activate Internet usage.  
"Wi-Fi hotspot"
8. Tilt the Controller to the left.
9. Search for WLAN networks on the mobile device. Select network name on the device.
10. Enter hotspot code on the device and connect.

The device is displayed in the device list. Additionally, a QR code will be displayed on the Control Display. Alternatively, this QR code can be used to pair the mobile device with the hotspot.

All devices connected via the hotspot use this data volume.

## Deactivating Internet usage via the Wi-Fi hotspot

Internet usage may be deactivated if the data volume is used up, for instance.

1. "COM"
2. "Mobile devices"
3. Tilt the Controller to the right.
4. "Settings"
5. "Wi-Fi hotspot"
6. Select the desired setting.

## Apple CarPlay® preparation

### Principle

CarPlay allows select functions of a compatible Apple iPhone to be used via Siri voice control and iDrive.

### Functional requirements

- ▶ Compatible iPhone, iPhone 5 or later with iOS 7.1 or later.  
Compatible devices, refer to page [73](#).
- ▶ Corresponding mobile contract.
- ▶ Bluetooth, Wi-Fi, and Siri voice control are activated on the iPhone.
- ▶ If necessary, the setting for mobile data must be activated on the iPhone.
- ▶ Wi-Fi and Bluetooth are enabled in the vehicle.

### Pairing the iPhone with CarPlay

1. "COM"
2. "Mobile devices"
3. Tilt the Controller to the right.
4. "New device"
5. "Phone calls and audio"

The vehicle's Bluetooth name is displayed on the Control Display.



6. On the mobile device, search for Bluetooth devices in the vicinity and select the vehicle. A control number is displayed.
7. Compare the control number displayed on the Control Display with the control number on the display of the mobile device, and confirm that the two match.
8. "Use Apple CarPlay"

The iPhone is connected to the vehicle and displayed in the device list.

## Operation

For more information, refer to the Integrated Owner's Manual or the Owner's Manual for Navigation, Entertainment, Communication.

## Frequently Asked Questions

All prerequisites are met and all required steps were completed in the specified order. Despite that, the mobile device does not function as expected.

In this case, the following explanations can help:

The iPhone has already been paired with Apple CarPlay. When a new connection is set up, CarPlay can no longer be selected.

- ▶ Delete the iPhone concerned from the device list.
- ▶ On the iPhone, delete the vehicle concerned from the list of stored connections under Bluetooth and under WLAN.
- ▶ Pair the iPhone as a new device.

If the desired function is still not carried out after the measures listed have been performed: contact Customer Relations, an authorized service center or another qualified service center or repair shop.

## Android Auto<sup>®</sup> preparation

### Principle

Android Auto allows select functions of a compatible smartphone to be operated via Google Assistant voice control and via iDrive.

### General information

The range of services offered depends on the country.

### Functional requirements

- ▶ Compatible Android smartphone: Samsung or Google smartphone with Android 10 or an Android smartphone with Android 11, regardless of the manufacturer.
- ▶ Compatible devices, refer to page 73.
- ▶ Corresponding mobile contract.
- ▶ Bluetooth and WLAN are enabled on the smartphone.
- ▶ The smartphone must support a Wi-Fi connection with 5 GHz.
- ▶ If necessary, the setting for mobile data must be activated on the smartphone.
- ▶ Wi-Fi and Bluetooth are enabled in the vehicle.

### Pairing a smartphone with Android Auto

1. "COM"
2. "Mobile devices"
3. Tilt the Controller to the right.
4. "New device"
5. "Phone calls and audio"  
The vehicle's Bluetooth name is displayed on the Control Display.
6. On the mobile device, search for Bluetooth devices in the vicinity and select the vehicle. A control number is displayed.

7. Compare the control number displayed on the Control Display with the control number on the display of the mobile device, and confirm that the two match.
8. "Use Android Auto"
9. If necessary, finish the setup on the mobile device.

The smartphone is connected to the vehicle and displayed in the device list.

## Operation

For more information, refer to the Integrated Owner's Manual or the Owner's Manual for Navigation, Entertainment, Communication.

## Frequently Asked Questions

All prerequisites are met and all required steps were completed in the specified order. Despite that, the mobile device does not function as expected.

In this case, the following explanations can help:

The smartphone has already been paired with Android Auto. When a new connection is set up, Android Auto can no longer be selected.

- ▷ Delete the smartphone concerned from the device list.
- ▷ On the smartphone, delete the vehicle concerned from the list of stored connections under Bluetooth and under WLAN.
- ▷ Pair the smartphone as a new device.

If the desired function is still not carried out after the measures listed have been performed: contact Customer Relations, an authorized service center or another qualified service center or repair shop.

## USB connection

### General information

The following mobile devices can be connected to the USB port:

- ▷ Mobile phones.
- ▷ Audio devices such as MP3 players.
- ▷ USB storage devices.

Common file systems are supported. FAT32 and exFAT are the recommended formats.

A connected USB device will be supplied with charge current via the USB port if the device supports this. Follow the maximum charge current of the USB port.

The following uses are possible on USB ports with data transfer:

- ▷ Playing music files.
- ▷ Playing videos.

Follow the following when connecting:

- ▷ Do not use force when plugging the connector into the USB port.
- ▷ Use a flexible adapter cable.
- ▷ Protect the USB device against mechanical damage.
- ▷ Due to the large number of USB devices available on the market, it cannot be guaranteed that every device is operable on the vehicle.
- ▷ Do not expose USB devices to extreme environmental conditions, such as very high temperatures; refer to the operating instructions of the device.
- ▷ Due to the many different compression techniques, proper playback of the media stored on the USB device cannot be guaranteed in all cases.
- ▷ To ensure proper transmission of the stored data, do not charge a USB device



via the onboard socket, when it is connected to the USB port.

- ▷ Depending on how the USB device is being used, settings may be required on the USB storage device, refer to the operating instructions of the device.

Not compatible USB devices:

- ▷ USB hard drives.
- ▷ USB hubs.
- ▷ USB memory card readers with multiple slots.
- ▷ HFS-formatted USB devices.
- ▷ Devices such as fans or bulbs.

## Functional requirement

Compatible device with USB port.

Additional information:

Compatible devices, refer to page [73](#).

## Connecting the device

Connect the USB device using a suitable adapter cable to a USB port.

The USB device is displayed in the device list.

Additional information:

USB port, refer to page [293](#).



# Opening and closing

## Vehicle features and options

This chapter describes all standard, country-specific and optional features offered with the series. It also describes features and functions that are not necessarily available in your vehicle, e.g., due to the selected options or country versions. This also applies to safety-related functions and systems. When using these functions and systems, the applicable laws and regulations must be observed.

## Vehicle key

### General information

Depending on the equipment version, the scope of delivery includes two vehicle keys or one vehicle key and the BMW display key.

Each vehicle key contains a replaceable battery.

Depending on the equipment and national-market version, various settings are possible for the button functions.

A driver profile with personal settings can be assigned to a vehicle key.

To provide information on maintenance recommendations, the service data is stored in the vehicle key.

To prevent possible locking in of the vehicle key, take the vehicle key with you when exiting the vehicle.

## Safety information

### **Warning**

The vehicle key has a button cell battery. Batteries or button cell batteries can be swallowed and lead to serious or fatal injuries within two hours, for example due to internal burns or chemical burns. There is a risk of injury or danger to life. Keep the vehicle key and batteries out of reach of children. Immediately seek medical help if there is any suspicion that a battery or button cell battery has been swallowed or is located in any part of the body.

### **Warning**

People or animals in the vehicle can lock the doors from the inside and lock themselves in. In this case, the vehicle cannot be opened from the outside. There is a risk of injury. Take the vehicle key with you so that the vehicle can be opened from the outside.

### **Warning**

For some national-market versions, unlocking from the inside is only possible with particular knowledge.

If persons spend a lengthy time in the vehicle and are thereby exposed to extreme temperatures, there is a risk of injury or danger to life. Do not lock the vehicle from the outside when there are people in it.

**Warning**

Unattended children or animals in the vehicle can cause the vehicle to move and endanger themselves and traffic, for instance due to the following actions:

- ▷ Pressing the Start/Stop button.
- ▷ Releasing the parking brake.
- ▷ Opening and closing the doors or windows.
- ▷ Engaging selector lever position N.
- ▷ Using vehicle equipment.

There is a risk of accidents or injuries. Do not leave children or animals unattended in the vehicle. Take the vehicle key with you when exiting and lock the vehicle.

Overview

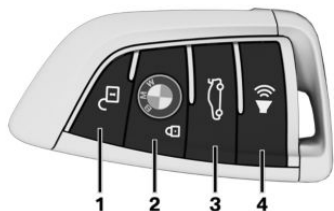

- 1** Unlocking
- 2** Locking  
Stationary climate control through Remote Engine Start [283](#)
- 3** To open the tailgate
- 4** Panic mode, pathway lighting

Unlocking

General information

The behavior of the vehicle during unlocking using the vehicle key depends on the following settings:

- ▷ If only the driver's door and the fuel filler flap or all access to the vehicle will be unlocked when the button is pressed for the first time.
- ▷ If the unlocking of the vehicle is confirmed with a light signal or a sound signal.
- ▷ If the welcome light is switched on when the vehicle is being unlocked.  
Welcome lights, refer to page [176](#).

Unlocking the vehicle



Press the button on the vehicle key.

If only the driver's door and fuel filler flap have been unlocked due to the settings, press the button on the vehicle key again to unlock the other vehicle access points.

In addition, the following functions are executed:

- ▷ If a driver profile has been assigned to the vehicle key, this driver profile will be activated and the settings that are saved in it will be applied.
- ▷ The interior lights are switched on, unless they were manually switched off.
- ▷ Folded in exterior mirrors are folded out.  
If the exterior mirrors were folded in via the button in the vehicle interior, they will not be folded out during unlocking.
- ▷ With anti-theft protection: Anti-theft protection is switched off.
- ▷ With alarm system: The alarm system will be switched off.

After opening one of the front doors, the vehicle is ready for operation.

The lighting functions may depend on the ambient brightness.

Convenient opening



Press and hold the button on the vehicle key after unlocking.

The windows and the glass sunroof with sun protection are opened, as long as the button on the vehicle key is pressed.

## Locking

### General information

The behavior of the vehicle during locking using the vehicle key depends on the following settings:

- ▶ If the locking of the vehicle is confirmed with a light signal or a sound signal.
- ▶ If the exterior mirrors are automatically folded in when the vehicle is locked. The exterior mirrors are not folded in when the hazard warning flashers are switched on.
- ▶ If pathway lighting is activated during locking.

### Locking the vehicle

1. Close the driver's door.

2.  Press the button on the vehicle key.

The following functions are executed:

- ▶ All doors, the tailgate, and the fuel filler flap are locked.
- ▶ With anti-theft protection: Anti-theft protection is switched on. This prevents the doors from being unlocked using the lock buttons or the door openers.
- ▶ With alarm system: The alarm system will be switched on.

If the drive readiness is still turned on when you lock the vehicle, the vehicle horn will honk twice. In this case, the drive-ready state must be switched off by means of the Start/Stop button.

## With Comfort Access: convenient closing

### Safety information

#### Warning

With convenient closing, body parts can be jammed. There is a risk of injury. Make sure that the area of movement of the doors is clear during convenient closing.

### Closing



- ▶ Press and hold the button on the vehicle key in close range to the vehicle after locking.

The windows and the glass sunroof with sun protection are closed, as long as the button on the vehicle key is pressed.

The exterior mirrors are folded in unless they were folded in during locking. The exterior mirrors are not folded in when the hazard warning flashers are switched on.

### Switching on the interior and exterior lighting



- ▶ Press the button on the vehicle key with the vehicle locked.

The function is not available for the first 10 seconds after locking.

- ▶ The interior lights are switched on, unless they were manually switched off.  
Interior lights, refer to page 180.
- ▶ Depending on the settings, parts of the exterior lighting will be switched on.

The lighting functions may depend on the ambient brightness.



## Tailgate

### General information

To avoid locking the vehicle key in the vehicle, do not place the vehicle key in the cargo area.

Depending on the vehicle equipment and country version, it is possible to specify whether the tailgate can be unlocked with the vehicle key and how the vehicle doors will respond to this.

Selector lever position P must be engaged to open the tailgate with the vehicle key.

When the trailer power socket is occupied, the tailgate cannot be opened with the vehicle key or with the button in the car's interior.

### Safety information

#### **Warning**

Body parts can be jammed when operating the tailgate. There is a risk of injury. Make sure that the travel path of the tailgate is clear during opening and closing.

#### **Warning**

The tailgate swings back and up when it opens. There is a risk of injury or risk of damage to property. Make sure that the travel path of the tailgate is clear during opening and closing.

#### **NOTICE**

Sharp-edged or pointed objects can hit the windows and heating elements while driving. There is a risk of damage to property, among other potential damage. Cover the edges and ensure that pointed objects do not hit the windows.

### Opening



Press and hold the button on the vehicle key for approx. 1 second.

### Switching pathway lighting on



Press and hold the button on the vehicle key for approx. 1 second.

It is possible to adjust the duration of the pathway lighting feature.

Additional information:

Pathway lighting, refer to page [177](#).

### Replacing the battery

#### **NOTICE**

Improper batteries in a battery-operated device can damage the device. There is a risk of damage to property, among other potential damage. Always replace the discharged battery with a battery with the same voltage, the same size and the same specification.

1. Remove the integrated key from the vehicle key.  
Integrated key, refer to page [95](#).
2. Place the integrated key underneath the battery compartment cover, arrow 1, and lift the lid with a lever movement of the integrated key, arrow 2.

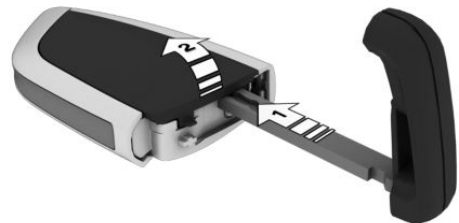

3. Push battery in arrow direction using a pointed object and lift it out.

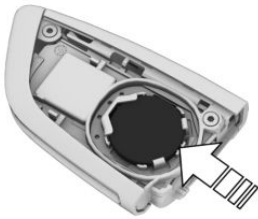

4. Insert a type CR 2032 3 V battery with the positive side facing up.
5. Press the lid closed.
6. Push the integrated key into the vehicle key until the integrated key engages.



Have old batteries disposed of by an authorized service center or another qualified service center or repair shop or take them to a collection point.

## Additional vehicle keys

Additional vehicle keys are available from an authorized service center or another qualified service center or repair shop.

## Loss of vehicle keys

A lost vehicle key can be disabled and replaced by an authorized service center or another qualified service center or repair shop.

If the lost vehicle key has an assigned driver profile, the connection to this vehicle key must be deleted. A new vehicle key can then be assigned to the driver profile.

## Malfunction

### General information

A Check Control message is displayed.

Vehicle key detection by the vehicle may malfunction under the following circumstances:

- ▶ The battery of the vehicle key is discharged.
- ▶ Fault of the radio link from transmission towers or other equipment with high transmitting power.
- ▶ Shielding of the vehicle key due to metal objects.

Do not transport the vehicle key together with metal objects.

- ▶ Fault of the radio link from mobile phones or other electronic devices in direct proximity to the vehicle key.

Do not carry the vehicle key in close proximity to other electronic devices.

- ▶ Fault of radio transmission by a charging process of mobile devices, for instance charging of a mobile phone.
- ▶ The vehicle key is located in direct proximity of the wireless charging tray.

Place the vehicle key in a different location.

In the case of interference, the vehicle can also be unlocked and locked from the outside with the integrated key.

Additional information:

Integrated key, refer to page 95.

## Switching the drive-ready state on via emergency detection of the vehicle key

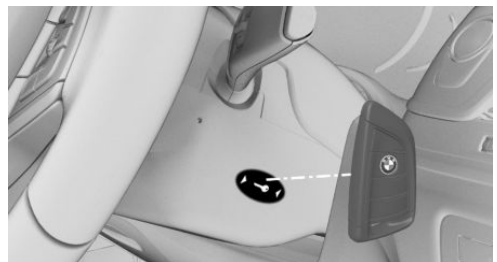

It is not possible to switch on the drive-ready state if the vehicle key has not been detected.

Proceed as follows in this case:

1. Hold the rear of the vehicle key against the mark on the steering column. Pay attention to the display in the instrument cluster.
2. If the vehicle key is detected:  
Turn on drive-ready state within 10 seconds.

If the vehicle key is not recognized, slightly change the position of the vehicle key and repeat the procedure.

## Frequently Asked Questions

What precautions can be taken to be able to open a vehicle, despite accidentally locking in the vehicle key?

- ▶ The options provided by the Remote Services of the BMW app include the ability to lock and unlock a vehicle.  
This requires an active BMW ConnectedDrive contract and the BMW app must be installed on a smartphone.
- ▶ Unlocking the vehicle can be requested via the BMW ConnectedDrive Call Center.  
An active BMW ConnectedDrive contract is required.

## BMW display key

### General information

Depending on the country, the BMW display key may not be available.

In this case, independent heating can be operated via the BMW app.

The scope of delivery of the BMW display key includes an additional mechanical key. If the display key is used, the mechanical key should be carried with you, for instance in the wallet. The mechanical key is used like the integrated key.

The display key supports all functions of the standard vehicle key.

In addition, the following functions are also available:

- ▶ Display status of doors and windows.
- ▶ Display status of the alarm system.
- ▶ Display service information.
- ▶ Call up range with available fuel.
- ▶ With pre-heating: operate pre-heating.  
Without pre-heating: operate pre-ventilation.
- ▶ Pre-conditioning through Remote Engine Start

Additional information:

Integrated key, refer to page 95.

## Safety information

### **Warning**

People or animals in the vehicle can lock the doors from the inside and lock themselves in. In this case, the vehicle cannot be opened from the outside. There is a risk of injury. Take the vehicle key with you so that the vehicle can be opened from the outside.

### **Warning**

For some national-market versions, unlocking from the inside is only possible with particular knowledge.

If persons spend a lengthy time in the vehicle and are thereby exposed to extreme temperatures, there is a risk of injury or danger to life. Do not lock the vehicle from the outside when there are people in it.

### **Warning**

Unattended children or animals in the vehicle can cause the vehicle to move and endanger themselves and traffic, for instance due to the following actions:

- ▷ Pressing the Start/Stop button.
- ▷ Releasing the parking brake.
- ▷ Opening and closing the doors or windows.
- ▷ Engaging selector lever position N.
- ▷ Using vehicle equipment.

There is a risk of accidents or injuries. Do not leave children or animals unattended in the vehicle. Take the vehicle key with you when exiting and lock the vehicle.

With pre-heating: the pre-heating can be operated.

Without pre-heating: the pre-ventilation can be operated.

- ▷ Outside of the reception range of the vehicle, you can display the last transmitted status information from the vehicle.
-  The icon is shown on the display if one of the buttons is pressed outside of the reception range.

## Overview



- 1 To open the tailgate
- 2 Unlocking
- 3 Press and hold or press three times in quick succession: panic mode  
Press briefly: pathway lighting
- 4 Locking
- 5 Display
- 6 Back
- 7 Turn the display on/off
- 8 Micro-USB charging interface

## Reception range

The number of available display key functions depends on the distance from the vehicle.

- ▷ When you are in close proximity to the vehicle, all functions of the display key are available.
- ▷ The status information can be called up in the extended reception range.



## Display

### General information

The display is divided into the upper status line, the information area, and the lower status line.

### Upper status line

The upper status line displays the following information:

- ▷  /  Vehicle secured/vehicle unsecured.
- ▷ Set time in the vehicle.
- ▷  Charge state of the display key battery.

### Information area

The information area can be used to access information and perform additional functions.

If the information area contains more than one page, then page indicators are shown beneath the information.

 A solid indicator denotes the current page.

Swipe to the right or left with a finger to change between the pages.

If further information is available on a page, tap the appropriate icon.

To return to the original page:  tap on the icon beneath the display.

## Lower status line

The lower status line indicates whether or not the display key is within reception range.

- ▶ "Connected": the display key is within reception range.
- ▶ "Updated": the display key is not within reception range. It indicates when the last data transfer from the vehicle took place.

## Turning on/off

The display will go out automatically after a short time to conserve battery power.

Hiding the display on the display manually: press the button on the left side of the display key.

To show the display:

1. Press the button on the left side of the display key.
2. Then, swipe with your finger from bottom to top to unlock the screen lock.

To turn off the display to increase the usable battery life:



1. If necessary, cancel the screen lock.
2. Press and hold the button on the left side of the display key for longer than 4 seconds.
3. "OK"

To turn the display on:

Press the button on the left side of the display key.

## Operating concept

The following information shows how to access the information and functions using the main menus.

Main menu	Information/Function
"Security information"	 Door status. Alarm system status. After alarm activation: date, time, and reason for the alarm activation.
	<hr/>  Window status. Glass sunroof status.
"Vehicle information"	Service interval indicators of Condition Based Service. Status of the roadside parking lights.
"Mobility info"	Range with available fuel.
"Preconditioning setting"	With pre-heating: operate pre-heating. Without pre-heating: operate pre-ventilation. Stationary climate control through Remote Engine Start.

## Display key battery

### General information

Follow the following information:

- ▶ If the charge state of the display key battery declines, the display is switched off automatically. The battery must be recharged so that the display can be switched back on. The operability of the standard buttons is retained until the battery is completely discharged.
- ▶ Charge the battery for at least three hours before using the display key for the first time or if the key has not been used for an extended period.



- ▷ The display key can be used while it is being charged via the USB port. If the battery is fully discharged, it may take some time before the display key can be used again.
- ▷ Due to the large number of USB chargers available on the market, it cannot be guaranteed that every charger will function properly. The charging time depends on the charger used.
- ▷ Charging via the USB port may heat up the charger and the display key.  
Charging in the wireless charging tray may heat up the tray and the display key.  
At higher temperatures, the charge current through the display key may be reduced, and in isolated cases the charging process may be interrupted temporarily.
- ▷ When inserting the display key into the wireless charging tray, make sure there are no objects between it and the wireless charging tray.

## Safety information

### **Warning**

When charging a device that meets the Qi standard in the wireless charging tray, any metal objects located between the device and the tray can become very hot. Placing storage devices or electronic cards, such as chip cards, cards with magnetic strips or cards for signal transmission, between the device and the tray may impair the card function. There is a risk of injury and risk of damage to property. When charging mobile devices, make sure there are no objects between the device and the tray.

## Charging

### Via USB

Connect the display key via the micro-USB charging interface to a USB port.

### Manual transmission: in the center armrest



1. Open the center armrest.
2. Place the display key into the bulge of the wireless charging tray underneath the center armrest.  
Make sure that the display is on the side of the retaining clip and that the lock button points upward.
3. Close the center armrest.

### Steptronic transmission: in the center console



1. Open the tray cover.
2. Place the display key into the middle of the wireless charging tray in front of the cup holders.  
Ensure that the display is facing up.
3. Close the tray cover.

## LED displays

Color	Meaning
Blue	The display key is charging. The blue LED stays illuminated once the inserted display key is fully charged.
Orange	The display key is not charging. Temperature on the display key possibly too high or foreign object in charging tray.
Red	The display key is not charging. Contact an authorized service center or another qualified service center or repair shop.

## Malfunction

### General information

A Check Control message is displayed. BMW display key detection by the vehicle may malfunction under the following circumstances:

- ▶ The battery of the display key is discharged.
- ▶ Fault of the radio link from transmission towers or other equipment with high transmitting power.
- ▶ Shielding of the display key due to metal objects.
- ▶ Fault of the radio link from mobile phones or other electronic devices in direct proximity.
- ▶ Fault of radio transmission by a charging process of mobile devices, for instance charging of a mobile phone.

Do not transport the display key together with metal objects or electronic devices.

In the case of interference, the vehicle can also be unlocked and locked from the outside with the mechanical key.

## Turning on drive-ready state via emergency detection of the BMW display key

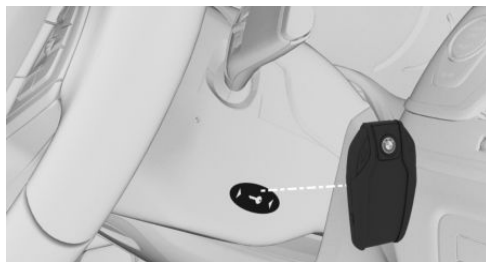

It is not possible to switch on the drive-ready state if the display key has not been detected. Proceed as follows in this case:

1. Hold the display key with its rear against the mark on the steering column. Pay attention to the display in the instrument cluster.
2. If the display key is detected:  
Turn on drive-ready state within 10 seconds.

If the display key is not detected, slightly change the position of the display key and repeat the procedure.

### Resetting the BMW display key

If the charged display key cannot be turned on anymore or if the display does not respond to entries anymore, the display key can be reset.

Press and hold the following buttons on the display key at the same time for at least 10 seconds until the display is switched off and then on again:



## Key Card

### Principle

The Key Card allows the vehicle to be unlocked and locked, as well as started.

### General information

The availability of the Key Card depends on the equipment and the country.

A digital key that has already been paired with the vehicle is installed on the Key Card. The digital key must be activated via iDrive.

Before leaving the vehicle, deactivate the Key Card or take the Key Card with you because the active Key Card can be used to start the vehicle. Always take the vehicle key with you to a service appointment.

### Safety information

#### **Warning**

People or animals in the vehicle can lock the doors from the inside and lock themselves in. In this case, the vehicle cannot be opened from the outside. There is a risk of injury. Take the vehicle key with you so that the vehicle can be opened from the outside.

#### **Warning**

For some national-market versions, unlocking from the inside is only possible with particular knowledge.

If persons spend a lengthy time in the vehicle and are thereby exposed to extreme temperatures, there is a risk of injury or danger to life. Do not lock the vehicle from the outside when there are people in it.

#### **Warning**

Unattended children or animals in the vehicle can cause the vehicle to move and endanger themselves and traffic, for instance due to the following actions:

- ▷ Pressing the Start/Stop button.
- ▷ Releasing the parking brake.
- ▷ Opening and closing the doors or windows.
- ▷ Engaging selector lever position N.
- ▷ Using vehicle equipment.

There is a risk of accidents or injuries. Do not leave children or animals unattended in the vehicle. Take the vehicle key with you when exiting and lock the vehicle.

### Connection to the vehicle

The communication between the vehicle and the Key Card uses near field communication, NFC.

### Activating/deactivating Key Card in the vehicle

#### General information

The Key Card must be located in the smartphone tray and a vehicle key must be located in the vehicle to activate the Key Card.

A vehicle key must be located in the vehicle to deactivate the Key Card.

When the BMW Digital Key is activated for the vehicle, a digital key can be used instead of the vehicle key.

A deactivated Key Card remains in the list of paired digital keys.

## Activating Key Card

1. Open the cover of the smartphone tray.
2. Place Key Card in the center of the smartphone tray.
3. Follow the instructions on the Control Display to activate the Key Card.

## Deactivating Key Card

1. "CAR"
2. "Settings"
3. "Doors/ vehicle access"
4. "Digital Key"
5. Select Key Card.
6. "Key Card active"

A deactivated Key Card remains in the list of paired digital keys.

## Unlocking and locking the vehicle

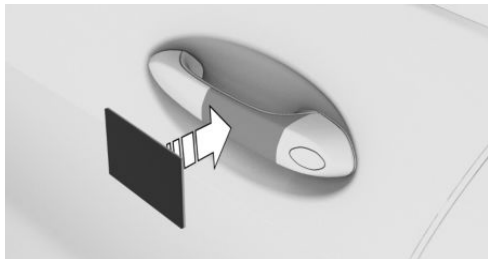

Hold activated Key Card directly on the center of the external door handle of the driver's door. If the Key Card is not detected, slightly change the position of the Key Card and repeat the procedure.

## Turning on the drive-ready state

### **NOTICE**

If the Key Card and a mobile device are in the wireless charging tray at the same time, the Key Card could become damaged. There is a risk of damage to property, among other potential damage. Do not place the Key Card

in the wireless charging tray at the same time as a mobile device.

1. Open the cover of the smartphone tray.
2. Place activated Key Card in the center of the smartphone tray.
3. Press the Start/Stop button to start the engine.

With wireless charging tray: After starting the engine, take the Key Card out of the tray to make tray available for charging compatible smartphones.

## Malfunction

The detection of the Key Card by the vehicle may be disrupted by objects between the sensors and the Key Card, for instance a wallet or smartphone cover.

## BMW Digital Key

### Principle

BMW Digital Key allows the vehicle to be unlocked and locked, as well as started, with a compatible smartphone.

### General information

The availability of the BMW Digital Key depends on the equipment and national-market version.

BMW Digital Key can be used with a compatible smartphone or other compatible mobile devices, such as a Smartwatch.

To unlock and start a vehicle with a compatible smartphone, this function must be offered by the smartphone manufacturer. The BMW app provides a check to determine if the smartphone and the vehicle are compatible.

A driver profile with individual settings can be assigned to a digital key.

Additional information:

Driver profiles, refer to page 67.

When using a smartphone as a digital key, always carry a vehicle key or the activated Key Card with you. This ensures access to the vehicle, even in the event of a smartphone failure. It is also helpful to have the vehicle key or Key Card with you if the vehicle needs to be handed over to another person. You can then hand over the vehicle key or the Key Card instead of your smartphone. Always take the vehicle key with you to a service appointment.

## Safety information

### **Warning**

People or animals in the vehicle can lock the doors from the inside and lock themselves in. In this case, the vehicle cannot be opened from the outside. There is a risk of injury. Take the vehicle key with you so that the vehicle can be opened from the outside.

### **Warning**

For some national-market versions, unlocking from the inside is only possible with particular knowledge.

If persons spend a lengthy time in the vehicle and are thereby exposed to extreme temperatures, there is a risk of injury or danger to life. Do not lock the vehicle from the outside when there are people in it.

### **Warning**

Unattended children or animals in the vehicle can cause the vehicle to move and endanger themselves and traffic, for instance due to the following actions:

- ▷ Pressing the Start/Stop button.
- ▷ Releasing the parking brake.
- ▷ Opening and closing the doors or windows.

- ▷ Engaging selector lever position N.
- ▷ Using vehicle equipment.

There is a risk of accidents or injuries. Do not leave children or animals unattended in the vehicle. Take the vehicle key with you when exiting and lock the vehicle.

## Connection to the vehicle

The communication between the vehicle and the smartphone uses near field communication, NFC.

## Functional requirements

- ▷ The smartphone is compatible with BMW Digital Key
- ▷ The vehicle is linked with the Connected-Drive account of the vehicle owner.
- ▷ The rechargeable battery of the smartphone has a sufficient charge. The necessary minimum charge of the rechargeable battery depends on the smartphone.

## Enabling the digital remote control key

Vehicle owner's smartphone is enabled as a digital remote control key in the vehicle. The vehicle owner must prove his authorization for the vehicle for this purpose.

The proof of authorization can be started via the BMW app or the activation code in the corresponding smartphone function, e.g., the Wallet app. Both vehicle keys must be located in the vehicle to be enabled.

Follow the instructions in the Digital Key menu in the BMW app or on the Control Display.

## Sharing digital keys

### General information

Digital key allows the sharing of digital keys with other people. This option is available via the smartphone that is enabled as digital re-

remote control key. This function must be supported by the smartphone.

### Forwarding authorization

To share the digital key, select the corresponding function on the smartphone, for instance in the Wallet app.

As soon as a digital key is shared with another person, the person will receive an invitation. When the invitation is accepted, the digital key on the recipient's smartphone will be activated.

### Limiting the range of functions

Certain functions of the digital key can be limited before handing it over. For instance, if the Digital Key is passed on to a novice driver, the switch-off for driving stability control systems can be disabled and the engine power can be reduced. For more information, refer to the ConnectedDrive portal and the BMW app.

### Authentication

Depending on the recipient's smartphone model, an authentication may be required for security and safety reasons.

An authorized vehicle key, the digital remote control key or another method may be used for authentication. Follow the corresponding instructions on the smartphone or the Control Display.

### Deleting a shared key

#### General information

Shared keys can be deleted via the smartphone with the digital remote control key, via the smartphone with a shared key or via iDrive.

The deletion via the smartphone using the digital remote control will not be performed until the vehicle is used with a key other than the key to be deleted.

The deletion via the smartphone with a shared key or via iDrive is executed immediately.

Deleted digital keys will be removed from the list of enabled digital keys.

Deleted digital keys cannot be restored.

### Deletion via iDrive

To be able to delete a digital key via iDrive, an authorized vehicle key must be located in the vehicle or the remote control key must be located in the smartphone tray.

1. "CAR"
2. "Settings"
3. "Doors/ vehicle access"
4. "Digital Key"
5. If necessary, select the digital key.
6. "Delete key"

### Resetting the function

To reset the BMW Digital Key function, an authorized vehicle key must be located in the vehicle.

When resetting the BMW Digital Key function, all digital keys including the digital main key will be deleted. The Key Card digital key is not deleted.

After the reset, the vehicle can no longer be unlocked, locked or started with a digital key.

The digital remote control key must be enabled again to be able to use BMW Digital Key again.

1. "CAR"
2. "Settings"
3. "Doors/ vehicle access"
4. "Digital Key"
5. "Reset function"

## Unlocking and locking the vehicle

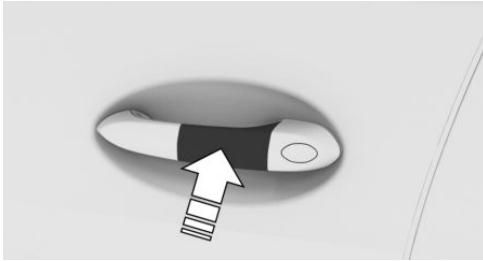

Hold the near field communication antenna of the smartphone directly and centered on the external door handle of the driver's door.

The position of the near field communication antenna depends on the smartphone model.

When locking the vehicle with the smartphone, make sure that all doors and also the tailgate are closed.

## Turning on the drive-ready state

1. Open the cover of the smartphone tray.
2. Place smartphone in the center of the smartphone tray.  
Ensure that the display is facing up.
3. Close the cover of the smartphone tray.
4. Press the Start/Stop button to start the engine.

## Sale of the smartphone

Delete all digital keys on the smartphone prior to selling the smartphone. This ensures that the smartphone can no longer be used for the vehicle.

## Sale of the vehicle

Prior to selling a vehicle, reset the Digital Key function or remove the vehicle from the ConnectedDrive account of the current vehicle owner.

When the vehicle is removed from the ConnectedDrive account, all digital keys for the ve-

hicle will be deleted. The Key Card digital key is not deleted.

## System limits

The interior motion sensor and tilt alarm sensor of the alarm system cannot be switched off with a digital key.

Additional information:

Alarm system, refer to page [107](#).

## Malfunction

Digital key recognition by the vehicle may malfunction under the following circumstances:

- ▶ The smartphone is shielded from the sensors in the vehicle by a smartphone cover that is not suitable.
- ▶ Objects such as a chip card or the Key Card are located between the smartphone and the smartphone cover.

## Integrated key

### General information

The driver's door can be locked and unlocked without the vehicle key using the integrated key.

Depending on the national-market version, the integrated key also fits in the glove compartment.

## Safety information

### Warning

For some national-market versions, unlocking from the inside is only possible with particular knowledge.

If persons spend a lengthy time in the vehicle and are thereby exposed to extreme temperatures, there is a risk of injury or danger to life. Do not lock the vehicle from the outside when there are people in it.

**NOTICE**

The door lock is permanently joined with the door. The door handle can be moved. When pulling the door handle with the integrated key inserted, paint or the integrated key can be damaged. There is a risk of damage to property, among other potential damage. Remove the integrated key before pulling the external door handle.

Removing

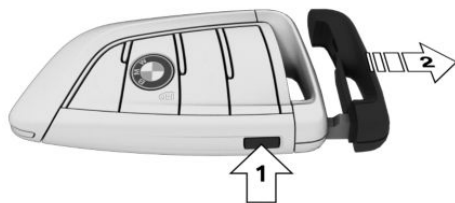

Press the button, arrow 1, and pull out the integrated key, arrow 2.

Locking/unlocking via the door lock

1. Pull and hold the door handle outward with one hand.

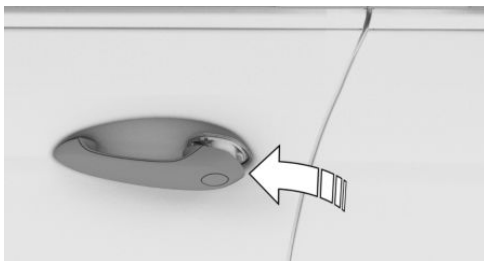

2. Guide one finger of your other hand from the back under the cover cap and push the cover cap out.

Use the thumb for counter support to prevent the cover cap from falling out of the door handle.

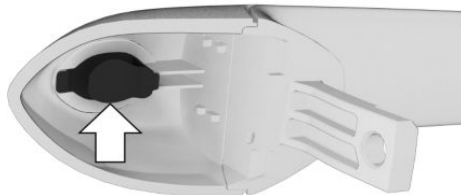

3. Remove the cover cap.
4. Unlock or lock the door lock using the integrated key.

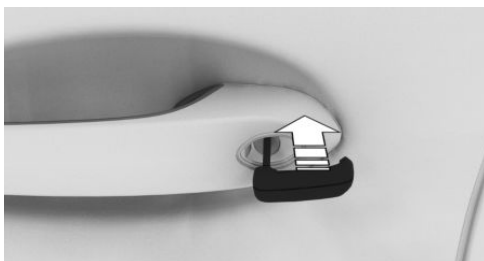

The other doors must be unlocked or locked from the inside.



## Alarm system

If the vehicle is unlocked with the integrated key via the door lock, the activated alarm system will be triggered when the door is opened.

If the vehicle is locked with the integrated key via the door lock, the alarm system will not be activated.

## Buttons for the central locking system

### General information

In the event of a severe accident, the vehicle is automatically unlocked. The hazard warning system and interior lights come on.

### Overview



Buttons for the central locking system.

### Locking

 Press the button with the front doors closed.

- ▷ The fuel filler flap remains unlocked.
- ▷ The vehicle is not secured against theft when locking.

### Unlocking

 Press the button.

## Opening

- ▷  Press the button to unlock all the doors.  
Pull the door opener above the armrest.
- ▷ Front doors: pull the door handle on the door to open the door. The other doors remain locked.
- ▷ Back doors: pull twice on the door handle on the door to be opened; the first time unlocks the door, the second time opens it. The other doors remain locked.

## Comfort Access

### Principle

The vehicle can be accessed without operating the vehicle key.

Carrying the vehicle key with you, e.g., in your pants pocket, is sufficient.

The vehicle automatically detects the vehicle key when it is in close proximity or in the interior.

### General information

Comfort Access supports the following functions:

- ▷ Unlocking and locking the vehicle from the door handle.
- ▷ Convenient closing.
- ▷ Touchless unlocking and locking of the vehicle.
- ▷ Unlocking and locking the vehicle using the BMW Digital Key.
- ▷ Open the tailgate.
- ▷ Contactless trunk opening and closing.



## Functional requirements

- ▷ To lock the vehicle, the vehicle key must be outside of the vehicle near the doors.
- ▷ The next unlocking and locking cycle is not possible until after approx. 2 seconds.

## Unlocking

### General information

The behavior of the vehicle during unlocking via the Comfort Access depends on the following settings:

- ▷ If the unlocking of the vehicle is confirmed with a light signal or a sound signal.
- ▷ If the welcome light is switched on when the vehicle is being unlocked.

### Unlocking the vehicle



Grasp the handle of a vehicle door completely.

In addition, the following functions are executed:

- ▷ If a driver profile was assigned to the vehicle key, this driver profile will be activated and the settings that are stored in it will be applied.
- ▷ The interior lights are switched on, unless they were manually switched off.
- ▷ Folded in exterior mirrors are folded out.  
If the exterior mirrors were folded in via the button in the interior, they will not be folded out when unlocking.

- ▷ With anti-theft protection: Anti-theft protection is switched off.
- ▷ With alarm system: The alarm system will be switched off.

## Locking

### General information

The behavior of the vehicle during locking via the Comfort Access depends on the following settings:

- ▷ If the locking of the vehicle is confirmed with a light signal or a sound signal.
- ▷ If the exterior mirrors are automatically folded in when the vehicle is locked. The exterior mirrors are not folded in when the hazard warning flashers are switched on.
- ▷ If pathway lighting is activated during locking.

### Locking the vehicle

Close the driver's door.

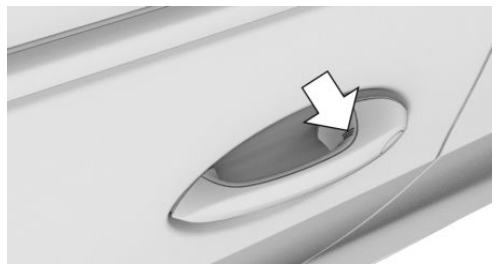

Touch the grooved surface on the handle of a closed vehicle door with your finger for approx. 1 second without grasping the door handle.

The following functions are executed:

- ▷ All doors, the tailgate, and the fuel filler flap are locked.
- ▷ With anti-theft protection: Anti-theft protection is switched on. This prevents the doors

from being unlocked using the lock buttons or the door openers.

- ▶ With alarm system: The alarm system will be switched on.

## Convenient closing

### Safety information

#### **Warning**

With convenient closing, body parts can be jammed. There is a risk of injury. Make sure that the area of movement of the doors is clear during convenient closing.

### Closing

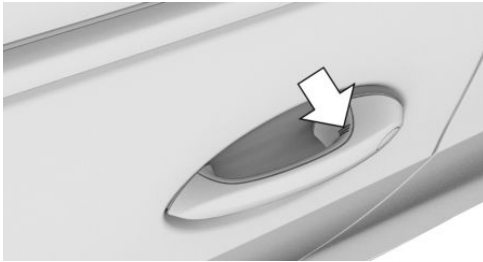

Touch the grooved surface on the handle of a closed vehicle door with your finger and hold it there without grasping the door handle.

In addition to locking, the windows and glass sunroof with sun protection will be closed.

The exterior mirrors are folded in unless they were folded in during locking. The exterior mirrors are not folded in when the hazard warning flashers are switched on.

## Opening the tailgate

### General information

If the tailgate is opened via Comfort Access, locked doors are not unlocked.

To avoid locking the vehicle key in the vehicle, do not place the vehicle key in the cargo area.

### Safety information

#### **Warning**

Body parts can be jammed when operating the tailgate. There is a risk of injury. Make sure that the travel path of the tailgate is clear during opening and closing.

#### **Warning**

The tailgate swings back and up when it opens. There is a risk of injury or risk of damage to property. Make sure that the travel path of the tailgate is clear during opening and closing.

#### **NOTICE**

Sharp-edged or pointed objects can hit the windows and heating elements while driving. There is a risk of damage to property, among other potential damage. Cover the edges and ensure that pointed objects do not hit the windows.

### Opening

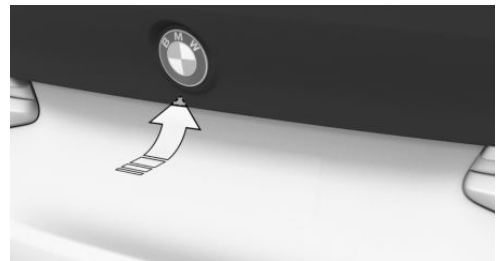

Press the button on the outer side of the tailgate.

## Opening and closing the tailgate with no-touch activation

### Principle

The trunk can be opened and closed contactless using the vehicle key you are carrying. Two sensors detect a forward-directed foot movement in the central rear area and the tailgate is opened and closed.

### General information

To avoid locking the vehicle key in the vehicle, do not place the vehicle key in the cargo area. If the vehicle key is in the sensor area, the tailgate may open or close inadvertently if you unintentionally move your foot or if a foot movement is detected.

The sensor has an approximate range of 5 ft/1.50 m extending from the rear area.

If contactless opening of the tailgate is activated, the locked doors will not be unlocked.

### Safety information

#### **Warning**

During no-touch activation, vehicle parts may be touched, such as the hot exhaust system. There is a risk of injury. When moving your foot, make sure you have a firm stance and do not touch the vehicle.

#### **Warning**

Body parts can be jammed when operating the tailgate. There is a risk of injury. Make sure that the travel path of the tailgate is clear during opening and closing.

#### **Warning**

The tailgate swings back and up when it opens. There is a risk of injury or risk of damage to property. Make sure that the travel path of the tailgate is clear during opening and closing.

#### **NOTICE**

Sharp-edged or pointed objects can hit the windows and heating elements while driving. There is a risk of damage to property, among other potential damage. Cover the edges and ensure that pointed objects do not hit the windows.

### Functional requirements

Touchless opening and closing of the tailgate is not possible when the trailer socket is in use. Selector lever position P must be engaged for touchless opening of the tailgate. Contactless trunk opening and closing must be activated in the settings.

### Settings

Contactless opening and closing of the tailgate can be switched on or off.

1. "CAR"
2. "Settings"
3. "Doors/ vehicle access"
4. "Tailgate"

### Performing the foot movement

1. Stand in the middle behind the vehicle at approx. one arm's length away from the rear of the vehicle.
2. Wave a foot under the vehicle in the driving direction and immediately pull it back. With

this movement, the leg must pass through the ranges of both sensors.

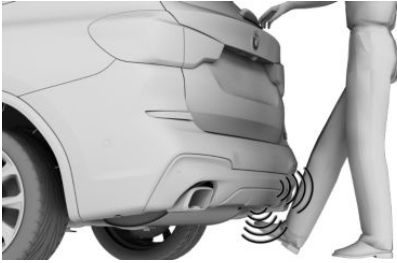

## Opening

Perform the foot movement described earlier. Before the tailgate opens, the hazard warning system flashes.

Moving your foot again will stop the opening procedure, and moving it one more time after that will close the tailgate.

## Closing

Perform the foot movement described earlier. The hazard warning system flashes and an acoustic signal sounds.

Moving your foot again will stop the closing motion, and moving it one more time after that will re-open the tailgate.

## System limits

The detection of the foot movement may be limited due to the following external conditions:

- ▶ Ice, snow or slush on the rear of the vehicle.
- ▶ Dirt or road salt on the rear of the vehicle.

Movement in the range of the sensors may cause unintended opening or closing of the cargo area, for instance due to water running down when cleaning the vehicle or with heavy rainfall. To prevent such unintended opening or closing of the cargo area in such cases, keep the vehicle key at a sufficient distance from the rear of the vehicle.

## Touchless unlocking and locking of the vehicle

### Principle

When the driver approaches the locked vehicle with the vehicle key, the vehicle is unlocked.

When the driver walks away from the unlocked vehicle with the vehicle key, the vehicle will be locked.

### General information

The vehicle will be unlocked when an authorized vehicle key is detected in the unlocking zone.

The unlocking zone is located within a radius of approx. 5 ft/1.50 m around the door handles.

The vehicle will be locked when the vehicle key leaves the locking zone.

The locking zone is located within a radius of approx. 9 ft/2 m around the door handles.

If the vehicle key is located in the unlocking zone for an extended period of time without movement, the vehicle will be locked automatically.

If a passenger is detected in the front passenger seat during locking and the seat belt of the front passenger is engaged in the seat belt buckle during locking:

- ▶ The vehicle will be locked but not secured against theft.
- ▶ The fuel filler flap remains unlocked.

The behavior of the vehicle during touchless unlocking/locking depends on the following settings:

- ▶ If the automatic unlocking is active.
- ▶ If the automatic locking is active.
- ▶ If only the driver's door and the fuel filler flap or all access to the vehicle will be unlocked.

Only driver's door and fuel filler flap: the driver's door and fuel filler flap will only be



unlocked when the driver approaches the vehicle on the driver's side.

All vehicle entry points: the vehicle will be unlocked regardless of the side on which the driver approaches the vehicle.

- ▶ If the unlocking and locking of the vehicle is confirmed with a light signal or a sound signal.
- ▶ If the welcome light is switched on when the vehicle is being unlocked.
- ▶ If pathway lighting is activated during locking.
- ▶ If the exterior mirrors are automatically folded out and in when the vehicle is unlocked and locked.

## Functional requirements

- ▶ The drive-ready state must be turned off.
- ▶ Unlocking: when entering the unlocking zone, the doors and tailgate must be closed.
- ▶ Locking: when leaving the locking zone, the doors and tailgate must be closed.
- ▶ For contactless locking of the vehicle, no second vehicle key may be within a radius of 18 ft/6 m around the vehicle.
- ▶ If the vehicle has been in the idle state for several days, contactless unlocking/locking will only be available after the vehicle has been driven.

## Malfunction

Vehicle key detection by the vehicle may malfunction under the following circumstances:

- ▶ The battery of the vehicle key is discharged. For replacing the battery, refer to page 84.
- ▶ Fault of the radio link from transmission towers or other equipment with high transmitting power.
- ▶ Shielding of the vehicle key due to metal objects.

Do not transport the vehicle key together with metal objects.

- ▶ Fault of the radio link from mobile phones or other electronic devices in direct proximity to the vehicle key.

Do not carry the vehicle key in close proximity to other electronic devices.

Wet or snowy conditions may disrupt the locking request detection on the door handles.

In the case of a malfunction, unlock and lock the vehicle using the buttons of the vehicle key or use the integrated key.

Additional information:

Integrated key, refer to page 95.

## Tailgate

### General information

To avoid locking the vehicle key in the vehicle, do not place the vehicle key in the cargo area.

Selector lever position P must be engaged to open the tailgate with the vehicle key.

Depending on the equipment and national-market version, it is possible to specify whether the tailgate can be unlocked with the vehicle key and how the vehicle doors will function.

Additional information:

Settings, refer to page 106.

### Safety information

#### **Warning**

Body parts can be jammed when operating the tailgate. There is a risk of injury. Make sure that the travel path of the tailgate is clear during opening and closing.

**⚠ Warning**

The tailgate swings back and up when it opens. There is a risk of injury or risk of damage to property. Make sure that the travel path of the tailgate is clear during opening and closing.

**⚠ NOTICE**

Sharp-edged or pointed objects can hit the windows and heating elements while driving. There is a risk of damage to property, among other potential damage. Cover the edges and ensure that pointed objects do not hit the windows.

## Tailgate

### Opening

#### General information

When the trailer power socket is occupied, the tailgate cannot be opened with the vehicle key or with the button in the car's interior.

#### From the outside

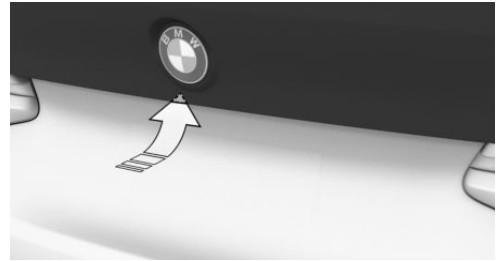

- ▷ Unlock the vehicle and then press the button on the outer side of the tailgate.
- ▷ With Comfort Access: carry the vehicle key with you and press the button on the outer side of the tailgate.
- ▷  Press the button on the vehicle key for approx. 1 second.

Depending on the setting, the doors may also be unlocked.

If the vehicle is stationary, the tailgate opens automatically to the adjusted opening height.

#### From the inside

 Press the button in the driver's door downward.

If the vehicle is locked, selector lever position P must be engaged first.

The tailgate will be opened to the configured opening height.

#### Interruption of the opening procedure

The opening procedure is interrupted in the following situations:

- ▷ When the vehicle starts moving.
- ▷ By pressing the button on the outer side of the tailgate. Pressing again closes the tailgate.
- ▷ By pressing the button on the inside of the tailgate. Pressing again closes the tailgate.

- ▶ By pressing the button on the vehicle key. Pressing again continues the opening procedure.
- ▶ By pressing or pulling the button in the driver's door. Pressing again continues the opening procedure.

## Closing

### From the outside

- ▶  Press the button on the inside of the tailgate.

With Comfort Access:

- ▶  Press the button on the inside of the tailgate.

The vehicle will be locked after closing the tailgate. The driver's door must be closed for this purpose and the vehicle key must be outside of the vehicle in the area of the tailgate.

### From the inside

- ▶  Pull and hold the button in the driver door.

The vehicle key must be located in the interior for this function.

An acoustic signal sounds before the tailgate is closed.

### Interruption of the closing procedure

The closing procedure is interrupted in the following situations:

- ▶ If the vehicle drives off with a jerky movement.
- ▶ By pressing the button on the outer side of the tailgate. Pressing again re-opens the tailgate.

- ▶ By pressing the button on the inside of the tailgate. Pressing again re-opens the tailgate.
- ▶ By releasing the button in the driver's door. Pulling again and holding continues the closing motion.

## Malfunction

### Safety information

#### **Warning**

With manual operation of a blocked tailgate, it can release itself unexpectedly from the blocking. There is a risk of injury or risk of damage to property. Do not operate the tailgate manually if it is blocked. Have it checked by an authorized service center or another qualified service center or repair shop.

In the event of an electrical malfunction, operate the unlocked tailgate manually with a slow and smooth motion.

To close the tailgate fully, press down lightly only. Closing occurs automatically.

## Valet parking mode

### Principle

In the valet parking mode, the Control Display is disabled. The operation via iDrive is no longer possible.

E.g., this mode can be used when the vehicle is handed over for valet parking.

### General information

In the valet parking mode, it is not possible to change vehicle settings via iDrive. Personal profiles cannot be changed. Personal data cannot be displayed.

Additionally, the following actions are carried out:



- ▶ The volume of the audio system is limited.
- ▶ The integrated Universal Remote Control is deactivated.
- ▶ The Dynamic Stability Control cannot be turned off.

## Functional requirements

- ▶ At least one driver profile has been created.
- ▶ A driver profile or the guest profile is active.
- ▶ At least one driver profile has an assigned ConnectedDrive account.

## Accessing the menu for the valet parking mode

### Via the switch-off screen

After switching off drive-ready state the switch-off screen will be displayed. Select the entry for the valet parking mode on the switch-off screen.

### Via the display bar at the upper edge of the Control Display

1. Tip the Controller up.
2. "Valet parking mode"

### Via the vehicle settings

1. "CAR"
2. "Settings"
3. "General settings"
4. "Valet parking mode"

## Activating the valet parking mode

### General information

Before activating the valet parking mode, a PIN must be set up to be able to deactivate the valet parking mode at a future time.

The procedure for the PIN input varies depending on the active driver profile.

### Driver profile with PIN

A PIN has been stored for the active driver profile.

It is not necessary to enter another PIN.  
"Activate now"

### Driver profile without PIN

A PIN must be assigned to the driver profile.

1. "PIN"
2. Enter PIN.
3. "Activate now"

### Guest profile

The guest profile is the active driver profile.

A PIN must be entered.

1. "PIN"
2. Enter PIN.
3. "Activate now"

This PIN can be used once to deactivate the valet parking mode for the active guest profile.

## Deactivating valet parking mode

### General information

The lock screen of the valet parking mode is displayed on the Control Display.

The deactivation of the valet parking mode depends on which driver profile is selected on the lock screen.

### Driver profile with PIN

Regardless of which driver activated the valet parking mode, a driver can deactivate the valet parking mode by entering his/her PIN.

1. Select driver profile.
  2. Enter the assigned PIN for the driver profile.
- If you forgot the PIN, the valet parking mode must be deactivated by entering the assigned ConnectedDrive access data.

## Driver profile without PIN

The valet parking mode was activated by another person. To deactivate the valet parking mode, a driver without a PIN has to enter the access data for his ConnectedDrive account.

1. Select driver profile.
2. Enter the ConnectedDrive access data assigned to the driver profile.

## Guest profile

In the guest profile, the valet parking mode can only be deactivated if the valet parking mode was activated in the guest profile.

1. Select guest profile.
2. Enter the PIN that was specified during activation.

If the PIN has been forgotten, the valet parking mode must be deactivated via a personal driver profile.

# Settings

---

## General information

Depending on the equipment and national-market version, various settings for opening and closing are possible.

These settings are stored for the driver profile currently used.

## Unlocking and locking

### Doors

1. "CAR"
2. "Settings"
3. "Key button settings"
4.  Select the icon.
5. Select the desired setting:
  - ▷ "Driver's door only"

Only the driver's door and the fuel filler flap are unlocked. Pressing again unlocks the entire vehicle.

- ▷ "All doors"
  - The entire vehicle is unlocked.

## Confirmation signals from the vehicle

1. "CAR"
2. "Settings"
3. "Doors/ vehicle access"
4. Deactivate or activate the desired confirmation signals:
  - ▷ "Flash when locking/unlocking"
    - Unlocking is signaled by blinking twice, locking by blinking once.
  - ▷ With alarm system:
    - "Sound when locking/unlocking"
      - Unlocking is confirmed with two sound signals, locking is confirmed with one sound signal.

## Folding mirrors in automatically

1. "CAR"
2. "Settings"
3. "Doors/ vehicle access"
4. "Fold mirrors in when locked"

## Automatic unlocking

1. "CAR"
2. "Settings"
3. "Doors/ vehicle access"
4. Select the desired setting:
  - ▷ "Unlock doors when in Park"
  - ▷ "Unlock at end of trip"
    - After drive-ready state is switched off by pressing the Start/Stop button, the locked vehicle is automatically unlocked.

## Automatic locking

1. "CAR"
  2. "Settings"
  3. "Doors/ vehicle access"
  4. "Lock in a few minutes"
- The vehicle locks automatically after a short period of time if no door is opened after unlocking.

## Tailgate

### Tailgate and doors

Depending on the vehicle equipment and country version, this setting may not be offered.

1. "CAR"
2. "Settings"
3. "Key button settings"
4.  Select the icon.
5. Select the desired setting:
  - ▶ "Tailgate"
 

Depending on your vehicle's optional features, the tailgate is either unlocked or opened.
  - ▶ "Tailgate opens only when vehicle is unlocked."
 

The vehicle must be unlocked before the tailgate can be used with the vehicle key.
  - ▶ "Tailgate and door(s)"
 

Depending on your vehicle's optional features, the tailgate is either unlocked or opened and the doors unlocked.
  - ▶ "Lock tailgate button"
 

The operation of the tailgate via the vehicle key is disabled.

### Adjusting the opening height

You can set how far the tailgate can be opened.

When adjusting the opening height, make sure the clearance above the tailgate is at least 4 in/10 cm.

1. "CAR"
2. "Settings"
3. "Doors/ vehicle access"
4. "Tailgate"
5. "Opening height"
6. Monitor the tailgate and set the desired opening height.

## Comfort Access

### Touchless locking and unlocking

Contactless locking and unlocking can be switched on or off.

1. "CAR"
2. "Settings"
3. "Doors/ vehicle access"
4. "Comfort access"

### Establishing idle state after opening the front doors

1. "CAR"
2. "Settings"
3. "Doors/ vehicle access"
4. "Turn off vehicle after opening door"
 

Idle state, refer to page 39.

## Alarm system

### Principle

The alarm system issues a visual and acoustic signal when someone attempts to open the locked vehicle incorrectly.

### General information

When the vehicle is locked, the vehicle alarm system reacts to the following changes:



- ▷ Opening a door, the hood, or the tailgate.
- ▷ Movements in the interior.
- ▷ Changes in the vehicle inclination, such as during attempts at stealing a wheel or when towing the vehicle.
- ▷ Disconnected battery voltage.
- ▷ Improper use of the socket for OBD on-board diagnostics.
- ▷ Locking the vehicle while a device is connected to the diagnostic socket.

The alarm system signals these changes visually and acoustically:

- ▷ **Acoustic alarm:**  
Depending on local regulations, the acoustic alarm may be suppressed.
- ▷ **Optical alarm:**  
By blinking of the hazard warning system and headlights, where required.

Do not modify the system to ensure function of the alarm system.

### Turning on/off

The alarm system is turned on or off as soon as the vehicle is locked or unlocked with the vehicle key or via Comfort Access.

### Opening the doors with the alarm system switched on

The alarm system is triggered when a door is opened if the door was unlocked using the integrated key in the door lock.

### Opening the tailgate with the alarm system switched on

The tailgate can be opened even when the alarm system is switched on.

After the tailgate is closed, it is locked and monitored again provided the doors are locked. The hazard warning system flashes once.

### Panic mode

You can trigger the alarm system if you find yourself in a dangerous situation.



- ▷ Press the button on the vehicle key and hold for at least 3 seconds.
- ▷ Briefly press the button on the vehicle key three times in succession.

To switch off the alarm: press any button.

### Indicator light on the interior mirror



- ▷ The indicator light flashes briefly every 2 seconds:  
The alarm system is switched on.
- ▷ Indicator light flashes for approx. 10 seconds, then it flashes briefly every 2 seconds:  
Interior motion sensor and tilt alarm sensor are not active, as doors, hood, or tailgate are not correctly closed. Correctly closed access points are secured.  
When the remaining open access points are closed, the interior motion sensor and tilt alarm sensor will be turned on.
- ▷ The indicator light goes out after unlocking:  
The vehicle has not been tampered with.
- ▷ The indicator light flashes after unlocking until drive-ready state is switched on, but no longer than approx. 5 minutes:  
An alarm has been deployed.

## Tilt alarm sensor

The inclination of the vehicle is monitored.

The alarm system responds in situations such as attempts to steal a wheel or when the vehicle is towed.

## Interior motion sensor

The vehicle interior is monitored.

The alarm system responds when movement is detected in the vehicle interior.

The windows and the glass sunroof must be closed for the system to function properly.

## Avoiding unintentional alarms

### General information

The tilt alarm sensor and interior motion sensor can trigger an alarm, although no unauthorized action occurred.

Possible situations for an unwanted alarm:

- ▷ In car washes.
- ▷ In duplex garages.
- ▷ During transport on trains carrying vehicles, at sea or on a trailer.
- ▷ With animals in the vehicle.
- ▷ When the vehicle is locked after start of refueling.

The tilt alarm sensor and the interior motion sensor can be switched off in such situations.

### Switching off the tilt alarm sensor and interior motion sensor



Press the button on the vehicle key within 10 seconds as soon as the vehicle is locked.

The indicator light lights up for approx. 2 seconds and then continues to flash.

The tilt alarm sensor and interior motion sensor are switched off until the vehicle is locked again.

## Ending the alarm

- ▷ Unlock the vehicle with the vehicle key.
- ▷ Unlock the vehicle with the integrated key and activate the drive-ready state via emergency detection of the vehicle key.  
Malfunction, refer to page 85.
- ▷ With Comfort Access: when carrying the vehicle key, grasp the driver's door or front passenger door handle completely.

## Power windows

### General information

The windows can be opened with the vehicle key from the outside as well as closed with Comfort Access.

With Comfort Access: The windows can be closed from the outside via Comfort Access.

When a window is frequently opened to the same position, this task can be performed by the BMW Intelligent Personal Assistant. For instance when the same parking garage is frequently used.

Additional information:

- ▷ Vehicle key, refer to page 81.
- ▷ BMW Intelligent Personal Assistant, refer to page 50.

## Safety information

### Warning

When operating the windows, body parts and objects can be jammed. There is a risk of injury or risk of damage to property. Make sure that the travel path of the windows is clear during opening and closing.

## Overview



 Power windows

 Safety switch

## Functional requirements

The windows can be operated under the following conditions.

- ▶ Standby state is switched on.
- ▶ Drive-ready state is switched on.

The vehicle key must be in the car's interior.

## Opening

- ▶  Press the switch to the resistance point.

The window opens while the switch is being held.

- ▶  Press the switch beyond the resistance point.

The window opens automatically. Pressing the switch again stops the motion.

## Closing

- ▶  Pull the switch to the resistance point.

The window closes while the switch is being held.

- ▶  Pull the switch beyond the resistance point.

The window closes automatically if the door is closed. Pulling again stops the motion.

## Jam protection system

### Principle

The jam protection prevents objects or body parts becoming jammed between the door frame and window while a window is being closed.

### General information

If resistance or blockage is detected while a window is being closed, the closing will be interrupted.

### Safety information

#### **Warning**

Accessories on the windows such as antennas can impact jam protection. There is a risk of injury. Do not install accessories in the area of movement of the windows.

## Closing without the jam protection system

In case of danger from the outside or if icing might prevent normal closing, proceed as follows:

1.  Pull the switch past the resistance point and hold it there.

The window closes with limited jam protection. If the closing force exceeds a specific threshold, closing is interrupted.

2.  Pull the switch past the resistance point again within approx. 4 seconds and hold it there.

The window closes without jam protection.

## Safety switch

### Principle

The safety switch can be used to prevent children, for instance, from opening and closing the rear windows using the switches in the rear.

If an accident of a certain severity occurs, the safety function is switched off automatically.

### Turning on/off



Press the button.

The LED lights up if the safety function is switched on.

## Roller sunblinds, rear side windows

### Safety information

#### **Warning**

With closed roller sunblinds and open windows, the roller sunblinds may be strained while driving due to the air stream. The roller sunblinds may be damaged and vehicle occupants may be harmed. There is a risk of injury. Do not open the windows while driving if the roller sunblinds are closed.

Pull out the roller sunblind at the loop and hook it onto the bracket.

## Glass sunroof

### General information

The glass sunroof and the sun protection are operated using the same switch.

The glass sunroof can be opened from the outside with the vehicle key and also closed with Comfort Access.

With Comfort Access: The glass sunroof can be closed from the outside via Comfort Access.

### Safety information

#### **Warning**

Body parts can be jammed when operating the glass sunroof. There is a risk of injury. Make sure that the area of movement of the glass sunroof is clear during opening and closing.

### Overview



Opening/closing the glass sunroof/sun protection.

### Functional requirements

The glass sunroof and the sun protection can be operated under the following conditions.

- ▶ Standby state is switched on.
- ▶ Drive-ready state is switched on.

The vehicle key must be in the car's interior.

## Lifting/closing glass sunroof



- Push switch briefly upward.
- ▶ The closed glass sunroof tilts and the sun protection opens slightly.
  - ▶ The opened glass sunroof closes until it is in the tilted position. The sun protection does not move.

- ▶ The tilted glass sunroof closes.

## Opening/closing the glass sunroof and sun protection separately

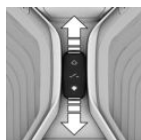

- ▶ Slide switch back to the resistance point and hold. Holding down the switch opens the sun protection. If the sun protection is already fully open, the glass sunroof opens.

- ▶ Slide switch forward to the resistance point and hold.

The glass sunroof closes while the switch is being held. If the glass sunroof is already closed or in the tilted position, the sun protection closes.

- ▶ Slide the switch back past the resistance point. The sun protection opens automatically. If the sun protection is already fully open, the glass sunroof opens automatically. Pressing the switch again stops the motion.
- ▶ Push the switch forward past the resistance point. The glass sunroof closes automatically. If the glass sunroof is already closed or in the tilted position, the sun protection closes automatically. Pressing the switch again stops the motion.

## Opening/closing the glass sunroof and sun protection together

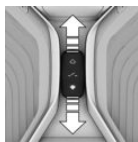

- ▶ Briefly press out the switch twice in succession toward the rear past the resistance point. The glass sunroof and sun protection open together. Pressing the switch again stops the motion.
- ▶ Briefly press out the switch twice in succession toward the front past the resistance point. The glass sunroof and sun protection close together. Pressing the switch again stops the motion.

## Comfort position

In some models, the wind noises in the car's interior are lowest when the glass sunroof is not fully open. In these models, the automatic function initially only opens the glass sunroof up to this comfort position.

Pressing the switch again opens the glass sunroof fully.

## Jam protection system

### Principle

The jam protection prevents objects or body parts from becoming jammed between the roof frame and glass sunroof while the glass sunroof is closing.

### General information

If a resistance or blockage is detected while the glass sunroof is closing, the closing operation is interrupted once the roof reaches the half-open position, or it is stopped when closing from the tilted position.



## Closing from the open position without jam protection

In case of danger from the outside or if icing might prevent normal closing, proceed as follows:

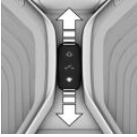

1. Close all doors.
2. Push the switch forward past the resistance point and hold.

The glass sunroof closes with limited jam protection. If the closing force exceeds a specific threshold, closing is interrupted.

3. Push the switch forward again past the resistance point and hold until the glass sunroof closes without jam protection. Make sure that the closing path is clear.

## Closing from the lifted position without jam protection

In case of danger from the outside or if icing might prevent normal closing, proceed as follows:

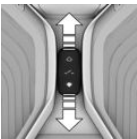

1. Close all doors.
2. Push the switch forward past the resistance point and hold.

## Initializing after a power interruption

### General information

After a power interruption during the opening or closing process, the glass sunroof can only be operated to a limited extent. Initializing the system can help in this case.

The system can be initialized under the following conditions:

- ▶ The vehicle is parked in a horizontal position.
- ▶ The vehicle will not be moved until the initialization is completed.
- ▶ The drive-ready state is established.
- ▶ The outside temperature is above 41 °F/5 °C.

During initialization, the glass sunroof closes without jam protection.

Make sure that the closing path is clear.

### Initializing the system

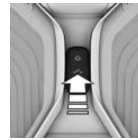

Press the switch up and hold it until the initialization is complete:

Initialization begins within 15 seconds.

- ▶ If the glass sunroof is closed, it opens then closes again.
- ▶ If the glass sunroof is open, it first closes, then opens and closes again.

Initialization is complete once the glass sunroof and sun protection have opened then closed again.

# Seats, mirrors and steering wheel

## Vehicle features and options

This chapter describes all standard, country-specific and optional features offered with the series. It also describes features and functions that are not necessarily available in your vehicle, e.g., due to the selected options or country versions. This also applies to safety-related functions and systems. When using these functions and systems, the applicable laws and regulations must be observed.

## Sitting safely

An ideal seat position that meets the needs of the occupants can make a vital contribution to relaxed, fatigue-free driving.

In the event of an accident, the correct seat position plays an important role. Follow the information in the following chapters.

Additional information:

- ▶ Seats, refer to page 114.
- ▶ Seat belts, refer to page 117.
- ▶ Head restraints, refer to page 119.
- ▶ Airbags, refer to page 182.

## Seats, front

### Safety information

**Warning**

Seat setting while driving can lead to unexpected movements of the seat. Vehicle control could be lost. There is a risk of accident. Only adjust the seat on the driver's side when the vehicle is stationary.

**Warning**

With a backrest inclined too far to the rear, the protective effect of the seat belt can no longer be ensured. There is a risk of sliding under the seat belt in an accident. There is a risk of injury or danger to life. Adjust the seat prior to starting the trip. Adjust the backrest so that it is in the most upright position as possible and do not adjust again while driving.

**Warning**

There is a danger of jamming when moving the seats. There is a risk of injury or risk of damage to property. Make sure that the travel path of the seat is clear prior to any adjustment.

## Electrically adjustable seats

### General information

The current seat position can be stored using the memory function.

### Overview

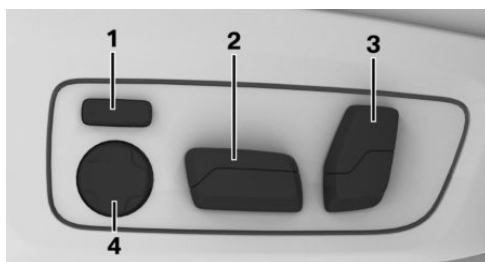

- 1 Backrest width
- 2 Forward/backward, height, seat tilt

- 3 Backrest tilt, head restraint
- 4 Lumbar support

### Longitudinal direction

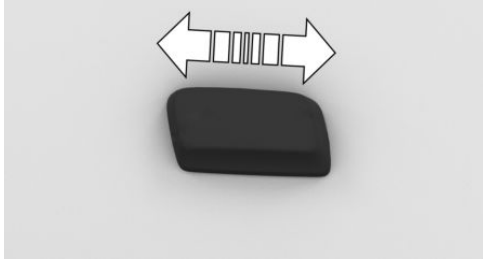

Press switch forward or backward.

### Height

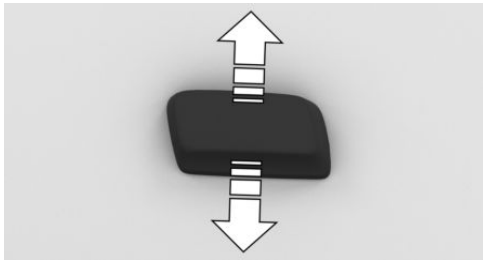

Press switch up or down.

### Seat tilt

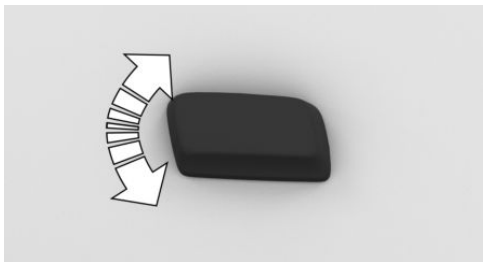

Tilt switch up or down.

### Backrest tilt

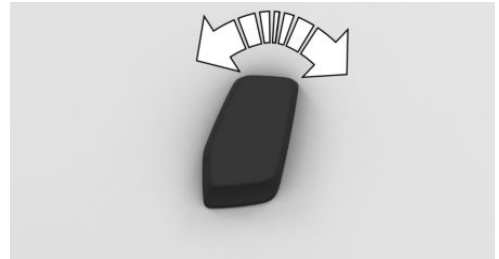

Tilt switch forward or backward.

### Calibrating the front seats

#### General information

As soon as the electric seat setting no longer functions precisely, a Check Control message is displayed on the control display.

To restore the accuracy of the electric seat setting, the front seats must be calibrated.

#### Safety information

##### **Warning**

There is a danger of jamming when moving the seats. There is a risk of injury or risk of damage to property. Make sure that the travel path of the seat is clear prior to any adjustment.

#### Calibrating the front seat

1. Press the longitudinal direction switch forward until the seat stops.
2. Press the switch forward again until the seat stops.
3. Readjust the seat to the desired position.

As soon as the message on the control display disappears, the calibration is complete. If the message remains active, repeat the calibration.

If the message is still shown after repeated calibration, have the system checked by an authorized service center or another qualified service center or a repair shop.

## Thigh support

### Sport seat

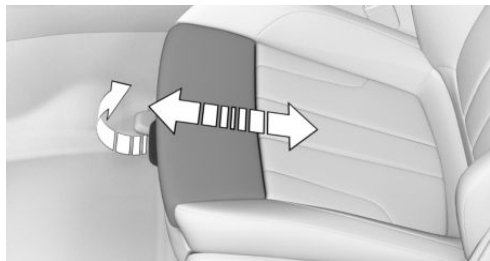

Pull the lever at the front of the seat and push the thigh support forward or back.

## Lumbar support

### Principle

The curvature of the seat backrest can be adjusted in a way that it supports the lumbar region of the spine. The lower back and the spine are supported for upright sitting position.

### Adjusting



- ▷ Press the front/rear section of the button:  
The curvature is increased/decreased.
- ▷ Press the upper/lower section of the button:  
The curvature is shifted up/down.

### Functional limitations

It may not be possible to adjust the lumbar support at very high and very low temperatures.

## Backrest width

### Principle

Adjusting the backrest width may improve side support when cornering.

### General information

The backrest width is changed by adjusting the side sections of the backrest.

### Adjusting



- ▷ Press the front section of the button:  
The backrest width decreases.
- ▷ Press the rear section of the button:  
The backrest width increases.

### Functional limitations

It may not be possible to adjust the backrest width at very high and very low temperatures.

## Rear seats

### General information

The backrest tilt can be adjusted for the rear seats. The backrest tilt for the center section is adjusted together with the left rear seat backrest.

## Backrest tilt



Pull the lever and apply your weight to the rear seat backrest or lift it off, as necessary.

After adjusting, move the rear seat backrest forward or back slightly making sure it engages properly.

## Seat belts

### General information

The vehicle is fitted with five seat belts to ensure occupant safety. However, the seat belts can only offer protection when adjusted correctly.

Always make sure that seat belts are being worn by the occupants before driving off. The airbags supplement the seat belts as an additional safety device. The airbags do not replace seat belts.

All belt fastening points are designed to achieve the best possible protective effect of the seat belts with proper use of the seat belts and correct seat setting. Notes on sitting safely, refer to page 114.

The two outer seat belt buckles of the rear seats are intended for the persons sitting on the left and right.

The center seat belt buckle of the rear seats is intended for the person sitting in the middle.

## Safety information

### Warning

Use of a seat belt to buckle more than one person will potentially defeat the ability of the seat belt to serve its protective function. There is a risk of injury or danger to life. Do not strap in more than one person per single seat belt. Infants and children are not allowed on an occupant's lap, but must be transported and secured in designated child restraint systems.

### Warning

The protective effect of safety gear, including seat belts, can be limited or lost when seat belts are fastened incorrectly. An incorrectly fastened seat belt can cause additional injuries, for instance in the event of an accident, braking or evasive maneuvers. There is a risk of injury or danger to life. Make sure that all occupants are wearing seat belts correctly.

### Warning

With a rear seat backrest that is not locked, the protective effect of the middle seat belt is not guaranteed. There is a risk of injury or danger to life. If you are using the middle seat belt, lock the wider rear seat backrest.

### Warning

The protective effect of safety gear, including seat belts, may not be fully functional or fail in the following situations:

- ▷ The seat belts or seat belt buckles are damaged, soiled, or changed in any other way.
- ▷ Seat belt tensioners or roll-up mechanism were modified.

Seat belts can be imperceptibly damaged in the event of an accident. There is a risk of injury or danger to life. Do not modify seat belts, seat belt buckles, seat belt tensioners, roll-up mechanisms, or belt anchors and keep them clean. Have the seat belts checked after an accident at the authorized service center or another qualified service center or repair shop.

### Correct use of seat belts

- ▶ Wear the seat belt tight to your body over your lap and shoulders, without twisting it.
- ▶ Wear the seat belt deep on your hips over your lap. The seat belt must not press on your stomach.
- ▶ Do not rub the seat belt against sharp edges, or guide it or jam it in across hard or fragile objects.
- ▶ Avoid thick clothing.
- ▶ Re-tighten the seat belt frequently upward around your upper body area.

### Buckling the seat belt

1. Guide the seat belt slowly over shoulder and hip to put it on.
2. Insert the buckle tongue into the seat belt buckle. The seat belt buckle must engage audibly.

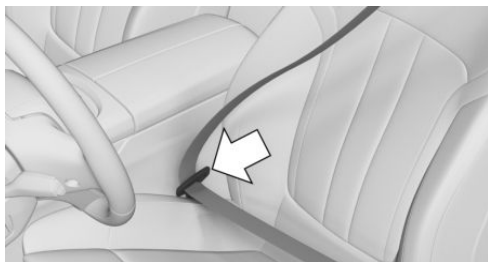

To ease accessibility to the seat belt buckle, an adjustable slider is available on the belt to help position the buckle when not in use.

When the seat belt is fastened, the driver's and front passenger's belt straps are automatically tightened once after driving away.

### Unbuckling the seat belt

1. Hold down the seat belt firmly.
2. Press the red button in the seat belt buckle.
3. Guide the seat belt back into its roll-up mechanism.

### Seat belt reminder for driver's seat and passenger's seat

#### General information

The seat belt reminder is issued when the driver's side seat belt is not buckled.

The seat belt reminder is also active when the front passenger seat belt is not buckled or objects are on the front passenger seat.

The seat belt reminder is also activated when a passenger unbuckles a seat belt during the trip.

#### Display in the instrument cluster



The indicator light lights up and a signal sounds. Make sure that the seat belts are positioned correctly. The seat belt reminder can also be activated if objects are placed on the front passenger seat.

### Seat belt reminder for rear seats

#### General information





The seat belt reminder is automatically activated each time the engine starts.

The seat belt reminder is also activated when a passenger unbuckles a rear seat belt during the trip.

#### Display in the instrument cluster

The indicator light in the instrument cluster illuminates after the engine is started.

The displays may vary depending on the equipment version and country variant.

Icon	Description
	Green: the seat belt is buckled on the corresponding rear seat.
	
	Red: the seat belt is not buckled on the corresponding rear seat.
	

## Safety mode

In critical driving situations, for instance during emergency braking, the front seat belts tighten automatically.

If the driving situation passes without an accident occurring, the belt tension relaxes.

If the belt tension does not loosen automatically, stop the vehicle and unbuckle the seat belt using the red button in the seat belt buckle. Fasten the seat belt before continuing to drive.

## Front head restraints

### Safety information

#### Warning

Removal or incorrect adjustment of head restraints can cause injuries in the head and neck area. There is a risk of injury.

- ▷ Before driving, install the removed head restraints on the occupied seats.
- ▷ Adjust the head restraint so its center supports the back of the head at as close to eye level as possible.
- ▷ Adjust the distance so that the head restraint is as close as possible to the back of the head. Adjust the distance via the backrest tilt as needed.

#### Warning

Body parts can be jammed when moving the head restraint. There is a risk of injury. Make sure that the area of movement is clear when moving the head restraint.

#### Warning

Objects on the head restraint reduce the protective effect in the head and neck area. There is a risk of injury.

- ▷ Do not use seat or head restraint covers.
- ▷ Do not hang objects, for instance clothes hangers, directly on the head restraint.
- ▷ Only use accessories that have been determined to be safe for attachment to a head restraint.
- ▷ Do not use any accessories, for instance pillows, while driving.

## Adjusting the height

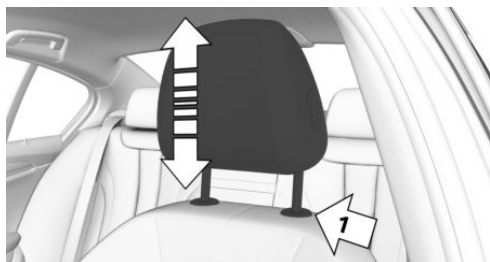

- ▶ To lower: press the button, arrow 1, and push the head restraint down.
- ▶ To raise: push the head restraint up.

After setting the height, make sure that the head restraint engages correctly.

## Adjusting distance



- ▶ Back: press the button and push the head restraint toward the rear.
- ▶ Forward: pull the head restraint toward the front.

After setting the distance, make sure that the head restraint engages correctly.

## Removing

Only remove the head restraint if no one will be sitting in the seat in question.

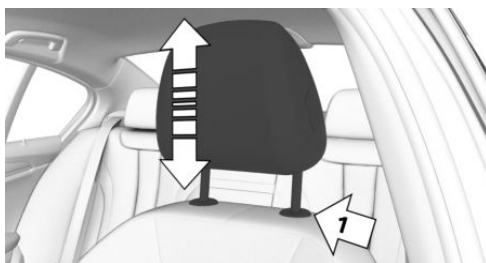

1. Raise the head restraint up against the resistance.
2. Press the button, arrow 1, and pull the head restraint out completely.

## Installing

Proceed in the reverse order to install the head restraint.

## Rear head restraints

### Safety information

#### **Warning**

Removal or incorrect adjustment of head restraints can cause injuries in the head and neck area. There is a risk of injury.

- ▶ Before driving, install the removed head restraints on the occupied seats.
- ▶ Adjust the head restraint so its center supports the back of the head at as close to eye level as possible.
- ▶ Adjust the distance so that the head restraint is as close as possible to the back of the head. Adjust the distance via the backrest tilt as needed.



**⚠ Warning**

Body parts can be jammed when moving the head restraint. There is a risk of injury. Make sure that the area of movement is clear when moving the head restraint.

**⚠ Warning**

Objects on the head restraint reduce the protective effect in the head and neck area. There is a risk of injury.

- ▷ Do not use seat or head restraint covers.
- ▷ Do not hang objects, for instance clothes hangers, directly on the head restraint.
- ▷ Only use accessories that have been determined to be safe for attachment to a head restraint.
- ▷ Do not use any accessories, for instance pillows, while driving.

## Folding down the head restraints

To improve the view to the rear, the head restraints can be folded back. Only fold the head restraint back if no one will be sitting in the corresponding seat.

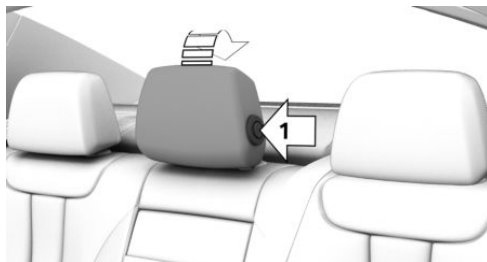

- ▷ To the rear: press the button, arrow 1, and fold the head restraint backward.
- ▷ Forward: fold the head restraint toward the front as far as it will go. Make sure that the head restraint engages correctly.

## Adjusting the height



The height of the outer head restraints can be adjusted.

- ▷ To lower: press the button, arrow 1, and push the head restraint down.
- ▷ To raise: push the head restraint up.

After setting the height, make sure that the head restraint engages correctly.

## Removing

Only remove the head restraint if no one will be sitting in the seat in question.



1. Fold down the rear seat backrest in question.  
Enlarging the cargo area, refer to page 305.
2. Raise the head restraint up against the resistance.
3. Press the button, arrow 1, and pull the head restraint out completely.

## Installing

Proceed in the reverse order to install the head restraint.

After the installation, make sure that the head restraint engages correctly.

## Exterior mirrors

### General information

The front passenger's side exterior mirror is more curved than the driver's side mirror.

The mirror setting is stored for the driver profile currently in use. When a driver profile is selected, the saved position is called up automatically.

The current exterior mirror position can be stored using the memory function.

### Safety information

#### **Warning**

Objects reflected in the mirror are closer than they appear. The distance to the road users behind could be incorrectly estimated, for instance while changing lanes. There is a risk of accident. Estimate the distance to the traffic behind by looking over your shoulder.

### Overview

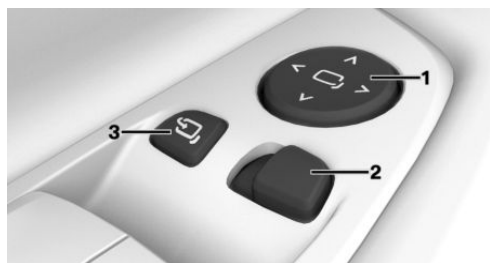

- 1 Adjusting
- 2 Selecting a mirror, Automatic Curb Monitor
- 3 Folding in and out

### Adjusting the exterior mirrors



Press the button.

The selected mirror moves along with the button movement.

### Selecting a mirror



To change over to the other mirror:

Slide the switch.

### Malfunction

In case of an electrical malfunction, adjust the mirror by pressing the edges of the mirror glass.

### Folding in and out

#### **NOTICE**

Depending on the vehicle width, the vehicle can be damaged in car washes. There is a risk of damage to property, among other potential damage. Before washing, fold in the mirrors by hand or with the button.



Press the button.

Folding is only possible up to a speed of approx. 15 mph/20 km/h.

Folding the mirrors in and out is helpful in the following situations:

- ▶ In car washes.
- ▶ On narrow roads.

Mirrors that were folded in are folded out automatically at a speed of approx. 25 mph/40 km/h.

### Automatic heating

Both exterior mirrors are automatically heated as needed and when the drive-ready state is switched on.

## Automatic dimming feature

The exterior mirror on the driver's side is automatically dimmed. Photocells in the interior mirror are used to control this.

## Automatic Curb Monitor

### Principle

If reverse gear is engaged, the mirror glass on the passenger's side is tilted downward. This improves your view of the curb and other low-lying obstacles when parking, for instance.

### Activating

-  slide the switch to the driver's side mirror position.
- Engage selector lever position R.

When the trailer socket is in use or trailer towing is activated, the Automatic Curb Monitor is deactivated.

### Deactivating

Slide the switch to the front passenger's side exterior mirror position.

## Interior mirror, manually dimmable

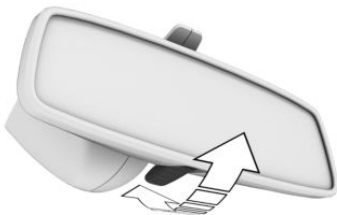

To reduce the blinding glare of the interior mirror, flip the lever forward.

## Interior mirror, automatic dimming feature

### General information

The interior mirror is dimmed automatically. Photocells are used for control:

- ▷ In the mirror glass.
- ▷ On the rear of the mirror.

### Overview

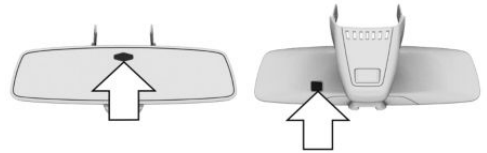

### Functional requirements

- ▷ Keep the photocells clean.
- ▷ Do not cover the area between the interior mirror and the windshield.

## Steering wheel

### Safety information

#### **Warning**

Steering wheel adjustments while driving can lead to unexpected steering wheel movements. Vehicle control could be lost. There is a risk of accident. Adjust the steering wheel while the vehicle is stationary only.

## Manual steering wheel adjustment

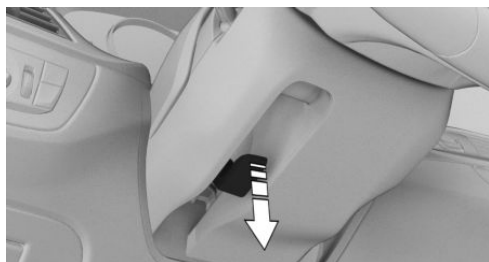

1. Fold the lever down completely.
2. Grip the steering wheel with both hands and move the steering wheel to the preferred height and angle to suit your seat position.
3. Fold the lever back up.

## Steering wheel heating

### Overview



Button for steering wheel heating

### Turning on/off



Press the button.

A Check Control message is displayed.

If the trip is resumed within approx. 15 minutes after an intermediate stop, the steering wheel heating turns on automatically if the function was turned on at the completion of the last trip.

## Memory function

### Principle

The following settings can be stored and, if necessary, retrieved using the memory function:

- ▷ Seat position.
- ▷ Exterior mirror position.
- ▷ Height of the Head-up Display.

### General information

Two memory locations with different settings can be set for each driver profile.

The following settings are not stored:

- ▷ Backrest width.
- ▷ Lumbar support.

### Safety information

#### **Warning**

Using the memory function while driving can lead to unexpected seat or steering wheel movements. Vehicle control could be lost. There is a risk of accident. Only retrieve the memory function when the vehicle is stationary.

#### **Warning**

There is a danger of jamming when moving the seats. There is a risk of injury or risk of damage to property. Make sure that the travel path of the seat is clear prior to any adjustment.

## Overview



The memory buttons are located on the front door.

## Storing

1. Set the desired position.
2.  Press the button. The lettering on the button is illuminated.
3. Press desired button 1 or 2 while the lettering is illuminated. A signal sounds.

## Calling up settings

Press the desired button 1 or 2.

The stored position is called up.

The procedure stops when a switch for setting the seat is pressed or one of the memory buttons is pressed again.

The adjustment of the seat position on the driver's side is interrupted after a short time while driving.

## Seat heating

### Overview

#### Front

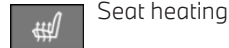
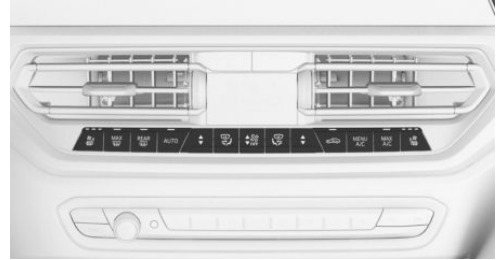

#### Back

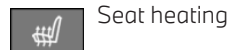

## Turning on

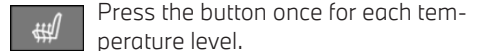

The maximum temperature is reached when three LEDs are lit.

When ECO PRO is activated, the heater output is reduced.

Additional information:

ECO PRO, refer to page [321](#).

## Turning off



Press and hold the button until the LEDs turn off.

## Seat heating distribution

The heating effect in the seat surface and the seat backrest can be distributed in different ways.

1. "CAR"
2. "Settings"
3. "Climate control"
4. Select the desired menu item.
5. Select desired seat.
6. Press the Controller and turn it to set the seat heating distribution.

## Active seat ventilation

### Principle

Integrated fans in the seat and armrest areas provide a comfortable seat temperature.

### Overview

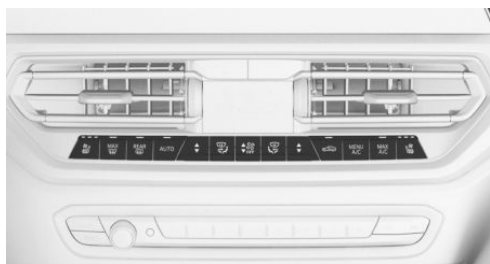

Active seat ventilation



## Switching on active seat ventilation



Press the button once for each ventilation level.

The highest level is active when three LEDs are lit.

The ventilation switches back by one level after a short time.

## Switching off active seat ventilation



Press and hold the button until the LEDs turn off.

## Climate control rules

### Principle

Depending on the equipment, some heating and air conditioning functions can be automatically activated depending on the outside temperature.

### General information

The outside temperature at which the functions are to be automatically activated can be set via iDrive.

Activation is performed if the outside temperature exceeds or falls below the set temperature in the first few minutes after drive-ready state has been switched on. A new adjustment is carried out after the settings have been changed.

Depending on the equipment package, the following functions can be automatically activated:

- ▶ Seat heating.
- ▶ Steering wheel heating
- ▶ Seat ventilation.

If the trip is continued within approx. 15 minutes after a stop, the functions are activated automatically with the levels that were last selected.

## Functional requirement

Drive-ready state is switched on.

### Activate/deactivate

1. "CAR"
2. "Settings"
3. "Climate control"
4. If necessary, "Automate habits"
5. Select the desired function.
6. Activate the desired rule.
7. Set the level.

# Transporting children safely

## Vehicle features and options

This chapter describes all standard, country-specific and optional features offered with the series. It also describes features and functions that are not necessarily available in your vehicle, e.g., due to the selected options or country versions. This also applies to safety-related functions and systems. When using these functions and systems, the applicable laws and regulations must be observed.

## The right place for children

### Safety information

#### **Warning**

Unattended children or animals in the vehicle can cause the vehicle to move and endanger themselves and traffic, for instance due to the following actions:

- ▷ Pressing the Start/Stop button.
- ▷ Releasing the parking brake.
- ▷ Opening and closing the doors or windows.
- ▷ Engaging selector lever position N.
- ▷ Using vehicle equipment.

There is a risk of accidents or injuries. Do not leave children or animals unattended in the vehicle. Take the vehicle key with you when exiting and lock the vehicle.

#### **Warning**

A hot vehicle may result in death to persons, especially children, or animals. There is a risk of injury or danger to life. Do not leave persons, especially children, or animals unattended in the vehicle.

#### **Warning**

Exposure to intense sunlight can cause child restraint systems and their components to become very hot. Persons may sustain burn injuries when touching the hot components. There is a risk of injury. Do not expose the child restraint system to direct sunlight or cover where necessary. If necessary, let the child restraint system cool down before transporting a child. Do not leave children unattended in the vehicle.

## Children in the rear seat

### General information

Accident research shows that the safest place for children is in the rear seat.

Children younger than 13 years of age or shorter than 5 ft/150 cm should be transported in the rear seat in suitable child restraint systems designed for the age, weight and size of the child. Children 13 years of age or older must wear a seat belt as soon as a suitable child restraint system can no longer be used due to their age, weight, or size.



## Safety information

### **Warning**

The seat belt cannot be fastened correctly on children shorter than 5 ft/150 cm without suitable additional child restraint systems. The protective effect of safety gear, including seat belts, can be limited or lost when seat belts are fastened incorrectly. An incorrectly fastened seat belt can cause additional injuries, for instance in the event of an accident, braking or evasive maneuvers. There is a risk of injury or danger to life. Secure children shorter than 5 ft/150 cm using suitable child restraint systems.

## Children on the front passenger seat

### General information

Before using a child restraint system on the front passenger seat, ensure that the front, knee, and side airbags on the passenger's side are deactivated.

Additional information:

For automatic deactivation of front passenger airbags, refer to page [184](#).

### Safety information

### **Warning**

Active front passenger airbags can injure a child in a child restraint system when the airbags are deployed. There is a risk of injury. Make sure that the front passenger airbags are deactivated and that the PASSENGER AIRBAG OFF indicator light lights up.

## Installing child restraint systems

### General information

Pay attention to the specifications and the operating and safety information of the child restraint system manufacturer when selecting, installing, and using child restraint systems.

### Safety information

### **Warning**

The protective effect of child restraint systems and their fastening systems which have been damaged or exposed to an accident can be limited or lost. A child cannot be properly restrained in the event of an accident, braking or evasive maneuvers. There is a risk of injury or danger to life.

Do not use child restraint systems which have been damaged or exposed to an accident.

If a child restraint system and its fastening system has been damaged or exposed to an accident, have these systems checked and replaced by an authorized service center or another qualified service center or repair shop.

### **Warning**

The stability of the child restraint system is limited or compromised with incorrect seat setting or improper installation of the child seat. There is a risk of injury or danger to life. Make sure that the child restraint system fits securely against the backrest. If possible, adjust the backrest tilt for all affected backrests and correctly adjust the seats. Make sure that seats and backrests are securely engaged or locked. If possible and necessary, adjust the height of the head restraints or remove them.

## On the front passenger seat

### Deactivating the airbags

**Warning**

Active front passenger airbags can injure a child in a child restraint system when the airbags are deployed. There is a risk of injury. Make sure that the front passenger airbags are deactivated and that the PASSENGER AIRBAG OFF indicator light lights up.

Before installing a child restraint system in the front passenger seat, make sure that the front, knee and side airbags on the passenger's side are deactivated.

Additional information:

For automatic deactivation of front passenger airbags, refer to page 184.

### Seat position and height

After installing a child restraint system, move the front passenger seat as far back as it will go and, if possible, bring it up to the highest position. This seat position and height ensure the best possible position for the belt and offers optimal protection in the event of an accident.

If the upper attachment point of the seat belt is located in front of the belt guide of the child restraint seat, move the front passenger seat carefully forward until the best possible belt guide position is reached.

### Backrest width

Adjustable backrest width: before installing a child restraint system in the front passenger seat, open the backrest width completely. Do not change the backrest width again and do not call up a memory position.

## Child seat security



The seat belts in the rear and the front passenger seat belt can be permanently locked to fasten child restraint systems.

### Locking the seat belt

1. Pull out the belt strap completely.
2. Secure the child restraint system with the seat belt.
3. Allow the belt strap to be pulled in and pull it tight against the child restraint system. The seat belt is disabled.

### Unlocking the seat belt

1. Unbuckle the seat belt buckle.
2. Remove the child restraint system.
3. Allow the belt strap to be pulled in completely.

## LATCH child seat mountings

### General information

LATCH: Lower Anchors and Tether for Children.

Pay attention to the specifications, operating tips and safety instructions from the child restraint system manufacturer when selecting, installing, and using LATCH child restraint fixing systems.

## Mounts for the lower LATCH anchors

### General information

The lower anchors may be used to attach the CRS to the vehicle seat up to a combined child and CRS weight of 65 lbs/30 kg when the child is restrained by the internal harnesses.

### Safety information



#### **Warning**

If the lower mountings of the child restraint system are not correctly engaged, the protective effect of the child restraint system is limited. There is a risk of injury or danger to life. Make sure that the lower mountings are correctly engaged and that the child restraint system fits securely against the backrest.

#### **Warning**

The mounts for the lower mountings and attachment points of the child restraint system are intended for attaching child restraint systems only. If other objects are attached, the mounts or attachment points can be damaged. There is a risk of injury or risk of damage to property. Only attach child restraint systems at the corresponding mounts for the lower mountings or attachment points.

## Position

Icon	Meaning
	The corresponding icon shows the mounts for the lower LATCH anchors.
	Seats equipped with lower mountings are marked with a pair (2) of LATCH icons. For vehicles equipped with a middle seat: It is not recommended to use the inner lower mountings of standard outer LATCH positions to fasten a child restraint system on the middle seat. Use the vehicle seat belt instead for the middle seat.

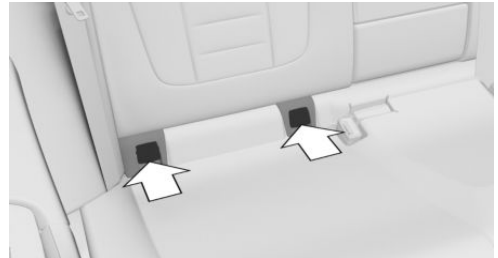

Mounts for the lower LATCH anchors are located behind the marked covers.

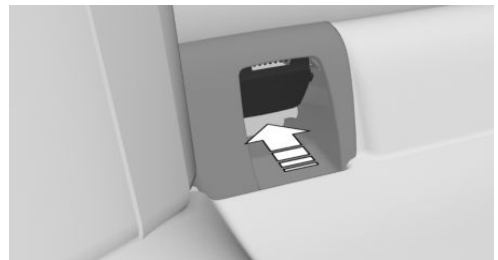

The covers fold back automatically when the mountings of a child restraint system are inserted.



## Before installing the LATCH child restraint fixing systems

Pull the seat belt away from the area of the child seat mountings.

## Installation of the LATCH child restraint fixing systems

1. Mount child restraint system, see manufacturer's information.
2. Ensure that both LATCH anchors are properly engaged.

## Child restraint systems with tether strap

### Safety information

#### **Warning**

If the upper retaining strap is incorrectly used for the child restraint system, the protective effect is reduced. There is a risk of injury. Make sure that the upper retaining strap does not run over sharp edges and is not twisted as it passes the upper anchor.

#### **Warning**

If the rear seat backrest is not locked, the protective effect of the child restraint system is limited or nonexistent. In certain situations, for instance braking maneuvers or in case of an accident, the rear seat backrest can fold forward. There is a risk of injury or danger to life. Make sure that the rear seat backrests are locked.

#### **Warning**

The mounts for the lower mountings and attachment points of the child restraint system are intended for attaching child restraint systems only. If other objects are attached, the mounts or attachment points can be damaged. There is a risk of injury or risk of damage to property. Only attach child restraint systems at the corresponding mounts for the lower mountings or attachment points.

## Attachment points

Icon	Meaning
	The respective icon shows the attachment point for the upper retaining strap. Seats with an upper top tether are marked with this icon. It is located on the rear seat backrest, the rear shelf or the rear seat.

## Routing the retaining strap

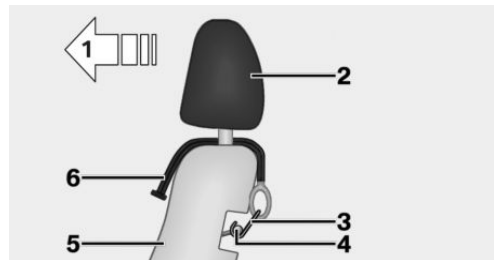

- 1 Driving direction
- 2 Head restraint
- 3 Hook for upper retaining strap
- 4 Attachment point
- 5 Seat backrest
- 6 Upper retaining strap

## Attaching the upper retaining strap to the attachment point

1. Raise the head restraint, if needed.
2. Guide the upper retaining strap between or along both sides of the supports for the head restraint to the attachment point.  
For the middle seat, guide it over or along both sides of the head restraint to the attachment point where applicable.
3. If there is a retaining strap, run it between the backrest and the cargo cover.
4. Attach the hook of the retaining strap to the attachment point.
5. Tighten the retaining strap by pulling it down.

## Locking the doors and windows in the rear

### General information

In certain situations it may be advisable to secure the rear doors and windows, for instance when transporting children.

### Doors



Push the locking lever on the rear doors up.

The door can now be opened from the outside only.

## Safety switch for the rear



Press the button on the driver's door.

This disables various functions so that they cannot be operated from the rear.

Additional information:

Safety switch, refer to page [111](#).

# Driving

## Vehicle features and options

This chapter describes all standard, country-specific and optional features offered with the series. It also describes features and functions that are not necessarily available in your vehicle, e.g., due to the selected options or country versions. This also applies to safety-related functions and systems. When using these functions and systems, the applicable laws and regulations must be observed.

## Start/Stop button

### Principle



Pressing the Start/Stop button switches drive-ready state on or off.

Steptronic transmission: the drive-ready state is switched on

when you depress the brake pedal while pressing the Start/Stop button.

Pressing the Start/Stop button again switches the drive-ready state back off and standby state is switched back on.

Additional information:

- ▶ Drive-ready state, refer to page 40.
- ▶ Standby state, refer to page 40.

### Driving off

1. Turn on drive-ready state.
2. Apply gear position.
3. Release the parking brake.
4. Driving off.

## Auto Start/Stop function

### Principle

The Auto Start/Stop function helps save fuel. The system switches off the engine during a stop, for instance in traffic jam or at traffic lights. Drive-ready state remains switched on. The engine starts automatically for driving off.

Additional information:

Coasting, refer to page 323.

### General information

After each engine start using the Start/Stop button, the Auto Start/Stop function is ready. The function is activated from speeds of approx. 3 mph/5 km/h.

Depending on the selected driving mode, the system is automatically activated or deactivated.

### Engine stop

### Functional requirements

#### Steptronic transmission

The engine is switched off automatically during a stop under the following conditions:

- ▶ The selector lever is in selector lever position D.
- ▶ The brake pedal remains depressed while the vehicle is at a standstill or the vehicle is held by Automatic Hold.
- ▶ The driver's seat belt is buckled or the driver's door is closed.

## Steptronic transmission: manual engine stop

If the engine was not switched off automatically when the vehicle stopped, the engine can be switched off manually:

- ▷ Depress the brake pedal forcefully again from the current pedal position.
- ▷ Engage selector lever position P.

When all functional preconditions are fulfilled, the engine switches off.

## Air conditioning system when the engine is switched off

The air flow from the air conditioning system is reduced when the engine is switched off.

## Displays in the instrument cluster

### General information

Instrument cluster with enhanced features:

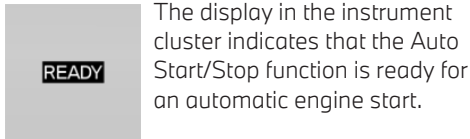

Instrument cluster without enhanced features:

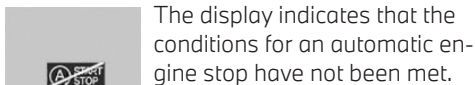
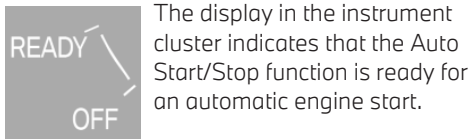

## Total time with switched-off engine

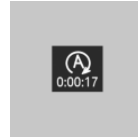

ECO PRO driving mode: depending on the vehicle equipment, the total time that the engine has been switched off using the Auto Start/Stop function is displayed on an automatic engine stop.

The total time can be reset via the trip data.

Additional information:

ECO PRO, refer to page [321](#).

## Functional limitations

The engine is not switched off automatically in the following situations:

- ▷ In case of a steep downhill grade.
- ▷ Brake not engaged strongly enough.
- ▷ The outside temperature is high and automatic climate control is running.
- ▷ The car's interior has not yet been heated or cooled to the required level.
- ▷ Where there is a risk of window condensation when the automatic climate control is switched on.
- ▷ Engine or other parts not at operating temperature.
- ▷ Engine cooling is required.
- ▷ The wheels are at a sharp angle or the steering wheel is being turned.
- ▷ Vehicle battery is heavily discharged.
- ▷ At higher elevations.
- ▷ Hood is unlocked.
- ▷ Hill Descent Control is activated.
- ▷ The Automatic Parking Assistant is activated.
- ▷ Stop-and-go traffic.
- ▷ Steptronic transmission: selector lever position in N or R.
- ▷ After driving in reverse.
- ▷ Use of fuel with high ethanol content.

## Starting the engine

### Functional requirements

#### Steptronic transmission

The engine starts automatically under the following preconditions:

- ▷ By releasing the brake pedal.
- ▷ When Automatic Hold is activated: step on the accelerator pedal.

#### Driving off

After the engine starts, accelerate as usual.

#### Safety mode

After the engine switches off automatically, it will not start again automatically if any one of the following conditions are met:

- ▷ The driver's seat belt is unbuckled and the driver's door is open.
- ▷ Hood was unlocked.

Some indicator lights light up for a varied length of time.

The engine can only be started via the Start/Stop button.

#### System limits

Even if driving off was not intended, the deactivated engine starts up automatically in the following situations:

- ▷ In case of excessive warming of the interior when air conditioning is turned on.
- ▷ In case of excessive cooling of the interior when the heating is turned on.
- ▷ In case of a risk of window condensation when the automatic climate control is turned on.
- ▷ Without mild hybrid technology: in case of a steering operation.
- ▷ When changing from selector lever position D to N or R.

- ▷ When changing from selector lever position P to N, D, or R.
- ▷ In case of seriously discharged vehicle battery.
- ▷ When starting an oil level measurement.

### Without Mild-Hybrid technology: additional functions Auto Start/Stop

Depending on the equipment and national-market version, the vehicle features a variety of sensors for assessing the traffic situation. The Auto Start/Stop function uses this information to adapt to various traffic situations in a proactive manner.

For instance, this applies to the following situations:

- ▷ A situation is detected in which the stopping time is expected to be very short. The engine is not automatically switched off. A message appears on the Control Display, depending on the situation.
- ▷ A situation is detected in which the vehicle should be started up immediately. The switched-off engine starts automatically.

The function may be restricted if the navigation data is invalid, outdated or not available, for example.

### Activating/deactivating the system manually

#### Principle

The engine is not automatically switched off. The engine is started during an automatic engine stop.



## Without Mild-Hybrid technology: via button



Press the button.

## Steptronic transmission: via selector lever position

The Auto Start/Stop function is also deactivated in selector lever position M/S.

## Via the Driving Dynamics Control

The Auto Start/Stop function is also deactivated in SPORT driving mode of the Driving Dynamics Control.

## Without Mild-Hybrid technology: display

- ▷ LED comes on: Auto Start/Stop function is deactivated.
- ▷ LED goes out: Auto Start/Stop function is activated.

## Switching off the vehicle during an automatic engine stop

### General information

During an automatic engine stop, the vehicle can be switched off permanently, for instance when leaving it.

### Steptronic transmission

1. Press the Start/Stop button.

- ▷ Drive-ready state is switched off.
- ▷ Standby state is switched on.
- ▷ Selector lever position P is engaged automatically.

2. Set the parking brake.

## Automatic deactivation

### General information

In certain situations, the Auto Start/Stop function is deactivated automatically for safety reasons, for instance if no driver is detected.

### Malfunction

The Auto Start/Stop function no longer switches off the engine automatically. A Check Control message is displayed. It is possible to continue driving. Have the system checked by an authorized service center or another qualified service center or repair shop.

## Driving Dynamics Control

### Principle

The Driving Dynamics Control influences the driving dynamics properties of the vehicle.

The vehicle can be adjusted depending on the situation using various driving modes.

### General information

The following systems are affected, for instance:

- ▷ Characteristics of the drivetrain
- ▷ Steptronic transmission.
- ▷ Adaptive suspension.
- ▷ Adaptive M chassis.
- ▷ Steering.
- ▷ Display in the instrument cluster.
- ▷ Cruise control.

## Overview



## Displays in the instrument cluster

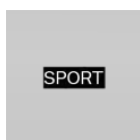

The selected driving mode is displayed in the instrument cluster.

## Driving modes

Button	Driving mode	Configuration
	SPORT	INDIVIDUAL
	SPORT PLUS	
	COMFORT	
	ECO PRO	INDIVIDUAL

When drive-ready state is switched on, the COMFORT driving mode is selected automatically.

## Driving modes in detail

### COMFORT

#### Principle

The COMFORT driving mode is a balanced setting between sporty and consumption-optimized driving.

#### Turning on



Press the button repeatedly until COMFORT is displayed in the instrument cluster.

### SPORT

#### Principle

The SPORT driving mode is a dynamic setting for more agility with an optimized suspension.

#### Turning on



Press the button repeatedly until SPORT is displayed in the instrument cluster.

### SPORT INDIVIDUAL

#### Principle

In the SPORT INDIVIDUAL driving mode, individual settings can be adjusted to support driving dynamics properties.

#### Configuration

1. "CAR"
2. "Settings"
3. "Driving mode"
4. "SPORT INDIVIDUAL"
5. Select the desired setting.

Reset SPORT INDIVIDUAL to the standard settings:

"Reset to SPORT STANDARD".

### SPORT PLUS

#### Principle

The SPORT PLUS driving mode is a dynamic setting for maximum agility with an adjusted drive.

## Turning on

 Press the button repeatedly until SPORT PLUS is displayed in the instrument cluster.

## ECO PRO

### Principle

In ECO PRO driving mode, consumption is optimized.

### Turning on

 Press the button repeatedly until ECO PRO is displayed in the instrument cluster.

## ECO PRO INDIVIDUAL

### Principle

In the ECO PRO INDIVIDUAL driving mode, individual settings can be adjusted to support an economical driving style.

The engine control and comfort features, for instance the climate control output, are adjusted.

### Configuration

1. "CAR"
2. "Settings"
3. "Driving mode"
4. "ECO PRO INDIVIDUAL"
5. Select the desired setting.

Reset ECO PRO INDIVIDUAL to the standard settings:

"Reset to ECO PRO STANDARD".

## INDIVIDUAL configuration

### General information

The individual configuration set last is activated directly when the driving mode is called up again.

### Activating configuration of the driving mode

Press the button for the desired driving mode several times.

## Parking brake

### Principle

The parking brake is used to prevent the vehicle from rolling away when it is parked.

### Safety information

#### **Warning**

An unsecured vehicle can begin to move and possibly roll away. There is a risk of accident. Before leaving the vehicle, secure the vehicle against rolling away.

In order to ensure that the vehicle is secured against rolling away, follow the following:

- ▷ Set the parking brake.
- ▷ On uphill grades or on downhill slopes, turn the front wheels in the direction of the curb.
- ▷ On uphill grades or on downhill slopes, also secure the vehicle, for instance with a wheel chock.

#### **Warning**

Unattended children or animals in the vehicle can cause the vehicle to move and endanger themselves and traffic, for instance due to the following actions:



- ▷ Pressing the Start/Stop button.
- ▷ Releasing the parking brake.
- ▷ Opening and closing the doors or windows.
- ▷ Engaging selector lever position N.
- ▷ Using vehicle equipment.

There is a risk of accidents or injuries. Do not leave children or animals unattended in the vehicle. Take the vehicle key with you when exiting and lock the vehicle.

## Overview



 Parking brake

## Setting the parking brake

### With a stationary vehicle

 Pull the switch.  
The LED lights up.

 The indicator light in the instrument cluster illuminates red. The parking brake is set.

## While driving

### General information

Use while driving serves as an emergency braking function.

 Pull the switch and hold it. The vehicle brakes hard while the switch is being pulled.

 The indicator light in the instrument cluster illuminates red, a signal sounds, and the brake lights illuminate.

A Check Control message is displayed.

The parking brake is engaged when the vehicle is stationary.

### With Emergency Stop Assistant

 Pull the switch briefly to activate the emergency stop function.

Additional information:

Emergency Stop Assistant, refer to page [206](#).

## Releasing the parking brake

### Releasing the parking brake manually

1. Turn on drive-ready state.
2.  Steptronic transmission: press the switch while the brake is pressed or selector lever position P is set.  
The LED and the indicator light go out.  
The parking brake is released.

### Releasing the parking brake automatically

The parking brake is released automatically when you drive off.

The LED and the indicator light go out.

## Steptronic transmission: Automatic Hold

### Principle

Automatic Hold assists the driver by automatically setting and releasing the brake, such as when moving in stop-and-go traffic.

The vehicle is automatically held in place when it is stationary.

On uphill grades the system prevents the vehicle from rolling back when driving off.

## General information

Under the following conditions, the parking brake is automatically engaged:

- ▷ Drive-ready state is switched off.
- ▷ The driver's door is opened while the vehicle is stationary.
- ▷ The moving vehicle is brought to a standstill using the parking brake.

## Safety information

### Warning

An unsecured vehicle can begin to move and possibly roll away. There is a risk of accident. Before leaving the vehicle, secure the vehicle against rolling away.

In order to ensure that the vehicle is secured against rolling away, follow the following:

- ▷ Set the parking brake.
- ▷ On uphill grades or on downhill slopes, turn the front wheels in the direction of the curb.
- ▷ On uphill grades or on downhill slopes, also secure the vehicle, for instance with a wheel chock.

### Warning

Unattended children or animals in the vehicle can cause the vehicle to move and endanger themselves and traffic, for instance due to the following actions:

- ▷ Pressing the Start/Stop button.
- ▷ Releasing the parking brake.
- ▷ Opening and closing the doors or windows.

- ▷ Engaging selector lever position N.
- ▷ Using vehicle equipment.

There is a risk of accidents or injuries. Do not leave children or animals unattended in the vehicle. Take the vehicle key with you when exiting and lock the vehicle.

### NOTICE

If the vehicle is stationary, Automatic Hold engages the parking brake and prevents the vehicle from rolling in a car wash. There is a risk of damage to property, among other potential damage. Deactivate Automatic Hold prior to entering the car wash.

## Overview



 Automatic Hold

## Establishing operational readiness of Automatic Hold

1. Turn on drive-ready state.

2.  Press the button.

The LED lights up.

 The indicator light lights up green.

Automatic Hold is ready to use.

After every vehicle restart, the last selected setting is active.



## Automatic Hold holding the vehicle

Operational readiness is established and the driver's door is closed.



After the brake is applied, the vehicle is kept from rolling away as soon as the indicator light illuminates green.

## Driving off

Press the accelerator pedal to drive off.

The brake is released automatically and the indicator light of the parking brake is no longer illuminated.

## Activating the parking brake automatically

The parking brake is automatically set if drive-ready state is switched off while the vehicle is being held by Automatic Hold or if the vehicle is exited.



The indicator light changes from green to red.

The parking brake is not set automatically if the drive-ready state was switched off while the vehicle was coasting. Automatic Hold is deactivated.

## Switching operational readiness off



Press the button.

The LED goes out.



The indicator light goes out.

Automatic Hold is switched off.

If the vehicle is being held by Automatic Hold, also press on the brake pedal when switching off.

## Malfunction

If the parking brake fails or in case of a fault, secure the vehicle against rolling away before exiting.

A Check Control message is displayed.

Secure the vehicle against rolling away, for instance with a wheel chock, after getting out of the vehicle.

## After a power interruption

To reestablish parking brake functionality after a power interruption:

1. Turn on standby state.
2.  Pull the switch while stepping on the brake pedal or selector lever position P is set and then push.

This process may take a few seconds. Some mechanical sounds associated with this process are normal.



The indicator light is no longer illuminated as soon as the parking brake is ready for operation again.

## Turn signal

### Turn signal in exterior mirror

When driving and during operation of the turn signals or hazard warning system, do not fold in the exterior mirrors so that the turn signal lamps on the exterior mirror are easy to see.

## Blinking

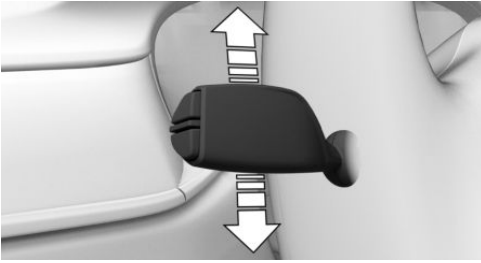

Press the lever past the resistance point.

## Triple turn signal activation

Lightly tap the lever up or down.

The triple turn signal duration can be adjusted.

1. "CAR"
2. "Settings"
3. "Exterior lighting"
4. "One-touch turn signal"
5. Select the desired setting.

## Brief blinking

Press the lever to the resistance point and hold it there for as long as you want the turn signal to flash.

## High beams, headlight flasher

Press the lever forward or pull it backward.

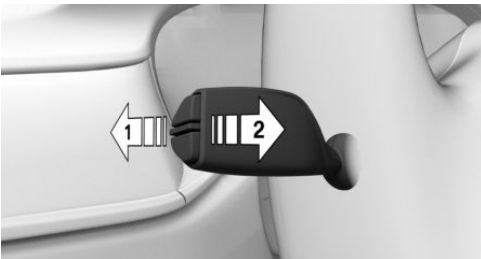

- ▶ High beams on, arrow 1.

The high beams light up when the low beams are switched on.

- ▶ High beams off/headlight flasher, arrow 2.

## Window wiper system

### Safety information

#### **Warning**

If the wipers start moving in the folded away state, body parts can be jammed or damage may occur to parts of the vehicle. There is a risk of injury or risk of damage to property. Make sure that the vehicle is switched off when the wipers are in the folded-away state and the wipers are folded in when switching on.

#### **NOTICE**

The wiper blades can wear out or become damaged prematurely when wiping on a dry window for a longer period of time. The wiper motor can overheat. There is a risk of damage to property, among other potential damage. Do not use the wipers when the window is dry.

#### **NOTICE**

If the wipers are frozen to the windshield, the wiper blades can be torn off and the wiper motor can overheat when switching on. There is a risk of damage to property, among other potential damage. Defrost the windshield prior to switching the wipers on.

## Turning on window wiper system

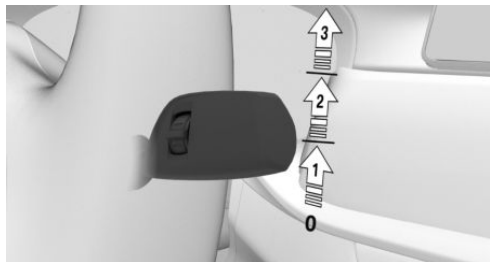

Press the lever up until the desired position is reached.

- ▷ Resting position of the wipers, position 0.
- ▷ Rain sensor, position 1.
- ▷ Normal wiper speed, position 2.
- ▷ Fast wiper speed, position 3.

When the journey is interrupted with the window wiper system turned on: when the journey continues, the wipers resume at their previous speed.

## Turning off the window wiper system and flick wipe

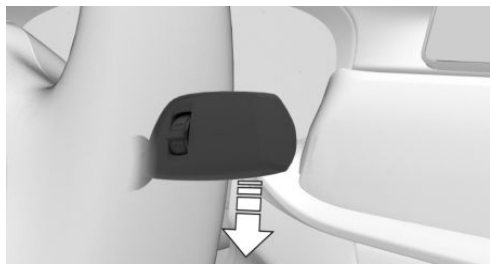

Press the lever down.

- ▷ Turn off: press the lever down until it reaches the 0 position.
- ▷ Flick wipe: press the lever down from the 0 position.

The lever automatically returns to its 0 position when released.

## Rain sensor

### Principle

The rain sensor automatically controls the wiper operation depending on the intensity of the rainfall.

### General information

The sensor is located on the windshield, directly in front of the interior mirror.

### Safety information

#### NOTICE

If the rain sensor is activated, the wipers can accidentally start moving in car washes. There is a risk of damage to property, among other potential damage. Deactivate the rain sensor in car washes.

## Activating rain sensor

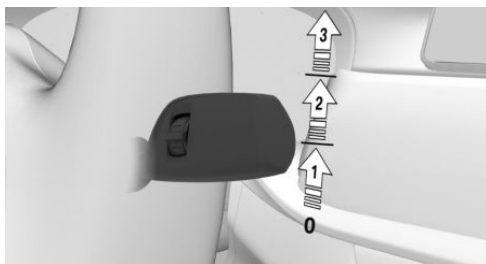

Press the lever up once from its 0 position, arrow 1.

Wiping operation is started.

The LED in the wiper lever is illuminated.

In frosty conditions, wiping operation may not start.

## Deactivating rain sensor

Press the lever back into the 0 position.



## Adjusting the rain sensor sensitivity

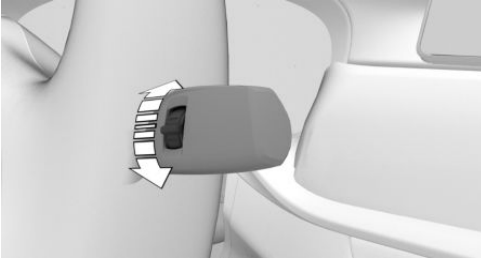

Turn the thumbwheel to adjust the sensitivity of the rain sensor.

Upward: high rain sensor sensitivity.

Downward: low rain sensor sensitivity.

## Windshield washer system

### Safety information

#### **Warning**

The washer fluid can freeze onto the window at low temperatures and obstruct the view. There is a risk of accident. Only use the washer systems if the washer fluid cannot freeze. Use washer fluid with antifreeze, if needed.

#### **NOTICE**

When the washer fluid reservoir is empty, the washer pump cannot work as intended. There is a risk of damage to property, among other potential damage. Do not use the washer system when the washer fluid reservoir is empty.

## Cleaning the windshield



Pull the lever.

The washer fluid is sprayed on the windshield, and the wipers are turned on briefly.

### Windshield washer nozzles

The windshield washer nozzles are automatically heated while standby state is switched on.

## Rear wiper

### Switching on the rear wiper

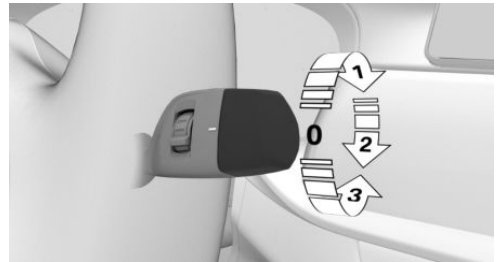

Turn the outer switch upward.

- ▶ Resting position of the wiper, position 0.
- ▶ Intermittent operation, arrow 1. When reverse gear is engaged, the system switches to continuous operation.

### Clean the rear window

Turn the outer switch in the desired direction.

- ▶ In resting position: turn the switch downward, arrow 3. The switch automatically returns to its idle position when released.
- ▶ In intermittent operation: turn the switch further, arrow 2. The switch automatically returns to its interval position when released.

The function is deactivated if the washer fluid reservoir fill level is low.

## Fold-out position of the wipers

### Principle

In the fold-out position, the wipers can be folded out from the windshield, which is important, for instance, when changing the wiper blades or for folding away under frosty conditions.

### Safety information

**Warning**

If the wipers start moving in the folded away state, body parts can be jammed or damage may occur to parts of the vehicle. There is a risk of injury or risk of damage to property. Make sure that the vehicle is switched off when the wipers are in the folded-away state and the wipers are folded in when switching on.

**NOTICE**

If the wipers are frozen to the windshield, the wiper blades can be torn off and the wiper motor can overheat when switching on. There is a risk of damage to property, among other potential damage. Defrost the windshield prior to switching the wipers on.

## Folding out the wipers

1. Turn on standby state.
2. Press and hold the wiper lever down until the wipers stop in a nearly vertical position.

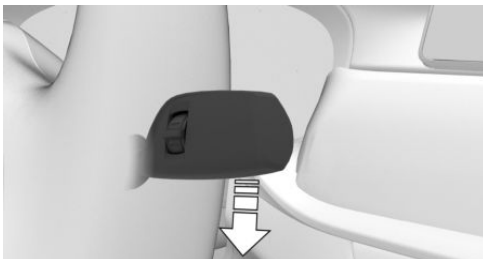

3. Fold the wipers all the way out from the windshield.



## Folding in the wipers

1. Fold the wipers back in onto the windshield.
2. Switch on standby state and press and hold the wiper lever down again.

Wipers return to their resting position and are ready again for operation.

## Steptronic transmission

### Principle

The Steptronic transmission combines the functions of an automatic transmission with the possibility of manual shifting, if needed.

## Safety information

### **Warning**

An unsecured vehicle can begin to move and possibly roll away. There is a risk of accident. Before leaving the vehicle, secure the vehicle against rolling away, e.g. by applying the parking brake.

## Selector lever positions

### Gear position D

Selector lever position for normal driving. All gears for forward travel are activated automatically.

### R is reverse

Engage selector lever position R only when the vehicle is stationary.

### Neutral N

The vehicle may be pushed or roll without power, for instance in car washes, in selector lever position N.

### Parking position P

#### General information

Selector lever position, for instance for parking the vehicle. The transmission blocks the individual wheels in selector lever position P.

Engage selector lever position P only when the vehicle is stationary.

#### P is engaged automatically

Selector lever position P is engaged automatically in situations such as the following:

- ▶ After the drive-ready state is switched off and selector lever position R, D or M/S is engaged.
- ▶ After the standby state has been turned off when selector lever position N is engaged.
- ▶ The driver's seat belt is unbuckled, the driver's door is opened, and the brake pedal is not pressed while the vehicle is stationary and the selector lever is set to D, M/S, or R.

Before exiting the vehicle, make sure that selector lever position P is set. Otherwise, the vehicle may begin to move. Also set parking brake.

Additional information:

Parking brake, refer to page 139.

## Engaging selector lever positions

### General information

To prevent the vehicle from creeping after you select a gear position or reverse, maintain pressure on the brake pedal until you are ready to drive off.

### Functional requirements

Only when the drive-ready state is switched on and the brake pedal is depressed is it possible to change from selector lever position P to another selector lever position.

The selection lever position P cannot be changed until all technical prerequisites are met.

### Engaging selector lever position D, N, R

A selector lever lock prevents the following incorrect operation:

- ▶ Unintentional shifting into selector lever position R.
- ▶ Unintentional shifting from selector lever position P into another selector lever position.

1. Fasten driver's seat belt.
2. Press and hold the button to release the selector lever lock.

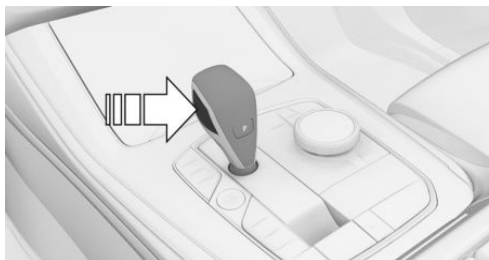

3. Push the selector lever in the desired direction, past a resistance point, if needed. The selector lever automatically returns to the center position when released.



### Engaging selector lever position P



Press button P.

## Rolling or pushing the vehicle

### General information

In some situations, the vehicle is supposed to roll without its own power for a short distance, for instance in a car wash or to be pushed.

### Engaging selector lever position N

#### NOTICE

Selector lever position P is automatically engaged when standby state is switched off. The wheels are blocked. There is a risk of damage to property. Do not switch off standby if the vehicle is meant to coast, e.g., in a car wash.

1. Switch on drive-ready state while pressing on the brake pedal.
2. If necessary, release the parking brake.
3. If necessary, switch off Automatic Hold. Automatic Hold, refer to page 140.
4. Depress the brake pedal.
5. Touch the selector lever lock and engage selector lever position N.
6. Switch off drive-ready state.

In this way, standby state remains switched on, and a Check Control message is displayed.

The vehicle can roll.

Selector lever position P is engaged automatically after approximately 35 minutes.

If there is a malfunction, you may not be able to change the selector lever position.

Electronically unlock the transmission lock, if needed.

Additional information:

Electronic unlocking of the transmission lock, refer to page 150.

## Kickdown

Kickdown is used to achieve maximum driving performance.

Step on the accelerator pedal beyond the resistance point at the full throttle position.

## Sport program M/S

### Principle

The shifting points and shifting times in the Sport program are designed for sportier handling. The transmission, for instance shifts up later and the shifting times are shorter.

### Activating the Sport program

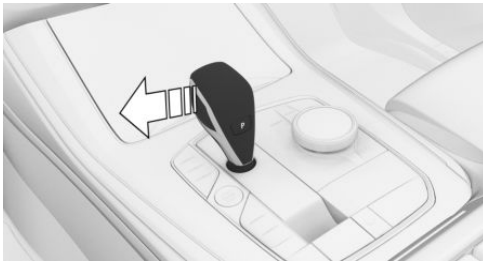

Press the selector lever to the left from selector lever position D.

The engaged gear is displayed in the instrument cluster, for instance S1.

The sport program of the transmission is activated.

### Ending the Sport program

Press the selector lever to the right.

D is displayed in the instrument cluster.

## Manual mode M/S

### Principle

Manual gear-shifting is possible in manual mode.

## Activating manual mode

1. Press the selector lever to the left from selector lever position D, arrow 1.

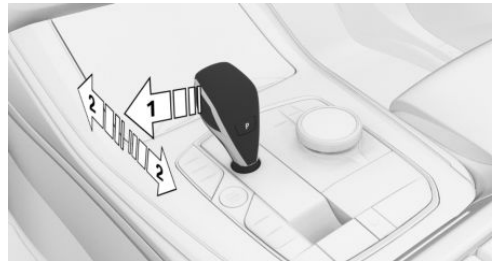

2. Press the selector lever forward or pull it backward, arrows 2.

Manual mode becomes active and the gear is changed.

The engaged gear is displayed in the instrument cluster, for instance M1.

### Shifting

- ▶ To downshift: press the selector lever forward.
- ▶ Upshifting: pull the selector lever rearwards.

The transmission continues shifting automatically in certain situations, for instance when RPM limits are reached.

### Steptronic Sport transmission: prevent automatic upshifting in M/S manual mode

Depending on the motorization: if driving mode SPORT is selected, the Steptronic Sport transmission does not automatically upshift in M/S manual mode once the maximum speed is reached.

In addition, there is no downshifting for kickdown.

Additional information:  
SPORT, refer to page 138.

## Ending the manual mode

Press the selector lever to the right.  
D is displayed in the instrument cluster.

## Shift paddles

### Principle

The shift paddles on the steering wheel allow you to change gears quickly while keeping both hands on the steering wheel.

### General information

#### Shifting

The vehicle only shifts at suitable RPM and road speeds.

#### Short-term manual mode

In selector lever position D, actuating a shift paddle switches into manual mode temporarily.

After conservative driving in manual mode without acceleration or shifting via the shift paddles for a certain amount of time, the transmission switches back to automatic mode.

It is possible to switch into automatic mode:

- ▶ Keep the right shift paddle pulled until D is displayed in the instrument cluster.
- ▶ In addition to the pulled right shift paddle, pull the left shift paddle.

#### Continuous manual mode

In selector lever position S, actuating a shift paddle switches into manual mode permanently.

With the transmission version it is possible to switch into automatic mode:

- ▶ Keep the right shift paddle pulled until S is displayed in the instrument cluster.
- ▶ In addition to the pulled right shift paddle, pull the left shift paddle.

## Steptronic Sport transmission

With the appropriate transmission version, the lowest possible gear can be selected by simultaneously activating kickdown and operating the left shift paddles. This is not possible in short-term manual mode.

### Shifting



- ▶ Upshifting: pull the right shift paddle.
- ▶ Downshifting: pull left shift paddle.
- ▶ Downshifting to the lowest possible gear: keep the left shift paddle pulled.

The selected gear is briefly displayed in the instrument cluster, followed by the current gear.

### Displays in the instrument cluster

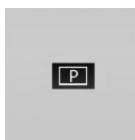

The selector lever position is displayed, for example P.

## Electronic unlocking of the transmission lock

### General information

Unlock the transmission lock electronically, e.g., to maneuver the vehicle out of a hazardous area in the event of a malfunction.

Before unlocking the transmission lock, set the parking brake to prevent the vehicle from rolling away.

In vehicles with Mild-Hybrid technology and corresponding vehicle battery, the action steps for unlocking the transmission vary.

Additional information:

Vehicle battery, refer to page [374](#).

### Without Mild-Hybrid technology: engage selector lever position N

Unlocking is possible, if the starter can crank the engine.

1. Press and hold down brake pedal.
2. Press and hold the Start/Stop button. The starter must audibly start.
3. With your free hand, press the button on the selector lever, arrow 1, and press the selector lever into selector lever position N and hold, arrow N, until selector lever position N is displayed in the instrument cluster. A Check Control message is displayed.



4. Release Start/Stop button and selector lever.
5. Release brake, as soon as the starter stops.
6. Maneuver the vehicle from the hazardous area and secure it against rolling away.

Additional information:

Tow-starting/towing, refer to page [381](#).

### With Mild-Hybrid technology: engage selector lever position N

1. Press and hold down brake pedal.
2. Press and hold the Start/Stop button.

3. With your free hand, press the button on the selector lever, arrow 1, and press the selector lever into selector lever position N and hold, arrow N, until selector lever position N is displayed in the instrument cluster. A Check Control message is displayed.



4. Release Start/Stop button and selector lever.
5. Release the brake.
6. Maneuver the vehicle from the hazardous area and secure it against rolling away.

Additional information:

Tow-starting/towing, refer to page [381](#).

## Launch Control

### Principle

Launch Control enables optimum acceleration on roads with good traction under dry surrounding conditions.

### General information

The use of Launch Control causes premature component wear since this function represents a very heavy load for the vehicle.

Do not use Launch Control during the break-in.

Do not steer the steering wheel when driving off with Launch Control.

Additional information:

Breaking-in period, refer to page [310](#).

## Functional requirement

Launch Control is available when the engine is at operating temperature. The engine is at operating temperature after an uninterrupted trip of at least 6 miles/10 km.

## Starting with launch control

1. Turn on drive-ready state.
2.  Press the button.  
 TRACTION is displayed in the instrument cluster and the indicator light for DSC OFF lights up.
3. Engage selector lever position S.
4. With the left foot, forcefully press down on the brake.
5. Press and hold down the accelerator pedal beyond the resistance point at the full throttle position, kickdown.  
 A destination flag is displayed in the instrument cluster.
6. The starting engine speed adjusts. Wait briefly until the engine speed is constant. Keep the accelerator pedal in this position.
7. Release the brake within 3 seconds after the destination flag illuminates.  
 The vehicle accelerates.  
 Upshifting occurs automatically as long as the destination flag is displayed and the accelerator pedal is not released.

## Repeated use during a trip

After Launch Control has been used, the transmission must cool down for approx. 5 minutes before Launch Control can be used again. Launch Control adjusts to the surrounding conditions, when used again.

## After using Launch Control

To support driving stability, reactivate Dynamic Stability Control as soon as possible.

## System limits

An experienced driver may be able to achieve better acceleration values in DSC OFF mode.



# Displays

## Vehicle features and options

This chapter describes all standard, country-specific and optional features offered with the series. It also describes features and functions that are not necessarily available in your vehicle, e.g., due to the selected options or country versions. This also applies to safety-related functions and systems. When using these functions and systems, the applicable laws and regulations must be observed.

## Instrument cluster

### Principle

The instrument cluster consists of various digital displays, e.g., a speedometer, time, range, temperatures as well as indicator and warning lights.

### General information

Depending on the vehicle equipment, it may be possible to deactivate the display change in the instrument cluster via iDrive.

Some of the displays in the instrument cluster may differ from the illustrations in the Owner's Manual.

### Safety information

#### **Warning**

If the displays on the instrument cluster fail, do not use the vehicle. There may be a risk of accident or risk of damage to property. Immediately park the vehicle in a safe manner. If drive readiness is switched off and on again, the malfunction may be rectified and it may be possible to continue driving. If the malfunction cannot be remedied, have

the system checked by an authorized service center or by another qualified service center or a repair shop.

## Instrument cluster with enhanced features: Overview

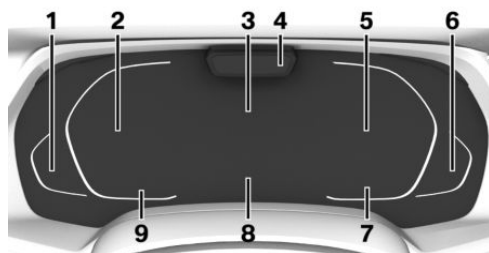

- 1 Fuel gauge [165](#)  
Range [168](#)
- 2 Speedometer
- 3 Central display range [154](#)  
Navigation display
- 4 Depending on the equipment: Driver Attention Camera
- 5 Tachometer [166](#)  
Selection lists [169](#)  
Widgets [156](#)  
Trip odometer, see Trip data [170](#)  
ECO PRO displays [321](#)  
Power gauge [166](#)  
Status, Driving Dynamics Control [137](#)  
Transmission display [146](#)
- 6 Engine temperature [167](#)
- 7 Outside temperature [168](#)
- 8 Check Control [158](#)
- 9 Speed Limit Assistant [234](#)  
Speed Limit Info [219](#)

Time 61

## Instrument cluster without enhanced features: Overview

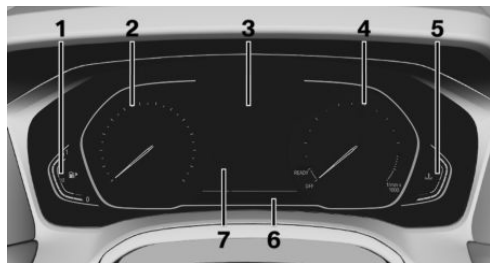

- 1 Fuel gauge 165
- 2 Speedometer
- 3 Check Control 158
  - Widgets 157
  - Service notifications 168
  - Trip odometer, see Trip data 170
  - Navigation display
  - Range 168
- 4 Tachometer 166
  - Power gauge 166
- 5 Engine temperature 167
- 6 Outside temperature 168
  - Transmission display
  - Status, Driving Dynamics Control 137
  - Time 61
- 7 Speed Limit Info 219

## Central display range

Depending on the equipment and configuration, the following is displayed in the central display range of the instrument cluster:

- ▷ Navigation displays such as the map view or, if destination guidance is active, a route preview with route guidance information.
- ▷ Displays showing service notifications.
- ▷ Assisted Driving View. Information about the assist systems is displayed in an animated surrounding area of the vehicle.

Some displays in the central display range can be configured individually.

The displays may vary depending on the equipment and national-market version.

## Driving mode view

### Principle

Depending on the equipment, if the driving mode view is activated, the displays in the instrument cluster will adapt to the respective driving mode when a program is changed via the Driving Dynamics Control.

### Activate/deactivate

1. "CAR"
2. "Settings"
3. "Displays"
4. "Driving mode view"

### Settings

Specific displays can be configured individually.

1. "CAR"
2. "Settings"
3. "Displays"
4. "Instrument panel"
5. Select the desired setting.

## Assisted Driving View

### Principle

Depending on vehicle equipment, information on driver assistance systems is displayed using an animation of the vehicle when driver assistance is enabled.

### General information

Depending on the settings, Assisted Driving View can be displayed permanently or temporarily with active Driver Assistance in the instrument cluster.

### Safety information

#### **Warning**

The system cannot serve as a substitute for the driver's personal judgment in assessing the traffic situation. Based on the limits of the system, it cannot independently react to all traffic situations. There is a risk of accident. Adjust driving style to traffic conditions. Watch the surrounding traffic situation closely, be ready to take over steering and braking at any time, and actively intervene where appropriate.

## Settings

### Permanent display

1. "CAR"
2. "Settings"
3. "Displays"
4. "Instrument panel"
5. "Central display area"
6. "Assisted Driving View"

### Temporary display

1. "CAR"
2. "Settings"
3. "Displays"
4. "Instrument panel"
5. "Display Assisted Driving View when Driver Assistance is active"

### Display



An example: the indicator and warning lights for the Active Cruise Control with Stop&Go function and the Automatic Lane Change Assistant indicate a lane change to the next lane. At the same time, the lane change to the next lane is shown with animation in the Assisted Driving View.

### System limits

The system's detection capability is limited. The system may indicate something wrong. Only objects that are detected by the system are taken into account.

Additional information:

- ▷ Cameras, refer to page 35.
- ▷ Radar sensors, refer to page 36.

## Instrument cluster with extended features: Widgets

### Principle

Displays for specific functions can be displayed in the instrument cluster.

The following displays can be selected:

- ▷ Current entertainment source, e.g., radio.
- ▷ Torque and power.
- ▷ G-meter.
- ▷ Trip data.
- ▷ Efficiency display.

### Selecting

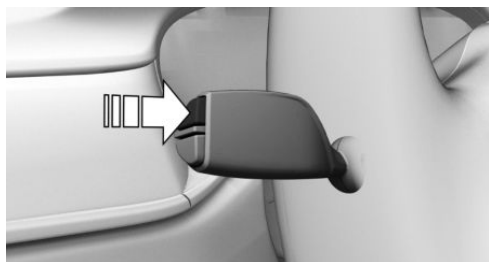

Continue to press the button on the turn signal lever until the desired widget is selected.

### Display

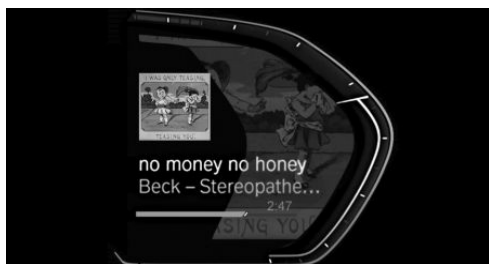

### G-meter

The G-meter indicates the forces that are applied in longitudinal and transverse direction on the vehicle occupants while driving.

### Efficiency display

#### Principle

Information about driving style and consumption can be displayed in the form of a consumption display as a widget in the instrument cluster, for example.

### General information

Depending on the activated driving mode, different information will be displayed:

Driving mode	Display
COMFORT	Average consumption.
SPORT	Current consumption. Energy recovery.
ECO PRO	ECO PRO bonus range. Distance traveled in Coasting mode. Current consumption.

### Average consumption

The average consumption indicates the fuel consumption when driving a specific route.

### Current consumption

The current fuel consumption display allows you to check the current fuel consumption, e.g., to drive economically and in an environmentally-friendly manner.

### Energy recovery

During energy recovery, the kinetic energy of the vehicle is converted into electric energy in coasting/overrun mode. The vehicle battery is

partially charged and fuel consumption can be reduced.

### ECO PRO bonus range

In the ECO PRO driving mode, the yielded extension of the range as a result of fuel-efficient driving is displayed as ECO PRO bonus range.

## Instrument cluster without enhanced features: widgets

### Principle

Displays for specific functions can be displayed in the instrument cluster.

- ▷ Distance covered.
- ▷ Consumption display.
- ▷ Current consumption and average consumption.
- ▷ Digital speed.
- ▷ Navigation data.  
When destination guidance is activated in the navigation system.
- ▷ Driver assistance systems.
- ▷ Compass display for the driving direction.
- ▷ Current entertainment source, e.g., radio.

### Selecting

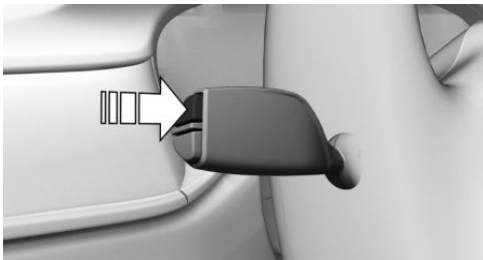

Continue to press the button on the turn signal lever until the desired widget is selected.

## Configuring widgets

Some widgets can be configured individually.

1. "CAR"
2. "Settings"
3. "Displays"
4. "Instrument panel"
5. "Configure widgets"
6. Select the desired setting.

### Information in detail

#### Distance covered

The widget for the distance covered shows the total distance and traveled distance depending on the setting for the display of the trip data.

#### Consumption display

##### Principle

During energy recovery, the kinetic energy of the vehicle is converted into electric energy in coasting/overrun mode. The vehicle battery is partially charged and fuel consumption can be reduced.

The current consumption displays the current fuel consumption. Check whether you are currently driving in an efficient and environmentally-friendly manner.

##### General information

Energy recovery and current consumption can be displayed as bar displays.

## Display



- ▷ Energy recovery, arrow 1.
- ▷ Current consumption, arrow 2.
- ▷ Average consumption, arrow 3.

## Current consumption and average consumption

The widget shows the current consumption and average consumption depending on the setting for the display of the trip data.

## Navigation data

### General information

The estimated arrival time and the distance remaining to the destination are displayed if a destination is entered in the navigation system before the trip is started.

### Display

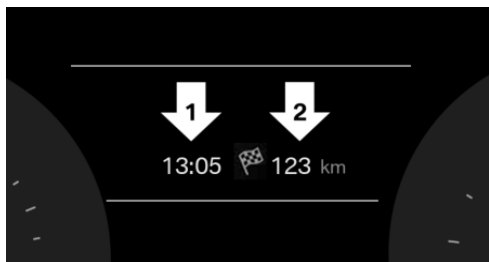

- ▷ Arrival time, arrow 1.
- ▷ Distance to destination, arrow 2.

## Compass

### General information

The compass shows the current driving direction.

### Display

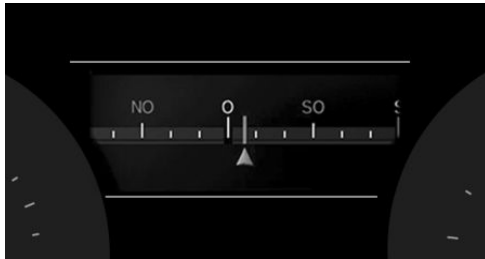

## Check Control

### Principle

The Check Control system monitors functions in the vehicle and notifies you of faults in the monitored systems.

### General information

A Check Control message is displayed as a combination of indicator or warning lights and text messages in the instrument cluster and, if applicable, in the Head-up display.

In addition, an acoustic signal may sound and a text message may appear on the Control Display.

## Hiding Check Control messages

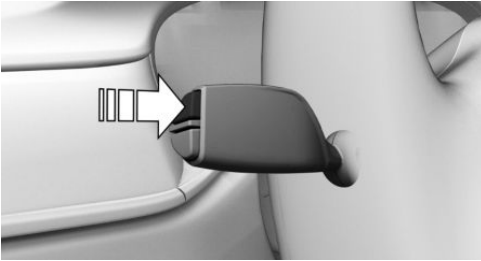

Press the button on the turn signal lever.

### Continuous display

Some Check Control messages are displayed continuously and are not cleared until the fault is eliminated. If several faults occur at once, the messages are displayed consecutively.

The messages can be hidden for approx. 8 seconds. After this time, they are displayed again automatically.

### Temporary display

Some Check Control messages are hidden automatically after approx. 20 seconds. The Check Control messages are stored and can be displayed again later.

## Displaying stored Check Control messages

1. "CAR"
2. "Vehicle status"
3.  "Check Control messages"
4. Select the desired text message.

## Display

### Check Control



At least one Check Control message is displayed or stored.

## Text messages

Text messages in combination with an icon in the instrument cluster explain a Check Control message and the meaning of the indicator/warning lights.

### Supplementary text messages

Additional information, such as the cause of a fault or the required action, can be called up via Check Control.

With urgent messages the added text will be automatically displayed on the Control Display.

Depending on the Check Control message, further help can be selected.

1. "CAR"
2. "Vehicle status"
3.  "Check Control messages"
4. Select the desired text message.
5. Select the desired setting.

### Messages after trip completion

Certain messages displayed while driving are displayed again after drive-ready state is switched off.

## Indicator/warning lights

### Principle

Indicator/warning lights in the instrument cluster display the status of some functions in the vehicle and indicate when a fault is present in the monitored systems.

### General information

The indicator/warning lights can light up in a variety of combinations and colors.

Several of the lights are checked for proper functioning and light up temporarily when drive-ready state is turned on.

## Red lights

### Seat belt reminder

 Indicator lamp lights up in the following situations:

- ▷ Seat belt on the driver or passenger side is not buckled.
- ▷ The seat belt reminder can also be activated if objects are placed on the front passenger seat.
- ▷ The seat belt is not buckled on the corresponding rear seat.

Make sure that the seat belts are positioned correctly.

### Rear seat belt reminder: Seat detection

 The seat belt is not buckled on the corresponding rear seat.

### Airbag system

 Airbag system and seat belt tensioner may not be working.

Have the vehicle checked immediately by an authorized service center or another qualified service center or repair shop.

### Parking brake

 The parking brake is set.

Additional information:

For releasing the parking brake, refer to page 140.

### Brake system

 Brake system fault. Continue to drive moderately.

 Have the vehicle checked immediately by an authorized service center or an-

other qualified service center or repair shop.

### If equipped with Equipment Stop Assistant

 Emergency Stop function active.

Additional information:

Emergency Stop Assistant, refer to page 206.

### Risk of collision

 Indicator light illuminates or flashes in conjunction with an acoustic signal if a collision is imminent.

Additional information:

- ▷ Intersection warning with City light braking function, refer to page 192.
- ▷ Pedestrian Warning with City Collision Mitigation, refer to page 195.

### Forward Collision Warning with light braking function

 The indicator light is illuminated: prewarning. Brake and increase distance.

Indicator light flashes and an acoustic signal sounds: acute warning. Brake and make an evasive maneuver, if necessary.

Additional information:

Forward Collision Warning with light braking function, refer to page 187.

### Intersection Collision Warning: vehicle detected from the right

 Indicator light illuminates: prewarning for risk of collision with a vehicle crossing from the right.

Indicator light flashes and a signal sounds: acute warning for an immediate risk of collision.

Additional information:



Intersection warning with City light braking function, refer to page [192](#).

### Intersection Collision Warning: vehicle detected from the left



Indicator light illuminates: prewarning for risk of collision with a vehicle crossing from the left.

Indicator light flashes and a signal sounds: acute warning for an immediate risk of collision.

Additional information:

Intersection warning with City light braking function, refer to page [192](#).

### Pedestrian Warning with City Collision Mitigation



Indicator light flashes and an acoustic signal sounds: imminent collision with a detected person or a cyclist.

Intervene immediately by braking or make an evasive maneuver.

Additional information:

Pedestrian Warning with City Collision Mitigation, refer to page [195](#).

### Active Cruise Control with Stop&Go function



Indicator light flashes and an acoustic signal sounds: braking and evading.

Additional information:

Active Cruise Control with Stop&Go function, refer to page [226](#).

### Steering Assistant



Depending on the equipment and national-market version: steering wheel icon flashes red or lights up red.

A signal sounds: the system is switched off.

Additional information:

Steering Assistant, refer to page [236](#).

### Drive power



Reduced drive power due to an overheated drivetrain.

Additional information:

Power gauge, refer to page [166](#).

### Yellow lights

#### Steering Assistant



The indicator light lights up and an acoustic signal may sound: a system interruption is imminent.

The indicator warning light flashes: lane boundary driven over.

Additional information:

Steering Assistant, refer to page [236](#).

#### Antilock Braking System



The Brake Assistant function may not activate. Avoid abrupt braking. Take the longer braking distance into account.



Have the system immediately checked by an authorized service center or another qualified service center or repair shop.

#### Dynamic Stability Control



Indicator light blinks: Dynamic Stability Control controls the drive and brake forces. The vehicle is stabilized. Reduce speed and modify your driving style to the driving circumstances.

Indicator light illuminates: the Dynamic Stability Control has malfunctioned.

Have the system immediately checked by an authorized service center or another qualified service center or repair shop.



Additional information:

Dynamic Stability Control, refer to page 213.

### The Dynamic Stability Control deactivated or the Dynamic Traction Control activated



The Dynamic Stability Control is deactivated or the Dynamic Traction Control is activated.

Additional information:

- ▷ Dynamic Stability Control, refer to page 213.
- ▷ Dynamic Traction Control, refer to page 215.

### Flat tire monitor



Flat tire monitor reports tire pressure loss in a tire.

Reduce your speed and stop cautiously. Avoid sudden braking and steering maneuvers.

Additional information:

Flat tire monitor, refer to page 351.

### Tire pressure monitor



The indicator light illuminates: the Tire Pressure Monitor reports a low tire pressure or a flat tire. Follow the information in the Check Control message.

The indicator light flashes and is then illuminated continuously: flat tires or tire pressure losses cannot be detected.

- ▷ Fault caused by systems or devices with the same radio frequency: after leaving the area of the interference, the system automatically becomes active again.
- ▷ In the case of tires with special approval: the tire pressure monitor was unable to complete the reset. Reset the system again.

- ▷ Wheel without wheel electronics installed: have it checked by an authorized service center or another qualified service center or repair shop as needed.
- ▷ Malfunction: have the system checked by an authorized service center or another qualified service center or repair shop.

Additional information:

Tire pressure monitor, refer to page 344.

### Steering system



Steering system may be faulty.

Have the system checked by an authorized service center or another qualified service center or repair shop.

### Emissions



- ▷ The warning light lights up:

Emissions are deteriorating. Have the vehicle checked as soon as possible.

- ▷ The warning light flashes under certain circumstances:  
This indicates that there is excessive misfiring in the engine.

Reduce the vehicle speed and have the system checked immediately; otherwise, serious engine misfiring within a brief period can seriously damage emission control components, in particular the catalytic converter.

Additional information:

Socket for OBD on-board diagnostics, refer to page 371.

### Green lights

#### Rear seats: Seat belt fastened



The seat belt is buckled on the corresponding rear seat.

## Rear seats: Seat detection



The seat belt is buckled on the corresponding rear seat.

## Turn signal



Turn signal is on.

Unusually rapid blinking of the indicator light indicates that a turn signal bulb has failed.

Additional information:

Turn signal, refer to page [142](#).

## Parking lights



Parking lights are switched on.

Additional information:

Parking lights/low beams, refer to page [176](#).

## Low beams



Low beams are switched on.

Additional information:

Parking lights/low beams, refer to page [176](#).

## Lane departure warning



Depending on vehicle equipment and national-market version:

The indicator light lights up: the system is switched on. A lane boundary has been detected on at least one side of the vehicle and the system is ready to intervene. Warnings will be issued.

Icon flashes green: the system is performing a steering intervention.

Additional information:

Lane departure warning, refer to page [197](#).

## Automatic High Beam Assistant



Automatic High Beam Assistant is switched on.

High beams are switched on and off automatically depending on the traffic situation.

Additional information:

Automatic High Beam Assistant, refer to page [178](#).

## Automatic Hold: vehicle is held automatically



Automatic Hold is activated. The vehicle is automatically held in place when it is stationary.

Additional information:

Automatic Hold, refer to page [140](#).

## Automatic Hold: vehicle secured against rolling away



After the brake is applied, the vehicle is kept from rolling away.

Additional information:

Automatic Hold, refer to page [140](#).

## Manual Speed Limiter



The indicator light lights up: the system is switched on.

The indicator light flashes: the set speed limit has been exceeded.

Additional information:

Manual Speed Limiter, refer to page [221](#).

## Cruise Control



The system is active.

Additional information:

Cruise control, refer to page [223](#).

### Active Cruise Control with Stop&Go function switched on



The system is turned on.

Additional information:

Active Cruise Control with Stop&Go function, refer to page [226](#).

### Active Cruise Control with Stop&Go function: vehicle ahead



The indicator light lights up: the system is switched on. Vehicle ahead has been detected.

Indicator lamp flashes: preceding vehicle has started driving.

Additional information:

Active Cruise Control with Stop&Go function, refer to page [226](#).

### Speed Limit Assistant activated



Depending on the equipment, the indicator light is illuminated together with the icon for a speed control system:

Speed Limit Assistant is active and detected speed limits can be accepted manually for the displayed system.

Additional information:

Speed Limit Assistant, refer to page [234](#).

### Speed Limit Assistant: Apply speed limit



The detected speed limit can be applied with the SET button. As soon as the speed limit has been applied, a green checkmark is displayed.

Additional information:

Speed Limit Assistant, refer to page [234](#).

### Steering Assistant



The system supports the driver in keeping the vehicle within the lane.

Additional information:

Steering Assistant, refer to page [236](#).

### Automatic Lane Change Assistant: lane change in progress



Arrow icon for lane change green: the system is carrying out a lane change.

Additional information:

Automatic Lane Change Assistant, refer to page [242](#).

### Automatic Lane Change Assistant: lane change not possible



Gray line for lane boundary on the appropriate side: system detected a lane change request. Lane change not currently possible.

Additional information:

Automatic Lane Change Assistant, refer to page [242](#).

### Automatic Lane Change Assistant: functional requirements not met



Depending on the national-market version:

Arrow icon for lane change gray: lane change not possible; functional requirements not met.

Additional information:

Automatic Lane Change Assistant, refer to page [242](#).

### Assisted Driving Plus



The system is active.

Additional information:

Assisted Driving Plus, refer to page [240](#).

## Blue lights

### High beams



High beams have been switched on.  
Additional information:  
High beams, refer to page [143](#).

### Drive power



Reduced drive power due to a cold drivetrain.

Additional information:

Power gauge, refer to page [166](#).

## Gray lights

### Active Cruise Control with Stop&Go function



Indicator light is illuminated: the system is interrupted.

Indicator light flashes: the conditions are not adequate for the system to work or the system has been deactivated.

Additional information:

Active Cruise Control with Stop&Go function, refer to page [226](#).

### Steering Assistant



Indicator light is illuminated: the system is ready.

Additional information:

Steering Assistant, refer to page [236](#).

### Assisted Driving Plus



Indicator light is illuminated: the system is interrupted.

Additional information:

Assisted Driving Plus, refer to page [240](#).

## White lights

### Assisted Driving Plus



Indicator light is illuminated: the system is ready.

Additional information:

Assisted Driving Plus, refer to page [240](#).

## Fuel gauge

### Principle

The current fill level of the fuel tank is displayed.

### General information

Vehicle inclination may cause the display to vary.

Additional information:

Refueling, refer to page [326](#).

### Display

Instrument cluster with enhanced features:

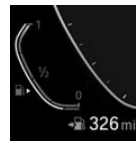

An arrow next to the fuel pump icon indicates the vehicle side on which the fuel filler flap is located.

The current range is displayed as numerical value.

Instrument cluster without enhanced features:



An arrow next to the fuel pump icon indicates the vehicle side on which the fuel filler flap is located.

## Indicator light in the instrument cluster



The yellow indicator light illuminates, once the fuel reserve is reached.

## Tachometer

### General information

Always avoid RPM in the red warning field. In this range, the fuel supply is reduced to protect the engine.

Depending on the equipment, the tachometer can also be shown in the Head-up display.

### Instrument cluster with enhanced features: Activating/deactivating

1. "CAR"
2. "Settings"
3. "Displays"
4. "Instrument panel"
5. "Engine display"
6. "Tachometer"

When the setting for the driving mode view is activated, the activated tachometer is only shown in the COMFORT or SPORT driving mode.

To display the tachometer in the Head-up display, the sport displays of the Head-up display must be activated.

### Reduced engine speed range

The available engine speed range may be reduced due certain factors such as a cold drive system. The tachometer display is automatically adjusted depending on the available engine speed range.

## Instrument cluster with extended features: Power gauge

### Principle

The power gauge indicates the available drive power as a percentage.

### Activate/deactivate

1. "CAR"
2. "Settings"
3. "Displays"
4. "Instrument panel"
5. "Engine display"
6. "Power meter"

When the setting for the driving mode view is activated, the activated power gauge is only shown in the COMFORT driving mode.

### Display

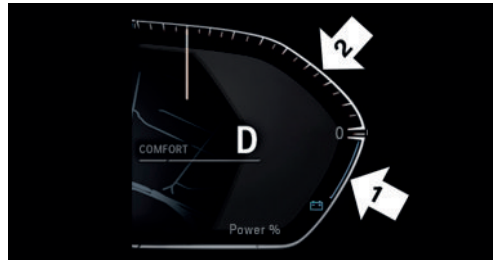



Needle in the area of arrow 1: display of the energy recovered by coasting or when decelerating, CHARGE.

Needle in the range of arrow 2: the drive power in percent, POWER.

### Drive power

The available drive power may be reduced due to certain factors, for instance a cold engine. Depending on the available drive power, the range for POWER is adjusted automatically.

If needed, icons in the power gauge indicate a reduction of the drive power.

Example icon	Description
	Reduced drive power due to a cold drivetrain.
	Reduced drive power due to an overheated drivetrain.

## Standby state and drive-ready state

Instrument cluster with enhanced features:

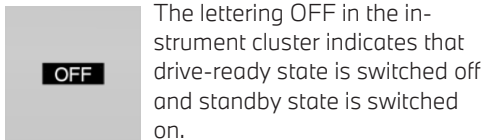

The lettering OFF in the instrument cluster indicates that drive-ready state is switched off and standby state is switched on.

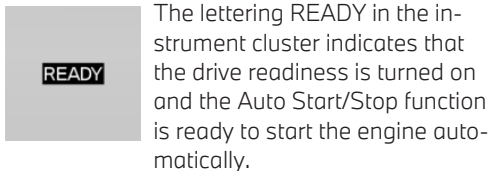

The lettering READY in the instrument cluster indicates that the drive readiness is turned on and the Auto Start/Stop function is ready to start the engine automatically.

Instrument cluster without enhanced features:

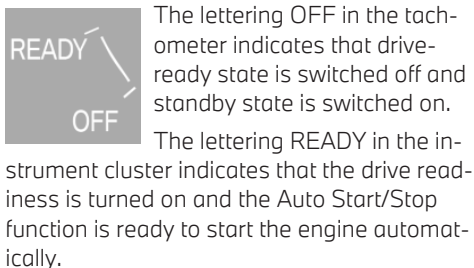

The lettering OFF in the tachometer indicates that drive-ready state is switched off and standby state is switched on.

The lettering READY in the instrument cluster indicates that the drive readiness is turned on and the Auto Start/Stop function is ready to start the engine automatically.

Additional information:

Operating condition of the vehicle, refer to page [39](#).

## Engine temperature

### Display

Instrument cluster with enhanced features:



- ▶ Cold engine: the needle is at the low temperature value. Drive at moderate RPM and vehicle speeds.
- ▶ Normal operating temperature: the needle is in the middle or in the lower half of the temperature display.
- ▶ Hot engine: the needle is at the high temperature value. In addition, a Check Control message is displayed.

Instrument cluster without enhanced features:

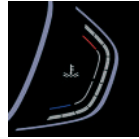

- ▶ Cold engine: the LEDs of the indicator show a low temperature value. Drive at moderate RPM and vehicle speeds.
- ▶ Normal operating temperature: the LEDs of the indicator show an average temperature value.
- ▶ Hot engine: the LEDs of the indicator show a high temperature value. In addition, a Check Control message is displayed.

Additional information:

Coolant level, refer to page [368](#).

### Indicator light in the instrument cluster



A red indicator light is displayed.

## Outside temperature

### General information

If the indicator drops to +37 °F/+3 °C or lower, a signal sounds.

A Check Control message is displayed.

There is an increased risk of ice on roads.

### Safety information

#### Warning

Even at temperatures above +37 °F/+3 °C there is a risk of icy roads, for instance on bridges or shady sections of the road. There is a risk of accident. Modify your driving style to the weather conditions at low temperatures.

## Range

### Principle

The range indicates the distance that can still be covered with the current full tank of fuel.

### General information

The estimated range with remaining fuel is permanently displayed on the instrument cluster.

With a low remaining range, a Check Control message is briefly displayed. A low remaining range means that engine functions cannot always be ensured for sporty driving, e.g., when cornering at speed.

The Check Control message appears continuously below a range of approx. 30 miles/50 km.

## Safety information

#### NOTICE

With a range below 30 miles/50 km, the engine may no longer have sufficient fuel. Engine functions are not ensured anymore. There is a risk of damage to property, among other potential damage. Refuel promptly.

### Display

Instrument cluster with enhanced features:



The current range is displayed as a numerical value next to the fuel gauge.

Instrument cluster without enhanced features:

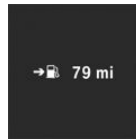

The current range is displayed as numerical value between speedometer and tachometer.

## Service notifications

### Principle

The function displays the service notifications and the corresponding maintenance scopes.

### General information

After turning on the drive readiness, the next service appointment or the distance remaining until the next service is displayed briefly in the instrument cluster.

A service advisor can read out the current service notifications from your vehicle key.

Some information on service notifications can also be shown on the BMW display key.





## Display

### Detailed information on service notifications

More information on the type of service required may be displayed on the Control Display.

1. "CAR"
2. "Vehicle status"
3.  "Required services"  
Maintenance work and legally mandated inspections are displayed.
4. Select an entry to call up detailed information.

### Icons

Icons	Description
	No service is currently required.
	The time for recommended maintenance or a legally mandated inspection is approaching.
	Service interval is exceeded.

### Entering appointment dates

Enter the dates for the mandatory vehicle inspections.

Make sure that the vehicle's date and time are set correctly.

1. "CAR"
2. "Vehicle status"
3.  "Required services"
4. "Vehicle inspection"
5. "Date:"
6. Select the desired setting.

## Gear shift indicator

### Principle

The shift point indicator recommends the gear that best suits the current driving situation. Using the optimal gear supports an efficient driving style.



### General information

Depending on the equipment and national-market version, the gear shift indicator is active in the M manual mode of the Steptronic transmission and with manual transmission.

### Steptronic transmission: displaying

Suggestions to upshift or downshift are displayed in the instrument cluster.

On vehicles without a gear shift indicator, the engaged gear is displayed.

Example	Description
	Efficient gear is set.
	Shift into efficient gear.

## Selection lists

### Principle

Lists can be displayed and, if necessary, used for certain functions in the instrument cluster or the Head-up Display.

- ▷ Entertainment source.
- ▷ Current audio source.
- ▷ List of most recent telephone calls.

If necessary, the corresponding menu will open on the Control Display.



## Display



Depending on the equipment version, the list in the instrument cluster may differ from the illustration.

### Displaying and using the list

The lists can be displayed and operated using the buttons on the steering wheel.

Button	Function
	<p>Change the entertainment source.</p> <p>Pressing the button again will close the currently displayed list.</p>
	<p>Show list of most recent telephone calls.</p>
	<p>Turn the thumbwheel to select the desired setting.</p> <p>Press the thumbwheel to confirm the setting.</p> <p>The list of the current entertainment source can be displayed in the instrument cluster again by turning the thumbwheel.</p>

## Trip data

### Principle

The trip data display provides various information about the trip, e.g., trip distance.

### General information

The trip data can be displayed on the Control Display and in the instrument cluster.

The values can be displayed and reset depending on various intervals, such as after refueling.

### Display on the control display

### Overview

The following information is displayed depending on the set interval and driving mode:

- ▶ Configured interval for displaying trip data.
- ▶ Average consumption depending on the configured interval.
- ▶ Average speed.
- ▶ Total time for shut off engine through the Auto Start/Stop function.
- ▶ Distance traveled in Coasting mode.
- ▶ Consumption history in form of a chart.

### Displays

1. "CAR"
2. "Driving information"
3. "Trip data"

### Consumption history

The average consumption is shown in the consumption history in form of a chart based on the distance traveled and the driving mode.

### Display in the instrument cluster

Depending on the equipment, information about the distance covered can be displayed as widget in the instrument cluster.

The following information is displayed:

- ▷ Total kilometers.
- ▷ Configured interval for displaying trip data.
- ▷ Distance traveled depending on the configured interval.
- ▷ Average speed.

Selecting and setting widgets in the instrument cluster.

Additional information:

Instrument cluster with enhanced features:

Widgets, refer to page 156.

Instrument cluster without enhanced features:

Widgets, refer to page 157.

## Adjusting the display of the trip data

The intervals for the display of the trip data in the instrument cluster and on the Control Display are adjustable.

1. "CAR"
2. "Driving information"
3. "Trip data"
4. "Data since"
5. Select the desired setting:
  - ▷ "Start of trip ( )": the values are automatically reset approx. four hours after the vehicle has come to a standstill.
  - ▷ "Refueling ( )": the values are automatically reset after refueling with a larger quantity of fuel.
  - ▷ "Factory": average consumption since delivery from the factory.  
The values since the time of the factory delivery are displayed.
  - ▷ "Individual ( )": the values since the last manual reset are displayed. The values can be reset at any time.

## Resetting average values manually

The following interval can be reset manually at any time: "Individual ( )".

With the button on the turn signal lever:

1. Continue to press the button on the turn signal lever until the widget for the trip data is selected.

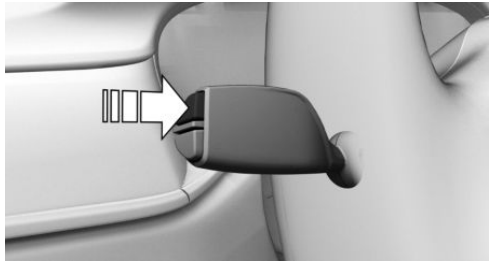

2. Press and hold the button on the turn signal lever.

Via iDrive:

1. "CAR"
2. "Driving information"
3. "Trip data"
4. "Data since"
5. "Reset individual"

The average values and counters are reset. Once the average values and counters have been reset, the following interval is automatically set: "Individual ( )".

## Sport displays

### Principle

The Sport displays especially support a sporty driving style.

### Display on the control display

### Overview

The following information is displayed:

- ▷ Boost pressure.
- ▷ Engine oil temperature.
- ▷ G-meter.

- ▷ Torque.
- ▷ Power.

## Displays

1. "CAR"
2. "Driving information"
3. "Sport displays"

## Instrument cluster with enhanced features: Display in the instrument cluster

The Sport displays can be displayed in form of widgets in the instrument cluster.

The following widgets can be selected:

- ▷ Widget for torque and power.
- ▷ Widget for G-meter.

Additional information:

Widgets, refer to page 156.

## Vehicle status



### General information



The status can be displayed and actions performed for several systems.

### Going to the vehicle status

1. "CAR"
2. "Vehicle status"

### Information at a glance

Icons	Description
	"Flat Tire Monitor": Status of the flat tire monitor, refer to page 351.
	"Tire Pressure Monitor": status of the Tire Pressure Monitor, refer to page 344.

Icons	Description
	"Engine oil level": electronic oil measurement, refer to page 365.
	"Check Control messages": displaying stored Check Control messages, refer to page 158.
	"Required services": displaying service notifications, refer to page 168.

## BMW Head-up Display

### Principle

The Head-up display projects important information in the driver's field of view, for instance the speed.

### General information

Follow instructions for cleaning the Head-up display in the Vehicle Care chapter.

### Overview



The protective glass of the Head-up display is located in the position marked.

### Turning on/off

1. "CAR"
2. "Settings"

3. "Displays"
4. "Head-up display"
5. "Head-up display"

## Display

### Overview

The following information is displayed on the Head-up display:

- ▷ Vehicle speed.
- ▷ Navigation instructions.
- ▷ Check Control messages.
- ▷ Selection list in the instrument cluster.
- ▷ Driver assistance systems.
- ▷ Sport displays.

Some of this information is only displayed briefly as needed.

### Selecting displays in the Head-up Display

1. "CAR"
2. "Settings"
3. "Displays"
4. "Head-up display"
5. Select the desired setting.

### Setting the brightness

The brightness is automatically adjusted to the ambient brightness.

The base setting can be adjusted manually.

1. "CAR"
2. "Settings"
3. "Displays"
4. "Head-up display"
5. "Brightness"
6. Turn the Controller until the desired brightness is set.
7. Press the Controller.

When the low beams are switched on, the brightness of the Head-up Display can be adjusted using the instrument lighting.

### Adjusting the height

1. "CAR"
2. "Settings"
3. "Displays"
4. "Head-up display"
5. "Height"
6. Turn the Controller until the desired height is reached.
7. Press the Controller.

The height of the Head-up Display can be stored using the memory function.

### Setting the rotation

The Head-up Display view can be rotated.

1. "CAR"
2. "Settings"
3. "Displays"
4. "Head-up display"
5. "Rotation"
6. Turn the Controller until the desired setting is selected.
7. Press the Controller.

### Additional settings

1. "CAR"
2. "Settings"
3. "Displays"
4. "Head-up display"
5. Select the desired setting:
  - ▷ "Speed Limit Assistance": access the settings for the speed assistant.
  - ▷ "Display infotainment lists in": set up if the selection lists are displayed in the instrument cluster or the Head-up Display.

- ▷ "Sport displays":
  - ▷ "Off": the Sport displays are not displayed in the Head-up Display.
  - ▷ "In SPORT mode": the Sport displays are only displayed in SPORT driving mode.
  - ▷ "Always": the Sport displays are continuously displayed in the Head-up Display.
- ▷ "Reduced height": if not all of the information is in the driver's field of view, the information can be displayed in the lower section of the Head-up Display.

### Visibility of the display

The visibility of the displays in the Head-up display is influenced by the following factors:

- ▷ Seat position.
- ▷ Objects on the protective glass of the Head-up display.
- ▷ Dust or dirt on the protective glass of the Head-up display.
- ▷ Windshield dirty on inside or outside.
- ▷ Sunglasses with certain polarization filters.
- ▷ Wet road.
- ▷ Unfavorable light conditions.

If the image is distorted, have the base settings checked by an authorized service center or another qualified service center or repair shop.

### Special windshield

The windshield is part of the system.

The shape and coating of the special windshield enable the system to function.

In the event of damage, have the special windshield replaced by an authorized service center or by another qualified service center or a repair shop.

# Lights

## Vehicle features and options



This chapter describes all standard, country-specific and optional features offered with the series. It also describes features and functions that are not necessarily available in your vehicle, e.g., due to the selected options or country versions. This also applies to safety-related functions and systems. When using these functions and systems, the applicable laws and regulations must be observed.





## Lights and lighting

### Switches in the vehicle



The light switch element is located next to the steering wheel.

Icon	Function
	Lights off. Daytime driving lights.
	Parking lights.
	Automatic headlight control. Adaptive lighting functions.

Icon	Function
	Low beams.
	Instrument lighting.
	Right roadside parking light.
	Left roadside parking light.

## Automatic headlight control

### Principle

The low beams are switched on and off automatically depending on the ambient brightness, for example in tunnels, in twilight or if there is precipitation.

### General information

A blue sky with the sun low on the horizon can cause the lights to be turned on.

### Activating

Switch position: 

The indicator light in the instrument cluster is illuminated when the low beams are switched on.

### System limits

The automatic headlight control cannot replace your personal judgment of lighting conditions.

For example, the sensors are unable to detect fog or hazy weather. In these situations, turn the lights on manually.

## Parking lights, low-beams and roadside parking lights

### General information

Switch position: , , 

If the driver's door is opened when the drive-ready state is switched off, the exterior lighting is automatically switched off after a period of time.

### Parking lights

#### Turning on

Switch position:  



The indicator light in the instrument cluster lights up.

The vehicle is illuminated on all sides.

Do not use the parking lights for extended periods; otherwise, they might drain the vehicle battery and it would then be impossible to switch on drive-ready state.

### Low beams

#### Turning on

Switch position: 

The low beams illuminate when drive-ready state is switched on.



The indicator light in the instrument cluster lights up.

### Roadside parking lights

When the vehicle is parked, a one-sided roadside parking light can be switched on.

Button	Function
	Right roadside parking light on/off.
	Left roadside parking light on/off.

## Welcome lights

### Principle

The welcome light turns on automatically for a limited period of time when approaching or unlocking the vehicle.

### General information

Depending on the equipment, the exterior lighting of the vehicle can be set individually.

### Activating/deactivating welcome light

1. "CAR"
2. "Settings"
3. "Exterior lighting"
4. Depending on the equipment, select the following setting:
  - ▷ "Welcome and goodbye"
 

When unlocking the vehicle, individual lighting functions are switched on for a limited time.
  - ▷ "Door handle lights"
 

Door handles and the ground in front of the doors are illuminated for a limited time.
  - ▷ "Welcome Light Carpet"
 

The area next to the vehicle is illuminated for a limited time.



## LED light carpet

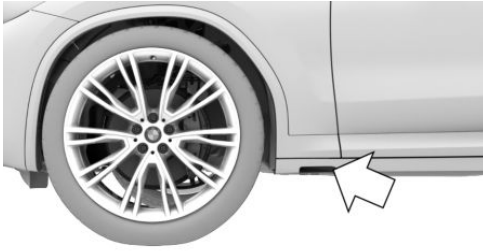

The light source is located in the position indicated.

Keep the light source clean and unobstructed.

## Pathway lighting

### Principle

For the pathway lighting, the exterior lighting turns on for a certain period of time after leaving the vehicle in order to illuminate the area surrounding the vehicle.

### Switching pathway lighting on

After switching off the drive-ready state, briefly push the turn signal lever forward.

### Setting the duration

1. "CAR"
2. "Settings"
3. "Exterior lighting"
4. "Pathway lighting"
5. Select the desired setting.
6. "OK"

## Daytime driving lights

### General information

Switch position:

▷ 0, 

- ▷ Depending on the national-market version: 

The daytime driving lights light up when drive-ready state is switched on.

Depending on the national-market version: after turning off the drive-ready state, the parking lights will illuminate in position  .

### Activating/deactivating daytime driving lights

In some countries, daytime driving lights are mandatory, so it may not be possible to deactivate the daytime driving lights in front.

1. "CAR"
2. "Settings"
3. "Exterior lighting"
4. Depending on the national-market version: "Daytime driving lights" or "Daytime driving lights, rear"

## Adaptive lighting functions

### Principle

Adaptive lighting functions enable dynamic illumination of the road.

### General information

The adaptive lighting functions may consist of one system or multiple systems, depending on the equipment version:

- ▷ Adaptive Light Control.
- ▷ Cornering light.

### Activating

Switch position: 

The adaptive lighting functions are active when the drive-ready state is switched on.



## Adaptive Light Control

### General information

Depending on the steering-wheel angle and other parameters, the laser high beams follow the course of the road.

## Cornering light

### Principle

In tight curves, for instance on mountainous roads or when turning, an additional cornering light is switched on that lights up the inside of the curve when the vehicle is moving below a certain speed.

### General information

The cornering light is automatically switched on depending on the steering-wheel angle or, where applicable, the use of turn signals.

When driving in reverse, the cornering lights may be automatically switched on regardless of the steering-wheel angle.

## Adaptive headlight range control

The adaptive headlight range control feature balances out acceleration and braking processes as well as the vehicle load conditions in order to avoid blinding oncoming traffic.

## Automatic High Beam Assistant

### Principle

The Automatic High Beam Assistant detects other road users early on and automatically

switches the high beams on or off depending on the traffic situation.

### General information

The Automatic High Beam Assistant ensures that the high beams are switched on, whenever the traffic situation allows. In the low speed range, the high beams are not switched on by the system.

The system responds to light from oncoming traffic and traffic driving ahead of you, and to ambient lighting, for instance in towns and cities.

The high beams can be switched on and off manually at any time.

## Activating Automatic High Beam Assistant

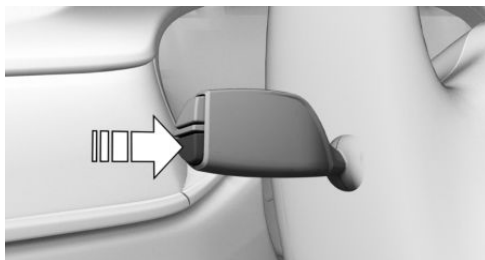

Switch position:

Press the button on the turn signal lever.



The indicator light in the instrument cluster is illuminated when the low beams are switched on.

The headlights are automatically changed between low beams and high beams.



The blue indicator light in the instrument cluster lights up when the system switches on the high beams.

The Automatic High Beam Assistant is deactivated when manually switching the high beams on and off.

To reactivate the Automatic High Beam Assistant, press the button on the turn signal lever.

## Deactivating Automatic High Beam Assistant

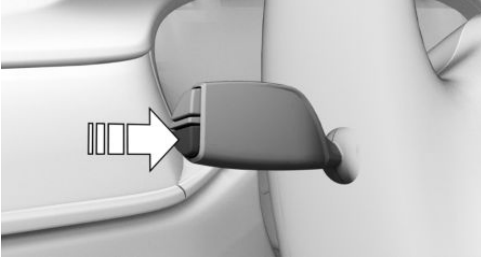

Press the button on the turn signal lever.

## Sensitivity of the Automatic High Beam Assistant

### General information

The sensitivity of the Automatic High Beam Assistant can be adjusted.

### Safety information

#### Warning

If adjustments have been made or the sensitivity has been modified, oncoming traffic may be momentarily blinded. There is a risk of accident. If adjustments have been made and the sensitivity has been modified, make sure that oncoming traffic is not momentarily blinded. Switch off the high beams manually if required.

### Functional requirements

- ▷ Setting at standstill only.
- ▷ Drive-ready state is switched on.
- ▷ Light is turned off.

### Increasing sensitivity

Push the turn signal lever to the front for approximately 10 seconds.

A Check Control message is displayed. The system responds more sensitively.

### Resetting the sensitivity

Push the turn signal lever to the front again for approx. 10 seconds or switch off the drive-ready state.

The sensitivity of the Automatic High Beam Assistant is reset to the factory settings.

### System limits

The Automatic High Beam Assistant cannot replace the driver's personal judgment of when to use the high beams. In situations that require this, therefore dim manually.

The system is not fully functional in the following situations, and driver intervention may be necessary:

- ▷ In very unfavorable weather conditions, such as fog or heavy precipitation.
- ▷ When detecting poorly-lit road users such as pedestrians, cyclists, horseback riders and wagons; when driving close to train or ship traffic; or at animal crossings.
- ▷ In tight curves, on hilltops or in depressions, in crossing traffic or half-observed oncoming traffic on highways.
- ▷ In poorly-lit towns and cities or in the presence of highly reflective signs.
- ▷ When the windshield in front of the interior mirror is fogged up, dirty or covered with stickers, etc.

## Laser high beams

### Principle

The headlight range of the high beams is increased and provides better illumination of the road.

### General information

The laser high beams are integrated into the headlights and emit from there.

When the high beams are switched-on, starting with a speed of approx. 37 mph/60 km/h, the laser high beams in the headlight are automatically switched on in addition to the LED high beams.

Depending on the national-market version, additional information can be taken from the laser sign on the headlight.

### Safety information



The sign is in the headlight and is visible from the outside.

## Instrument lighting

### Functional requirement

The parking lights or low beams must be switched on to set the brightness.

## Setting the brightness



Adjust the brightness with the thumbwheel.

## Interior lighting

### General information

Depending on the equipment version, interior lights, footwell lights, entry lights, ambient lighting, and speaker lighting are automatically controlled.

### Overview

### Buttons in the vehicle



Interior lights



Reading lights

### Turning interior lights on/off



Press the button.

To switch off permanently: press the button and hold for approx. 3 seconds.

The interior lights in the rear of the vehicle can be switched on and off independently. The button is located in the rear headliner.

## Turning reading lights on/off



Press the button.

Depending on the vehicle equipment, the reading lights are located next to the interior lights in the front and rear.

## Ambient light

---

### General information

Depending on the equipment version, lighting can be adjusted for some lights in the car's interior.

### Activating/deactivating ambient light

1. "CAR"
2. "Settings"
3. "Interior lighting"
4. "Ambient lighting"

### Turning ambient light on/off

The ambient light is switched on when the vehicle is unlocked, and switched off when the vehicle is locked.

If the ambient light was deactivated via iDrive, it will not be turned on when the vehicle is unlocked.

### Selecting the color

1. "CAR"
2. "Settings"
3. "Interior lighting"
4. "Color"
5. Select the desired setting.

### Setting the brightness

1. "CAR"
2. "Settings"

3. "Interior lighting"
4. "Brightness"
5. Select the desired setting.

### Dynamic light

Individual actions, for example incoming calls or opened doors, are indicated by light effects.

1. "CAR"
2. "Settings"
3. "Interior lighting"
4. "Dynamic light"
5. Select the desired setting.

### Dimmed while driving

Some lights of the interior lighting are dimmed when the vehicle is driven in the dark.

1. "CAR"
2. "Settings"
3. "Interior lighting"
4. "Dimmed for night driving"

# Safety

## Vehicle features and options

This chapter describes all standard, country-specific and optional features offered with the series. It also describes features and functions that are not necessarily available in your vehi-

cle, e.g., due to the selected options or country versions. This also applies to safety-related functions and systems. When using these functions and systems, the applicable laws and regulations must be observed.

## Airbags

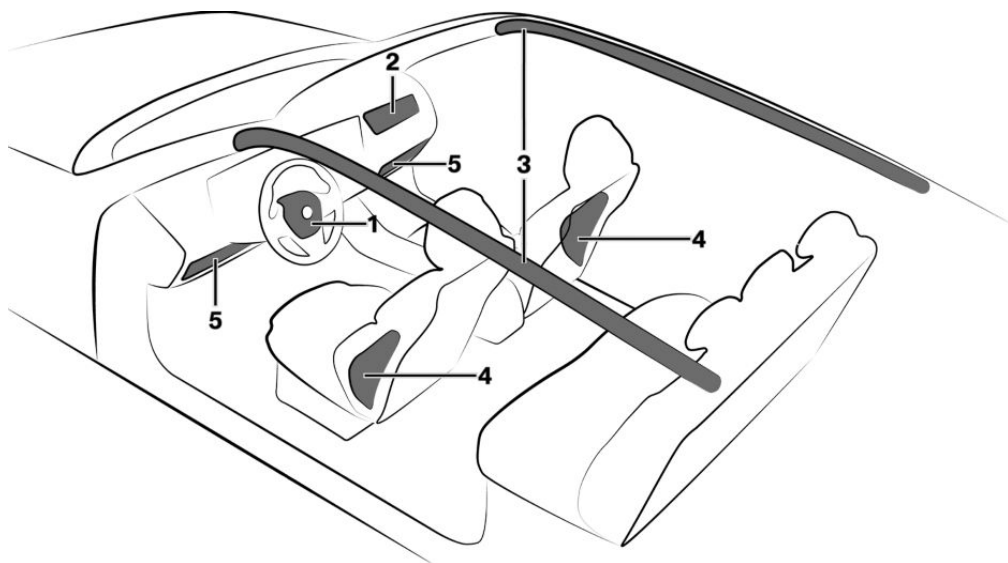

- 1 Front airbag, driver
- 2 Front airbag, front passenger
- 3 Head airbag
- 4 Side airbag
- 5 Knee airbag

### Front airbags

Front airbags help protect the driver and the front passenger by responding to frontal impacts in which seat belts alone would not provide adequate protection.

### Side airbag

In the event of a side collision, the side airbag protects the side of the body in the chest and lap area.

## Head airbag

In the event of a side collision, the head airbag protects the head.

## Ejection Mitigation

The head airbag system is designed as an ejection mitigation countermeasure to reduce the likelihood of ejections of vehicle occupants through side windows during rollovers or side collision events.

## Knee airbag

The knee airbag protects the legs in the event of a frontal impact.

## Protective effect

### General information

Airbags are not deployed in every impact situation, e.g., in less severe accidents.

### Information on optimum protective effect of the airbags

#### **Warning**

If the seat position is incorrect or the deployment area of the airbags is impaired, the airbag system cannot provide protection as intended and may cause additional injuries due to deployment. There is a risk of injury or danger to life. Follow the information on achieving the optimum protective effect of the airbag system.

- ▷ Keep a distance from the airbags.
- ▷ Always grasp the steering wheel on the steering wheel rim. Hold your hands at the 3 o'clock and 9 o'clock positions to keep the risk of injury to your hands or arms as low as possible when the airbag is deployed.
- ▷ Adjust seat and steering wheel so that hands can be crossed over the steering wheel. Select the settings so that the

shoulder rests against the backrest when crossing the hands and the upper body is as far back as possible while still maintaining a comfortable grip on the steering wheel.

- ▷ Make sure that the front passenger is sitting correctly, i.e., keeps his or her feet and legs in the footwell and does not support them on the dashboard.
- ▷ Make sure that occupants keep their heads away from the side airbag.
- ▷ There should be no additional persons, animals or objects between an airbag and a person.
- ▷ Dashboard and windshield on the passenger's side must stay clear - do not attach adhesive film or coverings and do not attach brackets or cables, for instance for navigation devices or mobile phones.
- ▷ Do not bond the airbag cover panels with adhesive, do not cover them or modify them in any way.
- ▷ Do not use the cover of the front airbag on the passenger's side as a storage area.
- ▷ Do not attach slip covers, seat cushions or other objects to the front seats that are not specifically suited for seats with integrated side airbags.
- ▷ Do not hang pieces of clothing, such as jackets, over the backrests.
- ▷ Never modify either the individual components or the wiring in the airbag system. This also applies to steering wheel covers, the dashboard, and the seats.
- ▷ Do not disassemble the airbag system.

Even when you follow all instructions very closely, injury from contact with the airbags cannot be fully ruled out in certain situations.

The ignition and inflation noise may lead to short-term and, in most cases, temporary hearing impairment in sensitive occupants.

Vehicle modifications for a person with disabilities may affect the air bag system; contact



BMW Customer Relations for further information.

Warnings and information on the airbags are also found on the sun visors.

## Operational readiness of the airbag system

### Safety information

#### **Warning**

Individual components can be hot after deployment of the airbag system. There is a risk of injury. Do not touch individual components.

#### **Warning**

Improperly executed work can lead to failure, malfunction or unintentional deployment of the airbag system. In the case of a malfunction, the airbag system might not deploy as intended despite the accident severity. There is a risk of injury or danger to life. Have the airbag system checked, repaired, disassembled and scrapped by an authorized service center or another qualified service center or repair shop.

### Display in the instrument cluster



When drive-ready state is turned on, the warning light in the instrument cluster lights up briefly, thereby indicating the operational readiness of the entire airbag system and the seat belt tensioners.

### Malfunction



- ▶ Warning light does not come on when drive-ready state is turned on.
- ▶ The warning light lights up continuously.

Have the system checked.

## Setting the front seat positions

The power that deploys the driver's/front passenger airbags depends on the position of the driver's/front passenger seat.

To maintain the accuracy of this function, calibrate the electrical front seats as soon as a respective message appears on the control display.

Additional information:

Seats, refer to page 114.

## Automatic deactivation of the front passenger airbags

### Principle

The system reads if the front passenger seat is occupied by measuring the human body's resistance.

Front, knee, and side airbag on the front passenger's side are activated or deactivated.

### General information

Before transporting a child on the front passenger seat, refer to the safety information and instructions for children on the front passenger seat, see Children.

### Safety information

#### **Warning**

To ensure the front passenger airbag function, the system must be able to detect whether a person is sitting in the front passenger seat. The entire seat surface must be used for this purpose. There is a risk of injury or danger to life. Make sure that the front passenger keeps his or her feet in the footwell.



## Fault of the automatic deactivation system

When transporting older children and adults, the front passenger airbags may be deactivated in certain seat positions. In this case, the indicator light for the front passenger airbags lights up.

In this case, change the seat position so that the front passenger airbags are activated and the indicator light goes out.

If it is not possible to activate the airbags, have the person sit in the rear seat.

To enable accurate recognition of the occupied seat surface:

- ▷ Do not attach covers, cushions, ball mats or other items to the front passenger seat unless they are specifically determined to be safe for use on the front passenger seat.
- ▷ Do not place any electronic devices on the front passenger seat if a child restraint system is to be installed on it.
- ▷ Do not place objects under the seat that can press against the seat from below.
- ▷ No moisture in or on the seat.

## Indicator light for the front passenger airbags

The indicator light for the front-seat passenger airbag in the headliner indicates the operating state of the front-seat passenger airbag.

The light indicates whether the airbags are either activated or deactivated.

After drive-ready state is switched on, the light shortly lights up and then indicates whether the airbags are either activated or deactivated.



- ▷ The indicator light lights up when a child is properly seated in a child restraint system or when the seat is empty. The airbags on the

passenger's side are not activated.

- ▷ The indicator light does not light up when, for instance, a correctly seated person of sufficient size is detected on the seat. The airbags on the passenger's side are activated.

## Detected child restraint systems

The system generally detects children seated in a child restraint system, particularly in child restraint systems required by NHTSA at the point in time when the vehicle was manufactured. After installing a child restraint system, make sure that the indicator light for the front passenger airbags lights up. This indicates that the child restraint system has been detected and the front passenger airbags are not activated.

## Intelligent Safety

### Principle

Intelligent Safety enables central operation of the driver assistance systems.

### General information

Depending on how the vehicle is equipped, Intelligent Safety consists of one or more systems that can help prevent an imminent collision.

- ▷ Forward Collision Warning with light braking function, refer to page [187](#).
- ▷ Evasion Assistant, refer to page [190](#).
- ▷ Intersection warning with City light braking function, refer to page [192](#).
- ▷ Pedestrian Warning with City Collision Mitigation, refer to page [195](#).
- ▷ Lane departure warning, refer to page [197](#).
- ▷ Active Blind Spot Detection, refer to page [200](#).

- ▷ Side collision mitigation, refer to page 203.
- ▷ Rear-end collision preparation, refer to page 205.

## Safety information

### **Warning**

The system cannot serve as a substitute for the driver's personal judgment in assessing the traffic situation. Based on the limits of the system, it cannot independently react to all traffic situations. There is a risk of accident. Adjust driving style to traffic conditions. Watch the surrounding traffic situation closely, be ready to take over steering and braking at any time, and actively intervene where appropriate.

### **Warning**

Indicators and warnings cannot serve as a substitute for the driver's personal judgment. Due to its limits, the system may not issue warnings or responses, or these may be issued late or in a manner that is not consistent with their normal use. There is a risk of accident. Adjust driving style to traffic conditions. Watch surrounding traffic closely and actively intervene where appropriate.

### **Warning**

When towing with Intelligent Safety systems enabled or Cruise Control switched on, individual functions may not work correctly. There is a risk of accident. Switch off all Intelligent Safety systems and Cruise Control before towing.

## Overview

### Button in the vehicle



 Intelligent Safety



## Settings

The following settings can be selected for Intelligent Safety systems:

- ▷ "ALL ON": all Intelligent Safety systems are switched on. Basic settings are activated for the sub-functions, for instance setting for warning time.
- ▷ "INDIVIDUAL": the Intelligent Safety systems are switched on according to the individual settings.
- ▷ "Configure INDIVIDUAL": Intelligent Safety systems can be configured individually. The individual settings are activated and stored. As soon as a setting is changed on the menu, all settings of the menu are activated.
- ▷ "ALL OFF": All Intelligent Safety systems are switched off.

## Display

### Button Status

-  Button lights up green: all Intelligent Safety systems are switched on.
-  Button lights up orange: some Intelligent Safety systems are switched off or currently unavailable.
-  Button does not light up: all Intelligent Safety systems are switched off.

## Switching Intelligent Safety systems on/off

### General information

Some Intelligent Safety systems are automatically active after every departure. Some Intelligent Safety systems activate according to the last setting.

### Operation

-  Press the button.  
 The menu for the Intelligent Safety system is displayed.  
 If all Intelligent Safety systems were switched off, all systems are now switched on.  
 "Configure INDIVIDUAL": Configure Intelligent Safety systems individually if required.

-  Press the button repeatedly. The following settings are switched between:
  - ▷ "ALL ON"
  - ▷ "INDIVIDUAL"

Some Intelligent Safety systems cannot be individually switched off.

-  Press and hold this button.  
 "ALL OFF": The menu is selected. All Intelligent Safety systems are switched off.

## Forward Collision Warning with light braking function

### Principle

The Forward Collision Warning warns of a possible risk of collision and may brake independently. In the event of an accident, the system may reduce impact speed.

### General information

Sensors detect the traffic situation in their detection range.

The system issues a two-phase warning of a possible risk of collision with vehicles at speeds above approx. 3 mph/5 km/h. The timing of warnings may vary with the current driving situation.

The system considers the driver's vehicle handling when responding. If an active driving style is detected, warnings and brake interventions occur less frequently.

Depending on the vehicle equipment, the Driver Attention Camera in the instrument cluster captures the driver's field of vision. Additionally, the system checks for visual impairments. Field of vision and visibility also affect the timing of the warnings.

### Safety information

#### Warning

The system cannot serve as a substitute for the driver's personal judgment in assessing the traffic situation. Based on the limits of the system, it cannot independently react to all traffic situations. There is a risk of accident. Adjust driving style to traffic conditions. Watch the surrounding traffic situation closely, be ready to take over steering and braking at any time, and actively intervene where appropriate.

 **Warning**

Indicators and warnings cannot serve as a substitute for the driver's personal judgment. Due to its limits, the system may not issue warnings or responses, or these may be issued late or in a manner that is not consistent with their normal use. There is a risk of accident. Adjust driving style to traffic conditions. Watch surrounding traffic closely and actively intervene where appropriate.

 **Warning**

When towing with Intelligent Safety systems enabled or Cruise Control switched on, individual functions may not work correctly. There is a risk of accident. Switch off all Intelligent Safety systems and Cruise Control before towing.

## Sensors

The system is controlled by the following sensors:

- ▷ Cameras behind the windshield.
- ▷ With radar sensor: front radar sensor.

Additional information:

Sensors of the vehicle, refer to page 35.

## Switching Forward Collision Warning on/off

### Turning on the system automatically

The system is automatically active when the vehicle is turned on.

### Turning the system on/off manually

 Follow instructions for settings, display, and operation in the Intelligent Safety chapter.

Additional information:

Intelligent Safety, refer to page 185.

## Setting the Collision Warning



### Setting the warning time

1. "CAR"
2. "Settings"
3. "Driver Assistance"
4. "Safety and Warnings"
5. "Forward Collision Mitigation"
6. Select the desired setting:
  - ▷ "Early"
  - ▷ "Medium"
  - ▷ "Late": only acute warnings are displayed.

## Warning with braking function

### Display

A warning icon appears in the instrument cluster and in the Head-up Display, where available, if a collision with a detected vehicle is imminent.

Icon	Measure
	Icon lights up red: prewarning. Brake and increase distance.
	Icon flashes red and an acoustic signal sounds: acute warning. Brake and make an evasive maneuver, if necessary.

### Prewarning

This prewarning is provided, for instance when there is impending risk of a collision or the distance to the vehicle ahead is too small.

If a prewarning is provided, respond by braking as warranted.

## Acute warning with braking function

An acute warning is displayed in case of the imminent risk of a collision when the vehicle approaches another object at a high differential speed.

Actively intervene if an acute warning is given, e.g., apply brakes. Depending on the driving situation and the equipment version, the acute warning may be accompanied by a brief activation of the braking system.

With the warning time setting "Late" the brief activation of the braking system is omitted.

If an acute warning is provided, the system may also provide assistance, such as through automatic brake intervention, when there is risk of collision.

Acute warnings may be provided even when there has been no prior warning.

## Brake intervention

The warning prompts the driver to intervene. When the brake pedal is pressed quickly and hard, the maximum braking force of the vehicle is used.

The system may also assist in braking if there is a risk of collision.

When the vehicle is traveling at a low speed, the vehicle may come to a complete stop.

City brake function: the brake intervention occurs to up to approx. 50 mph/80 km/h.

With radar sensor: the brake intervention occurs to up to approx. 155 mph/250 km/h.

At speeds above approx. 130 mph/210 km/h, the brake intervention occurs as a brief activation of the braking system. No automatic delay occurs.

The braking intervention can be interrupted by stepping on the accelerator pedal with sufficient force or by actively moving the steering wheel.

## System limits

### Safety information

#### Warning

Due to its limits, the system may not react, or it may react too late or in a manner that is not consistent with normal use. There may be a risk of accident or risk of damage to property. Actively intervene as warranted. Refer to the information in this Owner's Manual regarding the scope of the system's operation and limitations.

### Detection range

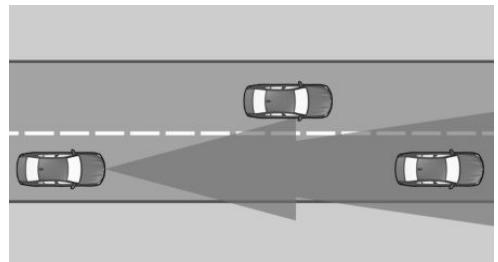

The system's detection capability is limited. Only objects that are detected by the system are taken into account.

Thus, a system response might not come or might come late.

The following situations may not be detected, for instance:

- ▶ Vehicle driving slowly in front and being approached at high speed.
- ▶ Vehicles that suddenly swerve in front of you, or strongly decelerating vehicles.
- ▶ Vehicles with unusual rear designs.
- ▶ Two-wheeled vehicles ahead of you.

### Upper speed limit

If the vehicle speed exceeds approx. 155 mph/250 km/h, the system is deactivated

temporarily. The system is enabled as soon as the speed drops below this value again.

## System limits of the sensors

Additional information:

- ▷ Cameras, refer to page 35.
- ▷ Radar sensors, refer to page 36.

## Functional limitations

The system may be limited in the following situations:

- ▷ In tight curves.
- ▷ If the driving stability control systems are limited or deactivated, for instance DSC OFF.
- ▷ Up to 10 seconds after the start of the engine via the Start/Stop button.

## Warning sensitivity

The more sensitive the warning settings are, for example the warning time, the more warnings are displayed. Therefore, there may also be an excess of unwarranted warnings and responses.

# Evasion Assistant

## Principle

The Evasion Assistant supports the driver in making evasive maneuvers in certain situations, such as when obstacles or persons suddenly appear.

## General information

The system issues a warning and intervenes to support the driver if a lateral evasive maneuver is possible. Sensors monitor and detect the clearance around the vehicle. If the system identifies space alongside the vehicle, it supports an evasive maneuver made by the driver by safely performing automatic steering movements.

# Safety information

## Warning

The system cannot serve as a substitute for the driver's personal judgment in assessing the traffic situation. Based on the limits of the system, it cannot independently react to all traffic situations. There is a risk of accident. Adjust driving style to traffic conditions. Watch the surrounding traffic situation closely, be ready to take over steering and braking at any time, and actively intervene where appropriate.

## Warning

Indicators and warnings cannot serve as a substitute for the driver's personal judgment. Due to its limits, the system may not issue warnings or responses, or these may be issued late or in a manner that is not consistent with their normal use. There is a risk of accident. Adjust driving style to traffic conditions. Watch surrounding traffic closely and actively intervene where appropriate.

## Sensors

The system is controlled by the following sensors:

- ▷ Cameras behind the windshield.
- ▷ Front radar sensor.
- ▷ Radar sensors, side, front.
- ▷ Radar sensors, side, rear.

Additional information:

Sensors of the vehicle, refer to page 35.

## Functional requirements

- ▷ Pedestrian Warning with braking function is switched on.

Pedestrian Warning with City Collision Mitigation, refer to page 195.

- ▶ Forward Collision Warning with light braking function is switched on.

Forward Collision Warning with light braking function, refer to page 187.

- ▶ Sensors detect sufficient clearance around the vehicle.



## Switching Evasion Assistant on/off

The system is automatically active when the vehicle is turned on.

## Warning with evasion support

### Display in the instrument cluster

If a collision with a detected vehicle or a detected person is imminent, a warning icon appears on the instrument cluster and in the Head-up Display.

Icon	Measure
	Icon lights up red: prewarning. Brake and increase distance.
	Icon flashes red and an acoustic signal sounds: acute warning for obstacles. Brake and make an evasive maneuver, if necessary.
	Icon flashes red and an acoustic signal sounds: acute warning for pedestrians. Brake and make an evasive maneuver, if necessary.

## Acute warning with evasion support

An acute warning is displayed when there is an imminent danger of collision due to the vehicle approaching another object at a high speed.

Intervene in the case of an acute warning. The system is designed to provide assistance by

taking evasive action when there is a risk of collision.

Acute warnings may be provided even when there has been no prior warning.

## System limits

### Safety information

#### Warning

Due to its limits, the system may not react, or it may react too late or in a manner that is not consistent with normal use. There may be a risk of accident or risk of damage to property. Actively intervene as warranted. Refer to the information in this Owner's Manual regarding the scope of the system's operation and limitations.

### Detection range

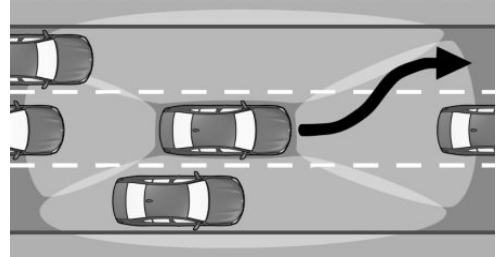

The system's detection capability is limited.

Only objects that are detected by the system are taken into account.

Thus, a system response might not come or might come late.

The following situations may not be detected, for example:

- ▶ Vehicle driving slowly in front and being approached at high speed.
- ▶ Vehicles that suddenly swerve in front of you, or strongly decelerating vehicles.

- ▶ Vehicles with unusual rear designs.
- ▶ Two-wheeled vehicles ahead of you.

### System limits of the sensors

Additional information:

- ▶ Cameras, refer to page 35.
- ▶ Radar sensors, refer to page 36.

### Functional limitations

The system may be limited in the following situations:

- ▶ In tight curves.
- ▶ If the driving stability control systems are limited or deactivated, for instance DSC OFF.
- ▶ Up to 10 seconds after the start of the engine via the Start/Stop button.

## Intersection warning with City light braking function

### Principle

The Intersection Collision Warning can help to prevent accidents with cross traffic at intersections and junctions. In the event of an accident, the system may reduce impact speed.

At speeds that are common in towns and cities, the system warns the driver of a possible risk of collision and brakes automatically if necessary.

### General information

Sensors detect the traffic situation in their detection range.

Vehicles that cross your driving direction can be detected by the system as soon as these vehicles enter into the detection range of the system.

At intersections and junctions, a warning is issued when a risk of collision with crossing traffic is detected.

The system issues a two-phase warning of a possible risk of collision with vehicles at speeds above approx. 6 mph/10 km/h. The timing of warnings may vary with the current driving situation.

The Driver Attention Camera in the instrument cluster captures the driver's field of vision. Additionally, the system checks for visual impairments. Field of vision and visibility also affect the timing of the warnings.

### Safety information

#### **Warning**

The system cannot serve as a substitute for the driver's personal judgment in assessing the traffic situation. Based on the limits of the system, it cannot independently react to all traffic situations. There is a risk of accident. Adjust driving style to traffic conditions. Watch the surrounding traffic situation closely, be ready to take over steering and braking at any time, and actively intervene where appropriate.

#### **Warning**

Indicators and warnings cannot serve as a substitute for the driver's personal judgment. Due to its limits, the system may not issue warnings or responses, or these may be issued late or in a manner that is not consistent with their normal use. There is a risk of accident. Adjust driving style to traffic conditions. Watch surrounding traffic closely and actively intervene where appropriate.

#### **Warning**

When towing with Intelligent Safety systems enabled or Cruise Control switched on, individual functions may not work correctly. There is a risk of accident. Switch off all In-



Intelligent Safety systems and Cruise Control before towing.

## Sensors

The system is controlled by the following sensors:

- ▷ Cameras behind the windshield.
- ▷ Front radar sensor.
- ▷ Radar sensors, side, front.

Additional information:

Sensors of the vehicle, refer to page [35](#).

## Switching Intersection Collision Warning on/off

### Turning on the system automatically

The system is automatically active when the vehicle is turned on.

### Turning the system on/off manually



Follow instructions for settings, display, and operation in the Intelligent Safety chapter.

Additional information:

Intelligent Safety, refer to page [185](#).

## Setting the Intersection Collision Warning

### Setting the warning time

1. "CAR"
2. "Settings"
3. "Driver Assistance"
4. "Safety and Warnings"
5. "Forward Collision Mitigation"
6. Select the desired setting:

- ▷ "Early"
- ▷ "Medium"
- ▷ "Late": only acute warnings are displayed.

## Warning with braking function

### Display

A warning icon appears in the instrument cluster and in the Head-up Display, where available, if a collision with a detected vehicle is imminent.

Icon	Meaning
	Icon illuminates red: prewarning for risk of collision with a vehicle crossing from the right.  Icon illuminates red and a signal sounds: acute warning for immediate risk of collision.
	Icon illuminates red: prewarning for risk of collision with a vehicle crossing from the left.  Icon illuminates red and a signal sounds: acute warning for immediate risk of collision.
	Icon illuminates red: prewarning for risk of collision with a vehicle from an undetectable direction of travel.  Icon illuminates red and a signal sounds: acute warning for immediate risk of collision.



Icon illuminates red: prewarning for risk of collision with a vehicle crossing from the right.

Icon illuminates red and a signal sounds: acute warning for immediate risk of collision.



Icon illuminates red: prewarning for risk of collision with a vehicle crossing from the left.

Icon illuminates red and a signal sounds: acute warning for immediate risk of collision.



Icon illuminates red: prewarning for risk of collision with a vehicle from an undetectable direction of travel.

Icon illuminates red and a signal sounds: acute warning for immediate risk of collision.

### Prewarning

For example, a prewarning is displayed when a risk of collision with a crossing vehicle is detected.

Intervene if a prewarning is issued, e.g., apply brakes.



## Acute warning with braking function

An acute warning is displayed in the event of an immediate risk of collision with a crossing vehicle.

If an acute warning is issued, brake and evade as necessary. If an acute warning is provided, the system may provide assistance, such as through automatic brake intervention, when there is risk of collision.

Acute warnings may be provided even when there has been no prior warning.

## Brake intervention

The warning prompts the driver to intervene.

The system may also assist in braking if there is a risk of collision.

The vehicle can be decelerated to a standstill.

The braking intervention can be interrupted by stepping on the accelerator pedal with sufficient force or by actively moving the steering wheel.

The system's ability to detect objects may be limited in some circumstances. Refer to the information in this Owner's Manual regarding the limitations of the system and actively intervene as warranted.

## System limits

### Safety information

#### Warning

Due to its limits, the system may not react, or it may react too late or in a manner that is not consistent with normal use. There may be a risk of accident or risk of damage to property. Actively intervene as warranted. Refer to the information in this Owner's Manual regarding the scope of the system's operation and limitations.

## Upper speed limit

The system responds to crossing vehicles when the vehicle speed is below approx. 50 mph/80 km/h.

## Detection range

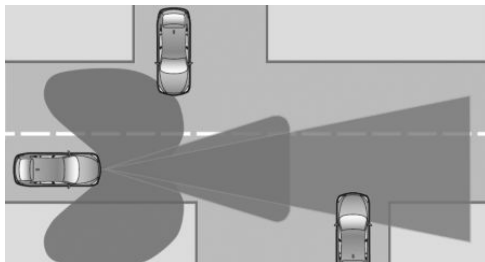

The system's detection capability is limited.

Thus, a system response might not come or might come late.

The following situations may not be detected, for instance:

- ▶ Crossing vehicles when they are hidden, e.g. by buildings.
- ▶ Vehicles that suddenly swerve in front of you, or strongly decelerating vehicles.
- ▶ Crossing two-wheeled vehicles.
- ▶ Vehicles with an unusual side view.

## System limits of the sensors

Additional information:

- ▶ Cameras, refer to page 35.
- ▶ Radar sensors, refer to page 36.

## Functional limitations

The system may be limited in the following situations:

- ▶ In tight curves.
- ▶ If the driving stability control systems are limited or deactivated, for instance DSC OFF.
- ▶ Up to 10 seconds after the start of the engine via the Start/Stop button.

## Warning sensitivity

The more sensitive the warning settings are, for example the warning time, the more warnings are displayed. Therefore, there may also be an excess of unwarranted warnings and responses.

## Pedestrian Warning with City Collision Mitigation

### Principle

At speeds that are common in towns and cities, the Pedestrian Warning warns the driver of a risk of collision with pedestrians and cyclists, and brakes automatically if necessary. In the event of an accident, the system may reduce impact speed.

### General information

Sensors detect the traffic situation in their detection range.

The system issues a warning of a possible risk of collision with pedestrians and cyclists at speeds above approx. 3 mph/5 km/h.

### Safety information

#### Warning

The system cannot serve as a substitute for the driver's personal judgment in assessing the traffic situation. Based on the limits of the system, it cannot independently react to all traffic situations. There is a risk of accident. Adjust driving style to traffic conditions. Watch the surrounding traffic situation closely, be ready to take over steering and braking at any time, and actively intervene where appropriate.

#### Warning

Indicators and warnings cannot serve as a substitute for the driver's personal judgment. Due to its limits, the system may not issue warnings or responses, or these may be issued late or in a manner that is not consistent with their normal use. There is a risk of accident. Adjust driving style to traffic conditions. Watch surrounding traffic closely and actively intervene where appropriate.

#### Warning

When towing with Intelligent Safety systems enabled or Cruise Control switched on, individual functions may not work correctly. There is a risk of accident. Switch off all Intelligent Safety systems and Cruise Control before towing.

## Sensors

The system is controlled by the following sensors:

- ▶ Cameras behind the windshield.
- ▶ With radar sensor: front radar sensor.

Additional information:

Sensors of the vehicle, refer to page 35.

## Detection range

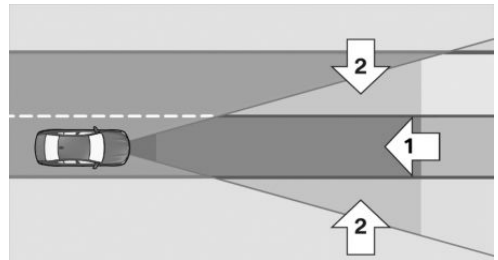

The detection range in front of the vehicle is divided into two areas:



- ▷ Central area, arrow 1, directly in front of the vehicle.
- ▷ Extended area, arrows 2, to the right and left of the central area.

A collision is imminent if pedestrians are located within the central area. A warning is issued about pedestrians who are located within the extended area only if they are moving in the direction of the central area.

## Switching Pedestrian Warning on/off

### Turning on the system automatically

The system is automatically active when the vehicle is turned on.

### Turning the system on/off manually



Follow instructions for settings, display, and operation in the Intelligent Safety chapter.

Additional information:

Intelligent Safety, refer to page [185](#).

## Warning with braking function

### Display

If a collision with a pedestrian or a cyclist is imminent, a warning icon appears on the instrument cluster and in the Head-up Display.



The red icon is displayed and a signal sounds.



Alternatively, depending on the vehicle equipment, a red warning triangle lights up in the instrument cluster.

Intervene immediately by braking or make an evasive maneuver.

## Brake intervention

The warning prompts the driver to intervene. When the brake pedal is pressed quickly and hard, the maximum braking force of the vehicle is used.

If there is a risk of collision, the system may also assist with brake intervention.

When the vehicle is traveling at a low speed, the vehicle may come to a complete stop.

The braking intervention can be interrupted by stepping on the accelerator pedal with sufficient force or by actively moving the steering wheel.

## System limits

### Safety information

#### **Warning**

Due to its limits, the system may not react, or it may react too late or in a manner that is not consistent with normal use. There may be a risk of accident or risk of damage to property. Actively intervene as warranted. Refer to the information in this Owner's Manual regarding the scope of the system's operation and limitations.

### Upper speed limit

The system responds to pedestrians and cyclists when the vehicle speed is below approx. 50 mph/80 km/h.

### Detection range

The system's detection capability is limited.

Thus, a warning might not be issued or be issued late.

The following situations may not be detected, for instance:

- ▶ Partially covered pedestrians.
- ▶ Pedestrians that are not detected as such because of the viewing angle or contour.
- ▶ Pedestrians outside of the detection range.
- ▶ Pedestrians having a body size less than 32 in/80 cm.

## System limits of the sensors

Additional information:

- ▶ Cameras, refer to page 35.
- ▶ Radar sensors, refer to page 36.

## Functional limitations

The system may be limited or may not be available in the following situations:

- ▶ If the driving stability control systems are deactivated, for instance DSC OFF.
- ▶ Up to 10 seconds after the start of the engine via the Start/Stop button.

# Lane departure warning

## Principle

The lane departure warning alerts when the vehicle is about to run off the road or exit the lane.

## General information

This camera-based system warns starting at a minimum speed.

The minimum speed is country-specific and is displayed in the menu for the intelligent Safety systems.

Warnings are issued by means of a steering wheel vibration.

The system does not provide a warning if the turn signal is set in the respective direction before exiting the lane.

Depending on the equipment version, if in the speed range up to 130 mph/210 km/h a lane boundary is crossed, the system may inter-

vene with a brief active steering intervention in addition to vibrating. The system thus helps keep the vehicle in the lane.

## Safety information

### Warning

The system cannot serve as a substitute for the driver's personal judgment in assessing road and traffic situations. There is a risk of accident. Adjust driving style to traffic conditions. Watch surrounding traffic closely and actively intervene where appropriate. Do not jerk the steering wheel in response to a warning.

### Warning

Indicators and warnings cannot serve as a substitute for the driver's personal judgment. Due to its limits, the system may not issue warnings or responses, or these may be issued late or in a manner that is not consistent with their normal use. There is a risk of accident. Adjust driving style to traffic conditions. Watch surrounding traffic closely and actively intervene where appropriate.

## Sensors

The system is controlled by cameras behind the windshield.

Additional information:

Sensors of the vehicle, refer to page 35.

## Functional requirement

The camera must detect the lane boundaries for the lane departure warning to be active.

## Turning the Lane Departure Warning on/off

### Turning on the system automatically

Depending on the national-market version, the system is automatically active after every departure.

### Turning the system on/off manually



Follow instructions for settings, display, and operation in the Intelligent Safety chapter.

Additional information:

Intelligent Safety, refer to page [185](#).

## Setting Lane Departure Warning

### Setting the warning time

1. "CAR"
2. "Settings"
3. "Driver Assistance"
4. "Safety and Warnings"
5. "Lane Departure Warning"
6. Select the desired setting:
  - ▷ "Early"
  - ▷ "Medium"
  - ▷ "Reduced": some warnings are suppressed depending on the situation, for instance when purposely driving over pathway lines in curves or with dynamic passing without blinker.
  - ▷ "Off": no warnings are issued.

### Setting the intensity of the steering wheel vibration

1. "CAR"
2. "Settings"
3. "Driver Assistance"
4. "Steering Wheel Feedback"

5. "Vibration intensity"
6. Select the desired setting.

The setting is applied to all Intelligent Safety systems.

### Switching steering intervention on/off

The steering intervention can be switched on and off separately for Active Blind Spot Detection and lane departure warning.

1. "CAR"
2. "Settings"
3. "Driver Assistance"
4. "Safety and Warnings"
5. "Lane Departure Warning"
6. "Steering intervention"

Depending on the national-market version, the steering intervention is automatically active after every driving off.

### Display in the instrument cluster

Different system statuses are displayed on the instrument cluster, depending on vehicle equipment and national-market version.

Icon	Meaning
	The icon is illuminated green: the system is turned on. A lane boundary has been detected on at least one side of the vehicle and the system is ready to intervene. Warnings will be issued.
	Icon flashes green: the system is performing a steering intervention.



Depending on the equipment and national-market version, information for the system is displayed in the Assisted Driving View of the instrument cluster.

Additional information:

Assisted Driving View, refer to page [155](#).

## Warning function

### If you leave the lane

If you leave the lane and if a lane boundary has been detected, the steering wheel vibrates in accordance with the steering wheel vibration setting.

When the turn signal is switched on in the corresponding direction before changing the lane, a warning is not issued.

### Steering intervention

Depending on the equipment and national-market version: if, in the speed range up to 130 mph/210 km/h a lane boundary is crossed, the system may intervene with a brief active steering intervention in addition to vibrating. The steering intervention helps keep the vehicle in the lane. The steering intervention can be noticed on the steering wheel and can be manually overridden at any time. During an active steering intervention, the display in the instrument cluster will blink.

For instance, the steering intervention will be suppressed in the following situations:

- ▷ With hard accelerating or braking.
- ▷ When blinking.
- ▷ With hazard warning system switched on.
- ▷ In driving situation with high driving dynamics.
- ▷ While Dynamic Stability Control is adjusting.
- ▷ Immediately following a steering intervention by the vehicle systems.
- ▷ When actively merging back to your own lane after passing.

### Warning signal

Depending on the equipment version: in the event of multiple active steering interventions by the system within 3 minutes without the driver's intervention at the steering wheel, an acoustic warning will sound. A short warning signal will sound at the second steering inter-

vention. Beginning with the third steering intervention, a continuous warning will sound.

In addition, a Check Control message is displayed.

The warning signal and Check Control message are an encouragement to pay closer attention to the lane.

### With trailer towing

If the trailer power socket is occupied or trailer towing is activated, for instance during operation with trailer or bicycle rack, no steering intervention takes place.

### End of warning

For instance, the warning will be canceled in the following situations:

- ▷ Automatically after a few seconds.
- ▷ When returning to your own lane.
- ▷ With hard accelerating or braking.
- ▷ With hazard warning system switched on.
- ▷ When blinking.
- ▷ While Dynamic Stability Control is adjusting or is disabled.
- ▷ Immediately following a steering intervention by the vehicle systems.
- ▷ With manual steering intervention.
- ▷ When another driver assistance system is activated, if applicable.
- ▷ Lane boundaries are not detected.
- ▷ When the system limits are reached.

## System limits

### Safety information

#### **Warning**

Due to its limits, the system may not react, or it may react too late or in a manner that is not consistent with normal use. There may be a risk of accident or risk of damage to property.



Actively intervene as warranted. Refer to the information in this Owner's Manual regarding the scope of the system's operation and limitations.

## System limits of the sensors

Additional information:

- ▶ Cameras, refer to page 35.

## Functional limitations

The system may be limited in the following situations:

- ▶ In the event of missing, worn, poorly visible, merging, diverging, or multiple lane boundaries such as in construction areas.
- ▶ With lane boundaries that are covered in snow, ice, dirt or water.
- ▶ In tight corners or on narrow roads.
- ▶ With lane boundaries that are covered by objects.
- ▶ When driving very close to the vehicle in front of you.
- ▶ Up to 10 seconds after the start of the engine via the Start/Stop button.

A Check Control message may be displayed when the system is limited.

## Active Blind Spot Detection

### Principle

Active Blind Spot Detection detects vehicles in the blind spot or vehicles approaching from behind in the adjacent lane.

The light in the exterior mirror warns the driver in different steps.

## General information

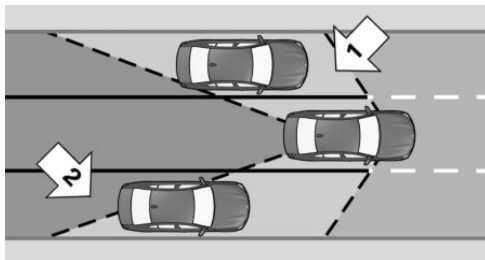

Radar sensors monitor the area behind and next to the vehicle when traveling faster than a minimum speed.

The minimum speed is country-specific and is displayed in the menu for the intelligent Safety systems.

The system indicates whether there are vehicles in your blind spot, arrow 1, or approaching from behind in an adjacent lane, arrow 2. The light in the exterior mirror lights up dimly.

Before you change lanes after setting the turn signal, the system issues a warning in the situations described above. The light in the exterior mirror flashes and the steering wheel vibrates.

Vehicles with side collision mitigation: at speeds of up to 130 mph/210 km/h, the system can intervene with a brief active steering intervention and help guide the vehicle back into the lane. The steering intervention occurs when a minimum speed is reached. This minimum speed is displayed on the Control Display in the menu for the steering intervention.

## Safety information

### Warning

The system cannot serve as a substitute for the driver's personal judgment in assessing the traffic situation. Based on the limits of the system, it cannot independently react to all traffic situations. There is a risk of accident. Adjust driving style to traffic condi-



tions. Watch the surrounding traffic situation closely, be ready to take over steering and braking at any time, and actively intervene where appropriate.

### **Warning**

Indicators and warnings cannot serve as a substitute for the driver's personal judgment. Due to its limits, the system may not issue warnings or responses, or these may be issued late or in a manner that is not consistent with their normal use. There is a risk of accident. Adjust driving style to traffic conditions. Watch surrounding traffic closely and actively intervene where appropriate.

## Sensors

The system is controlled by the following sensors:

- ▶ Radar sensors, side, rear.
- ▶ For vehicles with steering intervention: cameras behind the windshield.

Additional information:

Sensors of the vehicle, refer to page [35](#).

## Turning Active Blind Spot Detection on/off

### Turning the system on/off manually



Follow instructions for settings, display, and operation in the Intelligent Safety chapter.

Additional information:

Intelligent Safety, refer to page [185](#).

## Adjusting the Active Blind Spot Detection

### Setting the warning time

1. "CAR"
2. "Settings"
3. "Driver Assistance"
4. "Safety and Warnings"
5. "Active Blind Spot Detection"
6. Select the desired setting.

### Setting the intensity of the steering wheel vibration

1. "CAR"
2. "Settings"
3. "Driver Assistance"
4. "Steering Wheel Feedback"
5. "Vibration intensity"
6. Select the desired setting.

The setting is applied to all Intelligent Safety systems.

### Vehicles with steering intervention: Switching steering intervention on/off

The steering intervention can be switched on and off separately for Active Blind Spot Detection and lane departure warning.

1. "CAR"
2. "Settings"
3. "Driver Assistance"
4. "Safety and Warnings"
5. "Active Blind Spot Detection"
6. "Steering intervention"

## Displays in the instrument cluster

Depending on the equipment and national-market version, information for the system is displayed in the Assisted Driving View of the instrument cluster.

Additional information:

Assisted Driving View, refer to page 155.

## Warning function

### Light in the exterior mirror



### Prewarning

The dimmed light in the exterior mirror indicates when there are vehicles in the blind spot or approaching from behind.

### Acute warning

When the turn signal is switched on while a vehicle is in the critical zone, the steering wheel vibrates briefly and the light in the exterior mirror flashes brightly.

The warning stops when the other vehicle has left the critical area or the turn signal has been deactivated.

### Vehicles with steering intervention

When there is no response to the vibration of the steering wheel at speeds of up to 130 mph/210 km/h and the lane marking is crossed, the system intervenes with a brief active steering intervention. The steering intervention helps return the vehicle into the lane. The steering intervention can be noticed on the steering wheel and can be manually overridden at any time.

## Flashing of the light

A flashing of the light during vehicle unlocking serves as system self-test.

## System limits

### Safety information

#### **Warning**

Due to its limits, the system may not react, or it may react too late or in a manner that is not consistent with normal use. There may be a risk of accident or risk of damage to property. Actively intervene as warranted. Refer to the information in this Owner's Manual regarding the scope of the system's operation and limitations.

### Upper speed limit

If the vehicle speed exceeds approx. 155 mph/250 km/h, the system is deactivated temporarily.

If the vehicle speed falls below approx. 155 mph/250 km/h, the system is reactivated.

### System limits of the sensors

Additional information:

- ▶ Radar sensors, refer to page 36.
- ▶ For vehicles with steering intervention: cameras, refer to page 35.

### Functional limitations

The system may be limited in the following situations:

- ▶ When a vehicle is approaching at a speed much faster than your own.
- ▶ In tight corners or on narrow roads.
- ▶ The bumper is dirty, iced up or covered, for instance by stickers.

For vehicles with steering intervention, this intervention can be limited, for instance in the following situations:

- ▶ In the event of missing, worn, poorly visible, merging, diverging, or multiple lane boundaries such as in construction areas.
- ▶ With lane boundaries that are covered in snow, ice, dirt or water.
- ▶ With lane boundaries that are not white.
- ▶ With lane boundaries that are covered by objects.
- ▶ When driving very close to the vehicle in front of you.
- ▶ If the camera is impaired.
- ▶ Up to 10 seconds after the start of the engine via the Start/Stop button.

A Check Control message may be displayed when the system is limited.

If the trailer power socket is occupied or trailer towing is activated, for instance during operation with trailer or bicycle rack, the system cannot be switched on. A Check Control message is displayed.

## Displaying warnings

Depending on the selected warning settings, e.g., warning time, more or fewer warnings can be displayed. However, there may also be an excess of unwarranted warnings of critical situations.

## Side collision mitigation

### Principle

The side-collision warning helps to avoid imminent side collisions.

## General information

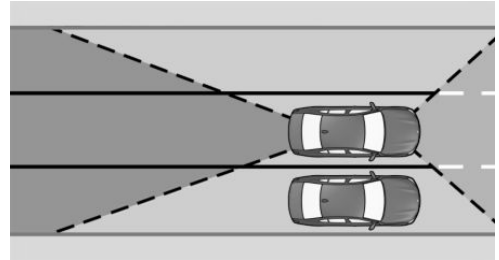

Radar sensors monitor the space next to the vehicle when traveling faster than a minimum speed and up to approx. 130 mph/210 km/h.

The minimum speed is country-specific and is displayed in the menu for the intelligent Safety systems.

If, for instance, another vehicle is detected next to the vehicle and if there is a risk of collision with this vehicle, the system helps avoid the collision. For this purpose, the system issues a warning with a blinking LED in the exterior mirror and a vibrating steering wheel. If necessary, the system will carry out an active steering intervention.

## Safety information

### Warning

The system cannot serve as a substitute for the driver's personal judgment in assessing the traffic situation. Based on the limits of the system, it cannot independently react to all traffic situations. There is a risk of accident. Adjust driving style to traffic conditions. Watch the surrounding traffic situation closely, be ready to take over steering and braking at any time, and actively intervene where appropriate.

**Warning**

Indicators and warnings cannot serve as a substitute for the driver's personal judgment. Due to its limits, the system may not issue warnings or responses, or these may be issued late or in a manner that is not consistent with their normal use. There is a risk of accident. Adjust driving style to traffic conditions. Watch surrounding traffic closely and actively intervene where appropriate.

## Sensors

The system is controlled by the following sensors:

- ▷ Cameras behind the windshield.
- ▷ Radar sensors, side, front.
- ▷ Radar sensors, side, rear.

Additional information:

Sensors of the vehicle, refer to page [35](#).

## Functional requirement

The camera behind the windshield determines the lane boundary positions.

The camera must detect the lane markings for the side collision mitigation with steering intervention to be active.

## Turning the side collision warning on/off

### Turning the system on/off manually



Follow instructions for settings, display, and operation in the Intelligent Safety chapter.

Additional information:

Intelligent Safety, refer to page [185](#).

## Setting the Side Collision Warning

### Setting the intensity of the steering wheel vibration

1. "CAR"
2. "Settings"
3. "Driver Assistance"
4. "Steering Wheel Feedback"
5. "Vibration intensity"
6. Select the desired setting.

The setting is applied to all Intelligent Safety systems.

### Displays in the instrument cluster

Depending on the equipment and national-market version, information for the system is displayed in the Assisted Driving View of the instrument cluster.

Additional information:

Assisted Driving View, refer to page [155](#).

## Warning function

### Light in the exterior mirror

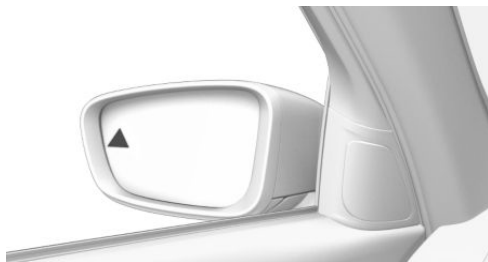

### Acute warning

If there is a risk of collision, the light in the exterior mirror flashes and the steering wheel vibrates.

A Check Control message is displayed at the same time.

If necessary, an active steering intervention is performed to prevent the collision and maintain the vehicle within its own lane.

The steering intervention can be noticed on the steering wheel and can be manually overridden at any time.

## System limits

### Safety information

#### Warning

Due to its limits, the system may not react, or it may react too late or in a manner that is not consistent with normal use. There may be a risk of accident or risk of damage to property. Actively intervene as warranted. Refer to the information in this Owner's Manual regarding the scope of the system's operation and limitations.

### System limits of the sensors

Additional information:

- ▶ Cameras, refer to page 35.
- ▶ Radar sensors, refer to page 36.

### Functional limitations

The system may be limited in the following situations:

- ▶ When a vehicle is approaching at a speed much faster than your own.
- ▶ In tight corners or on narrow roads.
- ▶ In the event of missing, worn, poorly visible, merging, diverging, or multiple lane boundaries such as in construction areas.
- ▶ With lane boundaries that are covered in snow, ice, dirt or water.
- ▶ With lane boundaries that are covered by objects.

- ▶ When driving very close to the vehicle in front of you.
- ▶ Up to 10 seconds after the start of the engine via the Start/Stop button.

A Check Control message may be displayed when the system is limited.

If the trailer power socket is occupied or trailer towing is activated, for instance during operation with trailer or bicycle rack, the system cannot be switched on. A Check Control message is displayed.

## Rear-end collision preparation

### Principle

Depending on the equipment and national-market version, the rear-end collision preparation can react to vehicles approaching from behind.

### General information

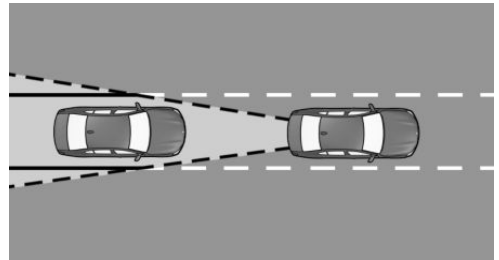

Radar sensors monitor the area behind the vehicle.

When a vehicle approaches from the rear at a certain speed, the system can react as follows:

- ▶ Where applicable, the hazard warning flashers will be switched on.
- ▶ Where applicable, the PreCrash functions are triggered.

## Safety information

### Warning

The system cannot serve as a substitute for the driver's personal judgment in assessing the traffic situation. Based on the limits of the system, it cannot independently react to all traffic situations. There is a risk of accident. Adjust driving style to traffic conditions. Watch the surrounding traffic situation closely, be ready to take over steering and braking at any time, and actively intervene where appropriate.

### Warning

Indicators and warnings cannot serve as a substitute for the driver's personal judgment. Due to its limits, the system may not issue warnings or responses, or these may be issued late or in a manner that is not consistent with their normal use. There is a risk of accident. Adjust driving style to traffic conditions. Watch surrounding traffic closely and actively intervene where appropriate.

## Sensors

The system is controlled by radar sensors on the sides at the rear.

Additional information:

Sensors of the vehicle, refer to page 35.

## Turning rear-end collision preparation on/off

The system is automatically active when the vehicle is turned on.

The system is deactivated in the following situations:

- ▷ When driving in reverse.
- ▷ When the trailer power socket is in use or trailer towing is activated, for instance during operation with trailer or bicycle rack.

## System limits

### System limits of the sensors

Additional information:

- ▷ Radar sensors, refer to page 36.

### Functional limitations

The system function may be limited in the following situations:

- ▷ When a vehicle is approaching at a speed much faster than your own.
- ▷ The speed of the approaching vehicle is very slow.

## If equipped with Equipment Stop Assistant

### Principle

If the driver is no longer fit to drive, the Emergency Stop Assistant helps to safely bring the vehicle to a standstill.

### General information

The emergency stop function can only be triggered manually by the occupants. The emergency stop function is not triggered automatically.

When the system is activated, the vehicle is brought to a standstill in its own lane by use of lane guidance.

Depending on the vehicle equipment and national-market version, the system includes a lane change function.

With lane change function: on motorways or motorway-like roads, the system steers the vehicle to the side of the road or shoulder where

possible. On other roads or with high traffic volume, the vehicle is brought to a standstill in the current lane.

## Overview



 Parking brake

## Functional requirements

- ▷ The function can be activated at speeds of approx. 6 mph/10 km/h up to approx. 155 mph/250 km/h.
- ▷ With lane change function: lane changes are executed when the traffic situation allows.

## Activating the emergency stop function

-  Pull the switch for the parking brake briefly to activate the emergency stop function.
- ▷ With lane change function: releasing the switch may trigger an automatic lane change.
- ▷ The system will take control of the vehicle for a maximum of 2 minutes.
- ▷ The hazard warning system is switched on.
- ▷ An emergency call is triggered.

## Canceling the emergency stop function

The driver can cancel the emergency stop function by actively taking control of the vehicle throughout the entire process.

For instance, the emergency stop function will be canceled in the following situations:

- ▷ When steering.
- ▷ When blinking.
- ▷ When depressing the accelerator pedal.
- ▷ When switching off the hazard warning system.
- ▷ When canceling the Emergency Request.
- ▷ When switching the selector lever position at a standstill.
- ▷ The parking brake switch is pressed.

## At standstill



As soon as the vehicle is stationary, the system will carry out the following settings:

- ▷ The vehicle is secured against rolling away.
- ▷ The interior lights are switched on.
- ▷ The central locking system is unlocked.

## Displays in the instrument cluster

Icon	Status
	Icon illuminates red: emergency stop function enabled.

Without lane change function:

Icon	Status
	Icon illuminates green: when a lane boundary is detected, the system keeps the vehicle in the lane.
	Icon illuminates gray: lane guidance has been temporarily interrupted.

**Icon Status**

Icon illuminates yellow: the lane boundary has been crossed.

When lane markings are detected, the system keeps the vehicle in the lane.



Steering wheel icon illuminates yellow: do not grip the steering wheel with your hands. The system is still active.



Steering wheel icon illuminates red and a signal sounds: do not grip the steering wheel with your hands. Interruption of lane guidance is imminent.



Icon illuminates red and a signal sounds: lane guidance is switched off.

## System limits

Use the system only in the event of a driver failure.

The system cannot replace the driving performance of a driver who is fit to drive.

## BMW Drive Recorder

### Principle

The BMW Drive Recorder stores brief video recordings of the vehicle surroundings, e.g., to document surrounding traffic.

### General information

Video recordings can be saved in different ways:

- ▷ Automatic storage of the recording.
  - The function allows the documentation of the event of an accident.
- ▷ Manual storage of the recording.

The function allows the documentation of traffic situations.

The system saves recordings made up to 20 seconds before and after saving was triggered.

The assistance systems' cameras are used to record, e.g., Panorama View.

Additionally, the following parameters are stored for the trip:

- ▷ Date.
- ▷ Time.
- ▷ Vehicle speed.
- ▷ Global Positioning System coordinates.

### Data protection

The permissibility of recording and using video recordings is contingent upon the statutory regulations of the country in which the system is to be used. The user is responsible for the use of the system and compliance with respective applicable regulations.

The manufacturer of the vehicle recommends confirming there are no statutory or regulatory constraints on use of the system in your state or country prior to the initial use. In addition, the laws regarding use of the system should be verified at regular intervals, especially when frequently crossing borders.

Other drivers of the vehicle must be informed about the system. In addition, information about the system is required when handing off the vehicle.

### Functional requirements

- ▷ Standby or drive readiness is switched on.
- ▷ BMW Drive Recorder is activated.
- ▷ Privacy Policy was accepted.
- ▷ Recording type was selected.
- ▷ Recording time was selected.



## Activating/deactivating the BMW Drive Recorder

The BMW Drive Recorder must be activated before the first use of the recording function.

1. "Apps"
2. "Drive Recorder"
3. Accept Privacy Policy.
4. "Settings"
5. "Recording allowed"
6. Select the desired setting.

## Recording functions

### Automatic recording

Recordings are saved automatically when the vehicle sensors detect an accident.

### Manual recording

#### Using the button



Press and hold this button.

#### Via iDrive

1. "Apps"
2. "Drive Recorder"
3. "Start recording"

To stop the recording: "Cancel".

Recording can also be started by selecting the widget on the Control Display.

### Recording playback and administration

Stored video recordings can be played back, exported and deleted.

For your own safety, the video recording is only displayed on the Control Display up to approx. 2 mph/3 km/h. In some national-market versions, the video recording is only displayed

if the parking brake is engaged or if the selector lever is in the P position.

1. "Apps"
2. "Drive Recorder"
3. "Saved recordings"
4. Select desired recording.
5. Select the desired setting.

If a camera change occurred during the recording, different segments of the video can be selected.

## Settings

### General information

Various settings can be applied.

### Recording type

1. "Apps"
2. "Drive Recorder"
3. "Settings"
4. "RECORDING TYPE"
5. Select the desired setting.

### Recording time

1. "Apps"
2. "Drive Recorder"
3. "Settings"
4. Select the desired setting.

### Cameras

1. "Apps"
2. "Drive Recorder"
3. "Settings"
4. "Camera selection"
5. Select desired camera.

In case of an accident, the system switches automatically to "All" cameras.

If driver assistance systems are enabled, their camera views are automatically selected.

## System limits

In the event of serious accidents, it may not be possible to store recordings if the damage on the vehicle is too great or the power supply was interrupted.

## Active Protection

---

### Principle

Active Protection prepares occupants and the vehicle for a possible accident in critical driving or collision situations.

### General information

Depending on vehicle equipment and national-market version, Active Protection consists of various PreCrash functions.

The system is used to detect certain critical driving situations that might lead to an accident. This includes the following critical driving situations:

- ▶ Emergency braking.
- ▶ Severe understeering.
- ▶ Severe oversteering.

Certain functions of several systems can, within the system limits, lead to Active Protection triggering:

- ▶ Forward Collision Warning with light braking function: automatic brake intervention.
- ▶ Front collision mitigation: Brake Assistant
- ▶ Rear-end collision preparation: detection of impending rear-end collisions.

## Safety information

### Warning

The system cannot serve as a substitute for the driver's personal judgment. Due to the system limits, critical situations might not be detected reliably or in time. There is a risk of accident. Adjust driving style to traffic con-

ditions. Watch surrounding traffic closely and actively intervene where appropriate.

## Function

When the seat belt is fastened, the driver's and front passenger's belt straps are automatically tightened once after driving away.

In accident-critical situations, the following individual functions become active as needed:

- ▶ Automatic pretensioning of the front seat belts.
- ▶ Automatic closing of the windows. The windows remain open with a small gap.
- ▶ The panoramic glass sunroof closes automatically. The sun protection is also closed.
- ▶ Depending on the equipment: automatic positioning of the backrest for the front passenger seat.

After a critical driving situation without an accident, the front seat belts are loosened again.

If the belt tension does not loosen automatically, stop the vehicle and unbuckle the seat belt using the red button in the buckle. Fasten the seat belt before continuing to drive.

All other systems can be restored to the desired setting.

## PostCrash – iBrake

---

### Principle

In certain accident situations, the PostCrash iBrake can automatically bring the vehicle to a standstill without intervention by the driver.

### General information

The PostCrash iBrake can reduce the risk of a further collision and its consequences.

## At standstill

After coming to a halt, the brake is released automatically.

## Harder vehicle deceleration

In certain situations, it may be necessary to bring the vehicle to a halt more quickly than automatic braking allows.

To do this, quickly apply extra force to the brake. For a brief period, the brake pressure will be higher than the brake pressure that is achieved by the automatic braking function. Automatic brake actuation is interrupted.

## Canceling automatic braking

It may be necessary to interrupt automatic braking in certain situations, for instance when making an evasive maneuver.

Cancel automatic braking:

- ▷ By pressing the brake pedal.
- ▷ By pressing the accelerator pedal.

## Fatigue alert

### Principle

The Fatigue Alert can detect decreasing alertness or fatigue of the driver during long, monotonous trips, for instance on highways. The system recommends a break.

### Safety information

#### **Warning**

The system cannot serve as a substitute for the driver's personal judgment in assessing one's physical state. An increasing lack of alertness or fatigue may not be detected or not be detected in time. There is a risk of accident. Make sure that the driver is rested

and alert. Adjust driving style to traffic conditions.

## Function

The system is switched on each time drive-ready state is switched on.

After start of the trip, the system monitors certain aspects of the driver's behavior, so that decreasing alertness or fatigue can be detected.

This procedure takes the following criteria into account:

- ▷ Personal driving style, for instance steering behavior.
- ▷ Driving conditions, for instance time, length of trip.
- ▷ Depending on the equipment: attention of the driver through the Driver Attention Camera.

Starting at approx. 43 mph/70 km/h, the system is active and can also display a break recommendation.

## Break recommendation

### Setting break recommendation

The fatigue alert is active automatically each time the drive-ready state is switched on and can thus display a break recommendation.

The break recommendation can also be switched on or off and adjusted via iDrive.

1. "CAR"
2. "Settings"
3. "General settings"
4. "Fatigue and Focus Alert"
5. Select the desired setting.

### Display

If the driver becomes less alert or fatigued, a message is displayed in the Control Display with the recommendation to take a break.



During the display, various settings can be selected.

After a break, another break recommendation cannot be displayed until after approximately 45 minutes.

## System limits

System functionality may be limited. If system functionality is limited, either no warning is issued or an incorrect warning is issued. The system function may be limited in the following situations:

- ▷ When the time is set incorrectly.
- ▷ When the vehicle speed is mainly below about 43 mph/70 km/h.
- ▷ With a sporty driving style, such as during rapid acceleration or when cornering fast.
- ▷ In active driving situations, such as when changing lanes frequently.
- ▷ When the road condition is poor.
- ▷ In the event of strong side winds.

The system is reset approx. 45 minutes after parking the vehicle, for instance in the case of a break during longer trips on highways.

# Driving stability control systems

## Vehicle features and options

---

This chapter describes all standard, country-specific and optional features offered with the series. It also describes features and functions that are not necessarily available in your vehicle, e.g., due to the selected options or country versions. This also applies to safety-related functions and systems. When using these functions and systems, the applicable laws and regulations must be observed.

## Antilock Braking System

---

The Antilock Braking System prevents locking of the wheels during braking.

The vehicle maintains its steerability even during emergency braking, which increases the active driving safety.

The Antilock Braking System is ready after each engine start.

## Brake assistant

---

The brake assistant applies maximum braking assistance when the brake is depressed quickly. It reduces the braking distance to a minimum during emergency braking. The advantages of the Antilock Braking System are thereby utilized.

Do not reduce the pressure on the brake pedal for the duration of emergency braking.

## Adaptive brake assistant

---

In combination with Active Cruise Control, this system ensures that the brake responds even more rapidly when braking in critical situations.

## Drive-off assistant

---

### Principle

The drive-off assistant supports driving off on uphill grades.

### Driving off

1. Hold the vehicle in place with the foot brake.
2. Release the foot brake and drive off without delay.

After the foot brake is released, the vehicle is held in place for approx. 2 seconds.

Depending on the vehicle loading or with trailer towing, the vehicle may roll back slightly.

## Dynamic Stability Control

---

### Principle

The Dynamic Stability Control helps to keep the vehicle on a steady course by reducing drive power and by brake intervention on individual wheels.

### General information

The Dynamic Stability Control will detect, e.g., the following unstable driving conditions:

- ▶ Skidding, which can lead to oversteering.
- ▶ Loss of adhesion of the front wheels, which can lead to understeering.

## Safety information

### Warning

The system cannot serve as a substitute for the driver's personal judgment in assessing the traffic situation. Based on the limits of the system, it cannot independently react to all traffic situations. There is a risk of accident. Adjust driving style to traffic conditions. Watch the surrounding traffic situation closely, be ready to take over steering and braking at any time, and actively intervene where appropriate.

### Warning

When driving with a roof load, for instance with roof-mounted luggage rack, the vehicle's center of gravity is higher, which increases the risk of the vehicle tipping in critical driving situations. There may be a risk of accident or risk of damage to property. Drive with roof load only with activated Dynamic Stability Control.

## Overview

### Button in the vehicle



DSC OFF

## Deactivating/activating the Dynamic Stability Control

### General information

When the Dynamic Stability Control is deactivated, driving stability is limited when accelerating and cornering.

To support driving stability, reactivate Dynamic Stability Control as soon as possible.

### Deactivating the system



Hold the button down until DSC OFF is displayed in the instrument cluster and the DSC OFF indicator light is illuminated.

### Activating the system



Press the button.

DSC OFF and the DSC OFF indicator light turn off.

## Display

### In the instrument cluster

If the Dynamic Stability Control is deactivated, DSC OFF is displayed in the instrument cluster.

### Indicator/warning lights



Indicator light illuminates: Dynamic Stability Control is deactivated.



Indicator light blinks: Dynamic Stability Control controls the drive and brake forces.

Indicator light illuminates: the Dynamic Stability Control has malfunctioned.

## Dynamic Traction Control

### Principle

The Dynamic Traction Control is a variant of the Driving Stability Control where the drive power is optimized.

The system ensures maximum drive power on unusual road conditions, for instance unplowed snow covered roads or loose road surfaces, but with somewhat limited driving stability.

### General information

When the Dynamic Traction Control is activated, there is maximum traction. Driving stability is limited during acceleration and when cornering.

A brief activation of the Dynamic Traction Control may be useful in the following situations:

- ▶ When driving in slush or on uncleared, snow-covered roads.
- ▶ When driving off from deep snow or loose ground.
- ▶ When driving with tire chains.

### Overview

#### Button in the vehicle



DSC OFF

## Activating/deactivating the Dynamic Traction Control

### Activating the system



Press the button.

TRACTION is displayed in the instrument cluster and the indicator light for DSC OFF lights up.

### Deactivating the system



Press the button again.

TRACTION and the DSC OFF indicator light turn off.

### Display

#### Display in the instrument cluster

When the Dynamic Traction Control is activated, TRACTION is displayed in the instrument cluster.

#### Indicator/warning lights



The indicator light illuminates: the Dynamic Traction Control is activated.

### Automatic program change

In certain situations, the Dynamic Stability Control is activated automatically:

- ▶ The Active Cruise Control with Stop&Go function is activated.
- ▶ On a brake intervention by the Intelligent Safety systems.
- ▶ The vehicle has a flat tire.

## xDrive

### Principle

xDrive is the all-wheel-drive system of the vehicle. Concerted action by the xDrive and other

suspension control systems, such as Dynamic Stability Control, further optimizes traction and driving dynamics.

## General information

xDrive variably distributes the driving power to the front and rear axles as demanded by the driving situation and road condition.

Because of the needs-based use of the all-wheel-drive system, Efficient4x4 yields a reduction in consumption.

## Display on the control display

### Display xView display

1. "CAR"
2. "Driving information"
3. "xVIEW"

The following information is displayed:

- ▶ With a navigation system: compass display for the driving direction.
- ▶ With navigation system: elevation for the current position.
- ▶ With navigation system: destination flag in compass direction to the destination.
- ▶ Pitch attitude with degree indication and percentage.
- ▶ Transverse gradient with degree indication.
- ▶ Graphic display for the steering-wheel angle.

## Automatic Differential Brake

### Principle

Automatic Differential Brake controls the driving power by automatic brake intervention on individual wheels.

### General information

The function works in the same way as a differential lock and improves traction on a

loose surface, for example. The system detects when a wheel begins to spin and automatically brakes this wheel.

The driving power is diverted to the wheel with better traction.

As a result, the driving power is transferred more efficiently to the wheels during accelerations.

## Hill Descent Control

### Principle

Hill Descent Control is a downhill control feature that adjusts the vehicle speed on steep downhill gradients, e.g., when driving on unpaved roads.

### General information

When the system is active, the vehicle moves at the speed set by the driver, without the driver having to depress the brake pedal.

While Hill Descent Control is adjusting the speed, the system automatically distributes the brake force to the individual wheels. This improves driving stability and steerability. If necessary, the Antilock Braking System prevents the wheels from locking.

The system can be activated below approx. 25 mph/40 km/h.

Speeds can be set between approx. 2 mph/3 km/h and approx. 20 mph/30 km/h. When the vehicle is driving downhill, the system reduces the speed to the set value, within the physical limits.



## Overview

### Button in the vehicle



Hill Descent Control

### Activate Hill Descent Control



Press the button.

Speeds between approx. 2 mph/3 km/h and approx. 20 mph/30 km/h are adopted as the set speed.

Active Park Distance Control: the Park Distance Control brake function is deactivated.

Additional information:

Active Park Distance Control, refer to page 247.

### Display in the instrument cluster



An icon and the selected desired speed are displayed.

- ▶ Indicator green: Hill Descent Control is active. The system is actively braking the vehicle.
- ▶ Indicator gray: Hill Descent Control is on standby.

### Display in the Head-up display

The status of the system can also be shown in the Head-up display.

## Increasing or decreasing vehicle speed

### Using the cruise control rocker switch

The set speed can be changed using the cruise control rocker switch on the steering wheel.

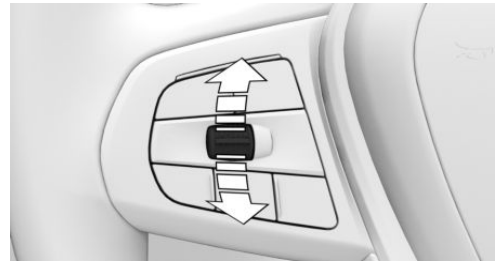

- ▶ Press the rocker switch up: the speed increases gradually.
- ▶ Press the rocker switch up and hold: the speed increases while the rocker switch is pressed.
- ▶ Press the rocker switch down: the speed decreases gradually.
- ▶ Press the rocker switch down and hold: the speed decreases while the rocker switch is pressed.

### Using the brake pedal

While the system is adjusting the speed, the set speed can be reduced by depressing the brake pedal.

### Deactivating Hill Descent Control



Press the button again.

The system is automatically deactivated above approx. 25 mph/40 km/h.

### Malfunction

If a malfunction occurs, a message is displayed in the instrument cluster.



## Variable sport steering

---

The variable sport steering facilitates direct and agile handling with little steering effort. The variable sports steering works independently of the current speed, varying the steering ratio in line with the steering angle.

# Driver assistance systems

## Vehicle features and options

This chapter describes all standard, country-specific and optional features offered with the series. It also describes features and functions that are not necessarily available in your vehicle, e.g., due to the selected options or country versions. This also applies to safety-related functions and systems. When using these functions and systems, the applicable laws and regulations must be observed.

## Speed Limit Info

### Speed Limit Info

#### Principle

Speed Limit Info shows the currently valid speed limit in the instrument cluster and, if necessary, the Head-up Display.

#### General information

The camera in the area of the interior mirror detects traffic signs at the edge of the road as well as overhead sign posts.

Traffic signs with extra symbols are considered and compared with the vehicle's onboard data. The traffic sign will then be either displayed or ignored depending on the situation in the instrument cluster and the Head-up display.

With the navigation system, the system takes into account the information stored in the navigation system and also displays speed limits present on routes without signs.

Information on the current map version can be found under Map update in the Navigation system chapter.

Without a navigation system, the system is subject to limitations imposed by technology.

Traffic signs with speed limitations are detected and displayed only. Speed limits due to entering towns/cities, highway signs, etc., are not displayed. Speed limits with extra traffic signs are always displayed.

Speed limits for trailer towing will be displayed when the trailer power socket is occupied or trailer towing was activated via iDrive.

Additional information:

Owner's Manual for Navigation, Entertainment, and Communication, refer to page 6.

Trailer towing, refer to page 315.

## Safety information

### Warning

The system cannot serve as a substitute for the driver's personal judgment in assessing the traffic situation. Based on the limits of the system, it cannot independently react to all traffic situations. There is a risk of accident. Adjust driving style to traffic conditions. Watch the surrounding traffic situation closely, be ready to take over steering and braking at any time, and actively intervene where appropriate.

## Overview

### Sensors

The system is controlled by cameras behind the windshield.

Additional information:

Sensors of the vehicle, refer to page 35.

## Displaying Speed Limit Info

### General information





Depending on the vehicle equipment, Speed Limit Info is displayed permanently in the instrument cluster or via iDrive.

### Activating

1. "CAR"
2. "Settings"
3. "Driver Assistance"
4. If necessary, "Driving"
5. "Speed Limit Assistance"
6. "Speed limits"
7. "Show current limit"

## Display

### Speed Limit Info

Icon	Description
	Current speed limit. Depending on the national-market version, it is possible to switch between the units of measurement.
	Without a navigation system the traffic signals are grayed out after curves or longer stretches of distance travelled.
	No data for the current speed limit available.
	The displays may vary depending on vehicle equipment.
	Depending on the equipment, Speed Limit Info not available.

If the detected speed limit has been exceeded, the indicator light will flash.

### Settings

1. "CAR"
2. "Settings"
3. "Driver Assistance"
4. If necessary, "Driving"
5. "Speed Limit Assistance"
6. Select the desired setting.

The warning that is issued when a speed limit is exceeded may depend on the Speed Limit Assistant settings.

Additional information:

Speed Limit Assistant, refer to page [234](#).

## System limits

### System limits of the sensors

Additional information:

- ▶ Cameras, refer to page [35](#).

### Functional limitations

The system function may be limited and may provide incorrect information in the following situations:

- ▶ For traffic signs that are fully or partially concealed by objects, stickers, or paint.
- ▶ When driving very close to the vehicle in front of you.
- ▶ In the case of navigation data that is invalid, outdated or not available.
- ▶ In areas not covered by the navigation system.
- ▶ When roads deviate from the navigation, such as due to changes in road layout.
- ▶ In case of electronic traffic signs.
- ▶ When passing buses or trucks with traffic signs applied to them.
- ▶ When the traffic signs do not correspond to the standard.
- ▶ When traffic signs that are valid for a parallel road are detected.
- ▶ In the presence of country-specific road signs or road layouts.

## Manual Speed Limiter

### Principle



The system can be used to set a speed limit, for instance to prevent the vehicle from exceeding speed limits.

## General information

The system can limit the speed, starting at 20 mph/30 km/h. The vehicle can be driven at any speed below the set speed limit.

### Overview

#### Buttons on the steering wheel

Button	Function
	System on/off.
	Store current speed. Speed Limit Assistant: accept suggested speed manually.
	Rocker switch: Changing the speed limit.

### Operation

#### Turning on

 Press the button on the steering wheel.

The current speed is accepted as the speed limit.

If the system is switched on while the vehicle is stationary or driving at low speeds, the speed limit is set to 20 mph/30 km/h.

The marking in the speedometer is set to the corresponding speed.

When the speed limit is activated, Dynamic Stability Control is switched on and the vehicle may change to COMFORT drive mode.

#### Turning off

 Press the button on the steering wheel.

The system switches off automatically in the following situations, for example:

- ▷ When the engine is switched off.
- ▷ When Cruise Control is switched on.
- ▷ When certain programs are activated via the Driving Dynamics Control.

The displays turn off.

### Interrupting

If the reverse gear is engaged or in Neutral, the system is interrupted when rolling backwards.

### Changing the speed limit

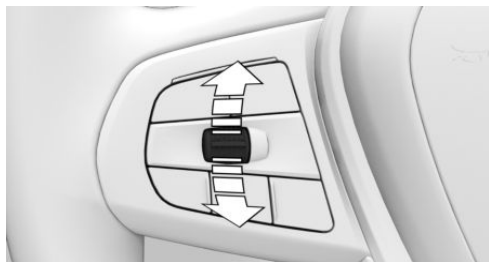

Press the rocker switch up or down repeatedly until the desired speed limit is set.

- ▷ Each time the rocker switch is pressed to the resistance point, the speed limit increases or decreases by 1 mph/1 km/h.
- ▷ Each time the rocker switch is pressed past the resistance point, the desired speed changes by a maximum of 5 mph/10 km/h.

If the set speed limit is reached or unintentionally exceeded, such as when driving downhill, the vehicle is not actively braked.

When the speed limit is set during a trip to a value below the current speed, the vehicle coasts until it drops to the set speed limit.

The current speed can also be stored by pressing a button:



Press the button on the steering wheel.

### Exceeding the speed limit

When the vehicle speed exceeds the set speed limit, a warning is issued.

The speed limit can be exceeded intentionally.

Press the accelerator pedal all the way down to intentionally exceed the set speed limit.

When the vehicle speed drops below the set speed limit, the limit is automatically reactivated.

### Warning when the speed limit is exceeded

#### Visual warning



If the speed limit is exceeded: the indicator light in the instrument cluster flashes while the vehicle speed is greater than the set speed limit.

#### Acoustic warning

- ▷ If the speed limit is exceeded unintentionally, a signal sounds.
- ▷ When the speed limit is reduced to below the vehicle speed while driving, the signal sounds after some time.
- ▷ When the speed limit is intentionally exceeded by stepping on the accelerator pedal all the way down, there is no signal.

### Displays in the instrument cluster

#### Display in the speedometer

Depending on the equipment, a mark in the speedometer displays the status of the system.

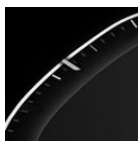

- ▷ Green marking: system is active.
- ▷ Gray marking: system is interrupted.
- ▷ No marking: system is switched off.

## Indicator light



- ▶ The indicator light lights up: the system is switched on.
- ▶ The indicator light flashes: the set speed limit has been exceeded.
- ▶ Gray indicator light: the system has been interrupted.

## Cruise Control

### Principle

With the Cruise Control, a set speed can be adjusted using the buttons on the steering wheel. The system maintains the set speed. The system accelerates and brakes automatically as needed.

### General information

The system can be activated starting at 20 mph/30 km/h.

Depending on the vehicle setting, the cruise control settings may change under certain conditions. For instance, acceleration can change depending on the driving mode.

### Safety information

#### Warning

The system cannot serve as a substitute for the driver's personal judgment in assessing the traffic situation. Based on the limits of the system, it cannot independently react to all traffic situations. There is a risk of accident. Adjust driving style to traffic conditions. Watch the surrounding traffic situation closely, be ready to take over steering and braking at any time, and actively intervene where appropriate.

#### Warning

The use of the system can lead to an increased risk of accidents in the following situations, for instance:

- ▶ On winding roads.
- ▶ With high traffic volume.
- ▶ On slippery roads, in fog, snow, or wet conditions, or on a loose road surface.

There may be a risk of accident or risk of damage to property. Only use the system if driving at constant speed is possible.

#### Warning

The set speed can be incorrectly adjusted or called up by mistake. There is a risk of accident. Adjust the set speed to the traffic conditions. Watch surrounding traffic closely and actively intervene where appropriate.

#### Warning

When towing with Intelligent Safety systems enabled or Cruise Control switched on, individual functions may not work correctly. There is a risk of accident. Switch off all Intelligent Safety systems and Cruise Control before towing.

## Overview

### Buttons on the steering wheel

#### Button Function





Cruise control on/off.





RESUME Continue cruise control with the last setting.

**Button Function**

	Interrupt cruise control.
	Store current speed. Speed Limit Assistant: accept suggested speed manually.
	Rocker switch: Set speed.

## Switching cruise control on/off

### Turning on



-  Depending on the equipment version, press the relevant button on the steering wheel.
- 

The indicator lights in the instrument cluster light up and the mark on the speedometer is set to the current speed.

Cruise control is active. The current speed is maintained and stored as set speed.

If necessary, the Dynamic Stability Control will be turned on.

### Turning off

-  Depending on the equipment version, press the relevant button on the steering wheel.
- 

The displays turn off. The stored set speed is deleted.

## Interrupting Cruise Control

### Interrupting manually

-  When active, press the button.

## Interrupting automatically

The system is automatically interrupted in the following situations, for example:

- ▷ When braking manually.
- ▷ Steptronic transmission: selector lever position D is disengaged.
- ▷ While Dynamic Traction Control is enabled or Dynamic Stability Control is disabled.
- ▷ While Dynamic Stability Control is adjusting.

## Adjusting the speed

### Maintaining and storing the speed

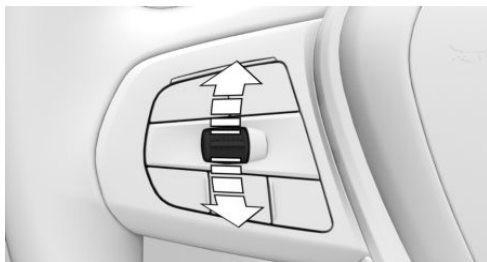

Press the rocker switch up or down once while the system is interrupted.

When the system is switched on, the current speed is maintained and stored as the set speed.

The stored speed is displayed on the speedometer.

If necessary, the Dynamic Stability Control will be turned on.

The speed can also be stored by pressing a button.

-  Press the button.



## Changing the speed

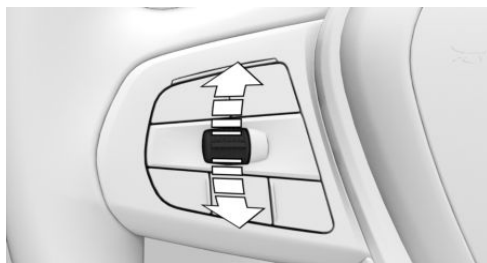

Press the rocker switch up or down repeatedly until the desired speed is set.

If active, the displayed speed is stored and the vehicle reaches the stored speed when the road is clear.

- ▶ Each time the rocker switch is tapped to the resistance point, the set speed increases or decreases by 1 mph/1 km/h.
- ▶ Each time the rocker switch is pressed past the resistance point, the desired speed changes by a maximum of 5 mph/10 km/h.

The maximum speed that can be set depends on the vehicle.

- ▶ Pressing the rocker switch to the resistance point and holding it: vehicle accelerates or decelerates without pressure on the accelerator pedal.

After the rocker switch is released, the vehicle maintains its final speed. Pressing the switch beyond the resistance point causes the vehicle to accelerate more rapidly.

## Continuing cruise control

An interrupted cruise control can be continued by calling up the stored speed.

Make sure that the difference between current speed and stored speed is not too large before calling up the stored speed. Otherwise, unintentional deceleration or acceleration may occur.

 Press the button with the system interrupted.

Cruise control is continued with the stored values.

In the following cases, the stored speed value is deleted and cannot be called up again:

- ▶ When the system is switched off.
- ▶ When drive-ready state is switched off.

## Displays in the instrument cluster

### Display in the speedometer

Depending on the equipment, a mark in the speedometer displays the status of the system.

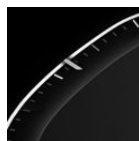

- ▶ Green marking: system is active, the marking indicates the desired speed.
- ▶ Gray marking: system is interrupted, the marking indicates the stored speed.
- ▶ No marking: system is switched off.

### Indicator light



- ▶ Indicator light green: system is active.
- ▶ Gray indicator light: the system has been interrupted.
- ▶ No indicator light: system is switched off.

## Displays in the Head-up display

Some system information can also be displayed in the Head-up display.



The icon is displayed when the set speed is reached.

## System limits

The set speed is also maintained downhill. The speed may not be maintained on uphill grades if the drive power is insufficient.

In ECO PRO driving mode, the vehicle may exceed or drop below the set desired speed

in some situations, for instance on downhill or uphill grades.

## Active Cruise Control with Stop&Go function

### Principle

Using the Cruise Control, a desired speed and a distance to a vehicle ahead can be adjusted using the buttons on the steering wheel.

### General information

The system maintains the set speed on clear roads. The vehicle accelerates or brakes automatically.

If a vehicle is driving ahead of you, the system adjusts the speed of your vehicle so that the set distance to the vehicle ahead is maintained. The speed is adjusted as far as the given situation allows.

The distance can be adjusted at several levels. For safety reasons, it depends on the respective speed.

If the vehicle ahead of you brakes to a standstill and then drives off again within a brief period, the system is able to detect this within the given system limits.

Depending on the vehicle setting, the cruise control settings may change under certain conditions. For instance, acceleration can change depending on the driving mode.

### Safety information

#### Warning

The system cannot serve as a substitute for the driver's personal judgment in assessing the traffic situation. Based on the limits of the system, it cannot independently react to all traffic situations. There is a risk of accident. Adjust driving style to traffic conditions. Watch the surrounding traffic situation

closely, be ready to take over steering and braking at any time, and actively intervene where appropriate.

#### Warning

An unsecured vehicle can begin to move and possibly roll away. There is a risk of accident. Before leaving the vehicle, secure the vehicle against rolling away.

In order to ensure that the vehicle is secured against rolling away, follow the following:

- ▷ Set the parking brake.
- ▷ On uphill grades or on downhill slopes, turn the front wheels in the direction of the curb.
- ▷ On uphill grades or on downhill slopes, also secure the vehicle, for instance with a wheel chock.

#### Warning

The set speed can be incorrectly adjusted or called up by mistake. There is a risk of accident. Adjust the set speed to the traffic conditions. Watch surrounding traffic closely and actively intervene where appropriate.

#### Warning

Risk of accident is greater when there is a high speed differential to other vehicles, for instance in the following situations:

- ▷ When approaching a slowly moving vehicle at speed.
- ▷ Vehicle suddenly swerving into own lane.
- ▷ When approaching stationary vehicles at speed.









There is a risk of injury or danger to life. Watch surrounding traffic closely and actively intervene where appropriate.

**Warning**



When towing with Intelligent Safety systems enabled or Cruise Control switched on, individual functions may not work correctly. There is a risk of accident. Switch off all Intelligent Safety systems and Cruise Control before towing.

## Overview

### Buttons on the steering wheel

Button	Function
	With Steering Assistant: Cruise control on/off.
	With Steering Assistant: Select function.
	Without Steering Assistant: Cruise control on/off.
	Store current speed. Speed Limit Assistant: accept suggested speed manually.
	With Steering Assistant: Interrupt cruise control. Continue cruise control with the last setting.
	Without Steering Assistant: Continue cruise control with the last setting.
	Without Steering Assistant: Interrupt cruise control.
	Increase the distance. Switch Distance Control on/off.

**Button Function**

	Reduce distance. Switch Distance Control on/off.
	Rocker switch: Set speed.

## Sensors

The system is controlled by the following sensors:

- ▷ Cameras behind the windshield.
- ▷ Front radar sensor.

Additional information:

Sensors of the vehicle, refer to page 35.

## Application range

The system is best used on well-maintained roads.

The minimum speed that can be set is 20 mph/30 km/h.

The maximum speed that can be set is limited and depends, for example, on the vehicle and the vehicle equipment.

The system can also be activated when stationary.

## Turning on/off and interrupting cruise control

### With Steering Assistant: Assisted Driving Mode

#### General information

 This button is used to switch the configured function on and off.

 The button can be used to set the primarily used function.

### Setting the function

 When the system is active, press the button repeatedly until the desired function is selected in the toolbar. The toolbar for Assisted Driving mode is displayed at the bottom of the instrument cluster.

Icon	Function
------	----------

	Cruise Control with Distance Control.
--	---------------------------------------

	Depending on the equipment version, cruise control with distance control and Steering Assistant.
--	--

	
--	--

The selected function is shown in green.

### Turning on

With Steering Assistant:

1.  Press the button on the steering wheel.

2.  If necessary, set the cruise control.

Without Steering Assistant:

 Press the button on the steering wheel.

The indicator lights in the instrument cluster light up and the mark on the speedometer is set to the current speed.

Cruise control is active. The current speed is maintained and stored as set speed.

If necessary, the Dynamic Stability Control will be turned on.

### Turning off

To switch off the system while stationary, step on brake pedal at the same time.

Press the button on the steering wheel:

 With Steering Assistant.

 Without Steering Assistant.

The displays turn off. The stored set speed is deleted.

### Interrupting manually

When active, press the button on the steering wheel:

 With Steering Assistant.

 Without Steering Assistant.

If interrupting the system while stationary, press on the brake pedal at the same time.

### Interrupting automatically

The system is automatically interrupted in the following situations:

- ▶ The driver applies the brakes.
- ▶ Selector lever position D is disengaged.
- ▶ While Dynamic Traction Control is enabled or Dynamic Stability Control is disabled.
- ▶ While Dynamic Stability Control is adjusting.
- ▶ When the vehicle is stationary, the seat belt is unbuckled and the driver's door is opened.
- ▶ The system has not detected objects for an extended period, for instance on a road with very little traffic without curb or shoulder markings.
- ▶ The detection range of the radar is impaired, for instance by contamination or heavy precipitation.
- ▶ After a longer stationary period when the vehicle has been braked to a stop by the system.

## Adjusting the speed

### Maintaining and storing the speed

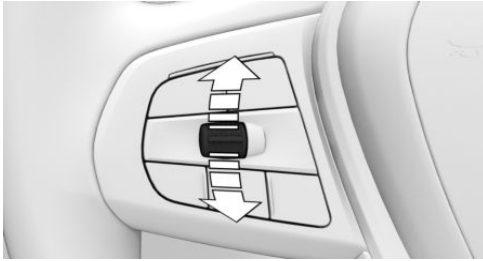

Press the rocker switch up or down once while the system is interrupted. The system will be activated.

The current speed is maintained and stored as desired speed.

The stored speed is displayed on the speedometer.

If necessary, the Dynamic Stability Control will be turned on.

The speed can also be stored by pressing a button.

 Press the button.

### Changing the speed

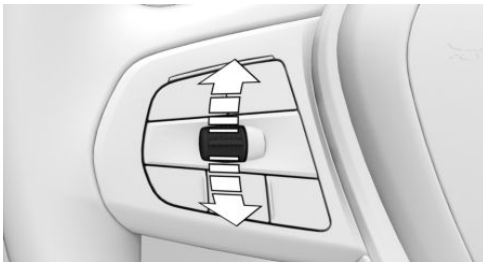

Press the rocker switch up or down repeatedly until the desired speed is set.

If active, the displayed speed is stored and the vehicle reaches the stored speed when the road is clear.

- ▷ Each time the rocker switch is tapped to the resistance point, the set speed increases or decreases by 1 mph/1 km/h.
- ▷ Each time the rocker switch is pressed past the resistance point, the desired speed changes by a maximum of 5 mph/10 km/h.

Hold the rocker switch in position to repeat the action.

## Adjusting the distance

### Safety information

#### **Warning**

The system cannot serve as a substitute for the driver's personal judgment. Due to the system limits, deceleration can be late. There may be a risk of accident or risk of damage to property. Be aware to the surrounding traffic situation at all times. Adjust the distance to the traffic and weather conditions and maintain the prescribed safety distance, possibly by braking.

### Reducing the distance



Press the button repeatedly until the desired distance is set.

Instrument cluster will display selected distance.

### Increasing the distance



Press the button repeatedly until the desired distance is set.

Instrument cluster will display selected distance.

### Automatic adaptation of the distance

Depending on the equipment and national-market version: the system can be adjusted so that the distance to the vehicle driving in front is automatically adjusted within the configured

distance according to the traffic situation or the ambient conditions, for instance poor visibility.

1. "CAR"
2. "Settings"
3. "Driver Assistance"
4. If necessary, "Driving"
5. "Speed Limit Assistance"
6. "Adjust distance acc. to situation"

### Continuing cruise control

An interrupted cruise control can be continued by calling up the stored speed.

Make sure that the difference between current speed and stored speed is not too large before calling up the stored speed. Otherwise, unintentional deceleration or acceleration may occur.

Press the button on the steering wheel with the system interrupted:

 With Steering Assistant.

 Without Steering Assistant.

Cruise control is continued with the stored values.

In the following cases, the stored speed value is deleted and cannot be called up again:

- ▷ When the system is switched off.
- ▷ When drive-ready state is switched off.

### Changing between Cruise Control with/without Distance Control

#### Safety information

 **Warning**

The system does not react to traffic driving ahead of you, but instead maintains the stored speed. There may be a risk of accident or risk of damage to property. Adjust the set

speed to the traffic conditions and brake as needed.

### Changing over the Cruise Control mode

Switching Cruise Control without Distance Control off and on:

▷  Press and hold this button.

▷  Press and hold this button.

With Steering Assistant: switch on Distance Control:

 Press the button.

Without Steering Assistant: switch on Distance Control:

▷  Press the button.

▷  Press the button.

After changing, a Check Control message is displayed.

### Displays in the instrument cluster

#### General information

Depending on the equipment version, the displays in the instrument cluster may vary.

#### Display in the speedometer

Depending on the equipment, a mark in the speedometer displays the status of the system.



▷  Green marking: system is active, the marking indicates the desired speed.

▷  Gray marking: system is interrupted, the marking indicates the stored speed.

▷ No marking: system is switched off.

## Distance to vehicle ahead of you

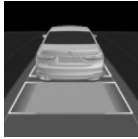
Selected distance to the vehicle ahead of you is shown.

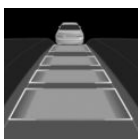
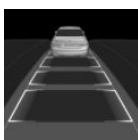
Icon	Description
	Distance 1
	Distance 2
	Distance 3
	Distance 4 This value is set automatically after the system is switched on.
	No distance control display, as the accelerator pedal is being pressed.



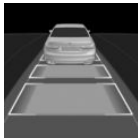

## Detected vehicle

Icon	Description
	Green icon: A vehicle has been detected ahead of you.

When the distance to the detected vehicle increases, the vehicle icon in the distance display will move away.

If necessary, drive off on your own, such as by stepping on the accelerator pedal or by pressing the rocker switch.

## Indicator/warning lights

Icon	Description
	Vehicle icon white: No distance control display, as the accelerator pedal is being pressed.
	Green icon: A vehicle has been detected ahead of you. The vehicle icon goes out if no vehicle in front is detected. Vehicle icon flashes green: Vehicle in front drove off.
	Gray icon: System interrupted.
	Icon flashes gray: The conditions are not adequate for the system to work. The system was deactivated but applies the brakes until you actively resume control by pressing on the brake pedal or accelerator pedal.
	Vehicle icon flashes red and a signal sounds: Brake and make an evasive maneuver, if necessary.

## Alternative displays

Icon	Description
------	-------------



Indicator light green: system is active.

No indicator light: system is switched off.



Vehicle icon flashes:  
The conditions are not adequate for the system to work.  
The system was deactivated but applies the brakes until you actively resume control by pressing on the brake pedal or accelerator pedal.

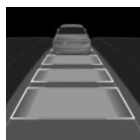

The vehicle icon and distance bars blink red and an acoustic signal sounds:  
Brake and make an evasive maneuver, if necessary.



System interrupted.

## Assisted Driving View

Depending on the equipment and national-market version, information for the system is displayed in the Assisted Driving View in the central display area of the instrument cluster.

Additional information:

Assisted Driving View, refer to page 155.

## Displays in the Head-up display

### Set speed

Some system information can also be displayed in the Head-up display.



The icon is displayed when the set speed is reached.

## Distance information



The icon is displayed when the distance from the vehicle traveling ahead is too short.

The distance information is active in the following situations:

- ▶ Active Cruise Control switched off.
- ▶ Display in the Head-up display selected. Head-Up Display, refer to page 172.
- ▶ Distance too short.
- ▶ Speed greater than approx. 40 mph/70 km/h.

## System limits

### System limits of the sensors

Additional information:

- ▶ Cameras, refer to page 35.
- ▶ Radar sensors, refer to page 36.

## Detection range

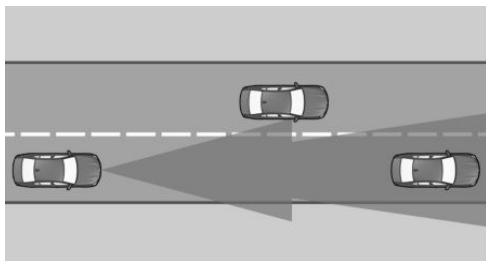

The detection capability of the system and the automatic braking performance are limited.

For instance, two-wheeled vehicles may not be detected.



## Deceleration

The system does not decelerate in the following situations:

- ▶ For pedestrians or similarly slow-moving road users.
- ▶ Depending on the vehicle equipment and national availability, for red traffic lights.
- ▶ For cross traffic.
- ▶ For oncoming traffic.

## Merging vehicles

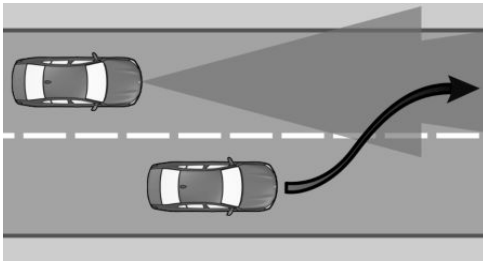

If a vehicle driving ahead of you suddenly merges into your lane, the system may not be able to automatically restore the selected distance. It may not be possible to restore the selected distance in certain situations, including if you are driving significantly faster than vehicles driving ahead of you, for instance when rapidly approaching a truck. When a vehicle driving ahead of you is reliably detected, the system requests that the driver intervene by braking and carrying out evasive maneuvers, if needed.

## Cornering

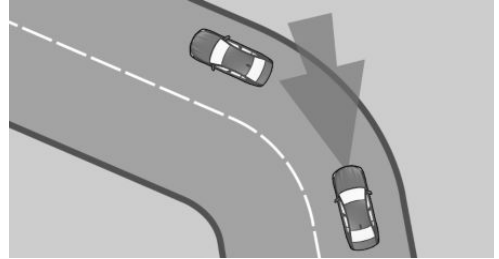

When the set speed is too high for a curve, the speed is reduced slightly. Because curves may not be anticipated in advance, drive into a curve at an appropriate speed.

The system has a limited detection range. Situations can arise in tight curves where a vehicle driving ahead will not be detected or will be detected very late.

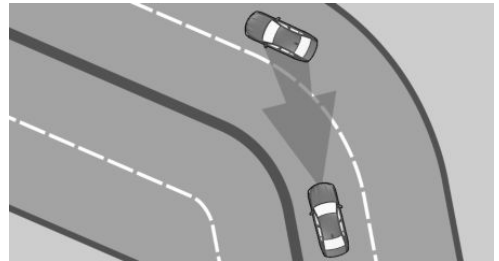

When you approach a curve the system may briefly report vehicles in the next lane due to the bend of the curve. If the system decelerates you may compensate for it by briefly accelerating. After releasing the accelerator pedal the system is reactivated and controls speed independently.

## Driving off

In some situations, the vehicle cannot drive off automatically; for example:

- ▶ On steep uphill grades.
- ▶ In front of bumps in the road.
- ▶ With a heavy trailer.

In these cases, step on the accelerator pedal.

## Weather

The following restrictions can occur under unfavorable weather or light conditions:

- ▷ Poorer vehicle detection.
- ▷ Short-term interruptions for vehicles that are already recognized.

Drive attentively, and react to the current surrounding traffic situation. If necessary, intervene actively, for instance by braking, steering or evading.

## Drive power

The set speed is also maintained downhill. The speed may not be maintained on uphill grades if the drive power is insufficient.

In ECO PRO driving mode, the vehicle may exceed or drop below the set desired speed in some situations, for instance on downhill or uphill grades.

## Speed Limit Assistant

### Principle

Speed Limit Assistant supports driving at the speed limit. A suggested speed can be applied.

### General information

When the systems in the vehicle, e.g., Speed Limit Info, detect a change of the speed limit, this new speed value can be applied for the following systems:

- ▷ Manual Speed Limiter.
- ▷ Cruise control.
- ▷ Active Cruise Control with Stop&Go function.

The speed value is suggested as the new desired speed to be applied. To apply the speed value, the corresponding system must be activated.

## Safety information

### Warning



The system cannot serve as a substitute for the driver's personal judgment in assessing the traffic situation. Based on the limits of the system, it cannot independently react to all traffic situations. There is a risk of accident. Adjust driving style to traffic conditions. Watch the surrounding traffic situation closely, be ready to take over steering and braking at any time, and actively intervene where appropriate.

### Warning

The set speed can be incorrectly adjusted or called up by mistake. There is a risk of accident. Adjust the set speed to the traffic conditions. Watch surrounding traffic closely and actively intervene where appropriate.

## Overview

### Buttons on the steering wheel

Button	Function
	Accept suggested speed manually.
	Rocker switch: Set speed, refer to Cruise Control.





### Turning Speed Limit Assistant on/off

1. "CAR"
2. "Settings"
3. "Driver Assistance"
4. If necessary, "Driving"
5. "Speed Limit Assistance"

6. "Speed limits"
7. Select the desired setting:
  - ▷ "Adjust manually": detected speed limits can be applied manually.
  - ▷ "Show anticipation": Depending on the national-market version: current and upcoming speed limits are displayed in the instrument cluster without being applied.
  - ▷ "Show current limit": current speed limits are displayed without being applied in the instrument cluster.
  - ▷ "Off": depending on the national-market version, Speed Limit Info and Speed Limit Assistant will be turned off.

## Displays in the instrument cluster

A message is displayed in the instrument cluster when the system and a driver assistance system are activated.

Icon	Function
	Depending on the equipment version, the indicator light illuminates green, together with the icon for a speed control system:  Speed Limit Assistant is active and detected speed limits can be applied manually for the displayed system.
	Detected change of a speed limit with immediate effect.
	Depending on the national-market version, it is possible to switch between the units of measurement.
	Indicator light illuminates green: the detected speed limit can be applied with the SET button.  After it has been applied, a green checkmark is displayed.

## Manual adoption

A detected speed limit can be applied manually for the active driver assistance system.

**SET**

When the SET icon lights up, press the button.

## Speed adjustment

### Principle

It can be adjusted whether the speed limit is applied exactly or with a tolerance.

### General information

You can configure a speed adaptation for all speed limits and an additional speed adaptation for speed limits up to 40 mph/60 km/h.

The additional speed adaptation for speed limits up to 40 mph/60 km/h can be activated or deactivated.

### Setting the speed adjustment

1. "CAR"
2. "Settings"
3. "Driver Assistance"
4. If necessary, "Driving"
5. "Speed Limit Assistance"
6. To perform the desired setting:
  - ▷ "Adjust speed limits": set tolerance for the speed adaptation that affects all speeds.
  - ▷ "2nd adjustment up to": activate or deactivate additional speed adaptation.
  - ▷ "Adjust speed limits": With additional speed adjustment activated, set the tolerance for speed limits up to 40 mph/60 km/h.

## Adapting to route

### Principle

Depending on the national-market version, the system can be configured so that the vehicle adapts the speed automatically to the route.

For instance, the speed will be reduced in the following situations as necessary:

- ▷ Before making turns.
- ▷ Before a roundabout.
- ▷ Before a curve.

### Adjustment

1. "CAR"
2. "Settings"
3. "Driver Assistance"
4. If necessary, "Driving"
5. "Speed Limit Assistance"
6. "Adjust to route" or "Automatically adjust speed to route"

### System limits

Speed Limit Assistant is based on the Speed Limit Info system.

Consider the system limits of Speed Limit Info.

Upcoming speed limits can only be accepted for the Active Cruise Control.

Depending on the national-market version, the system may not respond at all or with limitations to the route when the navigation system is unable to clearly identify the position of the vehicle.

Additional information:

- ▷ System limits of Speed Limit Information, refer to page 221.
- ▷ System limits of the sensors, refer to page 35.

## Steering Assistant

### Principle

The Steering Assistant helps keep the vehicle in the lane. For this purpose, the system executes supporting steering movements, for instance when cornering.

### General information

Depending on the speed, the system orients itself according to the lane boundaries or vehicles in front.

Sensors on the steering wheel detect whether the steering wheel is being touched.

### Safety information

#### Warning

The system cannot serve as a substitute for the driver's personal judgment in assessing the traffic situation. Based on the limits of the system, it cannot independently react to all traffic situations. There is a risk of accident. Adjust driving style to traffic conditions. Watch the surrounding traffic situation closely, be ready to take over steering and braking at any time, and actively intervene where appropriate.

### Overview

#### Buttons on the steering wheel

Button	Function
	Steering Assistant with Traffic Jam Assistant on/off.
	Switch function on.



Steering Assistant with Traffic Jam Assistant on/off.



Switch function on.

## Sensors

The system is controlled by the following sensors:

- ▶ Cameras behind the windshield.
- ▶ Front radar sensor.
- ▶ Radar sensors, side, front.
- ▶ Radar sensors, side, rear.

Additional information:

Sensors of the vehicle, refer to page 35.

## Functional requirements

- ▶ Speed below 130 mph/210 km/h.
- ▶ Sufficient lane width.
- ▶ Above approx. 43 mph, 70 km/h: lane boundary on both sides is detected.
- ▶ Below approx. 43 mph, 70 km/h: lane boundary on both sides or a vehicle driving ahead is detected.
- ▶ Hands on the steering wheel rim.
- ▶ Wide curves.
- ▶ Drive in the center of the lane.
- ▶ Turn signal switched off.
- ▶ The sensor system calibration process is complete.
- ▶ Cruise Control with Distance Control active.
- ▶ Seat belt on the driver's side fastened.
- ▶ Forward Collision Warning active.
- ▶ Pedestrian Warning active.
- ▶ Side Collision Warning active.

## Turning on/off

### Assisted Driving Mode

#### General information



This button is used to switch the configured function on and off.



The button can be used to set the primarily used function.

#### Setting the function





When the system is active, press the button repeatedly until the desired function is selected in the toolbar. The toolbar for Assisted Driving mode is displayed at the bottom of the instrument cluster.

Icon	Function
	Cruise Control with Distance Control.
	Depending on the equipment version, cruise control with distance control and Steering Assistant.
	



The selected function is shown in green.

#### Turning on

1.  Press the button on the steering wheel.
2.  Adjust the Steering Assistant if necessary.



Steering wheel icon lights up gray.

The system is on standby and does not manipulate steering movements.

System activates automatically as soon as all function conditions are fulfilled.



Steering wheel icon lights up green.

The system is active.

With the system switched on, the Daytime Pedestrian Collision Mitigation system and the Side Collision Warning are activated.

## Turning off

 Press the button on the steering wheel.

The indicator goes out.

The system does not perform supportive steering wheel movements.

## Interrupting automatically







The system interrupts the supporting steering movements automatically, for example in the following situations:

- ▶ At a speed above 130 mph/210 km/h.
- ▶ When the steering wheel is released.
- ▶ The driver applies the brakes.
- ▶ With strong steering intervention.
- ▶ When leaving own lane.
- ▶ When the turn signal is switched on.
- ▶ When the lane is too narrow.
- ▶ If a lane boundary is not detected for a certain period of time and no vehicle is driving ahead.
- ▶ The Active Cruise Control is interrupted.
- ▶ The seat belt on the driver's side is unfastened.

 Steering wheel icon lights up gray.  
The system is on standby and does not manipulate steering movements.

System activates automatically as soon as all function conditions are fulfilled.

## Displays in the instrument cluster

Icon	Description
	Gray steering wheel icon: The system is on standby.
	Green steering wheel icon: The system is activated. The system supports the driver in keeping the vehicle within the lane.
	Yellow flashing steering wheel icon: Lane boundary driven over. The steering wheel vibrates where applicable.
	Yellow steering wheel icon and a signal sounds, if applicable: System interruption is imminent.
	Depending on the equipment and national-market version: steering wheel icon flashes red or lights up red. A signal sounds: System is switching off.
	Yellow steering wheel icon: The hands are not grasping the steering wheel. The system is still active.
	Red steering wheel icon and a signal sounds: The hands are not grasping the steering wheel. System interruption is imminent. The system reduces the speed to a standstill if applicable. It is possible that the system will not execute any supporting steering movements.

Depending on the equipment and national-market version, information for the system is







displayed in the Assisted Driving View in the central display area of the instrument cluster.



Additional information:

Assisted Driving View, refer to page 155.

## Alternative displays

Depending on the equipment version, the displays in the instrument cluster may vary and are displayed as follows:

Icon	Description
	Gray steering wheel icon: The system is on standby.
	Green steering wheel icon: The system is activated.
	Depending on equipment, yellow flashing steering wheel icon: Lane boundary driven over. The steering wheel vibrates where applicable.
	Yellow steering wheel icon and a signal sounds, if applicable: System interruption is imminent.
	Depending on the equipment and national-market version: steering wheel icon flashes red or lights up red. A signal sounds: System is switching off.
	Green steering wheel icon and lane boundary icon: The system supports the driver in keeping the vehicle within the lane.

Icon	Description
	Yellow steering wheel icon: The hands are not grasping the steering wheel. The system is still active.
	Red steering wheel icon and a signal sounds: The hands are not grasping the steering wheel. System interruption is imminent. It is possible that the system will not execute any supporting steering movements. With Active Cruise Control, the system may reduce the speed.

## Displays on the steering wheel



The two LED lights above the buttons illuminate analogously to the displays in the instrument cluster:

- ▷ Yellow: system interruption is imminent.
- ▷ Red: system will be deactivated.

The steering wheel displays can be switched on/off if required.

1. "CAR"
2. "Settings"
3. "Driver Assistance"
4. "Steering Wheel Feedback"
5. "Light elements"



## Displays in the Head-up display

All system information can also be displayed in the Head-up display.

## System limits

### General information

The system cannot be activated or meaningfully used in certain situations.

### Safety information

#### **Warning**

Due to its limits, the system may not react, or it may react too late or in a manner that is not consistent with normal use. There may be a risk of accident or risk of damage to property. Actively intervene as warranted. Refer to the information in this Owner's Manual regarding the scope of the system's operation and limitations.

### System limits of the sensors

Additional information:

- ▶ Cameras, refer to page 35.
- ▶ Radar sensors, refer to page 36.

### Hands on the steering wheel

The sensors cannot detect hand-steering wheel contact in the following situations:

- ▶ Driving with gloves.
- ▶ Protective covers on the steering wheel.

### Narrow lanes

When driving within narrow lanes, the system cannot be activated or effectively used, for instance in the following situations:

- ▶ In construction areas.
- ▶ Depending on the equipment, with automatic formation of emergency lanes.
- ▶ Within city limits.

## Weather

The following restrictions can occur under unfavorable weather or light conditions:

- ▶ Poorer recognition of vehicles and lane boundaries.
- ▶ Short-term interruptions for vehicles that are already recognized.

Drive attentively, and react to the current surrounding traffic situation. If necessary, intervene actively, for instance by braking, steering or evading.

## Assisted Driving Plus

### Principle

Assisted Driving Plus supports the driver with vehicle control in traffic queues.

Supporting steering movements take place without the driver actively steering.

### General information

The system uses the sensors of the Steering Assistant.

### Safety information

#### **Warning**

The system cannot serve as a substitute for the driver's personal judgment in assessing the traffic situation. Based on the limits of the system, it cannot independently react to all traffic situations. There is a risk of accident. Adjust driving style to traffic conditions. Watch the surrounding traffic situation closely, be ready to take over steering and braking at any time, and actively intervene where appropriate.

Federal, state, or local laws may differ, and the use of this function may be prohibited or limited. Before use, check federal, state, and local laws.



Additionally, the notices for the Steering Assistant apply.

Additional information:

Steering Assistant, refer to page [236](#).

## Functional requirements

- ▶ The functional requirements of the Steering Assistant are fulfilled.

Functional requirements, refer to page [237](#).

- ▶ The Steering Assistant is active.
- ▶ The function is only available on certain street types, e.g. freeways.
- ▶ Driving on a road without pedestrians or cyclists.
- ▶ Sufficient lane width.
- ▶ Lane markings and a vehicle driving ahead are detected.
- ▶ Speed below approx. 40 mph/60 km/h.
- ▶ The Driver Attention Camera in the instrument cluster detects that the driver is paying attention to the surrounding traffic.
- ▶ The function must be available in the country in which the vehicle is driven.

## Turning on



As soon as all functional requirements are met, Assisted Driving Plus will be displayed as an additional icon in the toolbar. The toolbar is displayed at the bottom of the instrument cluster.



Select Assisted Driving Plus with the  button on the steering wheel.



The icon for Assisted Driving Plus is shown in green.

Two green LED lights are illuminated on the steering wheel.

The indicator light in the instrument cluster is shown in green.

The system begins to assist the driver with vehicle control.

## Displays in the instrument cluster

Icon	Description
	Indicator light green: system is active.
	Indicator light white: system is ready.
	Gray indicator light: the system has been interrupted.

## Alternative displays

Depending on the equipment version, the displays in the instrument cluster may vary and are displayed as follows:

Icon	Description
	Indicator light green: system is active.

## Displays on the steering wheel



The two LED lights above the buttons illuminate analogously to the displays in the instrument cluster:

- ▶ Green: the system is active.
- ▶ Yellow: system will be interrupted.
- ▶ Red: system will be deactivated.

## System limits

### General information

The limits of the Steering Assistant system apply.

Additional information:

Steering Assistant, refer to page [236](#).

### Driver Attention Camera

The limits of the Driver Attention Camera system apply.

Additional information:

Driver Attention Camera, refer to page [62](#).

## Automatic Lane Change Assistant

### Principle

The Automatic Lane Change Assistant also assists when changing lanes on multi-lane roads.

### General information

The system uses the sensors of the Steering Assistant.

### Safety information

#### **Warning**

The system cannot serve as a substitute for the driver's personal judgment in assessing the traffic situation. Based on the limits of the system, it cannot independently react to all traffic situations. There is a risk of accident. Adjust driving style to traffic conditions. Watch the surrounding traffic situation closely, be ready to take over steering and braking at any time, and actively intervene where appropriate.

Additionally, the notices for the Steering Assistant apply.

Additional information:

Steering Assistant, refer to page [236](#).

### Functional requirements

- ▶ The functional requirements of the Steering Assistant are fulfilled.  
Functional requirements, refer to page [237](#).
- ▶ Driving on a road without pedestrians or cyclists and with physical barriers to oncoming traffic, such as crash barriers.
- ▶ Lane boundaries have been detected.
- ▶ Maximum speed approx. 110 mph, 180 km/h.
- ▶ The minimum speed is country-specific.
- ▶ The function must be available in the country in which the vehicle is driven.

### Switch lane change assist on/off

1. "CAR"
2. "Settings"
3. "Driver Assistance"
4. If necessary, "Driving"
5. "Steering Assistance"
6. "Automatic Lane Change"

### Changing lanes

1. Ensure that the traffic situation permits changing lanes.
2. Press the turn signal lever in the required direction to the pressure point for signaling briefly.

A supporting steering movement in the required direction can be detected a short time later.

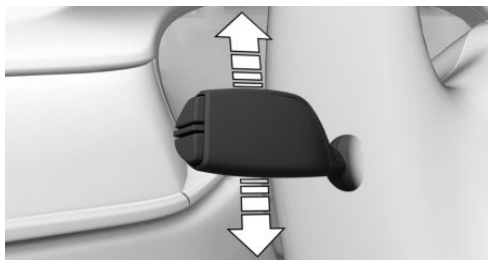







After the lane change, the system helps keep the vehicle in the new lane.

## Canceling a lane change

The lane change can be canceled by steering movement into the opposite direction.

## Displays in the instrument cluster

Icon	Description
	Green steering wheel icon.
	Green arrow icon for lane-changing.
	The system carries out a lane change.
	Green steering wheel icon.
	Gray line for lane marking on the appropriate side.
	The system detected the lane change request. Lane change not currently possible.
	Depending on the national-market version:
	Green steering wheel icon.
	Gray arrow icon for lane-changing.
	Lane change not possible; functional requirements not met.

Depending on the equipment and national-market version, information for the system is











displayed in the Assisted Driving View in the central display area of the instrument cluster.

Additional information:

Assisted Driving View, refer to page 155.

## Alternative displays

Depending on the equipment version, the displays in the instrument cluster may vary and are displayed as follows:

Icon	Description
	Green steering wheel icon.
	Gray line for lane marking on the appropriate side.
	Green arrow icon for lane-changing.
	The system carries out a lane change.
	Green steering wheel icon.
	Gray line for lane marking on the appropriate side.
	No arrow icon for lane-changing on the display.
	The system detected the lane change request. Lane change not currently possible.
	Depending on the national-market version:
	Green steering wheel icon.
	Gray line for lane marking on the appropriate side.
	Gray arrow icon for lane-changing.
	Lane change not possible; functional requirements not met.

## System limits

The limits of the Steering Assistant system apply.



Additional information:

Steering Assistant, refer to page [236](#).

## Parking assistance systems

### General information

The parking assistance systems include different individual systems. The individual systems provide support with assistance functions, sensors and different camera views when parking and maneuvering or driving in reverse.

Additional information:

- ▷ Park Distance Control, refer to page [244](#).
- ▷ Active Park Distance Control, refer to page [247](#).
- ▷ Side protection, refer to page [248](#).
- ▷ Rearview camera without Surround View, refer to page [249](#).
- ▷ Automatic Parking Assistant, refer to page [252](#).
- ▷ Automatic Parking Assistant, driving out of parking space, refer to page [257](#).
- ▷ Back-up Assistant, refer to page [258](#).
- ▷ Surround View with rearview camera, refer to page [260](#).
- ▷ Panorama View, refer to page [265](#).
- ▷ Cross traffic warning, refer to page [267](#).
- ▷ Remote 3D View, refer to page [269](#).

## Park Distance Control

### Principle

The Park Distance Control helps with parking. Acoustic and visual warnings signal obstacles in front of or behind the vehicle.

Depending on the equipment, obstacles that are detected by the side ultrasonic sensors may also be reported by the side protection.

### General information

The range of the system, depending on obstacles and environmental conditions, is approx. 6 ft/2 m.

An acoustic warning sounds in case of an impending collision at a distance to the object of approx. 27 in/70 cm.

For objects behind the vehicle, the acoustic warning is issued as early as a distance to the object of approx. 5 ft/1.50 m.

### Safety information

#### **Warning**

The system cannot serve as a substitute for the driver's personal judgment in assessing the traffic situation. Based on the limits of the system, it cannot independently react to all traffic situations. There is a risk of accident. Adjust driving style to traffic conditions. Check surrounding traffic and vehicle's surroundings closely and actively intervene where appropriate.

#### **Warning**

Due to high speeds when the Park Distance Control is activated, the warning can be delayed due to physical circumstances. There is a risk of injury or risk of damage to property. Avoid approaching an object too fast. Avoid driving off quickly while Park Distance Control is not yet active.

## Overview

### Button in the vehicle



 Park assistance button

### Sensors

The system is controlled by the following sensors:

- ▷ Ultrasonic sensors in the front/rear bumpers.
- ▷ Depending on the equipment: ultrasonic sensors on the side.

Additional information:

Sensors of the vehicle, refer to page 35.

### Turning on/off

#### Turning on automatically

The system switches on automatically in the following situations:

- ▷ When the engine is running, selector lever position R is engaged.
- ▷ Depending on the equipment version: while approaching detected obstacles at a speed lower than approx. 2.5 mph/4 km/h. The activation distance depends on the situation in question.

You may switch automatic activation when obstacles are detected on and off.

1. "CAR"
2. "Settings"

3. "Driver Assistance"
4. "Parking and Maneuvering"
5. If necessary, "Automatic PDC Activation"
6. "Automatic PDC Activation"

Depending on equipment, an additional camera view is also switched on.

### Automatic deactivation during forward travel

The system switches off when a certain distance travelled or speed is exceeded.

Switch the system back on, if needed.

### Switching on/off manually

 Press the park assistance button.

- ▷ On: the LED lights up.
- ▷ Off: the LED goes out.

The rearview camera image is displayed if the reverse gear is engaged when pressing the park assistance button.

Depending on the equipment version, the system cannot be switched off manually if the reverse gear is engaged.

### Warning

#### Signal tones

##### General information

An intermittent tone indicates when the vehicle is approaching an object. If, for example, an object is detected at the front left of the vehicle, a signal tone sounds from the front left speaker.

The shorter the distance to the object, the shorter the intervals.

When the distance to a detected object is less than approx. 8 in/20 cm, a continuous tone is sounded.

When there are objects in front of and behind the vehicle at the same time, with a distance

smaller than approx. 8 in/20 cm, an alternating continuous tone will sound.

Steptronic transmission: the intermittent tone and continuous tone are switched off if the selector lever position P is engaged.

Depending on design version, the intermittent tone is switched off after a short time when the vehicle is stationary.

If an object approaches when the vehicle is stationary, the acoustic signal is reactivated.

### Volume

The volume of the Park Distance Control acoustic signals can be adjusted.

1. "CAR"
2. "Settings"
3. "Driver Assistance"
4. "Parking and Maneuvering"
5. "Volume PDC signal"
6. Set the desired value.

### Visual warning

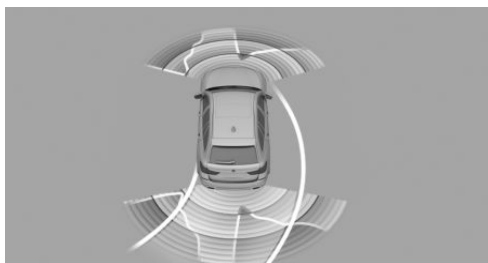

The approach of the vehicle to an object is shown on the Control Display. Objects that are farther away are already displayed on the Control Display before a signal sounds.

The display appears as soon as the Park Distance Control is activated.

The detection range of the sensors is represented in the colors green, yellow and red when obstacles are detected.

Pathway lines are faded in for better estimation of the space required.

When the image of the rearview camera is displayed, you can switch to the Park Distance Control or to a different view with obstacle markings if necessary:

1. Press the Controller to the left, if needed.
2. For instance "Park. sensors only"

Cross traffic warning: depending on the equipment, you will be warned in the Park Distance Control display against vehicles approaching in the front or rear from the side.

Additional information:

Cross traffic warning, refer to page 267.

## System limits

### Safety information

#### Warning

Due to its limits, the system may not react, or it may react too late or in a manner that is not consistent with normal use. There may be a risk of accident or risk of damage to property. Actively intervene as warranted. Refer to the information in this Owner's Manual regarding the scope of the system's operation and limitations.

### Trailer towing

The rear functions of Park Distance Control are switched off with a trailer attached or when the trailer socket is occupied.

Depending on vehicle equipment and national-market version, the rear functions of Park Distance Control remain switched on when trailer towing is enabled.



White icon is displayed.

Depending on the vehicle equipment, the detection range of the sensors is

shown as a shaded area on the Control Display.

Additional information:

Activating trailer towing, refer to page 317.

### System limits of the sensors

Additional information:

▶ Ultrasonic sensors, refer to page 37.

### Limits of ultrasonic measurement

The detection of objects with ultrasonic measurements can run into physical limits, e.g., in the following situations:

- ▶ With obstacles and persons at the edge of the lane.
- ▶ Low objects already displayed, for instance curbs, can move into the blind area of the sensors before or after a continuous tone sounds.

### Unwarranted warnings

Reaching the system limits can cause unwarranted warnings.

To prevent unwarranted warnings, for instance in car washes, turn off automatic Park Distance Control activation on obstacle detection.

### Malfunction



White icon is displayed, and the detection range of the sensors is dimmed on the Control Display.

A Check Control message is displayed.

Park Distance Control malfunction. Have the system checked by an authorized service center or another qualified service center or repair shop.

## Active Park Distance Control

### Principle

The Park Distance Control brake function initiates emergency braking if there is an acute risk of collision.

### General information

Due to system limits, a collision cannot be prevented under all circumstances.

The function is available below walking speed when driving in reverse or rolling backward.

A press of the accelerator pedal interrupts the brake intervention.

After emergency braking to a stop, further creeping toward an obstacle is possible. Proceed with caution. To move forward, lightly press the accelerator pedal and release as needed.

If the accelerator pedal is depressed longer, the vehicle drives off. Manual braking is possible at any time.

The system uses the ultrasonic sensors of Park Distance Control and the Automatic Parking Assistant.

### Safety information

#### **Warning**

The system cannot serve as a substitute for the driver's personal judgment in assessing the traffic situation. Based on the limits of the system, it cannot independently react to all traffic situations. There is a risk of accident. Adjust driving style to traffic conditions. Check surrounding traffic and vehicle's surroundings closely and actively intervene where appropriate.

In addition, the safety information for the Park Distance Control and the Automatic Parking Assistant apply.



Additional information:

- ▷ Park Distance Control, refer to page [244](#).
- ▷ Automatic Parking Assistant, refer to page [252](#).

## Temporary switching off

The Park Distance Control brake function can be temporarily switched off:

Confirm the message on the Control Display. During continued driving in this surrounding situation, no further emergency braking will occur.

## Settings

It is possible to set which areas on the vehicle will be protected by the system.

1. "CAR"
2. "Settings"
3. "Driver Assistance"
4. "Parking and Maneuvering"
5. "Active PDC with braking interv."
6. Select the desired setting.

## System limits

The limits of the systems of the Park Distance Control and the Automatic Parking Assistant apply.

The system cannot be used in the following situations, for example:

- ▷ Active Park Distance Control is deactivated when Hill Descent Control is active.  
Hill Descent Control, refer to page [216](#).
- ▷ When driving with a trailer.

If required, deactivate the system via iDrive where applicable.

## Side protection

### Principle

The side protection warns of obstacles on the side of the vehicle.

### General information

The system uses the ultrasonic sensors of Park Distance Control and the Automatic Parking Assistant.

### Safety information

#### **Warning**

The system cannot serve as a substitute for the driver's personal judgment in assessing the traffic situation. Based on the limits of the system, it cannot independently react to all traffic situations. There is a risk of accident. Adjust driving style to traffic conditions. Check surrounding traffic and vehicle's surroundings closely and actively intervene where appropriate.

In addition, the safety information for the Park Distance Control and the Automatic Parking Assistant apply.

Additional information:

- ▷ Park Distance Control, refer to page [244](#).
- ▷ Automatic Parking Assistant, refer to page [252](#).



## Display

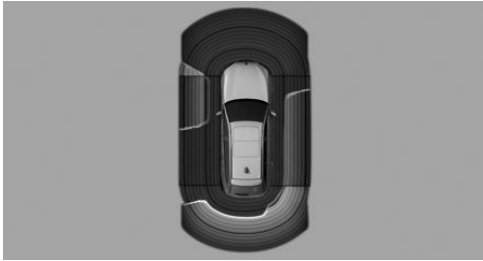

To protect the sides of the vehicle, obstacle markings are displayed on the sides of the vehicle.

- ▶ Color marks: warning against detected obstacles.
- ▶ Gray marks, hatched area: no obstacles were detected.
- ▶ No marks, black area: the area next to the vehicle was not yet captured.

## Limits of the side protection

The system only displays stationary obstacles that were previously detected by sensors while passing them.

The system does not detect whether an obstacle moves later on. If the vehicle is stationary, the marks are shown in black after a certain time. The area next to the vehicle must be newly captured.

The side protection is not available when the trailer socket is occupied or trailer towing is activated.

In addition, the limits of the systems of the Park Distance Control and the Automatic Parking Assistant apply.

## Without Surround View: rearview camera

### Principle

The rearview camera helps when reverse parking and maneuvering. The area behind the vehicle is shown on the Control Display.

Additionally, assistance functions can be shown in the display, e.g., help lines.

### Safety information

#### **Warning**

The system cannot serve as a substitute for the driver's personal judgment in assessing the traffic situation. Based on the limits of the system, it cannot independently react to all traffic situations. There is a risk of accident. Adjust driving style to traffic conditions. Check surrounding traffic and vehicle's surroundings closely and actively intervene where appropriate.

### Overview

#### Depending on the vehicle equipment: button in the vehicle



Park assistance button



## Sensors

The system is controlled by the following sensors:

- ▷ Rearview camera.

Additional information:

Sensors of the vehicle, refer to page 35.

## Turning on/off

### Turning on automatically

The system is switched on automatically if selector lever position R is engaged when the engine is running.

### Automatic deactivation during forward travel

The system switches off when a certain distance travelled or speed is exceeded.

Switch the system back on, if needed.

### Depending on the vehicle equipment: switching on/off manually



Press the park assistance button.

- ▷ On: the LED lights up.
- ▷ Off: the LED goes out.

The parking assistance functions are shown on the Control Display.

### Switching the view via iDrive

If the rearview camera view is not displayed, change the view via iDrive:

1. If necessary, tilt the Controller to the side.
2. "Rear view camera"

The rearview camera image is displayed.

## Functional requirements

- ▷ The tailgate is fully closed.
- ▷ Keep the detection range of the camera open. Protruding cargo, a rear-mounted

luggage rack or trailer can limit the detection range of the camera.

## Display on the control display

### Toolbars

The assistance functions can be activated manually via the toolbars on the sides of the Control Display.

1. Move the Controller to the right, if needed.
2. With corresponding equipment:
  - "Camera image"
3. ▷ "Parking aid lines".
  - Pathway lines and turning circle lines are displayed.
  - ▷ "Obstacle mark.".
    - Depending on the equipment, the obstacles detected by the Park Distance Control are displayed by marks.

Zoom on trailer hitch:

1. Tilt the Controller to the left, if needed.
2. "Trailer hitch".
  - A zoomed image of the trailer hitch is shown.

More than one assistance function can be active at the same time.

## Parking aid lines

### General information

Additional assistance functions can be shown in the camera image on the control display.

More than one assistance function can be active at the same time.

### Pathway lines

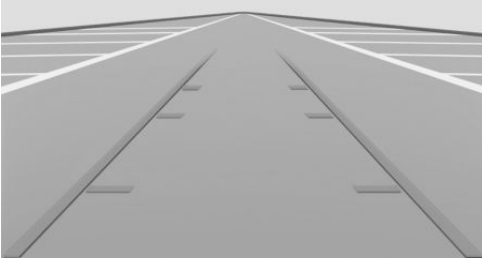

Pathway lines help you to estimate the space required when parking and maneuvering on level roads.

The pathway lines are continuously adjusted to the steering wheel movements depending on the steering-wheel angle.

### Turning circle lines

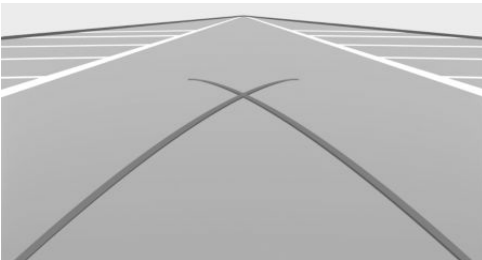

Turning circle lines can only be superimposed on the camera image together with pathway lines.

Turning circle lines show the course of the smallest possible turning radius on a level road.

Only one turning circle line is displayed after the steering wheel is turned past a certain angle.

### Parking using lanes and turning circle lines

1. Position the vehicle so that the red turning circle line leads to within the limits of the parking space.
2. Turn the steering wheel to the point where the green pathway line covers the corresponding turning circle line.

### Obstacle marking

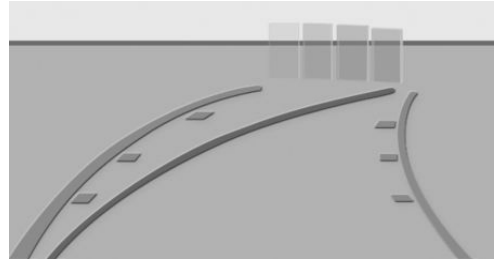

Depending on the equipment, obstacles behind the vehicle are detected by the Park Distance Control sensors.

Obstacle markings can be faded into the image of the rearview camera.

The colored steps of the obstacle markings match the marks of the Park Distance Control.

### Zoom on trailer hitch

To make it easier to attach a trailer, you can zoom in on the view of the trailer hitch.

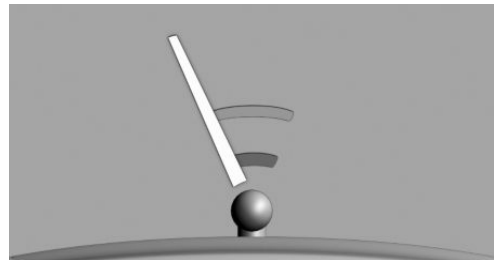

Two static circle segments show the distance between the trailer and the trailer hitch.

A docking line dependent on the steering-wheel angle helps with aiming for the trailer with the trailer hitch.

When zooming in, remember that the view may no longer show certain obstacles.

## Setting brightness and contrast

With the rearview camera switched on:

1. Move the Controller to the right, if needed.
2.  "Camera image"
3. Select the desired setting.

## System limits

### System limits of the sensors

Additional information:

- ▶ Cameras, refer to page 35.

### Deactivated camera

When the camera is deactivated, for instance when the tailgate is open, the camera image is displayed hatched in gray.

### Detection of objects

Very low obstacles as well as high, protruding objects such as ledges may not be detected by the system.

Depending on the equipment, some assistance functions also take into account data from the Park Distance Control.

Follow the notes in the Park Distance Control chapter.

The objects displayed on the Control Display may be closer than they appear. Do not estimate the distance from the objects on the display.

## Automatic Parking Assistant

### Principle

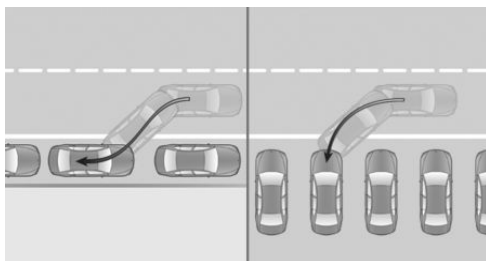

The Automatic Parking Assistant supports the driver in the following situations:

- ▶ When parking parallel to the road, parallel parking.
- ▶ When reverse parking perpendicular to the road, perpendicular parking. The system orients itself with the middle of the parking space.
- ▶ Depending on the equipment version: when driving out of parallel parking spaces.

### General information

#### Handling

Automatic Parking Assistant handling is divided into three steps:

- ▶ Turn on and activate.
- ▶ Parking space search.
- ▶ Parking.

System status and instructions on required actions are displayed on the Control Display.

Ultrasonic sensors measure parking spaces on both sides of the vehicle.

#### Steptronic transmission

The Automatic Parking Assistant calculates the best possible parking line and takes control of the following functions during the parking operation:

- ▷ Steering.
- ▷ Acceleration and braking.
- ▷ Changing gears.

The parking operation is automatic.

## Safety information

### **Warning**

The system cannot serve as a substitute for the driver's personal judgment in assessing the traffic situation. Based on the limits of the system, it cannot independently react to all traffic situations. There is a risk of accident. Adjust driving style to traffic conditions. Check surrounding traffic and vehicle's surroundings closely and actively intervene where appropriate.

### **Warning**

When using the trailer hitch, the assistance system cannot react correctly because the sensors are concealed. There may be a risk of accident or risk of damage to property. The driver assistance system should not be used during trailer towing or if the trailer hitch is used, for instance bicycle rack.

### **NOTICE**

The system can steer the vehicle over or onto curbs. There is a risk of damage to property, among other potential damage. Watch surrounding traffic closely and actively intervene where appropriate.

In addition, the safety information for the Park Distance Control and for opening the tailgate apply.

Additional information:

- ▷ Park Distance Control, refer to page [244](#).
- ▷ Tailgate, refer to page [102](#).

## Overview

### Button in the vehicle



 Park assistance button

### Sensors

The system is controlled by the following sensors:

- ▷ Ultrasonic sensors in the front/rear bumpers.
- ▷ Ultrasonic sensors, side.

Additional information:

Sensors of the vehicle, refer to page [35](#).

## Functional requirements

### For the measurement of parking spaces

- ▷ Maximum speed while driving forward approx. 22 mph/35 km/h.
- ▷ Maximum distance to row of parked vehicles: 5 ft/1.5 m.

### Suitable parking space

General information:

- ▷ Gap behind an object that has a min. length of 1.7 ft/0.5 m.
- ▷ Gap between two objects, each with a minimum length of approx. 1.7 ft/0.5 m.

Parallel parking to the road:

- ▶ Minimum length of gap between two objects: own vehicle length plus approx. 2.6 ft/0.8 m.

- ▶ Minimum depth: approx. 5 ft/1.5 m.

Perpendicular parking:

- ▶ Minimum width of the gap: own vehicle width plus approx. 2.3 ft/0.7 m.

- ▶ Minimum depth: own vehicle length.

The depth of diagonal parking spaces must be estimated by the driver. Due to technical limitations, the system is only able to approximate the depth of perpendicular parking spaces.

### For the parking operation

- ▶ Doors and tailgate are closed.

Steptronic transmission:

- ▶ Driver's seat belt is fastened.

### Switching on with the button

- ▶  Press the park assistance button. The LED lights up.

The current status of the parking space search is indicated on the Control Display.

- ▶  Automatic Parking Assistant is activated automatically.

### Switching on with reverse gear

1. Shift into reverse.

The current status of the parking space search is indicated on the Control Display.

2. If necessary, activate:  "Autom. Parking"





### Switching on via iDrive

The display of the rearview camera or the view of the Park Distance Control must be active.

1. Move the Controller to the right.
2. Activate the Automatic Parking Assistant on the Control Display:  "Autom. Parking"

## Display on the control display

### System activated/deactivated

Icon	Meaning
	Gray: the system is not available. White: the system is available but not activated.
	System is activated.
	Parking space search is active.
	The parking operation is active. The system takes over the steering.

### Parking space search and system status

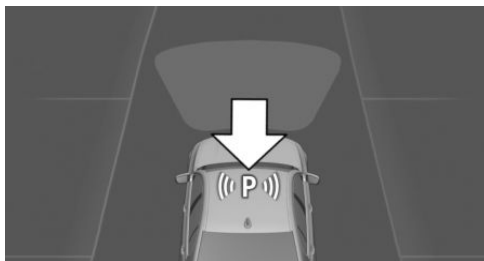

- ▶  Automatic Parking Assistant is activated and parking space search is active.
- ▶ Control Display shows suitable parking spaces at the edge of the road next to the vehicle icon. When Automatic Parking Assistant is active, suitable parking spaces are highlighted and an acoustic signal sounds.
- ▶ If a diagonal or parallel parking space is clearly detected, the system automatically adjusts the suitable parking method. In the case of parking spaces suitable for parallel and diagonal parking, a selection menu is displayed. In this case, the desired parking method must be selected manually.

- ▶  The parking operation is active. The system takes over the steering.
- ▶ Parking space search is always active whenever the vehicle is moving forward slow and straight, even if the system is deactivated. When the system is deactivated, the displays on the Control Display are shown in gray.

## Switching signal tone for suitable parking spaces on/off

1. "CAR"
2. "Settings"
3. "Driver Assistance"
4. "Parking and Maneuvering"
5. "Automatic Parking"
6. "Alert if parking space detected"

## Acoustic signals of the Park Distance Control

Depending on national-market version, an intermittent tone for Park Distance Control sounds during an automatic parking operation. A continuous tone sounds when the distance to a detected object is less than approx. 8 inches/20 cm.

## Parking using the Automatic Parking Assistant

### Parking

1. Switching on and activating the Automatic Parking Assistant.

For this, engage the reverse gear or press the parking assist button and activate the system on the Control Display, if needed.

 Automatic Parking Assistant is activated.



2. Pass the row of parked vehicles forward at a speed of up to approx. 22 mph/35 km/h and at a distance of maximum 5 ft/1.5 m.

The status of the parking space search and possible parking spaces are displayed on the Control Display.

3. Confirm the suggested parking space for the parking operation: select the parking space on the Control Display.  
The system takes over the steering.
4. Follow the instructions on the Control Display.  
Steptronic transmission:  
At the end of the parking operation, selector lever position P is set.  
The end of the parking operation is indicated on the Control Display.
5. Adjust the parking position yourself, if needed.

### Canceling manually

The Automatic Parking Assistant can be interrupted at any time:

- ▶  Press the park assistance button.
- ▶  "Autom. Parking": select the icon on the Control Display.

### Canceling automatically

The system is interrupted automatically in the following situations:

- ▶ When the driver grasps the steering wheel or takes over steering.
- ▶ Possibly on snow-covered or slippery road.
- ▶ When there are obstacles that are hard to overcome, such as curbs.
- ▶ When there are obstacles that suddenly appear.
- ▶ The Park Distance Control indicates distances that are too small.
- ▶ When a maximum number of parking attempts or the time taken for parking is exceeded.

- ▷ When changing over to another function on the Control Display.
- ▷ The turn signal opposite to the desired parking side is switched on.

Steptronic transmission:

- ▷ If the tailgate is open.
- ▷ If doors are open.
- ▷ When setting the parking brake.
- ▷ During acceleration.
- ▷ The brake pedal remains depressed for longer while the vehicle is at a standstill.
- ▷ When unfastening the driver's seat belt.

A Check Control message is displayed.

## Resuming

An interrupted parking operation can be continued, if needed.

Reactivate the Automatic Parking Assistant and follow the instructions on the Control Display.

## Turning off

The system can be switched off manually:



Press the park assistance button.

## System limits

### Safety information

#### **Warning**

Due to its limits, the system may not react, or it may react too late or in a manner that is not consistent with normal use. There may be a risk of accident or risk of damage to property. Actively intervene as warranted. Refer to the information in this Owner's Manual regarding the scope of the system's operation and limitations.

## No parking assistance

The Automatic Parking Assistant does not offer assistance in the following situations:

- ▷ In tight curves.
- ▷ When towing a trailer.
- ▷ For parking spaces that are only marked with lines on the ground. The system orients itself according to objects.
- ▷ For diagonal parking spaces.

## System limits of the sensors

Additional information:

- ▷ Ultrasonic sensors, refer to page [37](#).

## Functional limitations

The system may be limited in the following situations:

- ▷ On bumpy road surfaces such as gravel roads.
- ▷ On slippery ground.
- ▷ On steep uphill or downhill grades.
- ▷ With accumulations of leaves/snow in the parking space.
- ▷ With a mounted emergency wheel.
- ▷ In case of changes to an already-measured parking space.
- ▷ With ditches or edges, for instance an edge of a port.
- ▷ Parking spaces that are not suitable may be detected or suitable parking spaces may not be detected at all.

## Malfunction

A Check Control message is displayed.

The Automatic Parking Assistant has malfunctioned. Have the system checked by an authorized service center or another qualified service center or repair shop.



# Driving out of a parking space using the Automatic Parking Assistant

## Principle

The system makes driving out of parallel parking spaces easier.

## General information

### Steptronic transmission

The Automatic Parking Assistant calculates an optimal line for pulling out of a parking space and takes control of the following functions during the maneuver:

- ▷ Steering.
- ▷ Accelerating and braking.
- ▷ Changing gears.

The vehicle maneuvers automatically until the vehicle reaches a position in which the driver can drive out of the parking space without further steering movements.

## Safety information

### Warning

The system cannot serve as a substitute for the driver's personal judgment in assessing the traffic situation. Based on the limits of the system, it cannot independently react to all traffic situations. There is a risk of accident. Adjust driving style to traffic conditions. Check surrounding traffic and vehicle's surroundings closely and actively intervene where appropriate.

### Warning

When using the trailer hitch, the assistance system cannot react correctly because the sensors are concealed. There may be a risk of accident or risk of damage to property. The driver assistance system should not be used during trailer towing or if the trailer hitch is used, for instance bicycle rack.

In addition, the safety instructions for the Park Distance Control, the Automatic Parking Assistant and for opening the tailgate apply.

Additional information:

- ▷ Park Distance Control, refer to page [244](#).
- ▷ Automatic Parking Assistant, refer to page [252](#).
- ▷ Tailgate, refer to page [102](#).

## Functional requirements

- ▷ The vehicle was parked manually and objects in front of and behind the car are detected. The distance to a detected curb is at least 6 inches/15 cm.
- ▷ The vehicle was parked using the Automatic Parking Assistant and an object is detected in front of the vehicle.
- ▷ The parking space is at least 2.6 ft/0.8 m longer than your vehicle.
- ▷ The vehicle has been parked in reverse.

## Driving out of parking spaces

1. Turn on drive-ready state.
2. Steptronic transmission:
 

Press the park assistance button or shift into reverse gear when the vehicle is stationary to switch on the Automatic Parking Assistant.
3. Tilt the Controller to the right and activate the Automatic Parking Assistant on the Control Display:  "Autom. Parking"

4. On the Control Display, confirm the required direction for driving out of the parking space if necessary.
5. Follow the instructions on the Control Display.

Steptronic transmission:

The system takes control of the maneuver. A message will be displayed at the end of the maneuver.

6. Make sure that the traffic situation permits driving out of parking space and driving off as usual.

The Automatic Parking Assistant is switched off automatically.

## System limits

The driving out of a parking space function may not be offered temporarily under certain environmental conditions. The system limits of the Park Distance Control and the Automatic Parking Assistant continue to apply.

## Back-up assistant

### Principle

The Back-up Assistant supports the driver when driving in reverse, for instance when driving out of tight or confusing parking or street situations.

The vehicle stores the driving movements of the last distance covered. This stored distance covered can be driven back with automated steering.

### General information

The system takes control of the steering when driving in reverse along the stored route.

The driver controls driving the vehicle via accelerator pedal and brake.

The Back-up Assistant uses the operating elements and sensors of the Park Distance Control and the Automatic Parking Assistant.

Additional information:

- ▷ Park Distance Control, refer to page [244](#).
- ▷ Automatic Parking Assistant, refer to page [252](#).

## Safety information

### Warning

The system cannot serve as a substitute for the driver's personal judgment in assessing the traffic situation. Based on the limits of the system, it cannot independently react to all traffic situations. There is a risk of accident. Adjust driving style to traffic conditions. Check surrounding traffic and vehicle's surroundings closely and actively intervene where appropriate.

### Warning

When using the trailer hitch, the assistance system cannot react correctly because the sensors are concealed. There may be a risk of accident or risk of damage to property. The driver assistance system should not be used during trailer towing or if the trailer hitch is used, for instance bicycle rack.

In addition, the safety instructions for the Park Distance Control, the Automatic Parking Assistant and for opening the tailgate apply.

Additional information:

- ▷ Park Distance Control, refer to page [244](#).
- ▷ Automatic Parking Assistant, refer to page [252](#).
- ▷ Tailgate, refer to page [102](#).

## Functional requirements

- ▷ Drive forward without interruption to store the distance covered.
- ▷ A maximum of 165 ft/50 meters are stored.

- ▷ To store the distance covered, do not drive faster than 22 mph/36 km/h.
- ▷ Dynamic Stability Control is activated.

## Driving in reverse with automated steering

1. Press the park assistance button or shift into reverse gear when the vehicle is stationary and the drive-ready state is switched on.
2. Move the Controller to the right.
3. "Back-up Assistant"  
The system takes over the steering.
4. Follow the instructions on the Control Display where required.
5. Take your hands off the steering wheel and carefully drive off using the accelerator pedal and the brake.

When driving in reverse, pay attention to the vehicle's surroundings, and if you encounter an obstacle, stop immediately and take over control of the vehicle. Follow the instructions for Park Distance Control.

6. Stop no later than when normal road traffic is reached and take control of the vehicle, such as by shifting to a forward gear.  
At the end of the stored distance travelled, a signal will sound and a request will be displayed, also with the instruction to take control of the vehicle.

## Canceling the Back-up Assistant manually

The assisted reversing by the Back-up Assistant can be canceled manually:

- ▷ Via touchscreen:  "Back-up Assistant"
- ▷  Press the button.

## Canceling the Back-up Assistant automatically

The system automatically cancels in situations such as the following:

- ▷ When the driver grasps the steering wheel or takes over steering.
- ▷ When engaging a forward gear.
- ▷ During activation or intervention by driving control systems or assist systems.
- ▷ After a few minutes when the vehicle is stationary.
- ▷ The vehicle leaves the stored lane when reversing, for instance at maximum steering angle.
- ▷ The view on the control display is overlaid with messages such as incoming calls.

## System limits

- ▷ When you reach normal road traffic or if you encounter an obstacle, stop immediately and take over control of the vehicle.
- ▷ The maximum speed when driving in reverse is limited to approx. 6 mph/9 km/h. If the maximum speed is exceeded, a warning is issued and the function may be canceled.
- ▷ After driving a stored distance covered with major steering-wheel angles, the function of the system will be limited for the return trip.
- ▷ In addition, the limits of the systems of the Park Distance Control and the Automatic Parking Assistant apply.

Different influences can lead to side deviations when driving the stored distance covered in reverse. For example, this includes the following factors:

- ▶ Steering movements when the vehicle is stationary while storing the distance covered.
- ▶ The speed is not adapted to the distance covered.
- ▶ Road characteristics, such as gradients or inclines.

## Surround View

### Principle

The Surround View uses various vehicle cameras, for instance, a rearview camera and front camera to assist with parking and maneuvering. Depending on the view, the vehicle's surroundings or a part of it is depicted on the control display.

### General information

Several cameras capture the area from different selectable perspectives.

The following camera perspectives can be displayed:

- ▶ The automatic camera perspective automatically shows the appropriate perspective according to the respective driving situation.
- ▶ The rearview camera shows the areas behind the vehicle.
- ▶ The flank view on the right and left shows the areas on the sides of the vehicle.
- ▶ The free camera perspective, which can be moved via iDrive, shows defined perspectives on a circular path.
- ▶ The Panorama View shows crossing traffic, depending on the gear currently engaged.

## Safety information

### Warning

The system cannot serve as a substitute for the driver's personal judgment in assessing the traffic situation. Based on the limits of the system, it cannot independently react to all traffic situations. There is a risk of accident. Adjust driving style to traffic conditions. Check surrounding traffic and vehicle's surroundings closely and actively intervene where appropriate.

### Overview

#### Buttons in the vehicle



 Park assistance button

 Panorama View

### Sensors

The system is controlled by the following sensors:

- ▶ Front camera.
- ▶ Top view cameras.
- ▶ Rearview camera.

Additional information:

Sensors of the vehicle, refer to page [35](#).

## Turning on/off

### Turning on automatically

The system is switched on automatically if selector lever position R is engaged when the engine is running.

The camera perspective suitable for the respective driving situation is displayed.

Additional information:

Park Distance Control, turn on/off, refer to page 245.

### Switching on/off manually



Press the park assistance button.

- ▷ On: the LED lights up.
- ▷ Off: the LED goes out.

Depending on the equipment version, the rearview camera cannot be switched off when the reverse gear is engaged.

### Automatic deactivation during forward travel

The system switches off when a certain distance travelled or speed is exceeded.

Switch the system back on, if needed.

## Display on the control display

### Overview

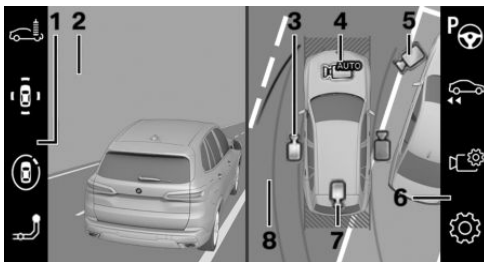





- 1 Toolbar, left
- 2 Camera image

- 3 Side view
- 4 Automatic camera perspective
- 5 Movable unobstructed camera perspective
- 6 Toolbar, right
- 7 Rearview camera
- 8 Selection window

### Toolbar on the left

The left toolbar can be used for the direct selection of various views via iDrive. Move the Controller to the left, if needed.

- ▷  "Parking": around the vehicle.
- ▷  "3D view": available camera.
- ▷  "Trailer hitch".
- ▷  "Car wash".

### Side view

The side view can be selected for the right or left vehicle side.

This view helps when positioning the vehicle at the curb or with other obstacles on the side by displaying the side surroundings.

The side view looks from rear to front and, in case of danger, focuses automatically on possible obstacles.

### Automatic camera perspective

The automatic camera perspective shows a steering-dependent view in the respective driving direction.

This perspective adapts to the respective driving situation.

As soon as obstacles are detected, the view changes to a fixed display of the area in front or at the rear behind the bumper or, if necessary, changes to a side view.

When reverse gear is engaged, the automatic camera perspective is, if necessary, exited and the system uses a fixed perspective of the rearview camera. If necessary, manually select the automatic camera perspective when

reverse gear is engaged. The automatic camera perspective will be retained for the current parking operation.

### Movable unobstructed camera perspective

With selection of the movable camera perspective, a circle appears on the Control Display.









By turning the Controller or via touch function, specified perspectives on the circle can be selected.

The current perspective is marked with a camera icon.

To leave the function, move the Controller sideways and select another camera function.

### Toolbar on the right

Assistance functions can be activated and settings can be entered via the right toolbar via iDrive. Move the Controller to the right, if needed.

- ▷  "Autom. Parking".
- ▷  "Back-up Assistant".
- ▷  "Camera image":
  - ▷  "Brightness".
  - ▷  "Contrast".
  - ▷  "Parking aid lines".
  - ▷  "Obstacle mark".
- ▷  "Settings": apply settings, for instance to use the activation points for Panorama View.

### Rearview camera

The rearview camera helps when reverse parking and maneuvering. The area behind the vehicle is shown on the Control Display.

### Selection window

The individual camera perspectives can be selected in the selection window via iDrive.

### Parking aid lines

#### General information

Additional assistance functions can be shown in the camera image on the control display.

More than one assistance function can be active at the same time.

#### Pathway lines

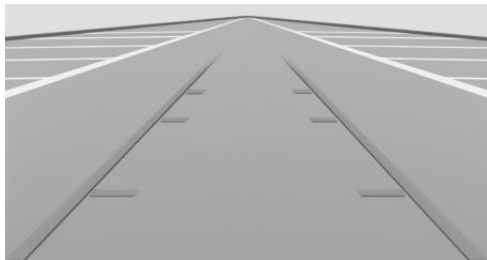

Pathway lines help you to estimate the space required when parking and maneuvering on level roads.

The pathway lines are continuously adjusted to the steering wheel movements depending on the steering-wheel angle.

#### Turning circle lines

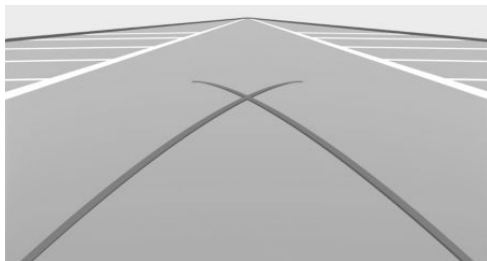

Turning circle lines can only be superimposed on the camera image together with pathway lines.

Turning circle lines show the course of the smallest possible turning radius on a level road.

Only one turning circle line is displayed after the steering wheel is turned past a certain angle.

### Parking using lanes and turning circle lines

1. Position the vehicle so that the red turning circle line leads to within the limits of the parking space.
2. Turn the steering wheel to the point where the green pathway line covers the corresponding turning circle line.

### Obstacle marking

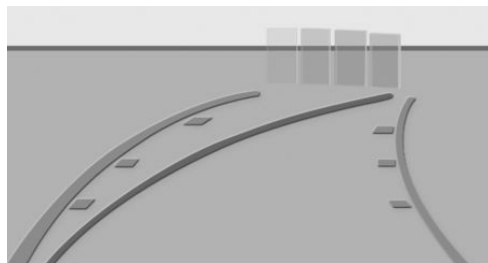

Obstacles behind the vehicle are detected by the Park Distance Control sensors.

Obstacle markings can be shown in the camera image.

The colored steps of the obstacle markings match the marks of the Park Distance Control.

### Car wash view

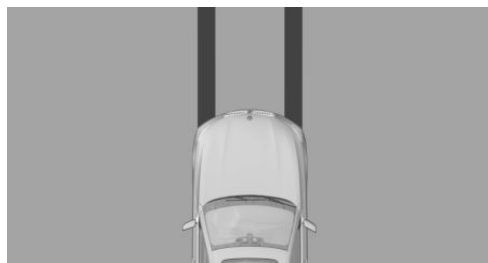

The car wash view assists when entering a car wash by displaying the floor and the vehicle's own track.

### Zoom on trailer hitch

To make it easier to attach a trailer, you can zoom in on the view of the trailer hitch.

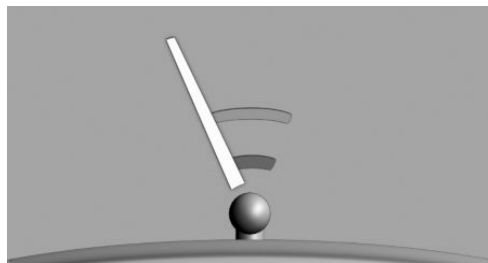

Two static circle segments show the distance between the trailer and the trailer hitch.

A docking line dependent on the steering-wheel angle helps with aiming for the trailer with the trailer hitch.

When zooming in, remember that the view may no longer show certain obstacles.

### Side protection

#### Principle

The side Park Distance Control is automatically displayed when the automatic camera perspective is turned on. The function shows obstacles located next to the vehicle.

#### Display



To protect the sides of the vehicle, obstacle markings are displayed on the sides of the vehicle.

- ▷ No marks: no obstacles were detected.
- ▷ Color marks: warning against detected obstacles.

**Limits of the side protection**

The system only displays stationary obstacles that were previously detected by sensors while passing them.

The system does not detect whether an obstacle moves later on. For this reason, at standstill, the marks are not shown anymore in the display after a certain time. The area next to the vehicle must be newly captured.

**Door opening angle**

**Principle**

If obstacle marking is activated, the Surround View indicates fixed obstacles that obstruct the opening angles of the doors.

The system does not provide a warning of approaching road users.

**Display**



Steptronic transmission: the maximum opening angles of the doors are displayed in selector lever position P. As soon as the vehicle begins moving, the opening angles are replaced by parking aid lines.

**Limits of the display**

The vehicle's surroundings are distorted in the display for technical reasons.

Even if the icons for the door opening angles do not cross other objects on the Control Display, the following needs to be noted when parking next to other objects:

Because of the perspective, higher, protruding objects may be closer than they appear on the Control Display.

**Setting brightness and contrast**

Brightness and contrast can be adjusted with Surround View or Panorama View switched on.

1. Move the Controller to the right, if needed.
2.  "Camera image"
3. Select the desired setting.

**Functional limitations**

The system can be used only to a limited extent in the following situations:

- ▷ In poor light.
- ▷ In case of soiled cameras.
- ▷ With a door open.
- ▷ With the tailgate open.
- ▷ With exterior mirrors folded in.

Areas with gray hatching with an icon in the camera image identify areas that are currently not shown, such as an open door.

**System limits**

**System limits of the sensors**

Additional information:

- ▷ Cameras, refer to page 35.

**Non-visible areas**

Because of the camera angle, the areas under the vehicle cannot be viewed by the cameras.

**Detection of objects**

Very low obstacles as well as high, protruding objects such as ledges may not be detected by the system.



Some assistance functions also take into consideration data from the Park Distance Control. Follow the notes in the Park Distance Control chapter.

The objects displayed on the Control Display may be closer than they appear. Do not estimate the distance from the objects on the display.

Additional information:

Park Distance Control, refer to page [244](#).

## Malfunction

A camera failure is displayed on the Control Display.



A yellow icon is displayed and the detection range of the malfunctioning camera is displayed in black on the Control Display.

## Panorama View

### Principle

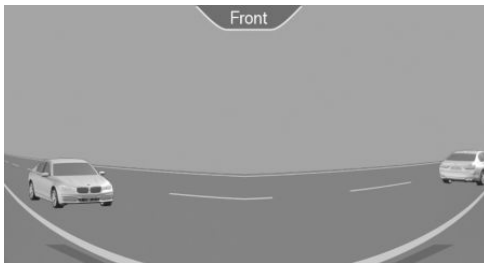

Panorama View gives you an earlier view of crossing traffic at blind driveway exits and intersections.

### General information

Road users concealed by obstacles to the left and right of the vehicle can only be detected relatively late from the driver's seat. The cameras in the front and rear capture the side areas around the vehicle to improve the view.

Yellow lines in the screen display mark the front and rear end of the vehicle.

The camera image shows different levels of distortion in some areas and is thus not suitable for distance estimations.

Depending on the equipment version, the function can only be used when driving forward.

Additional information:

Surround View, refer to page [260](#).

## Safety information

### Warning

The system cannot serve as a substitute for the driver's personal judgment in assessing the traffic situation. Based on the limits of the system, it cannot independently react to all traffic situations. There is a risk of accident. Adjust driving style to traffic conditions. Check surrounding traffic and vehicle's surroundings closely and actively intervene where appropriate.

## Overview

### Button in the vehicle



 Panorama View

## Sensors

The system is controlled by the following sensors:

- ▷ Front camera.
- ▷ Depending on the equipment: rearview camera.

Additional information:

Sensors of the vehicle, refer to page [35](#).

## Display on the control display

 Press the button when the engine is running.

Depending on the driving direction, the image of the respective camera is displayed:

- ▷ "Front": front camera image.
- ▷ "Rear": rear camera image.

Depending on the vehicle equipment, cross traffic warning can additionally warn of approaching vehicles using radar sensors.

Additional information:

Cross traffic warning, refer to page [267](#).

## With navigation system: activation points

### Principle

Positions where Panorama View should switch on automatically can be stored as activation points provided that a Global Positioning System signal is received.

### General information

Up to ten activation points can be stored.

Activation points can be used when driving forward for the front camera.

### Storing activation points

1. Drive to the position at which the system is to be switched on, and stop.
2.  Press the button.
3. Tilt the Controller to the right.
4. "Activation point"

The current position is displayed.



5. "Save activation point"

Activation points are stored with one of the following pieces of information if possible:



- ▷ With the city/town.
- ▷ With the city/town and the street.
- ▷ With the GPS coordinates.

### Using activation points



The use of activation points can be switched on and off.

1.  Press the button.
2. Tilt the Controller to the right.
3.  "Settings"
4. "Panorama View, GPS-based"
5. "Panorama View is displayed automatically when set activation points are reached."

### Displaying activation points

1.  Press the button.
2. Tilt the Controller to the right.
3.  "Manage points"  
A list of all activation points is displayed.

### Renaming or deleting activation points

1.  Press the button.
2. Tilt the Controller to the right.
3.  "Manage points"  
A list of all activation points is displayed.
4. Select an activation point as needed.
5. Select the desired setting.

### Functional limitations

The Surround View functional limitations apply.

Additional information:

Surround View, refer to page [260](#).

## System limits

The limits of the Surround View system apply.

Additional information:

Surround View, refer to page 260.

## Cross traffic warning

### Principle

At blind driveway exits or when driving out of perpendicular parking spaces, road users approaching from the side are detected sooner by the cross traffic warning than is possible from the driver's seat.

### General information

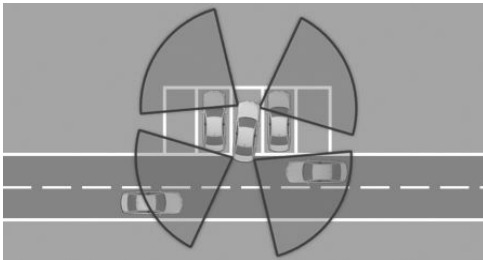

Two radar sensors in the rear bumper monitor the area behind the vehicle.

The system indicates approaching road users.

Depending on the vehicle equipment, the area around the vehicle in front of the vehicle is monitored as well. Two additional radar sensors are located in the front bumpers.

### Safety information

#### **Warning**

The system cannot serve as a substitute for the driver's personal judgment in assessing the traffic situation. Based on the limits of the system, it cannot independently react to all traffic situations. There is a risk of accident. Adjust driving style to traffic condi-

tions. Watch the surrounding traffic situation closely, be ready to take over steering and braking at any time, and actively intervene where appropriate.

## Overview

### Button in the vehicle



 Park assistance button

### Sensors

The system is controlled by the following sensors:

- ▶ Radar sensors, side, rear.
- ▶ Depending on the equipment: radar sensors, side, front.



Additional information:

Sensors of the vehicle, refer to page 35.

### Turning on/off

### Activating/deactivating the system

#### With the button

1.  Press the park assistance button.
2. Tilt the Controller to the right.
3.  "Settings"
4. "Cross traffic warning"
5. "Cross traffic warning"

**Via iDrive**

1. "CAR"
2. "Settings"
3. "Driver Assistance"
4. "Parking and Maneuvering"
5. "Cross traffic warning"
6. "Cross traffic warning"

**Turning on automatically**

If the system was activated on the control display, it will automatically be turned on as soon as the Park Distance Control or the Panorama View is active and a gear is engaged.

If reverse gear is engaged, the rear system is switched on.

Depending on the vehicle equipment, the front system is switched on when a forward gear is engaged.

**Switching off automatically**

The system is automatically switched off in the following situations:

- ▶ When the speed exceeds walking speed.
- ▶ When a certain distance travelled is exceeded.
- ▶ With an active parking operation of the Automatic Parking Assistant.

**Warning**

**General information**

The respective display is called up on the Control Display. A signal tone may sound and the light in the exterior mirror may flash.

**Light in the exterior mirror**



The light in the exterior mirror flashes if vehicles are detected by the rear sensors and your own vehicle is moving in reverse.

**Display in the Park Distance Control view**



In the Park Distance Control view, the respective boundary area flashes red if vehicles are detected by the sensors.

**Display in the camera view**

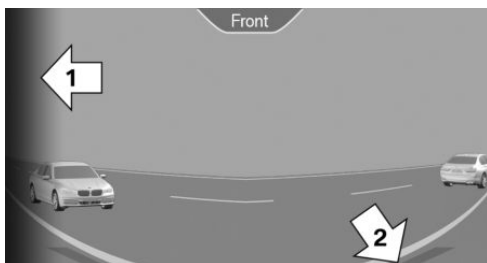

The respective boundary area, arrow 1, in the camera view flashes red, if vehicles are detected by the sensors.

Yellow lines, arrow 2, mark the bumper of your own vehicle.

## Acoustic warning

In addition to the optical indicator, a warning signal sounds if your own vehicle moves into the respective direction.

## System limits

### System limits of the sensors

Additional information:

- ▷ Radar sensors, refer to page 36.

### Functional limitations

The system may be limited in the following situations:

- ▷ In tight curves.
- ▷ Crossing objects are moving at a very slow or a very fast speed.
- ▷ Other objects that hide cross traffic are in the capture range of the sensors.

If the trailer power socket is occupied or trailer towing is activated, for instance during operation with trailer or bicycle rack, cross traffic warning is not available for the area behind the vehicle.

## Remote 3D View

### Principle

The BMW app and the pictures of the Surround View cameras in combination with the corresponding equipment enable the display of the vehicle's surroundings on a mobile device.

The function displays a snapshot of the situation.

### Sensors

The system is controlled by the following sensors:

- ▷ Front camera.
- ▷ Top view cameras.
- ▷ Rearview camera.

Additional information:

Sensors of the vehicle, refer to page 35.

### Functional requirements

- ▷ Data transfer must be activated.  
Data protection, refer to page 66.
- ▷ The BMW app must be installed on the mobile end device.
- ▷ ConnectedDrive countries: a driver profile with an existing ConnectedDrive account must be activated.  
Driver profiles, refer to page 67.

### Switching the function on/off

#### Switching on/off with other functions

1. "CAR"
2. "Settings"
3. "General settings"
4. "Data privacy"
5. Select the desired setting.

#### Switching on/off individually

##### Pre-adjustment

1. "CAR"
2. "Settings"
3. "General settings"
4. "Data privacy"
5. "Select services individually"
6. "My BMW app & customer portal"
7. "Remote 3D View"

##### Turning on/off

1. "CAR"
2. "Settings"



3. "General settings"
4. "Data privacy"
5. "Individual selection"

## System limits of the sensors

Additional information:

- ▷ Cameras, refer to page [35](#).

## Functional limitations

The system may not be fully functional or may not be available in the following situations:

- ▷ With a door or the tailgate open. Dark fields in the display indicate areas that are not recorded by the system.
- ▷ With manually folded-in exterior mirrors.
- ▷ When other camera functions are being performed in the vehicle.
- ▷ The vehicle moves faster than walking speed.
- ▷ It may not be possible to use the function in every country.
- ▷ For reasons of data protection, the function can only be used three times within two hours.



# Driving comfort

## Vehicle features and options

---

This chapter describes all standard, country-specific and optional features offered with the series. It also describes features and functions that are not necessarily available in your vehicle, e.g., due to the selected options or country versions. This also applies to safety-related functions and systems. When using these functions and systems, the applicable laws and regulations must be observed.

## Chassis components

---

The chassis components are optimized for the vehicle and its application range and thereby ensure the best possible driving experience.

## Adaptive suspension

---

### Principle

The adaptive suspension is an intelligent controllable suspension.

The chassis reduces body movements with a sporty driving style or on an uneven road.

### General information

The intelligent control of the chassis increases the driving dynamics and driving comfort depending on the road condition and driving style.

### Setting

The system offers different shock absorber settings ranging from comfortable travel to sporty driving.

The shock absorbers are adjusted depending on the road condition and driving style as well

as, depending on the equipment, the selected driving mode.

Additional information:

Driving Dynamics Control, refer to page [137](#).

## Adaptive M chassis

---

### Principle

The Adaptive M chassis is an intelligent, controllable sport chassis.

The chassis reduces body movements with a sporty driving style or on an uneven road.

### General information

The intelligent control of the chassis increases the driving dynamics and driving comfort depending on the road condition and driving style.

### Setting

The system offers different shock absorber settings ranging from comfortable travel to sporty driving.

The shock absorbers are adjusted depending on the selected driving mode as well as the road condition and driving style.

Additional information:

Driving Dynamics Control, refer to page [137](#).

## Performance Control

---

Performance Control enhances the agility of the vehicle.

To increase maneuverability, wheels are braked individually when a sporty driving style is used.



## Engine sound

---

Depending on the equipment and national-market version, you may be able to configure the sound of the engine.

1. "CAR"
2. "Settings"
3. "General settings"
4. "Engine sound"
5. Select the desired setting.



# Climate control

## Vehicle features and options

This chapter describes all standard, country-specific and optional features offered with the series. It also describes features and functions that are not necessarily available in your vehicle, e.g., due to the selected options or country versions. This also applies to safety-related functions and systems. When using these functions and systems, the applicable laws and regulations must be observed.

## Air quality

### General information

The air quality in the interior is improved by the following components:

- ▶ Emission tested passenger compartment.
- ▶ Interior filter.
- ▶ Air conditioning system to control the temperature, air flow and recirculated-air mode.
- ▶ Pre-ventilation.
- ▶ Ionizer.
- ▶ Fragrancing.
- ▶ Automatic recirculated-air control.

### Interior filter

The interior filter cleans the incoming fresh air or the circulated interior air in recirculation mode.

Depending on the equipment:

- ▶ Dust and pollen is filtered out from the in-flowing air.
- ▶ Nano-particle emissions are reduced.

- ▶ Gaseous pollutants are filtered.
- ▶ Microbial particles, viruses and allergens are filtered.

The manufacturer of the vehicle recommends having the interior filter changed during vehicle maintenance.





## Automatic climate control

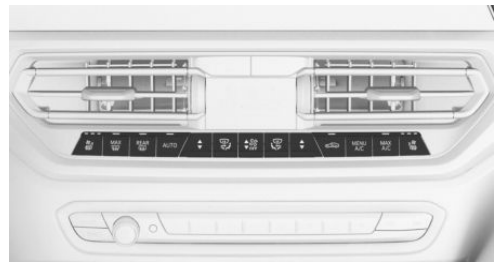





### Overview

#### Buttons in the vehicle



#### Climate control functions

Button	Function
	Temperature.
	Air recirculation mode.
	Maximum cooling.
	AUTO program.
	Air flow, manual. Switching off. Intensity AUTO program.

Button	Function
	Air distribution, manual.
	Defrost function.
	Rear window defroster.
	Depending on the equipment:
	Seat heating, refer to page 125.
	or
	Active seat ventilation, refer to page 126.
	Air conditioning. Open Climate menu, such as for the following settings: upper body temperature adjustment, pre-ventilation.

Some of the functions can also be used via voice, e.g., temperature.

## Opening the Climate menu

 Press the button.

The Climate menu is displayed.

For example, the following climate control functions can be accessed via the Climate menu:

- ▷ Fragrance.
- ▷ Air quality.
- ▷ Heating/ventilation.
- ▷ Pre-ventilation/heating
- ▷ Air conditioning.

Individual settings can be entered for some of the climate functions, e.g., switching on/off, intensity.

## Switching climate control functions on/off

### Turning on

Press one of the following buttons:

- ▷ Temperature.
- ▷ Climate menu.
- ▷ Maximum cooling.
- ▷ AUTO program.
- ▷ Air recirculation mode.
- ▷ Upper side of the air flow, manual button.
- ▷ Air distribution, manual.
- ▷ Defrosting the windshield

### Turning off

Complete system:

 Press and hold the button until the integrated automatic climate control switches off.

## Temperature

### Principle

The automatic climate control cools or heats to the configured temperature and then keeps the temperature constant.

### Setting the temperature

Using the button:

 Press the upper or lower button side to set the desired temperature.

Via iDrive:

1. "CAR"
2. "Settings"
3. "Climate control"
4. "Heating/ventilation"
5. "Driver" or "Front passenger"
6. "Temperature:"

7. Set the desired temperature.
8. "OK"

Do not rapidly change between different temperature settings. Otherwise, the automatic climate control will not have sufficient time to adjust the set temperature.

## Temperature of the ventilation

### General information

The temperature of the ventilation in the upper body area can be adjusted.

The air flow of the ventilation in the upper body area heats or cools noticeably, depending on the adjusted temperature.

This does not change the set interior temperature for the driver and front passenger.

### Adjust temperature of the ventilation

1. "CAR"
2. "Settings"
3. "Climate control"
4. "Heating/ventilation"
5. "Temperature adjustment"
6. Set the desired temperature.

The temperature is individually adjusted, e.g. colder toward blue, warmer toward red.

## Air conditioning

### Principle

The air in the interior will be cooled and dehumidified and, depending on the temperature setting, warmed again.

### Functional requirement

The interior can only be cooled with the drive-ready state switched on.

### Switch air conditioning on/off

Using the button:



Press the button.

Via iDrive:

1. "CAR"
2. "Settings"
3. "Climate control"
4. "Heating/ventilation"
5. "A/C"

Depending on the weather, the windshield and the side windows may fog up briefly when drive-ready state is switched on.

Air conditioning is switched on automatically with the AUTO program.

When using the cooling mode, condensation that will exit below the vehicle.

## Maximum cooling

### Principle

The system is set to the lowest temperature, optimum air flow and recirculated-air mode with the drive-ready state switched on.

### Functional requirement

The function is available at an outside temperature above approx. 32 °F/0 °C and with the drive-ready state switched on.

### Switching maximum cooling on/off



Press the button.

The LED is illuminated when maximum cooling is switched on.

Air flows out of the air vents to the upper body area. The air vents need to be open for this.

The air flow can be adjusted with the program active.

## AUTO program

### Principle

The AUTO program cools, ventilates or heats the car's interior automatically.

The air distribution and the temperature are controlled automatically depending on the interior temperature and the desired temperature setting including the selected intensity of the air flow.

### Switching the AUTO program on/off

Using the button:

 Press the button. The LED of the button is illuminated with the AUTO program switched on.

Via iDrive:

1. "CAR"
2. "Settings"
3. "Climate control"
4. "Heating/ventilation"
5. "Driver"
6. "Automatic"

Depending on the selected settings and outside influences, the air is directed to the windshield, side windows, upper body, and into the footwell.

Point the side air vents toward the side windows.

The air conditioning is switched on with the AUTO program.

At the same time, a condensation sensor controls the program so as to prevent window condensation as much as possible.

The AUTO program is switched off automatically, when manual air distribution is set.

## Adjusting the intensity of the air flow

With the AUTO program switched on, the intensity can be adjusted. This changes the automatic control for the air mass.

Using the button:

 Press the lower or upper side of the button: decrease or increase intensity.

Via iDrive:

1. "CAR"
2. "Settings"
3. "Climate control"
4. "Heating/ventilation"
5. "Driver"
6. "Level"
7. Set the desired intensity.

The selected intensity is shown on the climate control display.

## Automatic recirculated-air control

### Principle

The automatic recirculated-air control recognizes pollutants in the outside air. The outside air supply is shut off and the interior air is recirculated.

### General information

If the system is activated, a sensor detects pollutants in the outside air and controls the shut-off automatically.

If the system is deactivated, outside air continuously flows into the interior.

With constant air recirculation mode, the air quality in the interior deteriorates and window fogging increases.

If there is window condensation, switch off recirculated-air mode or defog the windows.

## Switching automatic recirculated-air control on/off

1. "CAR"
2. "Settings"
3. "Climate control"
4. "Air quality"
5. "Automatic"

## Air recirculation mode

### Principle

You may react to unpleasant odors or pollutants in the immediate environment by temporarily suspending the supply of outside air. The system then recirculates the interior air.

When recirculated-air mode is switched off, fresh air is directed into the vehicle's interior.

### Switch air recirculation on/off

Using the button:



Press the button.

The LED of the button is illuminated when the air-recirculation mode is switched on.

Via iDrive:

1. "CAR"
2. "Settings"
3. "Climate control"
4. "Air quality"
5. Select the desired setting:
  - ▷ "Air recirculation"
  - ▷ "Fresh air"

To prevent window condensation, recirculated-air mode switches off automatically after a certain amount of time, depending on the environmental conditions.

With constant air recirculation mode, the air quality in the interior deteriorates and window fogging increases.

If there is window condensation, switch off recirculated-air mode or defog the windows.

## Air flow, manual

### Principle

The air flow for climate control can be adjusted manually.

### General information

To adjust the air flow manually switch off AUTO program first.

### Adjusting the air flow manually



Press the lower or upper side of the button: decrease or increase air flow.

The selected air flow is shown on the climate control display.

The air flow may be reduced to preserve the vehicle battery.

## Manual air distribution

### Principle

The air distribution for climate control can be adjusted manually.

### Adjusting the air distribution manually



Press the button repeatedly. Select the desired setting:

- ▷ Windows, upper body area, and footwell.
- ▷ Upper body area and footwell.
- ▷ Footwell.
- ▷ Windows and footwell.
- ▷ Windows.
- ▷ Windows and upper body area.
- ▷ Upper body area.

The selected air distribution is shown on the climate control display.

## SYNC program

### Principle

The Sync program can be used to apply the settings on the driver's side to the passenger's side.

### Switching the SYNC program on/off

1. "CAR"
2. "Settings"
3. "Climate control"
4. "Synchronize"

The following settings of the driver's side can be transferred to the passenger's side:

- ▷ Temperature.
- ▷ Air flow.
- ▷ Air distribution.
- ▷ AUTO program.

The program is switched off automatically if the settings on the front passenger side are changed.

## Defrost function

### Principle

Ice and condensation are quickly removed from the windshield and the front side windows.

### Switching the Defrost function on/off



Press the button.

The LED of the button is illuminated when the system is switched on.

The air flow can be adjusted manually with the system switched on.

If there is window condensation, switch on the AUTO program or the air conditioning to utilize the condensation sensor. Make sure that air can flow to the windshield.

## Rear window defroster

### Principle

Ice and condensation are removed from the rear window quickly.

### Functional requirement

The function is operational when the drive-ready state is switched on.

### Switching rear window defroster on/off



Press the button. The LED is illuminated with rear window defroster switched on.

The rear window defroster switches off automatically after a certain period of time.

## Ventilation

### Principle

The air flow directions can be adjusted individually for direct or indirect ventilation.

### Setting the ventilation

### General information

Open the air vents and position them to ensure effective climate control.

### Direct ventilation

The air flow is directed towards the passengers. The air flow heats or cools noticeably, depending on the adjusted temperature.

### Indirect ventilation

The air flow is not directed towards the passengers. The vehicle interior is warmed or cooled indirectly, depending on the set temperature.

## Front ventilation

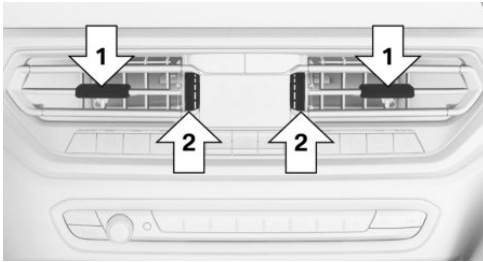

- ▶ Lever for changing the airflow direction, arrow 1.
- ▶ Thumbwheel for variable opening and closing of the air vents, arrow 2.

## Ventilation in rear, center

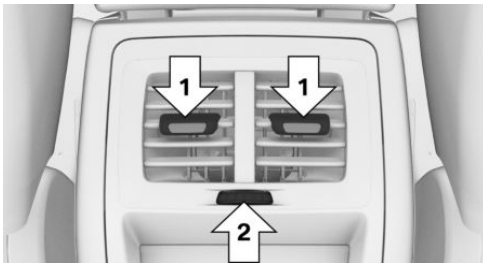

- ▶ Lever for changing the airflow direction, arrow 1.
- ▶ Thumbwheel for variable opening and closing of the air vents, arrow 2.





## Rear automatic climate control

### Overview

### Buttons in the vehicle



### Climate control functions

Button	Function
	Temperature.
	AUTO program.
	Air distribution, manual.
	Seat heating, refer to page <a href="#">125</a> .
	Switching off.

### Switching climate control functions on/off

#### Functional requirement

The rear automatic climate control is not ready for operation if the automatic climate control is switched off or if the function for defrosting the windows and removing condensation is active.

## Switching on/off using iDrive

1. "CAR"
2. "Settings"
3. "Climate control"
4. "Heating/ventilation"
5. "Second row of seats"
6. "Activate heating/cooling"

## Switching on using the button

Press one of the following buttons:

- ▷ Temperature.
- ▷ AUTO program.
- ▷ Air distribution, manual.

## Switching off using the button

 Press the button.

## Temperature

### Principle

The automatic climate control cools or heats to the configured temperature and then keeps the temperature constant.

### Setting the temperature

Using the button:

 Press the left or right button side to set the desired temperature.

Via iDrive:

1. "CAR"
2. "Settings"
3. "Climate control"
4. "Heating/ventilation"
5. "Second row of seats"
6. "Temperature:"
7. Set the desired temperature.

The selected temperature is shown on the climate control display.

Do not rapidly switch between different temperature settings. Otherwise, the automatic climate control will not have sufficient time to adjust the set temperature.

## AUTO program

### Principle

The air flow, air distribution and the temperature are controlled automatically.

### Switching the AUTO program on/off

Using the button:

 Press the button.  
The LED of the button is illuminated with the AUTO program switched on.

Via iDrive:

1. "CAR"
2. "Settings"
3. "Climate control"
4. "Heating/ventilation"
5. "Second row of seats"
6. "Automatic"

Depending on the selected settings and outside influences, the air is directed to the upper body and into the floor area.

## Manual air distribution

### Principle

The air distribution for climate control can be adjusted manually.

### Adjusting the air distribution manually

 Press the button repeatedly. Select the desired setting:



- ▷ Upper body area.
- ▷ Upper body area and footwell.
- ▷ Footwell.

## Locking the control elements

### Principle

The control elements of the rear automatic climate control can be disabled.

### Activate/deactivate

1. "CAR"
2. "Settings"
3. "Climate control"
4. "Heating/ventilation"
5. "Second row of seats"
6. "Disable controller"

## Pre-ventilation

### Principle

The car's interior can be cooled or heated before driving off with the pre-ventilation. Depending on set temperature and ambient temperature, the car's interior is ventilated or possibly heated using the residual engine heat.

### General information

The system can be switched on and off directly or via a preset departure time.

The activation time is determined based on the outside temperature. The system promptly switches on before the selected departure time.

### Functional requirements

- ▷ The vehicle is in idle state or standby state and not in drive-ready state.
- ▷ The vehicle battery is sufficiently charged.

If pre-ventilation is switched on, the vehicle battery will be discharged. Thus, limit the maximum activation time to save the vehicle battery. The system will be available again after the engine is started or after a short trip.

- ▷ Make sure that the vehicle's date and time are set correctly.
- ▷ Open the air vents to allow air to flow out.

## Switching on/off directly

### General information

There are different ways to switch the system on or off.

The system switches off automatically after a certain period of time. The system continues to run for some time after being switched off.

### Using the button

#### Functional requirement

When the vehicle is in standby state, the pre-ventilation can be switched on or off with the automatic climate control buttons.

#### Turning on

Press one of the following buttons:

- ▷ Temperature.
- ▷ Air conditioning.
- ▷ Maximum cooling.
- ▷ AUTO program.
- ▷ Air recirculation mode.
- ▷ Upper side of the air flow, manual button.
- ▷ Air distribution, manual.
- ▷ Defrosting the windshield

#### Turning off



Press and hold the bottom button.

The system switches off after leaving and locking the vehicle.



### Via iDrive

#### Turning on



1. "CAR"
2. "Settings"
3. "Climate control"
4. "Pre-ventilation"
5. "Start now"

### Via BMW display key

#### Turning on

1. Switch on the display of the BMW display key.
2. "Preconditioning setting"
3. Tap the  icon or the  icon.
4. "Activate now"
5. "Start"

#### Turning off

1. Switch on the display of the BMW display key.
2. "Preconditioning setting"
3. Tap the  icon or the  icon.
4. "Stop"

### Display

Icon	Description
	Icon on the climate control display. Flashing: the pre-ventilation is switched on.

## Departure time

### Principle

Different departure times can be set to ensure a comfortable interior temperature in the vehicle at the time of departure.

- ▶ One-time departure time: the time can be set.  
The system is switched on once.
- ▶ Departure time with weekday: time and day of the week can be set.  
On the desired weekdays, the system will be switched on before the set departure time.

The departure time is preselected in two steps:

- ▶ Set departure times.
- ▶ Activate departure times.



A minimum of 10 minutes should pass between setting/activating the departure time and the planned departure time to allow a sufficient period of time for the climate control.

### Setting the departure time

#### Via iDrive

1. "CAR"
2. "Settings"
3. "Climate control"
4. "Pre-ventilation"
5. "Departure plan"
6. Select the desired departure time.
7. Set the departure time.
8. Select day of the week, if needed.
9. "OK"

#### Via BMW display key

1. Switch on the display of the BMW display key.
2. "Preconditioning setting"
3. Tap the  icon or the  icon.

4. Select the desired departure time.
5. Set the departure time.
6. Select day of the week, if needed.
7. "OK"

## Activating the departure time



### Functional requirement

To switch on the parked-car ventilation automatically at the departure time, the departure time must be activated first.



### Via iDrive

1. "CAR"
2. "Settings"
3. "Climate control"
4. "Pre-ventilation"
5. "Departure plan"
6. Activate the desired departure time.

### Via BMW display key

1. Switch on the display of the BMW display key.
2. "Preconditioning setting"
3. Tap the  icon or the  icon.
4.  Tap on the icon.
5. Activate the desired departure time.

### Display

 ,  Icon on the climate control display signals an activated departure time.

## Pre-conditioning through Remote Engine Start

### Principle

Pre-conditioning cools or heats the car's interior prior to start of the trip to a comfortable temperature. The system automatically cools, vents, and heats depending on the interior, ex-

ternal, and set temperature. Snow and ice may be removed more easily.

The system starts the engine automatically and allows it to run for a limited period of time.

## Safety information

### **DANGER**

If the exhaust pipe is blocked or ventilation is insufficient, harmful exhaust gases can pollute the area in and around the vehicle or penetrate the vehicle. The exhaust gases contain pollutants which are colorless and odorless. In enclosed areas or areas with insufficient ventilation, exhaust gases can also accumulate outside of the vehicle. There is a danger to life. Keep the exhaust pipe free and ensure sufficient ventilation. Do not switch on stationary climate control in enclosed areas or areas with insufficient ventilation, e.g. in enclosed garages.

### **Warning**

When stationary climate control is in operation, high temperatures can occur underneath the body, for instance caused by the exhaust system. If combustible materials, such as leaves or grass, come in contact with hot parts of the exhaust system, these materials can ignite. There is a risk of fire. Make sure that no combustible materials can come in contact with hot vehicle parts during stationary climate control operation, e.g. leaves, grass, gas, gasoline, oil or other combustible objects.

## Functional requirements

- ▷ The vehicle is in idle state or standby state and not in drive-ready state.
- ▷ Battery is sufficiently charged.
- ▷ For reasons of safety, the system can only be switched on twice consecutively. The

system will be available again as soon as the drive-ready state is activated and deactivated again.

- ▷ The fuel tank capacity is sufficient.
- ▷ Hood is closed.
- ▷ Make sure that the vehicle's date and time are set correctly.
- ▷ Air vents are opened.

## Enabling the automatic engine start function

The automatic engine start must be enabled once before using the system. Otherwise, the engine cannot switch on automatically to climatize the car's interior.

Via iDrive:

1. "CAR"
2. "Settings"
3. "Climate control"
4. "Preconditioning/ventilation"
5. "Remote Engine Start"
6. "Starting engine for clim. control"
7. Confirm the disclaimer.

## Switching on/off directly

### General information

The system switches off automatically after approx. 15 minutes.

For reasons of safety, the system can only be switched on twice consecutively. The system will be available again as soon as the drive-ready state is activated and deactivated again.

### Switching on via iDrive

1. "CAR"
2. "Settings"
3. "Climate control"
4. "Preconditioning/ventilation"
5. "Start now"

## Switching on/off via vehicle key

The system can be switched on and off using the vehicle key.



Press the button on the vehicle key three times within 1 second.

After operating the vehicle key, it will take approximately 3 seconds until the engine is switched on.

To switch off the system, press the button again three times.

## Switching on via BMW display key

1. Switch on the display of the BMW display key.
2. "Preconditioning setting"
3.  Tap on the icon.
4. "Activate now"
5. "Start"

## Switching off via BMW display key

1. Switch on the display of the BMW display key.
2. "Preconditioning setting"
3.  Tap on the icon.
4. "Stop"

## Switching off with the Start/Stop button

The system can be switched off directly as follows: pressing the Start/Stop button, without operating the brake pedal.

## Switching on via departure time

### General information

Scheduled departure times can be set up in the system to ensure a comfortable interior temperature in the vehicle at the time of departure.

- ▷ One-time departure time: the time of the scheduled departure can be set.

The system is switched on once.

- ▷ Departure time with weekday: time and day of the week of the scheduled departure can be set.

The departure time is preselected in two steps:

- ▷ Set departure times.
- ▷ Activate departure times.

The climate control function will start approximately 10 minutes before the set departure time and continue for approximately 5 more minutes after the departure time.

A minimum of 10 minutes should pass between setting/activating the departure time and the planned departure time to allow a sufficient period of time for the climate control.

For reasons of safety, the system can only be switched on once. The system will be available again as soon as the drive-ready state is activated and deactivated again.

Observe the information about the intended use of the vehicle.

Additional information:

For Your Own Safety, refer to page 8.

### Adjusting the departure time via iDrive

1. "CAR"
2. "Settings"
3. "Climate control"
4. "Preconditioning/ventilation"
5. "Departure plan"
6. Select the desired departure time.
7. Set the departure time.
8. Select day of the week, if needed.

### Adjusting the departure time via BMW display key



1. Switch on the display of the BMW display key.
2. "Preconditioning setting"
3.  Tap on the icon.

4. Select the desired departure time.
5. Set the departure time.
6. Select day of the week, if needed.
7. "OK"

### Activating the departure time via iDrive

1. "CAR"
2. "Settings"
3. "Climate control"
4. "Preconditioning/ventilation"
5. "Departure plan"
6. Activate the desired departure time.

### Activating the departure time via BMW display key



1. Switch on the display of the BMW display key.
2. "Preconditioning setting"
3.  Tap on the icon.
4. Activating the desired departure time:
  -  Tap on the icon.

### Display



In the instrument cluster:

The engine runs for the purpose of operating the pre-conditioning. The vehicle is not ready to drive.

-   The icon on the automatic climate control signals an activated departure time.
-  The icon flashes while Remote Engine Start is running.

### Confirmation signals from the vehicle

The activation of the system is confirmed by flashing twice.

The parking lights are switched on as long as the system is switched on.

## Ambient air package

### Principle

The Ambient Air Package can be used to clean and scent the interior air with high-quality fragrances.

### General information

Two different fragrances can be selected in the vehicle. A variety of other fragrances is possible by exchanging the fragrance cartridges.

The following criteria can influence the perception of scents in the vehicle interior:

- ▷ Automatic climate control settings.
- ▷ Temperature and moisture.
- ▷ Time of day and season.
- ▷ Physical condition of the vehicle occupants, for instance fatigue.

BMW recommends the use of genuine BMW fragrance cartridges.

The genuine BMW fragrance cartridges are not suitable for refilling. When a cartridge is empty, replace it with a new fragrance cartridge.

### Safety information

#### Warning

Refilled genuine BMW fragrance cartridges can cause the emission of harmful substances, malfunctions, and damage to the system. There is a risk of injury or risk of damage to property. Do not refill genuine fragrance cartridges. When a cartridge is empty, replace it with a new fragrance cartridge.

### Opening the Climate menu

 MENU  
A/C

Press the button.

The Climate comfort menu is displayed.

Individual settings can be entered for some of the climate control functions.

### Ionizer

#### Principle

The ionizer cleans the car's interior air of suspended particles and improves the air quality.

#### Switching the ionizer on/off

1. "CAR"
2. "Settings"
3. "Climate control"
4. "Air quality"
5. "Ionization"

### Fragrancing

#### General information

Fragrancing is done at intervals in order to avoid a habituation effect.

Two fragrance cartridges in the vehicle allow switching between the fragrances.

The fragrance cartridges are located in the glove compartment.

To ensure a pleasant fragrance inside of the vehicle when starting the trip, fragrancing can occur prior to the trip. The system is automatically switched on with the pre-ventilation if fragrancing was switched on at the completion of the last trip.

#### Functional requirements

- ▷ The fragrance cartridges are sufficiently filled.
- ▷ The interior temperature is between 41 °F/+5 °C and 104 °F/+40 °C.
- ▷ Open the air vents to allow the fragrance to flow out.

## Selecting the fragrance

The car's interior is fragranced depending on the selected fragrance.

Two different fragrances can be selected in the vehicle.

1. "CAR"
2. "Settings"
3. "Climate control"
4. "Fragrance"
5. Select the desired fragrance.

## Switching fragrancing on/off, adjusting intensity

1. "CAR"
2. "Settings"
3. "Climate control"
4. "Fragrance"
5. "Level"
6. Select the desired setting.

## Display

The illustrations on the Control Display show the actual fill level of the fragrance cartridges.

1. "CAR"
2. "Settings"
3. "Climate control"
4. "Fragrance"

When an empty fragrance cartridge is indicated, the cartridge still contains a fluid carrying the fragrance. However, it is not sufficient for fragrancing.

When the fragrance cartridges are empty, a Check Control message is displayed once.

## Inserting fragrance cartridges

The fragrance cartridges are located in the glove compartment.

1. Open the glove compartment.

Front passenger side glove compartment, refer to page 297.

2. Press on the bottom of the cartridge holder. The cartridge holder slides down.

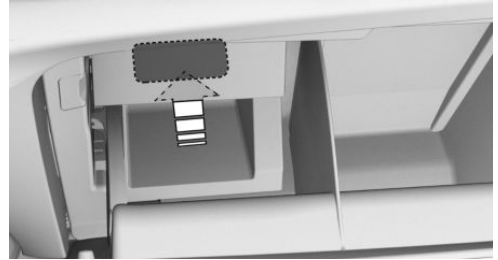

3. Remove the cover of the fragrance cartridge. Hold the cover on the top to slide it from the fragrance cartridge.



4. Insert the removed cover on the rear of the fragrance cartridge.

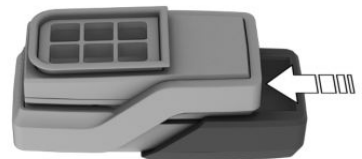

5. Position fragrance cartridge such that the chip faces away from the cartridge holder.

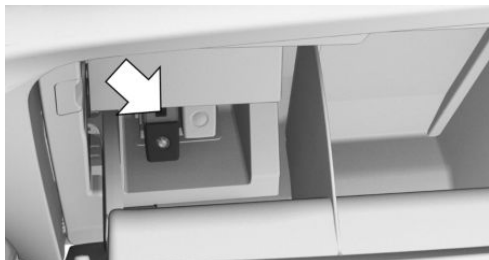

6. Insert the fragrance cartridge without pressure into the cartridge holder. The cartridge snaps lightly into place.

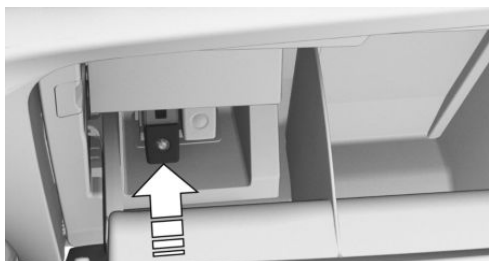

7. Push the cartridge holder up, until it engages.  
Make sure that no objects press against the cartridge holder from below, otherwise the function of the ambient air package could be impacted.

8. Close the glove compartment.

### Removing the fragrance cartridge

The fragrance cartridges are located in the glove compartment.

1. Open the glove compartment.  
Front passenger side glove compartment, refer to page 297.
2. Press on the bottom of the cartridge holder.

The cartridge holder slides down.

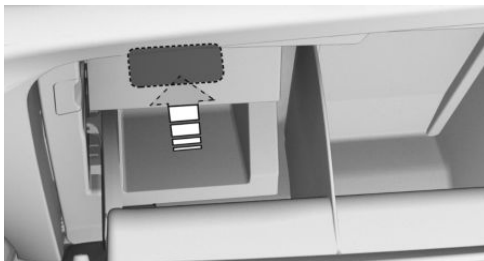

3. Pull desired fragrance cartridge from the holder.  
Fragrance cartridge, arrow 1: first fragrance indicated on the Control Display.  
Fragrance cartridge, arrow 2: second fragrance indicated on the Control Display.



4. Pull desired fragrance cartridge from the holder.

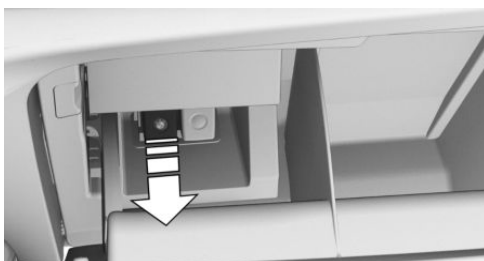

### Recycling



Empty fragrance cartridges can be taken to an authorized service center or another qualified service center or repair shop for recycling.



# Interior equipment

## Vehicle features and options

This chapter describes all standard, country-specific and optional features offered with the series. It also describes features and functions that are not necessarily available in your vehicle, e.g., due to the selected options or country versions. This also applies to safety-related functions and systems. When using these functions and systems, the applicable laws and regulations must be observed.

## Integrated universal remote control

### Principle

The integrated Universal Remote Control in the interior mirror can operate up to 3 functions of remote-controlled systems such as garage door drives, barriers, or lighting systems.

### General information

The Integrated Universal Remote Control replaces up to 3 different hand-held transmitters. To operate the remote control, the buttons on the interior mirror must be programmed with the desired functions. The hand-held transmitter for the particular system is required in order to program the remote control.

Before selling the vehicle, delete the stored functions for the sake of security.

If possible, do not install the antenna of the remote-controlled system, e.g. the garage door drive, near metal objects to ensure the best possible operation.

## Safety information

### Warning

The operation of remote-controlled systems with the integrated universal remote control, such as the garage door, may result in injury, for example, body parts becoming jammed in a garage door. There is a risk of injury or risk of damage to property. Make sure that the travel path of the respective system is clear during programming and operation. Also follow the safety information for the hand-held transmitter.

## Compatibility



If this icon is printed on the packaging or in the operating instructions of the system to be controlled, the system is generally compatible with the integrated Universal Remote Control.

Additional questions are answered by:

- ▶ An authorized service center or another qualified service center or repair shop.
- ▶ [www.homelink.com](http://www.homelink.com) on the Internet.

HomeLink is a registered trademark of Gentex Corporation.

## Control elements on the interior mirror

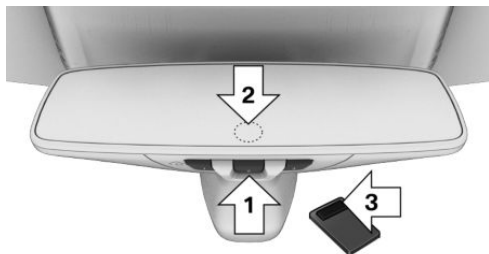

- ▶ Buttons, arrow 1.
- ▶ LED, arrow 2.
- ▶ The hand-held transmitter, arrow 3, is required for programming.

## Programming

### General information

The battery of the hand-held transmitter must be fully charged at the time of programming to ensure an optimal range of the integrated universal remote control.

1. Turn on standby state.
2. Initial commissioning:  
Press and hold the two outer buttons on the interior mirror simultaneously for approximately 10 seconds until the LED flashes green rapidly. This erases all programming of the buttons on the interior mirror.
3. Press the interior mirror button to be programmed. The LED on the interior mirror will slowly begin flashing orange.
4. Hold the hand-held transmitter for the system to be used approx. 1 to 12 in/2.5 to 30 cm away from the buttons on the interior mirror. The required distance depends on the hand-held transmitter.
5. Press and hold the button of the desired function on the hand-held transmitter.

Canada: if programming with the hand-held transmitter was interrupted, hold down the interior mirror button and repeatedly press and release the hand-held transmitter button for 2 seconds.

6. ▶ The LED lights up green: programming completed.  
Release the button.
  - ▶ The LED flashes fast: programming is not complete.  
Press the button on the interior mirror for 2 seconds and release. Perform this procedure three times to complete the programming procedure.  
If the integrated universal remote control remains nonoperational, continue with the special features for change code wireless systems.
  - ▶ LED does not flash green after 60 seconds: programming not completed.  
Repeat steps 3 to 6.

To program other functions on other buttons, repeat steps 3 to 5.

### Special feature of the rolling code wireless system

If you are unable to operate the remote-controlled system after repeated programming, please check if the system to be controlled features a rolling code radio system.

Refer to the operating instructions for the system.

For systems with a rolling code radio system, the integrated universal remote control and the system also have to be synchronized.

Please read the operating instructions to find out how to synchronize the system.

Synchronizing is easier with the aid of a second person.

Synchronizing the universal remote control with the system:

1. Park the vehicle within range of the remote-controlled system.
2. Program the relevant button on the interior mirror as described.
3. Locate and press the synchronizing button on the system being programmed, e.g. at the garage gate. You have approx. 30 seconds for the next step.
4. Hold down the programmed button on the interior mirror for approximately 3 seconds and then release it. If necessary, repeat this step up to three times in order to end synchronization. Once synchronization is complete, the programmed function will be carried out.

## Reprogramming individual buttons

1. Turn on standby state.
2. Press and hold the interior mirror button to be programmed.
3. As soon as the LED on the interior mirror flashes orange after approx. 20 seconds, release the button.
4. Hold the hand-held transmitter for the system to be used approx. 1 to 12 in/2.5 to 30 cm away from the buttons on the interior mirror. The required distance depends on the hand-held transmitter.
5. Press and hold the button of the desired function on the hand-held transmitter.

Canada: if programming with the hand-held transmitter was interrupted, hold down the interior mirror button and repeatedly press and release the hand-held transmitter button for 2 seconds.

6. The LED can light up in different ways.
  - ▶ The LED lights up green: the programming procedure is completed.

Release the button.

- ▶ The LED flashes fast: the hand-held transmitter was detected but programming is not complete.

Press the button on the interior mirror for 2 seconds and release. Perform this procedure three times to complete the programming procedure.

If the integrated universal remote control remains nonoperational, continue with the special features for change code wireless systems.

- ▶ LED does not flash green after 60 seconds: programming not completed.

Repeat steps 3 to 6.

If the programming procedure is not completed, the previous programming will remain unchanged.

## Operation

### **Warning**

The operation of remote-controlled systems with the integrated universal remote control, such as the garage door, may result in injury, for example, body parts becoming jammed in a garage door. There is a risk of injury or risk of damage to property. Make sure that the travel path of the respective system is clear during programming and operation. Also follow the safety information for the hand-held transmitter.

The system, such as the garage door, can be operated using the button on the interior mirror while the drive-ready or standby state is switched on. To do this, hold down the button within receiving range of the system until the function is activated. The interior mirror LED stays lit while the wireless signal is being transmitted.



## Deleting stored functions

All stored functions will be deleted. The functions cannot be deleted individually.

Press and hold the two outer buttons on the interior mirror simultaneously for approximately 10 seconds until the LED on the interior mirror flashes green fast.

## Sun visor

### Glare shield

Fold the sun visor down or up.

### Glare shield from the side

### Folding out

1. Fold the sun visor down.
2. Detach it from the holder and swing it toward the side window.

### Folding in

Proceed in the reverse order to close the sun visor.

### Vanity mirror

A vanity mirror is located in the sun visor behind a cover. When the cover is opened, the mirror lighting switches on.

## Sockets

### Principle

The socket can be used for electronic devices when the standby or drive-ready state is switched on.

### General information

The total load of all sockets must not exceed 140 watts at 12 volts.

Do not damage the socket by using unsuitable connectors.

## Safety information

### **Warning**

Devices and cables in the unfolding area of the airbags, such as portable navigation devices, can hinder the unfolding of the airbag or be thrown around in the car's interior during unfolding. There is a risk of injury. Make sure that devices and cables are not in the airbag's area of unfolding.

### **NOTICE**

Battery chargers that charge the vehicle battery via sockets or cigarette lighters in the vehicle may overload or damage the 12 V electrical system. There is a risk of damage to property, among other potential damage. Only connect battery chargers for the vehicle battery to the jump-start terminals in the engine compartment.

### **NOTICE**

If metal objects fall into the socket, they can cause a short circuit. There is a risk of damage to property, among other potential damage. Insert the cigarette lighter or socket cover again after using the socket.

## Front center console



Slide the cover forward.

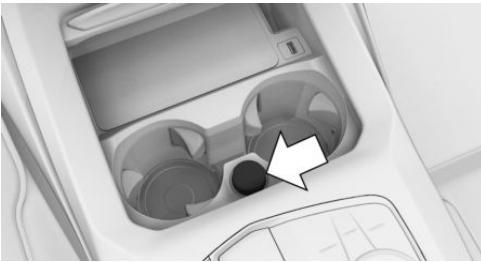

A socket is located between the cup holders.  
Detach the cover.

## In the cargo area



A socket is located on the right side in the cargo area. Unfold the cover.

## USB port

### General information

Follow the information regarding the connection of mobile devices to the USB port in the section on USB connections.

Additional information:

USB connections, refer to page 79.

### In the center armrest



A USB port is located in the center armrest.  
Properties:

- ▶ USB port Type C.
- ▶ For charging mobile devices.
- ▶ Charge current: max. 3 A.

### In the front center console

#### NOTICE

Objects in the storage compartment, e.g., large USB connectors, may block or damage the cover when it is being opened or closed. There is a risk of damage to property, among other potential damage. Make sure that the area of movement of the cover is clear while opening and closing it.

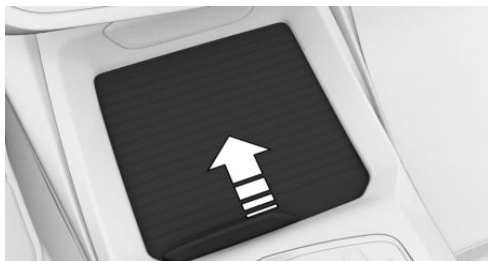

Slide the cover forward.



A USB port is located in the center console.

Properties:

- ▷ USB port Type A.
- ▷ For charging mobile devices and for data transfer.
- ▷ Charge current: max. 1.5 A.

### In the rear center console



Two USB ports are located in the center console in the rear passenger compartment.

Properties:

- ▷ USB port Type C.
- ▷ For charging mobile devices.
- ▷ Charge current: maximum 3 A per port.

## Wireless charging tray

### Principle

The wireless charging tray allows wireless charging of mobile phones and other mobile devices certified according to the Qi standard.

### General information

When inserting the device to be charged, ensure that there are no objects between the device to be charged and the wireless charging tray.

**(⚡)** The charging process is shown by the charge indicator on the control display.

### NOTE

This device has been tested for human exposure limits and found compliant at a minimum distance of 2 in/5 cm during operation.

Therefore, a distance of 4 in/10 cm must be maintained in every direction when operating the device.

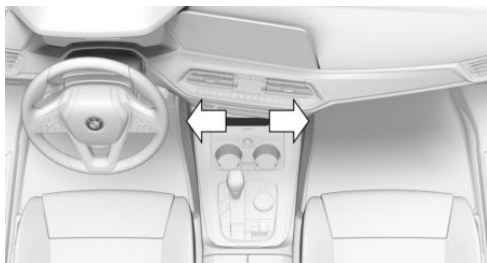

Mounting position of the product.

## Safety information

### Warning

When charging a device that meets the Qi standard in the wireless charging tray, any metal objects located between the device and the tray can become very hot. Placing storage devices or electronic cards, such as chip cards, cards with magnetic strips or cards for signal transmission, between the device and the tray may impair the card function. There is a risk of injury and risk of damage to property. When charging mobile devices, make sure there are no objects between the device and the tray.

## Overview

Tray in the center console:

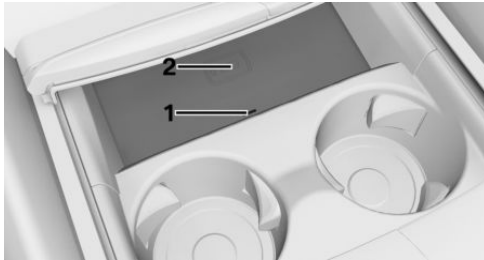

- 1 LED
- 2 Storage area

## Functional requirements

- ▶ The device to be charged must be certified according to the Qi standard.
- ▶ Standby state is switched on.
- ▶ The mobile phone must not exceed the maximum size of approximately 6.0 x 3.1 x 0.7 in/154.5 x 80 x 18 mm.
- ▶ Use only protective sleeves and covers up to a maximum thickness of 0.07 in/2 mm;

otherwise, the charging function may be impaired.

- ▶ The mobile phone to be charged is located in the center of the tray. The mobile phone display is pointing upwards.

## Inserting the mobile phone

1. Open the tray cover.
2. Place the mobile phone centered in the tray with the display facing up.
3. Close the tray cover.

## LED displays

Color	Meaning
Blue	The mobile phone is charging. The blue LED stays illuminated once the inserted mobile phone with Qi capability is fully charged.
Orange	The mobile phone is not charging. Temperature of the mobile phone may be too high or foreign object may be in charging tray.
Red	The mobile phone is not charging. Contact an authorized service center or another qualified service center or repair shop.

## Forgotten warning

### General information

A warning can be given if a Qi-certified mobile phone was forgotten in the wireless charging tray when leaving the vehicle.

The forgotten warning is displayed in the instrument cluster.

### Activating

1. "CAR"
2. "Settings"

3. "General settings"
4. "Wireless charging tray"
5. Activate reminder.

### System limits

The charge current may be reduced or the charging process may be temporarily interrupted in the following situations:

- ▷ Due to excessive temperatures on the surface of the tray and mobile phone.
- ▷ If there are objects between the mobile phone and the wireless charging tray.
- ▷ By settings on the mobile phone, for instance for charging. Follow the relevant instructions on the control display and in the instructions for the mobile phone, if applicable.

### LTE-Compensator - Information and User Manual

Your car is equipped with a wireless charging tray (WCA) to charge your mobile phone and connect it to the mobile network. To ensure the best possible connection a signal booster (LTE-Compensator) is used in conjunction with the WCA. The following paragraphs refer to this booster:

This is a CONSUMER device.

BEFORE USE, you MUST REGISTER THIS DEVICE with your wireless provider and have your provider's consent. Most wireless providers consent to the use of Compensators. Some providers may not consent to the use of this device on their network. If you are unsure, contact your provider. You MUST operate this device with approved antennas and cables as specified by the manufacturer. Antennas MUST be installed at least 20 cm (8 inches) from any person. You MUST cease operating this device immediately if requested by the FCC or a licensed wireless service provider. Warning E911 location information may not be

provided or may be inaccurate for calls served by using this device.

Please observe additionally the following information

- ▷ Sprint Nextel will allow consumers to register their signal boosters by calling their toll-free number.
- ▷ T-Mobile online registration link: ([www.T-Mobile.com/BoosterRegistration](http://www.T-Mobile.com/BoosterRegistration)); (<https://saqat.t-mobile.com/sites/SignalBooster#>).
- ▷ Verizon's online registration link: (<http://www.verizon-wireless.com/wcms/consumer/register-signal-booster.html>).
- ▷ AT&T online registration link (<https://securec45.securewebsession.com/attsignalbooster.com/>).
- ▷ U.S.Cellular online registration link (<http://www.uscellular.com/uscellular/support/fcc-booster-registration.jsp>).

Before use you must register your booster device with your wireless provider.

If you should be requested by the FCC to cease operating your booster you are not allowed to insert your mobile phone in the charging tray anymore unless the booster is permanently deactivated by your local BMW dealer.

You must not remove the booster from the car nor use it with any other than the preinstalled coupling device or antenna. Any modification of the existing antenna or coupling device as well as the use of other antennas or coupling devices will cause the cease of the booster's operating license.

The booster device fulfills the network protection standards as required by the FCC, such as intermodulation limits, oscillation detection and gain limits.

Booster Manufacturer: Kathrein Automotive

Model Number: LTECOMPB0

Part Number: 6803145-01

FCC-ID: 2ACC7LTECOMPB0



# Storage compartments

## Vehicle features and options

This chapter describes all standard, country-specific and optional features offered with the series. It also describes features and functions that are not necessarily available in your vehicle, e.g., due to the selected options or country versions. This also applies to safety-related functions and systems. When using these functions and systems, the applicable laws and regulations must be observed.

## Storage compartments

### General information

The vehicle interior contains multiple storage compartments for stowing objects.

### Safety information

#### **Warning**

Devices connected to the vehicle via a cable, such as mobile phones or loose objects, can be thrown through the vehicle interior while driving, such as in the event of an accident, braking or evasive maneuver. There is a risk of injury. Secure loose objects or devices that are connected to the vehicle via a cable.

#### **NOTICE**

Anti-slip pads such as anti-slip mats can damage the dashboard. There is a risk of damage to property, among other potential damage. Do not use anti-slip pads.

## Glove compartment

### Safety information

#### **Warning**

Folded open, the glove compartment protrudes in the car's interior. Objects in the glove compartment can be thrown into the car's interior while driving, for instance in the event of an accident, braking or evasive maneuvers. There is a risk of injury. Always close the glove compartment immediately after using it.

### Opening the glove compartment



Pull the handle.

The light in the glove compartment switches on.

### Closing the glove compartment

Fold the lid closed.

### Locking the glove compartment

The glove compartment can be locked with an integrated key. This prevents access to the glove compartment.

After the glove compartment is locked, the vehicle key can be handed over without the

integrated key, for instance when the vehicle is parked by valet parking.

Additional information:

Integrated key, refer to page 95.

## Fold-out compartment

### Safety information

**Warning**

The open fold-out compartment protrudes into the vehicle interior. Objects in the fold-out compartment can be thrown into the vehicle interior during the trip, for instance, in the event of an accident or braking or evasive maneuvers. There is a risk of injury. Always close the fold-out compartment immediately after using it.

### Opening the fold-out compartment

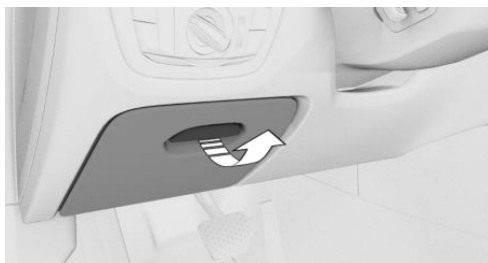

Pull the handle.

### Closing the fold-out compartment

Fold the lid closed.

## Storage compartments in the doors

### General information

There are storage compartments in the doors.

## Safety information

**Warning**

Breakable objects, such as glass bottles or glasses, can break in the event of an accident, braking or an evasive maneuver. Broken glass can be scattered in the car's interior. There is a risk of injury or risk of damage to property. Do not use any breakable objects while driving. Only stow breakable objects in closed storage compartments.

## Storage compartment in the center console

### Opening the storage compartment

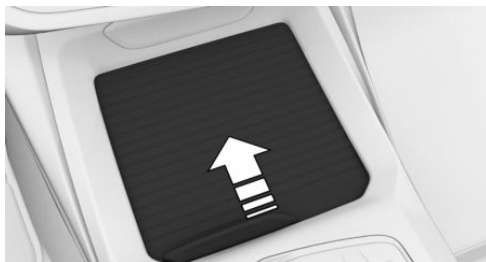

Slide the cover forward.

### Closing the storage compartment

Slide the cover rearward.

## Storage compartment in the rear center console

The rear center console contains one or two storage compartments.

## Center armrest, front

### General information

A storage compartment is located in the center armrest between the seats.

### Opening the storage compartment

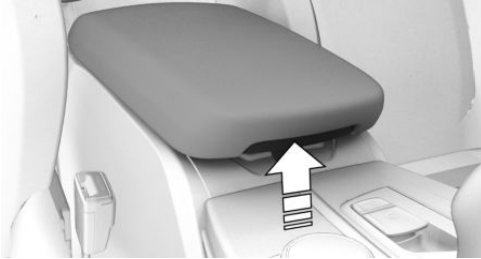

Press the button.

### Closing the storage compartment

Press the lid down until it engages.

## Front cup holder

### Safety information

#### **Warning**

Unsuitable containers in the cup holders may damage the cup holders or be thrown about the car's interior in the event of an accident, an evasive maneuver, or forceful braking. Spilled liquids can distract from the surrounding traffic conditions and lead to an accident. Hot drinks can damage the cup holder or lead to scalding. There is a risk of injury or risk of damage to property. Do not force objects into the cup holder. Use lightweight, shatterproof, and sealable containers. Do not transport hot beverages.

## Opening the cup holder



Slide the cover forward.



Two cup holders are located in the center console.

### Closing the cup holder

Slide the cover rearward.

## Rear cup holder

### Safety information

#### **Warning**

Unsuitable containers in the cup holders may damage the cup holders or be thrown about the car's interior in the event of an accident, an evasive maneuver, or forceful braking. Spilled liquids can distract from the surrounding traffic conditions and lead to an accident. Hot drinks can damage the cup holder or lead to scalding. There is a risk of injury or risk of damage to property. Do not force objects into the cup holder. Use lightweight,



shatterproof, and sealable containers. Do not transport hot beverages.

**⚠ NOTICE**

With an open cup holder, the center armrest cannot be folded back up. There is a risk of damage to property, among other potential damage. Press back the covers before the center armrest is folded up.

## Opening and closing the cup holder

### Opening the cup holder

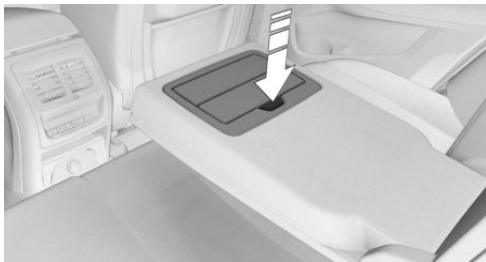

Fold the center armrest forward.

Press the button.

### Closing the cup holder

Press both covers back inward in sequence and fold the center armrest back.

## Coat hooks

### General information

The coat hooks are located in the grab handles in the rear.

## Safety information

**⚠ Warning**

Clothing articles on the coat hooks can obstruct the view while driving. There is a risk of accident. When suspending clothing articles from the coat hooks, ensure that they will not obstruct the driver's view.

**⚠ Warning**

Improper use of the coat hooks can lead to a risk of objects flying about during braking and evasive maneuvers. There is a risk of injury and risk of damage to property. Only hang lightweight objects, for instance clothing articles, from the coat hooks.

# Cargo area

## Vehicle features and options

This chapter describes all standard, country-specific and optional features offered with the series. It also describes features and functions that are not necessarily available in your vehicle, e.g., due to the selected options or country versions. This also applies to safety-related functions and systems. When using these functions and systems, the applicable laws and regulations must be observed.

## Loading

### Safety information

#### **Warning**

High gross vehicle weight can overheat the tires, damage them internally and cause a sudden tire pressure loss. Driving characteristics may be negatively impacted, reducing directional stability, lengthening the braking distances and changing the steering response. There is a risk of accident. Pay attention to the permitted load-carrying capacity of the tires and never exceed the permitted gross vehicle weight.

#### **Warning**

Devices connected to the vehicle via a cable, such as mobile phones or loose objects, can be thrown through the vehicle interior while driving, such as in the event of an accident, braking or evasive maneuver. There is a risk of injury. Secure loose objects or devices that are connected to the vehicle via a cable.

#### **Warning**

Improperly stowed objects can slip and be thrown into the car's interior, for instance in the event of an accident, braking or an evasive maneuver. Vehicle occupants can be hit and injured. There is a risk of injury. Stow and secure objects and cargo properly.

#### **NOTICE**

Fluids in the cargo area can cause damage. There is a risk of damage to property, among other potential damage. Make sure that no fluids leak in the cargo area.

## Steps for determining correct load limit

1. Locate the statement "The combined weight of occupants and cargo should never exceed XXX kg or XXX lbs" on your vehicle's placard.
2. Determine the combined weight of the driver and passengers that will be riding in your vehicle.
3. Subtract the combined weight of the driver and passengers from XXX kg or XXX lbs
4. The resulting figure equals the available amount of cargo and luggage load capacity. For example, if the "XXX" amount equals 1,400 lbs and there will be five 150 lbs passengers in your vehicle, the amount of available cargo and luggage load capacity is 650 lbs (1,400 - 750 (5 x 150) = 650 lbs)
5. Determine the combined weight of luggage and cargo being loaded on the vehicle. That weight may not safely exceed the

available cargo and luggage load capacity calculated in Step 4.

- If your vehicle will be towing a trailer, load from your trailer will be transferred to your vehicle. Consult this manual to determine how this reduces the available cargo and luggage load capacity of your vehicle.

## Payload

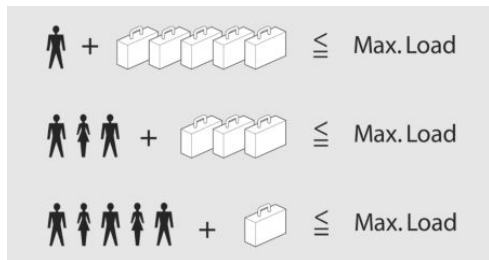

The maximum payload is the sum of the weight of the occupants and the cargo.

The greater the weight of the occupants, the less cargo that can be transported.

## Stowing and securing cargo

- ▶ Cover sharp edges and corners on the cargo.
- ▶ Heavy cargo: stow as far forward as possible, directly behind and at the bottom of the rear seat backrests.
- ▶ Very heavy cargo: stow as far forward as possible, directly behind and at the bottom of the rear seat backrests. When the rear seat is not occupied, secure each of the outer seat belts in the opposite buckle.
- ▶ Fold down the rear seat backrests completely to stow large cargo.
- ▶ Do not stack cargo above the upper edge of the backrests.

- ▶ Small and light cargo: secure with luggage straps or, depending on the equipment, with a cargo net or draw straps.
- ▶ Larger and heavy cargo: secure with cargo straps.

## Lashing eyes in the cargo area

### General information

Attach auxiliary materials to secure the cargo, such as lashing straps, tensioning straps, draw straps or cargo nets, to the lashing eyes in the cargo area.

### Fixed lashing eyes

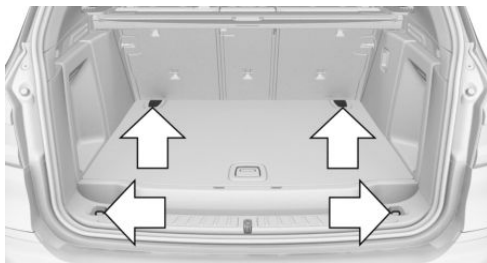

There are four lashing eyes in the cargo area for securing cargo.

### Movable lashing eyes

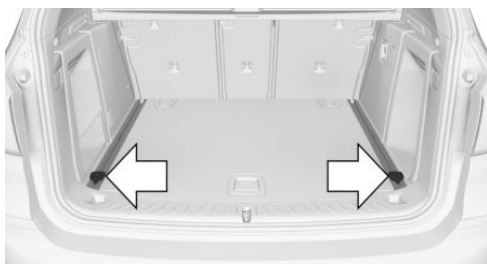

To secure the cargo there are additional movable lashing eyes in the cargo area.

The lashing eyes may be located underneath the cargo floor panel. The lashing eyes can be inserted into the recesses in the rails.

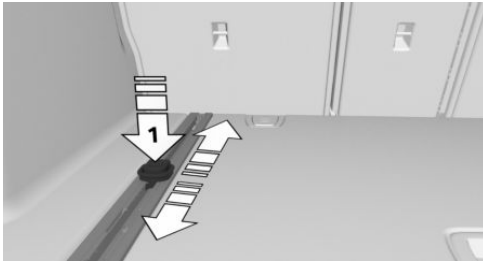

To shift the lashing eyes, press the button, arrow 1. Make sure that the lashing eyes latch at the new position.

## Multifunction hook

### General information

A multifunction hook is located on the left or right side in the cargo area.

### Safety information

#### **Warning**

Improper use of the multifunction hooks can lead to a risk of objects flying about, e.g., during braking and evasive maneuvers. There is a risk of injury and risk of damage to property. Only hang lightweight objects from the multifunction hooks. Only transport heavy luggage in the cargo area if it has been appropriately secured.

### Folding out the multifunction hook

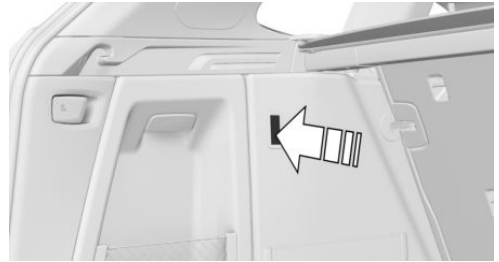

Press on the multifunction hook and turn until it engages.

### Hold function for the cargo floor panel

The cargo area floor can be hooked onto the right multifunction hook.

Without storage compartment package:

1. Fold the rear part of the cargo floor panel forward.



2. Lift the cargo area floor up until it is over the multifunction hook.

3. Fold out the multifunction hook.
4. Lower the cargo area floor, arrow 1, until it is resting on the multifunction hook, arrow 2.

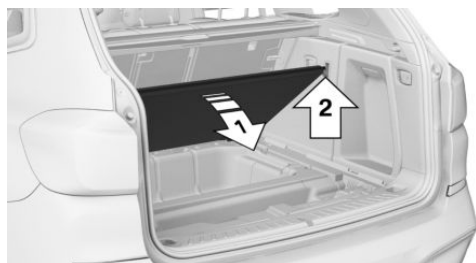

With storage compartment package:

1. Fold out the multifunction hook.
2. Lift the cargo area floor.
3. Release the loop from the cargo floor panel.
4. Attach the loop, arrow 1, on the multifunction hook, arrow 2.

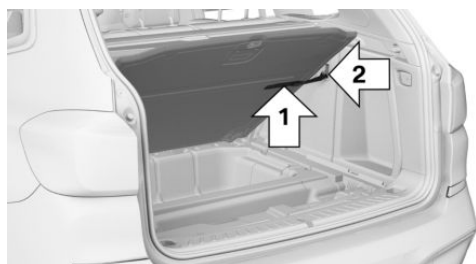

## Retaining strap

A retaining strap is available on the left side trim panel for fastening small objects.

## Net

Small objects can be stowed in the net on the left side.

## Storage compartment on the right side

### General information

Depending on the vehicle equipment, a storage compartment is located on the right side.

### Opening the storage compartment

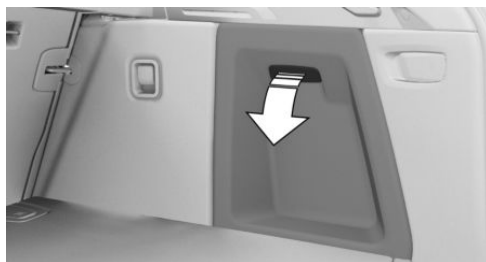

Pull the handle.

## Storage compartment on the left side

### General information

A storage compartment is located on the left side in the cargo area.

### Opening the storage compartment

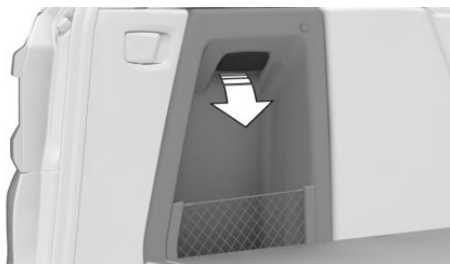

Pull the handle.



## Storage compartment under the cargo floor panel

### General information

There is a storage compartment under the cargo area floor.

### Opening the storage compartment

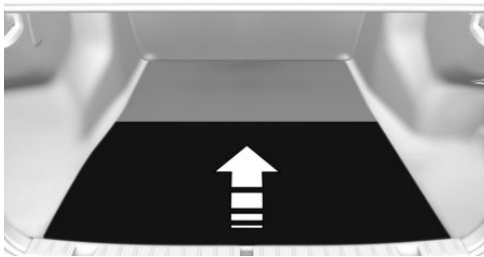

Fold up the cargo area floor.

### Closing the storage compartment

Push the cargo floor panel downward.

## Through-loading system

### Principle

Depending on the equipment version, the cargo area can be enlarged as follows:

- ▶ The rear seat backrests can be folded down.
- ▶ The rear seat backrests can be moved into an upright loading position using the cargo setting.

### General information

The rear seat backrest is divided at a ratio of 40–20–40. The right rear seat backrest and the center section can be folded down separately. The left rear seat backrest can be folded down together with the center section.

Depending on the vehicle equipment, the rear seat backrests can be folded down from the rear or from the cargo area.

### Safety information

#### **Warning**

There is a danger of jamming with folding down the rear seat backrests. There is a risk of injury or risk of damage to property. Make sure that the area of movement of the rear seat backrest and the of the head restraint is clear prior to folding down.

#### **Warning**

If a rear seat backrest is not locked, unsecured cargo can be thrown about the car's interior; for instance, in the event of an accident, braking or an evasive maneuver. There is a risk of injury. Make sure that the rear seat backrest is locked after folding it back.

#### **Warning**

The stability of the child restraint system is limited or compromised with incorrect seat setting or improper installation of the child seat. There is a risk of injury or danger to life. Make sure that the child restraint system fits securely against the backrest. If possible, adjust the backrest tilt for all affected backrests and correctly adjust the seats. Make sure that seats and backrests are securely engaged or locked. If possible and necessary, adjust the height of the head restraints or remove them.

#### **Warning**

Once the rear seat backrest has been folded down, the locking bracket protrudes into the car's interior. There is a risk of damage to property, among other potential dam-

age. When the rear seat backrest is folded down, pay attention to the protruding locking bracket and keep this area unobstructed.

**NOTICE**

Vehicle parts can be damaged when folding down the rear seat backrest. There is a risk of damage to property, among other potential damage. Make sure that the area of movement of the rear seat backrest including head restraint is clear when folding down.

- ▷ Left lever: fold down the left and middle rear seat backrest.
- ▷ Right lever: fold down the right rear seat backrest.

**Folding back the backrest**

Return the rear seat backrest to the seat position and engage it.

**Folding down the center section**

1. Fold down the center head restraint.
2. Pull lever and fold the center section forward.

**Folding down the rear seat backrest**

**From the rear**

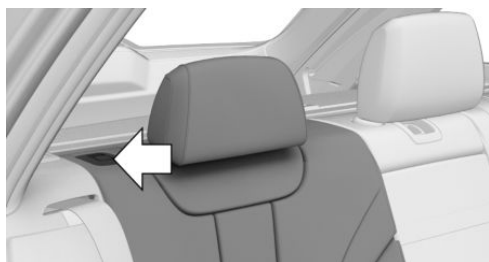

Pull the lever and fold the rear seat backrest forward.

**From the cargo area**

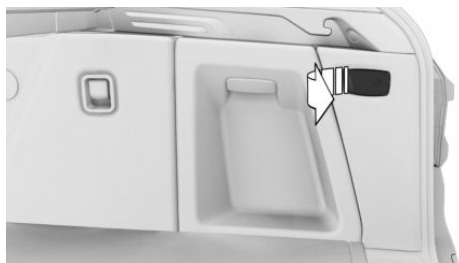

Pull the corresponding lever in the cargo area to release the rear seat backrest.

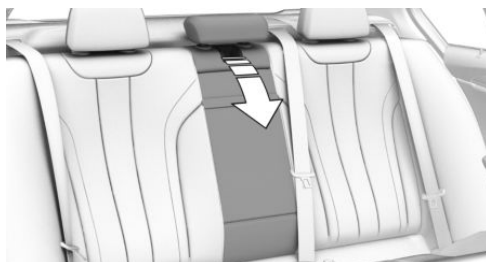

**Cargo position**

**Principle**

The rear seat backrests can be moved into an upright loading position individually. An adjustment in several tilt stages is possible as needed.

**General information**

The backrest tilt for the center section is adjusted together with the left backrest.

## Adjusting

1. Pull the lever and hold it.



2. Adjust the inclination of the rear seat backrest if required.

After the adjustment, move the backrest slightly forward or back to engage it correctly.

## Cargo cover

### Safety information

#### Warning

Devices connected to the vehicle via a cable, such as mobile phones or loose objects, can be thrown through the vehicle interior while driving, such as in the event of an accident, braking or evasive maneuver. There is a risk of injury. Secure loose objects or devices that are connected to the vehicle via a cable.

#### Warning

A cargo cover that snaps back quickly can jam body parts or cause damage. There is a risk of injury or risk of damage to property. Do not let the cargo cover snap back into place.

#### Warning

An incorrectly inserted cargo cover can be thrown about the car's interior, such as in the event of an accident or a braking or evasive maneuver. There is a risk of injury and risk of damage to property. Make sure the cargo cover is securely engaged in the brackets.

### Closing the cargo cover

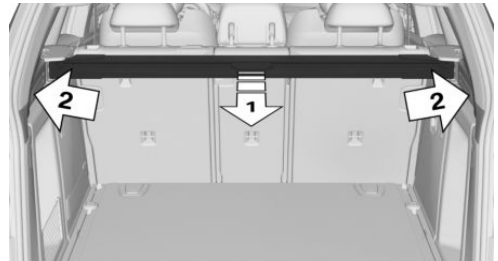

Pull out the cargo cover, arrow 1, and hook both sides into the brackets, arrow 2.

### Removing the cargo cover

The cover can be removed to load bulky luggage.

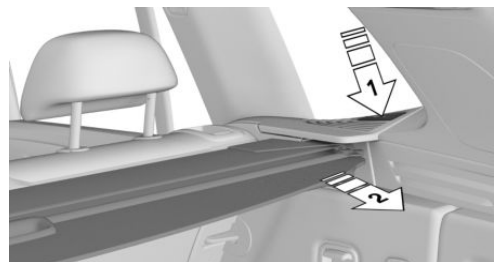

Press the release button, arrow 1, and pull the cargo cover out toward the rear, arrow 2.

The cargo cover can be stowed in the storage compartment under the cargo floor panel.

## Stowing the cargo cover

1. Open the storage compartment on the left side.  
Storage compartment on the left side, refer to page [304](#).
2. Lift the cargo area floor and attach it to the right multi-function hook.  
Multifunction hook, refer to page [303](#).
3. Stow the cargo cover on the left and lower it on the right side.

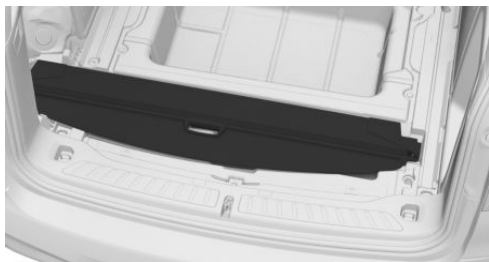

4. Close the cargo floor panel.

## Inserting the cargo cover

Slide the cover forward horizontally into the two side brackets. Make sure that the cover audibly engages on both sides.



# Things to remember when driving

## Vehicle features and options

This chapter describes all standard, country-specific and optional features offered with the series. It also describes features and functions that are not necessarily available in your vehicle, e.g., due to the selected options or country versions. This also applies to safety-related functions and systems. When using these functions and systems, the applicable laws and regulations must be observed.

## Break-in procedures

### General information

Moving parts need to work together smoothly. The following instructions will help you to achieve a long vehicle life and good efficiency. During break-in, do not use the Launch Control.

### Safety information

#### **Warning**

Due to new parts and components, safety and driver assistance systems can react with a delay. There is a risk of accident. After installing new parts or with a new vehicle, drive conservatively and intervene early if necessary. Observe the break-in procedures of the respective parts and components.

## Engine, transmission, and axle drive

### Up to 1,200 miles/2,000 km

Do not exceed the maximum engine and road speed:

- ▶ For gasoline engine 4,500 rpm and 100 mph/160 km/h.

Avoid full throttle or kickdown under all circumstances.

### From 1,200 miles/2,000 km

The engine and vehicle speed can gradually be increased.

### Tires

Tire traction is not optimal due to manufacturing circumstances when tires are brand new.

Drive conservatively for the first 200 miles/300 km.

### Brake system

Brake disks and brake pads only reach their full effectiveness after approx. 300 miles/500 km. Drive moderately during this break-in period.

### Following part replacement

Observe the break-in procedures again if components mentioned above are replaced.

## Driving on poor roads

### Principle

Because of its greater ground clearance, the vehicle can be driven on a variety of road types and qualities.

All-wheel drive can help improve drive power.

## Safety information

### NOTICE

Objects in unpaved areas, for instance stones or branches, can damage the vehicle. There is a risk of damage to property, among other potential damage. Do not drive on unpaved terrain.

## When driving on poor roads

For your own safety, for the safety of passengers and of the vehicle, note the following points:

- ▶ Familiarize yourself with the vehicle before driving.
- ▶ Do not take risks when driving.
- ▶ Adjust the speed to the road surface conditions. The steeper and more uneven the road, the slower the speed should be.
- ▶ When driving on steep uphill or downhill grades: add engine oil and coolant up to near the maximum mark.
- ▶ On steep downhill driving, use Hill Descent Control.
- ▶ Do not allow the vehicle body or underbody to come into contact with the ground.

The ground clearance is no more than 7.8 inches/20 cm and can vary according to the vehicle's load status.

- ▶ When wheels continue to spin, depress the accelerator pedal sufficiently so that driving stability control systems can distribute the driving power to the wheels. If necessary, activate the Dynamic Traction Control.

## After a trip on poor roads

After a trip on poor roads, check wheels and tires for damage to maintain driving safety. Clear heavy soiling from the body.

Have the vehicle checked by an authorized service center or another qualified service cen-

ter or repair shop after the vehicle body or floor has come into contact with the ground.

## General driving notes

### Closing the tailgate

#### Safety information

### Warning

An open tailgate protrudes from the vehicle and can endanger occupants and other road users or damage the vehicle in the event of an accident, braking or evasive maneuvers. In addition, exhaust fumes may enter the vehicle interior. There is a risk of injury or risk of damage to property. Do not drive with the tailgate open.

### Driving with the tailgate open

If the vehicle still needs to be driven with the tailgate open:

- ▶ Close all windows and the glass sunroof.
- ▶ Greatly increase the blower output.
- ▶ Drive moderately.

### Hot exhaust system

### Warning

High temperatures can occur underneath the body, for instance caused by the exhaust system, while driving. Contact with the exhaust system can cause burns. There is a risk of injury. Do not touch the hot exhaust system, including the exhaust pipe.

** Warning**

If combustible materials, such as leaves or grass, come in contact with hot parts of the exhaust system, these materials can ignite. There is a risk of fire and an injury hazard. Do not remove the heat shields installed and never apply undercoating to them. Make sure that no combustible materials can come in contact with hot vehicle parts while driving, in Neutral or during parking.

## Mobile radio in the vehicle

** Warning**

Vehicle electronics and mobile communication devices can influence one another. There is radiation due to the transmission operations of mobile communication devices. There is a risk of injury or risk of damage to property. If possible, in the car's interior only use mobile communication devices, such as mobile phones, with a direct connection to an external antenna or the Personal eSIM in order to prevent mutual interference and to deflect radiation from the vehicle interior.

## Aquaplaning

On wet or slushy roads, a wedge of water can form between the tires and road surface.

This phenomenon is referred to as aquaplaning. It is characterized by a partial or complete loss of contact between the tires and the road surface, ultimately undermining your ability to steer and brake the vehicle.

## Driving through water

### General information

When driving through water, follow the following:

- ▷ Deactivate Auto Start/Stop function.
- ▷ Drive through calm water only.
- ▷ Drive through water only up to a maximum height of 19.6 inches/50 cm.
- ▷ Drive through water at a maximum of walking speed, up to 3 mph/5 km/h.

## Safety information

** NOTICE**

When driving too quickly through deep water, the water can penetrate the engine compartment, the electrical system, or the transmission. There is a risk of damage to property, among other potential damage. When driving through water, do not exceed the maximum indicated water level and the maximum speed for driving through water.

## Braking safely

### General information

The vehicle is equipped with an Antilock Braking System as a standard feature.

Perform emergency braking in situations that require such.

Steering is still responsive. You can still avoid any obstacles with a minimum of steering movement.

The pulsation of the brake pedal and sounds from the hydraulic circuits indicate that the Antilock Braking System is in its active mode.

In certain braking situations, the perforated brake disks can emit functional noises. However, functional noises have no effect on the performance and operational reliability of the brake.



## Objects in the travel path of the pedals

### Warning

Objects in the driver's footwell can limit the pedal travel or block a depressed pedal. There is a risk of accident. Stow objects in the vehicle such that they are secured and cannot enter into the driver's footwell. Use floor mats that are suitable for the vehicle and can be safely attached to the floor. Do not use loose floor mats and do not layer several floor mats. Make sure that there is sufficient clearance for the pedals. Ensure that the floor mats are securely fastened again after they were removed, for instance for cleaning.

## Driving in wet conditions

In case of wet roads, exposure to road salt or in heavy rain, gently depress the brake pedal every few kilometers.

Ensure that this action does not endanger other road users.

The heat generated during braking dries brake disks and brake pads and protects them against corrosion.

In this way the brake force will be available when you need it.

## Hills

### General information

Drive long or steep downhill gradients in the gear that requires least braking effort. Otherwise, the brake system may overheat and reduce braking effect.

You can increase the engine's braking effect by downshifting, going all the way to first gear, if needed.

## Safety information

### Warning

Light but consistent pressure on the brake pedal can lead to high temperatures, brake wear and possibly even brake system failure. There is a risk of accident. Avoid placing excessive stress on the brake system.

### Warning

In idle state or with the engine switched off, safety functions, for instance engine braking effect, braking assistance and steering assistance, may not be available. There is a risk of accident. Do not attempt to drive in idle state or with the engine switched off.

## Brake disk corrosion

Corrosion on the brake disks and contamination on the brake pads are increased by the following circumstances:

- ▶ Low mileage.
- ▶ Extended stationary periods.
- ▶ Infrequent use of the brakes.
- ▶ Aggressive, acidic, or alkaline cleaning agents.

Corrosion buildup on the brake disks will cause a pulsating effect on the brakes when braking slowly - generally this cannot be corrected.

## Condensation water under the parked vehicle

When using the automatic climate control, condensation water develops and collects underneath the vehicle.

## Roof-mounted luggage rack

### General information

Installation only possible with roof rack.

Roof-mounted luggage racks are available as optional accessories.

### Safety information

#### **Warning**

When driving with a roof load, for instance with roof-mounted luggage rack, the vehicle's center of gravity is higher, which increases the risk of the vehicle tipping in critical driving situations. There may be a risk of accident or risk of damage to property. Drive with roof load only with activated Dynamic Stability Control.

### Installation

Follow the assembly instructions of the roof rack.

Be sure that adequate clearance is maintained for tilting and opening the glass sunroof.

### Loading

Because roof-mounted luggage racks raise the vehicle's center of gravity when loaded, they have a major effect on vehicle handling and steering response.

Therefore, note the following when loading and driving:

- ▷ Do not exceed the approved roof/axle weights and the approved gross vehicle weight.
- ▷ Be sure that adequate clearance is maintained for tilting and opening the glass sunroof.
- ▷ Distribute the roof load uniformly.

- ▷ The roof load should not extend past the loading area.
- ▷ Always place the heaviest pieces on the bottom.
- ▷ Secure the roof luggage firmly, for instance using luggage straps.
- ▷ Do not let objects project into the swiveling range of the tailgate.
- ▷ Drive cautiously and avoid driving off and braking with jerky movements or fast cornering.

## Driving on racetracks

#### **Warning**

The vehicle is not designed for use in M Sport or motorsport-like competition. There is a risk of accident. Do not use the vehicle for M Sport or motorsport-like competitions.

Higher mechanical and thermal loads during racetrack operation lead to increased wear. Use of the vehicle in M Sport or motor sport type competition is an improper use of the vehicle and may affect your warranty coverage. Please consult the "New Vehicle Limited Warranty" Booklet for further information on warranty matters.

# Trailer towing

## Vehicle features and options

This chapter describes all standard, country-specific and optional features offered with the series. It also describes features and functions that are not necessarily available in your vehicle, e.g., due to the selected options or country versions. This also applies to safety-related functions and systems. When using these functions and systems, the applicable laws and regulations must be observed.

## General information

The permissible trailer loads, axle weights, drawbar nose weights, and the permissible gross vehicle weight are specified in the technical data.

The vehicle is equipped with an enhanced suspension system on the rear axle and, depending on the vehicle type, with a more powerful cooling system.

## Before driving

### Drawbar nose weight

The maximum payload of the towing vehicle is reduced by the weight of the trailer hitch and the drawbar nose weight. The drawbar nose weight increases the vehicle weight. Do not exceed the approved gross vehicle weight of the towing vehicle.

### Loading

Distribute cargo as evenly as possible on the loading platform.

Stow the payload as low and close to the trailer axle as possible. A low center of gravity

in the trailer increases the driving safety of the entire car-trailer combination.

Do not exceed the approved gross vehicle weight of the trailer and the permissible trailer load of the vehicle. The smaller value applies in each case.

### Tire pressure

Note the tire inflation pressure of the vehicle and trailer.

For the vehicle, the tire inflation pressure for higher loads applies.

For the trailer, the specifications of the manufacturer apply.

Additional information:

Tire pressure specifications, refer to page [328](#).

### Flat tire monitor

After correcting the tire inflation pressure or hitching/unhitching a trailer, initialize the Flat Tire Monitor.

Additional information:

Flat tire monitor, refer to page [351](#).

### Tire pressure monitor

After correcting the tire pressure or hitching/unhitching a trailer, reset the Tire Pressure Monitor.

Additional information:

Tire pressure monitor, refer to page [344](#).

### Exterior mirrors

Exterior mirrors, which allow the driver to see both rear edges of the trailer, are available as optional accessories from an authorized service center or another qualified service center or repair shop.

## Electrical consumption

### General information

Before start of the trip, check the function of the trailer tail lights.

Keep the activation times of the electrical components short during camper operation to save the vehicle battery power.

### Trailer tail lights

- ▶ Turn signals/brake lights: 54 watts per side.
- ▶ Rear lights: 100 watts in total.
- ▶ Backlight: 54 watts in total.

## Towing a trailer

### General information

If the trailer power socket is occupied, some driver assistance systems are unavailable, or available to a limited extent. A Check Control message is displayed where applicable.

When driving with a trailer or load carrier and the trailer power socket is not occupied, some driver assistance systems may have functional limitations or may malfunction.

To prevent malfunctions, activate trailer towing.

When the trailer socket is occupied or trailer towing is activated, some driver assistance systems are unavailable, or available to a limited extent. A Check Control message is displayed where applicable.

Additional information:

Activating trailer towing, refer to page [317](#).

## Safety information

### **Warning**

Depending on the design and loading of trailers, they may begin swinging at speeds exceeding approx. 50 mph/80 km/h. There may be a risk of accident or risk of damage to property.

Adapt your speed when driving with a trailer. Immediately brake in the case of swinging. Apply necessary steering corrections as carefully as possible.

### **Warning**

The tire inflation pressure must be adjusted to the increased axle weight in trailer towing. Driving with too low tire inflation pressure can damage the tires. There may be a risk of accident or risk of damage to property. Do not exceed a speed of 60 mph / 100 km/h. Increase the tire inflation pressure of the towing vehicle by 0.2 bar. Note the maximum possible tire inflation pressure indicated on the tire.

## Uphill grades

### General information

In the interest of safety and to avoid hindering the smooth flow of traffic, the towing of trailers is permissible on uphill grades up to 12 %.

If higher trailer loads are approved at a later point in time, the gradient limit is 8%.

### Driving off on uphill grades

The parking brake is automatically released when the accelerator pedal is activated.

In order to prevent rolling back when driving off, use the parking brake.

1.  Pull and release switch before driving off.  
The parking brake is set.
2. Step on the accelerator pedal sufficiently to drive off.

## Hills

A car-trailer combination has the tendency to swing more readily on hills.

Manually downshift to the next-lowest gear before driving on a hill and drive downhill slowly.

Depending on vehicle equipment, change gear using the shift paddle or selector lever position D/L.

## Trailer stabilization control

### Principle

Trailer stabilization control helps by absorbing the swinging movements of the trailer.

The system detects swinging and automatically brakes the vehicle quickly in order to leave the critical speed range and stabilize the car-trailer combination.

### General information

If the trailer power socket is occupied but a trailer has not been hitched, the system can also become active in extreme driving situations, e.g., when using a bicycle rack with lighting.

### Functional requirement

The system is functional at speeds beginning at approx. 40 mph/65 km/h while a trailer is being towed and the trailer power socket is occupied.

## System limits

The system cannot intervene or not intervene in time in the following situations, for instance:

- ▶ If a trailer jackknifes suddenly, for instance on slippery roads or loose surfaces.
- ▶ If a trailer with a high center of gravity tilts, before swinging is detected.
- ▶ If Dynamic Stability Control is deactivated or has malfunctioned.
- ▶ When the power consumption of a trailer is too low, for instance due to tail lights with LED technology, to be detected by the system.

## Activating trailer towing

### Principle

When driving with a trailer or load carrier and the trailer power socket is not occupied, some driver assistance systems may have functional limitations or may malfunction. To prevent malfunctions, activate trailer towing.

### Activating

1. "CAR"
2. "Settings"
3. "General settings"
4. "Trailer mode"
5. "Trailer mode"

## Mount for trailer hitch

### General information

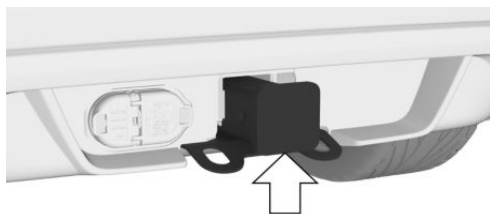

The mount for the trailer hitch is located on the rear of the vehicle.

Information on suitable trailer hitches is found on the underside of the mount, see arrow.

Remove the ball head when driving without a trailer or load carrier.

Follow the Maintenance Instructions, refer to page 386.

### Safety information

**Warning**

During driving, high temperatures can occur underneath the vehicle body, for instance caused by the exhaust system. Contact with the hot components can cause burns. There is a risk of injury. Do not touch hot components. Do not perform work in the vicinity of hot components until after they have cooled down.

### Removing the cover

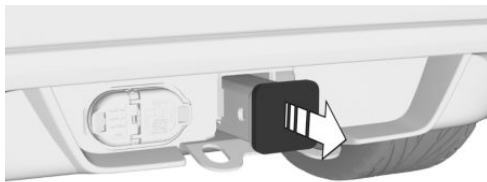

Pull the cover out of the back of the mount, and stow it in the vehicle.

### Trailer power socket

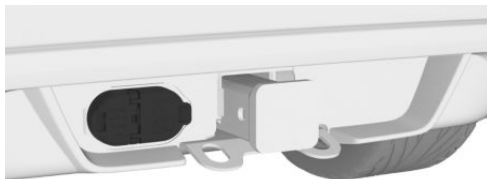

The socket is located to the left of the mount for the trailer hitch.

### Loops for trailer safety chain

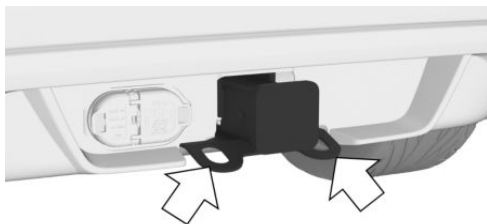

There are two loops on the mount for the trailer hitch for locking the trailer safety chain.

Secure the trailer safety chain to the loops for increased safety when driving with a trailer.

Ensure that the trailer safety chain can move freely and is not dragging on the ground.

## Brake Controller

---

The vehicle manufacturer recommends that you have a Brake Controller installed by an authorized service center or another qualified service center or repair shop.

Information on installing a Brake Controller can be obtained from an authorized service center or another qualified service center or repair shop.

# Saving fuel

## Vehicle features and options

This chapter describes all standard, country-specific and optional features offered with the series. It also describes features and functions that are not necessarily available in your vehicle, e.g., due to the selected options or country versions. This also applies to safety-related functions and systems. When using these functions and systems, the applicable laws and regulations must be observed.

## Reducing fuel consumption

### General information

The vehicle contains advanced technologies for the reduction of consumption and emission values.

The fuel consumption depends on various factors, such as driving style, road conditions, maintenance or environmental factors.

Carrying out certain measures, such as a moderate driving style and regular maintenance, can influence fuel consumption and the environmental pollution.

### Removing unnecessary cargo

Additional weight increases fuel consumption.

### Removing attached parts following use

Remove auxiliary mirrors, roof-mounted or rear carriers which are no longer required following use.

Attached parts on the vehicle impair the aerodynamics and increase the fuel consumption.

### Close the windows and glass sunroof

Driving with the glass sunroof and windows open results in increased drag and raises fuel consumption.

### Tires

#### General information

Tires can affect consumption in various ways, for instance tire size may influence consumption.

#### Checking the tire pressure regularly

Check and, if needed, correct the tire inflation pressure at least twice a month and before starting on a long trip.

Low tire pressure increases rolling resistance and thus fuel consumption and tire wear.

Observe the correct tire inflation pressure as well as the ECO tire inflation pressure, where applicable.

Additional information:

Tire pressure specifications, refer to page [328](#).

#### Drive away without delay

Do not wait for the engine to warm-up while the vehicle remains stationary. Start driving right away, but at moderate RPM.

This is the fastest way of warming the cold engine up to operating temperature.

#### Anticipatory driving

A smooth and anticipatory driving style reduces fuel consumption.

Avoid unnecessary acceleration and braking.

Maintain a suitable distance to the vehicle driving ahead of you.



## Avoid high RPM

Driving at low engine speeds lowers fuel consumption and reduces wear.

If necessary, observe the vehicle's gear shift indicator.

## Using coasting/overrun mode

When approaching a red traffic light, take your foot off the accelerator and let the vehicle coast to a halt.

For going downhill take your foot off the accelerator and let the vehicle roll.

The fuel supply is interrupted in coasting/overrun mode.

## Switch off the engine during longer stops

### Switching off the engine

Switch off the engine during longer stops, for instance at traffic lights, railroad crossings or in traffic jam.

### Auto Start/Stop function

The Auto Start/Stop function of the vehicle automatically switches off the engine during a stop.

If the engine is switched off and then restarted rather than leaving the engine running constantly, fuel consumption and emissions are reduced. Savings can begin within a few seconds of an engine stop.

## Switching off any functions that are not currently needed

Functions such as seat heating and the rear window defroster require a lot of energy and increase fuel consumption, especially in city traffic and with stop-and-go driving.

Switch off these functions if they are not needed.

The ECO PRO driving mode supports the energy conserving use of comfort features.

These functions are automatically deactivated partially or completely.

## Having maintenance carried out

Have the vehicle maintained regularly to achieve optimal vehicle efficiency and service life. BMW recommends that maintenance work be performed by a BMW service center.

Also refer to BMW Maintenance System.

## ECO PRO

---

### Principle

ECO PRO supports a driving style that saves on consumption. For this purpose, the engine control and comfort features, for instance the climate control output, are adjusted.

Steptronic transmission: under certain conditions the engine is automatically decoupled from the transmission in the D selector lever position. The vehicle continues traveling in Neutral to reduce consumption. The D selector lever position remains engaged.

In addition, situational information and ECO PRO tips are displayed to help promote a power-saving driving style.

The achieved extended range is displayed in the instrument cluster as bonus range.

### General information

The system includes the following EfficientDynamics functions and EfficientDynamics displays:

- ▷ ECO PRO bonus range.
- ▷ ECO PRO seat climate control.
- ▷ ECO PRO climate control.
- ▷ ECO PRO light and sight.
- ▷ ECO PRO speed.

- ▷ Coasting mode.
- ▷ Driving style analysis.

## Overview



Button

## Activating ECO PRO

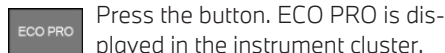

Press the button. ECO PRO is displayed in the instrument cluster.

## Configuring ECO PRO INDIVIDUAL

### Via the Driving Dynamics Control

1. Activate ECO PRO.
2. "ECO PRO INDIVIDUAL"

### Via iDrive

1. "CAR"
2. "Settings"
3. "Driving mode"
4. "ECO PRO INDIVIDUAL"
5. Select the desired setting.

## ECO PRO speed

- ▷ "ECO PRO speed": activate ECO PRO speed.

An ECO PRO tip is displayed if the speed of the set ECO PRO speed is exceeded.

- ▷ "Notification at:"

Set the desired speed for the ECO PRO speed.

## Activating/deactivating ECO PRO functions

The following ECO PRO functions can be activated/deactivated:

- ▷ "ECO PRO seat heating"
- ▷ "ECO PRO climate control"
- ▷ "ECO PRO light and sight"

## Coasting

Efficiency can be optimized by disengaging or switching off the engine and coasting in Neutral.

## ECO PRO seat climate control

The activation of ECO PRO will reduce the output of the seat heating.

## ECO PRO climate control

The air conditioning is adjusted.

This means it is possible to deviate slightly from the set temperature and heat or cool the car interior more slowly to economize on electrical consumption.

## ECO PRO light and view

The output of exterior mirror heating and rear window defroster is reduced.

## Resetting the settings

Reset ECO PRO INDIVIDUAL to the standard settings:

"Reset to ECO PRO STANDARD"

## Displays in the instrument cluster

## General information

When ECO PRO driving mode is activated, the display switches to a special configuration.

## ECO PRO bonus range



A modified driving style helps you extend your driving range.

The range extension can be displayed as the bonus range in the instrument cluster.

The efficiency display includes the bonus range.

If the bonus range appears in gray, the current driving style is inefficient.

The display turns blue as soon as all conditions for efficient driving are met.

The intervals for resetting the bonus range depend on the settings of the trip data.

## Consumption display

Instrument cluster with enhanced features:

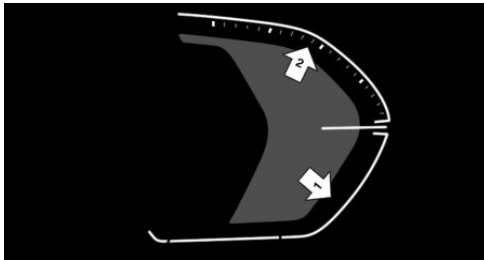

Instrument cluster without enhanced features:

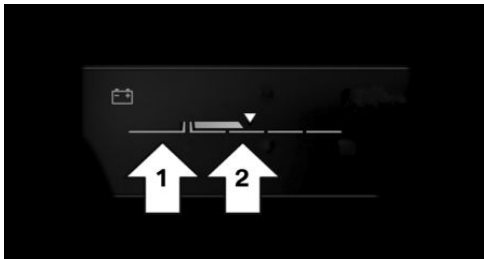

A needle in the consumption display informs about the current driving style:

- ▷ The current consumption in relation to the average consumption is displayed.
- ▷ Needle in the area of arrow 1: display of the energy recovered by coasting or when braking.
- ▷ Needle in the area of arrow 2: display when accelerating.

If the acceleration is inefficient, the area between the average consumption and the current consumption is colored red.

In addition, the following information is displayed, depending on the situation:

- ▷ Depending on the equipment: the total distance driven in Coasting mode.
- ▷ The total time that the engine has been switched off during automatic engine stops.
- ▷ A gear shift indicator recommending the use of a more efficient gear.

## Indications on the Control Display

### General information

Information about the current operating principle of the ECO PRO functions can be displayed as energy flow.

### Displaying energy flow information

1. "CAR"
2. "Driving information"
3. "Energy flow"

The following functions are displayed:

- ▷ Auto Start/Stop function.
- ▷ Energy recovery.
- ▷ Coasting.

## Engine-Off / Coasting

### Principle

Under certain conditions the engine is automatically decoupled from the transmission in

the D selector lever position. The vehicle continues traveling in Neutral to reduce consumption. Selector lever position D remains engaged. This driving condition is referred to as coasting.

Under certain conditions, the engine will not be operated in Neutral while coasting but switched off automatically in vehicles with Mild-Hybrid technology. When the engine is switched off, the lettering READY is displayed in the instrument cluster. The vehicle continues to coast without consuming fuel. This driving condition is referred to as engine-off coasting.

As soon as the brake or accelerator pedal is depressed, the engine is automatically coupled to the transmission again.

## General information

Coasting is a component of the ECO PRO driving mode.

Coasting is automatically activated when ECO PRO driving mode is called via the Driving Dynamics Control.

A proactive driving style helps the driver to use the function often and supports the efficient effect of coasting.

## Functional requirements

The function is available in the speed range from approx. 16 mph/25 km/h to 100 mph/160 km/h.

The function is active if the following conditions are met:

- ▶ The accelerator pedal is not depressed or the accelerator pedal is released.
- ▶ Brake pedal not depressed or only slightly depressed.
- ▶ The selector lever is in selector lever position D.
- ▶ Engine and transmission are at operating temperature.
- ▶ Active Cruise Control with Stop&Go function, ACC, not activated.

## Operation via shift paddles

### Principle

The Coasting mode can be influenced with the shift paddles.

### Activating/deactivating coasting via shift paddles

1. Shift to the highest gear by pulling the right shift paddle.
2. To activate Coasting mode, actuate the right shift paddle again.

To deactivate, actuate the left shift paddle.

### Display

#### Display in the instrument cluster

 The coasting distance traveled is indicated in Coasting mode.

#### Indications on the Control Display

The Coasting mode is displayed under energy flow while driving.

The distance traveled in Coasting mode is displayed in the trip data.

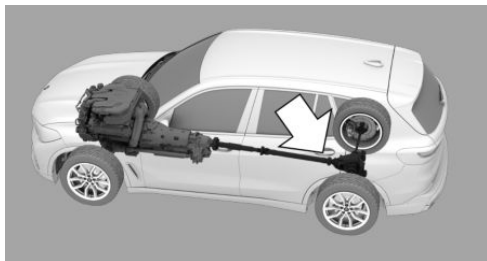

Color code blue: Coasting mode.

#### Displaying energy flow information

1. "CAR"
2. "Driving information"
3. "Energy flow"

## System limits

The function is not available under one of the following conditions.

- ▷ DSC OFF or TRACTION activated.
- ▷ Driving in the dynamic limit range and on steep uphill or downhill grades.
- ▷ Battery charge status temporarily too low or vehicle electrical system drawing excessive current.
- ▷ Trailer towing.
- ▷ HDC Hill Descent Control activated

## Driving style analysis

---

### Principle

The function helps develop an especially efficient driving style and to conserve fuel.

For this purpose, the driving style is analyzed. The assessment is done in various categories and is displayed on the Control Display.

This display will help you adjust your driving style and save some fuel.

### General information

The current trip is assessed.

To support an efficient driving style, ECO PRO tips are displayed during driving.

The range of the vehicle can be extended by adjusting your driving style.

This gain in range is displayed as a bonus range in the instrument cluster and on the Control Display.

### Functional requirement

This function is available in ECO PRO driving mode.

## Calling up the Driving style analysis

1. "CAR"
2. "Driving information"
3. "Driving style analysis"

### Display on the control display

The display of the Driving style analysis shows the efficiency of the Driving style.

The more efficient the driving style, the more bars are displayed in color and the faster the bonus range increases.

In contrast, a reduced number of bars will be displayed with an inefficient driving style.

# Refueling

## Vehicle features and options

This chapter describes all standard, country-specific and optional features offered with the series. It also describes features and functions that are not necessarily available in your vehicle, e.g., due to the selected options or country versions. This also applies to safety-related functions and systems. When using these functions and systems, the applicable laws and regulations must be observed.

## Follow the following when refueling

### General information

Follow the fuel recommendation prior to refueling.

When refueling, hook the filler nozzle completely into the filler pipe. Lifting up the filler nozzle during refueling causes:

- ▶ Premature switching off.
- ▶ Reduced return of the fuel vapors.

The fuel tank is full when the filler nozzle clicks off the first time.

Make sure that the fuel cap is closed properly after refueling, otherwise the emissions warning light may light up.

Follow safety regulations posted at the filling station.

Additional information:

Fuel quality, refer to page [363](#).

## Safety information

### ⚠ NOTICE

With a range below 30 miles/50 km, the engine may no longer have sufficient fuel. Engine functions are not ensured anymore. There is a risk of damage to property, among other potential damage. Refuel promptly.

### ⚠ NOTICE

Fuels are toxic and aggressive. Overfilling of the fuel tank can damage the fuel system. Painted surfaces may be damaged by contact with fuel. Escaping fuel can harm the environment. There is a risk of damage to property, among other potential damage. Avoid overfilling.

## Fuel cap

### Opening

1. To open the fuel filler flap, press on the rear edge, arrow. The fuel filler flap opens.



2. Turn the fuel cap counterclockwise.

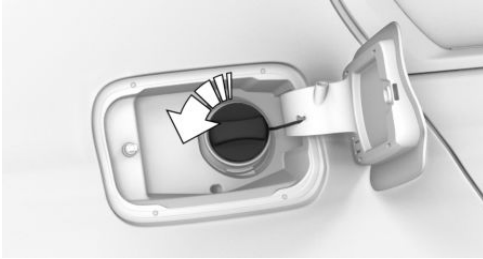

Have fuel filler flap unlocked by an authorized service center or another qualified service center or repair shop.

3. Place the fuel cap in the bracket attached to the fuel filler flap.

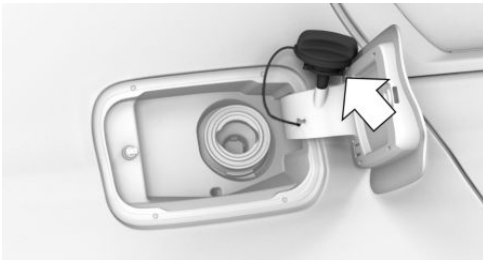

## Closing

### **Warning**

The retaining strap of the fuel cap can be jammed and crushed during closing. The cap cannot be correctly closed. Fuel or fuel vapors can escape. There is a risk of injury or risk of damage to property. Pay attention that the retaining strap is not jammed or crushed when closing the cap.

1. Fit the fuel cap and turn it clockwise until you clearly hear a click.
2. Press on the fuel filler flap until it engages.

## Emergency unlocking

It may be necessary in certain situations to unlock the fuel filler flap manually, for instance with an electrical malfunction.

# Wheels and tires

## Vehicle features and options

This chapter describes all standard, country-specific and optional features offered with the series. It also describes features and functions that are not necessarily available in your vehicle, e.g., due to the selected options or country versions. This also applies to safety-related functions and systems. When using these functions and systems, the applicable laws and regulations must be observed.

## Tire pressure

### General information

The tire condition and tire pressure influence the following:

- ▶ The service life of the tires.
- ▶ Driving safety.
- ▶ Driving comfort.
- ▶ Fuel consumption.

### Safety information

#### **Warning**

A tire with too little or no tire inflation pressure may heat up significantly and sustain damage. This will have a negative impact on aspects of handling, such as steering and braking response. There is a risk of accident. Regularly check the tire inflation pressure, and correct it as needed, for instance twice a month and before a long trip.

## Tire pressure specifications

### In the tire inflation pressure table

The tire inflation pressure table, refer to page 328, contains all tire inflation pressure specifications for the specified tire sizes at the ambient temperature. The tire inflation pressure values apply to tire sizes approved by the manufacturer of the vehicle for the vehicle type.

To identify the correct tire inflation pressure, please note the following:

- ▶ Tire sizes of your vehicle.
- ▶ Maximum speed for driving.

### On the control display

The current tire inflation pressure values and the intended tire inflation pressure values for the mounted tires can be displayed on the Control Display.

To ensure that they are displayed correctly, the tire sizes must be stored in the system and must have been set for the mounted tires.

The current tire inflation pressure value is located on each tire.

The reference tire inflation pressure value is located in the lower area of the control display.

## Checking the tire pressure

### General information

Tires heat up while driving. The tire pressure increases with the tire temperature.

Tires have a natural, consistent tire pressure loss.

The displays of inflation devices may under-read by up to 0.1 bar/2 psi.



## Checking using tire inflation pressure specifications in the tire inflation pressure table

1. Determine the intended tire inflation pressure levels for the mounted tires.
2. Check the tire inflation pressure in all four tires, using a pressure gage, for example.
3. Correct the tire inflation pressure if the actual tire inflation pressure deviates from the intended tire inflation pressure.
4. Check whether all valve caps are screwed onto the tire valves.

The tire inflation pressure specifications in the tire inflation pressure table only relate to cold tires or tires at the same temperature as the ambient temperature.

Only check the tire inflation pressure levels when the tires are cold, i.e.:

- ▶ A distance traveled of max. 1.25 miles/2 km has not been exceeded.
- ▶ If the vehicle has not moved again for at least 2 hours after a trip.

Check the tire inflation pressure of the emergency wheel in the cargo area regularly, and correct it as needed.

## Checking using the tire inflation pressure specifications on the Control Display

1. "CAR"
2. "Vehicle status"
3.  "Tire Pressure Monitor"
4. Check whether the current tire inflation pressure levels deviate from the intended tire pressure value.
5. Correct the tire inflation pressure if the actual tire inflation pressure deviates from the intended tire inflation pressure.

The display of the current tire pressure may be limited when the vehicle is stationary. After a short drive, the tire pressure is updated.

## After correcting the tire pressure

For the flat tire monitor:

Reinitialize the Flat Tire Monitor.

With Tire Pressure Monitor:

The corrected tire inflation pressures are applied automatically. Make sure that the correct tire settings have been made.

With tires that cannot be found in the tire pressure values on the control display, reset the Tire Pressure Monitor (TPM).

## Tire inflation pressures up to 100 mph/160 km/h

For speeds of up to 100 mph/160 km/h and for optimum driving comfort, note the pressure values in the tire inflation pressure table and adjust as necessary.



These pressure values can also be found on the tire pressure label on the driver's door pillar.

Do not exceed a speed of 100 mph/160 km/h.

## Tire pressure values up to 100 mph/160 km/h

### X3 xDrive30i, X3 sDrive30i

Tire size	Pressure specifications in bar/PSI	
-----------	------------------------------------	--

Specifications in bar/PSI with cold tires

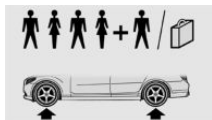

245/50 R 19 105 H XL A/S	2.3 / 33	2.5 / 36
245/50 R 19 105 W XL		
245/50 R 19 105 V XL M+S		
225/60 R 18 104 H XL A/S	2.4 / 35	2.6 / 38
225/60 R 18 104 H XL M+S		
Front: 245/45 R 20 103 Y XL	2.3 / 33	-
Rear: 275/40 R 20 106 Y XL	-	2.5 / 36
Front: 245/45 R 20 103 W XL	2.3 / 33	-
Rear: 275/40 R 20 106 W XL	-	2.5 / 36
Front: 245/40 R 21 100 Y XL	2.6 / 38	-
Rear: 275/35 R 21 103 Y XL	-	2.8 / 41
Front: 245/45 R 20 103 V XL M+S	2.3 / 33	-

Tire size	Pressure specifications in bar/PSI	
-----------	------------------------------------	--

Rear: 275/40 R 20 106 V XL M+S	-	2.5 / 36
Emergency wheel: T 135/80 R 18 104 M	Speed up to a max. of 50 mph / 80 km/h	
	4.2 / 60	

### X3 M40i

Tire size	Pressure specifications in bar/PSI	
-----------	------------------------------------	--

Specifications in bar/PSI with cold tires

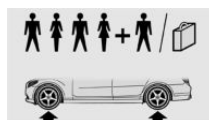

245/50 R 19 105 H XL A/S	2.3 / 33	2.5 / 36
245/50 R 19 105 W XL		
245/50 R 19 105 V XL M+S		
Front: 245/45 R 20 103 W XL	2.2 / 32	-
Rear: 275/40 R 20 106 W XL	-	2.4 / 35
Front: 245/45 R 20 103 Y XL	2.2 / 32	-
Rear: 275/40 R 20 106 Y XL	-	2.4 / 35
Front: 245/40 R 21 100 Y XL	2.5 / 36	-
Rear: 275/35 R 21 103 Y XL	-	2.7 / 39

Tire size	Pressure specifications in bar/PSI	
Front: 245/45 R 20 103 V XL M+S	2.2 / 32	-
Rear: 275/40 R 20 106 V XL M+S	-	2.4 / 35
Emergency wheel: T 135/80 R 18 104 M	Speed up to a max. of 50 mph / 80 km/h 4.2 / 60	

### Tire inflation pressures at max. speeds above 100 mph/160 km/h

#### Warning

In order to drive at maximum speeds in excess of 100 mph/160 km/h, please observe and, if necessary, adjust tire pressures for speeds exceeding 100 mph/160 km/h from the relevant table on the following pages. Otherwise, tire damage and accidents could occur.

For speeds over 100 mph/160 km/h and for optimum driving comfort, note the pressure values in the tire inflation pressure table and adjust as necessary.

### Tire pressure values over 100 mph/160 km/h

#### X3 xDrive30i, X3 sDrive30i

Without high-speed tuning feature

Tire size	Pressure specifications in bar/PSI	
Specifications in bar/PSI with cold tires 		
245/50 R 19 105 H XL A/S	2.6 / 38	2.8 / 41
245/50 R 19 105 W XL		
245/50 R 19 105 V XL M+S		
225/60 R 18 104 H XL A/S	2.7 / 39	2.9 / 42
225/60 R 18 104 H XL M+S		
Front: 245/45 R 20 103 Y XL	2.3 / 33	-
Rear: 275/40 R 20 106 Y XL	-	2.5 / 36
Front: 245/45 R 20 103 W XL	2.4 / 35	-
Rear: 275/40 R 20 106 W XL	-	2.6 / 38
Front: 245/40 R 21 100 Y XL	2.6 / 38	-
Rear: 275/35 R 21 103 Y XL	-	2.8 / 41
Front: 245/45 R 20 103 V XL M+S	2.5 / 36	-
Rear: 275/40 R 20 106 V XL M+S	-	2.7 / 39
Emergency wheel: T 135/80 R 18 104 M	Speed up to a max. of 50 mph / 80 km/h 4.2 / 60	

With high-speed tuning feature

**Tire size**      **Pressure specifications in bar/PSI**

Specifications in bar/PSI with cold tires

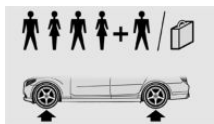

245/50 R 19 105 W XL	3.0 / 44	3.2 / 46
245/50 R 19 105 V XL M+S		
225/60 R 18 104 H XL M+S	2.7 / 39	2.9 / 42
Front: 245/45 R 20 103 Y XL	2.5 / 36	-
Rear: 275/40 R 20 106 Y XL	-	2.7 / 39
Front: 245/45 R 20 103 W XL	2.9 / 42	-
Rear: 275/40 R 20 106 W XL	-	3.1 / 45
Front: 245/40 R 21 100 Y XL	2.8 / 41	-
Rear: 275/35 R 21 103 Y XL	-	3.0 / 44
Front: 245/45 R 20 103 V XL M+S	2.9 / 42	-
Rear: 275/40 R 20 106 V XL M+S	-	3.1 / 45
Emergency wheel: T 135/80 R 18 104 M	Speed up to a max. of 50 mph / 80 km/h	4.2 / 60

**Tire size**      **Pressure specifications in bar/PSI**

Specifications in bar/PSI with cold tires

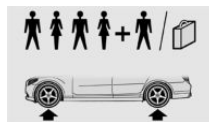

245/50 R 19 105 H XL A/S	2.6 / 38	2.8 / 41
245/50 R 19 105 W XL		
245/50 R 19 105 V XL M+S		
Front: 245/45 R 20 103 Y XL	2.2 / 32	-
Rear: 275/40 R 20 106 Y XL	-	2.4 / 35
Front: 245/45 R 20 103 W XL	2.4 / 35	-
Rear: 275/40 R 20 106 W XL	-	2.6 / 38
Front: 245/40 R 21 100 Y XL	2.5 / 36	-
Rear: 275/35 R 21 103 Y XL	-	2.7 / 39
Front: 245/45 R 20 103 V XL M+S	2.5 / 36	-
Rear: 275/40 R 20 106 V XL M+S	-	2.7 / 39
Emergency wheel: T 135/80 R 18 104 M	Speed up to a max. of 50 mph / 80 km/h	4.2 / 60

With high-speed tuning feature

**X3 M40i**

Without high-speed tuning feature

### Tire size Pressure specifications in bar/PSI

Specifications in bar/PSI with cold tires

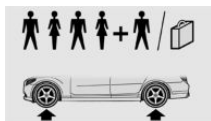

245/50 R 19 105 3.0 / 44 3.2 / 46  
W XL

245/50 R 19 105  
V XL M+S

Front: 245/45 R 2.5 / 36 -  
20 103 Y XL

Rear: 275/40 R - 2.7 / 39  
20 106 Y XL

Front: 245/45 R 2.9 / 42 -  
20 103 W XL

Rear: 275/40 R - 3.1 / 45  
20 106 W XL

Front: 245/40 R 2.8 / 41 -  
21 100 Y XL

Rear: 275/35 R - 3.0 / 44  
21 103 Y XL

Front: 245/45 R 2.8 / 41 -  
20 103 V XL  
M+S

Rear: 275/40 R - 3.0 / 44  
20 106 V XL  
M+S

Emergency wheel: Speed up to a max. of  
50 mph / 80 km/h

T 135/80 R 18 4.2 / 60  
104 M

## Tire marking

### Tire size

245/45 R 18 96 Y

245: nominal width in mm

45: cross-sectional relationship in %

R: radial tire code

18: rim diameter in inches

96: load bearing capacity

Y: speed code letter

ZR tires: reinforced radial tire for speeds exceeding 150 mph/240 km/h

### Maximum tire load

Maximum tire load is the maximum permissible weight for which the tire is approved.

Locate the maximum tire load on the tire sidewall and the Gross Axle Weight Rating – GAWR – on the certification label on the driver door B-pillar. Divide the tire load by 1.1. It must be greater than one-half of the vehicle's Gross Axle Weight Rating – GAWR. Note, front vs. rear GAWR and tire loads, respectively.

### Tire Identification Number

DOT code: DOT xxxx xxx 1922

xxxx: manufacturer code for the tire brand

xxx: tire size and tire design

1922: tire age

Tires with DOT codes meet the guidelines of the U.S. Department of Transportation.

### Tire age

### Recommendation

Regardless of the tire tread depth, replace tires at least every 6 years.

### Manufacture date

You can find the manufacture date of the tire on the tire sidewall.

Designation	Manufacture date
DOT ... 1922	19th week 2022

## Uniform Tire Quality Grading

Quality grades can be found where applicable on the tire sidewall between tread shoulder and maximum section width.

E.g.: Treadwear 200; Traction AA; Temperature A

## DOT Quality Grades

Treadwear

Traction AA A B C

Temperature A B C

All passenger vehicle tires must conform to Federal Safety Requirements in addition to these grades.

## Treadwear

The treadwear grade is a comparative rating based on the wear rate of the tire when tested under controlled conditions on a specified government test course. E.g., a tire graded 150 would wear one and one-half, 1 g, times as well on the government course as a tire graded 100. The relative performance of tires depends upon the actual conditions of their use, however, and may depart significantly from the norm due to variations in driving habits, service practices and differences in road characteristics and climate.

## Traction

The traction grades, from highest to lowest, are AA, A, B, and C.

Those grades represent the tire's ability to stop on wet pavement as measured under controlled conditions on specified government test surfaces of asphalt and concrete. A tire marked C may have poor traction performance.

The traction grade assigned to this tire is based on straight-ahead braking traction tests, and does not include acceleration, cornering, hydroplaning, or peak traction characteristics.

## Temperature

The temperature grades are A, the highest, B, and C, representing the tire's resistance to the generation of heat and its ability to dissipate heat when tested under controlled conditions on a specified indoor laboratory test wheel. Sustained high temperature can cause the material of the tire to degenerate and reduce tire life, and excessive temperature can lead to sudden tire failure. The grade C corresponds to a level of performance which all passenger car tires must meet under the Federal Motor Vehicle Safety Standard No. 109. Grades Band A represent higher levels of performance on the laboratory test wheel than the minimum required by law.

### Warning

The temperature grade for this tire is established for a tire that is properly inflated and not overloaded. Excessive speed, underinflation, or excessive loading, either separately or in combination, can cause heat buildup and possible tire failure.

## Runflat tires

Runflat tires, refer to page 338, are labeled with a circular icon containing the letters RSC marked on the tire sidewall.

## M+S

Winter and all-season tires with better cold weather performance than summer tires.

## Tire tread

### Summer tires

Do not drive with a tire tread depth of less than 0.12 in/3 mm, otherwise there is an increased risk of aquaplaning.

## Winter tires

Do not drive with a tire tread depth of less than 0.16 in/4 mm, as such tires are less suitable for winter driving conditions.

## Minimum tread depth

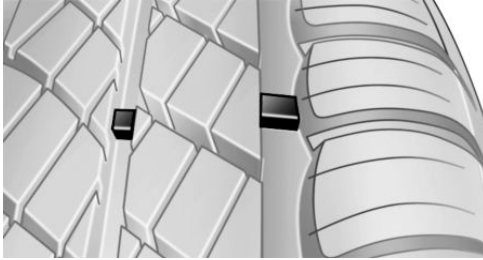

Distributed over the tire circumference are the tire manufacturer's wear indicators with a height of at least 0.06 in/1.6 mm, which serve as an indicator of tire tread wear.

The positions of the wear indicators are marked on the tire sidewall with TWI, Tread Wear Indicator.

Irrespective of the wear indicators, observe the statutory regulations on the minimum tread depth.

## Tire damage

### General information

Check your tires regularly for damage, foreign bodies lodged in the tread, and tread wear.

Driving over rough or damaged road surfaces, as well as debris, curbs and other obstacles can cause serious damage to wheels, tires and suspension parts. This is more likely to occur with low-profile tires, which provide less cushioning between the wheel and the road. Be careful to avoid road hazards and reduce your speed, especially if your vehicle is equipped with low-profile tires.

Indications of tire damage or other vehicle malfunctions:

- ▷ Unusual vibrations.
- ▷ Unusual tire or running noises.
- ▷ Unusual handling such as a strong tendency to pull to the left or right.
- ▷ Uneven wear pattern, e.g., increased wear in the area of the tire shoulder.

Damage can be caused by the following situations, for instance:

- ▷ Driving over curbs.
- ▷ Road damage.
- ▷ Tire pressure too low.
- ▷ Vehicle overloading.
- ▷ Incorrect tire storage.

## Safety information

### Warning

Damaged tires can lose tire inflation pressure, which can lead to loss of vehicle control. There is a risk of accident. If tire damage is suspected while driving, immediately reduce speed and stop. Have wheels and tires checked. For this purpose, drive carefully to the nearest authorized service center or another qualified service center or repair shop. Have vehicle towed or transported as needed. Do not repair damaged tires, but have them replaced.

### Warning

Tires can become damaged by driving over obstacles, e.g., curbs or road damage, at high speed. Larger wheels have a smaller tire cross-section. The smaller the tire cross-section, the higher the risk of tire damage. There may be a risk of accidents and risk of damage to property. If possible, avoid driving over objects or road conditions that may damage tires, or drive over them slowly and carefully.

## Exchanging wheels and tires

### Mounting and wheel balancing

Have mounting and wheel balancing carried out by an authorized service center or another qualified service center or repair shop.

### Approved wheels and tires

#### General information

The following sizes are recommended and approved by the vehicle manufacturer for the approved wheels and tires per vehicle type and special equipment:

- ▶ Wheel and tire combinations.
- ▶ Rim designs.
- ▶ Tire sizes.
- ▶ Tire brands.

You can ask an authorized service center or another qualified service center or repair shop about the approved wheels and tires for the vehicle and the special equipment.

#### Safety information

##### Warning

Wheels and tires which are not suitable for your vehicle can damage parts of the vehicle, for instance due to contact with the body due to tolerances despite the same official size rating. There is a risk of an accident. The manufacturer of your vehicle strongly suggests that you use wheels and tires that have been recommended by the vehicle manufacturer for your vehicle type.

##### Warning

Mounted steel wheels can cause technical problems, for instance unexpected loosening of the lug bolts and damage to the brake disks. There is a risk of accident. Do not mount steel wheels.

##### Warning

Incorrect wheel/tire combinations will impair the vehicle's handling characteristics and a variety of system functions, such as the Antilock Braking System or Dynamic Stability Control. There is a risk of accident. To maintain good handling and vehicle response, use only tires with a single tread configuration from a single manufacturer. The manufacturer of the vehicle recommends that you use wheels and tires that have been recommended by the vehicle manufacturer for your vehicle type. Following tire damage, have the original wheel/tire combination remounted on the vehicle as soon as possible.

### Recommended tire brands



For each tire size, the manufacturer of the vehicle recommends certain tire brands. The tire brands can be identified by a star on the tire sidewall.



## New tires

Tire traction is not optimal due to manufacturing circumstances when tires are brand new.

Drive conservatively for the first 200 miles/300 km.

## Retreaded tires

### Warning

Retreaded tires can have different tire casing structures. With advanced age the service life can be limited. There is a risk of accident. The manufacturer of the vehicle does not recommend the use of retreaded tires.

## Winter tires

### General information



Winter tires are recommended for operating on winter roads.

Winter tires can be identified by the icon with mountain and snowflake, as well as the M+S marking on the tire sidewall.

All-season tires with the M+S designation, but without icon with mountain and snowflake, have better winter characteristics than summer tires but generally do not achieve the performance of winter tires.

## Safety information

### Warning

If the vehicle is equipped with an M Sport differential and all-weather tires on 19 inch rims, this can alter handling, for instance the vehicle may skid. There may be a risk of accident or risk of damage to property. If the vehicle is equipped with an M Sport differential, do not mount all-weather tires on 19 inch rims.

### Maximum speed of winter tires

If the maximum speed of the vehicle is higher than the permissible speed for the winter tires, then attach a sign showing the permissible maximum speed in the field of vision. The sign is available from an authorized service center or another qualified service center or repair shop.

With winter tires mounted, observe and do not exceed the permissible maximum speed.

### Changing runflat tires

When changing from runflat tires to standard tires, it must be ensured that the vehicle contains an emergency wheel or tire mobility kit. Further information is available from an authorized service center or another qualified service center or repair shop.

### Wheel change between axles

### Warning

A wheel change between the axles on vehicles with different tire sizes or rim sizes on the front and rear axles can cause damage to the tires and the vehicle. There is a risk of accident. Do not rotate the tires between the axles on vehicles with different tire sizes or rim sizes on the front and rear axles.

Different abrasion patterns can occur on the front and rear axles depending on individual driving conditions. The tires can be rotated in pairs between the axles to achieve even abrasion. Further information is available from an authorized service center or another qualified service center or repair shop. After changing, check the tire pressure and correct, if needed.

## Storing tires

### Tire pressure

Do not exceed the maximum tire inflation pressure indicated on the tire sidewall.

### Storage

- ▶ Store wheels and tires in a cool, dry and dark place.
- ▶ Always protect tires against all contact with oil, grease, and solvents.
- ▶ Do not leave tires in plastic bags.
- ▶ Remove dirt from wheels or tires.

## Runflat tires

### Principle

Runflat tires permit continued driving under limited conditions even in the event of a complete tire pressure loss.

### General information

The wheels consist of tires that are self-supporting to a limited degree and may also include special rims.

The reinforcement of the sidewall allows the tire to remain drivable to a limited degree in the event of a tire pressure loss.

Follow the instructions for continued driving with a flat tire.

## Safety information

### Warning

The vehicle handles differently when a runflat tire has insufficient or no tire pressure; for instance, reduced directional stability when braking, braking distances are longer and the self-steering properties will change. There is a risk of accident. Drive moderately and do not exceed a speed of 50 mph/80 km/h.

### Warning

Heavy trailers can start swinging when continuing to drive with a flat tire. There may be a risk of accident or risk of damage to property. Do not exceed a speed of 35 mph/60 km/h when driving with a trailer and a flat tire. Immediately brake in the case of swinging. Apply necessary steering corrections as carefully as possible.

## Identification



Runflat tires are labeled with a circular icon containing the letters RSC marked on the tire sidewall.

## Repairing a flat tire

### Safety precautions

- ▷ Park the vehicle as far away as possible from passing traffic and on solid ground.
- ▷ Turn on the hazard warning system.
- ▷ Secure the vehicle against rolling away by setting the parking brake.
- ▷ Turn the steering wheel until the front wheels are in the straight-ahead position and engage the steering wheel lock.
- ▷ Have all vehicle occupants get out and make sure that they remain outside the hazardous area such as behind a guardrail.
- ▷ If necessary, set up a warning triangle at an appropriate distance.

## Tire repair set

### Principle

With the tire repair set, minor tire damage can be sealed temporarily to enable continued driving.

### General information

- ▷ To enable continued driving, liquid sealant is pumped into the tire, which hardens and seals the damage from the inside.
- ▷ Follow the instructions on using the tire repair set found on the compressor and sealant bottle.
- ▷ The use of a tire repair set can be ineffective if the tire puncture measures above approx. 0.16 in/4 mm.
- ▷ Contact an authorized service center or another qualified service center or repair shop if the tire cannot be made drivable.
- ▷ Do not remove foreign objects that have penetrated the tire. Remove foreign objects

only when they are visibly protruding from the tire.

- ▷ Detach the speed limit sticker from the sealant bottle and apply it to the steering wheel.
- ▷ The use of a sealing compound can damage the wheel electronics. In this case, have the electronics checked and replaced at the next opportunity.
- ▷ The compressor can be used to check the tire inflation pressure.

### Overview

### Storage



Storage for the tire repair set is provided in the compartment under the cargo area floor.

Fold up the cargo floor panel.

### Sealant bottle

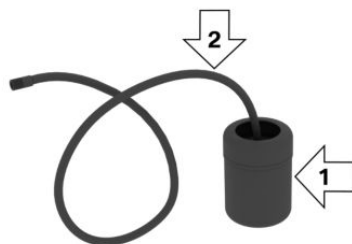

- ▷ Sealant bottle, arrow 1.
- ▷ Filler hose, arrow 2.

Observe expiration date on the sealant bottle.

## Compressor

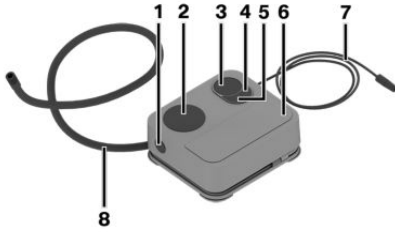

- 1 Sealant bottle unlocking
- 2 Sealant bottle mount
- 3 Tire pressure display
- 4 Reduce tire inflation pressure button
- 5 On/off switch
- 6 Compressor
- 7 Connector/cable for socket
- 8 Connection hose

## Safety precautions

- ▷ Park the vehicle as far away as possible from passing traffic and on solid ground.
- ▷ Turn on the hazard warning system.
- ▷ Secure the vehicle against rolling away by setting the parking brake.
- ▷ Turn the steering wheel until the front wheels are in the straight-ahead position and engage the steering wheel lock.
- ▷ Have all vehicle occupants get out and make sure that they remain outside the hazardous area such as behind a guardrail.
- ▷ If necessary, set up a warning triangle at an appropriate distance.

## Filling the tire with sealing compound

### Safety information

#### **⚠ DANGER**

If the exhaust pipe is blocked or ventilation is insufficient, harmful exhaust gases can penetrate the vehicle. The exhaust gases contain pollutants which are colorless and odorless. In enclosed areas, exhaust gases can also accumulate outside of the vehicle. There is a danger to life. Keep the exhaust pipe free and ensure sufficient ventilation.

#### **⚠ NOTICE**

The compressor can overheat during extended operation. There is a risk of damage to property, among other potential damage. Do not run the compressor for more than 10 minutes.

### Filling

1. Shake the sealant bottle.



2. Pull filler hose completely out of the cover of the sealant bottle. Do not kink the hose.

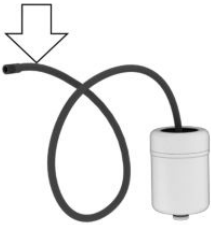

3. Slide the sealant bottle into the mount on the compressor housing, ensuring that it engages audibly.

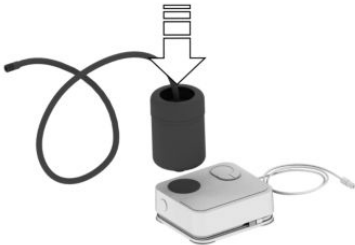

4. Screw the filler hose of the sealant bottle onto the tire valve of the faulty wheel.

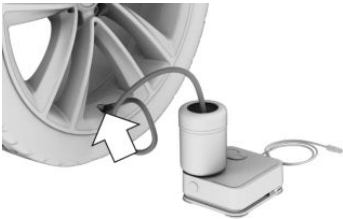

5. With the compressor switched off, insert the connector into the power socket in the vehicle interior.



6. With standby state or drive-ready state switched on, switch on the compressor.



Let the compressor run for a maximum of 10 minutes to fill the tire with sealant and reach a tire pressure of approx. 2 bar.

While the tire is being filled with sealing compound, the tire inflation pressure may sporadically reach approx. 5 bar. Do not switch off the compressor in this phase.

## Checking and adjusting the tire inflation pressure

### Checking

1. Switch off the compressor.
2. Read the tire pressure on the tire pressure display.

To continue the trip, a tire pressure of at least 2 bar must be reached.

### Removing and stowing the sealant bottle

1. Unscrew the filler hose of the sealant bottle from the tire valve.
2. Press the red unlocking device.
3. Remove the sealant bottle from the compressor.
4. Wrap and store the sealant bottle in suitable material to avoid contamination of the cargo area.

### Minimum tire inflation pressure is not reached

1. Pull the connector out of the power socket in the vehicle interior.
2. Drive 33 ft/10 m forward and back to distribute the sealing compound in the tire.
3. Screw the connection hose of the compressor directly onto the tire valve stem.

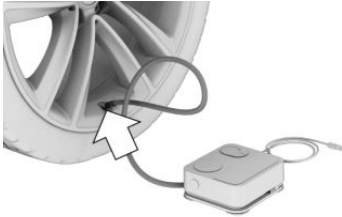

4. Insert the connector into the power socket in the vehicle interior.



5. With standby or drive readiness turned on, turn on the compressor and let it run for a maximum of 10 minutes.

When the tire pressure does not reach at least 2 bar, contact an authorized service center or another qualified service center or repair shop.

When a tire pressure of at least 2 bar is reached, see Minimum tire inflation pressure is reached.

6. Unscrew the connection hose of the compressor from the tire valve.
7. Pull the connector out of the power socket in the vehicle interior.
8. Stow the tire repair set in the vehicle.

### Minimum tire inflation pressure is reached

1. Unscrew the connection hose of the compressor from the tire valve.
2. Pull the connector out of the power socket in the vehicle interior.
3. Stow the tire repair set in the vehicle.
4. Immediately drive approx. 5 miles/10 km to ensure that the sealing compound is evenly distributed in the tire.

Do not exceed a speed of 50 mph/80 km/h.

If possible, do not drive at speeds less than 12 mph/20 km/h.

### Adjustment

1. Stop at a suitable location.
2. Screw the connection hose of the compressor directly onto the tire valve stem.

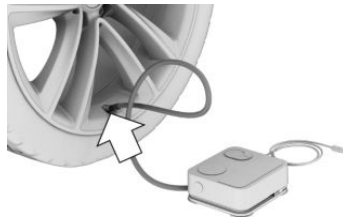

3. Insert the connector into the power socket in the vehicle interior.



4. Correct the tire pressure to at least 2 bar:
  - ▶ Increase tire pressure: with standby or drive readiness turned on, turn on the compressor and let it run for a maximum of 10 minutes.
  - ▶ Reduce tire inflation pressure: press the button on the compressor.
5. Unscrew the connection hose of the compressor from the tire valve.
6. Pull the connector out of the power socket in the vehicle interior.
7. Stow the tire repair set in the vehicle.

## Continuing the trip

Do not exceed the permissible maximum speed of 50 mph/80 km/h.

Reinitialize the Flat Tire Monitor.

Reset the Tire Pressure Monitor again.

Replace the faulty tire and the sealant bottle of the tire repair set promptly.

Additional information:

- ▶ Flat tire monitor, refer to page [351](#).
- ▶ Tire pressure monitor, refer to page [344](#).

## Tire chains

### Safety information

#### **Warning**

Mounting tire chains on unsuitable tires can cause the tire chains to come into contact with vehicle parts. There may be a risk of accident or risk of damage to property. Only mount tire chains on tires that are designated by their manufacturer as suitable for the use of tire chains.

#### **Warning**

Insufficiently tight tire chains may damage tires and vehicle components. There may be a risk of accident or risk of damage to property. Make sure that the tire chains are always sufficiently tight. Re-tighten as needed according to the tire chain manufacturer's instructions.

### Fine-link tire chains

The manufacturer of the vehicle recommends the use of fine-link tire chains. Certain types of fine-link tire chains have been tested by the manufacturer of the vehicle and recommended as road-safe and suitable.

Information regarding suitable tire chains is available from an authorized service center or another qualified service center or repair shop.

## Hubcap



Remove hubcaps before using tire chains.

For mounting, align the hubcap with the groove to the tire valve and press on all the way around until it is snapped into place.

## Use

Use only in pairs on the rear wheels, equipped with the tires of the following size:

- ▷ 225/60 R 18.
- ▷ 245/50 R 19.

Information on the wheel size and rim offset is located on the inside of the wheel.

The list can also include wheel/tire sizes that are only suitable for certain models.

Information about approved wheels and tires for the vehicle can be requested from an authorized service center or another qualified service center or repair shop.

Follow the tire chain manufacturer's instructions.

Do not initialize the flat tire monitor after mounting tire chains, as doing so may result in incorrect readings.

Do not reset the Tire Pressure Monitor after mounting tire chains, as doing so may result in incorrect readings.

When driving with tire chains, activate the Dynamic Traction Control briefly to optimize the drive power.

## Maximum speed with tire chains

Do not exceed a speed of 30 mph/50 km/h when using tire chains.

## Tire pressure monitor

### Principle

The Tire Pressure Monitor monitors the tire pressure and issues a warning if the tire pressure has dropped.

### General information

Sensors in the tire valves measure the tire inflation pressure and tire temperature.

Depending on the tires detected or registered, the system displays the specified nominal pressures on the control display and compares them with the current tire pressures.

If tires are being used that are not specified in the tire inflation pressure details on the vehicle, such as tires with special approval, the system needs to be actively reset. The system will then take over the actual tire inflation pressures as the target pressures.

When operating the system, also note the information found in the Tire inflation pressure chapter.

Additional information:

Tire inflation pressure, refer to page [328](#).

### Safety information

#### **Warning**

The display of the target pressures is not a substitute for the tire inflation pressure details on the vehicle. Incorrect entries in the tire settings can lead to incorrect target tire inflation pressure values. In this case, it cannot be guaranteed that the notification of a tire pressure loss will be reliable. There is a risk of injury and risk of damage to property.



Ensure that the tire sizes of the mounted tires are displayed correctly and match the details on the tires and on the vehicle.

## Functional requirements

The following prerequisites must be met for the system; otherwise, reliable notification of a tire pressure loss is not assured:

- ▶ Every time a tire or wheel is changed, the correct details on the mounted tires must be entered in the tire settings.
- ▶ The Tire Pressure Monitor does not activate until after driving for a few minutes:
  - ▶ After a tire or wheel change.
  - ▶ After a reset, for tires with special approval.
  - ▶ After changing the tire setting.
- ▶ For tires with special approval:
  - ▶ After a tire or wheel change, a reset was performed with the correct tire inflation pressure.
  - ▶ After the tire inflation pressure was adjusted to a new value, a reset was performed.
- ▶ Wheels with wheel electronics.

## Tire settings

### General information

The tire sizes of the mounted tires can be gathered from the tire inflation pressure details on the vehicle or directly on the tires.

The tire details do not need to be re-entered when the tire pressure is corrected.

For summer and winter tires, the tire details entered last are stored. After a tire or wheel change, the settings of the tire sets used last can be selected.

## Changing settings

1. "CAR"
2. "Vehicle status"
3.  "Tire Pressure Monitor"
4. "Tire settings"
5. "Tire selection"
6. "Manual"
7. "Tire type"
8. Select the tire type that is mounted on the rear axle.  
For tires with special approval:  
"Other tires"  
Observe further proceeding in the perform a reset section.
9. Select the maximum road speed that will be used with the tires.
10. "Save tire settings"

The measurement of the current tire inflation pressure is started. The measurement progress is displayed.

## Status display

### Current status

The system status can be displayed on the Control Display, e.g., whether or not the system is active.

1. "CAR"
2. "Vehicle status"
3.  "Tire Pressure Monitor"  
The current status is displayed.

### Current tire pressure

The current tire pressure is displayed for each tire.

The current tire inflation pressures may change during driving or depending on the outside temperature.

## Current tire temperature

Depending on the model, the current tire temperatures are displayed.

The current tire temperatures may change while driving or due to the outside temperature.

## Nominal pressure

The nominal pressure for the tires on the front and rear axles is displayed.

The specified nominal pressures take the influence of driving and outside temperature on the tire temperature into account. The appropriate nominal pressure is always displayed, independent of the weather situation, tire temperatures and travel times.

The displayed nominal pressure may change and may differ from the tire inflation pressure details on the door pillar of the driver's door. The tire inflation pressure can thus be corrected to the value of the displayed target pressures.

The nominal pressure is immediately adjusted if the vehicle load status is changed in the tire settings.

## Tire conditions

### General information

Tire and system status are indicated by the color of the wheels and a text message on the control display.

Any existing messages may not be deleted if the nominal pressure is not reached after the tire inflation pressure is corrected.

### All wheels green

- ▶ The system is active and bases warnings on the target pressures.
- ▶ For tires with special approval: the system is active and bases warnings on the tire inflation pressures stored during the last reset.

## One to four yellow wheels

A flat tire or major tire pressure loss has occurred in the indicated tires.

### Gray wheels

It may not be possible to identify tire pressure losses.

Possible causes:

- ▶ Malfunction.
- ▶ During tire inflation pressure measurement, after confirmation of the tire settings.
- ▶ For tires with special approval: a reset is performed for the system.

### For tires with special approval: performing a reset

1. "CAR"
2. "Vehicle status"
3. "Tire Pressure Monitor"
4. Make sure that correct tire settings have been made.  
Tire settings, refer to page [345](#).
5. Turn on drive-ready state and do not drive off.
6. Reset tire pressure: "Perform reset".
7. Drive off.

The wheels are displayed in gray and the following is displayed: "Resetting tire pressure...".

After a travel time of several minutes, the set tire inflation pressures are accepted as the predefined tire inflation pressures. The reset is completed automatically while driving.

After a successfully completed reset, the wheels on the control display are shown in green and the following is displayed: "Reset successful."

You may interrupt this trip at any time. When you continue driving the reset resumes automatically.

## Messages: for tires without special approval

### General information

When a flat tire is indicated, the Dynamic Stability Control may be turned on.

### Safety information

#### **Warning**

A damaged regular tire with low or no tire inflation pressure impacts handling, such as steering and braking response. Runflat tires can maintain limited stability. There is a risk of accident. Do not continue driving if the vehicle is equipped with normal tires. Follow the information on runflat tires and continued driving with these tires.

### If a tire inflation pressure check is required

#### Message

An icon with a Check Control message appears on the control display.

Icon	Possible cause
	Inflation was not carried out according to specifications, for instance when the tire has not been sufficiently inflated or in the case of a natural steady tire pressure loss.

#### Measure

Check the tire pressure and correct as needed.

### If the tire inflation pressure is too low

#### Message

 A yellow warning light is illuminated in the instrument cluster.

In addition, an icon with a Check Control message appears on the control display.

Icon	Possible cause
	There is a tire pressure loss.

#### Measure

1. Reduce the vehicle speed. Do not exceed a speed of 80 mph/130 km/h.
2. At the next opportunity, for instance at a filling station, check the tire inflation pressure in all four tires and correct if necessary.

### If there is a significant tire pressure loss

#### Message

 A yellow warning light is illuminated in the instrument cluster.

In addition, an icon with the affected tire appears in a Check Control message on the control display.

Icon	Possible cause
	There is a flat tire or a major tire pressure loss.

#### Measure

1. Reduce your speed and stop cautiously. Avoid sudden braking and steering maneuvers.
2. Check whether the vehicle is fitted with standard tires or runflat tires.  
Runflat tires are labeled with a circular icon containing the letters RSC marked on the tire sidewall.  
Runflat tires, refer to page 338.
3. Read the description on what to do in case of a flat tire.

Actions in the event of a flat tire, refer to page 349.

## Messages: for tires with special approval

### General information

When a flat tire is indicated, the Dynamic Stability Control may be turned on.

### Safety information

#### Warning

A damaged regular tire with low or no tire inflation pressure impacts handling, such as steering and braking response. Runflat tires can maintain limited stability. There is a risk of accident. Do not continue driving if the vehicle is equipped with normal tires. Follow the information on runflat tires and continued driving with these tires.

## If a tire inflation pressure check is required

### Message

An icon with a Check Control message appears on the control display.

Icon	Possible cause
------	----------------



Inflation was not carried out according to specifications, e.g., the tire has not been sufficiently inflated.

The system has detected a wheel change, but no reset was done.

The tire inflation pressure has fallen below the level of the last reset.

No reset was performed for the system. The system issues a warning based on the tire inflation pressures stored during the last reset.

### Measure

1. Check the tire pressure and correct as needed.
2. Perform a system reset.

## If the tire inflation pressure is too low

### Message



A yellow warning light is illuminated in the instrument cluster.

In addition, an icon with a Check Control message appears on the control display.

Icon	Possible cause
------	----------------



There is a tire pressure loss.

No reset was performed for the system. The system issues a warning based on the tire inflation pressures stored during the last reset.

### Measure

1. Reduce the vehicle speed. Do not exceed a speed of 80 mph/130 km/h.
2. At the next opportunity, for instance at a filling station, check the tire inflation pressure in all four tires and correct if necessary.
3. Reset the system.

## If there is a significant tire pressure loss

### Message



A yellow warning light is illuminated in the instrument cluster.

In addition, an icon with the affected tire appears in a Check Control message on the control display.

**Icon Possible cause**

There is a flat tire or a major tire pressure loss.

No reset was performed for the system. The system issues a warning based on the tire inflation pressures stored during the last reset.

**Measure**

1. Reduce your speed and stop cautiously. Avoid sudden braking and steering maneuvers.
2. Check whether the vehicle is fitted with standard tires or runflat tires.

Runflat tires are labeled with a circular icon containing the letters RSC marked on the tire sidewall.

Runflat tires, refer to page [338](#).

3. Read the description on what to do in case of a flat tire.

Actions in the event of a flat tire, refer to page [349](#).

**Actions in the event of a flat tire****Standard tires**

1. Identify the damaged tire.

Check the tire pressure in all four tires, for instance using the tire pressure display from a tire repair set.

For tires with special approval: when the tire pressure in all four tires is correct, the Tire Pressure Monitor may not have been reset. In this case, perform the reset.

If tire damage cannot be found, contact an authorized service center or another qualified service center or repair shop.

2. Repair the flat tire, for instance with a tire repair set or by changing the wheel.

Using a sealing compound, for instance from the tire repair set, may damage the wheel

electronics. Have the electronics replaced at the next opportunity.

**Runflat tires****Safety information**** Warning**

The vehicle handles differently when a runflat tire has insufficient or no tire pressure; for instance, reduced directional stability when braking, braking distances are longer and the self-steering properties will change. There is a risk of accident. Drive moderately and do not exceed a speed of 50 mph/80 km/h.

** Warning**

Heavy trailers can start swinging when continuing to drive with a flat tire. There may be a risk of accident or risk of damage to property. Do not exceed a speed of 35 mph/60 km/h when driving with a trailer and a flat tire. Immediately brake in the case of swinging. Apply necessary steering corrections as carefully as possible.

**Maximum speed**

You may continue driving with a damaged tire at speeds up to 50 mph/80 km/h.

**Continued driving with a flat tire**

Follow the following when continuing to drive with a damaged tire:

1. Avoid sudden braking and steering maneuvers.
2. Do not exceed a speed of 50 mph/80 km/h.
3. Check the tire inflation pressure in all four tires at the next opportunity.

### Possible distance traveled with a depressurized tire

The possible distance which may be safely traveled varies depending on how the vehicle is loaded and used, e.g., speed, road conditions, outside temperature. The distance traveled may be less but may also be more if an economical driving style is used.

If the vehicle is loaded with an average weight and used under favorable conditions, the possible distance traveled may be up to 50 miles/80 km.

### Vehicle handling with damaged tires

Vehicles driven with a damaged tire will handle differently, potentially leading to conditions such as the following:

- ▶ Greater likelihood of skidding of the vehicle.
- ▶ Longer braking distances.
- ▶ Changed self-steering properties.

Modify your driving style. Avoid abrupt steering or driving over obstacles, for instance curbs or potholes.

### Final tire failure

Vibrations or loud noises while driving can indicate the final failure of a tire.

Reduce speed and stop; otherwise, pieces of the tire could come loose and cause an accident.

Do not continue driving. Contact an authorized service center or another qualified service center or repair shop.

## System limits

### Temperature

The tire inflation pressure depends on the tire's temperature.

Driving or exposure to the sun will increase the tire temperature, thus increasing the tire inflation pressure.

The tire inflation pressure is reduced when the tire temperature falls again.

These circumstances may cause a warning when temperatures fall very sharply.

Following a temperature-related warning, the target pressures are displayed on the Control Display again after a short distance.

### Sudden tire pressure loss

The system cannot indicate sudden serious tire damage caused by external circumstances.

### Failure performing a reset

Tires with special approval: the system will not function correctly if a reset was not performed, for example a flat tire may be indicated although the tire inflation pressures are correct.

## Malfunction

### Message



The yellow warning light flashes and is then illuminated continuously. A Check Control message is displayed. It may not be possible to identify tire pressure losses.

### Measure

- ▶ A wheel without wheel electronics is mounted: have the wheels checked, if needed.
- ▶ A wheel without wheel electronics, such as an emergency wheel, is mounted: have the wheels checked, if needed.
- ▶ Fault caused by systems or devices with the same radio frequency: after leaving the area of the interference, the system automatically becomes active again.
- ▶ For tires with special approval: the system was unable to complete the reset. Perform a system reset again.
- ▶ Tire Pressure Monitor malfunction: have the system checked by an authorized serv-

ice center or another qualified service center or repair shop.

## Declaration according to NHTSA/FMVSS 138 Tire Pressure Monitoring System

Each tire, including the spare (if provided) should be checked monthly when cold and inflated to the inflation pressure recommended by the vehicle manufacturer on the vehicle placard or tire inflation pressure label. (If your vehicle has tires of a different size than the size indicated on the vehicle placard or tire inflation pressure label, you should determine the proper tire inflation pressure for those tires.) As an added safety feature, your vehicle has been equipped with a tire pressure monitoring system (TPMS) that illuminates a low tire pressure telltale when one or more of your tires is significantly under-inflated. Accordingly, when the low tire pressure telltale illuminates, you should stop and check your tires as soon as possible, and inflate them to the proper pressure. Driving on a significantly under-inflated tire causes the tire to overheat and can lead to tire failure. Under-inflation also reduces fuel efficiency and tire tread life, and may affect the vehicle's handling and stopping ability. Please note that the TPMS is not a substitute for proper tire maintenance, and it is the driver's responsibility to maintain correct tire pressure, even if under-inflation has not reached the level to trigger illumination of the TPMS low tire pressure telltale. Your vehicle has also been equipped with a TPMS malfunction indicator to indicate when the system is not operating properly. The TPMS malfunction indicator is combined with the low tire pressure telltale. When the system detects a malfunction, the telltale will flash for approximately one minute and then remain continuously illuminated. This sequence will continue upon subsequent vehicle start-ups as long as the malfunction exists. When the malfunction indicator is illuminated, the system may not be able to detect or signal low tire pressure as

intended. TPMS malfunctions may occur for a variety of reasons, including the installation of replacement or alternate tires or wheels on the vehicle that prevent the TPMS from functioning properly. Always check the TPMS malfunction telltale after replacing one or more tires or wheels on your vehicle to ensure that the replacement or alternate tires and wheels allow the TPMS to continue to function properly.

## Flat tire monitor

### Principle

The flat tire monitor detects a tire pressure loss while driving and issues a warning if the tire pressure has dropped.

### General information

The system detects tire pressure loss on the basis of rotation speed differences between the individual wheels while driving.

In the event of a tire pressure loss, the diameter and therefore the rotational speed of the corresponding wheel changes. The difference will be detected and reported as a flat tire.

The system does not measure the actual inflation pressure in the tires.

### Functional requirements

The following prerequisites must be met for the system; otherwise, reliable notification of a tire pressure loss is not assured:

- ▶ After a tire or wheel change, an initialization was performed with the correct tire inflation pressure.
- ▶ After the tire pressure was adjusted to a new value, an initialization was performed.

## Status display

The current status of the flat tire monitor can be displayed, e.g., whether the flat tire monitor is active.

1. "CAR"
2. "Vehicle status"
3.  "Flat Tire Monitor"

The status is displayed.

## Initialization required

An initialization must be performed in the following situations:

- ▷ After the tire inflation pressure has been adjusted.
- ▷ After a tire or wheel change.

## Performing initialization

When initializing, the set tire inflation pressures serve as reference values in order to detect a flat tire. Initialization is started by confirming the tire inflation pressures.

Do not initialize the system when driving with tire chains.

1. "CAR"
2. "Vehicle status"
3. "Flat Tire Monitor"
4. Turn on drive-ready state and do not drive off.
5. Start the initialization with: "Perform reset"
6. Drive off.

The initialization is completed while driving, which can be interrupted at any time.

The initialization automatically continues when driving continues.

## Messages

### General information

When a flat tire is indicated, the Dynamic Stability Control (DSC) is turned on, if needed.

## Safety information

### **Warning**

A damaged regular tire with low or no tire inflation pressure impacts handling, such as steering and braking response. Runflat tires can maintain limited stability. There is a risk of accident. Do not continue driving if the vehicle is equipped with normal tires. Follow the information on runflat tires and continued driving with these tires.

## Indication of a flat tire



A yellow warning light is illuminated in the instrument cluster.

In addition, an icon with a Check Control message appears on the control display.

Icon	Possible cause
	There is a flat tire or a major tire pressure loss.

## Measure

1. Reduce your speed and stop cautiously. Avoid sudden braking and steering maneuvers.
2. Check whether the vehicle is fitted with standard tires or runflat tires.
 

Runflat tires are labeled with a circular icon containing the letters RSC marked on the tire sidewall.

Runflat tires, refer to page [338](#).

## Actions in the event of a flat tire

### Standard tires

1. Identify the damaged tire.
 

To do this, check the tire pressure in all four tires, for instance using the tire pressure display from a tire repair set.



When the tire inflation pressure in all four tires is correct, the flat tire monitor may not have been initialized. In this case, initialize the system.

If identification of flat tire damage is not possible, please contact an authorized service center or another qualified service center or repair shop.

2. Repair the flat tire, for instance with a tire repair set or by changing the wheel.

## Runflat tires

### Safety information

#### **Warning**

The vehicle handles differently when a runflat tire has insufficient or no tire pressure; for instance, reduced directional stability when braking, braking distances are longer and the self-steering properties will change. There is a risk of accident. Drive moderately and do not exceed a speed of 50 mph/80 km/h.

#### **Warning**

Heavy trailers can start swinging when continuing to drive with a flat tire. There may be a risk of accident or risk of damage to property. Do not exceed a speed of 35 mph/60 km/h when driving with a trailer and a flat tire. Immediately brake in the case of swinging. Apply necessary steering corrections as carefully as possible.

### Maximum speed

You may continue driving with a damaged tire at speeds up to 50 mph/80 km/h.

### Continued driving with a flat tire

Follow the following when continuing to drive with a damaged tire:

1. Avoid sudden braking and steering maneuvers.
2. Do not exceed a speed of 50 mph/80 km/h.
3. Check the tire inflation pressure in all four tires at the next opportunity.

When the tire inflation pressure in all four tires is correct, the flat tire monitor may not have been initialized. In this case, initialize the system.

### Possible distance traveled with a depressurized tire

The possible distance which may be safely traveled varies depending on how the vehicle is loaded and used, e.g., speed, road conditions, outside temperature. The distance traveled may be less but may also be more if an economical driving style is used.

If the vehicle is loaded with an average weight and used under favorable conditions, the possible distance traveled may be up to 50 miles/80 km.

### Vehicle handling with damaged tires

Vehicles driven with a damaged tire will handle differently, potentially leading to conditions such as the following:

- ▷ Greater likelihood of skidding of the vehicle.
- ▷ Longer braking distances.
- ▷ Changed self-steering properties.

Modify your driving style. Avoid abrupt steering or driving over obstacles, for instance curbs or potholes.

### Final tire failure

Vibrations or loud noises while driving can indicate the final failure of a tire.

Reduce speed and stop; otherwise, pieces of the tire could come loose and cause an accident.

Do not continue driving. Contact an authorized service center or another qualified service center or repair shop.

## System limits

The system could be delayed or malfunction in the following situations:

- ▷ A natural, even tire pressure loss in all four tires will not be recognized. Therefore, check the tire inflation pressure regularly.
- ▷ Sudden serious tire damage caused by external circumstances cannot be recognized in advance.
- ▷ The system has not been initialized.
- ▷ When driving on a snowy or slippery road.
- ▷ Sporty driving style: slip on traction wheels, high lateral acceleration (drifting).
- ▷ When driving with tire chains.

## Changing wheels/tires

### General information

When using runflat tires or a tire repair set, the wheel does not always need to be changed immediately in the event of a breakdown when there is tire pressure loss.

If needed, the appropriate tool for a wheel change, e.g., a jack, is available as an accessory from an authorized service center, another qualified service center or a repair shop.

### Safety information

#### **Warning**

The jack is only provided for short-term lifting of the vehicle for wheel changes. Even if all safety precautions are observed, there is a risk of the raised vehicle falling if the jack tips

over. There is a risk of injury or danger to life. When the vehicle is raised with the jack, do not lie under the vehicle and do not switch on the drive-ready state.

#### **Warning**

Supports such as wooden blocks under the jack reduce the load-carrying capacity of the jack to bear weight. The load-carrying capacity of the wooden blocks may be exceeded and the vehicle may tip over. There is a risk of injury or danger to life. Do not place supports under the jack.

#### **Warning**

The jack, issued by the vehicle manufacturer, is provided in order to perform a wheel change in the event of a breakdown. The jack is not designed for frequent use; for example, changing from summer to winter tires. Using the jack frequently may cause it to become jammed or damaged. There is a risk of injury and risk of damage to property. Only use the jack to change an emergency or spare wheel in the event of a breakdown.

#### **Warning**

On soft, uneven or slippery ground, for example snow, ice, tiles, etc., the jack can slip away. There is a risk of injury. If possible, change the wheel on a flat, solid, and slip-resistant surface.

#### **Warning**

The jack is optimized for lifting the vehicle and for the jacking points on the vehicle only. There is a risk of injury. Do not lift any other vehicle or cargo using the jack.

**⚠ Warning**

When the jack is not inserted into the jacking point provided for this purpose, the vehicle may be damaged or the jack may slip when it is being cranked up. There is a risk of injury or risk of damage to property. When cranking up the jack, ensure that it is inserted in the jacking point next to the wheel well.

**⚠ Warning**

A vehicle that is raised on a jack may fall off of the jack if lateral forces are exerted on it. There is a risk of injury and risk of damage to property. While the vehicle is raised, do not exert lateral effort on the vehicle or pull abruptly on the vehicle. Have a stuck wheel removed by an authorized service center or another qualified service center or repair shop.

**⚠ NOTICE**

Using an impact wrench to loosen or tighten the wheel lock bolt can damage it. There is a risk of damage to property, among other potential damage. Only use a lug wrench to loosen and tighten the wheel lock bolt.

## Securing the vehicle against rolling away

### General information

The vehicle manufacturer recommends to additionally secure the vehicle against rolling away when changing a wheel.

### On a level surface



Place wheel chocks or other suitable objects in front and behind the wheel that is diagonal to the wheel to be changed.

### On a slight downhill gradient



If you need to change a wheel on a slight downhill grade, place chocks and other suitable objects, for instance rocks, under the proper side of the wheels of both the front and rear axles to block the car from rolling downhill.

## Lug bolt lock

### Principle

The wheel lug bolts have a special coding. The lug bolts can only be released with the adapter which matches the coding.

### Overview

The adapter of the lug bolt lock is in the on-board vehicle tool kit or in a storage compartment close to the onboard vehicle tool kit.

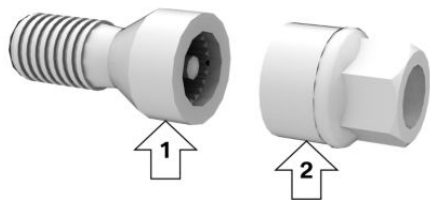

- ▷ Lug lock bolt, arrow 1.
- ▷ Adapter, arrow 2.

### Unscrewing

1. Attach the adapter to the lug lock bolt.
2. Unscrew the lug lock bolt.
3. Remove the adapter after unscrewing the lug bolt.

### Screwing on

1. Attach the adapter to the lug lock bolt. If necessary, turn the adapter until it fits on the lug lock bolt.
2. Screw on the lug lock bolt. The tightening torque is 101 lbs ft/140 Nm.
3. Remove the adapter and stow it after screwing on the lug bolt.

### Preparing the vehicle

- ▷ Park the vehicle on solid and non-slip ground at a safe distance from road traffic.
- ▷ Turn on the hazard warning system.
- ▷ Set the parking brake.
- ▷ Engage a gear or move the selector lever to position P.
- ▷ As soon as permitted by the traffic flow, have all vehicle occupants get out and make sure that they remain outside the hazardous area such as behind a guardrail.
- ▷ Depending on the vehicle equipment, get wheel change tools and, if necessary, the emergency wheel from the vehicle.

- ▷ If necessary, set up a warning triangle or portable hazard warning light at an appropriate distance.
- ▷ Secure the vehicle additionally against rolling away.
- ▷ Loosen the lug bolts a half turn.

### Jacking points

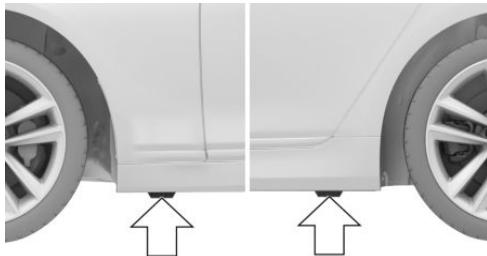

The jacking points are located at the indicated positions.

### Jacking up the vehicle

#### **Warning**

Hands and fingers can be jammed when using the jack. There is a risk of injury. Comply with the described hand position and do not change this position while using the jack.

1. Hold the vehicle jack with one hand, arrow 1, and grasp the jack crank handle or lever with your other hand, arrow 2.

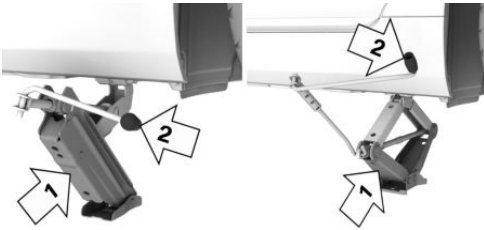

2. Insert the jack into the rectangular recess of the jacking point closest to the wheel to be changed.

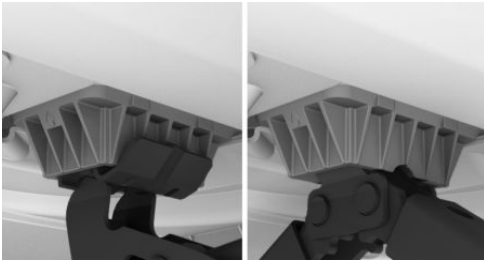

3. Extend the jack by turning the jack crank handle or lever clockwise.



4. Take your hand away from the jack as soon as the jack is under load and continue turning the jack crank handle or lever with one hand.

5. Make sure that the car jack foot extends vertically and is at a right angle beneath the jacking point.

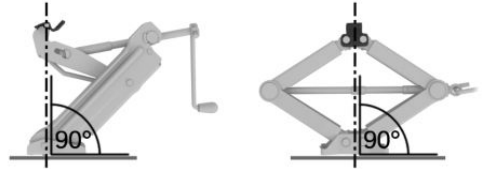

6. Make sure that the car jack foot is vertical and at a right angle beneath the jacking point after extending the vehicle jack.

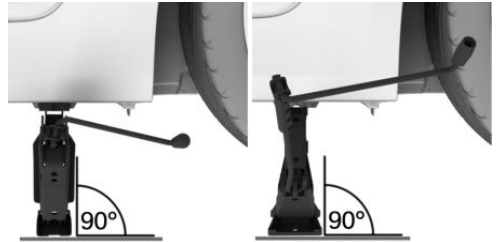

7. Crank the vehicle up until the vehicle jack has the entire surface on the ground and the relevant wheel is maximum 1.2 inches/3 cm above ground.

## Mounting a wheel

Mount one emergency wheel only, as required.

1. Unscrew the lug bolts.
2. Remove the wheel.
3. Put the new wheel or emergency wheel on and screw in at least two lug bolts in a crosswise pattern until hand-tight.

When non-original light-alloy wheels of the vehicle manufacturer are mounted, the accompanying lug bolts may have to be used as well.

4. Hand-tighten the remaining lug bolts and tighten all lug bolts well in a crosswise pattern.
5. Turn the jack crank handle counterclockwise to retract the jack and lower the vehicle.
6. Remove the jack and stow it securely.

## After the wheel change

1. Tighten the lug bolts crosswise. The tightening torque is 101 lbs ft/140 Nm.
2. Stow the faulty wheel in the cargo area, if necessary.
3. Check tire inflation pressure at the next opportunity and correct as needed.
4. Re-initialize the flat tire monitor or reset the Tire Pressure Monitor.
5. Check to make sure the lug bolts are tight with a calibrated torque wrench.
6. Have the damaged tire renewed at the nearest authorized service center or another qualified service center or repair shop.

## Emergency wheel

### Principle

In the event of a flat tire, the emergency wheel can be used in place of the wheel with the faulty tire. The emergency wheel is only intended for temporary use until the faulty tire/wheel has been replaced.

### General information

Mount one emergency wheel only.

Also check the tire inflation pressure of the emergency wheel in the cargo area regularly, and correct it as needed.

## Safety information

### Warning

The emergency wheel has particular dimensions. When driving with an emergency wheel, changed driving properties may occur, for instance reduced directional stability when braking, longer braking distance, and changed self-steering properties in the limit range. There is a risk of accident. Drive moderately and do not exceed a speed of 50 mph/80 km/h.

## Overview

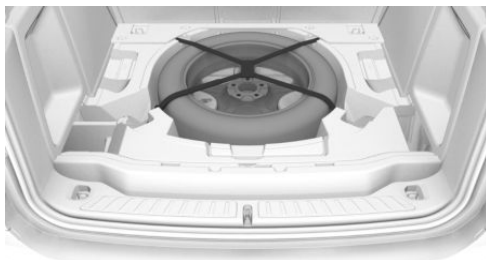

The emergency wheel and the wheel change tools are located in the cargo area under the cargo floor panel.

## Removing the emergency wheel

1. Fold the rear part of the cargo floor panel forward.
2. Lift the cargo area floor and place it onto the folded out multi-function hook.

3. Remove the cover.

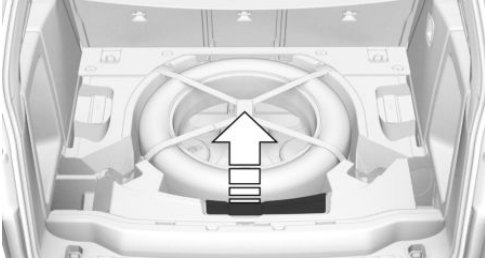

4. Open the luggage strap at the clasp, arrow 1.

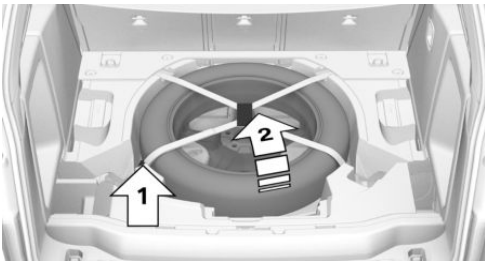

5. Remove the emergency wheel from the storage tray, arrow 2.

### Inserting the emergency wheel

1. Place the emergency wheel in the storage tray.
2. Tie the luggage strap. Make sure that it is correctly and firmly seated.
3. Install the cover.
4. Lift the cargo floor panel up slightly and fold in the multi-function hook.
5. Lower the cargo floor panel and fold it toward the rear.

# Engine compartment

## Vehicle features and options

This chapter describes all standard, country-specific and optional features offered with the series. It also describes features and functions that are not necessarily available in your vehi-

cle, e.g., due to the selected options or country versions. This also applies to safety-related functions and systems. When using these functions and systems, the applicable laws and regulations must be observed.

## Overview

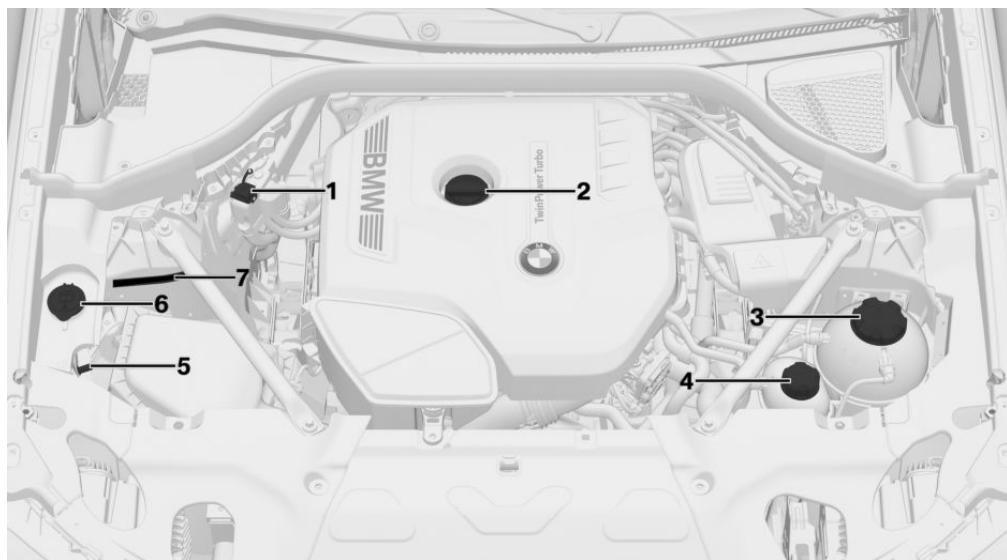

- |   |   |
|---|---|
| <b>1</b> Jump-starting, positive battery terminal                             | <b>5</b> Jump-starting, negative battery terminal |
| <b>2</b> Oil filler neck  | <b>6</b> Filler neck for washer fluid             |
| <b>3</b> Coolant reservoir, engine  | <b>7</b> Vehicle identification number            |
| <b>4</b> Depending on motorization: coolant reservoir for additional radiator |   |



## Hood

### Safety information

#### **Warning**

Improperly executed work in the engine compartment can damage vehicle components and impair vehicle functions. There is a risk of an accident and damage to property. Have work in the engine compartment performed by an authorized service center or another qualified service center or repair shop.

#### **Warning**

The engine compartment accommodates moving components. Certain components in the engine compartment can also move with the vehicle switched off, for instance the radiator fan. There is a risk of injury. Do not reach into the area of moving parts. Keep articles of clothing and hair away from moving parts.

#### **Warning**

There are protruding parts, for instance locking hooks, on the inside of the hood. There is a risk of injury. If the hood is open, pay attention to protruding parts and keep clear of these areas.

#### **Warning**

An incorrectly locked hood can open while driving and restrict visibility. There is a risk of accident. Stop immediately and correctly close the hood.

#### **Warning**

Body parts can be jammed when opening and closing the hood. There is a risk of injury. Make sure that the area of movement of hood is clear during opening and closing.

#### **NOTICE**

Folded-out wipers can be jammed when the hood is opened. There is a risk of damage to property, among other potential damage. Make sure that the wipers with the wiper blades mounted are folded down onto the windshield before opening the hood.

#### **NOTICE**

When the hood is closed, it must engage on both sides. Pressing again can damage the hood. There is a risk of damage to property, among other potential damage. Open the hood again and then close it energetically. Avoid pressing again.

### Opening hood

1. Pull lever, arrow 1. Hood is unlocked.



2. After the lever is released, pull the lever again, arrow 2.  
Hood can be opened.
3. Be careful of protruding parts on the hood.

## Closing the hood

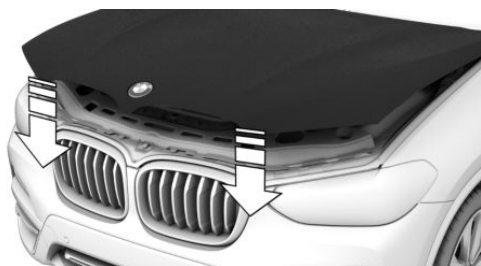

Energetically close the hood from approx.  
20 in/50 cm.

The hood must engage on both sides.

# Operating materials

## Vehicle features and options

This chapter describes all standard, country-specific and optional features offered with the series. It also describes features and functions that are not necessarily available in your vehicle, e.g., due to the selected options or country versions. This also applies to safety-related functions and systems. When using these functions and systems, the applicable laws and regulations must be observed.

## Fuel recommendation

### General information

Depending on the region, many filling stations sell fuel that has been customized to winter or summer conditions. Fuel that is available in winter, for instance helps make a cold start easier.

### Gasoline

#### General information

For the best fuel efficiency, the gasoline should be sulfur-free or very low in sulfur content.

Fuels that are marked on the gas pump as containing metal must not be used.

Fuels with a maximum ethanol content of 25 %, i. e. E10 or E25, may be used for refueling.

To achieve nominal values for mileage and consumption, follow the specified fuel quality in the sales literature.



The use of fuels of minimum quality has no influence on the service life of the engine.

### Safety information

#### **Caution**

The use of poor-quality fuels may result in harmful engine deposits or damage. Additionally, problems relating to drivability, starting and stalling, especially under certain environmental conditions such as high ambient temperature and high altitude, may occur.

If drivability problems are encountered, we recommend switching to a high quality gasoline brand and a higher octane grade — AKI number — for a few tank fills. To avoid harmful engine deposits, it is highly recommended to purchase gasoline from Top Tier retailers.

Failure to comply with these recommendations may result in the need for additional maintenance.

#### **NOTICE**

Even small quantities of the wrong fuel or wrong fuel additives can damage the fuel system and engine. Furthermore, the catalytic converter is permanently damaged. There is a risk of damage to property, among other potential damage. Do not refuel or add the following in the case of gasoline engines:

- ▷ Leaded gasoline.
- ▷ Metallic additives, for instance manganese or iron.

Do not press the Start/Stop button after refueling with the wrong fuel. Contact an authorized service center or another qualified service center or repair shop.

### NOTICE

Fuel that does not comply with the minimum quality can compromise engine function or cause engine damage. There is a risk of damage to property, among other potential damage. Do not fill with fuel that does not comply with the minimum quality.

### NOTICE

Incorrect fuels can damage the fuel system and the engine. There is a risk of damage to property, among other potential damage. Do not use fuels with a higher ethanol content than recommended. Do not refuel with fuels containing methanol, e.g. M5 to M100.

## Recommended gas quality

BMW recommends AKI 91.

M Performance model:

BMW recommends AKI 93.

## Minimum fuel grade

BMW recommends AKI 87.

If you use gasoline with this minimum AKI Rating, the engine may produce knocking sounds when starting at high external temperatures. This has no effect on the engine life.

**BMW recommends**  
**Shell Quality Fuels** 

## Engine oil

### General information

The engine oil consumption is dependent on your driving style and driving conditions.

Therefore, regularly check the engine oil level after refueling by taking a detailed measurement.

The engine oil consumption can increase in the following situations, for instance:

- ▷ Sporty driving style.
- ▷ Break-in of the engine.
- ▷ Idle operation of the engine.
- ▷ With use of engine oil types that are classified as not suitable.

Different Check Control messages appear on the Control Display depending on the engine oil level.

The vehicle manufacturer recommends that you have an authorized service center or another qualified service center or repair shop change the engine oil.

### Safety information

#### NOTICE

An engine oil level that is too low causes engine damage. There is a risk of damage to property, among other potential damage. Immediately add engine oil.

**⚠ NOTICE**

Too much engine oil can damage the engine or the catalytic converter. There is a risk of damage to property, among other potential damage. Do not add too much engine oil. When too much engine oil is added, have the engine oil level corrected by an authorized service center or another qualified service center or repair shop.

**⚠ NOTICE**

Engine oil that is not changed in timely fashion can cause increased engine wear and thus engine damage. There is a risk of damage to property. It is recommended that you do not exceed the service intervals indicated in the vehicle.

## Electronic oil measurement

### General information

The electronic oil measurement has two measuring principles:

- ▷ Monitoring.
- ▷ Detailed measurement.

When making frequent short-distance trips or using a sporty driving style, for instance when cornering aggressively, regularly perform a detailed measurement.

### Monitoring

#### Principle

The engine oil level is monitored electronically while driving and can be shown on the Control Display.

If the engine oil level is outside its permissible operating range, a Check Control message is displayed.

#### Functional requirements

A current measured value is available after approx. 30 minutes of normal driving.

#### Displaying the engine oil level

1. "CAR"
2. "Vehicle status"
3.  "Engine oil level"

The engine oil level is displayed.

#### System limits

When making frequent short-distance trips or using a sporty driving style, it may not be possible to calculate a measured value. In this case, the measured value for the last, sufficiently long trip is displayed.

### Detailed measurement

#### Principle

The engine oil level is checked when the vehicle is stationary and displayed via a scale.

If the engine oil level is outside its permissible operating range, a Check Control message is displayed.

#### General information

During the measurement, the idle speed is increased somewhat.

#### Functional requirements

- ▷ Vehicle is parked in a horizontal position.
- ▷ Steptronic transmission: selector lever in selector lever position N or P and accelerator pedal not depressed.
- ▷ The drive-ready state is switched on by pressing the Start/Stop button.
- ▷ The engine is at operating temperature.

#### Performing a detailed measurement

1. "CAR"
2. "Vehicle status"

3. : "Engine oil level"
4. "Engine oil measurement"
5. "Start measurement"

The engine oil level is checked and displayed via a scale.

## Adding engine oil

### General information

Only add engine oil when the message is displayed in the instrument cluster. The top-up quantity is indicated in the message shown on the Control Display.

Only add suitable types of engine oil.

Safely park the vehicle and switch off drive-ready state before adding engine oil.

Take care not to add too much engine oil.

### Safety information

#### **Warning**

Operating materials, for instance oils, greases, coolants, fuels, can contain harmful ingredients. There is a risk of injury or danger to life. Follow the instructions on the containers. Avoid the contact of articles of clothing, skin or eyes with operating materials. Do not refill operating materials into different bottles. Store operating materials out of reach of children.

#### **NOTICE**

An engine oil level that is too low causes engine damage. There is a risk of damage to property, among other potential damage. Immediately add engine oil.

#### **NOTICE**

Too much engine oil can damage the engine or the catalytic converter. There is a risk of damage to property, among other potential damage. Do not add too much engine oil. When too much engine oil is added, have the engine oil level corrected by an authorized service center or another qualified service center or repair shop.

### Overview

The oil filler neck is located in the engine compartment.

Additional information:

For an overview, refer to page [360](#).

### Adding engine oil

1. Opening the hood.  
Opening, refer to page [361](#).
2. Open the lid counterclockwise.



3. Add engine oil.
4. Close the lid.

### Engine oil types to add

#### General information

The engine oil grade is critical for the service life of the engine.

Only add with the types of engine oil which are listed.

## Safety information

### NOTICE

Oil additives can damage the engine. There is a risk of damage to property, among other potential damage. Do not use oil additives.

### NOTICE

Incorrect engine oil can cause malfunctions in the engine or damage it. There is a risk of damage to property, among other potential damage. When selecting an engine oil, make sure that the engine oil has the correct oil specification.

## Suitable engine oil types

Up to 1 US quart/liter of an engine oil with the following oil specification can be topped up:

### Gasoline engine

BMW Longlife-17 FE+.

## Alternative engine oil types

If an engine oil suitable for continuous use is not available, up to 1 US quart/liter of an engine oil with the following oil rating can be added:

### Oil specification

API SL.

API SM.

API SN.

## Viscosity grades

When selecting an engine oil, make sure that the engine oil has a suitable viscosity grade. The suitable viscosity grade is indicated on a sign in the engine compartment.

## Viscosity grades

SAE 0W-20.

More information about suitable oil specifications and viscosity grades of engine oils can be requested from an authorized service center or another qualified service center or repair shop.

**BMW recommends  
Original BMW Engine Oil.**

## Coolant

### General information

Coolant consists of water and coolant additive. Not all commercially available additives are suitable for the vehicle. The vehicle manufacturer recommends using coolant with the BMW LC-18 specification. Do not mix additives of different colors. Observe the water - additive mixture ratio of 50:50. Information about suitable additives is available from an authorized service center or another qualified service center or repair shop.

## Safety information

### Warning

With the engine hot and the cooling system open, coolant can escape and lead to scalding. There is a risk of injury. Only open the cooling system with the engine cooled down.

**Warning**

Additives are harmful and incorrect additives can damage the engine. There is a risk of injury and risk of damage to property. Do not allow additives to come into contact with skin, eyes or articles of clothing. Use suitable additives only.

## Coolant level

### General information

Depending on the motorization, there are up to two coolant reservoirs in the engine compartment. Check and add the coolant levels on a regular basis.

The coolant may be overfilled in the coolant reservoir when the vehicle is delivered from the factory. The normal coolant level is achieved by operating the vehicle for a longer period.

The coolant level is indicated using minimum and maximum marks in the filler neck of the coolant reservoir.

Depending on the motorization, the coolant reservoir is located on the right side or the left side of the engine compartment.

Additional information:

For an overview, refer to page 360.

### Checking the coolant level in the filler neck

1. Let the engine cool down.
2. Opening the hood.  
Opening, refer to page 361.
3. Turn the lid of the coolant reservoir slightly counterclockwise to allow any excess pressure to dissipate, then open it.
4. Open the coolant reservoir lid.

5. The coolant level is correct if it lies between the minimum and maximum marks in the filler neck.

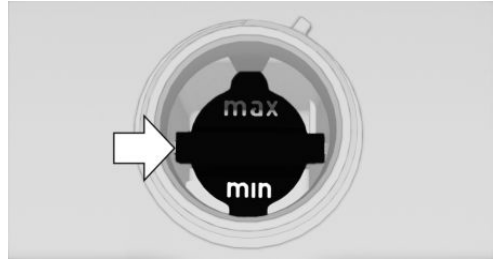

6. Close the lid.

### Adding coolant

1. Let the engine cool down.
2. Opening the hood.  
Opening, refer to page 361.
3. Turn the lid of the coolant reservoir slightly counterclockwise to allow any excess pressure to dissipate, then open it.
4. Open the coolant reservoir lid.
5. If the coolant is low, slowly add coolant up to the specified fill level; do not overfill.
6. Close the lid.
7. Have the cause of the coolant loss eliminated as soon as possible.

### Disposal



Comply with the relevant environmental protection regulations when disposing of coolant and coolant additives.

## Washer fluid

### General information

All windshield washer jets are supplied from one tank.

Use a mixture of tap water and windshield washer concentrate. If desired, a windshield



washer concentrate containing antifreeze can be used.

Recommended minimum fill quantity:  
0.2 US gal/1 liter.

## Safety information

### **Warning**

Some types of antifreeze can contain harmful substances and are flammable. There is a risk of fire and an injury hazard. Follow the instructions on the containers. Keep antifreeze away from ignition sources. Do not refill operating materials into different bottles. Store operating materials out of reach of children.

United States: the washer fluid mixture ratio is regulated by the U.S. EPA and many individual states; do not exceed the allowable washer fluid dilution ratio limits that apply. Follow the usage instructions on the washer fluid container.

Use of BMW's Windshield Washer Concentrate or the equivalent is recommended.

### **Warning**

Washer fluid can ignite and catch fire on contact with hot engine parts. There is a risk of injury or risk of damage to property. Only add washer fluid when the engine is cooled down. Next, fully close the lid of the washer fluid reservoir.

### **NOTICE**

Silicon-containing additives in the washer fluid for the water-repelling effect on the windows can lead to damage to the washing system. There is a risk of damage to property, among other potential damage. Do not add silicon-containing additives to the washer fluid.

### **NOTICE**

Mixing different windshield washer fluid concentrates or antifreeze can damage the washer system. There is a risk of damage to property, among other potential damage. Do not mix different windshield washer fluid concentrates or antifreeze. Follow the information and mixture ratios provided on the containers.

## Overview



The washer fluid reservoir is located in the engine compartment.

## Malfunction

The use of undiluted windshield washer fluid concentrate or alcohol-based antifreeze can lead to incorrect readings at temperatures below +5 °F/-15 °C.

# Maintenance

## Vehicle features and options

This chapter describes all standard, country-specific and optional features offered with the series. It also describes features and functions that are not necessarily available in your vehicle, e.g., due to the selected options or country versions. This also applies to safety-related functions and systems. When using these functions and systems, the applicable laws and regulations must be observed.

## BMW maintenance system

The maintenance system provides service notifications and thereby provides support in maintaining road safety and the operational reliability of the vehicle.

In some cases, scopes and intervals of the maintenance system may vary according to the country version. Replacement work, spare parts, fuels and lubricants, and wear materials are calculated separately. Further information is available from an authorized service center or another qualified service center or repair shop.

## Condition Based Service

### Principle

Condition Based Service determines the maintenance recommendation using sensors and special algorithms that take into account the operating conditions of the vehicle.

The system makes it possible to adapt the amount of maintenance corresponding to your user profile.

## General information

Information on service notifications can be displayed on the control display.

Additional information:

Service notifications, refer to page [168](#).

## Service data in the vehicle key

Information on the service notifications is continuously stored in the vehicle key. The service center can read this data out and suggest a maintenance scope for the vehicle.

Therefore, hand the service advisor the vehicle key with which the vehicle was driven most recently.

## Stationary periods

Stationary periods during which the vehicle battery was disconnected are not taken into account.

If this occurs, have an authorized service center or another qualified service center or repair shop update the time-dependent maintenance procedures, such as checking brake fluid and, if necessary, changing the engine oil and the microfilter/activated-charcoal filter.

## Maintenance Booklet for US Models

Please consult your Maintenance Booklet for additional information on the performance of service and maintenance work.

The manufacturer of your vehicle recommends that maintenance and repair be performed by a service center or another qualified service center or repair shop. Records of regular maintenance and repair work should be retained.

## Diagnostic socket

### General information

Devices connected to the diagnostic socket will trigger the alarm system after locking the vehicle.

Remove devices connected to the diagnostic socket before locking the vehicle.

### Safety information

#### NOTICE

The socket for Onboard Diagnosis is an intricate component intended to be used in conjunction with specialized equipment to check the vehicle's primary emissions system. Improper use of the socket for Onboard Diagnosis, or contact with the socket for Onboard Diagnosis for other than its intended purpose, can cause vehicle malfunctions and creates risks of personal and property damage. Given the foregoing, the manufacture of your vehicle strongly recommends that access to the socket for Onboard Diagnosis be limited to an authorized service center or another qualified service center or repair shop or other persons that have the specialized training and equipment for purposes of properly utilizing the socket for Onboard Diagnosis.

### Position

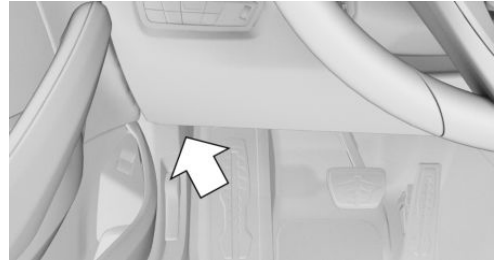

There is a diagnostic socket on the driver's side for reading out vehicle data.

### Emissions



▶ The warning light lights up: Emissions are deteriorating. Have the vehicle checked as soon as possible.

▶ The warning light flashes under certain circumstances: This indicates that there is excessive misfiring in the engine.

Reduce the vehicle speed and have the system checked immediately; otherwise, serious engine misfiring within a brief period can seriously damage emission control components, in particular the catalytic converter.

# Replacing components

## Vehicle features and options

This chapter describes all standard, country-specific and optional features offered with the series. It also describes features and functions that are not necessarily available in your vehicle, e.g., due to the selected options or country versions. This also applies to safety-related functions and systems. When using these functions and systems, the applicable laws and regulations must be observed.

## Onboard vehicle tool kit



The onboard vehicle tool kit is located under the cargo area floor.

## Wiper blades

### Safety information

#### **!** NOTICE

The window may sustain damage if the wiper falls onto it without the wiper blade installed. There is a risk of damage to property, among other potential damage. Hold the wiper firmly when changing the wiper blade. Do not fold

in or switch on the wiper without a wiper blade installed.

#### **!** NOTICE

Folded-out wipers can be jammed when the hood is opened. There is a risk of damage to property, among other potential damage. Make sure that the wipers with the wiper blades mounted are folded down onto the windshield before opening the hood.

## Replacing the front wiper blades

1. To change the wiper blades, bring wipers into fold-out position.  
Fold-out position of the wipers, refer to page 146.
2. Lift the wiper off of the windshield and hold.



3. Press the button, arrow 1, and pull out the wiper blade, arrow 2.

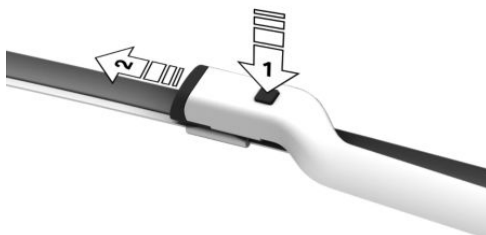

4. Insert the new wiper blade and press it on until it you hear it snap into the holder.
5. Fold in the wipers.

## Replacing the rear wiper blade

The wiper blade is engaged at the end of the wiper arm.

1. Lift off the wiper fully and pull off the wiper blade, arrow.



2. Attach a new wiper blade. The wiper blade must engage audibly.
3. Fold in the wipers.

## Lights and bulbs

### General information

Lights and bulbs make an essential contribution to driving safety.

All headlights and lights are made using LED or laser technology.

Some items of equipment use light-emitting diodes installed behind a cover as a light source. These light-emitting diodes are related to conventional lasers and are officially designated as Class 1 light-emitting diodes.

The manufacturer of the vehicle recommends that you let an authorized service center or another qualified service center or repair shop perform the work in case of a malfunction.

## Safety information

### Warning

Bulbs can get hot during operation. Contact with the bulbs can cause burns. There is a risk of injury. Only change bulbs after they have cooled off.

### Warning

Work on switched-on lighting systems can cause short circuits. There is a risk of injury or risk of damage to property. When working on the lighting system, switch off the lights in question. If necessary, heed the bulb manufacturer's instructions.

### Warning

Focused laser light can irritate or permanently damage the retina of the eye. There is a risk of injury. The manufacturer of the vehicle recommends that the work on the lighting system including bulb exchange be performed by an authorized service center or another qualified service center or repair shop.

### Warning

Intense brightness can irritate or damage the retina of the eye. There is a risk of injury. Do not look directly into the headlights or other light sources. Do not remove the LED covers.

### NOTICE

Dirty bulbs have a reduced service life. There is a risk of damage to property, among other potential damage. Do not hold new glass bulbs with your bare hands. Use a clean cloth

or something similar, or hold the bulb by its base.

## Headlight glass

The inside of the headlight glass can fog up in cool or humid weather. When driving with the lights switched on, the condensation evaporates after a short time. The headlight glass does not need to be changed.

If, despite driving with the headlights switched on, moisture such as water droplets increasingly forms in the light, have the headlights checked.

## Vehicle battery

### General information

The battery is maintenance-free.

More information about the battery can be requested from an authorized service center or another qualified service center or repair shop.

### Safety information

#### DANGER

Contact with live components can lead to an electric shock. There is a risk of injury or danger to life. Do not touch any components that are under voltage.

#### Warning

Vehicle batteries that are not compatible can damage vehicle systems and impair vehicle functions. There is a risk of an accident and damage to property. Only vehicle batteries that are compatible with your vehicle type should be installed in your vehicle. Information on compatible vehicle batteries is available at an authorized service center.

## Registering the battery to the vehicle

The manufacturer of the vehicle recommends that you have an authorized service center or another qualified service center or repair shop register the vehicle battery to the vehicle after the battery has been changed. Once the battery has been registered again, all comfort features will be available without limitation and any Check Control messages displayed which relate to comfort features will disappear.

## Charging the battery

### General information

Make sure that the battery is always sufficiently charged to guarantee that the battery remains usable for its full service life.



A discharged battery is indicated by a red indicator light.

Charge the battery when acceleration is insufficient.

The following circumstances can have a negative effect on the performance of the battery:

- ▶ Frequent short-distance drives.
- ▶ Stationary periods of more than one month.

### Safety information

#### NOTICE

Battery chargers that charge the vehicle battery via sockets or cigarette lighters in the vehicle may overload or damage the 12 V electrical system. There is a risk of damage to property, among other potential damage. Only connect battery chargers for the vehicle battery to the jump-start terminals in the engine compartment.

## Charging the battery

Charge the battery only when the engine is off and via the jump-start terminals in the engine compartment.

With Mild Hybrid technology: charge the battery only when the hood is opened.

Additional information:

Jump-start terminals, refer to page [381](#).

## Power interruption

After a power interruption, some equipment needs to be newly initialized or individual settings updated, for example:

- ▶ With Memory function: store the positions again.
- ▶ Time: update.
- ▶ Date: update.
- ▶ Glass sunroof: initialize the system.

## Mild Hybrid technology

### Principle

Part of the Mild Hybrid technology is a battery that works with a voltage of 48 volts. Mild Hybrid technology can lower the fuel consumption.

Mild Hybrid technology influences the following functions.

Additional information:

- ▶ Auto Start/Stop function, refer to page [134](#).
- ▶ Engine-Off Coasting, refer to page [323](#).

## Safety information

### DANGER

Contact with live components can lead to an electric shock. There is a risk of injury or danger to life. Do not touch any components that are under voltage.

## Overview

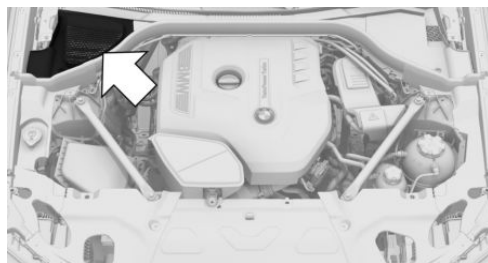

The battery for the Mild-Hybrid technology is located under a cover in the engine compartment on the front passenger side.

## Removing the cover

1. Turn lid up to the opened lock symbol  arrow 1.

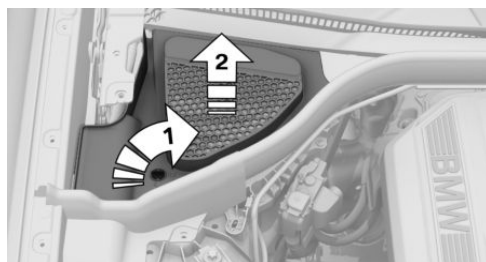

2. Remove cover, arrow 2.

## Information

A purple cable leads from the battery to the center of the vehicle.

Do not exchange or work on the battery for the Mild Hybrid technology.

## Disposing of old batteries



Have old batteries disposed of by an authorized service center or another qualified service center or repair shop or take them to a collection point.

Maintain the filled battery in an upright position for transport and storage. Secure the battery so that it does not tip over during transport.

## Fuses

### General information

The fuses are located at different places in the vehicle.

### Safety information

#### Warning

Incorrect and repaired fuses can overload electrical lines and components. There is a risk of fire. Never attempt to repair a blown fuse. Do not replace a nonworking fuse with a substitute of another color or amperage rating.

### In the car's interior

The fuses are located in the car's interior in the front passenger footwell behind a cover.

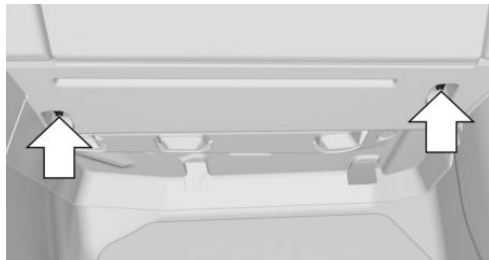

Loosen fasteners, arrows, and open cover.

The fuse box is located on the front right.

### In the cargo area

The fuses are located in the cargo area on the right side behind a cover.

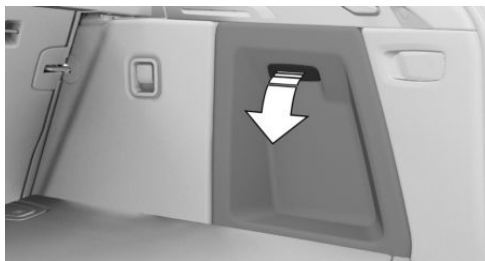

Open the cover on the right side trim panel.

The fuse box may be located behind the sound insulation.

Information on the fuse layout as well as the positions of other fuse boxes is available on the Internet: [fusecard.bmw.com](http://fusecard.bmw.com).

### Additional fuse boxes

Additional fuse boxes are located in the vehicle. In the case of a malfunction, contact an authorized service center or another qualified service center or repair shop.

### Replacing fuses

The vehicle manufacturer recommends that you have an authorized service center or another qualified service center or repair shop replace the fuses.



# Breakdown Assistance

## Vehicle features and options

This chapter describes all standard, country-specific and optional features offered with the series. It also describes features and functions that are not necessarily available in your vehicle, e.g., due to the selected options or country versions. This also applies to safety-related functions and systems. When using these functions and systems, the applicable laws and regulations must be observed.

## Hazard warning flashers



The button is located in the center console. The red light in the button flashes when the hazard warning flashers are activated.

## Warning triangle

The warning triangle is located in the left storage compartment of the cargo area.

1. Open the cover on the left side trim panel.



2. Open the bracket and take the warning triangle out in the direction of the car's interior.



## First-aid kit

### General information

Depending on the vehicle equipment and national-market version, the vehicle is equipped with a first-aid kit.

Some of the articles have a limited service life.

Check the expiration dates of the contents regularly and replace any expired items promptly.

## Storage



Storage for the first-aid kit is provided in the left storage compartment of the cargo area.

To open, pull on the handle.

## BMW Roadside Assistance

### Principle

BMW Group Roadside Assistance can be contacted if assistance is needed in the event of a breakdown.

### General information

In the event of a breakdown, data on the vehicle's condition is transmitted to the BMW Roadside Assistance.

There are various ways of contacting BMW Roadside Assistance.

- ▶ Via a Check Control message.  
Supplementary text messages, refer to page 159.
- ▶ Via a call with a mobile phone.
- ▶ Via the BMW app.

### Functional requirements

- ▶ Active ConnectedDrive contract, equipment with intelligent emergency call or BMW ConnectedDrive services.
- ▶ Cellular network reception.
- ▶ Standby state is switched on.

## Starting BMW Roadside Assistance manually

If the vehicle is equipped with Teleservices, support is first offered through Teleservice Diagnosis and, where applicable, then through Teleservice Help.

1. "APPS"
2. "Installed apps"
3. "BMW Assist"
4. If necessary, "BMW Roadside Assistance"  
A voice connection is established.

## Teleservice Diagnosis

Teleservice Diagnosis enables the wireless transmission of detailed vehicle data that is important for vehicle diagnosis. This data is transmitted automatically. It may be necessary to approve this on the control display.

## Teleservice Help

Depending on the country, Teleservice Help enables an in-depth diagnosis of the vehicle by BMW Roadside Assistance via wireless transmission.

You can launch Teleservice Help by requesting it through BMW Roadside Assistance.

1. Park the vehicle in a safe place.
2. Set the parking brake.
3. Control Display is switched on.
4. Confirm Teleservice Help.

## BMW Accident Assistance

### Principle

BMW Group Accident Assistance can be contacted if assistance is needed in the event of an accident.

## General information

If the vehicle sensors detect a minor to moderately severe accident, which did not deploy any airbags, a Check Control message appears on the instrument cluster. In addition, a text message appears on the Control Display.

When BMW Accident Assistance is triggered, data on the vehicle's condition is sent to BMW.

## Functional requirements

- ▷ Active ConnectedDrive contract, equipment with intelligent emergency call or BMW ConnectedDrive services.
- ▷ Cellular network reception.
- ▷ Standby state is switched on.

## Starting BMW Accident Assistance

### If an accident is detected automatically

A text message relating to BMW Accident Assistance appears on the control display.

The connection can be established directly:

"Contact accident assistance"

The Check Control message for BMW Accident Assistance can also be called up from the stored Check Control messages for a certain length of time.

Additional information:

Check Control, refer to page 158.

### Starting manually

BMW Accident Assistance can also be contacted independently of the automatic accident detection function.

1. "APPS"
2. "Installed apps"
3. "BMW Assist"
4. "BMW Accident Assistance"

Follow the displays on the control display. A voice connection is established.

## Emergency Call

### Intelligent emergency call

#### Principle

In case of an emergency, an emergency call can be triggered automatically by the system or manually.

#### General information

Depending on the vehicle equipment and national-market version, the vehicle is equipped with an Assist system.

Only press the SOS button in an emergency.

The Intelligent Assist system establishes a connection with the BMW Response Center.

For technical reasons, the emergency call cannot be guaranteed under unfavorable conditions.

#### Overview



SOS button.

#### Functional requirements

- ▷ Standby state is switched on.
- ▷ The Assist system is functional.
- ▷ If the vehicle is equipped with intelligent emergency call: the integrated SIM card in the vehicle has been activated.

## Automatic triggering

When certain prerequisites are met, for instance if the airbags deploy, an emergency call is automatically initiated immediately after an accident of corresponding severity. Automatic Collision Notification is not affected by pressing the SOS button.

## Manual triggering

1. Tap the cover flap.
  2. Press and hold the SOS button until the LED in the area of the button illuminates green.
- ▶ The LED is illuminated green when an emergency call has been initiated.  
If a cancel prompt appears on the control display, the emergency call can be aborted. If the situation allows, wait in your vehicle until the voice connection has been established.
  - ▶ The LED flashes green when a connection to the BMW Response Center has been established.

The BMW Response Center then makes contact with the occupants of the vehicle and initiates further steps to help.

Even if you are unable to respond, the BMW Response Center can take further steps to help you under certain circumstances.

For this purpose, data that serves to determine the necessary rescue measures, for instance the current position of the vehicle when it can be determined, is transmitted to the BMW Response Center.

Even if the BMW Response Center is no longer heard through the loudspeakers, the BMW Response Center may still be able to hear the occupants of the vehicle.

The BMW Response Center ends the emergency call.

## Malfunction

The function of the emergency call may be impaired.

The LED in the area of the SOS button blinks for approximately 30 seconds. A Check Control message is displayed.

Have it checked by an authorized service center or another qualified service center or repair shop.

## Jump-starting

### General information

If the battery is discharged, the engine can be started using the battery of another vehicle and two jumper cables. Only use jumper cables with fully insulated clamp handles.

### Safety information

#### **DANGER**

Contact with live components can lead to an electric shock. There is a risk of injury or danger to life. Do not touch any components that are under voltage.

#### **Warning**

If the jumper cables are connected in the incorrect order, spark formation may occur. There is a risk of injury. Pay attention to the correct order during connection.

#### **NOTICE**

In the case of body contact between the two vehicles, a short circuit can occur during jump-starting. There is a risk of damage to property, among other potential damage. Make sure that no body contact occurs.

## Preparation

1. Check whether the battery of the other vehicle has a voltage of 12 volts. The voltage information can be found on the battery.
2. Switch off the engine of the assisting vehicle.
3. Switch off any electrical components in both vehicles.

## Jump-start terminals

The jump-start terminal in the engine compartment acts as the positive battery terminal.

A special connection on the body in the engine compartment acts as the negative battery terminal.

Additional information:

Overview of engine compartment, refer to page [360](#).

Open the cover of the positive battery terminal.

## Connecting the cables

Before you begin, switch off all unnecessary electronic systems/components, such as the radio, on the assisting and receiving vehicles.

1. Open the lid of the jump-start terminal.
2. Attach one terminal clamp of the positive jumper cable to the positive battery terminal, or to the corresponding jump-start terminal of the vehicle providing assistance.
3. Attach the terminal clamp on the other end of the cable to the positive battery terminal, or to the corresponding jump-start terminal of the vehicle to be started.
4. Attach one terminal clamp of the negative jumper cable to the negative battery terminal, or to the corresponding engine or body ground of assisting vehicle.
5. Attach the second terminal clamp to the negative battery terminal, or to the corresponding engine or body ground of the vehicle to be started.

## Starting the engine

Never use spray fluids to start the engine.

1. Start the engine of the assisting vehicle and let it run for several minutes at an increased idle speed.
2. Start the engine of the vehicle that is to be started in the usual way.  
If the first attempt to start the engine is not successful, wait a few minutes before making another attempt in order to allow the discharged battery to recharge.
3. Let both engines run for several minutes.
4. Disconnect the jumper cables in the reverse order.

Check the battery and recharge, if needed.

## Tow-starting and towing

### Safety information

#### **Warning**

When towing with Intelligent Safety systems enabled or Cruise Control switched on, individual functions may not work correctly. There is a risk of accident. Switch off all Intelligent Safety systems and Cruise Control before towing.

### Steptronic transmission: transporting the vehicle

#### General information

Do not transport the vehicle by towing it.

## Safety information

### **NOTICE**

The vehicle can be damaged when towing the vehicle with a single lifted axle. There is a risk of damage to property, among other potential damage. The vehicle should only be transported on a loading platform.

### **NOTICE**

The vehicle can become damaged when lifting and securing it.

There is a risk of damage to property, among other potential damage.

- ▷ Lift the vehicle using suitable means.
- ▷ Do not lift or secure the vehicle by its tow fitting, body parts, or suspension parts.

## Pushing the vehicle

To remove a broken-down vehicle from the hazardous area, push it for a short distance at a speed of no more than 6 mph/10 km/h.

Additional information:

Rolling or pushing the vehicle, refer to page 148.

## Tow truck

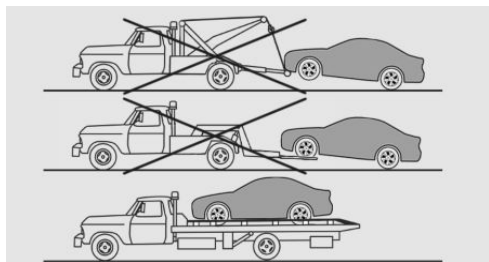

The vehicle should only be transported on a loading platform.

## Towing other vehicles

### General information

Switch on the hazard warning system, depending on local regulations.

If the electrical system has failed, clearly identify the vehicle being towed by placing a sign or a warning triangle in the rear window.

### Safety information

#### **Warning**

If the approved gross vehicle weight of the towing vehicle is lighter than the vehicle to be towed, the tow fitting can tear off or it will not be possible to control handling. There is a risk of accident. Make sure that the gross vehicle weight of the towing vehicle is heavier than the vehicle to be towed.

#### **NOTICE**

If the tow bar or tow rope is attached incorrectly, damage to other vehicle parts can occur. There is a risk of damage to property, among other potential damage. Correctly attach the tow bar or tow rope to the tow fitting.

### Tow bar

The tow fittings used should be on the same side on both vehicles.

If it is impossible to avoid mounting the tow bar at an inclination, note the following:

- ▷ Free movement is limited when cornering.
- ▷ The tow bar will generate lateral forces if it is secured with an inclination.

### Tow rope

Observe the following notes when using the tow rope:

- ▶ Use nylon ropes or straps, which will enable the vehicle to be towed without jerking.
- ▶ Make sure the tow rope is not twisted when fastening.
- ▶ Check the attachment of the tow fitting and tow rope in regular intervals.
- ▶ Do not exceed a towing speed of 30 mph/50 km/h.
- ▶ Do not exceed a towing distance of 3 miles/5 km.
- ▶ When driving off to tow the vehicle, make sure that the tow rope is taut.
- ▶ Avoid lateral loading of the tow fitting, for instance do not lift the vehicle by the tow fitting.
- ▶ Check the attachment of the tow fitting in regular intervals.

Additional information:

Onboard vehicle tool kit, refer to page 372.

## Safety information

### NOTICE

If the tow fitting is not used as intended, there may be damage to the vehicle or to the tow fitting. There is a risk of damage to property, among other potential damage. Follow the notes on using the tow fitting.

## Tow fitting

### General information



The screw-in tow fitting should always be carried in the vehicle.

The tow fitting can be screwed in at the front or rear of the vehicle.

The tow fitting is found in the onboard vehicle tool kit.

Observe the following notes when using the tow fitting:

- ▶ Use only the tow fitting provided with the vehicle.
- ▶ Turn the tow fitting at least 5 turns clockwise and screw it in as far as it will go. If necessary, tighten with a suitable object.
- ▶ After use, unscrew the tow fitting counter-clockwise.
- ▶ Use the tow fitting for towing on paved roads only.

### Screw thread for tow fitting



Press on the mark on the edge of the cover to push it out.

For covers which have an opening instead of a marking, pull the cover out by the opening.

### Tow-starting

Do not tow-start the vehicle.

Start the engine by jump-starting, if possible. Have the cause of the starting difficulties corrected by an authorized service center or another qualified service center or repair shop.

Additional information:

Jump-starting, refer to page 380.

# Vehicle Care

## Vehicle features and options

This chapter describes all standard, country-specific and optional features offered with the series. It also describes features and functions that are not necessarily available in your vehicle, e.g., due to the selected options or country versions. This also applies to safety-related functions and systems. When using these functions and systems, the applicable laws and regulations must be observed.

## Washing the vehicle

### General information

Regularly remove foreign bodies such as leaves in the area below the windshield when the hood is raised.

Wash your vehicle frequently, particularly in winter. Intense contamination and road salt can damage the vehicle.

### Safety information

#### NOTICE

When washing with an open fuel filler flap, damage may occur. There is a risk of damage to property, among other potential damage. Close the fuel filler flap before washing. Clean dirt behind the fuel filler flap with a cloth.

## Steam cleaner and high pressure cleaner

### Safety information

#### NOTICE

When cleaning with high pressure cleaners, components can be damaged due to the pressure or temperatures being too high. There is a risk of damage to property, among other potential damage. Maintain sufficient distance and do not spray too long continuously. Follow the operating instructions for the high pressure cleaners.

### Distances and temperature

- ▶ Maximum temperature: 140 °F/60 °C.
- ▶ Minimum distance from sensors, cameras, seals and lights: 12 inches/30 cm.
- ▶ Minimum distance from glass sunroof: 31.5 in/80 cm.

## Automatic car washes or car washes

### Safety information

#### NOTICE

Improper use of automatic car washes can cause damage to the vehicle. There is a risk of damage to property, among other potential damage. Follow the following instructions:



- ▷ Give preference to cloth car washes or those that use soft brushes in order to avoid paint damage.
- ▷ Do not drive through a car wash with guide rails higher than 4 in/10 cm to avoid damage to the body.
- ▷ Observe the tire width of the guide rail to avoid damage to tires and rims.
- ▷ Fold in exterior mirrors to avoid damage to the exterior mirrors.
- ▷ Deactivate the wiper and, if necessary, rain sensor to avoid damage to the window wiper system.

## Driving into a car wash with a Steptronic transmission

### NOTICE

Selector lever position P is automatically engaged when standby state is switched off. The wheels are blocked. There is a risk of damage to property. Do not switch off standby if the vehicle is meant to coast, e.g., in a car wash.

In a car wash, the vehicle must be able to roll freely.

Some car washes do not permit persons in the vehicle. The vehicle cannot be locked from the outside when in selector lever position N. A signal sounds when an attempt is made to lock the vehicle.

Additional information:

Rolling or pushing the vehicle, refer to page [148](#).

## Driving out of a car wash

Ensure that the vehicle key is in the car.

Turn on drive-ready state.

Additional information:

Drive-ready state, refer to page [40](#).

## Lights

Do not rub wet lights dry and do not use abrasive or acidic cleaning agents or cleaning agents containing alcohol.

Soak areas that have been dirtied, for instance from insects, with auto shampoo and wash off with water.

Thaw ice with de-icing spray; do not use an ice scraper.

## After washing the vehicle

After washing the vehicle, apply the brakes briefly to dry them; otherwise, braking effect can be reduced. The heat generated during braking dries brake disks and brake pads and protects them against corrosion.

Completely remove all residues on the windows to minimize loss of visibility due to smearing and to reduce wiper noises and wiper blade wear.

## Vehicle care

### Vehicle care products

### General information

BMW recommends using vehicle care and cleaning agents from BMW. Suitable vehicle care products are available from an authorized service center or another qualified service center or repair shop.

### Safety information

#### Warning

Cleaning agents can contain substances that are dangerous and harmful to your health. There is a risk of injury. When cleaning the interior, open the doors or windows. Only use products intended for cleaning vehicles. Follow the instructions on the packaging.

## Vehicle paintwork

### General information

Regular vehicle care contributes to driving safety and value retention. Environmental influences in areas with elevated air pollution or natural contaminants, such as tree resin or pollen, can affect the vehicle paintwork. Tailor the frequency and extent of your vehicle care to these influences.

Corrosive substances such as spilled fuel, oil, grease or bird droppings, must be removed immediately to prevent the finish from being altered or discolored.

### Matte paintwork

Only use cleaning and care products suitable for vehicles with matte paintwork.

### Leather care

Remove dust from the leather regularly, using a cloth or vacuum cleaner.

Otherwise, particles of dust and road grime chafe in pores and folds, and lead to heavy abrasion and premature degradation of the leather surface.

To guard against discoloration, such as from clothing, clean leather and provide leather care roughly every two months.

Clean light-colored leather more frequently because contamination on such surfaces is substantially more visible.

Use leather care products; otherwise, dirt and grease will gradually break down the protective coating of the leather surface.

### Synthetic leather care

Clean synthetic leather regularly with a damp microfiber cloth or vacuum cleaner.

Otherwise, dust and road grime particles will rub into pores and folds, causing significant abrasion and premature degradation of the surface.

In case of major soiling, use a moist soft sponge or microfiber cloth with suitable interior cleaners.

Immediately remove aggressive substances such as sunscreen to prevent the synthetic leather from being altered or discolored.

## Upholstery material care

### General information

Vacuum the cushions regularly with a vacuum cleaner.

If upholstery is very contaminated, for instance with beverage stains, use a soft sponge or microfiber cloth with a suitable interior cleaner.

Clean the cushions down to the seams using large sweeping motions. Avoid rubbing the material vigorously.

### Safety information

#### NOTICE

Open hook and loop fasteners on articles of clothing can damage the seat covers and other cloth upholstery in the vehicle. There is a risk of damage to property, among other potential damage. Ensure that any Velcro® fasteners are closed.

## Caring for special components

### Light-alloy wheels

When cleaning the vehicle, use only neutral rim cleaners having a pH value from 5 to 9. Do not use abrasive cleaning agents or steam cleaners above 140 °F/60 °C. Follow the manufacturer's instructions.

Aggressive, acidic or alkaline cleaning agents can destroy the protective coating of adjacent components, such as the brake disk.

After cleaning, apply the brakes shortly to dry them. The heat generated during braking dries

brake disks and brake pads and protects them against corrosion.

## Chrome surfaces

Carefully clean Chrome surfaces, especially in case of exposure to road salt, with plenty of water and added auto shampoo as needed.

## Rubber components

Environmental influences can cause surface contamination of rubber parts and a loss of gloss. Use only water and suitable cleaning agents for cleaning.

Treat especially worn rubber parts with rubber care products at regular intervals. When cleaning rubber seals, do not use any silicon-containing vehicle care products in order to avoid damage or noises.

## Wiper blades

The wiper blades are cleaned by using the washer system.

Avoid cleaning the wiper blades manually, as this may reduce wiper performance.

## Fine wood parts

Clean the fine wood veneer and fine wood components solely with a moist rag. Then dry with a soft cloth.

## Kenaf

Only treat parts made of Kenaf fibers using suitable care products.

## Plastic components

### NOTICE

Solvent cleaners that contain alcohol or solvents, such as lacquer thinners, cold cleaning agents, fuel and such, can damage plastic parts. There is a risk of damage to property, among other potential damage. Clean with a

microfiber cloth. Dampen the cloth lightly with water, if needed.

Clean with a microfiber cloth.

Dampen the cloth lightly with water, if needed.

Do not soak the headliner.

## Seat belts

### Warning

Chemical solvent cleaners can destroy the seat belt fabric. Missing protective effect of the seat belts. There is a risk of injury or danger to life. Use only a mild soap solution for cleaning the seat belts.

Dirty belt straps impede the reeling action and thus have a negative impact on safety.

Use only a mild soap solution for cleaning the installed belt straps.

Seat belts should only be allowed to retract if they are dry.

## Carpets and floor mats

### Warning

Objects in the driver's footwell can limit the pedal travel or block a depressed pedal. There is a risk of accident. Stow objects in the vehicle such that they are secured and cannot enter into the driver's footwell. Use floor mats that are suitable for the vehicle and can be safely attached to the floor. Do not use loose floor mats and do not layer several floor mats. Make sure that there is sufficient clearance for the pedals. Ensure that the floor mats are securely fastened again after they were removed, for instance for cleaning.

The floor mats can be removed from the interior for cleaning.

If the floor carpets are very contaminated, clean with a microfiber cloth and water or a

textile cleaner. To prevent matting of the carpet, rub back and forth in the driving direction only.

### Mount for trailer hitch

Keep the mount clean.

Regularly grease or oil bearings and sliding surfaces with resin-free greases or oils.

Before using steam cleaners or high pressure cleaners on the vehicle, remove the ball head and insert the cover into the mount.

### Sensors and camera lenses

To clean sensors and camera lenses, use a cloth moistened with a small amount of glass detergent.

### Displays, operating elements and protective glass of the Head-up display

#### NOTICE

Surfaces can be damaged by improper cleaning, e.g., by using chemical cleaners, or from moisture or liquid of any kind. Physical damage to the material is possible.

- ▷ Avoid pressure that is too high and do not use any scratching materials.
- ▷ Use a dry, clean antistatic microfiber cloth for cleaning displays.
- ▷ Clean the operating elements and, depending on vehicle equipment, the protective glass of the Head-up display with a damp microfiber cloth and standard household dish soap.

### Taking the vehicle out of service

When the vehicle is shut down for longer than three months, special measures must be taken. Further information is available from an authorized service center or another qualified service center or repair shop.



# Technical data

## Vehicle features and options

This chapter describes all standard, country-specific and optional features offered with the series. It also describes features and functions that are not necessarily available in your vehi-

cle, e.g., due to the selected options or country versions. This also applies to safety-related functions and systems. When using these functions and systems, the applicable laws and regulations must be observed.

## General information

The technical data and specifications in the Owner's Manual are used as guidance values. Vehicle-specific data may deviate from this, for instance due to the optional equipment chosen, national-market version, or country-

specific measuring process. Detailed values can be found in the approval documents, on signs on the vehicle or can be obtained from an authorized service center or another qualified service center or repair shop.

## Dimensions

The dimensions can vary depending on the model version, equipment version or country-specific measurement procedure.

The height of the vehicle can also differ, e.g., due to tires and vehicle load.

### BMW X3

Width with mirrors	in/mm	84.2/2,138
Width without mirrors	in/mm	74.7/1,897
Height	in/mm	66/1,676
Length	in/mm	185.9/4,723
Wheelbase	in/mm	112.8/2,864
Smallest turning radius diam.	ft/m	39.4/12.0

## Weights

### X3 sDrive30i

Approved gross vehicle weight	lbs/kg	5,203/2,360
Payload	lbs/kg	904/410
Approved front axle weight	lbs/kg	2,403/1,090
Approved rear axle weight	lbs/kg	3,042/1,380

### X3 xDrive30i

Approved gross vehicle weight	lbs/kg	5,357/2,430
Payload	lbs/kg	941/427
Approved front axle weight	lbs/kg	2,646/1,200
Approved rear axle weight	lbs/kg	3,109/1,410

### X3 M40i powered by BMW M

Approved gross vehicle weight	lbs/kg	5,556/2,520
Payload	lbs/kg	902/409
Approved front axle weight	lbs/kg	2,668/1,210
Approved rear axle weight	lbs/kg	3,109/1,410

## Trailer towing

### X3 sDrive30i

Details about possible increases or a reduced trailer load can be requested from an authorized service center or another qualified service center or repair shop.

Trailer load unbraked	lbs/kg	1,653/750
Trailer load with brakes on uphill grades of up to 12 %	lbs/kg	4,409/2,000
Maximum drawbar nose weight	lbs/kg	441/200
Approved rear axle weight, towing vehicle	lbs/kg	3,042/1,380
Approved gross vehicle weight, towing vehicle	lbs/kg	5,203/2,360

**X3 xDrive30i**

Details about possible increases or a reduced trailer load can be requested from an authorized service center or another qualified service center or repair shop.

Trailer load unbraked	lbs/kg	1,653/750
Trailer load with brakes on uphill grades of up to 12 %	lbs/kg	4,409/2,000
Maximum drawbar nose weight	lbs/kg	441/200
Approved rear axle weight, towing vehicle	lbs/kg	3,109/1,410
Approved gross vehicle weight, towing vehicle	lbs/kg	5,357/2,430

**X3 M40i powered by BMW M**

Details about possible increases or a reduced trailer load can be requested from an authorized service center or another qualified service center or repair shop.

Trailer load unbraked	lbs/kg	1,653/750
Trailer load with brakes on uphill grades of up to 12 %	lbs/kg	4,409/2,000
Maximum drawbar nose weight	lbs/kg	441/200
Approved rear axle weight, towing vehicle	lbs/kg	3,109/1,410
Approved gross vehicle weight, towing vehicle	lbs/kg	5,556/2,520

## Filling capacities

**BMW X3**

Fuel tank, approx.	US gal/liters	17.2/65.0
--------------------	---------------	-----------

Observe further information on fuel quality, refer to page [363](#).



# Appendix

## General information

---

Any updates to the Owner's Manual of the vehicle are listed here.

## Updates made after the editorial deadline

---

The following chapters were updated in the printed version of the Owner's Manual after the editorial deadline for the Integrated Owner's Manual in the vehicle had closed:

- ▶ Operation: sensors of the vehicle: radar sensors; safety instructions.

# Everything from A to Z

## Index

---

### 0-9

3D View, see Surround View [260](#)  
 48V technology, see Mild Hybrid technology [375](#)

### A

ABS, see Antilock Braking System [213](#)  
 Acceleration Assistant, see Launch Control [151](#)  
 Acceleration sensor, see G-meter [156](#)  
 Accessories and parts [9](#)  
 Accident prevention, see Active Protection [210](#)  
 ACC, see Cruise Control with Distance Control [226](#)  
 Activated carbon filter, see Interior filter [273](#)  
 Activation points, panorama View [265](#)  
 Activation, trailer towing [317](#)  
 Activation word [51](#)  
 Active Blind Spot Detection [200](#)  
 Active Cruise Control [226](#)  
 Active damping control, see Adaptive M chassis/suspension [271](#)  
 Active Guard Plus, see Intelligent Safety [185](#)  
 Active Guard, see Intelligent Safety [185](#)  
 Active Park Distance Control [247](#)  
 Active Protection [210](#)  
 Active seat ventilation [126](#)  
 Adaptive brake assistant [213](#)  
 Adaptive chassis [271](#)  
 Adaptive Light Control [178](#)  
 Adaptive lighting functions [177](#)  
 Adaptive M chassis/suspension [271](#)  
 Adaptive suspension [271](#)  
 Adding engine oil types [366](#)  
 Additives, engine oil types [366](#)  
 Adjusting contents, iDrive [47](#)  
 Adjustments, steering wheel [123](#)  
 Airbags [182](#)  
 Airbags, indicator and warning light [184](#)

Air circulation, see Recirculated-air mode [277](#)  
 Air conditioning, climate [275](#)  
 Air distribution, manual [277](#)  
 Air drying, see air conditioning [275](#)  
 Air flow, automatic climate control [277](#)  
 Air outlets, see Ventilation [278](#)  
 Air pressure, tires [328](#)  
 Air quality [273](#)  
 Air vent, see Ventilation [278](#)  
 Alarm system [107](#)  
 Alarm, unintentional [109](#)  
 All-season tires, see Winter tires [337](#)  
 All-wheel-drive, see xDrive [215](#)  
 Ambient air package [286](#)  
 Ambient light [181](#)  
 Android Auto, connection to the vehicle [78](#)  
 Android Auto preparation, connection to the vehicle [78](#)  
 Android Auto preparation, smartphone integration [78](#)  
 Antifreeze, see Washer fluid [368](#)  
 Antilock Braking System [213](#)  
 Anti-theft protection [83](#)  
 Anti-theft protection, lug bolt lock [355](#)  
 Apple CarPlay preparation, connection to the vehicle [77](#)  
 Apple CarPlay preparation, smartphone integration [77](#)  
 Approach control warning with City braking function [187](#)  
 Approach control warning with City light braking function [187](#)  
 Approach control warning with light braking function [187](#)  
 Apps, see Owner's Manual for Navigation, Entertainment, Communication [6](#)  
 Aquaplaning [312](#)  
 Arrival time at destination, navigation [158](#)  
 Assistance when driving off, see Drive-off assistant [213](#)

Assistance with breakdown [377](#)  
Assisted Driving Mode, see Steering Assistant [236](#)  
Assisted Driving Plus [240](#)  
Assisted Driving View [155](#)  
Audio, see Owner's Manual for Navigation, Entertainment and Communication [6](#)  
AUTO H button, see Parking brake [139](#)  
Automatic activation, see Climate control rules [126](#)  
Automatic climate control [273](#)  
Automatic control, headlight [175](#)  
Automatic Curb Monitor, exterior mirror [123](#)  
Automatic deactivation, front-seat passenger airbags [184](#)  
Automatic Differential Brake [216](#)  
Automatic dimming, see Automatic High Beam Assistant [178](#)  
Automatic headlight control [175](#)  
Automatic High Beam Assistant [178](#)  
Automatic Hold, see Parking brake [139](#)  
Automatic Lane Change Assistant [242](#)  
Automatic locking [107](#)  
Automatic Parking Assistant [252](#)  
Automatic Parking Assistant, driving out of parking space [257](#)  
Automatic Parking Assistant Plus, see Surround View [260](#)  
Automatic program, automatic climate control [276](#)  
Automatic Recirculating Air Control [276](#)  
Automatic time setting [61](#)  
Automatic transmission, see Steptronic transmission [146](#)  
Automatic unlocking [106](#)  
Automating routines, BMW Intelligent Personal Assistant [53](#)  
AUTO program, automatic climate control [276](#)  
AUTO program, intensity [276](#)  
Auto Start/Stop function [134](#)  
Average consumption [156](#), [157](#)  
Average consumption, see Trip data [170](#)  
Axle loads, approved [391](#)

**B**

Backrest curvature, see Lumbar support [116](#)  
Backrest, seats [114](#)  
Backrest tilt [115](#)  
Backrest width [116](#)  
Back-up Assistant [258](#)  
Bad road trips [310](#)  
Ball head, removable [318](#)  
Bandages, see First-aid kit [377](#)  
Bar for tow-starting/towing [382](#)  
Battery, disposing of [375](#)  
Battery, vehicle [374](#)  
Being towed, see Tow-starting and towing [381](#)  
Belts, see Seat belts [117](#)  
Blind spot collision warning [200](#)  
Blocking, power window, see Safety switch [111](#)  
Blower [277](#)  
Bluetooth connection [75](#)  
Blu-ray, see Owner's Manual for Navigation, Entertainment, Communication [6](#)  
BMW Accident Assistance [378](#)  
BMW Assist, see Owner's Manual for Navigation, Entertainment and Communication [6](#)  
BMW Digital Key [92](#)  
BMW display key [86](#)  
BMW display key, malfunction [90](#)  
BMW Drive Recorder [208](#)  
BMW Gesture Control [54](#)  
BMW Intelligent Personal Assistant [50](#)  
BMW maintenance system [370](#)  
BMW Natural Interaction, see BMW Gesture Control [54](#)  
BMW Roadside Assistance [378](#)  
Bonus range, ECO PRO [323](#)  
Bottle holder, front, see Cup holder, front [299](#)  
Bottle holder, rear, see Cup holder, rear [299](#)  
Brake assistant [213](#)  
Brake assistant, adaptive [213](#)  
Brake Controller [319](#)  
Brake disks, breaking in [310](#)  
Brake disks, see Brake system [310](#)  
Brake pads, breaking in [310](#)  
Brake pads, see Brake system [310](#)  
Brake system [310](#)  
Braking, information [312](#)

Breakdown assistance [377](#)  
 Breaking in [310](#)  
 Break recommendation, see Fatigue alert [211](#)  
 Brightness, Control Display [63](#)  
 Button, central locking system [97](#)  
 Button, Hill Descent Control [216](#)  
 Buttons on the steering wheel [30](#)  
 Button, SOS, see Intelligent emergency call [379](#)  
 Button, Start/Stop [134](#)  
 Bypassing, see Jump-starting [380](#)

## C

Cable for tow-starting/towing [382](#)  
 Calendar day, see Date [61](#)  
 Calibration of the front seats [115](#)  
 California Proposition 65 Warning [9](#)  
 Call, gesture control [55](#)  
 Camera-based assistance systems, see Intelligent Safety [185](#)  
 Camera, instrument cluster, see Driver Attention Camera [62](#)  
 Camera lenses, care [388](#)  
 Camera, rearview camera, see Surround View [260](#)  
 Camera, rearview camera, without Surround View [249](#)  
 Camera, see Surround View [260](#)  
 Cameras, see Sensors of the vehicle [35](#)  
 CANCEL button, Active Cruise Control [226](#)  
 CANCEL button, Cruise Control [223](#)  
 Can holder, front, see Cup holder, front [299](#)  
 Can holder, rear, see Cup holder, rear [299](#)  
 Care [384](#)  
 Care, displays, screens [388](#)  
 Care, Head-up display [388](#)  
 Care, light-alloy wheels [386](#)  
 Care, vehicle [385](#)  
 Cargo [301](#)  
 Cargo area [301](#)  
 Cargo area, enlarging [305](#)  
 Cargo cover [307](#)  
 Cargo position, rear seat backrest [305](#)  
 Cargo, stowing and securing [302](#)

Cargo straps, see Lashing eyes in the cargo area [302](#)  
 Caring Car, BMW Intelligent Personal Assistant [54](#)  
 Car key, see Vehicle key [81](#)  
 Carpet, care [387](#)  
 CarPlay, connection to the vehicle [77](#)  
 Car seats, see Transporting children safely [128](#)  
 Cartridge replacement, see Ambient air package [286](#)  
 Car wash [384](#)  
 Car wash, automatic [384](#)  
 Car wash view, Surround View [261](#)  
 Catalytic converter, see Hot exhaust gas system [311](#)  
 CBS, see Condition Based Service [370](#)  
 Cell phone, see Owner's Manual for Navigation, Entertainment and Communication [6](#)  
 Center armrest, front [299](#)  
 Center console [32](#)  
 Central Information Display (CID), see Control Display [45](#)  
 Central locking switch, see Central locking system [97](#)  
 Central locking system [97](#)  
 Central screen, see Control Display [45](#)  
 Changes, technical, see For Your Own Safety [8](#)  
 Change, wheels and tires [336](#)  
 Changing parts [372](#)  
 Changing wheels [354](#)  
 Charging cradle [294](#)  
 Charging smartphone, see Wireless charging tray [294](#)  
 Charging tray for smartphones, see Wireless charging tray [294](#)  
 Chassis/suspension, electronic, see Adaptive M chassis/suspension [271](#)  
 Chassis number, see Vehicle identification number [13](#)  
 Check Control [158](#)  
 Checking the engine oil level electronically [365](#)  
 Children, seating position [128](#)  
 Children, transporting safely [128](#)  
 Child restraint seats [128](#)  
 Child restraint systems, mounting [129](#)

- Child restraint systems, see Transporting children safely [128](#)
- Child safety latch [133](#)
- Child safety locks [133](#)
- Child seat installation [129](#)
- Child seat, mounting [129](#)
- Child seat mountings LATCH [130](#)
- Child seats, see Transporting children safely [128](#)
- Chrome-plated surfaces, care [387](#)
- Chrome surfaces, care [387](#)
- Cleaning, displays, screens [388](#)
- Cleaning, Head-up display [388](#)
- Clearance, water [312](#)
- Climate control [273](#)
- Climate control rules [126](#)
- Closing with the Key Card [91](#)
- Closing with the smartphone, see BMW Digital Key [92](#)
- Clothes hooks [300](#)
- Coasting [323](#)
- Coasting with idling engine [323](#)
- Coat hooks [300](#)
- Combination switch, see Turn signals [142](#)
- Combination switch, see Washer/wiper system [143](#)
- Comfort Access [97](#)
- COMFORT, see Driving Dynamics Control [137](#)
- Communication, see Owner's Manual for Navigation, Entertainment and Communication [6](#)
- Compact wheel, see Emergency wheel [358](#)
- Comparison of entries, see Entry comparison [43](#)
- Compartments in the doors [298](#)
- Compass [158](#)
- Compatible devices, see Suitable devices [73](#)
- Compatible mobile phones [73](#)
- Compressor [340](#)
- Concierge Service, see Owner's Manual for Navigation, Entertainment, Communication [6](#)
- Condensation water under the parked vehicle [313](#)
- Condensation, windshield [278](#)
- Condition Based Service [370](#)
- Confirmation signal from the vehicle [106](#)
- ConnectedDrive, see Owner's Manual for Navigation, Entertainment and Communication [6](#)
- Connection, electrical devices, see Sockets [292](#)
- Consumption display, average consumption [156](#), [157](#)
- Consumption display, current consumption [156](#), [157](#)
- Consumption display, ECO PRO [323](#)
- Consumption, see Trip data [170](#)
- Contactless opening and closing of the tailgate [100](#)
- Contacts, see Owner's Manual for Navigation, Entertainment, Communication [6](#)
- Continued driving with a flat tire, see Tire Pressure Monitor [344](#)
- Continued driving with flat tire, see Flat tire monitor [351](#)
- Control Display [45](#)
- Control Display, brightness [63](#)
- Control display, pop-ups [63](#)
- Controller [45](#)
- Control systems, driving stability [213](#)
- Convenient closing, vehicle key [83](#)
- Convenient opening, vehicle key [82](#)
- Coolant [367](#)
- Coolant level [368](#)
- Coolant temperature, see Engine temperature [167](#)
- Cooling, maximum [275](#)
- Cooling system [367](#)
- Cornering light [178](#)
- Corrosion, brake disks [313](#)
- Cosmetic mirror [292](#)
- Cross traffic warning [267](#)
- Cruise Control, see Cruise Control with Distance Control [226](#)
- Cruise Control with Distance Control [226](#)
- Cruise Control without Distance Control [223](#)
- Cruising range [168](#)
- Cup holder, front [299](#)
- Cup holder, rear [299](#)
- Current consumption [156](#), [157](#)
- Customer service, see Owner's Manual for Navigation, Entertainment, Communication [6](#)
- Customer Support [6](#)

**D**

- Damage, tires [335](#)
- Damping control active, see Adaptive M chassis/suspension [271](#)
- Dashboard [30](#)
- Dashboard, see Instrument cluster [153](#)
- Dashcam, see BMW Drive Recorder [208](#)
- Data memory [10](#)
- Data protection, settings [66](#)
- Data, see Personal data, deleting [66](#)
- Data, technical [390](#)
- Date [61](#)
- Daytime driving lights [177](#)
- Daytime running lights [177](#)
- DCC, see Cruise Control without Distance Control [223](#)
- Defrost function [278](#)
- Defrost, windshield [278](#)
- Deleting, personal data [66](#)
- Departure schedule, see Pre-ventilation [281](#)
- Departure time, pre-conditioning [284](#)
- Departure time, pre-ventilation [282](#)
- Destination distance, on-board computer [158](#)
- Destination input [6](#)
- Device, connecting [72](#)
- Device list [73](#)
- Device, registering [72](#)
- Devices, managing [73](#)
- Devices, suitable [73](#)
- Diagnostic connection [371](#)
- Diagnostic socket [371](#)
- Digital Key [92](#)
- Digital Key, see BMW Digital Key [92](#)
- Dimensions [390](#)
- Dimmable exterior mirrors [123](#)
- Dimmable interior mirror [123](#)
- Direct dial buttons, see Programmable memory buttons [44](#)
- Direction indicator, see Turn signals [142](#)
- Display, iDrive [42](#)
- Display in the windshield, see Head-up display [172](#)
- Display key [86](#)
- Display key, malfunction [90](#)
- Display key, see BMW display key [86](#)
- Display lighting, see Instrument lighting [180](#)
- Display, notifications, BMW Intelligent Personal Assistant [64](#)
- Display panel, see Instrument cluster [153](#)
- Displays [153](#)
- Displays and icons [7](#)
- Displays, ECO PRO [321](#)
- Display, speed limiting function, see Speed Limit Info [219](#)
- Disposal, coolant [368](#)
- Disposal, vehicle battery [375](#)
- Distance control, see Cruise Control [226](#)
- Distance to destination, on-board computer [158](#)
- Distance warning, see Park Distance Control [244](#)
- Door handle lighting, see Welcome lights [176](#)
- Door opening angle, Surround View [261](#)
- Downhill control, see Hill Descent Control [216](#)
- Drawbar nose weight, technical data [391](#)
- Drive-off assistant [213](#)
- Drive-off assistant, see Dynamic Stability Control [213](#)
- Drive power, reduced [166](#)
- Driver activity, see Driver Attention Camera [62](#)
- Driver assistance, driving, see Intelligent Safety [185](#)
- Driver assistance, parking, see Parking assistance systems [244](#)
- Driver assistance, see Intelligent Safety [185](#)
- Driver assistance systems [219](#)
- Driver Attention Camera [62](#)
- Drive readiness, see Operating condition of the vehicle [39](#)
- Drive-ready state, engine start [40](#)
- Drive Recorder [208](#)
- Driver profiles [67](#)
- Driver profile, setup [67](#)
- Driver profiles, welcome screen [67](#)
- Driving [134](#)
- Driving Assistant, see Intelligent Safety [185](#)
- Driving comfort [271](#)
- Driving Dynamics Control [137](#)
- Driving mode, ECO PRO [321](#)
- Driving mode, see Driving Dynamics Control [137](#)

Driving notes, breaking in [310](#)  
Driving notes, general [311](#)  
Driving on bad roads [310](#)  
Driving out of parking space [257](#)  
Driving stability control systems [213](#)  
Driving, Start/Stop button [134](#)  
Driving style analysis, ECO PRO [325](#)  
Driving through water [312](#)  
Driving tips, see General driving notes [311](#)  
DSC, see Dynamic Stability Control [213](#)  
DTC, see Dynamic Traction Control [215](#)  
Dynamic damping, see Adaptive chassis [271](#)  
Dynamic damping, see Adaptive M chassis/suspension [271](#)  
Dynamic Stability Control [213](#)  
Dynamic Traction Control [215](#)

## E

ECO PRO [321](#)  
ECO PRO, bonus range [323](#)  
ECO PRO, driving style analysis [325](#)  
ECO PRO INDIVIDUAL, see Driving Dynamics Control [137](#)  
ECO PRO, see Driving Dynamics Control [137](#)  
Efficient4x4, see xDrive [215](#)  
Electronic oil measurement [365](#)  
Electronic Stability Program ESP, see Dynamic Stability Control [213](#)  
E-mail, see Owner's Manual for Navigation, Entertainment, Communication [6](#)  
Emergency brake, see Emergency stop assistant [206](#)  
Emergency braking, see PostCrash – iBrake [210](#)  
Emergency call [379](#)  
Emergency service, see BMW Accident Assistance [378](#)  
Emergency service, see BMW Roadside Assistance [378](#)  
Emergency stop assistant [206](#)  
Emergency unlocking, transmission lock [150](#)  
Emergency wheel [358](#)  
Energy recovery [156](#), [157](#)  
Energy savings, see Gear shift indicator [169](#)  
Engine, automatic Start/Stop function [134](#)

Engine compartment [360](#)  
Engine coolant [367](#)  
Engine idling when driving, see Coasting [323](#)  
Engine oil filler neck [366](#)  
Engine oil temperature [167](#)  
Engine oil, topping up [366](#)  
Engine oil types to add [366](#)  
Engine sound, setting [272](#)  
Engine start, see Drive-ready state [40](#)  
Engine start, see Jump-starting [380](#)  
Engine stopping, see Drive-ready state [40](#)  
Engine temperature [167](#)  
Entering a destination, see Owner's Manual for Navigation, Entertainment, Communication [6](#)  
Entering an address, navigation, see Owner's Manual for Navigation, Entertainment and Communication [6](#)  
Entertainment, see Owner's Manual for Navigation, Entertainment and Communication [6](#)  
Entertainment, selection list in the instrument cluster [169](#)  
Entry comparison [43](#)  
Equipment, interior [289](#)  
Error indicators, see Check Control [158](#)  
ESP Electronic Stability Program, see Dynamic Stability Control [213](#)  
Evasion Assistant [190](#)  
Exchange, wheels and tires [336](#)  
Exhaust gas system [311](#)  
Exhaust, see Exhaust gas system [311](#)  
Exterior lighting during unlocking [82](#)  
Exterior lighting, locked vehicle [83](#)  
Exterior mirror [122](#)  
Exterior mirror, Automatic Curb Monitor [123](#)  
Exterior mirror, automatic dimming feature [123](#)  
Exterior mirrors, malfunction [122](#)  
External start, see Jump-starting [380](#)  
Eyelet for towing [383](#)  
Eyes, see Lashing eyes in the cargo area [302](#)

## F

Factory settings, see Vehicle data, resetting [63](#)  
Failure message, see Check Control [158](#)  
Fan, see Air flow [277](#)  
Fastening seat belts, see Seat belts [117](#)

Fatigue Alert [211](#)  
 Fatigue Alert, see Driver Attention Camera [62](#)  
 Fatigue warner, see Fatigue Alert [211](#)  
 Fault indicators, see Check Control [158](#)  
 Filler neck for engine oil [366](#)  
 Filter, see Interior filter [273](#)  
 Fine wood, care [387](#)  
 Fine wood parts, care [387](#)  
 First-aid kit [377](#)  
 First Steps, see Setup Wizard [67](#)  
 Fittings for trailer safety chain, trailer towing [318](#)  
 Flat tire, changing wheels [354](#)  
 Flat tire, continued driving, see Flat tire monitor [351](#)  
 Flat tire, continued driving, see Tire Pressure Monitor [344](#)  
 Flat tire message, see Flat tire monitor [352](#)  
 Flat tire message, see Tire Pressure Monitor [347](#)  
 Flat tire monitor [351](#)  
 Flat tire, repairing [339](#)  
 Flat tire, see Flat tire monitor [351](#)  
 Flat tire, see Tire Pressure Monitor [344](#)  
 Flat tire warning light, see Flat tire monitor [352](#)  
 Flat tire warning light, see Tire Pressure Monitor [347](#)  
 Flooding, driving through [312](#)  
 Floor carpet, care [387](#)  
 Floor mats, care [387](#)  
 Fold-away position, wiper [146](#)  
 Fold-out position [146](#)  
 Foot brake [312](#)  
 Forward collision mitigation, see Intelligent Safety [185](#)  
 For Your Own Safety [8](#)  
 Fragrance cartridge, see Ambient air package [286](#)  
 Fragrance, see Ambient air package [286](#)  
 Fragrancing, see Ambient air package [286](#)  
 Front airbags [182](#)  
 Front collision mitigation [187](#)  
 Front collision mitigation, see Forward Collision Warning [187](#)  
 Front collision mitigation, see Intersection Collision Warning [192](#)

Front collision mitigation, see Pedestrian Warning [195](#)  
 Front fog lights, changing, see Lights and bulbs [373](#)  
 Front lights, replacing, see Lights and bulbs [373](#)  
 Front passenger's side exterior mirror, tilting down, see Automatic Curb Monitor [123](#)  
 Front passenger airbags, automatic deactivation [184](#)  
 Front-seat passenger airbag, indicator light [185](#)  
 Front seats [114](#)  
 Fuel [363](#)  
 Fuel cap [326](#)  
 Fuel filler flap [326](#)  
 Fuel filler flap, emergency unlocking [327](#)  
 Fuel filler flap, manual operation [327](#)  
 Fuel filler flap, unlocking manually [327](#)  
 Fuel gauge [165](#)  
 Fuel quality [363](#)  
 Fuel recommendation [363](#)  
 Fuel, saving [320](#)  
 Fuel tank, see Filling capacity [392](#)  
 Fuses [376](#)

## G

Garage door opener, see Integrated Universal Remote Control [289](#)  
 Gasoline [363](#)  
 Gasoline quality [364](#)  
 Gear change, Steptronic transmission [146](#)  
 General driving notes [311](#)  
 General settings [61](#)  
 Gesture Control [54](#)  
 Gestures, see BMW Gesture Control [54](#)  
 Glare shield, see Sun visor [292](#)  
 Glass sunroof, electric [111](#)  
 Glass sunroof, initialize the system [113](#)  
 Global Positioning System, navigation [6](#)  
 Glove compartment [297](#)  
 G-meter [156](#)  
 GPS, navigation, see Owner's Manual for Navigation, Entertainment, Communication [6](#)  
 Gross vehicle weight, approved [391](#)



Gross vehicle weight, trailer mode [391](#)

## H

Handbrake, see Parking brake [139](#)

Hand-held transmitter, alternating code [290](#)

Hands-free device, see Owner's Manual for Navigation, Entertainment, Communication [6](#)

Hands-free system [6](#)

Hazard warning system [377](#)

HDC, see Hill Descent Control [216](#)

Head airbag [183](#)

Headlight control, automatic [175](#)

Headlight flasher [143](#)

Headlight glass [374](#)

Headlights, care [385](#)

Headlights, replacing, see Lights and bulbs [373](#)

Headlights, turning up, dimming, see Automatic High Beam Assistant [178](#)

Headliner [33](#)

Head restraints and seats [114](#)

Head restraints, front [119](#)

Head restraints, rear [120](#)

Head-up display [172](#)

Head-up display, care [388](#)

Head-up display, position, saving see Memory function [124](#)

Heated steering wheel [124](#)

Heated steering wheel, climate control rules [126](#)

Heavy cargo, stowing [302](#)

Height, vehicle [390](#)

High beams [143](#)

Hill Descent Control [216](#)

Hills [313](#)

Hill start assistant, see Drive-off assistant [213](#)

Holder for beverages, front [299](#)

Holder for beverages, rear [299](#)

HomeLink, see Integrated Universal Remote Control [289](#)

Homepage, see Internet [7](#)

Hood [361](#)

Horn [30](#)

Hotel function, see Valet parking mode [104](#)

Hot exhaust gas system [311](#)

Hour, see Time [61](#)

Humidity in the headlight, see Headlight glass [374](#)

## I

iBrake – PostCrash [210](#)

Ice, see Outside temperature [168](#)

Ice warning, see Outside temperature [168](#)

Icons and displays [7](#)

Identification marks, tires [333](#)

Identification number, see Vehicle identification number [13](#)

iDrive [42](#)

ID transmitter, see Vehicle key [81](#)

Ignition key, see Vehicle key [81](#)

Inclination [115](#)

Indicator light, front-seat passenger airbag [185](#)

Indicator lights [159](#)

Individual air distribution [277](#)

Individual settings, see Driver profiles [67](#)

Inductive charging, smartphone, see Wireless charging tray [294](#)

Information [6](#)

Initialization, see flat tire monitor [352](#)

Input, iDrive [42](#)

Installation of child restraint systems [129](#)

Instrument cluster [153](#)

Instrument lighting [180](#)

Instrument panel, see Instrument cluster [153](#)

Integrated key [95](#)

Integrated Owner's Manual in the vehicle [6](#)

Integrated Universal Remote Control [289](#)

Intelligent emergency call [379](#)

Intelligent Personal Assistant [50](#)

Intelligent Safety [185](#)

Intended use [8](#)

Intensity, AUTO program [276](#)

Interior equipment [289](#)

Interior filter [273](#)

Interior lights [180](#)

Interior lights during unlocking [82](#)

Interior lights, locked vehicle [83](#)

Interior mirror [123](#)

Interior mirror, automatic dimming feature [123](#)

Interior motion sensor [109](#)

Internet page [7](#)  
 Intersection collision warning [192](#)  
 Intersection warning with City light braking function [192](#)  
 Interval indicator, see Service notifications [168](#)  
 Ionization, see Ambient air package [286](#)  
 Ionizer [286](#)

**J**

Jacking points [356](#)  
 Jacking points for the vehicle jack [356](#)  
 Jam protection system, glass sunroof [112](#)  
 Jam protection system, windows [110](#)  
 Joystick, Steptronic transmission [146](#)  
 Jump-starting [380](#)  
 Jump-starting terminals [381](#)  
 Jump-start terminals [381](#)

**K**

Kenaf, care [387](#)  
 Key Card [91](#)  
 Keyless Go, see Comfort Access [97](#)  
 Key, mechanical [95](#)  
 Key, see BMW display key [86](#)  
 Key, see Vehicle key [81](#)  
 Kickdown, Steptronic transmission [146](#)  
 Knee airbag [183](#)

**L**

Labeling [333](#)  
 Label on recommended tires [336](#)  
 Lane boundary [197](#)  
 Lane change assistant [242](#)  
 Lane control assistant with active side collision mitigation [203](#)  
 Lane control assistant with active side collision protection, see Side collision mitigation [203](#)  
 Lane departure warning [197](#)  
 Lane lines, Surround View [261](#)  
 Lane threshold, warning [197](#)  
 Language, setting [62](#)  
 Laser headlights, changing, see Lights and bulbs [373](#)

Laser high beams [180](#)  
 Lashing eyes in the cargo area [302](#)  
 LATCH child seat mountings [130](#)  
 Launch Control [151](#)  
 Leather care [386](#)  
 LED headlights, changing, see Lights and bulbs [373](#)  
 Length, vehicle [390](#)  
 Letters and numbers, entering [43](#)  
 Light-alloy wheels, care [386](#)  
 Light carpet, see Welcome Light Carpet [176](#)  
 Light control, adaptive [178](#)  
 Lighting [175](#)  
 Light in the exterior mirror, see Active Blind Spot Detection [200](#)  
 Light in the exterior mirror, see Cross traffic warning [267](#)  
 Light replacement, see Lights and bulbs [373](#)  
 Lights [175](#)  
 Lights and bulbs [373](#)  
 Lights, care [385](#)  
 Light switch [175](#)  
 LIM button, see Manual Speed Limiter [221](#)  
 List, instrument cluster, see Selection lists [169](#)  
 List, notifications, see Notifications [64](#)  
 Load [302](#)  
 Loading [301](#)  
 Loading position [305](#)  
 Loading the cargo area, see Stowing cargo [302](#)  
 Local time, see Time [61](#)  
 Lock control elements, rear automatic climate control [281](#)  
 Locking, automatic [107](#)  
 Locking, see Opening and Closing [81](#)  
 Locking, settings [106](#)  
 Locking using the vehicle key [83](#)  
 Lock, lug bolts [355](#)  
 Loop [383](#)  
 Low beams, operation [176](#)  
 Lower back support, see Lumbar support [116](#)  
 Lug bolt lock [355](#)  
 Luggage rack, see Roof-mounted luggage rack [314](#)  
 Luggage straps [302](#)  
 Lumbar support [116](#)

**M**

Maintenance [370](#)  
Maintenance recommendation, see Condition Based Service [370](#)  
Maintenance, see Service requirements [168](#)  
Maintenance system, BMW [370](#)  
Make-up mirror [292](#)  
Malfunction, BMW display key [90](#)  
Malfunction, vehicle key [85](#)  
Manual brake, see Parking brake [139](#)  
Manual control, air distribution [277](#)  
Manual control, air flow [277](#)  
Manual mode, Steptronic transmission [146](#)  
Manual Speed Limiter [221](#)  
Map update, see Owner's Manual for Navigation, Entertainment, Communication [6](#)  
Marking, run-flat tire [338](#)  
Matte paintwork [386](#)  
Matt paint, care [386](#)  
Maximum cooling [275](#)  
Maximum speed, display, see Speed Limit Info [219](#)  
Maximum speed, winter tires [337](#)  
M chassis/suspension, adaptive, see Adaptive M chassis/suspension [271](#)  
Medical supplies, see First-aid kit [377](#)  
Memory function [124](#)  
Menus, operating, iDrive [42](#)  
Messages, see Check Control [158](#)  
Meters, see Instrument cluster [153](#)  
Microfilter, see Interior filter [273](#)  
Mild Hybrid technology [375](#)  
Minimum tread depth, tires [335](#)  
Mirror position, saving, see Memory function [124](#)  
Mobile devices, connecting [72](#)  
Mobile devices, managing [73](#)  
Mobile phone, connecting [72](#)  
Mobile phone, see Owner's Manual for Navigation, Entertainment and Communication [6](#)  
Mobile phones, suitable [73](#)  
Mobile radio in the vehicle [312](#)  
Mobile Service, see BMW Accident Assistance [378](#)

Mobile Service, see BMW Roadside Assistance [378](#)  
Mobility System, see Tire repair set [339](#)  
MODE button, see Active Cruise Control [226](#)  
Mode, ECO PRO [321](#)  
Modifications, technical, see For Your Own Safety [8](#)  
Moisture [374](#)  
Monitor, see Control Display [45](#)  
Mount for trailer hitch, care [388](#)  
Mounting of child restraint systems [129](#)  
MP3 player, see Owner's Manual for Navigation, Entertainment, Communication [6](#)  
Multifunction hook [303](#)  
Multi-function steering wheel [30](#)  
Multifunction steering wheel, buttons [30](#)  
Multimedia, see Owner's Manual for Navigation, Entertainment and Communication [6](#)

**N**

Navigation data, on-board computer [158](#)  
Navigation, see Owner's Manual for Navigation, Entertainment and Communication [6](#)  
Neck restraints, front, see Head restraints, front [119](#)  
Neck restraints, rear, see Head restraints, rear [120](#)  
Net, cargo area [304](#)  
Neutral cleaner, see Light-alloy wheels, care [386](#)  
Notifications [64](#)  
Nylon rope for tow-starting/towing [382](#)

**O**

OBD, see On-board diagnosis [371](#)  
Obstacle marking, rearview camera [250](#)  
Obstacle marking, Surround View [261](#)  
Octane number, see Gasoline quality [364](#)  
Odometer, see Trip data [170](#)  
Oil filler neck [366](#)  
Oil level, checking electronically [365](#)  
Oil service interval, see Service notifications [168](#)  
Oil, topping up [366](#)

- Oil types to add, engine [366](#)
  - Old battery [375](#)
  - On-board computer, see Trip data [170](#)
  - On-board diagnosis [371](#)
  - Onboard vehicle tool kit [372](#)
  - On-call service, see BMW Accident Assistance [378](#)
  - On-call service, see BMW Roadside Assistance [378](#)
  - Opening and closing [81](#)
  - Opening with the Key Card [91](#)
  - Opening with the smartphone, see BMW Digital Key [92](#)
  - Operating concept, iDrive [42](#)
  - Operating condition of the vehicle [39](#)
  - Operation via voice [50](#)
  - Optional equipment, see Vehicle equipment [8](#)
  - Outside air, see Automatic Recirculating Air Control [276](#)
  - Outside temperature [168](#)
  - Overheating of the engine, see Engine temperature [167](#)
  - Overwintering, see Long-term vehicle storage [388](#)
  - Owner's Manual via voice operation, BMW Intelligent Personal Assistant [52](#)
- P**
- Paint, vehicle care [386](#)
  - Paintwork [386](#)
  - Panic alarm, see Panic mode [108](#)
  - Panic mode [108](#)
  - Panorama View [265](#)
  - Panoramic glass sunroof, see Glass sunroof [111](#)
  - Park Distance Control [244](#)
  - Parking assistance, see Park Distance Control [244](#)
  - Parking assistance systems [244](#)
  - Parking assistant [252](#)
  - Parking Assistant for driving out of parking space [257](#)
  - Parking Assistant Plus, see Parking assistance systems [244](#)
  - Parking Assistant, see Automatic Parking Assistant [252](#)
  - Parking Assistant, see Parking assistance systems [244](#)
  - Parking, Automatic Hold, see Parking brake [139](#)
  - Parking brake [139](#)
  - Parking brake function, Active Park Distance Control [247](#)
  - Parking lights [176](#)
  - Parts and accessories [9](#)
  - Pathway lighting [177](#)
  - Pathway lighting, turning on [84](#)
  - Pathway lines [261](#)
  - Pathway lines, rearview camera [250](#)
  - Payload [302](#)
  - Payload, technical data [391](#)
  - PDC, see Park Distance Control [244](#)
  - Pedestrian Warning with braking function [195](#)
  - Performance Control [271](#)
  - Performance display, see Sport displays [171](#)
  - Personal Assistant [50](#)
  - Personal data, deleting [66](#)
  - Personal profile, see Driver profiles [67](#)
  - Personal settings [66](#)
  - Physical units, see Units of measurement, setting [62](#)
  - Plastic, care [387](#)
  - Plastic parts, care [387](#)
  - Pop-ups, control display [63](#)
  - Possible gestures, gesture control [55](#)
  - PostCrash – iBrake [210](#)
  - Power Display, instrument cluster [166](#)
  - Power failure [375](#)
  - Power interruption [375](#)
  - Power Meter, see Power Display [166](#)
  - Power windows [109](#)
  - Pre-conditioning [283](#)
  - Pressure monitor, tire, see Tire Pressure Monitor [344](#)
  - Pressure, tires [328](#)
  - Pressure warning, see Flat tire monitor [351](#)
  - Pressure warning, see Tire Pressure Monitor [344](#)
  - Pre-ventilation [281](#)
  - Prevention of rear-end collision, see Rear-end collision preparation [205](#)
  - Profiles, see Driver profiles [67](#)

Programmable memory buttons, iDrive [44](#)  
Protective function, glass sunroof, see Jam protection system [112](#)  
Protective function, windows, see Jam protection system [110](#)  
Push-and-turn reel, see Controller [45](#)

## Q

Queuing Assistant, see Assisted Driving Plus [240](#)

## R

Racing track [314](#)  
Radar sensors, see Sensors of the vehicle [35](#)  
Radiator fluid [367](#)  
Radio, see Owner's Manual for Navigation, Entertainment and Communication [6](#)  
Rain sensor [144](#)  
Rear automatic climate control [279](#)  
Rear automatic climate control, lock control elements [281](#)  
Rear-end collision preparation [205](#)  
Rear lights, replacing, see Lights and bulbs [373](#)  
Rear seat backrests, folding down [305](#)  
Rear seats [116](#)  
Rearview camera, see Surround View [260](#)  
Rearview camera, without Surround View [249](#)  
Rear-view mirror, exterior [122](#)  
Rearview mirror, interior [123](#)  
Rear window defroster [278](#)  
Rear window wiper, operation [145](#)  
Rear wiper [145](#)  
Recirculated-air mode [277](#)  
Recirculating air filter, see Interior filter [273](#)  
Recommended tire brands [336](#)  
Reduced drive power [166](#)  
Refueling [326](#)  
Registering, mobile devices, see Connections [72](#)  
Remote 3D View [269](#)  
Remote control for audio, see Owner's Manual for Navigation, Entertainment, Communication [6](#)  
Remote control, see Vehicle key [81](#)  
Remote control, universal [289](#)  
Remote Engine Start, see Stationary climate control [283](#)  
Remote services, app, see Owner's Manual for Navigation, Entertainment, Communication [6](#)  
Remote Software Upgrade [57](#)  
removable [318](#)  
Renewal, wheels and tires [336](#)  
Replace battery, vehicle key [84](#)  
Replacement, wheels and tires [336](#)  
Replacing bulbs, see Lights and bulbs [373](#)  
Replacing light diodes, see Lights and bulbs [373](#)  
Replacing parts [372](#)  
Reporting safety malfunctions [14](#)  
RES CNCL button, Active Cruise Control [226](#)  
RES CNCL button, Cruise Control [223](#)  
Reserve warning, see Range [168](#)  
Reservoir, washer fluid [368](#)  
Resetting, Tire Pressure Monitor [346](#)  
Reset, Tire Pressure Monitor [346](#)  
Reset, vehicle settings [63](#)  
Restricted Driving, see BMW Digital Key [92](#)  
RESUME button, Active Cruise Control [226](#)  
RESUME button, Cruise Control [223](#)  
Retreaded tires [337](#)  
Reversing Assistant [258](#)  
Roadside parking lights [176](#)  
Roller cover for luggage compartment, see Cargo cover [307](#)  
Roller sunblinds, rear side windows [111](#)  
Rolling code hand-held transmitter [290](#)  
Rolling to a stop with engine decoupled, see Coasting [323](#)  
RON, see gasoline quality [364](#)  
Roofliner [33](#)  
Roof-mounted luggage rack [314](#)  
Rope for tow-starting/towing [382](#)  
Route, navigation, see Owner's Manual for Navigation, Entertainment, Communication [6](#)  
RSC, see Runflat tires [338](#)  
RTTI, see Owner's Manual for Navigation, Entertainment, Communication [6](#)  
Rubber components, care [387](#)  
Runflat tires [338](#)

Runflat tires, see Runflat tires [338](#)

## S

Safe braking [312](#)

Safe Share function, see BMW Digital Key [92](#)

Safety locks, doors, and windows [133](#)

Safety package, see Active Protection [210](#)

Safety switch, windows [111](#)

Safety systems, see Airbags [182](#)

Safety systems, see Intelligent Safety [185](#)

Screen, see Control Display [45](#)

Sealing compound, see Tire repair set [339](#)

Seat belt reminder for driver and front passenger seat, see Seat belts [118](#)

Seat belt reminder for the rear seats [118](#)

Seat belts [117](#)

Seat belts, care [387](#)

Seat calibration [115](#)

Seat heating [125](#)

Seat heating, climate control rules [126](#)

Seating position for children [128](#)

Seat position, saving, see Memory function [124](#)

Seats and head restraints [114](#)

Seats, front [114](#)

Seats, rear [116](#)

Seat ventilation, active [126](#)

Seat ventilation, climate control rules [126](#)

Securing, cargo [302](#)

Selection list on the instrument cluster [169](#)

Selector lever, Steptronic transmission [146](#)

Sensors, care [388](#)

Sensors of the vehicle [35](#)

Service and warranty [10](#)

Service Center, see BMW Accident Assistance [378](#)

Service Center, see BMW Roadside Assistance [378](#)

Service notifications [168](#)

Service notifications, see Condition Based Service [370](#)

Services, ConnectedDrive, see Owner's Manual for Navigation, Entertainment and Communication [6](#)

SET button, Active Cruise Control [226](#)

SET button, Cruise Control [223](#)

Set clock [61](#)

Set day, see Date [61](#)

Set time, see Time [61](#)

Setting, Control Display [63](#)

Settings, general [61](#)

Settings, locking/unlocking [106](#)

Settings, resetting, vehicle [63](#)

Settings, seats and head restraints [114](#)

Setup Wizard [67](#)

Shift paddles on the steering wheel [146](#)

Shift point display [169](#)

Shift recommendation for fuel-efficient driving, see Shift point display [169](#)

Side airbag [182](#)

Side collision mitigation [203](#)

Side parking aid, Surround View [261](#)

Side parking aid without Surround View [248](#)

Side protection [248](#), [261](#)

Side protection aid, Surround View, see Side parking aid [261](#)

Side protection aid without Surround View, see Side parking aid [248](#)

Signaling, horn [30](#)

Signals when unlocking, see Confirmation signals from the vehicle [106](#)

Sitting safely [114](#)

Sleep mode, see Operating condition of the vehicle [39](#)

Slide/tilt glass roof, see Glass sunroof [111](#)

Slipperiness, see Outside temperature [168](#)

Slippery road, see Outside temperature [168](#)

Smallest turning circle, vehicle [390](#)

Smartphone, connecting [72](#)

Smartphone Integration, Android Auto preparation [78](#)

Smartphone Integration, Apple CarPlay preparation [77](#)

Smartphone, see Owner's Manual for Navigation, Entertainment and Communication [6](#)

Smartphone, using via voice control [53](#)

SMS, see Short messages, see Owner's Manual for Navigation, Entertainment, Communication [6](#)

Sockets, electrical devices [292](#)

Software Update, see Remote Software Upgrade [57](#)

- Software Upgrade, see Remote Software Upgrade [57](#)
- SOS button, see Intelligent emergency call [379](#)
- Sound [6](#)
- Sound, engine, setting [272](#)
- Sound output, see Owner's Manual for Navigation, Entertainment, Communication [6](#)
- Spare tire, see Emergency wheel [358](#)
- Speech recognition [50](#)
- Speed Limit Assist [234](#)
- Speed Limit Assistant [234](#)
- Speed Limit Device, Speed Limiter [221](#)
- Speed limit, display, see Speed Limit Info [219](#)
- Speed Limit Info [219](#)
- Speed warning [63](#)
- Sport chassis/suspension, see Adaptive M chassis/suspension [271](#)
- Sport displays [171](#)
- SPORT INDIVIDUAL, see Driving Dynamics Control [137](#)
- SPORT PLUS, see Driving Dynamics Control [137](#)
- Sport program, Steptronic transmission [146](#)
- SPORT, see Driving Dynamics Control [137](#)
- Sport steering, variable [218](#)
- Stability control systems [213](#)
- Standard equipment, see Vehicle equipment [8](#)
- Standby, see Operating condition of the vehicle [39](#)
- Start/stop, automatic function [134](#)
- Start/Stop button [134](#)
- Starting aid terminals [381](#)
- Starting, see Drive-ready state [40](#)
- Starting the engine, see Drive-ready state [40](#)
- Starting the engine with the Key Card [91](#)
- Stationary climate control via Remote Engine Start [283](#)
- Stations, AM/FM, see Owner's Manual for Navigation, Entertainment, Communication [6](#)
- Status control display, tires [346](#)
- Status information, iDrive [43](#)
- Status of Owner's Manual [8](#)
- Status, vehicle [172](#)
- Steering and Lane Control Assistant [236](#)
- Steering Assistant [236](#)
- Steering Assistant, see Steering and Lane Control Assistant [236](#)
- Steering column adjustment [123](#)
- Steering wheel, adjusting [123](#)
- Steering wheel, buttons [30](#)
- Steering wheel heating [124](#)
- Steering wheel heating, climate control rules [126](#)
- Steering wheel position, saving, see Memory function [124](#)
- Steptronic Sport transmission, see Steptronic transmission [146](#)
- Steptronic transmission [146](#)
- Stopping the engine, see Drive-ready state [40](#)
- Storage compartment, cargo area [304](#)
- Storage compartment, center console [298](#)
- Storage compartments [297](#)
- Storage compartments, locations [297](#)
- Storage, tires [338](#)
- Storing the vehicle [388](#)
- Stowing, cargo [302](#)
- Straps for cargo, see Lashing eyes in the cargo area [302](#)
- Suitable devices [73](#)
- Suitable mobile phones [73](#)
- Summer tires, tread [334](#)
- Sun visor [292](#)
- Supplementary Owner's Handbooks [7](#)
- Supplementary Owner's Manuals [7](#)
- Surround View [260](#)
- Surround View, gesture control [55](#)
- Suspension settings, see Driving Dynamics Control [137](#)
- Swinging of trailer, see Trailer stabilization control [317](#)
- Switches, see Dashboard [30](#)
- Switch for driving dynamics, see Driving Dynamics Control [137](#)
- SYNC program, automatic climate control [278](#)
- System language, setting, see Language, setting [62](#)
- System settings, see General settings [61](#)

**T**

Tachometer [166](#)

- Tailgate, contactless opening and closing [100](#)
- Tailgate, vehicle key [84](#)
- Tail light, changing, see [Lights and bulbs 373](#)
- Taking the vehicle out of service [388](#)
- Tank capacity [392](#)
- Technical changes, see [For Your Own Safety 8](#)
- Technical data [390](#)
- Telephone, see [Owner's Manual for Navigation, Entertainment and Communication 6](#)
- Telephone, selection list in the instrument cluster [169](#)
- Teleservices, see [Owner's Manual for Navigation, Entertainment, Communication 6](#)
- Temperature, automatic climate control [274](#)
- Temperature display, see [outside temperature 168](#)
- Temperature, engine oil [167](#)
- Tensioning straps, cargo area [304](#)
- Theft alarm system, see [Alarm system 107](#)
- Thigh support [116](#)
- Tilt alarm sensor [109](#)
- Tilt, backrest [115](#)
- Tilting down, front passenger's side exterior mirror, see [Automatic Curb Monitor 123](#)
- Time [61](#)
- Time of day, see [Time 61](#)
- Time setting, automatic [61](#)
- Tire brands, recommended [336](#)
- Tire chains [343](#)
- Tire change [336](#)
- Tire damage [335](#)
- Tire identification marks [333](#)
- Tire inflation pressure [328](#)
- Tire marking [333](#)
- Tire pressure [328](#)
- Tire Pressure Monitor [344](#)
- Tire pressure monitoring, see [Flat tire monitor 351](#)
- Tire Pressure Monitor, reset [346](#)
- Tire Pressure Monitor, resetting [346](#)
- Tire pressure, tires [328](#)
- Tire pressure warning, see [Flat tire monitor 351](#)
- Tire repair set [339](#)
- Tires and wheels [328](#)
- Tire sealant, see [Tire repair set 339](#)
- Tire settings [345](#)
- Tires, run-flat [338](#)
- Tire tread [334](#)
- Title, gesture control [55](#)
- Tone, see [Owner's Manual for Navigation, Entertainment and Communication 6](#)
- Tools [372](#)
- Top View, see [Surround View 260](#)
- Torque display, see [Sport displays 171](#)
- Touchpad, Controller [48](#)
- Tow bar [382](#)
- Tow fitting [383](#)
- Towing [381](#)
- Tow rope [382](#)
- Tow-starting [381](#)
- Traction Control [215](#)
- Traction control system, see [Dynamic Stability Control 213](#)
- TRACTION, driving dynamics [215](#)
- Traffic bulletins, see [Owner's Manual for Navigation, Entertainment, Communication 6](#)
- Traffic Jam Assistant, see [Assisted Driving Plus 240](#)
- Traffic jam assistant, see [Steering and Lane Control Assistant 236](#)
- Trailer hitch, ball head [318](#)
- Trailer hitch, care [388](#)
- Trailer hitch, mount for [318](#)
- Trailer hitch, view of rearview camera [250](#)
- Trailer hitch, view of Surround View [261](#)
- Trailer loads [391](#)
- Trailer stabilization control [317](#)
- Trailer towing [315, 391](#)
- Trailer towing, activation [317](#)
- Trailer towing, technical data [391](#)
- Transmission lock, electronic unlocking [150](#)
- Transmission, see [Steptronic transmission 146](#)
- Transporting children safely [128](#)
- Tread, tires [334](#)
- Trip data [170](#)
- Triple turn signal activation [143](#)
- Trip odometer, see [Trip data 170](#)
- Trunk, see [Cargo area 301](#)
- Turning circle lines, rearview camera [250](#)
- Turning circle line, Surround View [261](#)
- Turning circle, vehicle [390](#)
- Turn signal, indicator light [163](#)



Turn signal, replacing bulbs, see Lights and bulbs [373](#)  
Turn signals, high beams, headlight flasher [142](#)

## U

Ultrasonic sensors, see Sensors of the vehicle [35](#)  
Unintentional alarm, avoiding [109](#)  
Units of measurement, setting [62](#)  
Units, see Units of measurement, setting [62](#)  
Universal remote control [289](#)  
Unlock button, Steptronic transmission [146](#)  
Unlocking, automatic [106](#)  
Unlocking, see Opening and Closing [81](#)  
Unlocking, settings [106](#)  
Unlocking, vehicle key [82](#)  
Unpaved roads, cross-country trips [310](#)  
Updates made after the editorial deadline [8](#)  
Upgrade, see Remote Software Upgrade [57](#)  
Upholstery material care [386](#)  
Upper retaining strap, top tether [132](#)  
USB connection [79](#)  
USB port, position in vehicle [293](#)  
Used battery, disposing of [375](#)  
Use, intended [8](#)

## V

Valet parking mode [104](#)  
Vanity mirror [292](#)  
Variable sport steering [218](#)  
Vehicle battery [374](#)  
Vehicle breakdown, see Breakdown assistance [377](#)  
Vehicle, breaking in [310](#)  
Vehicle care [385](#)  
Vehicle care products [385](#)  
Vehicle data, resetting [63](#)  
Vehicle equipment [8](#)  
Vehicle identification number [13](#)  
Vehicle issues [377](#)  
Vehicle key [81](#)  
Vehicle key, additional [85](#)  
Vehicle key, integrated key [95](#)  
Vehicle key, loss [85](#)

Vehicle key, malfunction [85](#)  
Vehicle key, replace battery [84](#)  
Vehicle key with display, malfunction [90](#)  
Vehicle key with display, see BMW display key [86](#)  
Vehicle paint, care [386](#)  
Vehicle paintwork [386](#)  
Vehicle status [172](#)  
Vehicle storage [388](#)  
Ventilation [278](#)  
Ventilation, see Pre-ventilation [281](#)  
Venting, see Ventilation [278](#)  
Version Software, see Remote Software Upgrade [57](#)  
Video recording, see BMW Drive Recorder [208](#)  
Video, see Owner's Manual for Navigation, Entertainment and Communication [6](#)  
VIN, see Vehicle identification number [13](#)  
Voice activation system [50](#)  
Voice command response [50](#)  
Voice control [50](#)  
Voice control, gesture control [55](#)  
Voice control, see BMW Intelligent Personal Assistant [50](#)  
Voice control system [50](#)  
Volume, gesture control [55](#)

## W

Wake word [51](#)  
Warning against cross traffic [267](#)  
Warning function, rear-end collision [205](#)  
Warning light in the exterior mirror, see Active Blind Spot Detection [200](#)  
Warning light in the exterior mirror, see Cross traffic warning [267](#)  
Warning lights [159](#)  
Warning messages, see Check Control [158](#)  
Warning triangle [377](#)  
Warranty [8](#)  
Warranty Booklet, see Warranty [8](#)  
Washer fluid [368](#)  
Washer nozzles, windshield [145](#)  
Washer system [143](#)  
Washing the vehicle [384](#)  
Washing, vehicle [384](#)

Water on roads [312](#)  
 Water, see Condensation water under the parked vehicle [313](#)  
 Web page [7](#)  
 Website, see Internet [7](#)  
 Weights [391](#)  
 Welcome Light Carpet, see Welcome light [176](#)  
 Welcome light during unlocking [82](#)  
 Welcome lights [176](#)  
 Welcome screen, driver profiles [67](#)  
 Wheelbase [390](#)  
 Wheel base, vehicle [390](#)  
 Wheel change [354](#)  
 Wheels and tires [328](#)  
 Wheels and tires, exchange [336](#)  
 Widgets, iDrive [43](#)  
 Widgets, instrument cluster [156](#), [157](#)  
 Width, vehicle [390](#)  
 Wi-Fi [76](#)  
 WiFi connection, see WLAN connection [76](#)  
 Wi-Fi hotspot [76](#)  
 Wi-Fi hotspot, see Wi-Fi hotspot [76](#)  
 WiFi, see Wi-Fi [76](#)  
 Window, defrosting [278](#)  
 Windows, powered [109](#)  
 Windshield, defrosting [278](#)  
 Windshield washer fluid, see Washer fluid [368](#)  
 Windshield washer nozzles [145](#)  
 Windshield wiper, see Wiper system [143](#)  
 Winter storage, see Long-term vehicle storage [388](#)  
 Winter tires [337](#)  
 Winter tires, tread [335](#)  
 Wiper blades, changing [372](#)  
 Wiper fluid, see Washer fluid [368](#)  
 Wiper, fold-away position [146](#)  
 Wiper, see Washer/wiper system [143](#)  
 Wiper system [143](#)  
 Wireless charging, smartphone, see Wireless charging tray [294](#)  
 Wireless charging tray for smartphones [294](#)  
 WLAN connection [76](#)  
 Wood, care [387](#)  
 Wordmatch principle, see Entry comparison [43](#)  
 Workshop, see Service requirements [168](#)  
 Wrench, see Onboard vehicle tool kit [372](#)

X

xDrive [215](#)



01405A602E0 ue







# California Proposition 65 Warning

---

For vehicles sold in California:

## **California Proposition 65 Warning**



### **WARNING**

Operating, servicing and maintaining a passenger vehicle or off-highway motor vehicle can expose you to chemicals including engine exhaust, carbon monoxide, phthalates, and lead, which are known to the State of California to cause cancer and birth defects or other reproductive harm. To minimize exposure, avoid breathing exhaust, do not idle the engine except as necessary, service your vehicle in a well-ventilated area and wear gloves or wash your hands frequently when servicing your vehicle. For more information go to [www.P65Warnings.ca.gov/passenger-vehicle](http://www.P65Warnings.ca.gov/passenger-vehicle).

# BMW DRIVER'S GUIDE APP.

YOUR DIGITAL VEHICLE INFORMATION.

The BMW Driver's Guide app explains the equipment of your vehicle and offers further scopes and functions:

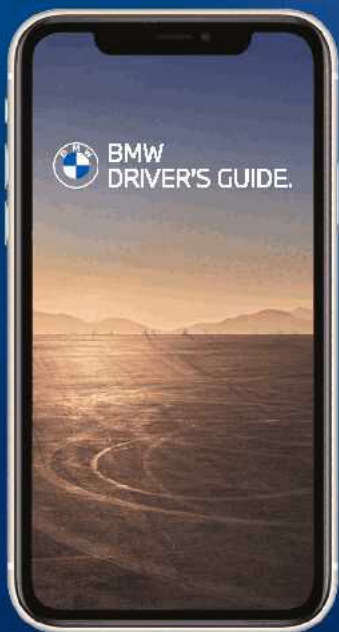

All information surrounding navigation, entertainment and communication

Photorealistic animations for various vehicle functions

Keyword search

360° view: Explore your vehicle interactively inside and out

Smart Scan for Apple iPhone: Icon and optical character recognition on the buttons in the vehicle

Available in more than 30 languages

Can be used offline after download



01405A602E0 ue

