

Hilux

Owner's Manual



TOYOTA

ALWAYS A
BETTER WAY

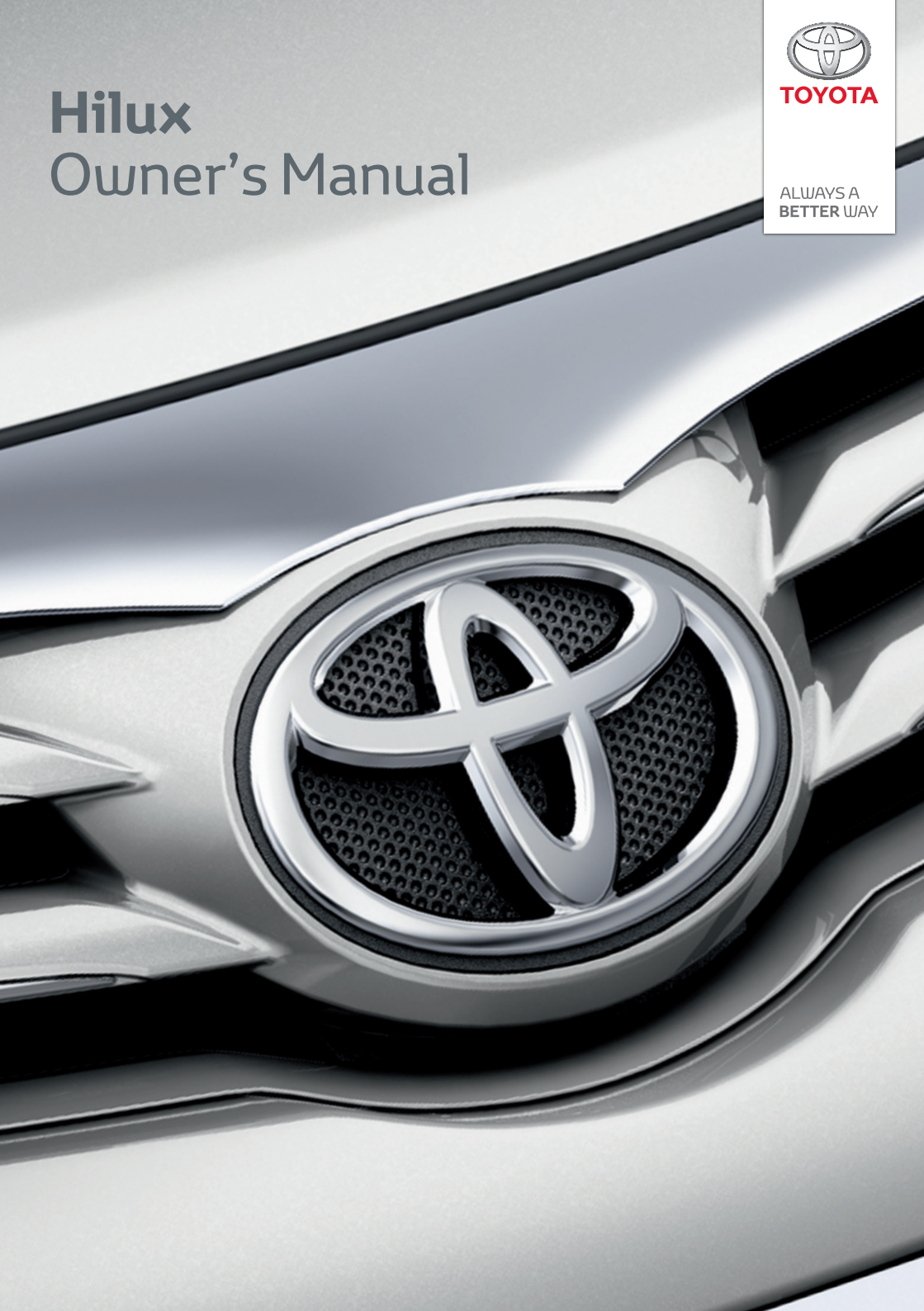

Toyota Motor Europe NV/SA Address: Avenue du bourget
60 -1140 Brussels, Belgium

2015 TOYOTA MOTOR CORPORATION All rights reserved. This material may not be reproduced or copied, in whole or in part, without the written permission of Toyota Motor Corporation

Pictorial index	Search by illustration	
1 For safety and security	Make sure to read through them	
2 Instrument cluster	How to read the gauges and meters, the variety of warning lights and indicators, etc.	
3 Operation of each component	Opening and closing the doors and windows, adjustment before driving, etc.	
4 Driving	Operations and advice which are necessary for driving	
5 Audio system	Operating the audio system	
6 Interior features	Usage of the interior features, etc.	
7 Maintenance and care	Caring for your vehicle and maintenance procedures	
8 When trouble arises	What to do in case of malfunction or emergency	
9 Vehicle specifications	Vehicle specifications, etc.	
Index	Search by symptom	
	Search alphabetically	

For your information8
 Reading this manual..... 14
 How to search 15
 Pictorial index..... 16

1 For safety and security

1-1. For safe use
 Before driving.....36
 For safe driving38
 Seat belts40
 SRS airbags.....45
 Exhaust gas precautions56

1-2. Child safety
 Front passenger occupant
 classification system57
 Airbag manual on-off
 system62
 Riding with children.....64
 Child restraint systems65

1-3. Emergency assistance
 eCall.....98
 ERA-GLONASS/EVAK 110

1-4. Theft deterrent system
 Engine immobilizer
 system 115
 Alarm 117

2 Instrument cluster

2. Instrument cluster
 Warning lights
 and indicators..... 122
 Gauges and meters..... 130
 Multi-information display ... 135
 Fuel consumption
 information 144

3 Operation of each component

3-1. Key information
 Keys 148

3-2. Opening, closing and locking the doors
 Side doors 153
 Access panels (smart-cab
 models only)..... 159
 Tailgate 160
 Smart entry & start
 system..... 163

3-3. Adjusting the seats
 Front seats 170
 Rear seats..... 172
 Head restraints 175

3-4. Adjusting the steering wheel and mirrors
 Steering wheel 178
 Inside rear view mirror..... 180
 Outside rear view
 mirrors 182

3-5. Opening and closing the windows

- Power windows 185
- Quarter windows (smart-cab models) 189

4 Driving

4-1. Before driving

- Driving the vehicle 192
- Cargo and luggage 205
- Trailer towing (without towing hitch) 206
- Trailer towing (with towing hitch) 207

4-2. Driving procedures

- Engine (ignition) switch (vehicles without smart entry & start system) 220
- Engine (ignition) switch (vehicles with smart entry & start system) 223
- Automatic transmission 231
- Manual transmission 239
- Turn signal lever 246
- Parking brake 247

4-3. Operating the lights and wipers

- Headlight switch 248
- Fog light switch 255
- Windshield wipers and washer 258

4-4. Refueling

- Opening the fuel tank cap 261

4-5. Using the driving support systems

- Toyota Safety Sense 266
- PCS (Pre-Collision System) 273
- LDA (Lane Departure Alert With Yaw Assist Function) 284
- RSA (Road Sign Assist) 295
- Dynamic radar cruise control 301
- Cruise control 317
- Toyota parking assist-sensor 321
- Four-wheel drive system 331
- Rear differential lock system 341
- Stop & Start system 345
- Driving assist systems 355
- Downhill assist control system 364
- AUTO LSD 367
- DPF (Diesel Particulate Filter) system 369

4-6. Driving tips

- Winter driving tips 374

5 Audio system

5-1. Basic Operations

- Audio system types 378
- Using the steering wheel audio switches 379
- AUX port/USB port 381

5-2. Using the audio system
 Optimal use of the audio system382

5-3. Using the radio
 Radio operation384

5-4. Playing an audio CD and MP3/WMA/AAC discs
 CD player operation387

5-5. Using an external device
 Listening to an iPod395
 Listening USB memory device401
 Using the AUX port407

5-6. Using Bluetooth® devices
 Bluetooth® audio/phone.....408
 Using the steering wheel switches413
 Registering a Bluetooth® device414

5-7. “SETUP” menu
 Using the “SETUP” menu (“Bluetooth” menu).....415
 Using the “SETUP” menu (“TEL” menu)419

5-8. Bluetooth® Audio
 Operating a Bluetooth® enabled portable player424

5-9. Bluetooth® Phone
 Making a phone call.....426
 When receiving a phone call427
 Speaking on the phone.....428

5-10. Bluetooth®
 Bluetooth®430

6 Interior features

6-1. Using the air conditioning system and defogger
 Manual air conditioning system..... 434
 Automatic air conditioning system..... 441
 Heated steering wheel/ seat heaters 450

6-2. Using the interior lights
 Interior lights list 453
 • Personal/interior light main switch 454
 • Personal/interior lights 454
 • Interior light 454

6-3. Using the storage features
 List of storage features..... 456
 • Glove box..... 457
 • Console box 457
 • Cup holders 458
 • Bottle holders 459
 • Auxiliary boxes..... 460
 Luggage compartment features 463

6-4. Using the other interior features
 Other interior features 464
 • Sun visors 464
 • Vanity mirror 464
 • Clock 465
 • Power outlets 466
 • Grocery bag hooks 468
 • Coat hooks 469
 • Armrest 469
 Using the steering wheel audio switches 470

7 Maintenance and care

7-1. Maintenance and care

- Cleaning and protecting the vehicle exterior472
- Cleaning and protecting the vehicle interior476

7-2. Maintenance

- Maintenance requirements.....479

7-3. Do-it-yourself maintenance

- Do-it-yourself service precautions482
- Hood484
- Engine compartment.....486
- Tires507
- Tire inflation pressure510
- Wheels512
- Air conditioning filter514
- Wireless remote control/ electronic key battery.....516
- Checking and replacing fuses520
- Light bulbs525

8 When trouble arises

8-1. Essential information

- Emergency flashers554
- If your vehicle has to be stopped in an emergency.....555
- If the vehicle is submerged or water on the road is rising557

8-2. Steps to take in an emergency

- If your vehicle needs to be towed 559
- If you think something is wrong 564
- Fuel pump shut off system (gasoline engine only) 565
- If a warning light turns on or a warning buzzer sounds 566
- If a warning message is displayed 575
- If you have a flat tire..... 581
- If the engine will not start 598
- If the electronic key does not operate properly (vehicles with smart entry & start system) 600
- If the vehicle battery is discharged 604
- If your vehicle overheats 610
- If you run out of fuel and the engine stalls (diesel engine only)..... 614
- If the vehicle becomes stuck..... 615

1

2

3

4

5

6

7

8

9

9 Vehicle specifications

9-1. Specifications

Maintenance data (fuel, oil level, etc.).....	620
Fuel information	643

9-2. Customization

Customizable features	646
-----------------------------	-----

9-3. Initialization

Items to initialize	654
---------------------------	-----

Index

What to do if... (Troubleshooting)	656
Alphabetical index	660

For vehicles with navigation system or multimedia system, refer to the “Navigation and multimedia system Owner’s manual” or “Multimedia Owner’s Manual” for information regarding the equipment listed below.

- Navigation system
- Audio system
- Panoramic view monitor
- Rear view monitor system

Toyota Motor Europe NV/SA, Avenue du Bourget 60 - 1140
Brussels, Belgium www.toyota-europe.com

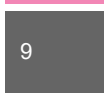
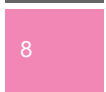
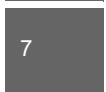

For your information

Main Owner's Manual

Please note that this manual applies to all models and all equipment, including options. Therefore, you may find some explanations for equipment not installed on your vehicle.

Also, for the models that have a model code last letter of 3*, specification information that changes due to mounting and remodeling is not written in this manual.

All specifications provided in this manual are current at the time of printing. However, because of the Toyota policy of continual product improvement, we reserve the right to make changes at any time without notice.

Depending on specifications, the vehicle shown in the illustrations may differ from your vehicle in terms of equipment.

For Eurasian Economic Union: The information on the procedure for the safe use of the vehicle and its systems, presented on the manufacturer's labels on the body in English, is intended only for service workers.

*: The model code is indicated on the manufacturer' plate or label. (→P. 624)

Accessories, spare parts and modification of your Toyota

Both genuine Toyota and a wide variety of other spare parts and accessories for Toyota vehicles are currently available on the market. Should it be determined that any of the genuine Toyota parts or accessories supplied with the vehicle need to be replaced, Toyota recommends that genuine Toyota parts or accessories, be used to replace them. Other parts or accessories of matching quality can also be used. Toyota cannot accept any liability or guarantee spare parts and accessories which are not genuine Toyota products, nor for replacement or installation involving such parts. In addition, damage or performance problems resulting from the use of non-genuine Toyota spare parts or accessories may not be covered under warranty.

Also, remodeling like this will have an effect on advanced safety equipment such as Toyota Safety Sense and there is a danger that it will not work properly or the danger that it may work in situations where it should not be working.

Installation of an RF-transmitter system

The installation of an RF-transmitter system in your vehicle could affect electronic systems such as:

- Multiport fuel injection system/sequential multiport fuel injection system
- Toyota Safety Sense
- Cruise control system
- Anti-lock brake system
- SRS airbag system
- Seat belt pretensioner system

Be sure to check with any authorized Toyota retailer or Toyota authorized repairer, or any reliable repairer for precautionary measures or special instructions regarding installation of an RF-transmitter system.

Further information regarding frequency bands, power levels, antenna positions and installation provisions for the installation of RF-transmitters, is available on request at any authorized Toyota retailer or Toyota authorized repairer, or any reliable repairer.

Vehicle data recording

The vehicle is equipped with sophisticated computers that will record certain data, such as:

- Engine speed/Electric motor speed (traction motor speed)
- Accelerator status
- Brake status
- Vehicle speed
- Operation status of the driving assist systems
- Images from the cameras

Your vehicle is equipped with cameras. Contact any authorized Toyota retailer or Toyota authorized repairer, or any reliable repairer for the location of recording cameras.

The recorded data varies according to the vehicle grade level, options and destinations with which it is equipped.

These computers do not record conversations or sounds, and only record images outside of the vehicle in certain situations.

● Data usage

Toyota may use the data recorded in this computer to diagnose malfunctions, conduct research and development, and improve quality.

Toyota will not disclose the recorded data to a third party except:

- With the consent of the vehicle owner or with the consent of the lessee if the vehicle is leased
- In response to an official request by the police, a court of law or a government agency
- For use by Toyota in a lawsuit
- For research purposes where the data is not tied to a specific vehicle or vehicle owner

● Recorded image information can be erased by any authorized Toyota retailer or Toyota authorized repairer, or any reliable repairer.

The image recording function can be disabled. However, if the function is disabled, data from when the system operates will not be available.

Scrapping of your Toyota

The SRS airbag and seat belt pretensioner devices in your Toyota contain explosive chemicals. If the vehicle is scrapped with the airbags and seat belt pretensioners left as they are, this may cause an accident such as fire. Be sure to have the systems of the SRS airbag and seat belt pretensioner removed and disposed of by a qualified service shop or by any authorized Toyota retailer or Toyota authorized repairer, or any reliable repairer before you scrap your vehicle.

WARNING

■ General precautions while driving

Driving under the influence: Never drive your vehicle when under the influence of alcohol or drugs that have impaired your ability to operate your vehicle. Alcohol and certain drugs delay reaction time, impair judgment and reduce coordination, which could lead to an accident that could result in death or serious injury.

Defensive driving: Always drive defensively. Anticipate mistakes that other drivers or pedestrians might make and be ready to avoid accidents.

Driver distraction: Always give your full attention to driving. Anything that distracts the driver, such as adjusting controls, talking on a cellular phone or reading can result in a collision with resulting death or serious injury to you, your occupants or others.

■ General precaution regarding children's safety

Never leave children unattended in the vehicle, and never allow children to have or use the key.

Children may be able to start the vehicle or shift the vehicle into neutral. There is also a danger that children may injure themselves by playing with the windows or other features of the vehicle. In addition, heat build-up or extremely cold temperatures inside the vehicle can be fatal to children.

Checking your vehicle's model

Check the model code to see what type of model your vehicle is.

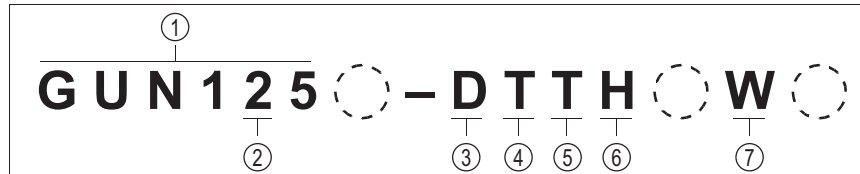

- ① Basic code
 - TGN1*6: Models with 2TR-FE engine
 - GUN1*6: Models with 1GD-FTV engine
 - GUN1*5: Models with 2GD-FTV engine
- ② Driving system
 - 2: 4WD models
 - 3: Pre Runner (2WD models)
- ③ Cab type
 - B: Single-cab
 - C: Smart-cab
 - D: Double-cab
- ④ Made in
 - N: South Africa
 - T: Thailand
- ⑤ Transmission type
 - T: Automatic transmission
 - M: 5-speed manual transmission
 - F: 6-speed manual transmission
- ⑥ Grade
 - H: HIGH
 - S: STD
 - L: LOW
- ⑦ Destination
 - W: Models for European countries etc.
 - Blank: Models for Kazakhstan etc.

The model code appears on the manufacturer's label or plate with the heading "MODEL".

The label or plate is placed as shown in the following illustrations.

► Type A

The manufacturer's label is located on the left pillar.

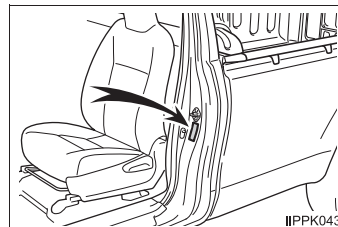

► Type B

The manufacturer's label is located on the left pillar.

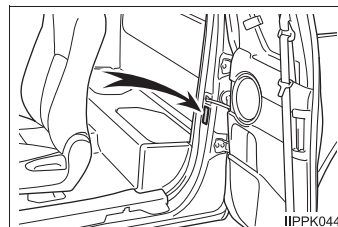

► Type C

The manufacturer's label is located on the left pillar.

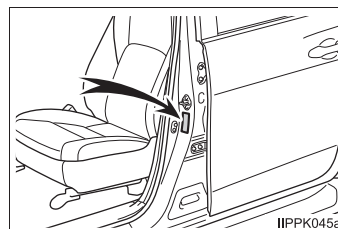

► Type D

The manufacturer's plate is located beside the engine compartment.

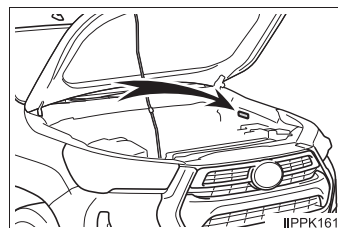

Reading this manual



WARNING:

Explains something that, if not obeyed, could cause death or serious injury to people.



NOTICE:

Explains something that, if not obeyed, could cause damage to or a malfunction in the vehicle or its equipment.



Indicates operating or working procedures. Follow the steps in numerical order.



Indicates the action (pushing, turning, etc.) used to operate switches and other devices.



Indicates the outcome of an operation (e.g. a lid opens).

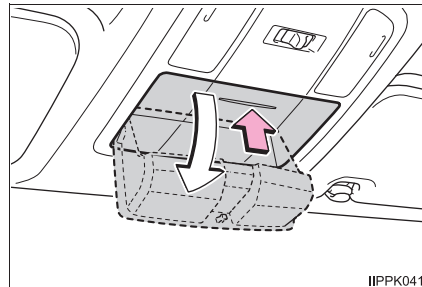

Indicates the component or position being explained.



Means “Do not”, “Do not do this”, or “Do not let this happen”.

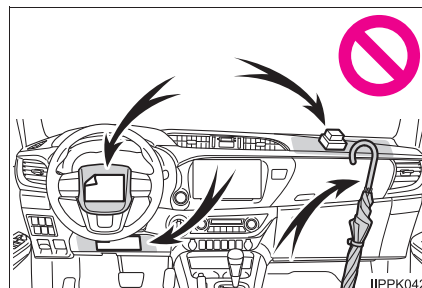

How to search

■ Searching by name

- Alphabetical index P. 660

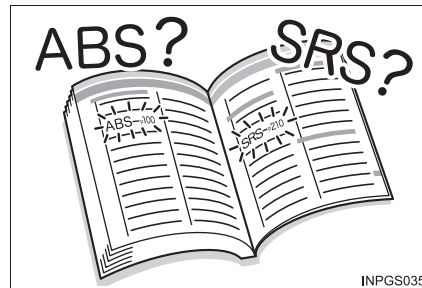

■ Searching by installation position

- Pictorial index P. 16

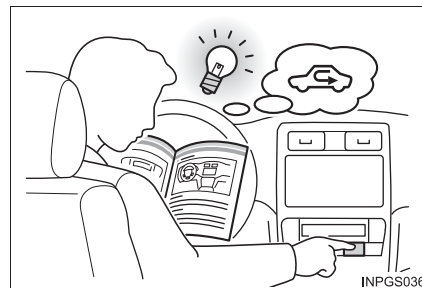

■ Searching by symptom or sound

- What to do if...
(Troubleshooting) P. 656



■ Searching by title

- Table of contents P. 2

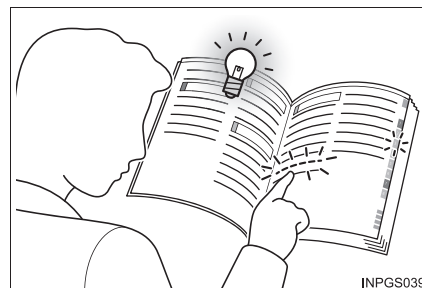

Pictorial index

■ Exterior

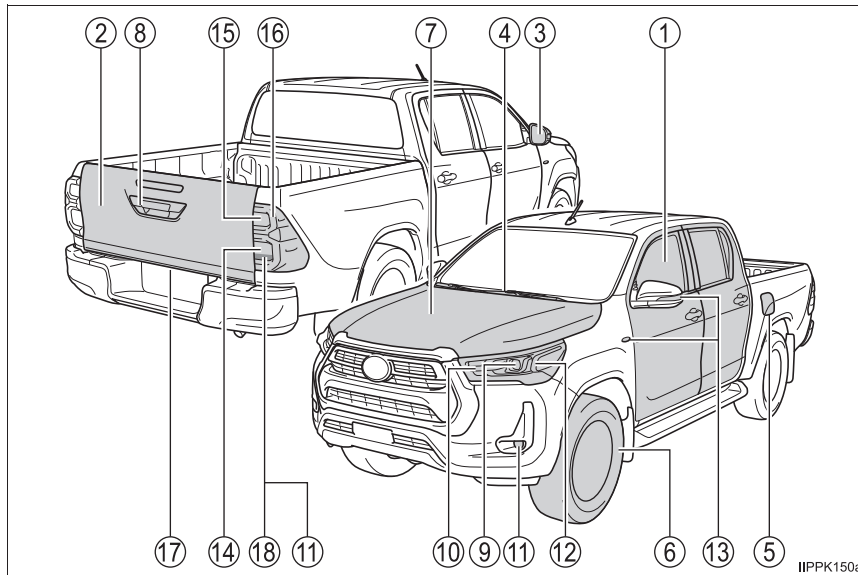

The shape of the exterior lights may differ depending on the grade, etc. (→P. 525)

- ① **Side doors** **P. 153**
Access panels (smart-cab models only) **P. 159**
 Locking/unlocking P. 153
 Opening/closing the door glasses P. 185
 Locking/unlocking by using the mechanical key*¹ P. 600
 Warning lights*¹/warning messages*¹ P. 155, 570
- ② **Tailgate***¹ **P. 160**
- ③ **Outside rear view mirrors** **P. 182**
 Adjusting the mirror angle P. 182
 Folding the mirrors P. 183
 Defogging the mirrors*¹ P. 435, 444
- ④ **Windshield wipers** **P. 258**
 Precautions against winter season P. 374
 To prevent freezing (windshield wiper de-icer)*¹ P. 436, 444

- ⑤ **Fuel filler door*1** P. 261
 - Refueling method P. 261
 - Fuel type/fuel tank capacity P. 627
- ⑥ **Tires** P. 507
 - Tire size/inflation pressure P. 639
 - Winter tires/tire chain P. 374
 - Checking/rotation P. 508
 - Coping with flat tires P. 581
- ⑦ **Hood** P. 484
 - Opening P. 484
 - Engine oil P. 628
 - Coping with overheat P. 610
- ⑧ **Camera*1, 2**

Light bulbs of the exterior lights for driving

(Replacing method: P. 525, Watts: P. 642)

- ⑨ **Headlights** P. 248
- ⑩ **Front position lights/daytime running lights*1** P. 248
- ⑪ **Front fog lights*1/rear fog light*1, 3** P. 255
- ⑫ **Front turn signal lights** P. 246
- ⑬ **Side turn signal lights (fender-mounted type or mirror-mounted type)** P. 246
- ⑭ **Rear turn signal lights** P. 246
- ⑮ **Stop lights**
 - Downhill assist control system*1 P. 364
- ⑯ **Tail lights** P. 248
- ⑰ **License plate light** P. 248
- ⑱ **Back-up lights*3**
 - Shifting the shift lever to R. P. 231, 239

*1: If equipped

*2: Refer to "Navigation and multimedia system Owner's manual" or "Multimedia Owner's Manual".

*3: They may be located on the opposite side depending on the target region.

■ Instrument panel (Left-hand drive vehicles)

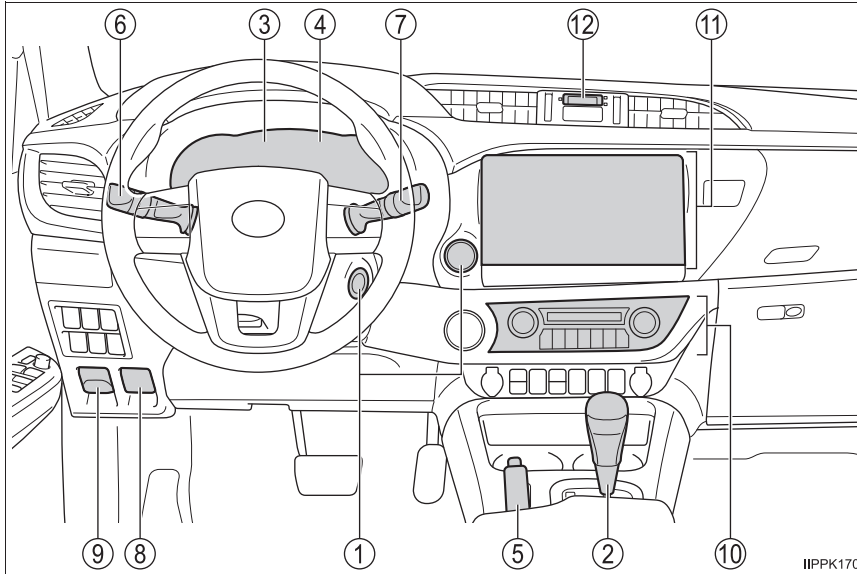

- ① **Engine switch** **P. 220, 223**
 - Starting the engine/changing the positions or modes . . . P. 220, 223
 - Emergency stop of the engine P. 555
 - When the engine will not start P. 598
 - Warning messages*1 P. 575
- ② **Shift lever (Automatic transmission)** **P. 231**
 - Changing the shift position P. 231
 - Precautions against towing P. 559
 - When the shift lever does not move P. 237
- Shift lever (Manual transmission)** **P. 239**
 - Changing the shift position P. 239
 - Precautions against towing P. 559

③	Meters	P. 130
	Reading the meters	P. 130
	Adjusting the instrument panel light* ¹	P. 130
	Warning lights/indicator lights	P. 122
	When the warning lights come on	P. 566
④	Multi-information display*¹	P. 135
	When the warning messages are displayed	P. 575
⑤	Parking brake lever	P. 247
	Applying/releasing	P. 247
	Precautions against winter season	P. 375
	Warning light/buzzer	P. 566
⑥	Turn signal lever	P. 246
	Headlight switch	P. 248
	Headlights/front position lights/tail lights/ daytime running lights* ¹	P. 248
	Front fog lights* ¹ /rear fog light* ¹	P. 255
⑦	Windshield wiper and washer switch	P. 258
	Usage	P. 258
	Adding washer fluid	P. 498
	Warning messages* ¹	P. 575
⑧	Hood lock release lever	P. 484
⑨	Fuel filler door opener*¹	P. 263
⑩	Manual air conditioning system*¹	P. 434
	Automatic air conditioning system*¹	P. 441
⑪	Audio system*¹	P. 378
	AUX port/USB port	P. 381
	Multimedia system*^{1, 2}	
	Navigation system*^{1, 2}	
	Rear view monitor system*^{1, 2}	
⑫	Clock	P. 465

*¹: If equipped

*²: Refer to "Navigation and multimedia system Owner's manual" or
"Multimedia Owner's Manual".

■ Switches (Left-hand drive vehicles)

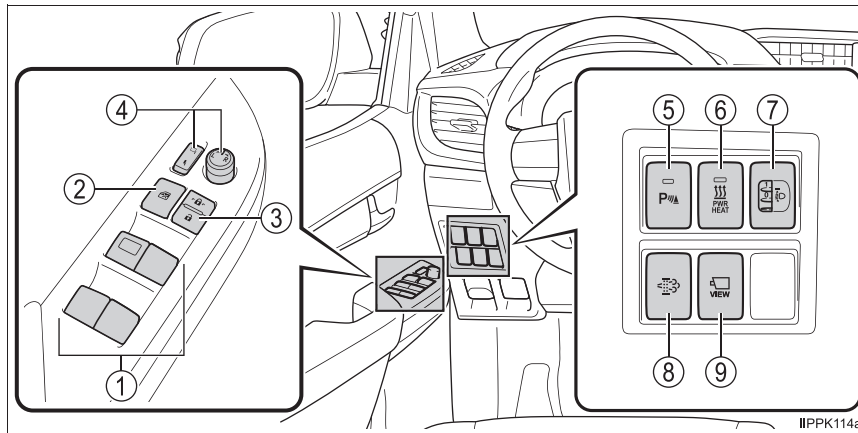

- ① Power window switches*¹ P. 185
- ② Window lock switch*¹ P. 186
- ③ Door lock switch*¹ P. 155
- ④ Outside rear view mirror switches*¹ P. 182
- ⑤ Toyota parking assist-sensor switch*¹ P. 321
- ⑥ Power heater switch*¹ P. 436, 444
- ⑦ Manual headlight leveling dial*¹ P. 250
- ⑧ DPF system switch*¹ P. 369
- ⑨ Camera switch*^{1,2}

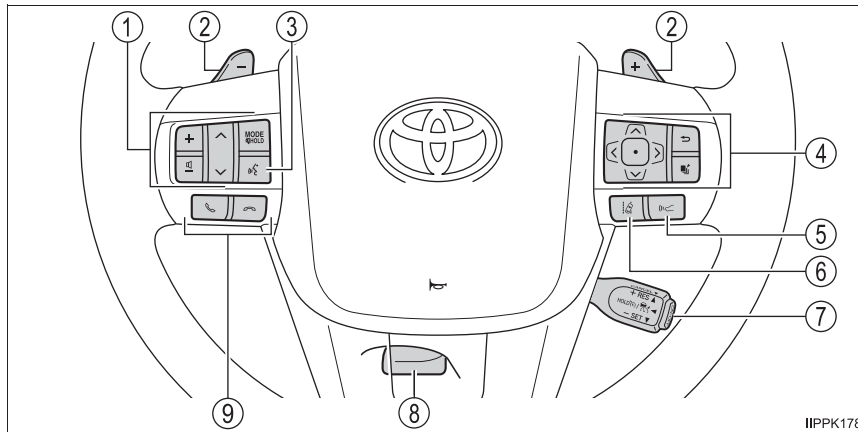

- ① Audio remote control switches^{*1, 2} P. 379, 470
- ② Paddle shift switches^{*1} P. 234, 235
- ③ Talk switch^{*1, 2, 3} P. 470
- ④ Meter control switches^{*1} P. 136
- ⑤ Vehicle-to-vehicle distance switch^{*1} P. 309
- ⑥ LDA (Lane Departure Alert with Yaw Assist Function) switch^{*1} P. 284
- ⑦ Cruise control switch^{*1}
Dynamic radar cruise control^{*1} P. 301
Cruise control^{*1} P. 317
- ⑧ Tilt steering lock release lever P. 178
- ⑨ Telephone switches^{*1, 2} P. 136, 413, 470

^{*1}: If equipped

^{*2}: Refer to "Navigation and multimedia system Owner's manual" or "Multimedia Owner's Manual".

^{*3}: The switch can not be used depending on the type of audio system or navigation system.

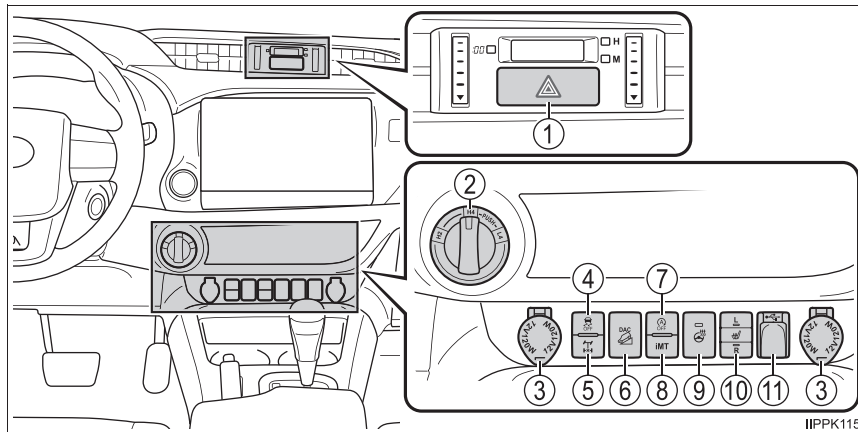

- ① Emergency flasher switch P. 554
- ② Front-wheel drive control switch*¹ P. 331
- ③ Power outlets*¹ P. 466
- ④ VSC OFF switch*¹ P. 357
- ⑤ Rear differential lock switch*¹ P. 341
- ⑥ “DAC” (Downhill Assist Control system) switch*¹ P. 364
- ⑦ Stop & Start cancel switch*¹ P. 346
- ⑧ “iMT” switch*¹ P. 241
- ⑨ Heated steering wheel switch*¹ P. 450
- ⑩ Seat heater switches*¹ P. 450
- ⑪ USB port*^{1, 2}

■ Interior (Left-hand drive vehicles)

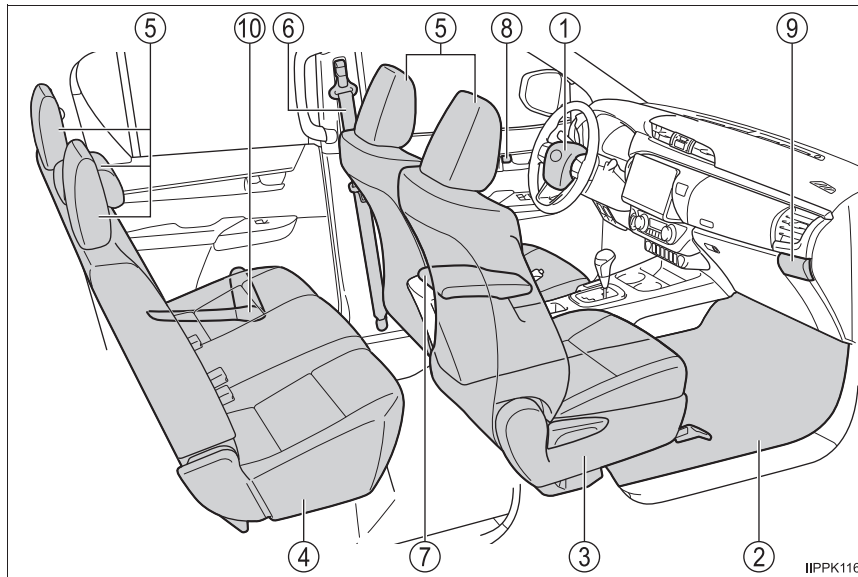

① SRS airbags	P. 45
② Floor mats	P. 36
③ Front seats	P. 170
④ Rear seats* ¹	P. 172
⑤ Head restraints	P. 175
⑥ Seat belts	P. 40
⑦ Console box* ¹	P. 457
⑧ Inside lock buttons	P. 155
⑨ Cup holders	P. 458
Auxiliary boxes	P. 460
⑩ Bottle holders* ¹	P. 459

*¹: If equipped

*²: Refer to "Navigation and multimedia system Owner's manual" or "Multimedia Owner's Manual".

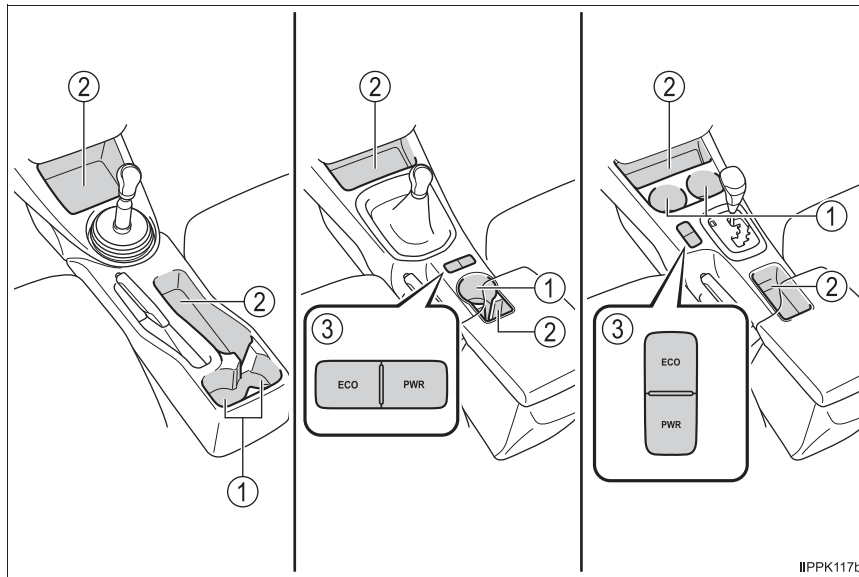

- ① Cup holders*1 P. 458
- ② Auxiliary boxes*1 P. 460
- ③ Driving mode select switches*1 P. 233, 240

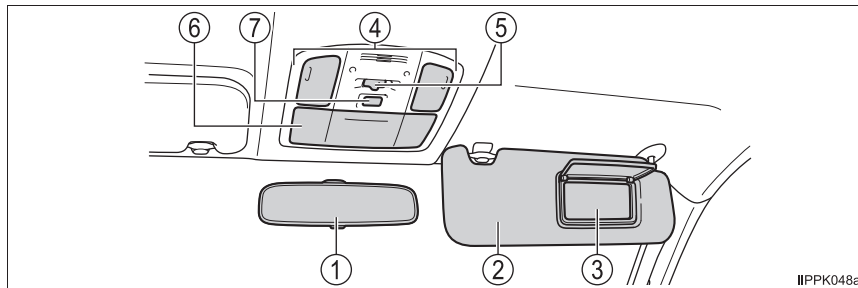

①	Inside rear view mirror	P. 180
②	Sun visors* ²	P. 464
③	Vanity mirror* ¹	P. 464
④	Personal lights	P. 454
	Interior lights* ^{1, 3}	P. 454
⑤	Personal/interior light main switch	P. 454
⑥	Auxiliary boxes	P. 460
⑦	“SOS” button* ¹	P. 98, 110

*¹: If equipped

*²: NEVER use a rearward facing child restraint on a seat protected by an ACTIVE AIRBAG in front of it, DEATH or SERIOUS INJURY to the CHILD can occur. (→P. 70)



*³: The illustration shows the front, but they are also equipped in the rear.

■ Instrument panel (Right-hand drive vehicles)

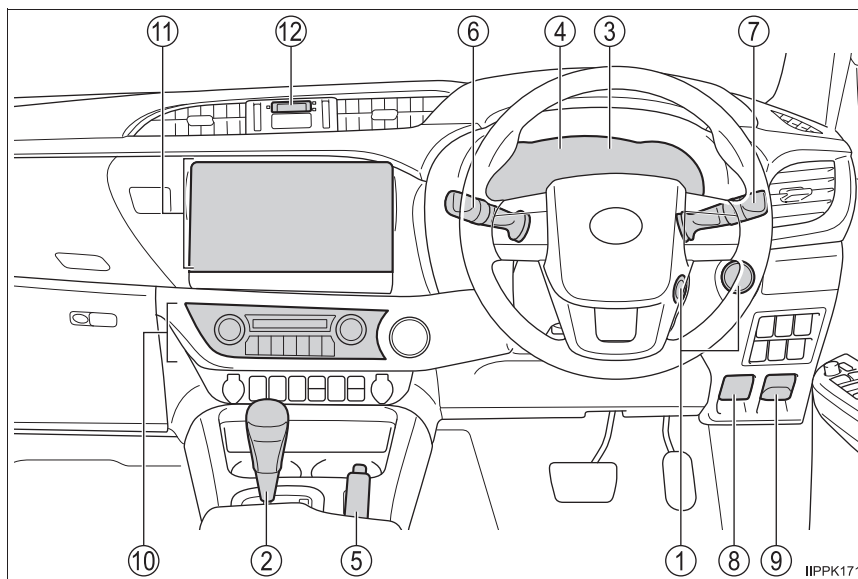

- ① **Engine switch** **P. 220, 223**
 - Starting the engine/changing the positions or modes . . . P. 220, 223
 - Emergency stop of the engine P. 555
 - When the engine will not start P. 598
 - Warning messages P. 575
- ② **Shift lever (Automatic transmission)** **P. 231**
 - Changing the shift position P. 231
 - Precautions against towing P. 559
 - When the shift lever does not move P. 237
- Shift lever (Manual transmission)** **P. 239**
 - Changing the shift position P. 239
 - Precautions against towing P. 559

③	Meters	P. 130
	Reading the meters	P. 130
	Adjusting the instrument panel light.	P. 130
	Warning lights/indicator lights	P. 122
	When the warning lights come on	P. 566
④	Multi-information display	P. 135
	When the warning messages are displayed	P. 575
⑤	Parking brake lever	P. 247
	Applying/releasing	P. 247
	Precautions against winter season	P. 375
	Warning light/buzzer	P. 566
⑥	Turn signal lever	P. 246
	Headlight switch	P. 248
	Headlights/front position lights/tail lights/ daytime running lights	P. 248
	Front fog lights ^{*1} /rear fog light	P. 255
⑦	Windshield wiper and washer switch	P. 258
	Usage	P. 258
	Adding washer fluid	P. 498
	Warning messages	P. 575
⑧	Hood lock release lever	P. 484
⑨	Fuel filler door opener^{*1}	P. 263
⑩	Manual air conditioning system^{*1}	P. 434
	Automatic air conditioning system^{*1}	P. 441
⑪	Audio system^{*1}	P. 378
	AUX port/USB port	P. 381
	Multimedia system^{*1, 2}	
	Navigation system^{*1, 2}	
	Rear view monitor system^{*1, 2}	
⑫	Clock	P. 465

^{*1}: If equipped

^{*2}: Refer to "Navigation and multimedia system Owner's manual" or
"Multimedia Owner's Manual".

■ Switches (Right-hand drive vehicles)

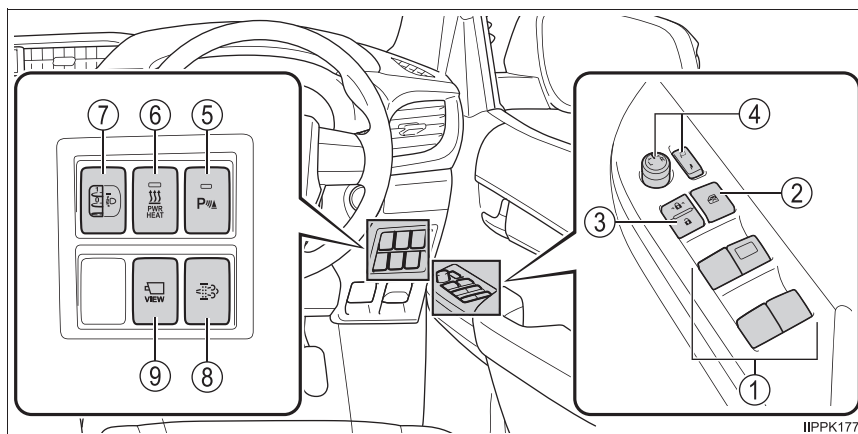

- ① Power window switches P. 185
- ② Window lock switch P. 186
- ③ Door lock switch P. 155
- ④ Outside rear view mirror switches*¹ P. 182
- ⑤ Toyota parking assist-sensor switch*¹ P. 321
- ⑥ Power heater switch P. 436, 444
- ⑦ Manual headlight leveling dial*¹ P. 250
- ⑧ DPF system switch P. 369
- ⑨ Camera switch*^{1,2}

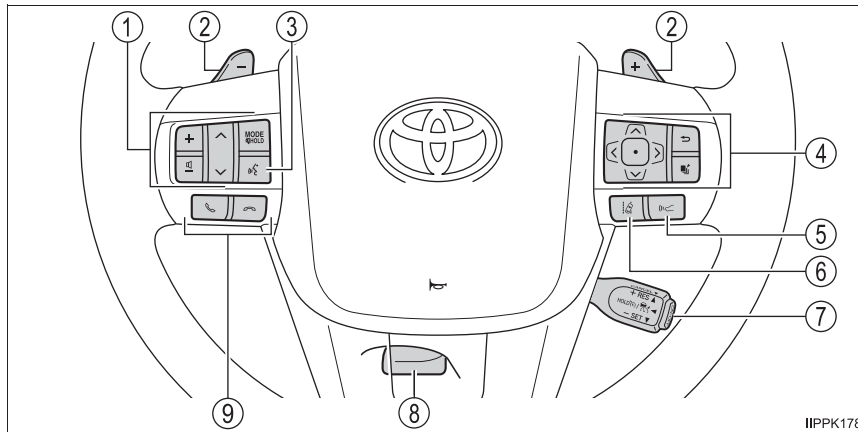

- ① Audio remote control switches*2 P. 379, 470
- ② Paddle shift switches*1 P. 234, 235
- ③ Talk switch*2, 3 P. 470
- ④ Meter control switches P. 136
- ⑤ Vehicle-to-vehicle distance switch*1 P. 309
- ⑥ LDA (Lane Departure Alert with Yaw Assist Function) switch*1 P. 284
- ⑦ Cruise control switch*1
 Dynamic radar cruise control*1 P. 301
 Cruise control*1 P. 317
- ⑧ Tilt steering lock release lever P. 178
- ⑨ Telephone switches*2 P. 136, 413, 470

*1: If equipped

*2: Refer to "Navigation and multimedia system Owner's manual" or "Multimedia Owner's Manual".

*3: The switch can not be used depending on the type of audio system or navigation system.

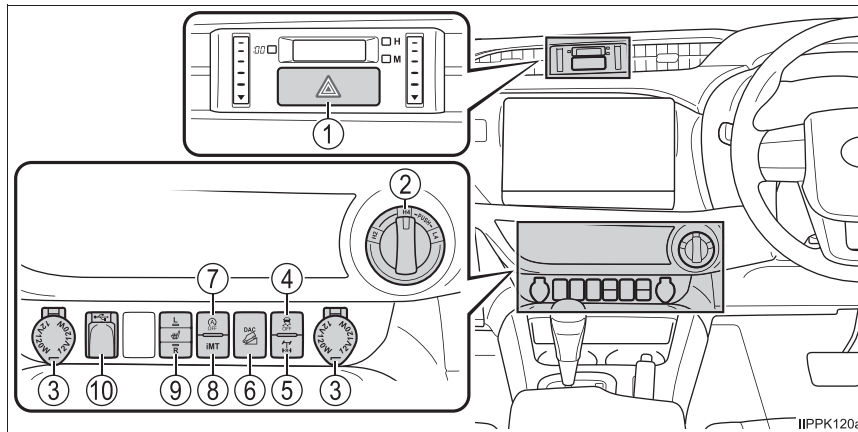

- ① Emergency flasher switch P. 554
- ② Front-wheel drive control switch P. 331
- ③ Power outlets*¹ P. 466
- ④ VSC OFF switch P. 357
- ⑤ Rear differential lock switch*¹ P. 341
- ⑥ “DAC” (Downhill Assist Control system) switch*¹ P. 364
- ⑦ Stop & Start cancel switch*¹ P. 346
- ⑧ “iMT” switch*¹ P. 241
- ⑨ Seat heater switches*¹ P. 450
- ⑩ USB port*^{1, 2}

■ Interior (Right-hand drive vehicles)

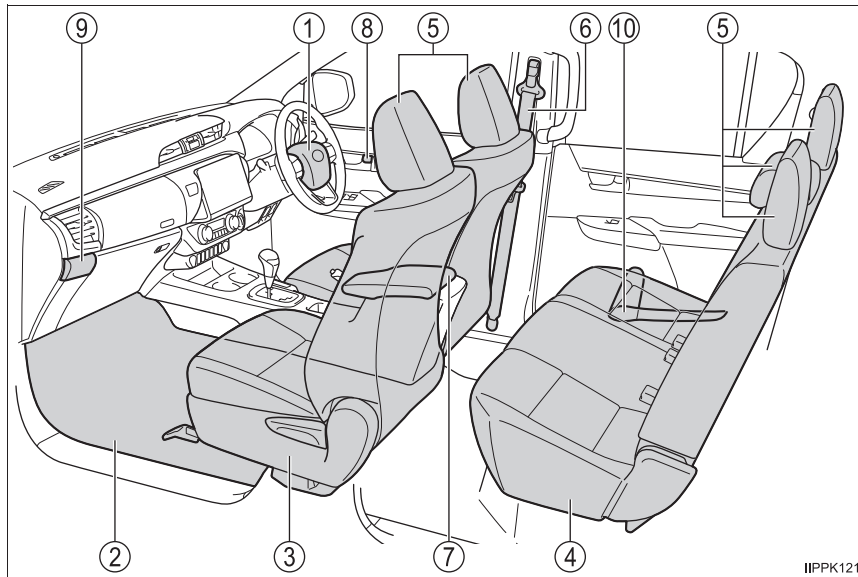

① SRS airbags	P. 45
② Floor mats	P. 36
③ Front seats	P. 170
④ Rear seats* ¹	P. 172
⑤ Head restraints	P. 175
⑥ Seat belts	P. 40
⑦ Console box* ¹	P. 457
⑧ Inside lock buttons	P. 155
⑨ Cup holders	P. 458
Auxiliary boxes	P. 460
⑩ Bottle holders* ¹	P. 459

*¹: If equipped

*²: Refer to "Navigation and multimedia system Owner's manual" or "Multimedia Owner's Manual".

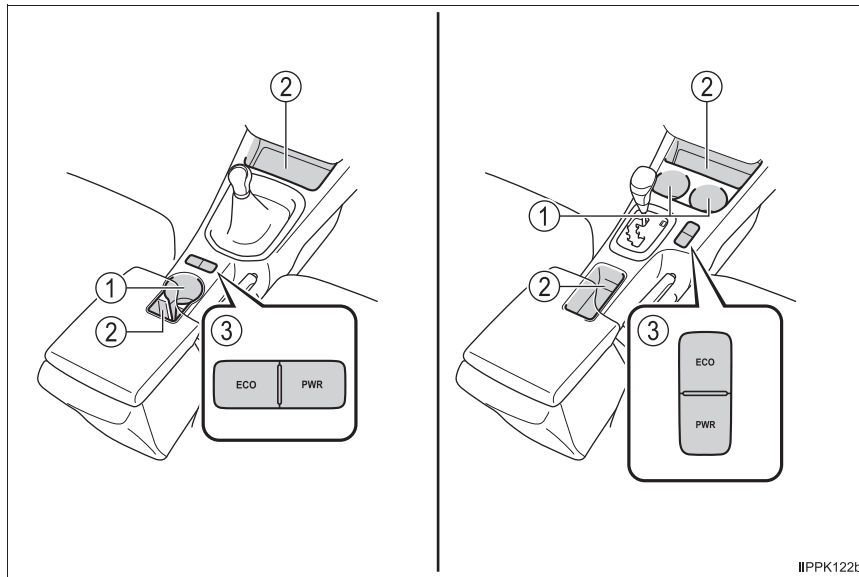

- ① Cup holders*1 P. 458
- ② Auxiliary boxes*1 P. 460
- ③ Driving mode select switches P. 233, 240

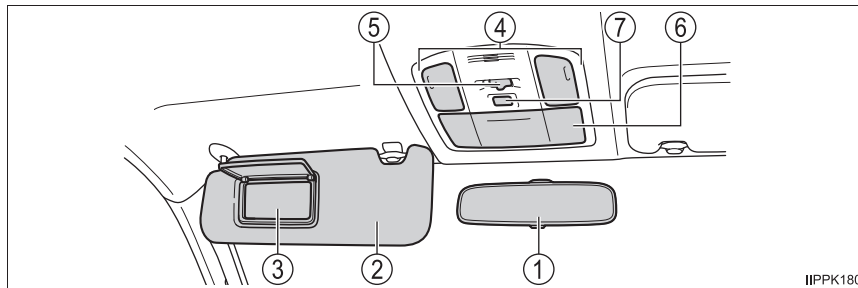

①	Inside rear view mirror	P. 180
②	Sun visors*2	P. 464
③	Vanity mirror*1	P. 464
④	Personal lights	P. 454
	Interior lights*1, 3	P. 454
⑤	Personal/interior light main switch	P. 454
⑥	Auxiliary boxes	P. 460
⑦	“SOS” button*1	P. 98

*1: If equipped

*2: NEVER use a rearward facing child restraint on a seat protected by an ACTIVE AIRBAG in front of it, DEATH or SERIOUS INJURY to the CHILD can occur. (→P. 70)



*3: The illustration shows the front, but they are also equipped in the rear.

For safety and security**1****1-1. For safe use**

Before driving.....	36
For safe driving.....	38
Seat belts.....	40
SRS airbags.....	45
Exhaust gas precautions	56

1-2. Child safety

Front passenger occupant classification system.....	57
Airbag manual on-off system	62
Riding with children.....	64
Child restraint systems	65

1-3. Emergency assistance

eCall.....	98
ERA-GLONASS/EVAK	110

1-4. Theft deterrent system

Engine immobilizer system	115
Alarm	117

Before driving

Floor mat

Use only floor mats designed specifically for vehicles of the same model and model year as your vehicle. Fix them securely in place onto the carpet.

- 1 Insert the retaining hooks (clips) into the floor mat eyelets.

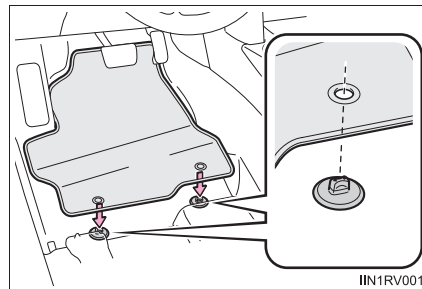

- 2 Turn the upper knob of each retaining hook (clip) to secure the floor mats in place.

*: Always align the \triangle marks.

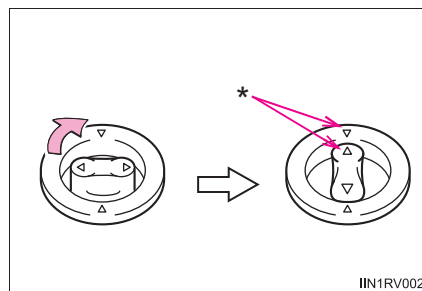

The shape of the retaining hooks (clips) may differ from that shown in the illustration.

⚠ WARNING

Observe the following precautions.

Failure to do so may cause the driver's floor mat to slip, possibly interfering with the pedals while driving. An unexpectedly high speed may result or it may become difficult to stop the vehicle. This could lead to an accident, resulting in death or serious injury.

■ When installing the driver's floor mat

- Do not use floor mats designed for other models or different model year vehicles, even if they are Toyota Genuine floor mats.
- Only use floor mats designed for the driver's seat.
- Always install the floor mat securely using the retaining hooks (clips) provided.
- Do not use two or more floor mats on top of each other.
- Do not place the floor mat bottom-side up or upside-down.

■ Before driving

- Check that the floor mat is securely fixed in the correct place with all the provided retaining hooks (clips). Be especially careful to perform this check after cleaning the floor.
- With the engine stopped and the shift lever in P (automatic transmission) or N (manual transmission), fully depress each pedal to the floor to make sure it does not interfere with the floor mat.

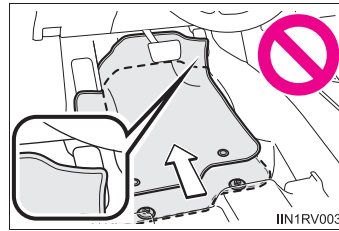

For safe driving

For safe driving, adjust the seat and mirror to an appropriate position before driving.

Correct driving posture

- ① Adjust the angle of the seat-back so that you are sitting straight up and so that you do not have to lean forward to steer. (→P. 170)
- ② Adjust the seat so that you can depress the pedals fully and so that your arms bend slightly at the elbow when gripping the steering wheel. (→P. 170)
- ③ Vehicles with adjustable type head restraint: Lock the head restraint in place with the center of the head restraint closest to the top of your ears. (→P. 175)
- ④ Wear the seat belt correctly. (→P. 40)

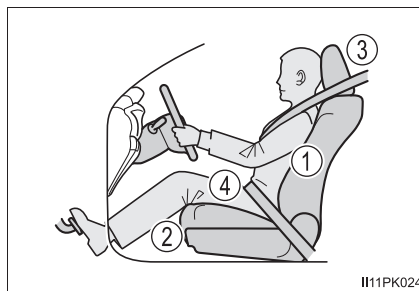

Correct use of the seat belts

Make sure that all occupants are wearing their seat belts before driving the vehicle. (→P. 40)

Use a child restraint system appropriate for the child until the child becomes large enough to properly wear the vehicle's seat belt. (→P. 65)

Adjusting the mirrors

Make sure that you can see backward clearly by adjusting the inside and outside rear view mirrors properly. (→P. 180, 182)

WARNING

Observe the following precautions.

Failure to do so may result in death or serious injury.

- Do not adjust the position of the driver's seat while driving.
Doing so could cause the driver to lose control of the vehicle.
- Do not place a cushion between the driver or passenger and the seatback.
A cushion may prevent correct posture from being achieved, and reduce the effectiveness of the seat belt and head restraint.
- Do not place anything under the front seats.
Objects placed under the front seats may become jammed in the seat tracks and stop the seat from locking in place. This may lead to an accident and the adjustment mechanism may also be damaged.
- Always observe the legal speed limit when driving on public roads.
- When driving over long distances, take regular breaks before you start to feel tired.
Also, if you feel tired or sleepy while driving, do not force yourself to continue driving and take a break immediately.

Seat belts

Make sure that all occupants are wearing their seat belts before driving the vehicle.

Correct use of the seat belts

◆ 3-point type

- Extend the shoulder belt so that it comes fully over the shoulder, but does not come into contact with the neck or slide off the shoulder.
- Position the lap belt as low as possible over the hips.
- Adjust the position of the seatback. Sit up straight and well back in the seat.
- Do not twist the seat belt.

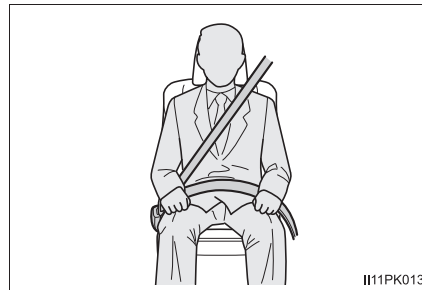

◆ 2-point type (if equipped)

- Position the lap belt as low as possible over the hips and remove excess length of the belt.
- Do not twist the seat belt.

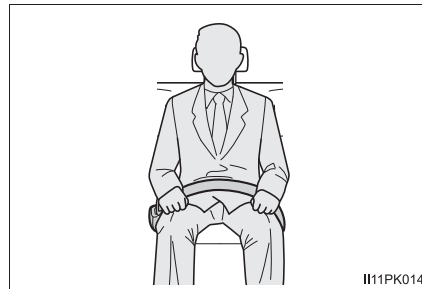

Fastening and releasing the seat belt

- ① To fasten the seat belt, push the plate into the buckle until a click sound is heard.
- ② To release the seat belt, press the release button.

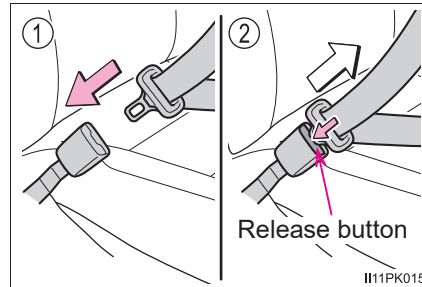

Adjusting the seat belt shoulder anchor height (if equipped for front seats)

- ① Push the seat belt shoulder anchor down while pulling the lock release knob.
- ② Push the seat belt shoulder anchor up.

Move the height adjuster up and down as needed until you hear a click.

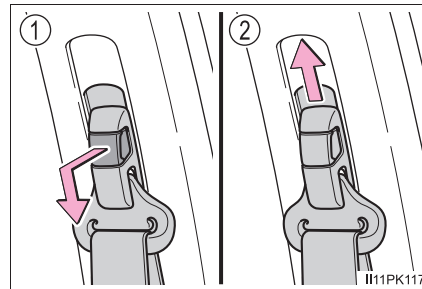

Adjusting the length of the belt (2-point type seat belt) (if equipped)

- ① Lengthen
- ② Shorten

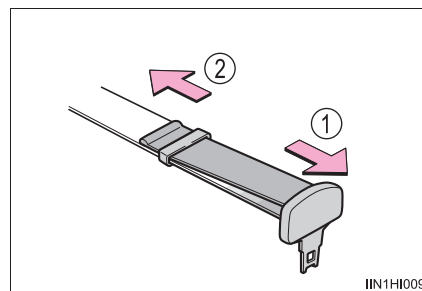

Seat belt pretensioners (if equipped)

▶ Vehicles without SRS side and curtain shield airbags

The pretensioners help the seat belts to quickly restrain the occupants by retracting the seat belts when the vehicle is subjected to certain types of severe frontal collision.

The pretensioners do not activate in the event of a minor frontal impact, a side impact, a rear impact or a vehicle rollover.

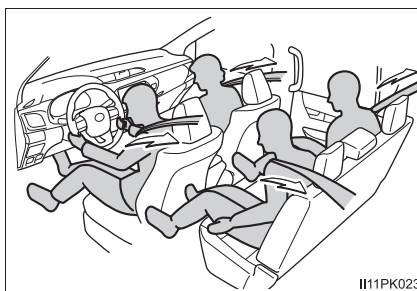

II11PK023

▶ Vehicles with SRS side and curtain shield airbags

The pretensioners help the seat belts to quickly restrain the occupants by retracting the seat belts when the vehicle is subjected to certain types of severe frontal or side collision.

The pretensioners do not activate in the event of a minor frontal impact, a minor side impact, a rear impact or a vehicle rollover.

■ Emergency locking retractor (ELR) (3-point type seat belt)

The retractor will lock the belt during a sudden stop or on impact. It may also lock if you lean forward too quickly. A slow, easy motion will allow the belt to extend so that you can move around fully.

■ Child seat belt usage

The seat belts of your vehicle were principally designed for persons of adult size.

- Use a child restraint system appropriate for the child, until the child becomes large enough to properly wear the vehicle's seat belt. (→ P. 65)
- When the child becomes large enough to properly wear the vehicle's seat belt, follow the instructions regarding seat belt usage. (→P. 40)

■ Replacing the belt after the pretensioner has been activated

If the vehicle is involved in multiple collisions, the pretensioner will activate for the first collision, but will not activate for the second or subsequent collisions.

■ Seat belt regulations

If seat belt regulations exist in the country where you reside, please contact any authorized Toyota retailer or Toyota authorized repairer, or any reliable repairer for seat belt replacement or installation.

⚠ WARNING

Observe the following precautions to reduce the risk of injury in the event of sudden braking, sudden swerving or an accident. Failure to do so may cause death or serious injury.

■ **Wearing a seat belt**

- Ensure that all passengers wear a seat belt.
- Always wear a seat belt properly.
- Each seat belt should be used by one person only. Do not use a seat belt for more than one person at once, including children.
- Toyota recommends that children be seated in the rear seat and always use a seat belt and/or an appropriate child restraint system.
- To achieve a proper seating position, do not recline the seat more than necessary. The seat belt is most effective when the occupants are sitting up straight and well back in the seats.
- Do not wear the shoulder belt under your arm.
- Always wear your seat belt low and snug across your hips.

■ **Pregnant women**

Obtain medical advice and wear the seat belt in the proper way. (→P. 40)

Women who are pregnant should position the lap belt as low as possible over the hips in the same manner as other occupants, extending the shoulder belt completely over the shoulder and avoiding belt contact with the rounding of the abdominal area.

If the seat belt is not worn properly, not only the pregnant woman, but also the fetus could suffer death or serious injury as a result of sudden braking or a collision.

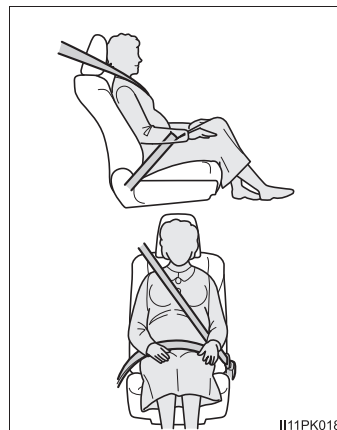

■ **People suffering illness**

Obtain medical advice and wear the seat belt in the proper way. (→P. 40)

**WARNING****■ When children are in the vehicle**

→P. 91

■ Seat belt pretensioners

- Do not place anything, such as a cushion, on the front passenger's seat. Doing so will disperse the passenger's weight, which prevents the sensor from detecting the passenger's weight properly. As a result, the seat belt pretensioner for the front passenger's seat may not activate in the event of a collision.

- If the pretensioner has activated, the SRS warning light will come on. In that case, the seat belt cannot be used again and must be replaced at any authorized Toyota retailer or Toyota authorized repairer, or any reliable repairer.

■ Adjustable shoulder anchor (if equipped)

Always make sure the shoulder belt is positioned across the center of your shoulder. The belt should be kept away from your neck, but not falling off your shoulder. Failure to do so could reduce the amount of protection in an accident and cause death or serious injuries in the event of a sudden stop, sudden swerve or accident. (→P. 41)

■ Seat belt damage and wear

- Do not damage the seat belts by allowing the belt, plate, or buckle to be jammed in the door.

- Inspect the seat belt system periodically. Check for cuts, fraying, and loose parts. Do not use a damaged seat belt until it is replaced. Damaged seat belts cannot protect an occupant from death or serious injury.

- Ensure that the belt and plate are locked and the belt is not twisted. If the seat belt does not function correctly, immediately contact any authorized Toyota retailer or Toyota authorized repairer, or any reliable repairer.

- Replace the seat assembly, including the belts, if your vehicle has been involved in a serious accident, even if there is no obvious damage.

- Do not attempt to install, remove, modify, disassemble or dispose of the seat belts. Have any necessary repairs carried out by any authorized Toyota retailer or Toyota authorized repairer, or any reliable repairer. Inappropriate handling may lead to incorrect operation.

SRS airbags

The SRS airbags inflate when the vehicle is subjected to certain types of severe impacts that may cause significant injury to the occupants. They work together with the seat belts to help reduce the risk of death or serious injury.

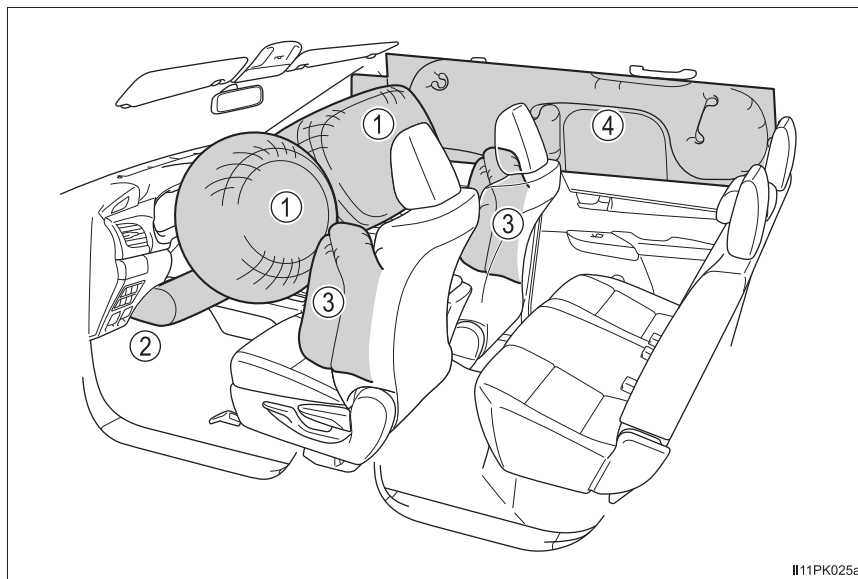

◆ SRS front airbags

- ① SRS driver airbag/front passenger airbag
Can help protect the head and chest of the driver and front passenger from impact with interior components
- ② SRS driver's knee airbag (if equipped)
Can help provide driver protection

◆ SRS side and curtain shield airbags

- ③ SRS side airbags (if equipped)
Can help protect the torso of the front seat occupants
- ④ SRS curtain shield airbags (if equipped)
Can help protect primarily the head of occupants in the outer seats

SRS airbag system components

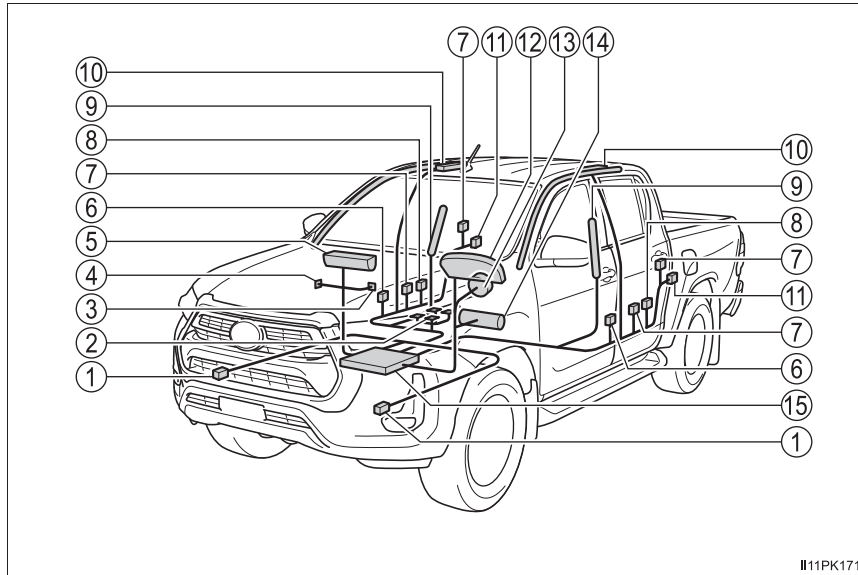

II11PK171

- | | |
|--|--|
| ① Front impact sensors | ⑧ Safing sensor (front) (if equipped) |
| ② Front passenger occupant classification system (ECU and sensors) (if equipped) | ⑨ Side airbags (if equipped) |
| ③ "PASSENGER AIR BAG" indicator (if equipped) | ⑩ Curtain shield airbags (if equipped) |
| ④ Airbag manual on-off switch (if equipped) | ⑪ Side impact sensors (rear) (if equipped) |
| ⑤ Front passenger airbag | ⑫ SRS warning light |
| ⑥ Side impact sensors (front door) (if equipped) | ⑬ Driver airbag |
| ⑦ Seat belt pretensioners and force limiters (if equipped) | ⑭ Driver's knee airbag (if equipped) |
| | ⑮ Airbag sensor assembly |

The main SRS airbag system components are shown above. The SRS airbag system is controlled by the airbag sensor assembly. As the airbags deploy, a chemical reaction in the inflators quickly fills the airbags with non-toxic gas to help restrain the motion of the occupants.

**WARNING****■ SRS airbag precautions**

Observe the following precautions regarding the SRS airbags. Failure to do so may cause death or serious injury.

- The driver and all passengers in the vehicle must wear their seat belts properly.

The SRS airbags are supplemental devices to be used with the seat belts.

- The SRS driver airbag deploys with considerable force, and can cause death or serious injury especially if the driver is very close to the airbag.

Since the risk zone for the driver's airbag is the first 50 - 75 mm (2 - 3 in.) of inflation, placing yourself 250 mm (10 in.) from your driver airbag provides you with a clear margin of safety. This distance is measured from the center of the steering wheel to your breastbone. If you sit less than 250 mm (10 in.) away now, you can change your driving position in several ways:

- Move your seat to the rear as far as you can while still reaching the pedals comfortably.
- Slightly recline the back of the seat. Although vehicle designs vary, many drivers can achieve the 250 mm (10 in.) distance, even with the driver seat all the way forward, simply by reclining the back of the seat somewhat. If reclining the back of your seat makes it hard to see the road, raise yourself by using a firm, non-slippery cushion, or raise the seat if your vehicle has that feature.
- If your steering wheel is adjustable, tilt it downward. This points the airbag toward your chest instead of your head and neck.

The seat should be adjusted as recommended above, while still maintaining control of the foot pedals, steering wheel, and your view of the instrument panel controls.

⚠ WARNING**■ SRS airbag precautions**

- The SRS front passenger airbag also deploys with considerable force, and can cause death or serious injury especially if the front passenger is very close to the airbag. The front passenger seat should be as far from the airbag as possible with the seatback adjusted, so the front passenger sits upright.
- Improperly seated and/or restrained infants and children can be killed or seriously injured by a deploying airbag. An infant or child who is too small to use a seat belt should be properly secured using a child restraint system. Toyota strongly recommends that all infants and children be placed in the rear seats (if equipped) of the vehicle and properly restrained. The rear seats (if equipped) are safer for infants and children than the front passenger seat. (→P. 65)
- Do not sit on the edge of the seat or lean against the dashboard.

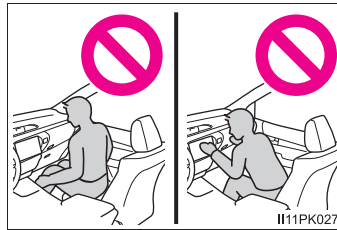

- Do not allow a child to stand in front of the SRS front passenger airbag unit or sit on the knees of a front passenger.
- Do not allow the front seat occupants to hold items on their knees.

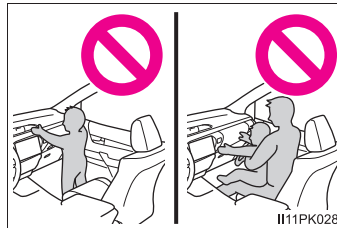

 WARNING

■ SRS airbag precautions

- Vehicles with SRS side and curtain shield airbags: Do not lean against the door, the roof side rail or the front, side and rear pillars.

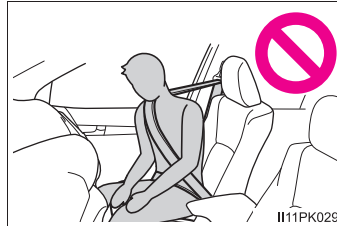

- Vehicles with SRS side and curtain shield airbags: Do not allow anyone to kneel on the passenger seat toward the door or put their head or hands outside the vehicle.

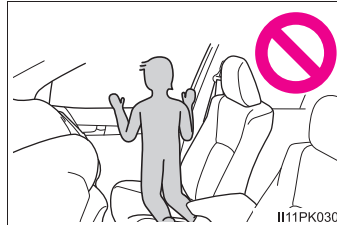

- Do not attach anything to or lean anything against areas such as the dashboard, steering wheel pad and lower portion of the instrument panel.

These items can become projectiles when the SRS driver, front passenger and knee airbags (if equipped) deploy.

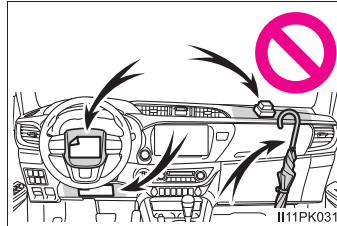

- Vehicles with SRS side and curtain shield airbags: Do not attach anything to areas such as a door, windshield, side door glass, front or rear pillar, roof side rail and assist grip.



⚠ WARNING

■ SRS airbag precautions

- Vehicles without smart entry & start system: Do not attach any heavy, sharp or hard objects such as keys or accessories to the key. The objects may restrict the SRS knee airbag (if equipped) inflation or be thrust into the driver's seat area by the force of the deploying airbag, thus causing a danger.

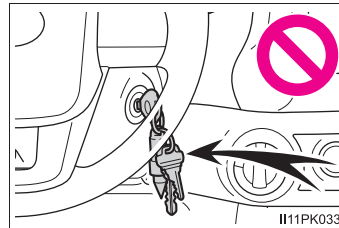

- Vehicles with SRS side and curtain shield airbags: Do not hang coat hangers or other hard objects on the coat hooks. All of these items could become projectiles and may cause death or serious injury, should the SRS curtain shield airbags deploy.
- Vehicles with SRS driver's knee airbag: If the vinyl cover is put on the area where the SRS knee airbag will deploy, be sure to remove it.
- Vehicles with SRS side and curtain shield airbags: Do not use seat accessories which cover the parts where the SRS side airbags inflate as they may interfere with inflation of the SRS airbags. Such accessories may prevent the side airbags from activating correctly, disable the system or cause the side airbags to inflate accidentally, resulting in death or serious injury.
- Do not strike or apply significant levels of force to the area of the SRS airbag components.
Doing so can cause the SRS airbags to malfunction.
- Do not touch any of the component parts immediately after the SRS airbags have deployed (inflated) as they may be hot.
- If breathing becomes difficult after the SRS airbags have deployed, open a door or window to allow fresh air in, or leave the vehicle if it is safe to do so. Wash off any residue as soon as possible to prevent skin irritation.
- Vehicles with SRS side and curtain shield airbags: If the areas where the SRS airbags are stored, such as the steering wheel pad and front and rear pillar garnishes, are damaged or cracked, have them replaced by any authorized Toyota retailer or Toyota authorized repairer, or any reliable repairer.
- Vehicles without SRS side and curtain shield airbags: If the areas where the SRS airbags are stored, such as the steering wheel pad, are damaged or cracked, have them replaced by any authorized Toyota retailer or Toyota authorized repairer, or any reliable repairer.
- Vehicles with front passenger occupant classification system: Do not place anything, such as a cushion, on the front passenger's seat. Doing so will disperse the passenger's weight, which prevents the sensor from detecting the passenger's weight properly. As a result, the SRS front airbags for the front passenger may not deploy in the event of a collision.

 WARNING**■ Modification and disposal of SRS airbag system components**

Do not dispose of your vehicle or perform any of the following modifications without consulting any authorized Toyota retailer or Toyota authorized repairer, or any reliable repairer. The SRS airbags may malfunction or deploy (inflate) accidentally, causing death or serious injury.

- Installation, removal, disassembly and repair of the SRS airbags
- Repairs, modifications, removal or replacement of the steering wheel, instrument panel, dashboard, seats or seat upholstery, front, side and rear pillars or roof side rails
- Repairs or modifications of the front fender, front bumper, or side of the occupant compartment
- Installation of a grille guard (bull bars, kangaroo bar, etc.), snow plows or winches
- Modifications to the vehicle's suspension system
- Installation of electronic devices such as mobile two-way radios (RF-transmitter) and CD players

1

For safety and security

■ If the SRS airbags deploy (inflate)

- Slight abrasions, burns, bruising etc., may be sustained from SRS airbags, due to the extremely high speed deployment (inflation) by hot gases.
- A loud noise and white powder will be emitted.
- Vehicles without SRS curtain shield airbags: Parts of the airbag module (steering wheel hub, airbag cover and inflator) as well as the front seats may be hot for several minutes. The airbag itself may also be hot.
- Vehicles with SRS curtain shield airbags: Parts of the airbag module (steering wheel hub, airbag cover and inflator) as well as the front seats, parts of the front and rear pillars, and roof side rails, may be hot for several minutes. The airbag itself may also be hot.
- The windshield may crack.
- Vehicles with impact detection door lock release system: All of the doors will be unlocked. (→P. 158)
- Fuel supply to the engine will be stopped. (Gasoline engine) (→P. 565)
- Vehicles with eCall: If any of the following situations occur, the system is designed to send an emergency call to the eCall control center, notifying them of the vehicle's location (without needing to push the "SOS" button) and an agent will attempt to speak with the occupants to ascertain the level of emergency and assistance required. If the occupants are unable to communicate, the agent automatically treats the call as an emergency and helps to dispatch the necessary emergency services. (→P. 98)
 - An SRS airbag is deployed.
 - A seat belt pretensioner is activated.
 - The vehicle is involved in a severe rear-end collision.
- Vehicles with ERA-GLONASS/EVAK: If any of the following situations occur, the system is designed to send an emergency call* to the ERA-GLONASS/EVAK control center, notifying them of the vehicle's location (without needing to push the "SOS" button) and an agent will attempt to speak with the occupants to ascertain the level of emergency and assistance required. If the occupants are unable to communicate, the agent automatically treats the call as an emergency and helps to dispatch the necessary emergency services. (→P. 110)
 - An SRS airbag is deployed.
 - A seat belt pretensioner is activated.
 - The vehicle is involved in a severe side collision. (if equipped)
 - The vehicle is involved in a severe rear-end collision.
 - The vehicle is involved in a rollover accident.

*: In some cases, the call cannot be made. (→P. 113)

■ SRS airbag deployment conditions (SRS front airbags)

- The SRS front airbags will deploy in the event of an impact that exceeds the set threshold level (the level of force corresponding to an approximately 20 - 30 km/h [12 - 18 mph] frontal collision with a fixed wall that does not move or deform).

However, this threshold velocity will be considerably higher in the following situations:

- If the vehicle strikes an object, such as a parked vehicle or sign pole, which can move or deform on impact
- If the vehicle is involved in an underride collision, such as a collision in which the front of the vehicle “underrides”, or goes under, the bed of a truck
- Depending on the type of collision, it is possible that only the seat belt pretensioners will activate.
- Vehicles with front passenger occupant classification system: The SRS front airbags for the front passenger will not activate if there is no passenger sitting in the front passenger seat. However, the SRS front airbags for the front passenger may deploy if luggage is put in the seat, even if the seat is unoccupied.

■ SRS airbag deployment conditions (SRS side and curtain shield airbags)

- The SRS side and curtain shield airbags will deploy in the event of an impact that exceeds the set threshold level (the level of force corresponding to the impact force produced by an approximately 1500 kg [3300 lb.] vehicle colliding with the vehicle cabin from a direction perpendicular to the vehicle orientation at an approximate speed of 20 - 30 km/h [12 - 18 mph]).
- All SRS side and curtain shield airbags will deploy in the event of a severe frontal collision.

■ Conditions under which the SRS airbags may deploy (inflate), other than a collision

The SRS front airbags, SRS side and curtain shield airbags may also deploy if a serious impact occurs to the underside of your vehicle. Some examples are shown in the illustration.

- Hitting a curb, edge of pavement or hard surface
- Falling into or jumping over a deep hole
- Landing hard or falling

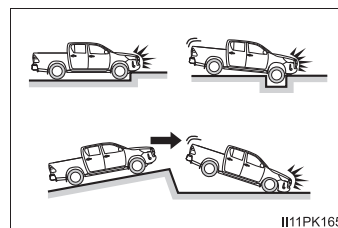

■ Types of collisions that may not deploy the SRS airbags (SRS front airbags)

The SRS front airbags do not generally inflate if the vehicle is involved in a side or rear collision, if it rolls over, or if it is involved in a low-speed frontal collision. But, whenever a collision of any type causes sufficient forward deceleration of the vehicle, deployment of the SRS front airbags may occur.

- Collision from the side
- Collision from the rear
- Vehicle rollover

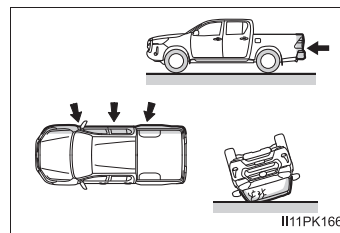

■ Types of collisions that may not deploy the SRS airbags (SRS side and curtain shield airbags)

The SRS side and curtain shield airbags may not activate if the vehicle is subjected to a collision from the side at certain angles, or a collision to the side of the vehicle body other than the passenger compartment.

- Collision from the side to the vehicle body other than the passenger compartment
- Collision from the side at an angle

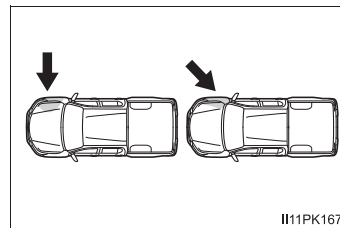

The SRS side and curtain shield airbags do not generally inflate if the vehicle is involved in a rear collision, if it rolls over, or if it is involved in a low-speed side or low-speed frontal collision.

- Collision from the rear
- Vehicle rollover

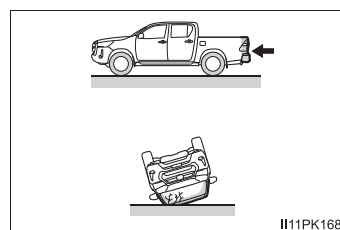

■ When to contact any authorized Toyota retailer or Toyota authorized repairer, or any reliable repairer

In the following cases, the vehicle will require inspection and/or repair. Contact any authorized Toyota retailer or Toyota authorized repairer, or any reliable repairer as soon as possible.

- Any of the SRS airbags have been inflated.
- The front of the vehicle is damaged or deformed, or was involved in an accident that was not severe enough to cause the SRS airbags to inflate.

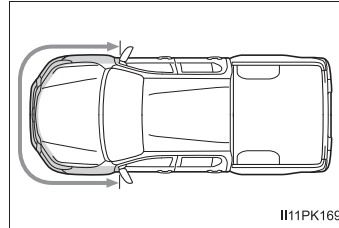

- Vehicles with SRS side and curtain shield airbags: A portion of a door or its surrounding area is damaged or deformed, or the vehicle was involved in an accident that was not severe enough to cause the SRS side and curtain shield airbags to inflate.

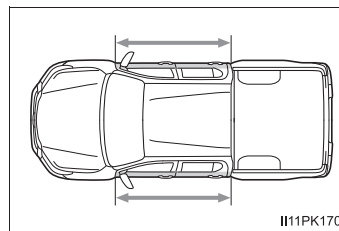

- Vehicles without SRS driver's knee airbag: The pad section of the steering wheel or dashboard near the front passenger airbag is scratched, cracked, or otherwise damaged.

Vehicles with SRS driver's knee airbag: The pad section of the steering wheel, dashboard near the front passenger airbag cover or lower portion of the instrument panel is scratched, cracked, or otherwise damaged.

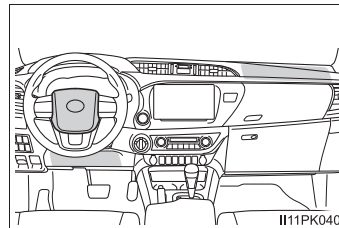

- Vehicles with SRS side airbags: The surface of the seats with the SRS side airbag is scratched, cracked, or otherwise damaged.

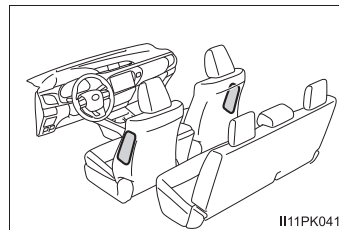

- Vehicles with SRS curtain shield airbags: The portion of the front pillars, rear pillars or roof side rail garnishes (padding) containing the SRS curtain shield airbags inside is scratched, cracked, or otherwise damaged.

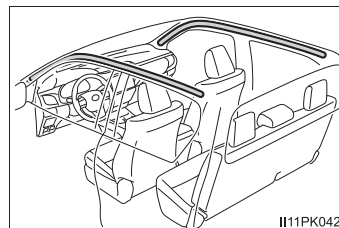

Exhaust gas precautions

Harmful substance to the human body is included in exhaust gases if inhaled.

WARNING

Exhaust gases include harmful carbon monoxide (CO), which is colorless and odorless. Observe the following precautions.

Failure to do so may cause exhaust gases enter the vehicle and may lead to an accident caused by light-headedness, or may lead to death or a serious health hazard.

■ Important points while driving

If you smell exhaust gases in the vehicle, open the windows and have the vehicle inspected at any authorized Toyota retailer or Toyota authorized repairer, or any reliable repairer as soon as possible.

■ When parking

- If the vehicle is in a poorly ventilated area or a closed area, such as a garage, stop the engine.
- Do not leave the vehicle with the engine running for a long time.
If such a situation cannot be avoided, park the vehicle in an open space and ensure that exhaust fumes do not enter the vehicle interior.
- Do not leave the engine running in an area with snow build-up, or where it is snowing. If snowbanks build up around the vehicle while the engine is running, exhaust gases may collect and enter the vehicle.

■ Exhaust pipe

The exhaust system needs to be checked periodically. If there is a hole or crack caused by corrosion, damage to a joint or abnormal exhaust noise, be sure to have the vehicle inspected and repaired by any authorized Toyota retailer or Toyota authorized repairer, or any reliable repairer.

Front passenger occupant classification system*

Your vehicle is equipped with a front passenger occupant classification system. This system detects the conditions of the front passenger seat and activates or deactivates the front passenger airbag and front passenger's seat belt pretensioner.

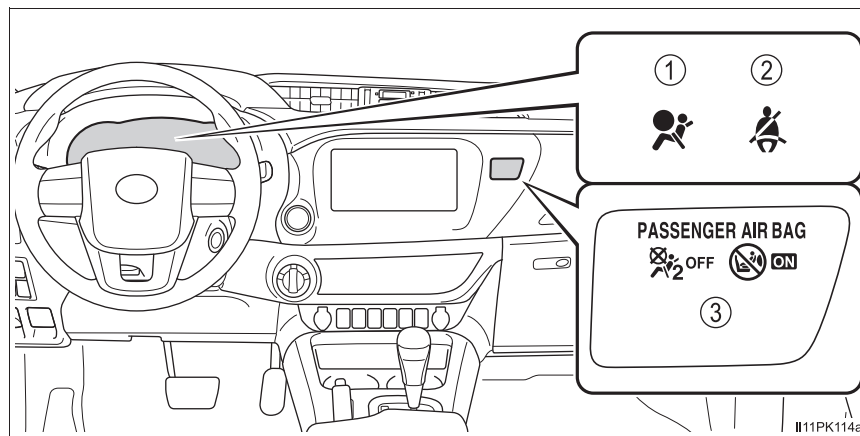

- ① SRS warning light
- ② Seat belt reminder light
- ③ "PASSENGER AIR BAG" indicator

Vehicles without smart entry & start system: The ON indicator light turns on when the airbag system is on (only when the engine switch is in the "ON" position).

Vehicles with smart entry & start system: The ON indicator light turns on when the airbag system is on (only when the engine switch is in IGNITION ON mode).

*: If equipped

Condition and operation in the front passenger occupant classification system

■ Adult*¹

Indicator/ warning light	"PASSENGER AIR BAG" indicator	ON indicator
	SRS warning light	Off
	Seat belt reminder light	Off* ² or flashing* ³
Devices	Front passenger airbag	Activated
	Front passenger's seat belt pretensioner	

■ Child*⁴ or child restraint system*⁵

Indicator/ warning light	"PASSENGER AIR BAG" indicator	OFF indicator* ⁶
	SRS warning light	Off
	Seat belt reminder light	Off* ² or flashing* ³
Devices	Front passenger airbag	Deactivated
	Front passenger's seat belt pretensioner	Activated

■ Unoccupied

Indicator/ warning light	"PASSENGER AIR BAG" indicator	OFF indicator
	SRS warning light	Off
	Seat belt reminder light	
Devices	Front passenger airbag	Deactivated
	Front passenger's seat belt pretensioner	Activated* ⁷ or deactivated* ⁸

■ There is a malfunction in the system

Indicator/ warning light	"PASSENGER AIR BAG" indicator	OFF indicator
	SRS warning light	On
	Seat belt reminder light	flashing
Devices	Front passenger airbag	Deactivated
	Front passenger's seat belt pretensioner	Activated

*1: The system judges a person of adult size as an adult. When a smaller adult sits in the front passenger seat, the system may recognize him/her as a child depending on his/her physique and posture.

*2: In the event the front passenger is wearing a seat belt.

*3: In the event the front passenger does not wear a seat belt.

*4: When a larger child who has outgrown a child restraint system sits in the front passenger seat, the system may recognize him/her as an adult depending on his/her physique or posture.

*5: For the child's safety, install the child restraint system to a rear seat. When it is unavoidable, a child restraint system can be installed on the front passenger seat. A rear-facing child restraint system should be installed when "OFF" of the "PASSENGER AIR BAG" indicator is illuminated. (→P. 65)

*6: In case the indicator light is not illuminated, consult this manual on how to install the child restraint system properly. (→P. 65)

*7: In the event of a side collision.

*8: In the event of a frontal collision.

 WARNING**■ Front passenger occupant classification system precautions**

Observe the following precautions regarding the front passenger occupant classification system.

Failure to do so may cause death or serious injury.

- Wear the seat belt properly.
- Make sure the front passenger's seat belt plate has not been left inserted into the buckle before someone sits in the front passenger seat.
- Do not apply a heavy load to the front passenger seat or equipment (e.g. seatback pocket or armrest).
- Do not put weight on the front passenger seat by putting your hands or feet on the front passenger seat seatback from the rear passenger seat.
- Do not let a rear passenger lift the front passenger seat with their feet or press on the seatback with their legs.
- Do not put objects under the front passenger seat.

 WARNING**■ Front passenger occupant classification system precautions**

- Do not recline the front passenger seatback so far that it touches a rear seat. This may cause “OFF” of the “PASSENGER AIR BAG” indicator to be illuminated, which indicates that the SRS airbags for the front passenger will not activate in the event of a severe accident. If the seatback touches the rear seat, return the seatback to a position where it does not touch the rear seat. Keep the front passenger seatback as upright as possible when the vehicle is moving. Reclining the seatback excessively may lessen the effectiveness of the seat belt system.
- If an adult sits in the front passenger seat, “ON” of the “PASSENGER AIR BAG” indicator is illuminated. If “OFF” of the “PASSENGER AIR BAG” indicator is illuminated, ask the passenger to sit up straight, well back in the seat, feet on the floor, and with the seat belt worn correctly. If “OFF” of the “PASSENGER AIR BAG” indicator still remains illuminated, either ask the passenger to move to the rear seat, or if that is not possible, move the front passenger seat fully rearward.
- When it is unavoidable to install a forward-facing child restraint system on the front passenger seat, install the child restraint system on the front passenger seat in the proper order. (→P. 65)
- Do not modify or remove the front seats.
- Do not kick the front passenger seat or subject it to severe impact. Otherwise, the SRS warning light may come on to indicate a malfunction of the front passenger occupant classification system. In this case, contact any authorized Toyota retailer or Toyota authorized repairer, or any reliable repairer immediately.
- Child restraint systems installed on the rear seat should not contact the front seatbacks.
- Do not use a seat accessory, such as a cushion and seat cover, that covers the seat cushion surface.
- Do not modify or replace the upholstery of the front seat.
- When it is unavoidable to install a rear-facing child restraint system on the front passenger seat, do not release the seat belt while the vehicle is moving. Doing so may cause the airbag system to be on.

Airbag manual on-off system*

**This system deactivates the front passenger airbag.
Only deactivate the airbag when using a child restraint system
on the front passenger seat.**

① “PASSENGER AIR BAG” indicator

Vehicles without smart entry & start system: The ON indicator light turns on when the airbag system is on (only when the engine switch is in the “ON” position).

Vehicles with smart entry & start system: The ON indicator light turns on when the airbag system is on (only when the engine switch is in IGNITION ON mode).

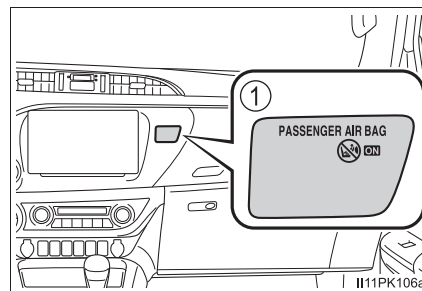

② Airbag manual on-off switch

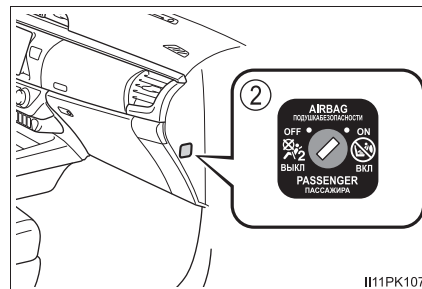

*: If equipped

Deactivating the airbag for the front passenger

Vehicles without smart entry & start system:

Insert the key into the cylinder and turn to the “OFF” position.

The OFF indicator light turns on (only when the engine switch is in the “ON” position).

Vehicles with smart entry & start system:

Insert the mechanical key into the cylinder and rotate to the “OFF” position.

The OFF indicator light turns on (only when the engine switch is in IGNITION ON mode).

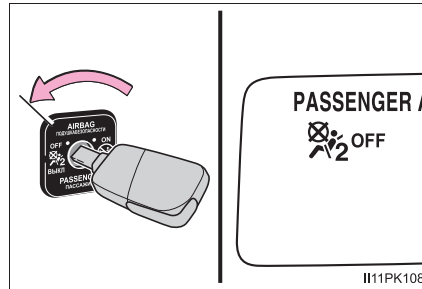

■ “PASSENGER AIR BAG” indicator information

If any of the following problems occur, it is possible that there is a malfunction in the system. Have the vehicle inspected by any authorized Toyota retailer or Toyota authorized repairer, or any reliable repairer.

- Neither “ON” nor “OFF” comes on.
- The indicator light does not change when the airbag manual on-off switch is switched to “ON” or “OFF”.

⚠ WARNING

■ When installing a child restraint system

For safety reasons, always install the child restraint system in a rear seat. In the event that the rear seat cannot be used, the front seat can be used as long as the airbag manual on-off system is set to “OFF”.

If the airbag manual on-off system is left on, the strong impact of the airbag deployment (inflation) may cause serious injury or even death.

■ When a child restraint system is not installed on the front passenger seat

Ensure that the airbag manual on-off system is set to “ON”.

If it is left off, the airbag may not deploy in the event of an accident, which may result in serious injury or even death.

Riding with children

Observe the following precautions when children are in the vehicle.

Use a child restraint system appropriate for the child, until the child becomes large enough to properly wear the vehicle's seat belt.

- It is recommended that children sit in the rear seats (if equipped) to avoid accidental contact with the shift lever, wiper switch etc.
- Use the rear door child-protector lock (double-cab models only) or the window lock switch (vehicles with power windows) to avoid children opening the door while driving or operating the power window accidentally.
- Do not let small children operate equipment which may catch or pinch body parts, such as the power window (if equipped), hood, tailgate (if equipped), seats etc.



WARNING

Never leave children unattended in the vehicle, and never allow children to have or use the key.

Children may be able to start the vehicle or shift the vehicle into neutral. There is also a danger that children may injure themselves by playing with the windows or other features of the vehicle. In addition, heat build-up or extremely cold temperatures inside the vehicle can be fatal to children.

Child restraint systems

Before installing a child restraint system in the vehicle, there are precautions that need to be observed, different types of child restraint systems, as well as installation methods, etc., written in this manual.

- Use a child restraint system when riding with a small child that cannot properly use a seat belt. For the child's safety, install the child restraint system to a rear seat. Be sure to follow the installation method that is in the operation manual enclosed with the restraint system.
- The use of a Toyota genuine child restraint system is recommended, as it is safer to use in this vehicle. Toyota genuine child restraint systems are made specifically for Toyota vehicles. They can be purchased at a Toyota dealer.

Table of contents

Points to remember.....	P. 66
When using a child restraint system	P. 68
Child restraint system compatibility for each seating position....	P. 72
Child restraint system installation method	P. 89
• Fixed with a seat belt	P. 90
• Fixed with an ISOFIX lower anchorage (if equipped).....	P. 92
• Using a top tether anchorage (if equipped).....	P. 95

Points to remember

- Prioritize and observe the warnings, as well as the laws and regulations for child restraint systems.
- Use a child restraint system until the child becomes large enough to properly wear the vehicle's seat belt.
- Choose a child restraint system appropriate to the age and size of the child.
- Note that not all child restraint systems can fit in all vehicles.

Before using or purchasing a child restraint system, check the compatibility of the child restraint system with seat positions. (→P. 72)

 **WARNING****■ When a child is riding**

Observe the following precautions.

Failure to do so may result in death or serious injury.

- For effective protection in automobile accidents and sudden stops, a child must be properly restrained, using a seat belt or child restraint system which is correctly installed. For installation details, refer to the operation manual enclosed with the child restraint system. General installation instruction is provided in this manual.
- Toyota strongly urges the use of a proper child restraint system that conforms to the weight and size of the child, installed on the rear seat. According to accident statistics, the child is safer when properly restrained in the rear seat than in the front seat.
- Holding a child in your or someone else's arms is not a substitute for a child restraint system. In an accident, the child can be crushed against the windshield or between the holder and the interior of the vehicle.

■ Handling the child restraint system

If the child restraint system is not properly fixed in place, the child or other passengers may be seriously injured or even killed in the event of sudden braking, sudden swerving, or an accident.

- If the vehicle were to receive a strong impact from an accident, etc., it is possible that the child restraint system has damage that is not readily visible. In such cases, do not reuse the restraint system.
- Depending on the child restraint system, installation may be difficult or impossible. In those cases, check whether the child restraint system is suitable for installment in the vehicle. (→P. 72) Be sure to install and observe the usage rules after carefully reading the child restraint system fixing method in this manual, as well as the operation manual enclosed with the child restraint system.
- Keep the child restraint system properly secured on the seat even if it is not in use. Do not store the child restraint system unsecured in the passenger compartment.
- If it is necessary to detach the child restraint system, remove it from the vehicle.

When using a child restraint system**■ When installing a child restraint system to a front passenger seat**

For the safety of a child, install child restraint systems to a rear seats. When installing child restraint system to a front passenger seat is unavoidable, adjust the seat as follows and install the child restraint system.

- Adjust the seatback angle to the most upright position.

When installing a forward-facing child seat, if there is a gap between the child seat and the seatback, adjust the seatback angle until good contact is achieved.

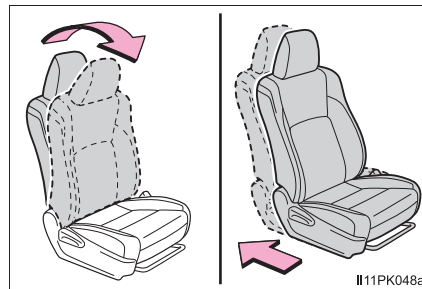

- Move the front seat fully rearward. If the passenger seat height can be adjusted, move it to the upper most position.
- If the head restraint interferes with your child restraint system, and the head restraint can be removed, remove the head restraint. Otherwise, put the head restraint in the upper most position.

⚠ WARNING

■ **When using a child restraint system**

Observe the following precautions.

Failure to do so may result in death or serious injury.

- Vehicles without front passenger occupant classification system or airbag manual on-off switch: Never use a rear-facing child restraint system on the front passenger seat.

The force of the rapid inflation of the front passenger airbag can cause death or serious injury to children in the event of an accident.

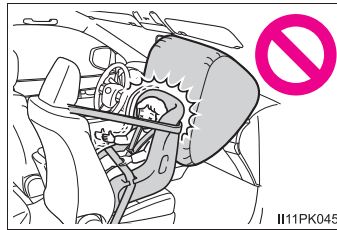

- Vehicles with front passenger occupant classification system: Never use a rear-facing child restraint system on the front passenger seat when "ON" of the "PASSENGER AIR BAG" indicator is illuminated. (→P. 57)

The force of the rapid inflation of the front passenger airbag can cause death or serious injury to children in the event of an accident.

- Vehicles with airbag manual on-off switch: Never use a rear-facing child restraint system on the front passenger seat when the airbag manual on-off switch is on. (→P. 62)

The force of the rapid inflation of the front passenger airbag can cause death or serious injury to children in the event of an accident.

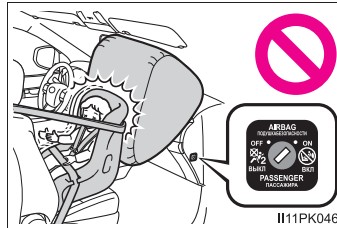

⚠ WARNING

■ **When using a child restraint system**

- There is a label(s) on the passenger side sun visor, indicating it is forbidden to attach a rear-facing child restraint system to the front passenger seat. Details of the label(s) are shown in the illustration below.

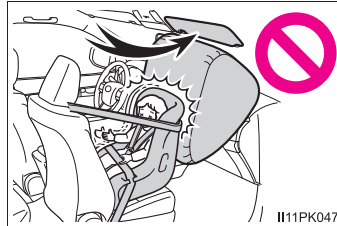

II11PK047



STY12ZY001

- Only put a forward-facing child restraint system on the front seat when unavoidable. When installing a forward-facing child restraint on the front passenger seat, move the seat as far back as possible. Failing to do so may result in death or serious injury if the airbags deploy (inflate).

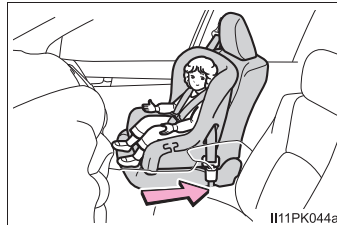

II11PK044a

 **WARNING**

■ **When using a child restraint system**

● Vehicles with SRS side and curtain shield airbags: Do not allow the child to lean his/her head or any part of his/her body against the door or the area of the seat, front or rear pillars, or roof side rails from which the SRS side airbags or SRS curtain shield airbags deploy even if the child is seated in the child restraint system. It is dangerous if the SRS side airbags and curtain shield airbags inflate, and the impact could cause death or serious injury to the child.

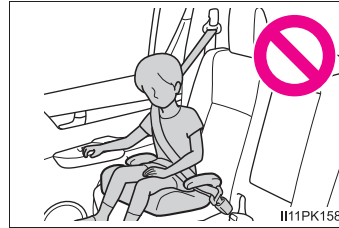

● When a junior seat is installed, always ensure that the shoulder belt is positioned across the center of the child's shoulder. The belt should be kept away from the child's neck, but not so that it could fall off the child's shoulder.

● Use child restraint system suitable to the age and size of the child and install it to the rear seat.

● Double-cab models: If the driver's seat interferes with the child restraint system and prevents it from being attached correctly, attach the child restraint system to the right-hand rear seat (left-hand drive vehicles) or the left-hand rear seat (right-hand drive vehicles). (→P. 88)

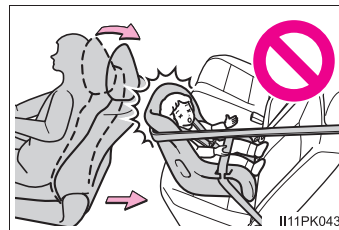

Child restraint system compatibility for each seating position

■ Child restraint system compatibility for each seating position

Compatibility of each seating position with child restraint systems (→P. 74) displays the type of child restraint systems that can be used and possible seating positions for installation using symbols. Also, the recommended child restraint system that is suitable for your child can be selected.

Otherwise, check [Recommended child restraint systems and Compatibility table] for recommended child restraint systems. (→P. 85)

Check the selected child restraint system together with the following [Before confirming the compatibility of each seating position with child restraint systems].

■ Before confirming the compatibility of each seating position with child restraint systems

- 1 Checking the child restraint system standards.

Use a child restraint system that conforms to UN(ECE) R44*¹ or UN(ECE) R129*^{1, 2}.

The following approval mark is displayed on child restraint systems which are conformed.

Check for an approval mark attached to the child restraint system.

Example of the displayed regulation number

- ① UN(ECE) R44 approval mark*³

The weight range of the child who is applicable for an UN(ECE) R44 approval mark is indicated.

- ② UN(ECE) R129 approval mark*³

The height range of the child who is applicable as well as available weights for an UN(ECE) R129 approval mark is indicated.

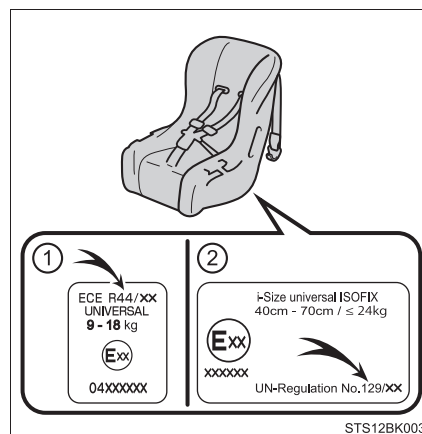

*1: UN(ECE) R44 and UN(ECE) R129 are U.N. regulations for child restraint systems.

*2: The child restraint systems mentioned in the table may not be available outside of the EU area.

*3: The displayed mark may differ depending on the product.

2 Checking the category of the child restraint system.

Check the approval mark of the child restraint system for which of the following categories the child restraint system is suitable.

Also, if there are any uncertainties, check the user's guide included with the child restraint system or contact the retailer of the child restraint system.

- “universal”
- “semi-universal”
- “restricted”
- “vehicle specific”

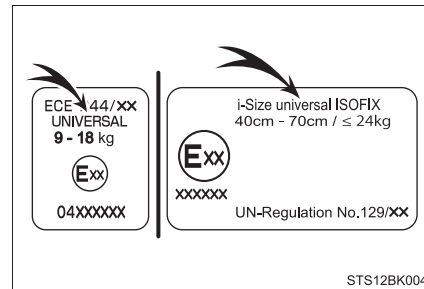

■ Compatibility of each seating position with child restraint systems

▶ Single-cab and smart-cab models without rear seats

Left-hand drive vehicles:

Right-hand drive vehicles:

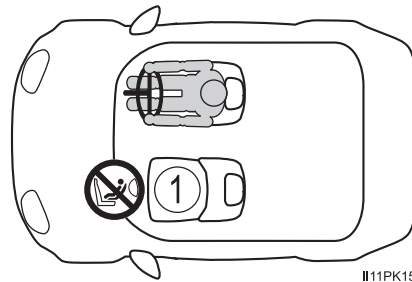
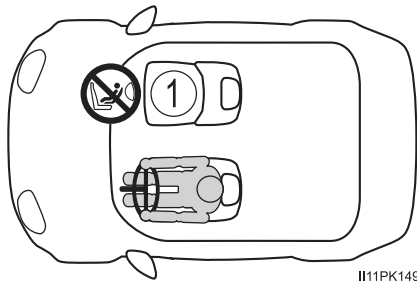

*1, 2, 3 ①	*4 U L
---------------	-----------



Suitable for “universal” category child restraint system fixed with the seat belt.



Suitable for child restraint systems given on recommended child restraint systems and compatibility table (→P. 85).



Never use a rear-facing child restraint system on the front passenger seat when “ON” of the “PASSENGER AIR BAG” indicator is illuminated.

*1: Move the front seat fully rearward. If the passenger seat height can be adjusted, move it to the upper most position.

*2: Adjust the seatback angle to the most upright position.

When installing a forward-facing child seat, if there is a gap between the child seat and the seatback, adjust the seatback angle until good contact is achieved.

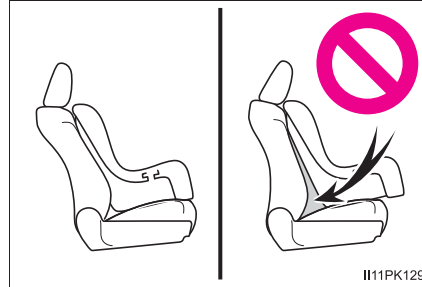

*3: If the head restraint interferes with your child restraint system, and the head restraint can be removed, remove the head restraint. Otherwise, put the head restraint in the upper most position.

*4: Use only a front-facing child restraint system when "ON" of the "PASSENGER AIR BAG" indicator is illuminated.

▶ Smart-cab models with rear seats

Left-hand drive vehicles:

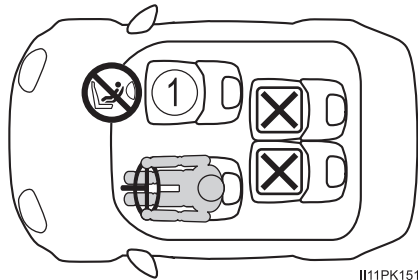

II11PK151

Right-hand drive vehicles:

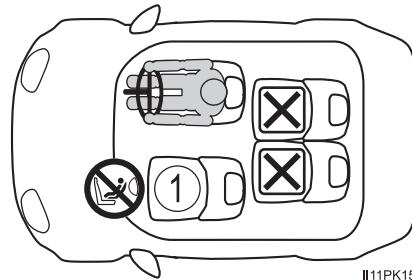

II11PK152

*1, 2, 3 ①	*4 U L
---------------	-----------



Suitable for “universal” category child restraint system fixed with the seat belt.



Suitable for child restraint systems given on recommended child restraint systems and compatibility table (→P. 85).



Not suitable for child restraint system.



Never use a rear-facing child restraint system on the front passenger seat when “ON” of the “PASSENGER AIR BAG” indicator is illuminated.

*1: Move the front seat fully rearward. If the passenger seat height can be adjusted, move it to the upper most position.

*2: Adjust the seatback angle to the most upright position.

When installing a forward-facing child seat, if there is a gap between the child seat and the seatback, adjust the seatback angle until good contact is achieved.

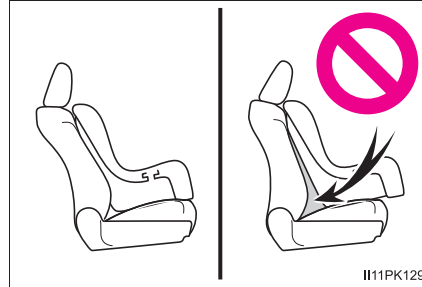

*3: If the head restraint interferes with your child restraint system, and the head restraint can be removed, remove the head restraint. Otherwise, put the head restraint in the upper most position.

*4: Use only a front-facing child restraint system when "ON" of the "PASSENGER AIR BAG" indicator is illuminated.

► Double-cab models



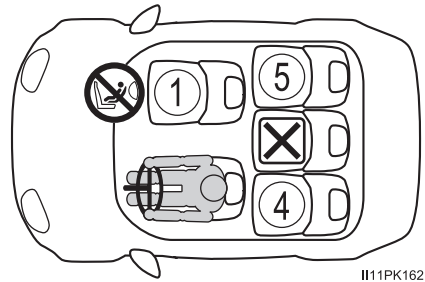
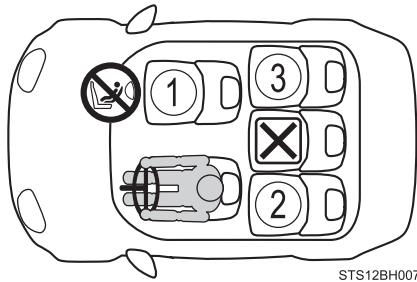

Left-hand drive vehicles with 3-point type rear center seat belt:

Left-hand drive vehicles with 2-point type rear center seat belt:

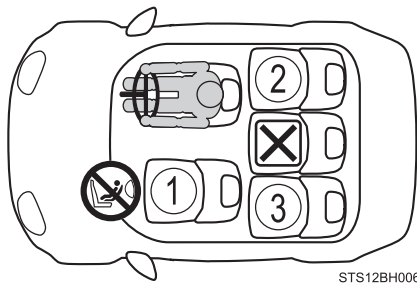

Right-hand drive vehicles:



*1, 2, 3 ①	*4 U L
*3 ②	U L  
*3 ③	U L  
*3 ④	U L
*3 ⑤	U L



Suitable for “universal” category child restraint system fixed with the seat belt.



Suitable for child restraint systems given on recommended child restraint systems and compatibility table (→P. 85).



Suitable for i-Size and ISOFIX child restraint system.



Includes a top tether anchorage point.



Not suitable for child restraint system.

Vehicles without front passenger occupant classification system or airbag manual on-off switch: Never use a rear-facing child restraint system on the front passenger seat.



Vehicles with front passenger occupant classification system: Never use a rear-facing child restraint system on the front passenger seat when “ON” of the “PASSENGER AIR BAG” indicator is illuminated.

Vehicles with airbag manual on-off switch: Never use a rear-facing child restraint system on the front passenger seat when the airbag manual on-off switch is on.

*1: Move the front seat fully rearward. If the passenger seat height can be adjusted, move it to the upper most position.

*2: Adjust the seatback angle to the most upright position.

When installing a forward-facing child seat, if there is a gap between the child seat and the seatback, adjust the seatback angle until good contact is achieved.

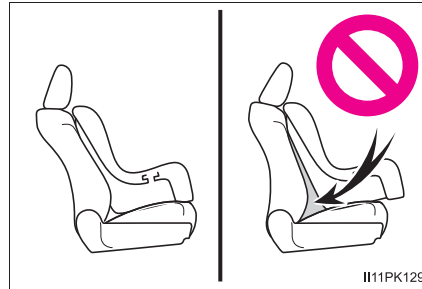

*3: If the head restraint interferes with your child restraint system, and the head restraint can be removed, remove the head restraint. Otherwise, put the head restraint in the upper most position.

*4: Vehicles without front passenger occupant classification system or airbag manual on-off switch: Use only a front-facing child restraint system.

Vehicles with front passenger occupant classification system: Use only a front-facing child restraint system when "ON" of the "PASSENGER AIR BAG" indicator is illuminated.

Vehicles with airbag manual on-off switch: Use only a front-facing child restraint system when the airbag manual on-off switch is on.

■ Detail information for child restraint systems installation

▶ Single-cab and smart-cab models

Seating position		
Seat position number	①	
	Vehicles with front passenger occupant classification system	
	“PASSENGER AIR BAG” indicator	
	ON	OFF*
Seating position suitable for universal belted (Yes/No)	Yes Forward facing only	Yes
i-Size seating position (Yes/No)	No	No
Seating position suitable for lateral fixture (L1/L2/No)	No	No
Suitable rearward facing fixture (R1/R2X/R2/R3/No)	No	No
Suitable forward facing fixture (F2X/F2/F3/No)	No	No
Suitable junior seat fixture (B2/B3/No)	No	No

*: When it is unavoidable to install a rear-facing child restraint system on the front passenger seat, a child restraint system can be installed if “OFF” of the “PASSENGER AIR BAG” indicator is illuminated.

ISOFIX child restraint systems are divided into different “fixture”. The child restraint system can be used in the seating positions for “fixture” mentioned in the table above. For kind of “fixture” relation, confirm the following table.

If your child restraint system has no kind of “fixture” (or if you cannot find information in the table below), please refer to the child restraint system “vehicle list” for compatibility information or ask the retailer of your child seat.

Fixture	Description
F3	Full-height, forward-facing child restraint systems
F2	Reduced-height forward-facing child restraint systems
F2X	Reduced-height forward-facing child restraint systems
R3	Full-size, rearward-facing child restraint systems
R2	Reduced-size, rearward-facing child restraint systems
R2X	Reduced-size, rearward-facing child restraint systems
R1	Rearward-facing infant seat
L1	Left lateral-facing (carrycot) infant seat
L2	Right lateral-facing (carrycot) infant seat
B2	Junior seat
B3	Junior seat

► Double-cab models

Seating position							
Seat position number	①					② ③	④ ⑤
	Vehicles without front passenger occupant classification system or airbag manual on-off switch	Vehicles with airbag manual on-off switch		Vehicles with front passenger occupant classification system			
		Airbag manual on-off switch		"PASSENGER AIR BAG" indicator			
		ON	OFF	ON	OFF*		
Seating position suitable for universal belted (Yes/No)	Yes Forward facing only	Yes Forward facing only	Yes	Yes Forward facing only	Yes	Yes	Yes
i-Size seating position (Yes/No)	No	No	No	No	No	Yes	No
Seating position suitable for lateral fixture (L1/L2/No)	No	No	No	No	No	No	No
Suitable rearward facing fixture (R1/R2X/R2/R3/No)	No	No	No	No	No	R1, R2X, R2, R3	No
Suitable forward facing fixture (F2X/F2/F3/No)	No	No	No	No	No	F2X, F2, F3	No
Suitable junior seat fixture (B2/B3/No)	No	No	No	No	No	B2, B3	No

*: When it is unavoidable to install a rear-facing child restraint system on the front passenger seat, a child restraint system can be installed if “OFF” of the “PASSENGER AIR BAG” indicator is illuminated.

ISOFIX child restraint systems are divided into different “fixture”. The child restraint system can be used in the seating positions for “fixture” mentioned in the table above. For kind of “fixture” relation, confirm the following table.

If your child restraint system has no kind of “fixture” (or if you cannot find information in the table below), please refer to the child restraint system “vehicle list” for compatibility information or ask the retailer of your child seat.

Fixture	Description
F3	Full-height, forward-facing child restraint systems
F2	Reduced-height forward-facing child restraint systems
F2X	Reduced-height forward-facing child restraint systems
R3	Full-size, rearward-facing child restraint systems
R2	Reduced-size, rearward-facing child restraint systems
R2X	Reduced-size, rearward-facing child restraint systems
R1	Rearward-facing infant seat
L1	Left lateral-facing (carrycot) infant seat
L2	Right lateral-facing (carrycot) infant seat
B2	Junior seat
B3	Junior seat

■ Recommended child restraint systems and Compatibility table

▶ Single-cab and smart-cab models

Mass groups	Recommended Child Restraint System	Seating position	
		①	
		Vehicles with front passenger occupant classification system	
		“PASSENGER AIR BAG” indicator	
		ON	OFF*
0, 0+ Up to 13 kg (28 lb.)	G0+, BABY SAFE PLUS (Yes/No)	No	Yes
	G0+ BABY SAFE PLUS with SEAT BELT FIXATION, BASE PLATFORM (Yes/No)	No	Yes
I 9 to 18 kg (20 to 39 lb.)	DUO PLUS (Yes/No)	Yes Belt fix only	Yes Belt fix only
II, III 15 to 36 kg (34 to 79 lb.)	KIDFIX XP SICT (Yes/No)	Yes Belt fix only	Yes Belt fix only
	MAXI PLUS (Yes/No)	No	No

*: When it is unavoidable to install a rear-facing child restraint system on the front passenger seat, a child restraint system can be installed if “OFF” of the “PASSENGER AIR BAG” indicator is illuminated.

The child restraint systems mentioned in the table may not be available outside the EU area.

- When installing a child seat with support base, if the child seat interferes with the seatback when latching it into the support base, adjust the seatback rearward until there is no interference.
- If the seat belt shoulder anchor is ahead of the child seat belt guide, move the seat cushion forward.

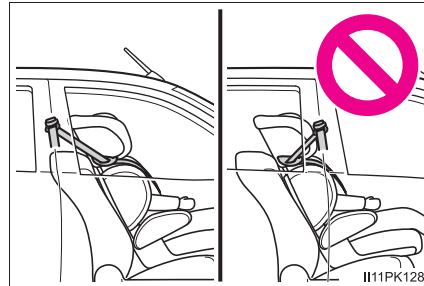

- When installing a junior seat, if the child in your child restraint system is in a very upright position, adjust the seatback angle to the most comfortable position. And if the seat belt shoulder anchor is ahead of the child seat belt guide, move the seat cushion forward.

► Double-cab models

Mass groups	Recommended Child Restraint System	Seating position						
		①					②	④
		Vehicles without front passenger occupant classification system or airbag manual on-off switch	Vehicles with airbag manual on-off switch		Vehicles with front passenger occupant classification system			
			ON	OFF	ON	OFF*	③	⑤
0, 0+ Up to 13 kg (28 lb.)	G0+, BABY SAFE PLUS (Yes/No)	No	No	Yes	No	Yes	Yes	Yes
	G0+ BABY SAFE PLUS with SEAT BELT FIXATION, BASE PLATFORM (Yes/No)	No	No	Yes	No	Yes	Yes	Yes
I 9 to 18 kg (20 to 39 lb.)	DUO PLUS (Yes/No)	Yes Belt fix only	Yes Belt fix only	Yes Belt fix only	Yes Belt fix only	Yes Belt fix only	Yes	Yes Belt fix only
II, III 15 to 36 kg (34 to 79 lb.)	KIDFIX XP SICT (Yes/No)	Yes Belt fix only	Yes Belt fix only	Yes Belt fix only	Yes Belt fix only	Yes Belt fix only	Yes	Yes Belt fix only
	MAXI PLUS (Yes/No)	Yes Belt fix only	Yes Belt fix only	Yes Belt fix only	Yes Belt fix only	Yes Belt fix only	Yes	Yes Belt fix only

*: When it is unavoidable to install a rear-facing child restraint system on the front passenger seat, a child restraint system can be installed if “OFF” of the “PASSENGER AIR BAG” indicator is illuminated.

The child restraint systems mentioned in the table may not be available outside the EU area.

When securing some types of child restraint systems in rear seat, it may not be possible to properly use the seat belts in positions next to the child restraint without interfering with it or affecting seat belt effectiveness. Be sure your seat belt fits snugly across your shoulder and low on your hips. If it does not, or if it interferes with the child restraint, move to a different position.

Failure to do so may result in death or serious injury.

- When installing a child restraint in the rear seats, adjust the front seat so that it does not interfere with the child or child restraint system (if equipped).
- When installing a child seat with support base in the front seats, if the child seat interferes with the seatback when latching it into the support base, adjust the seatback rearward until there is no interference.
- If the seat belt shoulder anchor is ahead of the child seat belt guide, move the seat cushion forward.

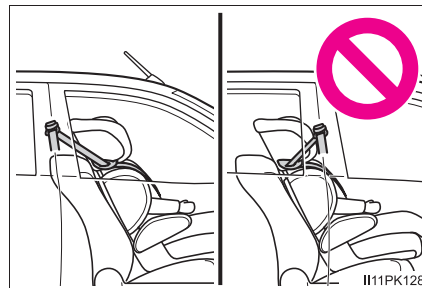

- When installing a junior seat in the front seats, if the child in your child restraint system is in a very upright position, adjust the seatback angle to the most comfortable position. And if the seat belt shoulder anchor is ahead of the child seat belt guide, move the seat cushion forward.

Child restraint system installation method

Confirm with the operation manual enclosed with the child restraint system about the installation of the child restraint system.

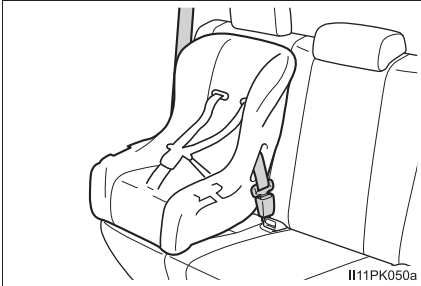
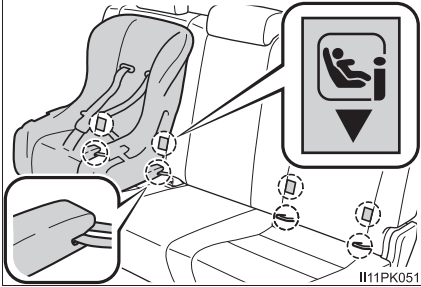
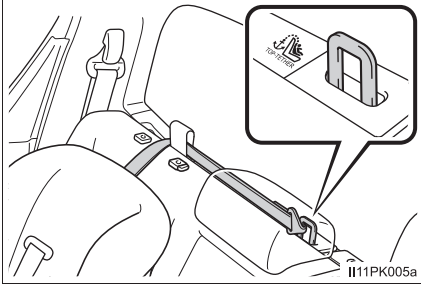
	Installation method	Page
<p>Seat belt attachment</p>		<p>P. 90</p>
<p>ISOFIX lower anchorage attachment</p>		<p>P. 92</p>
<p>Top tether anchorage attachment</p>		<p>P. 95</p>

Child restraint system fixed with a seat belt

■ Installing child restraint system using a seat belt

Install the child restraint system in accordance to the operation manual enclosed with the child restraint system.

If the child restraint system on hand is not within the “universal” category (or the necessary information is not in the table), refer to the “Vehicle List” provided by the child restraint system maker for various possible installation positions, or check the compatibility after asking the retailer of the child restraint system. (→P. 73, 74)

- 1 If installing the child restraint system to the front passenger seat is unavoidable, refer to P. 68 for front passenger seat adjustment.
- 2 Double-cab models: If the head restraint interferes with the child restraint system installation and the head restraint can be removed, remove the head restraint. Otherwise, put the head restraint in the upper most position. (→P. 175)

- 3 Run the seat belt through the child restraint system and insert the plate into the buckle. Make sure that the belt is not twisted. Securely fix the seat belt to the child restraint system in accordance to the directions enclosed with the child restraint system.

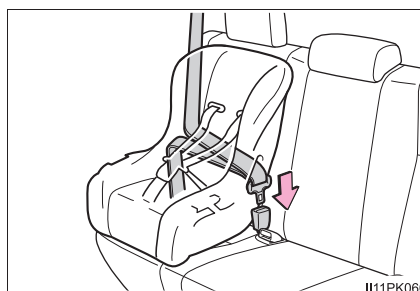

- 4 If your child restraint system is not equipped with a lock-off (a seat belt locking feature), secure the child restraint system using a locking clip.

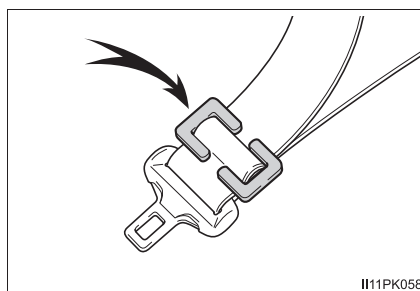

- 5 After installing the child restraint system, rock it back and forth to ensure that it is installed securely. (→P. 91)

■ Removing a child restraint system installed with a seat belt

Press the buckle release button and fully retract the seat belt.

When releasing the buckle, the child restraint system may spring up due to the rebound of the seat cushion. Release the buckle while holding down the child restraint system.

Since the seat belt automatically reels itself, slowly return it to the stowing position.

■ When installing a child restraint system

You may need a locking clip to install the child restraint system. Follow the instructions provided by the manufacturer of the system. If your child restraint system does not provide a locking clip, you can purchase the following item from any authorized Toyota retailer or Toyota authorized repairer, or any reliable repairer: Locking clip for child restraint system (Part No. 73119-22010)

■ When removing the head restraint to install a child restraint system

After removing the child restraint system, make sure to reinstall the head restraint.

WARNING

■ When installing a child restraint system

Observe the following precautions.
Failure to do so may result in death or serious injury.

- Do not allow children to play with the seat belt. If the seat belt becomes twisted around a child's neck, it may lead to choking or other serious injuries that could result in death. If this occurs and the buckle cannot be unfastened, scissors should be used to cut the belt.
- Ensure that the belt and plate are securely locked and the seat belt is not twisted.
- Shake the child restraint system left and right, and forward and backward to ensure that it has been securely installed.
- After securing a child restraint system, never adjust the seat.
- When a junior seat is installed, always ensure that the shoulder belt is positioned across the center of the child's shoulder. The belt should be kept away from the child's neck, but not so that it could fall off the child's shoulder.
- Follow all installation instructions provided by the child restraint system manufacturer.

Child restraint system fixed with an ISOFIX lower anchorage (if equipped)**■ ISOFIX lower anchorages (ISOFIX child restraint system)**

Lower anchorages are provided for the outboard rear seats. (Tags displaying the location of the anchorages are attached to the seats.)



■ Installation with ISOFIX lower anchorage (ISOFIX child restraint system)

Install the child restraint system in accordance to the operation manual enclosed with the child restraint system.

If the child restraint system on hand is not within the “universal” category (or the necessary information is not in the table), refer to the “Vehicle List” provided by the child restraint system maker for various possible installation positions, or check the compatibility after asking the retailer of the child restraint system. (→P. 73, 74)

- 1 If the head restraint interferes with the child restraint system installation and the head restraint can be removed, remove the head restraint. Otherwise, put the head restraint in the upper most position. (→P. 175)
- 2 Check the positions of the exclusive fixing bars, and install the child restraint system to the seat.

The bars are installed in the clearance between the seat cushion and seatback.



- 3 After installing the child restraint system, rock it back and forth to ensure that it is installed securely. (→P. 91)

■ When removing the head restraint to install a child restraint system

After removing the child restraint system, make sure to reinstall the head restraint.

**WARNING****■ When installing a child restraint system**

Observe the following precautions.

Failure to do so may result in death or serious injury.

- After securing a child restraint system, never adjust the seat.
- When using the lower anchorages, be sure that there are no foreign objects around the anchorages and that the seat belt is not caught behind the child restraint system.
- Follow all installation instructions provided by the child restraint system manufacturer.

Using a top tether anchorage (if equipped)

■ Top tether anchorage

Top tether anchorage is located the center of the rear seat and provided for the outboard rear seat.

Use top tether anchorage when fixing the top strap.

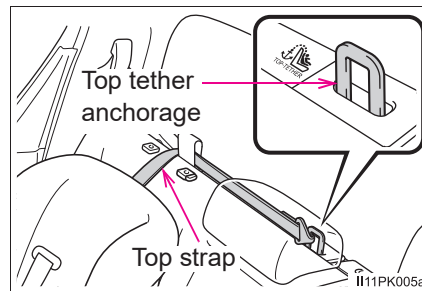

■ Fixing the top strap to the top tether anchorage

Install the child restraint system in accordance to the operation manual enclosed with the child restraint system.

- 1 Remove the head restraint.

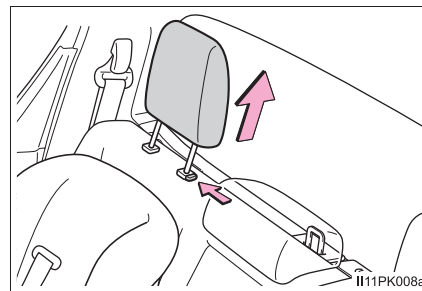

- 2 Pull up the anchor strap router.

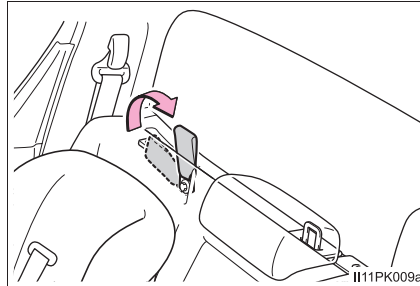

- 3 Route the top strap through the anchor strap router as shown in the illustration.

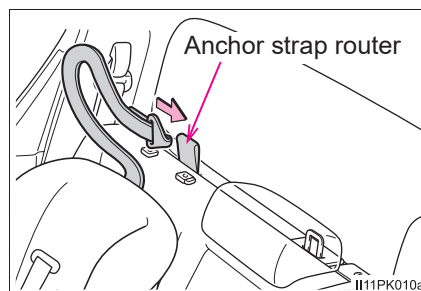

- 4 Latch the hook onto the top tether anchorage and tighten the top strap.

Make sure the top strap is securely latched. (→P. 91)

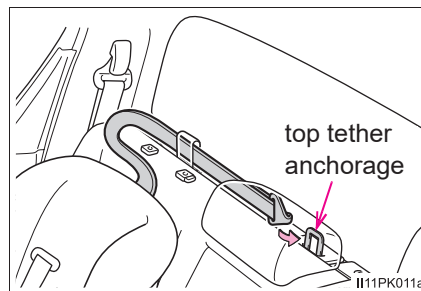

■ **When removing the head restraint to install a child restraint system**

After removing the child restraint system, make sure to reinstall the head restraint.

 WARNING**■ When installing a child restraint system**

Observe the following precautions.

Failure to do so may result in death or serious injury.

- Firmly attach the top strap.
- Do not attach the top strap to anything other than the top tether anchorage.
- After securing a child restraint system, never adjust the seat.
- Follow all installation instructions provided by the child restraint system manufacturer.
- When installing the child restraint system, do not install the head restraint.

eCall*^{1, 2}

eCall is a telematics service that uses Global Navigation Satellite System (GNSS) data and embedded cellular technology to enable the following emergency calls to be made: Automatic emergency calls (Automatic Collision Notification) and manual emergency calls (by pressing the “SOS” button). This service is required by European Union Regulations.

System components

- ① Microphone
- ② “SOS” button*
- ③ Indicator lights

*: This button is intended for communication with the eCall system operator.

Other SOS buttons available in other systems of a motor vehicle do not relate to the device and are not intended for communication with the eCall system operator.

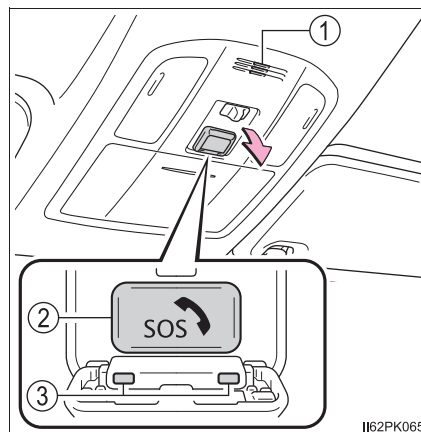

*¹: If equipped

*²: Operates within the eCall coverage. The system name differs depending on the country.

Emergency Notification Services

■ Automatic Emergency Calls

If any airbag deploys, the system is designed to automatically call the eCall control center.* The answering operator receives the vehicle's location, the time of the incident and the vehicle VIN, and attempts to speak with the vehicle occupants to assess the situation. If the occupants are unable to communicate, the operator automatically treats the call as an emergency and contacts the nearest emergency services provider (112 system etc.) to describe the situation and request that assistance be sent to the location.

*: In some cases, the call cannot be made. (→P. 101)

■ Manual Emergency Calls

In the event of an emergency, press the "SOS" button to call the eCall control center.* The answering operator will determine your vehicle's location, assess the situation, and dispatch the necessary assistance required.

Make sure to open the cover before pressing the "SOS" button.

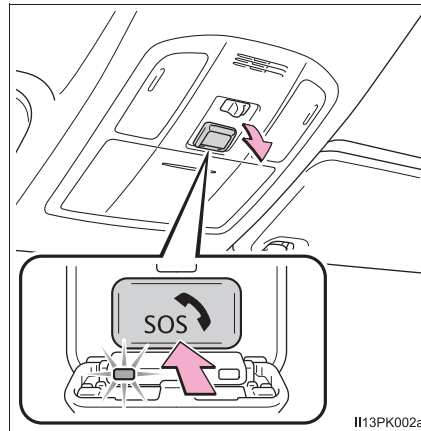

If you accidentally press the "SOS" button, tell the operator that you are not experiencing an emergency.

*: In some cases, the call cannot be made. (→P. 101)

Indicator lights

When the engine switch is turned to the “ON” position (vehicles without smart entry & start system) or IGNITION ON mode (vehicles with smart entry & start system), the red indicator light will illuminate for 10 seconds. Then, the green indicator light will illuminate for 2 seconds and remain illuminated if the system is functioning properly. The indicator lights indicate the following:

- If the green indicator light illuminates and stays on, the system is enabled.
- If the green indicator light flashes twice per second, an automatic or manual Emergency Call is being made.
- If the red indicator light illuminates at any time other than immediately after the engine switch is turned to the “ON” position (vehicles without smart entry & start system) or IGNITION ON mode (vehicles with smart entry & start system), the system may be malfunctioning or the backup battery may be depleted. Contact any authorized Toyota retailer or Toyota authorized repairer, or any reliable repairer.
- If the red indicator light blinks for approximately 30 seconds during an Emergency Call, the call has been disconnected or the cellular network signal is weak.

■ Free/Open Source Software Information

This product contains Free/Open Source Software (FOSS). The license information and/or the source code of such FOSS can be found at the following URL.

<http://www.opensourceautomotive.com/dcm/toyota/>

 WARNING**■ When the Emergency Call may not be made**

- It may not be possible to make Emergency Calls in any of the following situations. In such cases, report to emergency services provider (112 system etc.) by other means such as nearby public phones.
 - Even when the vehicle is in the cellular phone service area, it may be difficult to connect to the eCall control center if the reception is poor or the line is busy. In such cases, even though the system attempts to connect to the eCall control center, you may not be able to connect to the eCall control center to make Emergency Calls and contact emergency services.
 - When the vehicle is out of the cellular phone service area, the Emergency Calls cannot be made.
 - When any related equipment (such as the “SOS” button panel, indicator lights, microphone, speaker, DCM, antenna, or any wires connecting the equipment) is malfunctioning, damaged or broken, the Emergency Call cannot be made.
 - During an Emergency Call, the system makes repeated attempts to connect to the eCall control center. However, if it cannot connect to the eCall control center due to poor radio wave reception, the system may not be able to connect to the cellular network and the call may finish without connecting. The red indicator light will blink for approximately 30 seconds to indicate this disconnection.
- If the battery’s voltage decreases or there is a disconnection, the system may not be able to connect to the eCall control center.
- The Emergency Call system might not work outside of EU area, depending on the available infrastructure in the country.

■ When the Emergency Call system is replaced with a new one

The Emergency Call system should be registered. Contact any authorized Toyota retailer or Toyota authorized repairer, or any reliable repairer.

 WARNING**■ For your safety**

- Please drive safely.

The function of this system is to assist you in making the Emergency Call in case of accidents such as traffic accidents or sudden medical emergencies, and it does not protect the driver or passengers in any way. Please drive safely and fasten your seatbelts at all times for your safety.

- In case of an emergency, make lives the top priority.
- If you smell anything burning or other unusual smells, leave the vehicle and evacuate to a safe area immediately.
- If the airbags deploy when the system is operating normally, the system makes emergency call. The system also makes emergency call when the vehicle is struck from the rear or rolls over, even if the airbags do not deploy.
- For safety, do not make the Emergency Call while driving.

Making calls during driving may cause mishandling of the steering wheel, which may lead to unexpected accidents.

Stop the vehicle and confirm the safety of your surroundings before making the Emergency Call.

- When changing fuses, please use the specified fuses. Using other fuses may cause ignition or smoke in the circuit and lead to a fire.
- Using the system while there is smoke or an unusual smell may cause a fire. Stop using the system immediately and consult any authorized Toyota retailer or Toyota authorized repairer, or any reliable repairer.

 NOTICE**■ To prevent damage**

Do not pour any liquids onto the “SOS” button panel, etc. and do not impact it.

■ If the “SOS” button panel, speaker or microphone malfunctions during an Emergency Call or manual maintenance check

It may not be possible to make Emergency Calls, confirm the system status, or communicate with the eCall control center operator. If any of the above equipment is damaged, please consult any authorized Toyota retailer or Toyota authorized repairer, or any reliable repairer.

System overview of added service

■ Data processing flow

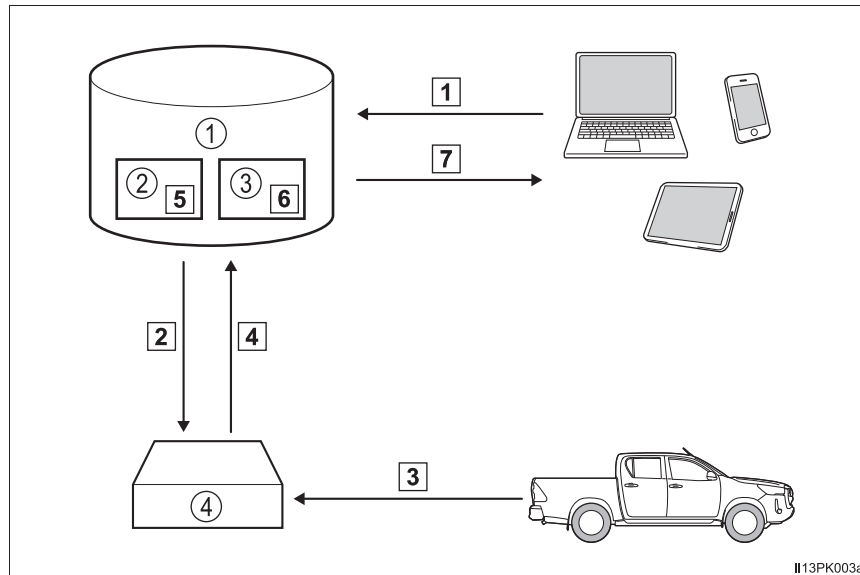

- ① Server
- ② Storage
- ③ Processing
- ④ DCM
- ① Activation of data sharing is done by enabling a service on the "MyT by Toyota" app or purchasing a service that requires data collection.
- ② Server activates the service in the DCM and defines which vehicle data to collect.
- ③ Defined vehicle data is collected by the DCM.
- ④ Data is shared with the server.
- ⑤ Data is stored in the server.
- ⑥ Data is processed in the server for fulfilling the service.
- ⑦ Processed data is presented to the customer.

For a list of eligible services in your region please visit the Toyota website or contact any authorized Toyota retailer or Toyota authorized repairer, or any reliable repairer.

Implementing Regulation

Implementing Regulation Annex1 PART3 User Information			Conformity
1. DESCRIPTION OF THE ECALL IN-VEHICLE SYSTEM			
1.1.	Overview of the 112-based eCall in-vehicle system, its operation and functionalities		○
1.2.	The 112-based eCall service is a public service of general interest and is accessible free of charge.		○
1.3.	The 112-based eCall in-vehicle system is activated by default. It is activated automatically by means of in-vehicle sensors in the event of a severe accident. It will also be triggered automatically when the vehicle is equipped with a TPS system which does not function in the event of a severe accident.		○
1.4.	The 112-based eCall in-vehicle system can also be triggered manually, if needed. Instructions for manual activation of the system		○
1.5.	In the event of a critical system failure that would disable the 112-based eCall in-vehicle system, the following warning will be given to the occupants of the vehicle		○

Implementing Regulation Annex1 PART3 User Information		Conformity
2. INFORMATION ON DATA PROCESSING		
2.1.	Any processing of personal data through the 112-based eCall in-vehicle system shall comply with the personal data protection rules provided for in Directives 95/46/EC and 2002/58/EC, and in particular, shall be based on the necessity to protect the vital interests of the individuals in accordance with Article 7(d) of Directive 95/46/EC.	O
2.2.	Processing of such data is strictly limited to the purpose of handling the emergency eCall to the single European emergency number 112.	O
2.3. Types of data and its recipients		
2.3.1.	The 112-based eCall in-vehicle system may collect and process only the following data: Vehicle Identification Number, Vehicle type (passenger vehicle or light commercial vehicle), Vehicle propulsion storage type (gasoline/diesel/CNG/LPG/electric/hydrogen), Vehicle last three locations and direction of travel, Log file of the automatic activation of the system and its timestamp, Any additional data (if applicable)	O
2.3.2.	Recipients of data processed by the 112-based eCall in-vehicle system are the relevant public safety answering points designated by the respective public authorities of the country on which territory they are located, to first receive and handle eCalls to the single European emergency number 112. Additional information (if available):	O

Implementing Regulation Annex1 PART3 User Information		Conformity
2.4. Arrangements for data processing		
2.4.1.	The 112-based eCall in-vehicle system is designed in such a way as to ensure that the data contained in the system memory is not available outside the system before an eCall is triggered. Additional remarks (if any):	O
2.4.2.	The 112-based eCall in-vehicle system is designed in such a way as to ensure that it is not traceable and not subject to any constant tracking in its normal operation status. Additional remarks (if any):	O
2.4.3.	The 112-based eCall in-vehicle system is designed in such a way as to ensure that data in the system internal memory is automatically and continuously removed.	O
2.4.3.1.	The vehicle location data is constantly overwritten in the internal memory of the system so as always to keep maximum of the last three up-to-date locations of the vehicle necessary for the normal functioning of the system.	O
2.4.3.2.	The log of activity data in the 112-based eCall in-vehicle system is kept for no longer than necessary for attaining the purpose of handling the emergency eCall and in any case not beyond 13 hours from the moment an emergency eCall was initiated.	O

Implementing Regulation Annex1 PART3 User Information		Conformity
2.5. Modalities for exercising data subject's rights		
2.5.1.	The data subject (the vehicle's owner) has a right of access to data and as appropriate to request the rectification, erasure or blocking of data, concerning him or her, the processing of which does not comply with the provisions of Directive 95/46/EC. Any third parties to whom the data have been disclosed have to be notified of such rectification, erasure or blocking carried out in compliance with this Directive, unless it proves impossible or involves a disproportionate effort.	O
2.5.2.	The data subject has a right to complain to the competent data protection authority if he or she considers that his or her rights have been infringed as a result of the processing of his or her personal data.	O
2.5.3.	Contact service responsible for handling access requests (if any): P. 109	O

Implementing Regulation Annex1 PART3 User Information		Conformity
3. INFORMATION ON THIRD PARTY SERVICES AND OTHER ADDED VALUE SERVICES (IF FITTED)		
3.1.	Description of the operation and the functionalities of the TPS system/added value service	→P. 103
3.2.	Any processing of personal data through the TPS system/other added value service shall comply with the personal data protection rules provided for in Directives 95/46/EC and 2002/58/EC.	O
3.2.1.	Legal basis for the use of TPS system and/or added value services and for processing data through them	The European Union General Data Protection Regulation
3.3.	The TPS system and/or other added value services shall process personal data only on the base of the explicit consent of the data subject (the vehicle's owner or owners).	O
3.4.	Modalities for data processing through TPS system and/or other added value services, including any necessary additional information regarding traceability, tracking and processing of personal data	→P. 103
3.5.	The owner of a vehicle equipped with a TPS eCall system and/or other added value service in addition to the 112-based eCall in-vehicle system has the right to choose to use the 112-based eCall in-vehicle system rather than the TPS eCall system and the other added value service.	O
3.5.1.	Contact details for handling TPS eCall system deactivation requests	N/A

■ Service responsible for handling access requests

Country	Contact information
Austria	datenschutz@toyota-frey.at
Belgium/Luxembourg	privacy@toyota.be
Croatia	dpcp@toyota.hr
Czech Republic /Hungary/Slovakia	adatvedelem@toyota-ce.com
Denmark	toyota@toyota.dk og
Estonia	privacy@toyota.ee
Finland	tietosuoja@toyota.fi
France	delegue.protectiondonnees@toyota-europe.com
Germany	Toyota.Datenschutz@toyota.de
Great Britain	privacy@tgb.toyota.co.uk
Greece	customer@toyota.gr
Iceland	personuvernd@toyota.is
Ireland	customerservice@toyota.ie
Italy	tmi.dpo@toyota-europe.com
Netherlands	www.toyota.nl/klantenservice
Norway	personvern@toyota.no
Poland	klient@toyota.pl
Portugal	gestaodadospessoais@toyotacaetano.pt
Romania	relatii.clienti@toyota.ro
Slovenia	dpcp@toyota.si
Spain	clientes@toyota.es / dpo@toyota.es.
Sweden	integritet@toyota.se
Switzerland	info@toyota.ch

ERA-GLONASS/EVAK*1, 2, 3

The Emergency Call system is a device installed on a vehicle to determine its location and movement direction (using GLONASS [Global Navigation Satellite System] and GPS [Global Positioning System] signals), and ensure the generation and transmission of vehicle information (in a nonadjustable form) in case of traffic accidents or other incidents on motor roads in the countries offering emergency notification services. In addition, it ensures two-way voice communication between the vehicle and an ERA-GLONASS/EVAK system operator through cellular networks (GSM).

Automatic Emergency Calls (via Automatic Collision Notification) and manual Emergency Calls (by pressing the “SOS” button) can be made to the ERA-GLONASS/EVAK control center.

This service is mandatory according to the technical regulations of the Customs Union.

System components

- ① Microphone
- ② “SOS” button*
- ③ Indicator lights

*: This button is intended for communication with the ERA-GLONASS/EVAK system operator.

Other SOS buttons available in other systems of a motor vehicle do not relate to the device and are not intended for communication with the ERA-GLONASS/EVAK system operator.

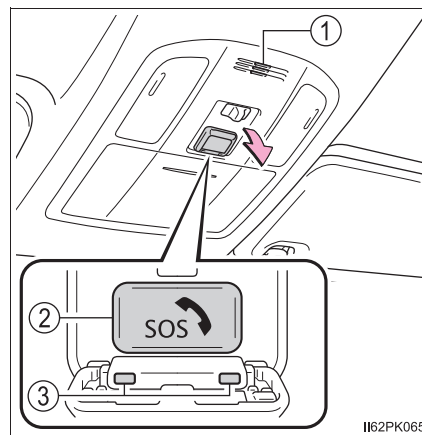

*1: If equipped

*2: Operates within regions offering emergency notification services. Ask any authorized Toyota retailer or Toyota authorized repairer, or any reliable repairer for details.

*3: The system name differs depending on the country.

Emergency Notification Services

■ Automatic Emergency Calls

If any airbag deploys, the system is designed to automatically call the ERA-GLONASS/EVAK control center.* The answering operator receives the vehicle's location, the time of the incident and the vehicle VIN, and attempts to speak with the vehicle occupants to assess the situation. If the occupants are unable to communicate, the operator automatically treats the call as an emergency and contacts the nearest emergency services provider (112 system etc.) to describe the situation and request that assistance be sent to the location.

*: In some cases, the call cannot be made. (→P. 113)

■ Manual Emergency Calls

In the event of an emergency, press the "SOS" button to call the ERA-GLONASS/EVAK control center.* The answering operator will determine your vehicle's location, assess the situation, and dispatch the necessary assistance required.

If you accidentally press the "SOS" button, tell the operator that you are not experiencing an emergency.

*: In some cases, the call cannot be made. (→P. 113)

Indicator lights

When the engine switch is turned to the “ON” position (vehicles without smart entry & start system) or IGNITION ON mode (vehicles with smart entry & start system), the red indicator light will illuminate for 10 seconds and then the green indicator light will illuminate, indicating that the system is enabled. The indicator lights indicate the following:

- If the green indicator light illuminates and stays on, the system is enabled.
- If the green indicator light flashes twice per second, an automatic or manual Emergency Call is being made.
- If no indicator lights illuminate, the system is not enabled.
- If the red indicator light illuminates at any time other than immediately after the engine switch is turned to the “ON” position (vehicles without smart entry & start system) or IGNITION ON mode (vehicles with smart entry & start system), the system may be malfunctioning or the backup battery may be depleted. Contact any authorized Toyota retailer or Toyota authorized repairer, or any reliable repairer.
- If the red indicator light blinks for approximately 30 seconds during an Emergency Call, the call has been disconnected or the cellular network signal is weak.

Device test mode

A test mode is provided for to check the performance of the Emergency Call system. To test the device, contact any authorized Toyota retailer or Toyota authorized repairer, or any reliable repairer.

 WARNING**■ When the Emergency Call may not be made**

- It may not be possible to make Emergency Calls in any of the following situations. In such cases, report to emergency services provider (112 system etc.) by other means such as nearby public phones.
 - Even when the vehicle is in the cellular phone service area, it may be difficult to connect to the ERA-GLONASS/EVAK control center if the reception is poor or the line is busy. In such cases, even though the system attempts to connect to the ERA-GLONASS/EVAK control center, you may not be able to connect to the ERA-GLONASS/EVAK control center to make Emergency Calls and contact emergency services.
 - When the vehicle is out of the cellular phone service area, the Emergency Calls cannot be made.
 - When any related equipment (such as the “SOS” button panel, indicator lights, microphone, speaker, DCM, antenna, or any wires connecting the equipment) is malfunctioning, damaged or broken, the Emergency Call cannot be made.
 - During an Emergency Call, the system makes repeated attempts to connect to the ERA-GLONASS/EVAK control center. However, if it cannot connect to the ERA-GLONASS/EVAK control center due to poor radio wave reception, the system may not be able to connect to the cellular network and the call may finish without connecting. The red indicator light will blink for approximately 30 seconds to indicate this disconnection.
 - This device may not function if a shock is applied to it.
- If the battery’s voltage decreases or there is a disconnection, the system may not be able to connect to the ERA-GLONASS/EVAK control center.

■ When the Emergency Call system is replaced with a new one

The Emergency Call system should be registered. Contact any authorized Toyota retailer or Toyota authorized repairer, or any reliable repairer.

 WARNING**■ For your safety**

- Please drive safely.

The function of this system is to assist you in making the Emergency Call in case of accidents such as traffic accidents or sudden medical emergencies, and it does not protect the driver or passengers in any way. Please drive safely and fasten your seatbelts at all times for your safety.

- In case of an emergency, make lives the top priority.
- If you smell anything burning or other unusual smells, leave the vehicle and evacuate to a safe area immediately.
- Since the system detects shocks, the automatic reporting may not always occur synchronized with the operation of the airbag system. (If the vehicle is struck from behind, etc.)
- For safety, do not make the Emergency Call while driving.

Making calls during driving may cause mishandling of the steering wheel, which may lead to unexpected accidents.

Stop the vehicle and confirm the safety of your surroundings before making the Emergency Call.

- When changing fuses, please use the specified fuses. Using other fuses may cause ignition or smoke in the circuit and lead to a fire.
- Using the system while there is smoke or an unusual smell may cause a fire. Stop using the system immediately and consult any authorized Toyota retailer or Toyota authorized repairer, or any reliable repairer.

 NOTICE**■ To prevent damage**

Do not pour any liquids onto the “SOS” button panel, etc. and do not impact it.

■ If the “SOS” button panel, speaker or microphone malfunctions during an Emergency Call or manual maintenance check

It may not be possible to make Emergency Calls, confirm the system status, or communicate with the ERA-GLONASS/EVAK control center operator. If any of the above equipment is damaged, please consult any authorized Toyota retailer or Toyota authorized repairer, or any reliable repairer.

Engine immobilizer system

The vehicle's keys have built-in transponder chips that prevent the engine from starting if a key has not been previously registered in the vehicle's on-board computer.

Never leave the keys inside the vehicle when you leave the vehicle.

This system is designed to help prevent vehicle theft but does not guarantee absolute security against all vehicle thefts.

Vehicles without smart entry & start system:

The indicator light flashes after the key has been removed from the engine switch to indicate that the system is operating.

The indicator light stops flashing after the registered key has been inserted into the engine switch to indicate that the system has been canceled.

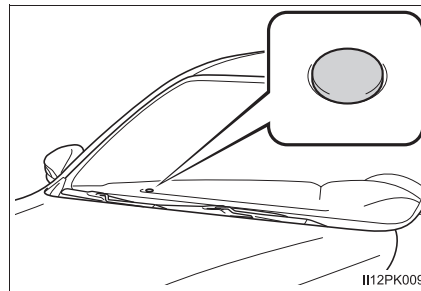

Vehicles with smart entry & start system:

The indicator light flashes after the engine switch has been turned off to indicate that the system is operating.

The indicator light stops flashing after the engine switch has been turned to ACCESSORY or IGNITION ON mode to indicate that the system has been canceled.

■ **System maintenance**

The vehicle has a maintenance-free type engine immobilizer system.

■ **Conditions that may cause the system to malfunction**

- If the grip portion of the key is in contact with a metallic object
- If the key is in close proximity to or touching a key to the security system (key with a built-in transponder chip) of another vehicle



NOTICE

■ **To ensure the system operates correctly**

Do not modify or remove the system. If modified or removed, the proper operation of the system cannot be guaranteed.

Alarm*

The alarm

The alarm uses light and sound to give an alert when an intrusion is detected.

The alarm is triggered in the following situations when the alarm is set:

- ▶ Models for model code destination Blank* (except for Kazakhstan)
- A locked door is opened in any way other than using the entry function (vehicles with smart entry & start system), wireless remote control or mechanical key.
- The hood is opened.
- ▶ Models for model code destination W*, and Kazakhstan
- A locked door is opened in any way other than using the entry function (vehicles with smart entry & start system) or wireless remote control.
- The hood is opened.

*: See "Checking your vehicle's model" if you are not sure of which model your vehicle is. (→P. 12)

*: If equipped

1

For safety and security

Setting the alarm system

Close the doors and hood, and lock all the doors using the entry function (vehicles with smart entry & start system) or wireless remote control. The system will be set automatically after 30 seconds.

Models for model code destination Blank* (except for Kazakhstan): The alarm can also be set using the mechanical key.

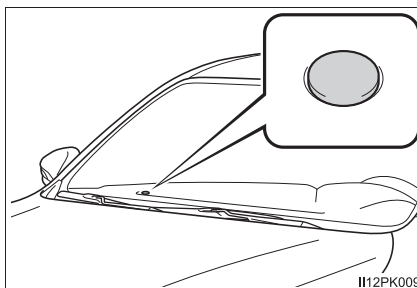

The indicator light changes from being on to flashing when the system is set.

*: See "Checking your vehicle's model" if you are not sure of which model your vehicle is. (→P. 12)

Deactivating or stopping the alarm

Do one of the following to deactivate or stop the alarms:

- ▶ Models for model code destination Blank* (except for Kazakhstan)
 - Unlock the doors.
 - Start the engine. (The alarm will be deactivated or stopped after a few seconds.)
- ▶ Models for model code destination W*, and Kazakhstan
 - Unlock the doors using the entry function (vehicles with smart entry & start system) or the wireless remote control.
 - Start the engine. (The alarm will be deactivated or stopped after a few seconds.)

*: See "Checking your vehicle's model" if you are not sure of which model your vehicle is. (→P. 12)

■ System maintenance

The vehicle has a maintenance-free type alarm system.

■ Items to check before locking the vehicle

To prevent unexpected triggering of the alarm and vehicle theft, make sure of the following:

- Nobody is in the vehicle.
- The windows are closed before the alarm is set.
- No valuables or other personal items are left in the vehicle.

■ Triggering of the alarm

The alarm may be triggered in the following situations:
(Stopping the alarm deactivates the alarm system.)

- Models for model code destination W*, and Kazakhstan: The doors are unlocked using the key and are opened.

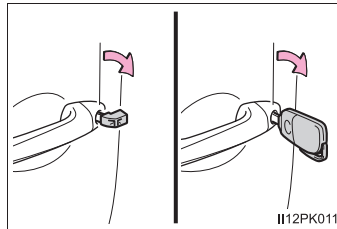

- A person inside the vehicle opens a door or hood.

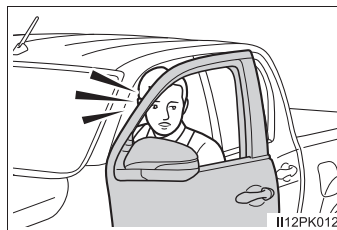

*: See "Checking your vehicle's model" if you are not sure of which model your vehicle is. (→P. 12)

⚠ NOTICE

■ To ensure the system operates correctly

Do not modify or remove the system. If modified or removed, the proper operation of the system cannot be guaranteed.

Instrument cluster

2

2. Instrument cluster

Warning lights
and indicators 122
Gauges and meters 130
Multi-information display 135
Fuel consumption
information 144

Warning lights and indicators

The warning lights and indicators on the instrument cluster and center panel inform the driver of the status of the vehicle's various systems.

For the purpose of explanation, the following illustrations display all warning lights and indicators illuminated.

► Vehicles without multi-information display

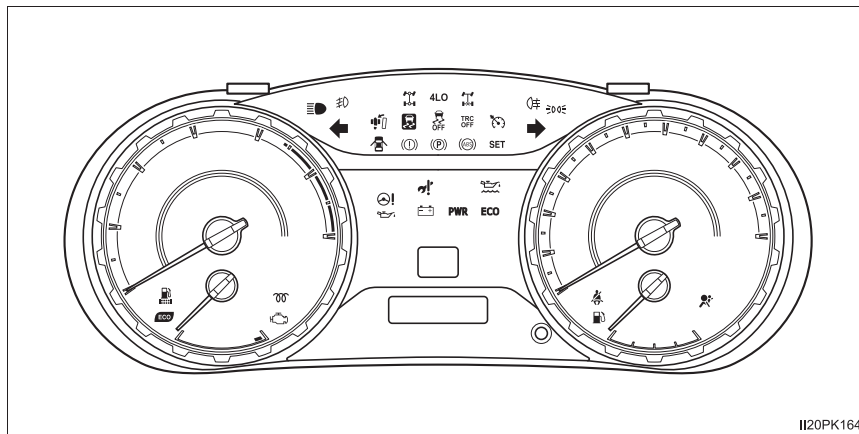



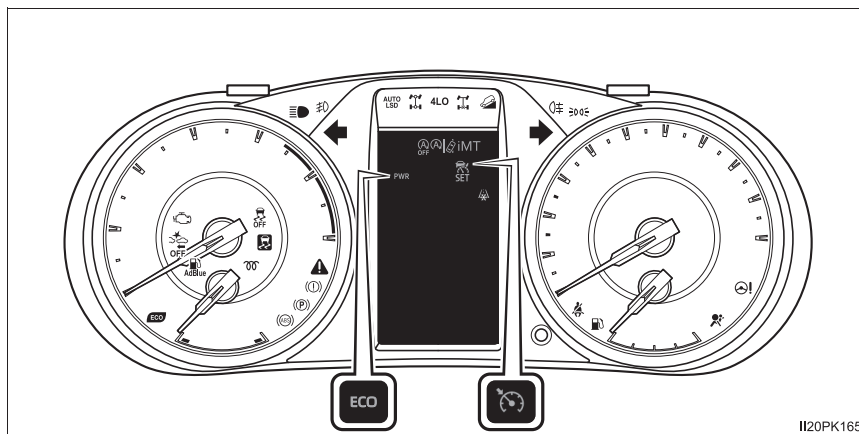











► Vehicles with multi-information display















The positions of some warning lights and indicators differ depending on vehicles.

Warning lights

Warning lights inform the driver of malfunctions in the indicated vehicle's systems.

<p>^{*1}</p> 	<p>Brake system warning light (→P. 566)</p>	<p>^{*1}</p> 	<p>Slip indicator (→P. 568)</p> <p>(if equipped)</p>
<p>^{*1, 2}</p> 	<p>Charging system warning light (→P. 566)</p> <p>(if equipped)</p>	<p>^{*4}</p> 	<p>Four-wheel drive indicator light (→P. 568)</p> <p>(Flashes)</p> <p>(if equipped)</p>
<p>^{*1, 2}</p> 	<p>Low engine oil pressure warning light (→P. 566)</p> <p>(if equipped)</p>	<p>^{*4}</p> 	<p>Low speed four-wheel drive indicator light (→P. 568)</p> <p>(Flashes)</p> <p>(if equipped)</p>
<p>^{*1, 3}</p> 	<p>Malfunction indicator lamp (→P. 567)</p> <p>(Flashes or illuminates)</p>	<p>^{*4}</p> 	<p>Rear differential lock indicator light (→P. 568)</p> <p>(Flashes)</p> <p>(if equipped)</p>
<p>^{*1}</p> 	<p>SRS warning light (→P. 567)</p>	<p>^{*1}</p> 	<p>Fuel system warning light (→P. 569)</p> <p>(Flashes or illuminates)</p> <p>(if equipped)</p>
<p>^{*1}</p> 	<p>ABS warning light (→P. 567)</p>	<p>^{*1, 2, 5}</p> 	<p>Brake Override System warning light (→P. 569)</p> <p>(Flashes or illuminates)</p> <p>(if equipped)</p>
<p>^{*1}</p> 	<p>Power steering system warning light (→P. 567)</p> <p>(if equipped)</p>	<p>^{*1}</p> 	<p>PCS warning light (→P. 569)</p> <p>(Flashes or illuminates)</p> <p>(if equipped)</p>

 (Yellow) (if equipped)	LDA indicator (→P. 570)	 (if equipped)	*1 Low engine oil level warning light (→P. 570)
 (if equipped)	*6 Cruise control indicator (→P. 569)	 (Flashes or illuminates) (if equipped)	*1 Master warning light (→P. 570)
 (if equipped)	*2 Open door warning light (→P. 570)	 (Flashes) (if equipped)	*1, 5 Stop & Start cancel indicator (→P. 570)
 (Flashes or illuminates)	Driver's and front passenger's seat belt reminder light (→P. 570)		Parking brake indicator light (→P. 571)
 (Flashes or illuminates) (if equipped)	*7 Rear passengers' seat belt reminder lights (→P. 570)	 (if equipped)	Low AdBlue™ level warning light (→P. 571)
	Low fuel level warning light (→P. 570)	 (Flashes) (if equipped)	*1 "AUTO LSD" indicator (→P. 571)
		 (if equipped)	Go to service warning light (→P. 571)





















*1: These lights turn on when the engine switch is turned to the "ON" position (vehicles without smart entry & start system) or IGNITION ON mode (vehicles with smart entry & start system) to indicate that a system check is being performed. They will turn off after the engine is started, or after a few seconds. There may be a malfunction in a system if a light does not come on, or if the lights do not turn off. Have the vehicle inspected by any authorized Toyota retailer or Toyota authorized repairer, or any reliable repairer.

*2: Vehicles with multi-information display: a indicator is displayed on the multi-information display.

- *3: The light turns on or flashes to indicate a malfunction.
- *4: The light flashes rapidly to indicate a malfunction.
- *5: The light flashes to indicate a malfunction.
- *6: The light turns to yellow to indicate a malfunction. (vehicles without multi-information display)
- *7: The lights illuminate on the center panel.

Indicators

The indicators inform the driver of the operating state of the vehicle's various systems.

	Turn signal indicator (→P. 246)		Dynamic radar cruise control indicator (→P. 301)
	Headlight high beam indicator (→P. 250)		Cruise control "SET" indicator (→P. 301, 317)
	Tail light indicator (→P. 248)		Downhill assist control system indicator (→P. 364)
	Front fog light indicator (if equipped) (→P. 255)		Slip indicator (→P. 356)
	Rear fog light indicator (if equipped) (→P. 256)		VSC OFF indicator (→P. 357)
	Eco Driving Indicator Light (→P. 128)		"TRC OFF" indicator (→P. 357)
	Stop & Start indicator (if equipped) (→P. 345)		Four-wheel drive indicator (→P. 331)
	Stop & Start cancel indicator (→P. 346)		Low speed four-wheel drive indicator light (→P. 331)
	Engine preheating indicator (→P. 220, 223) (diesel engine)		Rear differential lock indicator (→P. 341)
	Cruise control indicator (if equipped) (→P. 301, 317)		"ECO" indicator (→P. 233, 240)



(if equipped)

“PWR” indicator
(→P. 233, 240)



(if equipped)

Low outside
temperature indicator
(→P. 131)



(if equipped)

“iMT” indicator
(→P. 241)



Parking brake indicator
light (→P. 247)

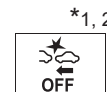

(if equipped)

*1, 2

PCS warning light
(→P. 273)



(if equipped)

*1

“AUTO LSD” indicator
(→P. 367)



(if equipped)

*4

LDA indicator (→P. 290)



(if equipped)

*1, 5

“PASSENGER AIR
BAG” indicator
(→P. 57, 62)

- *1: These lights turn on when the engine switch is turned to the “ON” position (vehicles without smart entry & start system) or IGNITION ON mode (vehicles with smart entry & start system) to indicate that a system check is being performed. They will turn off after the engine is started, or after a few seconds. There may be a malfunction in a system if a light does not come on, or if the lights do not turn off. Have the vehicle inspected by any authorized Toyota retailer or Toyota authorized repairer, or any reliable repairer.
- *2: The light turns on when the system is turned off.
- *3: The light flashes to indicate that the system is operating.
- *4: Depending on the operating condition, the color and illuminating/flashing state of the light change.
- *5: The light illuminates on the center panel.
- *6: The light turns to green.

■ Eco Driving Indicator

- ① Eco Driving Indicator Light
 Vehicles with automatic transmission:
 During Eco-friendly acceleration (Eco driving), Eco Driving Indicator Light will turn on. When the accelerator pedal is depressed excessively, or when the vehicle is stopped, the light turns off.
 Vehicles with manual transmission:
 During Eco-friendly acceleration or in Eco-friendly shift position (Eco driving), Eco Driving Indicator Light will turn on. When the accelerator pedal is depressed excessively, or when the vehicle is stopped, the light turns off.

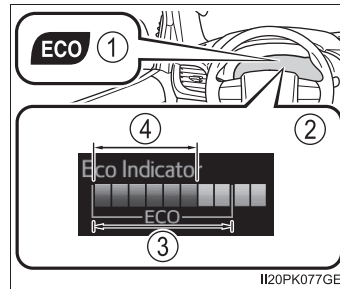

- ② Eco Driving Indicator Zone Display (if equipped)
 Suggests Zone of Eco driving with current Eco driving ratio based on acceleration.
- ③ Zone of Eco driving
- ④ Eco driving ratio based on acceleration
 If the vehicle exceeds Zone of Eco driving, the right side of Eco Driving Indicator Zone Display will illuminate.

Eco Driving Indicator Light and Eco Driving Indicator Zone Display will not operate in the following conditions:

- The shift lever is in anything other than D. (vehicles with automatic transmission)
- The shift lever is in R. (vehicles with manual transmission)
- A paddle shift switch is operated. (vehicles with paddle shift switches)
- The vehicle is in the power mode. (if equipped) (→P. 233, 240)
- Downhill assist control system is operating. (if equipped) (→P. 364)
- Front-wheel drive control switch is in L4. (if equipped) (→P. 331)
- The vehicle speed is approximately 130 km/h (81 mph) or higher.

Eco Driving Indicator Light can be activated or deactivated.

Vehicles without multi-information display:

While the odometer is being displayed, press and hold the odometer/trip meter display change button to display the Eco Driving Indicator Light customization screen.

Press the odometer/trip meter display change button to set Eco Driving Indicator Light to on or off.

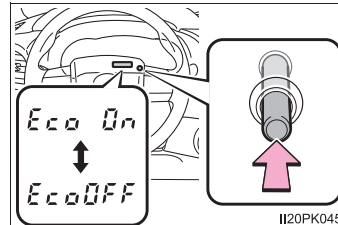

Press and hold the odometer/trip meter display change button for more than 2 seconds to complete the setting.

Vehicles with multi-information display: →P. 647

⚠ WARNING

■ **If a safety system warning light does not come on**

Should a safety system light such as ABS and the SRS warning light not come on when you start the engine, this could mean that these systems are not available to help protect you in an accident, which could result in death or serious injury. Have the vehicle inspected by any authorized Toyota retailer or Toyota authorized repairer, or any reliable repairer immediately if this occurs.

Gauges and meters

► Vehicles without multi-information display

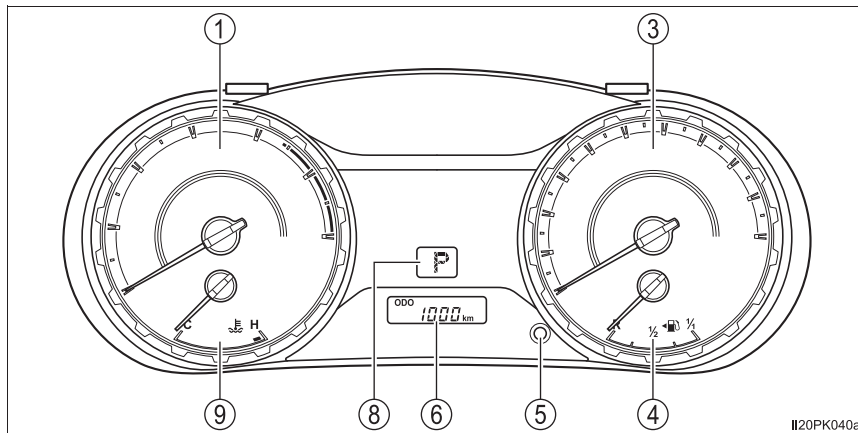

► Vehicles with multi-information display

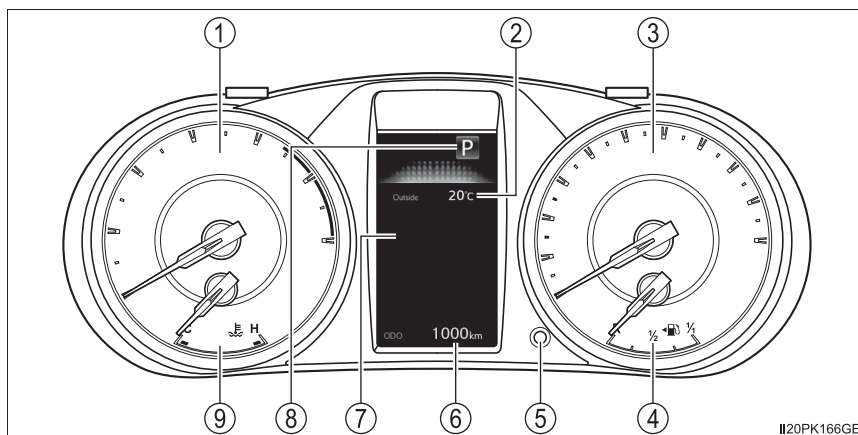

The units used on the speedometer may differ depending on the target region, and the positions of the outside temperature and shift position indicators differ depending on vehicles.

- ① Tachometer
Displays the engine speed in revolutions per minute.
- ② Outside temperature
Displays the outside temperature. The temperature range that can be displayed is from -40°C (-40°F) to 50°C (122°F). The low outside temperature indicator comes on when the ambient temperature is approximately 3°C (37°F) or lower, and goes off when approximately 5°C (41°F) or higher. (→P. 127)
- ③ Speedometer
Displays the vehicle speed.
- ④ Fuel gauge
Displays the quantity of fuel remaining in the tank.
- ⑤ Odometer/trip meter display change button
→P. 132
- ⑥ Odometer and trip meter
Odometer:
Displays the total distance the vehicle has been driven.
Trip meter:
Displays the distance the vehicle has been driven since the meter was last reset. Trip meters A and B can be used to record and display different distances independently.
- ⑦ Multi-information display
Presents the driver with a variety of driving-related data. (→P. 135)
- ⑧ Shift position and shift range (automatic transmission)
Displays the selected shift position or selected shift range. (→P. 231)
- ⑨ Engine coolant temperature gauge
Displays the engine coolant temperature.

Changing the display

► Vehicles without multi-information display

Pressing this button switches between odometer and trip meter displays.

- ① Odometer
- ② Trip meter A*
- ③ Trip meter B*

*: Pressing and holding the button will reset the trip meter.

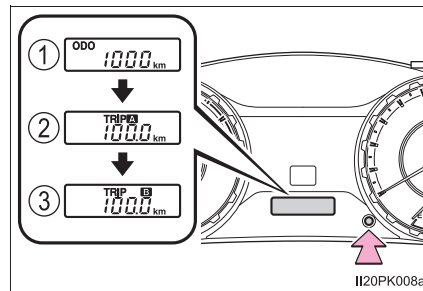

► Vehicles with multi-information display

Pressing this button switches among odometer, trip meter and instrument panel light control displays.

- ① Odometer
- ② Trip meter A*¹
- ③ Trip meter B*¹
- ④ Instrument panel light control display*²

*¹: Pressing and holding the button will reset the trip meter.

*²: Pressing and holding the button will adjust brightness of the instrument panel lights.

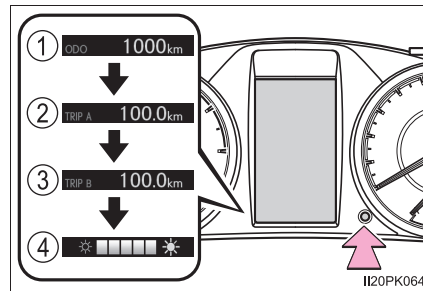

■ The meters illuminate when

The engine switch is in the "ON" position (vehicles without smart entry & start system) or IGNITION ON mode (vehicles with smart entry & start system).

■ The brightness of the instrument panel lights (vehicles with multi-information display)

The instrument panel brightness levels when the tail lights are on and off can be adjusted individually.

When the headlight switch is turned to on, the brightness will be reduced slightly unless the instrument panel brightness level is set to the brightest setting.

■ When disconnecting and reconnecting battery terminals

The trip meter data will be reset.

■ Outside temperature display

In the following situations, the correct outside temperature may not be displayed, or the display may take longer than normal to change:

- When the vehicle is stopped, or moving at low speeds (less than 25 km/h [15 mph])
- When the outside temperature has changed suddenly (at the entrance/exit of a garage, tunnel, etc.)

■ When "--" is displayed

The system may be malfunctioning. Take your vehicle to any authorized Toyota retailer or Toyota authorized repairer, or any reliable repairer.

 WARNING**■ The information display at low temperatures (vehicles with multi-information display)**

Allow the interior of the vehicle to warm up before using the liquid crystal information display. At extremely low temperatures, the display monitor may respond slowly, and display changes may be delayed.

For vehicles with automatic transmission: For example, there is a lag between the driver's shifting and the new gear number appearing on the display. This lag could cause the driver to downshift again, causing rapid and excessive engine braking and possibly an accident resulting in death or injury.

 NOTICE**■ To prevent damage to the engine and its components**

- Do not let the indicator needle of the tachometer enter the red zone, which indicates the maximum engine speed.
- The engine may be overheating if the engine coolant temperature gauge is in the red zone (H). In this case, immediately stop the vehicle in a safe place, and check the engine after it has cooled completely. (→P. 610)

Multi-information display*

Display contents

The multi-information display presents the driver with a variety of vehicle data.

The following information will be displayed when a menu icon is selected.

Menu icons are displayed for a few seconds when the meter control switches (→P. 136) are operated.

On the area, normally the outside temperature is displayed.

(→P. 130)

Some of the information may be displayed automatically depending on the situation.

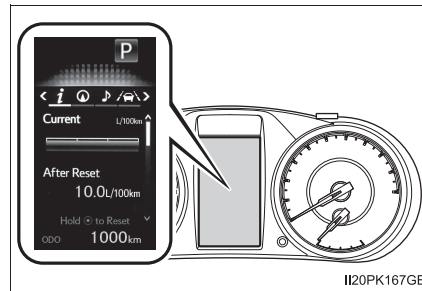

2

Instrument cluster

Drive information

Select to display various drive data. (→P. 137)

Navigation system-linked display (if equipped)

Select to display the following navigation system-linked information.

- Route guidance
- Compass display

Audio system-linked display (if equipped)

Select to enable selection of an audio source or track on the meter using the meter control switches.

Driving support system information (if equipped)

Select to display the operational status of the following systems:

- LDA (Lane Departure Alert With Yaw Assist Function) (→P. 284)
- RSA (Road Sign Assist) (→P. 295)
- Dynamic radar cruise control (→P. 301)

*: If equipped



Warning message display

Select to display warning messages and measures to be taken if a malfunction is detected. (→P. 575)



Settings display

Select to change the meter display settings. (→P. 647)

Operating the meter control switches

The multi-information display is operated using the meter control switches.

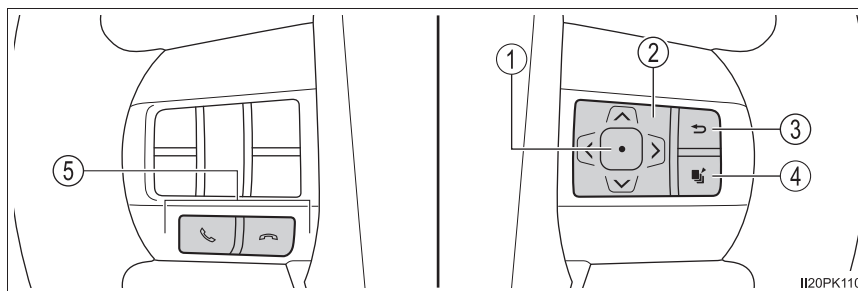

- ① Enter/Set
- ② Select an item/Change pages
- ③ Return to the previous screen
- ④ Press: Displays the screen registered as the top screen
 When no screen has been registered, the drive information screen will be displayed.
 Press and hold: Registers the currently displayed screen as the top screen
 When the confirmation screen is displayed, select yes to register the screen. If the selected screen cannot be registered, a registration failure message will be shown.
- ⑤ Incoming call display (if equipped)
 Linked with the hands-free system, incoming call is displayed. For details regarding the hands-free system, refer to "Navigation and multimedia system Owner's manual" or "Multimedia Owner's Manual".

Drive information

Items displayed can be switched by pressing “<” or “>” of the meter control switches to select  and pressing “^” or “v”.

■ Drive information 1 and 2

- Current fuel economy (bar type/value type)*1, 2

Displays the current rate of fuel consumption.

- Average fuel economy (after reset*3/after start/after refuel)*1, 2

Displays the average fuel consumption since the function was reset, the engine was started and the vehicle was refueled respectively.

- Average speed (after reset*3/after start)*1

Displays the average vehicle speed since function was reset and the engine was started respectively.

- Elapsed time (after reset*3/after start)*1

Displays the elapsed time since the function was reset and the engine was started respectively.

- Distance (range/after start)*1

Displays the estimated maximum distance that can be driven with the quantity of fuel remaining and the distance driven after the engine was started respectively.

- This distance is computed based on your average fuel consumption. As a result, the actual distance that can be driven may differ from that displayed.
- When only a small amount of fuel is added to the tank, the display may not be updated.

When refueling, turn the engine switch off. If the vehicle is refueled without turning the engine switch off, the display may not be updated.

*1: Can be registered to drive information 1 and 2. (→P. 139)

*2: Use the displayed fuel consumption as a reference.

*3: Resetting procedures:

- Select a function to be reset using the meter control switches and then press and hold  to reset.
- If there is more than one function that can be reset, check boxes will be displayed next to those functions.

■ **Eco Driving Indicator Zone Display/Eco Score**

- Displays Zone of Eco driving with current Eco driving ratio based on acceleration. (→P. 128)
- Displays the eco-driving total count to help improve the customer's eco driving techniques. (→P. 141)

■ **Eco Saving**

Displays the fuel consumption comparison, the average fuel consumption after reset, and the cost of the consumed fuel. (→P. 142)

■ **Steering angle**

Displays the direction of the front tires.

The tire direction is displayed in 3 stages for both left and right, in accordance with the angle of the tire.

While Toyota parking assist-sensor (→P. 321) is operating (if equipped) or any door is not fully closed, the related information is displayed with the direction of the front tires.

If a battery terminal is disconnected and reconnected, the display may be disabled temporarily. After driving the vehicle for a while, the display will be enabled.

■ **Speedometer display**

Displays the vehicle speed.

■ **AdBlue™ gauge (if equipped)**

Displays the quantity of AdBlue™ remaining in the tank. (→P. 143)

Settings display

The settings of the following items can be changed, refer to P. 646

■ LDA (Lane Departure Alert With Yaw Assist Function) (if equipped) (→P. 284)

Select to set up the following items.

- Yaw Assist

Select to enable/disable yaw assist function.

- Warning Sensitivity

Select to set the warning sensitivity.

- Sway Warning Function

Select to enable/disable the vehicle sway warning.

- Sway Warning Sensitivity

Select to set the vehicle sway warning sensitivity.

■ PCS (Pre-Collision System) (if equipped) (→P. 273)

Select to set up the following items.

- PCS On/Off

Select to enable/disable the pre-collision system.

- Sensitivity (adjust alert timing)

Select to change the pre-collision warning timing.

■ RSA (Road Sign Assist) (if equipped) (→P. 295)

Select to set up the following items.

- Road Sign Assist On/Off

Select to enable/disable the RSA system.

- Notification Method (excess speed/No overtaking/others*)

Select to change each notification method used to warn the driver when the system recognizes excess speed, no overtaking and no-entry sign.

*: No-entry notification only. (vehicles with navigation system)

- Notification Level

Select to change each notification level used to warn the driver when the system recognizes a speed limit sign.

■ **DRCC(RSA) (if equipped) (→P. 312)**

Select to enable/disable the Dynamic Radar Cruise Control with Road Sign Assist.

■ **Vehicle Setting**

Idling stop (if equipped)

Select to change the idling stop time (engine stop time via the Stop & Start system) when the air conditioning system is on.

■ **Meter Customization**

● **Language**

Select to change the language on the display.

● **Units**

Select to change the unit for measure of the fuel consumption.

● **Eco Driving Indicator Light**

Select to activate/deactivate the Eco Driving Indicator Light.
(→P. 128)

●  **switch settings**

You can register 1 screen as the top screen. To register, press and hold  while the desired screen is displayed.

● **Drive information 1 and 2**

Select to select up to 2 items that will be displayed on a drive information screen, up to 2 drive information screens can be set.

● **Pop-up display (if equipped)**

Select to set the pop-up displays, which may appear in some situations, on/off.

● **Accent color (if equipped)**

Select to change the accent colors on the screen, such as the cursor color.

- Eco Saving

Select to set or change the fuel consumption comparison and fuel price.

- Initialization

Registered or changed meter settings will be deleted or returned to their default setting.

■ Pop-up display

The pop-up display is displayed on the multi-information display according to the operating conditions of the following functions:

- Route guidance display of the navigation system-linked system (if equipped)
- Incoming call display of the hands-free phone system (if equipped)
- Stop & Start system operation time (if equipped)
- Stop & Start system operation status (if equipped)

The pop-up display function can be set on/off. (→P. 647)

■ Eco Score

Driving conditions are displayed in 5 stages and divided into 3 categories: start, cruise and stop. Every time the vehicle is stopped, the score is displayed. (Every time the vehicle is accelerated the score that was last displayed is reset. Accumulative scores are not calculated.)

① Eco Score

Totals the counts of the eco start, eco cruise and eco stop, and displays the result.

② Eco start

Displays the eco level calculated from degree of acceleration when starting the vehicle

③ Eco cruise

Displays the eco level calculated from acceleration operation amount when driving the vehicle

④ Eco stop

Displays the eco level calculated from time between releasing the accelerator pedal and vehicle stop

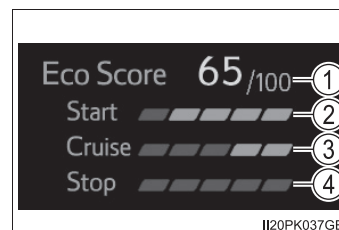

If the accelerator pedal is not depressed, such as when the vehicle is driven using cruise control (if equipped) or dynamic radar cruise control (if equipped), the driven distance is not included in the Eco Score.

The Eco Score evaluation differs depending on the driving conditions and environmental factors. The Eco Score may not be linked to fuel consumption. The Eco Score will not operate in the following conditions:

- The vehicle speed is approximately 130 km/h (80 mph) or higher.
- The shift lever is in a position other than D. (vehicles with automatic transmission)
- A paddle shift switch is operated. (vehicles with paddle shift switches)
- Front-wheel drive control switch is in L4. (if equipped)
- Downhill assist control system is operating. (if equipped)
- The vehicle is in the power mode. (if equipped)

■ Eco Saving

Displays the fuel consumption comparison, the average fuel consumption after reset, and the cost of the consumed fuel.

① Fuel consumption comparison

Displays the set fuel consumption that is compared with the actual fuel consumption.

② Average fuel consumption after reset

Displays the average fuel consumption since the function was reset.

- The function can be reset by pressing  more than 1 second when the average fuel consumption after reset is displayed
- Use the average fuel consumption as a reference



③ Savings/fuel cost

Displays the possible savings if the fuel consumption comparison is set, and displays the actual fuel cost if the fuel consumption comparison is not set.

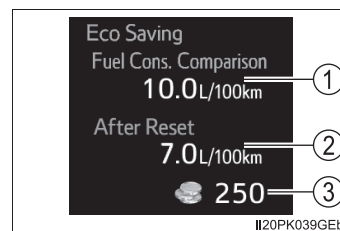
Use the displayed fuel cost and savings as a reference. Depending on refueling methods, driving conditions and environmental factors, the displayed fuel cost may differ from the actual fuel cost, and in some cases, the fuel cost and savings may not be linked to the Eco Score evaluation.



■ Eco Saving setting

The fuel price and fuel consumption comparison settings can be set in the settings display. Use the meter control switches to select  while the vehicle is stopped and press , and select "Eco Saving" and press .

■ AdBlue™ gauge (if equipped)

Displays the quantity of AdBlue™ remaining in the tank.

- ① Full
- ② Empty

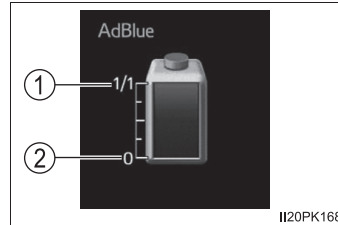

■ Setting display automatic cancelation

In the following situations, setting display in which the settings can be changed through the meter control switches will automatically be turned off.

- If a warning message appears while the setting display is displayed
- When the vehicle begins to move while the setting display is displayed

■ When disconnecting and reconnecting battery terminals

The drive information data and settings will be reset.

■ Liquid crystal display

Small spots or light spots may appear on the display. This phenomenon is characteristic of liquid crystal displays, and there is no problem continuing to use the display.



WARNING

■ Caution for use while driving

- When operating the multi-information display while driving, pay extra attention to the safety of the area around the vehicle.
- Do not look continuously at the multi-information display while driving as you may fail to see pedestrians, objects on the road, etc. ahead of the vehicle.

■ Eco Score

Use the Eco Score as a reference. Always drive safely in accordance with road and traffic conditions.

Fuel consumption information*

The fuel consumption information can be displayed on the navigation system or multimedia system type A* screen.

*: See “How to identify multimedia system type” to check the type of your multimedia system. (→P. 146)

- ① Navigation system or multimedia system screen
- ② “MENU” button
- ③ “INFO” button (if equipped)

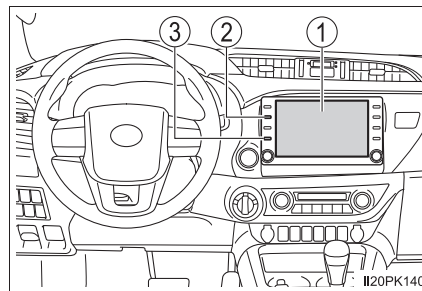

This illustration is for a left-hand drive vehicle. These button positions are reversed for right-hand drive vehicles.

Displaying trip information or history screen

- ▶ When using “INFO” button

Press the “INFO” button.

- ▶ When using “MENU” button

- ① Press the “MENU” button.
- ② Select “Info” on the “Menu” screen.

*: If equipped

Fuel consumption

■ Trip information

If the trip information screen does not appear, select “Trip Information”.

- ① Fuel consumption in the past 15 minutes
- ② Current fuel consumption
- ③ Reset the trip information data
- ④ “History” screen appears
- ⑤ Cruising range
- ⑥ Elapsed time since the engine was started
- ⑦ Average vehicle speed since the engine was started

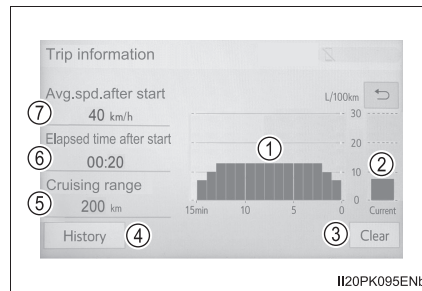

Average fuel consumption for the past 15 minutes is divided by color into past averages and averages attained since the engine switch was last turned to the “ON” position (vehicles without smart entry & start system) or IGNITION ON mode (vehicles with smart entry & start system). Use the displayed average fuel consumption as a reference.

These images are examples only, and may vary slightly from actual conditions.

History

If the history screen does not appear, select “History”.

- ① Best recorded fuel consumption
- ② Latest fuel consumption
- ③ Previous fuel consumption record
- ④ Reset the history data
- ⑤ Update the latest fuel consumption data
- ⑥ “Trip Information” screen appears

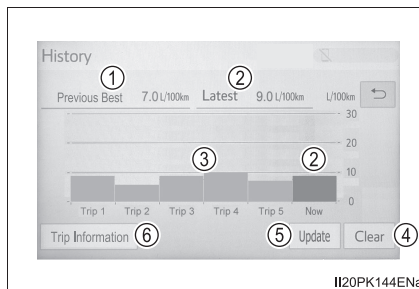

The average fuel consumption history is divided by color into past averages and the average fuel consumption since the last updated. Use the displayed average fuel consumption as a reference. These images are examples only, and may vary slightly from actual conditions.

How to identify multimedia system type

Check the type of the multimedia system in the following illustrations.

▶ Type A

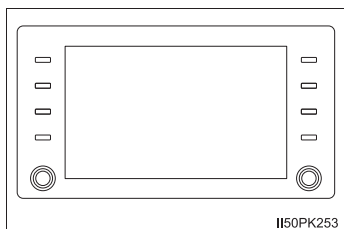

▶ Type B

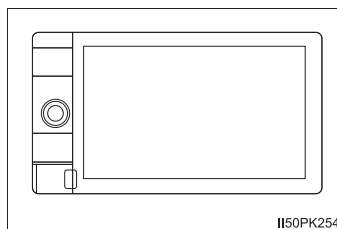

Updating the history data

Update the latest fuel consumption by selecting “Update” to measure the current fuel consumption again.

Resetting the data

The fuel consumption data can be deleted by selecting “Clear”.

Cruising range

Displays the estimated maximum distance that can be driven with the quantity of fuel remaining.

This distance is computed based on your average fuel consumption. As a result, the actual distance that can be driven may differ from that displayed.

**Operation of
each component****3**

3-1. Key information	
Keys.....	148
3-2. Opening, closing and locking the doors	
Side doors.....	153
Access panels (smart-cab models only)	159
Tailgate	160
Smart entry & start system	163
3-3. Adjusting the seats	
Front seats.....	170
Rear seats	172
Head restraints	175
3-4. Adjusting the steering wheel and mirrors	
Steering wheel.....	178
Inside rear view mirror	180
Outside rear view mirrors	182
3-5. Opening and closing the windows	
Power windows.....	185
Quarter windows (smart-cab models).....	189

Keys

The keys

The following keys are provided with the vehicle.

► Type A

- ① Master keys
- ② Valet key
- ③ Key number plate

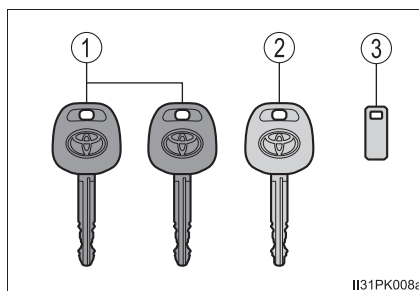

► Type B

- ① Master keys
 - Operating the wireless remote control function (→P. 149)
- ② Valet key
- ③ Key number plate

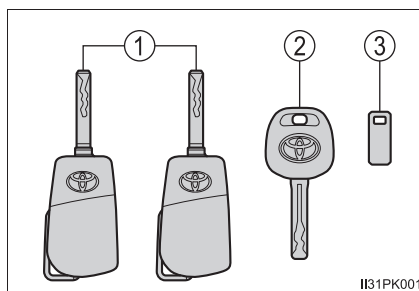

► Type C (vehicles with smart entry & start system)

- ① Electronic keys
 - Operating the smart entry & start system (→P. 163)
 - Operating the wireless remote control function (→P. 149)
- ② Mechanical keys
- ③ Key number plate
- ④ Mechanical keys (supplementary keys)
 - Locking and unlocking the tailgate (→P. 160)

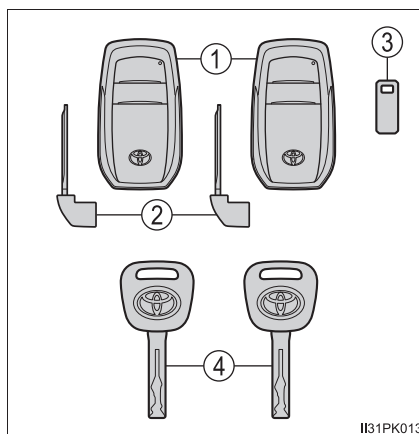

Wireless remote control (if equipped)

▶ Vehicles without smart entry & start system

- ① Locks all the doors (→P. 153)
Check that the door is securely locked.
 - ② Unlocks all the doors (→P. 153)
 - ③ Sounds the alarm* (→P. 150)
- *: If equipped

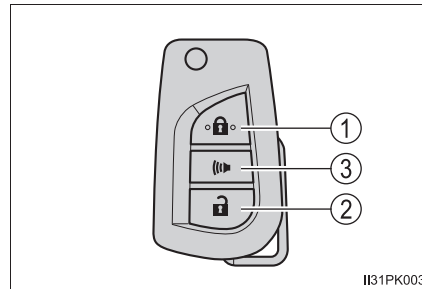

▶ Vehicles with smart entry & start system

- ① Locks all the doors (→P. 153)
Check that the door is securely locked.
- ② Unlocks all the doors (→P. 153)

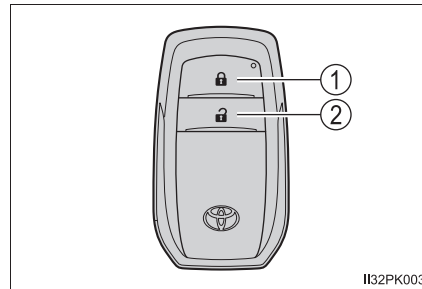
**Using the master key (type B)**

- ① Releasing
To release the key, press the button.
- ② Folding
To stow the key back in its case, push the key back to the stowed position while pressing the button.

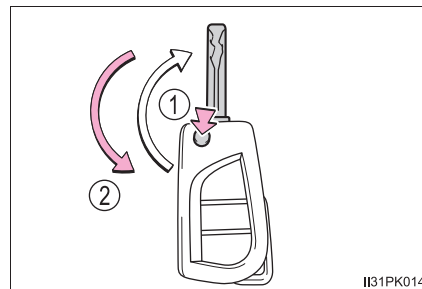

Using the mechanical key (vehicles with smart entry & start system)

To take out the mechanical key, slide the release lever and take the key out.

The mechanical key can only be inserted in one direction, as the key only has grooves on one side. If the key cannot be inserted in a lock cylinder, turn it over and re-attempt to insert it.

After using the mechanical key, store it in the electronic key. Carry the mechanical key together with the electronic key. If the electronic key battery is depleted or the entry function does not operate properly, you will need the mechanical key. (→P. 600)

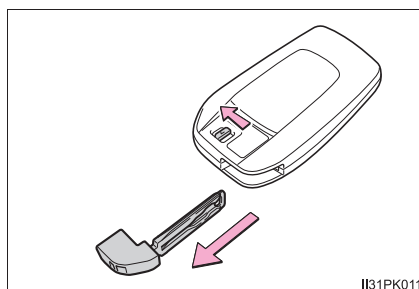

II31PK011

■ Panic mode (if equipped)

When  is pressed for longer than about one second, an alarm will sound intermittently and the vehicle lights will flash to deter any person from trying to break into or damage your vehicle.

To stop the alarm, press any button on the wireless remote control.



II31PK108

■ When required to leave the vehicle's key with a parking attendant

Lock the glove box as circumstances demand. (→P. 457)

▶ Vehicles without smart entry & start system

Carry the master key for your own use and provide the attendant with the valet key.

▶ Vehicles with smart entry & start system

Remove the mechanical key for your own use and provide the attendant with the electronic key only. If there is the supplementary key, carry the supplementary key for your own use as well as the mechanical key.

■ If you lose your keys

New genuine keys can be made by any authorized Toyota retailer or Toyota authorized repairer, or any reliable repairer using a master key (vehicles without smart entry & start system) or the other key of the same type (vehicles with smart entry & start system), and the key number stamped on your key number plate. Keep the plate in a safe place such as your wallet, not in the vehicle.

■ When riding in an aircraft (type B and C)

When bringing a key with wireless remote control function onto an aircraft, make sure you do not press any buttons on the key while inside the aircraft cabin. If you are carrying the key in your bag etc., ensure that the buttons are not likely to be pressed accidentally. Pressing a button may cause the key to emit radio waves that could interfere with the operation of the aircraft.

■ Key battery depletion

▶ Vehicles without smart entry & start system

If the wireless remote control function does not operate, the battery may be depleted. Replace the battery when necessary. (→P. 516)

▶ Vehicles with smart entry & start system

→P. 168

■ If a message regarding the state of the electronic key or engine switch mode, etc. is shown

To prevent trapping the electronic key inside the vehicle, leaving the vehicle without turning off the engine switch or other passengers from unintentionally taking the key out of the vehicle, etc., a message that prompts the user to confirm the state of the electronic key or engine switch mode may be shown on the multi-information display. In those cases, follow the instructions on the display immediately.

■ If “Key battery low” is shown on the multi-information display

The electronic key has a low battery. Replace the electronic key battery.

■ Replacing the electronic key battery

→P. 516

■ Confirmation of the registered key number

The number of keys already registered to the vehicle can be confirmed. Ask any authorized Toyota retailer or Toyota authorized repairer, or any reliable repairer for details.



NOTICE

■ To prevent key damage

- Do not drop the keys, subject them to strong shocks or bend them.
- Do not expose the keys to high temperatures for long periods of time.
- Do not get the keys wet or wash them in an ultrasonic washer etc.
- Do not attach metallic or magnetic materials to the keys or place the keys close to such materials.
- Do not disassemble the keys.
- Do not attach a sticker or anything else to the surface of the electronic key.
- Do not place the keys near objects that produce magnetic fields, such as TVs, audio systems and induction cookers, or medical electrical equipment, such as low-frequency therapy equipment.

■ Carrying the electronic key on your person (vehicles with smart entry & start system)

Carry the electronic key 10 cm (3.9 in.) or more away from electric appliances that are turned on. Radio waves emitted from electric appliances within 10 cm (3.9 in.) of the electronic key may interfere with the key, causing the key to not function properly.

■ In case of a smart entry & start system malfunction or other key-related problems (vehicles with smart entry & start system)

Take your vehicle with all the electronic keys provided with your vehicle to any authorized Toyota retailer or Toyota authorized repairer, or any reliable repairer.

■ When an electronic key is lost (vehicles with smart entry & start system)

If the electronic key remains lost, the risk of vehicle theft increases significantly. Visit any authorized Toyota retailer or Toyota authorized repairer, or any reliable repairer immediately with all remaining electronic keys that were provided with your vehicle.

Side doors

The vehicle can be locked and unlocked using the entry function, wireless remote control, key or door lock switch.

Locking and unlocking the doors from outside

◆ Smart entry & start system (if equipped)

While carrying the electronic key, press the button to lock and unlock.

After locking, check that the door is securely locked.

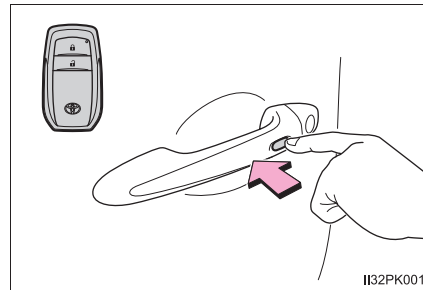

◆ Wireless remote control (if equipped)

▶ Vehicles without smart entry & start system

▶ Vehicles with smart entry & start system

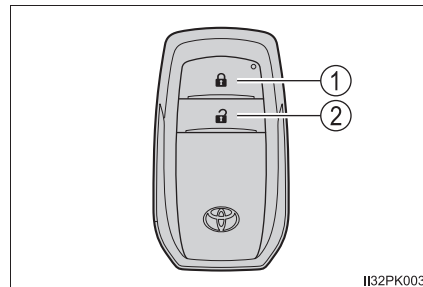
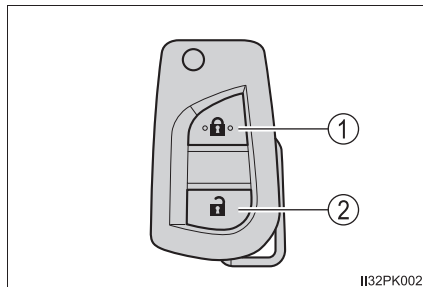

① Locks all the doors

Check that the door is securely locked.

② Unlocks all the doors

◆ **Key**

▶ Vehicles without smart entry & start system

Vehicles without power door lock system:

- ① Locks the door
- ② Unlocks the door

Vehicles with power door lock system:

- ① Locks all the doors
- ② Unlocks all the doors

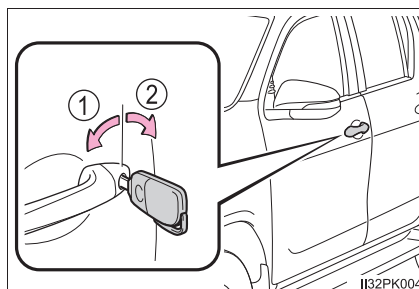

▶ Vehicles with smart entry & start system

The doors can also be locked and unlocked with the mechanical key. (→P. 600)

■ **Operation signals**

A buzzer (if equipped) sounds and the emergency flashers flash to indicate that the doors have been locked/unlocked using the smart entry & start system or the wireless remote control. (Locked: once; Unlocked: twice)

■ **Security feature**

If a door is not opened within approximately 30 seconds after the vehicle is unlocked using the smart entry & start system or the wireless remote control, the security feature automatically locks the vehicle again.

■ **Door lock buzzer (vehicles with wireless remote control and smart entry & start system)**

If an attempt to lock the doors is made when a door is not fully closed, a buzzer sounds continuously for 5 seconds. Fully close the door to stop the buzzer, and lock the vehicle once more.

■ **If the entry function (vehicles with smart entry & start system) or the wireless remote control (if equipped) does not operate properly**

- Vehicles without smart entry & start system: Use the key to lock and unlock the doors. (→P. 154)
- Vehicles with smart entry & start system: Use the mechanical key to lock and unlock the doors. (→P. 600)
- Replace the battery with a new one if it is depleted. (→P. 516)

■ Setting the alarm (if equipped)

Locking the doors will set the alarm system. (→P. 117)

■ If a symbol indicating one or more doors are open is shown on the multi-information display

One or more of the doors is not fully closed. The system also indicates which doors are not fully closed. If the vehicle reaches a speed of 5 km/h (3 mph), master warning light flashes and a buzzer sounds to indicate that the door(s) are not yet fully closed.

Make sure that all the doors are closed.

Locking and unlocking the doors from inside

◆ Door lock switch (if equipped)

- ① Locks all the doors
- ② Unlocks all the doors

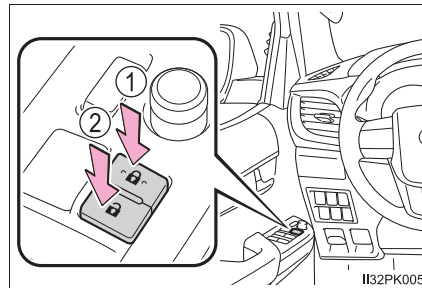

◆ Inside lock button

- ① Locks the door
- ② Unlocks the door

The driver's door can be opened by pulling the inside handle even if the lock button is in the lock position.

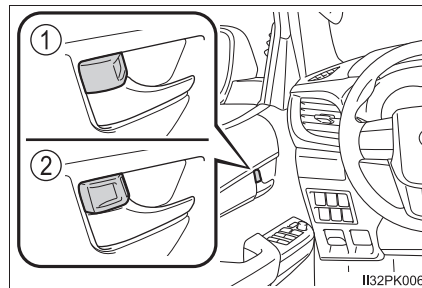

Locking the front doors from the outside without a key

- ① Move the inside lock button to the lock position.
- ② Close the door while pulling the door handle.

Vehicles without smart entry & start system (vehicles with power door lock system): The driver's door cannot be locked if either of the door is open and the key is in the engine switch.

Vehicles with smart entry & start system: The door cannot be locked if the engine switch is in ACCESSORY or IGNITION ON mode, or the electronic key is left inside the vehicle.

However, the key may not be detected correctly and the door may be locked.

Rear door child-protector lock (double-cab models only)

The door cannot be opened from inside the vehicle when the lock is set.

- ① Unlock
- ② Lock

These locks can be set to prevent children from opening the rear doors. Push down on each rear door switch to lock both rear doors.

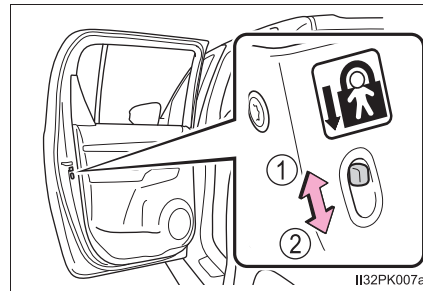



Automatic door locking and unlocking systems (if equipped)

The following functions can be set or canceled:

Function	Operation
Speed linked door locking function	All the doors are locked when the vehicle speed is approximately 20 km/h (12 mph) or higher.
Driver's door linked door unlocking function	All the doors are unlocked when the driver's door is opened within approximately 45 seconds after turning the engine switch off.

■ Setting and canceling the functions



To switch between setting and canceling, follow the procedure below.

- 1 Close all the doors and turn the engine switch to the "ON" position (vehicles without smart entry & start system) or IGNITION ON mode (vehicles with smart entry & start system). (Perform step 2 within 20 seconds.)
- 2 Press and hold the driver's door lock switch ( or ) for approximately 5 seconds and then release.

The switch positions corresponding to the desired function to be set are shown in the following table.

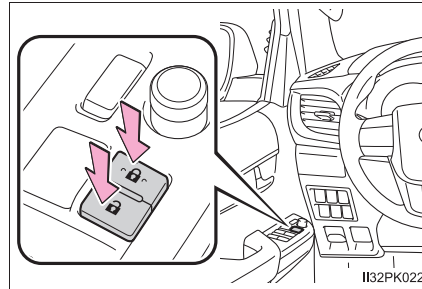
Use the same procedure to cancel the function.



Function	Driver's door lock switch position
Speed linked door locking function	
Driver's door linked door unlocking function	

When the setting or canceling operation is complete, all the doors are locked and then unlocked after the driver's door lock switch is released.

■ Impact detection door lock release system (if equipped)

In the event that the vehicle is subject to a strong impact, all the doors are unlocked. Depending on the force of the impact or the type of accident, however, the system may not operate.

■ Conditions affecting operation**▶ Vehicles without smart entry & start system**

The wireless remote control function may not operate normally in the following situations:

- Near a TV tower, radio station, electric power plant, airport or other facility that generates strong radio waves
- When carrying a portable radio, cellular phone or other wireless communication device
- When multiple wireless keys are in the vicinity
- When the wireless key is in contact with, or is covered by a metallic object
- When a wireless key (that emits radio waves) is being used nearby
- When the wireless key has been left near an electrical appliance such as a personal computer

▶ Vehicles with smart entry & start system

→P. 166

**WARNING****■ To prevent an accident**

Observe the following precautions while driving the vehicle.

Failing to do so may result in a door opening and an occupant falling out, resulting in death or serious injury.

- Ensure that all doors are properly closed and locked.
- Do not pull the inside handle of the doors while driving.
Be especially careful for the driver's door, as the door may be opened even if the inside lock button is in locked position.
- Set the rear door child-protector locks when children are seated in the rear seats.

Access panels (smart-cab models only)

The access panels (rear door) can be opened using the inside handle.

- 1 Open the front door widely.
- 2 Pull (from the outside) or push (from the inside) the inside handle of the access panels.

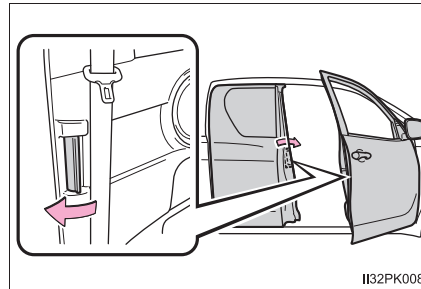

- 3 Open the access panels.

You can open and close the access panels only when the front door is widely opened.

 NOTICE

■ **When opening or closing the front door and access panels**

The front door and access panels could be damaged if they hit each other when being opened or closed.

Tailgate*

The tailgate can be locked/unlocked and opened by the following procedures.

Locking and unlocking the tailgate (vehicles with key hole)

- ① Lock with the master key or the mechanical key
- ② Unlock with the master key or the mechanical key

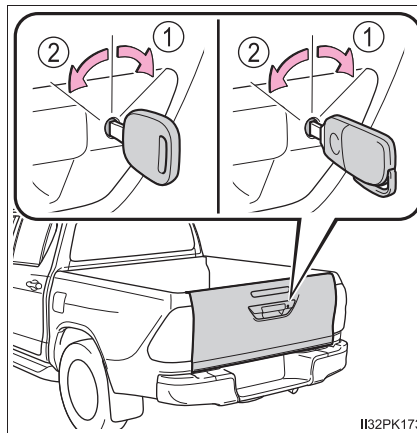

Opening the tailgate

► Type A

Unlock the latches and open the tailgate slowly.

The support stays will hold the tailgate horizontal.

After closing the tailgate, try pulling it toward you to make sure it is securely locked.

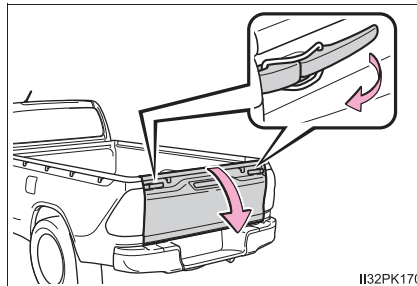

*: If equipped

► Type B

Pull the handle and open the tailgate slowly.

The support stays will hold the tailgate horizontal.

After closing the tailgate, try pulling it toward you to make sure it is securely locked.

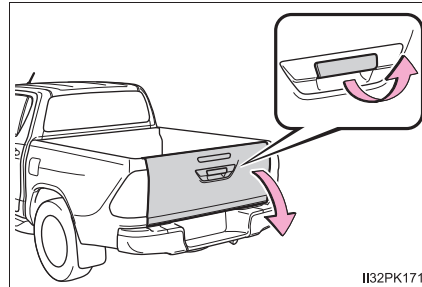

Lowering the tailgate (vehicles without rear bumper)

Release the brackets on the support stays from the lugs on both sides as shown in the illustration.

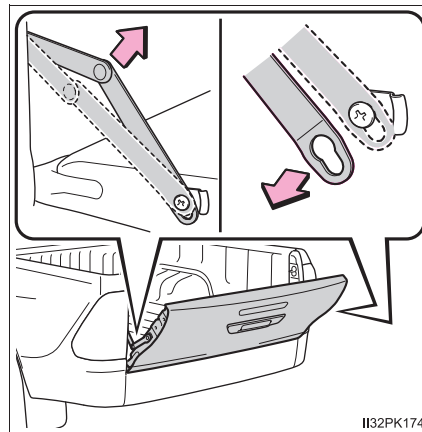

Rear step bumper (if equipped)

The rear step bumper is for rear end protection and easier step-up loading.

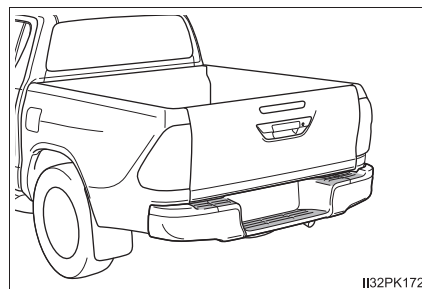

 WARNING

Observe the following precautions.
Failure to do so may result in death or serious injury.

■ **Caution while driving**

- Do not drive with the tailgate open.
- Do not get on the rear step bumper.

■ **When opening or closing the tailgate**

- Check the safety of the surrounding area, and be careful not to catch fingers etc. in the tailgate.
- Do not allow a child to open or close the tailgate. Doing so may cause the child's hand, head, arm or neck to be caught in the tailgate, resulting in death or serious injury.
- On an incline, it may be more difficult to open or close the tailgate than on a level surface.
Also, the tailgate may suddenly open or close. Be careful not to catch fingers etc. in the tailgate.
- When pulling the handle or releasing the support stays, hold and operate them properly. Failure to do so may cause the hands etc. to be caught, resulting in serious injury or an unexpected accident.
- Be careful when opening or closing the tailgate in windy weather, as it may forcefully move.
- After closing the tailgate, make sure it is securely locked.

 NOTICE

■ **To prevent damage to the rear step bumper**

Do not allow more than one person to get on the rear step bumper at a time.

■ **Handling of the tailgate (vehicles with rear bumper)**

If the support stays are removed, the tailgate comes into contact with the rear bumper and may be damaged.

Smart entry & start system*

The following operations can be performed simply by carrying the electronic key on your person, for example in your pocket. The driver should always carry the electronic key.

- Locks and unlocks the doors (→P. 153)
- Starts and stops the engine (→P. 223)

■ Antenna location

- ① Antennas outside the cabin
- ② Antennas inside the cabin

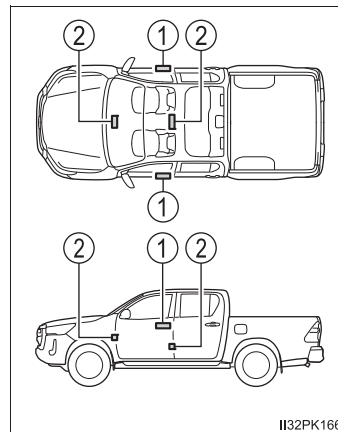

3

Operation of each component

*: If equipped

■ **Effective range (areas within which the electronic key is detected)**

- When locking or unlocking the doors

The system can be operated when the electronic key is within about 0.7 m (2.3 ft.) of either of the lock/unlock button on the outside door handle. (Only the doors detecting the key can be operated.)

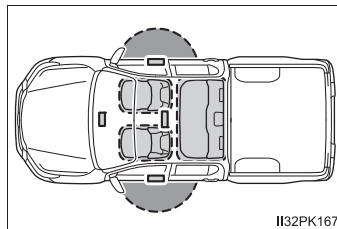

- When starting the engine or changing engine switch modes



The system can be operated when the electronic key is inside the vehicle. (The electronic key is not detected when it is on the floor or on the instrument panel.)

■ **Battery-saving function**

The battery-saving function will be activated in order to prevent the battery from being discharged while the vehicle is not in operation for a long time.

■ **Electronic Key Battery-Saving Function**

When battery-saving mode is set, battery depletion is minimized by stopping the electronic key from receiving radio waves.

Press  twice while pressing and holding . Confirm that the electronic key indicator flashes 4 times.

While the battery-saving mode is set, the smart entry & start system cannot be used. To cancel the function, press any of the electronic key buttons.

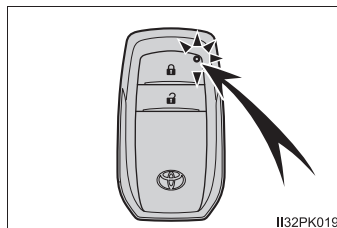

■ Alarms and warning indicators

A combination of exterior and interior alarms as well as warning messages shown on the multi-information display are used to prevent theft of the vehicle and accidents resulting from erroneous operation. Take appropriate measures in response to any warning message on the multi-information display.

The following table describes circumstances and correction procedures when only alarms are sounded.

Alarm	Situation	Correction procedure
Exterior alarm sounds once for 5 seconds	An attempt was made to lock the vehicle while a door was open.	Close all of the doors and lock the doors again.
Interior alarm pings continuously	The engine switch was turned to ACCESSORY mode while the driver's door was open (or the driver's door was opened while the engine switch was in ACCESSORY mode).	Turn the engine switch off and close the driver's door.

■ Conditions affecting operation

The smart entry & start system uses weak radio waves. In the following situations, the communication between the electronic key and the vehicle may be affected, preventing the smart entry & start system, wireless remote control and engine immobilizer system from operating properly.

(Ways of coping: →P. 600)

- When the electronic key battery is depleted
- Near a TV tower, electric power plant, gas station, radio station, large display, airport or other facility that generates strong radio waves or electrical noise
- When carrying a portable radio, cellular phone, cordless phone or other wireless communication device
- When the electronic key is in contact with, or is covered by the following metallic objects
 - Cards to which aluminum foil is attached
 - Cigarette boxes that have aluminum foil inside
 - Metallic wallets or bags
 - Coins
 - Hand warmers made of metal
 - Media such as CDs and DVDs
- When multiple electronic keys are in the vicinity
- When other wireless keys (that emit radio waves) are being used nearby
- When carrying the electronic key together with the following devices that emit radio waves
 - Another vehicle's electronic key or a wireless key that emits radio waves
 - Personal computers or personal digital assistants (PDAs)
 - Digital audio players
 - Portable game systems
- If window tint with a metallic content or metallic objects are attached to the rear window
- When the electronic key is placed near a battery charger or electronic devices

■ Note for the entry function

- Even if the electronic key is within the effective range (detection areas) when locking or unlocking the doors, the system may not operate properly if the electronic key is too close to the window or outside door handle, near the ground, or in a high place.
- Do not leave the electronic key on top of the instrument panel or near the door pockets when exiting the vehicle. Depending on the radio wave reception conditions, it may be detected by the antenna outside the cabin and the doors will become lockable from the outside, possibly trapping the electronic key inside the vehicle.
- As long as the electronic key is within the effective range, the doors may be locked or unlocked by anyone. However, only the doors detecting the electronic key can be used to unlock the vehicle.
- Even if the electronic key is not inside the vehicle, it may be possible to start the engine if the electronic key is near the window.
- If the wireless remote control is used to lock the doors when the electronic key is near the vehicle, there is a possibility that the door may not be unlocked by the entry function. (Use the wireless remote control to unlock the doors.)
- Pulling the outside door handle while pressing the lock/unlock button on the outside door handle may prevent the doors from being unlocked. In this case, return the door handle to the original position, press the lock/unlock button again, and check that the doors unlock before pulling the door handle again.
- Unlocking the vehicle may take more time if another electronic key is within the effective range.

■ When the vehicle is not driven for extended periods

- To prevent theft of the vehicle, do not leave the electronic key within 2 m (6 ft.) of the vehicle.
- The smart entry & start system can be deactivated in advance. Ask any authorized Toyota retailer or Toyota authorized repairer, or any reliable repairer for details.

■ To operate the system properly

Make sure to carry the electronic key when operating the system. Do not get the electronic key too close to the vehicle when operating the system from the outside of the vehicle.

Depending on the position and holding condition of the electronic key, the key may not be detected correctly and the system may not operate properly. (The alarm may go off accidentally, or the door lock prevention function may not operate.)

■ **If the smart entry & start system does not operate properly**

- Locking and unlocking the doors: Use the mechanical key. (→P. 600)
- Starting the engine: →P. 601

■ **Electronic key battery depletion**

- The standard battery life is 1 to 2 years.
- If the battery becomes low, an alarm will sound in the cabin when the engine stops.
- As the electronic key always receives radio waves, the battery will become depleted even if the electronic key is not used. The following symptoms indicate that the electronic key battery may be depleted. Replace the battery when necessary. (→P. 516)
 - The smart entry & start system or the wireless remote control does not operate.
 - The detection area becomes smaller.
 - The LED indicator on the key surface does not turn on.
- To avoid serious deterioration, do not leave the electronic key within 1 m (3 ft.) of the following electrical appliances that produce a magnetic field:
 - TVs
 - Personal computers
 - Cellular phones, cordless phones and battery chargers
 - Recharging cellular phones or cordless phones
 - Table lamps
 - Induction cookers

■ **If “Key left inside vehicle” is shown on the multi-information display**

An attempt was made to lock the doors using the smart entry & start system while the electronic key was still inside the vehicle, or an attempt was made to lock either front door by opening a door and putting the inside lock button into the lock position, then closing the door by pulling on the outside door handle with the electronic key still inside the vehicle.

Retrieve the electronic key from the vehicle and lock the doors again.

■ **Customization that can be configured at any authorized Toyota retailer or Toyota authorized repairer, or any reliable repairer**

Settings (e.g. smart entry & start system) can be changed.
(Customizable features: →P. 646)

■ **If the smart entry & start system has been deactivated in a customized setting**

- Locking and unlocking the doors:
Use the wireless remote control or mechanical key. (→P. 153, 600)
- Starting the engine and changing engine switch modes: →P. 601
- Stopping the engine: →P. 225

 **WARNING****■ Caution regarding interference with electronic devices**

- People with implantable cardiac pacemakers, cardiac resynchronization therapy-pacemakers or implantable cardioverter defibrillators should maintain a reasonable distance between themselves and the smart entry & start system antennas. (→P. 163)

The radio waves may affect the operation of such devices. If necessary, the entry function can be disabled. Ask any authorized Toyota retailer or Toyota authorized repairer, or any reliable repairer for details, such as the frequency of radio waves and timing of the emitting radio waves. Then, consult your doctor to see if you should disable the entry function.

- Users of any electrical medical device other than implantable cardiac pacemakers, cardiac resynchronization therapy-pacemakers or implantable cardioverter defibrillators should consult the manufacturer of the device for information about its operation under the influence of radio waves.

Radio waves could have unexpected effects on the operation of such medical devices.

Ask any authorized Toyota retailer or Toyota authorized repairer, or any reliable repairer for details on disabling the entry function.

Front seats

Adjustment procedure

► Manual seat

- ① Seat position adjustment lever
- ② Seatback angle adjustment lever
- ③ Vertical height adjustment lever (if equipped for driver's seat only)

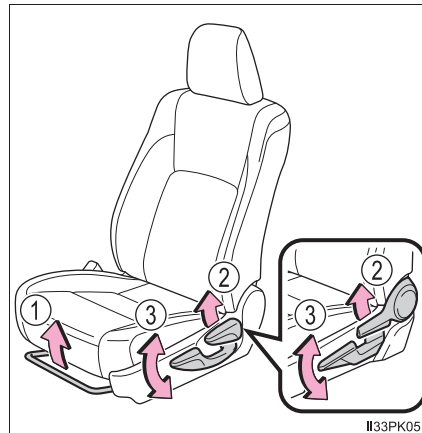

► Power seat (driver's seat only)

- ① Seat position adjustment switch
- ② Seatback angle adjustment switch
- ③ Seat cushion (front) angle adjustment switch
- ④ Vertical height adjustment switch

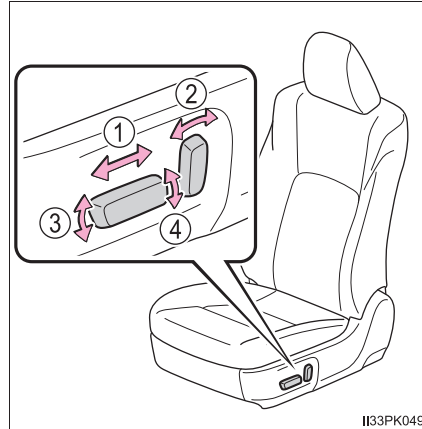

 WARNING**■ When adjusting the seat position**

- Take care when adjusting the seat position to ensure that other passengers are not injured by the moving seat.
- Do not put your hands under the seat or near the moving parts to avoid injury.
Fingers or hands may become jammed in the seat mechanism.

■ Seat adjustment

- To reduce the risk of sliding under the lap belt during a collision, do not recline the seat more than necessary.
If the seat is too reclined, the lap belt may slide past the hips and apply restraint forces directly to the abdomen, or your neck may contact the shoulder belt, increasing the risk of death or serious injury in the event of an accident.
Adjustments should not be made while driving as the seat may unexpectedly move and cause the driver to lose control of the vehicle.
- Manual seat: After adjusting the seat, make sure that the seat is locked in position.

Rear seats*

Removing the rear seat cushions (if equipped for smart-cab models)

- ① Unhook the lock release lever.
- ② Pull the seat cushions up and then pull toward the front of vehicle.

The seat cushions can be removed separately.

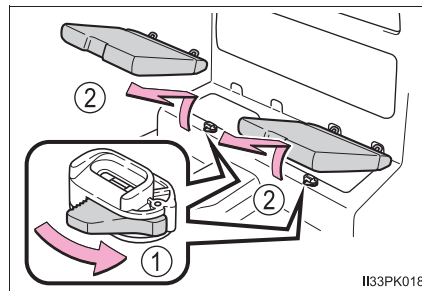

II33PK018

Raising the bottom cushion (double-cab models with integrated type rear seat)

- 1 Pull the head restraint up.

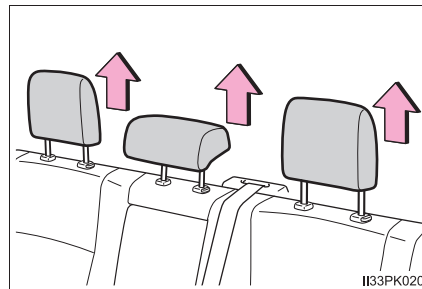

II33PK020

- 2 Pull the strap and raise the bottom cushion.

The latch under the bottom cushion will release allowing the bottom cushion to be raised.

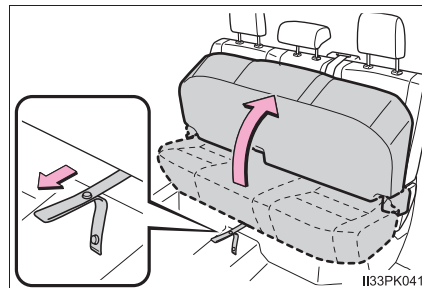

II33PK041

*: If equipped

- 3 Anchor the strap to the head restraint.

Vehicles without the rear center seat head restraint: Anchor the strap to the rear outboard seat head restraint.

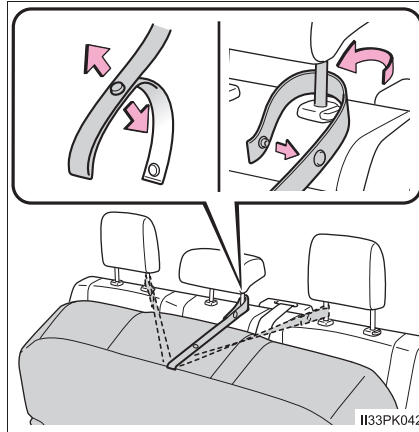

Raising the bottom cushion (double-cab models with separated type rear seats)

- 1 Pull the head restraints up.

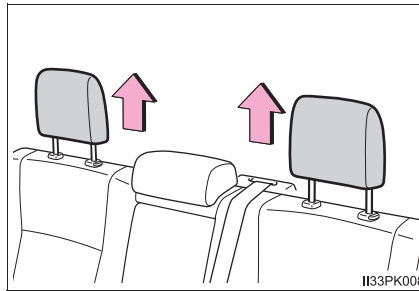

- 2 Pull the straps and raise the bottom cushions.

The latch under the bottom cushions will release allowing the bottom cushions to be raised.

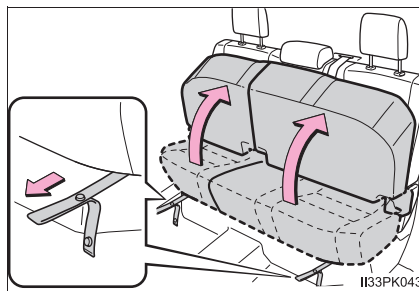

- 3 Anchor the straps to the head restraints.

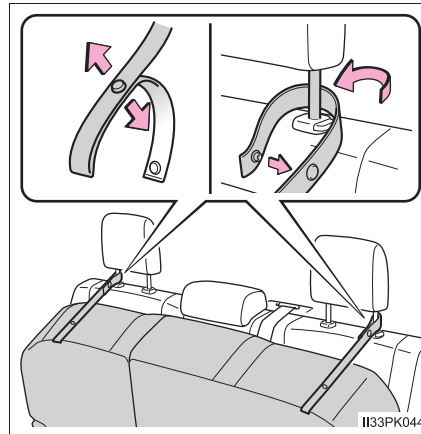

⚠ WARNING

Observe the following precautions. Failure to do so may result in death or serious injury.

- **When removing the rear seat cushions or raising the bottom cushion**
 - Do not operate the rear seat cushions or bottom cushion while driving.
 - Stop the vehicle on level ground, apply the parking brake firmly and shift the shift position to P (automatic transmission) or N (manual transmission).
- **When the rear seat cushions are removed**

Be careful not to hit the removed rear seat cushions against a person or drop it on yourself.
- **When reinstalling the rear seat cushions or returning the bottom cushions to their original position**
 - Be careful not to get your hands or feet pinched in the seat.
 - Make sure there are no obstacles under the seat which would prevent the seat from properly locking into place.
 - Make sure the rear seat cushions and bottom cushion are securely locked by pushing it upward and downward.
 - Check that the seat belts are not twisted or caught in the bottom cushions.

Head restraints

Head restraints are provided for all seats.

Front seats

► Adjustable type

- ① Up
Pull the head restraints up.
- ② Down
Push the head restraint down while pressing the lock release button.

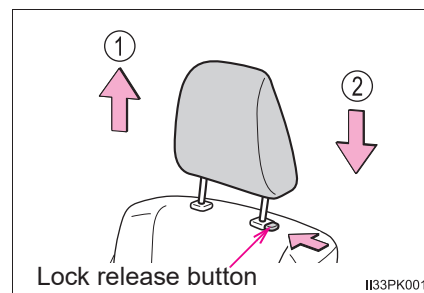

► Integrated type

Head restraints cannot be adjusted and removed.

Rear seats (if equipped)

► Adjustable type

- ① Up
Pull the head restraints up.
- ② Down
Push the head restraint down while pressing the lock release button.

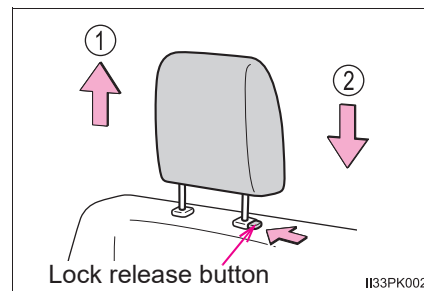

► Integrated type

Head restraints cannot be adjusted and removed.

■ **Removing the head restraints**

Pull the head restraint up while pressing the lock release button.

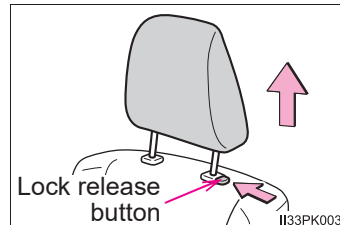

■ **Installing the head restraints**

Align the head restraint with the installation holes and push it down to the lock position.

Press and hold the lock release button when lowering the head restraint.

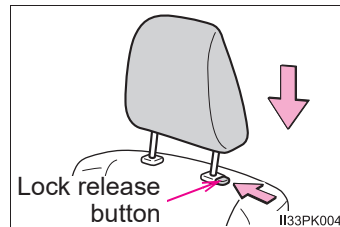

■ **Adjusting the height of the head restraints**

Make sure that the head restraints are adjusted so that the center of the head restraint is closest to the top of your ears.

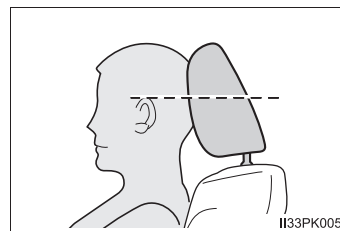

■ **Adjusting the rear center seat head restraint (if equipped)**

Always raise the head restraint one level from the stowed position when using.

 WARNING**■ Head restraint precautions**

Observe the following precautions regarding the head restraints. Failure to do so may result in death or serious injury.

- Use the head restraints designed for each respective seat.
- Adjust the head restraints to the correct position at all times.
- After adjusting the head restraints, push down on them and make sure they are locked in position.
- Do not drive with the head restraints removed.

Steering wheel

Adjustment procedure

- 1 Hold the steering wheel and push the lever down.

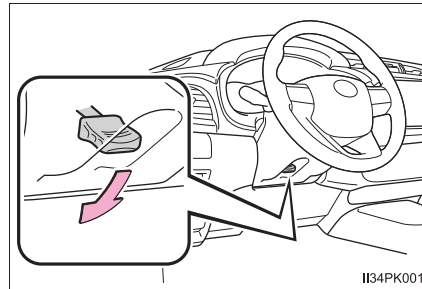

► Type A

- 2 Adjust to the ideal position by moving the steering wheel vertically.

After adjustment, pull the lever up to secure the steering wheel.

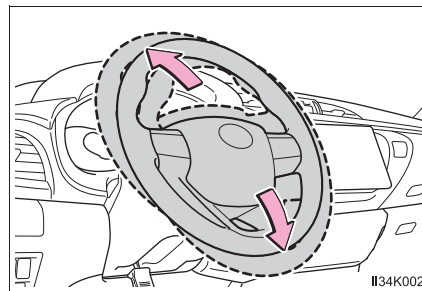

► Type B

- 2 Adjust to the ideal position by moving the steering wheel horizontally and vertically.

After adjustment, pull the lever up to secure the steering wheel.

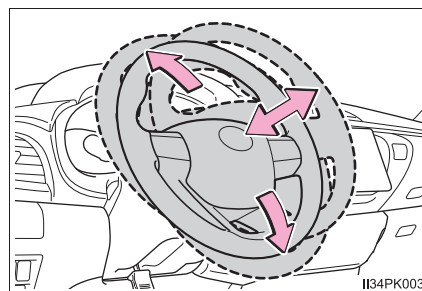

Horn

To sound the horn, press on or close to the  mark.

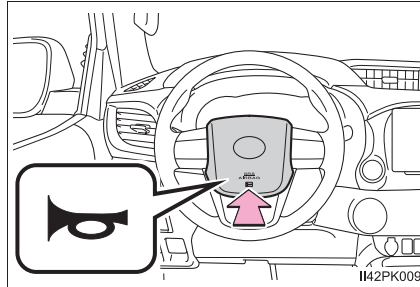

■ After adjusting the steering wheel

Make sure that the steering wheel is securely locked.
The horn may not sound if the steering wheel is not securely locked.

WARNING

■ Caution while driving

Do not adjust the steering wheel while driving.
Doing so may cause the driver to mishandle the vehicle and cause an accident, resulting in death or serious injury.

■ After adjusting the steering wheel

Make sure that the steering wheel is securely locked.
Otherwise, the steering wheel may move suddenly, possibly causing an accident, and resulting in death or serious injury.

Inside rear view mirror

The rear view mirror's position can be adjusted to enable sufficient confirmation of the rear view.

Adjusting the height of rear view mirror

The height of the rear view mirror can be adjusted to suit your driving posture.

Adjust the height of the rear view mirror by moving it up and down.

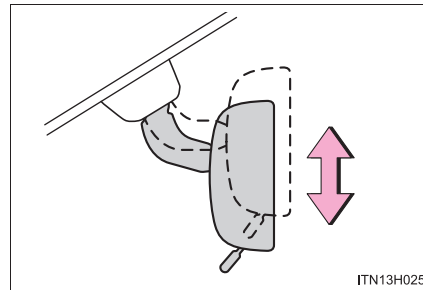

Anti-glare function

► Manual anti-glare inside rear view mirror

Reflected light from the headlights of vehicles behind can be reduced by operating the lever.

- ① Normal position
- ② Anti-glare position

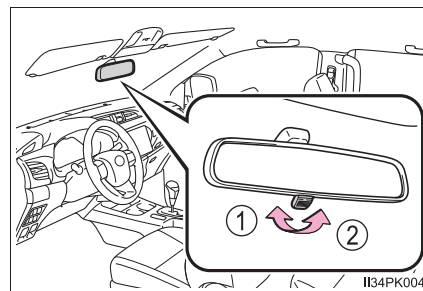

▶ Auto anti-glare inside rear view mirror

Responding to the level of brightness of the headlights of vehicles behind, the reflected light is automatically reduced.

Changing automatic anti-glare function mode

ON/OFF

When the automatic anti-glare function is in ON mode, the indicator illuminates.

The function will set to ON mode each time the engine switch is turned to "ON" position (vehicles without smart entry & start system) or IGNITION ON mode (vehicles with smart entry & start system).

Pressing the button turns the function to OFF mode. (The indicator also turns off.)

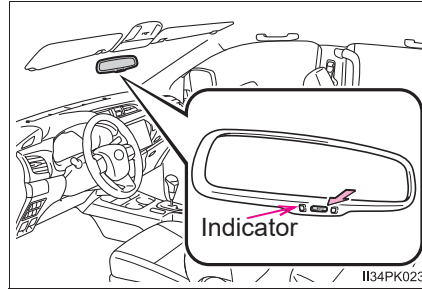

■ To prevent sensor error (vehicles with auto anti-glare inside rear view mirror)

To ensure that the sensors operate properly, do not touch or cover them.

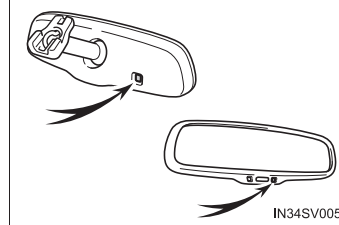

⚠ WARNING

Do not adjust the position of the mirror while driving. Doing so may lead to mishandling of the vehicle and cause an accident, resulting in death or serious injury.

Outside rear view mirrors

Adjustment procedure

► Manual adjustable type

Adjust a mirror.

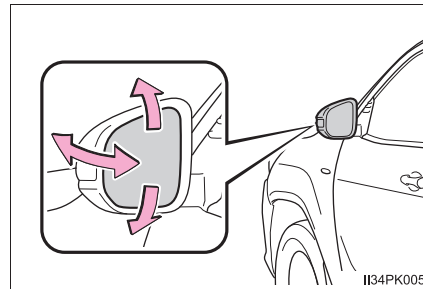

► Power adjustable type

1 To select a mirror to adjust, turn the switch.

- ① Left
- ② Right

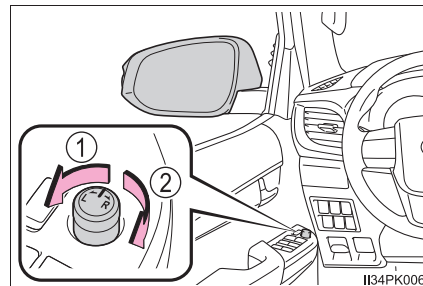

2 To adjust the mirror, move the switch.

- ① Up
- ② Right
- ③ Down
- ④ Left

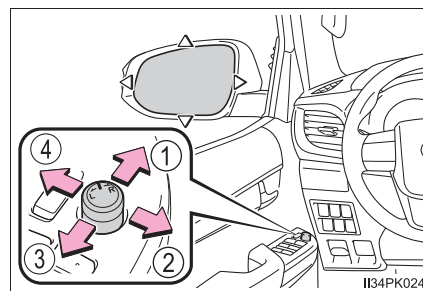

Folding the mirrors

▶ Manual folding type

Push the mirror back in the direction of the vehicle's rear.

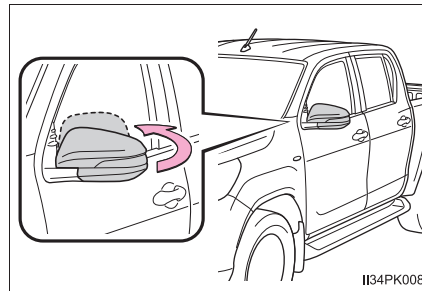

▶ Power folding type

Press the switch.

- ① Folding
- ② Extending

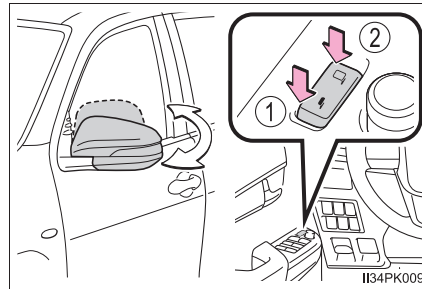

■ Mirror angle can be adjusted when (power adjustable type)

▶ Vehicles without smart entry & start system

The engine switch is in the "ACC" or "ON" position.

▶ Vehicles with smart entry & start system

The engine switch is in ACCESSORY or IGNITION ON mode.

■ When the mirrors are fogged up (vehicles with outside rear view mirror defoggers)

The outside rear view mirrors can be cleared using the mirror defoggers. Turn on the rear window defogger to turn on the outside rear view mirror defoggers. (→P. 435, 444)

 WARNING

■ **Important points while driving**

Observe the following precautions while driving.
Failure to do so may result in loss of control of the vehicle and cause an accident, resulting in death or serious injury.

- Do not adjust the mirrors while driving.
- Do not drive with the mirrors folded.
- Both the driver and passenger side mirrors must be extended and properly adjusted before driving.

■ **When a mirror is moving (power adjustable type)**

To avoid personal injury and mirror malfunction, be careful not to get your hand caught by the moving mirror.

■ **When the mirror defoggers are operating (vehicles with outside rear view mirror defoggers)**

Do not touch the rear view mirror surfaces, as they can become very hot and burn you.

 NOTICE

■ **If ice should jam the mirror**

Do not operate the control or scrape the mirror face. Use a spray de-icer to free the mirror.

Power windows*

Opening and closing procedures

The power windows can be opened and closed using the switches.

Operating the switch moves the windows as follows:

► Type A

- ① Closing
- ② Opening
- ③ One-touch opening*
(driver's window only)

*: To stop the window partway, operate the switch in the opposite direction.

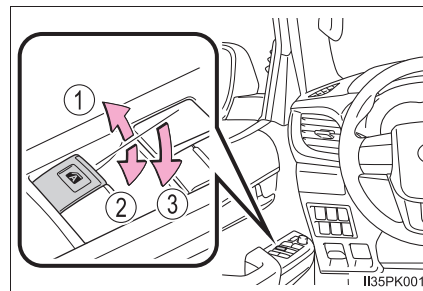

► Type B

- ① Closing
- ② Opening
- ③ One-touch opening*
(driver's window only)
- ④ One-touch closing*
(driver's window only)

*: To stop the window partway, operate the switch in the opposite direction.

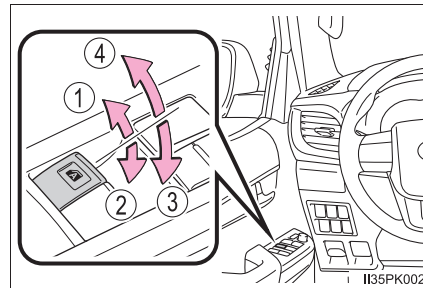

3

Operation of each component

*: If equipped

► Type C

- ① Closing
- ② Opening
- ③ One-touch opening*
(all windows)
- ④ One-touch closing*
(all windows)

*: To stop the window partway, operate the switch in the opposite direction.

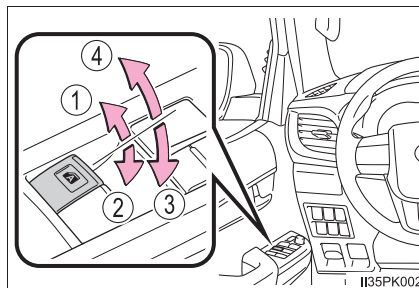

Window lock switch

Press the switch down to lock the passenger window switches.

Use this switch to prevent children from accidentally opening or closing a passenger window.

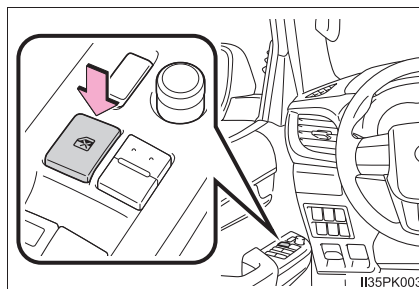

■ **The power windows can be operated when**

- Vehicles without smart entry & start system

The engine switch is in the “ON” position.

- Vehicles with smart entry & start system

The engine switch is in IGNITION ON mode.

■ **Jam protection function (windows with one-touch function for type B and C)**

If an object becomes jammed between the window and the window frame while the window is closing, window movement is stopped and the window is opened slightly.

■ **Catch protection function (windows with one-touch function for type B and C)**

If an object becomes caught between the door and window while the window is opening, window movement is stopped.

■ Operating the power windows after turning the engine off**▶ Vehicles without smart entry & start system**

The power windows can be operated for approximately 45 seconds even after the engine switch is turned to the “ACC” or “LOCK” position. They cannot, however, be operated once either front door is opened.

▶ Vehicles with smart entry & start system

The power windows can be operated for approximately 45 seconds even after the engine switch is turned to ACCESSORY mode or turned off. They cannot, however, be operated once either front door is opened.

■ When the window cannot be opened or closed (windows with one-touch function for type B and C)

When the jam protection function or catch protection function operates unusually and the window cannot be opened or closed, perform the following operations with the power window switch of that door.

- Stop the vehicle. With the engine switch in the “ON” position (vehicles without smart entry & start system) or IGNITION ON mode (vehicles with smart entry & start system), within 4 seconds of the jam protection function or catch protection function activating, continually operate the power window switch in the one-touch closing direction or one-touch opening direction so that the window can be opened and closed.
- If the window cannot be opened and closed even when performing the above operations, perform the following procedure for function initialization.
 - 1 Turn the engine switch to the “ON” position (vehicles without smart entry & start system) or IGNITION ON mode (vehicles with smart entry & start system).
 - 2 Pull and hold the power window switch in the one-touch closing direction and completely close the window.
 - 3 Release the power window switch for a moment, resume pulling the switch in the one-touch closing direction, and hold it there for approximately 6 seconds or more.
 - 4 Press and hold the power window switch in the one-touch opening direction. After the window is completely opened, continue holding the switch for an additional 1 second or more.
 - 5 Release the power window switch for a moment, resume pushing the switch in the one-touch opening direction, and hold it there for approximately 4 seconds or more.
 - 6 Pull and hold the power window switch in the one-touch closing direction again. After the window is completely closed, continue holding the switch for a further 1 second or more.

If you release the switch while the window is moving, start again from the beginning.

If the window reverses and cannot be fully closed or opened, have the vehicle inspected by any authorized Toyota retailer or Toyota authorized repairer, or any reliable repairer.

 **WARNING**

Observe the following precautions.

Failure to do so may result in death or serious injury.

■ Closing the windows

- The driver is responsible for all the power window operations, including the operation for the passengers. In order to prevent accidental operation, especially by a child, do not let a child operate the power windows. It is possible for children and other passengers to have body parts caught in the power window. Also, when riding with a child, it is recommended to use the window lock switch. (→P. 186)
- Check to make sure that all passengers do not have any part of their body in a position where it could be caught when a window is being operated.
- When exiting the vehicle, turn the engine switch off, carry the key and exit the vehicle along with the child. There may be accidental operation, due to mischief, etc., that may possibly lead to an accident.

■ Jam protection function (windows with one-touch function for type B and C)

- Never use any part of your body to intentionally activate the jam protection function.
- The jam protection function may not work if something gets jammed just before the window is fully closed. Be careful not to get any part of your body jammed in the window.

■ Catch protection function (windows with one-touch function for type B and C)

- Never use any part of your body or clothing to intentionally activate the catch protection function.
- The catch protection function may not work if something gets caught just before the window is fully opened. Be careful not to get any part of your body or clothing caught in the window.

 **NOTICE****■ Jam protection function and catch protection function (windows with one-touch function for type B and C)**

If the door is forcefully closed while the window is being opened or closed, the jam protection function or catch protection function may operate and the window may reverse directions or stop.

Quarter windows (smart-cab models)

Opening and closing procedures

The quarter windows can be opened and closed using the latch handle.

To open the quarter windows, pull the latch handle toward you and swing it fully out.

To close the quarter windows, reverse the opening procedure.

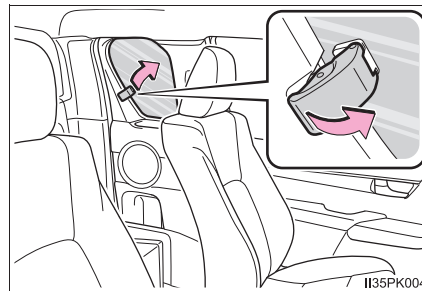

■ Closing the quarter windows

Make sure that the quarter windows are securely closed after closing them.

WARNING

■ Opening or closing the quarter windows

Observe the following precautions.

Failure to do so may result in death or serious injury.

- Check to make sure that all passengers do not have any part of their body in a position where it could be caught when a window is being operated.
- Do not allow children to operate the quarter windows.
Closing a quarter window on someone can cause serious injury, and in some instances, even death.

Driving

4

- | | |
|--|--|
| <p>4-1. Before driving</p> <ul style="list-style-type: none"> Driving the vehicle 192 Cargo and luggage 205 Trailer towing (without towing hitch) 206 Trailer towing (with towing hitch)..... 207 <p>4-2. Driving procedures</p> <ul style="list-style-type: none"> Engine (ignition) switch (vehicles without smart entry & start system)..... 220 Engine (ignition) switch (vehicles with smart entry & start system)..... 223 Automatic transmission 231 Manual transmission..... 239 Turn signal lever 246 Parking brake 247 <p>4-3. Operating the lights and wipers</p> <ul style="list-style-type: none"> Headlight switch 248 Fog light switch 255 Windshield wipers and washer 258 <p>4-4. Refueling</p> <ul style="list-style-type: none"> Opening the fuel tank cap..... 261 | <p>4-5. Using the driving support systems</p> <ul style="list-style-type: none"> Toyota Safety Sense 266 PCS (Pre-Collision System) 273 LDA (Lane Departure Alert With Yaw Assist Function)..... 284 RSA (Road Sign Assist)..... 295 Dynamic radar cruise control 301 Cruise control..... 317 Toyota parking assist-sensor 321 Four-wheel drive system 331 Rear differential lock system 341 Stop & Start system 345 Driving assist systems 355 Downhill assist control system 364 AUTO LSD..... 367 DPF (Diesel Particulate Filter) system 369 <p>4-6. Driving tips</p> <ul style="list-style-type: none"> Winter driving tips 374 |
|--|--|

Driving the vehicle

The following procedures should be observed to ensure safe driving:

Starting the engine

→P. 220, 223

Driving

▶ Automatic transmission

- 1 With the brake pedal depressed, shift the shift lever to D. (→P. 231)
- 2 Release the parking brake. (→P. 247)
- 3 Gradually release the brake pedal and gently depress the accelerator pedal to accelerate the vehicle.

▶ Manual transmission

- 1 While depressing the clutch pedal, shift the shift lever to 1. (→P. 239)
- 2 Release the parking brake. (→P. 247)
- 3 Gradually release the clutch pedal. At the same time, gently depress the accelerator pedal to accelerate the vehicle.

Stopping

▶ Automatic transmission

- 1 With the shift lever in D, depress the brake pedal.
- 2 If necessary, set the parking brake.
If the vehicle is to be stopped for an extended period of time, shift the shift lever to P or N. (→P. 231)

▶ Manual transmission

- 1 While depressing the clutch pedal, depress the brake pedal.
- 2 If necessary, set the parking brake.
If the vehicle is to be stopped for an extended period of time, shift the shift lever to N. (→P. 239)

Parking the vehicle

▶ Automatic transmission

- 1 With the shift lever in D, depress the brake pedal.
- 2 Set the parking brake (→P. 247), and shift the shift lever to P (→P. 231).
- 3 Vehicles without smart entry & start system:
Turn the engine switch to the "LOCK" position to stop the engine.
Vehicles with smart entry & start system:
Press the engine switch to stop the engine.
- 4 Lock the door, making sure that you have the key on your person.
If parking on a hill, block the wheels as needed.

▶ Manual transmission

- 1 While depressing the clutch pedal, depress the brake pedal.
- 2 Shift the shift lever to N. (→P. 239)
If parking on a hill, shift the shift lever to 1 or R as needed.
- 3 Set the parking brake. (→P. 247)
- 4 Vehicles without smart entry & start system:
Turn the engine switch to the "LOCK" position to stop the engine.
Vehicles with smart entry & start system:
Press the engine switch to stop the engine.
- 5 Lock the door, making sure that you have the key on your person.
If parking on a hill, block the wheels as needed.

Starting off on a steep uphill

▶ Automatic transmission

- 1 Make sure that the parking brake is set and shift the shift lever to D.
- 2 Gently depress the accelerator pedal.
- 3 Release the parking brake.

▶ Manual transmission

- 1 With the parking brake firmly set and the clutch pedal fully depressed, shift the shift lever to 1.
- 2 Lightly depress the accelerator pedal at the same time as gradually releasing the clutch pedal.
- 3 Release the parking brake.

■ When starting off on an uphill (vehicles with hill-start assist control system)

The hill-start assist control will activate. (→P. 355)

■ Driving in the rain

- Drive carefully when it is raining, because visibility will be reduced, the windows may become fogged-up, and the road will be slippery.
- Drive carefully when it starts to rain, because the road surface will be especially slippery.
- Refrain from high speeds when driving on an expressway in the rain, because there may be a layer of water between the tires and the road surface, preventing the steering and brakes from operating properly.

■ Engine speed while driving (automatic transmission)

In the following conditions, the engine speed may become high while driving. This is due to automatic up-shifting control or down-shifting implementation to meet driving conditions. It does not indicate sudden acceleration.

- The vehicle is judged to be driving uphill or downhill
- When the accelerator pedal is released

■ Restraining the engine output (Brake Override System)

- When the accelerator and brake pedals are depressed at the same time, the engine output may be restrained.
- Vehicles without multi-information display: A warning light comes on while the system is operating. (→P. 569)
- Vehicles with multi-information display: A warning message is displayed on the multi-information display while the system is operating. (→P. 577)

■ Restraining sudden start (Drive-Start Control) (vehicles with automatic transmission and VSC system)

- When the following unusual operation is performed, the engine output may be restrained.
 - When the shift lever is shifted from R to D, D to R, N to R, P to D, or P to R (D includes S) with the accelerator pedal depressed, a warning message is displayed on the multi-information display while the system is operating. If a warning message is shown on the multi-information display, read the message and follow the instructions.
 - When the accelerator pedal is depressed too much while the vehicle is in reverse.
- While Drive-Start Control is being activated, your vehicle may have trouble escaping from the mud or fresh snow. In such case, perform the following actions to cancel Drive-Start Control so that the vehicle may become able to escape from the mud or fresh snow.
 - Deactivate TRC/A-TRC (→P. 357)
 - Turn the front-wheel drive control switch to L4. (if equipped) (→P. 331)
- Vehicles with AUTO LSD system: Drive-Start Control does not work when the AUTO LSD system is turned on. (→P. 367)

■ **Breaking in your new Toyota**

To extend the life of the vehicle, observing the following precautions is recommended:

- For the first 300 km (200 miles):
Avoid sudden stops.
- For the first 800 km (500 miles) (with towing hitch):
Do not tow a trailer. (→P. 207)
- For the first 1000 km (600 miles):
 - Do not drive at extremely high speeds.
 - Avoid sudden acceleration.
 - Do not drive continuously in the low gears.
 - Do not drive at a constant speed for extended periods.
 - Do not drive slowly with the manual transmission in a high gear.

■ **Idling time before engine stop (diesel engine only)**

To prevent damage to the turbocharger, allow the engine to idle immediately after high-load driving.

Driving condition	Idling time
Normal city driving or high-speed driving (at the highway speed limit or recommended speed)	Not necessary
Steep hill driving, continuous driving (race track driving etc.), or towing a trailer or another vehicle (with towing hitch)	Approximately 1 minute

■ **Operating your vehicle in a foreign country**

Comply with the relevant vehicle registration laws and confirm the availability of the correct fuel. (→P. 627)

■ **Eco-friendly driving**

→P. 128

■ **After driving on muddy roads in poor condition (for EURO VI models* with 1GD-FTV and 2GD-FTV engines)**

Check the cooling fins of the urea injector and clear away any foreign objects or substances such as leaves or mud. If any of the above parts is extremely dirty or you are not sure of their condition, have your vehicle inspected by any authorized Toyota retailer or Toyota authorized repairer, or any reliable repairer.

*: EURO VI is an emission standard. If it is not clear that your vehicle meets relevant standards, contact any authorized Toyota retailer or Toyota authorized repairer, or any reliable repairer.

 **WARNING**

Observe the following precautions.
Failure to do so may result in death or serious injury.

■ When starting the vehicle

On vehicles with automatic transmission, always keep your foot on the brake pedal while stopped with the engine running. This prevents the vehicle from creeping.

■ When driving the vehicle

- Do not drive if you are unfamiliar with the location of the brake and accelerator pedals to avoid depressing the wrong pedal.
 - Accidentally depressing the accelerator pedal instead of the brake pedal will result in sudden acceleration that may lead to an accident.
 - When backing up, you may twist your body around, leading to a difficulty in operating the pedals. Make sure to operate the pedals properly.
 - Make sure to keep a correct driving posture even when moving the vehicle only slightly. This allows you to depress the brake and accelerator pedals properly.
 - Depress the brake pedal using your right foot. Depressing the brake pedal using your left foot may delay response in an emergency, resulting in an accident.
- Do not drive the vehicle over or stop the vehicle near flammable materials. The exhaust system and exhaust gases can be extremely hot. These hot parts may cause a fire if there is any flammable material nearby.
- During normal driving, do not turn off the engine. Turning the engine off while driving will not cause loss of steering or braking control, but the power assist to these systems will be lost. This will make it more difficult to steer and brake, so you should pull over and stop the vehicle as soon as it is safe to do so.
However, in the event of an emergency, such as if it becomes impossible to stop the vehicle in the normal way: →P. 555

**WARNING**

Observe the following precautions.

Failure to do so may result in death or serious injury.

■ When driving the vehicle

- Use engine braking (downshift) to maintain a safe speed when driving down a steep hill.
Using the brakes continuously may cause the brakes to overheat and lose effectiveness. (→P. 232)
- Do not adjust the positions of the steering wheel, the seat, or the inside or outside rear view mirrors while driving.
Doing so may result in a loss of vehicle control.
- Always check that all passengers' arms, heads or other parts of their body are not outside the vehicle.
- On vehicles with manual transmission, observe the following to prevent the clutch from being damaged.
 - Do not operate the clutch halfway for a long period of time unless it is necessary.
 - Do not operate the clutch half or partial engaged to control the vehicle speed, such as to drive the vehicle at a low speed, to hold the vehicle on a slope, etc.
 - Do not depress the brake pedal during operating the clutch half or partial engaged.
Doing so could not only speed up the clutch wear, but also damage the clutch or even cause a fatal accident such as vehicle fire.

■ When driving on slippery road surfaces

- Sudden braking, acceleration and steering may cause tire slippage and reduce your ability to control the vehicle.
- Sudden acceleration, engine braking due to shifting, or changes in engine speed could cause the vehicle to skid.
- After driving through a puddle, lightly depress the brake pedal to make sure that the brakes are functioning properly. Wet brake pads may prevent the brakes from functioning properly. If the brakes on only one side are wet and not functioning properly, steering control may be affected.

 **WARNING**

Observe the following precautions.
Failure to do so may result in death or serious injury.

■ When shifting the shift lever

- On vehicles with automatic transmission, do not let the vehicle roll backwards while the shift lever is in a driving position, or roll forward while the shift lever is in R.
Doing so may cause the engine to stall or lead to poor brake and steering performance, resulting in an accident or damage to the vehicle.
- On vehicles with automatic transmission, do not shift the shift lever to P while the vehicle is moving.
Doing so can damage the transmission and may result in a loss of vehicle control.
- Do not shift the shift lever to R while the vehicle is moving forward.
Doing so can damage the transmission and may result in a loss of vehicle control.
- Do not shift the shift lever to a driving position while the vehicle is moving backward.
Doing so can damage the transmission and may result in a loss of vehicle control.
- Moving the shift lever to N while the vehicle is moving will disengage the engine from the transmission. Engine braking is not available when N is selected.
- On vehicles with automatic transmission, be careful not to shift the shift lever with the accelerator pedal depressed. Shifting the shift lever to a gear other than P or N may lead to unexpected rapid acceleration of the vehicle that may cause an accident.

■ If you hear a squealing or scraping noise (brake pad wear indicators)

Have the brake pads checked and replaced by any authorized Toyota retailer or Toyota authorized repairer, or any reliable repairer as soon as possible.

Rotor damage may result if the pads are not replaced when needed.

It is dangerous to drive the vehicle when the wear limits of the brake pads and/or those of the brake discs are exceeded.

**WARNING**

Observe the following precautions.

Failure to do so may result in death or serious injury.

■ When the vehicle is stopped

- Do not race the engine.
If the vehicle is in any gear other than P (vehicles with automatic transmission only) or N, the vehicle may accelerate suddenly and unexpectedly, causing an accident.
- On vehicles with automatic transmission, in order to prevent accidents due to the vehicle rolling away, always keep depressing the brake pedal while the engine is running, and apply the parking brake as necessary.
- If the vehicle is stopped on an incline, in order to prevent accidents caused by the vehicle rolling forward or backward, always depress the brake pedal and securely apply the parking brake as needed.
- Avoid revving or racing the engine.
Running the engine at high speed while the vehicle is stopped may cause the exhaust system to overheat, which could result in a fire if combustible material is nearby.

■ When the vehicle is parked

- Do not leave glasses, cigarette lighters, spray cans, or soft drink cans in the vehicle when it is in the sun.
Doing so may result in the following:
 - Gas may leak from a cigarette lighter or spray can, and may lead to a fire.
 - The temperature inside the vehicle may cause the plastic lenses and plastic material of glasses to deform or crack.
 - Soft drink cans may fracture, causing the contents to spray over the interior of the vehicle, and may also cause a short circuit in the vehicle's electrical components.
- Do not leave cigarette lighters in the vehicle. If a cigarette lighter is in a place such as the glove box or on the floor, it may be lit accidentally when luggage is loaded or the seat is adjusted, causing a fire.
- Do not attach adhesive discs to the windshield or windows. Do not place containers such as air fresheners on the instrument panel or dashboard. Adhesive discs or containers may act as lenses, causing a fire in the vehicle.
- Do not leave a door or window open if the curved glass is coated with a metallized film such as a silver-colored one. Reflected sunlight may cause the glass to act as a lens, causing a fire.

 **WARNING**

Observe the following precautions.
Failure to do so may result in death or serious injury.

■ **When the vehicle is parked**

- Always apply the parking brake, shift the shift lever to P (vehicles with automatic transmission only), stop the engine and lock the vehicle.
Do not leave the vehicle unattended while the engine is running.
If the vehicle is parked with the shift lever in P but the parking brake is not set, the vehicle may start to move, possibly leading to an accident.
- Do not touch the exhaust pipes while the engine is running or immediately after turning the engine off.
Doing so may cause burns.

■ **When taking a nap in the vehicle**

Always turn the engine off. Otherwise, if you accidentally move the shift lever or depress the accelerator pedal, this could cause an accident or fire due to engine overheating. Additionally, if the vehicle is parked in a poorly ventilated area, exhaust gases may collect and enter the vehicle, leading to death or a serious health hazard.

■ **When braking**

- When the brakes are wet, drive more cautiously.
Braking distance increases when the brakes are wet, and this may cause one side of the vehicle to brake differently than the other side. Also, the parking brake may not securely hold the vehicle.
- If the brake booster device does not operate, do not follow other vehicles closely and avoid hills or sharp turns that require braking. In this case, braking is still possible, but the brake pedal should be depressed more firmly than usual. Also, the braking distance will increase. Have your brakes fixed immediately.
- Do not pump the brake pedal if the engine stalls.
Each push on the brake pedal uses up the reserve for the power-assisted brakes.
- The brake system consists of 2 individual hydraulic systems: If one of the systems fails, the other will still operate. In this case, the brake pedal should be depressed more firmly than usual and the braking distance will increase.
Have your brakes fixed immediately.

■ **If the vehicle becomes stuck (4WD models)**

Do not spin the wheels excessively when any of the tires is up in the air, or the vehicle is stuck in sand, mud, etc. This may damage the driveline components or propel the vehicle forward or backward, causing an accident.



NOTICE

■ When driving the vehicle

- Do not depress the accelerator and brake pedals at the same time during driving, as this may restrain the engine output.
- On vehicles with automatic transmission, do not use the accelerator pedal or depress the accelerator and brake pedals at the same time to hold the vehicle on a hill.
- On vehicles with manual transmission, do not shift gears unless the clutch pedal is fully depressed. After shifting, do not release the clutch pedal abruptly. Doing so may damage the clutch, transmission and gears.
- On vehicles with manual transmission, observe the following to prevent the clutch from being damaged. Failure to do so may cause excessive premature wear or damage to the clutch, eventually making it difficult to accelerate and start off from a stop. Have the vehicle inspected by any authorized Toyota retailer or Toyota authorized repairer, or any reliable repairer.
 - Do not rest your foot on the clutch pedal while driving.
Doing so may cause clutch trouble.
 - Do not use any gear other than the 1st gear when starting off and moving forward.
Doing so may damage the clutch.
 - Do not use the clutch to hold the vehicle when stopping on an uphill grade.
Doing so may damage the clutch.
 - Do not use the clutch pedal to adjust vehicle speed.
Doing so may damage the clutch.
 - When stopping the vehicle with the shift lever in a position other than N, make sure to fully depress the clutch pedal and stop the vehicle using the brakes.
- On vehicles with manual transmission, do not shift the shift lever to R without the vehicle completely stopped. Doing so may damage the clutch, transmission and gears.
- On vehicles with manual transmission, if you cannot accelerate the vehicle even when the clutch is engaged and the accelerator pedal is depressed, this may mean that the clutch is slipping, and the vehicle may be rendered undriveable. Have any authorized Toyota retailer or Toyota authorized repairer, or any reliable repairer inspect the vehicle as soon as possible.



NOTICE

■ When parking the vehicle

On vehicles with automatic transmission, always set the parking brake, and shift the shift lever to P. Failure to do so may cause the vehicle to move or the vehicle may accelerate suddenly if the accelerator pedal is accidentally depressed.

■ Avoiding damage to vehicle parts

- Do not turn the steering wheel fully in either direction and hold it there for an extended period of time.
Doing so may damage the power steering pump.
- When driving over bumps in the road, drive as slowly as possible to avoid damaging the wheels, underside of the vehicle, etc.
- Diesel engine: Make sure to idle the engine immediately after high-load driving. Stop the engine only after the turbocharger has cooled down.
Failure to do so may cause damage to the turbocharger.
- Diesel engine: In an extremely cold environment, idle the engine for more than 30 seconds after starting the engine. Do not race the engine while idling.

■ If you get a flat tire while driving

A flat or damaged tire may cause the following situations. Hold the steering wheel firmly and gradually depress the brake pedal to slow down the vehicle.

- It may be difficult to control your vehicle.
- The vehicle will make abnormal sounds or vibrations.
- The vehicle will lean abnormally.

Information on what to do in case of a flat tire. (→P. 581)



NOTICE

■ When encountering flooded roads or waterlogged roads

Do not drive on a road that has flooded after heavy rain etc. Doing so may cause the following serious damage to the vehicle:

- Engine stalling
- Short in electrical components
- Engine damage caused by water immersion
- Rubber or mechanical part damage or poor lubrication due to grease being washed away, or grease becoming contaminated with mud or dirt

In the event that you drive on a flooded road and the vehicle is flooded, or on a sandy road, be sure to have any authorized Toyota retailer or Toyota authorized repairer, or any reliable repairer check the following:

- Brake function
- Changes in quantity and quality of oil and fluid used for the engine, transmission, transfer (4WD models), clutch, differential, etc.
- Lubricant condition for the propeller shaft, clutch fork, bearings and suspension joints (where possible), and the function of all joints, bearings, etc.

■ Off-road driving (vehicles with type A wheel ornaments [→P. 588])

When driving on muddy roads, rocky terrain or sand, or crossing rivers, remove the wheel ornaments. Driving with the wheel ornaments installed may cause the wheel ornaments to be damaged or even fall off.

After off-road driving with the wheel ornaments removed, remove dirt or foreign objects from the wheel before reinstalling the wheel ornaments.

Cargo and luggage

Take notice of the following information about storage precautions, cargo capacity and load.

WARNING

■ Things that must not be carried in the rear deck

The following things may cause a fire if loaded in the rear deck:

- Receptacles containing gasoline
- Aerosol cans

■ Storage precautions

Observe the following precautions.

Failure to do so may prevent the pedals from being depressed properly, may block the driver's vision, or may result in items hitting the driver or passengers, possibly causing an accident.

- Stow cargo and luggage in the rear deck whenever possible.
- Except for single-cab models: Do not stack anything behind the front seats higher than the seatbacks.
- Do not place cargo or luggage in or on the following locations.
 - At the feet of the driver
 - On the front passenger or rear seats (if equipped) (when stacking items)
 - On the instrument panel
 - On the dashboard
- Secure all items in the occupant compartment.
- Never allow anyone to ride in the rear deck. It is not designed for passengers. They should ride in their seats with their seat belts properly fastened. Otherwise, they are much more likely to suffer death or serious bodily injury, in the event of sudden braking, sudden swerving or an accident.

■ Load and distribution

- Do not overload your vehicle.
- Do not apply loads unevenly.
Improper loading may cause deterioration of steering or braking control which may cause death or serious injury.

Trailer towing (without towing hitch)*

Toyota does not recommend towing a trailer with your vehicle. Toyota also does not recommend the installation of a tow hitch or the use of a tow hitch carrier for a wheelchair, scooter, bicycle, etc. Your vehicle is not designed for trailer towing or for the use of tow hitch mounted carriers.

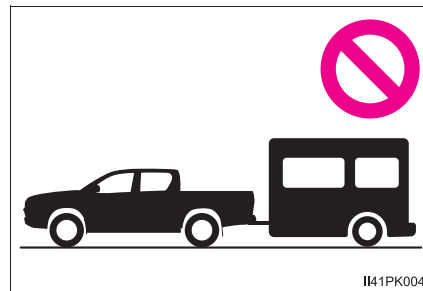

*: For TGN126L-DTTHK models except for Kazakhstan, and GUN125L-DTFSX model.
The model code is indicated on the manufacturer's plate or label. (→P. 624)

Trailer towing (with towing hitch)*

Your vehicle is designed primarily as a passenger-and-load-carrying vehicle. Towing a trailer will have an adverse effect on handling, performance, braking, durability, and fuel consumption. Your safety and satisfaction depend on the proper use of correct equipment and cautious driving habits. For your safety and the safety of others, do not overload the vehicle or trailer.

To tow a trailer safely, use extreme care and drive the vehicle in accordance with the trailer's characteristics and operating conditions.

Toyota warranties do not apply to damage or malfunction caused by towing a trailer for commercial purposes.

Ask your local authorized Toyota retailer or Toyota authorized repairer, or any reliable repairer for further details before towing, as there are additional legal requirements in some countries.

◆ Weight limits

Check the allowable towing capacity, GVM (Gross Vehicle Mass), MPAC (Maximum Permissible Axle Capacity), and permissible drawbar load before towing. (→P. 622)

◆ Towing hitch/bracket

Toyota recommends the use of the Toyota hitch/bracket for your vehicle. Other products of a suitable nature and comparable quality may also be used.

For vehicles where the towing device blocks any of the lights or license plate, the following shall be observed:

- Do not use towing devices that cannot be easily removed or repositioned.
- Towing devices must be removed or repositioned when not in use.

*: For Kazakhstan, and models for model code destination W (See "Checking your vehicle's model" if you are not sure of which model your vehicle is. [→P. 12]).

Installation positions for the towing hitch/bracket and hitch ball

- ① 570 mm (22.4 in.)
- ② 570 mm (22.4 in.)

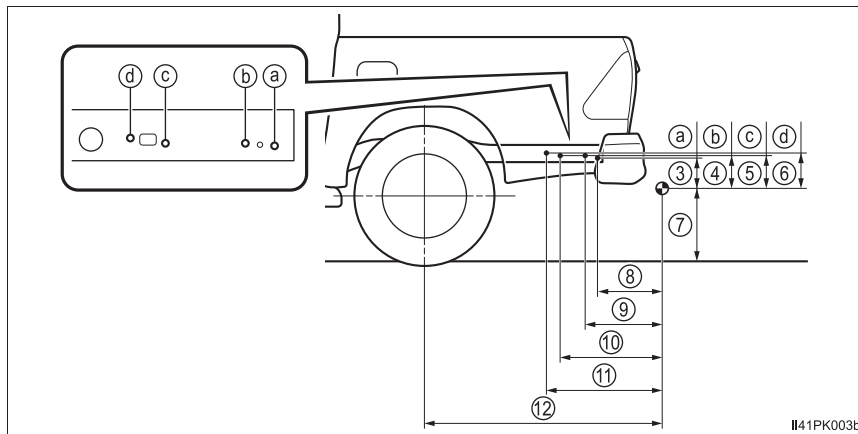
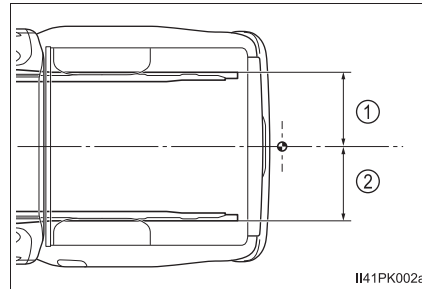

- ③ 178 mm (7.0 in.)
- ④ 183 mm (7.2 in.)
- ⑤ 183 mm (7.2 in.)
- ⑥ 193 mm (7.6 in.)
- ⑦ Except for Kazakhstan (with 225/70R17C tires):
380 mm (15.0 in.)
Except for Kazakhstan (with 265/65R17 or 265/60R18 tires):
365 mm (14.4 in.)
For Kazakhstan:
382 mm (15.0 in.)
- ⑧ 373 mm (14.7 in.)
- ⑨ 427 mm (16.8 in.)
- ⑩ 576 mm (22.7 in.)
- ⑪ 641 mm (25.2 in.)
- ⑫ 1343 mm (52.9 in.)

Guidance

Your vehicle will handle differently when towing a trailer. In order to avoid accident death or serious injury, keep the following in mind when towing:

■ Checking connections between trailer and lights

Stop the vehicle and check the operation of the connection between the trailer and lights after driving for a brief period as well as before starting off.

■ Practicing driving with a coupled trailer

- Get the feel for turning, stopping and reversing with the trailer coupled by practicing in an area with no or light traffic.
- When reversing with a coupled trailer, hold the section of the steering wheel nearest to you and rotate clockwise to turn the trailer left or counterclockwise to turn it right. Always rotate a little at a time to prevent steering error. Have someone guide you when reversing to lessen the risk of accident.

■ Increasing vehicle-to-vehicle distance

At a speed of 10 km/h (6 mph), the distance to the vehicle running ahead of you should be equivalent to or greater than the combined length of your vehicle and trailer. Avoid sudden braking that may cause skidding. Otherwise, the vehicle may spin out of control. This is especially true when driving on wet or slippery road surfaces.

■ Sudden acceleration/steering input/cornering

Executing sharp turns when towing may result in the trailer colliding with your vehicle. Decelerate well in advance when approaching turns and take them slowly and carefully to avoid sudden braking.

■ Important points regarding turning

The wheels of the trailer will travel closer to the inside of the curve than the wheels of the vehicle. To make allowance for this, take the turns wider than you would normally do.

■ Important points regarding stability

Vehicle movement resulting from uneven road surfaces and strong crosswinds will affect handling. The vehicle may also be rocked by passing buses or large trucks. Frequently check behind when moving alongside such vehicles. As soon as such vehicle movement occurs, immediately start to decelerate smoothly by slowly applying the brakes. Always steer the vehicle straight ahead while braking.

■ Passing other vehicles

Consider the total combined length of your vehicle and trailer and ensure that the vehicle-to-vehicle distance is sufficient before executing lane changes.

■ Transmission information

Vehicles with manual transmission: To maintain engine braking efficiency when using engine braking, do not use 5th gear and 6th gear.

Vehicles with automatic transmission: To maintain engine braking efficiency when using engine braking, do not use the transmission in D. Transmission shift range position must be in 4 or lower, in S mode.

■ If the engine overheats

Towing a loaded trailer up a long, steep incline in temperatures exceeding 30°C (85°F) may result in the engine overheating. If the engine coolant temperature gauge indicates that the engine is overheating, turn the air conditioning off immediately, leave the road and stop the vehicle in a safe place. (→P. 610)

■ When parking the vehicle

Always place wheel chocks under the wheels of both the vehicle and trailer. Firmly set the parking brake and shift the shift lever to P for automatic transmissions, and 1 or R for manual transmissions.

 **WARNING**

Follow all the instructions described in this section. Failure to do so could cause an accident resulting in death or serious injury.

■ Trailer towing precautions

When towing, make sure that none of the weight limits are exceeded.
(→P. 212)

■ Vehicle speed in towing

Observe the legal maximum speeds for trailer towing.

■ Before descending hills or long declines

Reduce speed and downshift. However, never downshift suddenly while descending steep or long down hill grades.

■ Operation of the brake pedal

Do not hold the brake pedal depressed often or for long periods of time. Doing so may result in the brake overheating or reduce braking effects.

■ To avoid accident or injury

● The gross combination mass (sum of your vehicle mass plus its load and the total trailer mass) must not exceed the following:

▶ Single-cab models

6000 kg (13228 lb.): 4WD models

▶ Smart-cab models

6200 kg (13669 lb.): 4WD models

▶ Double-cab models

6000 kg (13228 lb.): Pre Runner

6300 kg (13889 lb.): 4WD models except for Kazakhstan

● Do not use the following systems when trailer towing.

- Cruise control (if equipped)
- Dynamic radar cruise control (if equipped)

Important points regarding trailer loads (4WD models for Kazakhstan and Pre Runner)

■ Total trailer weight and permissible drawbar load

① Total trailer weight

Weight of the trailer itself plus the trailer load should be within the maximum towing capacity. Exceeding this weight is dangerous. (→P. 622)

When towing a trailer, use a friction coupler or friction stabilizer (sway control device).

When the total trailer weight is over 2000 kg (4409 lb.), a friction stabilizer (sway control device) is required.

② Permissible drawbar load

Allocate the trailer load so that the drawbar load is greater than 25 kg (55.1 lb.) or 4% of the towing capacity. Do not let the drawbar load exceed the indicated weight. (→P. 622)

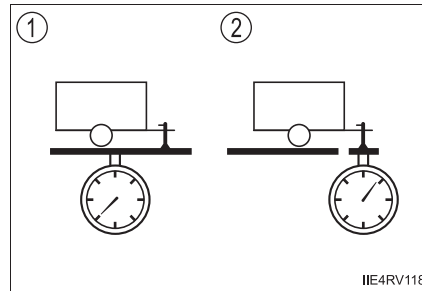

■ Information tag (manufacturer's label)

① Gross vehicle mass

The combined weight of the driver, passengers, luggage, towing hitch, total curb mass and drawbar load should not exceed the gross vehicle mass by more than 100 kg (220.5 lb.). Exceeding this weight is dangerous.

② Maximum permissible rear axle capacity

The weight borne by the rear axle should not exceed the maximum permissible rear axle capacity by 15% or more. Exceeding this weight is dangerous.

The values for towing capacity were derived from testing conducted at sea level. Take note that engine output and towing capacity will be reduced at high altitudes.

▶ Type A

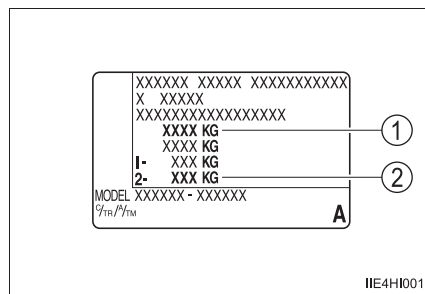

▶ Type B

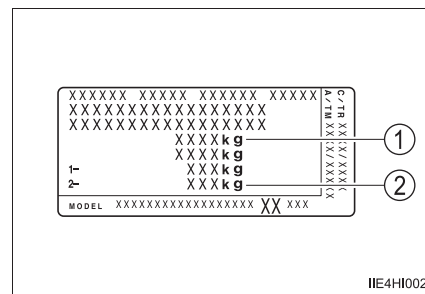

⚠ WARNING

■ **When the gross vehicle mass or maximum permissible axle capacity is exceeded**

Failing to observe this precaution may lead to an accident causing death or serious injury.

- Add an additional 20.0 kPa (0.2 kgf/cm² or bar, 3 psi) to the recommended tire inflation pressure value. (→P. 639)
- Do not exceed the established speed limit for towing a trailer in built-up areas or 100 km/h (62 mph), whichever is lower.

■ **Tire information**

- Increase the tire inflation pressure to 20.0 kPa (0.2 kgf/cm² or bar, 3 psi) greater than the recommended value when towing. (→P. 639)
- Increase the air pressure of the trailer tires in accordance with the total trailer weight and according to the values recommended by the manufacturer of your trailer.

■ **Trailer lights**

Check that the turn signal lights and stoplights are operating correctly every time you hitch up the trailer. Directly wiring up to your vehicle may damage the electrical system and stop the lights from functioning correctly.

■ **Break-in schedule**

Toyota recommends that vehicles fitted with new power train components should not be used for towing trailers for the first 800 km (500 miles).

■ **Safety checks before towing**

- Check that the maximum load limit for the towing hitch/bracket and hitch ball is not exceeded. Bear in mind that the coupling weight of the trailer will add to the load exerted on the vehicle. Also make sure that the total load exerted on the vehicle is within the range of the weight limits. (→P. 212)
- Ensure that the trailer load is secure.
- Supplementary outside rear view mirrors should be added to the vehicle if the traffic behind cannot be clearly seen with standard mirrors. Adjust the extending arms of these mirrors on both sides of the vehicle so that they always provide maximum visibility of the road behind.

■ **Maintenance**

- Maintenance must be performed more frequently when using the vehicle for towing due to the greater weight burden placed on the vehicle compared to normal driving.
- Retighten all bolts securing the hitching ball and bracket after towing for approximately 1000 km (600 miles).

■ If trailer sway occurs

One or more factors (crosswinds, passing vehicles, rough roads, etc.) can adversely affect handling of your vehicle and trailer, causing instability.

● If trailer swaying occurs:

- Firmly grip the steering wheel. Steer straight ahead.
Do not try to control trailer swaying by turning the steering wheel.
- Begin releasing the accelerator pedal immediately but very gradually to reduce speed.

Do not increase speed. Do not apply vehicle brakes.

If you make no extreme correction with the steering or brakes, your vehicle and trailer should stabilize (if enabled, Trailer Sway Control can also help to stabilize the vehicle and trailer.).

● After the trailer swaying has stopped:

- Stop in a safe place. Get all occupants out of the vehicle.
- Check the tires of the vehicle and the trailer.
- Check the load in the trailer.
Make sure the load has not shifted.
Make sure the tongue weight is appropriate, if possible.
- Check the load in the vehicle.
Make sure the vehicle is not overloaded after occupants get in.

If you cannot find any problems, the speed at which trailer swaying occurred is beyond the limit of your particular vehicle-trailer combination.

Drive at a lower speed to prevent instability. Remember that swaying of the towing vehicle-trailer increases as speed increases.

NOTICE

■ When the rear bumper strengthening material is aluminum

Ensure the steel bracket part does not come directly in contact with that area.

When steel and aluminum come into contact, there is a reaction similar to corrosion, which will weaken the section concerned and may result in damage. Apply a rust inhibitor to parts that will come in contact when attaching a steel bracket.

Important points regarding trailer loads (4WD models except for Kazakhstan)

■ **Total trailer weight and permissible drawbar load**

① Total trailer weight

Weight of the trailer itself plus the trailer load should be within the maximum towing capacity. Exceeding this weight is dangerous. (→P. 622)

When towing a trailer, use a friction coupler or friction stabilizer (sway control device).

When the total trailer weight is over 2000 kg (4409 lb.), a friction stabilizer (sway control device) is required.

② Permissible drawbar load

Allocate the trailer load so that the drawbar load is greater than 25 kg (55.1 lb.) or 4% of the towing capacity. Do not let the drawbar load exceed the indicated weight. (→P. 622)

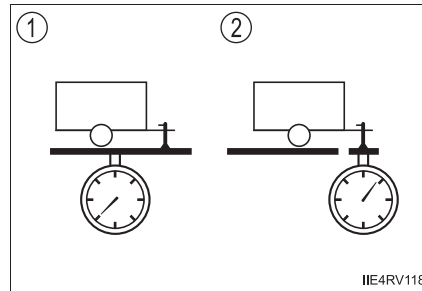

■ **Information tag (manufacturer's label)**

① Gross vehicle mass

The combined weight of the driver, passengers, luggage, towing hitch, total curb mass and drawbar load should not exceed the gross vehicle mass by more than 100 kg (220.5 lb.). Exceeding this weight is dangerous.

② Maximum permissible rear axle capacity

The weight borne by the rear axle should not exceed the maximum permissible rear axle capacity by 15% or more. Exceeding this weight is dangerous.

The values for towing capacity were derived from testing conducted at sea level. Take note that engine output and towing capacity will be reduced at high altitudes.

▶ Type A

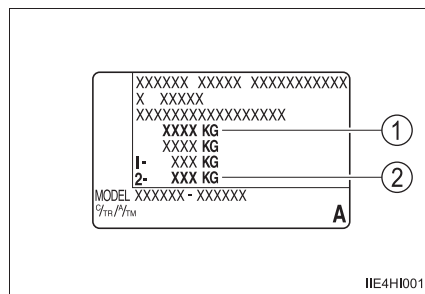

▶ Type B

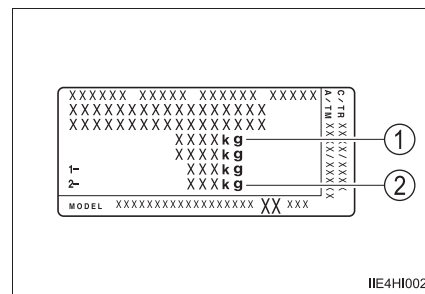

⚠ WARNING

- **When the total trailer weight exceeds 3200kg (7055 lb.)**
Do not exceed the legal speed limit for towing a trailer or 90 km/h (56 mph), whichever is lower.
Failing to observe this precaution may lead to an accident causing death or serious injury.
- **When the gross vehicle mass or maximum permissible axle capacity is exceeded**
Failing to observe this precaution may lead to an accident causing death or serious injury.
 - Add an additional 20.0 kPa (0.2 kgf/cm² or bar, 3 psi) to the recommended tire inflation pressure value. (→P. 639)
 - Do not exceed the established speed limit for towing a trailer in built-up areas or 100 km/h (62 mph), whichever is lower.

■ **Tire information**

- Increase the tire inflation pressure to 20.0 kPa (0.2 kgf/cm² or bar, 3 psi) greater than the recommended value when towing. (→P. 639)
- Increase the air pressure of the trailer tires in accordance with the total trailer weight and according to the values recommended by the manufacturer of your trailer.

■ **Trailer lights**

Check that the turn signal lights and stoplights are operating correctly every time you hitch up the trailer. Directly wiring up to your vehicle may damage the electrical system and stop the lights from functioning correctly.

■ **Break-in schedule**

Toyota recommends that vehicles fitted with new power train components should not be used for towing trailers for the first 800 km (500 miles).

■ **Safety checks before towing**

- Check that the maximum load limit for the towing hitch/bracket and hitch ball is not exceeded. Bear in mind that the coupling weight of the trailer will add to the load exerted on the vehicle. Also make sure that the total load exerted on the vehicle is within the range of the weight limits. (→P. 216)
- Ensure that the trailer load is secure.
- Supplementary outside rear view mirrors should be added to the vehicle if the traffic behind cannot be clearly seen with standard mirrors. Adjust the extending arms of these mirrors on both sides of the vehicle so that they always provide maximum visibility of the road behind.

■ **Maintenance**

- Maintenance must be performed more frequently when using the vehicle for towing due to the greater weight burden placed on the vehicle compared to normal driving.
- Retighten all bolts securing the hitching ball and bracket after towing for approximately 1000 km (600 miles).

■ If trailer sway occurs

One or more factors (crosswinds, passing vehicles, rough roads, etc.) can adversely affect handling of your vehicle and trailer, causing instability.

● If trailer swaying occurs:

- Firmly grip the steering wheel. Steer straight ahead.
Do not try to control trailer swaying by turning the steering wheel.
- Begin releasing the accelerator pedal immediately but very gradually to reduce speed.

Do not increase speed. Do not apply vehicle brakes.

If you make no extreme correction with the steering or brakes, your vehicle and trailer should stabilize (if enabled, Trailer Sway Control can also help to stabilize the vehicle and trailer.).

● After the trailer swaying has stopped:

- Stop in a safe place. Get all occupants out of the vehicle.
- Check the tires of the vehicle and the trailer.
- Check the load in the trailer.
Make sure the load has not shifted.
Make sure the tongue weight is appropriate, if possible.
- Check the load in the vehicle.

Make sure the vehicle is not overloaded after occupants get in.

If you cannot find any problems, the speed at which trailer swaying occurred is beyond the limit of your particular vehicle-trailer combination.

Drive at a lower speed to prevent instability. Remember that swaying of the towing vehicle-trailer increases as speed increases.

NOTICE

■ When the rear bumper strengthening material is aluminum

Ensure the steel bracket part does not come directly in contact with that area.

When steel and aluminum come into contact, there is a reaction similar to corrosion, which will weaken the section concerned and may result in damage. Apply a rust inhibitor to parts that will come in contact when attaching a steel bracket.



Engine (ignition) switch (vehicles without smart entry & start system)

Starting the engine

▶ Automatic transmission (gasoline engine)

- 1 Check that the parking brake is set.
- 2 Check that the shift lever is set in P.
- 3 Firmly depress the brake pedal.
- 4 Turn the engine switch to the “START” position to start the engine.



▶ Automatic transmission (diesel engine)

- 1 Check that the parking brake is set.
- 2 Check that the shift lever is set in P.
- 3 Firmly depress the brake pedal.
- 4 Turn the engine switch to the “ON” position.
The  indicator turns on.
- 5 After the  indicator light goes out, turn the engine switch to the “START” position to start the engine.

▶ Manual transmission (gasoline engine)

- 1 Check that the parking brake is set.
- 2 Check that the shift lever is set in N.
- 3 Firmly depress the clutch pedal.
- 4 Turn the engine switch to the “START” position to start the engine.

▶ Manual transmission (diesel engine)

- 1 Check that the parking brake is set.
- 2 Check that the shift lever is set in N.
- 3 Firmly depress the clutch pedal.
- 4 Turn the engine switch to the “ON” position.
The  indicator turns on.
- 5 After the  indicator light goes out, turn the engine switch to the “START” position to start the engine.

Changing the engine switch positions

① "LOCK"

The steering wheel is locked and the key can be removed. (Vehicles with automatic transmission: The key can be removed only when the shift lever is in P.)

② "ACC"

Some electrical components such as the audio system can be used.

③ "ON"

All electrical components can be used.

④ "START"

For starting the engine.

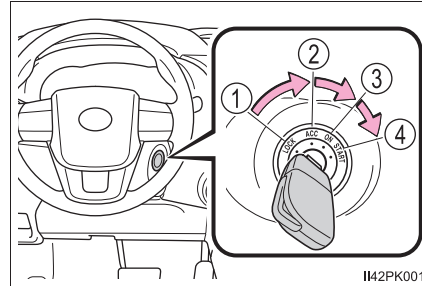

Turning the key from "ACC" to "LOCK"

- ① Shift the shift lever to P (automatic transmission) or N (manual transmission). (→P. 231, 239)
- ② Push in the key and turn it to the "LOCK" position.

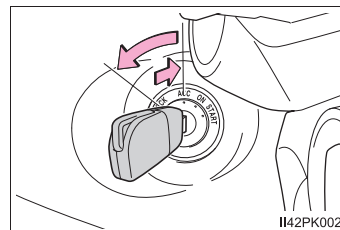

If the engine does not start

The engine immobilizer system may not have been deactivated. (→P. 115)

Contact any authorized Toyota retailer or Toyota authorized repairer, or any reliable repairer.

■ When the steering lock cannot be released

When starting the engine, the engine switch may seem stuck in the “LOCK” position. To free it, turn the key while turning the steering wheel slightly left and right.

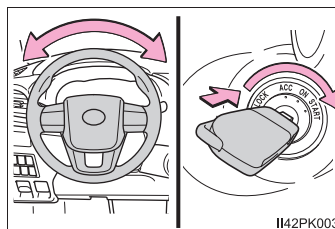

■ Key reminder function

A buzzer sounds if the driver's door is opened while the engine switch is in the “LOCK” or “ACC” position to remind you to remove the key.

⚠ WARNING

■ When starting the engine

Always start the engine while sitting in the driver's seat. Do not depress the accelerator pedal while starting the engine under any circumstances. Doing so may cause an accident resulting in death or serious injury.

■ Caution when driving

Do not turn the engine switch to the “LOCK” position while driving. If in an emergency, you must turn the engine off while the vehicle is moving, turn the engine switch only to the “ACC” position to stop the engine. An accident may result if the engine is stopped while driving. (→P. 555)

⚠ NOTICE

■ To prevent battery discharge

Do not leave the engine switch in the “ACC” or “ON” position for long periods of time without the engine running.

■ When starting the engine

- Do not crank the engine for more than 30 seconds at a time. This may overheat the starter and wiring system.
- Do not race a cold engine.
- If the engine becomes difficult to start or stalls frequently, have your vehicle checked by any authorized Toyota retailer or Toyota authorized repairer, or any reliable repairer immediately.

Engine (ignition) switch (vehicles with smart entry & start system)

Performing the following operations when carrying the electronic key on your person starts the engine or changes engine switch modes.

Starting the engine

► Automatic transmission

- 1 Check that the parking brake is set.
- 2 Check that the shift lever is set in P.
- 3 Firmly depress the brake pedal.

A message will be displayed on the multi-information display. If it is not displayed, the engine cannot be started.

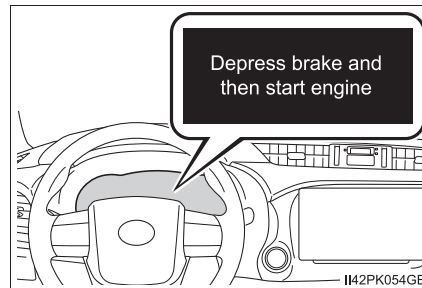

- 4 Press the engine switch shortly and firmly.

When operating the engine switch, one short, firm press is enough. It is not necessary to press and hold the switch.

The engine will crank until it starts or for up to 30 seconds, whichever is less.

Continue depressing the brake pedal until the engine is completely started.

Diesel engine only: the  indicator turns on. The engine will start after the indicator light goes out.

The engine can be started from any engine switch mode.

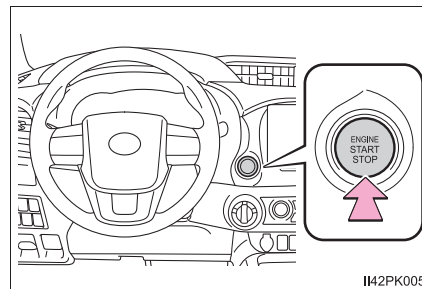

► Manual transmission

- 1 Check that the parking brake is set.
- 2 Check that the shift lever is set in N.
- 3 Firmly depress the clutch pedal.

A message will be displayed on the multi-information display. If it is not displayed, the engine cannot be started.

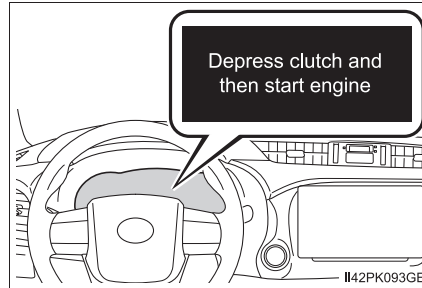

- 4 Press the engine switch shortly and firmly.

When operating the engine switch, one short, firm press is enough. It is not necessary to press and hold the switch.

The engine will crank until it starts or for up to 30 seconds, whichever is less.

Continue depressing the clutch pedal until the engine is completely started.

Diesel engine only: the  indicator turns on. The engine will start after the indicator light goes out.

The engine can be started from any engine switch mode.

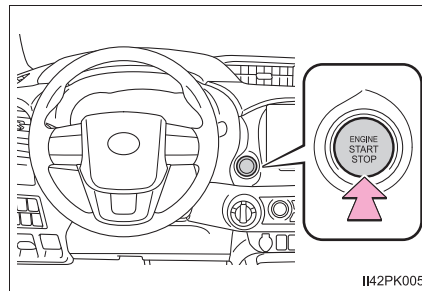

Stopping the engine

▶ Automatic transmission

- 1 Stop the vehicle.
- 2 Set the parking brake (→P. 247), and shift the shift lever to P.
- 3 Press the engine switch.
- 4 Release the brake pedal and check that the display on the instrument cluster is off.

▶ Manual transmission

- 1 Stop the vehicle.
- 2 Shift the shift lever to N.
- 3 Set the parking brake. (→P. 247)
- 4 Press the engine switch.
- 5 Release the brake pedal and check that the display on the instrument cluster is off.

Changing engine switch modes

Modes can be changed by pressing the engine switch with brake pedal (vehicles with automatic transmission) or clutch pedal (vehicles with manual transmission) released. (The mode changes each time the switch is pressed.)

① Off*

The emergency flashers can be used.

② ACCESSORY mode

Some electrical components such as the audio system can be used.

“ACCESSORY” will be displayed on the multi-information display.

③ IGNITION ON mode

All electrical components can be used.

“IGNITION ON” will be displayed on the multi-information display.

*: If the shift lever is in a position other than P when turning off the engine, the engine switch will be turned to ACCESSORY mode, not to off (vehicles with automatic transmission only).

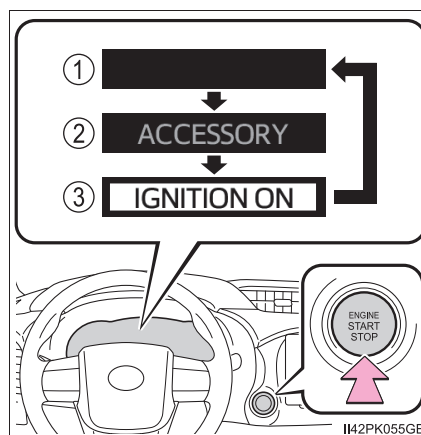

When stopping the engine with the shift lever in a position other than P (vehicles with automatic transmission)

If the engine is stopped with the shift lever in a position other than P, the engine switch will not be turned off but instead be turned to ACCESSORY mode. Perform the following procedure to turn the switch off:

- ① Check that the parking brake is set.
- ② Shift the shift lever to P.
- ③ Check that “Turn off vehicle” is displayed on the multi-information display and then press the engine switch once.
- ④ Check that “Turn off vehicle” on the multi-information display is off.

■ Note for the electronic key

Carry the electronic key on your person, for example in your pocket.

The smart entry & start system does not operate properly if the electronic key is on the floor or the instrument panel, or in the door pockets, cup holders or auxiliary boxes.

■ Auto power off function**▶ Vehicles with automatic transmission**

If the vehicle is left in ACCESSORY mode for more than 20 minutes or IGNITION ON mode (the engine is not running) for more than an hour with the shift lever in P, the engine switch will automatically turn off. However, this function cannot entirely prevent battery discharge. Do not leave the vehicle with the engine switch in ACCESSORY or IGNITION ON mode for long periods of time when the engine is not running.

▶ Vehicles with manual transmission

If the vehicle is left in ACCESSORY mode for more than 20 minutes or IGNITION ON mode (the engine is not running) for more than an hour, the engine switch will automatically turn off. However, this function cannot entirely prevent battery discharge. Do not leave the vehicle with the engine switch in ACCESSORY or IGNITION ON mode for long periods of time when the engine is not running.

■ Operation of the engine switch

If the switch is not pressed shortly and firmly, the engine switch mode may not change or the engine may not start.

■ Electronic key battery depletion

→P. 168

■ Conditions affecting operation

→P. 166

■ Note for the entry function

→P. 167

■ If the engine does not start

The engine immobilizer system may not have been deactivated. (→P. 115)
Contact any authorized Toyota retailer or Toyota authorized repairer, or any reliable repairer.

■ Steering lock

After turning the engine switch off and opening and closing the doors, the steering wheel will be locked due to the steering lock function. Operating the engine switch again automatically cancels the steering lock.

■ When the steering lock cannot be released

A message will be displayed on the multi-information display.

Check that the shift lever is set in P (except manual transmission). Press the engine switch while turning the steering wheel left and right.

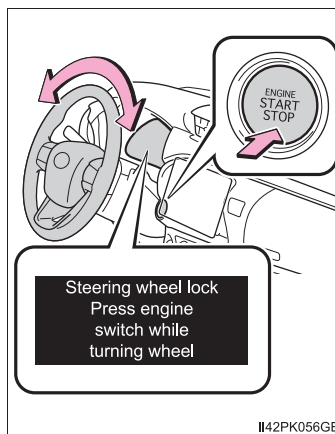

■ Steering lock motor overheating prevention

To prevent the steering lock motor from overheating, the motor may be suspended if the engine is turned on and off repeatedly in a short period of time. In this case, refrain from running the engine. After about 10 seconds, the steering lock motor will resume functioning.

■ If “Smart Entry & Start System malfunction See owner’s manual” is shown on the multi-information display

The system may be malfunctioning. Have the vehicle inspected by any authorized Toyota retailer or Toyota authorized repairer, or any reliable repairer immediately.

■ If the electronic key battery is depleted

→P. 516

■ If the smart entry & start system has been deactivated in a customized setting

→P. 600

 **WARNING****■ When starting the engine**

Always start the engine while sitting in the driver's seat. Do not depress the accelerator pedal while starting the engine under any circumstances. Doing so may cause an accident resulting in death or serious injury.

■ Caution while driving

If engine failure occurs while the vehicle is moving, do not lock or open the doors until the vehicle reaches a safe and complete stop. Activation of the steering lock in this circumstance may lead to an accident, resulting in death or serious injury.

■ Stopping the engine in an emergency

- If you want to stop the engine in an emergency while driving the vehicle, press and hold the engine switch for more than 2 seconds, or press it briefly 3 times or more in succession. (→P. 555)

However, do not touch the engine switch while driving except in an emergency. If the engine switch is pressed while the vehicle is moving, the warning message "Push and hold engine switch for emergency stop" is displayed on the multi-information display and a buzzer sounds. Turning the engine off while driving will not cause loss of steering or braking control, but the power assist to these systems will be lost. This will make it more difficult to steer and brake, so you should pull over and stop the vehicle as soon as it is safe to do so.

- To restart the engine after turning off the engine while driving, shift the shift lever to N (automatic transmission) or depress the clutch pedal (manual transmission) and then press the engine switch.



NOTICE

■ To prevent battery discharge

- Do not leave the engine switch in ACCESSORY or IGNITION ON mode for long periods of time without the engine running.
- If “ACCESSORY” or “IGNITION ON” is displayed on the multi-information display while the engine is not running, the engine switch is not off. Exit the vehicle after turning the engine switch off.
- On vehicles with automatic transmission, do not stop the engine when the shift lever is in a position other than P. If the engine is stopped in another shift lever position, the engine switch will not be turned off but instead be turned to ACCESSORY mode. If the vehicle is left in ACCESSORY mode, battery discharge may occur.

■ When starting the engine

- Do not race a cold engine.
- If the engine becomes difficult to start or stalls frequently, have your vehicle checked by any authorized Toyota retailer or Toyota authorized repairer, or any reliable repairer immediately.

■ Symptoms indicating a malfunction with the engine switch

If the engine switch seems to be operating somewhat differently than usual, such as the switch sticking slightly, there may be a malfunction. Contact any authorized Toyota retailer or Toyota authorized repairer, or any reliable repairer immediately.

Automatic transmission*

Select a shift position appropriate for the driving conditions.

Shifting the shift lever

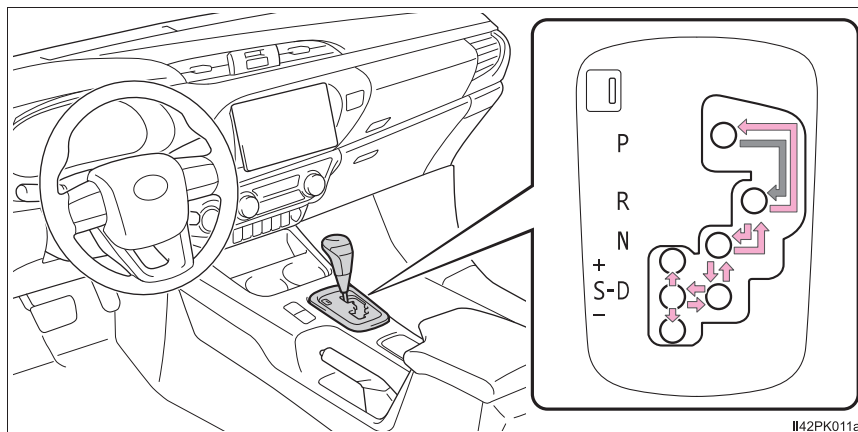

▶ Vehicles without smart entry & start system

- ← While the engine switch is in the “ON” position, move the shift lever with the brake pedal depressed.

When shifting the shift lever between P and D, make sure that the vehicle is completely stopped.

▶ Vehicles with smart entry & start system

- ← While the engine switch is in IGNITION ON mode, move the shift lever with the brake pedal depressed.

When shifting the shift lever between P and D, make sure that the vehicle is completely stopped.

*: If equipped

Shift position purpose

Shift position	Function
P	Parking the vehicle/starting the engine
R	Reversing
N	Neutral (Condition in which the power is not transmitted)
D	Normal driving ^{*1}
S	S mode driving ^{*2} (→P. 235)

^{*1}: To improve fuel efficiency and reduce noises, set the shift lever in the D position for normal driving.

^{*2}: Selecting shift ranges using S mode restricts the upper limit of the possible gear ranges, controls engine braking force, and prevents unnecessary upshifting.

Selecting the driving mode

The driving modes can be selected to suit driving conditions.

① Eco drive mode

Use Eco drive mode to help achieve low fuel consumption during trips that involve frequent accelerating.

Press the “ECO” switch to select Eco drive mode. The “ECO” indicator will come on.

Press the switch again to cancel Eco drive mode, and then the driving mode changes to normal mode for normal driving.

② Power mode

Use when high levels of response and feeling are desirable, such as when driving in mountainous regions or when overtaking.

Press the “PWR” switch to select power mode. The “PWR” indicator will come on.

Press the switch again to cancel power mode, and then the driving mode changes to normal mode for normal driving.

The driving modes cannot be selected when the front-wheel drive control switch is in L4. (if equipped)

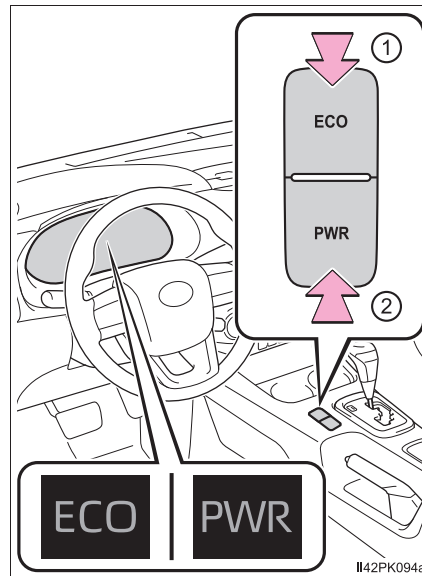

Selecting shift ranges in the D position (vehicles with paddle shift switches)

To drive using temporary shift range selection, operate the “-” or “+” paddle shift switch.

When the “-” paddle shift switch is operated, the shift range will be downshifted to a range that enables engine braking force that is suitable to driving conditions. When the “+” paddle shift switch is operated, the shift range will be one gear upper than the gear in use during normal D position driving.

Changing the shift range allows restriction of the highest gear, preventing unnecessary upshifting and enabling the level of engine braking force to be selected.

- ① Upshifting
- ② Downshifting

The selected shift range, from 1 to 6, will be displayed in the meter.

To return to normal D position driving, the “+” paddle shift switch must be held down for a period of time.

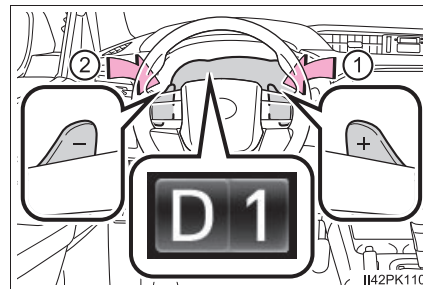

■ Shift ranges and their functions

- Automatically selecting shift ranges between 1 and 6 according to vehicle speed and driving conditions. But the gear is limited according to selected range.
- You can choose from 6 levels of engine braking force.
- A lower shift range will provide greater engine braking force than a higher shift range, and the engine speed will also increase.

Selecting shift ranges in the S position

To enter S mode, shift the shift lever to S. Shift ranges can be selected by operating the shift lever or paddle shift switches (if equipped), allowing you to drive in the shift range of your choosing.

- ① Upshifting
- ② Downshifting

The selected shift range, from 1 to 6, will be displayed in the meter.

The initial shift range in S mode is set automatically to 5 or 4 according to vehicle speed. However, the initial shift range may be set to 3 if AI-SHIFT has operated while the shift lever was in D. (→P. 238)

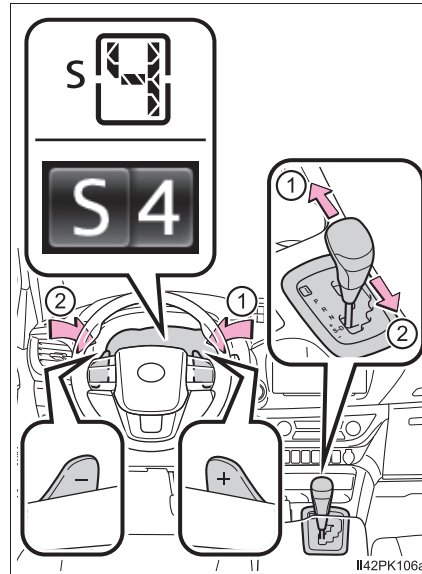

■ Shift ranges and their functions

- Automatically selecting shift ranges between 1 and 6 according to vehicle speed and driving conditions. But the gear is limited according to selected range.
- You can choose from 6 levels of engine braking force.
- A lower shift range will provide greater engine braking force than a higher shift range, and the engine speed will also increase.

■ Automatic deactivation of shift range selection in the D position (vehicles with paddle shift switches)

Shift range selection in the D position will be deactivated in the following situations:

- When the vehicle comes to a stop
- If the accelerator pedal is depressed for more than a certain period of time in 4 or higher without changing the shift range
- When the shift lever is shifted to other than D

■ S mode

When the shift range is 4 or lower, holding the shift lever toward “+” sets the shift range to 6.

■ Downshifting restrictions warning buzzer

To help ensure safety and driving performance, downshifting operation may sometimes be restricted. In some circumstances, downshifting may not be possible even when the shift lever is operated. (A buzzer will sound twice.)

■ Operation of the air conditioning system in Eco drive mode (vehicles with automatic air conditioning system)

Eco drive mode controls the heating/cooling operations and fan speed of the air conditioning system to enhance fuel efficiency (→P. 446). To improve air conditioning performance, adjust the fan speed or turn off Eco drive mode.

■ Deactivation of the driving mode

- Eco drive mode will not be canceled until the “ECO” switch is pressed, even if the engine is turned off after driving in Eco drive mode.
- Power mode will be canceled if the engine is turned off after driving in power mode.
- Driving mode will be canceled if the transfer mode is shifted to L4 while the driving mode is in other than normal mode. (if equipped)

■ When driving with cruise control or dynamic radar cruise control activated (if equipped)

Even when performing the following actions with the intent of enabling engine braking, engine braking will not activate because cruise control or dynamic radar cruise control will not be canceled.

- While driving in S mode, downshifting to 5 or 4. (→P. 235)
- When switching the driving mode to power mode while driving in D. (→P. 233)

■ Restraining sudden start (Drive-Start Control) (vehicles with VSC system)

→P. 195

■ Shift lock system

The shift lock system is a system to prevent accidental operation of the shift lever in starting.

The shift lever can be shifted from P only when the engine switch is in the “ON” position (vehicles without smart entry & start system) or IGNITION ON mode (vehicles with smart entry & start system) and the brake pedal is being depressed.

■ If the shift lever cannot be shifted from P

First, check whether the brake pedal is being depressed.

If the shift lever cannot be shifted with your foot on the brake pedal, there may be a problem with the shift lock system. Have the vehicle inspected by any authorized Toyota retailer or Toyota authorized repairer, or any reliable repairer immediately.

The following steps may be used as an emergency measure to ensure that the shift lever can be shifted.

Releasing the shift lock:

- 1 Set the parking brake.
- 2 Vehicles without smart entry & start system:
Turn the engine switch to the "LOCK" position.

Vehicles with smart entry & start system:
Turn the engine switch off.

- 3 Depress the brake pedal.
- 4 Pry the cover up with a flathead screwdriver or equivalent tool.

To prevent damage to the cover, cover the tip of the screwdriver with a rag.

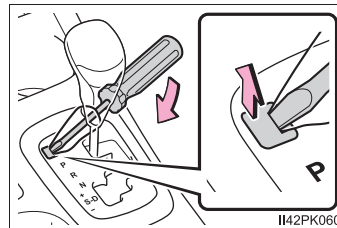

- 5 Press the shift lock override button.
- The shift lever can be shifted while the button is pressed.

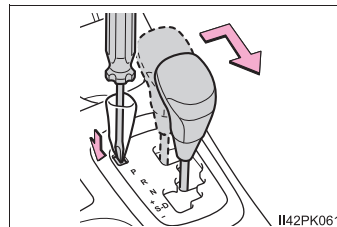

■ If the "S" indicator does not come on or the "D" indicator is displayed even after shifting the shift lever to S

This may indicate a malfunction in the automatic transmission system. Have the vehicle inspected by any authorized Toyota retailer or Toyota authorized repairer, or any reliable repairer immediately.

■ Transmission protection function

If the tires spin continually when the vehicle becomes stuck in mud, dirt or snow, or if the accelerator pedal is depressed and released repeatedly while driving, the automatic transmission temperature may become too high and the automatic transmission may be damaged.

To avoid damaging the automatic transmission, the system may temporarily lock the gear.

If the automatic transmission temperature falls, the gear locking is canceled and the automatic transmission is returned to the normal operation.

■ If the warning message is displayed

If the automatic transmission fluid temperature warning message is displayed while driving, make sure to return to D position driving and reduce speed by easing off the accelerator pedal. Stop the vehicle in a safe place, shift the shift lever to P and let the engine idle until the warning message goes out.

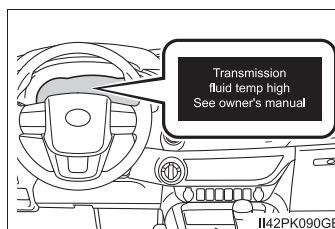

When the warning message goes out, the vehicle can be driven again.

If the warning message does not go out after waiting a while, have your vehicle inspected by any authorized Toyota retailer or Toyota authorized repairer, or any reliable repairer.

■ AI-SHIFT

The AI-SHIFT automatically selects the suitable gear according to driver performance and driving conditions.

The AI-SHIFT automatically operates when the shift lever is in D. (Shifting the shift lever to S cancels the function.)

⚠ WARNING

■ When driving on slippery road surfaces

Do not accelerate or shift gears suddenly. Sudden changes in engine braking may cause the vehicle to spin or skid, resulting in an accident.

■ To prevent an accident when releasing the shift lock

Before pressing the shift lock override button, make sure to set the parking brake and depress the brake pedal.

If the accelerator pedal is accidentally depressed instead of the brake pedal when the shift lock override button is pressed and the shift lever is shifted out of P, the vehicle may suddenly start, possibly leading to an accident resulting in death or serious injury.

Manual transmission*

Shifting the shift lever

► 5-speed transmission

- 1 Depress the clutch pedal firmly.
- 2 Shift the shift lever slowly and securely.
Make sure to only shift gears sequentially.
- 3 Gradually release the clutch pedal.

If it is difficult to shift in R, shift the shift lever to N, release the clutch pedal momentarily, and then try again.

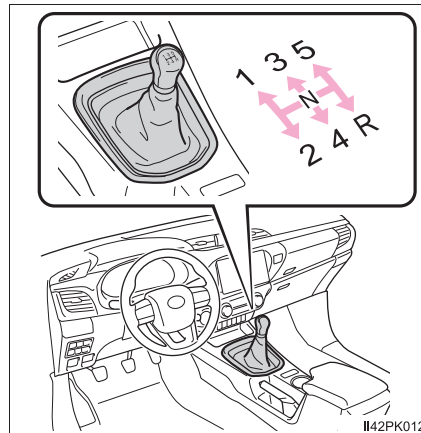

► 6-speed transmission

- 1 Depress the clutch pedal firmly.
- 2 Shift the shift lever slowly and securely.
Make sure to only shift gears sequentially.
- 3 Gradually release the clutch pedal.

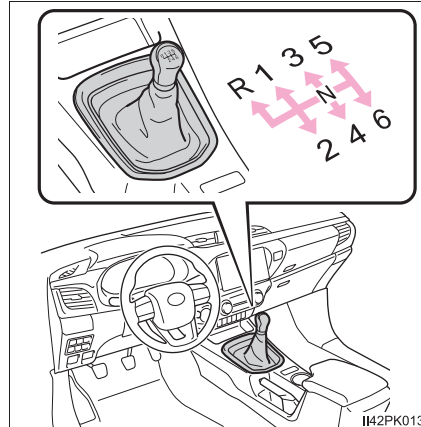

*: If equipped

Selecting the driving mode (if equipped)

The driving modes can be selected to suit driving conditions.

① Eco drive mode

Use Eco drive mode to help achieve low fuel consumption during trips that involve frequent accelerating.

Press the “ECO” switch to select Eco drive mode. The “ECO” indicator will come on.

Press the switch again to cancel Eco drive mode, and then the driving mode changes to normal mode for normal driving.

② Power mode

Use when high levels of response and feeling are desirable, such as when driving in mountainous regions or when overtaking.

Press the “PWR” switch to select power mode. The “PWR” indicator will come on.

Press the switch again to cancel power mode, and then the driving mode changes to normal mode for normal driving.

The driving modes cannot be selected when the front-wheel drive control switch is in L4. (if equipped)

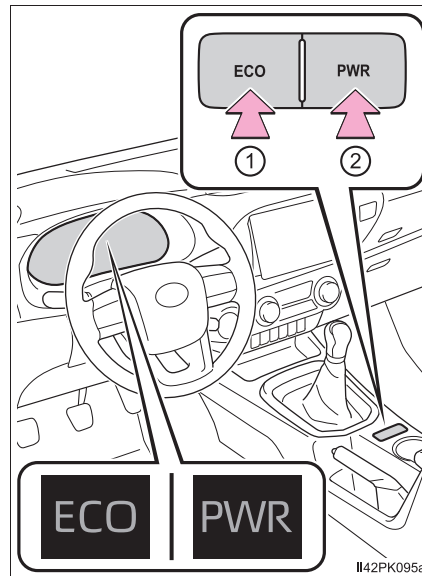

iMT (Intelligent Manual Transmission) (if equipped)

iMT detects clutch pedal and shift lever operations performed by the driver. When the shift position is changed, iMT judges the optimal engine speed and performs the appropriate control to help the driver to change the shift position smoothly.

Press the “iMT” switch.

The “iMT” indicator will come on.

Press the switch again to cancel iMT.

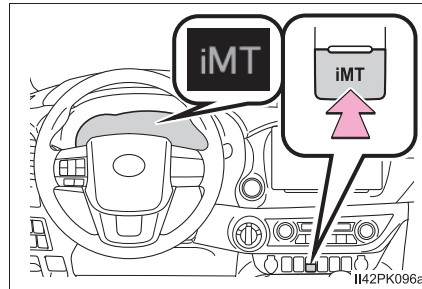

■ **Maximum downshifting speeds**

Observe the downshifting speeds in the following table to prevent over-revving the engine.

► 5-speed transmission

4WD models (front-wheel drive control switch in H2 or H4):

km/h (mph)

Shift position	Maximum speed			
	1	2	3	4
225/70R17C tires	38 (23)	71 (44)	114 (70)	164 (101)
265/65R17 tires	39 (24)	72 (44)	117 (72)	168 (104)
205R16C tires	37 (22)	69 (42)	112 (69)	160 (99)

4WD models (front-wheel drive control switch in L4):

km/h (mph)

Shift position	Maximum speed			
	1	2	3	4
225/70R17C tires	15 (9)	28 (17)	45 (27)	64 (39)
265/65R17 tires	15 (9)	28 (17)	46 (28)	65 (40)
205R16C tires	15 (9)	27 (16)	44 (27)	63 (39)

► 6-speed transmission

4WD models (front-wheel drive control switch in H2 or H4):

km/h (mph)

Shift position	Maximum speed				
	1	2	3	4	5
205R16C tires	34 (21)	67 (41)	113 (70)	163 (101)	170 (105)
225/70R17C tires	35 (21)	69 (42)	116 (72)	167 (103)	170 (105)
265/65R17, 265/60R18 tires	36 (22)	70 (43)	118 (73)	170 (105)	170 (105)

4WD models (front-wheel drive control switch in L4):

km/h (mph)

Shift position	Maximum speed				
	1	2	3	4	5
205R16C tires	13 (8)	26 (16)	44 (27)	64 (39)	82 (50)
225/70R17C tires	14 (8)	27 (16)	45 (27)	65 (40)	84 (52)
265/65R17 tires	14 (8)	27 (16)	46 (28)	67 (41)	86 (53)
265/60R18 tires	14 (8)	28 (17)	46 (28)	67 (41)	86 (53)

Pre Runner:

km/h (mph)

Shift position	Maximum speed				
	1	2	3	4	5
225/70R17C tires	35 (21)	69 (42)	116 (72)	167 (103)	175 (108)
265/60R18 tires	36 (22)	70 (43)	118 (73)	171 (106)	175 (108)
265/65R17 tires	36 (22)	70 (43)	118 (73)	170 (105)	175 (108)

■ Operation of the air conditioning system in Eco drive mode (vehicles with automatic air conditioning system)

Eco drive mode controls the heating/cooling operations and fan speed of the air conditioning system to enhance fuel efficiency (→P. 446). To improve air conditioning performance, adjust the fan speed or turn off Eco drive mode.

■ Deactivation of the driving mode

- Eco drive mode will not be canceled until the “ECO” button is pressed, even if the engine is turned off after driving in Eco drive mode.
- Power mode will be canceled if the engine is turned off after driving in power mode.
- Driving mode will be canceled if the transfer mode is shifted to L4 while the driving mode is in other than normal mode. (if equipped)

■ Reverse warning buzzer (6-speed transmission)

A buzzer will sound to alert the driver if the shift lever is shifted to the R position.

■ Operation of iMT

- When the clutch pedal is depressed and the shift lever is moved to a position, iMT controls the engine speed to be optimal for changing the shift position. However, iMT stops operating before the shift position is changed if the clutch pedal is not released for a while, and the engine speed cannot be controlled. To operate iMT again, depress the clutch pedal and operate the shift lever.
- The engine speed may be increased when the clutch pedal is depressed, however, this does not indicate a malfunction.

■ When iMT does not operate

In the following situations, iMT may not operate. However, this does not indicate a malfunction.

- The shift lever is not operated for a long time after the clutch pedal is depressed.
- The vehicle moves for a while after the shift lever is shifted to N and the clutch pedal is released, and then the clutch pedal is depressed and the shift lever is moved to a position.
- The clutch pedal is not completely released and depressed again.
- The clutch pedal is not fully depressed.

■ If the warning message for iMT is shown on the multi-information display

iMT may be malfunctioning and the function is disabled. Have the vehicle inspected at any authorized Toyota retailer or Toyota authorized repairer, or any reliable repairer as soon as possible.

 WARNING**■ Limitations of the iMT**

iMT is not a system that prevents shift lever operation error or engine over-revving. Depending on the situation, iMT may not operate normally and the shift position may not be changed smoothly. Overly relying on iMT may cause an unexpected accident.

 NOTICE**■ To prevent damage to the vehicle**

- Shift the shift lever to R only when the vehicle is stationary.
- Do not rest your hand on or hold the shift lever any time other than when shifting.
- In order not to cause the engine to overrev, make sure to only shift gears sequentially.
- Do not release the clutch pedal suddenly, as doing so may cause damage to the clutch or transmission.

Turn signal lever

Operating instructions

- ① Right turn
- ② Left turn
- ③ Lane change to the right (move the lever partway and release it)
The right hand signals will flash 3 times.
- ④ Lane change to the left (move the lever partway and release it)
The left hand signals will flash 3 times.

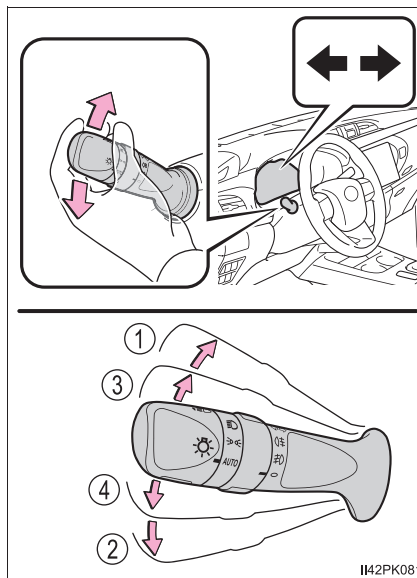

■ Turn signals can be operated when

- ▶ Vehicles without smart entry & start system

The engine switch is in the "ON" position.

- ▶ Vehicles with smart entry & start system

The engine switch is in IGNITION ON mode.

■ If the indicator flashes faster than usual

Check that a light bulb in the front or rear turn signal lights has not burned out.

■ If the turn signals stop flashing before a lane change has been performed

Operate the lever again.

■ To discontinue flashing of the turn signals during a lane change

Operate the lever in the opposite direction.

■ Customization

The number of times the turn signals flash during a lane change can be changed.

(Customizable features: →P. 646)

Parking brake

- ① Sets the parking brake

Fully pull the parking brake while depressing the brake pedal.
At this time, the parking brake indicator light will come on.
- ② Releases the parking brake

Slightly raise the lever and lower it completely while pressing the button.
At this time, the parking brake indicator light will go off.

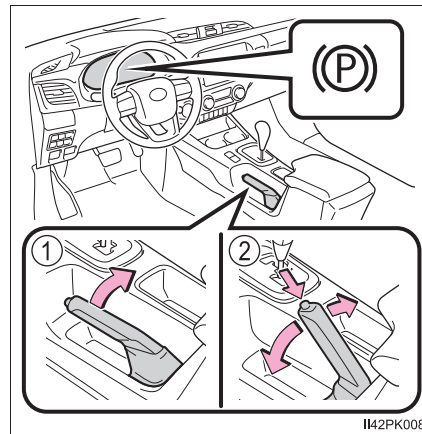

■ Parking the vehicle

→P. 193

■ Parking brake engaged warning buzzer

→P. 571

■ Usage in winter time

→P. 374

⚠ NOTICE

■ Before driving

Fully release the parking brake.
Driving the vehicle with the parking brake set will lead to brake components overheating, which may affect braking performance and increase brake wear.



Headlight switch

The headlights can be operated manually or automatically.

Operating instructions



Operating the  switch turns on the lights as follows:

► Type A

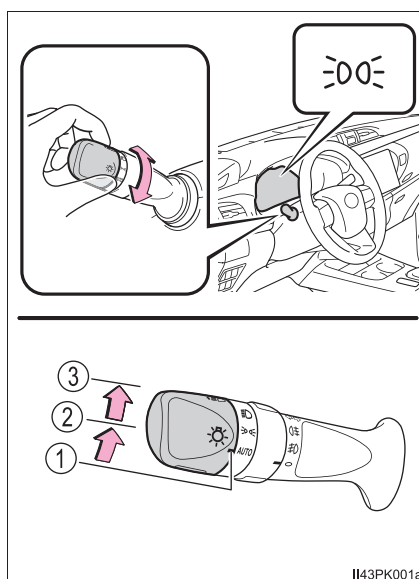
- ① **AUTO** The headlights, front position, tail, license plate, instrument panel lights, and daytime running lights (if equipped) (→P. 252) turn on and off automatically (when the engine switch is in the "ON" position [vehicles without smart entry & start system] or IGNITION ON mode [vehicles with smart entry & start system]).
- ②  The front position, tail, license plate and instrument panel lights turn on.
- ③  The headlights and all lights listed above turn on.



► Type B

- ① ○ Off.
- ② **AUTO** (if equipped) The headlights, front position, tail, license plate and instrument panel lights turn on and off automatically (when the engine switch is in the "ON" position [vehicles without smart entry & start system] or IGNITION ON mode [vehicles with smart entry & start system]).
- ③  The front position, tail, license plate and instrument panel lights turn on.
- ④  The headlights and all lights listed above turn on.

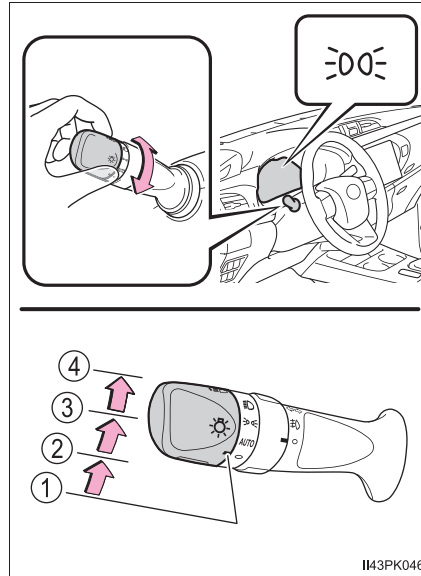

Turning on the high beam headlights

- ① With the headlights on, push the lever away from you to turn on the high beams.

Pull the lever toward you to the center position to turn the high beams off.

- ② Pull the lever toward you and release it to flash the high beams once.

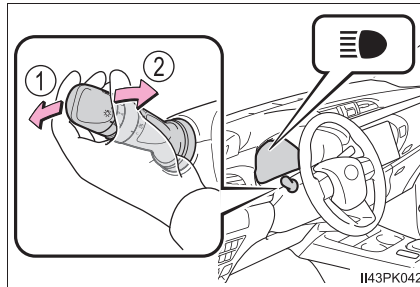

You can flash the high beams with the headlights on or off.

Manual headlight leveling dial (if equipped)

The level of the headlights can be adjusted according to the number of passengers and the loading condition of the vehicle.

- ① Raises the level of the headlights
- ② Lowers the level of the headlights

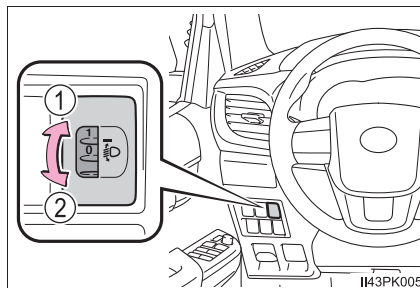

■ Guide to dial settings

Occupancy and luggage load conditions		Dial position			
Occupants	Luggage load	Single-cab models	Smart-cab models	Double-cab models	
				Except for Russia, Byelarus, Kazakhstan and Armenia	For Russia, Byelarus, Kazakhstan and Armenia
Driver	None	0	0	0	0
Driver	Full luggage loading	2 ^{*1} 2.5 ^{*2}	2.5 ^{*3} 3 ^{*4}	2.5 ^{*1} 3 ^{*2, 6} 3.5 ^{*2, 7}	2.5

*1: Halogen headlights type A (→P. 525)

*2: Halogen headlights type B (→P. 525)

*3: Vehicles with Heavy Duty Suspension^{*5}

*4: Vehicles without Heavy Duty Suspension^{*5}

*5: Contact any authorized Toyota retailer or Toyota authorized repairer, or any reliable repairer, if you are not sure of which specifications your vehicle is equipped with.

*6: Except for GUN135L-DTTSXW models^{*8} without Heavy Duty Suspension^{*5}

*7: For GUN135L-DTTSXW models^{*8} without Heavy Duty Suspension^{*5}

*8: The model code is indicated on the manufacturer' plate or label. (→P. 624)

Extended Headlight Lighting system (if equipped)

This system allows the headlights and front position lights to be turned on for 30 seconds when the engine switch is turned to the “LOCK” position (vehicles without smart entry & start system) or off (vehicles with smart entry & start system).

Pull the lever toward you and release it with the light switch is in **AUTO** or **O** after turning the engine switch to the “LOCK” position (vehicles without smart entry & start system) or off (vehicles with smart entry & start system).

Pull the lever toward you and release it again to turn off the lights.

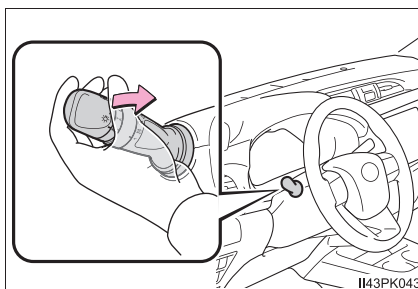
**Daytime running light system (if equipped)**

To make your vehicle more visible to other drivers during daytime driving, the daytime running lights turn on automatically whenever the engine is started and the parking brake is released with the headlight switch in **AUTO**. (Illuminate brighter than the front position lights.) The daytime running light system is not designed for use at night.

Headlight control sensor (if equipped)

The sensor may not function properly if an object is placed on the sensor, or anything that blocks the sensor is affixed to the windshield.

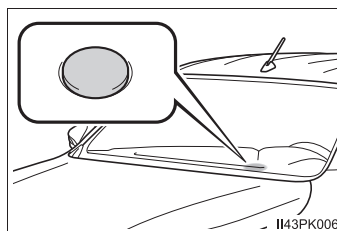

Doing so interferes with the sensor detecting the level of ambient light and may cause the automatic headlight system to malfunction.



■ Automatic light off system (if equipped)

- ▶ Models for model code destination Blank* (except for Kazakhstan)

The lights turn off after the engine switch is turned to the "LOCK" position (vehicles without smart entry & start system) or off (vehicles with smart entry & start system) and the driver's door is opened.

To turn the lights on again, turn the engine switch to the "ON" position (vehicles without smart entry & start system) or to IGNITION ON mode (vehicles with smart entry & start system), or turn the light switch to AUTO or  once and then back to  or .



- ▶ Models for model code destination W*, and Kazakhstan

When the light switch is in  or .

The headlights and front fog lights turn off after the engine switch is turned to the "LOCK" position (vehicles without smart entry & start system) or off (vehicles with smart entry & start system).

When the light switch is in AUTO:

The lights turn off after the engine switch is turned to the "LOCK" position (vehicles without smart entry & start system) or off (vehicles with smart entry & start system).

To turn the lights on again, turn the engine switch to the "ON" position (vehicles without smart entry & start system) or to IGNITION ON mode (vehicles with smart entry & start system), or turn the light switch to AUTO or  once and then back to  or .

*: See "Checking your vehicle's model" if you are not sure of which model your vehicle is. (→P. 12)

■ Light reminder buzzer (if equipped)

- ▶ Vehicles without smart entry & start system

A buzzer sounds when the engine switch is turned to the "LOCK" position, the key is removed and the driver's door is opened while the lights are turned on.

- ▶ Vehicles with smart entry & start system



A buzzer sounds when the engine switch is turned off and the driver's door is opened while the lights are turned on.

■ Battery-saving function

- ▶ Models for model code destination Blank* (except for Kazakhstan)

In order to prevent the battery of the vehicle from discharging, if the headlights and/or tail lights are on when the engine switch is turned to the “LOCK” position (vehicles without smart entry & start system) or off (vehicles with smart entry & start system), the battery-saving function will operate and automatically turn off all the lights after approximately 20 minutes.

- ▶ Models for model code destination W*, and Kazakhstan

In order to prevent the battery of the vehicle from discharging, if the light switch is in  or  position when the engine switch is turned to the “LOCK” position (vehicles without smart entry & start system) or off (vehicles with smart entry & start system), the battery-saving function will operate and automatically turn off all the lights after approximately 20 minutes.

When any of the following are performed, the battery-saving function is canceled once and then reactivated. All the lights will turn off automatically 20 minutes after the battery-saving function has been reactivated:

- When the headlight switch is operated
- When a door is closed once and then opened

*: See “Checking your vehicle’s model” if you are not sure of which model your vehicle is. (→P. 12)

■ Automatic headlight leveling system (if equipped)

The level of the headlights is automatically adjusted according to the number of passengers and the loading condition of the vehicle to ensure that the headlights do not interfere with other road users.

■ Customization

Settings (e.g. light sensor sensitivity) can be changed.
(Customizable features: →P. 646)

NOTICE

■ To prevent battery discharge

Do not leave the lights on longer than necessary when the engine is not running.

Fog light switch*

The fog lights secure excellent visibility in difficult driving conditions, such as in rain and fog.

■ Front fog light switch (if equipped)

- ① ○ Turns the front fog lights off
- ②  Turns the front fog lights on

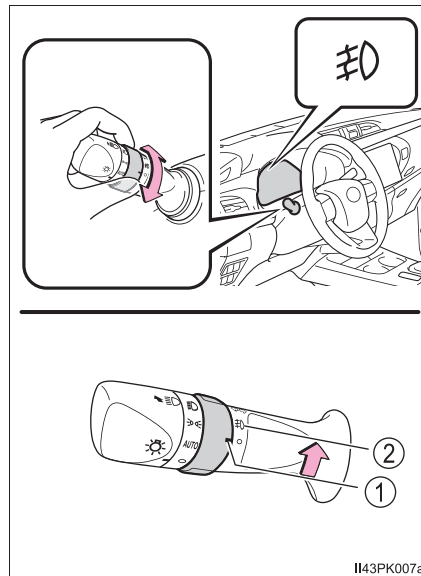

*: If equipped

■ Rear fog light switch (if equipped)

- ☰ Turns the rear fog light on
Releasing the switch ring returns it to ○ .
Operating the switch ring again turns the rear fog light off.

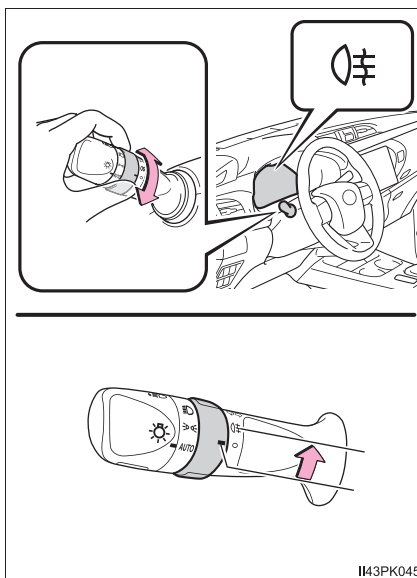

■ Front and rear fog light switch (if equipped)

- ① ○ Turns the front and rear fog lights off
② ☰ Turns the front fog lights on
③ ☰ Turns both front and rear fog lights on
Releasing the switch ring returns it to ☰.
Operating the switch ring again turns only the rear fog light off.

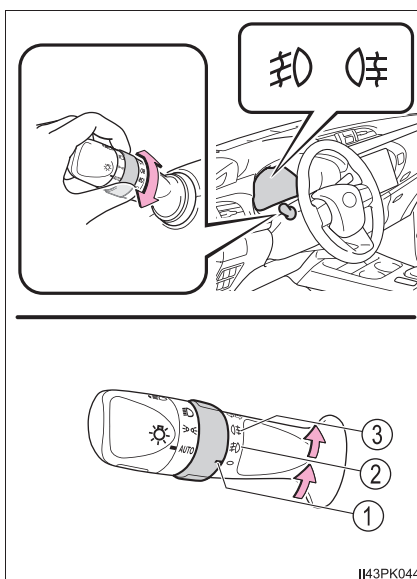

■ Fog lights can be used when

- ▶ Vehicles with front and rear fog lights

Front fog lights: The headlights or front position lights are turned on.

Rear fog light: The front fog lights are turned on.

- ▶ Vehicles with rear fog light only

The headlights are turned on.

Windshield wipers and washer

Operating the wiper lever

Operating the  lever operates the wipers or washer as follows.

■ Windshield wipers without intermittent operation



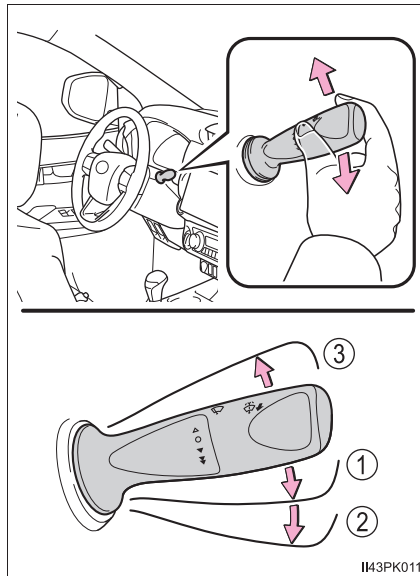

- ① ▼ Low speed operation
- ② ▾ High speed operation
- ③ ▲ Temporary operation

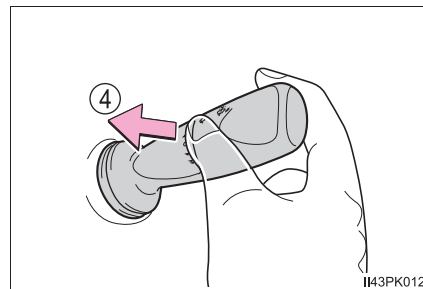

- ④  Washer operation
Pulling the lever operates the washer.



■ Windshield wipers with intermittent operation

- ①  Intermittent operation
- ②  Low speed operation
- ③  High speed operation
- ④  Temporary operation

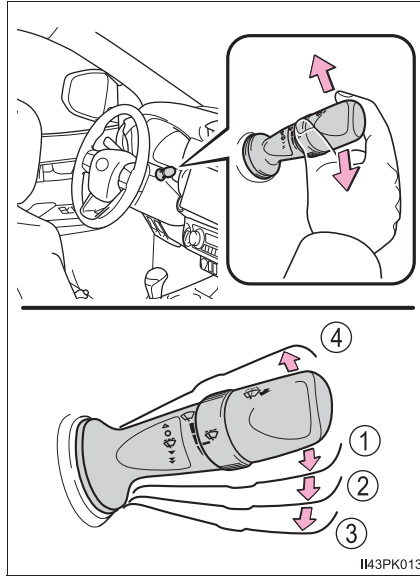

If equipped, wiper intervals can be adjusted when intermittent operation is selected.

- ⑤ Increases the intermittent windshield wiper frequency
- ⑥ Decreases the intermittent windshield wiper frequency

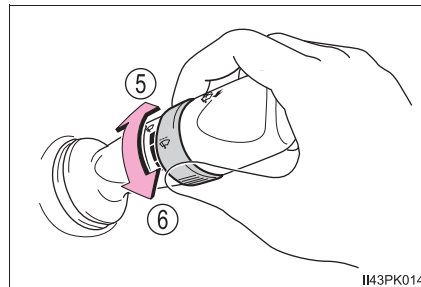

⑦  Washer/wiper dual operation

Pulling the lever operates the wipers and washer.

The wipers will automatically operate a couple of times after the washer squirts.

If the headlights are on, the headlight cleaners will operate once.

And then, the headlight cleaners will operate every five times you pull the lever. (if equipped)

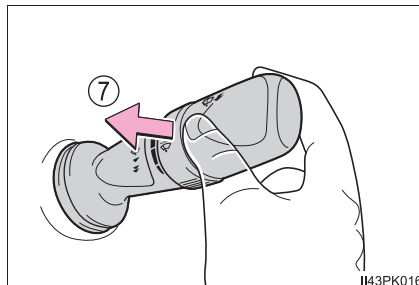

■ **The windshield wipers and washer can be operated when**

The engine switch is in the “ON” position (vehicles without smart entry & start system) or IGNITION ON mode (vehicles with smart entry & start system).

■ **If no windshield washer fluid sprays**

Check that the washer nozzles are not blocked if there is washer fluid in the windshield washer fluid reservoir.

 **WARNING**

■ **Caution regarding the use of washer fluid**

When it is cold, do not use the washer fluid until the windshield becomes warm. The fluid may freeze on the windshield and cause low visibility. This may lead to an accident, resulting in death or serious injury.

 **NOTICE**

■ **When the windshield is dry**

Do not use the wipers, as they may damage the windshield.

■ **When the washer fluid tank is empty**

Do not operate the switch continually as the washer fluid pump may over-heat.

■ **When a nozzle becomes blocked**

In this case, contact any authorized Toyota retailer or Toyota authorized repairer, or any reliable repairer.

Do not try to clear it with a pin or other object. The nozzle will be damaged.

Opening the fuel tank cap

Perform the following steps to open the fuel tank cap:

Before refueling the vehicle

- Close all the doors and windows, and turn the engine switch to the “LOCK” position (vehicles without smart entry & start system) or off (vehicles with smart entry & start system).
- Confirm the type of fuel.

■ Fuel types

→P. 643

■ Fuel tank opening for unleaded gasoline (gasoline engine)

To help prevent incorrect fueling, your vehicle has a fuel tank opening that only accommodates the special nozzle on unleaded fuel pumps.

**WARNING****■ When refueling the vehicle**

Observe the following precautions while refueling the vehicle. Failure to do so may result in death or serious injury.

- After exiting the vehicle and before opening the fuel cap, touch an unpainted metal surface to discharge any static electricity. It is important to discharge static electricity before refueling because sparks resulting from static electricity can cause fuel vapors to ignite while refueling.
- Type A (→P. 263) only: Always hold the grips on the fuel tank cap and turn it slowly to remove it.
A whooshing sound may be heard when the fuel tank cap is loosened. Wait until the sound cannot be heard before fully removing the cap. In hot weather, pressurized fuel may spray out the filler neck and cause injury.
- Do not allow anyone that has not discharged static electricity from their body to come close to an open fuel tank.
- Do not inhale vaporized fuel.
Fuel contains substances that are harmful if inhaled.
- Do not smoke while refueling the vehicle.
Doing so may cause the fuel to ignite and cause a fire.
- Do not return to the vehicle or touch any person or object that is statically charged.
This may cause static electricity to build up, resulting in a possible ignition hazard.

■ When refueling

Observe the following precautions to prevent fuel overflowing from the fuel tank:

- Securely insert the fuel nozzle into the fuel filler neck.
- Stop filling the tank after the fuel nozzle automatically clicks off.
- Do not top off the fuel tank.

 NOTICE

■ Refueling

- Do not spill fuel during refueling.
Doing so may damage the vehicle, such as causing the emission control system to operate abnormally or damaging fuel system components or the vehicle's painted surface.
- Vehicles with DPF system:
Use the specified fuel. If fuel other than the specified fuel is used, white smoke may be continuously emitted from the exhaust pipe during regenerating the filter. (→P. 369)

Opening the fuel tank cap

■ Type A

- 1 Pull up the opener to open the fuel filler door.

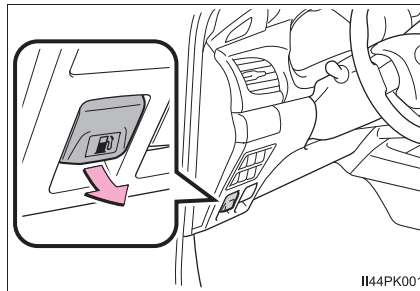

- 2 Turn the fuel tank cap slowly to remove it and hang it on the back of the fuel filler door.

▶ Without over fender

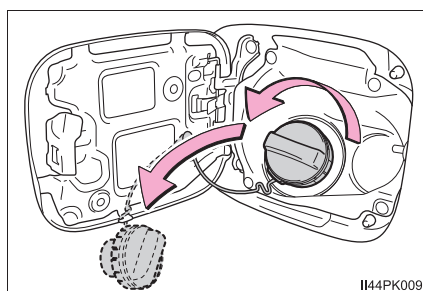

▶ With over fender

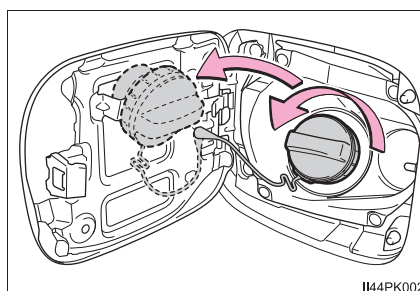

■ Type B

- 1 To unlock the fuel tank cap, insert the key and turn it counterclockwise.

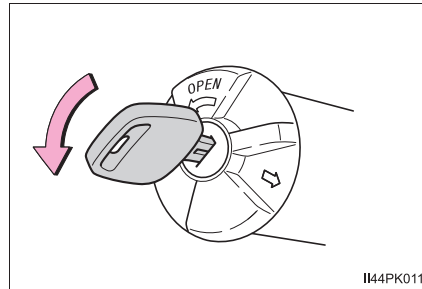

- 2 Turn the fuel tank cap slowly to open.
Make sure not to hold and turn the key.

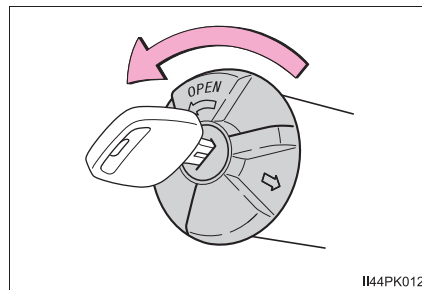

Closing the fuel tank cap

■ Type A

After refueling, turn the fuel tank cap until you hear a click. Once the cap is released, it will turn slightly in the opposite direction.

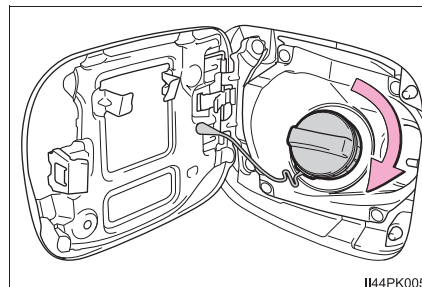

■ Type B**1** Close the fuel tank cap

Make sure to put the fuel tank cap with the arrow upward and turn it slowly to close.

When turning the fuel tank cap, do not hold and turn the key.

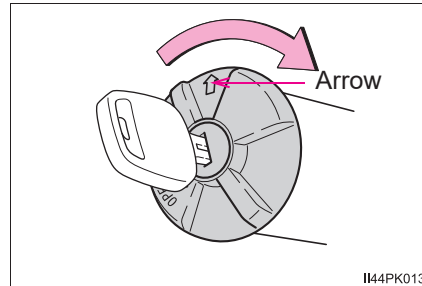
**2** Lock the fuel cap

Turning the fuel cap key clockwise.

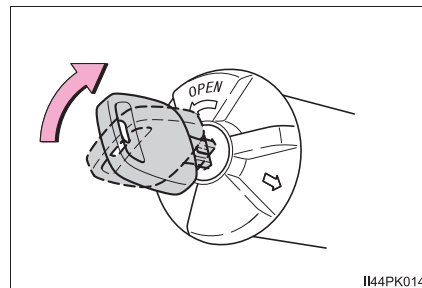
**⚠ WARNING****■ When replacing the fuel tank cap**

Do not use anything but a genuine Toyota fuel tank cap designed for your vehicle. Doing so may cause a fire or other incident which may result in death or serious injury.

Toyota Safety Sense*

The Toyota Safety Sense consists of the following drive assist systems and contributes to a safe and comfortable driving experience:

Driving assist system

◆ PCS (Pre-Collision System)

→P. 273

◆ LDA (Lane Departure Alert With Yaw Assist Function)

→P. 284

◆ RSA (Road Sign Assist)*

→P. 295

◆ Dynamic radar cruise control

→P. 301



WARNING

■ Toyota Safety Sense

The Toyota Safety Sense is designed to operate under the assumption that the driver will drive safely, and is designed to help reduce the impact to the occupants and the vehicle in the case of a collision or assist the driver in normal driving conditions.

As there is a limit to the degree of recognition accuracy and control performance that this system can provide, do not overly rely on this system. The driver is always responsible for paying attention to the vehicle's surroundings and driving safely.

*: If equipped

Sensors

Two types of sensors, located behind the front grille and windshield, detect information necessary to operate the drive assist systems.

- ① Radar sensor
- ② Front camera

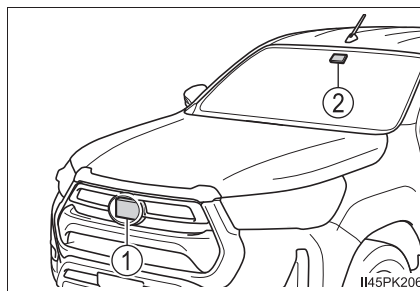

⚠ WARNING

■ **To avoid malfunction of the radar sensor**

Observe the following precautions.

Otherwise, the radar sensor may not operate properly, possibly leading to an accident resulting in death or serious injury.

● Keep the radar sensor and the radar sensor cover clean at all times.

- ① Radar sensor
- ② Radar sensor cover

If the front of the radar sensor or the front or back of the radar sensor cover is dirty or covered with water droplets, snow, etc., clean it.

Clean the radar sensor and radar sensor cover with a soft cloth to avoid damaging them.

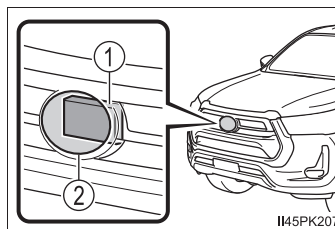

● Do not attach accessories, stickers (including transparent stickers) or other items to the radar sensor, radar sensor cover or surrounding area.

● Do not subject the radar sensor or its surrounding area to a strong impact. If the radar sensor, front grille, or front bumper has been subjected to a strong impact, have the vehicle inspected by any authorized Toyota retailer or Toyota authorized repairer, or any reliable repairer.

● Do not disassemble the radar sensor.

● Do not modify or paint the radar sensor or radar sensor cover.

● In the following cases, the radar sensor must be recalibrated. Contact any authorized Toyota retailer or Toyota authorized repairer, or any reliable repairer for details.

- When the radar sensor or front grille are removed and installed, or replaced
- When the front bumper is replaced

⚠ WARNING**■ To avoid malfunction of the front camera**

Observe the following precautions.

Otherwise, the front camera may not operate properly, possibly leading to an accident resulting in death or serious injury.

- Keep the windshield clean at all times.
 - If the windshield is dirty or covered with an oily film, water droplets, snow, etc., clean the windshield.
 - If a glass coating agent is applied to the windshield, it will still be necessary to use the windshield wipers to remove water droplets, etc. from the area of the windshield in front of the front camera.
 - If the inner side of the windshield where the front camera is installed is dirty, contact any authorized Toyota retailer or Toyota authorized repairer, or any reliable repairer.
- Do not attach objects, such as stickers, transparent stickers, etc., to the outer side of the windshield in front of the front camera (shaded area in the illustration).

A: From the top of the windshield to approximately 1 cm (0.4 in.) below the bottom of the front camera

B: Approximately 20 cm (7.9 in.) (Approximately 10 cm [4.0 in.] to the right and left from the center of the front camera)

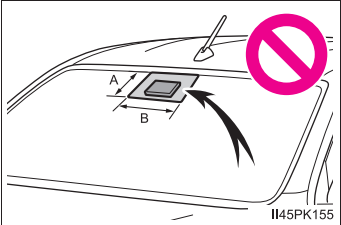
- If the part of the windshield in front of the front camera is fogged up or covered with condensation, or ice, use the windshield defogger to remove the fog, condensation, or ice. (→P. 435, 443)
- If water droplets cannot be properly removed from the area of the windshield in front of the front camera by the windshield wipers, replace the wiper insert or wiper blade.
- Do not attach window tint to the windshield.

**WARNING**

- Replace the windshield if it is damaged or cracked.
After replacing the windshield, the front camera must be recalibrated. Contact any authorized Toyota retailer or Toyota authorized repairer, or any reliable repairer for details.
- Do not allow liquids to contact the front camera.
- Do not allow bright lights to shine into the front camera.
- Do not dirty or damage the front camera.
When cleaning the inside of the windshield, do not allow glass cleaner to contact the lens of the front camera. Also, do not touch the lens.
If the lens is dirty or damaged, contact any authorized Toyota retailer or Toyota authorized repairer, or any reliable repairer.
- Do not subject the front camera to a strong impact.
- Do not change the installation position or direction of the front camera or remove it.
- Do not disassemble the front camera.
- Do not modify any components of the vehicle around the front camera (inside rear view mirror, etc.) or ceiling.
- Do not attach any accessories to the hood, front grille or front bumper that may obstruct the front camera. Contact any authorized Toyota retailer or Toyota authorized repairer, or any reliable repairer for details.
- If a surfboard or other long object is to be mounted on the roof, make sure that it will not obstruct the front camera.
- Do not modify the headlights or other lights.

■ If a warning message is displayed on the multi-information display

A system may be temporarily unavailable or there may be a malfunction in the system.

- In the following situations, perform the actions specified in the table. When the normal operating conditions are detected, the message will disappear and the system will become operational.

If the message does not disappear, contact any authorized Toyota retailer or Toyota authorized repairer, or any reliable repairer.

Situation	Actions
When the area around a camera is covered with dirt, moisture (fogged up, covered with condensation, ice, etc.), or other foreign matter	Using the wiper and A/C function, remove the dirt and other attached matter. (→P. 435, 443)
When the temperature around the front camera is outside of the operational range, such as when the vehicle is in the sun or in an extremely cold environment	If the front camera is hot, such as after the vehicle had been parked in the sun, use the air conditioning system to decrease the temperature around the front camera. If a sunshade was used when the vehicle was parked, depending on its type, the sunlight reflected from the surface of the sunshade may cause the temperature of the front camera to become excessively high.
	If the front camera is cold, such after the vehicle is parked in an extremely cold environment, use the air conditioning system to increase the temperature around the front camera.
The area in front of the front camera is obstructed, such as when the hood is open or a sticker is attached to the part of the windshield in front of the front camera.	Close the hood, remove the sticker, etc. to clear the obstruction.
When "Pre-Collision System Unavailable" is displayed.	Check whether there is attached materials on the radar sensor and radar sensor cover, and if there is, remove it.

- In the following situations, if the situation has changed (or the vehicle has been driven for some time) and the normal operating conditions are detected, the message will disappear and the system will become operational.

If the message does not disappear, contact any authorized Toyota retailer or Toyota authorized repairer, or any reliable repairer.

- When the temperature around the radar sensor is outside of the operational range, such as when the vehicle is in the sun or in an extremely cold environment
- When the front camera cannot detect objects in front of the vehicle, such as when driving in the dark, snow, or fog, or when bright lights are shining into the front camera
- Depending on the conditions in the vicinity of the vehicle, the radar may judge the surrounding environment can not be properly recognized. In that case, "Pre-Collision System Unavailable" is displayed.

PCS (Pre-Collision System)*

The pre-collision system uses a radar sensor and front camera to detect objects (→P. 273) in front of the vehicle. When the system determines that the possibility of a frontal collision with an object is high, a warning operates to urge the driver to take evasive action and the potential brake pressure is increased to help the driver avoid the collision. If the system determines that the possibility of a frontal collision with an object is extremely high, the brakes are automatically applied to help avoid the collision or help reduce the impact of the collision.

The pre-collision system can be disabled/enabled and the warning timing can be changed. (→P. 277)

Detectable objects

The system can detect the following:

- Vehicles
- Bicyclists
- Pedestrians

*: If equipped

System functions

■ Pre-collision warning

When the system determines that the possibility of a frontal collision is high, a buzzer will sound and a warning message will be displayed on the multi-information display to urge the driver to take evasive action.

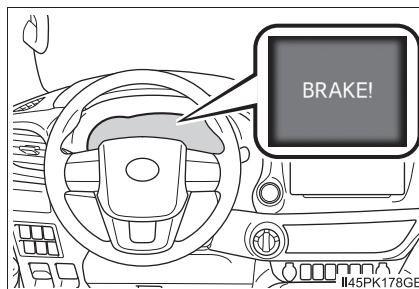

■ Pre-collision brake assist

When the system determines that the possibility of a frontal collision is high, the system applies greater braking force in relation to how strongly the brake pedal is depressed.

■ Pre-collision braking

If the system determines that the possibility of a frontal collision is extremely high, the brakes are automatically applied to help avoid the collision or reduce the impact of the collision.

 WARNING**■ Limitations of the pre-collision system**

- The driver is solely responsible for safe driving. Always drive safely, taking care to observe your surroundings.
Do not use the pre-collision system instead of normal braking operations under any circumstances. This system will not prevent collisions or lessen collision damage or injury in every situation. Do not overly rely on this system. Failure to do so may lead to an accident, resulting in death or serious injury.
- Although this system is designed to help avoid a collision or help reduce the impact of the collision, its effectiveness may change according to various conditions, therefore the system may not always be able to achieve the same level of performance.
Read the following conditions carefully. Do not overly rely on this system and always drive carefully.
 - Conditions under which the system may operate even if there is no possibility of a collision: →P. 279
 - Conditions under which the system may not operate properly: →P. 281
- Do not attempt to test the operation of the pre-collision system yourself. Depending on the objects used for testing (dummies, cardboard objects imitating detectable objects, etc.), the system may not operate properly, possibly leading to an accident.

■ Pre-collision braking

- When the pre-collision braking function is operating, a large amount of braking force will be applied.
- If the vehicle is stopped by the operation of the pre-collision braking function, the pre-collision braking function operation will be canceled after approximately 2 seconds. Depress the brake pedal as necessary.
- The pre-collision braking function may not operate if certain operations are performed by the driver. If the accelerator pedal is being depressed strongly or the steering wheel is being turned, the system may determine that the driver is taking evasive action and possibly prevent the pre-collision braking function from operating.
- In some situations, while the pre-collision braking function is operating, operation of the function may be canceled if the accelerator pedal is depressed strongly or the steering wheel is turned and the system determines that the driver is taking evasive action.
- If the brake pedal is being depressed, the system may determine that the driver is taking evasive action and possibly delay the operation timing of the pre-collision braking function.

**WARNING****■ When to disable the pre-collision system**

In the following situations, disable the system, as it may not operate properly, possibly leading to an accident resulting in death or serious injury:

- When the vehicle is being towed
- When your vehicle is towing another vehicle
- When transporting the vehicle via truck, boat, train or similar means of transportation
- When the vehicle is raised on a lift with the engine running and the tires are allowed to rotate freely
- When inspecting the vehicle using a drum tester such as a chassis dynamometer or speedometer tester, or when using an on vehicle wheel balancer
- When a strong impact is applied to the front bumper or front grille, due to an accident or other reasons
- If the vehicle cannot be driven in a stable manner, such as when the vehicle has been in an accident or is malfunctioning
- When the vehicle is driven in a sporty manner or off-road
- When the tires are not properly inflated
- When the tires are very worn
- When tires of a size other than specified are installed
- When tire chains are installed
- When a compact spare tire or an emergency tire puncture repair kit is used
- If equipment (snow plow, etc.) that may obstruct the radar sensor or front camera is temporarily installed to the vehicle

Changing settings of the pre-collision system

■ Enabling/disabling the pre-collision system

The pre-collision system can be enabled/disabled on  (→P. 139) of the multi-information display.

The system is automatically enabled each time the engine switch is turned to the “ON” position (vehicles without smart entry & start system) or IGNITION ON mode (vehicles with smart entry & start system).

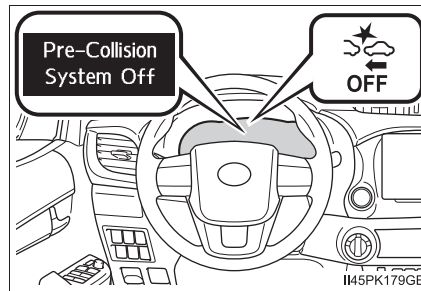

If the system is disabled, the PCS warning light will turn on and a message will be displayed on the multi-information display.

■ Changing the pre-collision warning timing

The pre-collision warning timing can be changed on  (→P. 139) of the multi-information display.

The warning timing setting is retained when the engine switch is turned to the “LOCK” position (vehicles without smart entry & start system) or off (vehicles with smart entry & start system). However, if the pre-collision system is disabled and re-enabled, the operation timing will return to the default setting (middle).

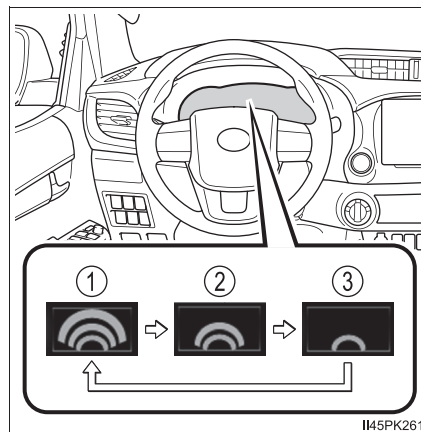

- ① Early
- ② Middle
This is the default setting.
- ③ Late

■ **Operational conditions**

The pre-collision system is enabled and the system determines that the possibility of a frontal collision with a detected object is high.

Each function is operational at the following speed

● Pre-collision warning

Detectable objects	Vehicle speed	Relative speed between your vehicle and object
Vehicles	Approx. 10 to 180 km/h (7 to 110 mph)	Approx. 10 to 180 km/h (7 to 110 mph)
Bicyclists and pedestrians	Approx. 10 to 80 km/h (7 to 50 mph)	Approx. 10 to 80 km/h (7 to 50 mph)

● Pre-collision brake assist

Detectable objects	Vehicle speed	Relative speed between your vehicle and object
Vehicles	Approx. 30 to 180 km/h (20 to 110 mph)	Approx. 30 to 180 km/h (20 to 110 mph)
Bicyclists and pedestrians	Approx. 30 to 80 km/h (20 to 50 mph)	Approx. 30 to 80 km/h (20 to 50 mph)

● Pre-collision braking

Detectable objects	Vehicle speed	Relative speed between your vehicle and object
Vehicles	Approx. 10 to 180 km/h (7 to 110 mph)	Approx. 10 to 180 km/h (7 to 110 mph)
Bicyclists and pedestrians	Approx. 10 to 80 km/h (7 to 50 mph)	Approx. 10 to 80 km/h (7 to 50 mph)

The system may not operate in the following situations:

- If a battery terminal has been disconnected and reconnected and then the vehicle has not been driven for a certain amount of time
- If the shift lever is in R
- When the VSC OFF indicator is illuminated (only the pre-collision warning function will be operational)

■ Object detection function

The system detects objects based on their size, profile, motion, etc. However, an object may not be detected depending on the surrounding brightness and the motion, posture, and angle of the detected object, preventing the system from operating properly. (→P. 281)

The illustration shows an image of detectable objects.

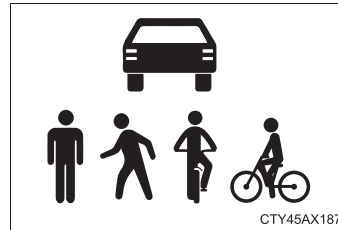

■ Cancellation of the pre-collision braking

If either of the following occur while the pre-collision braking function is operating, it will be canceled:

- The accelerator pedal is depressed strongly.
- The steering wheel is turned sharply or abruptly.

■ Conditions under which the system may operate even if there is no possibility of a collision

- In some situations such as the following, the system may determine that there is a possibility of a frontal collision and operate.
 - When passing a detectable object, etc.
 - When changing lanes while overtaking a detectable object, etc.
 - When approaching a detectable object in an adjacent lane or on the roadside, such as when changing the course of travel or driving on a winding road

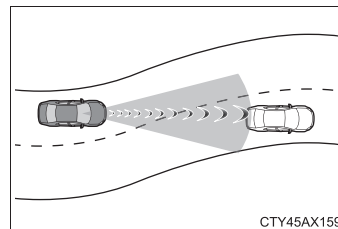

- When rapidly closing on a detectable object, etc.
- When approaching objects on the roadside, such as detectable objects, guardrails, utility poles, trees, or walls
- When there is a detectable object or other object by the roadside at the entrance of a curve

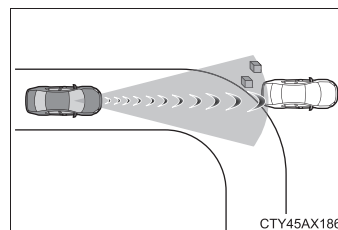

- When there are patterns or paint in front of your vehicle that may be mistaken for a detectable object
- When the front of your vehicle is hit by water, snow, dust, etc.
- When overtaking a detectable object that is changing lanes or making a right/left turn

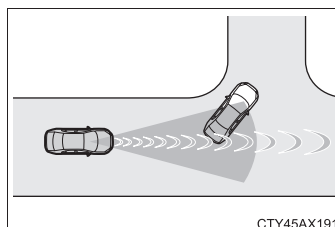

- When passing a detectable object in an oncoming lane that is stopped to make a right/left turn

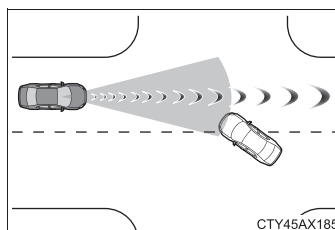

- When a detectable object approaches very close and then stops before entering the path of your vehicle
- If the front of your vehicle is raised or lowered, such as when on an uneven or undulating road surface
- When driving on a road surrounded by a structure, such as in a tunnel or on an iron bridge
- When there is a metal object (manhole cover, steel plate, etc.), steps, or a protrusion in front of your vehicle
- When passing under an object (road sign, billboard, etc.)

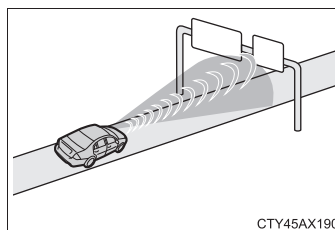

- When approaching an electric toll gate barrier, parking area barrier, or other barrier that opens and closes
- When using an automatic car wash

- When driving through or under objects that may contact your vehicle, such as thick grass, tree branches, or a banner

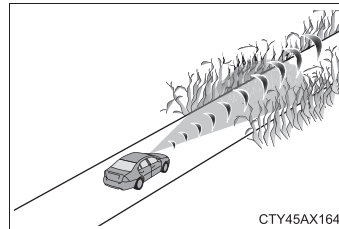

CTY45AX164

- When driving through steam or smoke
- When driving near an object that reflects radio waves, such as a large truck or guardrail
- When driving near a TV tower, broadcasting station, electric power plant, or other location where strong radio waves or electrical noise may be present

■ Situations in which the system may not operate properly

- In some situations such as the following, an object may not be detected by the radar sensor and front camera, preventing the system from operating properly:

- When a detectable object is approaching your vehicle
- When your vehicle or a detectable object is wobbling
- If a detectable object makes an abrupt maneuver (such as sudden swerving, acceleration or deceleration)
- When your vehicle approaches a detectable object rapidly
- When a detectable object is not directly in front of your vehicle

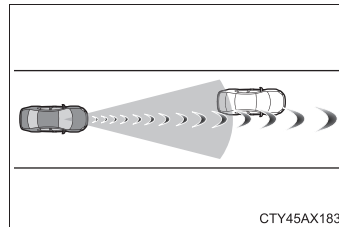

CTY45AX183

- When a detectable object is near a wall, fence, guardrail, manhole cover, vehicle, steel plate on the road, etc.
- When a detectable object is under a structure
- When part of a detectable object is hidden by an object, such as large baggage, an umbrella, or guardrail
- When multiple detectable objects are close together
- If the sun or other light is shining directly on a detectable object
- When a detectable object is a shade of white and looks extremely bright
- When a detectable object appears to be nearly the same color or brightness as its surroundings
- If a detectable object cuts or suddenly emerges in front of your vehicle
- When the front of your vehicle is hit by water, snow, dust, etc.
- When a very bright light ahead, such as the sun or the headlights of oncoming traffic, shines directly into the front camera
- When approaching the side or front of a vehicle ahead

- If a vehicle ahead is a motorcycle
- If a vehicle ahead is narrow, such as a personal mobility vehicle
- If a preceding vehicle has a small rear end, such as an unloaded truck
- If a preceding vehicle has a low rear end, such as a low bed trailer

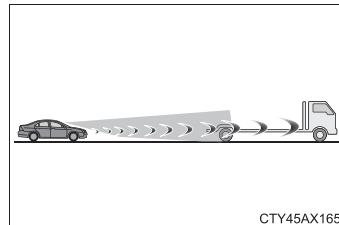

- If a vehicle ahead has extremely high ground clearance

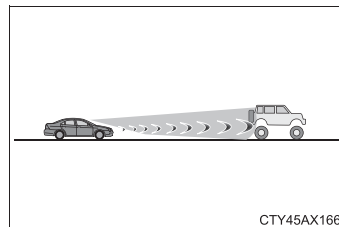

- If a vehicle ahead is carrying a load which protrudes past its rear bumper
- If a vehicle ahead is irregularly shaped, such as a tractor or side car
- If a vehicle ahead is a child sized bicycle, a bicycle that is carrying a large load, a bicycle ridden by more than one person, or a uniquely shaped bicycle (bicycle with a child seat, tandem bicycle, etc.)
- If a pedestrian/or the riding height of a bicyclist ahead is shorter than approximately 1 m (3.2 ft.) or taller than approximately 2 m (6.5 ft.)
- If a pedestrian/bicyclist is wearing oversized clothing (a rain coat, long skirt, etc.), making their silhouette obscure
- If a pedestrian is bending forward or squatting or bicyclist is bending forward
- If a pedestrian/bicyclist is moving fast
- If a pedestrian is pushing a stroller, wheelchair, bicycle or other vehicle
- When driving in inclement weather such as heavy rain, fog, snow or a sandstorm
- When driving through steam or smoke
- When the surrounding area is dim, such as at dawn or dusk, or while at night or in a tunnel, making a detectable object appear to be nearly the same color as its surroundings
- When driving in a place where the surrounding brightness changes suddenly, such as at the entrance or exit of a tunnel
- After the engine has started the vehicle has not been driven for a certain amount of time
- While making a left/right turn and for a few seconds after making a left/right turn
- While driving on a curve and for a few seconds after driving on a curve
- If your vehicle is skidding

- If the front of the vehicle is raised or lowered

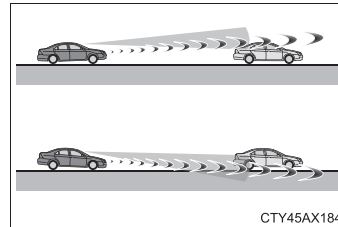

- If the wheels are misaligned
- If a wiper blade is blocking the front camera
- The vehicle is being driven at extremely high speeds
- When driving on a hill
- If the radar sensor or front camera is misaligned
- In some situations such as the following, sufficient braking force may not be obtained, preventing the system from performing properly:
 - If the braking functions cannot operate to their full extent, such as when the brake parts are extremely cold, extremely hot, or wet
 - If the vehicle is not properly maintained (brakes or tires are excessively worn, improper tire inflation pressure, etc.)
 - When the vehicle is being driven on a gravel road or other slippery surface
- **If VSC is disabled**
 - If VSC is disabled (→P. 359), the pre-collision brake assist and pre-collision braking functions are also disabled.
 - The PCS warning light will turn on and “VSC Turned Off Pre-Collision Brake System Unavailable” will be displayed on the multi-information display.

LDA (Lane Departure Alert With Yaw Assist Function)*

Summary of functions

When driving on a road with clear white (yellow) lane lines, this function alerts the driver when the vehicle might depart from its lane or course* and provides assistance by applying a brake force to keep the vehicle in its lane or course*.

The LDA system recognizes white (yellow) lane lines or a course* using the front camera. Additionally, it detects preceding vehicles using the front camera and radar.

*: Boundary between asphalt and the side of the road, such as grass, soil, or a curb

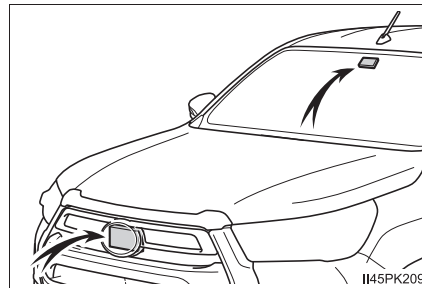

⚠ WARNING

■ Before using LDA system

- Do not rely solely upon the LDA system. The LDA system does not automatically drive the vehicle or reduce the amount of attention that must be paid to the area in front of the vehicle. The driver must always assume full responsibility for driving safely by paying careful attention to the surrounding conditions and operating the steering wheel to correct the path of the vehicle. Also, the driver must take adequate breaks when fatigued, such as from driving for a long period of time.
- Failure to perform appropriate driving operations and pay careful attention may lead to an accident, resulting in death or serious injury.
- When not using the LDA system, use the LDA switch to turn the system off.

*: If equipped

 WARNING**■ Situations unsuitable for LDA system**

In the following situations, use the LDA switch to turn the system off. Failure to do so may lead to an accident, resulting in death or serious injury.

- Vehicle is driven on a road surface which is slippery due to rainy weather, fallen snow, freezing, etc.
- Vehicle is driven on a snow-covered road.
- White (yellow) lines are difficult to see due to rain, snow, fog, dust, etc.
- A spare tire, tire chains, etc. are equipped.
- When the tires have been excessively worn, or when the tire inflation pressure is low.
- When your vehicle is towing a trailer (with towing hitch) or during emergency towing.

■ Preventing LDA system malfunctions and operations performed by mistake

- Do not modify the headlights or place stickers, etc. on the surface of the lights.
- Do not modify the suspension etc. If the suspension etc. needs to be replaced, contact any authorized Toyota retailer or Toyota authorized repairer, or any reliable repairer.
- Do not install or place anything on the hood or grille. Also, do not install a grille guard (bull bars, kangaroo bar, etc.).
- If your windshield needs repairs, contact any authorized Toyota retailer or Toyota authorized repairer, or any reliable repairer.

⚠ WARNING

■ **Conditions in which functions may not operate properly**

In the following situations, the functions may not operate properly and the vehicle may depart from its lane. Drive safely by always paying careful attention to your surroundings and operate the steering wheel to correct the path of the vehicle without relying solely on the functions.

- Vehicle is being driven around a sharp curve.

- Objects or patterns that could be mistaken for white (yellow) lines are present on the side of the road (guardrails, reflective poles, etc.).

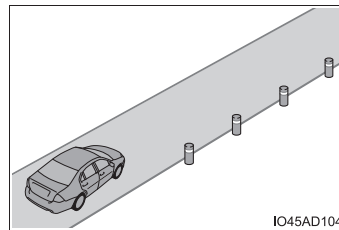

- Vehicle is driven where the road diverges, merges, etc.

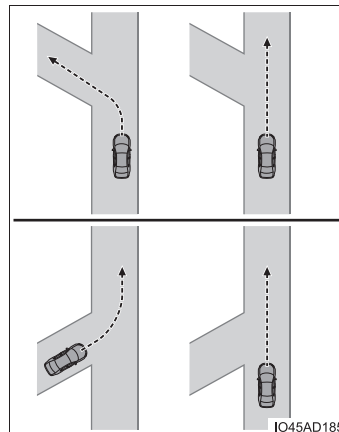

- Repair marks of asphalt, white (yellow) lines, etc. are present due to road repair.

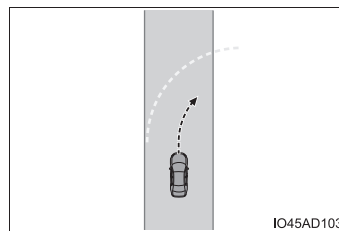

- There are shadows on the road that run parallel with, or cover, the white (yellow) lines.
- The vehicle is driven in an area without white (yellow) lines, such as in front of a tollgate or checkpoint, or at an intersection, etc.

 WARNING

- The white (yellow) lines are cracked, “Raised pavement marker” or stones are present.
- The white (yellow) lines cannot be seen or are difficult to see due to sand, etc.
- The vehicle is driven on a road surface that is wet due to rain, puddles, etc.
- The traffic lines are yellow (which may be more difficult to recognize than lines that are white).
- The white (yellow) lines cross over a curb, etc.
- The vehicle is driven on a bright surface, such as concrete.
- If the edge of the road is not clear or straight.
- The vehicle is driven on a surface that is bright due to reflected light, etc.
- The vehicle is driven in an area where the brightness changes suddenly, such as at the entrances and exits of tunnels, etc.
- Light from the headlights of an oncoming vehicle, the sun, etc. enters the camera.
- The vehicle is driven on a slope.
- The vehicle is driven on a road which tilts left or right, or a winding road.
- The vehicle is driven on an unpaved or rough road.
- The traffic lane is excessively narrow or wide.
- The vehicle is extremely tilted due to carrying heavy luggage or having improper tire pressure.
- The distance to the preceding vehicle is extremely short.
- The vehicle is moving up and down a large amount due to road conditions during driving (poor roads or road seams).
- When driving in a tunnel or at night with the headlights off or when a headlight is dim due to its lens being dirty or it being misaligned.
- The vehicle is struck by a crosswind.
- The vehicle has just changed lanes or crossed an intersection.
- Tires which differ by structure, manufacturer, brand or tread pattern are used.
- When tires of a size other than specified are installed.
- Snow tires, etc. are equipped.

Functions included in LDA system**■ Lane departure alert function**

When the system determines that the vehicle might depart from its lane or course*, a warning is displayed on the multi-information display, and a warning buzzer will sound to alert the driver.

When the warning buzzer sounds, check the area around your vehicle and carefully operate the steering wheel to move the vehicle back to the center of the lane.

*: Boundary between asphalt and the side of the road, such as grass, soil, or a curb

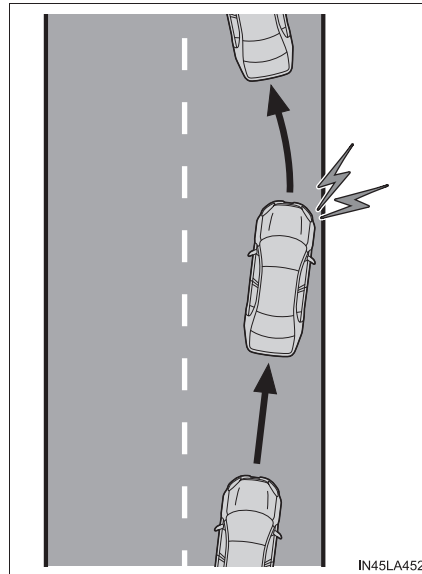

■ Yaw assist function

When the system determines that the vehicle might depart from its lane or course*, the system provides assistance as necessary by applying a brake force for a short period of time to keep the vehicle in its lane.

*: Boundary between asphalt and the side of the road, such as grass, soil, or a curb

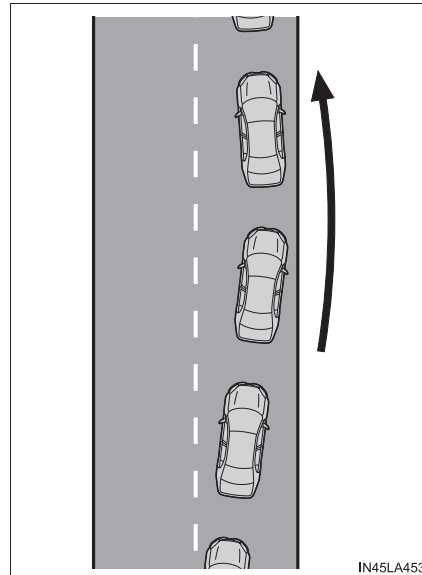

■ Vehicle sway warning function

When the vehicle is swaying within a lane, the warning buzzer will sound and a message will be displayed on the multi-information display to alert the driver.

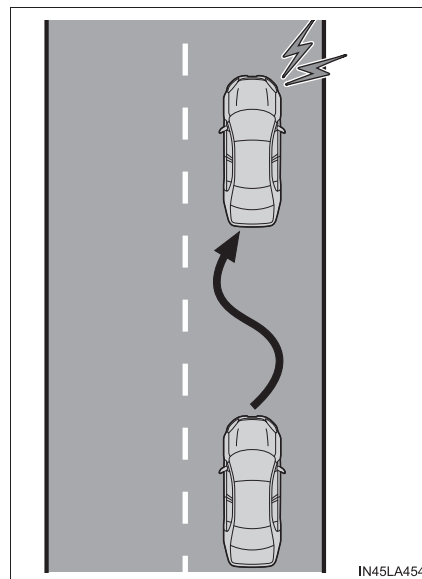

Turning LDA system on

Press the LDA switch to turn the LDA system on.

The LDA indicator illuminates and a message is displayed on the multi-information display.

Press the LDA switch again to turn the LDA system off.

When the LDA system is turned on or off, operation of the LDA system continues in the same condition the next time the engine is started.

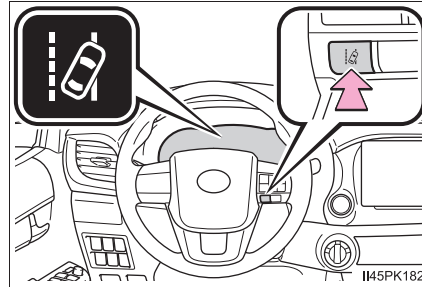

Indications on multi-information display

① LDA indicator

The illumination condition of the indicator informs the driver of the system operation status.

Illuminated in white:
LDA system is operating.

Illuminated in green:
Yaw assist function is operating.

Illuminated in yellow: Malfunctioning or suspended temporarily.

Flashing in yellow: Lane departure alert function is operating.

② Operation display of yaw assist function

Displayed when the multi-information display is switched to the driving support system information screen.

Indicates that yaw assist function is operating.

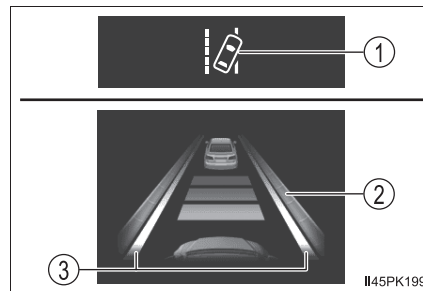

③ Lane departure alert function display

Displayed when the multi-information display is switched to the driving support system information screen.

- ▶ Inside of displayed lines is white
- ▶ Inside of displayed lines is black



IN45PK075

Indicates that the system is recognizing white (yellow) lines or a course*. When the vehicle departs from its lane, the white line displayed on the side the vehicle departs from flashes yellow.

*: Boundary between asphalt and the side of the road, such as grass, soil, or a curb

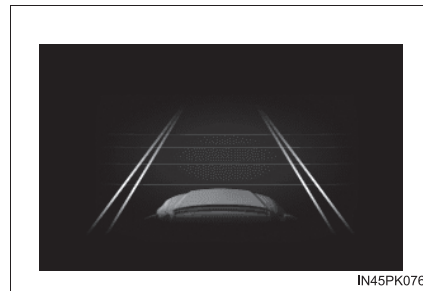

IN45PK076

Indicates that the system is not able to recognize white (yellow) lines or a course* or is temporarily canceled.

■ Operation conditions of each function**● Lane departure alert function**

This function operates when all of the following conditions are met.

- LDA is turned on.
- Vehicle speed is approximately 50 km/h (32 mph) or more.
- System recognizes white (yellow) lane lines or a course*. (When a white [yellow] line or course* is recognized on only one side, the system will operate only for the recognized side.)
- Width of traffic lane is approximately 3 m (9.8 ft.) or more.
- Turn signal lever is not operated.
- Vehicle is not being driven around a sharp curve.
- No system malfunctions are detected. (→P. 294)

*: Boundary between asphalt and the side of the road, such as grass, soil, or a curb

● Yaw assist function

This function operates when all of the following conditions are met in addition to the operation conditions for the lane departure alert function.

- Setting for “Yaw assist” in  of the multi-information display is set to “On” (→P. 135)
- Vehicle is not accelerated or decelerated by a fixed amount or more.
- Steering wheel is not operated with a steering force level suitable for changing lanes.
- ABS, VSC, TRC/A-TRC and PCS are not operating.
- TRC/A-TRC or VSC is not turned off.

● Vehicle sway warning function

This function operates when all of the following conditions are met.

- Setting for “Sway Warning” in  of the multi-information display is set to “On” (→P. 135)
- Vehicle speed is approximately 50 km/h (32 mph) or more.
- Width of traffic lane is approximately 3 m (9.8 ft.) or more.
- No system malfunctions are detected. (→P. 294)

■ Temporary cancelation of functions

When operation conditions are no longer met, a function may be temporarily canceled. However, when the operation conditions are met again, operation of the function is automatically restored. (→P. 292)

■ Yaw assist function

- Depending on the vehicle speed, lane departure situation, road conditions, etc., the driver may not feel the function is operating or the function may not operate at all.
- The yaw assist of the function is overridden by the driver's steering wheel operation.
- Do not attempt to test the operation of the yaw assist function.
- A sound may be heard from the engine compartment when the brake pedal is depressed, when the yaw assist function is operating. This sound does not indicate that a malfunction is occurred in the LDA system.

■ Lane departure alert function

- The warning buzzer may be difficult to hear due to external noise, audio playback, etc.
- If the edge of the course* is not clear or straight, the lane departure alert function may not operate.
- Do not attempt to test the operation of the lane departure alert function.

*: Boundary between asphalt and the side of the road, such as grass, soil, or a curb

■ Vehicle sway warning function

When the system determines that the vehicle is swaying while the vehicle sway warning function is operating, a buzzer sounds and a warning message urging the driver to rest and the symbol shown in the illustration are simultaneously displayed on the multi-information display.



Depending on the vehicle and road conditions, the warning may not operate.

■ Warning message

If the following warning message is displayed on the multi-information display, and the LDA indicator illuminates in yellow, follow the appropriate troubleshooting procedure. Also, if a different warning message is displayed, follow the instructions displayed on the screen.

● “LDA Malfunction Visit Your Dealer”

The system may not be operating properly. Have the vehicle inspected by any authorized Toyota retailer or Toyota authorized repairer, or any reliable repairer.

● “Lane Departure Alert Unavailable”

- The system is temporarily canceled due to a malfunction in a sensor other than the front camera. Turn the LDA system off, wait for a little while, and then turn the LDA system back on.
- The system is temporarily unavailable as the vehicle repeatedly departs from its lane or course* in a short period of time. Turn the engine switch to the “LOCK” position (vehicles without smart entry & start system) or off (vehicles with smart entry & start system), and then turn it to the “ON” position (vehicles without smart entry & start system) or IGNITION ON mode (vehicles with smart entry & start system) again.

*: Boundary between asphalt and the side of the road, such as grass, soil, or a curb

● “LDA Unavailable at Current Speed”

The function cannot be used as the vehicle speed exceeds the LDA operation range. Drive slower.

■ Customization

Function settings can be changed. (Customizable features: →P. 647)

RSA (Road Sign Assist)*

Summary of function

The RSA system recognizes specific road signs using the front camera and/or navigation system (when speed limit information is available) to provide information to the driver via the display.

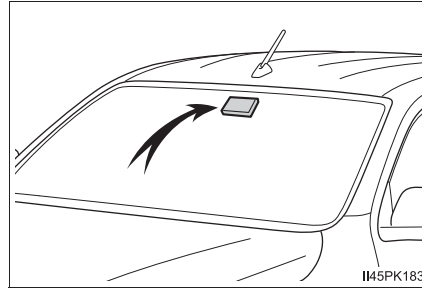

If the system judges that the vehicle is being driven over the speed limit, performing prohibited actions, etc., according to the recognized road signs, it notifies the driver through a visual notification and notification buzzer.

WARNING

■ Before using the RSA

Do not rely solely upon the RSA system. RSA is a system which supports the driver by providing information, but it is not a replacement for a driver's own vision and awareness. Drive safely by always paying careful attention to the traffic rules.

*: If equipped

Indication on the multi-information display

When the front camera recognizes a sign and/or information of a sign is available from the navigation system, the sign will be displayed on the multi-information display.

- When the driving support system information is selected, a maximum of 3 signs can be displayed. (→P. 135)

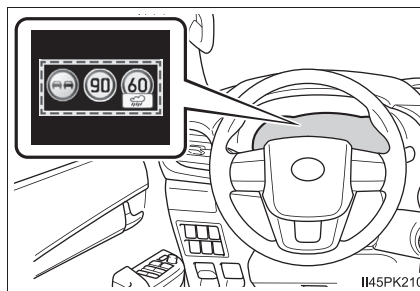

- When a tab other than the driving support system information is selected, the following types of road signs will be displayed. (→P. 135)

- Speed limit begins/ends sign
- Speed limit related information sign (Motorway, Expressway, Urban area, Residential area)
- End of prohibition sign
- No-entry sign* (when notification is necessary)
- Speed limit with supplemental sign (Ramp way only)

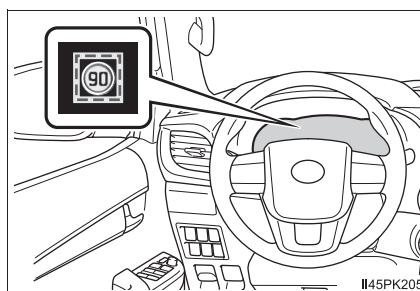

If signs other than speed limit signs are recognized, they will be displayed in an overlapping stack under the current speed limit sign.

*: For vehicles with navigation system

Supported types of road signs

The following types of road signs, including electronic signs and blinking signs, are displayed.

A non-official (not meeting the Vienna Convention) or a recently introduced traffic sign may not be displayed.

● Speed limit road signs*



Speed limit begins/
Maximum speed zone
begins



Speed limit ends/
Maximum speed zone
ends

*: No speed limit information  is displayed when speed limit sign or speed limit related sign information is not available.

● Speed limit related information*1, 2



Motorway entrance



Urban area ending



Motorway exit



Urban area beginning



Expressway entrance



Urban area ending



Expressway exit



Residential area begin-
ning



Urban area beginning



Residential area ending

*1: Displayed when a sign is recognized but speed limit information for the road is not available from the navigation system

*2: No speed limit information  is displayed when speed limit sign or speed limit related sign information is not available.

● No-overtaking road signs



No overtaking begins



No overtaking ends

● Other road signs



No-entry*



Stop



End of prohibition

*: For vehicles with navigation system

● Speed limit with supplemental mark*¹



Wet



Exit ramp on right*³



Rain



Exit ramp on left*³



Ice

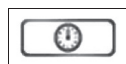

Time

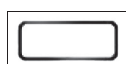

Supplemental mark exists*²

*¹: Displayed simultaneously with speed limit

*²: Contents not recognized.

*³: If the turn signal indicator is not operated when changing lanes, the mark does not display.

Notification function

In the following situations, the RSA system will notify the driver.

- When the vehicle speed exceeds the speed notification threshold of the speed limit sign displayed, the sign display will be emphasized and a buzzer will sound.
- When the RSA system recognizes a no-entry sign and detects that the vehicle has entered a no-entry area based on the map information of the navigation system, the no-entry sign flashes and a buzzer will sound. (For vehicles with navigation system)
- If it is detected that your vehicle is overtaking when a no overtaking sign is displayed on the multi-information display, the displayed sign will flash and a buzzer will sound.

Depending on the situation, traffic environment (traffic direction, speed unit) may be detected incorrectly and a notification function may not operate properly.

Setting procedure

Setting for "RSA" in  of the multi-information display is set to "On" (→P. 139)

Automatic turn-off of RSA sign display

One or more signs automatically turn off in the following situations.

- No sign has been recognized for a certain distance.
- The road changes due to a left or right turn, etc.

Conditions in which the function may not operate or detect correctly

In the following situations, RSA does not operate normally and may not recognize signs, display the incorrect sign, etc. However, this does not indicate a malfunction.

- The front camera is misaligned due to a strong impact being applied to the sensor, etc.
- Dirt, snow, stickers, etc. are on the windshield near the front camera.
- In inclement weather such as heavy rain, fog, snow or sand storms.
- Light from an oncoming vehicle, the sun, etc. enters the front camera.
- The sign is dirty, faded, tilted or bent.
- The contrast of electronic sign is low.
- All or part of the sign is hidden by the leaves of a tree, a pole, etc.
- The sign is only visible to the front camera for a short amount of time.
- The driving scene (turning, lane change, etc.) is judged incorrectly.

- If a sign not appropriate for the currently traveled lane, but the sign exists directly after a freeway branches, or in an adjacent lane just before merging.
- Stickers are attached to the rear of the preceding vehicle.
- A sign resembling a system compatible sign is recognized.
- Side road speed signs may be detected and displayed (if positioned in sight of the front camera) while the vehicle is traveling on the main road.
- Roundabout exit road speed signs may be detected and displayed (if positioned in sight of the front camera) while traveling on a roundabout.
- The front of the vehicle is raised or lowered due to the carried load.
- The surrounding brightness is not sufficient or changes suddenly.
- When a sign intended for trucks, etc. is recognized.
- The vehicle is driven in a country with a different direction of traffic.
- The navigation system map data is outdated.
- The navigation system is not operating.
- The speed information displayed on the meter and on the navigation system may be different due to the navigation system using map data.

■ **Speed limit sign display**

If the engine switch was last turned to the "LOCK" position (vehicles without smart entry & start system) or off (vehicles with smart entry & start system) while a speed limit sign was displayed on the multi-information display, the same sign displays again when the engine switch is turned to the "ON" position (vehicles without smart entry & start system) or IGNITION ON mode (vehicles with smart entry & start system).

■ **If "RSA Malfunction Visit Your Dealer" is shown**

The system may be malfunctioning. Have the vehicle inspected by any authorized Toyota retailer or Toyota authorized repairer, or any reliable repairer.

■ **Customization**

Some functions can be customized. (Customizable features: →P. 647)

Dynamic radar cruise control*

Summary of functions

In vehicle-to-vehicle distance control mode, the vehicle automatically accelerates and decelerates to match the speed changes of the preceding vehicle even if the accelerator pedal is not depressed. In constant speed control mode, the vehicle runs at a fixed speed.

Use the dynamic radar cruise control on freeways and highways.

- Vehicle-to-vehicle distance control mode (→P. 305)
- Constant speed control mode (→P. 311)

System Components

- ① Indicators
- ② Set speed
- ③ Vehicle-to-vehicle distance switch
- ④ Multi-information display
- ⑤ Cruise control switch

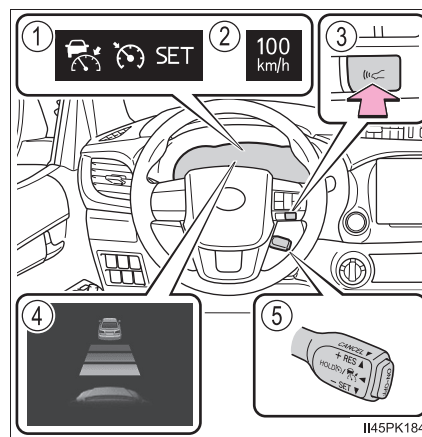

4

Driving

*: If equipped

**WARNING****■ Before using dynamic radar cruise control**

- Driving safely is the sole responsibility of the driver. Do not rely solely on the system, and drive safely by always paying careful attention to your surroundings.
- The dynamic radar cruise control provides driving assistance to reduce the driver's burden. However, there are limitations to the assistance provided. Read the following conditions carefully. Do not overly rely on this system and always drive carefully.
 - When the sensor may not be correctly detecting the vehicle ahead:
→P. 315
 - Conditions under which the vehicle-to-vehicle distance control mode may not function correctly: →P. 316
- Set the speed appropriately depending on the speed limit, traffic flow, road conditions, weather conditions, etc. The driver is responsible for checking the set speed.
- Even when the system is functioning normally, the condition of the preceding vehicle as detected by the system may differ from the condition observed by the driver. Therefore, the driver must always remain alert, assess the danger of each situation and drive safely. Relying solely on this system or assuming the system ensures safety while driving can lead to an accident, resulting in death or serious injury.
- Switch the dynamic radar cruise control setting to off, using the "ON-OFF" button when not in use.

 WARNING**■ Cautions regarding the driving assist systems**

Observe the following precautions, as there are limitations to the assistance provided by the system. Failure to do so may cause an accident resulting in death or serious injury.

● Assisting the driver to measure following distance

The dynamic radar cruise control is only intended to help the driver in determining the following distance between the driver's own vehicle and a designated vehicle traveling ahead. It is not a mechanism that allows careless or inattentive driving, and it is not a system that can assist the driver in low-visibility conditions.

It is still necessary for driver to pay close attention to the vehicle's surroundings.

● Assisting the driver to judge proper following distance

The dynamic radar cruise control determines whether the following distance between the driver's own vehicle and a designated vehicle traveling ahead is within a set range. It is not capable of making any other type of judgement. Therefore, it is absolutely necessary for the driver to remain vigilant and to determine whether or not there is a possibility of danger in any given situation.

● Assisting the driver to operate the vehicle

The dynamic radar cruise control does not include functions which will prevent or avoid collisions with vehicles ahead of your vehicle. Therefore, if there is ever any possibility of danger, the driver must take immediate and direct control of the vehicle and act appropriately in order to ensure the safety of all involved.

 WARNING**■ Situations unsuitable for dynamic radar cruise control**

Do not use dynamic radar cruise control in any of the following situations. Doing so may result in inappropriate speed control and could cause an accident resulting in death or serious injury.

- Roads where there are pedestrians, cyclists, etc.
- In heavy traffic
- On roads with sharp bends
- On winding roads
- On slippery roads, such as those covered with rain, ice or snow
- On steep downhills, or where there are sudden changes between sharp up and down gradients
Vehicle speed may exceed the set speed when driving down a steep hill.
- At entrances to freeways and highways
- When weather conditions are bad enough that they may prevent the sensors from detecting correctly (fog, snow, sandstorm, heavy rain, etc.)
- When there is rain, snow, etc. on the front surface of the radar or front camera
- In traffic conditions that require frequent repeated acceleration and deceleration
- When your vehicle is towing a trailer (with towing hitch) or during emergency towing
- When an approach warning buzzer is heard often

Driving in vehicle-to-vehicle distance control mode

This mode employs a radar to detect the presence of vehicles up to approximately 100 m (328 ft.) ahead, determines the current vehicle-to-vehicle following distance, and operates to maintain a suitable following distance from the vehicle ahead. The desired vehicle-to-vehicle distance can also be set by operating the vehicle-to-vehicle distance switch.

When driving on downhill slopes, the vehicle-to-vehicle distance may become shorter.

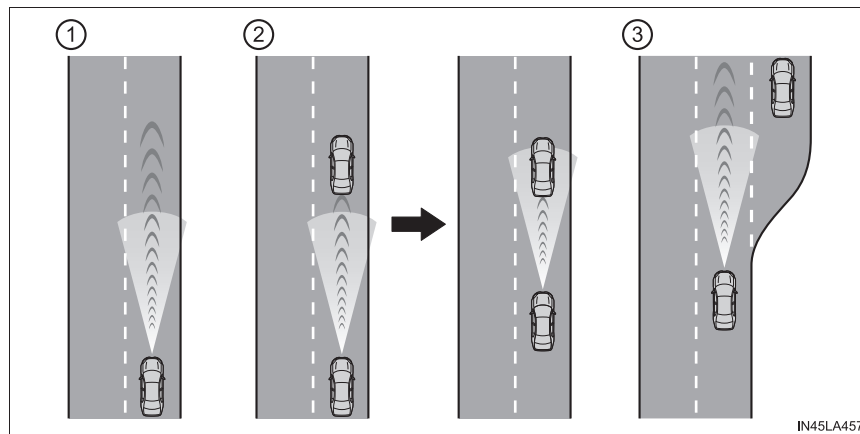

① Example of constant speed cruising

When there are no vehicles ahead

The vehicle travels at the speed set by the driver.

② Example of deceleration cruising and follow-up cruising

When a preceding vehicle driving slower than the set speed appears

When a vehicle is detected running ahead of you, the system automatically decelerates your vehicle. When a greater reduction in vehicle speed is necessary, the system applies the brakes (the stop lights will come on at this time). The system will respond to changes in the speed of the vehicle ahead in order to maintain the vehicle-to-vehicle distance set by the driver. Approach warning warns you when the system cannot decelerate sufficiently to prevent your vehicle from closing in on the vehicle ahead.

When the turn signal lever is operated and your vehicle moves to an overtaking lane while driving at 80 km/h (50 mph) or more, the vehicle will accelerate to help to overtake a passing vehicle.

The system's identification of what is an overtaking lane may be determined solely based on the location of the steering wheel in the vehicle (left side driver position versus right side driver position.) If the vehicle is driven to a region where the overtaking lane is on a different side from where the vehicle is normally driven, the vehicle may accelerate when the turn signal lever is operated in the opposite direction to the overtaking lane (e.g., if the driver normally operates the vehicle in a region where the overtaking lane is to the right but then drives to a region where the overtaking lane is to the left, the vehicle may accelerate when the right turn signal is activated).

③ Example of acceleration

When there are no longer any preceding vehicles driving slower than the set speed

The system accelerates until the set speed is reached. The system then returns to constant speed cruising.

Setting the vehicle speed (vehicle-to-vehicle distance control mode)

- 1 Press the “ON-OFF” button to activate the cruise control.

Dynamic radar cruise control indicator will come on and a message will be displayed on the multi-information display. Press the button again to deactivate the cruise control.

If the “ON-OFF” button is pressed and held for 1.5 seconds or more, the system turns on in constant speed control mode. (→P. 311)

- 2 Accelerate or decelerate, with accelerator pedal operation, to the desired vehicle speed (at or above approximately 30 km/h [20 mph]) and push the lever down to set the speed.

Cruise control “SET” indicator will come on.

The vehicle speed at the moment the lever is released becomes the set speed.

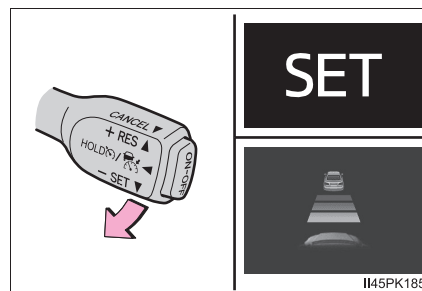
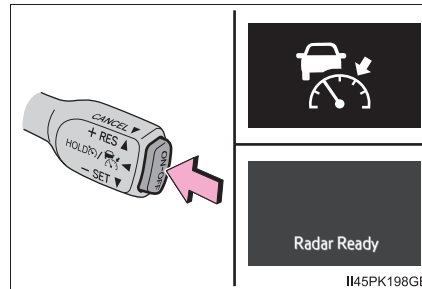

Adjusting the set speed

- Adjusting the set speed by the lever

To change the set speed, operate the lever until the desired set speed is displayed.

① Increases the speed

② Decreases the speed

Fine adjustment: Momentarily move the lever in the desired direction.

Large adjustment: Hold the lever up or down to change the speed, and release when the desired speed is reached.

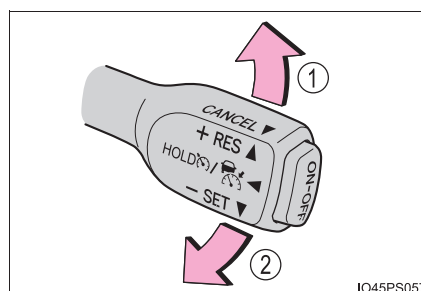

In the vehicle-to-vehicle distance control mode, the set speed will be increased or decreased as follows:

Fine adjustment: By 1 km/h (0.6 mph)^{*1} or 1 mph (1.6 km/h)^{*2} each time the lever is operated

Large adjustment: Increases or decreases in 5 km/h (3.1 mph)^{*1} or 5 mph (8 km/h)^{*2} increments for as long as the lever is held

In the constant speed control mode (→P. 311), the set speed will be increased or decreased as follows:

Fine adjustment: By 1 km/h (0.6 mph)^{*1} or 1 mph (1.6 km/h)^{*2} each time the lever is operated

Large adjustment: The speed will continue to change while the lever is held.

*1: When the set speed is shown in “km/h”

*2: When the set speed is shown in “MPH”

- Increasing the set speed by the accelerator pedal

① Accelerate with accelerator pedal operation to the desired vehicle speed

② Push the lever down

Changing the vehicle-to-vehicle distance (vehicle-to-vehicle distance control mode)

Pressing the switch changes the vehicle-to-vehicle distance as follows:

- ① Long
- ② Medium
- ③ Short

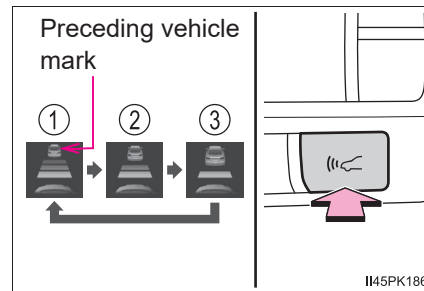

Vehicle-to-vehicle distance settings (vehicle-to-vehicle distance control mode)

Select a distance from the table below. Note that the distances shown correspond to a vehicle speed of 80 km/h (50 mph). Vehicle-to-vehicle distance increases/decreases in accordance with vehicle speed.

Distance options	Vehicle-to-vehicle distance
Long	Approximately 50 m (160 ft.)
Medium	Approximately 40 m (130 ft.)
Short	Approximately 30 m (100 ft.)

Canceling and resuming the speed control

- ① Pulling the lever toward you cancels the speed control.
The speed control is also canceled when the brake pedal is depressed.
- ② Pushing the lever up resumes the cruise control and returns vehicle speed to the set speed.

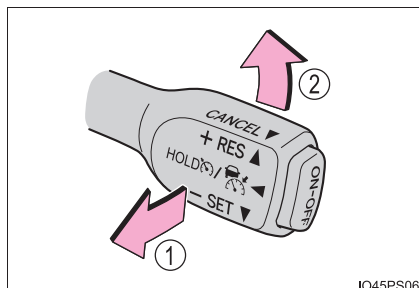

However, cruise control does not resume when the vehicle speed is approximately 25 km/h (16 mph) or less.

Approach warning (vehicle-to-vehicle distance control mode)

When your vehicle is too close to a vehicle ahead, and sufficient automatic deceleration via the cruise control is not possible, the display will flash and the buzzer will sound to alert the driver. An example of this would be if another driver cuts in front of you while you are following a vehicle. Depress the brake pedal to ensure an appropriate vehicle-to-vehicle distance.

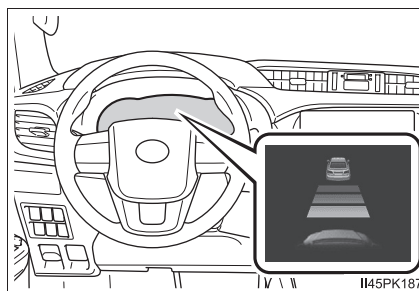

■ Warnings may not occur when

In the following instances, warnings may not occur even when the vehicle-to-vehicle distance is small.

- When the speed of the preceding vehicle matches or exceeds your vehicle speed
- When the preceding vehicle is traveling at an extremely slow speed
- Immediately after the cruise control speed was set
- When depressing the accelerator pedal

Selecting constant speed control mode

When constant speed control mode is selected, your vehicle will maintain a set speed without controlling the vehicle-to-vehicle distance. Select this mode only when vehicle-to-vehicle distance control mode does not function correctly due to a dirty radar, etc.

- 1 With the cruise control off, press and hold the "ON-OFF" button for 1.5 seconds or more.

Immediately after the "ON-OFF" button is pressed, the dynamic radar cruise control indicator will come on. Afterwards, it switches to the cruise control indicator.

Switching to constant speed control mode is only possible when operating the lever with the cruise control off.

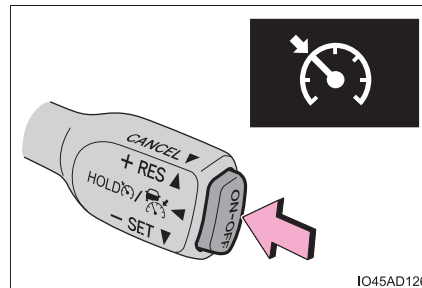

- 2 Accelerate or decelerate, with accelerator pedal operation, to the desired vehicle speed (at or above approximately 30 km/h [20 mph]) and push the lever down to set the speed.

Cruise control "SET" indicator will come on.

The vehicle speed at the moment the lever is released becomes the set speed.

Adjusting the speed setting: →P. 308

Canceling and resuming the speed setting: →P. 310

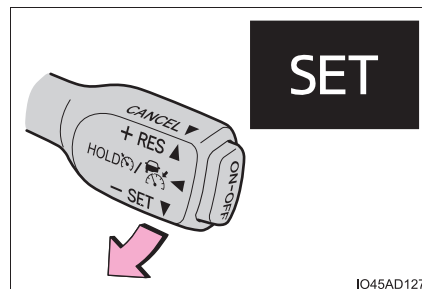

Dynamic Radar Cruise Control with Road Sign Assist

When this function is enabled and the system is operating in vehicle-to-vehicle distance control mode (→P. 305), when a speed limit sign is detected, the recognized speed limit will be displayed with an up/down arrow. The set speed can be increased/reduced to the recognized speed limit by pushing the lever up or down.

- When the current set speed is lower than the recognized speed limit

Push the lever up

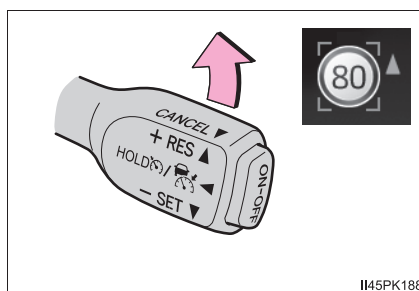

II45PK188

- When the current set speed is higher than the recognized speed limit

Push the lever down

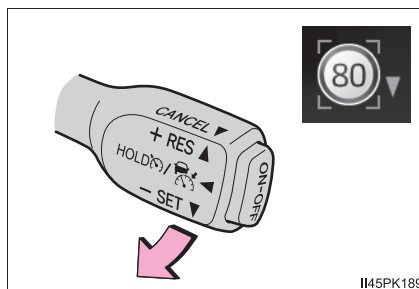

II45PK189

Enabling/Disabling the Dynamic Radar Cruise Control with Road Sign Assist

Dynamic Radar Cruise Control with Road Sign Assist can be enabled/disabled in  on the multi-information display. (→P. 135)

When the Dynamic Radar Cruise Control with Road Sign Assist is operating, while driving down a hill, the vehicle speed may exceed the set speed.

In this case, the displayed set vehicle speed will be highlighted and a buzzer will sound to alert the driver.

■ Dynamic radar cruise control can be set when

- The shift lever is in D. (Vehicles with automatic transmission)
- The shift lever is in range 2nd or higher. (Vehicles with manual transmission)
- Depending on the control mode, this item can be set at the following speeds.
 - Vehicle-to-vehicle distance control mode: Approximately 30 km/h (20 mph) or more
 - Constant speed control mode: Approximately 30 km/h (20 mph) or more

■ Accelerating after setting the vehicle speed

The vehicle can accelerate by operating the accelerator pedal. After accelerating, the set speed resumes. However, during vehicle-to-vehicle distance control mode, the vehicle speed may decrease below the set speed in order to maintain the distance to the preceding vehicle.

■ Shift position selection (vehicles with manual transmission)

Select a shift position according to the vehicle speed. If the engine speed is too high or too low, control may be automatically canceled.

■ Automatic cancelation of vehicle-to-vehicle distance control mode

Vehicle-to-vehicle distance control mode is automatically canceled in the following situations.

- Actual vehicle speed falls below approximately 25 km/h (16 mph).
- VSC is activated.
- TRC/A-TRC is activated for a period of time.
- When the VSC or TRC/A-TRC system is turned off.
- The sensor cannot detect correctly because it is covered in some way.
- When the brake control or output restriction control of a driving support system operates. (For example: Pre-Collision System, Drive-Start Control)
- When the shift lever is in N or the clutch pedal is depressed for a certain amount of time or more. (Vehicles with manual transmission)
- 4WD models: Switching the transfer mode is not completed within 5 seconds while the cruise control system is on.

If vehicle-to-vehicle distance control mode is automatically canceled for any reasons other than the above, there may be a malfunction in the system. Contact any authorized Toyota retailer or Toyota authorized repairer, or any reliable repairer.

■ Automatic cancelation of constant speed control mode

Constant speed control mode is automatically canceled in the following situations:

- Actual vehicle speed is more than approximately 16 km/h (10 mph) below the set vehicle speed.
- Actual vehicle speed falls below approximately 30 km/h (20 mph).
- VSC is activated.
- TRC/A-TRC is activated for a period of time.
- When the VSC or TRC/A-TRC system is turned off.
- When the brake control or output restriction control of a driving support system operates. (For example: Pre-Collision System, Drive-Start Control)
- When the shift lever is in N or the clutch pedal is depressed for a certain amount of time or more. (Vehicles with manual transmission)
- 4WD models: Switching the transfer mode is not completed within 5 seconds while the cruise control system is on.

If constant speed control mode is automatically canceled for any reasons other than the above, there may be a malfunction in the system. Contact any authorized Toyota retailer or Toyota authorized repairer, or any reliable repairer.

■ The Dynamic Radar Cruise Control with Road Sign Assist may not operate properly when

As the Dynamic Radar Cruise Control with Road Sign Assist may not operate properly in conditions in which RSA may not operate or detect correctly (→P. 299), when using this function, make sure to check the speed limit sign displayed.

In the following situations, the set speed may not be changed to the recognized speed limit by pushing the lever up or down.

- If speed limit information is not available
- When the recognized speed limit is the same as the set speed
- When the recognized speed limit is outside of the speed range that the dynamic radar cruise control system can operate

■ Brake operation

A brake operation sound may be heard and the brake pedal response may change, but these are not malfunctions.

■ Warning messages and buzzers for dynamic radar cruise control

Warning messages and buzzers are used to indicate a system malfunction or to inform the driver of the need for caution while driving. If a warning message is shown on the multi-information display, read the message and follow the instructions. (→P. 271, 575)

■ When the sensor may not be correctly detecting the vehicle ahead

In the case of the following and depending on the conditions, operate the brake pedal when deceleration of the system is insufficient or operate the accelerator pedal when acceleration is required.

As the sensor may not be able to correctly detect these types of vehicles, the approach warning (→P. 310) may not be activated.

- Vehicles that cut in suddenly
- Vehicles traveling at low speeds
- Vehicles that are not moving in the same lane
- Vehicles with small rear ends (trailers with no load on board, etc.)

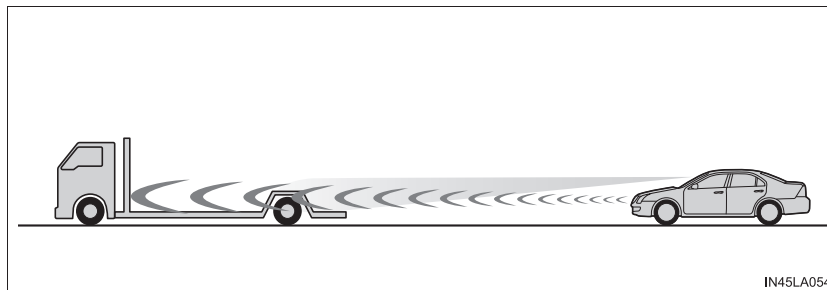

- Motorcycles traveling in the same lane
- When water or snow thrown up by the surrounding vehicles hinders the detecting of the sensor
- When your vehicle is pointing upwards (caused by a heavy load in the luggage compartment, etc.)

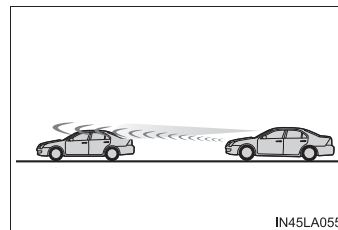

- Preceding vehicle has an extremely high ground clearance

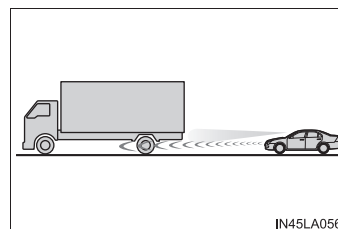

■ **Conditions under which the vehicle-to-vehicle distance control mode may not function correctly**

In the case of the following conditions, operate the brake pedal (or accelerator pedal, depending on the situation) as necessary.

As the sensor may not be able to correctly detect vehicles ahead, the system may not operate properly.

- When the road curves or when the lanes are narrow

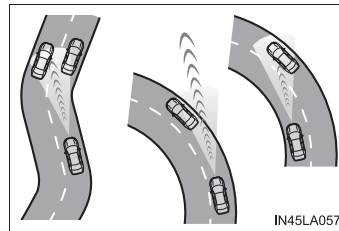

- When steering wheel operation or your position in the lane is unstable

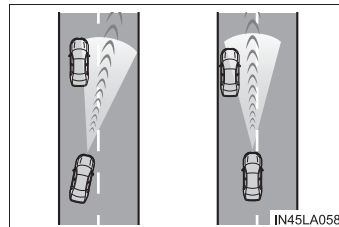

- When the vehicle ahead of you decelerates suddenly
- When driving on a road surrounded by a structure, such as in a tunnel or on a bridge
- While the vehicle speed is decreasing to the set speed after the vehicle accelerates by depressing the accelerator pedal

Cruise control*

Summary of functions

Use the cruise control to maintain a set speed without depressing the accelerator pedal.

- ① Indicators
- ② Cruise control switch

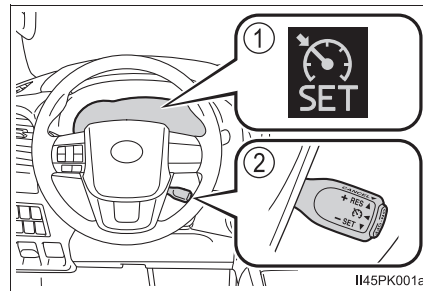

Setting the vehicle speed

- 1 Press the “ON-OFF” button to activate the cruise control.
Cruise control indicator will come on.
Press the button again to deactivate the cruise control.

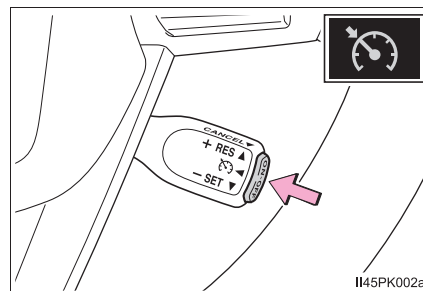

- 2 Accelerate or decelerate the vehicle to the desired speed, and push the lever down to set the speed.
“SET” indicator will come on.
The vehicle speed at the moment the lever is released becomes the set speed.

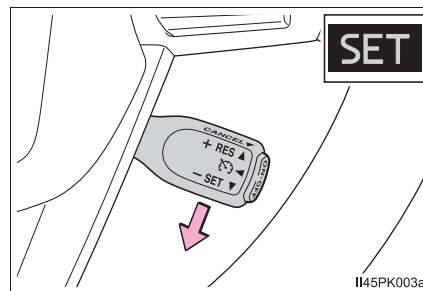

*: If equipped

Adjusting the set speed

To change the set speed, operate the lever until the desired set speed is obtained.

- ① Increases the speed
- ② Decreases the speed

Fine adjustment: Momentarily move the lever in the desired direction.

Large adjustment: Hold the lever in the desired direction.

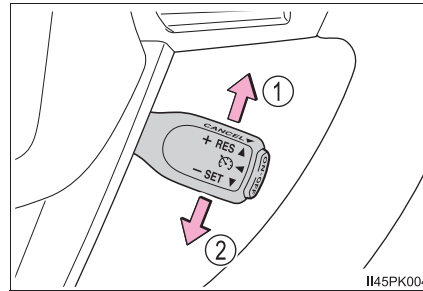

The set speed will be increased or decreased as follows:

Fine adjustment: By approximately 1.0 km/h (0.6 mph) each time the lever is operated.

Large adjustment: The set speed can be increased or decreased continually until the lever is released.

Canceling and resuming the constant speed control

- ① Pulling the lever toward you cancels the constant speed control.

The speed setting is also canceled when the brakes are applied or the clutch pedal (manual transmission only) is depressed.

- ② Pushing the lever up resumes the constant speed control.

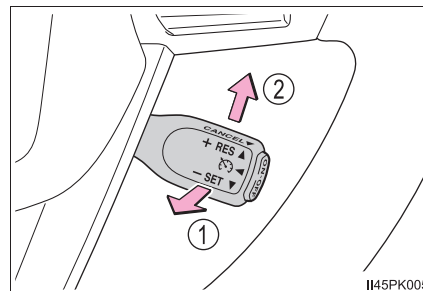

Resuming is available when the vehicle speed is more than approximately 30 km/h (20 mph).

■ Cruise control can be set when

- The shift lever is in D or shifted to range 4 or higher of S. (vehicles with automatic transmission)
- Range 4 or higher has been selected by using the paddle shift. (vehicles with paddle shift switches)
- Vehicle speed is above approximately 30 km/h (20 mph).

■ Accelerating after setting the vehicle speed

- The vehicle can be accelerated normally. After acceleration, the set speed resumes.
- Even without canceling the cruise control, the set speed can be increased by first accelerating the vehicle to the desired speed and then pushing the lever down to set the new speed.

■ Automatic cruise control cancelation

Cruise control will stop maintaining the vehicle speed in any of the following situations:

- Actual vehicle speed falls more than approximately 16 km/h (10 mph) below the preset vehicle speed.
At this time, the memorized set speed is not retained.
- Actual vehicle speed is below approximately 30 km/h (20 mph).
- VSC is activated. (if equipped)
- 4WD models: Switching the transfer mode is not completed within 5 seconds while the cruise control system is on.
- TRC/A-TRC is activated for a period of time. (if equipped)
- When the VSC or TRC/A-TRC system is turned off. (if equipped)

■ If the cruise control indicator turns to yellow (vehicles without multi-information display) or “Cruise Control Malfunction Visit Your Dealer” is shown on the multi-information display (vehicles with multi-information display)

Press the “ON-OFF” button once to deactivate the system, and then press the button again to reactivate the system.

If the cruise control speed cannot be set or if the cruise control cancels immediately after being activated, there may be a malfunction in the cruise control system. Have the vehicle inspected by any authorized Toyota retailer or Toyota authorized repairer, or any reliable repairer.

**WARNING****■ To avoid operating the cruise control by mistake**

Switch the cruise control off using the “ON-OFF” button when not in use.

■ Situations unsuitable for cruise control

Do not use cruise control in any of the following situations.

Doing so may result in loss of control and could cause an accident resulting in death or serious injury.

- In heavy traffic
- On roads with sharp bends
- On winding roads
- On slippery roads, such as those covered with rain, ice or snow
- On steep hills
Vehicle speed may exceed the set speed when driving down a steep hill.
- When your vehicle is towing a trailer (with towing hitch) or during emergency towing

Toyota parking assist-sensor*

The distance from your vehicle to objects, such as a wall, when parallel parking or maneuvering into a garage is measured by the sensors and communicated via the multi-information display and a buzzer. Always check the surrounding area when using this system.

Types of sensors

- ① Front corner sensors
- ② Rear corner sensors
- ③ Rear center sensors

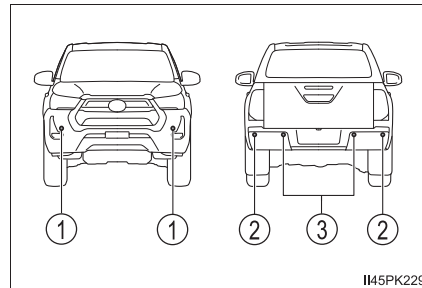

4

Driving

*: If equipped

Turning Toyota parking assist-sensor on/off

Turns Toyota parking assist-sensor on/off

When on, the indicator light comes on to inform the driver that the system is operational.

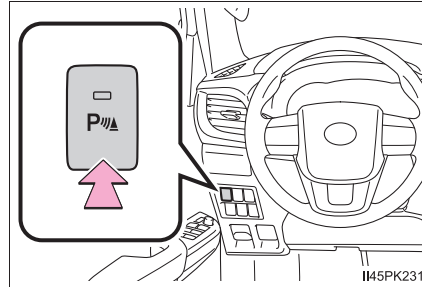

Display

When the sensors detect an object, the following displays inform the driver of the position and distance to the object.

■ Multi-information display*

- ① Front corner sensor operation
- ② Rear corner sensor operation
- ③ Rear center sensor operation



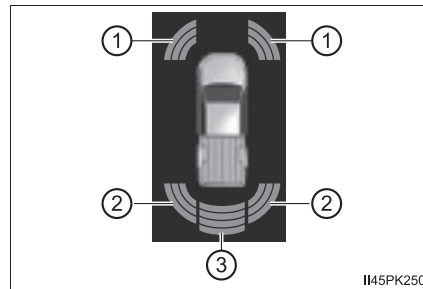

*: The vehicle shown in the illustrations may differ depending on the grade.



Sensor detection display, object distance

■ Distance display

When an object is detected by a sensor, the approximate distance to the object will be displayed on the multi-information display.

Multi-information display*	Approximate distance to object	
	Front corner sensor	Rear center and Rear corner sensor
 (continuous)	—	Rear center sensor only: 150 cm (4.9 ft.) to 80 cm (2.6 ft.)
 (continuous)	60 cm (2.0 ft.) to 45 cm (1.5 ft.)	Rear center sensor: 80 cm (2.6 ft.) to 70 cm (2.3 ft.) Rear corner sensor: 60 cm (2.0 ft.) to 50 cm (1.6 ft.)
 (continuous)	45 cm (1.5 ft.) to 35 cm (1.1 ft.)	Rear center sensor: 70 cm (2.3 ft.) to 60 cm (2.0 ft.) Rear corner sensor: 50 cm (1.6 ft.) to 40 cm (1.3 ft.)
 (blinking)	Less than 35 cm (1.1 ft.)	Rear center sensor: Less than 60 cm (2.0 ft.) Rear corner sensor: Less than 40 cm (1.3 ft.)

*: The images may differ from those shown in the illustrations. (→P. 322)

Buzzer operation and distance to an object

A buzzer sounds when the sensors are operating.

■ When an object is detected to the front or rear of the vehicle

- The buzzer sounds faster as the vehicle approaches an object. When the vehicle comes within the following distance of the object, the buzzer beeps continuously.
 - Front corner sensor: Approximately 35 cm (1.1 ft.)
 - Rear corner sensor: Approximately 40 cm (1.3 ft.)
 - Rear center sensor: Approximately 60 cm (2.0 ft.)
- When 2 or more objects are detected simultaneously, the buzzer system responds to the nearest object.

Detection range of the sensors

- ① Approximately 60 cm (24 in.)
- ② Approximately 150 cm (59 in.)

The diagram shows the detection range of the sensors. Note that the sensors may not be able to detect objects that are extremely close to the vehicle.

The range of the sensors may change depending on the shape of the object etc.

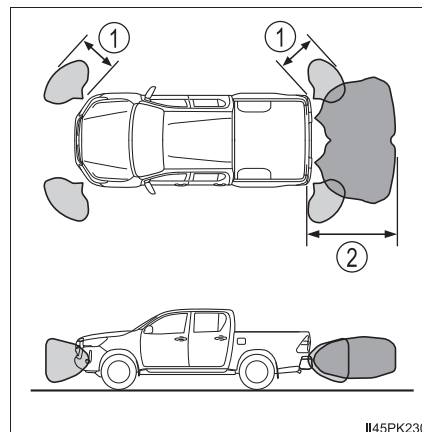

II45PK230

■ Toyota parking assist-sensor can be operated when

- The engine switch is in the “ON” position (vehicles without smart entry & start system) or IGNITION ON mode (vehicles with smart entry & start system).
- Front corner sensor:
 - The shift lever is in other than P.
 - The vehicle speed is approximately 10 km/h (6 mph) or less.
- Rear corner and rear center sensors:
The shift lever is in R.

■ Sensor detection information

- The sensor’s detection areas are limited to the areas around the vehicle’s bumper.
- Depending on the shape of the object and other factors, the detection distance may shorten, or detection may be impossible.
- Detection may be impossible if the objects draw too close to the sensor.
- There will be a short delay between object detection and display. Even at low speeds, there is a possibility that the object will come within the sensor’s detection areas before the display is shown and the warning beep sounds.
- Thin posts or objects lower than the sensor may not be detected when approached, even if they have been detected once.
- It might be difficult to hear the buzzer due to the volume of the audio system or air flow noise of the air conditioning system.

■ Objects which the system may not properly detect

The shape of the object may prevent the sensor from detecting it. Pay particular attention to the following objects:

- Wires, fences, ropes, etc.
- Cotton, snow and other materials that absorb sound waves
- Sharply-angled objects
- Low objects
- Tall objects with upper sections projecting outwards in the direction of your vehicle
- Moving objects such as people or animals

People may not be detected if they are wearing certain types of clothing.

■ Situations in which the system may not operate properly

Certain vehicle conditions and the surrounding environment may affect the ability of the sensor to correctly detect objects. Particular instances where this may occur are listed below.

- There is dirt, snow or ice on the sensor. (Wiping the sensors will resolve this problem.)

- The sensor is frozen. (Thawing the area will resolve this problem.)
In especially cold weather, if a sensor is frozen, the screen may show an abnormal display, or objects may not be detected.
- The sensor is covered in any way.
- When a sensor or the area around a sensor is extremely hot or cold

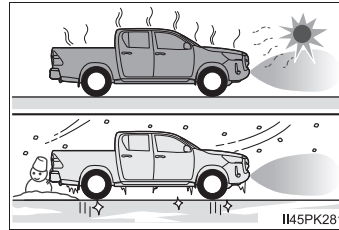

- On an extremely bumpy road, on an incline, on gravel, or on grass
- When vehicle horns, vehicle detectors, motorcycle engines, air brakes of large vehicles, the clearance sonar of other vehicles or other devices which produce ultrasonic waves are near the vehicle.
- A sensor is coated with a sheet of spray or heavy rain.
- If objects draw too close to the sensor.
- When a pedestrian is wearing clothing that does not reflect ultrasonic waves (ex. skirts with gathers or frills).
- When objects that are not perpendicular to the ground, not perpendicular to the vehicle traveling direction, uneven, or waving are in the detection range.
- Strong wind is blowing.
- When driving in inclement weather such as fog, snow or a sandstorm.
- When an object that cannot be detected is between the vehicle and a detected object.
- If an object such as a vehicle, motorcycle, bicycle or pedestrian cuts in front of the vehicle or runs out from the side of the vehicle.
- If the orientation of a sensor has been changed due to a collision or other impact.
- When equipment that may obstruct a sensor is installed, such as a towing eyelet, bumper protector (an additional trim strip, etc.), bicycle carrier, or snow plow.
- If the front of the vehicle is raised or lowered due to the carried load.
- If the vehicle cannot be driven in a stable manner, such as when the vehicle has been in an accident or is malfunctioning.
- When tire chains, a compact spare tire or an emergency tire puncture repair kit are used.

■ Situations in which the system may operate even if there is no possibility of a collision

In some situations, such as the following, the system may operate even though there is no possibility of a collision.

- When driving on a narrow road.

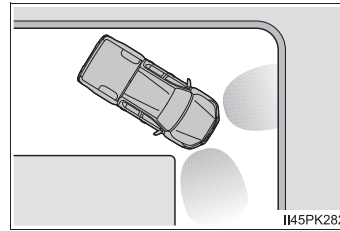

- When driving toward a banner, flag, low-hanging branch or boom barrier (such as those used at railroad crossings, toll gates and parking lots).
- When there is a rut or hole in the surface of the road.
- When driving on a metal cover (grating), such as those used for drainage ditches.
- When driving up or down a steep slope.
- If a sensor is hit by a large amount of water, such as when driving on a flooded road.
- There is dirt, snow, water drops or ice on a sensor. (Cleaning the sensors will resolve this problem.)
- A sensor is coated with a sheet of spray or heavy rain.
- When driving in inclement weather such as fog, snow or a sandstorm.
- When strong winds are blowing.

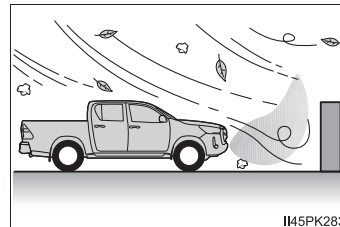

- When vehicle horns, vehicle detectors, motorcycle engines, air brakes of large vehicles, the clearance sonar of other vehicles or other devices which produce ultrasonic waves are near the vehicle.
- If the front of the vehicle is raised or lowered due to the carried load.
- If the orientation of a sensor has been changed due to a collision or other impact.
- The vehicle is approaching a tall or curved curb.
- Driving close to columns (H-shaped steel beams, etc.) in multi-story parking garages, construction sites, etc.

- If the vehicle cannot be driven in a stable manner, such as when the vehicle has been in an accident or is malfunctioning.
- On an extremely bumpy road, on an incline, on gravel, or on grass.

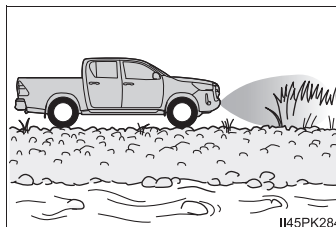

- When tire chains, a compact spare tire or an emergency tire puncture repair kit are used.

■ **If “Clean Parking Assist Sensor” is displayed on the multi-information display**

A sensor may be dirty or covered with snow or ice. In such cases, if it is removed from the sensor, the system should return to normal.

Also, due to the sensor being frozen at low temperatures, a malfunction display may appear or an object may not be detected. If the sensor thaws out, the system should return to normal.

■ **If “Parking Assist Malfunction Visit Your Dealer” is displayed on the multi-information display**

Depending on the malfunction of the sensor, the device may not be working normally. Have the vehicle inspected by any authorized Toyota retailer or Toyota authorized repairer, or any reliable repairer.

■ **If “Parking Assist Malfunction” is displayed on the multi-information display**

Water may be continuously flowing over the sensor surface, such as in a heavy rain. When the system determines that it is normal, the system will return to normal.

■ **Customization**

Setting of buzzer volume can be changed.
(Customizable features: →P. 647)

 **WARNING****■ Cautions regarding the use of the system**

There is a limit to the degree of recognition accuracy and control performance that this system can provide, do not overly rely on this system. The driver is always responsible for paying attention to the vehicle's surroundings and driving safely.

■ To ensure the system can operate properly

Observe the following precautions.

Failure to do so may result in the vehicle being unable to be driven safely and possibly cause an accident.

- Do not damage the sensors, and always keep them clean.
- Do not attach a sticker or install an electronic component, such as a backlit license plate (especially fluorescent type), fog lights, fender pole or wireless antenna near a radar sensor.
- Do not subject the surrounding area of the sensor to a strong impact. If subjected to an impact, have the vehicle inspected by any authorized Toyota retailer or Toyota authorized repairer, or any reliable repairer. If the front or rear bumper needs to be removed/installed or replaced, contact any authorized Toyota retailer or Toyota authorized repairer, or any reliable repairer.
- Do not modify, disassemble or paint the sensors.
- Do not attach a license plate cover.
- Keep your tires properly inflated.

■ When to disable the function

In the following situations, disable the function as it may operate even though there is no possibility of a collision.

- Failing to observe the warnings above.
- A non-genuine Toyota suspension (lowered suspension, etc.) is installed.

■ Notes when washing the vehicle

Do not apply intensive bursts of water or steam to the sensor area.

Doing so may result in the sensor malfunctioning.

- When using a high pressure washer to wash the vehicle, do not spray the sensors directly, as doing so may cause a sensor to malfunction.
- When using steam to clean the vehicle, do not direct steam too close to the sensors as doing so may cause a sensor to malfunction.

**NOTICE****■ When using the Toyota parking assist-sensor**

In the following situations, the system may not function correctly due to a sensor malfunction etc. Have the vehicle checked by any authorized Toyota retailer or Toyota authorized repairer, or any reliable repairer.

- Toyota parking assist-sensor operation display flashes, and a beep sounds when no objects are detected.
- If the area around a sensor collides with something, or is subjected to strong impact.
- If the bumper collides with something.
- If the display shows up and remains on without a beep.

Four-wheel drive system*

Use the front-wheel drive control switch to select the following transfer modes.

- ① H2 (high speed position, two-wheel drive)

Use this for normal driving on dry hard-surfaced roads. This position gives greater economy, quietest ride and least wear.

- ② H4 (high speed position, four-wheel drive)

Use this for driving only on tracks that permit the tires slide, like off-road, icy or snow-covered roads. This position provides greater traction than two-wheel drive.

The four-wheel drive indicator light comes on

- ③ L4 (low speed position, four-wheel drive)

Use this for maximum power and traction. Use L4 for climbing or descending steep hills, off-road driving, and hard pulling in sand, mud or deep snow.

The four-wheel drive and low speed four-wheel drive indicator lights come on

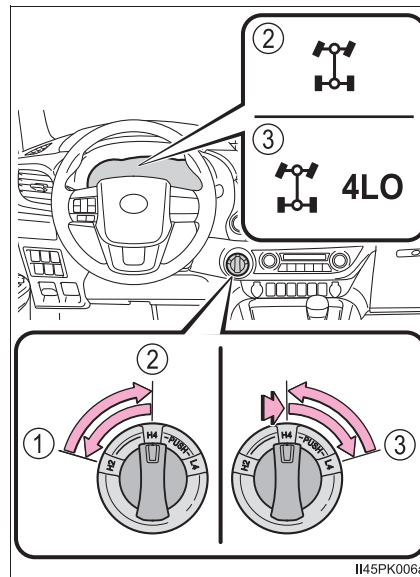

A.D.D. (automatic disconnecting differential) (if equipped)

The A.D.D. can be engaged or disengaged by the shifting operations described in the following shifting procedures.

*: If equipped

Shifting between H2 and H4

■ Shifting from H2 to H4

- 1 Reduce the vehicle speed to less than 100 km/h (62 mph).
The transfer mode cannot be switched if the vehicle speed is more than 100 km/h (62 mph).

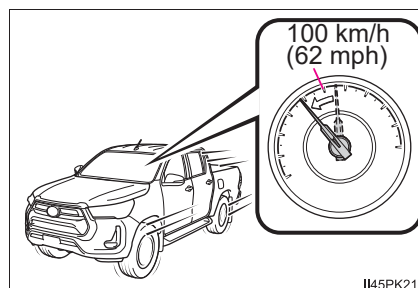

- 2 Turn the front-wheel drive control switch to H4.
The four-wheel drive indicator light flashes while switching.
If turning the front-wheel drive control switch when the vehicle speed is more than 100 km/h (62 mph), the four-wheel drive indicator light flashes and a buzzer sounds.

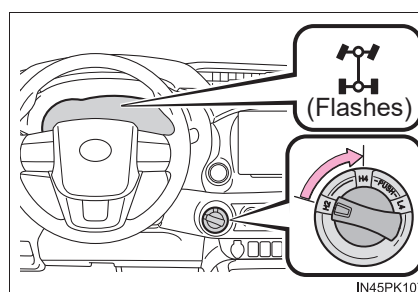

Reduce the vehicle speed to less than 100 km/h (62 mph), or return the front-wheel drive control switch to H2 and try step 1 again.

- 3 Check that the four-wheel drive indicator light comes on.
The four-wheel drive indicator light comes on when switching the transfer mode is completed.
If the four-wheel drive indicator light does not stop flashing after turning the front-wheel drive control switch from H2 to H4, perform any of the followings while driving straight.

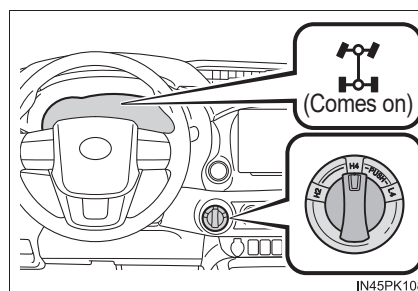

- Accelerating
- Decelerating
- Driving in reverse

The four-wheel drive indicator light may not stop flashing if the front-wheel drive control switch is turned from H2 to H4 while the vehicle is stopped. In this case, perform any of the followings.

- Driving forward
- Driving in reverse

■ Shifting from H4 to H2

- 1 Turn the front-wheel drive control switch to H2.

The four-wheel drive indicator light flashes while switching.

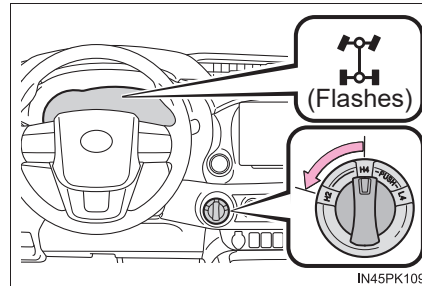

- 2 Check that the four-wheel drive indicator light goes off.

The four-wheel drive indicator light goes off when switching the transfer mode is completed.

If the four-wheel drive indicator light does not stop flashing after turning the front-wheel drive control switch from H4 to H2, perform the followings while driving straight.

- Accelerating
- Decelerating
- Driving in reverse

If the four-wheel drive indicator light is still flashing, perform the operations above while turning the steering wheel left and right.

Impact may be felt through the vehicle body and steering. However, this does not indicate a malfunction.

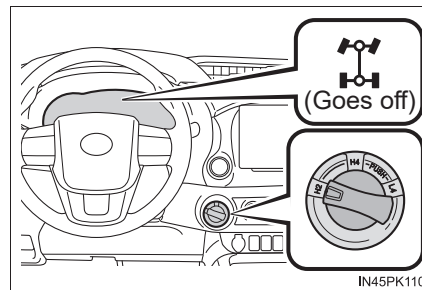

Shifting between H4 and L4 (automatic transmission)

■ **Shifting from H4 to L4**

- 1 Stop the vehicle.

The transfer mode cannot be switched if the vehicle is moving.

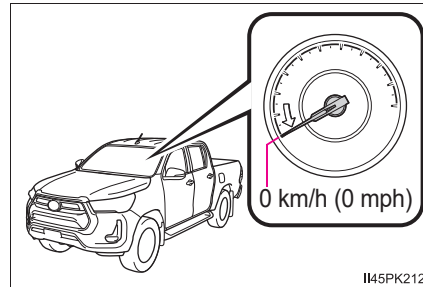

- 2 Shift the shift lever to N.

Keep the shift lever in N until switching the transfer mode is completed (indicator on).

The transfer mode cannot be switched if the shift lever is in other than N.

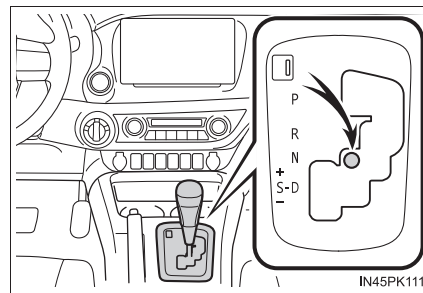

- 3 Push and turn the front-wheel drive control switch to L4.

The low speed four-wheel drive indicator light flashes while switching.

If turning the front-wheel drive control switch without following steps 1 and 2, the low speed four-wheel drive indicator light flashes and a buzzer sounds. Return the front-wheel drive control switch to H4 and try steps 1 and 2 again.

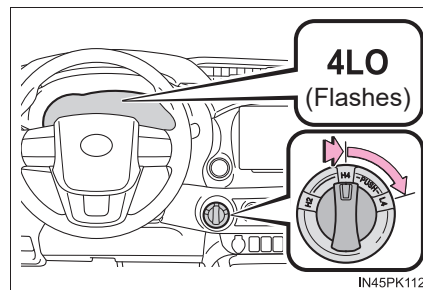

If the shift lever is shifted to other than N while the low speed four-wheel drive indicator light is flashing, gear noise may be caused. Immediately shift the shift lever to N and wait until switching the transfer mode is completed.

- 4 Check that the low speed four-wheel drive indicator light comes on.

The low speed four-wheel drive indicator light comes on when switching the transfer mode is completed.

Shift the shift lever from N to D or R to drive the vehicle.

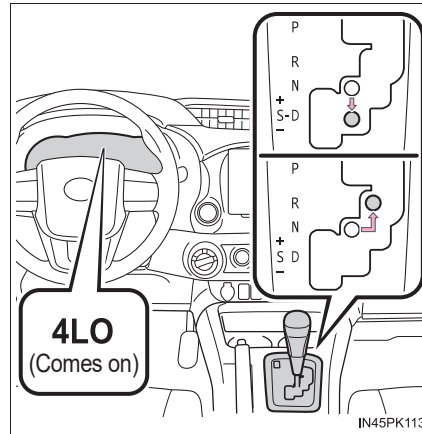

■ Shifting from L4 to H4

- 1 Stop the vehicle.

The transfer mode cannot be switched if the vehicle is moving.

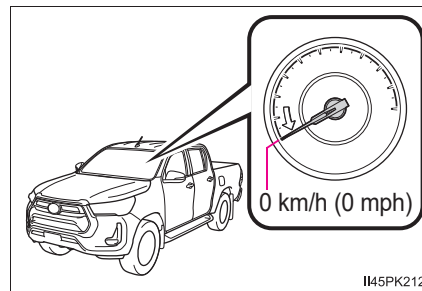

- 2 Shift the shift lever to N.

Keep the shift lever in N until switching the transfer mode is completed (indicator off).

The transfer mode cannot be switched if the shift lever is in other than N.

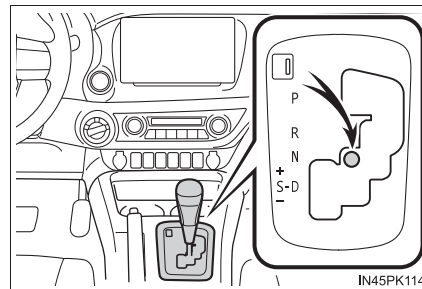

- 3 Turn the front-wheel drive control switch to H4.

The low speed four-wheel drive indicator light flashes while switching.

If turning the front-wheel drive control switch without following steps 1 and 2, the low speed four-wheel drive indicator light flashes and a buzzer sounds. Return the front-wheel drive control switch to L4 and try steps 1 and 2 again.

If the shift lever is shifted to other than N while the low speed four-wheel drive indicator light is flashing, gear noise may be caused. Immediately shift the shift lever to N and wait until switching the transfer mode is completed.

- 4 Check that the low speed four-wheel drive indicator light goes off.

The low speed four-wheel drive indicator light goes off when switching the transfer mode is completed.

Shift the shift lever from N to D or R to drive the vehicle.

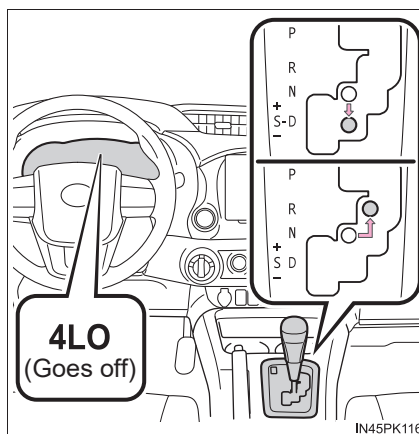
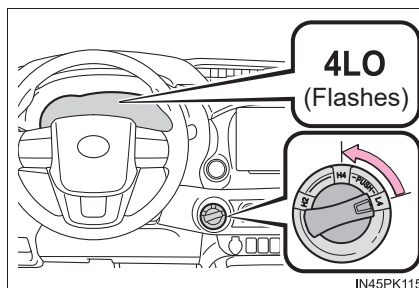

 NOTICE

■ **Shifting between H4 and L4**

Do not shift the shift lever to other than N or depress the accelerator pedal while the low speed four-wheel drive indicator light is flashing. Failure to do so may cause gear noise and result in a malfunction.

Shifting between H4 and L4 (manual transmission)

■ Shifting from H4 to L4

- 1 Stop the vehicle.

The transfer mode cannot be switched if the vehicle is moving.

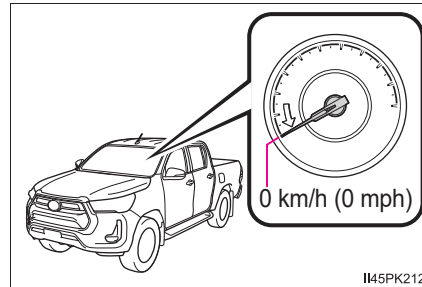

- 2 Firmly depress the clutch pedal.

Keep depressing the clutch pedal until switching the transfer mode is completed (indicator on).

The transfer mode cannot be switched if the clutch pedal is not fully depressed.

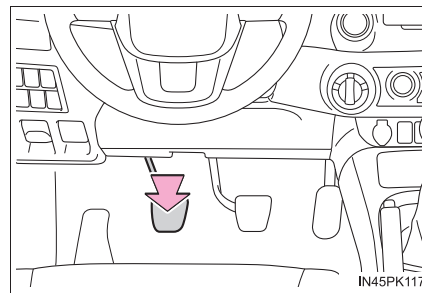

- 3 Push and turn the front-wheel drive control switch to L4.

The low speed four-wheel drive indicator light flashes while switching.

If turning the front-wheel drive control switch without following steps 1 and 2, the low speed four-wheel drive indicator light flashes and a buzzer sounds. Return the front-wheel drive control switch to H4 and try steps 1 and 2 again.

If the clutch pedal is released while the low speed four-wheel drive indicator light is flashing, gear noise may be caused. Immediately depress the clutch pedal firmly and wait until switching the transfer mode is completed.

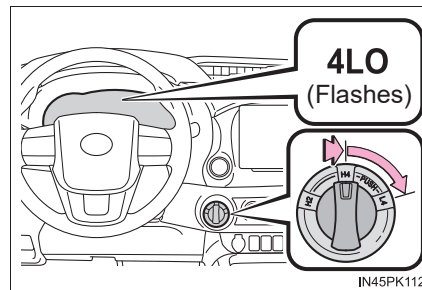

- 4 Check that the low speed four-wheel drive indicator light comes on.

The low speed four-wheel drive indicator light comes on when switching the transfer mode is completed.

Release the clutch pedal to drive the vehicle.

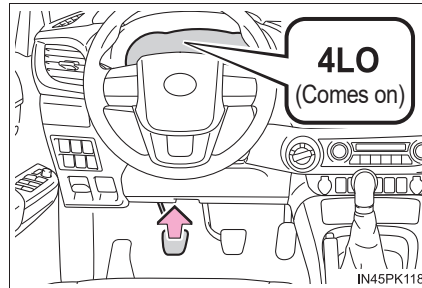

■ **Shifting from L4 to H4**

- 1 Stop the vehicle.

The transfer mode cannot be switched if the vehicle is moving.

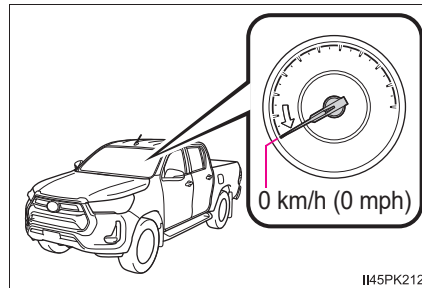

- 2 Firmly depress the clutch pedal.

Keep depressing the clutch pedal until switching the transfer mode is completed (indicator off).

The transfer mode cannot be switched if the clutch pedal is not fully depressed.

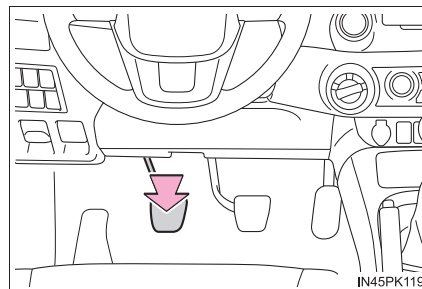

- 3 Turn the front-wheel drive control switch to H4.

The low speed four-wheel drive indicator light flashes while switching.

If turning the front-wheel drive control switch without following steps 1 and 2, the low speed four-wheel drive indicator light flashes and a buzzer sounds. Return the front-wheel drive control switch to L4 and try steps 1 and 2 again.

If the clutch pedal is released while the low speed four-wheel drive indicator light is flashing, gear noise may be caused. Immediately depress the clutch pedal firmly and wait until switching the transfer mode is completed.

- 4 Check that the low speed four-wheel drive indicator light goes off.

The low speed four-wheel drive indicator light goes off when switching the transfer mode is completed.

Release the clutch pedal to drive the vehicle.

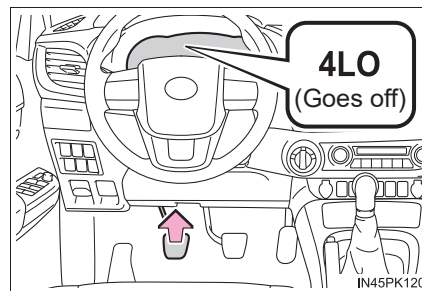
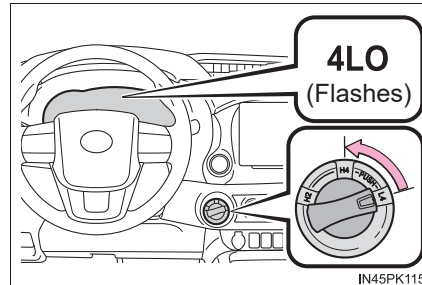

 NOTICE

■ **Shifting between H4 and L4**

Do not release the clutch pedal or depress the accelerator pedal while the low speed four-wheel drive indicator light is flashing. Failure to do so may cause gear noise and result in a malfunction.

■ Four-wheel drive usage frequency (vehicles with A.D.D.)

You should drive in four-wheel drive for at least 16 km (10 miles) each month. This will assure that the front drive components are lubricated.

■ Shifting between H2 and H4

If you have trouble shifting in cold weather, reduce your speed or stop the vehicle and reshift.

■ Shifting to L4 (vehicles with VSC)

VSC is automatically turned off.

■ When driving on dry paved surface roads and expressway

Use H2 position. If the vehicle is driven in H4 or L4 position for a long time, a warning buzzer sounds, and the four-wheel drive indicator light flashes rapidly or a warning message is shown on the multi-information display. If the warning message is shown on the multi-information display, follow the message.

⚠ WARNING**■ While driving**

- Never turn the front-wheel drive control switch from H2 to H4 if the wheels are slipping. Stop the slipping or spinning before shifting.
- For normal driving on dry and hard surface roads, use H2 position. Driving on dry and hard surface roads in H4 or L4 position may cause drive component oil leakage, seizure, or other problems resulting in an accident. Further, it may cause tire wear and increased fuel consumption.
- Avoid turning suddenly in H4 or L4 position. If you do turn suddenly, the difference in turning speeds between the front and rear wheels may have a similar effect to braking, thus making driving difficult.

Rear differential lock system*

The rear differential lock system is provided for use only when wheel spinning occurs in a ditch or on a slippery or ragged surface.

This differential lock system is effective in case one of the rear wheels is spinning.

Press the rear differential lock switch to lock the rear differential.

The rear differential lock indicator comes on.

To unlock the rear differential, push the switch again.

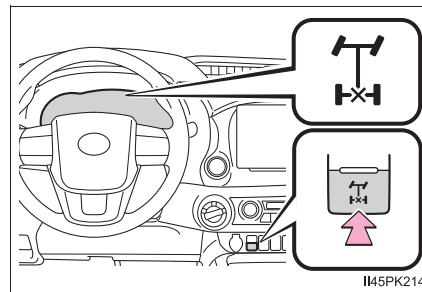

4

Driving

*: If equipped

Using the rear differential lock system

- 1 4WD models only: Before using the rear differential lock system, turn the front-wheel drive control switch to L4 and try to move the vehicle. (→P. 334, 337)

If this is not sufficient, use the rear differential lock system as well.

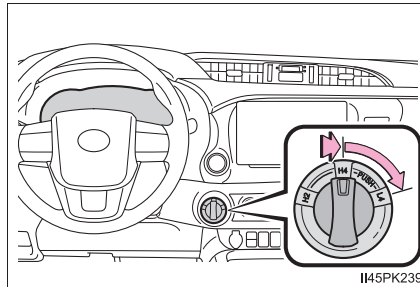

II45PK239

- 2 Reduce the vehicle speed to less than 8 km/h (5 mph).

Make sure that the wheels are not spinning.

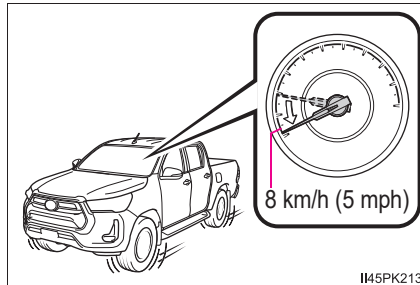

II45PK213

- 3 Press the rear differential lock switch.

The rear differential lock indicator flashes while the rear differential is being locked.

If pressing the rear differential lock switch without following steps 1 and 2, the rear differential lock indicator flashes three times and a buzzer sounds three times, and the rear differential cannot be locked. Try steps 1 and 2 again.

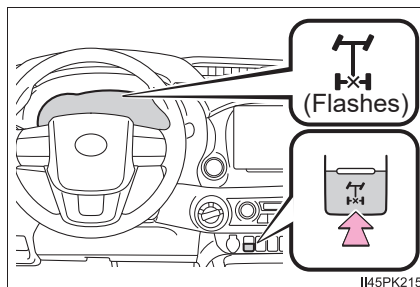

II45PK215

- 4 Gently depress the accelerator pedal.

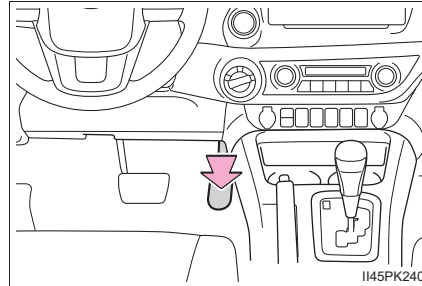

- 5 Check that the rear differential lock indicator comes on.

The rear differential lock indicator comes on when locking the rear differential is completed.

If the rear differential lock indicator does not stop flashing after pressing the rear differential lock switch, perform any of the followings while turning the steering wheel left and right.

- Accelerating
- Decelerating

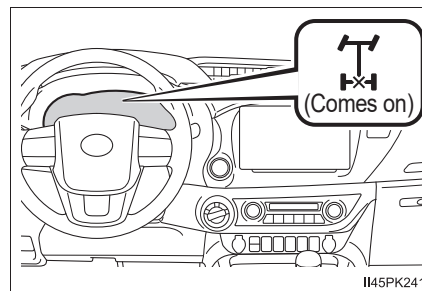

Unlock the rear differential as soon as the vehicle moves. To unlock the rear differential, push the switch again.

■ Locking the rear differential

The following systems do not operate when the rear differential is locked. It is normal operation for the ABS warning light, VSC OFF indicator (if equipped) and “TRC OFF” indicator (if equipped) to be on or for “TRC turned off” to be displayed on the multi-information display (if equipped) at this time.

- ABS
- Brake assist (if equipped)
- VSC (if equipped)
- TRC/A-TRC (if equipped)
- Trailer Sway Control (if equipped)
- Hill-start assist control (if equipped)
- Downhill assist control (if equipped)

■ Unlocking the rear differential

If the rear differential lock indicator still flashes even after unlocking the rear differential, check the safety of the surrounding area and slightly turn the steering wheel in either direction while the vehicle is in motion.

■ Automatic system cancelation of the rear differential lock system

The rear differential lock is also unlocked in any of the following situations:

- The front-wheel drive control switch is turned to H2 or H4 (4WD models)
- The engine switch is turned to the “ACC” or “LOCK” position (vehicles without smart entry & start system) or ACCESSORY or off (vehicles with smart entry & start system)

■ After unlocking the rear differential

Check that the indicator goes off.

⚠ WARNING**■ To avoid an accident**

Failure to observe the following precautions may result in an accident.

- Do not use the rear differential lock system except when wheel spinning occurs in a ditch or on a slippery or rugged surface. Large steering effort and careful cornering control will be required.
- Do not lock the rear differential until the wheels have stopped spinning. Otherwise, the vehicle may move in an unexpected direction when the differential lock is engaged, resulting in an accident. This may also lead to possible damage to rear differential lock component parts.
- Do not drive over 8 km/h (5 mph) when the differential is locked.
- Do not keep driving with the rear differential lock switch on.

Stop & Start system*

The Stop & Start system stops and starts the engine according to brake pedal (vehicles with automatic transmission) or clutch pedal (vehicles with manual transmission) or shift lever operation when the vehicle is stopped, such as at a stoplight, intersection, etc., in order to improve fuel economy and reduce noise pollution caused by the engine idling.

Stop & Start system operation

■ Stopping the engine

▶ Vehicles with automatic transmission

While driving with the D shift position selected, depress the brake pedal and stop the vehicle. The engine will stop automatically.

When the engine stops, the Stop & Start indicator will illuminate.

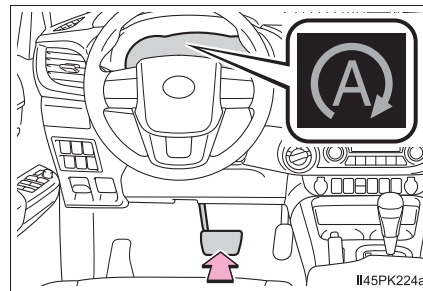

▶ Vehicles with manual transmission

- 1 Fully depress the clutch pedal and depress the brake pedal to stop the vehicle.
- 2 Move the shift lever to N and release the clutch pedal. The engine will stop automatically.

When the engine is stopped by the Stop & Start system, the Stop & Start indicator will illuminate.

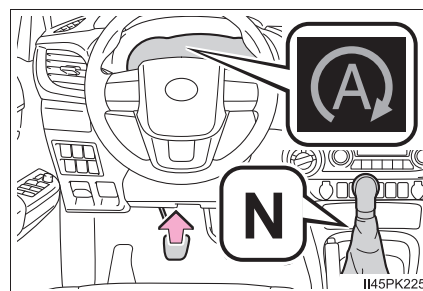

*: If equipped

■ **Restarting the engine**

- ▶ Vehicles with automatic transmission

Release the brake pedal. The engine will start automatically.

When the engine starts, the Stop & Start indicator will turn off.

- ▶ Vehicles with manual transmission

With the shift lever in N, depress the clutch pedal. The engine will start automatically.

When the engine starts, the Stop & Start indicator will turn off.

Disabling the Stop & Start system

Press the Stop & Start cancel switch to disable the Stop & Start system.

The Stop & Start cancel indicator will illuminate.

Pressing the switch again will enable the Stop & Start system and the Stop & Start cancel indicator will turn off.

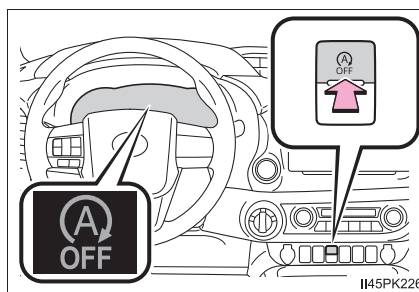

■ **Automatic enabling of the Stop & Start system**

If the Stop & Start system is disabled using the Stop & Start cancel switch, it will be automatically re-enabled once the engine switch is turned to the "LOCK" position*1 or off*2 and then the engine is started.

*1: Vehicles without smart entry & start system

*2: Vehicles with smart entry & start system

Hill-start assist control (vehicles with automatic transmission)

When the engine is stopped by the Stop & Start system when the vehicle is on an incline, when the brake pedal is released, brake force is temporarily maintained to prevent the vehicle from rolling backwards before the engine is restarted and drive force is generated. When drive force is generated, the maintained brake force is automatically canceled.

- This function operates on flat surfaces as well as steep inclines.
- Sound may be generated from the brake system, but this does not indicate a malfunction.
- Brake pedal response may change and vibration may occur, but this does not indicate a malfunction.

Points for use



- If the engine switch is pressed when the engine is stopped by the Stop & Start system, the engine will not be able to be restarted by the automatic engine start function. In this case, restart the engine using the normal engine starting procedure. (→P. 220, 223)
- When the engine is being restarted by the Stop & Start system, the power outlets may be temporarily unusable, but this does not indicate a malfunction.
- Installation and removal of electrical components and wireless devices may affect the Stop & Start system. Contact any authorized Toyota retailer or Toyota authorized repairer, or any reliable repairer for details.
- When stopping the vehicle for a longer period of time, turn the engine switch to the "LOCK" position^{*1} or off^{*2} to stop the engine completely.
- When the engine is restarted by the Stop & Start system, the steering wheel may temporarily feel heavy.
- 4WD models only: While driving in L4 mode, it is recommended that the Stop & Start system be canceled because the system may not operate properly.

*1: Vehicles without smart entry & start system

*2: Vehicles with smart entry & start system

■ **Operating conditions**

- The Stop & Start system is operational when all of the following conditions are met:
 - The vehicle has been driven a certain amount of time.
 - The brake pedal is being depressed firmly. (vehicles with automatic transmission)
 - The clutch pedal is not depressed. (vehicles with manual transmission)
 - The D shift position is selected. (vehicles with automatic transmission)
 - The shift lever is in N. (vehicles with manual transmission)
 - The driver's seat belt is fastened.
 - The driver's door is closed.
 - The selected driving mode is normal or Eco drive mode. (if equipped)
 - The rear differential is not locked. (if equipped)
 -  is off. (vehicles without manual air conditioning system)
 - The accelerator pedal is not being depressed. (vehicles with automatic transmission)
 - The engine is adequately warmed up.
 - The outside temperature is -5°C (23°F) or higher.
 - The hood is closed. (→P. 349)
- In the following situations, the engine may not be stopped by the Stop & Start system. This is not a malfunction of the Stop & Start system.
 - When the air conditioning system is being used.
 - When the battery is undergoing a periodic recharge.
 - When the battery is not sufficiently charged, such as if the vehicle has been parked for a long time and the battery charge has decreased, the electric load is large, the battery fluid temperature is excessively low or the battery has deteriorated.
 - When the brake booster vacuum is low.
 - When the elapsed time since the engine was restarted is short.
 - When the vehicle is stopped frequently, such as when in a traffic jam.
 - When the engine coolant temperature or transmission fluid temperature is extremely low or high.
 - When the vehicle is stopped on a steep incline. (vehicles with automatic transmission)
 - When the steering wheel is being operated.
 - When the vehicle is being driven in a high altitude area.
 - When the battery fluid temperature is extremely low or high.
 - For a while after the battery terminals have been disconnected and reconnected.

- When the engine is stopped by the Stop & Start system, the engine will be restarted automatically if any of the following conditions are met:
(To enable the engine to be stopped by the Stop & Start system again, drive the vehicle.)
 - The air conditioning system is turned on. (vehicles without manual air conditioning system)
 -  is turned on. (vehicles without manual air conditioning system)
 - The shift lever is shifted from D or P. (vehicles with automatic transmission)
 - The shift lever is shifted from P. (When the engine is stopped by the Stop & Start system when the shift lever is in P.) (vehicles with automatic transmission)
 - The driver's seat belt is unfastened.
 - The driver's door is opened.
 - The driving mode is changed from normal or Eco drive mode to another mode. (if equipped)
 - The rear differential is locked. (if equipped)
 - The Stop & Start cancel switch is pressed.
 - The steering wheel is operated.
 - The accelerator pedal is depressed. (vehicles with automatic transmission)
 - The vehicle starts to roll on an incline.
- When the engine is stopped by the Stop & Start system, the engine may restart automatically in the following situations:
(To enable the engine to be stopped by the Stop & Start system again, drive the vehicle.)
 - When the brake pedal is pumped or strongly depressed.
 - When the air conditioning system is being used.
 - When a switch of the air conditioning system is operated ( , etc.).
 - If the battery charge becomes low.

■ When the hood is opened

- If the hood is opened while the engine is stopped by the Stop & Start system, the engine will stall and will not be able to be restarted by the automatic engine start function. In this case, restart the engine using the normal engine starting procedure. (→P. 220, 223)
- If the hood is closed after the engine is started with the hood open, the Stop & Start system will not operate. Close the hood, turn the engine switch to the "LOCK" position^{*1} or off^{*2}, wait 30 seconds or more, and then start the engine.

*1: Vehicles without smart entry & start system

*2: Vehicles with smart entry & start system

■ Air conditioning system operation while the engine is stopped by the Stop & Start system

Vehicles with an automatic air conditioning system: When the air conditioning is in automatic mode and the engine is stopped by the Stop & Start system, the fan may operate at a low speed in order to prevent the temperature in the cabin from increasing or decreasing or may be stopped.

To prioritize air conditioning system performance when the vehicle is stopped, disable the Stop & Start system by pressing the Stop & Start cancel switch.

- If the windshield is fogged up

Turn  on. (→P. 443)

If the windshield fogs up frequently, press the Stop & Start cancel switch to disable the Stop & Start system.

- If an odor is emitted from the air conditioning system

- Vehicles with manual air conditioning system:

If the idling stop time setting is set to “Extended” change it to “Standard”. If an odor is emitted when the idling stop time setting is set to “Standard”, press the Stop & Start cancel switch to deactivate the Stop & Start system.

- Vehicles with automatic air conditioning system:

Press the Stop & Start cancel switch to deactivate the Stop & Start system.

■ Changing the idling stop time with the air conditioning system on

The length of time the Stop & Start system will operate when the air conditioning system is on can be changed in  of the multi-information display (→P. 646). (The length of time the Stop & Start system will operate when the air conditioning system is off cannot be changed.)



■ Displaying the Stop & Start system status



→P. 141

■ Multi-information display messages





If the following situations,  and a message may be displayed on the multi-information display.

- When the engine cannot be stopped by the Stop & Start system

Message	Details/Actions
 “Press Brake Harder to Activate”	Vehicles with automatic transmission: The brake pedal is not depressed enough. → If the brake pedal is depressed further, the system will operate.
 “Non-Dedicated Battery”	A non-dedicated battery for the Stop & Start system may have been installed. → The Stop & Start system does not operate. Have the vehicle inspected by any authorized Toyota retailer or Toyota authorized repairer, or any reliable repairer.
 “Battery Charging”	<ul style="list-style-type: none"> • The battery charge amount may be low. → Engine stop is temporarily prohibited to prioritize charging of the battery, but if the engine is operated for a short while, engine stop is allowed. • A refresh charge may be occurring, such as when the battery is undergoing a periodic recharge, for a while after the battery terminals have been disconnected and reconnected, for a while after the battery has been replaced, etc. → After a refresh charge for up to an hour completes, the system can be operated. • The engine may have been started with the hood opened. → Close the hood, turn the engine switch to the “LOCK” position (vehicles without smart entry & start system) or off (vehicles with smart entry & start system), wait 30 seconds or more, and then start the engine. <p>If the message is displayed continuously (60 minutes or more), the battery may have deteriorated. Contact any authorized Toyota retailer or Toyota authorized repairer, or any reliable repairer.</p>

Message	Details/Actions
 “Preparing to Operate”	<ul style="list-style-type: none"> • The vehicle is being driven in a high altitude area. • The brake booster vacuum is low. → When the brake booster vacuum reaches a predetermined level, the system will be enabled.
 “For Climate Control”	Vehicles with automatic air conditioning system: <ul style="list-style-type: none"> • The air conditioning system is being used when the ambient temperature is high or low. → If the difference between the set temperature and cabin temperature is small, the system will be enabled. <ul style="list-style-type: none"> •  is on.

- When the engine automatically restarts while stopped by the Stop & Start system

Message	Details/Actions
 “Preparing to Operate”	The brake pedal has been depressed further or pumped. → The system will be enabled after the engine runs and the brake booster vacuum reaches a predetermined level.
 “For Climate Control”	Vehicles with automatic air conditioning system: <ul style="list-style-type: none"> • The air conditioning system has been turned on or is being used. <ul style="list-style-type: none"> •  has been turned on.
 “Battery Charging”	The battery charge may be low. → The engine is restarted to prioritize battery charging. Operating the engine for a short while allows the system to recover.

■ When the buzzer sounds (vehicles with automatic transmission)

If the driver's door is opened when the engine is stopped by the Stop & Start system and the shift lever is in D, a buzzer will sound and the Stop & Start system indicator will flash. To stop the buzzer, close the driver's door.

■ The Stop & Start system protection function

- When the volume of the audio system is excessively high, sound output from the audio system may suddenly be cut off in order to reduce battery consumption. To prevent the audio system from being cut off, keep the volume of audio system at a moderate level. If the audio system has been cut off, turn the engine switch to the "LOCK" position^{*1} or off^{*2}, wait for 3 seconds or more and then turn it to the "ACC" position^{*1} or ACCESSORY mode^{*2} or the "ON" position^{*1} or IGNITION ON mode^{*2} to re-enable the audio system.
- The audio system may not be activated if the battery terminals are disconnected and then reconnected. If this occurs, turn the engine switch to the "LOCK" position^{*1} or off^{*2} and then repeat the following operation twice to activate the audio system normally.
 - Turn the engine switch to the "ON" position^{*1} or IGNITION ON mode^{*2} and then to the "LOCK" position^{*1} or off^{*2}.

*1: Vehicles without smart entry & start system

*2: Vehicles with smart entry & start system

■ Replacing the battery

→P. 607

■ If the Stop & Start cancel indicator flashes continuously

The system may be malfunctioning. Have the vehicle inspected by any authorized Toyota retailer or Toyota authorized repairer, or any reliable repairer.

■ If "Stop & Start System Malfunction Visit Your Dealer" is displayed on the multi-information display

The system may be malfunctioning. Have the vehicle inspected by any authorized Toyota retailer or Toyota authorized repairer, or any reliable repairer.

 WARNING**■ When the Stop & Start system is operating**

Make sure to disable the Stop & Start system while the vehicle is in a poorly ventilated area.

If not disabled, the engine may be automatically restarted unexpectedly, causing exhaust gases to collect and enter the vehicle, possibly resulting in death or a serious health hazard.

- Do not leave the vehicle while the engine is stopped by the Stop & Start system (while the Stop & Start indicator is on).
An accident may occur due to the automatic engine start function.
- Depress the brake pedal and apply the parking brake when necessary, while the engine is stopped by the Stop & Start system (while the Stop & Start indicator is on).

■ Off-road driving precaution

When driving off-road, such as driving through water, press the Stop & Start cancel switch to disable the Stop & Start system. Failure to do so may cause the engine to be unable to restart.

 NOTICE**■ To ensure the system operates correctly**

If any of the following situations occur, the Stop & Start system may not operate correctly. Have your vehicle inspected by any authorized Toyota retailer or Toyota authorized repairer, or any reliable repairer.

- While the driver's seat belt is fastened, the driver's and front passenger's seat belt reminder light flashes.
- Even though the driver's seat belt is not fastened, the driver's and front passenger's seat belt reminder light does not illuminate.
- Even though the driver's door is closed, the open door warning light is illuminated or the interior light is illuminated when the interior light switch is in the door position.
- Even though the driver's door is open, the open door warning light does not illuminate or the interior light does not illuminate when the interior light switch is in the door position.

■ If the engine stalls (vehicles with manual transmission)

If the Stop & Start system is enabled and the clutch pedal is depressed quickly, the engine may restart.

Driving assist systems

To keep driving safety and performance, the following systems operate automatically in response to various driving situations. Be aware, however, that these systems are supplementary and should not be relied upon too heavily when operating the vehicle.

◆ ABS (Anti-lock Brake System)

Helps to prevent wheel lock when the brakes are applied suddenly, or if the brakes are applied while driving on a slippery road surface

◆ Brake assist (if equipped)

Generates an increased level of braking force after the brake pedal is depressed when the system detects a panic stop situation

◆ VSC (Vehicle Stability Control) (if equipped)

Helps the driver to control skidding when swerving suddenly or turning on slippery road surfaces

◆ TRC (Traction Control) for Pre Runner and H2 position on 4WD models (if equipped)

Helps to maintain drive power and prevent the drive wheels from spinning when starting the vehicle or accelerating on slippery roads

◆ A-TRC (Active Traction Control) for H4 and L4 position on 4WD models (if equipped)

Helps to maintain drive power and prevent the four wheels from spinning when starting the vehicle or accelerating on slippery roads

◆ Hill-start assist control (if equipped)

Helps to reduce the backward movement of the vehicle when starting on an uphill

◆ Emergency brake signal (if equipped)

When the brakes are applied suddenly, the emergency flashers automatically flash to alert the vehicle behind.

◆ **Trailer Sway Control (if equipped)**

Helps the driver to control trailer sway by selectively applying brake pressure for individual wheels and reducing driving torque when trailer sway is detected.

Trailer Sway Control is part of the VSC system and will not operate if VSC is turned off or experiences a malfunction.

When the TRC/A-TRC/VSC/Trailer Sway Control systems are operating

The slip indicator will flash while the TRC/A-TRC/VSC/Trailer Sway Control systems are operating.

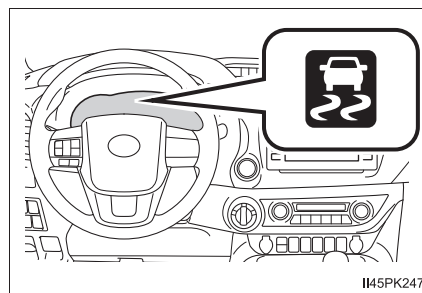

Disabling the TRC/A-TRC systems

If the vehicle gets stuck in mud, dirt or snow, the TRC/A-TRC systems may reduce power from the engine to the wheels. Pressing  to turn the system off may make it easier for you to rock the vehicle in order to free it.

- ▶ Vehicles without AUTO LSD system (without multi-information display)

To turn the TRC/A-TRC systems off, quickly press and release



The “TRC OFF” indicator light will come on.

Press  again to turn the system back on.

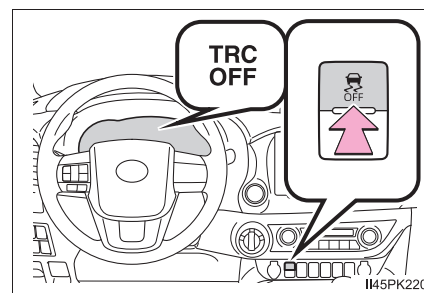

- ▶ Vehicles without AUTO LSD system (with multi-information display)

To turn the TRC/A-TRC systems off, quickly press and release



“TRC turned off” will be shown on the multi-information display.

Press  again to turn the system back on.

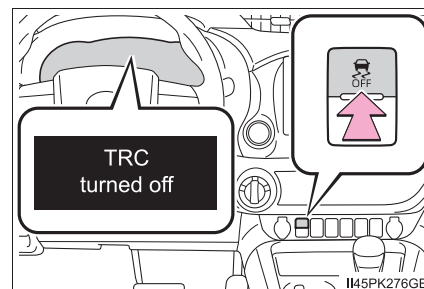

► Vehicles with AUTO LSD system

To turn the TRC/A-TRC systems off, quickly press and release . (The AUTO LSD system turns on.*1)

The “AUTO LSD” and VSC OFF indicators will come on.*2

Press  again to turn the system back on.

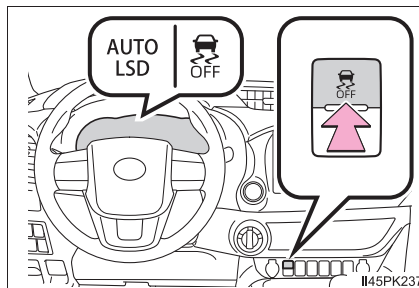

*1: Pre Runner and in 2WD mode on 4WD models only

*2: On vehicles with pre-collision system, pre-collision brake assist and pre-collision braking will also be disabled until the vehicle reaches a certain speed. The PCS warning light will come on and the message will be shown on the multi-information display. (if equipped) (→P. 283)

■ Turning off TRC, A-TRC, VSC and Trailer Sway Control systems

▶ Vehicles without multi-information display

To turn the TRC, A-TRC, VSC and Trailer Sway Control systems off, press and hold  for more than 3 seconds while the vehicle is stopped.

The “TRC OFF” indicator light and VSC OFF indicator light will come on.*

Press  again to turn the system back on.

▶ Vehicles with multi-information display

To turn the TRC, A-TRC, VSC and Trailer Sway Control systems off, press and hold  for more than 3 seconds while the vehicle is stopped.

The VSC OFF indicator light will come on and the “TRC turned off” will be shown on the multi-information display.*

Press  again to turn the system back on.

*: On vehicles with pre-collision system, pre-collision brake assist and pre-collision braking will also be disabled. The PCS warning light will come on and the message will be shown on the multi-information display. (→P. 283)

■ When “TRC OFF” indicator light comes on or the message is displayed on the multi-information display showing that TRC/A-TRC has been disabled even if has not been pressed

TRC, A-TRC and downhill assist control is temporary deactivated. If the indicator light continues to remain on or the information continues to show, contact any authorized Toyota retailer or Toyota authorized repairer, or any reliable repairer.

■ Sounds and vibrations caused by the ABS, brake assist, VSC, Trailer Sway Control, TRC, A-TRC and the hill-start assist control systems

- A sound may be heard from the engine compartment when the brake pedal is depressed repeatedly, when the engine is started or just after the vehicle begins to move. This sound does not indicate that a malfunction has occurred in any of these systems.
- Any of the following conditions may occur when the above systems are operating. None of these indicates that a malfunction has occurred.
 - Vibrations may be felt through the vehicle body and steering.
 - A motor sound may be heard also after the vehicle comes to a stop.
 - The brake pedal may pulsate slightly after the ABS is activated.
 - The brake pedal may move down slightly after the ABS is activated.

■ Automatic reactivation of TRC, A-TRC, VSC and Trailer Sway Control systems

After turning the TRC, A-TRC, VSC and Trailer Sway Control systems off, the systems will be automatically re-enabled in the following situations:

- When the engine switch is turned to the "LOCK" position (vehicles without smart entry & start system) or off (vehicles with smart entry & start system).
- If only the TRC/A-TRC system is turned off (→P. 357), the TRC/A-TRC will turn on when vehicle speed increases.

If the TRC, A-TRC, VSC and Trailer Sway Control systems are turned off (→P. 359), automatic re-enabling will not occur when vehicle speed increases.

■ Operating conditions of the hill-start assist control

When the following four conditions are met, the hill-start assist control will operate:

- Vehicles with automatic transmission: The shift lever is in a position other than P or N (when starting off forward/backward on an upward incline)
Vehicles with manual transmission: The shift lever is in a position other than R when starting off forward on an upward incline, or the shift lever is in R when starting off backward on an upward incline.
- The vehicle is stopped
- The accelerator pedal is not depressed
- The parking brake is not engaged

■ Automatic system cancelation of the hill-start assist control

The hill-start assist control will turn off in any of the following situations:

- Vehicles with automatic transmission: The shift lever is shifted to P or N
Vehicles with manual transmission: The shift lever is shifted to R when starting off forward on an upward incline, or the shift lever is shifted to other than R when starting off backward on an upward incline.
- The accelerator pedal is depressed
- The parking brake is engaged
- 2 seconds at maximum elapsed after the brake pedal is released

■ Operating conditions of emergency brake signal

When the following conditions are met, the emergency brake signal will operate:

- The emergency flashers are off.
- Actual vehicle speed is over 55 km/h (35 mph).
- The system judges from the vehicle deceleration that it is a sudden braking operation.

■ Automatic system cancelation of emergency brake signal

The emergency brake signal will be canceled in any of the following situations:

- The emergency flashers are turned on.
- The system judges from the vehicle deceleration that is not a sudden braking operation.

**WARNING****■ The ABS does not operate effectively when**

- The limits of tire gripping performance have been exceeded (such as excessively worn tires on a snow covered road).
- The vehicle hydroplanes while driving at high speed on wet or slick roads.

■ Stopping distance when the ABS is operating may exceed that of normal conditions

The ABS is not designed to shorten the vehicle's stopping distance. Always maintain a safe distance from the vehicle in front of you, especially in the following situations:

- When driving on dirt, gravel or snow-covered roads
- When driving with tire chains
- When driving over bumps in the road
- When driving over roads with potholes or uneven surfaces

**WARNING****■ TRC/A-TRC/VSC may not operate effectively when**

Directional control and power may not be achievable while driving on slippery road surfaces, even if the TRC/A-TRC/VSC system is operating. Drive the vehicle carefully in conditions where stability and power may be lost.

■ Hill-start assist control does not operate effectively when

- Do not overly rely on the hill-start assist control. The hill-start assist control may not operate effectively on steep inclines and roads covered with ice.

- Unlike the parking brake, the hill-start assist control is not intended to hold the vehicle stationary for an extended period of time. Do not attempt to use the hill-start assist control to hold the vehicle on an incline, as doing so may lead to an accident.

■ When the TRC/VSC/Trailer Sway Control is activated

The slip indicator flashes. Always drive carefully. Reckless driving may cause an accident. Exercise particular care when the indicator flashes.

■ When the TRC/A-TRC/VSC/Trailer Sway Control systems are turned off

Be especially careful and drive at a speed appropriate to the road conditions. As these are the systems to help ensure vehicle stability and driving force, do not turn the TRC/A-TRC/VSC/Trailer Sway Control systems off unless necessary.

■ Replacing tires

Make sure that all tires are of the specified size, brand, tread pattern and total load capacity. In addition, make sure that the tires are inflated to the recommended tire inflation pressure level.

The ABS, TRC, A-TRC, VSC, Trailer Sway Control, hill-start assist control and downhill assist control systems will not function correctly if different tires are installed on the vehicle.

Contact any authorized Toyota retailer or Toyota authorized repairer, or any reliable repairer for further information when replacing tires or wheels.

■ Handling of tires and the suspension

Using tires with any kind of problem or modifying the suspension will affect the driving assist systems, and may cause a system to malfunction.

 **WARNING****■ Trailer Sway Control precaution**

The Trailer Sway Control system is not able to reduce trailer sway in all situations. Depending on many factors such as the conditions of the vehicle, trailer, road surface, and driving environment, the Trailer Sway Control system may not be effective. Refer to your trailer owner's manual for information on how to tow your trailer properly.

■ If trailer sway occurs (vehicles with Trailer Sway Control)

Observe the following precautions.

Failing to do so may cause death or serious injury.

- Firmly grip the steering wheel. Steer straight ahead.
Do not try to control trailer sway by turning the steering wheel.
- Begin releasing the accelerator pedal immediately but very gradually to reduce speed.
Do not increase speed. Do not apply vehicle brakes.

If you make no extreme correction with the steering or brakes, your vehicle and trailer should stabilize. (→P. 215)

Downhill assist control system*

The downhill assist control system helps to prevent excessive speed on steep downhill slopes.

The system will operate when the vehicle is traveling under 30 km/h (18 mph) and transfer mode is in L4 or H4.

System operation

Press the “DAC” switch. The downhill assist control system indicator will come on and the system will operate.

When the system is in operation, the slip indicator will flash, and the stop lights/high mounted stop lights will be lit. A sound may also occur during the operation. This does not indicate a malfunction.

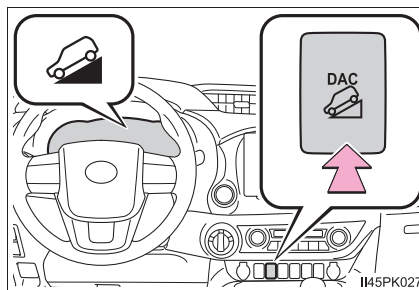

Turning off the system

Press the “DAC” switch while the system is in operation. The downhill assist control system indicator will flash as the system gradually ceases operation, and will turn off when the system is fully off.

Press the “DAC” switch while the downhill assist control system indicator is flashing to start the system again.

*: If equipped

■ Operating tips (vehicles with automatic transmission)

The system will operate when the shift lever is in a position other than P, however to make effective use of the system it is recommended to select a lower shift range.

■ The system will not operate when

- The transfer mode is in H2.
- The rear differential is locked. (if equipped)

■ If the downhill assist control system indicator flashes

- In the following situations, the indicator flashes and the system will not operate:
 - The transfer mode is not in L4 or H4.
 - The rear differential is locked. (if equipped)
 - The shift lever is in P. (vehicles with automatic transmission)
 - The accelerator or brake pedal is depressed.
 - The vehicle speed exceeds approximately 30 km/h (18 mph).
 - The brake system overheats.
- In the following situations, the indicator flashes to alert the driver, but the system will operate:
 - The shift lever is in N. (vehicles with automatic transmission)
 - The clutch pedal is depressed. (vehicles with manual transmission)
 - The “DAC” switch is turned off while the system is operating.
The system will gradually cease operation. The indicator will flash during operation, and then go off when the system is fully off.

■ When the downhill assist control system is operated continuously

This may cause the brake actuator to overheat. In this case, the downhill assist control system will stop operating, a buzzer will sound and the downhill assist control system indicator will start flashing, and “TRC turned off” will be shown on the multi-information display. Refrain from using the system until the downhill assist control system indicator stays on and the message goes off. (The vehicle can be driven normally during this time.)

■ Sounds and vibrations caused by the downhill assist control system

- A sound may be heard from the engine compartment when the engine is started or just after the vehicle begins to move. This sound does not indicate that a malfunction has occurred in downhill assist control system.
- Either of the following conditions may occur when the downhill assist control system is operating. None of these are indicators that a malfunction has occurred.
 - Vibrations may be felt through the vehicle body and steering.
 - A motor sound may be heard after the vehicle comes to a stop.

■ System malfunction

In the following cases, have your vehicle checked by any authorized Toyota retailer or Toyota authorized repairer, or any reliable repairer.

- The downhill assist control system indicator does not come on when the engine switch is turned to the “ON” position (vehicles without smart entry & start system) or IGNITION ON mode (vehicles with smart entry & start system).
- The downhill assist control system indicator does not come on when the “DAC” switch is pressed.
- The slip indicator comes on.

**WARNING****■ When using downhill assist control system**

- Do not rely overmuch on the downhill assist control system. This function does not extend the vehicle’s performance limitations. Always thoroughly check the road conditions, and drive safely.
- Vehicles with manual transmission: Drive in a low gear. Driving in a high gear when using downhill assist control system may cause the engine to stall, which may lose the brake effectiveness and lock the tires, resulting in an accident.
- Vehicles with manual transmission: On a steep slope, use the engine braking efficiently. If the vehicle is driven in N or with the clutch pedal depressed on a steep slope, the load on the brake increases and controlling the vehicle speed may be impossible, resulting in an accident.

■ The system may not operate on the following surfaces, which may lead to an accident causing death or serious injury



- Slippery surfaces such as wet or muddy roads
- Icy surface
- Unpaved roads

AUTO LSD*

The AUTO LSD system aids traction by using the traction control system to control engine performance and braking when one of the drive wheels begins to spin. The system should be used only when one of the drive wheels spinning occurs in a ditch or rough surface.

System operation

The system can be used on Pre Runner and in 2WD mode on 4WD models.

To turn the AUTO LSD system on, quickly press and release . The "AUTO LSD" indicator light and VSC OFF indicator light will come on. Press  again to turn the system off.

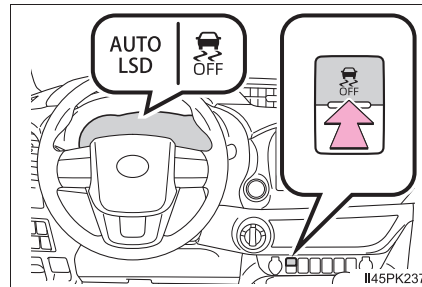

4

Driving

When the AUTO LSD system is operating

If the drive wheels spin, the slip indicator flashes to indicate that the AUTO LSD system has controlled the spinning of the drive wheels.

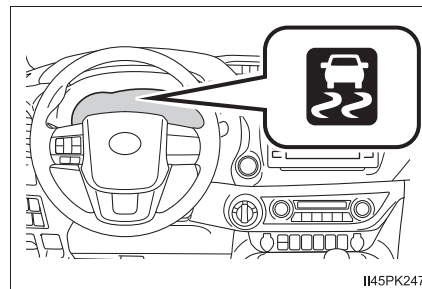

*: If equipped

■ If the engine is turned off and restarted

The AUTO LSD system and the indicators are automatically turned off.

■ Reactivation of the VSC system linked to vehicle speed

When the AUTO LSD system is turned on, the VSC and TRC systems will turn on automatically if vehicle speed increase.

■ If the brake system overheats

The system will cease operation and a buzzer will alert the driver. At this time, the "AUTO LSD" indicator will flash and "TRC turned off" will be shown on the multi-information display. Stop the vehicle in a safe place. (There is no problem with continuing normal driving.) The system will be automatically restored after a short time.

**WARNING****■ To avoid an accident**

Failure to do so, a much greater steering effort and more careful cornering control will be required.

- Do not use the AUTO LSD system in conditions other than when one of the drive wheels spinning occurs in a ditch or rough surface.
- Do not drive with the AUTO LSD system continuously turned on.

**NOTICE****■ Activating while driving**

Do not activate the AUTO LSD system if the wheel is slipping. Stop the slipping or spinning before activating.

DPF (Diesel Particulate Filter) system*

When the deposit collected by the filter reaches a predetermined amount, it is automatically regenerated.

⚠ WARNING

■ During regeneration

Observe the following precautions.

Failure to do so may result in serious injury such as burns caused by the hot exhaust pipe and exhaust gases, or may cause a fire.

- Do not stop the vehicle where flammable materials, such as dry grass, are near the exhaust pipe.

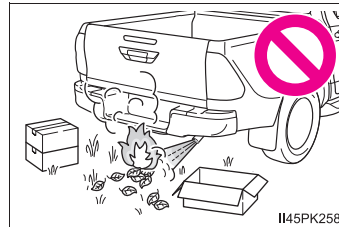

- Make sure that there are no people near the exhaust pipe.

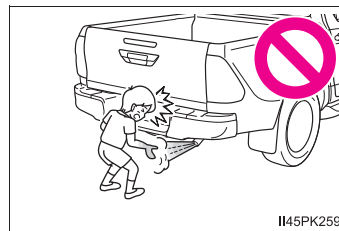

- Do not carry out regeneration when the vehicle is in an enclosed area, such as a garage.
- Do not touch the exhaust pipe and exhaust gases during regeneration.

⚠ NOTICE

■ To prevent the DPF system from failing

- Do not drive for long periods of time while the DPF system warning message "DPF full Visit your dealer" appears on the multi-information display and a buzzer sounds (malfunction indicator lamp comes on)
- Do not use fuel other than the specified type
- Do not use engine oil other than the recommended type
- Do not modify the exhaust pipe

*: If equipped

◆ Regeneration

- During normal driving, the filter is automatically regenerated every several hundred kilometers*. During regeneration, the DPF system warning message “DPF regeneration in progress” is displayed on the multi-information display.
- When the amount of accumulated deposit reaches a certain level, regeneration can be performed. (→P. 371)

*: Differs in accordance with weather, driving conditions, etc.

◆ System characteristics

The DPF system has the following characteristics:

- Idle speed increases during regeneration
- The smell of the exhaust gas differs from that of a conventional diesel vehicle
- White smoke may be emitted from the exhaust pipe during regeneration. However, this does not indicate a malfunction.

DPF deposition status

The amount of accumulated deposit in the DPF system can be confirmed on the multi-information display.

The DPF deposition status appears when the DPF system switch is pressed or the warning message is displayed. Use the displayed DPF deposition as a reference.

- ① Low
- ② Full

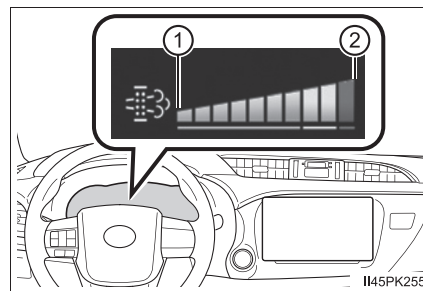

DPF system failure warning

- If the DPF system warning message “DPF full See owner’s manual” appears on the multi-information display, follow the procedure below to regenerate.
- ▶ When regenerating the filter during driving the vehicle

To regenerate the filter, the following driving methods are recommended.*1

- By driving continuously (for example, at around 60 km/h [37 mph] for 20 to 30 minutes).
- By avoiding short trips, or by driving continuously (leaving the engine running for long periods of time).

Check the engine is warmed up before driving the vehicle to regenerate the filter. If the engine is cold, warm up the engine by driving the vehicle downshifting to increase the engine speed.*2

The warning message will disappear on the multi-information display when regeneration is complete. However, depending on the driving condition such as heavy traffic, the amount of accumulated deposit increases and the warning message may not disappear on the multi-information display. If the warning message does not disappear on the multi-information display after driving, press the DPF system switch to manually regenerate the filter.

Regeneration during driving cannot be performed when the vehicle is higher than 4000 m (13124 ft.) above sea level.

*1: When driving, pay sufficient attention to weather, road conditions, terrain and traffic conditions, and drive according to traffic laws.

*2: Depending on the situation, it may be necessary to downshift until the engine speed is increased to 3000 rpm. If the engine coolant temperature or exhaust gas temperature is low, it may take a long time to regenerate, or regeneration may be impossible.

► When regenerating the filter by pressing the DPF system switch

- 1 Stop the vehicle in a safe place.
- 2 Shift the shift lever to P (automatic transmission) or N (manual transmission), and firmly set the parking brake.

Do not stop the engine.

Also, make sure that there are no flammable materials near the exhaust pipe. (→P. 369)

Check the engine is warmed up. If the engine is cold, warm up the engine by depressing the accelerator pedal.*1

- 3 Press the DPF system switch.

The DPF system warning message shown in the illustration appears on the multi-information display, and the idling engine speed will increase.

Regeneration will take around 15 - 40 minutes to complete.*2

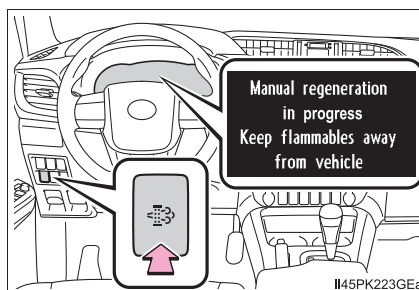

When the DPF system warning message disappears on the multi-information display, the idling engine speed will have finished returning to normal.

The DPF system switch may not operate when the vehicle is higher than 4000 m (13123 ft.) above sea level.

*1: Depending on the situation, it may be necessary to depress the accelerator pedal until the engine speed is increased to 3000 rpm. If the engine coolant temperature or exhaust gas temperature is low, it may take a long time to regenerate, or regeneration may be impossible.

*2: Time required for regeneration differs in accordance with the outside temperature. Also, if the engine speed is still approximately 2000 rpm 10 minutes after pressing the DPF system switch, the exhaust gas temperature may be low. In this case, depress the accelerator pedal to run the engine at approximately 3000 rpm for a while.

When depressing the accelerator pedal, regeneration will be stopped. In this case, restart regeneration.

- If the “DPF full Manual regeneration required See owner’s manual” appears on the multi-information display, press the DPF system switch to regenerate the filter. (→P. 371)
- If the DPF system warning message “DPF full Visit your dealer” appears on the multi-information display and a buzzer sounds (malfunction indicator lamp comes on), have the vehicle inspected by any authorized Toyota retailer or Toyota authorized repairer, or any reliable repairer immediately.

■ Regeneration with the DPF system switch

- After pressing the DPF system switch, depressing the accelerator pedal or clutch pedal (manual transmission) will stop regeneration. If regeneration has been stopped, restart regeneration as soon as possible.
- After regeneration is finished, race the engine several time to clean the exhaust system.

■ DPF system warning

Under the following driving conditions, the DPF system warning message may be displayed on the multi-information display earlier than normal.*

- When only driving at low speeds (for example 20 km/h [12 mph] or below).
- If the engine is turned on and off frequently (if the engine is not left running for more than 10 minutes at a time).

*: Differs in accordance with weather, driving conditions, etc.

NOTICE

■ If the malfunction indicator lamp comes on (warning buzzer)

The malfunction indicator lamp comes on if you continue driving while the DPF system warning message appears on the multi-information display. In this event, damage may be caused to the vehicle or an accident may occur. Have the vehicle inspected by any authorized Toyota retailer or Toyota authorized repairer, or any reliable repairer immediately.

Winter driving tips

Carry out the necessary preparations and inspections before driving the vehicle in winter. Always drive the vehicle in a manner appropriate to the prevailing weather conditions.

Preparation for winter

- Use fluids that are appropriate to the prevailing outside temperatures.
 - Engine oil
 - Engine coolant
 - Washer fluid
- Have a service technician inspect the condition of the battery.
- Have the vehicle fitted with four snow tires or purchase a set of tire chains for the rear tires.

Ensure that all tires are the same size and brand, and that chains match the size of the tires.

Before driving the vehicle

Perform the following according to the driving conditions:

- Do not try to forcibly open a window or move a wiper that is frozen. Pour warm water over the frozen area to melt the ice. Wipe away the water immediately to prevent it from freezing.
- To ensure proper operation of the climate control system fan, remove any snow that has accumulated on the air inlet vents in front of the windshield.
- Check for and remove any excess ice or snow that may have accumulated on the exterior lights, vehicle's roof, chassis, around the tires or on the brakes.
- Remove any snow or mud from the bottom of your shoes before getting in the vehicle.

When driving the vehicle

Accelerate the vehicle slowly, keep a safe distance between you and the vehicle ahead, and drive at a reduced speed suitable to road conditions.

When parking the vehicle (in the winter time or in the cold latitudes)

- Park the vehicle and move the shift lever to P (automatic transmission) or 1 or R (manual transmission) without setting the parking brake. The parking brake may freeze up, preventing it from being released. If the vehicle is parked without setting the parking brake, make sure to block the wheels.

Failure to do so may be dangerous because it may cause the vehicle to move unexpectedly, possibly leading to an accident.

- Vehicles with automatic transmission: If the vehicle is parked without setting the parking brake, confirm that the shift lever cannot be moved out of P*.

*: The shift lever will be locked if it is attempted to be shifted from P to any other position without depressing the brake pedal. If the shift lever can be shifted from P, there may be a problem with the shift lock system. Have the vehicle inspected by any authorized Toyota retailer or Toyota authorized repairer, or any reliable repairer.

Selecting tire chains

Use the correct tire chain size when mounting the snow chains. Chain size is regulated for each tire size.

Regulations on the use of tire chains

Regulations regarding the use of tire chains vary depending on location and type of road. Always check local regulations before installing chains.

■ Tire chain installation

Observe the following precautions when installing and removing chains:

- Install and remove tire chains in a safe location.
- Install tire chains on the rear tires. Do not install tire chains on the front tires.
- Install tire chains on rear tires as tightly as possible. Retighten chains after driving 0.5 - 1.0 km (1/4 - 1/2 mile).
- Install tire chains following the instructions provided with the tire chains.

⚠ WARNING**■ Driving with snow tires**

Observe the following precautions to reduce the risk of accidents. Failing to do so may result in a loss of vehicle control and cause death or serious injury.

- Use tires of the specified size.
- Maintain the recommended level of air pressure.
- Do not drive at speeds in excess of the speed limit or the speed limit specified for the snow tires being used.
- Use snow tires on all, not just some wheels.

■ Driving with tire chains

Observe the following precautions to reduce the risk of accidents. Failing to do so may result in the vehicle being unable to be driven safely, and may cause death or serious injury.

- Do not drive in excess of the speed limit specified for the tire chains being used, or 50 km/h (30 mph), whichever is lower.
- Avoid driving on bumpy road surfaces or over potholes.
- Avoid sudden acceleration, abrupt steering, sudden braking and shifting operations that cause sudden engine braking.
- Slow down sufficiently before entering a curve to ensure that vehicle control is maintained.
- Do not use LDA (Lane Departure Alert with Yaw Assist Function) system. (if equipped)

Audio system

5

- 5-1. Basic Operations**
 - Audio system types378
 - Using the steering wheel audio switches379
 - AUX port/USB port381
- 5-2. Using the audio system**
 - Optimal use of the audio system382
- 5-3. Using the radio**
 - Radio operation384
- 5-4. Playing an audio CD and MP3/WMA/AAC discs**
 - CD player operation.....387
- 5-5. Using an external device**
 - Listening to an iPod395
 - Listening USB memory device401
 - Using the AUX port.....407
- 5-6. Using Bluetooth® devices**
 - Bluetooth® audio/phone.....408
 - Using the steering wheel switches413
 - Registering a Bluetooth® device414
- 5-7. “SETUP” menu**
 - Using the “SETUP” menu (“Bluetooth” menu).....415
 - Using the “SETUP” menu (“TEL” menu)419
- 5-8. Bluetooth® Audio**
 - Operating a Bluetooth® enabled portable player.....424
- 5-9. Bluetooth® Phone**
 - Making a phone call.....426
 - When receiving a phone call427
 - Speaking on the phone.....428
- 5-10. Bluetooth®**
 - Bluetooth®430

Audio system types *

- ▶ Vehicles with navigation system or multimedia system

Refer to the “Navigation and multimedia system Owner’s manual” or “Multimedia Owner’s Manual”

- ▶ Vehicles without navigation system or multimedia system

CD player with AM/FM radio

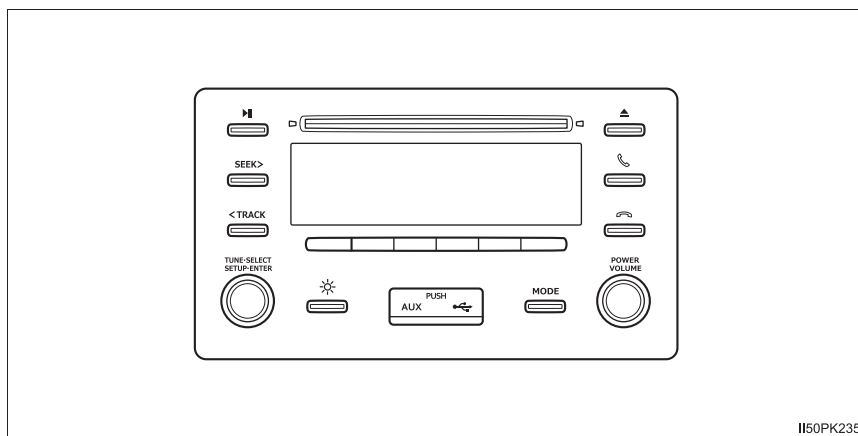

■ Using cellular phones

Interference may be heard through the audio system’s speakers if a cellular phone is being used inside or close to the vehicle while the audio system is operating.

■ Trademarks and registered trademarks

The company names and product names regarding the audio system are the trademarks or registered trademarks of their respective companies.

⚠ NOTICE

■ To prevent battery discharge

Do not leave the audio system on longer than necessary with the engine stopped.

■ To avoid damaging the audio system

Be careful not to spill drinks or other fluids over the audio system.

*: If equipped

Using the steering wheel audio switches

Some audio features can be controlled using the switches on the steering wheel.

Operation may differ depending on the type of audio system or navigation system. For details, refer to the manual provided with the audio system or navigation system.

Vehicles without audio system: →P. 470

① Volume

- Press: Increases/decreases volume
- Press and hold: Continuously increases/decreases volume

② Radio mode:

- Press: Select a radio station saved in preset stations
- Press and hold until you hear a beep: Seek up/down

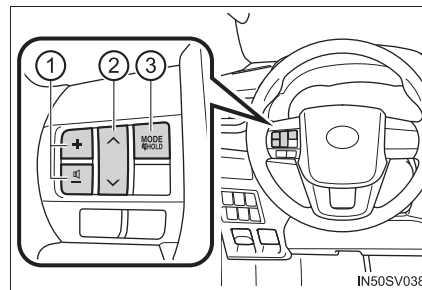

CD, MP3/WMA/AAC disc, iPod, USB or Bluetooth® audio mode:

- Press: Select a track/file
- Press and hold until you hear a beep: Select a folder or album

③ “MODE” switch

- Press: Turn the power on, select an audio source
- Press and hold until you hear a beep:

Radio or AUX mode: Mute

CD, MP3/WMA/AAC disc, iPod, USB or Bluetooth® audio mode:
Pause the current operation.

To cancel the mute or pause, press and hold the switch again.

■ Changing the audio source

Press the “MODE” switch when the audio system is turned on. The audio source changes as follows each time the button is pressed. If a mode cannot be used, it will be skipped.

AM→FM→CD mode→iPod or USB memory→Bluetooth® audio→AUX

 WARNING

■ **To reduce the risk of an accident**

Exercise care when operating the audio switches on the steering wheel.

AUX port/USB port

Connect an iPod, USB memory device or portable audio player to the AUX port/USB port as indicated below. Press the “MODE” button to select “iPod”, “USB” or “AUX”.

Connecting using the AUX port/USB port

■ iPod

Open the cover and connect an iPod using an iPod cable.

Turn on the power of the iPod if it is not turned on.

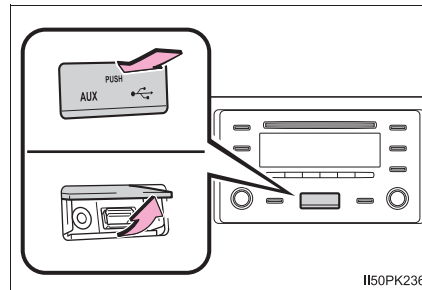

■ USB memory

Open the cover and connect the USB memory device.

Turn on the power of the USB memory device if it is not turned on.

■ Portable audio player

Open the cover and connect the portable audio player using an AUX cable.

Turn on the power of the portable audio player if it is not turned on.

■ AUX port

The AUX port only supports audio input.

⚠ WARNING

■ While driving

Do not connect a device or operate the device controls.

Optimal use of the audio system

The sound quality, volume balance and ASL settings can be adjusted and the day mode can be selected.

① “TUNE•SELECT” knob

Press: Displays the “SETUP” menu/Selects the mode

Turn: Changes the following settings

- “Sound Setting”
→P. 382
- “RADIO”
→P. 384
- “Bluetooth”
→P. 415
- “TEL”
→P. 419

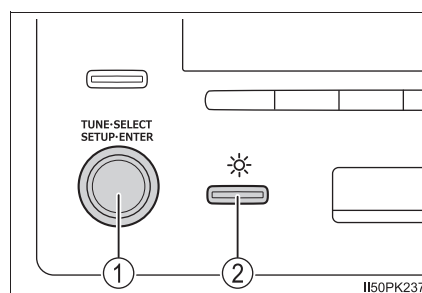

② Day mode button

Day mode

When the headlights are turned on, the screen dims.

However, the screen can be switched to day mode (full brightness) by selecting day mode.

The screen will stay in day mode when the headlights are turned on until day mode is selected again.

Using the audio control function

■ Changing sound quality modes

- 1 Press the “TUNE•SELECT” knob.
- 2 Turn the knob to select “Sound Setting”.
- 3 Press the knob.
- 4 Turn the knob as corresponds to the desired mode.
“BASS”, “TREBLE”, “FADER”, “BALANCE”, or “ASL” can be selected.
- 5 Press the knob.

■ Adjusting sound quality

Turning the “TUNE•SELECT” knob adjusts the level.

Sound quality mode	Mode displayed	Level	Turn to the left	Turn to the right
Bass*1	“BASS”	-5 to 5	Low	High
Treble*1	“TREBLE”	-5 to 5		
Front/rear volume balance*2	“FADER”	R7 to F7	Shifts to rear	Shifts to front
Left/right volume balance	“BALANCE”	L7 to R7	Shifts to left	Shifts to right

*1: The sound quality level is adjusted individually in each audio mode.

*2: For the vehicles with 2 speakers system, the sound will be mute if the sound balance is adjusted to the maximum level at the rear.

Press the knob or  (BACK) to return to the sound setting menu.

■ Adjusting the Automatic Sound Levelizer (ASL)

When ASL is selected, turn the “TUNE•SELECT” knob to change the amount of ASL.

“LOW”, “MID”, “HIGH”, or “OFF” can be selected.

ASL automatically adjusts the volume and tone quality according to vehicle speed.

Press the knob or  (BACK) to return to the sound setting menu.

Radio operation

Press the “MODE” button until “AM” or “FM” is displayed.

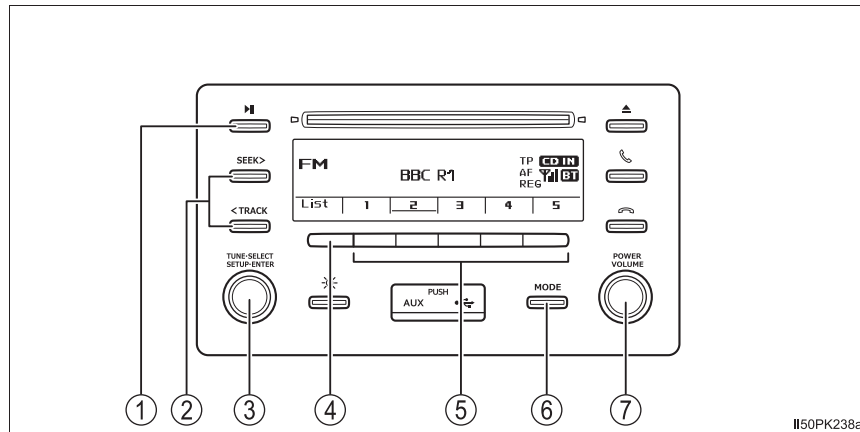

- ① Mute
- ② Seeking the frequency
- ③ “TUNE•SELECT” knob
Press: AF/region code/TA mode setup
Turn: Adjusting the frequency/selecting the station list (FM mode only)
- ④ Displaying the station list (FM mode only)
- ⑤ Station selectors
- ⑥ AM/FM mode button
- ⑦ “POWER VOLUME” knob
Press: Turning the audio system on or off
Turn: Adjusting the volume

Setting station presets

- 1 Search for the desired stations by turning the “TUNE•SELECT” knob or pressing the “SEEK >” or “< TRACK” button.
- 2 Press and hold one of the station selectors  to be set until you hear a beep.

Using the station list

■ Updating the station list

- 1 Press \square (LIST)

The station list will be displayed.

- 2 Press \square (UPDATE) to update the list.

“Updating” is displayed while the searching is in process, beep will be heard after the searching and then available stations will be listed on the display.

To cancel the updating process, press \square (BACK).

■ Selecting a station from the station list

- 1 Press \square (LIST).

The station list will be displayed.

- 2 Turn the “TUNE•SELECT” knob to select a station.

To return to the previous display, press \square (BACK).

- 3 Press the knob to tune in the station.

RDS (Radio Data System)

This feature allows your radio to receive station.

■ Listening to stations of the same network

- 1 Press the “TUNE•SELECT” knob.

- 2 Turn the knob to “RADIO” and press the knob.

- 3 Turn the knob as corresponds to the desired mode: “FM AF” or “Region code”.

- 4 Press the knob to select “ON” or “OFF”.

FM AF ON mode:

The station among those of the same network with strong reception is selected.

Region code ON mode:

The station among those of the same network with strong reception and broadcasting the same program is selected.

■ Traffic information

- 1 Press the “TUNE•SELECT” knob.
- 2 Turn the knob to “RADIO” and press the knob.
- 3 Turn the knob to “FM TA” mode.
- 4 Press the knob to select “ON” or “OFF”.

TP mode:

The system automatically switches to traffic information when a broadcast with a traffic information signal is received.

The station returns to the previous one when the traffic information ends.

TA mode:

The system automatically switches to traffic information when a broadcast with a traffic information signal is received. In FM modes, the system will be mute unless traffic information is being broadcast.

The audio system returns to the previous mode when the traffic information ends.

■ EON (Enhanced Other Network) system (for traffic announcement function)

If the RDS station (with EON data) you are listening to is not broadcasting a traffic information program and the audio system is in the TA (traffic announcement) mode, the radio will be switched automatically to a station broadcasting a traffic information program in the EON AF list when traffic information begins.

■ Reception sensitivity

- Maintaining perfect radio reception at all times is difficult due to the continually changing position of the antenna, differences in signal strength and surrounding objects, such as trains, transmitters, etc.
- The radio antenna is mounted on the roof. The antenna can be removed from the base by turning it.

 **NOTICE****■ To prevent damage, remove the antenna in the following cases**

- The antenna will touch the ceiling of a garage.
- A cover will be put on the roof.
- When driving through an automatic car wash.
- Any other cases where there is a risk of touching surrounding parts.

CD player operation

Insert a disc or press the “MODE” button (CD is already loaded) to begin listening to a CD.

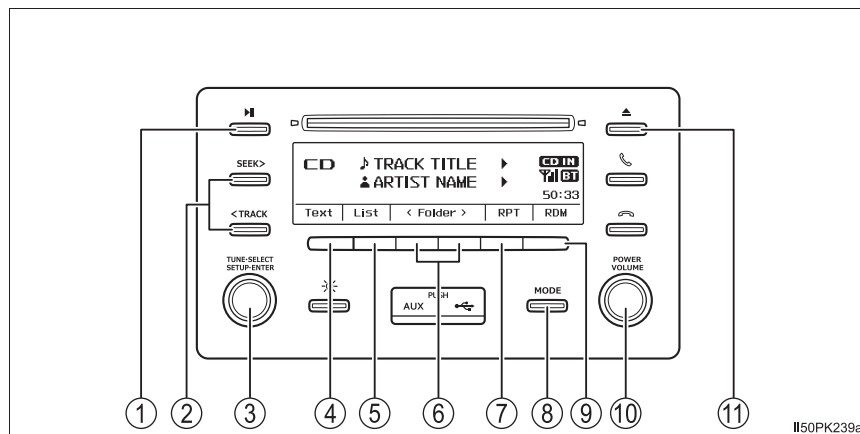

- ① Pause/playback
- ② Selecting a track, fast-forwarding or rewinding
- ③ “TUNE•SELECT” knob
Selecting a track/file
- ④ Displaying text message
- ⑤ Displaying track/folder list
- ⑥ Selecting a folder (MP3/WMA/AAC discs only)
- ⑦ Repeat play
- ⑧ Changing the audio source/playback
- ⑨ Random play or back button
- ⑩ “POWER VOLUME” knob
Press: Turning the audio system on or off
Turn: Adjusting the volume
- ⑪ Disc eject

Loading a CD or MP3/WMA/AAC disc

Insert a disc.

Ejecting a CD or MP3/WMA/AAC disc

Press the disc eject button and remove the disc.

Using the CD player

■ Selecting a track

Turn the “TUNE•SELECT” knob or press the “SEEK >” or “< TRACK” button to move up or down until the desired track number is displayed.

■ Selecting a track from a track list

1 Press  (LIST).

The track list will be displayed.

2 Turn and press the “TUNE•SELECT” knob to select a track.

To return to the previous display, press  (BACK).

■ Fast-forwarding and rewinding tracks

Press and hold the “SEEK >” or “< TRACK” button until you hear a beep.

■ Random play

Press  (RDM).

To cancel, press  (RDM) again.

■ Repeat play

Press  (RPT).

To cancel, press  (RPT) again.

■ Switching the display

Press  (TEXT) to display or hide the CD title.

If there are continuing texts,  is displayed.

Press and hold  (TEXT) until you hear a beep to display the remaining texts.

Playing back MP3/WMA/AAC disc**■ Selecting folders one at a time**

Press \square (<FOLDER) or \square (FOLDER>) to select the desired folder.

■ Selecting a folder and file from folder list

1 Press \square (LIST).

The folder list will be displayed.

2 Turn and press the knob to select a folder and a file.

To return to the previous display, press \square (BACK).

■ Returning to the first folder

Press and hold \square (<FOLDER) until you hear a beep.

■ Selecting a file

Turn the "TUNE•SELECT" knob or press the "SEEK >" or "< TRACK" button to move up or down to select the desired file.

■ Fast-forwarding and rewinding files

Press and hold the "SEEK >" or "< TRACK" button until you hear a beep.

■ Random play

Pressing \square (RDM) changes modes in the following order: Folder random→Disc random→Off

■ Repeat play

Pressing \square (RPT) changes modes in the following order: File repeat→Folder repeat*→Off

*: Available except when "RDM" (random play) is selected

■ Switching the display

Press \square (TEXT) to display or hide the album title.

If there are continuing texts, \blacktriangleright is displayed.

Press and hold \square (TEXT) until you hear a beep to display the remaining texts.

■ Display

Depending on the contents recorded, the characters may not be displayed properly or may not be displayed at all.

■ Error messages

If an error message is displayed, refer to the following table and take the appropriate measures. If the problem is not rectified, take the vehicle to any authorized Toyota retailer or Toyota authorized repairer, or any reliable repairer.

Message	Cause/Correction procedures
"CD CHECK"	The disc may be dirty, damaged or inserted upside-down. Clean the disc or insert it correctly.
"ERROR 3"	There is a trouble inside the system. Eject the disc.
"ERROR 4"	An over current error has occurred. Turn the engine switch off.
"WAIT"	Operation has stopped due to a high temperature inside the player. Wait for a while and then press the "MODE" button. If the CD still cannot be played back, contact any authorized Toyota retailer or Toyota authorized repairer, or any reliable repairer.
"NO SUPPORT"	This indicates that the MP3, WMA or AAC file is not included in the CD.

■ Discs that can be used

Discs with the marks shown below can be used.

Playback may not be possible depending on recording format or disc features, or due to scratches, dirt or deterioration.



CDs with copy-protect features may not play correctly.

■ CD player protection feature

To protect the internal components, playback is automatically stopped when a problem is detected while the CD player is being used.

■ If a CD is left inside the CD player or in the ejected position for extended periods

The CD may be damaged and may not play properly.

■ Lens cleaners

Do not use lens cleaners. Doing so may damage the CD player.

■ MP3, WMA and AAC files

MP3 (MPEG Audio LAYER3) is a standard audio compression format.

Files can be compressed to approximately 1/10 of their original size by using MP3 compression.

WMA (Windows Media Audio) is a Microsoft audio compression format.

This format compresses audio data to a size smaller than that of the MP3 format.

AAC is short for Advanced Audio Coding and refers to an audio compression technology standard used with MPEG2 and MPEG4.

There is a limit to the MP3, WMA and AAC file standards and to the media/formats recorded by them that can be used.

- MP3 file compatibility
 - Compatible standards
MP3 (MPEG1 LAYER3, MPEG2 LSF LAYER3)
 - Compatible sampling frequencies
MPEG1 LAYER3: 32, 44.1, 48 (kHz)
MPEG2 LSF LAYER3: 16, 22.05, 24 (kHz)
 - Compatible bit rates (compatible with VBR)
MPEG1 LAYER3: 32—320 (kbps)
MPEG2 LSF LAYER3: 8—160 (kbps)
 - Compatible channel modes: stereo, joint stereo, dual channel and monaural
- WMA file compatibility
 - Compatible standards
WMA Ver. 7, 8, 9 (9.1/9.2)
 - Compatible sampling frequencies
32, 44.1, 48 (kHz)
 - Compatible bit rates (only compatible with 2-channel playback)
Ver. 7, 8: CBR 48-192 (kbps)
Ver. 9 (9.1/9.2): CBR 48-320 (kbps)
- AAC file compatibility
 - Compatible standards
MPEG4/AAC-LC
 - Compatible sampling frequencies
11.025/12/16/22.05/24/32/44.1/48 (kHz)
 - Compatible bit rates (compatible with VBR)
8-320 (kbps)
 - Compatible channel modes
1ch, 2ch (Dual channel is not supported)

- **Compatible media**

Media that can be used for MP3, WMA and AAC playback are CD-ROMs, CD-Rs and CD-RWs.

Playback in some instances may not be possible, depending on the status of the CD-ROM, CD-R or CD-RW. Playback may not be possible or the audio may jump if the disc is scratched or marked with fingerprints.

- **Compatible disc formats**

The following disc formats can be used.

- Disc formats:
 - CD-ROM Mode 1 and Mode 2
 - CD-ROM XA Mode 2, Form 1 and Form 2
- File formats:
 - ISO9660 Level 1, Level 2, (Romeo, Joliet)
 - UDF (2.01)

MP3, WMA and AAC files written in any format other than those listed above may not play correctly, and their file names and folder names may not be displayed correctly.

Items related to standards and limitations are as follows.

- Maximum directory hierarchy: 8 levels (including the root)
- Maximum length of folder names/file names: 32 characters
- Maximum number of folders: 192 (including the root)
- Maximum number of files per disc: 255

- **File names**

The only files that can be recognized as MP3/WMA/AAC and played are those with the extension .mp3, .wma or .m4a.

- **Multi-sessions**

As the audio system is compatible with multi-sessions, it is possible to play discs that contain MP3, WMA and AAC files. However, only the first session can be played.

- **ID3, WMA and AAC tags**

ID3 tags can be added to MP3 files, making it possible to record the track title and artist name, etc.

The system is compatible with ID3 Ver. 1.0, 1.1, and Ver. 2.2, 2.3 ID3 tags. (The number of characters is based on ID3 Ver. 1.0 and 1.1.)

WMA tags can be added to WMA files, making it possible to record the track title, artist and album name in the same way as with ID3 tags.

AAC tags can be added to AAC files, making it possible to record the track title, artist and album name in the same way as with ID3 tags.

- MP3, WMA and AAC playback

When a disc containing MP3, WMA or AAC files is inserted, all files on the disc are first checked. Once the file check is finished, the first MP3, WMA or AAC file is played. To make the file check finish more quickly, we recommend you do not write in any files other than MP3, WMA or AAC files or create any unnecessary folders.

If the discs contain a mixture of music data and MP3, WMA or AAC format data, only music data can be played.

- Extensions

If the file extensions .mp3, .wma and .m4a are used for files other than MP3, WMA and AAC files, they will be mistakenly recognized and played as MP3, WMA and AAC files. This may result in large amounts of interference and damage to the speakers.

- Playback

- To play MP3 file with steady sound quality, we recommend a fixed bit rate of 128 kbps and a sampling frequency of 44.1 kHz.
- CD-ROM, CD-R or CD-RW playback may not be possible in some instances, depending on the characteristics of the disc.
- There is a wide variety of freeware and other encoding software for MP3, WMA and AAC files on the market, and depending on the status of the encoding and the file format, poor sound quality or noise at the start of playback may result. In some cases, playback may not be possible at all.
- When files other than MP3, WMA or AAC files are recorded on a disc, it may take more time to recognize the disc and in some cases, playback may not be possible at all.
- Microsoft, Windows, and Windows Media are the registered trademarks of Microsoft Corporation in the U.S.A. and other countries.
- This product is protected by certain intellectual property rights of Microsoft.

Use or distribution of such technology outside of this product is prohibited without a license from Microsoft.

 NOTICE**■ Discs and adapters that cannot be used**

Do not use the following types of discs.

Also, do not use 8 cm (3 in.) disc adapters, DualDiscs or printable discs.

Doing so may damage the player and/or the disc insert/eject function.

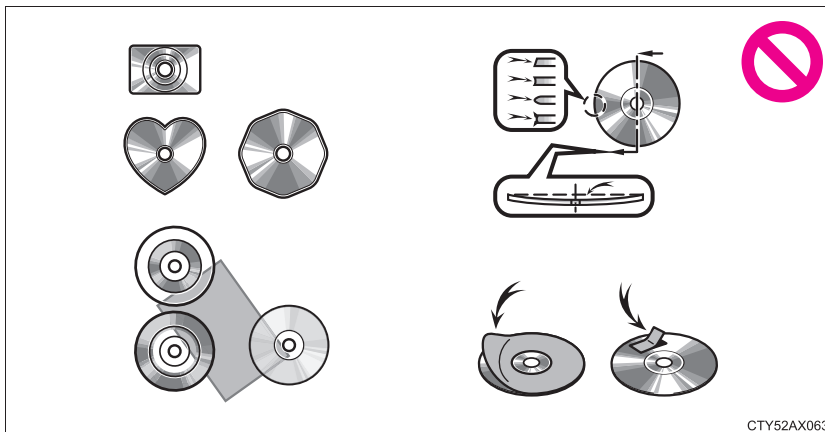

- Discs that have a diameter that is not 12 cm (4.7 in.)
- Low-quality and deformed discs
- Discs with a transparent or translucent recording area
- Discs that have tape, stickers or CD-R labels attached to them, or that have had the label peeled off

■ Player precautions

Failure to follow the precautions below may result in serious damage to the discs or the player itself.

- Do not insert anything other than discs into the disc slot.
- Do not apply oil to the player.
- Store discs away from direct sunlight.
- Never try to disassemble any part of the player.

Listening to an iPod

Connecting an iPod enables you to enjoy music from the vehicle speakers. Press the “MODE” button until “iPod” is displayed.

Connecting an iPod

→P. 381

Control panel

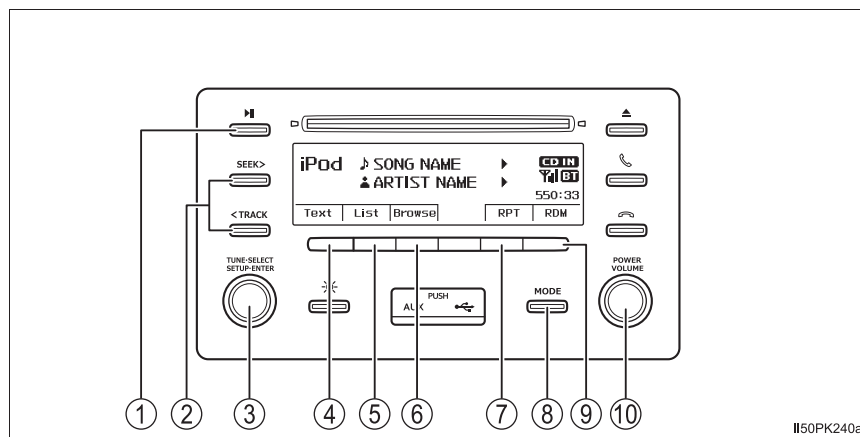

- ① Pause/playback
- ② Selecting a song, fast-forwarding or rewinding
- ③ “TUNE•SELECT” knob
Press: Displaying list of the current folder
Turn: Selecting an iPod menu/song
- ④ Displaying text message
- ⑤ Displaying current play list
- ⑥ Displaying play mode
- ⑦ Repeat play
- ⑧ Changing the audio source/playback
- ⑨ Random play or back button
- ⑩ “POWER VOLUME” knob
Press: Turning the audio system on or off
Turn: Adjusting the volume

Selecting a play mode

- 1 Press \square (BROWSE) to select iPod play mode.
- 2 Turning the “TUNE•SELECT” knob clockwise changes the play mode in the following order: “Playlists” → “Artists” → “Albums” → “Songs” → “Genres” → “Composers” → “Radio” → “Audiobooks” → “Podcasts” → “iTunes U”
- 3 Press the knob to select the desired play mode.

■ Play mode list

Play mode	First selection	Second selection	Third selection	Fourth selection
“Playlists”	Playlists select	Songs select	-	-
“Artists”	Artists select	Albums select	Songs select	-
“Albums”	Albums select	Songs select	-	-
“Songs”	Songs select	-	-	-
“Genres”	Genre select	Artists select	Albums select	Songs select
“Composers”	Composers select	Albums select	Songs select	-
“Radio”	Stations	-	-	-
“Audiobooks”	Audiobooks select	Chapter select	-	-
“Podcasts”	Programs	Episodes select	-	-
“iTunes U”	Courses	Episodes select	-	-

■ Selecting a list

- 1 Turn the “TUNE•SELECT” knob to display the first selection list.
- 2 Press the knob to select the desired item and display the second selection list.
- 3 Repeat the same procedure to select the desired item.

To return to the previous selection list, press \square (BACK).

Press \square (PLAY) to play the desired selection or press the knob when in the last hierarchy selection.

Selecting songs

Turn the “TUNE•SELECT” knob or press the “SEEK >” or “< TRACK” button to select the desired song.

Selecting a song from the song list

- 1 Press \square (LIST).
The song list will be displayed.
- 2 Turn the “TUNE•SELECT” knob to select a song.
- 3 Press the knob to play the song.

To return to the previous display, press \square (BACK).

Fast-forwarding and rewinding songs

Press and hold the “SEEK >” or “< TRACK” button until you hear a beep.

Repeat play

Pressing \square (RPT) changes modes in the following order: Track repeat → Album repeat* → Off.

*: Album repeat mode may not be available depending on the iPod devices you have.

Random play

Pressing \square (RDM) changes modes in the following order: Track random → Album random → Off.

Switching the display

Press the  (TEXT) to display or hide the album title.

If there are continuing texts,  is displayed.

Press and hold  (TEXT) until you hear a beep to display the remaining texts.

■ About iPod



- Use of the Made for Apple badge means that an accessory has been designed to connect specifically to the Apple product(s) identified in the badge, and has been certified by the developer to meet Apple performance standards.
- Apple is not responsible for the operation of this device or its compliance with safety and regulatory standards. Please note that the use of this accessory with an Apple product may affect wireless performance.
- iPhone, iPod, iPod touch, and iPod nano are trademarks of Apple Inc., registered in the U.S. and other countries.

■ iPod functions

- When an iPod is connected and the audio source is changed to iPod mode, the iPod will resume play from the same point in which it was last used.
- Depending on the iPod that is connected to the system, certain functions may not be available. Disconnecting the device and reconnecting it once again may resolve some malfunctions.
- While connected to the system, the iPod cannot be operated with its own controls. It is necessary to use the controls of the vehicle's audio system instead.

■ iPod problems

To resolve most problems encountered when using your iPod, disconnect your iPod from the vehicle iPod connection and reset it.

For instructions on how to reset your iPod, refer to your iPod Owner's Manual.

■ Display

→P. 390

■ Error messages

If an error message is displayed, refer to the following table and take the appropriate measures. If the problem is not rectified, take the vehicle to any authorized Toyota retailer or Toyota authorized repairer, or any reliable repairer.

Message	Cause/Correction procedures
"iPod ERROR"	This indicates that the data in the iPod cannot be read.
"ERROR 3"	This indicates that the iPod may be malfunctioning.
"ERROR 4"	This indicates that an over current error has occurred.
"ERROR 5"	This indicates that an iPod communication error has occurred.
"ERROR 6"	This indicates that an authentication error has occurred.
"NO SONGS"	This indicates that there is no music data in the iPod.
"NO PLAYLISTS"	This indicates that some available songs are not found in a selected playlist.
"UPDATE YOUR iPod"	This indicates that the version of the iPod is not compatible. Upgrade your iPod software to the latest version.

Compatible models

The following devices can be used with this system.

Made for

- iPhone 7
- iPhone 7 Plus
- iPhone SE
- iPhone 6s
- iPhone 6s Plus
- iPhone 6
- iPhone 6 Plus
- iPhone 5s
- iPhone 5c
- iPhone 5
- iPhone 4s
- iPod touch (6th generation)
- iPod touch (5th generation)
- iPod nano (7th generation)

This system only supports audio playback.

Depending on differences between models or software versions etc., some models might be incompatible with this system.

 **WARNING****While driving**

Do not connect iPod or operate the controls. Doing so may cause an accident, resulting in death or serious injury.

 **NOTICE****To prevent damage to iPod**

- Do not leave iPod in the vehicle. The temperature inside the vehicle may become high, resulting in damage to the iPod.
- Do not push down or apply unnecessary pressure to the iPod while it is connected as this may damage the iPod or its terminal.
- Do not insert foreign objects into the port as this may damage the iPod or its terminal.

Listening USB memory device

Connecting a USB memory enables you to enjoy music from the vehicle speakers. Press the “MODE” button until “USB” is displayed.

Connecting a USB memory

→P. 381

Control panel

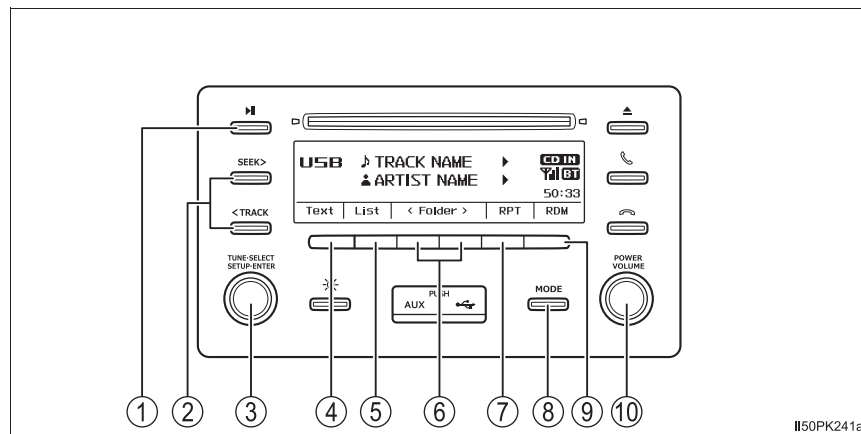

- ① Pause/playback
- ② Selecting a file, fast-forwarding or rewinding
- ③ “TUNE•SELECT” knob
Selecting a file
- ④ Displaying text message
- ⑤ Displaying folder list
- ⑥ Selecting a folder
- ⑦ Repeat play
- ⑧ Changing the audio source/playback
- ⑨ Random play or back button
- ⑩ “POWER VOLUME” knob
Press: Turning the audio system on or off
Turn: Adjusting the volume

Using a USB memory**■ Selecting folders one at a time**

Press \square (<FOLDER) or \square (FOLDER>) to select the desired folder.

■ Selecting a folder and file from folder list

1 Press \square (LIST).

The folder list will be displayed.

2 Turn and press the knob to select a folder and file.

To return to the previous display, press \square (BACK).

■ Returning to the first folder

Press and hold \square (<FOLDER) until you hear a beep.

■ Selecting a file

Turn the "TUNE•SELECT" knob or press the "SEEK >" or "< TRACK" button to move up or down to select the desired file.

■ Fast-forwarding and rewinding files

Press and hold the "SEEK >" or "< TRACK" button until you hear a beep.

■ Random play

Pressing \square (RDM) changes modes in the following order: Folder random→All folder random→Off

■ Repeat play

Pressing \square (RPT) changes modes in the following order: File repeat→Folder repeat*→Off

*: Available except when "RDM" (random play) is selected

■ Switching the display

Press \square (TEXT) to display or hide the album title.

If there are continuing texts, \blacktriangleright is displayed.

Press and hold \square (TEXT) until you hear a beep to display the remaining texts.

■ USB memory functions

- Depending on the USB memory that is connected to the system, the device itself may not be operable and certain functions may not be available. If the device is inoperable or a function is unavailable due to a malfunction (as opposed to a system specification), disconnecting the device and reconnecting it once again may resolve the problem.
- If the USB memory still does not begin operation after being disconnected and reconnected, format the memory.

■ Display

→P. 390

■ Error messages

If an error message is displayed, refer to the following table and take the appropriate measures. If the problem is not rectified, take the vehicle to any authorized Toyota retailer or Toyota authorized repairer, or any reliable repairer.

Message	Cause/Correction procedures
“USB ERROR”	This indicates that the data in the USB memory cannot be read or that the connected USB device is not supported.
“ERROR 3”	This indicates that the USB memory may be malfunctioning.
“ERROR 4”	This indicates that an over current error has occurred.
“ERROR 5”	This indicates that the USB memory communication error has occurred, has a version error, or that there is no response when USB memory is inserted (enumeration error).
“NO MUSIC”	This indicates that no MP3/WMA/AAC files are included on the USB memory device.
“Hubs are not supported”	This indicates that the hub connect error occurs.

■ USB memory**● Compatible devices**

USB memory that can be used for MP3, WMA and AAC playback

● Compatible device formats

The following device formats can be used:

- USB communication formats: USB2.0 FS (12mbps)
- File formats: FAT16/32 (Windows)
- Correspondence class: Mass storage class

MP3, WMA and AAC files written in any format other than those listed above may not play correctly, and their file names and folder names may not be displayed correctly.

Items related to standards and limitations are as follows:

- Maximum directory hierarchy: 8 levels (including the root)
- Maximum number of folders in a device: 3000 (including the root)
- Maximum number of files in a device: 9999
- Maximum number of files per folder: 255

● MP3, WMA and AAC files

MP3 (MPEG Audio LAYER3) is a standard audio compression format.

Files can be compressed to approximately 1/10 of their original size by using MP3 compression.

WMA (Windows Media Audio) is a Microsoft audio compression format.

This format compresses audio data to a size smaller than that of the MP3 format.

AAC is short for Advanced Audio Coding and refers to an audio compression technology standard used with MPEG2 and MPEG4.

There is a limit to the MP3, WMA and AAC file standards and to the media/formats recorded by them that can be used.

● MP3 file compatibility

- Compatible standards
MP3 (MPEG1 LAYER3, MPEG2 LSF LAYER3)
- Compatible sampling frequencies
MPEG1 LAYER3: 32, 44.1, 48 (kHz)
MPEG2 LSF LAYER3: 16, 22.05, 24 (kHz)
- Compatible bit rates (compatible with VBR)
MPEG1 LAYER3: 32-320 (kbps)
MPEG2 LSF LAYER3: 8-160 (kbps)
- Compatible channel modes: stereo, joint stereo, dual channel and monaural

- **WMA file compatibility**
 - Compatible standards
WMA Ver. 7, 8, 9 (9.1/9.2)
 - Compatible sampling frequencies
32, 44.1, 48 (kHz)
 - Compatible bit rates (only compatible with 2-channel playback)
Ver. 7, 8: CBR 48-192 (kbps)
Ver. 9 (9.1/9.2): CBR 48-320 (kbps)
- **AAC file compatibility**
 - Compatible standards
MPEG4/AAC-LC
 - Compatible sampling frequencies
11.025/12/16/22.05/24/32/44.1/48(kHz)
 - Compatible bit rates (compatible with VBR)
8-320(kbps)
 - Compatible channel modes
1ch, 2ch (Dual channel is not supported)
- **File names**

The only files that can be recognized as MP3/WMA/AAC and played are those with the extension .mp3, .wma or .m4a.
- **ID3, WMA and AAC tags**

ID3 tags can be added to MP3 files, making it possible to record the track title, artist name, etc.

The system is compatible with ID3 Ver. 1.0, 1.1, and Ver. 2.2, 2.3, ID3 tags. (The number of characters is based on ID3 Ver. 1.0 and 1.1.)

WMA tags can be added to WMA files, making it possible to record the track title, artist and album name in the same way as with ID3 tags.

AAC tags can be added to AAC files, making it possible to record the track title, artist and album name in the same way as with ID3 tags.
- **MP3, WMA and AAC playback**
 - When a device containing MP3, WMA or AAC files is connected, all files in the USB memory device are checked. Once the file check is finished, the first MP3, WMA or AAC file is played. To make the file check finish more quickly, we recommend that you do not include any files other than MP3, WMA or AAC files or create any unnecessary folders.
 - When the USB device is connected and the audio source is changed to USB memory mode, the USB device will start playing the first file in the first folder. If the same device is removed and reinserted (and the contents have not been changed), the USB memory will resume play from the same point in which it was last used.

- Extensions

If the file extensions .mp3, .wma and .m4a are used for files other than MP3, WMA and AAC files, they will be skipped (not played).

- Playback

- To play MP3 files with steady sound quality, we recommend a fixed bit rate of at least 128 kbps and a sampling frequency of 44.1 kHz.
- There is a wide variety of freeware and other encoding software for MP3, WMA and AAC files on the market, and depending on the status of the encoding and the file format, poor sound quality or noise at the start of playback may result. In some cases, playback may not be possible at all.
- Microsoft, Windows, and Windows Media are registered trademarks of Microsoft Corporation in the U.S.A. and other countries.

**WARNING****■ While driving**

Do not connect USB memory or operate the controls. Doing so may cause an accident, resulting in death or serious injury.

**NOTICE****■ To prevent damage to USB memory**

- Do not leave USB memory in the vehicle. The temperature inside the vehicle may become high, resulting in damage to the USB memory.
- Do not push down or apply unnecessary pressure to the USB memory while it is connected as this may damage the USB memory or its terminal.
- Do not insert foreign objects into the port as this may damage the USB memory or its terminal.

Using the AUX port

This port can be used to connect a portable audio device and listen to it using the vehicle's speakers. Press the "MODE" button until "AUX" is displayed.

Connecting a portable player

→P. 381

■ Operating portable audio devices connected to the audio system

The volume can be adjusted using the vehicle's audio controls. All other adjustments must be made on the portable audio device itself.

■ When using a portable audio device connected to the power outlet

Noise may occur during playback. Use the power source of the portable audio device.

Bluetooth® audio/phone

The following can be performed using Bluetooth® wireless communication:

◆ Bluetooth® audio

The Bluetooth® audio system enables you to enjoy music played on a portable digital audio player (portable player) from the vehicle speakers via wireless communication.

This audio system supports Bluetooth®, a wireless data system capable of playing portable audio music without cables. If your portable player does not support Bluetooth®, the Bluetooth® audio system will not function.

◆ Bluetooth® phone (hands-free phone system)

This system supports Bluetooth®, which allows you to make or receive calls without using cables to connect a cellular phone and the system, and without operating the cellular phone.

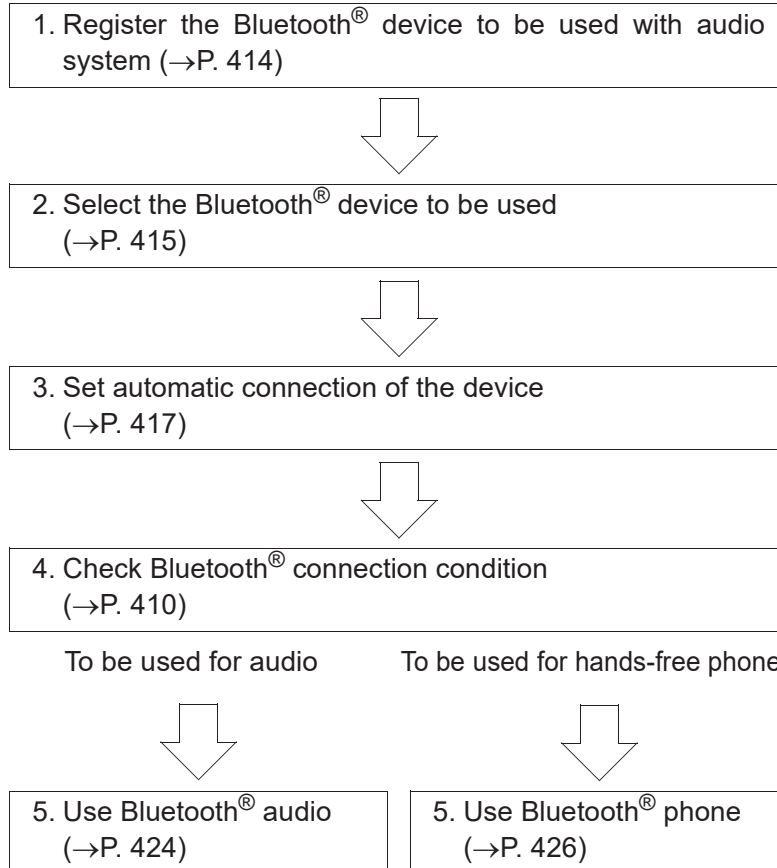
Device registration/connection flow

Audio unit

- ① “TUNE•SELECT” knob
 Displays set up menu or selects items such as menu and number
 Turn: Selects an item
 Press: Inputs the selected item
- ② Function button
- ③ “POWER VOLUME” knob
 Press: Turning the audio system on or off (except during hands-free mode: dialing, receiving call and talking)
 Turn: Adjusting the volume
- ④ On-hook button
 Turns the hands-free system off/ends a call/refuses a call
- ⑤ Off-hook button
 Turns the hands-free system on/starts a call
- ⑥ Bluetooth® connection condition
 If “BT” is not displayed, the Bluetooth® audio/phone cannot be used.
- ⑦ Display
 A message, name, number, etc. is displayed.

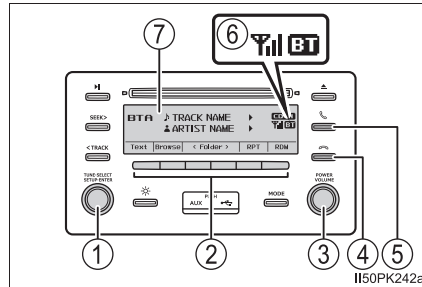

Microphone

You can use the microphone when talking on the phone.

The person you are speaking to can be heard from the speakers.

To use the hands-free system, you must register your Bluetooth® phone in the system. (→P. 414)

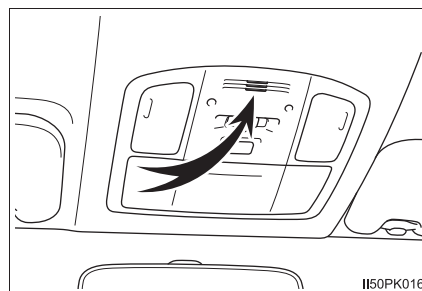

Menu list of the Bluetooth® audio/phone

To enter a menu, press the “TUNE•SELECT” knob and navigate menus by using the knob.

► “Bluetooth®” menu

First menu	Second menu	Third menu	Operation details	
“Bluetooth”	“Pairing”	-	Registering a Bluetooth® device (→P. 414)	
	“List phone”	-	Listing the registered cellular phones (→P. 415)	
	“List audio”	-	Listing the registered portable players (→P. 416)	
	“Passkey”	-	Changing the passkey (→P. 417)	
	“BT power”	-	Setting automatic connection of the device on or off (→P. 417)	
	“Bluetooth info”	“Device name” “Device address”	-	Displaying the device status (→P. 417)
	“Display setting”	-	Setting the automatic connection confirmation display to on or off (→P. 418)	
	“Reset”	-	Initializing the settings (→P. 418)	

► “TEL” menu

First menu	Second menu	Third menu	Operation details
“TEL”	“Phonebook”	“Auto transfer”	Setting automatic contact/call history transfer on or off (→P. 419)
		“Add contacts”	Adding a new number (→P. 419)
		“Delete contacts”*	Deleting a contact stored in the phonebook (→P. 419)
		“Sort contacts”	Sorting contacts by the first name or last name field (→P. 420)
		“Transfer history”	Transferring the call histories (→P. 420)
		“Delete call history”*	Deleting a number stored in the call history (→P. 420)
	“Favourites”	“Add favourites”	Adding a new contact to the favorite list (→P. 421)
		“Delete favourites”	Deleting a contact from the favorite list (→P. 422)
	“HF sound setting”	“Call volume”	Setting call volume (→P. 422)
		“Ringtone volume”	Setting ring tone volume (→P. 422)
		“Ringtone”	Setting the ring tone (→P. 423)

*: For PBAP compatible Bluetooth® phones, this function is available when “Automatic transfer” is set to off.

■ Bluetooth® audio/phone system functions

Depending on the Bluetooth® device, certain functions may not be available.

Using the steering wheel switches

The steering wheel switches can be used to operate a connected cellular phone, or portable digital audio player (portable player).

Vehicles without audio system: →P. 470

Operating Bluetooth® phone using the steering wheel switches

- ① Volume control switch
 - Press the “+” side to increase the volume.
 - Press the “-” side to decrease the volume.
- ② Off-hook switch
Turns the hands-free system on/starts a call
- ③ On-hook switch
Turns the hands-free system off/ends a call/refuses a call

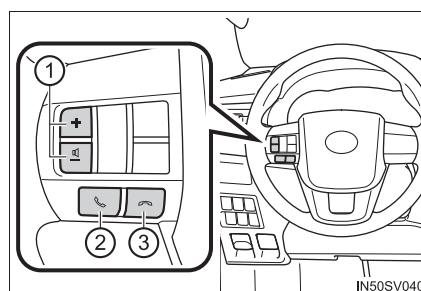

Registering a Bluetooth® device

Before using the Bluetooth® audio/phone, it is necessary to register a Bluetooth® device in the system. You can register up to 5 Bluetooth® devices.

How to register a Bluetooth® device

- 1 Press the “TUNE•SELECT” knob and select “Bluetooth” using the knob.
- 2 Press the knob and select “Pairing” using the knob.
A passkey will be displayed.
- 3 SSP (Secure Simple Pairing) incompatible Bluetooth® devices:
Input the passkey into the device.
SSP (Secure Simple Pairing) compatible Bluetooth® devices:
Select “Yes” to register the device. Depending on the type of device, it may register automatically.

If a Bluetooth® device has both music player and cellular phone functions, both functions will be registered at the same time. When deleting the device, both functions will be deleted at the same time.

If the off-hook button is pressed and the “TEL” mode is entered when no phones have been registered, the registration screen will be automatically displayed.

Using the "SETUP" menu ("Bluetooth" menu)

Registering a Bluetooth® device in the system allows the system to function. The following functions can be used for registered devices. To enter the set up menu, press the "TUNE•SELECT" knob and select "Bluetooth®" using the knob.

Registering a Bluetooth® device

Select "Pairing" using the "TUNE•SELECT" knob, and perform the procedure for registering a device. (→P. 414)

Listing the registered cellular phones

Select "List phone" using the "TUNE•SELECT" knob. The list of registered cellular phones will be displayed.

- Connecting the registered cellular phone to the audio system

- 1 Select the name of the cellular phone to be connected using the "TUNE•SELECT" knob.
- 2 Select "Select" using the knob.

- Deleting a registered cellular phone

- 1 Select the name of the cellular phone to be deleted using the "TUNE•SELECT" knob.
- 2 Select "Delete" using the knob.

- 3 Press \Rightarrow (YES).

- Disconnecting the registered cellular phone from the audio system

- 1 Select the name of the cellular phone to be disconnected using the "TUNE•SELECT" knob.
- 2 Select "Disconnect" using the knob.
- 3 Press \Rightarrow (YES).

Listing the registered portable players

Select "List audio" using the "TUNE•SELECT" knob. The list of registered portable players will be displayed.

● Connecting the registered portable player to the audio system

- 1 Select the name of the portable player to be connected using the "TUNE•SELECT" knob.
- 2 Select "Select" using the knob.

● Deleting the registered portable player

- 1 Select the name of the portable player to be deleted using the "TUNE•SELECT" knob.
- 2 Select "Delete" using the knob.
- 3 Press \Rightarrow (YES).

● Disconnecting the registered portable player from the audio system

- 1 Select the name of the portable player to be disconnected using the "TUNE•SELECT" knob.
- 2 Select "Disconnect" using the knob.
- 3 Press \Rightarrow (YES).

● Selecting the connection method

- 1 Select the name of the desired portable player using the "TUNE•SELECT" knob.
- 2 Select "Connection Method" using the knob.
- 3 Select "From vehicle" or "From audio" using the knob.

Changing the passkey

- 1 Select "Passkey" using the "TUNE•SELECT" knob.
- 2 Select a 4 to 8-digit passkey using the knob.
Input the number 1 digit at a time.
- 3 When the entire number to be registered as a passkey has been input, press \square (ENTER).
If the passkey to be registered has 8 digits, pressing \square (ENTER) is not necessary.

Setting automatic connection of the device on or off

If "BT power" is set to on, the registered device will be connected automatically when the engine switch is turned to the "ACC" position (vehicles without smart entry & start system) or ACCESSORY mode (vehicles with smart entry & start system).

Select "BT power ON" or "BT power OFF" using the "TUNE•SELECT" knob.

Displaying the device status

Select "Bluetooth info" using the "TUNE•SELECT" knob.

- Displaying the device name
Select "Device name" using the "TUNE•SELECT" knob.
- Displaying the device address
Select "Device address" using the "TUNE•SELECT" knob.

Setting the automatic connection confirmation display to on or off

If the "Display setting" is set to on, the portable player connection status will be displayed when the engine switch is turned to the "ACC" position (vehicles without smart entry & start system) or ACCESSORY mode (vehicles with smart entry & start system).

Select "Display setting ON" or "Display setting OFF" using the "TUNE•SELECT" knob.

Initialization

Select "Initialize" or "Reset" using the "TUNE•SELECT" knob.

● Initializing the HF sound settings

Select "HF sound setting" using the "TUNE•SELECT" knob and press (YES).

For details about HF sound settings: →P. 422

● Initializing the device information

Select "Car device info" using the "TUNE•SELECT" knob and press (YES).

Automatic connection of a portable device, automatic connection confirmation display and the passkey will be initialized.

● Initializing all settings

Select "All initialize" or "Reset all" using the "TUNE•SELECT" knob and press (YES).

Using the "SETUP" menu ("TEL" menu)

To enter the set up menu, press the "TUNE•SELECT" knob and select "TEL" using the knob.

Setting automatic contact/call history transfer

The automatic transfer function is available for PBAP compatible Bluetooth® phones only.

- 1 Select "Phonebook" using the "TUNE•SELECT" knob.
- 2 Select "Auto transfer ON" or "Auto transfer OFF" using the knob.

When set to on, the phone's contact data and call history are automatically transferred.

Adding a new phone number

Select "Phonebook" using the "TUNE•SELECT" knob, and select "Add contacts" using the knob.

- Transferring all contacts from the cellular phone

Select "Overwrite all" using the "TUNE•SELECT" knob and press (YES).

- Transferring one contact from the cellular phone

Select "Add one contact" using the "TUNE•SELECT" knob and press (YES).

Deleting a registered phone number

- 1 Select "Phonebook" using the "TUNE•SELECT" knob.
- 2 Select "Delete contacts" using the knob.
- 3 Select the desired phone number using the knob and press (YES).

To delete all the registered phone numbers, press (ALL) and then press (YES).

Press (A-Z) to display the registered names in alphabetical order of the initial.

Changing the sorting order of the contacts

- 1 Select "Phonebook" using the "TUNE•SELECT" knob.
- 2 Select "Sort contacts" using the knob.
- 3 Select "Sort by first" or "Sort by last" using the knob.

Transferring call histories

This function is available for PBAP compatible Bluetooth® phones only.

- 1 Select "Phonebook" using the "TUNE•SELECT" knob.
- 2 Select "Transfer history" using the knob and press \Rightarrow (YES).

Deleting call histories

Select "Phonebook" using the "TUNE•SELECT" knob, and select "Delete call history" using the knob.

● Deleting outgoing call history

- 1 Select "Outgoing calls" using the "TUNE•SELECT" knob.
- 2 Select the desired phone number using the knob and press \Rightarrow (YES).

To delete all outgoing call history data, press \Rightarrow (ALL) and then press \Rightarrow (YES).

● Deleting incoming call history

- 1 Select "Incoming calls" using the "TUNE•SELECT" knob.
- 2 Select the desired phone number using the knob and press \Rightarrow (YES).

To delete all incoming call history data, press \Rightarrow (ALL) and then press \Rightarrow (YES).

● Deleting missed call history

- 1 Select "Missed calls" using the "TUNE•SELECT" knob.
- 2 Select the desired phone number using the knob and press \Rightarrow (YES).

To delete all missed call history data, press \Rightarrow (ALL) and then press \Rightarrow (YES).

- Deleting a number from all call histories (Outgoing calls, Incoming calls and Missed calls)

- 1 Select "All calls" using the "TUNE•SELECT" knob.
- 2 Select the desired phone number using the knob and press \square (YES).

To delete all of the call histories data, press \square (ALL) and then press \square (YES).

Registering favorites

Up to 15 contacts can be registered in the favorites list.

■ Registering the contacts from the "SETUP" mode

- 1 Press the "TUNE•SELECT" knob.
- 2 Select "TEL" using the knob.
- 3 Select "Favourites" using knob.
- 4 Select "Add favourites" using the knob.

Press \square (A-Z) to display the registered names in alphabetical order of the initial.

- 5 Select desired contact using the knob.

■ Registering the contacts from the "TEL" mode

- 1 Press the off-hook button.
- 2 Select "Phonebook", "All calls", "Missed calls", "Incoming calls" or "Outgoing calls" using the "TUNE•SELECT" knob.
- 3 Select a desired number using the knob
- 4 Press \square (Add favourite).

- When 15 contacts have already been registered to the favorites list, a registered contact needs to be replaced.

- 1 Select the contact to be replaced using the "TUNE•SELECT" knob.
- 2 Select \square (YES) when the confirmation screen appears.

Deleting favorites

■ Deleting the contacts from the "SETUP" mode

- 1 Press the "TUNE•SELECT" knob.
- 2 Select "TEL" using the knob.
- 3 Select "Favourites" using the knob.
- 4 Select "Delete favourites" using the knob.
- 5 Select desired contact using the knob.
You can select all contacts by selecting (ALL).
- 6 Select (YES) when the confirmation screen appears.

■ Deleting the contacts from the "TEL" mode

- 1 Press the off-hook button.
- 2 Select "Favourites" using the "TUNE•SELECT" knob.
- 3 Select a desired contact using the knob
- 4 Press (Delete favourite).
- 5 Select (YES) when the confirmation screen appears.

Setting call volume

- 1 Select "HF sound setting" using the "TUNE•SELECT" knob.
- 2 Select "Call volume" using the knob.
- 3 Change the call volume.
To decrease the volume: Turn the knob counterclockwise.
To increase the volume: Turn the knob clockwise.
To set the volume, press (BACK).

Setting ring tone volume

- 1 Select "HF sound setting" using the "TUNE•SELECT" knob.
- 2 Select "Ringtone volume" using the knob.
- 3 Change the ring tone volume.
To decrease the volume: Turn the knob counterclockwise.
To increase the volume: Turn the knob clockwise.
To set the volume, press (BACK).

Setting ring tone

- 1 Select "HF sound setting" using the "TUNE•SELECT" knob.
- 2 Select "Ringtone" using the knob.
- 3 Using the knob, select a ring tone (1 - 3 or "From phone"). To set the selected ring tone, press  (BACK).

■ Phone number

Up to 5000 names (maximum of 1000 names per device) can be stored.

■ Call history

Up to 10 numbers can be stored in each of the outgoing, incoming and missed call history memories.

■ Limitation of number of digits

A phone number that exceeds 24 digits cannot be registered.

■ Bluetooth® phone system functions

Certain functions may not be available during driving.

Operating a Bluetooth® enabled portable player

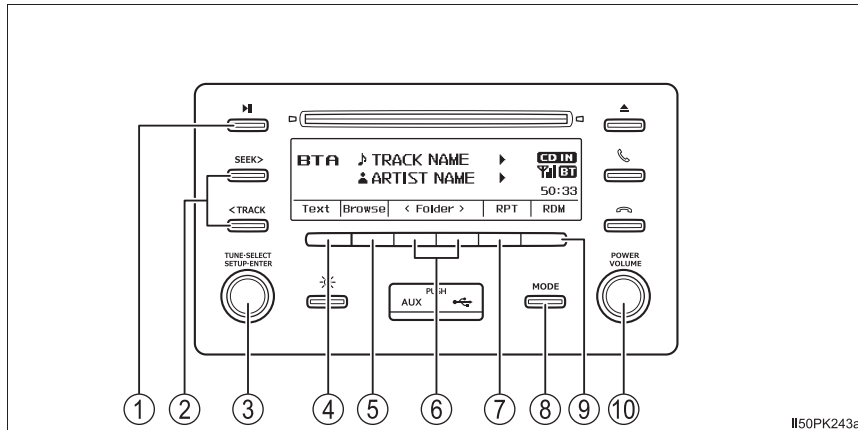

- ① Pause/playback
- ② Selecting a track, fast-forwarding or rewinding
- ③ “TUNE•SELECT” knob
Press: Displaying list of the current folder
Turn: Selecting an item
- ④ Displaying text message
- ⑤ Displaying play mode
- ⑥ Selecting a folder
- ⑦ Repeat play
- ⑧ Changing the audio source/playback
- ⑨ Random play or back button
- ⑩ “POWER VOLUME” knob
Press: Turning the audio system on or off
Turn: Adjusting the volume

Selecting an album

Press \square (<FOLDER) or \square (FOLDER>) to select desired album.

Selecting a track

Turn the “TUNE•SELECT” knob or press the “SEEK >” or “< TRACK” button to move up or down.

Fast-forwarding and rewinding tracks

Press and hold the “SEEK >” or “< TRACK” button until you hear a beep.

Repeat play

Pressing \square (RPT) changes modes in the following order: Track repeat→Album repeat→Off.

Random play

Pressing \square (RDM) changes modes in the following order: Album random→All track random→Off.

Selecting a play mode

- 1 Press \square (“BROWSE”). The playlist will be displayed.
- 2 Turn the “TUNE•SELECT” knob to display the folder/file list.
- 3 Press the knob to select the desired item.
- 4 Repeat the same procedure to select the desired file.

To return to the previous display, press \square (BACK).

Switching the display

Press \square (TEXT) to display or hide the album title.

If there are continuing texts, \blacktriangleright is displayed.

Press and hold \square (TEXT) until you hear a beep to display the remaining texts.

■ Bluetooth® audio system functions

Depending on the portable player that is connected to the system, certain functions may not be available.

■ Display

→P. 390

Making a phone call

To enter the “TEL” mode, press the off-hook button.

Dialing from the phonebook

- 1 Select “Phonebook” using the “TUNE•SELECT” knob.
- 2 Select the desired name using the knob and press the off-hook button.

Press \square (A-Z) to display the registered names in alphabetical order of the initial.

Dialing from favorites

- 1 Select “Favourites” using the “TUNE•SELECT” knob.
- 2 Select the desired name using the knob and press the off-hook button.

Dialing by entering the number

- 1 Select “Dial by number” using the “TUNE•SELECT” knob.
- 2 Enter the phone number and press the off-hook button.

Dialing from call histories

- 1 Select “All calls”, “Missed calls”, “Incoming calls” or “Outgoing calls” using the “TUNE•SELECT” knob.
- 2 Select a desired number using the knob and press the off-hook button.

The following operations can be performed:

- Registering a number as a Favorite

→P. 421

- Deleting the selected number

Press \square (DELETE) and press \square (YES).

When receiving a phone call

Answering the phone

Press the off-hook button.

Refusing the call

Press the on-hook button.

Receiving a call when on another call

Press the off-hook button.

Pressing the off-hook button again returns you to the previous call.

Adjusting the ring tone volume when receiving a call

To decrease the volume: Turn the “POWER VOLUME” knob counter-clockwise.

To increase the volume: Turn the “POWER VOLUME” knob clockwise.

Speaking on the phone

Transferring a call

A call can be transferred between the cellular phone and system while dialing, receiving a call, or during a call. Use one of the following methods:

- a. Operate the cellular phone.

Refer to the manual that comes with the cellular phone for the operation of the phone.

- b. Press \square (TEL).*

*: This operation can be performed only when transferring a call from the cellular phone to the system during a call.

Muting your voice

Press \square (MUTE).

Press \square (UNMUTE) to cancel the mute.

Inputting digits

This operation cannot be performed while driving.

- 1 Press \square ("0-9")
- 2 Turn the "TUNE•SELECT" knob to select the desired number.
- 3 Press the knob to decide the number.
- 4 Press \square (SEND) to send tones.

Pressing \square (BACK) preserves the number and returns to the previous screen.

Pressing \square ("EXIT") or ("Wait") deletes the number and go to "Entering a number" screen.

- ▶ Phone number containing a "p" symbol

When the "p" symbol is dialed in an outgoing call, there will be a pause for 2 seconds before the following digits are dialed automatically.

- ▶ Phone number containing a "w" symbol

When the "w" symbol is dialed in an outgoing call, you need to press \square (SEND) again to dial following digits.

This operation can be performed while driving.

Adjusting the outgoing volume

Your voice volume that the other party hears from their speaker can be adjusted.

- 1 Press  (Send Vol)
- 2 Use the “TUNE•SELECT” knob to adjust the volume. (-5 to +5)

Setting call volume

To decrease the volume: Turn the “POWER VOLUME” knob counter-clockwise.

To increase the volume: Turn the “POWER VOLUME” knob clockwise.

■ When talking on the phone

- Do not talk simultaneously with the other party.
- Keep the volume of the received voice down. Otherwise, voice echo will increase.

■ Automatic volume adjustment

When vehicle speed is 80 km/h (50 mph) or more, the volume automatically increases. The volume returns to the previous volume setting when vehicle speed drops to 70 km/h (43 mph) or less.

■ Phone call system functions

Depending on the cellular phone, certain functions may not be available.

■ Situations where the system may not recognize your voice

- When driving on a rough road
- When driving at high speeds
- When air is blowing out of the vents onto the microphone
- When the air conditioning fan emits a loud noise

Bluetooth®

■ When using the Bluetooth® audio/phone

- In the following situations, the system may not function.
 - The portable player does not support Bluetooth®
 - The cellular phone is located outside the service area
 - The Bluetooth® device is switched off
 - The Bluetooth® device has a low battery
 - The Bluetooth® device is not connected to the system
 - The Bluetooth® device is behind the seat or in the glove box or console box, or metal material covers or touches the device
- There may be a delay if a cellular phone connection is made during Bluetooth® audio play.
- Depending on the type of portable audio player that is connected to the system, operation may differ slightly and certain functions may not be available.
- This system is not guaranteed to operate with all Bluetooth® devices.

■ When transferring ownership of the vehicle

Be sure to initialize the system to prevent personal data from being improperly accessed. (→P. 418)

■ About Bluetooth®

Bluetooth is a registered trademark of Bluetooth SIG, Inc.



■ Compatible models

The Bluetooth® audio system supports portable audio players with the following specifications

- Bluetooth® specifications:

- Ver. 1.1 or higher (Recommended: Ver. 4.1)

- Profiles:

- A2DP (Advanced Audio Distribution Profile) Ver. 1.0, or higher (Recommended: Ver. 1.3)

- This is a profile to transmit stereo audio or high quality sound to the audio system.

- AVRCP (Audio/Video Remote Control Profile) Ver. 1.0 or higher (Recommended: Ver. 1.6)

- This is a profile to allow remote control the A/V equipment.

- However, please note that some functions may be limited depending on the type of portable audio player connected.

- The hands-free system supports cellular phones with the following specifications.

- Bluetooth® specifications: Ver. 2.0 or higher (Recommended: Ver. 4.1 +EDR or higher)

- Profiles:

- HFP (Hands Free Profile) Ver. 1.0 or higher (Recommended: Ver. 1.7)

- This is a profile to allow hands-free phone calls using a cellular phone. It has outgoing and incoming call functions.

- OPP (Object Push Profile) Ver. 1.1 or higher (Recommended: Ver. 1.2)

- This is a profile to transfer phonebook data. When a Bluetooth® compatible cellular phone has both PBAP and OPP, OPP cannot be used.

- PBAP (Phone Book Access Profile) Ver. 1.0 or higher (Recommended: Ver. 1.2)

- This is a profile to transfer phonebook data.

 WARNING

■ **While driving**

Do not operate the portable audio player, cellular phone or connect a device to the Bluetooth® system.

■ **Caution regarding interference with electronic devices**

- Your audio unit is fitted with Bluetooth® antennas. People with implantable cardiac pacemakers, cardiac resynchronization therapy-pacemakers or implantable cardioverter defibrillators should maintain a reasonable distance between themselves and the Bluetooth® antennas. The radio waves may affect the operation of such devices.
- Before using Bluetooth® devices, users of any electrical medical device other than implantable cardiac pacemakers, cardiac resynchronization therapy-pacemakers or implantable cardioverter defibrillators should consult the manufacturer of the device for information about its operation under the influence of radio waves. Radio waves could have unexpected effects on the operation of such medical devices.

 NOTICE

■ **When leaving the vehicle**

Do not leave your portable audio player or cellular phone in the vehicle. The inside of the vehicle may become hot, causing damage to the portable audio player or cellular phone.

Interior features

6

6-1. Using the air conditioning system and defogger

Manual air conditioning system	434
Automatic air conditioning system	441
Heated steering wheel/ seat heaters.....	450

6-2. Using the interior lights

Interior lights list.....	453
• Personal/interior light main switch.....	454
• Personal/interior lights	454
• Interior light.....	454

6-3. Using the storage features

List of storage features	456
• Glove box	457
• Console box	457
• Cup holders	458
• Bottle holders	459
• Auxiliary boxes	460
Luggage compartment features.....	463

6-4. Using the other interior features

Other interior features.....	464
• Sun visors.....	464
• Vanity mirror	464
• Clock	465
• Power outlets.....	466
• Grocery bag hooks	468
• Coat hooks	469
• Armrest.....	469
Using the steering wheel audio switches	470

Manual air conditioning system*

Air conditioning controls

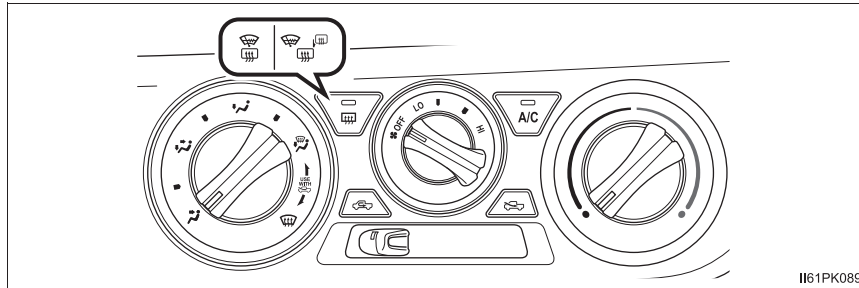



■ Adjusting the fan speed setting

Turn  clockwise (increase) or counterclockwise (decrease).

Turning the dial to "OFF" turns off the fan.

■ Adjusting the temperature setting

Turn  clockwise (warm) or counterclockwise (cool).

If  (if equipped) is not pressed, the system will blow ambient temperature air or heated air.

■ Changing the air flow mode

Set  to the desired position.



The positions between the air outlet selections can also be selected for more delicate adjustment.

*: If equipped

Other functions

■ Switching between outside air and recirculated air modes

Move the outside/recirculated air mode lever.



The mode switches between  (introduces air from outside the vehicle) and  (recycles air inside the vehicle) each time the lever is moved.

■ Defogging the windshield (vehicles with)

- 1 Set  to  position.

Set the outside/recirculated air mode lever to outside air mode if recirculated air mode is used.



- 2 Perform the following operations accordingly:

- To adjust the fan speed, turn .
- To adjust the temperature setting, turn .
- If the dehumidification function is not operating, press  to operate the dehumidification function.

To defog the windshield and the side windows early, turn the air flow and temperature up.

■ Defogging the rear window and outside rear view mirrors (if equipped)

Defoggers are used to defog the rear window, and to remove raindrops, dew and frost from the outside rear view mirrors.

Press  (vehicles with rear window defogger),  (vehicles with rear window defogger and windshield wiper de-icer) or  (vehicles with rear window defogger, outside rear view mirror defoggers and windshield wiper de-icer).

The indicator illuminates on the switch when the defoggers are on.

The defoggers will automatically turn off after approximately 15 minutes.

■ Windshield wiper de-icer (if equipped)

This feature is used to prevent ice from building up on the windshield and wiper blades.

Press  or .

The indicator illuminates on the switch when the windshield wiper de-icer is on.

The windshield wiper de-icer will automatically turn off after approximately 15 minutes.

■ Power heater (if equipped)

This feature is used to heat the engine coolant, speed up warming of the cab in cold weather, and keep the cab warm.

Press the switch to turn the power heater on/off.

The indicator illuminates on the switch when the power heater is on.

If you do not turn the switch to off, the engine speed may be increased when the engine is started.

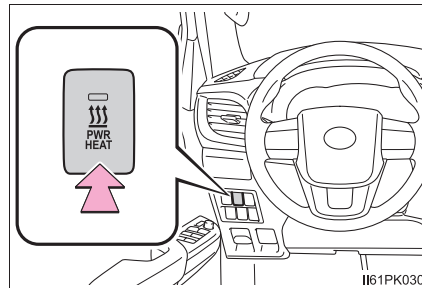

Air outlets

■ Location of air outlets

The air outlets and air volume changes according to the selected air flow mode.

← : Some models

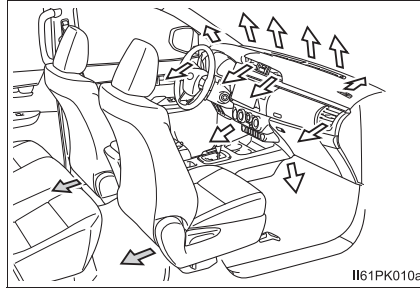

■ Adjusting the air flow direction and opening/closing the air outlets

► Center outlets

- ① Direct air flow to the left or right, up or down.
- ② Close the vents.

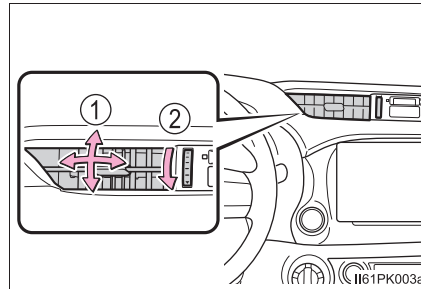

► Side outlets

- ① Direct air flow to the left or right, up or down.
- ② Close the vents.

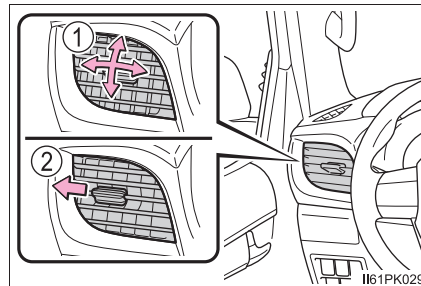

■ Fogging up of the windows

- The windows will easily fog up when the humidity in the vehicle is high.

Turning  (if equipped) on will dehumidify the air from the outlets and defog the windshield effectively.

- If you turn  (if equipped) off, the windows may fog up more easily.

- The windows may fog up if the recirculated air mode is used.

■ When driving on dusty roads

Close all windows. If dust thrown up by the vehicle is still drawn into the vehicle after closing the windows, it is recommended that the air intake mode be set to outside air mode and the fan speed to any setting except off.

■ Outside/recirculated air mode

Setting to the recirculated air mode temporarily is recommended in preventing dirty air from entering the vehicle interior and helping to cool the vehicle when the outside air temperature is high.

■ When the outside temperature falls to nearly 0°C (32°F) (vehicles with

The dehumidification function may not operate even when  is pressed.

■ Ventilation and air conditioning odors

- To let fresh air in, set the air conditioning system to the outside air mode.
- During use, various odors from inside and outside the vehicle may enter into and accumulate in the air conditioning system. This may then cause odor to be emitted from the vents.
- To reduce potential odors from occurring:

It is recommended that the air conditioning system be set to outside air mode prior to turning the vehicle off.

■ Air conditioning filter

→P. 514

■ **Air conditioning refrigerant (vehicles with  for models made in Thailand*)**

Type: R-134a (HFC-134a)

Capacity: 0.50 kg (1.10 lb.)



GWP (Global Warming Potential): 1430

CO2 equivalent: 0.72 t (1587.33 lb.)

Contains fluorinated greenhouse gases
Съдържа флуорсъдържащи парникови газове
Sadržava fluorirane stakleničke plinove
Obsahuje fluorované skleníkové plyny
Inneholder fluorholdige drivhusgasser
Bevat gefluoreerde broeikasgassen
Sisaldab fluoritud kasvuhoonegaase
Sisältää fluorattuja kasvihuonekaasuja
Contient des gaz à effet de serre fluorés
Enthält fluorierte Treibhausgase
Περιέχει φθοριούχα αέρια του θερμοκηπίου
Fluortartalmú üvegházhatású gázokat tartalmaz
Contiene gas fluorurati a effetto serra
Sudėtyje yra fluorintų šiltnamio efektą sukeliančių dujų
Satur fluorētas siltumnīcefekta gāzes
Fih gassijiet fluworurati b'effett ta' serra
Zawiera fluorowane gazy cieplarniane
Contém gases fluorados com efeito de estufa
Conține gaze fluorurate cu efect de seră
Obsahuje fluóované skleníkové plyny
Vsebuje fluorirane toplogredne pline
Contiene gases fluorados de efecto invernadero
Innehåller fluorerade växthusgaser
Inneholder fluorholdige drivhusgasser
Inniheldur flúraðar gróðurhúsalofttegundir

*: See “Checking your vehicle’s model” if you are not sure of which model your vehicle is. (→P. 12)

 WARNING**■ To prevent the windshield from fogging up**

- Do not set  to  during cool air operation in extremely humid weather. The difference between the temperature of the outside air and that of the windshield can cause the outer surface of the windshield to fog up, blocking your vision.
- Do not place anything on the instrument panel which may cover the air outlets. Otherwise, air flow may be obstructed, preventing the windshield defoggers from defogging.

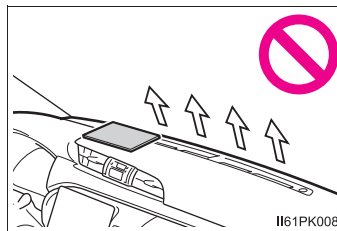
**■ To prevent burns**

- Vehicles with outside rear view mirror defoggers: Do not touch the rear view mirror surfaces when the outside rear view mirror defoggers are on.
- Vehicles with windshield wiper de-icer: Do not touch the glass at lower part of the windshield or the side of the front pillars when the windshield wiper de-icer is on.

 NOTICE**■ To prevent battery discharge**

Do not leave the air conditioning system on longer than necessary when the engine is not running.

Automatic air conditioning system*

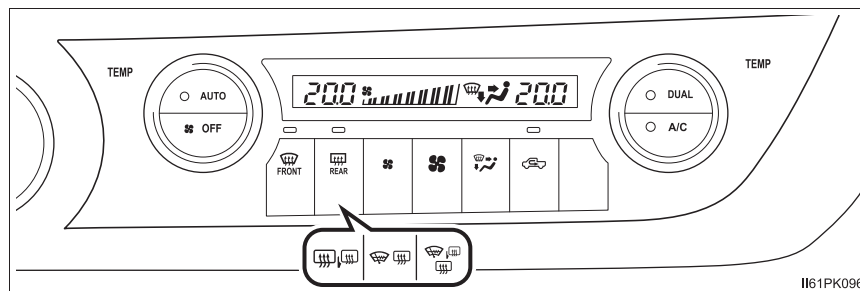

Air outlets and fan speed are automatically adjusted according to the temperature setting.

Air conditioning controls



This illustration is for a left-hand drive vehicle. Some button positions differ for right-hand drive vehicles.

■ Adjusting the fan speed setting

Press  to increase the fan speed and  to decrease the fan speed.

Press  to turn the fan off.

■ Adjusting the temperature setting

Turn  clockwise (warm) or counterclockwise (cool).

If  is not pressed, the system will blow ambient temperature air or heated air.

*: If equipped

■ **Changing the air flow mode**

Press  to change the air outlets.

The air outlets used are switched each time the button is pressed.

- ① Air flows to the upper body.
- ② Air flows to the upper body and feet.
- ③ Mainly air flows to the feet.
- ④ Air flows to the feet and the windshield defogger operates.

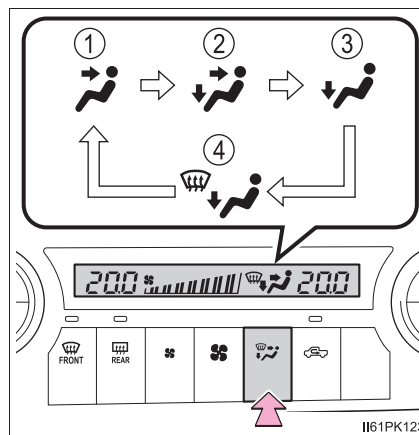

Using automatic mode

- 1 Press .

The dehumidification function begins to operate. Air outlets and fan speed are automatically adjusted according to the temperature setting.

- 2 Turn  clockwise (warm) or counterclockwise (cool) to adjust the temperature.

- 3 Press .

The cooling and dehumidification function switches between on and off each time  is pressed.

The  indicator illuminates when the function is on.



To stop the operation, press .

■ **Automatic mode indicator**

If the fan speed setting or air flow modes are operated, the automatic mode indicator goes off. However, automatic mode for functions other than that operated is maintained.

■ Adjusting the temperature for driver and passenger seats separately (“DUAL” mode)

To turn on the “DUAL” mode, perform the following either operation:

- Press .
- Turn  clockwise (warm) or counterclockwise (cool) to adjust the temperature.

The  indicator comes on when the “DUAL” mode is on.

Other functions

■ Switching between outside air and recirculated air modes

Press .

The mode switches between outside air mode (indicator off) and recirculated air mode (indicator on) each time the button is pressed.

■ Defogging the windshield

Press .

The dehumidification function operates and fan speed increases.

Set  to the outside air mode if the recirculated air mode is used. (It may switch automatically.)



To defog the windshield and the side windows early, turn the air flow and temperature up.

To return to the previous mode, press  again when the windshield is defogged.

The  indicator illuminates when the windshield dehumidification function is on.

■ Defogging the rear window and outside rear view mirrors (if equipped)

Defoggers are used to defog the rear window, and to remove rain-drops, dew and frost from the outside rear view mirrors.

Press  (vehicles with rear window defogger),  (vehicles with rear window defogger and outside rear view mirror defoggers),

 (vehicles with rear window defogger and windshield wiper de-icer) or

 (vehicles with rear window defogger, outside rear view mirror defoggers and windshield wiper de-icer).

The indicator illuminates on the switch when the defoggers are on.

The defoggers will automatically turn off after approximately 15 to 60 minutes.

■ Windshield wiper de-icer (if equipped)

This feature is used to prevent ice from building up on the windshield and wiper blades.

Press  or .

The indicator illuminates on the switch when the windshield wiper de-icer is on.

The windshield wiper de-icer will automatically turn off after approximately 15 to 60 minutes.

■ Power heater (if equipped)

This feature is used to heat the engine coolant, speed up warming of the cab in cold weather, and keep the cab warm.

Press the switch to turn the power heater on/off

The indicator illuminates on the switch when the power heater is on.

If you do not turn the switch to off, the engine speed may be increased when the engine is started.

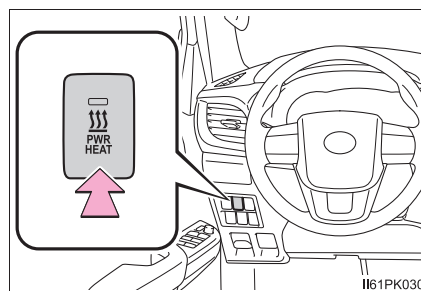

Air outlets

■ Location of air outlets

The air outlets and air volume changes according to the selected air flow mode.

← : Some models

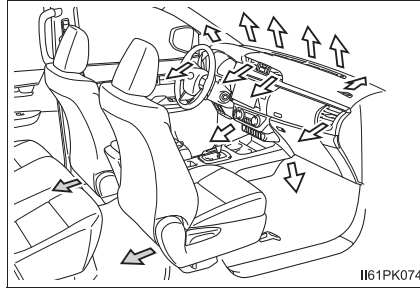

■ Adjusting the air flow direction and opening/closing the air outlets

► Center outlets

- ① Direct air flow to the left or right, up or down.
- ② Close the vents.

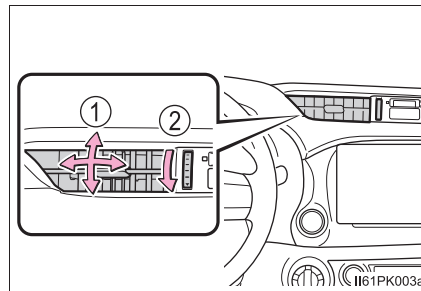

► Side outlets

- ① Direct air flow to the left or right, up or down.
- ② Close the vents.

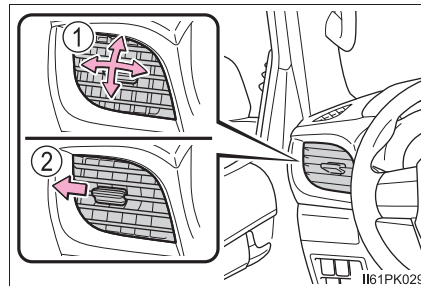

■ Using automatic mode

Fan speed is adjusted automatically according to the temperature setting and the ambient conditions.

Therefore, the fan may stop for a while until warm or cool air is ready to flow immediately after  is pressed.

■ Fogging up of the windows

- The windows will easily fog up when the humidity in the vehicle is high.

Turning  on will dehumidify the air from the outlets and defog the windshield effectively.

- If you turn  off, the windows may fog up more easily.

- The windows may fog up if the recirculated air mode is used.

■ When driving on dusty roads

Close all windows. If dust thrown up by the vehicle is still drawn into the vehicle after closing the windows, it is recommended that the air intake mode be set to outside air mode and the fan speed to any setting except off.

■ Outside/recirculated air mode

- Setting to the recirculated air mode temporarily is recommended in preventing dirty air from entering the vehicle interior and helping to cool the vehicle when the outside air temperature is high.
- Outside/recirculated air mode may automatically switch depending on the temperature setting or the inside temperature.

■ Operation of the air conditioning system in Eco drive mode (if equipped)

- In Eco drive mode, the air conditioning system is controlled as follows to prioritize fuel efficiency:
 - Engine speed and compressor operation controlled to restrict heating/cooling capacity
 - Fan speed restricted when automatic mode is selected
- To improve air conditioning performance, perform the following operations.
 - Adjust the fan speed
 - Turn off Eco drive mode
 - Adjust the temperature setting

■ When the outside temperature falls to nearly 0°C (32°F)

The dehumidification function may not operate even when  is pressed.

■ Ventilation and air conditioning odors

- To let fresh air in, set the air conditioning system to the outside air mode.
- During use, various odors from inside and outside the vehicle may enter into and accumulate in the air conditioning system. This may then cause odor to be emitted from the vents.
- To reduce potential odors from occurring:
 - It is recommended that the air conditioning system be set to outside air mode prior to turning the vehicle off.
 - For some models: The start timing of the blower may be delayed for a short period of time immediately after the air conditioning system is started in automatic mode.

■ Air conditioning filter

→P. 514

■ **Air conditioning refrigerant (models made in Thailand*)**

Type: R-134a (HFC-134a)

Capacity: 0.50 kg (1.10 lb.)

GWP (Global Warming Potential): 1430

CO2 equivalent: 0.72 t (1587.33 lb.)

Contains fluorinated greenhouse gases
Съдържа флуорсъдържащи парникови газове
Sadržava fluorirane stakleničke plinove
Obsahuje fluorované skleníkové plyny
Indeholder fluorholdige drivhusgasser
Bevat gefluoreerde broeikasgassen
Sisaldab fluoritud kasvuhonegaase
Sisältää fluorattuja kasvihuonekaasuja
Contient des gaz à effet de serre fluorés
Enthält fluorierte Treibhausgase
Περιέχει φθοριούχα αέρια του θερμοκηπίου
Fuortartalmú üvegházhatású gázokat tartalmaz
Contiene gas fluorurati a effetto serra
Sudėtyje yra fluorintų šiltnamio efekta sukeliančių dujų
Satur fluorētas siltumnīcefekta gāzes
Fih gassijiet fluworurati b'effett ta' serra
Zawiera fluorowane gazy cieplarniane
Contém gases fluorados com efeito de estufa
Contine gaze fluorurate cu efect de seră
Obsahuje fluóované skleníkové plyny
Vsebuje fluorirane toplogredne pline
Contiene gases fluorados de efecto invernadero
Innehåller fluorerade växthusgaser
Inneholder fluorholdige drivhusgasser
Inniheldur flúraðar gróðurhúsalofttegundir

*: See "Checking your vehicle's model" if you are not sure of which model your vehicle is. (→P. 12)

⚠ WARNING**■ To prevent the windshield from fogging up**

- Do not use  during cool air operation in extremely humid weather. The difference between the temperature of the outside air and that of the windshield can cause the outer surface of the windshield to fog up, blocking your vision.
- Do not place anything on the instrument panel which may cover the air outlets. Otherwise, air flow may be obstructed, preventing the windshield defoggers from defogging.

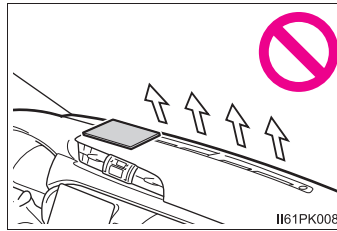
**■ To prevent burns**

- Vehicles with outside rear view mirror defoggers: Do not touch the rear view mirror surfaces when the outside rear view mirror defoggers are on.
- Vehicles with windshield wiper de-icer: Do not touch the glass at lower part of the windshield or the side of the front pillars when the windshield wiper de-icer is on.

⚠ NOTICE**■ To prevent battery discharge**

Do not leave the air conditioning system on longer than necessary when the engine is not running.

Heated steering wheel*/seat heaters*

Heated steering wheel and seat heaters heat the side grips of the steering wheel and seats, respectively.

WARNING

- Care should be taken to prevent injury if anyone in the following categories comes in contact with the steering wheel and seats when the heater is on:
 - Babies, small children, the elderly, the sick and the physically challenged
 - Persons with sensitive skin
 - Persons who are fatigued
 - Persons who have taken alcohol or drugs that induce sleep (sleeping drugs, cold remedies, etc.)
- Observe the following precautions to prevent minor burns or overheating:
 - Do not cover the seat with a blanket or cushion when using the seat heater.
 - Do not use seat heater more than necessary.

NOTICE

- Do not put heavy objects that have an uneven surface on the seat and do not stick sharp objects (needles, nails, etc.) into the seat.
- To prevent battery discharge, do not use the functions when the engine is not running.

*: If equipped

Heated steering wheel

Turns the steering wheel heater on/off

The indicator light comes on when the heater is operating.

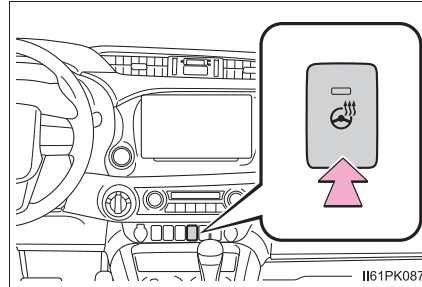

The heated steering wheel can be used when the engine switch is in the “ON” position (vehicles without smart entry & start system) or IGNITION ON mode (vehicles with smart entry & start system).

Seat heaters

■ Front seats

- ① Turns on the front left seat heater

The indicator light comes on.

- ② Turns on the front right seat heater

The indicator light comes on.

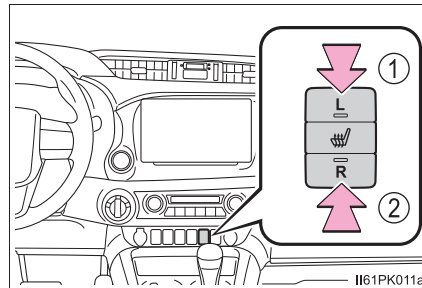

This illustration is for a left-hand drive vehicle. The switch position differs for right-hand drive vehicles.

■ Rear seats (if equipped)

- ① Turns on the rear left seat heater

The indicator light comes on.

- ② Turns on the rear right seat heater

The indicator light comes on.

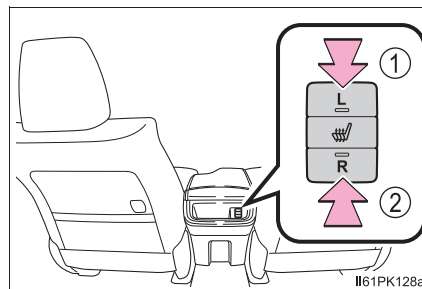

- The seat heaters can be used when the engine switch is in the "ON" position (vehicles without smart entry & start system) or IGNITION ON mode (vehicles with smart entry & start system).
- When not in use, press the seat heater switch to turn the seat heater off. The indicator light turns off.

Interior lights list

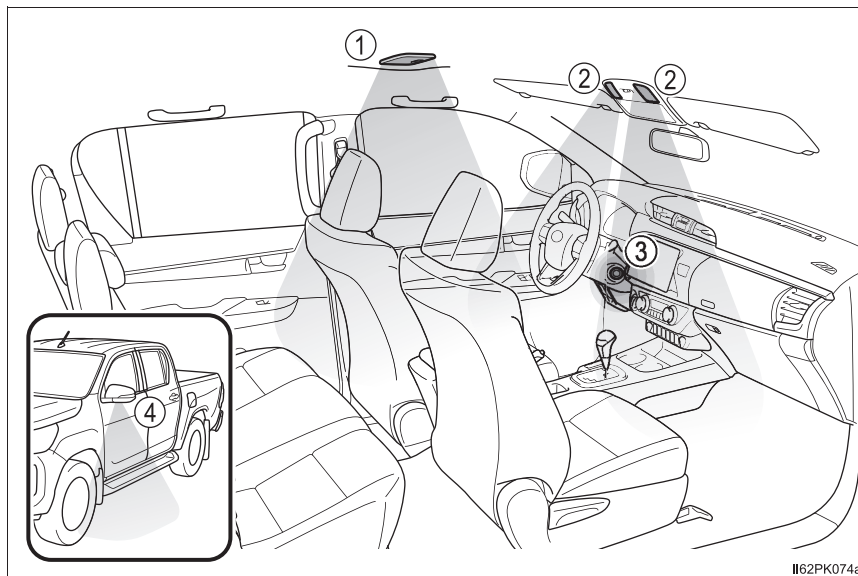

- ① Interior light (if equipped) (→P. 454)
- ② Personal/interior lights (→P. 454)
- ③ Engine switch light
- ④ Outer foot lights (if equipped)

Personal/interior light main switch

① Door position

The personal/interior lights come on when a door is opened. They turn off when the doors are closed.

② Off

The personal/interior lights can be individually turned on or off.

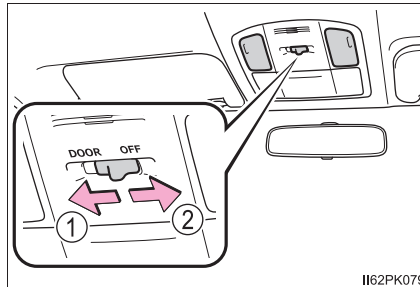

Personal/interior lights

On/off

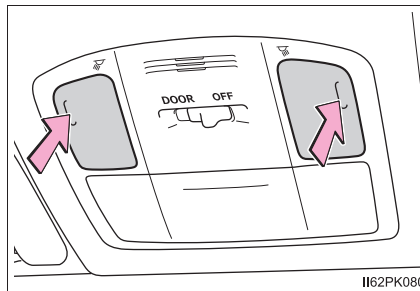

Interior light (if equipped)

① Off

② Door position

The interior light comes on when a door is opened. It turns off when the doors are closed.

③ On

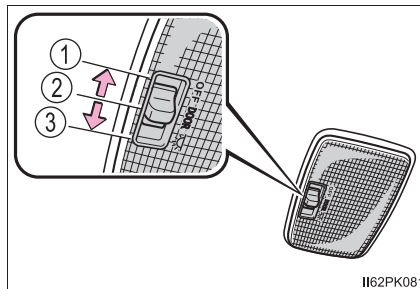

- Illuminated entry system:

- ▶ Vehicles without smart entry & start system

- The lights automatically turn on/off according to the engine switch position, whether the doors are locked/unlocked, and whether the doors are opened/closed.

- ▶ Vehicles with smart entry & start system

- The lights automatically turn on/off according to engine switch mode, whether the doors are locked/unlocked, and whether the doors are opened/closed.

- If the following lights remain on when the engine switch is turned to the “LOCK” position (vehicles without smart entry & start system) or off (vehicles with smart entry & start system), the lights will go off automatically after 20 minutes:

- Personal/interior light
 - Interior light (if equipped)
 - Engine switch light

**NOTICE**

To prevent battery discharge, do not leave the lights on longer than necessary when the engine is not running.

List of storage features

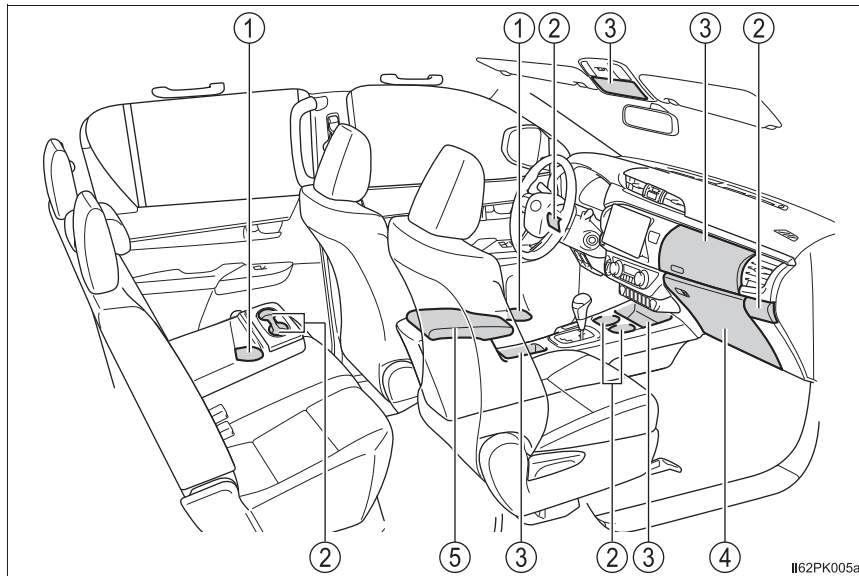

- | | |
|---|--|
| ① Bottle holders (if equipped)
(→P. 459) | ③ Auxiliary boxes (if equipped)
(→P. 460) |
| ② Cup holders (if equipped)
(→P. 458) | ④ Glove box
(→P. 457) |
| | ⑤ Console box (if equipped)
(→P. 457) |

⚠ WARNING

- Do not leave glasses, lighters or spray cans in the storage spaces, as this may cause the following when cabin temperature becomes high:
 - Glasses may be deformed by heat or cracked if they come into contact with other stored items.
 - Lighters or spray cans may explode. If they come into contact with other stored items, the lighter may catch fire or the spray can may release gas, causing a fire hazard.
- When driving or when the glove box and the console box are not in use, keep it closed.
In the event of sudden braking or sudden swerving, an accident may occur due to an occupant being struck by an open lid or the items stored inside.

Glove box

- ① Open (push button)
- ② Unlock with the master key or the mechanical key
- ③ Lock with the master key or the mechanical key

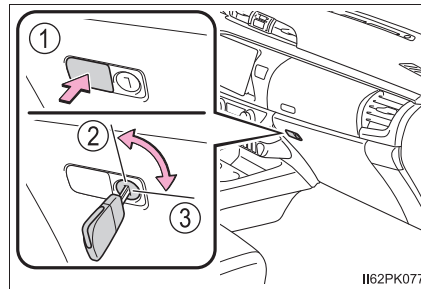
**Console box (if equipped)**

Lift the lid while pulling up the knob to release the lock.

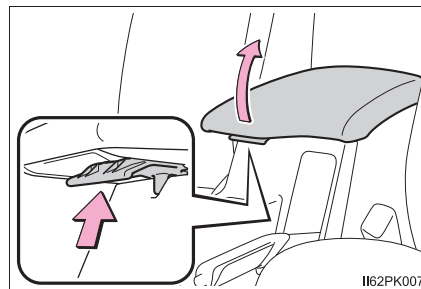

Cup holders

▶ Type A

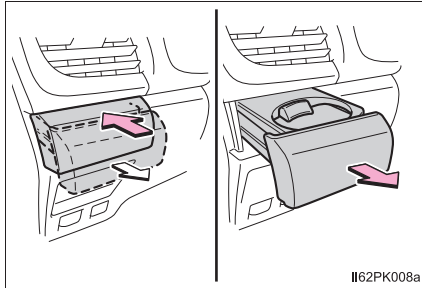

▶ Type B (if equipped)

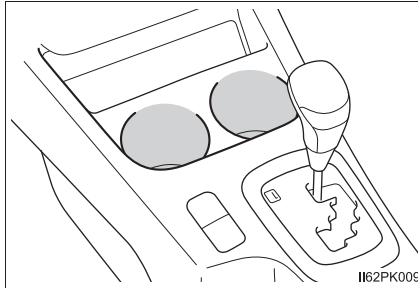

Press in and pull the cup holder.

▶ Type C (if equipped)

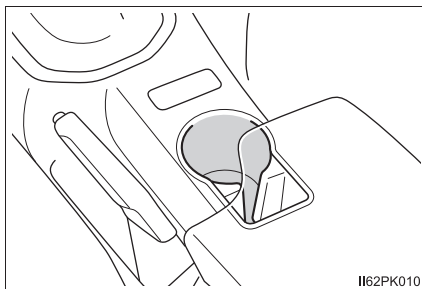

▶ Type D (if equipped)

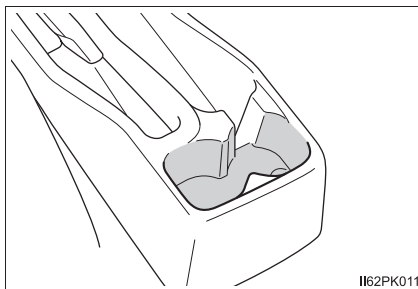

▶ Type E (if equipped)

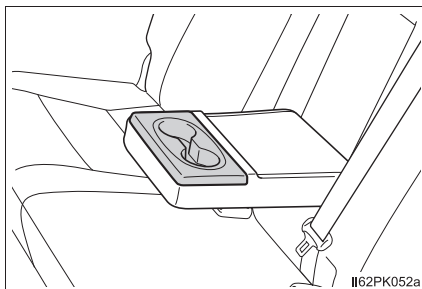

Pull the armrest down.

⚠ WARNING

Do not place anything other than cups or beverage cans in the cup holders. Even when the lid is closed, items must not be stored in the cup holders. Other items may be thrown out of the holders in the event of sudden braking, sudden swerving or an accident, cause injury. If possible, cover hot drinks to prevent burns.

Bottle holders

▶ For front seats

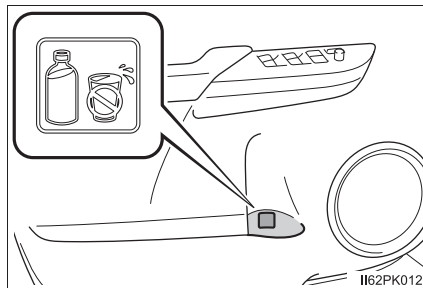

▶ For rear seats (if equipped)

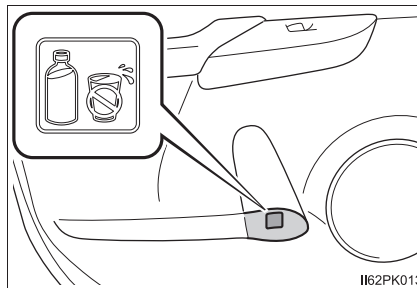

● When using the holder as a bottle holder:

- When storing a bottle, close the cap.
- The bottle may not be stored depending on its size or shape.

⚠ WARNING

Do not place anything other than a bottle in the bottle holders. Other items may be thrown out of the holders in the event of an accident or sudden braking and cause injury.

⚠ NOTICE

Do not place open bottles or glass and paper cups containing liquid in the bottle holders. The contents may spill and glasses may break.

Auxiliary boxes

▶ Type A

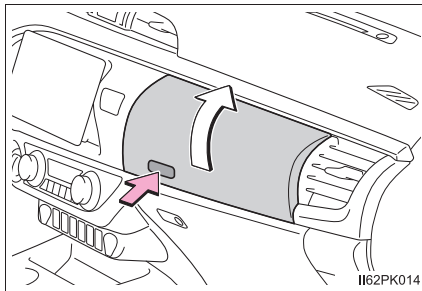

Press the button.

▶ Type B

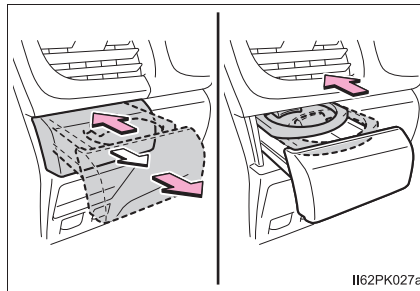

Press in and pull the cup holder, and push the cup tray.

▶ Type C

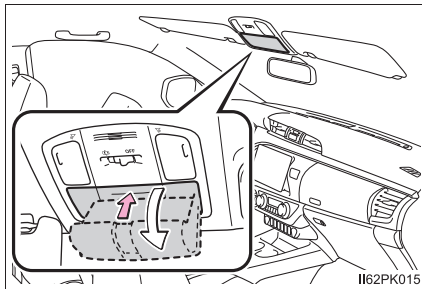

Press in the lid.

The auxiliary box is useful for temporarily storing sunglasses and similar small items.

▶ Type D*

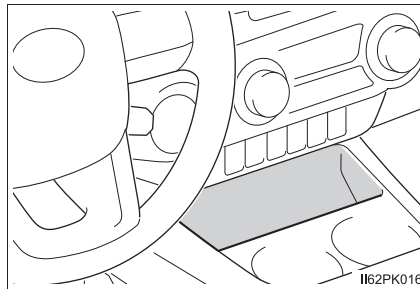

▶ Type E (if equipped)

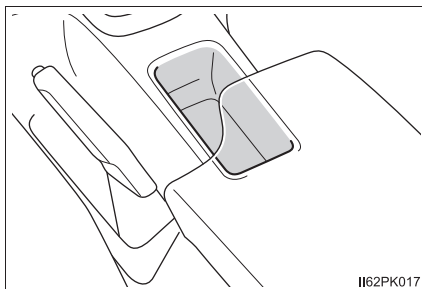

▶ Type F (if equipped)

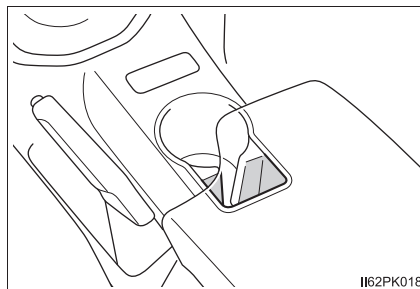

▶ Type G (if equipped)

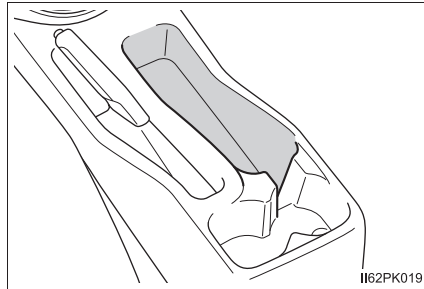

*: The shape of the auxiliary box may differ depending on the grade, etc.

● Air conditioning-linked temperature regulation function (type A) (if equipped):



By introducing air from the air conditioning system into the auxiliary box, canned drinks etc. can be kept hot or cold. However, as the temperature inside the auxiliary box will become the same as the temperature of the air flowing from the air conditioning system, extreme heating and cooling are not possible. In high humidity condition, be careful of objects inside the auxiliary box, as condensation may form.

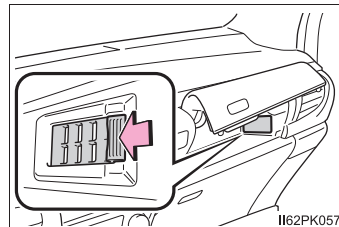

● Using the air conditioning-linked temperature regulation function (type A) (if equipped):

- 1 Open the air intake lid inside the auxiliary box.

To blow a large amount of air into the auxiliary box, close the passenger side vent. (→P. 437, 445)



- 2 Allow the air conditioning system to operate, and use  or  to

select either  or . (→P. 434, 442)

- 3 Adjust the temperature. (→P. 434, 441)

- Normal use (type A) (if equipped):
Close the air intake lid inside the auxiliary box.
- Items unsuitable for the auxiliary box (type A) (if equipped):
 - Drinks in unsealed container
 - Fragile items, perishables or anything with strong odor

 **WARNING**

- Do not store items heavier than 0.2 kg (0.4 lb.).
Doing so may cause the auxiliary box to open and the items inside may fall out, resulting in an accident. (type C)
- Keep the auxiliary boxes closed. In the event of sudden braking, an accident may occur due to an occupant being struck by an open auxiliary box or the items stored inside. (type A, B and C)
- When using the auxiliary boxes, do not use the cup tray.
If a cup, aluminum can or bottle is placed in the auxiliary box, it may be thrown out of the box in the event of an accident or sudden braking, resulting in injury. (type B)

Luggage compartment features

Deck hooks (if equipped)

Deck hooks are provided for securing loose items.

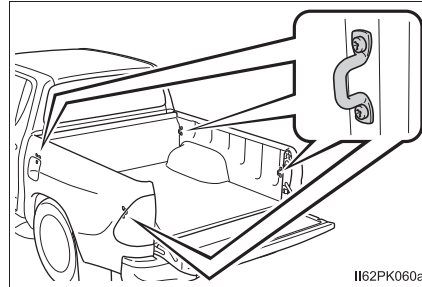

Other interior features

Sun visors

- ① To set the visor in the forward position, flip it down.
- ② To set the visor in the side position, flip down, unhook, and swing it to the side.

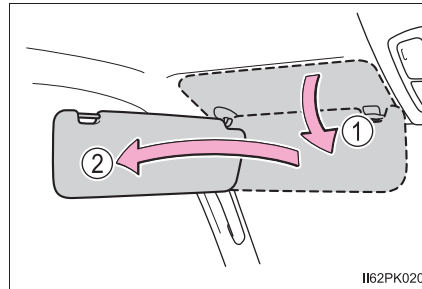

Vanity mirror (if equipped)

Open the cover to use.

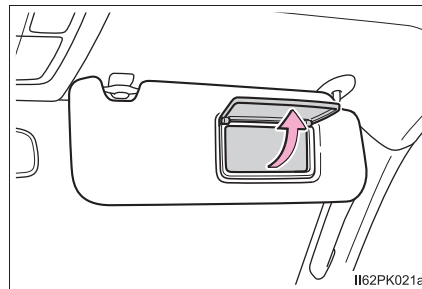

Clock

The clock can be adjusted by pressing the buttons.

- ① Adjusts the hours
- ② Adjusts the minutes
- ③ Rounds to the nearest hour*

*: e.g. 1:00 to 1:29 → 1:00
1:30 to 1:59 → 2:00

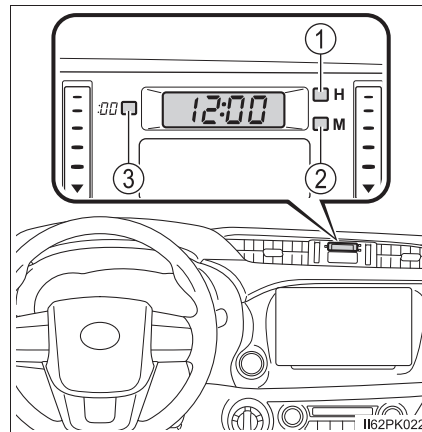

- The clock is displayed when:
 - ▶ Vehicles without smart entry & start system
The engine switch is in the "ACC" or "ON" position.
 - ▶ Vehicles with smart entry & start system
The engine switch is in ACCESSORY or IGNITION ON mode.
- When disconnecting and reconnecting battery terminals:
The time display will automatically be set to 1:00.

Power outlets (if equipped)

The power outlet can be used for the following components:

12 V DC:

Please use as a power supply for electronic goods that use less than 12 V DC / 10 A (power consumption of 120 W).

When using electronic goods, make sure that the power consumption of all the connected power outlets is less than 120 W.

220 V AC:

Accessories that use less than 100 W.

■ 12 V DC

Open the cover.

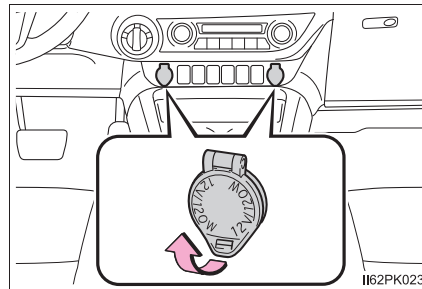

■ 220 V AC

Open the cover.

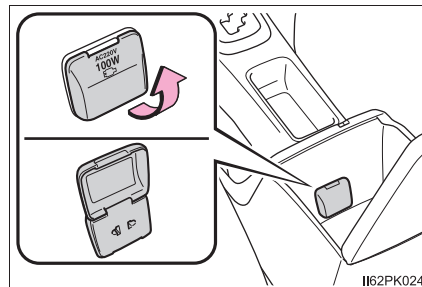

- The power outlet can be used when:
 - ▶ Vehicles without smart entry & start system
 - 12 V DC: The engine switch is in the “ACC” or “ON” position.
 - 220 V AC: The engine switch is in the “ON” position.
 - ▶ Vehicles with smart entry & start system
 - 12 V DC: The engine switch is in ACCESSORY or IGNITION ON mode.
 - 220 V AC: The engine switch is in IGNITION ON mode.
- When turning the engine switch off:
 - Disconnect electrical devices with charging functions, such as mobile battery packs.
 - If such devices are left connected, the engine switch may not be turned off normally.
- Vehicles with Stop & Start system: When the engine restarts after having been stopped by the Stop & Start system, the power outlet may be temporarily unusable, but this is not a malfunction.

 NOTICE

- To avoid damaging the power outlets, close the power outlet lid when the power outlet is not in use.
Foreign objects or liquids that enter the power outlet may cause a short circuit.
- To prevent blown fuse:
 - ▶ 12 V DC
Do not use an accessory that uses more than 12 V 10 A.
 - ▶ 220 V AC
Do not use a 220 V AC appliance that requires more than 100 W.
If a 220 V AC appliance that consumes more than 100 W is used, the protection circuit will cut the power supply.
- To prevent battery discharge, do not use the power outlet longer than necessary when the engine is not running.
- The following 220 V AC appliances may not operate properly even if their power consumption is under 100 W:
 - Appliances with high initial peak wattage
 - Measuring devices that process precise data
 - Other appliances that require an extremely stable power supply

Grocery bag hooks (if equipped)

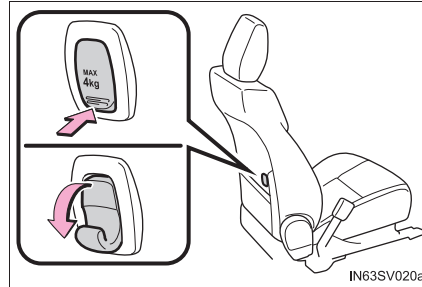

⚠ WARNING

Keep the hooks returned in place when not in use.

⚠ NOTICE

Do not hang any object heavier than 4 kg (8.8 lb.).

Coat hooks (if equipped)

The coat hooks are provided above the back window.

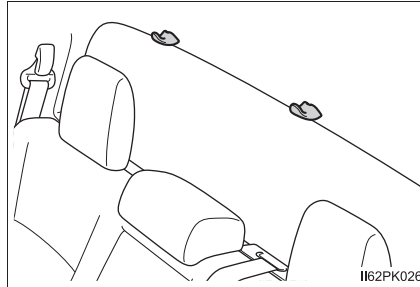
**Armrest (if equipped)**

Fold down the armrest for use.

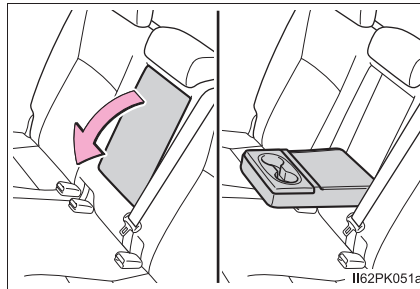
 **NOTICE**

To prevent damage to the armrest, do not apply too much load on the armrest.

Using the steering wheel audio switches*

Some audio features (audio volume control, radio, CD player etc.) can be controlled using the switches on the steering wheel. Operation may differ depending on the type of audio system or navigation system. For details, refer to the manual provided with the audio system or navigation system.

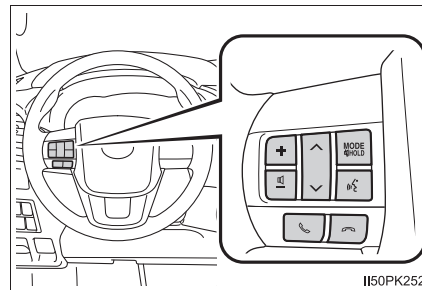

WARNING

■ **To reduce the risk of an accident**

Exercise care when operating the audio switches on the steering wheel.

*: If equipped

Maintenance and care**7**

- 7-1. Maintenance and care**
 - Cleaning and protecting the vehicle exterior472
 - Cleaning and protecting the vehicle interior 476
- 7-2. Maintenance**
 - Maintenance requirements..... 479
- 7-3. Do-it-yourself maintenance**
 - Do-it-yourself service precautions482
 - Hood484
 - Engine compartment..... 486
 - Tires.....507
 - Tire inflation pressure 510
 - Wheels.....512
 - Air conditioning filter514
 - Wireless remote control/ electronic key battery..... 516
 - Checking and replacing fuses520
 - Light bulbs525

Cleaning and protecting the vehicle exterior

Perform the following to protect the vehicle and maintain it in prime condition:

- Working from top to bottom, liberally apply water to the vehicle body, wheel wells and underside of the vehicle to remove any dirt and dust.
- Wash the vehicle body using a sponge or soft cloth, such as a chamois.
- For hard-to-remove marks, use car wash soap and rinse thoroughly with water.
- Wipe away any water.
- Wax the vehicle when the waterproof coating deteriorates.

If water does not bead on a clean surface, apply wax when the vehicle body is cool.

■ Automatic car washes

- Fold the mirrors and remove the antenna (vehicles with short pole antenna) before washing the vehicle. Start washing from the front of the vehicle. Make sure to re-install the antenna and extend the mirrors before driving.
- Brushes used in automatic car washes may scratch the vehicle surface, parts (wheel, etc.) and harm your vehicle's paint.

■ High pressure car washes

As water may enter the cabin, do not bring the nozzle tip near the gaps around the doors or perimeter of the windows, or spray these areas continuously.

■ Wheels and wheel ornaments

- Remove any dirt immediately by using a neutral detergent.
- Wash detergent off with water immediately after use.
- To protect the paint from damage, make sure to observe the following precautions.
 - Do not use acidic, alkaline or abrasive detergent
 - Do not use hard brushes
 - Do not use detergent on the wheels when they are hot, such as after driving or parking in hot weather

■ Brake pads and calipers

Rust may form if the vehicle is parked with wet brake pads or disc rotors, causing them to stick, or causing noises or vibrations. Before parking the vehicle after it is washed, drive slowly and apply the brakes several times to dry the parts.

■ Bumpers

Do not scrub with abrasive cleaners.

■ Plated portions

If dirt cannot be removed, clean the parts as follows:

- Use a soft cloth dampened with an approximately 5% solution of neutral detergent and water to clean the dirt off.
- Wipe the surface with a dry, soft cloth to remove any remaining moisture.
- To remove oily deposits, use alcohol wet wipes or a similar product.



WARNING

■ When washing the vehicle

Do not apply water to the inside of the engine compartment. Doing so may cause the electrical components etc. to catch fire.

■ Precautions regarding the exhaust pipe

Exhaust gases cause the exhaust pipe to become quite hot.

When washing the vehicle, be careful not to touch the pipe until it has cooled sufficiently, as touching a hot exhaust pipe can cause burns.



NOTICE

■ To prevent paint deterioration and corrosion on the body and components (aluminum wheels etc.)

- Wash the vehicle immediately in the following cases:
 - After driving near the sea coast
 - After driving on salted roads
 - If coal tar or tree sap is present on the paint surface
 - If dead insects, insect droppings or bird droppings are present on the paint surface
 - After driving in an area contaminated with soot, oily smoke, mine dust, iron powder or chemical substances
 - If the vehicle becomes heavily soiled with dust or mud
 - If liquids such as benzene and gasoline are spilled on the paint surface
- If the paint is chipped or scratched, have it repaired immediately.
- To prevent the wheels from corroding, remove any dirt and store in a place with low humidity when storing the wheels.

■ Cleaning the exterior lights

- Wash carefully. Do not use organic substances or scrub with a hard brush. This may damage the surfaces of the lights.
- Do not apply wax to the surfaces of the lights. Wax may cause damage to the lenses.

■ Antenna installation and removal precautions (vehicles with short pole antenna)

- Before driving, ensure that the antenna is installed.
- When the antenna is removed, such as before entering an automatic car wash, make sure to store it in a suitable place so as not to lose it. Also, before driving, make sure to reinstall the antenna in its original position.



NOTICE

■ When using a high pressure car wash

- Vehicles with Toyota Safety Sense:
Do not spray water directly on the radar which is equipped behind the emblem. Otherwise it may cause the device to be damaged.
- Do not bring the nozzle tip close to boots (rubber or resin manufactured cover), connectors or the following parts. The parts may be damaged if they come into contact with high-pressure water.
 - Traction related parts
 - Steering parts
 - Suspension parts
 - Brake parts
- Keep the cleaning nozzle at least 30 cm (11.9 in.) away from the vehicle body. Otherwise resin section, such as moldings and bumpers, may be deformed and damaged. Also, do not continuously hold the nozzle in the same place.
- Do not spray the lower part of the windshield continuously.
If water enters the air conditioning system intake located near the lower part of the windshield, the air conditioning system may not operate correctly.
- Do not wash the underside of the vehicle using a high pressure car washer.

Cleaning and protecting the vehicle interior

The following procedures will help protect your vehicle's interior and keep it in top condition:

Protecting the vehicle interior

- Remove dirt and dust using a vacuum cleaner. Wipe dirty surfaces with a cloth dampened with lukewarm water.
- If dirt cannot be removed, wipe it off with a soft cloth dampened with neutral detergent diluted to approximately 1%.
- Wring out any excess water from the cloth and thoroughly wipe off remaining traces of detergent and water.

Cleaning the leather areas

- Remove dirt and dust using a vacuum cleaner.
- Wipe off any excess dirt and dust with a soft cloth dampened with diluted detergent.

Use a diluted water solution of approximately 5% neutral wool detergent.

- Wring out any excess water from the cloth and thoroughly wipe off all remaining traces of detergent.
- Wipe the surface with a dry, soft cloth to remove any remaining moisture. Allow the leather to dry in a shaded and ventilated area.

Cleaning the synthetic leather areas

- Remove dirt and dust using a vacuum cleaner.
- Wipe it off with a soft cloth dampened with neutral detergent diluted to approximately 1%.
- Wring out any excess water from the cloth and thoroughly wipe off remaining traces of detergent and water.

■ Caring for leather areas

Toyota recommends cleaning the interior of the vehicle at least twice a year to maintain the quality of the vehicle's interior.

■ Shampooing the carpets

There are several commercial foaming-type cleaners available. Use a sponge or brush to apply the foam. Rub in overlapping circles. Do not use water. Wipe dirty surfaces and let them dry. Excellent results are obtained by keeping the carpet as dry as possible.

■ Seat belts

Clean with mild soap and lukewarm water using a cloth or sponge. Also check the belts periodically for excessive wear, fraying or cuts.

**WARNING****■ Water in the vehicle**

- Do not splash or spill liquid in the vehicle.
Doing so may cause electrical components etc. to malfunction or catch fire.
- Do not get any of the SRS components or wiring in the vehicle interior wet. (→P. 46)
An electrical malfunction may cause the airbags to deploy or not function properly, resulting in death or serious injury.

■ Cleaning the interior (especially instrument panel)

Do not use polish wax or polish cleaner. The instrument panel may reflect off the windshield, obstructing the driver's view and leading to an accident, resulting in death or serious injury.



NOTICE

■ Cleaning detergents

- Do not use the following types of detergent, as they may discolor the vehicle interior or cause streaks or damage to painted surfaces:
 - Non-seat portions: Organic substances such as benzene or gasoline, alkaline or acidic solutions, dye, and bleach
 - Seats: Alkaline or acidic solutions, such as thinner, benzene, and alcohol
- Do not use polish wax or polish cleaner. The instrument panel's or other interior part's painted surface may be damaged.

■ Preventing damage to leather surfaces

Observe the following precautions to avoid damage to and deterioration of leather surfaces:

- Remove any dust or dirt from leather surfaces immediately.
- Do not expose the vehicle to direct sunlight for extended periods of time. Park the vehicle in the shade, especially during summer.
- Do not place items made of vinyl, plastic, or containing wax on the upholstery, as they may stick to the leather surface if the vehicle interior heats up significantly.

■ Water on the floor

Do not wash the vehicle floor with water.

Vehicle systems such as the audio system may be damaged if water comes into contact with electrical components such as the audio system above or under the floor of the vehicle. Water may also cause the body to rust.

■ When cleaning the inside of the windshield (vehicles with Toyota Safety Sense)

Do not allow glass cleaner to contact the lens. Also, do not touch the lens. (→P. 267)

■ Cleaning the inside of the rear window (vehicles with rear window defogger)

- Do not use glass cleaner to clean the rear window, as this may cause damage to the rear window defogger heater wires. Use a cloth dampened with lukewarm water to gently wipe the window clean. Wipe the window in strokes running parallel to the heater wires.
- Be careful not to scratch or damage the heater wires.

Maintenance requirements

To ensure safe and economical driving, day-to-day care and regular maintenance are essential. Toyota recommends the following maintenance:

Scheduled maintenance

Scheduled maintenance should be performed at specified intervals according to the maintenance schedule.

For full details of your maintenance schedule, refer to the “Toyota Service Booklet” or “Toyota Warranty Booklet”.

Do-it-yourself maintenance

What about do-it-yourself maintenance?

Many maintenance items are easy to do yourself if you have a little mechanical ability and a few basic automotive tools.

Note, however, that some maintenance tasks require special tools and skills. These are best performed by qualified technicians. Even if you're an experienced do-it-yourself mechanic, we recommend that repairs and maintenance be conducted by any authorized Toyota retailer or Toyota authorized repairer, or any reliable repairer. Any authorized Toyota retailer or repairer will keep a record of maintenance, which could be useful should you ever require Warranty Service. Should you choose to select a qualified and equipped professional other than an authorized Toyota repairer to service or maintain your vehicle, we recommend that you request that a record of maintenance be kept.

■ Where to go for maintenance service?

In order to maintain your vehicle in the best possible condition, Toyota recommends that maintenance service operations as well as other inspections and repairs be carried out by authorized Toyota retailers or Toyota authorized repairers, or any reliable repairers. For repairs and services covered by your warranty, please visit an authorized Toyota retailer or repairer, who will use genuine Toyota parts in repairing any difficulties you may encounter. There can also be advantages in utilizing authorized Toyota retailers or repairers for non-warranty repairs and services, as members of the Toyota network will be able to expertly assist you with any difficulties you may encounter.

Your Toyota retailer or Toyota authorized repairer, or any reliable repairer will perform all of the scheduled maintenance on your vehicle reliably and economically due to their experience with Toyota vehicles.

■ Does your vehicle need repairs?

Be on the alert for changes in performance and sounds, and visual tip-offs that indicate service is needed. Some important clues are:

- Engine missing, stumbling or pinging
- Appreciable loss of power
- Strange engine noises
- A fluid leak under the vehicle (However, water dripping from the air conditioning system after use is normal.)
- Change in exhaust sound (This may indicate a dangerous carbon monoxide leak. Drive with the windows open and have the exhaust system checked immediately.)
- Flat-looking tires, excessive tire squeal when cornering, uneven tire wear
- Vehicle pulls to one side when driven straight on a level road
- Strange noises related to suspension movement
- Loss of brake effectiveness, spongy feeling brake pedal or clutch pedal, pedal almost touches the floor, vehicle pulls to one side when braking
- Engine coolant temperature continually higher than normal

If you notice any of these clues, take your vehicle to any authorized Toyota retailer or Toyota authorized repairer, or any reliable repairer as soon as possible. Your vehicle may need adjustment or repair.

 WARNING**■ If your vehicle is not properly maintained**

Improper maintenance could result in serious damage to the vehicle and possible serious injury or death.

■ Handling of the battery

Battery posts, terminals and related accessories contain lead and lead compounds which are known to cause brain damage. Wash your hands after handling. (→P. 494)

Do-it-yourself service precautions

If you perform maintenance by yourself, be sure to follow the correct procedure as given in these sections.

Items	Parts and tools
Battery condition (→P. 494)	<ul style="list-style-type: none"> • Warm water • Baking soda • Grease • Conventional wrench (for terminal clamp bolts) • Distilled water
Engine coolant/ intercooler coolant (if equipped) level (→P. 492)	<ul style="list-style-type: none"> • “Toyota Super Long Life Coolant” or a similar high quality ethylene glycol-based non-silicate, non-amine, non-nitrite and non-borate coolant with long-life hybrid organic acid technology “Toyota Super Long Life Coolant” is pre-mixed with 50% coolant and 50% deionized water. • Funnel (used only for adding coolant)
Engine oil level (→P. 489)	<ul style="list-style-type: none"> • “Toyota Genuine Motor Oil” or equivalent • Rag or paper towel • Funnel (used only for adding engine oil)
Fuses (→P. 520)	<ul style="list-style-type: none"> • Fuse with same amperage rating as original
Light bulbs (→P. 525)	<ul style="list-style-type: none"> • Bulb with same number and wattage rating as original • Phillips-head screwdriver • Flathead screwdriver • Wrench
Radiator, condenser and intercooler (if equipped) (→P. 493)	—
Tire inflation pressure (→P. 510)	<ul style="list-style-type: none"> • Tire pressure gauge • Compressed air source
Washer fluid (→P. 498)	<ul style="list-style-type: none"> • Water or washer fluid containing antifreeze (for winter use) • Funnel (used only for adding water or washer fluid)

 **WARNING**

The engine compartment contains many mechanisms and fluids that may move suddenly, become hot, or become electrically energized. To avoid death or serious injury, observe the following precautions.

■ When working on the engine compartment

- Keep hands, clothing and tools away from the moving fan and engine drive belt.
- Be careful not to touch the engine, radiator, exhaust manifold, etc. right after driving as they may be hot. Oil and other fluids may also be hot.
- Do not leave anything that may burn easily, such as paper and rags, in the engine compartment.
- Do not smoke, cause sparks or expose an open flame to fuel or the battery. Fuel and battery fumes are flammable.
- Be extremely cautious when working on the battery. It contains poisonous and corrosive sulfuric acid.
- Take care because brake fluid can harm your hands or eyes and damage painted surfaces. If fluid gets on your hands or in your eyes, flush the affected area with clean water immediately.
If you still experience discomfort, consult a doctor.

■ Safety glasses

Wear safety glasses to prevent flying or falling material, fluid spray, etc. from getting in your eyes.

 **NOTICE****■ If you remove the air cleaner filter**

Driving with the air cleaner filter removed may cause excessive engine wear due to dirt in the air.

■ If the fluid level is low or high

It is normal for the brake fluid level to go down slightly as the brake pads wear or when the fluid level in the accumulator is high.
If the reservoir needs frequent refilling, it may indicate a serious problem.

Hood

Release the lock from the inside of the vehicle to open the hood.

- 1 Pull the hood lock release lever.

The hood will pop up slightly.

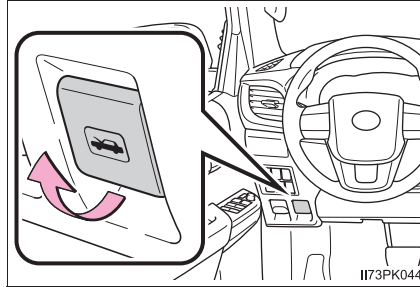

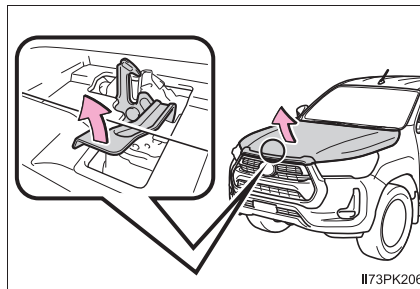

- 2 Pull up the auxiliary catch lever and lift the hood.

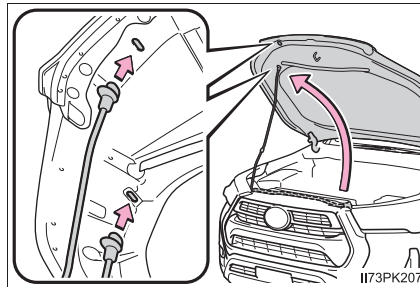

- 3 Hold the hood open by inserting the supporting rod into either of the slots.

Use the upper slots to open the hood normally, or use the lower slots when the hood needs to be opened wide.



 WARNING**■ Pre-driving check**

Check that the hood is fully closed and locked.

If the hood is not locked properly, it may open while the vehicle is in motion and cause an accident, which may result in death or serious injury.

■ After installing the support rod into the slot

Make sure the rod supports the hood securely from falling down on to your head or body.

 NOTICE**■ When closing the hood**

Be sure to return the support rod to its clip before closing the hood. Closing the hood with the support rod up could cause the hood to bend.

Engine compartment

► Gasoline engine

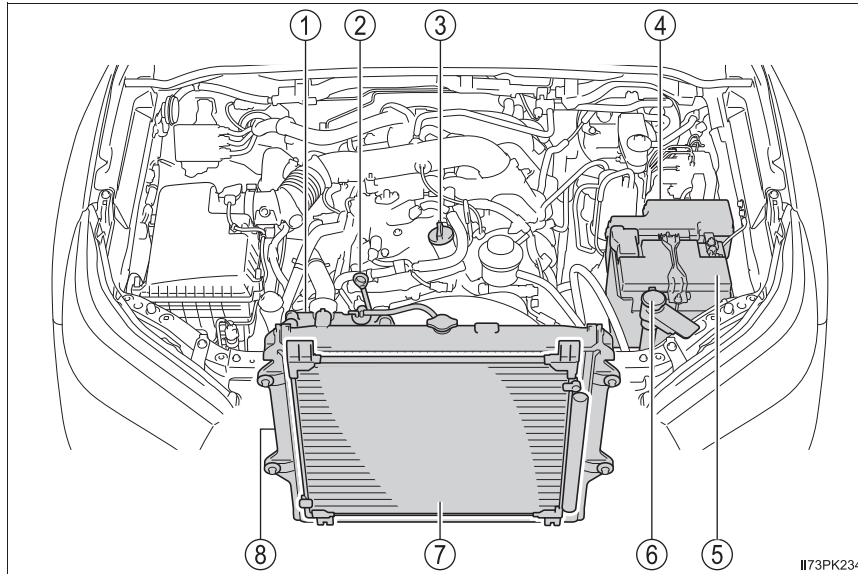

- | | | |
|--|-------------------------------|--|
| ① Engine coolant reservoir
(→P. 492) | ④ Fuse box
(→P. 520) | |
| ② Engine oil level dipstick
(→P. 489) | ⑤ Battery
(→P. 494) | |
| ③ Engine oil filler cap (→P. 490) | ⑥ Washer fluid tank (→P. 498) | |
| | ⑦ Condenser
(→P. 493) | |
| | ⑧ Radiator
(→P. 493) | |

► Diesel engine (vehicles without water-cooled intercooler)

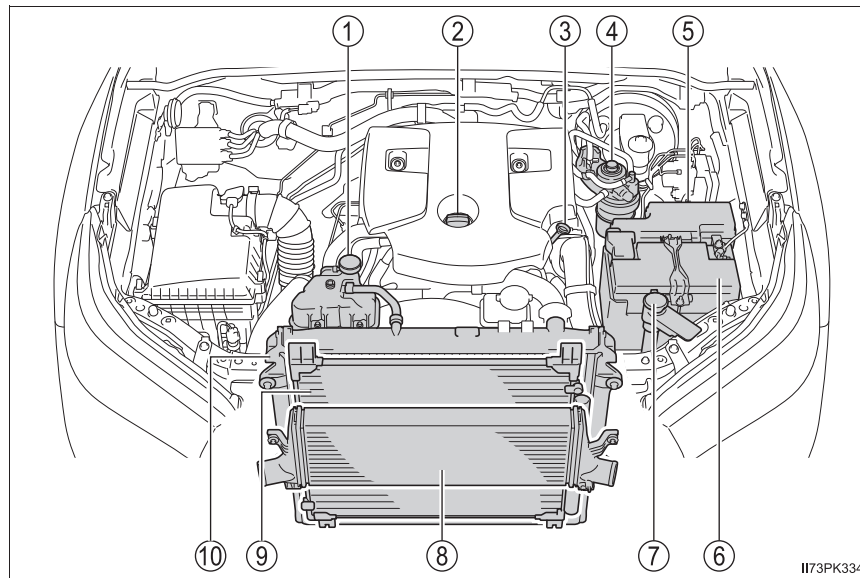

- | | |
|--|--|
| ① Engine coolant reservoir
(→P. 492) | ⑤ Fuse box
(→P. 520) |
| ② Engine oil filler cap (→P. 490) | ⑥ Battery
(→P. 494) |
| ③ Engine oil level dipstick
(→P. 489) | ⑦ Washer fluid tank (→P. 498) |
| ④ Fuel filter (→P. 499, 614) | ⑧ Intercooler
(→P. 493) |
| | ⑨ Condenser (if equipped)
(→P. 493) |
| | ⑩ Radiator
(→P. 493) |

► Diesel engine (vehicles with water-cooled intercooler)

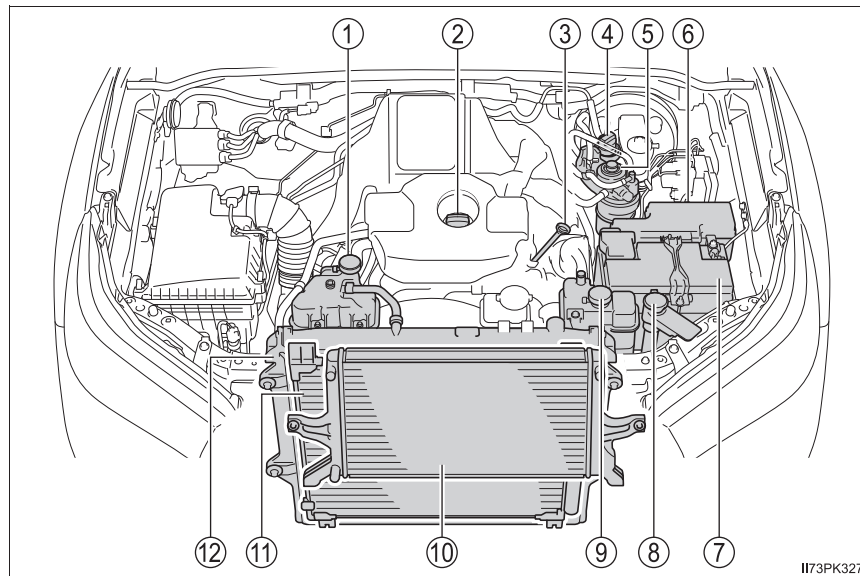

- | | |
|--|--|
| ① Engine coolant reservoir
(→P. 492) | ⑦ Battery
(→P. 494) |
| ② Engine oil filler cap (→P. 490) | ⑧ Washer fluid tank (→P. 498) |
| ③ Engine oil level dipstick
(→P. 489) | ⑨ Intercooler coolant reservoir
(→P. 492) |
| ④ AdBlue™ tank cap (→P. 500) | ⑩ Intercooler cooling radiator
(→P. 493) |
| ⑤ Fuel filter (→P. 499, 614) | ⑪ Condenser (if equipped)
(→P. 493) |
| ⑥ Fuse box (→P. 520) | ⑫ Radiator
(→P. 493) |

Engine oil

With the engine at operating temperature and turned off, check the oil level on the dipstick.

■ Checking the engine oil

- 1 Park the vehicle on level ground. After warming up the engine and turning it off, wait more than 5 minutes for the oil to drain back into the bottom of the engine.
- 2 Remove the sand and dust from around the dipstick.
- 3 Holding a rag under the end, pull the dipstick out.

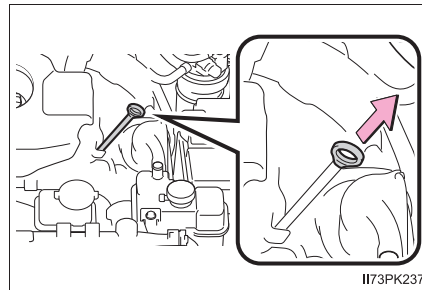

- 4 Wipe the dipstick clean.

Make sure that the inlet of the oil level gauge guide and O-ring of the dipstick are free from sand and dust. If the O-ring is damaged, replace it with a new one.

- 5 Reinsert the dipstick fully.
- 6 Holding a rag under the end, pull the dipstick out and check the oil level.

- ① Low
- ② Normal
- ③ Excessive

The shape of the dipstick may differ depending on the type of vehicle or engine.

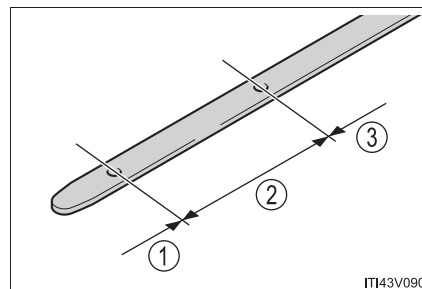

- 7 Wipe the dipstick and reinsert it fully.

■ **Adding engine oil**

If the oil level is below or near the low level mark, add engine oil of the same type as that already in the engine.

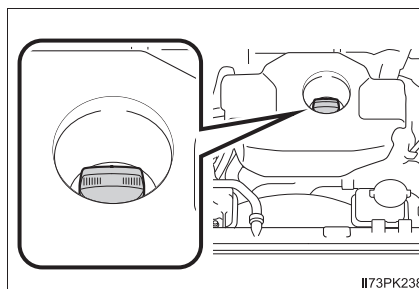

Make sure to check the oil type and prepare the items needed before adding oil.

Engine oil selection	→P. 628
Oil quantity (Low → Full)	1.5 L (1.6 qt., 1.3 Imp.qt.)
Items	Clean funnel

- 1 Remove the sand and dust from around the oil filler cap.
- 2 Remove the oil filler cap by turning it counterclockwise.
- 3 Add engine oil slowly, checking the dipstick.
- 4 Install the oil filler cap by turning it clockwise.

■ **Engine oil consumption**

A certain amount of engine oil will be consumed while driving. In the following situations, oil consumption may increase, and engine oil may need to be refilled in between oil maintenance intervals.

- When the engine is new, for example directly after purchasing the vehicle or after replacing the engine
- If low quality oil or oil of an inappropriate viscosity is used
- When driving at high engine speeds or with a heavy load, when towing (with towing hitch), or when driving while accelerating or decelerating frequently
- When leaving the engine idling for a long time, or when driving frequently through heavy traffic

■ After changing the engine oil (models for model code destination W*)

The engine oil maintenance data should be reset. Perform the following procedures:

- 1 Switch the display to the trip meter A (→P. 132) when the engine switch is in the “ON” position (vehicles without smart entry & start system) or IGNITION ON mode (vehicles with smart entry & start system).
- 2 Turn the engine switch to the “LOCK” position (vehicles without smart entry & start system) or off (vehicles with smart entry & start system).
- 3 While pressing the odometer/trip meter display change button (→P. 132), turn the engine switch to the “ON” position (vehicles without smart entry & start system) or IGNITION ON mode (vehicles with smart entry & start system). (Do not start the engine because reset mode will be canceled.) Continue to press and hold the button for more than one second after the trip meter displays “000000”.

*: See “Checking your vehicle’s model” if you are not sure of which model your vehicle is. (→P. 12)

WARNING

■ Used engine oil

- Used engine oil contains potentially harmful contaminants which may cause skin disorders such as inflammation and skin cancer, so care should be taken to avoid prolonged and repeated contact. To remove used engine oil from your skin, wash thoroughly with soap and water.
- Dispose of used oil and filters only in a safe and acceptable manner. Do not dispose of used oil and filters in household trash, in sewers or onto the ground. Call any authorized Toyota retailer or Toyota authorized repairer, or any reliable repairer, service station or auto parts store for information concerning recycling or disposal.
- Do not leave used engine oil within the reach of children.

NOTICE

■ To prevent serious engine damage

Check the oil level on a regular basis.

■ When replacing the engine oil

- Be careful not to spill engine oil on the vehicle components.
- Avoid overfilling, or the engine could be damaged.
- Check the oil level on the dipstick every time you refill the vehicle.
- Be sure the engine oil filler cap is properly tightened.

Coolant

The coolant level is satisfactory if it is between the “F” and “L” lines on the reservoir when the engine is cold.

■ Engine coolant reservoir

▶ Gasoline engine

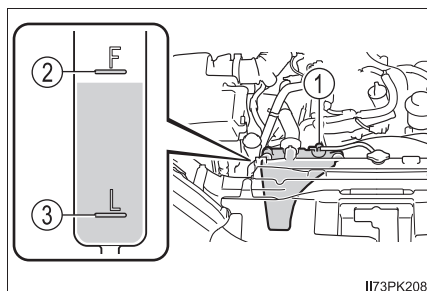

▶ Diesel engine

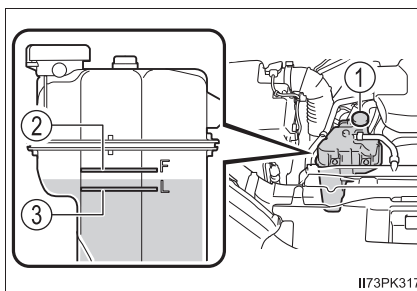

① Reservoir cap

③ “L” line

② “F” line

If the level is on or below the “L” line, add coolant up to the “F” line. (→P. 610)

■ Intercooler coolant reservoir (if equipped)

① Reservoir cap

② “F” line

③ “L” line

If the level is on or below the “L” line, add coolant up to the “F” line. (→P. 610)

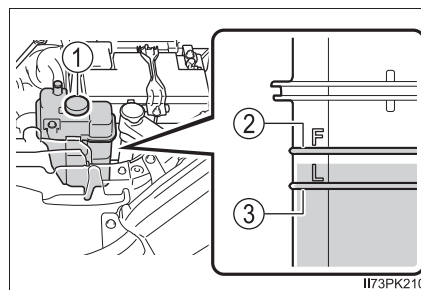

■ Coolant selection

Only use “Toyota Super Long Life Coolant” or a similar high quality ethylene glycol based non-silicate, non-amine, non-nitrite, and non-borate coolant with long-life hybrid organic acid technology.

“Toyota Super Long Life Coolant” is a mixture of 50% coolant and 50% deionized water. (Minimum temperature: -35°C [-31°F])

For more details about engine coolant, contact any authorized Toyota retailer or Toyota authorized repairer, or any reliable repairer.

■ If the coolant level drops within a short time of replenishing

Visually check the radiator, hoses, engine coolant reservoir cap, intercooler coolant reservoir cap (if equipped), drain cock and water pump. If you cannot find a leak, have any authorized Toyota retailer or Toyota authorized repairer, or any reliable repairer test the cap and check for leaks in the cooling system.

WARNING

■ When the engine is hot

Do not remove the radiator cap (if equipped), the engine coolant reservoir cap or intercooler coolant reservoir cap (if equipped). The cooling system may be under pressure and may spray hot coolant if the cap is removed, causing serious injuries, such as burns.

NOTICE

■ When adding coolant

Coolant is neither plain water nor straight antifreeze. The correct mixture of water and antifreeze must be used to provide proper lubrication, corrosion protection and cooling. Be sure to read the antifreeze or coolant label.

■ If you spill coolant

Be sure to wash it off with water to prevent it from damaging parts or paint.

■ Notice on coolant quality

Do not use improper coolant. If improper coolant is used, the engine cooling system may be damaged.

Radiator, condenser and intercooler coolant radiator/intercooler (if equipped)

Check the radiator, condenser and intercooler coolant radiator/intercooler and clear away any foreign objects. If any of the above parts is extremely dirty or you are not sure of their condition, have your vehicle inspected by any authorized Toyota retailer or Toyota authorized repairer, or any reliable repairer.

WARNING

■ When the engine is hot

Do not touch the radiator, condenser or intercooler coolant radiator/intercooler as they may be hot and cause serious injuries, such as burns.

Battery

Check the battery as follows.

■ Battery exterior

Make sure that the battery terminals are not corroded and that there are no loose connections, cracks, or loose clamps.

- ① Terminals
- ② Hold-down clamp

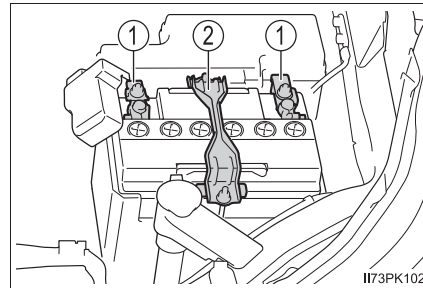

■ Checking battery fluid (vehicles with maintenance type battery)

If there are lines on the side of the battery:

Check that the level is between the upper and lower lines.

- ① Upper line
- ② Lower line

If the fluid level is at or below the lower line, add distilled water.

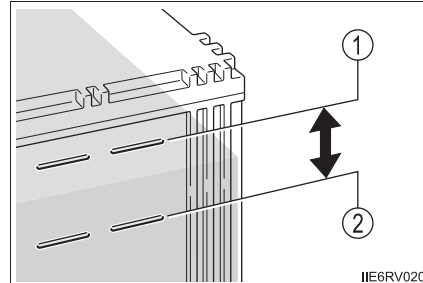

If there are not lines on the side of the battery:
Check the fluid level as follows.

- 1 Remove the vent plug.
- 2 Check the fluid level by looking directly at the cell.
If the fluid level is low, add distilled water.

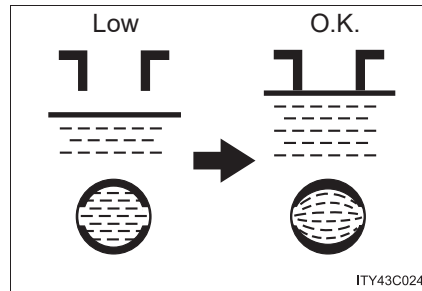

- 3 Put the vent plug back on and close it securely.
- **Adding distilled water (vehicles with maintenance type battery)**
- 1 Remove the vent plug.
 - 2 Add distilled water.
 - 3 Put the vent plug back on and close it securely.

■ Before recharging

When recharging, the battery produces hydrogen gas which is flammable and explosive. Therefore, observe the following before recharging:

- If recharging with the battery installed on the vehicle, be sure to disconnect the ground cable.
- Make sure the power switch on the charger is off when connecting and disconnecting the charger cables to the battery.

■ After recharging/reconnecting the battery (vehicles with smart entry & start system)

The engine may not start. Follow the procedure below to initialize the system.

- 1 Shift the shift lever to P (automatic transmission) or depress the brake pedal with the shift lever in N (manual transmission).
- 2 Open and close any of the doors.
- 3 Restart the engine.
 - Unlocking the doors using the smart entry & start system may not be possible immediately after reconnecting the battery. If this happens, use the wireless remote control or the mechanical key to lock/unlock the doors.
 - Start the engine with the engine switch in ACCESSORY mode. The engine may not start with the engine switch turned off. However, the engine will operate normally from the second attempt.
 - The engine switch mode is recorded by the vehicle. If the battery is reconnected, the vehicle will return the engine switch mode to the status it was in before the battery was disconnected. Make sure to turn off the engine before disconnect the battery. Take extra care when connecting the battery if the engine switch mode prior to discharge is unknown.

If the system will not start even after multiple attempts, contact any authorized Toyota retailer or Toyota authorized repairer, or any reliable repairer.

■ If a symbol of a battery is shown on the multi-information display

There is a malfunction in the vehicle's charging system.

Immediately stop the vehicle in a safe place and contact any authorized Toyota retailer or Toyota authorized repairer, or any reliable repairer. Continuing to drive the vehicle may be dangerous.

 **WARNING****■ Chemicals in the battery**

Batteries contain poisonous and corrosive sulfuric acid and may produce hydrogen gas which is flammable and explosive. To reduce the risk of death or serious injury, take the following precautions while working on or near the battery:

- Do not cause sparks by touching the battery terminals with tools.
- Do not smoke or light a match near the battery.
- Avoid contact with eyes, skin and clothes.
- Never inhale or swallow electrolyte.
- Wear protective safety glasses when working near the battery.
- Keep children away from the battery.

■ Where to safely charge the battery

Always charge the battery in an open area. Do not charge the battery in a garage or closed room where there is insufficient ventilation.

■ How to recharge the battery (vehicles with maintenance-free type battery)

Only perform a slow charge (5 A or less). The battery may explode if charged at a quicker rate.

■ Emergency measures regarding electrolyte

- If electrolyte gets in your eyes
Flush your eyes with clean water for at least 15 minutes and get immediate medical attention. If possible, continue to apply water with a sponge or cloth while traveling to the nearest medical facility.
- If electrolyte gets on your skin
Wash the affected area thoroughly. If you feel pain or burning, get medical attention immediately.
- If electrolyte gets on your clothes
It can soak through clothing on to your skin. Immediately take off the clothing and follow the procedure above if necessary.
- If you accidentally swallow electrolyte
Drink a large quantity of water or milk. Get emergency medical attention immediately.
- When there is insufficient battery fluid
Do not use if there is insufficient fluid in the battery. There is a possible danger that the battery may explode.

■ When disconnecting the battery

Do not disconnect the negative (-) terminal on the body. The disconnected negative (-) terminal may touch the positive (+) terminal, which may cause a short and result in death or serious injury.

 NOTICE

■ **When recharging the battery**

Never recharge the battery while the engine is running. Also, be sure all accessories are turned off.

■ **When adding distilled water (vehicles with maintenance type battery)**

Avoid overfilling. Water spilled during battery recharging may cause corrosion.

Washer fluid

Add washer fluid in the following situations:

- A washer does not work.
- The warning message appears on the multi-information display (if equipped).

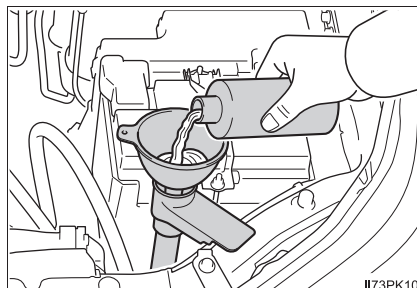

 WARNING

■ **When adding washer fluid**

Do not add washer fluid when the engine is hot or running as washer fluid contains alcohol and may catch fire if spilled on the engine etc.

 NOTICE

■ **Do not use any fluid other than washer fluid**

Do not use soapy water or engine antifreeze instead of washer fluid. Doing so may cause streaking on the vehicle's painted surfaces as well as damaging the pump leading to problems of the washer fluid not spraying.

■ **Diluting washer fluid**

Dilute washer fluid with water as necessary. Refer to the freezing temperatures listed on the label of the washer fluid bottle.

Fuel filter (diesel engine only)

You may drain the fuel filter yourself. However, as the operation is difficult, we recommend having it drained by any authorized Toyota retailer or Toyota authorized repairer, or any reliable repairer. Even if you decide to drain it yourself, contact any authorized Toyota retailer or Toyota authorized repairer, or any reliable repairer.

The water in the fuel filter needs to be drained if one of the following symptoms occurs:

- ▶ Vehicles without multi-information display
When the fuel system warning light flashes and a buzzer sounds.
(→P. 569)
- ▶ Vehicles with multi-information display
When “Water accumulation in fuel filter See owner’s manual” is shown on the multi-information display and a buzzer sounds*1.

- 1 Vehicles without smart entry & start system: Turn the engine switch to the “LOCK” position.
Vehicles with smart entry & start system: Turn the engine switch off.
- 2 Place a small tray under the drain plug or drain hose to catch the water and any fuel that comes out.
- 3 Perform the draining as shown in the illustration.

- ① Turn the drain plug counter-clockwise about 2 to 2 1/2 turns.
Loosening more than this will cause water oozing from around the drain plug.
- ② Operate the priming pump until fuel begins to run out.

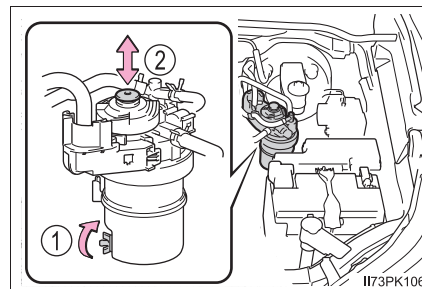

- 4 After draining, tighten the drain plug by hand.

*1: Models for model code destination Blank*2

*2: See “Checking your vehicle’s model” if you are not sure of which model your vehicle is. (→P. 12)

AdBlue™ (if equipped)

AdBlue™ is used to reduce the amount of nitrogen oxides in exhaust gas. Make sure to observe the following precautions regarding AdBlue™.

- AdBlue™ is consumed in the process of driving.
- When AdBlue™ is depleted, the engine cannot be restarted.
- When AdBlue™ needs to be refilled, have it refilled at any authorized Toyota retailer or Toyota authorized repairer, or any reliable repairer.

It may be a criminal offence to use a vehicle that does not consume any reagent if it is required for the reduction of emissions.

■ **Possible driving range**

The amount of AdBlue™ that is consumed while driving differs according to the driving conditions and driving environment. When the amount of AdBlue™ that is consumed increases, the possible driving range until it is necessary to refill AdBlue™ decreases.

Possible driving range		
Short*1		Long
<p>[High-load driving]</p> <ul style="list-style-type: none"> • When your vehicle is towing a trailer (with towing hitch) • When firmly depressing the accelerator pedal • When driving on long uphill slopes • When the DPF system is operating 	<p>[Normal driving]*2</p>	<p>[Low-load driving]</p> <ul style="list-style-type: none"> • When driving short distances • When in traffic congestion

*1: When the vehicle is used at high elevations and in low temperatures, the amount of AdBlue™ that is consumed increases.

*2: During normal driving, 1.0 L (1.1 qt., 0.9 Imp.qt.) of AdBlue™ is consumed approximately every 600 km (373 miles). Also, after a full refill, the vehicle can be driven for approximately 10000 km (6214 miles) before all AdBlue™ is depleted.

■ AdBlue™ warning light and warning message

When the AdBlue™ level is low, the low AdBlue™ level warning light turns on and a warning message appears on the multi-information display. (→P. 502)

When the possible driving range based on the remaining amount of AdBlue™ reaches approximately 2400 km (1492 miles), the low AdBlue™ level warning light turns on and a warning message is displayed.

When refilling AdBlue™ by yourself in an emergency, be sure to follow the correct refilling procedures. (→P. 503)

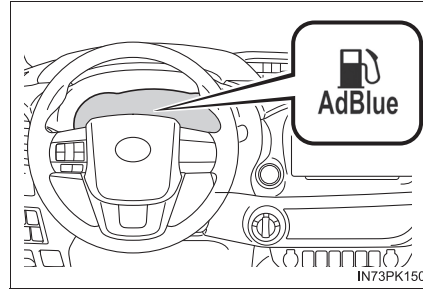

■ **Warning message**

If the following warning message is displayed on the multi-information display, follow the appropriate troubleshooting procedure.

Warning message	Details/Actions
“AdBlue Level Low Fill up AdBlue in 2400 km See Owner’s Manual” ^{*1}	When AdBlue™ needs to be refilled → Have AdBlue™ refilled at any authorized Toyota retailer or Toyota authorized repairer, or any reliable repairer.
“AdBlue level Low No start in 800 km Top up AdBlue See Owner’s Manual” ^{*1, 2}	When AdBlue™ needs to be refilled If the displayed driving distance is exceeded, the engine cannot be restarted. → Have AdBlue™ refilled at any authorized Toyota retailer or Toyota authorized repairer, or any reliable repairer immediately.
“AdBlue empty Unable to Restart Engine Fill up AdBlue See Owner’s Manual” ^{*2}	When AdBlue™ needs to be refilled → If the engine is stopped, it cannot be restarted. Without stopping the engine, contact any authorized Toyota retailer or Toyota authorized repairer, or any reliable repairer immediately.

*1: Use the driving range as a reference. The possible driving range that is displayed may differ from the actual driving range depending on the refill method, driving conditions and driving environment. (→P. 500)

*2: The master warning light turns on and the buzzer sounds in accordance with the warning message.

■ **AdBlue™ gauge**

The quantity of AdBlue™ remaining in the tank is displayed on the multi-information display. (→P. 137)

 NOTICE
<p>■ When the AdBlue™ level is low</p> <p>When AdBlue™ is depleted, the engine cannot be restarted. Be sure to have AdBlue™ refilled at any authorized Toyota retailer or Toyota authorized repairer, or any reliable repairer before it is completely depleted.</p>

■ Refilling AdBlue™ by yourself in an emergency

When the engine cannot be restarted due to the depletion of AdBlue™, adding approximately 11.0 L (11.6 qt., 9.7 Imp.qt.) or more of AdBlue™ will allow the engine to be started again. Perform the following procedures to refill AdBlue™. (The AdBlue™ tank has a capacity of 17.0 L [18.0 qt., 15.0 Imp.qt.])

▶ Refilling with the refilling equipment

1 Park the vehicle on a level surface, turn the engine switch off, and then open the hood. (→P. 484)

2 Open the AdBlue™ tank cap.

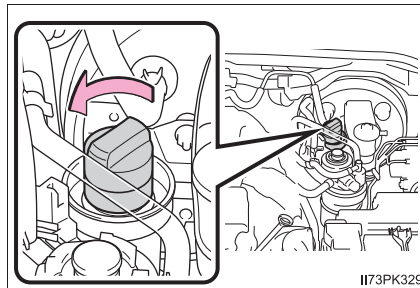

3 Insert the nozzle and refill AdBlue™.

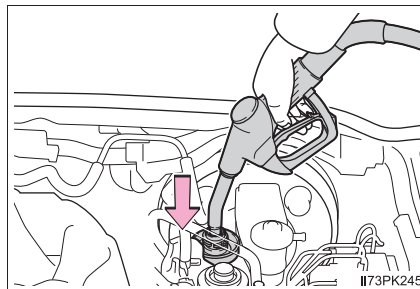

4 Close the AdBlue™ tank cap.
Turn the cap until you hear a click.

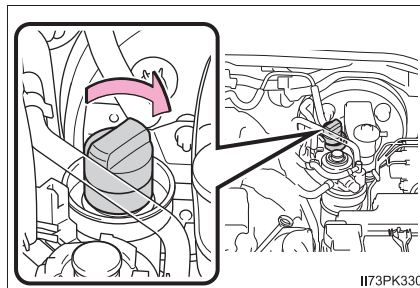

5 Check that the engine starts.

► Refilling with the bottle

- 1 Park the vehicle on a level surface, turn the engine switch off, and then open the hood. (→P. 484)
- 2 Open the AdBlue™ tank cap.

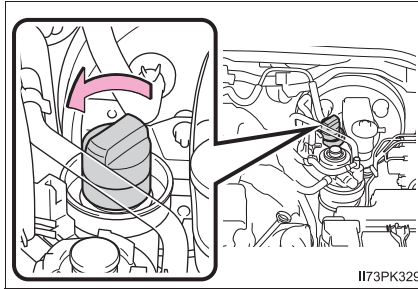

- 3 Insert a bottle of AdBlue™ and fully tighten it.

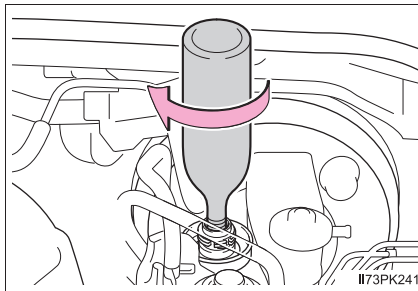

- 4 Push down on the bottle.
AdBlue™ will begin to be refilled. Refill AdBlue™ slowly so that it does not spill. Do not remove the bottle until it is empty.

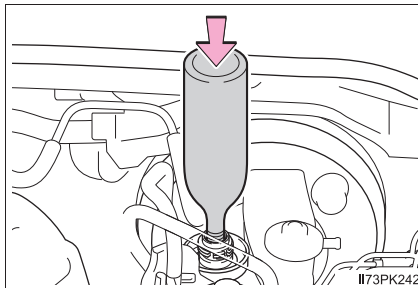

- 5 Check that no AdBlue™ remains in the bottle, and then remove it.
Repeat steps 3 to 5 until approximately 11.0 L (11.6 qt., 9.7 Imp.qt.) or more of AdBlue™ have been refilled.

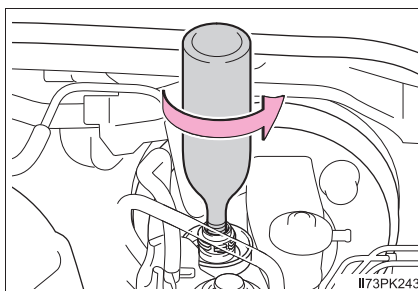

- 6 Close the AdBlue™ tank cap.
Turn the cap until you hear a click.

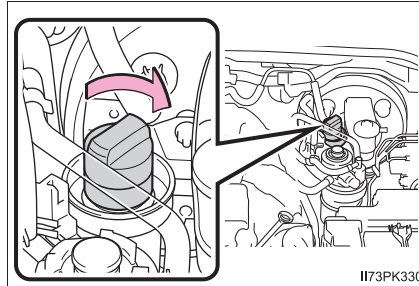

- 7 Check that the engine starts.
The way of refilling may differ from those shown in the illustration.

■ Refilling AdBlue™

- Use AdBlue™ (compliant with ISO 22241-1).
AdBlue™ is a trademark of the German Association of the Automotive Industry (VDA).
- Before driving for a long period of time in an area where AdBlue™ cannot be refilled, consult any authorized Toyota retailer or Toyota authorized repairer, or any reliable repairer.

■ When refilling AdBlue™

After refilling AdBlue™, the engine may take a few seconds longer than normal to start.



NOTICE

■ When refilling AdBlue™

Observe the following precautions.

Failure to do so may result in damage to the vehicle parts, paint, etc.

- Do not use urea solution other than AdBlue™.
- If AdBlue™ comes into contact with any painted surfaces on the vehicle, immediately wash the affected areas with water.
- If AdBlue™ is spilled inside the engine compartment, immediately wipe it with a wet cloth.

■ When refilling AdBlue™ with the refilling equipment

Observe the following precautions to prevent AdBlue™ overflowing from the AdBlue™ tank:

- Securely insert the nozzle into the AdBlue™ filler neck.
- Stop filling the tank after the nozzle automatically clicks off.
- Do not top off the AdBlue™ tank.

■ When storing AdBlue™ containers

Observe the following precautions.

Failure to do so may result in damage to vehicle parts, paint, etc., and changes in the chemical compounds of AdBlue™ may cause unpleasant odors.

- Do not leave AdBlue™ containers inside the vehicle.
- Tightly seal AdBlue™ containers and store them in a cool, dry location with good ventilation and no exposure to direct sunlight.

Tires

Replace or rotate tires in accordance with maintenance schedules and treadwear.

Checking tires

Check if the treadwear indicators are showing on the tires. Also check the tires for uneven wear, such as excessive wear on one side of the tread.

Check the spare tire condition and pressure if not rotated.

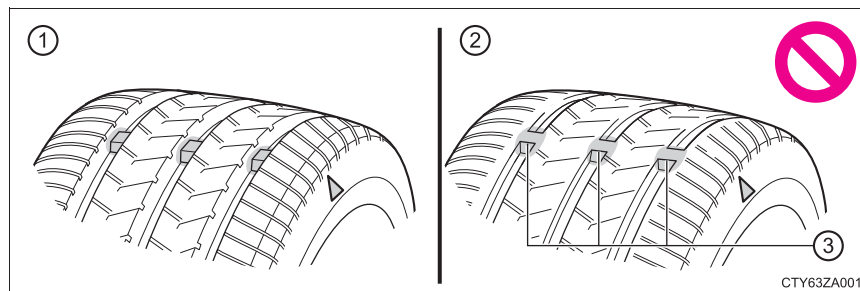

- ① New tread
- ② Worn tread
- ③ Treadwear indicator

The location of treadwear indicators is shown by a "TWI" or "Δ" mark, etc., molded into the sidewall of each tire.

Replace the tires if the treadwear indicators are showing on a tire.

Tire rotation

Rotate the tires in the order shown.

- ▶ Vehicles with spare tire of a different wheel type from the installed tires
- ▶ Vehicles with spare tire of the same wheel type as the installed tires

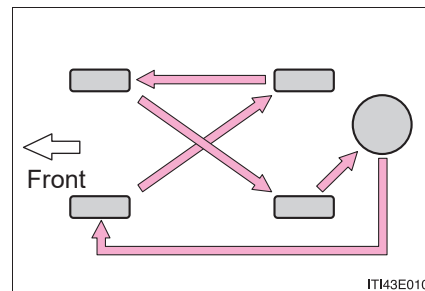
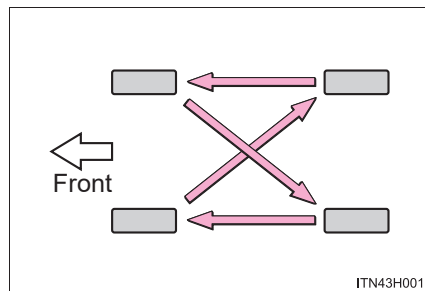

To equalize tire wear and help extend tire life, Toyota recommends that tire rotation is carried out approximately every 10000 km (6000 miles).

■ When to replace your vehicle's tires

Tires should be replaced if:

- The treadwear indicators are showing on a tire.
- You have tire damage such as cuts, splits, cracks deep enough to expose the fabric, and bulges indicating internal damage
- A tire goes flat repeatedly or cannot be properly repaired due to the size or location of a cut or other damage

If you are not sure, consult with any authorized Toyota retailer or Toyota authorized repairer, or any reliable repairer.

■ Tire life

Any tire over 6 years old must be checked by a qualified technician even if it has seldom or never been used or damage is not obvious.

■ If the tread on snow tires wears down below 4 mm (0.16 in.)

The effectiveness of the tires as snow tires is lost.

 WARNING**■ When inspecting or replacing tires**

Observe the following precautions to prevent accidents. Failure to do so may cause damage to parts of the drive train as well as dangerous handling characteristics, which may lead to an accident resulting in death or serious injury.

- Do not mix tires of different makes, models or tread patterns. Also, do not mix tires of remarkably different treadwear.
- Do not use tire sizes other than those recommended by Toyota.
- Do not mix differently constructed tires (radial, bias-belted or bias-ply tires).
- Do not mix summer, all season and snow tires.
- Do not use tires that have been used on another vehicle. Do not use tires if you do not know how they were used previously.

 NOTICE**■ Driving on rough roads**

Take particular care when driving on roads with loose surfaces or potholes. These conditions may cause losses in tire inflation pressure, reducing the cushioning ability of the tires. In addition, driving on rough roads may cause damage to the tires themselves, as well as the vehicle's wheels and body.

■ If tire inflation pressure of each tire becomes low while driving

Do not continue driving, or your tires and/or wheels may be ruined.

Tire inflation pressure

Make sure to maintain proper tire inflation pressure. Tire inflation pressure should be checked at least once per month. However, Toyota recommends that tire inflation pressure be checked once every two weeks. (→P. 639)

■ Effects of incorrect tire inflation pressure

Driving with incorrect tire inflation pressure may result in the following:

- Reduced fuel economy
- Reduced driving comfort and poor handling
- Reduced tire life due to wear
- Reduced safety
- Damage to the drive train

If a tire needs frequent inflating, have it checked by any authorized Toyota retailer or Toyota authorized repairer, or any reliable repairer.

■ Instructions for checking tire inflation pressure

When checking tire inflation pressure, observe the following:

- Check only when the tires are cold.
If your vehicle has been parked for at least 3 hours or has not been driven for more than 1.5 km or 1 mile, you will get an accurate cold tire inflation pressure reading.
- Always use a tire pressure gauge.
It is difficult to judge if a tire is properly inflated based only on its appearance.
- It is normal for the tire inflation pressure to be higher after driving as heat is generated in the tire. Do not reduce tire inflation pressure after driving.
- Passengers and luggage weight should be placed so that the vehicle is balanced.

 WARNING**■ Proper inflation is critical to save tire performance**

Keep your tires properly inflated.

If the tires are not properly inflated, the following conditions may occur which could lead to an accident resulting in death or serious injury:

- Excessive wear
- Uneven wear
- Poor handling
- Possibility of blowouts resulting from overheated tires
- Air leaking from between tire and wheel
- Wheel deformation and/or tire damage
- Greater possibility of tire damage while driving (due to road hazards, expansion joints, sharp edges in the road, etc.)

 NOTICE**■ When inspecting and adjusting tire inflation pressure**

Be sure to put the tire valve caps back on.

If a valve cap is not installed, dirt or moisture may get into the valve and cause an air leak, resulting in decreased tire inflation pressure.

Wheels

If a wheel is bent, cracked or heavily corroded, it should be replaced. Otherwise, the tire may separate from the wheel or cause a loss of handling control.

Wheel selection

When replacing wheels, care should be taken to ensure that they are equivalent to those removed in load capacity, diameter, rim width and inset*.

Replacement wheels are available at any authorized Toyota retailer or Toyota authorized repairer, or any reliable repairer.

*: Conventionally referred to as "offset".

Toyota does not recommend using the following:

- Wheels of different sizes or types
- Used wheels
- Bent wheels that have been straightened

Aluminum wheel precautions (if equipped)

- Use only Toyota wheel nuts and wrenches designed for use with your aluminum wheels.
- When rotating, repairing or changing your tires, check that the wheel nuts are still tight after driving 1600 km (1000 miles).
- Be careful not to damage the aluminum wheels when using tire chains.
- Use only Toyota genuine balance weights or equivalent and a plastic or rubber hammer when balancing your wheels.

 **WARNING****■ When replacing wheels**

- Do not use wheels that are a different size from those recommended in the Owner's Manual, as this may result in a loss of handling control.
- Never use an inner tube in a leaking wheel which is designed for a tubeless tire. Doing so may result in an accident, causing death or serious injury.

■ When installing the wheel nuts

- Be sure to install the wheel nuts with the tapered ends facing inward. (→P. 592) Installing the nuts with the tapered ends facing outward can cause the wheel to break and eventually cause the wheel to come off while driving, which could lead to an accident resulting in death or serious injury.
- Never use oil or grease on the wheel bolts or wheel nuts. Oil and grease may cause the wheel nuts to be excessively tightened, leading to bolt or disc wheel damage. In addition, the oil or grease can cause the wheel nuts to loosen and the wheel may fall off, causing an accident and resulting in death or serious injury. Remove any oil or grease from the wheel bolts or wheel nuts.

■ Use of defective wheels prohibited

Do not use cracked or deformed wheels.
Doing so could cause the tire to leak air during driving, possibly causing an accident.

Air conditioning filter

The air conditioning filter must be changed regularly to maintain air conditioning efficiency.

Removal method

- 1 Vehicles without smart entry & start system: Turn the engine switch to the "LOCK" position.
Vehicles with smart entry & start system: Turn the engine switch off.

- 2 Open the glove box. Turn the claws as shown in the illustration.

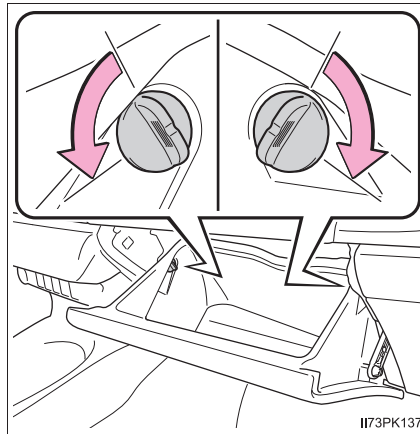

- 3 Pull out the claws.

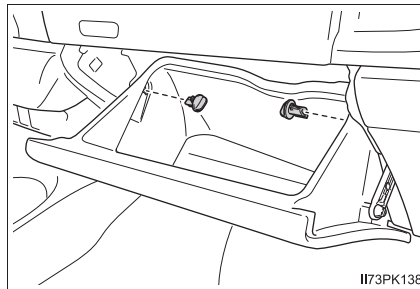

- 4 Pull out the damper (if equipped) as shown in the illustration, and then remove the glove box.

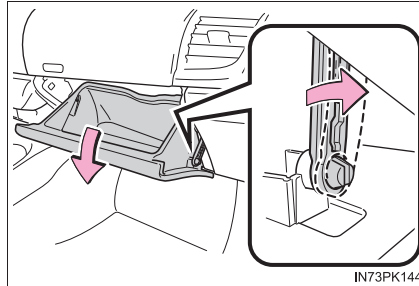

- 5 Remove the filter cover.

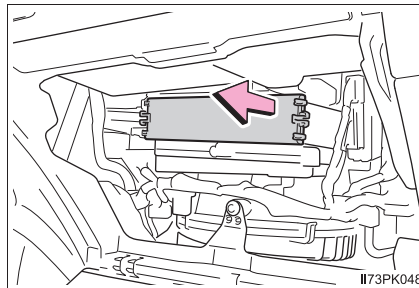

- 6 Remove the air conditioning filter and replace it with a new one.

The “↑UP” marks shown on the filter should be pointing up.

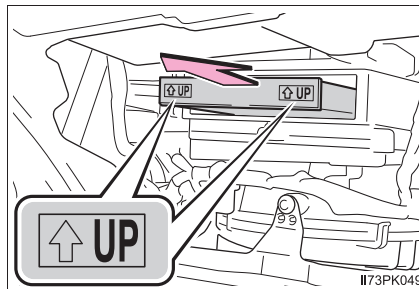

■ Changing interval

Inspect and replace the air conditioning filter according to the maintenance schedule. In dusty areas or areas with heavy traffic flow, early replacement may be required. (For scheduled maintenance information, please refer to the “Toyota Service Booklet” or “Toyota Warranty Booklet”.)

■ If air flow from the vents decreases dramatically

The filter may be clogged. Check the filter and replace if necessary.

⚠ NOTICE

■ When using the air conditioning system

Make sure that a filter is always installed.
Using the air conditioning system without a filter may cause damage to the system.

Wireless remote control/electronic key battery*

Replace the battery with a new one if it is depleted.

You will need the following items:

- Flathead screwdriver
- Small flathead screwdriver
- Lithium battery

Vehicles without smart entry & start system: CR1620

Vehicles with smart entry & start system: CR2032

Replacing the battery

► Vehicles without smart entry & start system

- 1 Remove the cover.

To prevent damage to the key, cover the tip of the screwdriver with a rag.

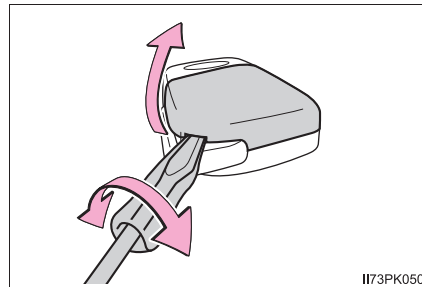

- 2 Remove the battery cover.

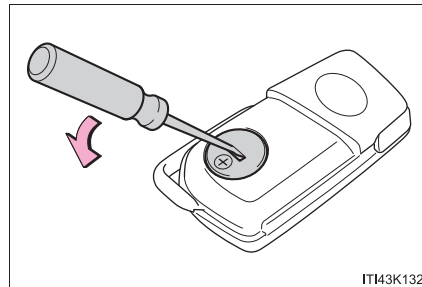

*: If equipped

- 3 Remove the depleted battery.
Insert a new battery with the "+" terminal facing up.

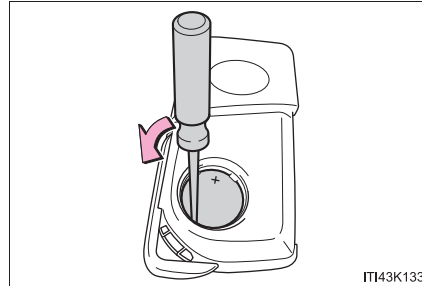

► Vehicles with smart entry & start system

- 1 Take out the mechanical key.

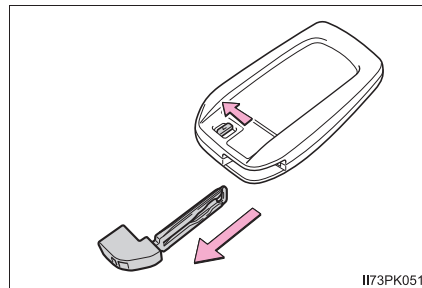

- 2 Remove the cover.
To prevent damage to the key, cover the tip of the screwdriver with a rag.

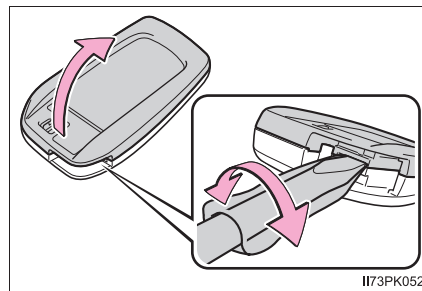

- 3 Remove the depleted battery.
Insert a new battery with the "+" terminal facing up.

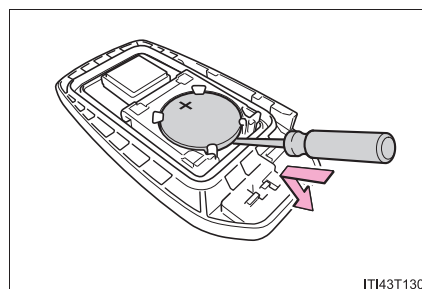

■ Use a lithium battery

Vehicles without smart entry & start system: CR1620

Vehicles with smart entry & start system: CR2032

- Batteries can be purchased at any authorized Toyota retailer or Toyota authorized repairer, or any reliable repairer, local electrical appliance shops or camera stores.
- Replace only with the same or equivalent type recommended by the manufacturer.
- Dispose of used batteries according to local laws.

■ If the key battery is depleted

The following symptoms may occur:

- The smart entry & start system (if equipped) and wireless remote control will not function properly.
- The operational range will be reduced.

⚠ WARNING**■ Battery precautions**

Observe the following precautions.

Failure to do so may result in death or serious injury.

- Do not swallow the battery. Doing so may cause chemical burns.
- A coin battery or button battery is used in the electronic key. If a battery is swallowed, it may cause severe chemical burns in as little as 2 hours and may result in death or serious injury.
- Keep away new and removed batteries from children.
- If the cover cannot be firmly closed, stop using the electronic key and stow the key in the place where children cannot reach, and then contact any authorized Toyota retailer or Toyota authorized repairer, or any reliable repairer.
- If you accidentally swallow a battery or put a battery into a part of your body, get emergency medical attention immediately.

■ To prevent battery explosion or leakage of flammable liquid or gas

- Replace the battery with a new battery of the same type. If a wrong type of battery is used, it may explode.
- Do not expose batteries to extremely low pressure due to high altitude or extremely high temperatures.
- Do not burn, break or cut a battery.



NOTICE

■ For normal operation after replacing the battery

Observe the following precautions to prevent accidents:

- Always work with dry hands.
Moisture may cause the battery to rust.
- Do not touch or move any other component inside the remote control.
- Do not bend either of the battery terminals.

Checking and replacing fuses

If any of the electrical components do not operate, a fuse may have blown. If this happens, check and replace the fuses as necessary.

- 1 Vehicles without smart entry & start system:
Turn the engine switch to the "LOCK" position.
Vehicles with smart entry & start system:
Turn the engine switch off.

- 2 Open the fuse box cover.

- ▶ In the engine compartment

Push the tab in and pull the lock release, and lift the lid off.

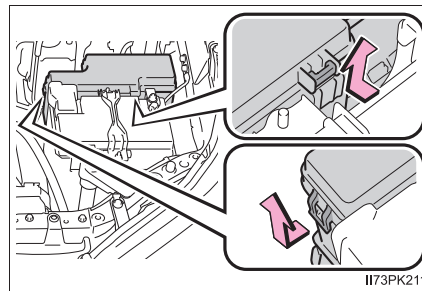

- ▶ Under the instrument panel (left-hand drive vehicles)

Remove the lid.

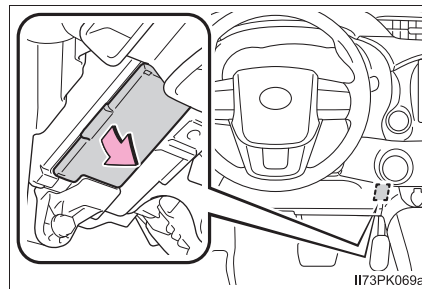

► Under the instrument panel (right-hand drive vehicles)

Remove the cover (if equipped).

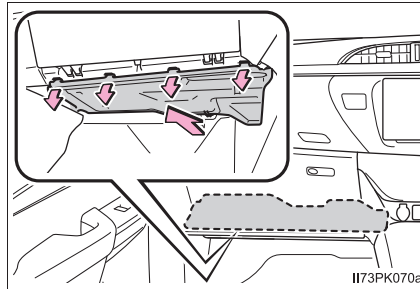

Remove the lid.

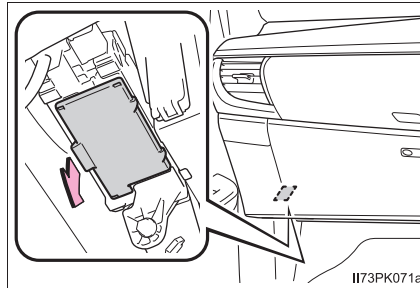

► Behind the instrument panel (left-hand drive vehicles)

Remove the glove box (→P. 514), and remove the lid.

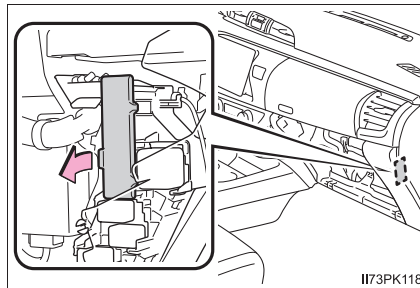

► Behind the instrument panel (right-hand drive vehicles)

Remove the glove box (→P. 514), and remove the lid.

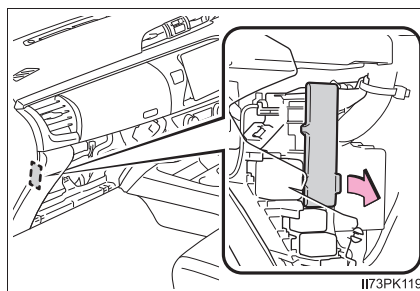

► Behind the cowl side panel

Remove the driver's door scuff plate (left-hand drive vehicles) or the front passenger's door scuff plate (right-hand drive vehicles).

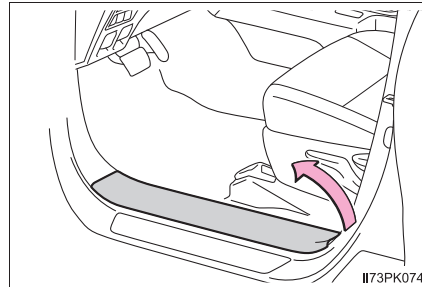

Remove the nut and the cowl side panel.

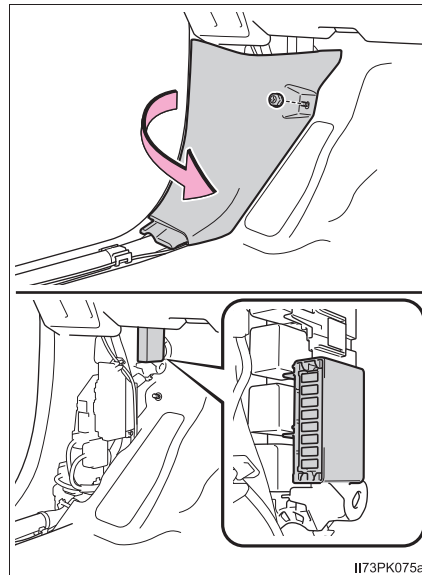

3 Remove the fuse.

Only type A fuse can be removed using the pullout tool.

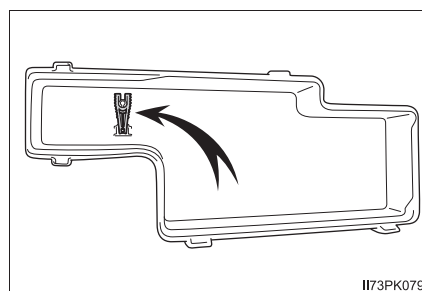

4 Check if the fuse is blown.

- ① Normal fuse
- ② Blown fuse

Type A, B, C and D:

Replace the blown fuse with a new fuse of an appropriate amperage rating. The amperage rating can be found on the fuse box lid.

Type E:

Contact any authorized Toyota retailer or Toyota authorized repairer, or any reliable repairer.

► Type A

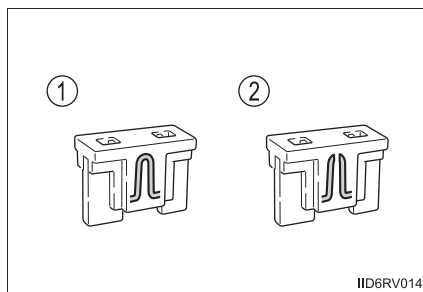

► Type B

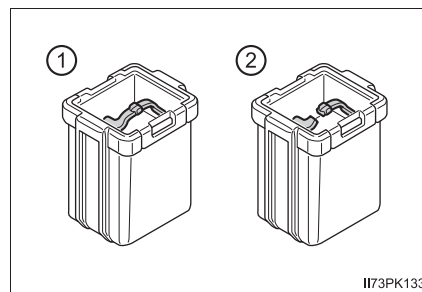

► Type C

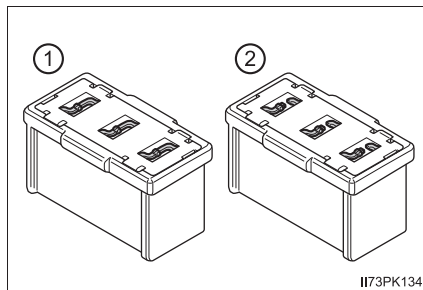

► Type D

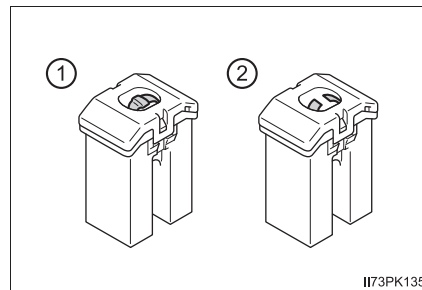

► Type E

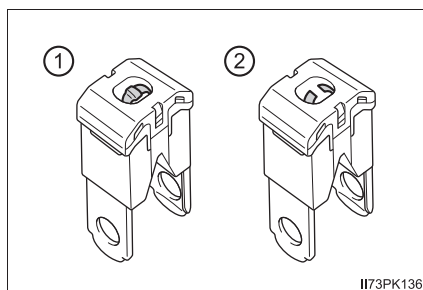

■ After a fuse is replaced

- If the lights do not turn on even after the fuse has been replaced, a bulb may need replacement. (→P. 525)
- If the replaced fuse blows again, have the vehicle inspected by any authorized Toyota retailer or Toyota authorized repairer, or any reliable repairer.

■ If there is an overload in a circuit

The fuses are designed to blow, protecting the wiring harness from damage.

 **WARNING****■ To prevent system breakdowns and vehicle fire**

Observe the following precautions.

Failure to do so may cause damage to the vehicle, and possibly a fire or injury.

- Never use a fuse of a higher amperage rating than that indicated, or use any other object in place of a fuse.
- Always use a genuine Toyota fuse or equivalent.
Never replace a fuse with a wire, even as a temporary fix.
- Do not modify the fuses or fuse boxes.

 **NOTICE****■ Before replacing fuses**

Have the cause of electrical overload determined and repaired by any authorized Toyota retailer or Toyota authorized repairer, or any reliable repairer as soon as possible.

Light bulbs

You may replace the following bulbs by yourself. The difficulty level of replacement varies depending on the bulb. As there is a danger that components may be damaged, we recommend that replacement is carried out by any authorized Toyota retailer or Toyota authorized repairer, or any reliable repairer.

Preparing for light bulb replacement

Check the wattage of the light bulb to be replaced. (→P. 642)

Bulb locations

The shape of the exterior lights may differ depending on the grade, etc.

■ Front

▶ Halogen headlights type A

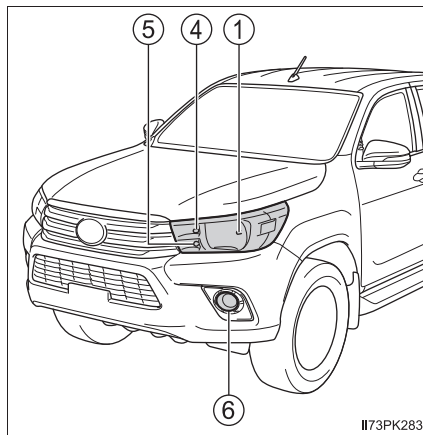

▶ Halogen headlights type B

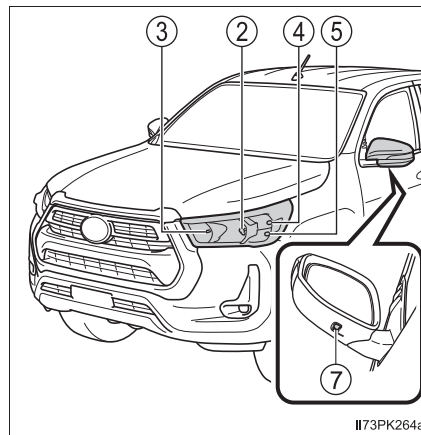

▶ LED headlights

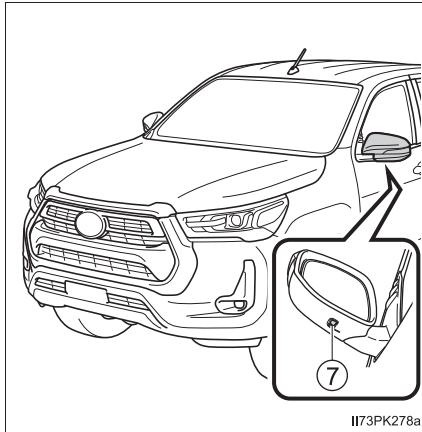

- ① Headlight (high/low beams) (if equipped)
- ② Headlight (low beam) (if equipped)
- ③ Headlight (high beam) (if equipped)
- ④ Front position light/daytime running light (if equipped)
- ⑤ Front turn signal light (if equipped)
- ⑥ Halogen front fog light (if equipped)
- ⑦ Outer foot light (if equipped)

■ Rear

▶ Without LED stop lights

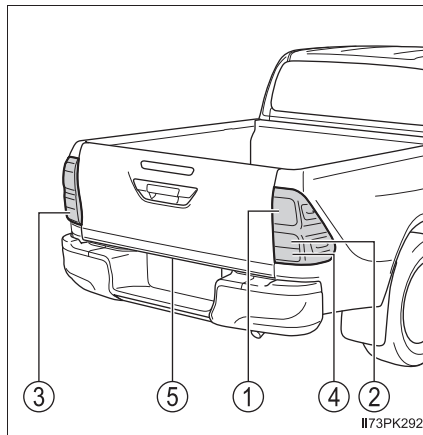

▶ With LED stop lights

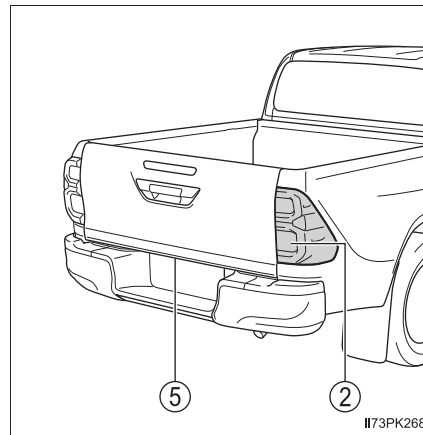

- ① Stop/tail light (if equipped)
- ② Rear turn signal light
- ③ Rear fog light (if equipped) (left-hand drive vehicles) or back-up light (if equipped)
- ④ Rear fog light (if equipped) (right-hand drive vehicles) or back-up light (if equipped)
- ⑤ License plate light

Replacing light bulbs**■ Headlight (high/low beams) (halogen headlights type A)**

- 1 Unplug the connector and remove the rubber cover.

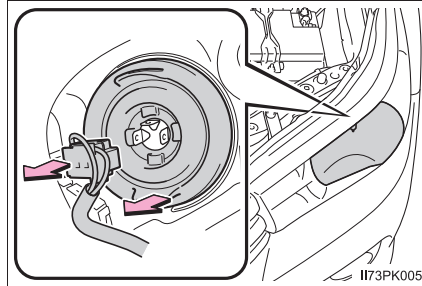

- 2 Release the bulb retaining spring.

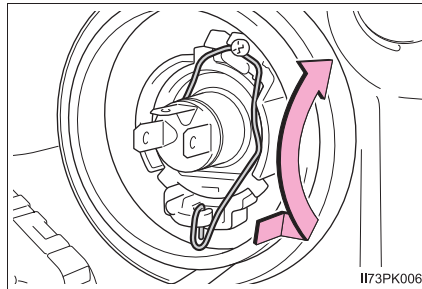

- 3 Remove the bulb.
To install a new bulb, align the tabs of the bulb with the cutouts of the mounting hole.

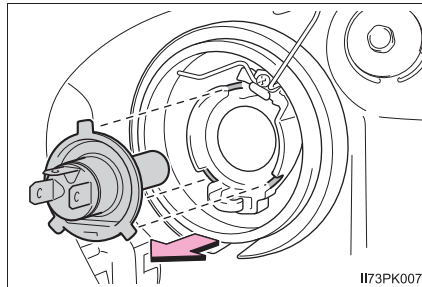

- 4 When installing, reverse the steps listed.

■ Headlight (low beams) (halogen headlights type B)

- 1 Unplug the connector while depressing the lock release.

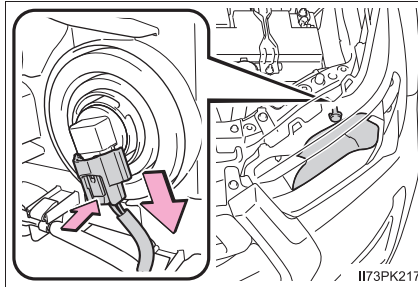

- 2 Turn the bulb base counter-clockwise.

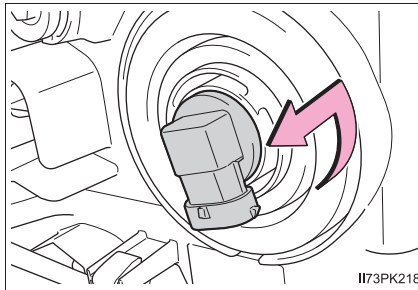

- 3 Replace the light bulb, and install the bulb base.
Align the 3 tabs on the light bulb with the mounting, and insert.

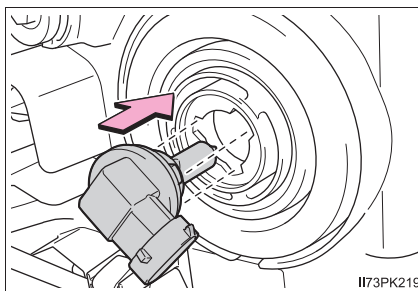

- 4 Turn and secure the bulb base.

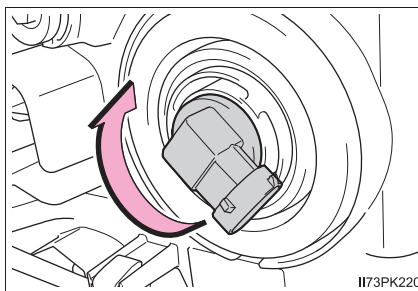

5 Install the connector

Shake the bulb base gently to check that it is not loose, turn the headlight low beams on once and visually confirm that no light is leaking through the mounting.

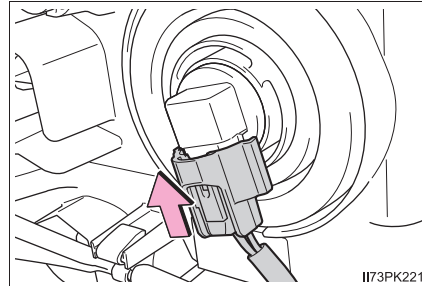

■ Headlight (high beams) (halogen headlights type B)

- 1 Unplug the connector while depressing the lock release.

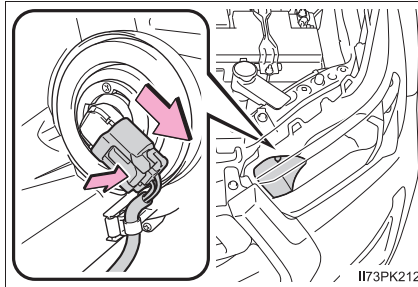

- 2 Turn the bulb base counter-clockwise.

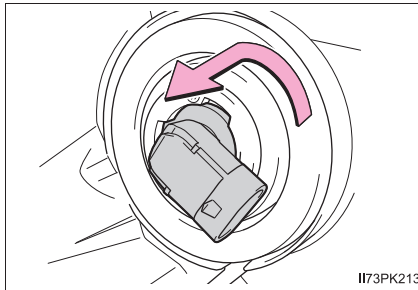

- 3 Replace the light bulb, and install the bulb base.
Align the 3 tabs on the light bulb with the mounting, and insert.

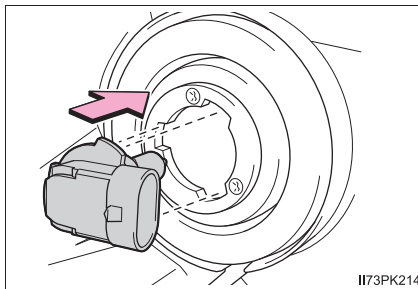

- 4 Turn and secure the bulb base.

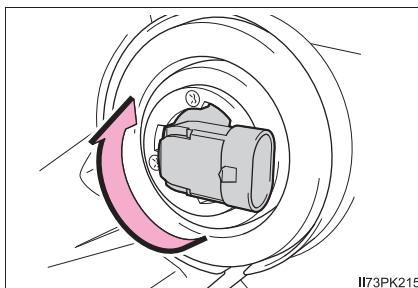

5 Install the connector

Shake the bulb base gently to check that it is not loose, turn the headlight high beams on once and visually confirm that no light is leaking through the mounting.

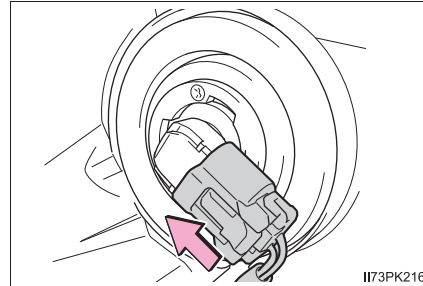

■ **Front position lights/daytime running lights (if equipped)
(halogen headlights type A)**

1 Turn the bulb base counterclockwise.

▶ Vehicles without daytime running lights

▶ Vehicles with daytime running lights

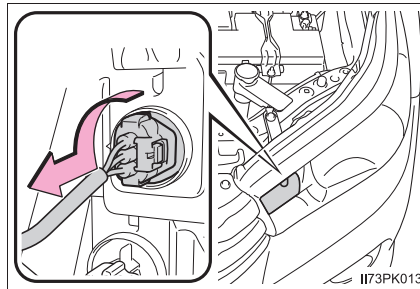
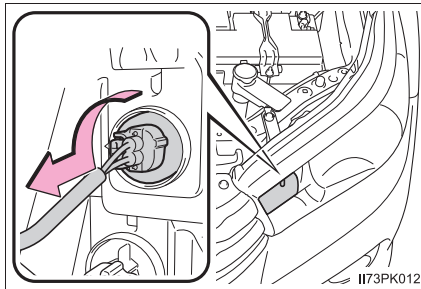

2 Remove the light bulb.

▶ Vehicles without daytime running lights

▶ Vehicles with daytime running lights

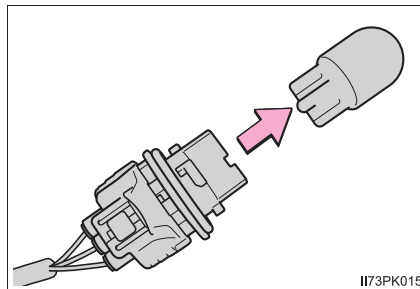
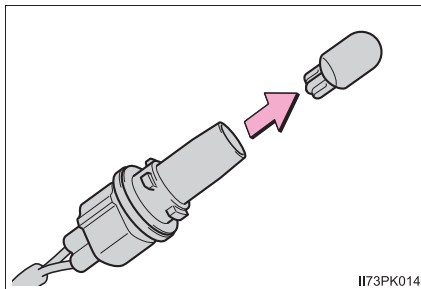

3 When installing, reverse the steps listed.

■ Front position lights/daytime running lights (if equipped) (halo- gen headlight type B)

- 1 To allow enough working space, turn the steering wheel to the opposite side where the bulb to be replaced is located.
Remove the screws and clips.

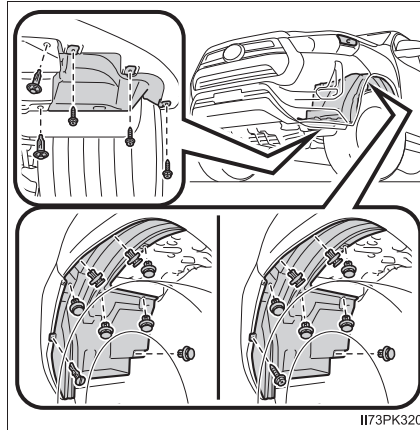

II73PK320

- ① Removing the clip
② Installing the clip

► Type A

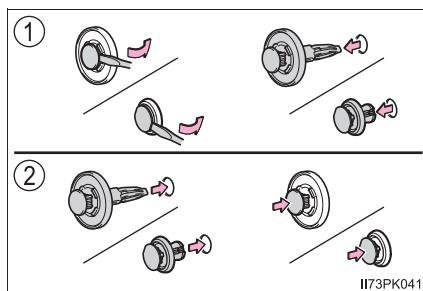

II73PK041

► Type B

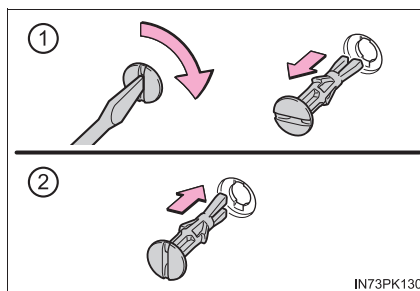

IN73PK130

- 2 Partly remove the fender liner and turn the bulb base counter-clockwise.

▶ Without daytime running lights

▶ With daytime running lights

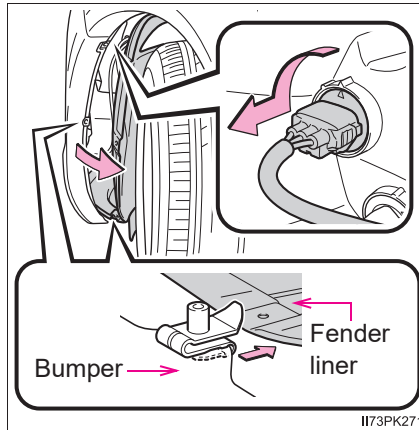
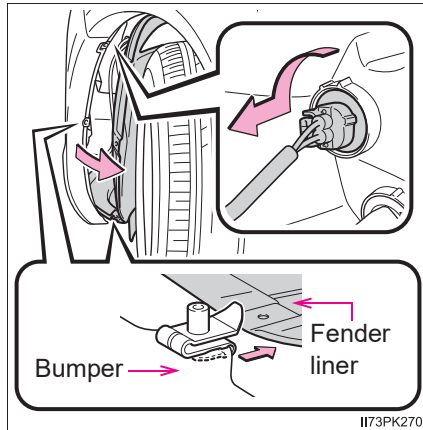

- 3 Remove the light bulb.

▶ Without daytime running lights

▶ With daytime running lights

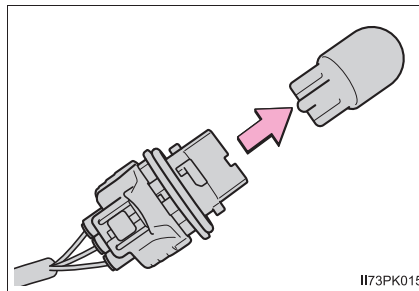
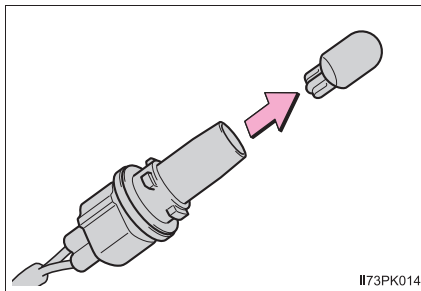

- 4 When installing, reverse the steps listed.

■ Front turn signal lights (halogen headlights type A)

- 1 Turn the bulb base counter-clockwise.

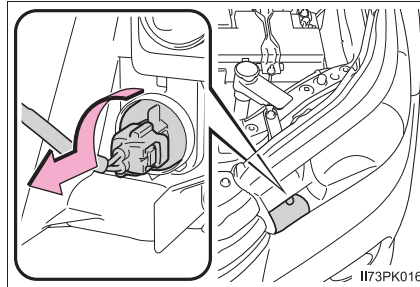

- 2 Remove the light bulb.

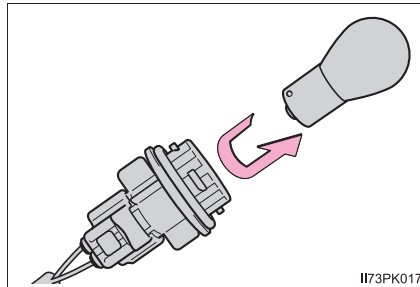

- 3 When installing, reverse the steps listed.

■ Front turn signal lights (halogen headlights type B)

- ① To allow enough working space, turn the steering wheel to the opposite side where the bulb to be replaced is located.
Remove the screws and clips.

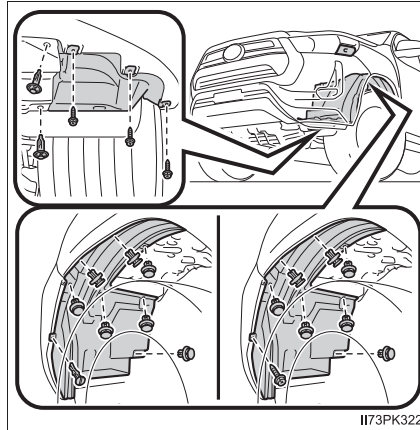

- ① Removing the clip
② Installing the clip

► Type A

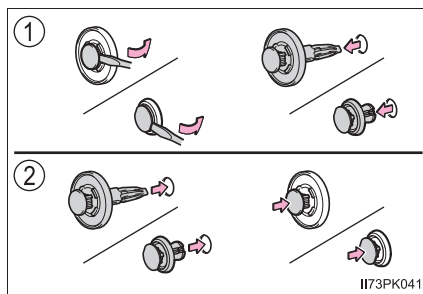

► Type B

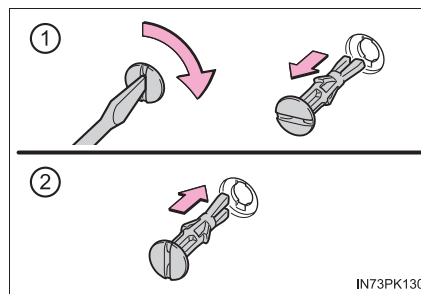

- 2 Partly remove the fender liner and turn the bulb base counterclockwise.

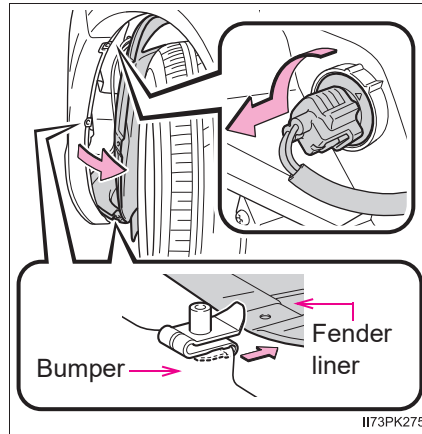

- 3 Remove the light bulb.

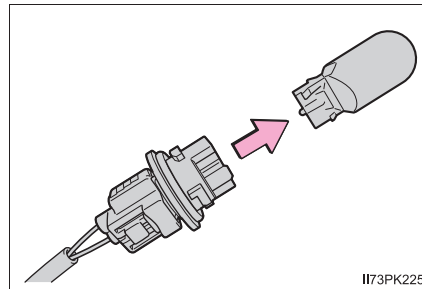

- 4 When installing, reverse the steps listed.

■ Halogen front fog lights (if equipped)

- ① To allow enough working space, turn the steering wheel to the opposite side where the bulb to be replaced is located.

Remove the screws and clips.

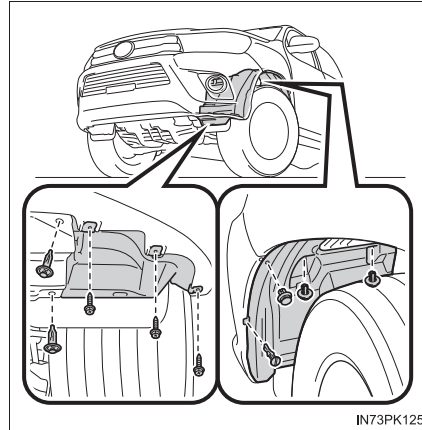

IN73PK125

① Removing the clip

② Installing the clip

► Type A

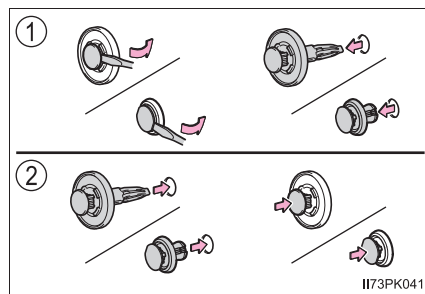

II73PK041

► Type B

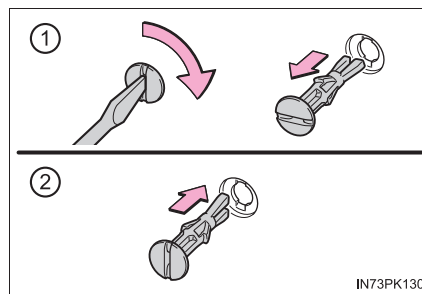

IN73PK130

- 2 Partly remove the fender liner and unplug the connector while pressing the lock release.

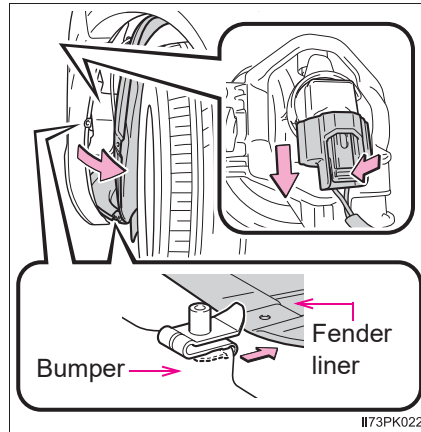

- 3 Turn the bulb base counter-clockwise.

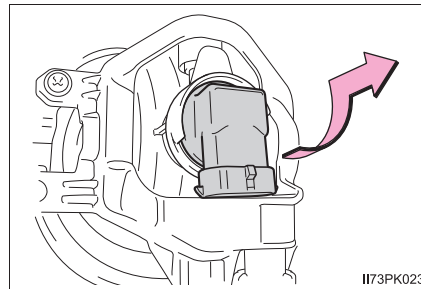

- 4 Replace the light bulb, and install the bulb base.
Align the 3 tabs on the light bulb with the mounting, and insert.

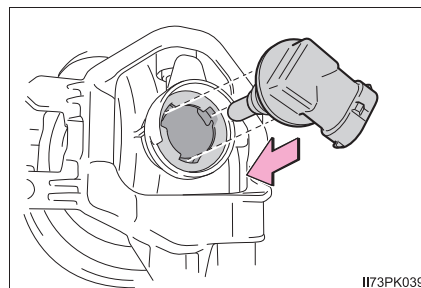

- 5 Turn and secure the bulb base.

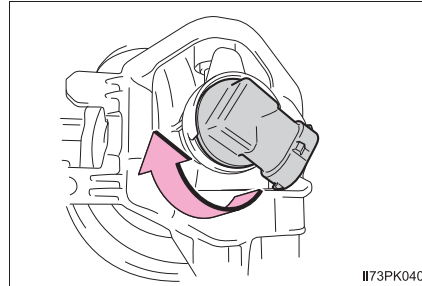

- 6 Install the connector.

Shake the bulb base gently to check that it is not loose, turn the front fog lights on once and visually confirm that no light is leaking through the mounting.

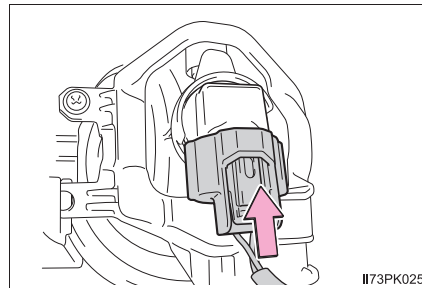

- 7 When installing the fender liner, screws and clips, reverse the removing procedure in steps 1 and 2.

■ **Stop/tail lights, rear turn signal lights, back-up lights and rear fog light (if equipped) (without LED stop lights)**

- 1 Remove the securing bolts and pull the unit sideways to remove.

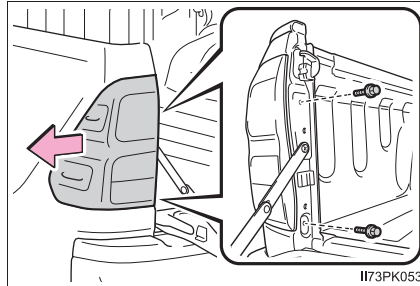

- 2 Turn the bulb base counter-clockwise.

- ① Stop/tail light
② Rear turn signal light
③ Back-up light or rear fog light

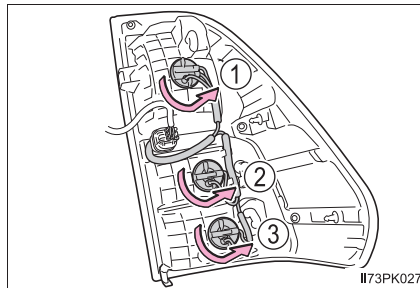

- 3 Remove the light bulb.

- ① Stop/tail light
② Rear turn signal light
③ Back-up light or rear fog light

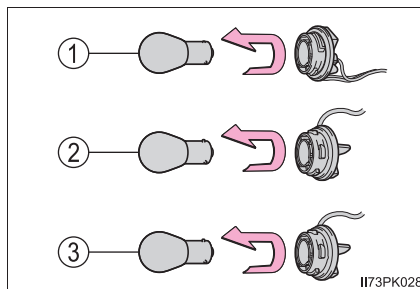

- 4 When installing, reverse the steps listed.

■ Rear turn signal lights (with LED stop lights)

- 1 Remove the securing bolts and pull the unit sideways to remove.

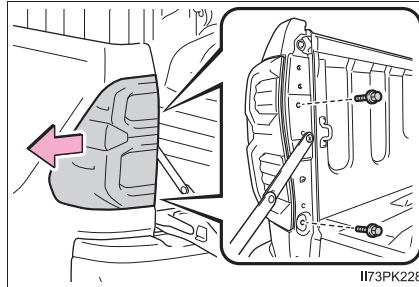

- 2 Turn the bulb base counter-clockwise.

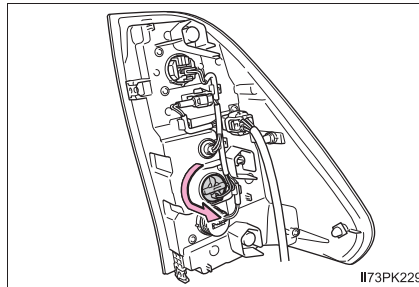

- 3 Remove the light bulb.

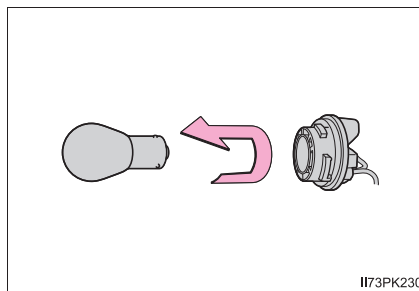

- 4 When installing, reverse the steps listed.

■ License plate light

- 1 Remove the unit.

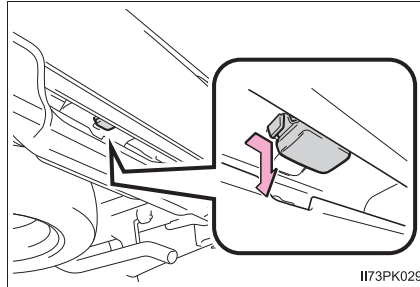

- 2 Turn the bulb base counter-clockwise.

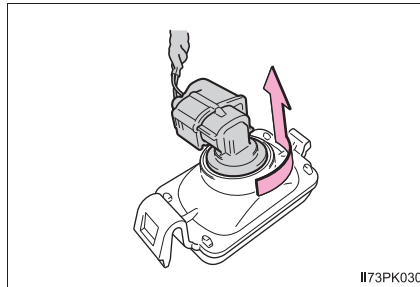

- 3 Remove the light bulb.

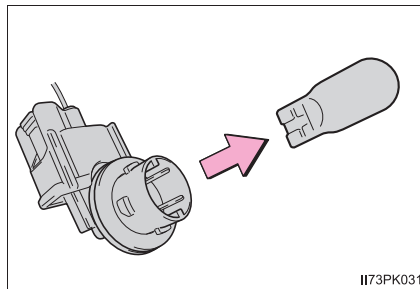

- 4 When installing, reverse the steps listed.

■ Outer foot lights (if equipped)

- 1 Press the upper part of the outside rear view mirror to tilt the mirror face upward, and apply protective tape to the lower part of the mirror cover.

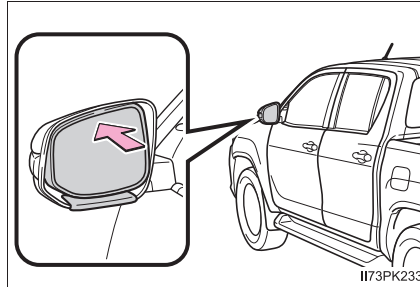

- 2 Insert 2 flathead screwdrivers wrapped in protective tape, and disconnect the tabs behind the mirror.

Pry the mirror out toward you, disconnecting the 2 tabs at a time.

Work carefully, ensuring that you do not drop the mirror.

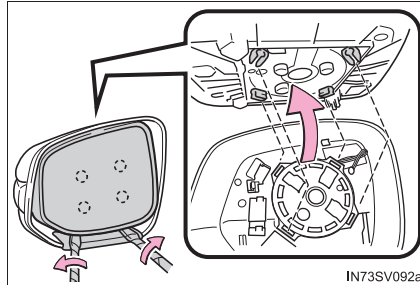

- 3 Disconnect the tab as shown in the illustration.

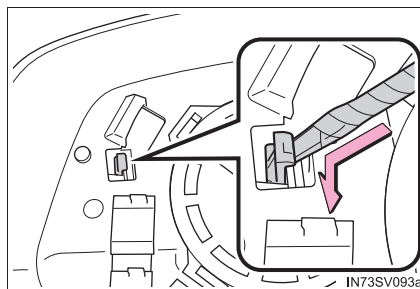

- 4 Remove the upper cover and screws.

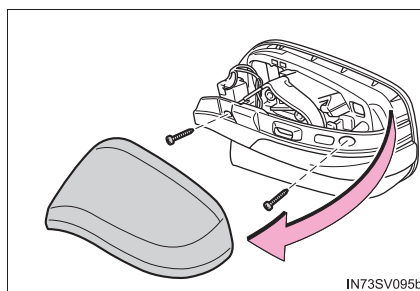

- 5 Fold the mirror forward.

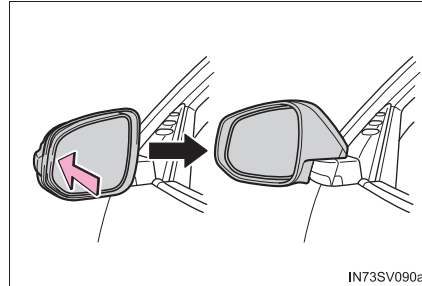

- 6 Remove the lower cover.

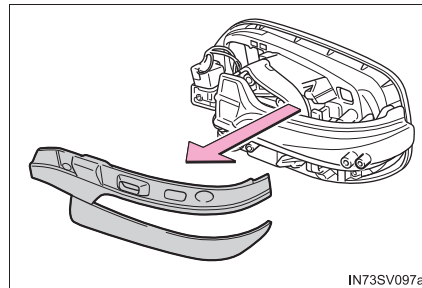

- 7 Remove the side turn signal light lens.

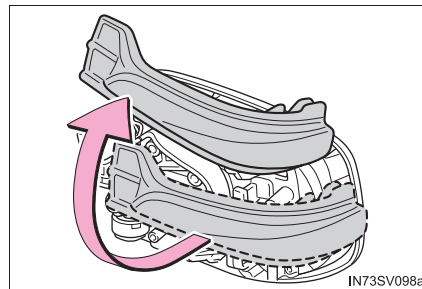

- 8 Remove the bulb base.

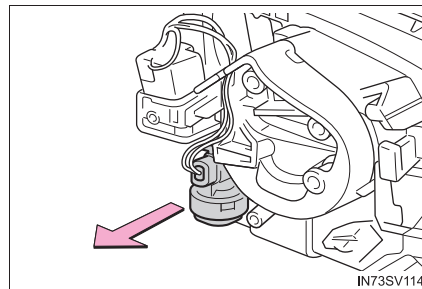

- 9 Turn the cover counterclockwise and remove it.

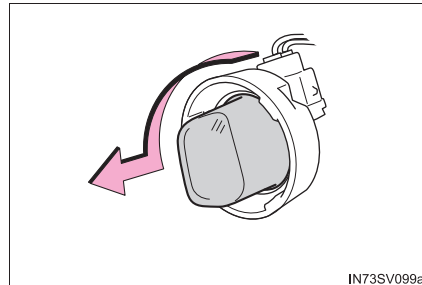

- 10 Remove the light bulb.

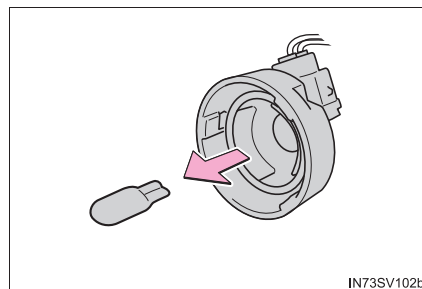

- 11 After installing the new bulb, install the cover clockwise.

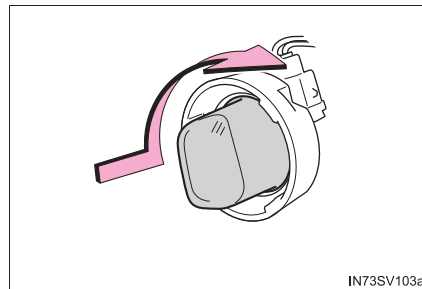

- 12 Install the bulb base.
Insert the two claws (left-hand side) or claw (right-hand side) into the hole(s).

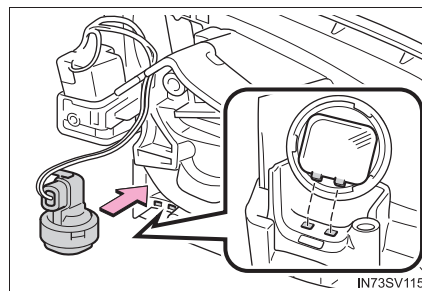

- 13 Install the side turn signal light lens.

Insert the projection into the hole of the lens, and align the lens corner with the plate, as shown in the illustration.

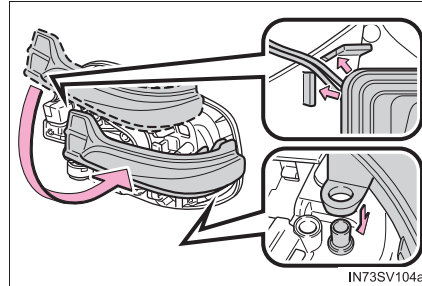

- 14 Install the lower cover.

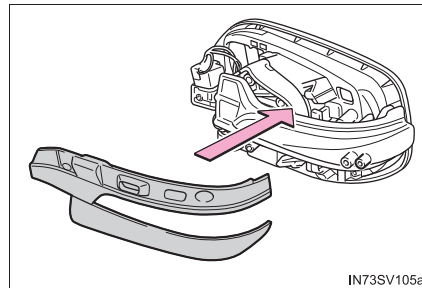

- 15 Return the mirror to its original position.

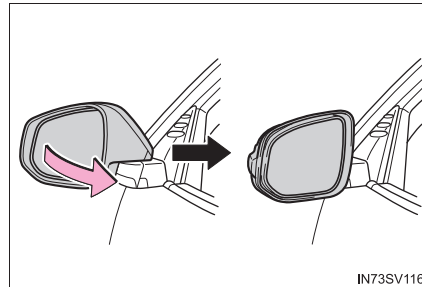

- 16 Install the screws and upper cover.

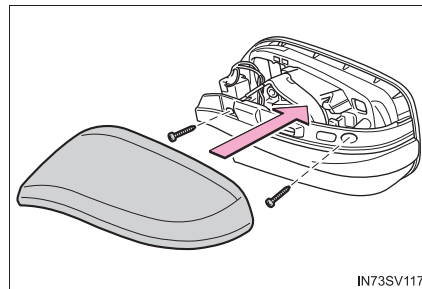

- 17 Align the tabs, and secure the mirror by pushing in each diagonally-opposite pair of tabs in order.

Make sure to insert the tabs in order as shown in the illustration, and push them in until a click is heard.

If you do not hear the click, do not force the tabs in. Instead, remove the mirror and check that the tabs are aligned.

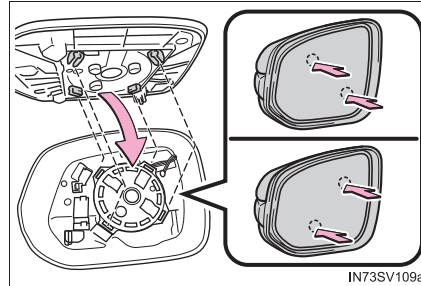

■ Replacing the following bulbs

If any of the lights listed below has burnt out, have it replaced by any authorized Toyota retailer or Toyota authorized repairer, or any reliable repairer.

- Headlights (high/low beams) (LED headlights)
- Front position lights/daytime running lights (if equipped) (LED headlights)
- Front turn signal lights (LED headlights)
- Side turn signal lights
- LED front fog lights (if equipped)
- LED stop lights
- Tail lights (LED stop lights)
- Rear fog lights (if equipped) or back-up lights (LED stop lights)
- High mounted stoplight (if equipped)

■ When installing the rubber cover of the headlight (halogen headlights type A)

Ensure the rubber cover is securely attached.

- ① Fit the rubber cover outer circumference in firmly.
- ② Fit the rubber cover around the light bulb in until the light bulb plug can be seen.

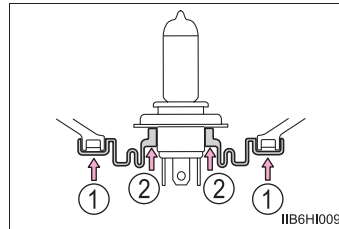

■ LED lights

The following lights consist of a number of LEDs. If any of the LEDs burn out, take your vehicle to any authorized Toyota retailer or Toyota authorized repairer, or any reliable repairer to have the light replaced.

- Headlights (high/low beams) (LED headlights)
- Front position lights/daytime running lights (if equipped) (LED headlights)
- Front turn signal lights (LED headlights)
- Side turn signal lights (mirror-mounted type)
- LED front fog lights (if equipped)
- LED stop lights
- Tail lights (LED stop lights)
- Rear fog lights (if equipped) or back-up lights (LED stop lights)
- High mounted stoplight (if equipped)

■ Condensation build-up on the inside of the lens

Temporary condensation build-up on the inside of the headlight lens does not indicate a malfunction. Contact any authorized Toyota retailer or Toyota authorized repairer, or any reliable repairer for more information in the following situations:

- Large drops of water have built up on the inside of the lens.
- Water has built up inside the headlight.

 WARNING**■ Replacing light bulbs**

- Turn off the lights. Do not attempt to replace the bulb immediately after turning off the lights.
The bulbs become very hot and may cause burns.
- Do not touch the glass portion of the light bulb with bare hands. When it is unavoidable to hold the glass portion, use and hold with a clean dry cloth to avoid getting moisture and oils on the bulb.
Also, if the bulb is scratched or dropped, it may blow out or crack.
- Fully install light bulbs and any parts used to secure them. Failure to do so may result in heat damage, fire, or water entering the headlight unit. This may damage the headlights or cause condensation to build up on the lens.
- Do not attempt to repair or disassemble light bulbs, connectors, electric circuits or component parts.
Doing so may result in death or serious injury due to electric shock.

■ To prevent damage or fire

- Make sure bulbs are fully seated and locked.
- Check the wattage of the bulb before installing to prevent heat damage.

 NOTICE**■ When replacing the outer foot lights**

If the front window is stopping you from conducting the replace operation properly, open the window on the side you are working on to allow you enough space to work. Continuing the operation without giving yourself enough space to work could lead you to scratch the vehicle.

When trouble arises

8

8-1. Essential information

Emergency flashers	554
If your vehicle has to be stopped in an emergency	555
If the vehicle is submerged or water on the road is rising	557

8-2. Steps to take in an emergency

If your vehicle needs to be towed	559
If you think something is wrong	564
Fuel pump shut off system (gasoline engine only)	565
If a warning light turns on or a warning buzzer sounds	566
If a warning message is displayed	575
If you have a flat tire	581
If the engine will not start	598
If the electronic key does not operate properly (vehicles with smart entry & start system)	600
If the vehicle battery is discharged	604
If your vehicle overheats	610
If you run out of fuel and the engine stalls (diesel engine only)	614
If the vehicle becomes stuck	615

Emergency flashers

The emergency flashers are used to warn other drivers when the vehicle has to be stopped in the road due to a breakdown, etc.

Press the switch.

All the turn signal lights will flash.

To turn them off, press the switch once again.

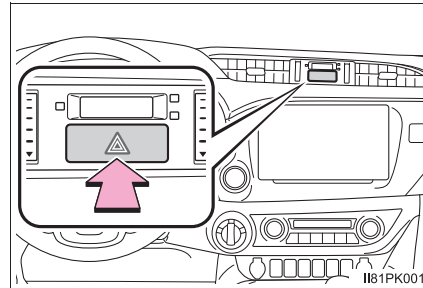

■ Emergency flashers

If the emergency flashers are used for a long time while the engine is not operating, the battery may discharge.

If your vehicle has to be stopped in an emergency

Only in an emergency, such as if it becomes impossible to stop the vehicle in the normal way, stop the vehicle using the following procedure:

- 1 Steadily step on the brake pedal with both feet and firmly depress it.
Do not pump the brake pedal repeatedly as this will increase the effort required to slow the vehicle.
- 2 Shift the shift lever to N.
 - ▶ If the shift lever is shifted to N
- 3 After slowing down, stop the vehicle in a safe place by the road.
- 4 Stop the engine.
 - ▶ If the shift lever cannot be shifted to N
- 3 Keep depressing the brake pedal with both feet to reduce vehicle speed as much as possible.
- 4 Vehicles without smart entry & start system:
Stop the engine by turning the engine switch to the "ACC" position.

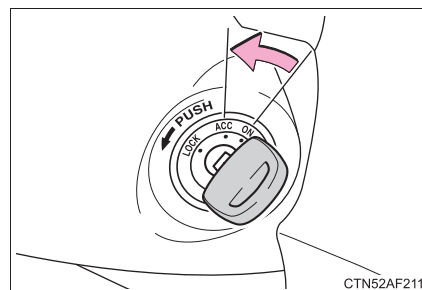

Vehicles with smart entry & start system:

To stop the engine, press and hold the engine switch for 2 consecutive seconds or more, or press it briefly 3 times or more in succession.

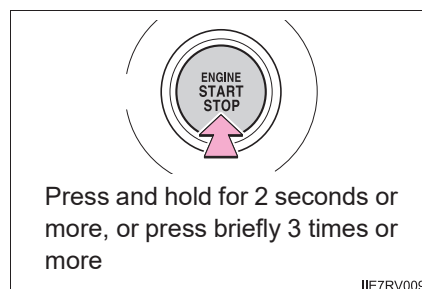

- 5 Stop the vehicle in a safe place by the road.

**WARNING****■ If the engine has to be turned off while driving**

- Power assist for the brakes and steering wheel will be lost, making the brake pedal harder to depress and the steering wheel heavier to turn. Decelerate as much as possible before turning off the engine.
- Vehicles without smart entry & start system: Never attempt to remove the key, as doing so will lock the steering wheel.

If the vehicle is submerged or water on the road is rising

This vehicle is not designed to be able to drive on roads that are deeply flooded with water. Do not drive on roads where the roads may be submerged or the water may be rising. It is dangerous to remain in the vehicle, if it anticipated that the vehicle will be flooded or set a drift. Remain calm and follow the following.

- If the door can be opened, open the door and exit the vehicle.
- If the door can not be opened, open the window using the power window switch and ensure an escape route.
- If the window can be opened, exit the vehicle through the window.
- If the door and window cannot be opened due to the rising water, remain calm, wait until the water level inside the vehicle rises to the point that the water pressure inside of the vehicle equals the water pressure outside of the vehicle and then open the door after waiting for the rising water to enter the vehicle, and exit the vehicle. When the outside water level exceeds half the height of the door, the door cannot be opened from the inside due to water pressure.

■ Water level exceeds the floor

When the water level exceeds the floor and time has passed, the electrical equipment will get damaged, the power windows will not operate, the engine stop, and the vehicle may not be able to get moving.

■ Using an emergency escape hammer*

Laminated glass is used in the windshield on this vehicle.

Laminated glass cannot be shattered with an emergency hammer*.

Tempered glass is used in the windows on this vehicle.

*: Contact any authorized Toyota retailer or Toyota authorized repairer, or any reliable repairer or aftermarket accessory manufacturer for further information about an emergency hammer.

 **WARNING****■ Caution while driving**

Do not drive on roads where the roads may be submerged or the water may be rising. Otherwise the vehicle may be damaged and cannot move, as well as become flooded and set a drift, which may lead to death.

If your vehicle needs to be towed

If towing is necessary, we recommend having your vehicle towed by any authorized Toyota retailer or Toyota authorized repairer, or any reliable repairer or commercial towing service, using a wheel-lift type truck or flatbed truck.

Use a safety chain system for all towing, and abide by all state/provincial and local laws.

Situations when it is necessary to contact dealers before towing

The following may indicate a problem with your transmission. Contact any authorized Toyota retailer or Toyota authorized repairer, or any reliable repairer or commercial towing service before towing.

- The engine is running but the vehicle does not move.
- The vehicle makes an abnormal sound.

Towing with a sling-type truck

Do not tow with a sling-type truck to prevent body damage.

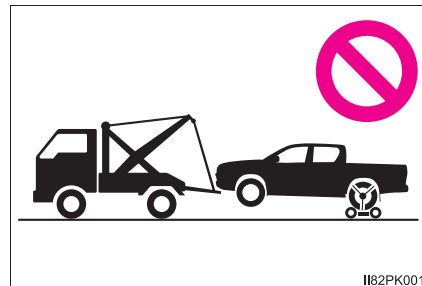

Towing with a wheel-lift type truck

▶ From the front

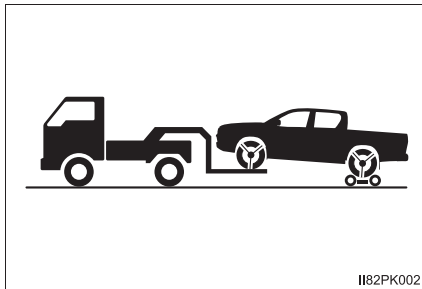

▶ From the rear

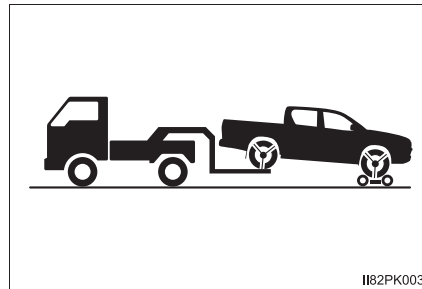

Use a towing dolly under the rear wheels.

Use a towing dolly under the front wheels.

Using a flatbed truck

When using a flatbed truck to transport the vehicle, use tire strapping belts. Refer to the owner's manual of the flatbed truck for the tire strapping method.

In order to suppress vehicle movement during transportation, set the parking brake and turn the engine switch to the "LOCK" position (vehicles without smart entry & start system) or off (vehicles with smart entry & start system).

Emergency towing

If a tow truck is not available in an emergency, your vehicle may be temporarily towed using cables or chains secured to the emergency towing hooks. This should only be attempted on hard surfaced roads for at most 80 km (50 miles) at under 30 km/h (18 mph).

A driver must be in the vehicle to steer and operate the brakes. The vehicle's wheels, drive train, axles, steering and brakes must be in good condition.

Emergency towing procedure

- 1 Securely attach cables or chains to the towing hooks.

Take care not to damage the vehicle body.

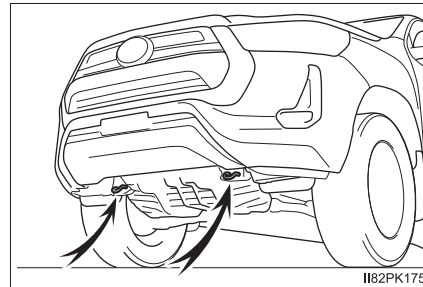

- 2 Enter the vehicle being towed and start the engine.

If the engine does not start, turn the engine switch to the "ON" position (vehicles without smart entry & start system) or IGNITION ON mode (vehicles with smart entry & start system).

Vehicles with Stop & Start system:

Before towing the vehicle, turn the engine switch to the "LOCK" position (vehicles without smart entry & start system) or off (vehicles with smart entry & start system) once, and then start the engine.

- 3 4WD models: Turn the front-wheel drive control switch to H2. (→P. 331)

- 4 Shift the shift lever to N and release the parking brake.

When the shift lever cannot be shifted (automatic transmission):
→P. 237

■ While towing

If the engine is not running, the power assist for the brakes and steering will not function, making steering and braking more difficult.

⚠ WARNING

Observe the following precautions.
Failure to do so may result in death or serious injury.

■ When towing the vehicle

Pre Runner (2WD models): Be sure to transport the vehicle with all four wheels raised off the ground. If the vehicle is towed with the tires contacting the ground, the drivetrain and related parts may be damaged or an accident may occur due to a change in direction of the vehicle.

4WD models: Be sure to transport the vehicle with all four wheels raised off the ground. If the vehicle is towed with the tires contacting the ground, the drivetrain and related parts may be damaged, and the vehicle may fly off the truck.

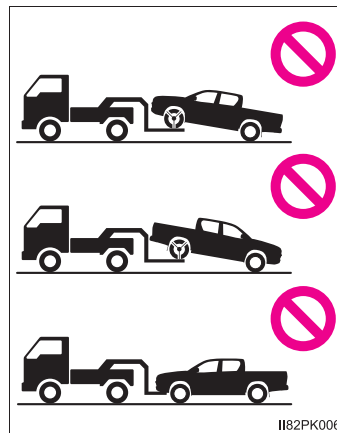

1182PK006

■ While towing

- When towing using cables or chains, avoid sudden starts, etc. which place excessive stress on the towing hooks, cables or chains. The towing hooks, cables or chains may become damaged, broken debris may hit people, and cause serious damage.
- Do not turn the engine switch to the "LOCK" position (vehicles without smart entry & start system) or off (vehicles with smart entry & start system).
There is a possibility that the steering wheel is locked and cannot be operated.



NOTICE

■ To prevent damage to the vehicle when towing using a wheel-lift type truck

- Do not tow the vehicle from the rear when the engine switch is in the “LOCK” position or the key is removed (vehicles without smart entry & start system) or the engine switch is turned to off (vehicles with smart entry & start system). The steering lock mechanism is not strong enough to hold the front wheels straight.
- When raising the vehicle, ensure adequate ground clearance for towing at the opposite end of the raised vehicle. Without adequate clearance, the vehicle could be damaged while being towed.

■ To prevent damage to the vehicle when towing with a sling-type truck

Do not tow with a sling-type truck, either from the front or rear.

■ To prevent damage to the vehicle during emergency towing

Do not secure cables or chains to the suspension components.

■ When towing a vehicle equipped with a Stop & Start system (if equipped)

If it is necessary to tow the vehicle with all 4 wheels on the ground, perform the following procedure before towing the vehicle, in order to protect the system.

Turn the engine switch to the “LOCK” position (vehicles without smart entry & start system) or off (vehicles with smart entry & start system) and then start the engine or turn the engine switch to the “ON” position (vehicles without smart entry & start system) or IGNITION ON mode (vehicles with smart entry & start system).

If you think something is wrong

If you notice any of the following symptoms, your vehicle probably needs adjustment or repair. Contact any authorized Toyota retailer or Toyota authorized repairer, or any reliable repairer as soon as possible.

Visible symptoms

- Fluid leaks under the vehicle.
(Water dripping from the air conditioning after use is normal.)
- Flat-looking tires or uneven tire wear
- Engine coolant temperature gauge needle continually points higher than normal.

Audible symptoms

- Changes in exhaust sound
- Excessive tire squeal when cornering
- Strange noises related to the suspension system
- Pinging or other noises related to the engine

Operational symptoms

- Engine missing, stumbling or running roughly
- Appreciable loss of power
- Vehicle pulls heavily to one side when braking
- Vehicle pulls heavily to one side when driving on a level road
- Loss of brake effectiveness, spongy feeling, pedal almost touches the floor

Fuel pump shut off system (gasoline engine only)

To minimize the risk of fuel leakage when the engine stalls or when an airbag inflates upon collision, the fuel pump shut off system stops the supply of fuel to the engine.

Follow the procedure below to restart the engine after the system is activated.

- 1 Turn the engine switch to the "ACC" or "LOCK" position (vehicles without smart entry & start system) or ACCESSORY mode or off (vehicles with smart entry & start system).
- 2 Restart the engine.

 NOTICE

■ **Before starting the engine**



Inspect the ground under the vehicle.





If you find that fuel has leaked onto the ground, the fuel system has been damaged and is in need of repair. Do not restart the engine.





If a warning light turns on or a warning buzzer sounds





Calmly perform the following actions if any of the warning lights comes on or flashes. If a light comes on or flashes, but then goes off, this does not necessarily indicate a malfunction in the system. However, if this continues to occur, have the vehicle inspected by any authorized Toyota retailer or Toyota authorized repairer, or any reliable repairer.









Warning light and warning buzzer list





Warning light	Warning light/Details/Actions
	<p>Brake system warning light (warning buzzer) Indicates:</p> <ul style="list-style-type: none"> • Low brake fluid • Malfunction in the brake system • Low negative pressure in the vacuum tank (diesel engine) <p>→ Immediately stop the vehicle in a safe place and contact any authorized Toyota retailer or Toyota authorized repairer, or any reliable repairer. Continuing to drive the vehicle may be dangerous.</p>
	<p>Charging system warning light*¹ (if equipped) Indicates a malfunction in the vehicle's charging system</p> <p>→ Immediately stop the vehicle in a safe place and contact any authorized Toyota retailer or Toyota authorized repairer, or any reliable repairer.</p>
	<p>Low engine oil pressure warning light (warning buzzer)*^{1, 2} (if equipped) Indicates that the engine oil pressure is too low (This warning light may come on if the vehicle is stopped on a slope. Move to a level surface and check to see if the light goes off.)</p> <p>→ Immediately stop the vehicle in a safe place and contact any authorized Toyota retailer or Toyota authorized repairer, or any reliable repairer.</p>

Warning light	Warning light/Details/Actions
 <p>(Flashes or illuminates)</p>	<p>Malfunction indicator lamp (warning buzzer) Indicates the followings if the warning light comes on or flashes:</p> <ul style="list-style-type: none"> • Malfunction in the emission control system. (if equipped) • Malfunction in the electronic engine control system. • Malfunction in the electronic automatic transmission control system. (if equipped) • The boost pressure in the turbocharger is abnormally high.*³ (diesel engine) • Malfunction in DPF system. (if equipped) <p>→ Have the vehicle inspected by any authorized Toyota retailer or Toyota authorized repairer, or any reliable repairer immediately.</p>
	<p>SRS warning light Indicates a malfunction in:</p> <ul style="list-style-type: none"> • The SRS airbag system; • The seat belt pretensioner system; or • The front passenger occupant classification system (if equipped) <p>→ Have the vehicle inspected by any authorized Toyota retailer or Toyota authorized repairer, or any reliable repairer immediately.</p>
	<p>ABS warning light Indicates a malfunction in:</p> <ul style="list-style-type: none"> • The ABS; or • The brake assist system (vehicles with VSC system) <p>→ Have the vehicle inspected by any authorized Toyota retailer or Toyota authorized repairer, or any reliable repairer immediately.</p>
	<p>Power steering system warning light (warning buzzer) (if equipped) Indicates a malfunction in the power steering system</p> <p>→ Have the vehicle inspected by any authorized Toyota retailer or Toyota authorized repairer, or any reliable repairer immediately.</p>

Warning light	Warning light/Details/Actions
	<p>Slip indicator (if equipped) Indicates a malfunction in:</p> <ul style="list-style-type: none"> • The VSC system (if equipped); • Trailer sway control system (if equipped); • The TRC/A-TRC system (if equipped); • The AUTO LSD system (if equipped); • The hill-start assist control system (if equipped); or • The downhill assist control system (if equipped) <p>→ Have the vehicle inspected by any authorized Toyota retailer or Toyota authorized repairer, or any reliable repairer immediately. The light will flash when any of the above systems other than the hill-start assist control system are operating.</p>
 <p>(Flashes)</p>	<p>Four-wheel drive indicator light (warning buzzer)*⁴ (if equipped) Indicates that the differential oil temperature is too high when the light flashes rapidly and a buzzer sounds.</p> <p>→ Turn the front-wheel drive control switch to H2, and reduce the vehicle speed or stop the vehicle in a safe place. (→P. 331) Indicates a malfunction in the four-wheel drive system when the light flashes rapidly and a buzzer does not sound.</p> <p>→ Have the vehicle inspected by any authorized Toyota retailer or Toyota authorized repairer, or any reliable repairer immediately.</p>
 <p>(Flashes)</p>	<p>Low speed four-wheel drive indicator light (if equipped) Indicates a malfunction in the four-wheel drive system when the light flashes rapidly.</p> <p>→ Have the vehicle inspected by any authorized Toyota retailer or Toyota authorized repairer, or any reliable repairer immediately.</p>
 <p>(Flashes)</p>	<p>Rear differential lock indicator light (if equipped) Indicates a malfunction in the rear differential lock system when the light flashes rapidly.</p> <p>→ Have the vehicle inspected by any authorized Toyota retailer or Toyota authorized repairer, or any reliable repairer immediately.</p>

Warning light	Warning light/Details/Actions
 <p>(Flashes or illuminates)</p>	<p>Fuel system warning light (warning buzzer)*⁵ (if equipped) The amount of accumulated water in the fuel filter has reached the specified level if the light flashes. → P. 499 The fuel filter need to be replaced if the light comes on. → Have the vehicle inspected by any authorized Toyota retailer or Toyota authorized repairer, or any reliable repairer immediately.</p>
 <p>(Flashes or illuminates)</p>	<p>Brake Override System warning light*¹ (if equipped) Indicates that the accelerator and brake pedal are being depressed simultaneously if the warning light comes on (→P. 195) → Release the accelerator pedal and depress the brake pedal. Indicates a malfunction in the Brake Override System if the warning light flashes → Have the vehicle inspected by any authorized Toyota retailer or Toyota authorized repairer, or any reliable repairer immediately.</p>
	<p>Cruise control indicator*⁶ (if equipped) Indicates a malfunction in the cruise control system → P. 317</p>
 <p>(Flashes or illuminates)</p>	<p>PCS warning light (if equipped) When a buzzer sounds simultaneously: Indicates a malfunction has occurred in the PCS (Pre-Collision System). → Have the vehicle inspected by any authorized Toyota retailer or Toyota authorized repairer, or any reliable repairer immediately. When a buzzer does not sound: The PCS (Pre-Collision System) has become temporarily unavailable, corrective action may be necessary. → Follow the instructions displayed on the multi-information display. (→P. 271, 575) If the PCS (Pre-Collision System) or VSC (Vehicle Stability Control) system is disabled, the PCS warning light will illuminate. → P. 283</p>

Warning light	Warning light/Details/Actions
 (Yellow)	LDA indicator (warning buzzer) (if equipped) Indicates a malfunction in the LDA (Lane Departure Alert with Yaw Assist Function) → Follow the instructions displayed on the multi-information display. (→P. 294)
	Open door warning light (warning buzzer)*1, 7 (if equipped) Indicates that a door is not fully closed → Check that all the doors are closed.
 (Flashes or illuminates)	Driver's and front passenger's seat belt reminder light (warning buzzer)*8 Warns the driver and front passenger to fasten his/her seat belt → Fasten the seat belt.
 (Flashes or illuminates)	Rear passengers' seat belt reminder lights (warning buzzer)*9 (if equipped) Warn the rear passengers to fasten their seat belts → Fasten the seat belt.
	Low fuel level warning light Indicates remaining fuel is approximately 12.0 L (3.2 gal., 2.6 Imp.gal.) or less → Refuel the vehicle.
	Low engine oil level warning light (if equipped) Indicates that engine oil level is low (This warning light may come on if the vehicle is stopped on a slope. Move the vehicle to a level surface and check to see if the light goes off.) → Check the level of engine oil and add more oil if necessary.
 (Flashes or illuminates)	Master warning light (warning buzzer) (if equipped) A buzzer sounds and the warning light comes on and flashes to indicate that the master warning system has detected a malfunction. → P. 575
 (Flashes)	Stop & Start cancel indicator (if equipped) Indicates a malfunction in the Stop & Start system (The Stop & Start cancel indicator will come on when the system is canceled: →P. 346) → Have the vehicle inspected by any authorized Toyota retailer or Toyota authorized repairer, or any reliable repairer immediately.

Warning light	Warning light/Details/Actions
	<p>Parking brake indicator light (warning buzzer)*11 Warns the driver to release parking brake. → Release the parking brake.</p>
	<p>Low AdBlue™ level warning light (if equipped) Indicates that AdBlue™ level is low → Have AdBlue™ refilled at any authorized Toyota retailer or Toyota authorized repairer, or any reliable repairer.</p>
	<p>AUTO LSD indicator (if equipped) Indicate that the system is temporarily unavailable, due to the brake system overheats. → P. 368</p>
	<p>Go to service warning light (warning buzzer) (if equipped) Indicates a malfunction in the electronic engine control system or electronic throttle control system. → Have the vehicle inspected by any authorized Toyota retailer or Toyota authorized repairer, or any reliable repairer.</p>

- *1: Vehicles with multi-information display: a indicator is displayed on the multi-information display.
- *2: The buzzer sounds if the vehicle reaches a speed of 5 km/h (3 mph).
- *3: Slow down until the lamp goes off.
- *4: The buzzer sounds when the differential oil temperature is too high and turning the front-wheel drive control switch to H2 is required.
- *5: The buzzer will sound at the same time the warning light flashes.
- *6: The light turns to yellow.
- *7: The open door warning buzzer sounds if the vehicle reaches or exceeds a speed of 5 km/h (3 mph).
- *8: The driver's and front passenger's seat belt warning buzzer sounds to alert the driver and front passenger that his or her seat belt is not fastened. If the seat belt is unfastened, the buzzer sounds intermittently for a certain period of time after the vehicle reaches a certain speed.
- *9: Models made in South Africa^{*10}, and models made in Thailand^{*10} with rear seat heaters:
The rear passengers' seat belt warning buzzer sounds to alert the rear passenger that his or her seat belt is not fastened. If the seat belt is unfastened, the buzzer sounds intermittently for a certain period of time after the vehicle reaches a certain speed.

Models made in Thailand^{*10} without rear seat heaters:
The rear passengers' seat belt warning buzzer sounds to alert the rear passenger that his or her seat belt is not fastened. If the seat belt is unfastened, the buzzer sounds intermittently for a certain period of time, after the seat belt is fastened and unfastened and the vehicle reaches a certain speed.
- *10: See "Checking your vehicle's model" if you are not sure of which model your vehicle is. (→P. 12)
- *11: The parking brake engaged warning buzzer sounds if the vehicle reaches a speed of approximately 5 km/h (3 mph) or more.

■ Passenger detection sensor, seat belt reminder and warning buzzer

- If luggage is placed on the passenger seat, the front passenger detection sensor or the rear passenger detection sensor (if equipped) may cause the warning light to flash and the warning buzzer to sound even if a passenger is not sitting in the seat.
- If a cushion is placed on the seat, the sensor may not detect a passenger, and the warning light may not operate properly.

■ If the malfunction indicator lamp comes on while driving

For some models, malfunction indicator lamp will come on if the fuel tank becomes completely empty. If the fuel tank is empty, refuel the vehicle immediately. The malfunction indicator lamp will go off after several trips.

If the malfunction indicator lamp does not go off, contact any authorized Toyota retailer or Toyota authorized repairer, or any reliable repairer as soon as possible.

■ Warning buzzer

In some cases, the buzzer may not be heard due to being in a noisy location or audio sound.

**WARNING**

- **If a warning light comes on or a warning buzzer sounds when a warning message is shown on the multi-information display (vehicles with multi-information display)**

Check and follow the message shown on the multi-information display. Failure to do so may result in death or serious injury.

- **If both the ABS and the brake system warning lights remain on**

Stop your vehicle in a safe place immediately and contact any authorized Toyota retailer or Toyota authorized repairer, or any reliable repairer. The vehicle will become extremely unstable during braking, and the ABS system may fail, which could cause an accident resulting in death or serious injury.

**NOTICE**

- **If the malfunction indicator lamp comes on when the boost pressure in the turbocharger is abnormally high (diesel engine)**

Never drive at high speed or race the engine even after the lamp goes off.

- **If the fuel system warning light flashes (diesel engine)**

Never drive the vehicle with the warning light flashing. Continued driving with water accumulated in the fuel filter will damage the fuel injection pump.

If a warning message is displayed*

The multi-information display shows warnings of system malfunctions, incorrectly performed operations, and messages that indicate a need for maintenance. When a message is shown, perform the correction procedure appropriate to the message.

① Master warning light

The master warning light also comes on or flashes in order to indicate that a message is currently being displayed on the multi-information display.

② Multi-information display

③ Handling method

Follow the instructions of the message on the multi-information display.

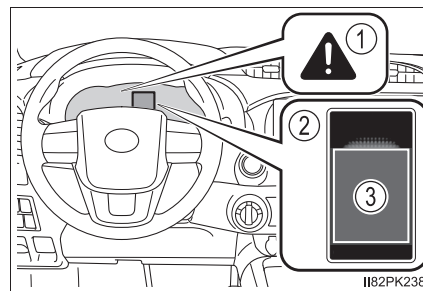

If any of the warning messages comes on again after the following actions have been performed, contact any authorized Toyota retailer or Toyota authorized repairer, or any reliable repairer.

*: If equipped

Messages and warnings

The warning lights and warning buzzers operate as follows depending on the content of the message. If a message indicates the need for inspection by a dealer, have the vehicle inspected by any authorized Toyota retailer or Toyota authorized repairer, or any reliable repairer immediately.

	System warning light	Warning buzzer*	Warning
Comes on	Comes on	Sounds	Indicates an important situation, such as when a system related to driving is malfunctioning or that danger may result if the correction procedure is not performed
Comes on	—	Sounds	
—	Comes on or flashes	Sounds	Indicates an important situation, such as when the systems shown on the multi-information display may be malfunctioning
Flashes	—	Sounds	Indicates a situation, such as when damage to the vehicle or danger may result
Comes on	—	Does not sound	Indicates a condition, such as malfunction of electrical components, their condition, or indicates the need for maintenance
Flashes	—	Does not sound	Indicates a situation, such as when an operation has been performed incorrectly, or indicates how to perform an operation correctly

The operation of the warning lights and warning buzzers may differ from those stated. In this case, perform the correction procedure according to the displayed message.

*: A buzzer sounds the first time a message is shown on the multi-information display.

■ Warning messages

The warning messages explained below may differ from the actual messages according to operation conditions and vehicle specifications.

■ If a message about an operation is shown

- If a message about an operation of the engine switch is shown

An instruction for operation of the engine switch is shown when the incorrect procedure for starting the engine is performed or the engine switch is operated incorrectly. Follow the instructions shown on the multi-information display to operate the engine switch again.

- If a message about a shift lever operation is shown

To prevent the shift lever from being operated incorrectly or the vehicle from moving unexpectedly, a message that requires shifting the shift lever may be shown on the multi-information display. In that case, follow the instruction of the message and shift the shift lever.

- If a message or image about an open/close state of a part or replenishment of a consumable is shown

Confirm the part indicated by the multi-information display or a warning light, and then perform the coping method such as closing the open door or replenishing a consumable.

■ If  is shown

The engine oil pressure is too low. (This warning message may be displayed if the vehicle is stopped on a slope. Move the vehicle to a level surface and check to see if the message goes off.)

Immediately stop the vehicle in a safe place and contact any authorized Toyota retailer or Toyota authorized repairer, or any reliable repairer. Continuing to drive the vehicle may be dangerous.

■ If “Accelerator and Brake Pedals Pressed Simultaneously” is shown

The accelerator and brake pedal are being depressed simultaneously.
(→P. 195)

Release the accelerator pedal and depress the brake pedal.

■ If “Windshield washer fluid low” is shown

The washer fluid level is low.
Add washer fluid. (→P. 498)

■ If “Oil maintenance required soon” is shown

The engine oil is scheduled to be changed.

Check the engine oil, and change if necessary. After changing the engine oil, the oil change system should be reset. (→P. 491)

For Russia, Armenia, Ukraine, Byelarus, Moldova, Bosnia Herzegovina, Montenegro, Serbia and Macedonia: You have forgotten to reset the oil change system. Change the engine oil in accordance with the maintenance schedule.

■ If “Oil maintenance required” is shown

The engine oil is scheduled to be changed.

Check and change the engine oil, and oil filter by any authorized Toyota retailer or Toyota authorized repairer, or any reliable repairer. After changing the engine oil, the oil change system should be reset. (→P. 491)

For Russia, Armenia, Ukraine, Byelarus, Moldova, Bosnia Herzegovina, Montenegro, Serbia and Macedonia: You have forgotten to reset the oil change system. Change the engine oil in accordance with the maintenance schedule.

■ If “Differential oil temp high Shift to 2WD mode Cooling time required” or “Differential oil temp high Cooling time required” is shown

The differential oil temperature is too high.

Turn the front-wheel drive control switch to H2, and reduce the vehicle speed or stop the vehicle in a safe place. (→P. 331)

■ If “Engine oil level low Add or replace” is shown

The engine oil level is low. (This warning message may be displayed if the vehicle is stopped on a slope. Move the vehicle to a level surface and check to see if the message goes off.)

Check the level of the engine oil and add or replace oil if necessary. (→P. 479)

■ If “Power turned off to save battery” is shown

Power was turned off due to the automatic power off function.

Next time when starting the engine, increase the engine speed slightly and maintain that level for approximately 5 minutes to recharge the battery.

■ If “DPF full Manual regeneration required See owner’s manual” is shown

The deposit collected in the filter needs to be regenerated. (→P. 371)

■ If “DPF regeneration in progress” is shown

Regeneration is being automatically carried out by the DPF system. (→P. 370)

■ **If a message that indicates the malfunction of front camera is shown**

The following systems may be suspended until the problem shown in the message is resolved. (→P. 271, 566)

- PCS (Pre-Collision System)*
- LDA (Lane Departure Alert With Yaw Assist Function)*
- RSA (Road Sign Assist)*
- Dynamic radar cruise control*

*: If equipped

■ **If a message that indicates the malfunction of radar sensor is shown**

The following systems may be suspended until the problem shown in the message is resolved. (→P. 271, 566)

- PCS (Pre-Collision System)*
- LDA (Lane Departure Alert With Yaw Assist Function)*
- Dynamic radar cruise control*

*: If equipped

■ **If “See owner’s manual” is shown**

- If the following messages are shown, follow the instructions accordingly.
 - “Engine Coolant Temp High Stop in a Safe Place” (→P. 610)
 - “Transmission fluid temp high” (→P. 238)
 - “Water accumulation in fuel filter” (→P. 499)
 - “AdBlue Level Low Fill up AdBlue in 2400 km” (→P. 502)
 - “AdBlue level Low No start in 800 km Top up AdBlue” (→P. 502)
 - “AdBlue empty Unable to Restart Engine Fill up AdBlue” (→P. 502)
 - “DPF full” (→P. 371)
 - “Front Camera Temporarily Unavailable” (→P. 271)
- If “Smart Entry & Start System malfunction” is shown, this may be a malfunction. Immediately have the vehicle inspected by any authorized Toyota retailer or Toyota authorized repairer, or any reliable repairer.
- If “Low Braking Power Stop in a Safe Place” is shown, there may be a malfunction. Immediately stop the vehicle in a safe place and contact any authorized Toyota retailer or Toyota authorized repairer, or any reliable repairer. Continuing to drive the vehicle may be dangerous.
- If the following messages are shown, there may be a malfunction. Immediately stop the vehicle in a safe place and contact any authorized Toyota retailer or Toyota authorized repairer, or any reliable repairer.
 - “Charging System Malfunction Stop in a Safe Place”
 - “Oil Pressure Low Stop in a Safe Place”

■ If “Radar Cruise Control Temporarily Unavailable See Owner’s Manual” is shown

The dynamic radar cruise control system is suspended temporarily or until the problem shown in the message is resolved. (causes and coping methods: →P. 271)

■ If “Radar Cruise Control Unavailable” is shown

The dynamic radar cruise control system cannot be used temporarily. Use the system when it becomes available again.

■ If “Visit your dealer” is shown

The system or part shown on the multi-information display is malfunctioning. Have the vehicle inspected by any authorized Toyota retailer or Toyota authorized repairer, or any reliable repairer immediately.

■ Warning buzzer

In some cases, the buzzer may not be heard due to being in a noisy location or audio sound.

**WARNING****■ If a warning light comes on or a warning buzzer sounds when a warning message is shown**

Check and follow the message shown on the multi-information display. Failure to do so may result in death or serious injury.

**NOTICE****■ While the engine oil level warning is shown**

Continued engine operation with low engine oil will damage the engine.

■ If “Water accumulation in fuel filter See owner’s manual” is shown

Never drive the vehicle if the warning message is displayed. Continued driving with water accumulated in the fuel filter will damage the fuel injection pump.

If you have a flat tire

Your vehicle is equipped with a spare tire. The flat tire can be replaced with the spare tire.

For details about tires: →P. 507

WARNING

■ If you have a flat tire

Do not continue driving with a flat tire.

Driving even a short distance with a flat tire can damage the tire and the wheel beyond repair, which could result in an accident.

Before jacking up the vehicle

- Stop the vehicle in a safe place on a hard, flat surface.
- Set the parking brake.
- Shift the shift lever to P (automatic transmission) or R (manual transmission).
- Stop the engine.
- Turn on the emergency flashers. (→P. 554)

Location of the spare tire

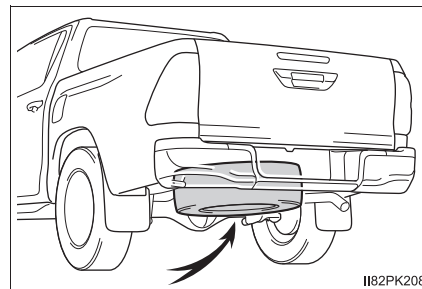

Location of the jack and tools

► Single-cab models

The jack and tools are stored behind the seat.

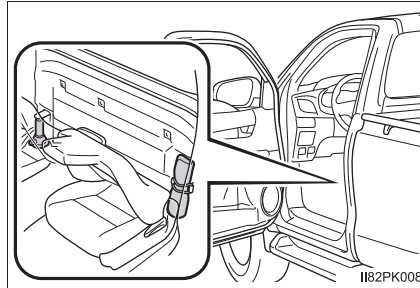

► Smart-cab models

The jack and tools are stored under the lid.

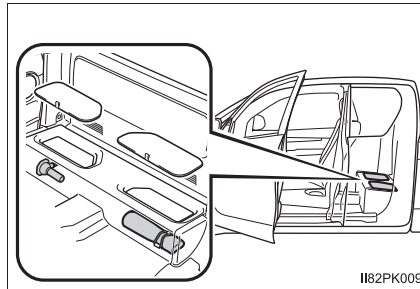

► Double-cab models

The jack and tools are stored under the bottom cushion.

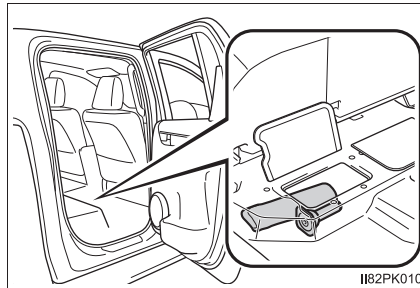

⚠ WARNING

■ **Using the tire jack**

Improper use of the tire jack may cause the vehicle to suddenly fall off the jack, leading to death or serious injury.

- Do not use the tire jack for any purpose other than replacing tires or installing and removing tire chains.
- Only use the tire jack that comes with this vehicle for replacing a flat tire. Do not use it on other vehicles, and do not use other tire jacks for replacing tires on this vehicle.
- Make sure the tire jack can be moved properly.
- Always check that the tire jack is securely set to the correct jack up point.
- Do not put any part of your body under the vehicle while it is supported by the jack.
- Do not start or run the engine while your vehicle is supported by the jack.
- Do not raise the vehicle while someone is inside.
- When raising the vehicle, do not put an object on or under the jack.
- Do not raise the vehicle to a height greater than that required to replace the tire.
- Do not continue jacking up once the yellow caution line has appeared.

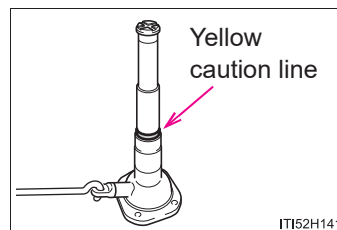

- Use a jack stand if it is necessary to get under the vehicle.

Take particular care when lowering the vehicle to ensure that no one working on or near the vehicle may be injured.

■ **Using the jack handle**

Insert the square head securely until you hear a click to prevent the extension parts from coming apart unexpectedly.

Taking out the jack and tool bag

► Single-cab models

- 1 Unhook the strap and take out the tool bag.

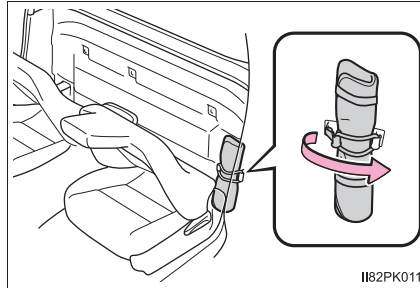

- 2 Take out the jack.

- ① For loosening
- ② For tightening

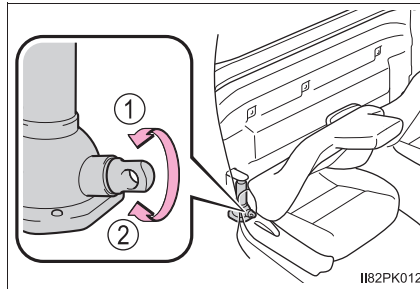

▶ Smart-cab models

- 1 Vehicles with rear seat cushions: Remove the rear seat cushions. (→P. 172)
- 2 Pull the tag and open the lid.

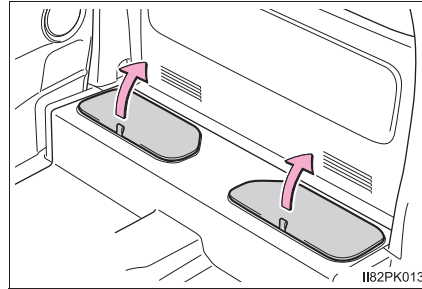

- 3 Unhook the strap and take out the tool bag.

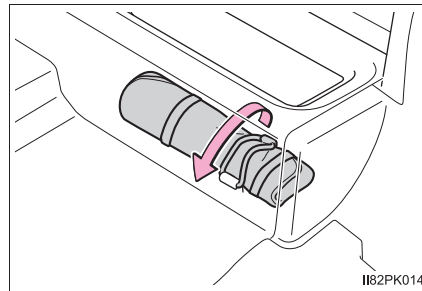

- 4 Take out the jack.
 - ① For loosening
 - ② For tightening

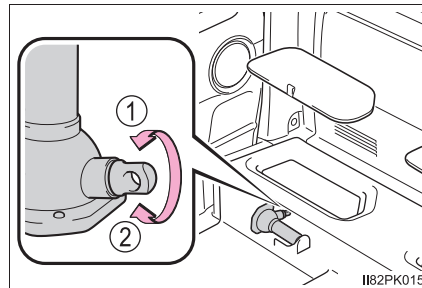

► Double-cab models

- 1 Tumbling the bottom cushion (→P. 172)
- 2 Open the lid.

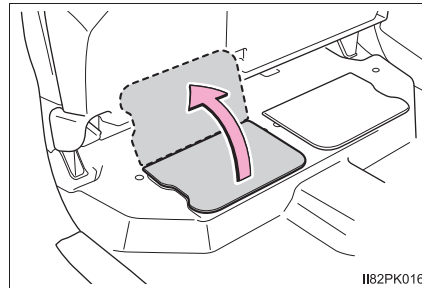

- 3 Take out the tool bag.

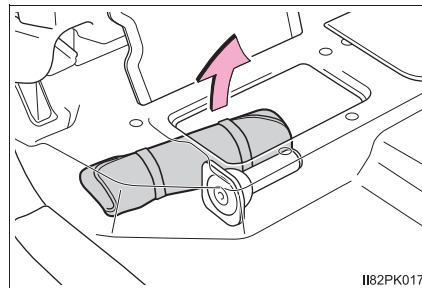

- 4 Take out the jack.
 - ① For loosening
 - ② For tightening

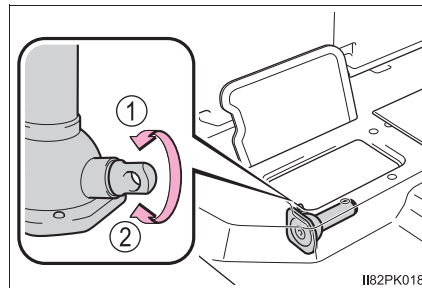

Taking out the spare tire

- 1 Assemble the jack handle end, jack handle extensions and wheel nut wrench.

To assemble the jack handle extension and wheel nut wrench, push in the projection on the jack handle extension.

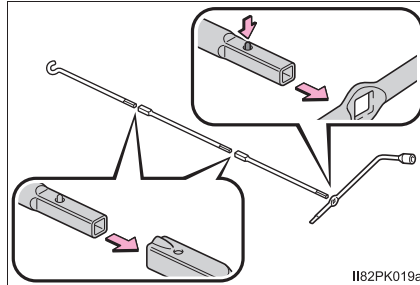

- 2 Insert the jack handle end into the lowering screw.

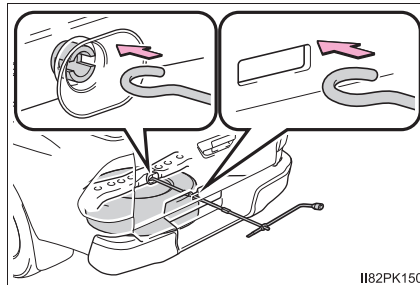

- 3 Lower the spare tire completely to the ground.

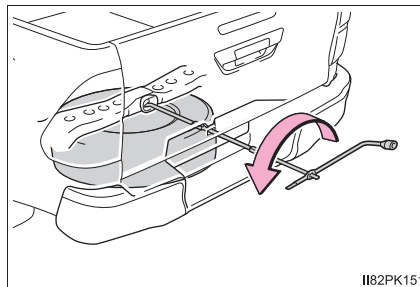

- 4 Remove the holding bracket and pull out the spare tire.

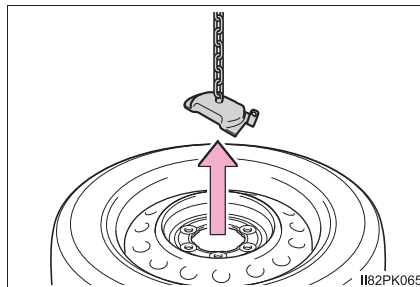

Replacing a flat tire

- 1 Chock the tires.

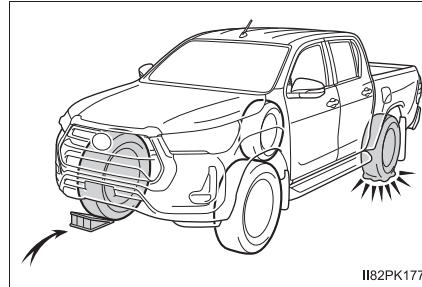

Flat tire		Wheel chock positions
Front	Left-hand side	Behind the rear right-hand side tire
	Right-hand side	Behind the rear left-hand side tire
Rear	Left-hand side	In front of the front right-hand side tire
	Right-hand side	In front of the front left-hand side tire

- 2 Remove the wheel ornament, using the beveled end of the wheel nut wrench as shown.

To protect the wheel ornament, place a rag between the wheel nut wrench and the wheel ornament.

► Type A

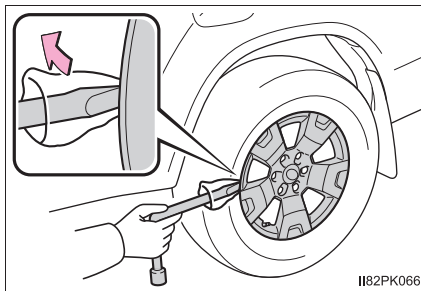

► Type B

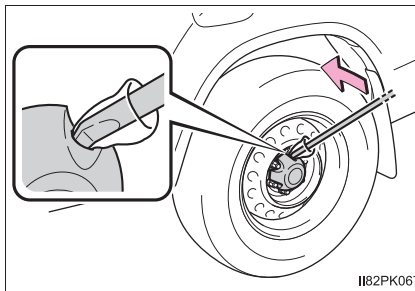

▶ Type C

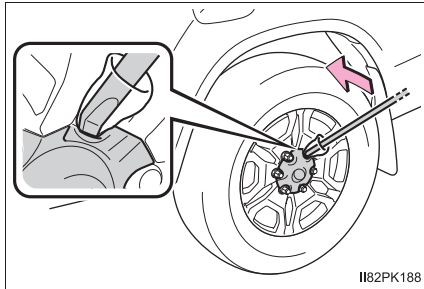

- 3 Slightly loosen the wheel nuts (one turn).

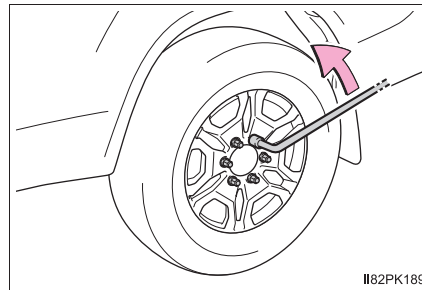

- 4 Assembling the jack handle. (→P. 587)
5 Position the jack at the jack points as shown.

▶ Front

Under the cross member

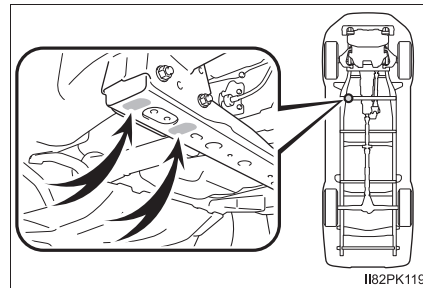

► Rear

Under the rear axle housing

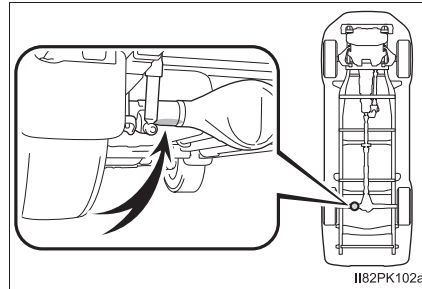

- 6 Raise the vehicle until the tire is slightly raised off the ground.

When positioning the jack under the rear axle housing, make sure the groove on the top of the jack fits with the rear axle housing.

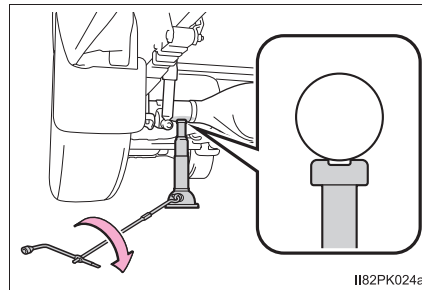

- 7 Remove all the wheel nuts and the tire.

When resting the tire on the ground, place the tire so that the wheel design faces up to avoid scratching the wheel surface.

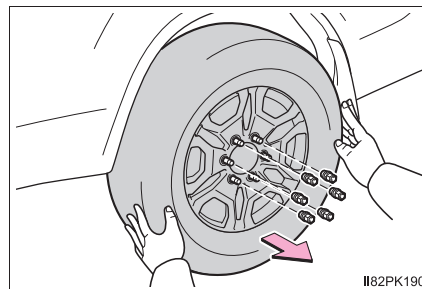

 **WARNING****■ Replacing a flat tire**

- Observe the following precautions.

Failure to do so may result in serious injury:

- Lower the spare tire completely to the ground before removing it from under the vehicle.
- Do not try to remove the wheel ornament by hand. Take due care in handling the ornament to avoid unexpected personal injury.
- Do not touch the disc wheels or the area around the brakes immediately after the vehicle has been driven.

After the vehicle has been driven the disc wheels and the area around the brakes will be extremely hot. Touching these areas with hands, feet or other body parts while changing a tire, etc. may result in burns.

- Failure to follow these precautions could cause the wheel nuts to loosen and the tire to fall off, resulting in death or serious injury.
 - Have the wheel nuts tightened with a torque wrench to 105 N•m (10.7 kgf•m, 77 ft•lbf) as soon as possible after changing wheels.
 - Do not attach a heavily damaged wheel ornament, as it may fly off the wheel while the vehicle is moving.
 - When installing a tire, only use wheel nuts that have been specifically designed for that wheel.
 - If there are any cracks or deformations in the bolt screws, nut threads or bolt holes of the wheel, have the vehicle inspected by any authorized Toyota retailer or Toyota authorized repairer, or any reliable repairer.
 - When installing the wheel nuts, be sure to install them with the tapered ends facing inward.

Installing the spare tire

- 1 Remove any dirt or foreign matter from the wheel contact surface.

If foreign matter is on the wheel contact surface, the wheel nuts may loosen while the vehicle is in motion, causing the tire to come off.

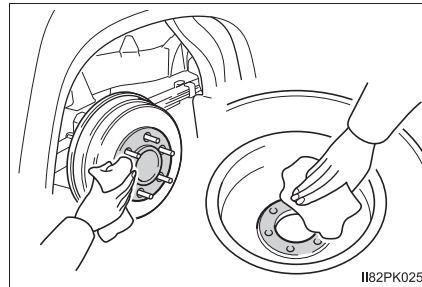

- 2 Install the tire and loosely tighten each wheel nut by hand by approximately the same amount.

► Steel wheels

Tighten the wheel nuts until the tapered portion comes into loose contact with the disc wheel seat.

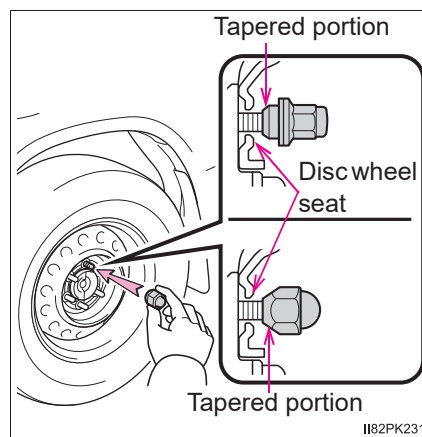

► Aluminum wheels

Turn the wheel nuts until the washers come into contact with the disc wheel.

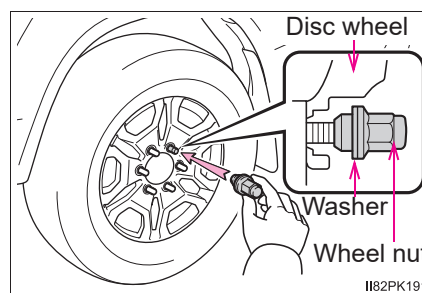

- 3 Lower the vehicle.

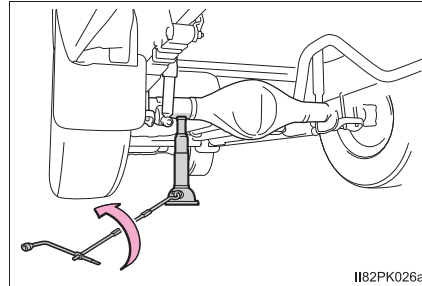

- 4 Firmly tighten each wheel nut two or three times in the order shown in the illustration.

Tightening torque:

105 N•m (10.7 kgf•m, 77 ft•lbf)

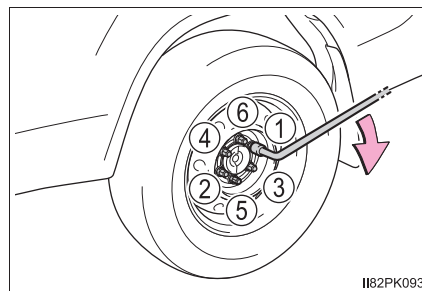

- 5 Vehicles with spare tire of the same wheel type as the installed tires: Reinstall the wheel ornament.

► Type A

Align the cutout of the wheel ornament with the valve stem as shown.

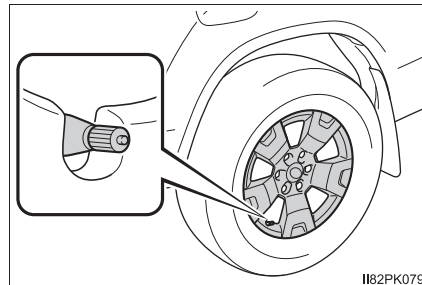

► Type B

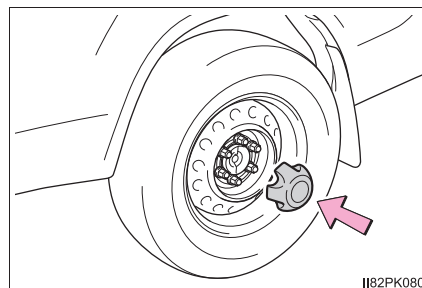

► Type C

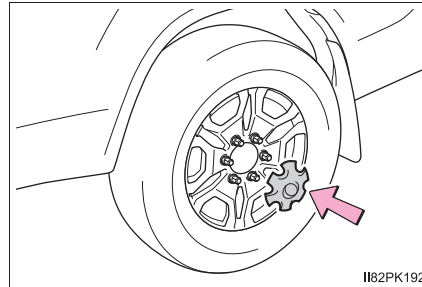

⚠ WARNING

■ **Stowing the flat tire**

Failure to follow steps listed under stowing the tire may result in damage to the spare tire carrier and loss of the tire, which could result in death or serious injury.

Stowing the flat tire, jack and all tools

- 1 Lay down the tire with the valve stem facing up and install the holding bracket, inserting the claw into the wheel lug nut hole. Turn the jack handle extension clockwise to take up slack in the chain.

Then, check to ensure the claw is in the wheel lug nut hole and the holding bracket is centered in the wheel hub.

- ① Holding bracket
- ② Claw

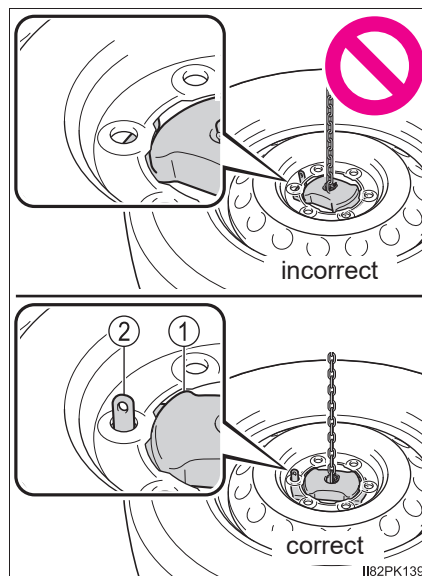

2 Raise the tire.

To protect the wheel design faces, place rags between the wheel design faces and the frame.

While raising, secure the tire, taking care that the tire goes straight up without catching on any surrounding part, to prevent it from flying forward during a collision or sudden braking.

After the tire goes half way up, check that the suspended chain is able to enter the tire hole, for proper storage.

Tightening torque:

37.0 N•m (3.8 kgf•m, 27.3 ft•lbf)

3 Confirm that the tire is not loose after tightening:

- ① Push and pull the tire
- ② Try rotating

Visually check to ensure the tire is not hung on surrounding parts.

If looseness or misassembly exists, repeat step **2** and step **3**.

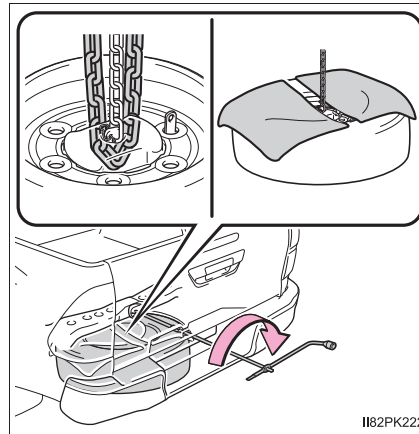
4 Repeat step **3**, any time the tire is lowered or disturbed.**5** Push in the projection on the jack handle and disassemble the jack handle end, jack handle extensions and wheel nut wrench.**6** Stow the tools and jack securely.

II82PK222

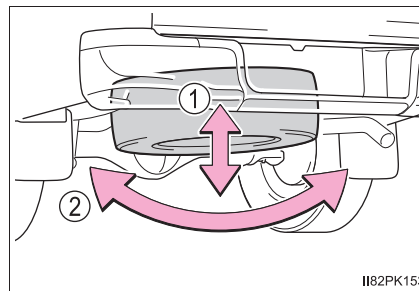

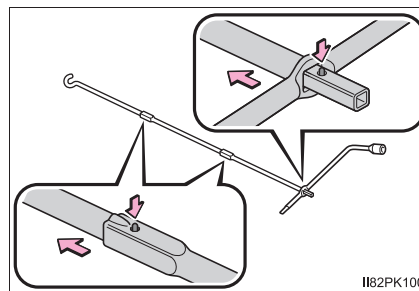

II82PK153



II82PK100

■ Certification for the jack

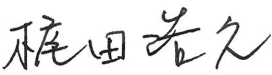
DECLARATION OF CONFORMITY	
 ATC AOYAMA THAI CO., LTD.	For 
Screw Jack	
Models: 09111-0K151, 09111-0K161 & 09111-0K181 for Toyota	
Manufactured by Aoyama Thai Co., Ltd. 64/49 Mu4, Eastern Seaboard Industrial Estate, Pluakdaeng, Rayong 21140 Thailand	
Means of Conformity The Product is in conformity with EC law as approximated by the following directives: Machinery Directive 2006/42/EC based on Technical Documentation File No. 2190 Issue 1, Revision 2	
Standards used as guidance Machinery Directive ISO12100: 2010 Limited reference to EN 1494:2000/A1:2008 Refer to complete listing in TF	
Technical File compiled from manufacturers documentation and held in the EU, on behalf of the manufacturer by Element Materials Technology Warwick Ltd 100 Frobisher Business Park, Leigh Sinton Road, Malvern, Worcestershire, WR14 1BX United Kingdom	
Signature of Responsible Person: Mr. Hirohisa Kajita Managing Director	
	
Date:	1st April 2016
Certificate No.	TRA-016130-00B DofC Issue 3

■ Flat tire

Repair or replace the flat tire as soon as possible.

When stowing the repaired or replaced tire to the carrier, remove the rags that are protecting the wheel design faces.

**WARNING****■ After using the tools and jack**

Before driving, make sure all the tools and jack are securely in place in their storage location to reduce the possibility of personal injury during a collision or sudden braking.

**NOTICE****■ When stowing the flat tire**

Ensure that there is no object caught between the tire and the vehicle underbody (except for rags that is used when stowing the flat tire).

■ When assembling the jack handle extension

Insert the square head securely until you hear a click. Otherwise the extension may come off and it may damage the paint or vehicle body.

If the engine will not start

If the engine will not start even though correct starting procedures are being followed (→P. 220, 223), consider each of the following points:

The engine will not start even though the starter motor operates normally.

One of the following may be the cause of the problem:

- There may not be sufficient fuel in the vehicle's tank.
Gasoline engine: Refuel the vehicle.
Diesel engine: →P. 614
- The engine may be flooded. (gasoline engine)
Try to restart the engine again following correct starting procedures.
(→P. 220, 223)
- There may be a malfunction in the engine immobilizer system.
(→P. 115)

The starter motor turns over slowly, the interior lights and headlights are dim, or the horn does not sound or sounds at a low volume.

One of the following may be the cause of the problem:

- The battery may be discharged. (→P. 604)
- The battery terminal connections may be loose or corroded.

The starter motor does not turn over (vehicles with smart entry & start system).

The engine starting system may be malfunctioning due to an electrical problem such as an open circuit or a blown fuse. However, an interim measure is available to start the engine. (→P. 599)

The starter motor does not turn over, the interior lights and headlights do not turn on, or the horn does not sound.

One of the following may be the cause of the problem:

- One or both of the battery terminals may be disconnected.
- The battery may be discharged. (→P. 604)
- There may be a malfunction in the steering lock system. (vehicles with smart entry & start system)

Contact any authorized Toyota retailer or Toyota authorized repairer, or any reliable repairer if the problem cannot be repaired, or if repair procedures are unknown.

Emergency start function (vehicles with smart entry & start system)

When the engine does not start, the following steps can be used as an interim measure to start the engine if the engine switch is functioning normally.

- 1 Set the parking brake.
- 2 Shift the shift lever to P (automatic transmission) or N (manual transmission).
- 3 Turn the engine switch to ACCESSORY mode.
- 4 Press and hold the engine switch for about 15 seconds while depressing the brake pedal and clutch pedal (manual transmission) firmly.

Even if the engine can be started using the above steps, the system may be malfunctioning. Have the vehicle inspected by your any authorized Toyota retailer or Toyota authorized repairer, or any reliable repairer.

If the electronic key does not operate properly (vehicles with smart entry & start system)

If communication between the electronic key and vehicle is interrupted (→P. 166) or the electronic key cannot be used because the battery is depleted, the smart entry & start system and wireless remote control cannot be used. In such cases, the doors can be opened and the engine can be started by following the procedure below.

Locking and unlocking the doors

Use the mechanical key (→P. 148, 150) in order to perform the following operations:

- ① Locks all doors
- ② Unlocks all doors

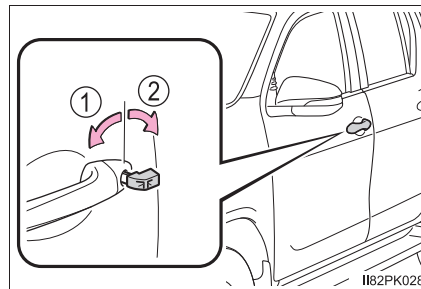

Starting the engine

► Automatic transmission

- 1 Ensure that the shift lever is in P and depress the brake pedal.
- 2 Touch the area behind the lock button and unlock button on the electronic key to the engine switch.

When the electronic key is detected, a buzzer sounds and the engine switch will turn to IGNITION ON mode.

When the smart entry & start system is deactivated in customization setting, the engine switch will turn to ACCESSORY mode.

- 3 Firmly depress the brake pedal.

A message indicating how to start the engine will be displayed on the multi-information display.

- 4 Press the engine switch.

In the event that the engine still cannot be started, contact any authorized Toyota retailer or Toyota authorized repairer, or any reliable repairer.

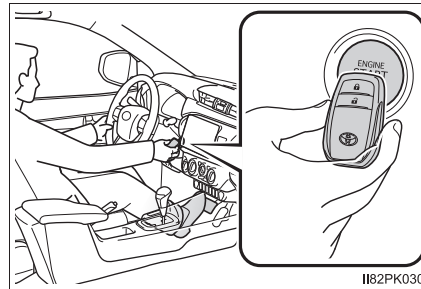

► Manual transmission

- 1 Ensure that the shift lever is in N and depress the clutch pedal.

- 2 Touch the area behind the lock button and unlock button on the electronic key to the engine switch.

When the electronic key is detected, a buzzer sounds and the engine switch will turn to IGNITION ON mode.

When the smart entry & start system is deactivated in customization setting, the engine switch will turn to ACCESSORY mode.

- 3 Firmly depress the clutch pedal.

A message indicating how to start the engine will be displayed on the multi-information display.

- 4 Press the engine switch.

In the event that the engine still cannot be started, contact any authorized Toyota retailer or Toyota authorized repairer, or any reliable repairer.

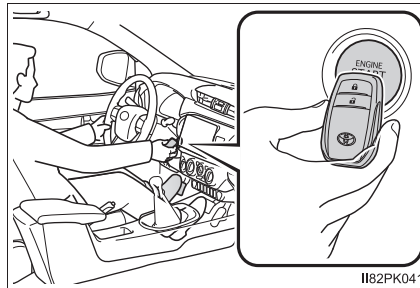

■ Stopping the engine

Shift the shift lever to P (automatic transmission) or N (manual transmission) and press the engine switch as you normally do when stopping the engine.

■ Replacing the key battery

As the above procedure is a temporary measure, it is recommended that the electronic key battery be replaced immediately when the battery is depleted. (→P. 516)

■ Alarm (vehicles with alarm for models for model code destination W*, and Kazakhstan)

Using the mechanical key to lock the doors will not set the alarm system. If a door is unlocked using the mechanical key and is opened when the alarm system is set, the alarm may be triggered.

*: See “Checking your vehicle’s model” if you are not sure of which model your vehicle is. (→P. 12)

■ Changing engine switch modes

Release the brake pedal (automatic transmission) or clutch pedal (manual transmission) and press the engine switch in step [3] above.

The engine does not start and modes will be changed each time the switch is pressed. (→P. 226)

■ When the electronic key does not work properly

- Make sure that the smart entry & start system has not been deactivated in the customization setting. If it is off, turn the function on. (Customizable features: →P. 646)
- Check if battery-saving mode is set. If it is set, cancel the function. (→P. 164)

If the vehicle battery is discharged

The following procedures may be used to start the engine if the vehicle's battery is discharged.

You can also call any authorized Toyota retailer or Toyota authorized repairer, or any reliable repairer or a qualified repair shop.

If you have a set of jumper (or booster) cables and a second vehicle with a 12-volt battery, you can jump start your vehicle by following the steps below.

- 1 Open the hood. (→P. 484)
- 2 Connect the jumper cables according to the following procedure:
 - ① Connect a positive jumper cable clamp to the positive (+) battery terminal on your vehicle.
 - ② Connect the clamp on the other end of the positive cable to the positive (+) battery terminal on the second vehicle.
 - ③ Connect a negative cable clamp to the negative (-) battery terminal on the second vehicle.
 - ④ Connect the clamp at the other end of the negative cable to a solid, stationary, unpainted metallic point away from the battery and any moving parts, as shown in the illustration.

► Gasoline engine

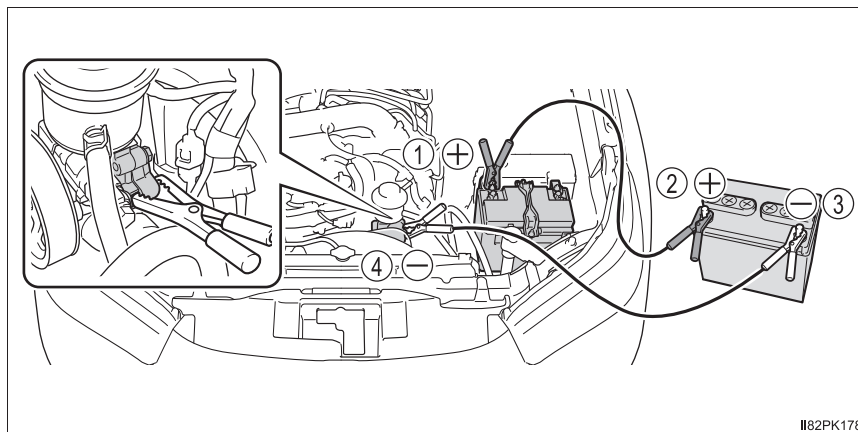

II82PK178

► Diesel engine (vehicles without water-cooled intercooler)

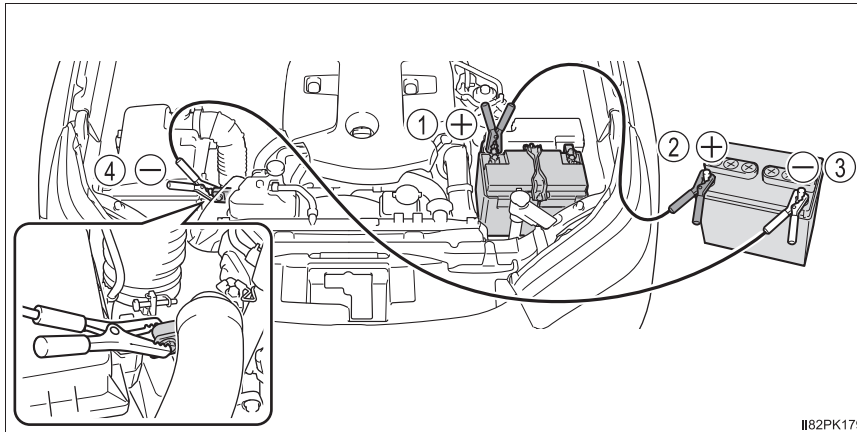

► Diesel engine (vehicles with water-cooled intercooler)

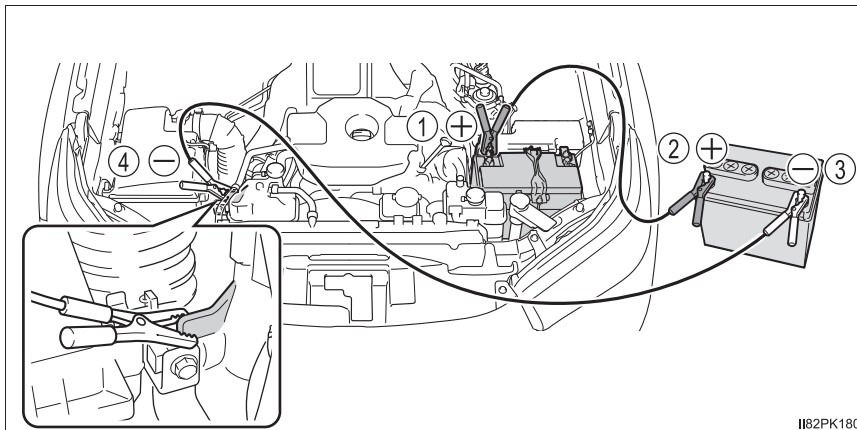

- 3 Start the engine of the second vehicle. Increase the engine speed slightly and maintain at that level for approximately 5 minutes to recharge the battery of your vehicle.
- 4 Vehicles with smart entry & start system: Open and close any of the doors with the engine switch off.
- 5 Maintain the engine speed of the second vehicle and start the engine of your vehicle by turning the engine switch to the "ON" position (vehicles without smart entry & start system) or IGNITION ON mode (vehicles with smart entry & start system).

- 6 Once the vehicle's engine has started, remove the jumper cables in the exact reverse order from which they were connected.

Once the engine starts, have the vehicle inspected at any authorized Toyota retailer or Toyota authorized repairer, or any reliable repairer as soon as possible.

■ **Starting the engine when the battery is discharged (vehicles with automatic transmission)**

The engine cannot be started by push-starting.

■ **To prevent battery discharge**

- Turn off the headlights and the audio system while the engine is off.
(Vehicles with Stop & Start system: Except when the engine is stopped due to the Stop & Start system)
- Turn off any unnecessary electrical components when the vehicle is running at a low speed for an extended period, such as in heavy traffic.

■ **When the battery is removed or discharged**

- Information stored in the ECU is cleared. When the battery is depleted, have the vehicle inspected at any authorized Toyota retailer or Toyota authorized repairer, or any reliable repairer.
- The power windows may not close normally. In this case, initialize the power windows. (if equipped) (→P. 187)
- If it is necessary to initialize the panoramic view monitor (if equipped), refer to "Navigation and multimedia system Owner's manual" or "Multimedia Owner's Manual".

■ **Charging the battery**

The electricity stored in the battery will discharge gradually even when the vehicle is not in use, due to natural discharge and the draining effects of certain electrical appliances. If the vehicle is left for a long time, the battery may discharge, and the engine may be unable to start. (The battery recharges automatically during driving.)

■ When recharging or replacing the battery (vehicles with smart entry & start system)

- In some cases, it may not be possible to unlock the doors using the smart entry & start system when the battery is discharged. Use the wireless remote control or the mechanical key to lock or unlock the doors.
- The engine may not start on the first attempt after the battery has recharged but will start normally after the second attempt. This is not a malfunction.
- The engine switch mode is memorized by the vehicle. When the battery is reconnected, the system will return to the mode it was in before the battery was discharged. Before disconnecting the battery, turn the engine switch off. If you are unsure what mode the engine switch was in before the battery discharged, be especially careful when reconnecting the battery.
- Vehicles with Stop & Start system: After the battery terminals have been disconnected and reconnected or, the battery has been replaced, the Stop & Start system may not automatically stop the engine for up to an hour.

■ When replacing the battery

- Use a battery that conforms to European regulations.
- Use a battery with the same case size as the previous battery and an equivalent 20 hour rate capacity (20HR) or greater.
 - If the sizes differ, the battery cannot be properly secured.
 - If the 20 hour rate capacity is low, even if the time period where the vehicle is not used is a short time, the battery may discharge and the engine may not be able to start.
- Vehicles with Stop & Start system: Use a genuine battery specifically designed for use with the Stop & Start system or a battery with equivalent specifications to a genuine battery. If an unsupported battery is used, Stop & Start system functions may be restricted to protect the battery.

Also, battery performance may decrease and the engine may not be able to restart. Contact any authorized Toyota retailer or Toyota authorized repairer, or any reliable repairer for details.
- For details, consult any authorized Toyota retailer or Toyota authorized repairer, or any reliable repairer.

**WARNING****■ When removing the battery terminals**

Always remove the negative (-) terminal first. If the positive (+) terminal contacts any metal in the surrounding area when the positive (+) terminal is removed, a spark may occur, leading to a fire in addition to electrical shocks and death or serious injury.

■ Avoiding battery fires or explosions

Observe the following precautions to prevent accidentally igniting the flammable gas that may be emitted from the battery:

- Make sure each jumper cable is connected to the correct terminal and that it is not unintentionally in contact with any other than the intended terminal.
- Do not allow the other end of the jumper cable connected to the “+” terminal to come into contact with any other parts or metal surfaces in the area, such as brackets or unpainted metal.
- Do not allow the + and - clamps of the jumper cables to come into contact with each other.
- Do not smoke, use matches, cigarette lighters or allow open flame near the battery.

■ Battery precautions

The battery contains poisonous and corrosive acidic electrolyte, while related parts contain lead and lead compounds. Observe the following precautions when handling the battery:

- When working with the battery, always wear safety glasses and take care not to allow any battery fluids (acid) to come into contact with skin, clothing or the vehicle body.
- Do not lean over the battery.
- In the event that battery fluid comes into contact with the skin or eyes, immediately wash the affected area with water and seek medical attention. Place a wet sponge or cloth over the affected area until medical attention can be received.
- Always wash your hands after handling the battery support, terminals, and other battery-related parts.
- Do not allow children near the battery.

 WARNING**■ When exchanging the battery**

- When the vent plug and indicator are close to the hold down bracket, the battery fluid (sulfuric acid) may leak.
- For information regarding battery replacement, contact any authorized Toyota retailer or Toyota authorized repairer, or any reliable repairer.

■ To prevent damage to the vehicle (vehicles with manual transmission)

Do not pull- or push-start the vehicle as the three-way catalytic converter or catalytic converter may overheat and become a fire hazard.

 NOTICE**■ When handling jumper cables**

When connecting the jumper cables, ensure that they do not become entangled in the cooling fan or belt.

If your vehicle overheats

The following may indicate that your vehicle is overheating.

- The needle of the engine coolant temperature gauge (→P. 130) enters the red zone or a loss of engine power is experienced. (For example, the vehicle speed does not increase.)
- Vehicles with multi-information display: “Engine Coolant Temp High Stop in a Safe Place See Owner’s Manual” is shown on the multi-information display.
- Steam comes out from under the hood.

Correction procedures

- 1 Stop the vehicle in a safe place and turn off the air conditioning system, and then stop the engine.
- 2 If you see steam:
Carefully lift the hood after the steam subsides.
If you do not see steam:
Carefully lift the hood.
- 3 After the engine has cooled down sufficiently, inspect the hoses and radiator core (radiator) for any leaks.

- ① Radiator
- ② Cooling fan

If a large amount of coolant leaks, immediately contact any authorized Toyota retailer or Toyota authorized repairer, or any reliable repairer.

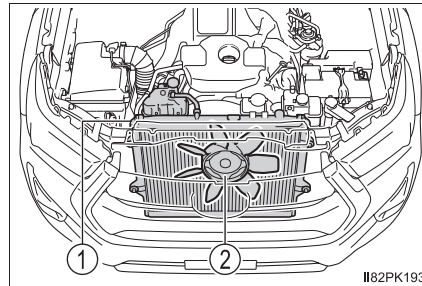

II82PK193

- 4 The coolant level is satisfactory if it is between the “F” and “L” lines on the reservoir.

① Reservoir

③ “L” line

② “F” line

④ Radiator cap (if equipped)

► Engine coolant (gasoline engine)

► Engine coolant (diesel engine)

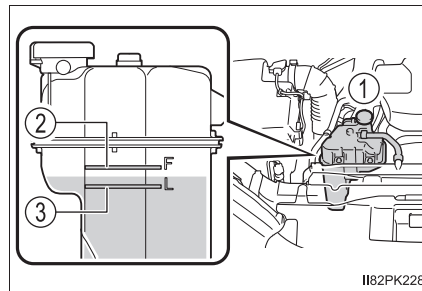
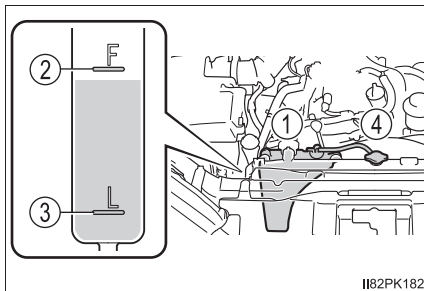

► Intercooler coolant (if equipped)

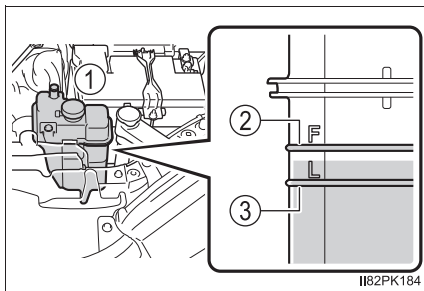

5 Add engine coolant if necessary. (→P. 634)

Water can be used in an emergency if engine coolant is unavailable.

- ▶ Engine coolant (gasoline engine)
- ▶ Engine coolant (diesel engine)

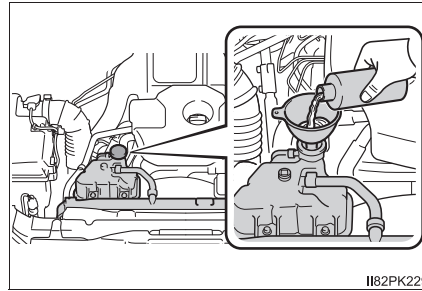
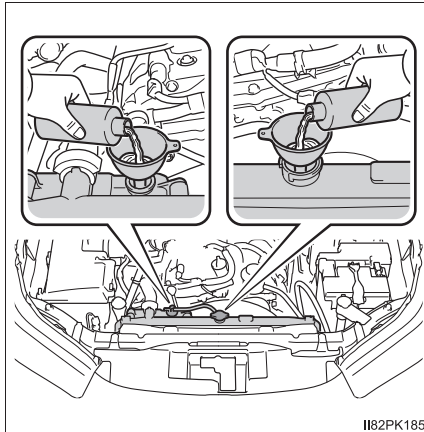

- ▶ Intercooler coolant (if equipped)

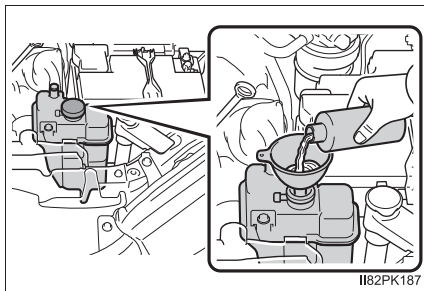

- 6 Start the engine to check that the radiator cooling fan operates and to check for coolant leaks from the radiator or hoses.
- 7 If the fan is not operating:
Stop the engine immediately and contact any authorized Toyota retailer or Toyota authorized repairer, or any reliable repairer.
- If the fan is operating:
Have the vehicle inspected at the nearest authorized Toyota retailer or Toyota authorized repairer, or any reliable repairer.

 **WARNING**

When inspecting under the hood of your vehicle

Observe the following precautions.

Failure to do so may result in serious injury such as burns.

- If steam is seen coming from under the hood, do not open the hood until the steam has subsided. The engine compartment may be very hot.
- Keep hands and clothing (especially a tie, a scarf or a muffler) away from the fans and belts. Failure to do so may cause the hands or clothing to be caught, resulting in serious injury.
- Do not loosen the radiator cap (if equipped), the engine coolant reservoir cap or intercooler coolant reservoir cap (if equipped) while the engine and radiator are hot. High temperature steam or coolant could spray out.

 **NOTICE**

When adding engine coolant

Add coolant slowly after the engine has cooled down sufficiently. Adding cool coolant to a hot engine too quickly can cause damage to the engine.

To prevent damage to the cooling system

Observe the following precautions:

- Avoid contaminating the coolant with foreign matter (such as sand or dust etc.).
- Do not use any coolant additive.

If you run out of fuel and the engine stalls (diesel engine only)

If you run out of fuel and the engine stalls:

- 1 Refuel your vehicle.
- 2 To bleed the fuel system, operate the priming pump until you feel more resistance.

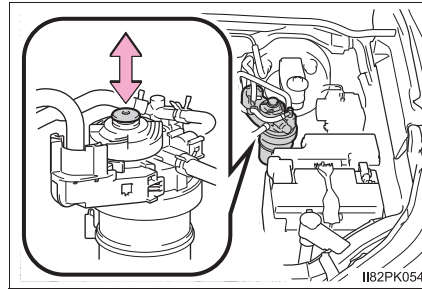

- 3 Start the engine. (→P. 220, 223)

If the engine does not start after the above steps have been performed, wait for 10 seconds and try steps 2 and 3 again. If the engine still does not start, contact any authorized Toyota retailer or Toyota authorized repairer, or any reliable repairer.

After starting the engine, depress the accelerator pedal lightly until the engine runs smoothly.

NOTICE

■ When restarting the engine

- Do not crank the engine before refueling and operating the priming pump. This may damage the engine and fuel system.
- Do not crank the engine for more than 30 seconds at a time. This may overheat the starter and wiring system.

If the vehicle becomes stuck

Carry out the following procedures if the tires spin or the vehicle becomes stuck in mud, dirt or snow:

- 1 Stop the engine. Set the parking brake and shift the shift lever to P (automatic transmission) or N (manual transmission).
- 2 Remove the mud, snow or sand from around the stuck tire.
- 3 Place wood, stones or some other material under the tires to help provide traction.
- 4 Restart the engine.
- 5 Vehicles with rear differential lock system: Lock the rear differential. (→P. 341)
- 6 Shift the shift lever to the D or R position (automatic transmission) or 1 or R position (manual transmission) and carefully apply the accelerator to free the vehicle.

■ When it is difficult to free the vehicle (vehicles with TRC/A-TRC system)

Press  to turn off TRC/A-TRC.

- ▶ Vehicles without AUTO LSD system (without multi-information display)

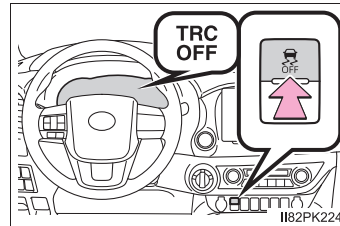

- ▶ Vehicles without AUTO LSD system (with multi-information display)

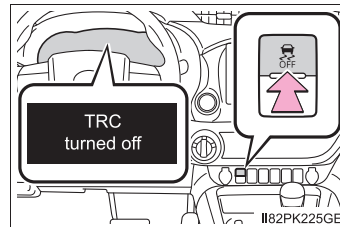

- ▶ Vehicles with AUTO LSD system

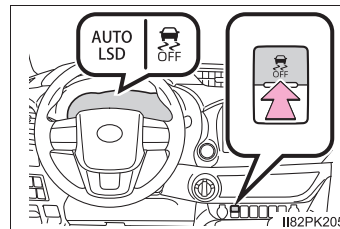

 WARNING**■ When attempting to free a stuck vehicle**

If you choose to push the vehicle back and forth to free it, make sure the surrounding area is clear to avoid striking other vehicles, objects or people. The vehicle may also lunge forward or lunge back suddenly as it becomes free. Use extreme caution.

■ When shifting the shift lever

For vehicles with automatic transmission, be careful not to shift the shift lever with the accelerator pedal depressed.

This may lead to unexpected rapid acceleration of the vehicle that may cause an accident resulting in death or serious injury.

 NOTICE**■ To avoid damage to the transmission and other components**

- Avoid spinning the wheels and depressing the accelerator pedal more than necessary.
- If the vehicle remains stuck even after these procedures are performed, the vehicle may require towing to be freed.
- Vehicles with automatic transmission: When a warning message for the automatic transmission fluid temperature is displayed while attempting to free a stuck vehicle, immediately remove your foot from the accelerator pedal and wait until the warning message disappears. Otherwise, the transmission may become damaged. (→P. 238)

Vehicle specifications**9****9-1. Specifications**

Maintenance data
(fuel, oil level, etc.).....620

Fuel information643

9-2. Customization

Customizable features646

9-3. Initialization

Items to initialize654

Maintenance data (fuel, oil level, etc.)

Dimensions

Overall length	Without over fender	Without rear bumper	5265 mm (207.3 in.) ^{*2} 5285 mm (208.1 in.) ^{*3}
		With rear bumper	5335 mm (210.0 in.)
	With over fender	Without rear bumper	5255 mm (206.9 in.) ^{*2} 5275 mm (207.7 in.) ^{*3}
		With rear bumper	5325 mm (209.6 in.)
Overall width	Without over fender		1800 mm (70.9 in.) ^{*4} 1815 mm (71.5 in.) ^{*5}
	With over fender		1855 mm (73.0 in.) ^{*6} 1900 mm (74.8 in.) ^{*7} 1910 mm (75.2 in.) ^{*8}
Overall height ^{*1}	Single-cab models		1855 mm (73.0 in.) ^{*10} 1795 mm (70.7 in.) ^{*11}
	Smart-cab models		1860 mm (73.2 in.) ^{*10} 1810 mm (71.3 in.) ^{*11}
	Double-cab models		1865 mm (73.4 in.) ^{*10} 1815 mm (71.5 in.) ^{*11}
Wheelbase			3090 mm (121.7 in.)
Front tread			1505 mm (59.3 in.) ^{*12} 1495 mm (58.9 in.) ^{*13} 1535 mm (60.4 in.) ^{*14}
Rear tread			1520 mm (59.8 in.) ^{*12} 1510 mm (59.4 in.) ^{*13} 1550 mm (61.0 in.) ^{*14}

*1: Unladen vehicle

*2: With tailgate type A (→P. 160)

*3: With tailgate type B (→P. 160)

*4: Without side step

*5: With side step

*6: With exterior type A^{*9}

*7: With exterior type B^{*9}

*8: With exterior type C^{*9}

- *9: See “How to identify exterior type” to check the type of your vehicle.
(→P. 621)
- *10: Without short pole antenna
- *11: With short pole antenna
- *12: With 205R16C tires
- *13: With 225/70R17C tires
- *14: With 265/65R17 or 265/60R18 tires

■ How to identify exterior type

Check the type of the exterior in the following illustrations.

▶ Type A

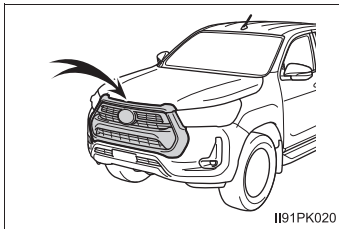

▶ Type B

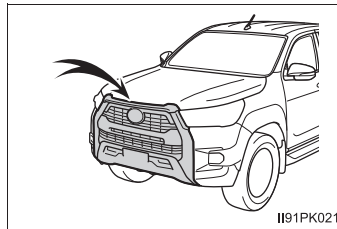

▶ Type C

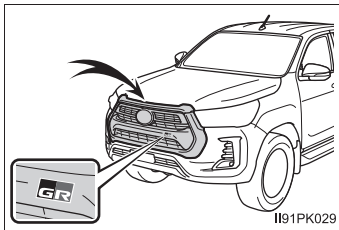

Weights (with towing hitch)

► Models for model code destination W*¹

Gross vehicle mass	Single-cab models	4WD models	3080 kg (6790 lb.) ^{*2} 3100 kg (6834 lb.) ^{*3}
		Pre Runner	3000 kg (6614 lb.)
	Smart-cab models	4WD models	3150 kg (6945 lb.)
		Pre Runner	3000 kg (6614 lb.)
	Double-cab models	4WD models	► Models made in South Africa ^{*1} 3210 kg (7077 lb.) ► Models made in Thailand ^{*1} 2910 kg (6415 lb.) ^{*5} 3130 kg (6900 lb.) ^{*6}
		Pre Runner	► Models made in South Africa ^{*1} 3050 kg (6724 lb.) ► Models made in Thailand ^{*1} 3030 kg (6680 lb.)
Maximum permissible axle capacity	Front		1450 kg (3197 lb.)
	Rear	Single-cab models	1850 kg (4079 lb.)
		Smart-cab models	1920 kg (4233 lb.)
		Double-cab models	► Except for GUN126L-DTTSXW and GUN126L-DTTHXW models ^{*4} 1920 kg (4233 lb.) ► For GUN126L-DTTSXW and GUN126L-DTTHXW models ^{*4} 1650 kg (3638 lb.) ^{*8} 1920 kg (4233 lb.) ^{*9}
Drawbar load	4WD models		140 kg (309 lb.)
	Pre Runner		120 kg (265 lb.)

Towing capacity	Without brake		750 kg (1653 lb.)
	With brake	4WD models	3500 kg (7716 lb.)
		Pre Runner	3000 kg (6614 lb.)

*1: See “Checking your vehicle’s model” if you are not sure of which model your vehicle is. (→P. 12)

*2: Except for GUN125R-BNFSXW3 model*4

*3: For GUN125R-BNFSXW3 model*4

*4: The model code is indicated on the manufacturer’ plate or label. (→P. 624)

*5: Except for EURO VI models*7 for Israel and Turkey

*6: For EURO VI models*7 for Israel and Turkey

*7: EURO VI is an emission standard. If it is not clear that your vehicle meets relevant standards, contact any authorized Toyota retailer or Toyota authorized repairer, or any reliable repairer.

*8: Except for EURO VI models*7 for Israel, Turkey and Ukraine

*9: For EURO VI models*7 for Israel, Turkey and Ukraine

► For Kazakhstan

Gross vehicle mass		2800 kg (6173 lb.)
Maximum permissible axle capacity	Front	1400 kg (3086 lb.)
	Rear	1650 kg (3638 lb.)
Drawbar load		100 kg (220 lb.)
Towing capacity	Without brake	750 kg (1653 lb.)
	With brake	2500 kg (5512 lb.)

Vehicle identification

■ Vehicle identification number

The vehicle identification number (VIN) is the legal identifier for your vehicle. This is the primary identification number for your Toyota. It is used in registering the ownership of your vehicle.

This number is stamped on the rear right frame.

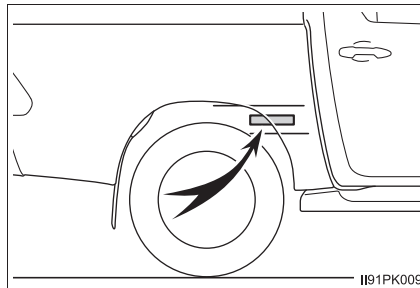

Single-cab models (models made in South Africa*):
This number is also on the manufacturer's label.



Smart-cab models (models made in South Africa*):
This number is also on the manufacturer's label.

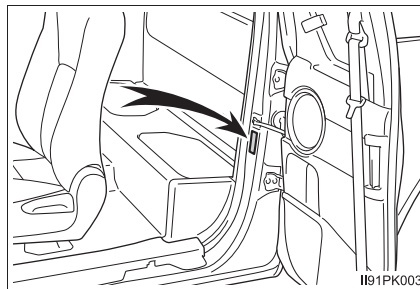

Double-cab models (models made in South Africa*):
This number is also on the manufacturer's label.

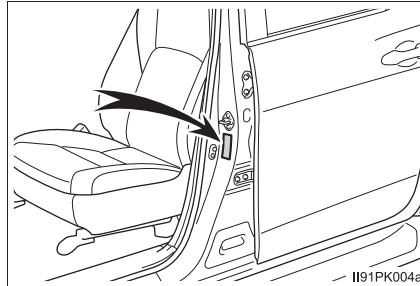

Models made in Thailand*:
This number is also on the manufacturer's plate.

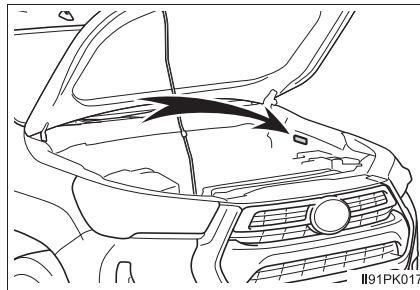

*: See "Checking your vehicle's model" if you are not sure of which model your vehicle is. (→P. 12)

■ **Engine number**

The engine number is stamped on the engine block as shown.

▶ Gasoline engine

▶ Diesel engine

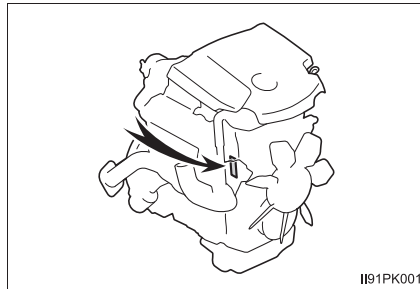
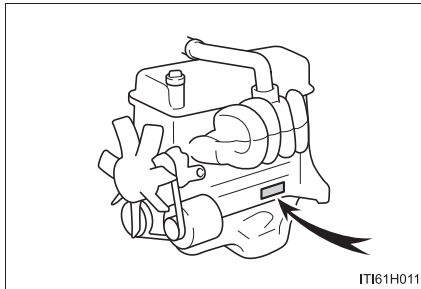

Engine

▶ 2TR-FE engine

Model	2TR-FE
Type	4 cylinder in line, 4 cycle, gasoline
Bore and stroke	95.0 × 95.0 mm (3.74 × 3.74 in.)
Displacement	2694 cm ³ (164.4 cu.in.)
Valve clearance	Automatic adjustment
Drive belt tension	Automatic adjustment

▶ 1GD-FTV engine

Model	1GD-FTV
Type	4 cylinder in line, 4 cycle, diesel (with turbocharger)
Bore and stroke	92.0 × 103.6 mm (3.62 × 4.08 in.)
Displacement	2755 cm ³ (168.1 cu.in.)
Valve clearance	Automatic adjustment
Drive belt tension	Automatic adjustment

▶ 2GD-FTV engine

Model	2GD-FTV
Type	4 cylinder in line, 4 cycle, diesel (with turbocharger)
Bore and stroke	92.0 × 90.0 mm (3.62 × 3.54 in.)
Displacement	2393 cm ³ (146.0 cu.in.)
Valve clearance	Automatic adjustment
Drive belt tension	Automatic adjustment

Fuel

▶ Gasoline engine

Fuel type	<p>When you find these types of fuel label at the gas station, use only the fuel with one of the following labels.</p>  <p>Unleaded gasoline only</p>
Research Octane Number	91 or higher
Fuel tank capacity (Reference)	80 L (21.1 gal., 17.6 Imp.gal.)

▶ Diesel engine

Fuel type	<p>When you find these types of fuel label at the gas station, use only the fuel with one of the following labels.</p>  <p>EU area: Diesel fuel conforming to European standard EN590 or EN16734 Except EU area (vehicles without DPF system): Diesel fuel only Except EU area (vehicles with DPF system): Diesel fuel that contains 10 ppm or less of sulfur</p>
Cetane number	48 or higher
Fuel tank capacity (Reference)	80 L (21.1 gal., 17.6 Imp.gal.)

Lubrication system

► Gasoline engine

Oil capacity (Drain and refill — reference*)	
With filter	5.6 L (5.9 qt., 4.9 Imp.qt.)
Without filter	5.3 L (5.6 qt., 4.7 Imp.qt.)

*: The engine oil capacity is a reference quantity to be used when changing the engine oil. Warm up and turn off the engine, wait more than 5 minutes, and check the oil level on the dipstick.

■ Engine oil selection

“Toyota Genuine Motor Oil” is used in your Toyota vehicle. Use Toyota approved “Toyota Genuine Motor Oil” or equivalent to satisfy the following grade and viscosity.

Oil grade:

0W-20, 5W-20, 5W-30 and 10W-30:

API grade SL “Energy-Conserving”, SM “Energy-Conserving”, SN “Resource-Conserving”, SN PLUS “Resource-Conserving” or SP “Resource-Conserving”; or ILSAC GF-6A multigrade engine oil

Recommended viscosity (SAE):

SAE 0W-20 is filled into your Toyota vehicle at manufacturing, and the best choice for good fuel economy and good starting in cold weather.

If you use SAE 10W-30 or a higher viscosity engine oil in extremely low temperatures, the engine may become difficult to start, so SAE 0W-20, 5W-20 or 5W-30 engine oil is recommended.

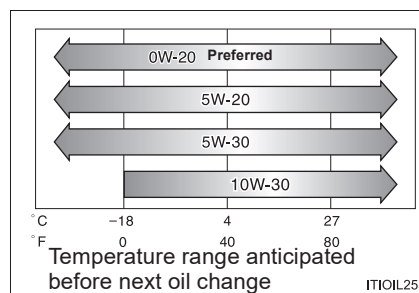

Oil viscosity (0W-20 is explained here as an example):

- The 0W in 0W-20 indicates the characteristic of the oil which allows cold startability. Oils with a lower value before the W allow for easier starting of the engine in cold weather.
- The 20 in 0W-20 indicates the viscosity characteristic of the oil when the oil is at high temperature. An oil with a higher viscosity (one with a higher value) may be better suited if the vehicle is operated at high speeds, or under extreme load conditions.

How to read oil container labels:

Either or both API registered marks are added to some oil containers to help you select the oil you should use.

① API Service Symbol

Top portion: "API SERVICE SP" means the oil quality designation by American Petroleum Institute (API).

Center portion: "SAE 0W-20" means the SAE viscosity grade.

Lower portion: "Resource-Conserving" means that the oil has fuel-saving and environmental protection capabilities.

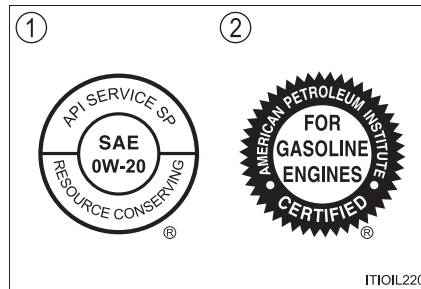

② ILSAC Certification Mark

The International Lubricant Specification Advisory Committee (ILSAC) Certification Mark is displayed on the front of the container.

► Diesel engine (except for EURO V and VI models*1)

Oil capacity (Drain and refill — reference*2)	
With filter	7.5 L (7.9 qt., 6.6 Imp.qt.)
Without filter	7.0 L (7.4 qt., 6.2 Imp.qt.)

*1: EURO V and VI are emission standards. If it is not clear that your vehicle meets relevant standards, contact any authorized Toyota retailer or Toyota authorized repairer, or any reliable repairer.

*2: The engine oil capacity is a reference quantity to be used when changing the engine oil. Warm up and turn off the engine, wait more than 5 minutes, and check the oil level on the dipstick.

■ Engine oil selection

“Toyota Genuine Motor Oil” is used in your Toyota vehicle. Use Toyota approved “Toyota Genuine Motor Oil” or equivalent to satisfy the following grade and viscosity.

Oil grade: API CF-4, CF or ACEA B3, B4, B5 or JASO DL-0

Recommended viscosity (SAE):

SAE 5W-30 is the best choice for good fuel economy and good starting in cold weather.

If you use SAE 10W-30 or a higher viscosity engine oil in extremely low temperatures, the engine may become difficult to start, so SAE 5W-30 engine oil is recommended.

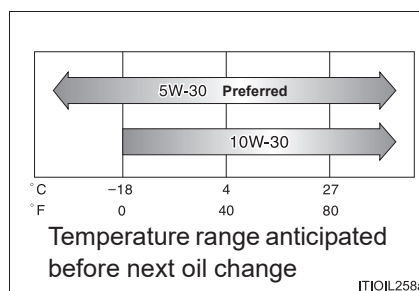

How to read oil container label:

The Japanese Automobile Standard Organization (JASO) DL-0 Mark is added to some oil containers to help you select the oil you should use.



Oil viscosity (5W-30 is explained here as an example):

- The 5W in 5W-30 indicates the characteristic of the oil which allows cold startability. Oils with a lower value before the W allow for easier starting of the engine in cold weather.
- The 30 in 5W-30 indicates the viscosity characteristic of the oil when the oil is at high temperature. An oil with a higher viscosity (one with a higher value) may be better suited if the vehicle is operated at high speeds, or under extreme load conditions.



► Diesel engine (for EURO V and VI models*1)

Oil capacity (Drain and refill — reference *2)	
With filter	7.5 L (7.9 qt., 6.6 Imp.qt.)
Without filter	7.0 L (7.4 qt., 6.2 Imp.qt.)

*1: EURO V and VI are emission standards. If it is not clear that your vehicle meets relevant standards, contact any authorized Toyota retailer or Toyota authorized repairer, or any reliable repairer.

*2: The engine oil capacity is a reference quantity to be used when changing the engine oil. Warm up and turn off the engine, wait more than 5 minutes, and check the oil level on the dipstick.

■ Engine oil selection

“Toyota Genuine Motor Oil” is used in your Toyota vehicle. Toyota recommends the use of approved “Toyota Genuine Motor Oil”. Another motor oil of matching quality can also be used.

Oil grade:

0W-20: ACEA C5

0W-30 and 5W-30: ACEA C2

 NOTICE

Using engine oil other than ACEA C5 or C2 may damage the catalytic converter.

Recommended viscosity (SAE):

SAE 0W-20 is filled into your Toyota vehicle at manufacturing, and the best choice for good fuel economy and good starting in cold weather.

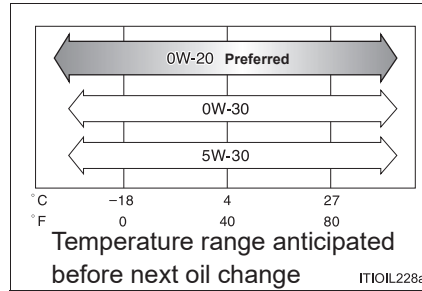

Oil viscosity (0W-20 is explained here as an example):

- The 0W in 0W-20 indicates the characteristic of the oil which allows cold startability. Oils with a lower value before the W allow for easier starting of the engine in cold weather.
- The 20 in 0W-20 indicates the viscosity characteristic of the oil when the oil is at high temperature. An oil with a higher viscosity (one with a higher value) may be better suited if the vehicle is operated at high speeds, or under extreme load conditions.

Cooling system

Engine coolant capacity	Gasoline engine		▶ With automatic transmission 8.1 L (8.6 qt., 7.1 Imp.qt.) ▶ With manual transmission 7.8 L (8.2 qt., 6.9 Imp.qt.)
	Diesel engine	Except for EURO IV, V and VI models*1	8.2 L (8.7 qt., 7.2 Imp.qt.)*2 8.6 L (9.1 qt., 7.6 Imp.qt.)*3
		For EURO IV, V and VI models*1	▶ With automatic transmission 9.8 L (10.4 qt., 8.6 Imp.qt.) ▶ With manual transmission 8.7 L (9.2 qt., 7.7 Imp.qt.)*2 9.3 L (9.8 qt., 8.2 Imp.qt.)*3
	Intercooler coolant capacity (if equipped)		2.95 L (3.12 qt., 2.60 Imp.qt.)
Coolant type			Use either of the following: <ul style="list-style-type: none"> • “Toyota Super Long Life Coolant” • Similar high-quality ethylene glycol-based non-silicate, non-amine, non-nitrite, and non-borate coolant with long-life hybrid organic acid technology Do not use plain water alone.

*1: EURO IV, V and VI are emission standards. If it is not clear that your vehicle meets relevant standards, contact any authorized Toyota retailer or Toyota authorized repairer, or any reliable repairer.

*2: Without power heater

*3: With power heater

Ignition system (gasoline engine)

Spark plug	
Make	DENSO FK20HR-A8
Gap	0.8 mm (0.031 in.)

 NOTICE**■ Iridium-tipped spark plugs**

Use only iridium-tipped spark plugs. Do not adjust the spark plug gap.

Electrical system

▶ Vehicles with maintenance type battery

Battery	
Specific gravity reading at 20°C (68°F):	1.25 or higher If the specific gravity is lower than the standard value, charge the battery.
Charging rates	
Quick charge	15 A max.
Slow charge	5 A max.

▶ Vehicles with maintenance-free type battery

Battery	
Open voltage at 20°C (68°F):	12.3 V or higher If the voltage is lower than the standard value, charge the battery. (After charging the battery, turn on the high beam headlights for 30 seconds with the engine switch in the "LOCK" position [vehicles without smart entry & start system] or off [vehicles with smart entry & start system], and turn the headlights off.)
Charging rates	5 A max.

Automatic transmission

Fluid capacity*	Gasoline engine	8.5 L (9.0 qt., 7.5 Imp.qt.)
	Diesel engine	9.5 L (10.0 qt., 8.4 Imp.qt.)
Fluid type		Toyota Genuine ATF WS

*: The fluid capacity is the quantity of reference.
 If replacement is necessary, contact any authorized Toyota retailer or Toyota authorized repairer, or any reliable repairer.

 NOTICE

■ **Automatic transmission fluid type**

Using transmission fluid other than the above type may cause abnormal noise or vibration, or damage the transmission of your vehicle.

Manual transmission

Oil capacity	5-speed models		2.2 L (2.3 qt., 1.9 Imp.qt.)
	6-speed models	4WD models	2.5 L (2.6 qt., 2.2 Imp.qt.)
		Pre Runner	2.7 L (2.9 qt., 2.4 Imp.qt.)
Oil type			TOYOTA Genuine Manual Transmission Gear Oil API GL-3 (GL-4) or equivalent
Recommended oil viscosity			SAE 75W-90

 NOTICE

■ **Manual transmission gear oil**

Please be aware that depending on the particular characteristics of the gear oil used or the operating conditions, idle sound, shift feeling and/or fuel efficiency may be different or affected. Toyota recommends to use "TOYOTA Genuine Manual Transmission Gear Oil" to achieve optimal performance.

Transfer (4WD models)

Oil capacity	1.0 L (1.1 qt., 0.9 Imp.qt.)
Oil type*	Toyota Genuine Transfer Gear oil LF or equivalent
Recommended oil viscosity	SAE 75W

*: Your Toyota vehicle is filled with “Toyota Genuine Transfer Gear oil LF” at the factory. Use Toyota approved “Toyota Genuine Transfer Gear oil LF” or an equivalent oil of matching quality that satisfies the above specifications. Please contact any authorized Toyota retailer or Toyota authorized repairer, or any reliable repairer for further details.

Differential

Oil capacity	Front (4WD models)	Without A.D.D.	1.45 L (1.53 qt., 1.28 Imp.qt.)
		With A.D.D.	1.60 L (1.69 qt., 1.41 Imp.qt.)
	Rear	Without rear differential lock system	3.65 L (3.86 qt., 3.21 Imp.qt.) ^{*2} 3.75 L (3.96 qt., 3.30 Imp.qt.) ^{*3}
		With rear differential lock system	3.60 L (3.80 qt., 3.17 Imp.qt.)
Oil type ^{*1} and oil viscosity			Toyota Genuine Differential gear oil LT 75W-85 GL-5 or equivalent

*1: Your Toyota vehicle is filled with “Toyota Genuine Differential Gear Oil” at the factory. Use Toyota approved “Toyota Genuine Differential Gear Oil” or an equivalent oil of matching quality that satisfies the above specifications. Please contact any authorized Toyota retailer or Toyota authorized repairer, or any reliable repairer for further details.

*2: Models made in Thailand^{*4}

*3: Models made in South Africa^{*4}

*4: See “Checking your vehicle’s model” if you are not sure of which model your vehicle is. (→P. 12)

Clutch (vehicles with manual transmission)

Pedal free play	5 — 15 mm (0.2 — 0.6 in.)
Fluid type	SAE J1703 or FMVSS No.116 DOT 3 or SAE J1704 or FMVSS No.116 DOT 4

Brakes

Pedal clearance*1	Without VSC	82 mm (3.2 in.)*3 92 mm (3.6 in.)*4
	With VSC	82 mm (3.2 in.)
Pedal free play		1.0 — 6.0 mm (0.04 — 0.24 in.)
Parking brake lever travel*2		7 — 9 clicks
Fluid type		SAE J1703 or FMVSS No.116 DOT 3 or SAE J1704 or FMVSS No.116 DOT 4

*1: Minimum pedal clearance when depressed with a force of 490 N (50 kgf, 110 lbf) while the engine is running

*2: Parking brake lever travel when pulled up with a force of 200 N (20 kgf, 45 lbf)

*3: Without 205R16C tires

*4: With 205R16C tires

Chassis lubrication

Propeller shafts	Front (4WD models)	Spider	Lithium base chassis grease, NLGI No.2
		Slide yoke*1	Molybdenum-disulfide lithium base chassis grease, NLGI No.2 or lithium base chassis grease, NLGI No.2
	Rear	Spider*2	Lithium base chassis grease, NLGI No.2

*1: Models made in Thailand*3

*2: With grease fitting only

*3: See "Checking your vehicle's model" if you are not sure of which model your vehicle is. (→P. 12)

Steering

Free play	Less than 30 mm (1.2 in.)
Power steering fluid type	Automatic transmission fluid DEXRON® II or III

Tires and wheels

▶ 16 inch tires

Tire size	205R16C 8PR 110/108S		
Tire inflation pressure (Recommended cold tire inflation pressure)	Front wheel kPa (kgf/cm ² or bar, psi)	Rear wheel (unladen) kPa (kgf/cm ² or bar, psi)	Rear wheel (full load) kPa (kgf/cm ² or bar, psi)
	270 (2.7, 39)	270 (2.7, 39)	340 (3.4, 49)
Wheel size	16 × 6J		
Wheel nut torque	105 N•m (10.7 kgf•m, 77 ft•lbf)		

▶ 17 inch tires (type A)

Tire size	225/70R17C 108/106S		
Tire inflation pressure (Recommended cold tire inflation pressure)	Front wheel kPa (kgf/cm ² or bar, psi)	Rear wheel (unladen) kPa (kgf/cm ² or bar, psi)	Rear wheel (full load) kPa (kgf/cm ² or bar, psi)
	240 (2.4, 35)	240 (2.4, 35)	300 (3.0, 44)
Wheel size	17 × 6J		
Wheel nut torque	105 N•m (10.7 kgf•m, 77 ft•lbf)		

► 17 inch tires (type B)

Tire size	265/65R17 112S			
Tire inflation pressure (Recommended cold tire inflation pressure)	Front wheel (unladen) kPa (kgf/cm ² or bar, psi)	Front wheel (full load) kPa (kgf/cm ² or bar, psi)	Rear wheel (unladen) kPa (kgf/cm ² or bar, psi)	Rear wheel (full load) kPa (kgf/cm ² or bar, psi)
Except for Kazakhstan, and except models for model code destination W*	200 (2.0, 29)	230 (2.3, 33)	200 (2.0, 29)	250 (2.5, 36)
For Kazakhstan, and models for model code destination W*	230 (2.3, 33)	230 (2.3, 33)	230 (2.3, 33)	250 (2.5, 36)
Wheel size	17 × 7 1/2J			
Wheel nut torque	105 N•m (10.7 kgf•m, 77 ft•lbf)			

*: See “Checking your vehicle’s model” if you are not sure of which model your vehicle is. (→P. 12)

► 18 inch tires

Tire size	265/60R18 110H			
Tire inflation pressure (Recommended cold tire inflation pressure)	Front wheel (unladen) kPa (kgf/cm ² or bar, psi)	Front wheel (full load) kPa (kgf/cm ² or bar, psi)	Rear wheel (unladen) kPa (kgf/cm ² or bar, psi)	Rear wheel (full load) kPa (kgf/cm ² or bar, psi)
Except for Kazakhstan, and except for models for model code destination W*	200 (2.0, 29)	230 (2.3, 33)	200 (2.0, 29)	250 (2.5, 36)
For Kazakhstan, and models for model code destination W*	230 (2.3, 33)	230 (2.3, 33)	230 (2.3, 33)	250 (2.5, 36)
Wheel size	18 × 7 1/2J			
Wheel nut torque	105 N•m (10.7 kgf•m, 77 ft•lbf)			

*: See “Checking your vehicle’s model” if you are not sure of which model your vehicle is. (→P. 12)

■ When towing a trailer (with towing hitch)

Add 20.0 kPa (0.2 kgf/cm² or bar, 3 psi) to the recommended tire inflation pressure and drive at speeds below 100 km/h (62 mph).

Light bulbs

	Light bulbs	W	Type
Exterior	Headlights High/low beams (halogen headlights type A)	60/55	A
	Low beams (halogen headlights type B)	55	B
	High beams (halogen headlights type B)	60	C
	Halogen front fog lights*	19	D
	Front position lights (halogen headlights) Without daytime running lights	5	E
	With daytime running lights	21/5	E
	Front turn signal lights (halogen headlights type A)	21	F
	Front turn signal lights (halogen headlights type B)	21	G
	Rear turn signal lights	21	F
	Back-up lights (without LED stop lights)	21	H
	Rear fog light (without LED stop lights)*	21	H
	Stop/tail lights (without LED stop lights)	21/5	H
License plate light	5	E	
Outer foot lights*	5	E	
Interior	Interior light*	8	I
	Personal/interior lights	5	E

A: H4 halogen bulbs

B: H11 halogen bulbs

C: HB3 halogen bulbs

D: H16 halogen bulbs

E: Wedge base bulbs (clear)

*: If equipped

F: Single end bulbs (amber)

G: Wedge base bulbs (amber)

H: Single end bulbs (clear)

I: Double end bulbs

Fuel information

◆ Gasoline engine

When you find these types of fuel label at the gas station, use only the fuel with one of the following labels.



You must only use unleaded gasoline.
Select unleaded gasoline with a Research Octane Number of 91 or higher for optimum engine performance.

◆ Diesel engine

When you find these types of fuel label at the gas station, use only the fuel with one of the following labels.



EU area:

You must use diesel fuel conforming to European standard EN590 or EN16734.

Except EU area (vehicles without DPF system):

You must use only diesel fuel with a cetane number of 48 or higher.

Except EU area (vehicles with DPF system):

You must use only diesel fuel that contains 10 ppm or less of sulfur with a cetane number of 48 or higher.

■ Use of ethanol blended gasoline in a gasoline engine

Toyota allows the use of ethanol blended gasoline where the ethanol content is up to 10%. Make sure that the ethanol blended gasoline to be used has a Research Octane Number that follows the above.

■ If you plan to drive in foreign countries (vehicles with DPF system)

Low sulfur diesel fuel may not be available, so please check the availability with your distributor.

■ If your engine knocks

- Consult any authorized Toyota retailer or Toyota authorized repairer, or any reliable repairer.
- You may occasionally notice light knocking for a short time while accelerating or driving uphill. This is normal and there is no need for concern.

 NOTICE**■ Notice on gasoline fuel quality**

- Do not use improper fuels. If improper fuels are used, the engine will be damaged.
- Do not use gasoline with metallic additives, for example manganese, iron or lead, otherwise it may cause damage on your engine or emission control system.
- Do not add aftermarket fuel additives which contain metallic additives.
- Do not use the methanol blended gasoline such as M15, M85, M100. The use of gasoline containing methanol may cause engine damage or failure.
- Bioethanol fuel sold under names such as “E50” or “E85” and fuel containing a large amount of ethanol should not be used. Your vehicle can use gasoline mixed with 10% max ethanol. The use of fuel with more than 10% ethanol content (E10) will damage the vehicle’s fuel system. You must ensure that refueling is carried out only from a source where fuel specification and quality can be guaranteed. In case of any doubt, ask any authorized Toyota retailer or Toyota authorized repairer, or any reliable repairer.



NOTICE

■ Notice on diesel fuel quality

- Do not use improper fuels. If improper fuels are used, the engine will be damaged.
- Vehicles with DPF system: Do not use a fuel that contains more than 10 ppm of sulfur. Use of such a high sulfur fuel may damage the engine.
- EU area: FAME (Fatty Acid Methyl Ester) fuel sold under names such as “B30” or “B100” and fuel containing a large amount of FAME should not be used. The use of these fuels will damage the vehicle’s fuel system. In case of any doubt, ask any authorized Toyota retailer or Toyota authorized repairer, or any reliable repairer.
- Except EU area: FAME (Fatty Acid Methyl Ester) fuel sold under names such as “B30” or “B100” and fuel containing a large amount of FAME should not be used. Your vehicle can use diesel mixed with 5% max biodiesel FAME (B5) or diesel equivalent to EN590/EN16734. The use of fuel with more than 5% FAME content (B5) or diesel not equivalent to EN590/EN16734 will damage the vehicle’s fuel system. You must ensure that refueling is carried out only from a source where fuel specification and quality can be guaranteed.
In case of any doubt, ask any authorized Toyota retailer or Toyota authorized repairer, or any reliable repairer.

Customizable features





Your vehicle includes a variety of electronic features that can be personalized to your preferences. The settings of these features can be changed using the multi-information display, navigation system, multimedia system type A* or at any authorized Toyota retailer or Toyota authorized repairer, or any reliable repairer.

Some function settings are changed simultaneously with other functions being customized. Contact any authorized Toyota retailer or Toyota authorized repairer, or any reliable repairer for further details.

*: See “How to identify multimedia system type” to check the type of your multimedia system. (→P. 652)

Customizing vehicle features

■ Changing using the multi-information display

- 1 Use the meter control switches to select  while the vehicle is stopped, and then press  to display the customize mode screen.
- 2 Select the desired item, and then press .
- 3 Select the desired setting, and then press .

To go back to the previous screen or exit the customize mode, press .

■ Changing using the navigation system or multimedia system type A

- 1 Press the “SETUP” button while the vehicle is stopped.
- 2 Select “Vehicle”.
- 3 Select “TOYOTA park assist”.





Customizable features

- ① Settings that can be changed using navigation system or multimedia system type A
- ② Settings that can be changed using the multi-information display
- ③ Settings that can be changed by any authorized Toyota retailer or Toyota authorized repairer, or any reliable repairer

Definition of symbols: O = Available, – = Not available

■ **Gauges, meters and multi-information display*1 (→P. 135)**

Function *2	Default setting	Customized setting	①	②	③
Language*3	English	German			
		French			
		Spanish			
		Italian			
		Russian			
		Turkish	–	O	–
		Ukrainian			
		Thai			
		Portuguese			
		Indonesian			
		Arabic			
Units*3	km (L/100 km)	km (km/L)	–	O	–
		miles (MPG)	–	O	–
Eco Driving Indicator Light	On (Self-lighting)	Off	–	O	–
 switch settings	Drive information 1	Desired status screen *4	–	O	–
Drive information 1	Current fuel economy	*5	–	O	–
	Average fuel economy		–	O	–

Function *2		Default setting	Customized setting	①	②	③
Drive information 2	Distance to empty	10.0	*5	-	O	-
	Average speed			-	O	-
Pop-up display*1		On	Off	-	O	-
Accent color*1, 3		Color 1	Color 1 to color 4	-	O	-
Eco Saving	Fuel consumption comparison	10.0	*6	-	O	-
	Fuel price	150	*6	-	O	-
	Currency*3	 (No currency unit)	 (Baht)  (Rupiah)  (Euro)	-	O	-

*1: If equipped

*2: For details about each function: →P. 135

*3: The default setting and the customized setting items that can be displayed vary according to country.

*4: Some status screens cannot be registered (indicated on multi-information display).

*5: Customized items are the following items except for default setting items: current fuel economy (bar type), current fuel economy (value type), average fuel economy (after reset), average fuel economy (after start), average fuel economy (after refuel), average speed (after reset), average speed (after start), elapsed time (after reset), elapsed time (after start), distance (range), distance (after start), blank.

*6: The values can be changed using the meter control switches.

■ PCS (Pre-Collision System)* (→P. 273)

Function	Default setting	Customized setting	①	②	③
PCS (Pre-Collision System)	On	Off	–	○	–
Sensitivity (adjust alert timing)	Middle	Early	–	○	–
		Late	–	○	–

*: If equipped

■ LDA (Lane Departure Alert With Yaw Assist Function)* (→P. 284)

Function	Default setting	Customized setting	①	②	③
Yaw Assist	On	Off	–	○	–
Warning sensitivity	Standard	High	–	○	–
Vehicle sway warning function	On	Off	–	○	–
Vehicle sway warning sensitivity	Standard	Low	–	○	–
		High	–	○	–

*: If equipped

■ RSA (Road Sign Assist)*¹ (→P. 295)

Function	Default setting	Customized setting	①	②	③
RSA (Road Sign Assist)* ²	On	Off	–	○	–
Excess speed notification method* ³	Display only	No notification	–	○	–
		Display and buzzer	–	○	–
No overtaking notification method	Display only	No notification	–	○	–
		Display and buzzer	–	○	–
Other notifications method (No-entry notification)* ⁴	Display only	No notification	–	○	–
		Display and buzzer	–	○	–
Excess speed notification level	2 km/h (1 mph)	5 km/h (3 mph)	–	○	–
		10 km/h (5 mph)	–	○	–

*¹: If equipped

*²: RSA function becomes on when the engine switch is turned to the “ON” position (vehicles without smart entry & start system) or IGNITION ON mode (vehicles with smart entry & start system).

*³: If a speed limit with supplemental mark is exceeded, the notification buzzer does not operate.

*⁴: Vehicles with navigation system

■ Dynamic Radar Cruise Control with Road Sign Assist* (→P. 312)

Function	Default setting	Customized setting	①	②	③
Dynamic Radar Cruise Control with Road Sign Assist	On	Off	–	○	–

*: If equipped

■ Stop & Start system* (→P. 345)

Function	Default setting	Customized setting	①	②	③
Idling stop	Standard	Extended	–	O	–

*: If equipped

■ Toyota parking assist-sensor* (→P. 321)

Function	Default setting	Customized setting	①	②	③
Detection distance of the rear center sensor	Long	Short	O	–	O
Buzzer volume	Level 2	Level 1 to 3	O	–	O

*: If equipped

■ Door lock (→P. 157)

Function	Default setting	Customized setting	①	②	③
Speed linked door locking function* ¹	On	Off	–	–	O* ²
Driver's door linked door unlocking function* ¹	Off	On	–	–	O* ²

*¹: If equipped

*²: Setting that can be changed manually (→P. 157) or at any authorized Toyota retailer or Toyota authorized repairer, or any reliable repairer

■ Smart entry & start system* (→P. 163)

Function	Default setting	Customized setting	①	②	③
Smart entry & start system	On	Off	–	–	O
Operational signal (buzzer)*	Level 5	Off	–	–	O
		Level 1 to 7	–	–	O

*: If equipped

■ Automatic light control system* (→P. 248)

Function	Default setting	Customized setting	①	②	③
Light sensor sensitivity	Standard	-2 to 2	-	-	O

*: If equipped

■ Turn signal lever (→P. 246)

Function	Default setting	Customized setting	①	②	③
Times of flashing of the lane change signal flashers	3	4	-	-	O
		5			
		6			
		7			
		Off			

■ How to identify multimedia system type

Check the type of the multimedia system in the following illustrations.

▶ Type A

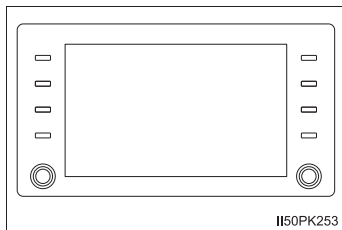

▶ Type B

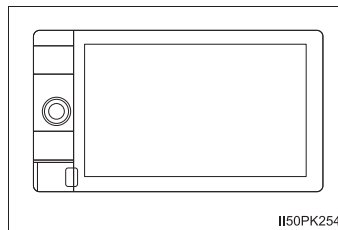

 WARNING**■ During customization**

As the engine needs to be running during customization, ensure that the vehicle is parked in a place with adequate ventilation. In a closed area such as a garage, exhaust gases including harmful carbon monoxide (CO) may collect and enter the vehicle. This may lead to death or a serious health hazard.

 NOTICE**■ During customization**

To prevent battery discharge, ensure that the engine is running while customizing features.

Items to initialize

The following items must be initialized for normal system operation after such cases as the battery is reconnected, or maintenance is performed on the vehicle.

Item	When to initialize	Reference
Engine oil maintenance data (if equipped)	After changing engine oil	P. 491
Panoramic view monitor (if equipped)	<ul style="list-style-type: none">• The battery has been reinstalled.• The steering wheel has been moved while the battery was being reinstalled.• The battery power is low.	Refer to the "Navigation and multimedia system Owner's manual" or "Multimedia Owner's Manual"

Index

What to do if...
(Troubleshooting) 656
Alphabetical index 660

For vehicles with navigation system or multimedia system, refer to the “Navigation and multimedia system Owner’s manual” or “Multimedia Owner’s Manual” for information regarding the equipment listed below.

- Navigation system
- Audio system
- Panoramic view monitor
- Rear view monitor system

What to do if... (Troubleshooting)

If you have a problem, check the following before contacting any authorized Toyota retailer or Toyota authorized repairer, or any reliable repairer.

The doors cannot be locked, unlocked, opened or closed



You lose your keys

- If you lose your keys or mechanical keys, new genuine keys or mechanical keys can be made by any authorized Toyota retailer or Toyota authorized repairer, or any reliable repairer. (→P. 151)
- Vehicles with smart entry & start system:
If you lose your electronic keys, the risk of vehicle theft increases significantly. Contact any authorized Toyota retailer or Toyota authorized repairer, or any reliable repairer immediately. (→P. 152)



The doors cannot be locked or unlocked

- Is the key battery weak or depleted? (→P. 516)
- Vehicles with smart entry & start system:
Is the engine switch in IGNITION ON mode?
When locking the doors, turn the engine switch off. (→P. 226)
- Vehicles with smart entry & start system:
Is the electronic key left inside the vehicle?
When locking the doors, make sure that you have the electronic key on your person.
- The function may not operate properly due to the condition of the radio wave. (→P. 158, 166)



The rear door cannot be opened (vehicles with rear door child-protector lock)

- Is the rear door child-protector lock set?
The rear door cannot be opened from inside the vehicle when the lock is set. Open the rear door from outside and then unlock the rear door child-protector lock. (→P. 156)

If you think something is wrong



The engine does not start (vehicles without smart entry & start system)

- Vehicles with manual transmission:
Do you turn the key with the clutch pedal depressed firmly? (→P. 220)
- Vehicles with automatic transmission:
Is the shift lever in P? (→P. 220)
- Is the steering wheel unlocked? (→P. 222)
- Is the battery discharged? (→P. 604)



The engine does not start (vehicles with smart entry & start system)

- Did you press the engine switch while firmly depressing the brake pedal?
(→P. 223)
- Vehicles with automatic transmission:
Is the shift lever in P? (→P. 223)
- Is the electronic key anywhere detectable inside the vehicle? (→P. 164)
- Is the steering wheel unlocked? (→P. 228)
- Is the electronic key battery weak or depleted?
In this case, the engine can be started in a temporary way. (→P. 601)
- Is the battery discharged? (→P. 604)



The shift lever cannot be shifted from P even if you depress the brake pedal (vehicles with automatic transmission)

- Vehicles without smart entry & start system:
Is the engine switch in the "ON" position?
If you cannot release the shift lever by depressing the brake pedal with the
engine switch in the "ON" position: →P. 237
- Vehicles with smart entry & start system:
Is the engine switch in IGNITION ON mode?
If you cannot release the shift lever by depressing the brake pedal with the
engine switch in IGNITION ON mode: →P. 237



The steering wheel cannot be turned after the engine is stopped

- Vehicles without smart entry & start system:
It is locked to prevent theft of the vehicle if the key is removed from the engine switch. (→P. 222)
- Vehicles with smart entry & start system:
It is locked automatically to prevent theft of the vehicle. (→P. 228)



The windows do not open or close by operating the power window switches (if equipped)

- Is the window lock switch pressed?
The power window except for the one at the driver's seat cannot be operated if the window lock switch is pressed. (→P. 186)



The engine switch is turned off automatically (vehicles with smart entry & start system)

- The auto power off function will be operated if the vehicle is left in ACCESSORY or IGNITION ON mode (the engine is not operating) for a period of time. (→P. 227)



A warning buzzer sounds during driving

- The seat belt reminder light is flashing
Are the driver and passengers wearing the seat belts? (→P. 570)
 - The parking brake indicator light is on
Is the parking brake released? (→P. 247)
- Depending on the situation, other types of warning buzzer may also sound. (→P. 566, 575)



An alarm is activated and the horn sounds (if equipped)

- Did anyone inside the vehicle open a door during setting the alarm?
The sensor detects it and the alarm sounds. (→P. 117)
- To stop the alarm, turn the engine switch to the "ON" position (vehicles without smart entry & start system) or IGNITION ON mode (vehicles with smart entry & start system) or start the engine.

**A warning buzzer sounds when leaving the vehicle
(vehicles with smart entry & start system)**

- Is the message displayed on the multi-information display?
Check the message on the multi-information display.

**A warning light turns on or a warning message is displayed**

- When a warning light turns on or a warning message is displayed, refer to P. 566, 575.

When a problem has occurred**If you have a flat tire**

- Stop the vehicle in a safe place and replace the flat tire with the spare tire.
(→P. 581)

**The vehicle becomes stuck**

- Try the procedure for when the vehicle becomes stuck in mud, dirt, or snow. (→P. 615)

Alphabetical index

A

A/C	434, 441
Air conditioning filter.....	514
Automatic air conditioning system.....	441
Manual air conditioning system.....	434
ABS (Anti-lock Brake System)	355
Function.....	355
Warning light.....	567
Access panels	159
AdBlue™	500
Capacity.....	503
Low AdBlue™ level warning light.....	571
Refilling.....	503
Air conditioning filter	514
Air conditioning system	434, 441
Air conditioning filter.....	514
Automatic air conditioning system.....	441
Manual air conditioning system.....	434
Airbags	45
Airbag manual on-off system.....	62
Airbag operating conditions.....	53
Airbag precautions for your child.....	47
Airbag warning light.....	567
Correct driving posture.....	38
Curtain shield airbag operating conditions.....	53
Curtain shield airbag precautions.....	49
Front passenger occupant classification system.....	57

General airbag precautions.....	47
Locations of airbags.....	45
Modification and disposal of airbags.....	51
Side airbag operating conditions.....	53
Side airbag precautions.....	49
Side and curtain shield airbags operating conditions.....	53
Side and curtain shield airbags precautions.....	49
SRS airbags.....	45
Airbag manual on-off system	62
Alarm	117
Antenna	386, 472
Antennas (smart entry & start system)	163
Anti-lock brake system (ABS)	355
Function.....	355
Warning light.....	567
Armrest	469
Audio input	395, 401, 407
Audio system	378
Antenna.....	386, 472
Audio input.....	381
AUX port.....	381
Bluetooth® audio.....	424
CD player.....	387
iPod.....	395
MP3/WMA disc.....	389
Optimal use.....	382
Portable music player.....	407
Radio.....	384
Steering wheel audio switches.....	379
USB memory.....	401
AUTO LSD	367

Automatic air conditioning system
 Air conditioning filter..... 514
 Automatic air conditioning system 441
Automatic disconnecting differential..... 331
Automatic light control system..... 252
Automatic transmission..... 231
 If the shift lever cannot be shifted from P 237
AUX port 407
Auxiliary boxes 460

B

Back-up lights
 Replacing light bulbs..... 542, 549
 Wattage..... 642
Battery
 Battery checking 494
 If the vehicle battery is discharged 604
 Preparing and checking before winter 374
 Warning light 566
Bluetooth®* 430
 Audio system 424
 Hands-free system (for cellular phone)..... 408
 Registering/removing a Bluetooth® device 415
 Selecting a Bluetooth® device 415
 Wireless communication 408
Bluetooth® audio* 408

Bluetooth® phone* 408
 Deleting the call history..... 420
 Making a call..... 426
 Managing the contacts..... 419
 Phone settings 419
 Receiving a call..... 427
 Speaking on the phone 426
Bottle holders 459
Brake
 Fluid 638
 Override system warning light..... 569
 Parking brake..... 247
 Warning light..... 566
Brake assist 355
Break-in tips 196
Brightness control
 Instrument panel light control..... 132

C

Care
 Exterior 472
 Interior..... 476
 Seat belts..... 477
 Wheels..... 473
CD player..... 387
Chains..... 375
Child restraint system 65
 Child restraint system installation method 89
 Fixed with a seat belt 90
 Fixed with an ISOFIX lower anchorage 92
 Points to remember 66
 Riding with children..... 64
 Using a top tether anchorage 95

*: Refer to “Navigation and multimedia system Owner’s manual” or “Multimedia Owner’s Manual”.

Child safety 64
 Airbag precautions 47
 Battery precautions 497, 608
 Child restraint system 65
 How your child should
 wear the seat belt 42
 Installing child restraints 90, 93
 Power window lock
 switch 186
 Power window precautions ... 188
 Rear door child-protectors 156
 Removed key battery
 precautions 518
 Seat belt precautions 44
 Seat heater precautions 450
Child-protectors 156
Cleaning 472, 476
 Exterior 472
 Interior 476
 Seat belts 477
 Wheels 473
Clock 465
Clutch 637
Coat hooks 469
Condenser 493
Console box 457
Cooling system
 Engine overheating 610
Cruise control
 Cruise control 317
 Dynamic radar cruise
 control 301
Cup holders 458
Curtain shield airbags 45

D

DAC 364
**Daytime running light
 system 252**
Deck hooks 463
Defogger
 Outside rear view
 mirrors 435, 444
 Rear window 435, 444
 Windshield 435, 443
Differential
 Oil 637
Dimension 620
Display
 Cruise control 317
 Dynamic radar cruise
 control 301
 LDA (Lane Departure
 Alert with Yaw Assist
 Function) 290
 Multi-information
 display 135
 Trip information 137
Do-it-yourself maintenance 482
Doors
 Door glasses 185
 Door lock 153
 Open door warning light 570
 Outside rear view mirrors 182
 Rear door child-protectors 156
 Side doors 153
**Downhill assist control
 system 364**
**DPF (Diesel Particulate Filter)
 system 369**
 Warning message 578
Drive-Start Control 195
**Driver's seat belt
 reminder light 570**

Driving

- Break-in tips 196
- Correct posture 38
- Procedures..... 192
- Winter drive tips 374

Dynamic radar cruise

- control 301**
- Function 301
- Warning message 580

E**Eco Driving Indicator..... 126, 128****Emergency flashers..... 554****Electronic key**

- If the electronic key does not operate properly 600
- Replacing the battery 516

Emergency, in case of

- If a warning buzzer sounds 566
- If a warning light turns on..... 566
- If the electronic key does not operate properly 600
- If the engine will not start 598
- If the vehicle battery is discharged 604
- If the vehicle is submerged or water on the road is rising 557
- If you have a flat tire..... 581
- If you lose your keys 151
- If you run out of fuel and the engine stalls..... 614
- If you think something is wrong..... 564
- If your vehicle becomes stuck 615
- If your vehicle has to be stopped in an emergency..... 555
- If your vehicle needs to be towed..... 559

If your vehicle overheats..... 610

Engine

- "ACC" position 221
- Compartment 486
- Engine switch..... 220, 223
- Hood 484
- How to start the engine..... 220, 223
- Identification number 625
- If the engine will not start..... 598
- If you run out of fuel and the engine stalls 614
- If your vehicle has to be stopped in an emergency..... 555
- Ignition switch (engine switch) 220, 223
- Overheating 610

Engine coolant

- Capacity 634
- Checking..... 492
- Preparing and checking before winter..... 374

Engine coolant**temperature gauge..... 131****Engine immobilizer system 115****Engine oil**

- Capacity 628
- Checking 489
- Oil level warning light..... 570
- Oil pressure warning light 566
- Preparing and checking before winter..... 374

Engine oil maintenance**data..... 491**

Engine switch
(ignition switch)..... 220, 223
 Auto power off function 227
 Changing the engine
 switch modes..... 226
 Changing the engine
 switch position 221
 If your vehicle has to be
 stopped in an
 emergency..... 555
 Starting the engine..... 220, 223
Engine switch light
(ignition switch light) 453
ERA-GLONASS 110
EVAK..... 110

F

Flat tire..... 581
Floor mat 36
Fluid
 Automatic transmission..... 636
 Brake..... 638
 Clutch..... 637
 Steering..... 639
 Transfer..... 637
 Washer..... 498
Fog lights
 Replacing light
 bulbs 539, 542, 549
 Switch 255
 Wattage..... 642
Four-wheel drive system
 Front-wheel drive control
 switch..... 331
 Warning light..... 568
Front fog lights
 Replacing light bulbs..... 539, 549
 Switch 255
 Wattage..... 642

Front passenger occupant
classification system..... 57
Front position lights
 Light switch 248
 Replacing light
 bulbs..... 533, 534, 549
 Wattage 642
Front seats
 Adjustment..... 170
 Cleaning..... 476
 Correct driving posture 38
 Head restraints 175
 Seat heaters 450
Front turn signal lights
 Replacing light
 bulbs..... 536, 537, 549
 Turn signal lever 246
 Wattage 642
Fuel
 Capacity..... 627
 Fuel filter..... 499
 Fuel gauge..... 131
 Fuel pump shut off system... 565
 If you run out of fuel
 and the engine stalls 614
 Information..... 643
 Refueling..... 261
 Type..... 627
 Warning light..... 569
Fuel consumption
information 144
Fuel filler door..... 261
 Refueling..... 261
Fuel filter 499, 569
Fuel pump shut off system.... 565
Fuses 520

G

Gauges.....	130
Glove box	457
Grocery bag hooks	468

H

Hands-free system (for cellular phone)*	408
Head restraints.....	175
Headlights	248
Light switch	248
Replacing	
light bulbs ...	528, 529, 531, 549
Wattage.....	642
Heated steering wheel.....	450
Heaters	
Automatic air conditioning	
system	441
Heated steering wheel	450
Manual air conditioning	
system	434
Seat heaters.....	450
Outside rear view mirrors.....	444
High mounted stoplight	
Replacing.....	549
Hill-start assist control.....	355
Hood.....	484
Hooks	
Coat hooks	469
Grocery bag hooks.....	468
Retaining hooks (floor mat).....	36
Horn	179

I

Identification	
Engine.....	625
Vehicle	624
Ignition switch (engine switch).....	220, 223
Auto power off function	227
Changing the engine	
switch modes.....	226
Changing the engine	
switch position	221
If your vehicle has to be	
stopped in an	
emergency.....	555
Starting the engine.....	220, 223
Ignition switch light (engine switch light)	453
Illuminated entry system	455
Immobilizer system	115
Indicators	122
Initialization	
Engine oil maintenance	
data	491
Items to initialize	654
Inside rear view mirror.....	180
Instrument panel light control	132
Intercooler	493
Intercooler coolant	
Capacity.....	634
Checking.....	492
Preparing and checking	
before winter.....	374
Interior lights.....	453
Switch	454
Wattage	642

*: Refer to "Navigation and multimedia system Owner's manual" or "Multimedia Owner's Manual".

J

- Jack**
 - Vehicle-equipped jack 582
- Jack handle 587**
- Jam protection function**
 - Power windows 186

K

- Keyless entry**
 - Smart entry & start system... 153
 - Wireless remote control 149
- Keys 148**
 - Electronic key 148
 - Engine switch 220
 - If the electronic key does
 - not operate properly 600
 - If you lose your keys 151
 - Key number plate 148
 - Keyless entry 149
 - Keys 148
 - Replacing the battery 516
 - Wireless remote
 - control key 149

L

- LDA (Lane Departure Alert With Yaw Assist Function) ... 284**
 - Warning message 294
- Lever**
 - Auxiliary catch lever 484
 - Hood lock release lever 484
 - Shift lever 231, 239
 - Turn signal lever 246
 - Wiper lever 258
- License plate light**
 - Light switch 248
 - Replacing light bulbs 544
 - Wattage 642

Light

- Engine switch light 453
- Fog light switch 255
- Headlight switch 248
- Illuminated entry system 455
- Interior lights 454
- Interior light list 453
- Outer foot lights 453
- Personal/interior lights 454
- Replacing light bulbs 525
- Turn signal lever 246
- Wattage 642

Light bulbs

- Replacing 525
- Wattage 642

Lock steering column 222, 228

M

Maintenance

- Do-it-yourself maintenance... 482
- Maintenance data 620
- Maintenance requirements ... 479

Malfunction indicator lamp..... 567

Manual headlight

- leveling dial..... 250**

Manual transmission..... 239

Master warning light..... 570

Meter

- Indicators 122
- Instrument panel light
 - control..... 132
- Meters 130
- Multi-information
 - display 135
- Warning lights 566

Microphone 410

Mirrors

- Inside rear view mirror 180
- Outside rear view mirror
 - defoggers 435, 444
- Outside rear view mirrors..... 182
- Vanity mirror 464

MP3 disc	389
Multi-information display	
Cruise control.....	317
Dynamic radar cruise control.....	301
LDA (Lane Departure Alert with Yaw Assist Function).....	290
PCS (Pre-Collision System)	274
Trip information	137

Multimedia system***N****Navigation system*****O**

Odometer.....	131
Oil	
Differential oil	637
Engine oil	628
Manual transmission oil	636
Transfer oil	637
Opener	
Fuel filler door	261
Hood	484
Outer foot lights	
Location	453
Replacing light bulbs.....	545
Wattage.....	642
Outside rear view mirrors	182
Adjusting and folding.....	182
Outside rear view mirror defoggers.....	444
Outside temperature display	131
Overhead console.....	460
Overheating, Engine.....	610

P

Paddle shift switches	234
Parking assist sensor (Toyota parking assist-sensor).....	321
Parking brake	
Operation	247
Parking brake indicator light.....	571
PCS (Pre-Collision System)....	273
Enabling/disabling the system.....	277
Function	274
Warning light.....	569
Warning message.....	579
Personal lights.....	453
Switch	454
Wattage	642
Power heater	436, 444
Power outlets	466
Power steering	
Fluid	639
Warning light.....	567
Power windows	
Jam protection function.....	186
Operation	185
Window lock switch.....	186
Pre-Collision System (PCS)....	273
Enabling/disabling the system.....	277
Function	274
Warning light.....	569
Warning message.....	579

Q

Quarter windows	189
------------------------------	------------

*: Refer to "Navigation and multimedia system Owner's manual" or "Multimedia Owner's Manual".

R

Radar cruise control (dynamic radar cruise control)	301
Radiator	493
Radio	384
Radio data system	385
RDS	385
Rear differential lock system	341
Rear fog light	
Replacing light bulb.....	542, 549
Switch	255
Wattage.....	642
Rear passengers' seat belt reminder light	570
Rear seat	
Removing the rear seat cushions	172
Raising the bottom cushion	172
Rear step bumper	161
Rear turn signal lights	
Replacing light bulbs.....	542
Turn signal lever	246
Wattage.....	642
Rear view mirror	
Inside rear view mirror	180
Outside rear view mirrors.....	182
Rear window defogger	435, 444
Refueling	261
Capacity	627
Fuel types	627
Opening the fuel tank cap	261

Replacing

Electronic key battery	516
Fuses	520
Light bulbs	525
Tires.....	581
Wireless remote control battery	516
Reset the maintenance data ...	491
Road Sign Assist	295
RSA (Road Sign Assist)	295

S

Seat belts	40
Adjusting the seat belt	41
Child restraint system installation	65
Cleaning and maintaining the seat belt.....	477
Emergency Locking Retractor.....	42
How to wear your seat belt	38
How your child should wear the seat belt.....	42
Pregnant women, proper seat belt use	43
Reminder light and buzzer.....	570
Seat belt pretensioners.....	42
SRS warning light	567
Seat heaters	450

- Seats**
 Adjustment 170
 Adjustment precautions 171
 Child seats/child restraint
 system installation 65
 Cleaning 476
 Head restraint 175
 Properly sitting in the seat 38
 Raising the bottom
 cushion 172
 Removing the rear seat
 cushions 172
 Seat heaters 450
- Sensor**
 Automatic headlight
 system 252
 LDA (Lane Departure
 Alert with Yaw Assist
 Function) 284
 Toyota parking
 assist-sensor 321
 Toyota safety sense 267
- Service reminder
 indicators 122**
- Shift lever**
 Automatic transmission 231
 If the shift lever cannot be
 shifted from P 237
 Manual transmission 239
- Shift lock system 236**
- Side airbags 45**
- Side doors 153**
- Side mirrors 182**
 Adjusting and folding 182
 Heaters 435, 444
- Side turn signal lights**
 Replacing light bulbs 549
 Turn signal lever 246
- Smart entry & start system 163**
 Antenna location 163
 Entry functions 153
 Starting the engine 223
 Warning message 575
- Snow tires 374**
- “SOS” button 98, 110**
- Spare tire**
 Inflation pressure 639
 Storage location 581
- Spark plug 635**
- Specifications 620**
- Speedometer 131**
- Steering**
 Column lock release 222, 228
 Fluid 639
- Steering wheel**
 Adjustment 178
 Audio switches 379
 Heated steering wheel 450
 Meter control switches 136
- Stop & Start system 345**
- Stop lights**
 Replacing light bulbs 542, 549
 Wattage 642
- Storage feature 456**
- Storage precautions 456**
- Stuck**
 If your vehicle becomes
 stuck 615
- Sun visors 464**

Switch

Audio remote control
switches* 379

Cruise control switch 317

Door lock switch 155

Driving mode select
switches 233, 240

Emergency flashers switch ... 554

Engine switch 220, 223

Fog light switch 255

Front-wheel drive control
switch 331

Heated steering wheel
switch 450

Ignition switch 220, 223

LDA (Lane Departure
Alert with Yaw Assist
Function) 290

Light switches 248

Meter control switches 136

Outside rear view mirror
switches 182

Power door lock switch 155

Power heater switch 436, 444

Power window switch 185

Rear differential lock
switch 341

Rear window and outside
rear view mirror
defoggers switch 435, 444

Seat heater switches 450

“SOS” button 98, 110

Telephone switches* 413

Toyota parking
assist-sensor 322

VSC OFF switch 357

Window lock switch 186

Windshield wipers and
washer switch 258

T

Tachometer 131

Tailgate 160

Tail lights
Light switch 248
Replacing light bulbs 542, 549
Wattage 642

Talk switch*

Telephone switches* 413

Theft deterrent system
Alarm 117
Engine immobilizer system ... 115

Tire inflation pressure
Maintenance data 639

Tires 507
Chains 375
Checking 507
If you have a flat tire 581
Inflation pressure 510, 639
Replacing 581
Rotating tires 508
Size 639
Snow tires 374
Spare tire 581

Tools 584

Towing
Emergency towing 559
Towing hook 561
Trailer towing 206, 207

**Toyota parking
assist-sensor** 321

Toyota Safety Sense 266

Traction control 355

Trailer towing 206, 207

Transmission
Automatic transmission 231
If the shift lever cannot be
shifted from P 237
Manual transmission 239

TRC (Traction Control)..... 355
Trip information 137
Trip meters 131
Turn signal lights
 Replacing light
 bulbs 536, 542, 549
 Turn signal lever 246
 Wattage..... 642

U

USB memory 401
USB port* 381

V

Valet key 148
Vanity mirror 464
Vehicle data recording 10
Vehicle identification
 number 624
Vehicle Stability Control
 (VSC)..... 355
VSC (Vehicle Stability
 Control) 355

W

Warning buzzers
 Fuel filter 569
 Key reminder..... 222
 Pre-collision braking..... 274
 Seat belt reminder..... 570
 Toyota parking
 assist-sensor 324

Warning lights

ABS..... 567
 AUTO LSD 571
 Brake Override system 569
 Brake system 566
 Charging system..... 566
 Electronic engine control
 system..... 567
 Four-wheel drive system..... 568
 Fuel system 569
 Go to service..... 571
 LDA (Lane Departure Alert
 with Yaw Assist
 Function) 570
 Low AdBlue™ 571
 Low engine oil level 570
 Low engine oil pressure..... 566
 Low fuel level 570
 Malfunction indicator lamp 567
 Master warning light..... 570
 Open door..... 570
 Parking brake..... 571
 PCS (Pre-Collision
 System) 569
 Power steering..... 567
 Seat belt reminder light..... 570
 Slip indicator 568
 SRS 567

*: Refer to "Navigation and multimedia system Owner's manual" or "Multimedia Owner's Manual".

Washer	
Checking	498
Preparing and checking	
before winter	374
Switch	258
Washing and waxing	472
Weights	622
Wheels	512
Replacing wheels	581
Size	639
Window glasses	185
Window lock switch	186
Windows	
Power windows	185
Rear window	
defogger	435, 444
Washer	258
Windshield wiper	
de-icer	436, 444
Windshield wipers	
Intermittent windshield	
wipers	258
Winter driving tips	374
Wireless communication	408
Wireless remote control	
key	149
Locking/Unlocking	149
Replacing the battery	516
WMA disc	387

Certifications

eCall

Manufacturer : Continental Automotive Singapore Pte Ltd
 Address : 80 Boon Keng Road, Continental Building Singapore 339780
 Model : 19EU NCBOX

Operation frequency (MHz) :

GSM 900 : Tx: 880 – 915 Rx: 925.0 – 960.0

GSM 1800 : Tx: 1710.2 – 1784.8 Rx: 1805.2 – 1879.8

WCDMA Band 1 : Tx: 1920 – 1980 Rx: 2110 – 2170

WCDMA Band 8 : Tx: 880 – 915 Rx: 925 – 960

LTE 1: Tx: 1920 – 1980 Rx: 2110 – 2170

LTE 3: Tx: 1710 – 1785 Rx: 1805 – 1880

LTE 7: Tx: 2500 – 2570 Rx: 2620 – 2690

LTE 8: Tx: 880 – 915 Rx: 925 – 960

LTE 20 : Tx: 832 – 862 Rx: 791 – 821

LTE 26: Tx: 814 – 849 Rx: 859 – 894

GNSS Receiver Frequency: 1559 – 1610

Maximum output power :

GSM 900 2W

GSM 1800 1W

WCDMA Band 1 : 0.25W

WCDMA Band 8 : 0.25W

LTE Band 1, 3, 7, 8, 20, 26 : 0.2W



The latest "DECLARATION of CONFORMITY" (DoC)
 is available at the following address:
<https://www.continental-homologation.com/>

Hereby, Continental Automotive Singapore declares that the radio equipment type is in compliance with Directive 2014/53/EU.

► For vehicles sold in Israel

שם המוצר וייעודו המסחרי: יחידת תקשורת לרכב
 שם היצרן וכתובתו: קונטיננטל אוטומוטיב רפובליקת צ'כיה
 סימן מסחרי רשום: Continental
 EU NCBOX שם דגם: 19
 ארץ ייצור: צ'כיה
 שנת ייצור: 2019

Engine immobilizer system (vehicles without smart entry & start system)

Hereby, TOKAI RIKA CO., LTD. declares that the radio equipment type RI-57BTY is in compliance with Directive 2014/53/EU.

The full text of the EU declaration of conformity is available at the following internet address:

<http://www.tokai-rika.co.jp/pc>

Frequency band: 119 - 135 kHz

Maximum radio-frequency power: 55dB μ A/m@10m

TOKAI RIKA CO., LTD. vakuuttaa, että radiolaitetyyppi RI-57BTY on direktiivin 2014/53/EU mukainen.

EU-vaatimustenmukaisuusvakuutuksen täysimittainen teksti on saatavilla seuraavassa internetosoitteessa:

<http://www.tokai-rika.co.jp/pc>

Radiotaajuus: 119 - 135 kHz

suurin mahdollinen lähetysteho: 55dB μ A/m@10m

Hierbij verklaar ik, TOKAI RIKA CO., LTD., dat het type radioapparatuur RI-57BTY conform is met Richtlijn 2014/53/EU.

De volledige tekst van de EU-conformiteitsverklaring kan worden geraadpleegd op het volgende internetadres:

<http://www.tokai-rika.co.jp/pc>

Frequentieband: 119 - 135 kHz

Maximaal radiofrequentievermogen: 55dB μ A/m@10m

Le soussigné, TOKAI RIKA CO., LTD., déclare que l'équipement radioélectrique du type RI-57BTY est conforme à la directive 2014/53/UE.

Le texte complet de la déclaration UE de conformité est disponible à l'adresse internet suivante:

<http://www.tokai-rika.co.jp/pc>

Bande de fréquences: 119 - 135 kHz

Puissance de radiofréquence maximale: 55dB μ A/m@10m

Härmed försäkrar TOKAI RIKA CO., LTD. att denna typ av radioutrustning RI-57BTY överensstämmer med direktiv 2014/53/EU.

Den fullständiga texten till EU-försäkran om överensstämmelse finns på följande webbadress:

<http://www.tokai-rika.co.jp/pc>

Frekvensband: 119 - 135 kHz

Maximal radiofrekvensseffekt: 55dB μ A/m@10m

Hermed erklærer TOKAI RIKA CO., LTD., at radioudstyrstypen RI-57BTY er i overensstemmelse med direktiv 2014/53/EU.

EU-overensstemmelseserklæringens fulde tekst kan findes på følgende internetadresse:

<http://www.tokai-rika.co.jp/pc>

Frekvensbånd: 119 - 135 kHz

Maksimal radiofrekvensseffekt: 55dB μ A/m@10m

Hiermit erklärt TOKAI RIKA CO., LTD., dass der Funkanlagentyp RI-57BTY der Richtlinie 2014/53/EU entspricht.

Der vollständige Text der EU-Konformitätserklärung ist unter der folgenden Internetadresse verfügbar:

<http://www.tokai-rika.co.jp/pc>

Frequenzband: 119 - 135 kHz

Abgestrahlte maximale Sendeleistung: 55dBμA/m@10m

Με την παρούσα ο/η TOKAI RIKA CO., LTD., δηλώνει ότι ο ραδιοεξοπλισμός RI-57BTY πληροί την οδηγία 2014/53/EE.

Το πλήρες κείμενο της δήλωσης συμμόρφωσης ΕΕ διατίθεται στην ακόλουθη ιστοσελίδα στο διαδίκτυο:

<http://www.tokai-rika.co.jp/pc>

Ζώνη συχνότητων: 119 - 135 kHz

Μέγιστη ισχύς ραδιοσυχνότητας: 55dBμA/m@10m

Il fabbricante, TOKAI RIKA CO., LTD., dichiara che il tipo di apparecchiatura radio RI-57BTY è conforme alla direttiva 2014/53/UE.

Il testo completo della dichiarazione di conformità UE è disponibile al seguente indirizzo Internet:

<http://www.tokai-rika.co.jp/pc>

Banda di frequenza: 119 - 135 kHz

Potenza massima radiofrequenza: 55dBμA/m@10m

Por la presente, TOKAI RIKA CO., LTD. declara que el tipo de equipo radioeléctrico RI-57BTY es conforme con la Directiva 2014/53/UE.

El texto completo de la declaración UE de conformidad está disponible en la dirección Internet siguiente:

<http://www.tokai-rika.co.jp/pc>

Banda de frecuencia: 119 - 135 kHz

Potencia máxima de radiofrecuencia: 55dB μ A/m@10m

O(a) abaixo assinado(a) TOKAI RIKA CO., LTD. declara que o presente tipo de equipamento de rádio RI-57BTY está em conformidade com a Diretiva 2014/53/UE.

O texto integral da declaração de conformidade está disponível no seguinte endereço de Internet:

<http://www.tokai-rika.co.jp/pc>

Banda de frequência: 119 - 135 kHz

Potência máxima de radiofrequências: 55dB μ A/m@10m

B'dan, TOKAI RIKA CO., LTD., niddikjara li dan it-tip ta' tagħmir tar-radju RI-57BTY huwa konformi mad-Direttiva 2014/53/UE.

It-test kollu tad-dikjarazzjoni ta' konformità tal-UE huwa disponibbli f'dan l-indirizz tal-Internet li ġej:

<http://www.tokai-rika.co.jp/pc>

Tíðnisvið: 119 - 135 kHz

Hámarks útvarpsbylgjutíðni: 55dB μ A/m@10m

Käesolevaga deklareerib TOKAI RIKAI CO., LTD., et käesolev raadioseadme tüüp RI-57BTY vastab direktiivi 2014/53/EL nõuetele.

ELi vastavusdeklaratsiooni täielik tekst on kättesaadav järgmises internetiaadressil:

<http://www.tokai-rika.co.jp/pc>

Sagedusriba: 119 - 135 kHz

Maksimaalne saatevõimsus: 55dB μ A/m@10m

TOKAI RIKAI CO., LTD. igazolja, hogy a RI-57BTY típusú rádióberendezés megfelel a 2014/53/EU irányelvnek.

Az EU-megfelelőségi nyilatkozat teljes szövege elérhető a következő internetes címen:

<http://www.tokai-rika.co.jp/pc>

Frekvenciasáv: 119 - 135 kHz

Maximális jelerősség: 55dB μ A/m@10m

TOKAI RIKAI CO., LTD. týmto vyhlasuje, že rádiové zariadenie typu RI-57BTY je v súlade so smernicou 2014/53/EÚ.

Úplné EÚ vyhlásenie o zhode je k dispozícii na tejto internetovej adrese:

<http://www.tokai-rika.co.jp/pc>

Frekvenčné pásmo: 119 - 135 kHz

Maximálny rádiový výkon: 55dB μ A/m@10m

Tímto TOKAI RIKA CO., LTD. prohlašuje, že typ rádiového zařízení RI-57BTY je v souladu se směrnicí 2014/53/EU.

Úplné znění EU prohlášení o shodě je k dispozici na této internetové adrese:

<http://www.tokai-rika.co.jp/pc>

Kmitočtové pásmo: 119 - 135 kHz

Maximální radiofrekvenční výkon: 55dB μ A/m@10m

TOKAI RIKA CO., LTD. potvrzuje, da je tip radijske opreme RI-57BTY skladen z Direktivo 2014/53/EU.

Celotno besedilo izjave EU o skladnosti je na voljo na naslednjem spletnem naslovu:

<http://www.tokai-rika.co.jp/pc>

Frekvenčni pas: 119 - 135 kHz

Največja moč radijske frekvence: 55dB μ A/m@10m

Aš, TOKAI RIKA CO., LTD., patvirtinu, kad radijo įrenginių tipas RI-57BTY atitinka Direktyvą 2014/53/ES.

Visas ES atitikties deklaracijos tekstas prieinamas šiuo interneto adresu:

<http://www.tokai-rika.co.jp/pc>

Dažnių juosta: 119 - 135 kHz

Didžiausia radijo dažnių galia: 55dB μ A/m@10m

Ar šo TOKAI RIKAI CO., LTD. deklarē, ka radioiekārta RI-57BTY atbilst Direktīvai 2014/53/ES.

Pilns ES atbilstības deklarācijas teksts ir pieejams šādā interneta vietnē:

<http://www.tokai-rika.co.jp/pc>

Frekvenču josla: 119 - 135 kHz

Maksimālā radiofrekvenču jauda: 55dB μ A/m@10m

TOKAI RIKAI CO., LTD. niniešzym oświadcza, że typ urządzenia radiowego RI-57BTY jest zgodny z dyrektywą 2014/53/UE.

Pełny tekst deklaracji zgodności UE jest dostępny pod następującym adresem internetowym:

<http://www.tokai-rika.co.jp/pc>

Zakres częstotliwości: 119 - 135 kHz

Maksymalna moc częstotliwości radiowej: 55dB μ A/m@10m

TOKAI RIKAI CO., LTD. lýsir því hér með yfir að fjarskiptatækið af gerð RI-57BTY er í samræmi við tilskipun 2014/53/EU.

Öll ESB-samræmisýfirlýsingin er tiltæk á eftirfarandi vefslóð:

<http://www.tokai-rika.co.jp/pc>

Tíðnisvið: 119 - 135 kHz

Hámarks útværpsbylgjutíðni: 55dB μ A/m@10m

TOKAI RIKА CO., LTD. erklærer herved at radioutstyrtypen RI-57BTY er i samsvar med direktivet 2014/53/EU.

Hele teksten av EU-samsvarserklæringen kan leses på det følgende nettstedet:

<http://www.tokai-rika.co.jp/pc>

Frekvensbånd: 119 - 135 kHz

Maksimal radiofrekvens effekt: 55dBµA/m@10m

С настоящото TOKAI RIKА CO., LTD. декларира, че този тип радиосъоръжение RI-57BTY е в съответствие с Директива 2014/53/ЕС.

Цялостният текст на ЕС декларацията за съответствие може да се намери на следния интернет адрес:

<http://www.tokai-rika.co.jp/pc>

Радиочестотна лента: 119 - 135 kHz

Максимална радиочестотна мощност: 55dBµA/m@10m

Prin prezenta, TOKAI RIKА CO., LTD. declară că tipul de echipamente radio RI-57BTY este în conformitate cu Directiva 2014/53/UE.

Textul integral al declarației UE de conformitate este disponibil la următoarea adresă internet:

<http://www.tokai-rika.co.jp/pc>

Banda de frecvență: 119 - 135 kHz

Puterea maximă de radiofrecvență: 55dBµA/m@10m

Ovime TOKAI RIKA CO., LTD. potvrđuje da je radio-oprema tipa RI-57BTY u skladu sa Direktivom 2014/53/EU.

Potpuni tekst EU deklaracije o usaglašenosti dostupan je na slijedećoj internet adresi:

<http://www.tokai-rika.co.jp/pc>

Frekvencijski opseg: 119 - 135 kHz

Maksimalna radio-frekvencijska snaga: 55dB μ A/m@10m

Me anë të këtij dokumenti, TOKAI RIKA CO., LTD. deklaron se tipi i radiopajisjes RI-57BTY është në përputhje me Direktivën 2014/53/EU.

Teksti i plotë i deklaratës së konformitetit të Bashkimit Evropian është i disponueshëm në adresën e mëposhtme të internetit:

<http://www.tokai-rika.co.jp/pc>

Brezi i frekuencës: 119 - 135 kHz

Fuqia maksimale e radiofrekuencës: 55dB μ A/m@10m

TOKAI RIKA CO., LTD. ovime izjavljuje da je radijska oprema tipa RI-57BTY u skladu s Direktivom 2014/53/EU.

Cjeloviti tekst EU izjave o sukladnosti dostupan je na sljedećoj internetskoj adresi:

<http://www.tokai-rika.co.jp/pc>

Frekvencijski pojas: 119 - 135 kHz

Maksimalna RF snaga: 55dB μ A/m@10m

Ovim TOKAI RIKA CO., LTD. potvrđuje da je radio-oprema tipa RI-57BTY u skladu sa Direktivom 2014/53/EU.

Potpuni tekst EU deklaracije o usaglašenosti dostupan je na sledećoj internet adresi:

<http://www.tokai-rika.co.jp/pc>

Frekventni opseg: 119 - 135 kHz

Maksimalna radio-frekventna snaga: 55dB μ A/m@10m

TOKAI RIKA CO., LTD., işbu belgeyle telsiz cihazı türünün RI-57BTY 2014/53/EU nolu Direktif ile uyumlu olduğunu beyan etmektedir.

AB uygunluk beyanının tam metnine aşağıdaki internet adresinden ulaşabilirsiniz:

<http://www.tokai-rika.co.jp/pc>

Frekans bandı: 119 - 135 kHz

Maksimum radyo frekans gücü: 55dB μ A/m@10m



Address: 1, Toyota-cho, Toyota, Aichi, 471-8572, Japan

► For vehicles sold in Ukraine

Справжнім TOKAI RIKAI CO., LTD. заявляє, що тип радіообладнання RI-57BTY відповідає Технічному регламенту радіообладнання;
КАБІНЕТ МІНІСТРІВ УКРАЇНИ ПОСТАНОВА №.355

Повний текст декларації про відповідність доступний на веб-сайті за такою адресою:
<http://www.tokai-rika.co.jp/pc>

Діапазон частот : 119 - 135 kHz
Максимальна потужність радіочастотного випромінювання :
55dBμA/m @10m



Адреса: 3-260 Toyota, Oguchi-cho, Niwa-gun, Aichi 480-0195,
Japan

► For vehicles sold in Serbia



Engine immobilizer system (vehicles with smart entry & start system)

Hereby, TOYOTA MOTOR CORPORATION declares that the radio equipment type TMIMB-3 is in compliance with Directive 2014/53/EU.

The full text of the EU declaration of conformity is available at the following internet address:

<http://www.tokai-rika.co.jp/pc>

Frequency band: 119 - 135 kHz

Maximum radio-frequency power: 55dB μ A/m @10m

TOYOTA MOTOR CORPORATION vakuuttaa, että radiolaitetyyppi TMIMB-3 on direktiivin 2014/53/EU mukainen.

EU-vaatimustenmukaisuusvakuutuksen täysimittainen teksti on saatavilla seuraavassa internetosoitteessa:

<http://www.tokai-rika.co.jp/pc>

Radiotaajuus: 119 - 135 kHz

suurin mahdollinen lähetysteho: 55dB μ A/m @10m

Hierbij verklaar ik, TOYOTA MOTOR CORPORATION, dat het type radioapparatuur TMIMB-3 conform is met Richtlijn 2014/53/EU.

De volledige tekst van de EU-conformiteitsverklaring kan worden geraadpleegd op het volgende internetadres:

<http://www.tokai-rika.co.jp/pc>

Frequentieband: 119 - 135 kHz

Maximaal radiofrequentievermogen: 55dB μ A/m @10m

Le soussigné, TOYOTA MOTOR CORPORATION, déclare que l'équipement radioélectrique du type TMIMB-3 est conforme à la directive 2014/53/UE.

Le texte complet de la déclaration UE de conformité est disponible à l'adresse internet suivante:

<http://www.tokai-rika.co.jp/pc>

Bande de fréquences: 119 - 135 kHz

Puissance de radiofréquence maximale: 55dB μ A/m @10m

Härmed försäkrar TOYOTA MOTOR CORPORATION att denna typ av radioutrustning TMIMB-3 överensstämmer med direktiv 2014/53/EU.

Den fullständiga texten till EU-försäkran om överensstämmelse finns på följande webbadress:

<http://www.tokai-rika.co.jp/pc>

Frekvensband: 119 - 135 kHz

Maximal radiofrekvensseffekt: 55dB μ A/m @10m

Hermed erklærer TOYOTA MOTOR CORPORATION, at radioudstyrstypen TMIMB-3 er i overensstemmelse med direktiv 2014/53/EU.

EU-overensstemmelseserklæringens fulde tekst kan findes på følgende internetadresse:

<http://www.tokai-rika.co.jp/pc>

Frekvensbånd: 119 - 135 kHz

Maksimal radiofrekvensseffekt: 55dB μ A/m @10m

Hiermit erklärt TOYOTA MOTOR CORPORATION, dass der Funkanlagentyp TMIMB-3 der Richtlinie 2014/53/EU entspricht.

Der vollständige Text der EU-Konformitätserklärung ist unter der folgenden Internetadresse verfügbar:

<http://www.tokai-rika.co.jp/pc>

Frequenzband: 119 - 135 kHz

Abgestrahlte maximale Sendeleistung: 55dBμA/m @10m

Με την παρούσα ο/η TOYOTA MOTOR CORPORATION, δηλώνει ότι ο ραδιοεξοπλισμός TMIMB-3 πληροί την οδηγία 2014/53/EE.

Το πλήρες κείμενο της δήλωσης συμμόρφωσης ΕΕ διατίθεται στην ακόλουθη ιστοσελίδα στο διαδίκτυο:

<http://www.tokai-rika.co.jp/pc>

Ζώνη συχνοτήτων: 119 - 135 kHz

Μέγιστη ισχύς ραδιοσυχνότητας: 55dBμA/m @10m

Il fabbricante, TOYOTA MOTOR CORPORATION, dichiara che il tipo di apparecchiatura radio TMIMB-3 è conforme alla direttiva 2014/53/UE.

Il testo completo della dichiarazione di conformità UE è disponibile al seguente indirizzo Internet:

<http://www.tokai-rika.co.jp/pc>

Banda di frequenza: 119 - 135 kHz

Potenza massima radiofrequenza: 55dBμA/m @10m

Por la presente, TOYOTA MOTOR CORPORATION declara que el tipo de equipo radioeléctrico TMIMB-3 es conforme con la Directiva 2014/53/UE.

El texto completo de la declaración UE de conformidad está disponible en la dirección Internet siguiente:

<http://www.tokai-rika.co.jp/pc>

Banda de frecuencia: 119 - 135 kHz

Potencia máxima de radiofrecuencia: 55dB μ A/m @10m

O(a) abaixo assinado(a) TOYOTA MOTOR CORPORATION declara que o presente tipo de equipamento de rádio TMIMB-3 está em conformidade com a Diretiva 2014/53/UE.

O texto integral da declaração de conformidade está disponível no seguinte endereço de Internet:

<http://www.tokai-rika.co.jp/pc>

Banda de frequência: 119 - 135 kHz

Potência máxima de radiofrequências: 55dB μ A/m @10m

B'dan, TOYOTA MOTOR CORPORATION, niddikjara li dan it-tip ta' tagħmir tar-radju TMIMB-3 huwa konformi mad-Direttiva 2014/53/UE.

It-test kollu tad-dikjarazzjoni ta' konformità tal-UE huwa disponibbli f'dan l-indirizz tal-Internet li ġej:

<http://www.tokai-rika.co.jp/pc>

Tíðnisvið: 119 - 135 kHz

Hámarks útværpsbylgjutíðni: 55dB μ A/m @10m

Käesolevaga deklareerib TOYOTA MOTOR CORPORATION, et käesolev raadioseadme tüüp TMIMB-3 vastab direktiivi 2014/53/EL nõuetele.

ELi vastavusdeklaratsiooni täielik tekst on kättesaadav järgmisel internetiaadressil:

<http://www.tokai-rika.co.jp/pc>

Sagedusriba: 119 - 135 kHz

Maksimaalne saatevõimsus: 55dB μ A/m @10m

TOYOTA MOTOR CORPORATION igazolja, hogy a TMIMB-3 típusú rádióberendezés megfelel a 2014/53/EU irányelvnek.

Az EU-megfelelőségi nyilatkozat teljes szövege elérhető a következő internetes címen:

<http://www.tokai-rika.co.jp/pc>

Frekvenciasáv: 119 - 135 kHz

Maximális jelerősség: 55dB μ A/m @10m

TOYOTA MOTOR CORPORATION týmto vyhlasuje, že rádiové zariadenie typu TMIMB-3 je v súlade so smernicou 2014/53/EÚ.

Úplné EÚ vyhlásenie o zhode je k dispozícii na tejto internetovej adrese:

<http://www.tokai-rika.co.jp/pc>

Frekvenčné pásmo: 119 - 135 kHz

Maximálny rádiový výkon: 55dB μ A/m @10m

Tímto TOYOTA MOTOR CORPORATION prohlašuje, že typ rádiového zařízení TMIMB-3 je v souladu se směrnicí 2014/53/EU.

Úplné znění EU prohlášení o shodě je k dispozici na této internetové adrese:

<http://www.tokai-rika.co.jp/pc>

Kmitočtové pásmo: 119 - 135 kHz

Maximální radiofrekvenční výkon: 55dB μ A/m @10m

TOYOTA MOTOR CORPORATION potvrzuje, da je tip radijske opreme TMIMB-3 skladen z Direktivo 2014/53/EU.

Celotno besedilo izjave EU o skladnosti je na voljo na naslednjem spletnem naslovu:

<http://www.tokai-rika.co.jp/pc>

Frekvenčni pas: 119 - 135 kHz

Največja moč radijske frekvence: 55dB μ A/m @10m

Aš, TOYOTA MOTOR CORPORATION, patvirtinu, kad radijo įrenginių tipas TMIMB-3 atitinka Direktyvą 2014/53/ES.

Visas ES atitikties deklaracijos tekstas prieinamas šiuo interneto adresu:

<http://www.tokai-rika.co.jp/pc>

Dažnių juosta: 119 - 135 kHz

Didžiausia radijo dažnių galia: 55dB μ A/m @10m

Ar šo TOYOTA MOTOR CORPORATION deklarē, ka radioiekārta TMIMB-3 atbilst Direktīvai 2014/53/ES.

Pilns ES atbilstības deklarācijas teksts ir pieejams šādā interneta vietnē:

<http://www.tokai-rika.co.jp/pc>

Frekvenču josla: 119 - 135 kHz

Maksimālā radiofrekvenču jauda: 55dB μ A/m @10m

TOYOTA MOTOR CORPORATION niniešzīm ošviadcza, że typ urządzenia radiowego TMIMB-3 jest zgodny z dyrektywą 2014/53/UE.

Pełny tekst deklaracji zgodności UE jest dostępny pod następującym adresem internetowym:

<http://www.tokai-rika.co.jp/pc>

Zakres częstotliwości: 119 - 135 kHz

Maksymalna moc częstotliwości radiowej: 55dB μ A/m @10m

TOYOTA MOTOR CORPORATION lýsir því hér með yfir að fjarskiptatækið af gerð TMIMB-3 er í samræmi við tilskipun 2014/53/EU.

Öll ESB-samræmisýfirlýsingin er tiltæk á eftirfarandi vefslóð:

<http://www.tokai-rika.co.jp/pc>

Tíðnisvið: 119 - 135 kHz

Hámarks útvarpsbylgjutíðni: 55dB μ A/m @10m

TOYOTA MOTOR CORPORATION erklærer herved at radioutstyrtypen TMIMB-3 er i samsvar med direktivet 2014/53/EU.

Hele teksten av EU-samsvarserklæringen kan leses på det følgende nettstedet:

<http://www.tokai-rika.co.jp/pc>

Frekvensbånd: 119 - 135 kHz

Maksimal radiofrekvensseffekt: 55dB μ A/m @10m

С настоящото TOYOTA MOTOR CORPORATION декларира, че този тип радиосъоръжение TMIMB-3 е в съответствие с Директива 2014/53/ЕС.

Цялостният текст на ЕС декларацията за съответствие може да се намери на следния интернет адрес:

<http://www.tokai-rika.co.jp/pc>

Радиочестотна лента: 119 - 135 kHz

Максимална радиочестотна мощност: 55dB μ A/m @10m

Prin prezenta, TOYOTA MOTOR CORPORATION declară că tipul de echipamente radio TMIMB-3 este în conformitate cu Directiva 2014/53/UE.

Textul integral al declarației UE de conformitate este disponibil la următoarea adresă internet:

<http://www.tokai-rika.co.jp/pc>

Banda de frecvență: 119 - 135 kHz

Puterea maximă de radiofrecvență: 55dB μ A/m @10m

Ovime TOYOTA MOTOR CORPORATION potvrđuje da je radio-oprema tipa TMIMB-3 u skladu sa Direktivom 2014/53/EU.

Potpuni tekst EU deklaracije o usaglašenosti dostupan je na sljedećoj internet adresi:

<http://www.tokai-rika.co.jp/pc>

Frekvencijski opseg: 119 - 135 kHz

Maksimalna radio-frekvencijska snaga: 55dB μ A/m @10m

Me anë të këtij dokumenti, TOYOTA MOTOR CORPORATION deklararon se tipi i radiopajisjes TMIMB-3 është në përputhje me Direktivën 2014/53/EU.

Teksti i plotë i deklaratës së konformitetit të Bashkimit Evropian është i disponueshëm në adresën e mëposhtme të internetit:

<http://www.tokai-rika.co.jp/pc>

Brezi i frekuencës: 119 - 135 kHz

Fuqia maksimale e radiofrekuencës: 55dB μ A/m @10m

TOYOTA MOTOR CORPORATION ovime izjavljuje da je radijska oprema tipa TMIMB-3 u skladu s Direktivom 2014/53/EU.

Cjeloviti tekst EU izjave o sukladnosti dostupan je na sljedećoj internetskoj adresi:

<http://www.tokai-rika.co.jp/pc>

Frekvencijski pojas: 119 - 135 kHz

Maksimalna RF snaga: 55dB μ A/m @10m

Ovim TOYOTA MOTOR CORPORATION potvrđuje da je radio-oprema tipa TMIMB-3 u skladu sa Direktivom 2014/53/EU.

Potpuni tekst EU deklaracije o usaglašenosti dostupan je na sledećoj internet adresi:

<http://www.tokai-rika.co.jp/pc>

Frekventni opseg: 119 - 135 kHz

Maksimalna radio-frekventna snaga: 55dB μ A/m @10m

TOYOTA MOTOR CORPORATION, işbu belgeyle telsiz cihazı türünün TMIMB-3 2014/53/EU nolu Direktif ile uyumlu olduğunu beyan etmektedir.

AB uygunluk beyanının tam metnine aşağıdaki internet adresinden ulaşabilirsiniz:

<http://www.tokai-rika.co.jp/pc>

Frekans bandı: 119 - 135 kHz

Maksimum radyo frekans gücü: 55dB μ A/m @10m



Address: 1, Toyota-cho, Toyota, Aichi, 471-8572, Japan

► For vehicles sold in Ukraine

Справжнім TOYOTA MOTOR CORPORATION заявляє, що тип радіобладнання TM1MB-3 відповідає Технічному регламенту радіобладнання;
КАБІНЕТ МІНІСТРІВ УКРАЇНИ ПОСТАНОВА №.355

Повний текст декларації про відповідність доступний на веб-сайті за такою адресою:
<http://www.tokai-rika.co.jp/pc>

Діапазон частот : 119 - 135 kHz

Максимальна потужність радіочастотного випромінювання :
55dВμA/m @10m



Адреса: 1, Toyota-cho, Toyota, Aichi-ken, 471-8572,Japan

Wireless remote control

Hereby, TOKAI RIKA CO., LTD. declares that the radio equipment type BA2TA is in compliance with Directive 2014/53/EU.

The full text of the EU declaration of conformity is available at the following internet address:

<http://www.tokai-rika.co.jp/pc>

Frequency band: 433.050 - 434.790 MHz

Maximum radio-frequency power: 10 mW(ERP)

TOKAI RIKA CO., LTD. vakuuttaa, että radiolaitetyyppi BA2TA on direktiivin 2014/53/EU mukainen.

EU-vaatimustenmukaisuusvakuutuksen täysimittainen teksti on saatavilla seuraavassa internetosoitteessa:

<http://www.tokai-rika.co.jp/pc>

Radiotaajuus: 433.050 - 434.790 MHz

suurin mahdollinen lähetysteho: 10 mW(ERP)

Hierbij verklaar ik, TOKAI RIKA CO., LTD., dat het type radioapparatuur BA2TA conform is met Richtlijn 2014/53/EU.

De volledige tekst van de EU-conformiteitsverklaring kan worden geraadpleegd op het volgende internetadres:

<http://www.tokai-rika.co.jp/pc>

Frequentieband: 433.050 - 434.790 MHz

Maximaal radiofrequentievermogen: 10 mW(ERP)

Le soussigné, TOKAI RIKA CO., LTD., déclare que l'équipement radioélectrique du type BA2TA est conforme à la directive 2014/53/UE.

Le texte complet de la déclaration UE de conformité est disponible à l'adresse internet suivante:

<http://www.tokai-rika.co.jp/pc>

Bande de fréquences: 433.050 - 434.790 MHz

Puissance de radiofréquence maximale: 10 mW(ERP)

Härmed försäkrar TOKAI RIKA CO., LTD. att denna typ av radioutrustning BA2TA överensstämmer med direktiv 2014/53/EU.

Den fullständiga texten till EU-försäkran om överensstämmelse finns på följande webbadress:

<http://www.tokai-rika.co.jp/pc>

Frekvensband: 433.050 - 434.790 MHz

Maximal radiofrekvensseffekt: 10 mW(ERP)

Hermed erklærer TOKAI RIKA CO., LTD., at radioudstyrstypen BA2TA er i overensstemmelse med direktiv 2014/53/EU.

EU-overensstemmelseserklæringens fulde tekst kan findes på følgende internetadresse:

<http://www.tokai-rika.co.jp/pc>

Frekvensbånd: 433.050 - 434.790 MHz

Maksimal radiofrekvensseffekt: 10 mW(ERP)

Hiermit erklärt TOKAI RIKA CO., LTD., dass der Funkanlagentyp BA2TA der Richtlinie 2014/53/EU entspricht.

Der vollständige Text der EU-Konformitätserklärung ist unter der folgenden Internetadresse verfügbar:

<http://www.tokai-rika.co.jp/pc>

Frequenzband: 433.050 - 434.790 MHz

Abgestrahlte maximale Sendeleistung: 10 mW(ERP)

Με την παρούσα ο/η TOKAI RIKA CO., LTD., δηλώνει ότι ο ραδιοεξοπλισμός BA2TA πληροί την οδηγία 2014/53/EE.

Το πλήρες κείμενο της δήλωσης συμμόρφωσης ΕΕ διατίθεται στην ακόλουθη ιστοσελίδα στο διαδίκτυο:

<http://www.tokai-rika.co.jp/pc>

Ζώνη συχνοτήτων: 433.050 - 434.790 MHz

Μέγιστη ισχύς ραδιοσυχνότητας: 10 mW(ERP)

Il fabbricante, TOKAI RIKA CO., LTD., dichiara che il tipo di apparecchiatura radio BA2TA è conforme alla direttiva 2014/53/UE.

Il testo completo della dichiarazione di conformità UE è disponibile al seguente indirizzo Internet:

<http://www.tokai-rika.co.jp/pc>

Banda di frequenza: 433.050 - 434.790 MHz

Potenza massima radiofrequenza: 10 mW(ERP)

Por la presente, TOKAI RIKA CO., LTD. declara que el tipo de equipo radioeléctrico BA2TA es conforme con la Directiva 2014/53/UE.

El texto completo de la declaración UE de conformidad está disponible en la dirección Internet siguiente:

<http://www.tokai-rika.co.jp/pc>

Banda de frecuencia: 433.050 - 434.790 MHz

Potencia máxima de radiofrecuencia: 10 mW(ERP)

O(a) abaixo assinado(a) TOKAI RIKA CO., LTD. declara que o presente tipo de equipamento de rádio BA2TA está em conformidade com a Diretiva 2014/53/UE.

O texto integral da declaração de conformidade está disponível no seguinte endereço de Internet:

<http://www.tokai-rika.co.jp/pc>

Banda de frequência: 433.050 - 434.790 MHz

Potência máxima de radiofrequências: 10 mW(ERP)

B'dan, TOKAI RIKA CO., LTD., niddikjara li dan it-tip ta' tagħmir tar-radju BA2TA huwa konformi mad-Direttiva 2014/53/UE.

It-test kollu tad-dikjarazzjoni ta' konformità tal-UE huwa disponibbli f'dan l-indirizz tal-Internet li ġej:

<http://www.tokai-rika.co.jp/pc>

Tíðnisvið: 433.050 - 434.790 MHz

Hámarks útværpsbylgjutíðni: 10 mW(ERP)

Käesolevaga deklareerib TOKAI RIKA CO., LTD., et käesolev raadioseadme tüüp BA2TA vastab direktiivi 2014/53/EL nõuetele.

ELi vastavusdeklaratsiooni täielik tekst on kättesaadav järgmisel internetiaadressil:

<http://www.tokai-rika.co.jp/pc>

Sagedusriba: 433.050 - 434.790 MHz
Maksimaalne saatevõimsus: 10 mW(ERP)

TOKAI RIKA CO., LTD. igazolja, hogy a BA2TA típusú rádióberendezés megfelel a 2014/53/EU irányelvnek.

Az EU-megfelelőségi nyilatkozat teljes szövege elérhető a következő internetes címen:

<http://www.tokai-rika.co.jp/pc>

Frekvenciasáv: 433.050 - 434.790 MHz
Maximális jelerősség: 10 mW(ERP)

TOKAI RIKA CO., LTD. týmto vyhlasuje, že rádiové zariadenie typu BA2TA je v súlade so smernicou 2014/53/EÚ.

Úplné EÚ vyhlásenie o zhode je k dispozícii na tejto internetovej adrese:

<http://www.tokai-rika.co.jp/pc>

Frekvénčné pásmo: 433.050 - 434.790 MHz
Maximálny rádiový výkon: 10 mW(ERP)

Tímto TOKAI RIKA CO., LTD. prohlašuje, že typ rádiového zařízení BA2TA je v souladu se směrnicí 2014/53/EU.

Úplné znění EU prohlášení o shodě je k dispozici na této internetové adrese:

<http://www.tokai-rika.co.jp/pc>

Kmitočtové pásmo: 433.050 - 434.790 MHz
Maximální radiofrekvenční výkon: 10 mW(ERP)

TOKAI RIKA CO., LTD. potvrzuje, da je tip radijske opreme BA2TA skladen z Direktivo 2014/53/EU.

Celotno besedilo izjave EU o skladnosti je na voljo na naslednjem spletnem naslovu:

<http://www.tokai-rika.co.jp/pc>

Frekvenčni pas: 433.050 - 434.790 MHz
Največja moč radijske frekvence: 10 mW(ERP)

Aš, TOKAI RIKA CO., LTD., patvirtinu, kad radijo įrenginių tipas BA2TA atitinka Direktyvą 2014/53/ES.

Visas ES atitikties deklaracijos tekstas prieinamas šiuo interneto adresu:

<http://www.tokai-rika.co.jp/pc>

Dažnių juosta: 433.050 - 434.790 MHz
Didžiausia radijo dažnių galia: 10 mW(ERP)

Ar šo TOKAI RIKA CO., LTD. deklarē, ka radioiekārta BA2TA atbilst Direktīvai 2014/53/ES.

Pilns ES atbilstības deklarācijas teksts ir pieejams šādā interneta vietnē:

<http://www.tokai-rika.co.jp/pc>

Frekvenču josla: 433.050 - 434.790 MHz
Maksimālā radiofrekvenču jauda: 10 mW(ERP)

TOKAI RIKA CO., LTD. niniešzym oświadcza, że typ urządzenia radiowego BA2TA jest zgodny z dyrektywą 2014/53/UE.

Pełny tekst deklaracji zgodności UE jest dostępny pod następującym adresem internetowym:

<http://www.tokai-rika.co.jp/pc>

Zakres częstotliwości: 433.050 - 434.790 MHz
Maksymalna moc częstotliwości radiowej: 10 mW(ERP)

TOKAI RIKA CO., LTD. lýsir því hér með yfir að fjarskiptatækið af gerð BA2TA er í samræmi við tilskipun 2014/53/EU.

Öll ESB-samræmisýfirlýsingin er tiltæk á eftirfarandi vefslóð:

<http://www.tokai-rika.co.jp/pc>

Tíðnisvið: 433.050 - 434.790 MHz
Hámarks útværpsbylgjutíðni: 10 mW(ERP)

TOKAI RIKА CO., LTD. erklærer herved at radioutstyrtypen BA2TA er i samsvar med direktivet 2014/53/EU.

Hele teksten av EU-samsvarserklæringen kan leses på det følgende nettstedet:

<http://www.tokai-rika.co.jp/pc>

Frekvensbånd: 433.050 - 434.790 MHz
Maksimal radiofrekvens effekt: 10 mW(ERP)

С настоящото TOKAI RIKА CO., LTD. декларира, че този тип радиосъоръжение BA2TA е в съответствие с Директива 2014/53/EC.

Цялостният текст на ЕС декларацията за съответствие може да се намери на следния интернет адрес:

<http://www.tokai-rika.co.jp/pc>

Радиочестотна лента: 433.050 - 434.790 MHz
Максимална радиочестотна мощност: 10 mW(ERP)

Prin prezenta, TOKAI RIKА CO., LTD. declară că tipul de echipamente radio BA2TA este în conformitate cu Directiva 2014/53/UE.

Textul integral al declarației UE de conformitate este disponibil la următoarea adresă internet:

<http://www.tokai-rika.co.jp/pc>

Banda de frecvență: 433.050 - 434.790 MHz
Puterea maximă de radiofrecvență: 10 mW(ERP)

Ovime TOKAI RIKA CO., LTD. potvrđuje da je radio-oprema tipa BA2TA u skladu sa Direktivom 2014/53/EU.

Potpuni tekst EU deklaracije o usaglašenosti dostupan je na sljedećoj internet adresi:

<http://www.tokai-rika.co.jp/pc>

Frekvencijski opseg: 433.050 - 434.790 MHz

Maksimalna radio-frekvencijska snaga: 10 mW(ERP)

Me anë të këtij dokumenti, TOKAI RIKA CO., LTD. deklaron se tipi i radiopajisjes BA2TA është në përputhje me Direktivën 2014/53/EU.

Teksti i plotë i deklaratës së konformitetit të Bashkimit Evropian është i disponueshëm në adresën e mëposhtme të internetit:

<http://www.tokai-rika.co.jp/pc>

Brezi i frekuencës: 433.050 - 434.790 MHz

Fuqia maksimale e radiofrekuencës: 10 mW(ERP)

TOKAI RIKA CO., LTD. ovime izjavljuje da je radijska oprema tipa BA2TA u skladu s Direktivom 2014/53/EU.

Cjeloviti tekst EU izjave o sukladnosti dostupan je na sljedećoj internetskoj adresi:

<http://www.tokai-rika.co.jp/pc>

Frekvencijski pojas: 433.050 - 434.790 MHz

Maksimalna RF snaga: 10 mW(ERP)

Ovim TOKAI RIKAI CO., LTD. potvrđuje da je radio-oprema tipa BA2TA u skladu sa Direktivom 2014/53/EU.

Potpuni tekst EU deklaracije o usaglašenosti dostupan je na sledećoj internet adresi:

<http://www.tokai-rika.co.jp/pc>

Frekventni opseg: 433.050 - 434.790 MHz

Maksimalna radio-frekventna snaga: 10 mW(ERP)

TOKAI RIKAI CO., LTD., işbu belgeyle telsiz cihazı türünün BA2TA 2014/53/EU nolu Direktif ile uyumlu olduğunu beyan etmektedir.

AB uygunluk beyanının tam metnine aşağıdaki internet adresinden ulaşabilirsiniz:

<http://www.tokai-rika.co.jp/pc>

Frekans bandı: 433.050 - 434.790 MHz

Maksimum radyo frekans gücü: 10 mW(ERP)



Address: 3-260 Toyota, Oguchi-cho, Niwa-gun, Aichi 480-0195, Japan

⚠: This mark is a safety/warning mark.

- Do not ingest battery.

Chemical Burn Hazard

- This product contains a coin / button cell battery.
- If the coin / button cell battery is swallowed, it can cause severe internal burns in just 2 hours and can lead to death.
- Keep new and used batteries away from children.
- If the battery compartment does not close securely, stop using the product and keep it away from children.
- If you think batteries might have been swallowed or placed inside any part of the body, seek immediate medical attention.

CAUTION

- Risk of explosion if the battery is replaced by an incorrect type.
- Replace battery with the same type.

CAUTION

- Risk of explosion or the leakage of flammable liquid or gas.
- Do not use in /store in /bring into environment of extremely high temperature or extremely low pressure due to the very high altitude.
- Do not attempt to burn, crush, or cut used battery.

⚠ : Tämä on turva-/varoituserkki.

- Paristoa ei saa laittaa suuhun.

Kemiallisen palovamman vaara

- Laitteessa on kolikko-/nappiparisto.
- Elimistöön joutunut kolikko-/nappiparisto voi aiheuttaa vakavia sisäisiä palovammoja vain 2 tunnissa, jolloin seurauksena voi olla hengen menetys.
- Uudet ja käytetyt paristot on pidettävä poissa lasten ulottuvilta.
- Jos paristolokero ei sulkeudu kunnolla, laitteen käyttö on lopetettava, ja laite on pidettävä poissa lasten ulottuvilta.
- Jos on syytä epäillä, että paristo on nielaistu tai muuten päässyt elimistöön, ota välittömästi yhteyttä lääkäriin.

TÄRKEÄ HUOMAUTUS

- Käytetyn pariston vaihtaminen tyypiltään väärään voi aiheuttaa räjähdysvaaran.
- Vaihda paristo tyypiltään samanlaiseen.

TÄRKEÄ HUOMAUTUS

- Räjähdysvaara tai syttyvän nesteen tai kaasun vuotovaara.
- Ei saa käyttää/säilyttää/tuoda lämpötilaltaan tai merenpinnasta mitattuna erittäin korkeaan ympäristöön, jossa ilmanpaine on erittäin alhainen.
- Käytettyä paristoa ei saa polttaa, murskata tai halkaista.

 : Dit teken is een veiligheids-/waarschuwingsteken.

- Slik de batterij niet in.

Risico op chemische brandwonden

- Dit product bevat een munt-/knoopcelbatterij.
- Als de munt-/knoopcelbatterij wordt ingeslikt, kan het al binnen 2 uur ernstige interne brandwonden veroorzaken en de dood tot gevolg hebben.
- Houd nieuwe en gebruikte batterijen buiten bereik van kinderen.
- Als het batterijcompartiment niet goed sluit, stop dan met het gebruik van het product en houd het buiten bereik van kinderen.
- Als u denkt dat batterijen zijn ingeslikt of in enig deel van het lichaam zijn gestopt, roep dan onmiddellijk medische hulp in.

VOORZICHTIG

- Er bestaat een risico op ontploffing als de batterij wordt vervangen door een verkeerd type.
- Vervang de batterij door een van hetzelfde type.

VOORZICHTIG

- Er bestaat een risico op ontploffing of lekkage van brandbare vloeistof of gas.

- Niet gebruiken in/bewaren in/meenemen naar een omgeving met extreem hoge temperatuur of met extreem lage druk als gevolg van zeer grote hoogte.
- Een gebruikte batterij niet verbranden, platdrukken, of doorsnijden.

 : Ce pictogramme est une marque de sécurité/avertissement.

- Ne pas ingérer la pile.

Risques de brûlure chimique

- Ce produit contient une pile bouton.
- Si la pile bouton est avalée, elle peut causer de graves brûlures internes en seulement 2 heures et peut entraîner la mort.
- Conservez les piles neuves et usagées hors de portée des enfants.
- Si le compartiment de la pile ne ferme pas correctement, cessez d'utiliser le produit et conservez-le hors de portée des enfants.
- Si vous pensez que des piles ont pu être avalées ou placées à l'intérieur d'une partie du corps, consultez immédiatement un médecin.

AVERTISSEMENT

- Risque d'explosion si la pile est remplacée par un type incorrect.
- Remplacez la pile par une pile du même type.

AVERTISSEMENT

- Risque d'explosion ou de fuite de liquide ou de gaz inflammable.

- Ne jamais utiliser, stocker, placer dans un environnement à la température extrêmement élevée ou à la pression extrêmement basse en raison d'une très haute altitude.

- Ne jamais essayer de brûler, écraser ou couper des piles usagées.

⚠: Det här märket är ett säkerhets-/varningsmärke.

- Förtär inte batteriet.

Risk för kemisk brännskada

- Den här produkten innehåller ett mynt-/knappbatteri.
- Om mynt-/knappbatteriet sväljs kan det orsaka allvarliga interna brännskador på bara två timmar, vilket kan leda till dödsfall.
- Håll nya och använda batterier borta från barn.
- Om batterifacket inte stängs ordentligt, sluta använda produkten och håll den undan från barn.
- Om du misstänker att batterier har svalts eller placerats inuti någon del av kroppen, sök omedelbart läkarvård.

VARNING

- Risk för explosion om batteriet byts ut mot ett av fel typ.
- Byt ut batteriet mot ett av samma typ.

VARNING

- Risk för explosion eller läckage av brandfarliga vätskor och gaser.

- Använd inte, förvara inte och ta inte in i miljö med extremt hög temperatur eller extremt lågt tryck p.g.a. hög höjd.

- Försök inte bränna, krossa eller skära använt batteri.

⚠ : Dette mærke er et sikkerheds-/advarselsmærke.

- Batteriet må ikke indtages.

Fare for kemisk forbrænding

- Dette produkt indeholder et mønt-/knapcellebatteri.
- Hvis mønt-/knapcellebatteriet sluges, kan det medføre alvorlige indre forbrændinger i løbet af kun 2 timer og kan føre til dødsfald.
- Opbevar nye og brugte batterier utilgængeligt for børn.
- Hvis batterirummet ikke kan lukkes ordentligt, skal du indstille brugen af produktet og opbevare det utilgængeligt for børn.
- Hvis du har mistanke om, at der måske er blevet slugt batterier, eller batterier på anden måde er kommet ind i kroppen, skal du øjeblikkeligt søge lægehjælp.

FORSIGTIG

- Risiko for eksplosion, hvis batteriet udskiftes med en forkert type.
- Udskift batteriet med et batteri af samme type.

FORSIGTIG

- Risiko for eksplosion eller lækage af brændbar væske eller gas.

- Må ikke anvendes på/opbevares på/tages med til meget varme steder eller steder med meget lavt tryk som følge af ekstreme højder.

- Forsøg ikke at brænde, knuse eller adskille brugte batterier.

: Dieses Symbol ist ein Sicherheits-/Warnsymbol.

- Verschlucken Sie die Batterie nicht.

Verätzungsgefahr

- Dieses Produkt enthält eine Knopfzellenbatterie.
- Falls die Knopfzellenbatterie verschluckt wird, kann dies innerhalb von nur 2 Stunden schwere innere Verätzungen verursachen und zum Tode führen.
- Halten Sie neue und gebrauchte Batterien von Kindern fern.
- Falls sich das Batteriefach nicht sicher schließen lässt, stellen Sie die Verwendung des Produkts ein und halten Sie es von Kindern fern.
- Falls Sie glauben, dass Batterien eventuell verschluckt oder in einen Teil des Körpers eingeführt worden sind, begeben Sie sich sofort in ärztliche Behandlung.

ACHTUNG

- Es besteht Explosionsgefahr, falls die Batterie durch eine Batterie der falschen Art ersetzt wird.
- Ersetzen Sie Batterien nur durch die gleiche Art.

ACHTUNG

- Es besteht Explosionsgefahr oder die Gefahr eines Austritts von brennbarer Flüssigkeit oder entzündlichem Gas.
- Das Produkt darf nicht in Umgebungen mit hohen Temperaturen oder extrem niedrigem Luftdruck aufgrund von extremen Höhenlagen verwendet / aufbewahrt / gebracht werden.
- Versuchen Sie nicht, gebrauchte Batterien zu verbrennen, zu zerstoßen oder zu schneiden.

: Το σήμα αυτό είναι ένα σήμα ασφαλείας/προειδοποίησης.

- Μην καταπίνετε την μπαταρία.

Κίνδυνος χημικού εγκαύματος

- Αυτό το προϊόν περιέχει μια μπαταρία σχήματος νομίσματος / κουμπιού.
- Αν η μπαταρία σχήματος νομίσματος / κουμπιού καταποθεί, μπορεί να προκαλέσει σοβαρά εσωτερικά εγκαύματα σε μόλις 2 ώρες και μπορεί να επέλθει θάνατος.
- Διατηρείτε τις καινούργιες και τις χρησιμοποιημένες μπαταρίες μακριά από παιδιά.
- Εάν το διαμέρισμα της μπαταρίας δεν κλείνει καλά, σταματήστε τη χρήση του προϊόντος και κρατήστε το μακριά από παιδιά.
- Αν νομίζετε ότι οι μπαταρίες ενδέχεται να έχουν καταποθεί ή τοποθετηθεί μέσα σε οποιοδήποτε μέρος του σώματος, ζητήστε αμέσως ιατρική φροντίδα.

ΠΡΟΣΟΧΗ

- Υπάρχει κίνδυνος έκρηξης εάν η μπαταρία αντικατασταθεί με μπαταρία εσφαλμένου τύπου.
- Αντικαταστήστε την μπαταρία με μπαταρία του ίδιου τύπου.

ΠΡΟΣΟΧΗ

- Υπάρχει κίνδυνος έκρηξης ή διαρροής εύφλεκτων υγρών ή αερίων.
- Μη χρησιμοποιείτε / αποθηκεύετε / μεταφέρετε το προϊόν σε περιβάλλον με εξαιρετικά υψηλή θερμοκρασία ή εξαιρετικά χαμηλή πίεση λόγω πολύ μεγάλου υψομέτρου.
- Μην επιχειρήσετε να κάψετε, να συνθλίψετε ή να κόψετε μια χρησιμοποιημένη μπαταρία.

 : Questo è un simbolo di sicurezza/avvertenza.

- Non ingerire la batteria.

Pericolo di ustioni chimiche

- Questo prodotto contiene una batteria a bottone/moneta.
- Se la batteria a bottone/moneta viene ingerita, può causare gravi ustioni interne in sole 2 ore e provocare la morte.
- Tenere le batterie nuove e usate lontano dalla portata dei bambini.
- Se il vano batteria non si chiude in modo saldo, interrompere l'utilizzo del prodotto e tenerlo lontano dalla portata dei bambini.
- Se si ritiene che le batterie siano state ingerite o inserite in qualsiasi parte del corpo, consultare immediatamente un medico.

ATTENZIONE

- Rischio di esplosione in caso di sostituzione della batteria con una di tipo errato.
- Sostituire la batteria con una dello stesso tipo.

ATTENZIONE

- Rischio di esplosione o di perdita di liquidi o gas infiammabili.

• Non utilizzare / immagazzinare / portare in ambienti con temperatura estremamente alta o pressione estremamente alta a causa dell'elevata altitudine.

- Non provare a bruciare, schiacciare o tagliare la batteria usata.

: Este símbolo es un símbolo de seguridad/precaución.

- No ingerir la batería.

Peligro de quemadura química

- Este producto contiene una batería de pila de botón.
- Si se ingiere la batería de pila de botón, esta puede causar graves quemaduras internas en solo 2 horas y puede provocar la muerte.
- Mantenga las baterías nuevas y usadas alejadas de los niños.
- Si el compartimento de la batería no se cierra correctamente, deje de usar el producto y manténgalo alejado de los niños.
- Si cree que las baterías hayan podido ser ingeridas o introducidas en alguna parte del cuerpo, busque inmediatamente atención médica.

ATENCIÓN

- Riesgo de explosión si la batería es reemplazada por una del tipo incorrecto.
- Reemplace la batería por una del mismo tipo.

ATENCIÓN

- Riesgo de explosión o escape de líquido o gas inflamable.

• No usar / almacenar / introducir en un ambiente de temperatura extremadamente alta o de presión extremadamente baja a causa de la alta altitud.

- No intente quemar, aplastar, o cortar la batería usada.

⚠: Esta marca é uma marca de segurança/aviso.

- Não ingerir a pilha.

Perigo de Queimadura Química

- Este produto contém uma pilha de tipo moeda/botão.
- Se a pilha de tipo moeda/botão for engolida, poderá causar queimaduras internas graves em apenas 2 horas e levar à morte.
- Manter as pilhas novas e usadas longe de crianças.
- Se o compartimento da pilha não se fechar completamente, cessar a utilização do produto e manter fora do alcance das crianças.
- Caso seja possível que as pilhas tenham sido engolidas ou colocadas dentro de qualquer parte do corpo, procurar cuidados médicos imediatamente.

CUIDADO

- Risco de explosão se a pilha for substituída por uma de tipo incorreto.
- Substituir a pilha por uma do mesmo tipo.

CUIDADO

- Risco de explosão ou fuga de líquidos ou gases inflamáveis.
- Não utilizar/armazenar/colocar em ambiente de temperatura extremamente alta, ou pressão extremamente baixa devido a altitude muito alta.
- Não tentar queimar, esmagar ou cortar a pilha usada.

⚠: Din il-marka hija marka ta' sigurtá/twissija.

- Tiblax il-batterija.

Periklu ta' Ħruq Kimiku

- Dan il-prodott fih batterija munita / button cell.
- Jekk tinbela' l-batterija munita / button cell, tista' tikkawża ħruq intern sever f'temp ta' sagħtejn biss u tista' twassal għall-mewt.
- Żomm il-batteriji godda u użati 'l bogħod mit-tfal.
- Jekk il-kompartiment tal-batterija ma jagħlaqx sew, waqqaf l-użu tal-prodott u żommu 'l bogħod mit-tfal.
- Jekk taħseb li l-batteriji setgħu nbelgħu jew tpoġġew ġewwa xi parti tal-ġisem, fittex attenzjoni medika immedjata.

ATTENZJONI

- Riskju ta' splużjoni jekk il-batterija tiġi ssostitwita b'tip inkorrett.
- Ibdel il-batterija bl-istess tip.

ATTENZJONI

- Riskju ta' splużjoni jew tnixxija ta' likwidu jew gass f'jammabbli.
- Tużahx / taħznux / iġġibux f'ambjent ta' temperatura estremament għolja jew pressjoni estremament baxxa minħabba l-altitudni għolja ħafna.
- Tippruvax taħraq, tfarrak jew tqatta' l-batteriji użati.

⚠: See märk on ohutus-/hoiatusmärk.

- Ärge patareid alla neelake.

Keemilise põletuse oht

- See toode sisaldab mündi/nööbi tüüpi elemendiga patareid.
- Mündi/nööbi tüüpi elemendiga patarei allaneelamine võib põhjustada raskeid sisemisi põletusi juba 2 tunni jooksul ning võib lõppeda surmaga.
- Hoidke uued ja kasutatud patareid lastele kättesaamatus kohas.
- Kui patareipesa ei sulgu kindlalt, lõpetage toote kasutamine ja hoidke seda lastele kättesaamatus kohas.
- Kui te arvate, et patareid võivad olla alla neelatud või mistahes kehaossa sattunud, pöörduge viivitamatult arsti poole.

ETTEVAATUST

- Plahvatusoht vahetamisel vale tüüpi patareiga.
- Vahetage sama tüüpi patareiga.

ETTEVAATUST

- Plahvatuse või tuleohtliku vedeliku või gaasi lekke oht.

- Ärge kasutage, hoidke ega tooge keskkonda eriti kõrge temperatuuriga või eriti madala rõhuga väga suure kõrguse tõttu merepinnast.

- Ärge üritage põletada, purustada ega lõigata kasutatud patareid.

⚠ : Ez a jelzés biztonsági/figyelmeztető jelzés.

- Ne nyelje le az elemet.

Vegyí anyag okozta égésisérülés-veszély

- Ez a termék gombelemet tartalmaz.
- Amennyiben a gombelemet lenyeli, az mindössze 2 órán belül komoly belső égési sérüléseket okozhat és halálhoz vezethet.
- Az új és használt elemeket tartsa távol a gyermekektől.
- Amennyiben az elemtartó rekesz nem zárható biztonságosan, függeszse fel a termék használatát és tartsa gyermekektől távol.
- Amennyiben úgy véli, hogy az elemet lenyelték vagy bármely testrészbe helyezték, haladéktalanul forduljon orvoshoz.

VIGYÁZAT

- Nem megfelelő típusú csereelem használata robbanásveszélyes.
- Az elemcseréhez azonos típusú elemet használjon.

VIGYÁZAT

- Robbanásveszély vagy gyúlékony folyadékok vagy gázok szivárgása.

- Ne használja/ne tárolja/ne helyezze szélsőségesen magas hőmérsékletű környezetbe, és ne tegye ki a nagy magasságokban kialakuló rendkívül alacsony nyomásnak.

- A használt elemet ne kísérelje meg elégetni, összezúzni vagy szétvágni.

⚠ : Toto je bezpečnostná/výstražná značka.

- Dbajte na to, aby nedošlo k prehlnutiu batérie.

Nebezpečenstvo poleptania chemikáliou

- Tento výrobok obsahuje mincovú/gombíkovú batériu.
- Ak dôjde k prehlnutiu mincovej/gombíkovej batérie, už v priebehu 2 hodín môže spôsobiť vážne vnútorné poleptanie a viesť k usmrteniu.
- Nové a použité batérie uchovávajte mimo dosahu detí.
- Ak sa priestor pre batériu nezatvorí bezpečne, prestaňte používať výrobok a uchovávajte ho mimo dosahu detí.
- Ak si myslíte, že mohlo dôjsť k prehlnutiu batérií alebo ich umiestneniu do ktorejkoľvek časti tela, okamžite vyhľadajte lekársku pomoc.

UPOZORNENIE

- Hrozí nebezpečenstvo výbuchu, ak sa batéria vymení za nesprávny typ.
- Vymeňte batériu za rovnaký typ.

UPOZORNENIE

- Nebezpečenstvo výbuchu alebo úniku horľavej kvapaliny alebo horľavého plynu.

- Nepoužívajte/neskladujte v prostredí/nepřinášajte do prostredia s mimoriadne vysokou teplotou, alebo mimoriadne nízkym tlakom v dôsledku veľmi vysokej nadmorskej výšky.

- Nepokúšajte sa spáliť, rozdrviť ani rozrezať použitú batériu.

⚠ : Tento symbol je bezpečnostným/výstražným symbolom.

- Baterii nepolykejte.

Nebezpečí chemických popálenin

- Tento výrobok obsahuje mincovou/knoflíkovú baterii.
- Pokud dojde ke spolknutí mincové/knoflíkové baterie, může za pouhé 2 hodiny způsobit závažné vnitřní popáleniny a v jejich důsledku případně i smrt.
- Použité a nové baterie udržujte mimo dosah dětí.
- Pokud nelze prostor pro baterii pevně uzavřít, přestaňte výrobek používat a udržujte jej mimo dosah dětí.
- Pokud si myslíte, že mohlo dojít ke spolknutí baterie nebo jejímu vsunutí dovnitř kterékoliv části těla, okamžitě vyhledejte lékařskou pomoc.

UPOZORNĚNÍ

- Nebezpečí výbuchu v případě výměny baterie za nesprávný druh baterie.
- Proto baterii vždy vyměňte za jinou stejného typu.

UPOZORNĚNÍ

- Nebezpečí výbuchu nebo úniku hořlavé kapaliny či plynu.

- Nepoužívejte/neskladujte/nepřinášejte je do prostředí s nesmírně vysokou teplotou nebo nesmírně nízkým tlakem zapříčiněným vysokou nadmořskou výškou.
- Nesnažte se baterii spálit, rozdrtit či rozříznout.

 : Ta oznaka je varnostna/opozorilna oznaka.

- Ne zaužijte baterije.

Nevarnost kemijske opekline

- Ta izdelek vsebuje gumbasto baterijo.
- Če se gumbasto baterijo zaužije, lahko to povzroči hude notranje opekline v le 2 urah in lahko vodi v smrt.
- Nove in rabljene baterije hranite izven dosega otrok.
- Če se predalček za baterijo ne zapira pravilno, prenehajte z uporabo izdelka in ga hranite izven dosega otrok.
- Če sumite, da je morda nekdo zaužil baterijo ali jo dal v kateri koli del telesa, takoj poiščite zdravniško pomoč.

POZOR

- Nevarnost eksplozije, če baterijo zamenjate z baterijo napačne vrste.
- Zamenjajte baterijo z istim tipom.

POZOR

- Tveganje za eksplozijo ali puščanje vnetljivih tekočin ali plinov.
- Ne uporabljajte/shranjujte/prinašajte v okolje izredno visoke temperature ali izredno nizkega tlaka zaradi zelo visoke nadmorske višine.
- Ne poskušajte zažigati, uničiti, ali rezati rabljene baterije.

: Šis ženklas yra saugos/įspėjamosis ženklas.

- Neprarykite baterijos.

Cheminio nudegimo pavojus

- Šiame gaminyje yra monetos/sagos formos baterija.
- Prarijęs monetos/sagos formos bateriją, asmuo per 2 valandas gali patirti sunkius vidinius nudegimus ir netgi mirti.
- Naujas ir panaudotas baterijas laikykite vaikams nepasiekiamoje vietoje.
- Jei baterijų skyrelio nepavyksta tvirtai uždaryti, nebenaudokite gaminio ir laikykite jį vaikams nepasiekiamoje vietoje.
- Jei manote, kad baterijos buvo prarytos arba pateko į kūną, nedelsdami kreipkitės į gydytoją.

PERSPĖJIMAS

- Bateriją pakeitus netinkamo tipo baterija, kyla sprogimo pavojus.
- Pakeiskite seną bateriją tik to paties tipo nauja baterija.

PERSPĖJIMAS

- Sprogimo arba degių skysčių ar dujų nuotėkio pavojus.
- Negalima naudoti/laikyti/turėti labai aukštos temperatūros arba labai dideliame aukštyje esančioje itin žemo slėgio aplinkoje.
- Naudotos baterijos nebandykite deginti, ardyti ar perpjauti.

⚠ : Šī zīme ir drošības/brīdinājuma zīme.

- Nenorijiet bateriju.

Ķīmisku apdegumu briesmas

- Šis izstrādājums satur tabletes tipa bateriju.
- Ja ir norīta tabletes tipa baterija, tā 2 stundu laikā var radīt smagus apdegumus un izraisīt nāvi.
- Jaunas un lietotas baterijas uzglabājiet bērniem nepieejamā vietā.
- Ja bateriju nodalījumu nevar droši aizvērt, pārtrauciet lietot izstrādājumu un novietojiet to bērniem nepieejamā vietā.
- Ja jūsuprāt baterijas ir norītas vai ievietotas kādā ķermeņa daļā, nekavējoties vērsieties pēc medicīniskās palīdzības.

UZMANĪBU!

- Eksplozijas risks, ja baterija tiek nomainīta ar nepareiza tipa bateriju.
- Bateriju nomainiet pret tāda paša tipa bateriju.

UZMANĪBU!

- Eksplozijas vai uzliesmojoša šķidrums vai gāzes noplūdes risks.

- Nelietojiet, neuzglabājiet un neievietojiet vidē ar ļoti augstu temperatūru, kā arī vidē, kur ļoti lielā augstuma virs jūras līmeņa dēļ ir ļoti zems spiediens.
- Nemēģiniet sadedzināt, sagraut vai sagriezt nolietoto bateriju.

⚠ : ten symbol oznacza niebezpieczeństwo/ostrożenie.

- Nie dotykać baterii.

Ryzyko oparzenia chemicznego

- Ten produkt zawiera baterię guzikową.
- Połknięta bateria guzikowa może spowodować poważne oparzenia wewnętrzne w czasie jedynie 2 godzin i prowadzić do śmierci.
- Przechowywać nowe i zużyte baterie z dala od dzieci.
- Jeśli solidne zamknięcie komory baterii jest niemożliwe, zaprzestać użytkowania produktu i przechowywać go w miejscu niedostępnym dla dzieci.
- W przypadku podejrzenia, że mogło dojść do połknięcia baterii lub ich umieszczenia w dowolnym otworze ciała, niezwłocznie uzyskać pomoc lekarską.

PRZESTROGA

- Istnieje ryzyko wybuchu, jeśli bateria zostanie zastąpiona baterią niewłaściwego typu.
- Wymieniać baterię na baterię tego samego typu.

PRZESTROGA

- Ryzyko wybuchu lub wycieku łatwopalnego płynu lub gazu.

- Nie używać i nie przechowywać w otoczeniu o skrajnie wysokiej temperaturze lub skrajnie niskim ciśnieniu wynikającym z bardzo dużej wysokości ani nie wносить do takiego otoczenia.

- Nie podejmować prób spalania, zgniecenia lub przecięcia zużytej baterii.

⚠ : Този знак е знак за безопасност/предупреждение.

- Не поглъщайте батерията.

Опасност от химическо изгаряне

- Този продукт съдържа плоска/бутонна батерия.
- Ако плоската/бутонна батерия бъде погълната, тя може да причини тежки вътрешни изгаряния само за 2 часа и може да доведе до смърт.
- Пазете новите и използваните батерии далеч от деца.
- Ако отделението за батериите не се затваря добре, спрете да използвате продукта и го дръжте далеч от деца.
- Ако смятате, че батериите може да са били погълнати или поставени в някоя част на тялото, незабавно потърсете медицинска помощ.

ВНИМАНИЕ

- Опасност от експлозия, ако батерията бъде сменена с неправилен тип.
- Сменете батерията със същия вид.

ВНИМАНИЕ

- Опасност от експлозия или изтичане на запалими течности или газове.

- Не използвайте/съхранявайте/носете в среда с изключително висока температура или изключително ниско налягане, причинено от голямата височина.

- Не се опитвайте да изгаряте, смачквате или режете използваната батерия.

⚠ : Acest marcaj este un marcaj de securitate/avertizare.

- Nu ingerați bateria.

Pericol de arsuri chimice

- Acest produs conține o baterie tip pastilă.
- Dacă bateria tip pastilă este înghițită, aceasta poate cauza arsuri interne grave în numai 2 ore și poate duce la deces.
- Nu lăsați bateriile noi și bateriile uzate la îndemâna copiilor.
- În cazul în care compartimentul bateriei nu se închide bine, încetați utilizarea produsului și nu îl lăsați la îndemâna copiilor.
- Dacă bănuiți că este posibil ca bateriile să fi fost înghițite sau introduse în orice parte a corpului, consultați imediat medicul.

ATENȚIE

- Risc de explozie dacă bateria este înlocuită cu un tip incorect.
- Înlocuiți bateria cu una de același tip.

ATENȚIE

- Risc de explozie sau de scurgeri de lichide sau gaze inflamabile.

- Nu utilizați/depozitați într-un mediu cu temperatură extrem de înaltă sau cu presiune extrem de joasă din cauza altitudinii foarte mari.

- Nu încercați să ardeți, să spargeți sau să tăiați bateriile uzate.

⚠ : Ova oznaka je oznaka sigurnosti/upozorenja.

- Nemojte gutati bateriju.

Opasnost od kemijskih opekline

- Ovaj proizvod sadrži novčić/gumb bateriju.
- Ako se novčić/gumb baterija proguta, može uzrokovati ozbiljne unutarnje opekline u samo 2 sata i može dovesti do smrti.
- Držite nove i rabljene baterije izvan dohvata djece.
- Ako se pretinac za baterije ne zatvara sigurno, prestanite koristiti proizvod i držite ga dalje od djece.
- Ako smatrate da su baterije možda progutane ili smještene unutar bilo kojeg dijela tijela, zatražite hitnu medicinsku pomoć.

OPREZ

- Ako je baterija zamijenjena pogrešnim tipom, postoji rizik od eksplozije.
- Zamijenite bateriju s baterijama iste vrste.

OPREZ

- Rizik od eksplozije ili istjecanja zapaljive tekućine ili plina.
- Nemojte koristiti u /pohranjivati u /unijeti u prostoru izuzetno visoke temperature ili izuzetno niskog tlaka zbog visoke nadmorske visine.
- Ne pokušavajte spaliti, lomiti ili rezati istrošenu bateriju.

⚠ : Þetta tákn er öryggis-/aðvörunartákn.

- Gleypið ekki rafhlöðuna.

Hætta á efnabruna

- Þessi vara inniheldur flata rafhlöðu.
- Ef rafhlaðan er gleypst getur hún valdið alvarlegum innvortis brunna á innan við 2 klukkustundum sem getur leitt til dauða.
- Geymið nýjar og notaðar rafhlöður þar sem börn ná ekki til.
- Ef rafhlöðuhólfíð lokast ekki örugglega skal hætta notkun vörunnar og geyma hana þar sem börn ná ekki til.
- Ef þú telur að rafhlöður hafi verið gleyptar eða settar inn í eitthvert líkamsop, skaltu hafa samband við lækni tafarlaust.

VARÚÐ

- Hætta á sprengingu ef rafhlöðunni er skipt út fyrir ranga tegund.
- Skiptið rafhlöðunni ávallt út fyrir sömu tegund.

VARÚÐ

- Hætta á sprengingu eða leka á eldfimum vökva eða lofttegundum.

- Má ekki nota/geyma/setja í umhverfi þar sem er afar hár hiti, eða afar lágur þrýstingur vegna mikillar hæðar.
- Ekki reyna að brenna, kremja eða skera notaða rafhlöðu.

⚠ : Dette merket er et sikkerhets-/advarselsmerke.

- Ikke svelg batteriet.

Kjemisk brannfare

- Dette produktet inneholder et mynt-/knappecellebatteri.
- Dersom mynt-/knappecellebatteriet svelges, kan det frembringe alvorlige indre forbrenninger i løpet av kun to timer, og kan være dødelig.
- Hold nye og brukte batterier borte fra barn.
- Lukkes ikke batterirommet sikkert må du stanse å bruke produktet og holde det utenfor barns rekkevidde.
- Oppsøk medisinsk hjelp umiddelbart hvis du tror at batterier kan være svelget eller plassert inne i kroppen.

FORSIKTIG

- Eksplosjonsfare hvis batteriet erstattes med feil type.
- Bytt batteri med samme type.

FORSIKTIG

- Fare for eksplosjon eller lekkasje av brannfarlig væske eller gass.

- Ikke bruk i/oppbevar i/ta med inn i miljø med ekstremt høy temperatur eller ekstremt lavt trykk på grunn av den svært store høyden.
- Ikke forsøk å brenne, knuse eller skjære opp et brukt batteri.

⚠ : Ova oznaka je sigurnosna/upozoravajuća oznaka.

- Nemojte gutati bateriju.

Opasnost od hemijskih opekotina

- Ovaj proizvod sadrži bateriju veličine kovanice/dugmeta.
- Ako se baterija veličine kovanice/dugmeta proguta, može izazvati ozbiljne unutrašnje opekotine za samo 2 sata i može dovesti do smrti.
- Čuvajte nove i korišćene baterije dalje od djece.
- Ako se prostor za baterije ne zatvori dobro, prestanite sa korišćenjem proizvoda i držite ga dalje od djece.
- Ako mislite da su baterije možda progutane ili stavljene u unutrašnjost bilo kog dijela tijela, potražite hitnu medicinsku pomoć.

OPREZ

- Opasnost od eksplozije ako se baterija zamijeni s baterijom pogrešnog tipa.
- Zamijenite bateriju sa baterijom istog tipa.

OPREZ

- Opasnost od eksplozije ili curenja zapaljive tečnosti ili gasa.

- Nemojte koristiti /skladištiti /unositi u okruženje izuzetno visoke temperature ili izuzetno niskog pritiska usljed veoma velike visine.
- Ne pokušavajte da spalite, lomite ili isječete iskorišćenu bateriju.

⚠ : Kjo është shenjë sigurie/paralajmërimi.

• Mos e gëlltisni baterinë.

Rrezik djegieje kimike

• Ky produkt përmban një bateri të hollë në formë monedhe/kopse.

• Nëse bateria e hollë në formë monedhe/kopse gëlltitet, ajo mund të shkaktojë djegie të rënda të brendshme brenda vetëm 2 orëve dhe mund të sjellë vdekjen.

• Mbajini bateritë e reja dhe të përdorura larg nga fëmijët.

• Nëse foleja e baterisë nuk mbyllet mirë, ndaloni përdorimin e produktit dhe mbajeni larg nga fëmijët.

• Nëse mendoni se bateritë mund të jenë gëlltitur ose futur brenda ndonjë pjese trupi, kërkoni menjëherë vëmendjen e mjekut.

KUJDES

• Rrezik shpërthimi nëse bateria zëvendësohet me një lloj të pasaktë.

• Zëvendësojeni baterinë me të njëjtin lloj.

KUJDES

• Rrezik shpërthimi nga rrjedhja e lëngut apo gazit të ndezshëm.

• Mos e përdorni / ruani / sillni në mjedise me temperaturë jashtëzakonisht të lartë ose presion jashtëzakonisht të ulët në lartësi shumë të mëdha.

• Mos u përpiqni të digjni, shtypni ose prisni baterinë e përdorur.

⚠ : Ova oznaka je oznaka za bezbednost/upozorenje.

• Nemojte gutati bateriju.

Opasnost od hemijskih opekotina

• Ovaj proizvod sadrži bateriju u obliku novčića/dugmeta.

• Ako se baterija u obliku novčića/gumba proguta, može da izazove ozbiljne interne opekotine za samo 2 sata i može da dovede do smrti.

• Nove i korišćene baterije čuvajte van domašaja dece.

• Ako se odeljak za bateriju ne zatvori dobro, prestanite da koristite proizvod i čuvajte ga van domašaja dece.

• Ako mislite da su baterije možda progutane ili stavljene unutar bilo kog dela tela, odmah zatražite medicinsku pomoć.

OPREZ

• Rizik od eksplozije ako je baterija zamenjena nepravilnim tipom.

• Zamenite bateriju sa istim tipom.

OPREZ

• Rizik od eksplozije ili curenja zapaljive tečnosti ili gasa.

• Ne koristite/ne čuvajte/ne donosite u sredinu izuzetno visoke temperature ili izuzetno niskog pritiska usled vrlo visoke visine.

• Ne pokušavajte da zapalite, smrvite ili isečete korišćenu bateriju.

⚠ : Bu işaret bir güvenlik/uyarı işaretidir.

•Pili yutmayın.

Kimyasal Yanma Tehlikesi

•Bu üründe bir düğme pil bulunmaktadır.

•Düğme pil yutulursa, sadece 2 saat içinde ağır iç yanıklara neden olabilir ve ölüme yol açabilir.

•Yeni ve kullanılmış pilleri çocuklardan uzak tutun.

•Pil yuvası emniyetli bir şekilde kapanmıyorsa, ürünü kullanmayı bırakın ve çocuklardan uzak tutun.

•Pillerin yutulduğunu veya vücudun herhangi bir parçasının içine yerleştirildiğini düşünüyorsanız, derhal tıbbi yardım alın.

DİKKAT

•Pil yanlış tür bir pille değiştirilirse patlama riski vardır.

•Pili aynı tür pillerle değiştirin.

DİKKAT

•Patlama ya da yanıcı sıvı veya gaz sızıntısı riski vardır.

•Aşırı derecede yüksek sıcaklıktaki veya çok yüksek rakımdan dolayı aşırı derecede düşük basınca sahip ortamlarda kullanmayın /saklamayın veya bu ortamlara götürmeyin.

•Kullanılmış pili yakmaya, ezmeye veya kesmeye çalışmayın.

► For vehicles sold in Ukraine

Справжнім TOKAI RIKAI CO., LTD. заявляє, що тип радіообладнання BA2TA відповідає Технічному регламенту радіообладнання;
КАБІНЕТ МІНІСТРІВ УКРАЇНИ ПОСТАНОВА №.355

Повний текст декларації про відповідність доступний на веб-сайті за такою адресою:
<http://www.tokai-rika.co.jp/pc>

Діапазон частот : 433.050 - 434.790 MHz
Максимальна потужність радіочастотного випромінювання :
10 mW(ERP)



Адреса: 3-260 Toyota, Oguchi-cho, Niwa-gun, Aichi 480-0195,
Japan



Ця позначка являє собою позначку про необхідність дотримання правил безпеки/застереження.

· Не допускайте проковтування батарейки.

Небезпека хімічного опіку

- Цей виріб містить батарейку монетного / таблеткового типу.
- Проковтування батарейки монетного / таблеткового типу може спричинити тяжкі внутрішні опіки всього лише за 2 години і може призвести до смерті.
- Зберігайте нові та використані батарейки подалі від дітей.
- Якщо кришка батарейного відсіку надійно не закривається, припиніть користуватися виробом і зберігайте його подалі від дітей.
- Якщо існує ймовірність проковтування батарейки або її розміщення всередині будь-якої частини тіла, негайно зверніться за медичною допомогою.

ОБЕРЕЖНО

- Ризик вибуху в разі заміни на батарею неналежного типу.
- Замініть батарею на батарею такого ж самого типу.

ОБЕРЕЖНО

- Ризик вибуху або витoku горючої рідини або газу.
- Не використовуйте /не зберігайте /не розміщуйте в умовах надзвичайно високої температури або надзвичайно низького тиску через дуже велику висоту над рівнем моря.
- Не намагайтеся спалити, розбити або розрізати використану батарею.

- For vehicles sold in Serbia



Hereby, TOKAI RIKA CO., LTD. declares that the radio equipment type B92RA is in compliance with Directive 2014/53/EU.

The full text of the EU declaration of conformity is available at the following internet address:

<http://www.tokai-rika.co.jp/pc>

TOKAI RIKA CO., LTD. vakuuttaa, että radiolaitetyyppi B92RA on direktiivin 2014/53/EU mukainen.

EU-vaatimustenmukaisuusvakuutuksen täysimittainen teksti on saatavilla seuraavassa internetosoitteessa:

<http://www.tokai-rika.co.jp/pc>

Hierbij verklaar ik, TOKAI RIKA CO., LTD., dat het type radioapparatuur B92RA conform is met Richtlijn 2014/53/EU.

De volledige tekst van de EU-conformiteitsverklaring kan worden geraadpleegd op het volgende internetadres:

<http://www.tokai-rika.co.jp/pc>

Le soussigné, TOKAI RIKA CO., LTD., déclare que l'équipement radioélectrique du type B92RA est conforme à la directive 2014/53/UE.

Le texte complet de la déclaration UE de conformité est disponible à l'adresse internet suivante:

<http://www.tokai-rika.co.jp/pc>

Härmed försäkrar TOKAI RIKA CO., LTD. att denna typ av radioutrustning B92RA överensstämmer med direktiv 2014/53/EU.

Den fullständiga texten till EU-försäkran om överensstämmelse finns på följande webbadress:

<http://www.tokai-rika.co.jp/pc>

Hermed erklærer TOKAI RIKA CO., LTD., at radioudstyrstypen B92RA er i overensstemmelse med direktiv 2014/53/EU.

EU-overensstemmelseserklæringens fulde tekst kan findes på følgende internetadresse:

<http://www.tokai-rika.co.jp/pc>

Hiermit erklärt TOKAI RIKA CO., LTD., dass der Funkanlagentyp B92RA der Richtlinie 2014/53/EU entspricht.

Der vollständige Text der EU-Konformitätserklärung ist unter der folgenden Internetadresse verfügbar:

<http://www.tokai-rika.co.jp/pc>

Με την παρούσα ο/η TOKAI RIKA CO., LTD., δηλώνει ότι ο ραδιοεξοπλισμός B92RA πληροί την οδηγία 2014/53/EE.

Το πλήρες κείμενο της δήλωσης συμμόρφωσης ΕΕ διατίθεται στην ακόλουθη ιστοσελίδα στο διαδίκτυο:

<http://www.tokai-rika.co.jp/pc>

Il fabbricante, TOKAI RIKA CO., LTD., dichiara che il tipo di apparecchiatura radio B92RA è conforme alla direttiva 2014/53/UE.

Il testo completo della dichiarazione di conformità UE è disponibile al seguente indirizzo Internet:

<http://www.tokai-rika.co.jp/pc>

Por la presente, TOKAI RIKA CO., LTD. declara que el tipo de equipo radioeléctrico B92RA es conforme con la Directiva 2014/53/UE.

El texto completo de la declaración UE de conformidad está disponible en la dirección Internet siguiente:

<http://www.tokai-rika.co.jp/pc>

O(a) abaixo assinado(a) TOKAI RIKA CO., LTD. declara que o presente tipo de equipamento de rádio B92RA está em conformidade com a Diretiva 2014/53/UE.

O texto integral da declaração de conformidade está disponível no seguinte endereço de Internet:

<http://www.tokai-rika.co.jp/pc>

B'dan, TOKAI RIKA CO., LTD., niddikjara li dan it-tip ta' tagħmir tar-radju B92RA huwa konformi mad-Direttiva 2014/53/UE.

It-test kollu tad-dikjarazzjoni ta' konformità tal-UE huwa disponibbli f'dan l-indirizz tal-Internet li ġej:

<http://www.tokai-rika.co.jp/pc>

Käesolevaga deklareerib TOKAI RIKA CO., LTD., et käesolev raadioseadme tüüp B92RA vastab direktiivi 2014/53/EL nõuetele.

ELi vastavusdeklaratsiooni täielik tekst on kättesaadav järgmisel internetiaadressil:

<http://www.tokai-rika.co.jp/pc>

TOKAI RIKA CO., LTD. igazolja, hogy a B92RA típusú rádióberendezés megfelel a 2014/53/EU irányelvnek.

Az EU-megfelelőségi nyilatkozat teljes szövege elérhető a következő internetes címen:

<http://www.tokai-rika.co.jp/pc>

TOKAI RIKA CO., LTD. týmto vyhlasuje, že rádiové zariadenie typu B92RA je v súlade so smernicou 2014/53/EÚ.

Úplné EÚ vyhlásenie o zhode je k dispozícii na tejto internetovej adrese:

<http://www.tokai-rika.co.jp/pc>

Tímto TOKAI RIKA CO., LTD. prohlašuje, že typ rádiového zařízení B92RA je v souladu se směrnicí 2014/53/EU.

Úplné znění EU prohlášení o shodě je k dispozici na této internetové adrese:

<http://www.tokai-rika.co.jp/pc>

TOKAI RIKA CO., LTD. potvrdjuje, da je tip radijske opreme B92RA skladen z Direktivo 2014/53/EU.

Celotno besedilo izjave EU o skladnosti je na voljo na naslednjem spletnem naslovu:

<http://www.tokai-rika.co.jp/pc>

Aš, TOKAI RIKA CO., LTD., patvirtinu, kad radijo įrenginių tipas B92RA atitinka Direktyvą 2014/53/ES.

Visas ES atitikties deklaracijos tekstas prieinamas šiuo interneto adresu:

<http://www.tokai-rika.co.jp/pc>

Ar šo TOKAI RIKA CO., LTD. deklarė, ka radioiekārta B92RA atbilst Direktīvai 2014/53/ES.

Pilns ES atbilstības deklarācijas teksts ir pieejams šādā interneta vietnē:

<http://www.tokai-rika.co.jp/pc>

TOKAI RIKA CO., LTD. niniejszym oświadcza, że typ urządzenia radiowego B92RA jest zgodny z dyrektywą 2014/53/UE.

Pełny tekst deklaracji zgodności UE jest dostępny pod następującym adresem internetowym:

<http://www.tokai-rika.co.jp/pc>

TOKAI RIKAI CO., LTD. lýsir því hér með yfir að fjarskiptatækið af gerð B92RA er í samræmi við tilskipun 2014/53/EU.

Öll ESB-samræmisýfirlýsingin er tiltæk á eftirfarandi vefslóð:
<http://www.tokai-rika.co.jp/pc>

TOKAI RIKAI CO., LTD. erklærer herved at radioutstyrten B92RA er i samsvar med direktivet 2014/53/EU.

Hele teksten av EU-samsvarserklæringen kan leses på det følgende nettstedet:
<http://www.tokai-rika.co.jp/pc>

С настоящото TOKAI RIKAI CO., LTD. декларира, че този тип радиосъоръжение B92RA е в съответствие с Директива 2014/53/ЕС.

Цялостният текст на ЕС декларацията за съответствие може да се намери на следния интернет адрес:
<http://www.tokai-rika.co.jp/pc>

Prin prezenta, TOKAI RIKAI CO., LTD. declară că tipul de echipamente radio B92RA este în conformitate cu Directiva 2014/53/UE.

Textul integral al declarației UE de conformitate este disponibil la următoarea adresă internet:
<http://www.tokai-rika.co.jp/pc>

Ovime TOKAI RIKA CO., LTD. potvrđuje da je radio-oprema tipa B92RA u skladu sa Direktivom 2014/53/EU.

Potpuni tekst EU deklaracije o usaglašenosti dostupan je na sljedećoj internet adresi:

<http://www.tokai-rika.co.jp/pc>

Me anë të këtij dokumenti, TOKAI RIKA CO., LTD. deklararon se tipi i radiopajisjes B92RA është në përputhje me Direktivën 2014/53/EU.

Teksti i plotë i deklaratës së konformitetit të Bashkimit Evropian është i disponueshëm në adresën e mëposhtme të internetit:

<http://www.tokai-rika.co.jp/pc>

TOKAI RIKA CO., LTD. ovime izjavljuje da je radijska oprema tipa B92RA u skladu s Direktivom 2014/53/EU.

Cjeloviti tekst EU izjave o sukladnosti dostupan je na sljedećoj internetskoj adresi:

<http://www.tokai-rika.co.jp/pc>

Ovim TOKAI RIKA CO., LTD. potvrđuje da je radio-oprema tipa B92RA u skladu sa Direktivom 2014/53/EU.

Potpuni tekst EU deklaracije o usaglašenosti dostupan je na sledećoj internet adresi:

<http://www.tokai-rika.co.jp/pc>

TOKAI RIKА CO., LTD., işbu belgeyle telsiz cihazı türünün B92RA 2014/53/EU nolu Direktif ile uyumlu olduğunu beyan etmektedir.

AB uygunluk beyanının tam metnine aşağıdaki internet adresinden ulaşabilirsiniz:

<http://www.tokai-rika.co.jp/pc>



Address: 3-260 Toyota, Oguchi-cho, Niwa-gun, Aichi 480-0195, Japan

Receiver Category (EN300 220): 2

► For vehicles sold in Ukraine

Справжнім TOKAI RIKА CO., LTD. заявляє, що тип радіообладнання B92RA відповідає Технічному регламенту радіообладнання;

КАБІНЕТ МІНІСТРІВ УКРАЇНИ ПОСТАНОВА №.355

Повний текст декларації про відповідність доступний на веб-сайті за такою адресою:

<http://www.tokai-rika.co.jp/pc>

Категорія приймача: 2



Адреса: 3-260 Toyota, Oguchi-cho, Niwa-gun, Aichi 480-0195, Japan

Smart entry & start system

Hereby, TOYOTA MOTOR CORPORATION declares that the radio equipment type TS-9TY is in compliance with Directive 2014/53/EU.

The full text of the EU declaration of conformity is available at the following internet address:

<http://www.tokai-rika.co.jp/pc>

Frequency band: 119 - 135 kHz

Maximum radio-frequency power: 55dB μ A/m @10m

TOYOTA MOTOR CORPORATION vakuuttaa, että radiolaitetyyppi TS-9TY on direktiivin 2014/53/EU mukainen.

EU-vaatimustenmukaisuusvakuutuksen täysimittainen teksti on saatavilla seuraavassa internetosoitteessa:

<http://www.tokai-rika.co.jp/pc>

Radiotaajuus: 119 - 135 kHz

suurin mahdollinen lähetysteho: 55dB μ A/m @10m

Hierbij verklaar ik, TOYOTA MOTOR CORPORATION, dat het type radioapparatuur TS-9TY conform is met Richtlijn 2014/53/EU.

De volledige tekst van de EU-conformiteitsverklaring kan worden geraadpleegd op het volgende internetadres:

<http://www.tokai-rika.co.jp/pc>

Frequentieband: 119 - 135 kHz

Maximaal radiofrequentievermogen: 55dB μ A/m @10m

Le soussigné, TOYOTA MOTOR CORPORATION, déclare que l'équipement radioélectrique du type TS-9TY est conforme à la directive 2014/53/UE.

Le texte complet de la déclaration UE de conformité est disponible à l'adresse internet suivante:

<http://www.tokai-rika.co.jp/pc>

Bande de fréquences: 119 - 135 kHz

Puissance de radiofréquence maximale: 55dB μ A/m @10m

Härmed försäkrar TOYOTA MOTOR CORPORATION att denna typ av radioutrustning TS-9TY överensstämmer med direktiv 2014/53/EU.

Den fullständiga texten till EU-försäkran om överensstämmelse finns på följande webbadress:

<http://www.tokai-rika.co.jp/pc>

Frekvensband: 119 - 135 kHz

Maximal radiofrekvensseffekt: 55dB μ A/m @10m

Hermed erklærer TOYOTA MOTOR CORPORATION, at radioudstyrstypen TS-9TY er i overensstemmelse med direktiv 2014/53/EU.

EU-overensstemmelseserklæringens fulde tekst kan findes på følgende internetadresse:

<http://www.tokai-rika.co.jp/pc>

Frekvensbånd: 119 - 135 kHz

Maksimal radiofrekvensseffekt: 55dB μ A/m @10m

Hiermit erklärt TOYOTA MOTOR CORPORATION, dass der Funkanlagentyp TS-9TY der Richtlinie 2014/53/EU entspricht.

Der vollständige Text der EU-Konformitätserklärung ist unter der folgenden Internetadresse verfügbar:

<http://www.tokai-rika.co.jp/pc>

Frequenzband: 119 - 135 kHz

Abgestrahlte maximale Sendeleistung: 55dBμA/m @10m

Με την παρούσα ο/η TOYOTA MOTOR CORPORATION, δηλώνει ότι ο ραδιοεξοπλισμός TS-9TY πληροί την οδηγία 2014/53/EE.

Το πλήρες κείμενο της δήλωσης συμμόρφωσης ΕΕ διατίθεται στην ακόλουθη ιστοσελίδα στο διαδίκτυο:

<http://www.tokai-rika.co.jp/pc>

Ζώνη συχνοτήτων: 119 - 135 kHz

Μέγιστη ισχύς ραδιοσυχνότητας: 55dBμA/m @10m

Il fabbricante, TOYOTA MOTOR CORPORATION, dichiara che il tipo di apparecchiatura radio TS-9TY è conforme alla direttiva 2014/53/UE.

Il testo completo della dichiarazione di conformità UE è disponibile al seguente indirizzo Internet:

<http://www.tokai-rika.co.jp/pc>

Banda di frequenza: 119 - 135 kHz

Potenza massima radiofrequenza: 55dBμA/m @10m

Por la presente, TOYOTA MOTOR CORPORATION declara que el tipo de equipo radioeléctrico TS-9TY es conforme con la Directiva 2014/53/UE.

El texto completo de la declaración UE de conformidad está disponible en la dirección Internet siguiente:

<http://www.tokai-rika.co.jp/pc>

Banda de frecuencia: 119 - 135 kHz

Potencia máxima de radiofrecuencia: 55dB μ A/m @10m

O(a) abaixo assinado(a) TOYOTA MOTOR CORPORATION declara que o presente tipo de equipamento de rádio TS-9TY está em conformidade com a Diretiva 2014/53/UE.

O texto integral da declaração de conformidade está disponível no seguinte endereço de Internet:

<http://www.tokai-rika.co.jp/pc>

Banda de frequência: 119 - 135 kHz

Potência máxima de radiofrequências: 55dB μ A/m @10m

B'dan, TOYOTA MOTOR CORPORATION, niddikjara li dan it-tip ta' tagħmir tar-radju TS-9TY huwa konformi mad-Direttiva 2014/53/UE.

It-test kollu tad-dikjarazzjoni ta' konformità tal-UE huwa disponibbli f'dan l-indirizz tal-Internet li ġej:

<http://www.tokai-rika.co.jp/pc>

Tíðnisvið: 119 - 135 kHz

Hámarks útværpsbylgjutíðni: 55dB μ A/m @10m

Käesolevaga deklareerib TOYOTA MOTOR CORPORATION, et käesolev raadioseadme tüüp TS-9TY vastab direktiivi 2014/53/EL nõuetele.

ELi vastavusdeklaratsiooni täielik tekst on kättesaadav järgmisel internetiaadressil:

<http://www.tokai-rika.co.jp/pc>

Sagedusriba: 119 - 135 kHz

Maksimaalne saatevõimsus: 55dB μ A/m @10m

TOYOTA MOTOR CORPORATION igazolja, hogy a TS-9TY típusú rádióberendezés megfelel a 2014/53/EU irányelvnek.

Az EU-megfelelőségi nyilatkozat teljes szövege elérhető a következő internetes címen:

<http://www.tokai-rika.co.jp/pc>

Frekvenciasáv: 119 - 135 kHz

Maximális jelerősség: 55dB μ A/m @10m

TOYOTA MOTOR CORPORATION týmto vyhlasuje, že rádiové zariadenie typu TS-9TY je v súlade so smernicou 2014/53/EÚ.

Úplné EÚ vyhlásenie o zhode je k dispozícii na tejto internetovej adrese:

<http://www.tokai-rika.co.jp/pc>

Frekvenčné pásmo: 119 - 135 kHz

Maximálny rádiový výkon: 55dB μ A/m @10m

Tímto TOYOTA MOTOR CORPORATION prohlašuje, že typ rádiového zařízení TS-9TY je v souladu se směrnicí 2014/53/EU.

Úplné znění EU prohlášení o shodě je k dispozici na této internetové adrese:

<http://www.tokai-rika.co.jp/pc>

Kmitočtové pásmo: 119 - 135 kHz

Maximální radiofrekvenční výkon: 55dB μ A/m @10m

TOYOTA MOTOR CORPORATION potvrzuje, da je tip radijske opreme TS-9TY skladen z Direktivo 2014/53/EU.

Celotno besedilo izjave EU o skladnosti je na voljo na naslednjem spletnem naslovu:

<http://www.tokai-rika.co.jp/pc>

Frekvenčni pas: 119 - 135 kHz

Največja moč radijske frekvence: 55dB μ A/m @10m

Aš, TOYOTA MOTOR CORPORATION, patvirtinu, kad radijo įrenginių tipas TS-9TY atitinka Direktyvą 2014/53/ES.

Visas ES atitikties deklaracijos tekstas prieinamas šiuo interneto adresu:

<http://www.tokai-rika.co.jp/pc>

Dažnių juosta: 119 - 135 kHz

Didžiausia radijo dažnių galia: 55dB μ A/m @10m

Ar šo TOYOTA MOTOR CORPORATION deklarē, ka radioiekārta TS-9TY atbilst Direktīvai 2014/53/ES.

Pilns ES atbilstības deklarācijas teksts ir pieejams šādā interneta vietnē:

<http://www.tokai-rika.co.jp/pc>

Frekvenču josla: 119 - 135 kHz

Maksimālā radiofrekvenču jauda: 55dBμA/m @10m

TOYOTA MOTOR CORPORATION niniešm ošwiadcz, że typ urządzenia radiowego TS-9TY jest zgodny z dyrektywą 2014/53/UE.

Pełny tekst deklaracji zgodności UE jest dostępny pod następującym adresem internetowym:

<http://www.tokai-rika.co.jp/pc>

Zakres częstotliwości: 119 - 135 kHz

Maksymalna moc częstotliwości radiowej: 55dBμA/m @10m

TOYOTA MOTOR CORPORATION lýsir því hér með yfir að fjarskiptatækið af gerð TS-9TY er í samræmi við tilskipun 2014/53/EU.

Öll ESB-samræmisýfirlýsingin er tiltæk á eftirfarandi vefslóð:

<http://www.tokai-rika.co.jp/pc>

Tíðnisvið: 119 - 135 kHz

Hámarks útvarpsbylgjutíðni: 55dBμA/m @10m

TOYOTA MOTOR CORPORATION erklærer herved at radioutstyrtypen TS-9TY er i samsvar med direktivet 2014/53/EU.

Hele teksten av EU-samsvarserklæringen kan leses på det følgende nettstedet:

<http://www.tokai-rika.co.jp/pc>

Frekvensbånd: 119 - 135 kHz

Maksimal radiofrekvensseffekt: 55dB μ A/m @10m

С настоящото TOYOTA MOTOR CORPORATION декларира, че този тип радиосъоръжение TS-9TY е в съответствие с Директива 2014/53/ЕС.

Цялостният текст на ЕС декларацията за съответствие може да се намери на следния интернет адрес:

<http://www.tokai-rika.co.jp/pc>

Радиочестотна лента: 119 - 135 kHz

Максимална радиочестотна мощност: 55dB μ A/m @10m

Prin prezenta, TOYOTA MOTOR CORPORATION declară că tipul de echipamente radio TS-9TY este în conformitate cu Directiva 2014/53/UE.

Textul integral al declarației UE de conformitate este disponibil la următoarea adresă internet:

<http://www.tokai-rika.co.jp/pc>

Banda de frecvență: 119 - 135 kHz

Puterea maximă de radiofrecvență: 55dB μ A/m @10m

Ovime TOYOTA MOTOR CORPORATION potvrđuje da je radio-oprema tipa TS-9TY u skladu sa Direktivom 2014/53/EU.

Potpuni tekst EU deklaracije o usaglašenosti dostupan je na sljedećoj internet adresi:

<http://www.tokai-rika.co.jp/pc>

Frekvencijski opseg: 119 - 135 kHz

Maksimalna radio-frekvencijska snaga: 55dB μ A/m @10m

Me anë të këtij dokumenti, TOYOTA MOTOR CORPORATION deklararon se tipi i radiopajisjes TS-9TY është në përputhje me Direktivën 2014/53/EU.

Teksti i plotë i deklaratës së konformitetit të Bashkimit Evropian është i disponueshëm në adresën e mëposhtme të internetit:

<http://www.tokai-rika.co.jp/pc>

Brezi i frekuencës: 119 - 135 kHz

Fuqia maksimale e radiofrekuencës: 55dB μ A/m @10m

TOYOTA MOTOR CORPORATION ovime izjavljuje da je radijska oprema tipa TS-9TY u skladu s Direktivom 2014/53/EU.

Cjeloviti tekst EU izjave o sukladnosti dostupan je na sljedećoj internetskoj adresi:

<http://www.tokai-rika.co.jp/pc>

Frekvencijski pojas: 119 - 135 kHz

Maksimalna RF snaga: 55dB μ A/m @10m

Ovim TOYOTA MOTOR CORPORATION potvrđuje da je radio-oprema tipa TS-9TY u skladu sa Direktivom 2014/53/EU.

Potpuni tekst EU deklaracije o usaglašenosti dostupan je na sledećoj internet adresi:

<http://www.tokai-rika.co.jp/pc>

Frekventni opseg: 119 - 135 kHz

Maksimalna radio-frekventna snaga: 55dB μ A/m @10m

TOYOTA MOTOR CORPORATION, işbu belgeyle telsiz cihazı türünün TS-9TY 2014/53/EU nolu Direktif ile uyumlu olduğunu beyan etmektedir.

AB uygunluk beyanının tam metnine aşağıdaki internet adresinden ulaşabilirsiniz:

<http://www.tokai-rika.co.jp/pc>

Frekans bandı: 119 - 135 kHz

Maksimum radyo frekans gücü: 55dB μ A/m @10m



Address: 1, Toyota-cho, Toyota, Aichi, 471-8572, Japan

► For vehicles sold in Ukraine

Справжнім TOYOTA MOTOR CORPORATION заявляє, що тип радіообладнання TS-9TY відповідає Технічному регламенту радіообладнання;
КАБІНЕТ МІНІСТРІВ УКРАЇНИ ПОСТАНОВА №.355

Повний текст декларації про відповідність доступний на веб-сайті за такою адресою:
<http://www.tokai-rika.co.jp/pc>

Діапазон частот : 119 - 135 kHz
Максимальна потужність радіочастотного випромінювання :
55dBμA/m @10m



Адреса: 1, Toyota-cho, Toyota, Aichi-ken, 471-8572,Japan

Hereby, TOKAI RIKA CO., LTD. declares that the radio equipment type B3U2K2P is in compliance with Directive 2014/53/EU.

The full text of the EU declaration of conformity is available at the following internet address:

<http://www.tokai-rika.co.jp/pc>

Frequency band: 433.050 - 434.790 MHz
Maximum radio-frequency power: 10 mW(ERP)

TOKAI RIKA CO., LTD. vakuuttaa, että radiolaitetyyppi B3U2K2P on direktiivin 2014/53/EU mukainen.

EU-vaatimustenmukaisuusvakuutuksen täysimittainen teksti on saatavilla seuraavassa internetosoitteessa:

<http://www.tokai-rika.co.jp/pc>

Radiotaajuus: 433.050 - 434.790 MHz
suurin mahdollinen lähetysteho: 10 mW(ERP)

Hierbij verklaar ik, TOKAI RIKA CO., LTD., dat het type radioapparatuur B3U2K2P conform is met Richtlijn 2014/53/EU.

De volledige tekst van de EU-conformiteitsverklaring kan worden geraadpleegd op het volgende internetadres:

<http://www.tokai-rika.co.jp/pc>

Frequentieband: 433.050 - 434.790 MHz
Maximaal radiofrequentievermogen: 10 mW(ERP)

Le soussigné, TOKAI RIKA CO., LTD., déclare que l'équipement radioélectrique du type B3U2K2P est conforme à la directive 2014/53/UE.

Le texte complet de la déclaration UE de conformité est disponible à l'adresse internet suivante:

<http://www.tokai-rika.co.jp/pc>

Bande de fréquences: 433.050 - 434.790 MHz

Puissance de radiofréquence maximale: 10 mW(ERP)

Härmed försäkrar TOKAI RIKA CO., LTD. att denna typ av radioutrustning B3U2K2P överensstämmer med direktiv 2014/53/EU.

Den fullständiga texten till EU-försäkran om överensstämmelse finns på följande webbadress:

<http://www.tokai-rika.co.jp/pc>

Frekvensband: 433.050 - 434.790 MHz

Maximal radiofrekvensseffekt: 10 mW(ERP)

Hermed erklærer TOKAI RIKA CO., LTD., at radioudstyrstypen B3U2K2P er i overensstemmelse med direktiv 2014/53/EU.

EU-overensstemmelseserklæringens fulde tekst kan findes på følgende internetadresse:

<http://www.tokai-rika.co.jp/pc>

Frekvensbånd: 433.050 - 434.790 MHz

Maksimal radiofrekvensseffekt: 10 mW(ERP)

Hiermit erklärt TOKAI RIKA CO., LTD., dass der Funkanlagentyp B3U2K2P der Richtlinie 2014/53/EU entspricht.

Der vollständige Text der EU-Konformitätserklärung ist unter der folgenden Internetadresse verfügbar:

<http://www.tokai-rika.co.jp/pc>

Frequenzband: 433.050 - 434.790 MHz

Abgestrahlte maximale Sendeleistung: 10 mW(ERP)

Με την παρούσα ο/η TOKAI RIKA CO., LTD., δηλώνει ότι ο ραδιοεξοπλισμός B3U2K2P πληροί την οδηγία 2014/53/EE.

Το πλήρες κείμενο της δήλωσης συμμόρφωσης ΕΕ διατίθεται στην ακόλουθη ιστοσελίδα στο διαδίκτυο:

<http://www.tokai-rika.co.jp/pc>

Ζώνη συχνότητων: 433.050 - 434.790 MHz

Μέγιστη ισχύς ραδιοσυχνότητας: 10 mW(ERP)

Il fabbricante, TOKAI RIKA CO., LTD., dichiara che il tipo di apparecchiatura radio B3U2K2P è conforme alla direttiva 2014/53/UE.

Il testo completo della dichiarazione di conformità UE è disponibile al seguente indirizzo Internet:

<http://www.tokai-rika.co.jp/pc>

Banda di frequenza: 433.050 - 434.790 MHz

Potenza massima radiofrequenza: 10 mW(ERP)

Por la presente, TOKAI RIKA CO., LTD. declara que el tipo de equipo radioeléctrico B3U2K2P es conforme con la Directiva 2014/53/UE.

El texto completo de la declaración UE de conformidad está disponible en la dirección Internet siguiente:

<http://www.tokai-rika.co.jp/pc>

Banda de frecuencia: 433.050 - 434.790 MHz

Potencia máxima de radiofrecuencia: 10 mW(ERP)

O(a) abaixo assinado(a) TOKAI RIKA CO., LTD. declara que o presente tipo de equipamento de rádio B3U2K2P está em conformidade com a Diretiva 2014/53/UE.

O texto integral da declaração de conformidade está disponível no seguinte endereço de Internet:

<http://www.tokai-rika.co.jp/pc>

Banda de frequência: 433.050 - 434.790 MHz

Potência máxima de radiofrequências: 10 mW(ERP)

B'dan, TOKAI RIKA CO., LTD., niddikjara li dan it-tip ta' tagħmir tar-radju B3U2K2P huwa konformi mad-Direttiva 2014/53/UE.

It-test kollu tad-dikjarazzjoni ta' konformità tal-UE huwa disponibbli f'dan l-indirizz tal-Internet li ġej:

<http://www.tokai-rika.co.jp/pc>

Tíðnisvið: 433.050 - 434.790 MHz

Hámarks útværpsbylgjutíðni: 10 mW(ERP)

Käesolevaga deklareerib TOKAI RIKA CO., LTD., et käesolev raadioseadme tüüp B3U2K2P vastab direktiivi 2014/53/EL nõuetele.

ELi vastavusdeklaratsiooni täielik tekst on kättesaadav järgmisel internetiaadressil:

<http://www.tokai-rika.co.jp/pc>

Sagedusriba: 433.050 - 434.790 MHz
Maksimaalne saatevõimsus: 10 mW(ERP)

TOKAI RIKA CO., LTD. igazolja, hogy a B3U2K2P típusú rádióberendezés megfelel a 2014/53/EU irányelvnek.

Az EU-megfelelőségi nyilatkozat teljes szövege elérhető a következő internetes címen:

<http://www.tokai-rika.co.jp/pc>

Frekvenciasáv: 433.050 - 434.790 MHz
Maximális jelerősség: 10 mW(ERP)

TOKAI RIKA CO., LTD. týmto vyhlasuje, že rádiové zariadenie typu B3U2K2P je v súlade so smernicou 2014/53/EÚ.

Úplné EÚ vyhlásenie o zhode je k dispozícii na tejto internetovej adrese:

<http://www.tokai-rika.co.jp/pc>

Frekvenčné pásmo: 433.050 - 434.790 MHz
Maximálny rádiový výkon: 10 mW(ERP)

Tímto TOKAI RIKA CO., LTD. prohlašuje, že typ rádiového zařízení B3U2K2P je v souladu se směrnicí 2014/53/EU.

Úplné znění EU prohlášení o shodě je k dispozici na této internetové adrese:

<http://www.tokai-rika.co.jp/pc>

Kmitočtové pásmo: 433.050 - 434.790 MHz
Maximální radiofrekvenční výkon: 10 mW(ERP)

TOKAI RIKA CO., LTD. potvrzuje, da je tip radijske opreme B3U2K2P skladen z Direktivo 2014/53/EU.

Celotno besedilo izjave EU o skladnosti je na voljo na naslednjem spletnem naslovu:

<http://www.tokai-rika.co.jp/pc>

Frekvenčni pas: 433.050 - 434.790 MHz
Največja moč radijske frekvence: 10 mW(ERP)

Aš, TOKAI RIKA CO., LTD., patvirtinu, kad radijo įrenginių tipas B3U2K2P atitinka Direktyvą 2014/53/ES.

Visas ES atitikties deklaracijos tekstas prieinamas šiuo interneto adresu:

<http://www.tokai-rika.co.jp/pc>

Dažnių juosta: 433.050 - 434.790 MHz
Didžiausia radijo dažnių galia: 10 mW(ERP)

Ar šo TOKAI RIKAI CO., LTD. deklarē, ka radioiekārta B3U2K2P atbilst Direktīvai 2014/53/ES.

Pilns ES atbilstības deklarācijas teksts ir pieejams šādā interneta vietnē:

<http://www.tokai-rika.co.jp/pc>

Frekvenču josla: 433.050 - 434.790 MHz
Maksimālā radiofrekvenču jauda: 10 mW(ERP)

TOKAI RIKAI CO., LTD. niniešzīm ošwiadcza, że typ urządzenia radiowego B3U2K2P jest zgodny z dyrektywą 2014/53/UE.

Pełny tekst deklaracji zgodności UE jest dostępny pod następującym adresem internetowym:

<http://www.tokai-rika.co.jp/pc>

Zakres częstotliwości: 433.050 - 434.790 MHz
Maksymalna moc częstotliwości radiowej: 10 mW(ERP)

TOKAI RIKAI CO., LTD. lýsir því hér með yfir að fjarskiptatækið af gerð B3U2K2P er í samræmi við tilskipun 2014/53/EU.

Öll ESB-samræmisýfirlýsingin er tiltæk á eftirfarandi vefslóð:

<http://www.tokai-rika.co.jp/pc>

Tíðnisvið: 433.050 - 434.790 MHz
Hámarks útværpsbylgjutíðni: 10 mW(ERP)

TOKAI RIKА CO., LTD. erklærer herved at radioutstyrtypen B3U2K2P er i samsvar med direktivet 2014/53/EU.

Hele teksten av EU-samsvarserklæringen kan leses på det følgende nettstedet:

<http://www.tokai-rika.co.jp/pc>

Frekvensbånd: 433.050 - 434.790 MHz
Maksimal radiofrekvensseffekt: 10 mW(ERP)

С настоящото TOKAI RIKА CO., LTD. декларира, че този тип радиосъоръжение B3U2K2P е в съответствие с Директива 2014/53/EC.

Цялостният текст на ЕС декларацията за съответствие може да се намери на следния интернет адрес:

<http://www.tokai-rika.co.jp/pc>

Радиочестотна лента: 433.050 - 434.790 MHz
Максимална радиочестотна мощност: 10 mW(ERP)

Prin prezenta, TOKAI RIKА CO., LTD. declară că tipul de echipamente radio B3U2K2P este în conformitate cu Directiva 2014/53/UE.

Textul integral al declarației UE de conformitate este disponibil la următoarea adresă internet:

<http://www.tokai-rika.co.jp/pc>

Banda de frecvență: 433.050 - 434.790 MHz
Puterea maximă de radiofrecvență: 10 mW(ERP)

Ovime TOKAI RIKA CO., LTD. potvrđuje da je radio-oprema tipa B3U2K2P u skladu sa Direktivom 2014/53/EU.

Potpuni tekst EU deklaracije o usaglašenosti dostupan je na sljedećoj internet adresi:

<http://www.tokai-rika.co.jp/pc>

Frekvencijski opseg: 433.050 - 434.790 MHz

Maksimalna radio-frekvencijska snaga: 10 mW(ERP)

Me anë të këtij dokumenti, TOKAI RIKA CO., LTD. deklararon se tipi i radiopajisjes B3U2K2P është në përputhje me Direktivën 2014/53/EU.

Teksti i plotë i deklaratës së konformitetit të Bashkimit Evropian është i disponueshëm në adresën e mëposhtme të internetit:

<http://www.tokai-rika.co.jp/pc>

Brezi i frekuencës: 433.050 - 434.790 MHz

Fuqia maksimale e radiofrekuencës: 10 mW(ERP)

TOKAI RIKA CO., LTD. ovime izjavljuje da je radijska oprema tipa B3U2K2P u skladu s Direktivom 2014/53/EU.

Cjeloviti tekst EU izjave o sukladnosti dostupan je na sljedećoj internetskoj adresi:

<http://www.tokai-rika.co.jp/pc>

Frekvencijski pojas: 433.050 - 434.790 MHz

Maksimalna RF snaga: 10 mW(ERP)

Ovim TOKAI RIKAI CO., LTD. potvrđuje da je radio-oprema tipa B3U2K2P u skladu sa Direktivom 2014/53/EU.

Potpuni tekst EU deklaracije o usaglašenosti dostupan je na sledećoj internet adresi:

<http://www.tokai-rika.co.jp/pc>

Frekventni opseg: 433.050 - 434.790 MHz

Maksimalna radio-frekventna snaga: 10 mW(ERP)

TOKAI RIKAI CO., LTD., işbu belgeyle telsiz cihazı türünün B3U2K2P 2014/53/EU nolu Direktif ile uyumlu olduğunu beyan etmektedir.

AB uygunluk beyanının tam metnine aşağıdaki internet adresinden ulaşabilirsiniz:

<http://www.tokai-rika.co.jp/pc>

Frekans bandı: 433.050 - 434.790 MHz

Maksimum radyo frekans gücü: 10 mW(ERP)



Address: 3-260 Toyota, Oguchi-cho, Niwa-gun, Aichi 480-0195, Japan

⚠: This mark is a safety/warning mark.

- Do not ingest battery.

Chemical Burn Hazard

- This product contains a coin / button cell battery.
- If the coin / button cell battery is swallowed, it can cause severe internal burns in just 2 hours and can lead to death.
- Keep new and used batteries away from children.
- If the battery compartment does not close securely, stop using the product and keep it away from children.
- If you think batteries might have been swallowed or placed inside any part of the body, seek immediate medical attention.

CAUTION

- Risk of explosion if the battery is replaced by an incorrect type.
- Replace battery with the same type.

CAUTION

- Risk of explosion or the leakage of flammable liquid or gas.
- Do not use in /store in /bring into environment of extremely high temperature or extremely low pressure due to the very high altitude.
- Do not attempt to burn, crush, or cut used battery.

⚠ : Tämä on turva-/varoituserkki.

- Paristoa ei saa laittaa suuhun.

Kemiallisen palovamman vaara

- Laitteessa on kolikko-/nappiparisto.
- Elimistöön joutunut kolikko-/nappiparisto voi aiheuttaa vakavia sisäisiä palovammoja vain 2 tunnissa, jolloin seurauksena voi olla hengen menetys.
- Uudet ja käytetyt paristot on pidettävä poissa lasten ulottuvilta.
- Jos paristolokero ei sulkeudu kunnolla, laitteen käyttö on lopetettava, ja laite on pidettävä poissa lasten ulottuvilta.
- Jos on syytä epäillä, että paristo on nielaistu tai muuten päässyt elimistöön, ota välittömästi yhteyttä lääkäriin.

TÄRKEÄ HUOMAUTUS

- Käytetyn pariston vaihtaminen tyypiltään väärään voi aiheuttaa räjähdysvaaran.
- Vaihda paristo tyypiltään samanlaiseen.

TÄRKEÄ HUOMAUTUS

- Räjähdysvaara tai syttyvän nesteen tai kaasun vuotoaara.
- Ei saa käyttää/säilyttää/tuoda lämpötilaltaan tai merenpinnasta mitattuna erittäin korkeaan ympäristöön, jossa ilmanpaine on erittäin alhainen.
- Käytettyä paristoa ei saa polttaa, murskata tai halkaista.

 : Dit teken is een veiligheids-/waarschuwingsteken.

• Slik de batterij niet in.

Risico op chemische brandwonden

• Dit product bevat een munt-/knoopcelbatterij.

• Als de munt-/knoopcelbatterij wordt ingeslikt, kan het al binnen 2 uur ernstige interne brandwonden veroorzaken en de dood tot gevolg hebben.

• Houd nieuwe en gebruikte batterijen buiten bereik van kinderen.

• Als het batterijcompartiment niet goed sluit, stop dan met het gebruik van het product en houd het buiten bereik van kinderen.

• Als u denkt dat batterijen zijn ingeslikt of in enig deel van het lichaam zijn gestopt, roep dan onmiddellijk medische hulp in.

VOORZICHTIG

• Er bestaat een risico op ontploffing als de batterij wordt vervangen door een verkeerd type.

• Vervang de batterij door een van hetzelfde type.

VOORZICHTIG

• Er bestaat een risico op ontploffing of lekkage van brandbare vloeistof of gas.

• Niet gebruiken in/bewaren in/meenemen naar een omgeving met extreem

hoge temperatuur of met extreem lage druk als gevolg van zeer grote hoogte.

• Een gebruikte batterij niet verbranden, platdrukken, of doorsnijden.

 : Ce pictogramme est une marque de sécurité/avertissement.

• Ne pas ingérer la pile.

Risques de brûlure chimique

• Ce produit contient une pile bouton.

• Si la pile bouton est avalée, elle peut causer de graves brûlures internes en seulement 2 heures et peut entraîner la mort.

• Conservez les piles neuves et usagées hors de portée des enfants.

• Si le compartiment de la pile ne ferme pas correctement, cessez d'utiliser le produit et conservez-le hors de portée des enfants.

• Si vous pensez que des piles ont pu être avalées ou placées à l'intérieur d'une partie du corps, consultez immédiatement un médecin.

AVERTISSEMENT

• Risque d'explosion si la pile est remplacée par un type incorrect.

• Remplacez la pile par une pile du même type.

AVERTISSEMENT

• Risque d'explosion ou de fuite de liquide ou de gaz inflammable.

• Ne jamais utiliser, stocker, placer dans un environnement à la température

extrêmement élevée ou à la pression extrêmement basse en raison d'une très haute altitude.

• Ne jamais essayer de brûler, écraser ou couper des piles usagées.

⚠: Det här märket är ett säkerhets-/varningsmärke.

•Förtär inte batteriet.

Risk för kemisk brännskada

•Den här produkten innehåller ett mynt-/knappbatteri.

•Om mynt-/knappbatteriet sväljs kan det orsaka allvarliga interna brännskador på bara två timmar, vilket kan leda till dödsfall.

•Håll nya och använda batterier borta från barn.

•Om batterifacket inte stängs ordentligt, sluta använda produkten och håll den undan från barn.

•Om du misstänker att batterier har svalts eller placerats inuti någon del av kroppen, sök omedelbart läkarvård.

VARNING

•Risk för explosion om batteriet byts ut mot ett av fel typ.

•Byt ut batteriet mot ett av samma typ.

VARNING

•Risk för explosion eller läckage av brandfarliga vätskor och gaser.

•Använd inte, förvara inte och ta inte in i miljö med extremt hög temperatur eller extremt lågt tryck p.g.a. hög höjd.

•Försök inte bränna, krossa eller skära använt batteri.

⚠ : Dette mærke er et sikkerheds-/advarselsmærke.

•Batteriet må ikke indtages.

Fare for kemisk forbrænding

•Dette produkt indeholder et mønt-/knapcellebatteri.

•Hvis mønt-/knapcellebatteriet sluges, kan det medføre alvorlige indre forbrændinger i løbet af kun 2 timer og kan føre til dødsfald.

•Opbevar nye og brugte batterier utilgængeligt for børn.

•Hvis batterirummet ikke kan lukkes ordentligt, skal du indstille brugen af produktet og opbevare det utilgængeligt for børn.

•Hvis du har mistanke om, at der måske er blevet slugt batterier, eller batterier på anden måde er kommet ind i kroppen, skal du øjeblikkeligt søge lægehjælp.

FORSIGTIG

•Risiko for eksplosion, hvis batteriet udskiftes med en forkert type.



•Udskift batteriet med et batteri af samme type.

FORSIGTIG

•Risiko for eksplosion eller lækage af brændbar væske eller gas.

•Må ikke anvendes på/opbevares på/tages med til meget varme steder eller steder med meget lavt tryk som følge af ekstreme højder.

•Forsøg ikke at brænde, knuse eller adskille brugte batterier.

<p>: Dieses Symbol ist ein Sicherheits-/Warnsymbol.</p> <ul style="list-style-type: none"> •Verschlucken Sie die Batterie nicht. <p>Verätzungsgefahr</p> <ul style="list-style-type: none"> •Dieses Produkt enthält eine Knopfzellenbatterie. •Falls die Knopfzellenbatterie verschluckt wird, kann dies innerhalb von nur 2 Stunden schwere innere Verätzungen verursachen und zum Tode führen. •Halten Sie neue und gebrauchte Batterien von Kindern fern. •Falls sich das Batteriefach nicht sicher schließen lässt, stellen Sie die Verwendung des Produkts ein und halten Sie es von Kindern fern. •Falls Sie glauben, dass Batterien eventuell verschluckt oder in einen Teil des Körpers eingeführt worden sind, begeben Sie sich sofort in ärztliche Behandlung. <p>ACHTUNG</p> <ul style="list-style-type: none"> •Es besteht Explosionsgefahr, falls die Batterie durch eine Batterie der falschen Art ersetzt wird. •Ersetzen Sie Batterien nur durch die gleiche Art. <p>ACHTUNG</p> <ul style="list-style-type: none"> •Es besteht Explosionsgefahr oder die Gefahr eines Austritts von brennbarer Flüssigkeit oder entzündlichem Gas. •Das Produkt darf nicht in Umgebungen mit hohen Temperaturen oder extrem niedrigem Luftdruck aufgrund von extremen Höhenlagen verwendet / aufbewahrt / gebracht werden. •Versuchen Sie nicht, gebrauchte Batterien zu verbrennen, zu zerstoßen oder zu schneiden.
<p>: Το σήμα αυτό είναι ένα σήμα ασφαλείας/προειδοποίησης.</p> <ul style="list-style-type: none"> • Μην καταπίνετε την μπαταρία. <p>Κίνδυνος χημικού εγκαύματος</p> <ul style="list-style-type: none"> • Αυτό το προϊόν περιέχει μια μπαταρία σχήματος νομίσματος / κουμπιού. • Αν η μπαταρία σχήματος νομίσματος / κουμπιού καταποθεί, μπορεί να προκαλέσει σοβαρά εσωτερικά εγκαύματα σε μόλις 2 ώρες και μπορεί να επέλθει θάνατος. • Διατηρείτε τις καινούργιες και τις χρησιμοποιημένες μπαταρίες μακριά από παιδιά. • Εάν το διαμέρισμα της μπαταρίας δεν κλείνει καλά, σταματήστε τη χρήση του προϊόντος και κρατήστε το μακριά από παιδιά. • Αν νομίζετε ότι οι μπαταρίες ενδέχεται να έχουν καταποθεί ή τοποθετηθεί μέσα σε οποιοδήποτε μέρος του σώματος, ζητήστε αμέσως ιατρική φροντίδα. <p>ΠΡΟΣΟΧΗ</p> <ul style="list-style-type: none"> • Υπάρχει κίνδυνος έκρηξης εάν η μπαταρία αντικατασταθεί με μπαταρία εσφαλμένου τύπου. • Αντικαταστήστε την μπαταρία με μπαταρία του ίδιου τύπου. <p>ΠΡΟΣΟΧΗ</p> <ul style="list-style-type: none"> • Υπάρχει κίνδυνος έκρηξης ή διαρροής εύφλεκτων υγρών ή αερίων. • Μη χρησιμοποιείτε / αποθηκεύετε / μεταφέρετε το προϊόν σε περιβάλλον με εξαιρετικά υψηλή θερμοκρασία ή εξαιρετικά χαμηλή πίεση λόγω πολύ μεγάλου υψομέτρου. • Μην επιχειρήσετε να κάψετε, να συνθλίψετε ή να κόψετε μια χρησιμοποιημένη μπαταρία.

 : Questo è un simbolo di sicurezza/avvertenza.

- Non ingerire la batteria.

Pericolo di ustioni chimiche

- Questo prodotto contiene una batteria a bottone/moneta.
- Se la batteria a bottone/moneta viene ingerita, può causare gravi ustioni interne in sole 2 ore e provocare la morte.
- Tenere le batterie nuove e usate lontano dalla portata dei bambini.
- Se il vano batteria non si chiude in modo saldo, interrompere l'utilizzo del prodotto e tenerlo lontano dalla portata dei bambini.
- Se si ritiene che le batterie siano state ingerite o inserite in qualsiasi parte del corpo, consultare immediatamente un medico.

ATTENZIONE

- Rischio di esplosione in caso di sostituzione della batteria con una di tipo errato.
- Sostituire la batteria con una dello stesso tipo.

ATTENZIONE

- Rischio di esplosione o di perdita di liquidi o gas infiammabili.
- Non utilizzare / immagazzinare / portare in ambienti con temperatura estremamente alta o pressione estremamente alta a causa dell'elevata altitudine.
- Non provare a bruciare, schiacciare o tagliare la batteria usata.

 : Este símbolo es un símbolo de seguridad/precaución.

- No ingerir la batería.

Peligro de quemadura química

- Este producto contiene una batería de pila de botón.
- Si se ingiere la batería de pila de botón, esta puede causar graves quemaduras internas en solo 2 horas y puede provocar la muerte.
- Mantenga las baterías nuevas y usadas alejadas de los niños.
- Si el compartimento de la batería no se cierra correctamente, deje de usar el producto y manténgalo alejado de los niños.
- Si cree que las baterías hayan podido ser ingeridas o introducidas en alguna parte del cuerpo, busque inmediatamente atención médica.

ATENCIÓN

- Riesgo de explosión si la batería es reemplazada por una del tipo incorrecto.
- Reemplace la batería por una del mismo tipo.

ATENCIÓN

- Riesgo de explosión o escape de líquido o gas inflamable.
- No usar / almacenar / introducir en un ambiente de temperatura extremadamente alta o de presión extremadamente baja a causa de la alta altitud.
- No intente quemar, aplastar, o cortar la batería usada.

⚠: Esta marca é uma marca de segurança/aviso.

- Não ingerir a pilha.

Perigo de Queimadura Química

- Este produto contém uma pilha de tipo moeda/botão.
- Se a pilha de tipo moeda/botão for engolida, poderá causar queimaduras internas graves em apenas 2 horas e levar à morte.
- Manter as pilhas novas e usadas longe de crianças.
- Se o compartimento da pilha não se fechar completamente, cessar a utilização do produto e manter fora do alcance das crianças.
- Caso seja possível que as pilhas tenham sido engolidas ou colocadas dentro de qualquer parte do corpo, procurar cuidados médicos imediatamente.

CUIDADO

- Risco de explosão se a pilha for substituída por uma de tipo incorreto.
- Substituir a pilha por uma do mesmo tipo.

CUIDADO

- Risco de explosão ou fuga de líquidos ou gases inflamáveis.
- Não utilizar/armazenar/colocar em ambiente de temperatura extremamente alta, ou pressão extremamente baixa devido a altitude muito alta.
- Não tentar queimar, esmagar ou cortar a pilha usada.

⚠: Din il-marka hija marka ta' sigurtá/twissija.

- Tiblax il-batterija.

Periklu ta' Hruq Kimiku

- Dan il-prodott fih batterija munita / button cell.
- Jekk tinbela' l-batterija munita / button cell, tista' tikkawża ħruq intern sever f'temp ta' sagħtejn biss u tista' twassal għall-mewt.
- Żomm il-batteriji godda u użati 'l bogħod mit-tfal.
- Jekk il-kompartiment tal-batterija ma jagħlaqx sew, waqqaf l-użu tal-prodott u żommu 'l bogħod mit-tfal.
- Jekk taħseb li l-batteriji setgħu nbelgħu jew tpoġġew ġewwa xi parti tal-ġisem, fittex attenzjoni medika immedjata.

ATTENZJONI

- Riskju ta' splużjoni jekk il-batterija tiġi ssostitwita b'tip inkorrett.
- Ibdel il-batterija bl-istess tip.

ATTENZJONI

- Riskju ta' splużjoni jew tnixxija ta' likwidu jew gass f'ammabli.
- Tużahx / taħznux / iġġibux f'ambjent ta' temperatura estremament għolja jew pressjoni estremament baxxa minħabba l-altitudni għolja ħafna.
- Tippruvax taħraq, tfarrak jew tqatta' l-batteriji użati.

⚠: See märk on ohutus-/hoiatusmärk.

•Ärge patareid alla neelake.

Keemilise põletuse oht

•See toode sisaldab mündi/nööbi tüüpi elemendiga patareid.

•Mündi/nööbi tüüpi elemendiga patarei allaneelamine võib põhjustada raskeid sisemisi põletusi juba 2 tunni jooksul ning võib lõppeda surmaga.

•Hoidke uued ja kasutatud patareid lastele kättesaamatus kohas.

•Kui patareipesa ei sulgu kindlalt, lõpetage toote kasutamine ja hoidke seda lastele kättesaamatus kohas.

•Kui te arvate, et patareid võivad olla alla neelatud või mistahes kehaossa sattunud, pöörduge viivitamatult arsti poole.

ETTEVAATUST

•Plahvatusoht vahetamisel vale tüüpi patareiga.

•Vahetage sama tüüpi patareiga.

ETTEVAATUST

•Plahvatuse või tuleohtliku vedeliku või gaasi lekke oht.

•Ärge kasutage, hoidke ega tooge keskkonda eriti kõrge temperatuuriga või eriti madala rõhuga väga suure kõrguse tõttu merepinnast.

•Ärge üritage põletada, purustada ega lõigata kasutatud patareid.

⚠ : Ez a jelzés biztonsági/figyelmeztető jelzés.

•Ne nyelje le az elemet.

Vegyí anyag okozta égésisérülés-veszély

•Ez a termék gombelemet tartalmaz.

•Amennyiben a gombelemet lenyeli, az mindössze 2 órán belül komoly belső égési sérüléseket okozhat és halálhoz vezethet.

•Az új és használt elemeket tartsa távol a gyermekektől.

•Amennyiben az elemtartó rekesz nem zárható biztonságosan, függeszse fel a termék használatát és tartsa gyermekektől távol.

•Amennyiben úgy véli, hogy az elemet lenyelték vagy bármely testrészbe helyezték, haladéktalanul forduljon orvoshoz.

VIGYÁZAT

•Nem megfelelő típusú csereelem használata robbanásveszélyes.

•Az elemcseréhez azonos típusú elemet használjon.

VIGYÁZAT

•Robbanásveszély vagy gyúlékony folyadékok vagy gázok szivárgása.

•Ne használja/ne tárolja/ne helyezze szélsőségesen magas hőmérsékletű környezetbe, és ne tegye ki a nagy magasságokban kialakuló rendkívül alacsony nyomásnak.

•A használt elemet ne kísérelje meg elégetni, összezúzni vagy szétvágni.

⚠ : Toto je bezpečnostná/výstražná značka.

• Dbajte na to, aby nedošlo k prehltnutiu batérie.

Nebezpečenstvo poleptania chemikáliou

• Tento výrobok obsahuje mincovú/gombíkovú batériu.

• Ak dôjde k prehltnutiu mincovej/gombíkovej batérie, už v priebehu 2 hodín môže spôsobiť vážne vnútorné poleptanie a viesť k usmrteniu.

• Nové a použité batérie uchovávajte mimo dosahu detí.

• Ak sa priestor pre batériu nezatvorí bezpečne, prestaňte používať výrobok a uchovávajte ho mimo dosahu detí.

• Ak si myslíte, že mohlo dôjsť k prehltnutiu batérií alebo ich umiestneniu do ktorejkoľvek časti tela, okamžite vyhľadajte lekársku pomoc.

UPOZORNENIE

• Hrozí nebezpečenstvo výbuchu, ak sa batéria vymení za nesprávny typ.

• Vymeňte batériu za rovnaký typ.

UPOZORNENIE

• Nebezpečenstvo výbuchu alebo úniku horľavej kvapaliny alebo horľavého plynu.

• Nepoužívajte/neskladujte v prostredí/nepřinášajte do prostredia s mimoriadne vysokou teplotou, alebo mimoriadne nízkym tlakom v dôsledku veľmi vysokej nadmorskej výšky.

• Nepokúšajte sa spáliť, rozdrviť ani rozrezať použitú batériu.

⚠ : Tento symbol je bezpečnostným/výstražným symbolom.

• Baterii nepolykejte.

Nebezpečí chemických popálenin

• Tento výrobek obsahuje mincovou/knoflíkovou baterii.

• Pokud dojde ke spolknutí mincové/knoflíkové baterie, může za pouhé 2 hodiny způsobit závažné vnitřní popáleniny a v jejich důsledku případně i smrt.

• Použité a nové baterie udržujte mimo dosah dětí.

• Pokud nelze prostor pro baterii pevně uzavřít, přestaňte výrobek používat a udržujte jej mimo dosah dětí.

• Pokud si myslíte, že mohlo dojít ke spolknutí baterie nebo jejímu vsunutí dovnitř kterékoliv části těla, okamžitě vyhledejte lékařskou pomoc.

UPOZORNĚNÍ

• Nebezpečí výbuchu v případě výměny baterie za nesprávný druh baterie.

• Proto baterii vždy vyměňte za jinou stejného typu.

UPOZORNĚNÍ

• Nebezpečí výbuchu nebo úniku hořlavé kapaliny či plynu.

• Nepoužívejte/neskladujte/nepřinášejte je do prostředí s nesmírně vysokou teplotou nebo nesmírně nízkým tlakem zapříčiněným vysokou nadmořskou výškou.

• Nesnažte se baterii spálit, rozdrtit či rozříznout.

⚠ : Ta oznaka je varnostna/opozorilna oznaka.

- Ne zaužijte baterije.

Nevarnost kemijske opekline

- Ta izdelek vsebuje gumbasto baterijo.
- Če se gumbasto baterijo zaužije, lahko to povzroči hude notranje opekline v le 2 urah in lahko vodi v smrt.
- Nove in rabljene baterije hranite izven dosega otrok.
- Če se predalček za baterijo ne zapira pravilno, prenehajte z uporabo izdelka in ga hranite izven dosega otrok.
- Če sumite, da je morda nekdo zaužil baterijo ali jo dal v kateri koli del telesa, takoj poiščite zdravniško pomoč.

POZOR

- Nevarnost eksplozije, če baterijo zamenjate z baterijo napačne vrste.
- Zamenjajte baterijo z istim tipom.

POZOR

- Tveganje za eksplozijo ali puščanje vnetljivih tekočin ali plinov.
- Ne uporabljajte/shranjujte/prinašajte v okolje izredno visoke temperature ali izredno nizkega tlaka zaradi zelo visoke nadmorske višine.
- Ne poskušajte zažigati, uničiti, ali rezati rabljene baterije.

⚠: Šis ženklas yra saugos/jspėjamasis ženklas.

- Neprarykite baterijos.

Cheminių nudegimų pavojus

- Šiame gaminyje yra monetos/sagos formos baterija.
- Prarijęs monetos/sagos formos bateriją, asmuo per 2 valandas gali patirti sunkius vidinius nudegimus ir netgi mirti.
- Naujas ir panaudotas baterijas laikykite vaikams nepasiekiamoje vietoje.
- Jei baterijų skyrelio nepavyksta tvirtai uždaryti, nebenaudokite gaminio ir laikykite jį vaikams nepasiekiamoje vietoje.
- Jei manote, kad baterijos buvo prarytos arba pateko į kūną, nedelsdami kreipkitės į gydytoją.

PERSPĖJIMAS

- Bateriją pakeitus netinkamo tipo baterija, kyla sprogdimo pavojus.
- Pakeiskite seną bateriją tik to paties tipo nauja baterija.

PERSPĖJIMAS

- Sprogdimo arba degių skysčių ar dujų nuotėkio pavojus.
- Negalima naudoti/laikyti/turėti labai aukštos temperatūros arba labai dideliame aukštyje esančioje itin žemo slėgio aplinkoje.
- Naudotos baterijos nebandykite deginti, ardyti ar perpjauti.

⚠ : Šī zīme ir drošības/brīdinājuma zīme.

- Nenorijiet bateriju.

Ķīmisku apdegumu briesmas

- Šis izstrādājums satur tabletes tipa bateriju.

- Ja ir norīta tabletes tipa baterija, tā 2 stundu laikā var radīt smagus apdegumus un izraisīt nāvi.

- Jaunas un lietotas baterijas uzglabājiet bērniem nepieejamā vietā.

- Ja bateriju nodalījumu nevar droši aizvērt, pārtrauciet lietot izstrādājumu un novietojiet to bērniem nepieejamā vietā.

- Ja jūsuprāt baterijas ir norītas vai ievietotas kādā ķermeņa daļā, nekavējoties vērsieties pēc medicīniskās palīdzības.

UZMANĪBU!

- Eksplozijas risks, ja baterija tiek nomainīta ar nepareiza tipa bateriju.

- Bateriju nomainiet pret tāda paša tipa bateriju.

UZMANĪBU!

- Eksplozijas vai uzliesmojoša šķidrums vai gāzes noplūdes risks.

- Nelietojiet, neuzglabājiet un neievietojiet vidē ar ļoti augstu temperatūru, kā arī vidē, kur ļoti lielā augstuma virs jūras līmeņa dēļ ir ļoti zems spiediens.

- Nemēģiniet sadedzināt, sagraut vai sagriezt nolietoto bateriju.

⚠ : ten symbol oznacza niebezpieczeństwo/ostreżenie.

- Nie połykać baterii.

Ryzyko oparzenia chemicznego

- Ten produkt zawiera baterię guzikową.

- Połknięta bateria guzikowa może spowodować poważne oparzenia wewnętrzne w czasie jedynie 2 godzin i prowadzić do śmierci.

- Przechowywać nowe i zużyte baterie z dala od dzieci.

- Jeśli solidne zamknięcie komory baterii jest niemożliwe, zaprzestać użytkowania produktu i przechowywać go w miejscu niedostępnym dla dzieci.

- W przypadku podejrzenia, że mogło dojść do połknięcia baterii lub ich umieszczenia w dowolnym otworze ciała, niezwłocznie uzyskać pomoc lekarską.

PRZESTROGA

- Istnieje ryzyko wybuchu, jeśli bateria zostanie zastąpiona baterią niewłaściwego typu.

- Wymieniać baterię na baterię tego samego typu.

PRZESTROGA

- Ryzyko wybuchu lub wycieku łatwopalnego płynu lub gazu.

- Nie używać i nie przechowywać w otoczeniu o skrajnie wysokiej temperaturze lub skrajnie niskim ciśnieniu wynikającym z bardzo dużej wysokości ani nie wносить do takiego otoczenia.

- Nie podejmować prób spalania, zgniecenia lub przecięcia zużytej baterii.

 : Този знак е знак за безопасност/предупреждение.

- Не поглъщайте батерията.

Опасност от химическо изгаряне

- Този продукт съдържа плоска/бутонна батерия.
- Ако плоската/бутонна батерия бъде погълната, тя може да причини тежки вътрешни изгаряния само за 2 часа и може да доведе до смърт.
- Пазете новите и използваните батерии далеч от деца.
- Ако отделението за батериите не се затваря добре, спрете да използвате продукта и го дръжте далеч от деца.
- Ако смятате, че батериите може да са били погълнати или поставени в някоя част на тялото, незабавно потърсете медицинска помощ.

ВНИМАНИЕ

- Опасност от експлозия, ако батерията бъде сменена с неправилен тип.
- Сменете батерията със същия вид.

ВНИМАНИЕ

- Опасност от експлозия или изтичане на запалими течности или газове.
- Не използвайте/съхранявайте/носете в среда с изключително висока температура или изключително ниско налягане, причинено от голямата височина.
- Не се опитвайте да изгаряте, смачквате или режете използваната батерия.

 : Acest marcaj este un marcaj de securitate/avertizare.

- Nu ingerați bateria.

Pericol de arsuri chimice

- Acest produs conține o baterie tip pastilă.
- Dacă bateria tip pastilă este înghițită, aceasta poate cauza arsuri interne grave în numai 2 ore și poate duce la deces.
- Nu lăsați bateriile noi și bateriile uzate la îndemâna copiilor.
- În cazul în care compartimentul bateriei nu se închide bine, încetați utilizarea produsului și nu îl lăsați la îndemâna copiilor.
- Dacă bănuți că este posibil ca bateriile să fi fost înghițite sau introduse în orice parte a corpului, consultați imediat medicul.

ATENȚIE

- Risc de explozie dacă bateria este înlocuită cu un tip incorect.
- Înlocuiți bateria cu una de același tip.

ATENȚIE

- Risc de explozie sau de scurgeri de lichide sau gaze inflamabile.
- Nu utilizați/depozitați într-un mediu cu temperatură extrem de înaltă sau cu presiune extrem de joasă din cauza altitudinii foarte mari.
- Nu încercați să ardeți, să spargeți sau să tăiați bateriile uzate.

⚠ : Ova oznaka je oznaka sigurnosti/upozorenja.

- Nemojte gutati bateriju.

Opasnost od kemijskih opekline

- Ovaj proizvod sadrži novčić/gumb bateriju.
- Ako se novčić/gumb baterija proguta, može uzrokovati ozbiljne unutarnje opekline u samo 2 sata i može dovesti do smrti.
- Držite nove i rabljene baterije izvan dohvata djece.
- Ako se pretinac za baterije ne zatvara sigurno, prestanite koristiti proizvod i držite ga dalje od djece.
- Ako smatrate da su baterije možda progutane ili smještene unutar bilo kojeg dijela tijela, zatražite hitnu medicinsku pomoć.

OPREZ

- Ako je baterija zamijenjena pogrešnim tipom, postoji rizik od eksplozije.
- Zamijenite bateriju s baterijama iste vrste.

OPREZ

- Rizik od eksplozije ili istjecanja zapaljive tekućine ili plina.

- Nemojte koristiti u /pohranjivati u /unijeti u prostoru izuzetno visoke temperature ili izuzetno niskog tlaka zbog visoke nadmorske visine.
- Ne pokušavajte spaliti, lomiti ili rezati istrošenu bateriju.

⚠ : Þetta tákn er öryggis-/aðvörunartákn.

- Gleypið ekki rafhlöðuna.

Hætta á efnabruna

- Þessi vara inniheldur flata rafhlöðu.
- Ef rafhlaðan er gleppt getur hún valdið alvarlegum innvortis brunna á innan við 2 klukkustundum sem getur leitt til dauða.
- Geymið nýjar og notaðar rafhlöður þar sem börn ná ekki til.
- Ef rafhlöðuhólfið lokast ekki örugglega skal hætta notkun vörunnar og geyma hana þar sem börn ná ekki til.
- Ef þú telur að rafhlöður hafi verið gleypar eða settar inn í eitthvert líkamsop, skaltu hafa samband við lækni tafarlaust.

VARÚÐ

- Hætta á sprengingu ef rafhlöðunni er skipt út fyrir ranga tegund.
- Skiptið rafhlöðunni ávallt út fyrir sömu tegund.

VARÚÐ

- Hætta á sprengingu eða leka á eldfimum vökva eða lofttegundum.

- Má ekki nota/geyma/setja í umhverfi þar sem er afar hár hiti, eða afar lágur þrýstingur vegna mikillar hæðar.
- Ekki reyna að brenna, kremja eða skera notaða rafhlöðu.

⚠ : Dette merket er et sikkerhets-/advarselsmerke.

- Ikke svelg batteriet.

Kjemisk brannfare

- Dette produktet inneholder et mynt-/knappcellebatteri.
- Dersom mynt-/knappcellebatteriet svelges, kan det frembringe alvorlige indre forbrenninger i løpet av kun to timer, og kan være dødelig.
- Hold nye og brukte batterier borte fra barn.
- Lukkes ikke batterirommet sikkert må du stanse å bruke produktet og holde det utenfor barns rekkevidde.
- Oppsøk medisinsk hjelp umiddelbart hvis du tror at batterier kan være svelget eller plassert inne i kroppen.

FORSIKTIG

- Eksplosjonsfare hvis batteriet erstattes med feil type.
- Bytt batteri med samme type.

FORSIKTIG

- Fare for eksplosjon eller lekkasje av brannfarlig væske eller gass.

- Ikke bruk i/oppbevar i/ta med inn i miljø med ekstremt høy temperatur eller ekstremt lavt trykk på grunn av den svært store høyden.
- Ikke forsøk å brenne, knuse eller skjære opp et brukt batteri.

⚠ : Ova oznaka je sigurnosna/upozoravajuća oznaka.

- Nemojte gutati bateriju.

Opasnost od hemijskih opekotina

- Ovaj proizvod sadrži bateriju veličine kovanice/dugmeta.
- Ako se baterija veličine kovanice/dugmeta proguta, može izazvati ozbiljne unutrašnje opekotine za samo 2 sata i može dovesti do smrti.
- Čuvajte nove i korišćene baterije dalje od djece.
- Ako se prostor za baterije ne zatvori dobro, prestanite sa korišćenjem proizvoda i držite ga dalje od djece.
- Ako mislite da su baterije možda progutane ili stavljene u unutrašnjost bilo kog dijela tijela, potražite hitnu medicinsku pomoć.

OPREZ

- Opasnost od eksplozije ako se baterija zamijeni s baterijom pogrešnog tipa.
- Zamijenite bateriju sa baterijom istog tipa.

OPREZ

- Opasnost od eksplozije ili curenja zapaljive tečnosti ili gasa.
- Nemojte koristiti /skladištiti /unositi u okruženje izuzetno visoke temperature ili izuzetno niskog pritiska usljed veoma velike visine.
- Ne pokušavajte da spalite, lomite ili isječete iskorišćenu bateriju.

⚠ : Kjo është shenjë sigurie/paralajmërimi.

• Mos e gëlltisni baterinë.

Rrezik djegieje kimike

• Ky produkt përmban një bateri të hollë në formë monedhe/kopse.

• Nëse bateria e hollë në formë monedhe/kopse gëlltitet, ajo mund të shkaktojë djegie të rënda të brendshme brenda vetëm 2 orëve dhe mund të sjellë vdekjen.

• Mbajini bateritë e reja dhe të përdorura larg nga fëmijët.

• Nëse foleja e baterisë nuk mbyllet mirë, ndaloni përdorimin e produktit dhe mbajeni larg nga fëmijët.

• Nëse mendoni se bateritë mund të jenë gëlltitur ose futur brenda ndonjë pjese trupi, kërkoni menjëherë vëmendjen e mjekut.

KUJDES

• Rrezik shpërthimi nëse bateria zëvendësohet me një lloj të pasaktë.

• Zëvendësojeni baterinë me të njëjtin lloj.

KUJDES

• Rrezik shpërthimi nga rrjedhja e lëngut apo gazit të ndezshëm.

• Mos e përdorni / ruani / sillni në mjedise me temperaturë jashtëzakonisht të lartë ose presion jashtëzakonisht të ulët në lartësi shumë të mëdha.

• Mos u përipiqi të digjni, shtypni ose prisni baterinë e përdorur.

⚠ : Ova oznaka je oznaka za bezbednost/upozorenje.

• Nemojte gutati bateriju.

Opasnost od hemijskih opekotina

• Ovaj proizvod sadrži bateriju u obliku novčića/dugmeta.

• Ako se baterija u obliku novčića/gumba proguta, može da izazove ozbiljne interne opekotine za samo 2 sata i može da dovede do smrti.

• Nove i korišćene baterije čuvajte van domašaja dece.

• Ako se odeljak za bateriju ne zatvori dobro, prestanite da koristite proizvod i čuvajte ga van domašaja dece.

• Ako mislite da su baterije možda progutane ili stavljene unutar bilo kog dela tela, odmah zatražite medicinsku pomoć.

OPREZ

• Rizik od eksplozije ako je baterija zamenjena nepravilnim tipom.

• Zamenite bateriju sa istim tipom.

OPREZ

• Rizik od eksplozije ili curenja zapaljive tečnosti ili gasa.

• Ne koristite/ne čuvajte/ne donosite u sredinu izuzetno visoke temperature ili izuzetno niskog pritiska usled vrlo visoke visine.

• Ne pokušavajte da zapalite, smrvite ili isečete korišćenu bateriju.

⚠ : Bu işaret bir güvenlik/uyarı işaretidir.

•Pili yutmayın.

Kimyasal Yanma Tehlikesi

•Bu üründe bir düğme pil bulunmaktadır.

•Düğme pil yutulursa, sadece 2 saat içinde ağır iç yanıklara neden olabilir ve ölüme yol açabilir.

•Yeni ve kullanılmış pilleri çocuklardan uzak tutun.

•Pil yuvası emniyetli bir şekilde kapanmıyorsa, ürünü kullanmayı bırakın ve çocuklardan uzak tutun.

•Pillerin yutulduğunu veya vücudun herhangi bir parçasının içine yerleştirildiğini düşünüyorsanız, derhal tıbbi yardım alın.

DİKKAT

•Pil yanlış tür bir pille değiştirilirse patlama riski vardır.

•Pili aynı tür pillerle değiştirin.

DİKKAT

•Patlama ya da yanıcı sıvı veya gaz sızıntısı riski vardır.

•Aşırı derecede yüksek sıcaklıktaki veya çok yüksek rakımdan dolayı aşırı derecede düşük basınca sahip ortamlarda kullanmayın /saklamayın veya bu ortamlara götürmeyin.

•Kullanılmış pili yakmaya, ezmeye veya kesmeye çalışmayın.

► For vehicles sold in Ukraine

Справжнім TOKAI RIKAI CO., LTD. заявляє, що тип радіобладнання В3U2K2P відповідає Технічному регламенту радіобладнання;
КАБІНЕТ МІНІСТРІВ УКРАЇНИ ПОСТАНОВА №.355

Повний текст декларації про відповідність доступний на веб-сайті за такою адресою:
<http://www.tokai-rika.co.jp/pc>

Діапазон частот : 433.050 - 434.790 MHz
Максимальна потужність радіочастотного випромінювання : 10 mW(ERP)



Адреса: 3-260 Toyota, Oguchi-cho, Niwa-gun, Aichi 480-0195, Japan



Ця позначка являє собою позначку про необхідність дотримання правил безпеки/застереження.

· Не допускайте проковтування батарейки.

Небезпека хімічного опіку

- Цей виріб містить батарейку монетного / таблеткового типу.
- Проковтування батарейки монетного / таблеткового типу може спричинити тяжкі внутрішні опіки всього лише за 2 години і може призвести до смерті.
- Зберігайте нові та використані батарейки подалі від дітей.
- Якщо кришка батарейного відсіку надійно не закривається, припиніть користуватися виробом і зберігайте його подалі від дітей.
- Якщо існує ймовірність проковтування батарейки або її розміщення всередині будь-якої частини тіла, негайно зверніться за медичною допомогою.

ОБЕРЕЖНО

- Ризик вибуху в разі заміни на батарейку неналежного типу.
- Замінійте батарейку на батарейку такого ж самого типу.

ОБЕРЕЖНО

- Ризик вибуху або витоку горючої рідини або газу.
- Не використовуйте /не зберігайте /не розміщуйте в умовах надзвичайно високої температури або надзвичайно низького тиску через дуже велику висоту над рівнем моря.
- Не намагайтеся спалити, розбити або розрізати використану батарейку.

► For vehicles sold in Serbia



Hereby, TOKAI RIKA CO., LTD. declares that the radio equipment type BF6UM is in compliance with Directive 2014/53/EU.

The full text of the EU declaration of conformity is available at the following internet address:

<http://www.tokai-rika.co.jp/pc>

TOKAI RIKA CO., LTD. vakuuttaa, että radiolaitetyyppi BF6UM on direktiivin 2014/53/EU mukainen.

EU-vaatimustenmukaisuusvakuutuksen täysimittainen teksti on saatavilla seuraavassa internetosoitteessa:

<http://www.tokai-rika.co.jp/pc>

Hierbij verklaar ik, TOKAI RIKA CO., LTD., dat het type radioapparatuur BF6UM conform is met Richtlijn 2014/53/EU.

De volledige tekst van de EU-conformiteitsverklaring kan worden geraadpleegd op het volgende internetadres:

<http://www.tokai-rika.co.jp/pc>

Le soussigné, TOKAI RIKA CO., LTD., déclare que l'équipement radioélectrique du type BF6UM est conforme à la directive 2014/53/UE.

Le texte complet de la déclaration UE de conformité est disponible à l'adresse internet suivante:

<http://www.tokai-rika.co.jp/pc>

Härmed försäkrar TOKAI RIKA CO., LTD. att denna typ av radioutrustning BF6UM överensstämmer med direktiv 2014/53/EU.

Den fullständiga texten till EU-försäkran om överensstämmelse finns på följande webbadress:

<http://www.tokai-rika.co.jp/pc>

Hermed erklærer TOKAI RIKA CO., LTD., at radioudstyrstypen BF6UM er i overensstemmelse med direktiv 2014/53/EU.

EU-overensstemmelseserklæringens fulde tekst kan findes på følgende internetadresse:

<http://www.tokai-rika.co.jp/pc>

Hiermit erklärt TOKAI RIKA CO., LTD., dass der Funkanlagentyp BF6UM der Richtlinie 2014/53/EU entspricht.

Der vollständige Text der EU-Konformitätserklärung ist unter der folgenden Internetadresse verfügbar:

<http://www.tokai-rika.co.jp/pc>

Με την παρούσα ο/η TOKAI RIKA CO., LTD., δηλώνει ότι ο ραδιοεξοπλισμός BF6UM πληροί την οδηγία 2014/53/ΕΕ.

Το πλήρες κείμενο της δήλωσης συμμόρφωσης ΕΕ διατίθεται στην ακόλουθη ιστοσελίδα στο διαδίκτυο:

<http://www.tokai-rika.co.jp/pc>

Il fabbricante, TOKAI RIKA CO., LTD., dichiara che il tipo di apparecchiatura radio BF6UM è conforme alla direttiva 2014/53/UE.

Il testo completo della dichiarazione di conformità UE è disponibile al seguente indirizzo Internet:

<http://www.tokai-rika.co.jp/pc>

Por la presente, TOKAI RIKA CO., LTD. declara que el tipo de equipo radioeléctrico BF6UM es conforme con la Directiva 2014/53/UE.

El texto completo de la declaración UE de conformidad está disponible en la dirección Internet siguiente:

<http://www.tokai-rika.co.jp/pc>

O(a) abaixo assinado(a) TOKAI RIKA CO., LTD. declara que o presente tipo de equipamento de rádio BF6UM está em conformidade com a Diretiva 2014/53/UE.

O texto integral da declaração de conformidade está disponível no seguinte endereço de Internet:

<http://www.tokai-rika.co.jp/pc>

B'dan, TOKAI RIKA CO., LTD., niddikjara li dan it-tip ta' tagħmir tar-radju BF6UM huwa konformi mad-Direttiva 2014/53/UE.

It-test kollu tad-dikjarazzjoni ta' konformità tal-UE huwa disponibbli f'dan l-indirizz tal-Internet li ġej:

<http://www.tokai-rika.co.jp/pc>

Käesolevaga deklareerib TOKAI RIKA CO., LTD., et käesolev raadioseadme tüüp BF6UM vastab direktiivi 2014/53/EL nõuetele.

ELi vastavusdeklaratsiooni täielik tekst on kättesaadav järgmisel internetiaadressil:

<http://www.tokai-rika.co.jp/pc>

TOKAI RIKA CO., LTD. igazolja, hogy a BF6UM típusú rádióberendezés megfelel a 2014/53/EU irányelvnek.

Az EU-megfelelőségi nyilatkozat teljes szövege elérhető a következő internetes címen:

<http://www.tokai-rika.co.jp/pc>

TOKAI RIKA CO., LTD. týmto vyhlasuje, že rádiové zariadenie typu BF6UM je v súlade so smernicou 2014/53/EÚ.

Úplné EÚ vyhlásenie o zhode je k dispozícii na tejto internetovej adrese:

<http://www.tokai-rika.co.jp/pc>

Tímto TOKAI RIKA CO., LTD. prohlašuje, že typ rádiového zařízení BF6UM je v souladu se směrnicí 2014/53/EU.

Úplné znění EU prohlášení o shodě je k dispozici na této internetové adrese:

<http://www.tokai-rika.co.jp/pc>

TOKAI RIKA CO., LTD. potrjuje, da je tip radijske opreme BF6UM skladen z Direktivo 2014/53/EU.

Celotno besedilo izjave EU o skladnosti je na voljo na naslednjem spletnem naslovu:

<http://www.tokai-rika.co.jp/pc>

Aš, TOKAI RIKA CO., LTD., patvirtinu, kad radijo įrenginių tipas BF6UM atitinka Direktyvą 2014/53/ES.

Visas ES atitikties deklaracijos tekstas prieinamas šiuo interneto adresu:

<http://www.tokai-rika.co.jp/pc>

Ar šo TOKAI RIKA CO., LTD. deklarė, ka radioiekārta BF6UM atbilst Direktīvai 2014/53/ES.

Pilns ES atbilstības deklarācijas teksts ir pieejams šādā interneta vietnē:

<http://www.tokai-rika.co.jp/pc>

TOKAI RIKA CO., LTD. niniejszym oświadcza, że typ urządzenia radiowego BF6UM jest zgodny z dyrektywą 2014/53/UE.

Pełny tekst deklaracji zgodności UE jest dostępny pod następującym adresem internetowym:

<http://www.tokai-rika.co.jp/pc>

TOKAI RIKA CO., LTD. lýsir því hér með yfir að fjarskiptatækið af gerð BF6UM er í samræmi við tilskipun 2014/53/EU.

Öll ESB-samræmisýfirlýsingin er tiltæk á eftirfarandi vefslóð:
<http://www.tokai-rika.co.jp/pc>

TOKAI RIKA CO., LTD. erklærer herved at radioutstyrten BF6UM er í samsvar med direktivet 2014/53/EU.

Hele teksten av EU-samsvarserklæringen kan leses på det følgende nettstedet:
<http://www.tokai-rika.co.jp/pc>

С настоящото TOKAI RIKA CO., LTD. декларира, че този тип радиосъоръжение BF6UM е в съответствие с Директива 2014/53/ЕС.

Цялостният текст на ЕС декларацията за съответствие може да се намери на следния интернет адрес:
<http://www.tokai-rika.co.jp/pc>

Prin prezenta, TOKAI RIKA CO., LTD. declară că tipul de echipamente radio BF6UM este în conformitate cu Directiva 2014/53/UE.

Textul integral al declarației UE de conformitate este disponibil la următoarea adresă internet:
<http://www.tokai-rika.co.jp/pc>

Ovime TOKAI RIKA CO., LTD. potvrđuje da je radio-oprema tipa BF6UM u skladu sa Direktivom 2014/53/EU.

Potpuni tekst EU deklaracije o usaglašenosti dostupan je na slijedećoj internet adresi:

<http://www.tokai-rika.co.jp/pc>

Me anë të këtij dokumenti, TOKAI RIKA CO., LTD. deklaroi se tipi i radiopajisjes BF6UM është në përputhje me Direktivën 2014/53/EU.

Teksti i plotë i deklaratës së konformitetit të Bashkimit Evropian është i disponueshëm në adresën e mëposhtme të internetit:

<http://www.tokai-rika.co.jp/pc>

TOKAI RIKA CO., LTD. ovime izjavljuje da je radijska oprema tipa BF6UM u skladu s Direktivom 2014/53/EU.

Cjeloviti tekst EU izjave o sukladnosti dostupan je na sljedećoj internetskoj adresi:

<http://www.tokai-rika.co.jp/pc>

Ovim TOKAI RIKA CO., LTD. potvrđuje da je radio-oprema tipa BF6UM u skladu sa Direktivom 2014/53/EU.

Potpuni tekst EU deklaracije o usaglašenosti dostupan je na sledećoj internet adresi:

<http://www.tokai-rika.co.jp/pc>

TOKAI RIKА CO., LTD., işbu belgeyle telsiz cihazı türünün BF6UM 2014/53/EU nolu Direktif ile uyumlu olduğunu beyan etmektedir.

AB uygunluk beyanının tam metnine aşağıdaki internet adresinden ulaşabilirsiniz:

<http://www.tokai-rika.co.jp/pc>



Address: 3-260 Toyota, Oguchi-cho, Niwa-gun, Aichi 480-0195, Japan

Receiver Category (EN300 220): 2

► For vehicles sold in Ukraine

Справжнім TOKAI RIKА CO., LTD. заявляє, що тип радіообладнання BF6UM відповідає Технічному регламенту радіообладнання;

КАБІНЕТ МІНІСТРІВ УКРАЇНИ ПОСТАНОВА №.355

Повний текст декларації про відповідність доступний на веб-сайті за такою адресою:

<http://www.tokai-rika.co.jp/pc>

Категорія приймача: 2



Адреса: 3-260 Toyota, Oguchi-cho, Niwa-gun, Aichi 480-0195, Japan

Millimeter wave radar sensor

<p>Transmitter: Model: DNMWR009 Operation frequency: 76.5 GHz Maximum output power: 416.87 mW or less</p> <p>Manufacturer: DENSO CORPORATION</p> <p>Address: 1-1, Showa-cho, Kariya-shi, Aichi-ken, 448-8661 Japan</p>	
<p>Hereby, DENSO CORPORATION declares that the radio equipment type is in compliance with Directive 2014/53/EU. The full text of the EU declaration of conformity is available at the following internet address: https://www.denso.com/global/en/contact-us/doc/</p>	01
<p>DENSO CORPORATION vakuuttaa, että radiolaitetyyppi on direktiivin 2014/53/EU mukainen. EU-vaatimustenmukaisuusvakuutuksen täysimittainen teksti on saatavilla seuraavassa internetosoitteessa: https://www.denso.com/global/en/contact-us/doc/</p>	02
<p>Hierbij verklaar ik, DENSO CORPORATION, dat het type radioapparatuur conform is met Richtlijn 2014/53/EU. De volledige tekst van de EU-conformiteitsverklaring kan worden geraadpleegd op het volgende internetadres: https://www.denso.com/global/en/contact-us/doc/</p>	03
<p>Le soussigné, DENSO CORPORATION, déclare que l'équipement radioélectrique du type est conforme à la directive 2014/53/UE. Le texte complet de la déclaration UE de conformité est disponible à l'adresse internet suivante: https://www.denso.com/global/en/contact-us/doc/</p>	04

Härmed försäkrar DENSO CORPORATION att denna typ av radioutrustning överensstämmer med direktiv 2014/53/EU.
Den fullständiga texten till EU-försäkran om överensstämmelse finns på följande webbadress:
<https://www.denso.com/global/en/contact-us/doc/>

05

Hermed erklærer DENSO CORPORATION, at radioudstyrstypen er i overensstemmelse med direktiv 2014/53/EU.
EU-overensstemmelseserklæringens fulde tekst kan findes på følgende internetadresse:
<https://www.denso.com/global/en/contact-us/doc/>

06

Hiermit erklärt DENSO CORPORATION, dass der Funkanlagentyp der Richtlinie 2014/53/EU entspricht.
Der vollständige Text der EU-Konformitätserklärung ist unter der folgenden Internetadresse verfügbar:
<https://www.denso.com/global/en/contact-us/doc/>

07

Με την παρούσα ο/η DENSO CORPORATION, δηλώνει ότι ο ραδιοεξοπλισμός πληροί την οδηγία 2014/53/ΕΕ.
Το πλήρες κείμενο της δήλωσης συμμόρφωσης ΕΕ διατίθεται στην ακόλουθη ιστοσελίδα στο διαδίκτυο:
<https://www.denso.com/global/en/contact-us/doc/>

08

Il fabbricante, DENSO CORPORATION, dichiara che il tipo di apparecchiatura radio è conforme alla direttiva 2014/53/UE.
Il testo completo della dichiarazione di conformità UE è disponibile al seguente indirizzo Internet:
<https://www.denso.com/global/en/contact-us/doc/>

09

Por la presente, DENSO CORPORATION declara que el tipo de equipo radioeléctrico es conforme con la Directiva 2014/53/UE. El texto completo de la declaración UE de conformidad está disponible en la dirección Internet siguiente:
<https://www.denso.com/global/en/contact-us/doc/>

10

O(a) abaixo assinado(a) DENSO CORPORATION declara que o presente tipo de equipamento de rádio está em conformidade com a Diretiva 2014/53/UE. O texto integral da declaração de conformidade está disponível no seguinte endereço de Internet:
<https://www.denso.com/global/en/contact-us/doc/>

11

B'dan, DENSO CORPORATION, niddikjara li dan it-tip ta' tagħmir tar-radju huwa konformi mad-Direttiva 2014/53/UE. It-test kollu tad-dikjarazzjoni ta' konformità tal-UE huwa disponibbli f'dan l-indirizz tal-Internet li ġej:
<https://www.denso.com/global/en/contact-us/doc/>

12

Käesolevaga deklareerib DENSO CORPORATION, et käesolev raadioseadme tüüp vastab direktiivi 2014/53/EL nõuetele. ELi vastavusdeklaratsiooni täielik tekst on kättesaadav järgmisel internetiaadressil:
<https://www.denso.com/global/en/contact-us/doc/>

13

DENSO CORPORATION igazolja, hogy a típusú rádióberendezés megfelel a 2014/53/EU irányelvnek. Az EU-megfelelőségi nyilatkozat teljes szövege elérhető a következő internetes címen:
<https://www.denso.com/global/en/contact-us/doc/>

14

DENSO CORPORATION týmto vyhlasuje, že rádiové zariadenie typu je v súlade so smernicou 2014/53/EÚ.

Úplné EÚ vyhlásenie o zhode je k dispozícii na tejto internetovej adrese:

<https://www.denso.com/global/en/contact-us/doc/>

15

Tímto DENSO CORPORATION prohlašuje, že typ rádiového zařízení je v souladu se směrnicí 2014/53/EU.

Úplné znění EU prohlášení o shodě je k dispozici na této internetové adrese:

<https://www.denso.com/global/en/contact-us/doc/>

16

DENSO CORPORATION potvrdzuje, da je tip radijske opreme skladen z Direktivo 2014/53/EU.

Celotno besedilo izjave EU o skladnosti je na voljo na naslednjem spletnem naslovu:

<https://www.denso.com/global/en/contact-us/doc/>

17

Aš, DENSO CORPORATION, patvirtinu, kad radijo įrenginių tipas atitinka Direktyvą 2014/53/ES.

Visas ES atitikties deklaracijos tekstas prieinamas šiuo interneto adresu:

<https://www.denso.com/global/en/contact-us/doc/>

18

Ar šo DENSO CORPORATION deklarė, ka radioiekārta atbilst Direktīvai 2014/53/ES.

Pilns ES atbilstības deklarācijas teksts ir pieejams šādā interneta vietnē:

<https://www.denso.com/global/en/contact-us/doc/>

19

DENSO CORPORATION niniejszym oświadcza, że typ urządzenia radiowego jest zgodny z dyrektywą 2014/53/UE.
Pełny tekst deklaracji zgodności UE jest dostępny pod następującym adresem internetowym:
<https://www.denso.com/global/en/contact-us/doc/>

20

Hér með lýsir DENSO CORPORATION yfir því að er í samræmi við grunnkröfur og aðrar kröfur, sem gerðar eru í tilskipun 2014/53/EU. Samræmisýfirlýsing er einnig aðgengileg á eftirfarandi vefslóð:
<https://www.denso.com/global/en/contact-us/doc/>

21

DENSO CORPORATION erklærer at er i overensstemmelse med direktiv 2014/53/EU.
Samsvarserklæringen i fulltekst er tilgjengelig på følgende internettadresse:
<https://www.denso.com/global/en/contact-us/doc/>

22

С настоящото DENSO CORPORATION декларира, че този тип радиосъоръжение е в съответствие с Директива 2014/53/ЕС. Цялостният текст на ЕС декларацията за съответствие може да се намери на следния интернет адрес:
<https://www.denso.com/global/en/contact-us/doc/>

23

Prin prezenta, DENSO CORPORATION declară că tipul de echipamente radio este în conformitate cu Directiva 2014/53/UE. Textul integral al declarației UE de conformitate este disponibil la următoarea adresă internet:
<https://www.denso.com/global/en/contact-us/doc/>

24

DENSO CORPORATION ovime izjavljuje da je radijska oprema tipa u skladu s Direktivom 2014/53/EU.

Cjeloviti tekst EU izjave o sukladnosti dostupan je na sljedećoj internetskoj adresi:

<https://www.denso.com/global/en/contact-us/doc/>

25

Овиме, DENSO CORPORATION изјављује да је радио опрема тип усаглашена са Директивом 2014/53/EU.

Цео текст ЕУ декларације о усаглашености доступан је на следећој интернет адреси:

<https://www.denso.com/global/en/contact-us/doc/>

26

Amb aquest document, DENSO CORPORATION declara que el tipus d'equipament radioelèctric es conforme a la Directiva 2014/53/UE.

El text complet de la declaració UE de conformitat està disponible en la següent adreça d'Internet:

<https://www.denso.com/global/en/contact-us/doc/>

27

İşbu belge; DENSO CORPORATION telsiz ekipmanı tipinin 2014/53/AB sayılı Direktif'e uygun olduğunu beyan eder.

AB uygunluk beyanının tam metni aşağıdaki internet adresinde mevcuttur:

<https://www.denso.com/global/en/contact-us/doc/>

28

Nepermjet kesaj, DENSO CORPORATION, deklaroj qe ky

DNMWR009 eshte ne pajtim me kerkesat thelbesore dhe dispozitat e tjera perkatese te Direktives 1999/5/EC.

29



The latest "DECLARATION of CONFORMITY" (DoC) is available at the following address:

<https://www.denso.com/global/en/contact-us/doc/>

- For vehicles sold in Ukraine



UA RF: 3DENS FR09

модель: DNMWR009
смуга радіочастот: 76-77 ГГц
максимальна вихідна потужність: 416.87 мВт або менше
виробник: DENSO CORPORATION
адреса: 1-1, Showa-cho, Kariya-shi, Aichi-ken, 448-8661 Japan
справжнім DENSO CORPORATION заявляє, що тип
радіообладнання відповідає Технічному регламенту
радіообладнання;
повний текст декларації про відповідність доступний на веб-сайті
за такою адресою:
<https://www.denso.com/global/en/contact-us/doc/>

- For vehicles sold in Moldova

For Vehicles sold in Moldova
MODEL: DNMWR009



024

► For vehicles sold in Israel

טיוטה מוטור אירופה נולסא, שדרות דו בורגט 60-1140 בריסל,

בלגיה www.toyota-europe.com

מוצר: מכ"מ התראה
סימן רשום: DENSO
ארץ ייצור: ראה מוצר
דגם: DNMWR009
שנת ייצור: ראה מוצר

Audio system

Information of the radio device: Type FT0117B

1. Name and postal address of the manufacturer

Name: DENSO TEN Limited
Address: 2-28, Goshu-dori 1-chome, Hyogo-ku, Kobe,
652-8510 Japan

2. Simplified UK declaration of conformity

Hereby, DENSO TEN Limited declares that the radio equipment type FT0117B is in compliance with Regulations 2017.

The full text of the UK declaration of conformity is available at the following internet address:

https://www.denso-ten.com/support/regulation/uk_doc/

Function	Operating frequency band	Maximum radio-frequency power
Bluetooth	2402 - 2480 MHz	5.02 mW e.i.r.p.

Information of the radio device: Type FT0117B		
1. Name and postal address of the manufacturer		
Name: DENSO TEN Limited		
Address: 2-28, Goshō-dori 1-chome, Hyogo-ku, Kobe, 652-8510 Japan		
2. Simplified EU declaration of conformity		
С настоящото DENSO TEN Limited декларира, че този тип радиосъоръжение FT0117B е в съответствие с Директива 2014/53/ЕС.		
Цялостният текст на ЕС декларацията за съответствие може да се намери на следния интернет адрес: https://www.denso-ten.com/support/regulation/eu_doc/		
Функция	Работна честотна лента	Максимална радиочестотна мощност
Bluetooth	2402 - 2480 MHz	5.02 mW e.i.r.p.
Ovim putem, DENSO TEN Limited izjavljuje da je vrsta radio opreme FT0117B u saglasnosti s Direktivom 2014/53/EU.		
Cijeli tekst EC deklaracije o usaglašenosti je dostupan na sljedećoj internetskoj adresi: https://www.denso-ten.com/support/regulation/eu_doc/		
Funkcija	Radni frekvencijski pojas	Maksimalna radiofrekvencijska snaga
Bluetooth	2402 - 2480 MHz	5.02 mW e.i.r.p.
Tímto DENSO TEN Limited prohlašuje, že typ rádiového zařízení FT0117B je v souladu se směrnicí 2014/53/EU.		
Úplné znění EU prohlášení o shodě je k dispozici na této internetové adrese: https://www.denso-ten.com/support/regulation/eu_doc/		
Funkce	Provozní frekvenční pásmo	Maximální radiofrekvenční výkon
Bluetooth	2402 - 2480 MHz	5.02 mW e.i.r.p.

Hermed erklærer DENSO TEN Limited, at radioudstyrstypen FT0117B er i overensstemmelse med direktiv 2014/53/EU.

EU-overensstemmelseserklæringens fulde tekst kan findes på følgende internetadresse:

https://www.denso-ten.com/support/regulation/eu_doc/

Funktion	Driftsfrekvensbandet	Maksimal radio-frekvens effekt
Bluetooth	2402 - 2480 MHz	5.02 mW e.i.r.p.

Hiermit erklärt DENSO TEN Limited, dass der Funkanlagentyp FT0117B der Richtlinie 2014/53/EU entspricht.

Der vollständige Text der EU-Konformitätserklärung ist unter der folgenden Internetadresse verfügbar:

https://www.denso-ten.com/support/regulation/eu_doc/

Funktion	Betriebsfrequenzband	Maximale Hochfrequenzleistung
Bluetooth	2402 - 2480 MHz	5.02 mW e.i.r.p.

Με την παρούσα ο/η DENSO TEN Limited, δηλώνει ότι ο ραδιοεξοπλισμός FT0117B πληροί την οδηγία 2014/53/ΕΕ.

Το πλήρες κείμενο της δήλωσης συμμόρφωσης ΕΕ διατίθεται στην ακόλουθη ιστοσελίδα στο διαδίκτυο:

https://www.denso-ten.com/support/regulation/eu_doc/

Λειτουργία	Ζώνη συχνοτήτων λειτουργίας	Μέγιστη ισχύς ραδιοσυχνότητας
Bluetooth	2402 - 2480 MHz	5.02 mW e.i.r.p.

Hereby, DENSO TEN Limited declares that the radio equipment type FT0117B is in compliance with Directive 2014/53/EU.

The full text of the EU declaration of conformity is available at the following internet address:

https://www.denso-ten.com/support/regulation/eu_doc/

Function	Operating frequency band	Maximum radio-frequency power
Bluetooth	2402 - 2480 MHz	5.02 mW e.i.r.p.

Por la presente, DENSO TEN Limited declara que el tipo de equipo radioeléctrico FT0117B es conforme con la Directiva 2014/53/UE. El texto completo de la declaración UE de conformidad está disponible en la dirección Internet siguiente:

https://www.denso-ten.com/support/regulation/eu_doc/

Función	Banda de frecuencia operativa	Potencia máxima de la radiofrecuencia
Bluetooth	2402 - 2480 MHz	5.02 mW e.i.r.p.

Käesolevaga deklareerib DENSO TEN Limited, et käesolev raadioseadme tüüp FT0117B vastab direktiivi 2014/53/EL nõuetele.

ELi vastavusdeklaratsiooni täielik tekst on kättesaadav järgmisel internetiaadressil:

https://www.denso-ten.com/support/regulation/eu_doc/

Funktsioon	Töösageduse laineala	Maksimaalne raadiosageduslik võimsus
Bluetooth	2402 - 2480 MHz	5.02 mW e.i.r.p.

DENSO TEN Limited vakuuttaa, että radiolaitetyypin FT0117B on direktiivin 2014/53/EU mukainen.

EU-vaatimustenmukaisuusvakuutuksen täysimittainen teksti on saatavilla seuraavassa internetosoitteessa:

https://www.denso-ten.com/support/regulation/eu_doc/

Toiminto	Toimintataajuuskaista	Maksimi radiotaajuusteho
Bluetooth	2402 - 2480 MHz	5.02 mW e.i.r.p.

Le soussigné, DENSO TEN Limited, déclare que l'équipement radioélectrique du type FT0117B est conforme à la directive 2014/53/UE.

Le texte complet de la déclaration UE de conformité est disponible à l'adresse internet suivante:

https://www.denso-ten.com/support/regulation/eu_doc/

Fonction	Bande de fréquence de fonctionnement	Puissance maximale de la radiofréquence
Bluetooth	2402 - 2480 MHz	5.02 mW e.i.r.p.

Leis seo, dearbhaíonn DENSO TEN Limited go gcomhlíonann an cineál trealaimh raidió FT0117B Treoir 2014/53/EU.

Tá an téacs iomlán den dearbhú comhréireachta AE ar fáil ag an seoladh Idirlín seo a leanas:

https://www.denso-ten.com/support/regulation/eu_doc/

Feidhm	Banda minicíochta oibriúcháin	Uaschumhacht radaimhnicíochta
Bluetooth	2402 - 2480 MHz	5.02 mW e.i.r.p.

DENSO TEN Limited ovime izjavljuje da je radijska oprema tipa FT0117B u skladu s Direktivom 2014/53/EU.

Cjeloviti tekst EU izjave o sukladnosti dostupan je na sljedećoj internetskoj adresi:

https://www.denso-ten.com/support/regulation/eu_doc/

Funkcija	Radni frekvencijski pojas	Maksimalna radiofrekvencijska snaga
Bluetooth	2402 - 2480 MHz	5.02 mW e.i.r.p.

DENSO TEN Limited igazolja, hogy a FT0117B típusú rádióberendezés megfelel a 2014/53/EU irányelvnek.

Az EU-megfelelőségi nyilatkozat teljes szövege elérhető a következő internetes címen:

https://www.denso-ten.com/support/regulation/eu_doc/

Funkció	Üzemi frekvencia-tartomány	Maximális rádiófrekvenciás teljesítmény
Bluetooth	2402 - 2480 MHz	5.02 mW e.i.r.p.

Hér með, lýsir DENSO TEN Limited því yfir að gerð útvörpsbúnaðarins FT0117B samræmist tilskipun 2014/53/EU.

Allur texti ESB-samræmisýfirlýsingarinnar er aðgengilegur á eftirfarandi veffangi:

https://www.denso-ten.com/support/regulation/eu_doc/

Aðgerð	Notkunartíðni hljómsveit	Hámarks útvarp-tíðni vald
Bluetooth	2402 - 2480 MHz	5.02 mW e.i.r.p.

Il fabbricante, DENSO TEN Limited, dichiara che il tipo di apparecchiatura radio FT0117B è conforme alla direttiva 2014/53/UE.

Il testo completo della dichiarazione di conformità UE è disponibile al seguente indirizzo Internet:

https://www.denso-ten.com/support/regulation/eu_doc/

Funzione	Frequenza operativa	Massima potenza a radiofrequenza
Bluetooth	2402 - 2480 MHz	5.02 mW e.i.r.p.

Aš, DENSO TEN Limited, patvirtinu, kad radijo įrenginių tipas FT0117B atitinka Direktyvą 2014/53/ES.

Visas ES atitikties deklaracijos tekstas prieinamas šiuo interneto adresu:

https://www.denso-ten.com/support/regulation/eu_doc/

Funkcija	Veikimo dažnių juosta	Maksimalus radijo dažnių galingumas
Bluetooth	2402 - 2480 MHz	5.02 mW e.i.r.p.

Ar šo DENSO TEN Limited deklarē, ka radioiekārta FT0117B atbilst Direktīvai 2014/53/ES.

Pilns ES atbilstības deklarācijas teksts ir pieejams šādā interneta vietnē:
https://www.denso-ten.com/support/regulation/eu_doc/

Funkcija	Darba frekvences josla	Maksimālā radiofrekvences jauda
Bluetooth	2402 - 2480 MHz	5.02 mW e.i.r.p.

Со ова, DENSO TEN Limited изјавува дека радио опремата од типот FT0117B е во согласност со Директивата 2014/53/EU.

Целиот текст на ЕУ изјавата за сообразност е достапен на следната интернет адреса:

https://www.denso-ten.com/support/regulation/eu_doc/

Функција	Работен фреквенциски опсег	Максимална радио-фреквенциска моќ
Bluetooth	2402 - 2480 MHz	5.02 mW e.i.r.p.

Ovim, DENSO TEN Limited izjavljuje da je tip radio opreme FT0117B u skladu sa Direktivom 2014/53/EU.

Cjelokupan tekst EU deklaracije o usklađenosti dostupan je na sljedećoj internet adresi:

https://www.denso-ten.com/support/regulation/eu_doc/

Funkcija	Operativni frekvencijski opseg	Maksimalna jačina radio frekvencije
Bluetooth	2402 - 2480 MHz	5.02 mW e.i.r.p.

B'dan, DENSO TEN Limited, niddikjara li dan it-tip ta' tagħmir tar-radju FT0117B huwa konformi mad-Direttiva 2014/53/UE.

It-test kollu tad-dikjarazzjoni ta' konformità tal-UE huwa disponibbli f'dan l-indirizz tal-Internet li ġej:

https://www.denso-ten.com/support/regulation/eu_doc/

Funzjoni	Band tal-frekwenza operattiva	I-enerġija massima bi frekwenza tar-radju
Bluetooth	2402 - 2480 MHz	5.02 mW e.i.r.p.

Hierbij verklaar ik, DENSO TEN Limited, dat het type radioapparatuur FT0117B conform is met Richtlijn 2014/53/EU.

De volledige tekst van de EU-conformiteitsverklaring kan worden geraadpleegd op het volgende internetadres:

https://www.denso-ten.com/support/regulation/eu_doc/

Functie	Actieve frequentieband	Maximale radiofrequentie
Bluetooth	2402 - 2480 MHz	5.02 mW e.i.r.p.

DENSO TEN Limited erklærer herved at radioutstyrstypen FT0117B er i samsvar med direktiv 2014/53/EU.

Den fullstendige teksten i EU-erklæringen er tilgjengelig på følgende internettadresse:

https://www.denso-ten.com/support/regulation/eu_doc/

Funksjon	Driftsfrekvensbånd	Maksimal radiofrekvent strøm
Bluetooth	2402 - 2480 MHz	5.02 mW e.i.r.p.

DENSO TEN Limited niniejszym oświadcza, że typ urządzenia radiowego FT0117B jest zgodny z dyrektywą 2014/53/UE.

Pełny tekst deklaracji zgodności UE jest dostępny pod następującym adresem internetowym:

https://www.denso-ten.com/support/regulation/eu_doc/

Funkcja	Pasmo częstotliwości pracy	Maksymalna moc częstotliwości radiowej
Bluetooth	2402 - 2480 MHz	5.02 mW e.i.r.p.

O(a) abaixo assinado(a) DENSO TEN Limited declara que o presente tipo de equipamento de rádio FT0117B está em conformidade com a Diretiva 2014/53/UE.

O texto integral da declaração de conformidade está disponível no seguinte endereço de Internet:

https://www.denso-ten.com/support/regulation/eu_doc/

Função	Faixa de frequência operacional	Potência máxima de radiofrequência
Bluetooth	2402 - 2480 MHz	5.02 mW e.i.r.p.

Prin prezenta, DENSO TEN Limited declară că tipul de echipamente radio FT0117B este în conformitate cu Directiva 2014/53/UE.

Textul integral al declarației UE de conformitate este disponibil la următoarea adresă internet:

https://www.denso-ten.com/support/regulation/eu_doc/

Funcție	Bandă de frecvență activă	Puterea maximă a radio-frecvenței
Bluetooth	2402 - 2480 MHz	5.02 mW e.i.r.p.

DENSO TEN Limited, FT0117B türü telsiz ekipmanının 2014/53/EU Direktifine uygun olduğunu beyan etmektedir.

AB uygunluk beyanının tam metnine aşağıdaki internet adresinden ulaşılabilir:

https://www.denso-ten.com/support/regulation/eu_doc/

İşlev	Çalışma frekans bandı	Maksimum radyo-frekans gücü
Bluetooth	2402 - 2480 MHz	5.02 mW e.i.r.p.

GAS STATION INFORMATION		
Auxiliary catch lever P. 484	Fuel filler door* P. 263	
Hood lock release lever P. 484	Fuel filler door opener* P. 263	Tire inflation pressure P. 639
Fuel tank capacity (Reference)	80 L (21.1 gal., 17.6 Imp.gal.)	
Fuel type	P. 627	
Cold tire inflation pressure	P. 639	
Engine oil capacity (Drain and refill — reference)	P. 628	
Engine oil type	P. 628	

*: If equipped