





## Your Operator's Manual

-  **Digital form inside the vehicle**  
Familiarize yourself with the contents of the Operator's Manual directly via your vehicle's multimedia system (Menu item "Vehicle").
-  **Booklet inside the vehicle**  
In addition to the vehicle's Operator's Manual, you can obtain the complete multimedia system Supplement from your authorized Mercedes-Benz Center.
-  **Digital form via the Internet**  
You can find the Operator's Manual on the Mercedes-Benz homepage.
-  **Digital form as an App**  
The Mercedes-Benz Guides App is available for free on the Apple® App store or Google Play.

Apple® iOS



Android™



# GLE

Operator's Manual



1665843808

Order no. P166 0444 13 Part no. 166 584 38 08 Edition A 2018

GLE Operator's Manual

Mercedes-Benz



## Symbols

Registered trademarks:

- Bluetooth® is a registered trademark of Bluetooth SIG Inc.
- DTSTM is a registered trademark of DTS, Inc.
- Dolby® and MLP™ are registered trademarks of DOLBY Laboratories.
- BabySmart™, ESP® and PRE-SAFE® are registered trademarks of Daimler AG.
- HomeLink® is a registered trademark of Johnson Controls.
- iPod® and iTunes® are registered trademarks of Apple Inc.
- Logic7® is a registered trademark of Harman International Industries.
- Microsoft® and Windows media® are registered trademarks of Microsoft Corporation.
- SIRIUS® is a registered trademark of Sirius XM Radio Inc.
- HD Radio™ is a registered trademark of iBiquity Digital Corporation.
- Gracenote® is a registered trademark of Gracenote, Inc.
- ZAGAT Survey® and related brands are registered trademarks of Zagat Survey, LLC.

In this Operator's Manual you will find the following symbols:

### **WARNING**

Warning notes make you aware of dangers which could pose a threat to your health or life, or to the health and life of others.

### **Environmental note**

Environmental notes provide you with information on environmentally aware actions or disposal.

 Notes on material damage alert you to dangers that could lead to damage to your vehicle.

 Practical tips or further information that could be helpful to you.

- ▶ This symbol indicates an instruction that must be followed.
- ▶ Several of these symbols in succession indicate an instruction with several steps.

 This symbol tells you where you can find more information about a topic.

 This symbol indicates a warning or an instruction that is continued on the next page.

 **Display** This text indicates a message on the multifunction display/multimedia display.

## Publication details

### Internet

Further information about Mercedes-Benz vehicles and about Daimler AG can be found on the following websites:

<http://www.mbusa.com> (USA only)

<http://www.mercedes-benz.ca> (Canada only)

### Editorial office

You are welcome to forward any queries or suggestions you may have regarding this Operator's Manual to the technical documentation team at the following address:

Customer Assistance Center

Mercedes-Benz USA, LLC

3 Mercedes Drive

Montvale, NJ 07645-0350

©Daimler AG: not to be reprinted, translated or otherwise reproduced, in whole or in part, without written permission from Daimler AG.

### Vehicle manufacturer

Daimler AG

Mercedesstraße 137

70327 Stuttgart

Germany

## Welcome to the world of Mercedes-Benz

We urge you to read this Operator's Manual carefully and familiarize yourself with the vehicle before driving. For your own safety and a longer vehicle life, follow the instructions and warning notices in this Operator's Manual. Ignoring them could result in damage to the vehicle or personal injury to you or others.

Vehicle damage caused by failure to follow instructions is not covered by the Mercedes-Benz Limited Warranty.

The equipment or product designation of your vehicle may vary depending on:

- Model
- Order
- Country specification
- Availability

Mercedes-Benz therefore reserves the right to introduce changes in the following areas:

- Design
- Equipment
- Technical features

The equipment in your vehicle may therefore differ from that shown in the descriptions and illustrations.

The following are integral components of the vehicle:

- Digital Operator's Manual
- Printed Operator's Manual
- Maintenance Booklet
- Equipment-dependent supplements

Keep these documents in the vehicle at all times. If you sell the vehicle, always pass all documents on to the new owner.

### Your Operator's Manual:

#### Digital form inside the vehicle

The Digital Operator's Manual provides comprehensive and specifically adapted information on your vehicle's equipment and multimedia system. It contains informative animations, individual language settings and an intuitive search function.

#### Booklet inside the vehicle

In addition to this manual and the aforementioned digital media, you also have the option to obtain a comprehensive printed version of the Supplement for your multimedia system from your authorized Mercedes-Benz Center.

#### Digital form via the Internet

The Operator's Manual on the Internet provides easy access to all information regarding your vehicle and multimedia system. It also provides helpful animations, interesting background information and a wide array of search options.

#### Digital form as an App

Using the Mercedes-Benz Guides App, you can view all the information on your vehicle and multimedia system via mobile Internet or download it independently of network access. Available for smartphones or tablets.

You can also use the Mercedes-Benz Guides App:



Apple® iOS



Android™

Please note that the Mercedes-Benz Guides App may not yet be available in your country.

Mercedes-Benz USA, LLC

Mercedes-Benz Canada, Inc.

A Daimler Company

<b>Index</b> .....	<b>4</b>	Memory function .....	108
<b>Digital Operator's Manual</b> .....	<b>26</b>	<b>Lights and windshield wipers</b> .....	<b>110</b>
Introduction .....	26	Exterior lighting .....	110
Operation .....	26	Interior lighting .....	114
<b>Introduction</b> .....	<b>27</b>	Replacing bulbs (vehicles with LED headlamps) .....	115
Protecting the environment .....	27	Replacing bulbs (vehicles with halogen headlamps) .....	115
Genuine Mercedes-Benz parts .....	27	Windshield wipers .....	117
Operator's Manual .....	28	<b>Climate control</b> .....	<b>122</b>
Service and vehicle operation .....	28	Overview of climate control systems ...	122
Operating safety .....	30	Operating the climate control systems .....	127
QR codes for the rescue card .....	32	Setting the air vents .....	132
Data stored in the vehicle .....	32	<b>Driving and parking</b> .....	<b>134</b>
Information on copyright .....	35	Notes on breaking-in a new vehicle ....	134
<b>At a glance</b> .....	<b>36</b>	Driving .....	134
Cockpit .....	36	DYNAMIC SELECT controller .....	142
Instrument cluster .....	37	Automatic transmission .....	143
Multifunction steering wheel .....	38	Refueling .....	150
Center console .....	39	Parking .....	156
Overhead control panel .....	42	Driving tips .....	159
Door control panel .....	43	Driving systems .....	169
<b>Safety</b> .....	<b>44</b>	Towing a trailer .....	219
Panic alarm .....	44	Bicycle rack .....	225
Occupant safety .....	44	<b>On-board computer and displays</b> ....	<b>228</b>
Children in the vehicle .....	59	Important safety notes .....	228
Pets in the vehicle .....	65	Displays and operation .....	228
Driving safety systems .....	66	Menus and submenus .....	231
Protection against theft .....	75	Display messages .....	243
<b>Opening and closing</b> .....	<b>77</b>	Warning and indicator lamps in the instrument cluster .....	274
SmartKey .....	77	<b>Multimedia system</b> .....	<b>287</b>
Doors .....	83	General notes .....	287
Cargo compartment .....	84	Important safety notes .....	287
Side windows .....	88	Function restrictions .....	287
Sliding sunroof .....	92	Operating system .....	288
<b>Seats, steering wheel and mirrors</b> ....	<b>97</b>	<b>Stowage and features</b> .....	<b>295</b>
Correct driver's seat position .....	97	Stowage areas .....	295
Seats .....	97		
Steering wheel .....	103		
Mirrors .....	105		

Features ..... 304

---

**Maintenance and care ..... 321**

Engine compartment ..... 321

ASSYST PLUS ..... 325

Care ..... 326

---

**Breakdown assistance ..... 334**

Where will I find...? ..... 334

Flat tire ..... 335

Battery (vehicle) ..... 340

Jump-starting ..... 342

Towing and tow-starting ..... 345

Fuses ..... 348

---

**Wheels and tires ..... 351**

Important safety notes ..... 351

Operation ..... 351

Winter operation ..... 353

Tire pressure ..... 354

Loading the vehicle ..... 361

All about wheels and tires ..... 364

Changing a wheel ..... 371

Wheel and tire combinations ..... 376

Emergency spare wheel ..... 376

---

**Technical data ..... 381**

Information regarding technical data ... 381

Vehicle electronics ..... 381

Identification plates ..... 382

Service products and filling capaci-

ties ..... 383

Vehicle data ..... 390

Vehicle data for off-road driving ..... 392

Trailer tow hitch ..... 394

## 1, 2, 3 ...

**4ETS (Electronic Traction System)**

see ETS/4ETS (Electronic Traction System)

**4MATIC (permanent four-wheel**

**drive)** ..... 213

**12 V socket**

see Sockets

**115 V socket** ..... 308

**360° camera**

Cleaning ..... 330

Display in the multimedia system .. 200

Function/notes ..... 198

**A****ABS (Anti-lock Braking System)**

Display message ..... 244

Function/notes ..... 66

Important safety notes ..... 66

Warning lamp ..... 277

**Accident**

Automatic measures after an accident ..... 59

**Activating media mode**

General notes ..... 293

**Activating/deactivating cooling**

**with air dehumidification** ..... 127

**Active Blind Spot Assist**

Activating/deactivating (on-board computer) ..... 237

Display message ..... 264

Function/information ..... 208

Trailer towing ..... 210

**Active Brake Assist**

Activating or deactivating ..... 237

Display message ..... 249

Function/notes ..... 67

**Active Brake Assist with cross-traffic function**

Activating or deactivating ..... 237

Display message ..... 250

Function/notes ..... 72

Important safety notes ..... 73

Warning lamp ..... 285

**Active Curve System**

Display message ..... 261

Function/notes ..... 184

**Active Lane Keeping Assist**

Activating/deactivating (on-board computer) ..... 237

Display message ..... 263

Function/information ..... 210

Trailer towing ..... 213

**Active light function** ..... 112

**ADAPTIVE BRAKE** ..... 72

**Adaptive Damping System**

see ADS (Adaptive Damping System)

**Adaptive Highbeam Assist**

Display message ..... 256

Function/notes ..... 113

Switching on/off ..... 114

**Additives (engine oil)** ..... 388

**Address book**

see also Digital Operator's Manual ..... 287

**Adjusting the volume**

Multimedia system ..... 288

**ADS (Adaptive Damping System)**

Function/notes ..... 183

**Air bags**

Deployment ..... 56

Display message ..... 253

Front air bag (driver, front passenger) ..... 50

Important safety notes ..... 49

Introduction ..... 49

Knee bag ..... 50

Occupant Classification System (OCS) ..... 51

PASSENGER AIR BAG indicator lamps ..... 45

Side impact air bag ..... 51

Window curtain air bag ..... 51

**Air filter (display message)** ..... 259

**AIR FLOW** ..... 128

**Air vents**

Glove box ..... 132

Important safety notes ..... 132

Rear ..... 133

Setting ..... 132

Setting the center air vents ..... 132

Setting the side air vents ..... 132

- Air-conditioning system**  
see Climate control
- AIRMATIC package**  
ADS (Adaptive Damping System) ... 183  
Function/notes ..... 183
- Alarm**  
ATA (Anti-Theft Alarm system) ..... 75  
Switching off (ATA) ..... 75  
Switching the function on/off (ATA) ..... 75
- Alarm system**  
see ATA (Anti-Theft Alarm system)
- AMG**  
Adaptive sport suspension system ..... 186
- AMG menu (on-board computer) .... 240**
- Anti-lock braking system**  
see ABS (Anti-lock Braking System)
- Anti-skid chains**  
see Snow chains
- Anti-Theft Alarm system**  
see ATA (Anti-Theft Alarm system)
- Approach/departure angle ..... 168**
- Ashtray ..... 307**
- Assistance display (on-board computer) ..... 236**
- Assistance menu (on-board computer) ..... 236**
- ASSYST PLUS**  
Displaying a service message ..... 325  
Hiding a service message ..... 325  
Resetting the service interval display ..... 325  
Service message ..... 325  
Special service requirements ..... 326
- ATA (Anti-Theft Alarm system)**  
Activating/deactivating ..... 75  
Function ..... 75  
Switching off the alarm ..... 75
- ATTENTION ASSIST**  
Activating/deactivating ..... 237  
Display message ..... 260  
Function/notes ..... 202
- Audio menu (on-board computer) .... 234**
- Authorized Mercedes-Benz Center**  
see Qualified specialist workshop
- Authorized workshop**  
see Qualified specialist workshop
- AUTO lights**  
Display message ..... 255  
see Lights
- Automatic car wash (care) ..... 326**
- Automatic engine start (ECO start/stop function) ..... 140**
- Automatic engine switch-off (ECO start/stop function) ..... 139**
- Automatic headlamp mode ..... 110**
- Automatic transmission**  
Accelerator pedal position ..... 146  
Changing gear ..... 146  
DIRECT SELECT lever ..... 143  
Display message ..... 270  
Drive program ..... 146  
Drive program display ..... 145  
Driving tips ..... 146  
DYNAMIC SELECT controller ..... 142  
Emergency running mode ..... 150  
Engaging drive position ..... 145  
Engaging neutral ..... 144  
Engaging park position automatically ..... 144  
Engaging reverse gear ..... 144  
Engaging the park position ..... 144  
Important safety notes ..... 143  
Kickdown ..... 146  
Manual shifting ..... 147  
Oil temperature (on-board computer, Mercedes-AMG vehicles) .... 240  
Overview ..... 143  
Problem (malfunction) ..... 150  
Pulling away ..... 138  
Starting the engine ..... 137  
Steering wheel paddle shifters ..... 147  
Trailer towing ..... 146  
Transmission position display ..... 145  
Transmission positions ..... 145
- Automatic transmission emergency mode ..... 150**
- AUX jacks**  
CD/DVD drive ..... 294
- Axle load, permissible (trailer towing) ..... 394**

- B**
- Back button** ..... 288
- Bag hook** ..... 300
- Ball coupling**  
 Installing ..... 221  
 Removing ..... 224
- BAS (Brake Assist System)** ..... 67
- Battery (SmartKey)**  
 Checking ..... 80  
 Important safety notes ..... 80  
 Replacing ..... 80
- Battery (vehicle)**  
 Charging ..... 342  
 Display message ..... 257  
 Important safety notes ..... 340  
 Jump starting ..... 342  
 Overview ..... 340
- Belt**  
 see Seat belts
- Belt warning** ..... 48
- Bicycle rack** ..... 225
- Blind Spot Assist**  
 Activating/deactivating ..... 237  
 Display message ..... 264  
 Notes/function ..... 204  
 Trailer towing ..... 206  
 see Active Blind Spot Assist
- BlueTEC**  
 Adding DEF ..... 153
- BlueTEC (DEF)** ..... 386
- Bluetooth®**  
 Searching for a mobile phone ..... 291  
 Searching for a mobile phone  
 (device manager) ..... 292  
 see also Digital Operator's Manual ..... 287  
 Telephony ..... 291
- Brake Assist**  
 see BAS (Brake Assist System)
- Brake fluid**  
 Display message ..... 249  
 Notes ..... 388
- Brake force distribution**  
 see EBD (electronic brake force  
 distribution)
- Brake lamps**  
 Display message ..... 255
- Brake linings**  
 Display message ..... 249
- Brakes**  
 ABS ..... 66  
 BAS ..... 67  
 Brake fluid (notes) ..... 388  
 Braking assistance appropriate to  
 the situation ..... 69  
 Display message ..... 244  
 High-performance brake system .... 163  
 Hill start assist ..... 139  
 Important safety notes ..... 161  
 Maintenance ..... 162  
 Parking brake ..... 157  
 Riding tips ..... 161  
 Warning lamp ..... 276
- Braking assistance appropriate to  
 the situation**  
 Function/notes ..... 69
- Breakdown**  
 Where will I find...? ..... 334  
 see Flat tire  
 see Towing away
- Brightness control (instrument  
 cluster lighting)** ..... 37
- Bulbs**  
 see Replacing bulbs
- C**
- California**  
 Important notice for retail cus-  
 tomers and lessees ..... 28
- Calling up a malfunction**  
 see Display messages
- Car**  
 see Vehicle
- Care**  
 360° camera ..... 330  
 Car wash ..... 326  
 Carpets ..... 333  
 Display ..... 331  
 Exhaust pipe ..... 330  
 Exterior lights ..... 329  
 Gear or selector lever ..... 332  
 Interior ..... 331  
 Matte finish ..... 328  
 Notes ..... 326



Paint .....	328	<b>Child-proof locks</b>	
Plastic trim .....	331	Important safety notes .....	64
Power washer .....	327	Rear doors .....	65
Rear view camera .....	330	<b>Children</b>	
Roof lining .....	333	Special seat belt retractor .....	60
Seat belt .....	332	<b>Children in the vehicle</b>	
Seat cover .....	332	Important safety notes .....	59
Sensors .....	330	<b>Cigarette lighter</b> .....	307
Side running board .....	330	<b>Cleaning</b>	
Steering wheel .....	332	Mirror turn signal .....	330
Trim pieces .....	332	Trailer tow hitch .....	331
Washing by hand .....	327	<b>Climate control</b>	
Wheels .....	329	Automatic climate control (3-	
Windows .....	329	zone) .....	125
Wiper blades .....	329	Controlling automatically .....	128
Wooden trim .....	332	Cooling with air dehumidification ..	127
<b>Cargo compartment cover</b>		Defrosting the windows .....	130
Notes/how to use .....	300	Defrosting the windshield .....	129
<b>Cargo compartment enlargement</b>		Dual-zone automatic climate con-	
Important safety notes .....	298	trol .....	123
<b>Cargo compartment floor</b>		General notes .....	122
Important safety notes .....	302	Indicator lamp .....	128
Opening/closing .....	303	Ionization .....	131
Stowage well (under) .....	302	Maximum cooling .....	130
<b>Cargo net</b>		Notes on using the automatic cli-	
Attaching .....	301	mate control .....	127
Important safety information .....	301	Overview of systems .....	122
<b>Cargo tie down rings</b> .....	299	Problem with the rear window	
<b>CD</b>		defroster .....	131
see also Digital Operator's Man-		Problems with cooling with air	
ual .....	287	dehumidification .....	128
<b>CD player (on-board computer)</b> .....	234	Rear control panel .....	125
<b>Center console</b>		Refrigerant .....	389
Lower section .....	40	Refrigerant filling capacity .....	390
Upper section .....	39	Setting the air distribution .....	129
<b>Central locking</b>		Setting the air vents .....	132
Automatic locking (on-board com-		Setting the airflow .....	129
puter) .....	239	Setting the climate mode (AIR	
Locking/unlocking (SmartKey) .....	77	FLOW) .....	128
<b>Child</b>		Setting the temperature .....	128
Restraint system .....	61	Switching air-recirculation mode	
<b>Child seat</b>		on/off .....	131
Forward-facing restraint system .....	64	Switching on/off .....	127
LATCH-type (ISOFIX) child seat		Switching residual heat on/off .....	131
anchors .....	62	Switching the rear window	
On the front-passenger seat .....	63	defroster on/off .....	130
Rearward-facing restraint system ....	64	Switching the ZONE function	
Top Tether .....	62	on/off .....	129

- Coat hooks** ..... 302
- Cockpit**  
 Overview ..... 36  
 see Instrument cluster
- Collapsible spare wheel**  
 Inflating ..... 379  
 see Emergency spare wheel
- COMAND**  
 Driving dynamics display ..... 218
- COMAND display**  
 Cleaning ..... 331
- Combination switch** ..... 111
- Connecting a USB device**  
 see also Digital Operator's Manual ..... 287
- Consumption statistics (on-board computer)** ..... 231
- Controller** ..... 288
- Convenience closing feature** ..... 90
- Convenience opening feature** ..... 89
- Coolant (engine)**  
 Checking the level ..... 324  
 Display message ..... 256  
 Filling capacity ..... 389  
 Important safety notes ..... 388  
 Temperature (on-board computer, Mercedes-AMG vehicles) ..... 240  
 Temperature gauge ..... 229  
 Warning lamp ..... 283
- Cooling**  
 see Climate control
- Copyright** ..... 35
- Cornering light function**  
 Display message ..... 255
- Crash-responsive emergency lighting** ..... 115
- Crosswind Assist** ..... 72
- Crosswind driving assistance** ..... 72
- Cruise control**  
 Activating ..... 170  
 Activation conditions ..... 170  
 Cruise control lever ..... 170  
 Deactivating ..... 171  
 Display message ..... 266  
 Driving system ..... 169  
 Function/notes ..... 169  
 Important safety notes ..... 169  
 Storing and maintaining current speed ..... 170
- Cup holder**  
 Center console ..... 305  
 Important safety notes ..... 304  
 Rear compartment ..... 305  
 Temperature controlled ..... 305
- Customer Assistance Center (CAC)** ..... 31
- Customer Relations Department** ..... 31
- D**
- Dashboard**  
 see Instrument cluster
- Data**  
 see Technical data
- Data carrier**  
 Selecting ..... 234
- Daytime running lamps**  
 Display message ..... 255  
 Function/notes ..... 110  
 Switching on/off (on-board computer) ..... 238
- Declarations of conformity** ..... 30
- DEF**  
 Adding ..... 153  
 Display message ..... 259  
 Filling capacity ..... 387  
 Important safety notes ..... 386
- Diagnostics connection** ..... 31
- Differential lock (display message)** ..... 262
- Digital Operator's Manual**  
 Help ..... 26  
 Introduction ..... 26
- Digital speedometer** ..... 232
- DIRECT SELECT lever**  
 Automatic transmission ..... 143
- Display messages**  
 ASSYST PLUS ..... 325  
 Calling up (on-board computer) ..... 243  
 Driving systems ..... 260  
 Engine ..... 256  
 General notes ..... 243  
 Hiding (on-board computer) ..... 243  
 KEYLESS-GO ..... 273  
 Lights ..... 255

- Safety systems ..... 244
- SmartKey ..... 273
- Tires ..... 268
- Vehicle ..... 270
- Distance Pilot DISTRONIC**
  - Activating ..... 173
  - Activation conditions ..... 173
  - Cruise control lever ..... 173
  - Display Message ..... 265
  - Displays in the instrument cluster .. 176
  - Driving tips ..... 177
  - Function/notes ..... 171
  - Important safety notes ..... 171
  - Setting the specified minimum distance ..... 175
  - Stopping ..... 174
  - Switching off ..... 175
  - Warning lamp ..... 285
- Distance recorder**
  - see Odometer
  - see Trip odometer
- Distance warning (warning lamp) ....** 285
- Distance warning function**
  - Function/notes ..... 68
  - Warning lamp ..... 285
- Doors**
  - Automatic locking (on-board computer) ..... 239
  - Automatic locking (switch) ..... 84
  - Central locking/unlocking (SmartKey) ..... 77
  - Control panel ..... 43
  - Display message ..... 272
  - Emergency locking ..... 84
  - Emergency unlocking ..... 84
  - Important safety notes ..... 83
  - Opening (from inside) ..... 83
  - Overview ..... 83
  - Power closing ..... 84
- Downhill speed regulation**
  - see DSR (Downhill Speed Regulation)
- Drinking and driving** ..... 160
- Drive program**
  - Automatic transmission ..... 146
  - Off-Road program (vehicles without Off-Road Engineering package) ..... 214
  - Off-road programs (vehicles with Off-Road Engineering package) ..... 215
  - SETUP (on-board computer, Mercedes-AMG vehicles) ..... 241
- Drive programs**
  - Display (DIRECT SELECT lever) ..... 145
- Driver's door**
  - see Doors
- Driving**
  - Important safety notes ..... 134
- Driving abroad**
  - Mercedes-Benz Service ..... 326
- Driving Assistance PLUS package ...** 208
- Driving in mountainous terrain**
  - Approach/departure angle ..... 168
- Driving lamps**
  - see Daytime running lamps
- Driving off-road**
  - see Off-road driving
- Driving safety system**
  - Active Brake Assist ..... 67
  - Braking assistance appropriate to the situation ..... 69
- Driving safety systems**
  - ABS (Anti-lock Braking System) ..... 66
  - Active Brake Assist with cross-traffic function ..... 72
  - ADAPTIVE BRAKE ..... 72
  - BAS (Brake Assist System) ..... 67
  - Distance warning function ..... 68
  - EBD (electronic brake force distribution) ..... 72
  - ESP® (Electronic Stability Program) ..... 70
  - Important safety information ..... 66
  - Overview ..... 66
  - STEER CONTROL ..... 75
- Driving system**
  - AIRMATIC package ..... 183
  - Distance Pilot DISTRONIC ..... 171
  - Distance Pilot DISTRONIC with Steering Pilot ..... 177
  - Parking assist PARKTRONIC ..... 187
  - Parking Pilot ..... 190
- Driving systems**
  - 360° camera ..... 198
  - Active Blind Spot Assist ..... 208
  - Active Curve System ..... 184

- Active Lane Keeping Assist ..... 210
- ADS ..... 183
- AMG adaptive sport suspension system ..... 186
- ATTENTION ASSIST ..... 202
- Blind Spot Assist ..... 204
- Cruise control ..... 169
- Display message ..... 260
- Driving Assistance Plus package ... 208
- HOLD function ..... 182
- Lane Keeping Assist ..... 206
- Level control (vehicle with the Off-Road Engineering package) ..... 179
- Rear view camera ..... 194
- Traffic Sign Assist ..... 203
- Driving tips**
  - Automatic transmission ..... 146
  - Brakes ..... 161
  - Break-in period ..... 134
  - Distance Pilot DISTRONIC ..... 177
  - Downhill gradient ..... 161
  - Drinking and driving ..... 160
  - Driving in winter ..... 164
  - Driving on flooded roads ..... 163
  - Driving on sand ..... 167
  - Driving on wet roads ..... 163
  - Driving over obstacles ..... 168
  - Exhaust check ..... 160
  - Fuel ..... 159
  - General ..... 159
  - Hydroplaning ..... 163
  - Icy road surfaces ..... 164
  - Limited braking efficiency on salted roads ..... 162
  - Off-road driving ..... 165
  - Off-road fording ..... 164
  - Snow chains ..... 353
  - The first 1000 miles (1500 km) .... 134
  - Tire ruts ..... 167
  - Towing a trailer ..... 220
  - Traveling uphill ..... 168
  - Wet road surface ..... 162
- DSR (Downhill Speed Regulation)**
  - Display message ..... 262
  - Function/notes ..... 213
- DVD video**
  - Operating (on-board computer) .... 234
- see also Digital Operator's Manual ..... 287
- DYNAMIC SELECT controller**
  - Automatic transmission ..... 142
- E**
- EASY-ENTRY feature**
  - Activating/deactivating ..... 239
  - Function/notes ..... 104
- EASY-EXIT feature**
  - Crash-responsive ..... 105
  - Function/notes ..... 104
  - Switching on/off ..... 239
- EASY-PACK cargo compartment management system** ..... 302
- EBD (electronic brake force distribution)**
  - Display message ..... 246
  - Function/notes ..... 72
- ECO display**
  - Function/notes ..... 160
  - On-board computer ..... 232
- ECO start/stop function**
  - Automatic engine start ..... 140
  - Automatic engine switch-off ..... 139
  - Deactivating/activating ..... 140
  - General information ..... 139
  - Important safety notes ..... 139
  - Introduction ..... 139
- Electronic Stability Program**
  - see ESP® (Electronic Stability Program)
- Emergency**
  - Automatic measures after an accident ..... 59
- Emergency release**
  - Driver's door ..... 84
  - Vehicle ..... 84
- Emergency spare wheel**
  - General notes ..... 377
  - Important safety notes ..... 376
  - Removing ..... 377
  - Storage location ..... 377
  - Stowing ..... 377
- Emergency Tensioning Devices**
  - Activation ..... 56
- Emergency unlocking**
  - Tailgate ..... 88

- Emissions control**  
 Service and warranty information .... 28
- Engine**  
 Check Engine warning lamp ..... 283  
 Display message ..... 256  
 ECO start/stop function ..... 139  
 Engine number ..... 383  
 Irregular running ..... 141  
 Jump-starting ..... 342  
 Starting (important safety notes) ... 136  
 Starting problems ..... 141  
 Starting the engine with the  
 SmartKey ..... 137  
 Starting via smartphone ..... 137  
 Starting with KEYLESS-GO ..... 137  
 Switching off ..... 157  
 Tow-starting (vehicle) ..... 348
- Engine electronics**  
 Problem (malfunction) ..... 141
- Engine jump starting**  
 see Jump starting (engine)
- Engine oil**  
 Adding ..... 323  
 Additives ..... 388  
 Checking the oil level ..... 322  
 Checking the oil level using the  
 dipstick ..... 323  
 Display message ..... 258  
 Filling capacity ..... 387  
 Notes about oil grades ..... 387  
 Notes on oil level/consumption .... 322  
 Temperature (on-board computer,  
 Mercedes-AMG vehicles) ..... 240
- Engine switch-off**  
 see ECO start/stop function
- Entering an address**  
 see also Digital Operator's Man-  
 ual ..... 287
- ESP® (Electronic Stability Pro-  
 gram)**  
 AMG menu (on-board computer) ... 241  
 Characteristics ..... 70  
 Deactivating/activating ..... 71  
 Display message ..... 244  
 Function/notes ..... 70  
 General notes ..... 70  
 Important safety information ..... 70  
 Warning lamp ..... 279
- ETS/4ETS (Electronic Traction Sys-  
 tem) ..... 70**
- Exhaust check ..... 160**
- Exhaust pipe (cleaning instruc-  
 tions) ..... 330**
- Exterior lighting**  
 see Lights
- Exterior mirrors**  
 Adjusting ..... 105  
 Dipping (automatic) ..... 107  
 Folding in when locking (on-board  
 computer) ..... 240  
 Folding in/out (automatically) ..... 106  
 Folding in/out (electrically) ..... 106  
 Out of position (troubleshooting) ... 107  
 Setting ..... 106  
 Storing settings (memory func-  
 tion) ..... 108  
 Storing the parking position ..... 107
- Eyeglasses compartment ..... 297**
- F**
- Favorites**  
 Overview ..... 289
- Filler cap**  
 see Refueling
- Flat tire**  
 MOExtended tires ..... 336  
 Preparing the vehicle ..... 335  
 TIREFIT kit ..... 337  
 see Emergency spare wheel
- Floor mats ..... 319**
- Fog lamps (extended range) ..... 113**
- Folding the rear bench seat for-  
 wards/back ..... 298**
- Fording**  
 Off-road ..... 164  
 On flooded roads ..... 163
- Frequencies**  
 Mobile phone ..... 381  
 Two-way radio ..... 381
- Fuel**  
 Additives ..... 385  
 Consumption statistics ..... 231  
 Displaying the current consump-  
 tion ..... 232  
 Displaying the range ..... 232

Driving tips .....	159
Flexible fuel vehicles .....	386
Fuel gauge .....	37
Grade (gasoline) .....	384
Important safety notes .....	384
Low outside temperatures .....	385
Problem (malfunction) .....	153
Quality (diesel) .....	385
Refueling .....	150
Tank content/reserve fuel .....	384
<b>Fuel filler flap</b>	
Opening .....	152
<b>Fuel filter (display message)</b> .....	259
<b>Fuel level</b>	
Calling up the range (on-board computer) .....	232
<b>Fuel tank</b>	
Capacity .....	384
Problem (malfunction) .....	153
<b>Fuses</b>	
Allocation chart .....	348
Before changing .....	348
Dashboard fuse box .....	349
Fuse box in the engine compartment .....	349
Fuse box under rear bench seat ....	350
Important safety notes .....	348

## G

<b>Garage door opener</b>	
Clearing the memory .....	319
General notes .....	316
Important safety notes .....	317
Opening/closing the garage door ..	319
Problems when programming .....	318
Programming (button in the rear-view mirror) .....	317
Synchronizing the rolling code .....	318
<b>Gear indicator (on-board computer, Mercedes-AMG vehicles)</b> .....	240
<b>Genuine parts</b> .....	27
<b>Glove box</b> .....	296
<b>Google™ Local Search</b>	
see also Digital Operator's Manual .....	287
<b>GTW (Gross Trailer Weight) (definition)</b> .....	370

## H

<b>Handbrake</b>	
see Parking brake	
<b>Hazard warning lamps</b> .....	112
<b>Head restraints</b>	
Adjusting .....	99
Adjusting (electrically) .....	100
Adjusting (manually) .....	99
Adjusting (rear) .....	100
Installing/removing (rear) .....	100
Luxury .....	100
<b>Headlamps</b>	
Fogging up .....	114
see Automatic headlamp mode	
<b>Heating</b>	
see Climate control	
<b>High beam flasher</b> .....	111
<b>High-beam headlamps</b>	
Adaptive Highbeam Assist .....	113
Display message .....	255
Replacing bulbs .....	116
Switching on/off .....	111
<b>Highway mode</b> .....	113
<b>Hill start assist</b> .....	139
<b>HOLD function</b>	
Deactivating .....	182
Display message .....	263
Function/notes .....	182
<b>Home address</b>	
see also Digital Operator's Manual .....	287
<b>Hood</b>	
Closing .....	322
Display message .....	272
Important safety notes .....	321
Opening .....	321
<b>Horn</b> .....	36
<b>Hydroplaning</b> .....	163

## I

<b>Ignition lock</b>	
see Key positions	
<b>Immobilizer</b> .....	75
<b>Indicator lamps</b>	
see Warning and indicator lamps	

- Indicators**  
see Turn signals
- Insect protection on the radiator** .... 322
- Instrument cluster**  
Overview ..... 37  
Warning and indicator lamps ..... 37
- Instrument cluster lighting** ..... 228
- Intelligent Light System**  
Activating/deactivating ..... 238  
Display message ..... 255  
Overview ..... 112
- Interior lighting**  
Automatic control ..... 114  
Emergency lighting ..... 115  
General notes ..... 114  
Manual control ..... 114  
Overview ..... 114  
Reading lamp ..... 114
- iPod®**  
see also Digital Operator's Manual ..... 287
- J**
- Jack**  
Storage location ..... 335  
Using ..... 373
- Jump starting (engine)** ..... 342
- K**
- Key positions**  
KEYLESS-GO ..... 135  
SmartKey ..... 135
- KEYLESS-GO**  
Activating ..... 78  
Convenience closing feature ..... 91  
Deactivation ..... 78  
Display message ..... 273  
Locking ..... 78  
Removing the Start/Stop button ... 136  
Start function ..... 79  
Start/Stop button ..... 135  
Starting the engine ..... 137  
Unlocking ..... 78
- Kickdown**  
Driving tips ..... 146  
Manual gearshifting ..... 149
- Knee bag** ..... 50
- L**
- Lamps**  
see Warning and indicator lamps
- Lane detection (automatic)**  
see Lane Keeping Assist
- Lane Keeping Assist**  
Activating/deactivating ..... 237  
Display message ..... 263  
Function/information ..... 206  
see Active Lane Keeping Assist
- Lap time (RACETIMER)** ..... 241
- LATCH-type (ISOFIX) child seat anchors** ..... 62
- Level control**  
AIRMATIC ..... 185
- Level control (display message)** ..... 260
- Level control (vehicle with the Off-Road Engineering package)**  
Basic settings ..... 179  
Function/notes ..... 179  
Important safety notes ..... 179
- License plate lamp (display message)** ..... 255
- Light function, active**  
Display message ..... 255
- Light sensor (display message)** ..... 255
- Light switch**  
Operation ..... 110
- Lights**  
Activating/deactivating the Intelligent Light System ..... 238  
Active light function ..... 112  
Adaptive Highbeam Assist ..... 113  
Automatic headlamp mode ..... 110  
Fog lamps (extended) ..... 113  
Hazard warning lamps ..... 112  
High beam flasher ..... 111  
High-beam headlamps ..... 111  
Highway mode ..... 113  
Light switch ..... 110  
Low-beam headlamps ..... 111  
Off-road lights ..... 113  
Parking lamps ..... 111  
Rear fog lamp ..... 111  
Standing lamps ..... 111

- Switching the daytime running lamps on/off (on-board computer) ..... 238
  - Turn signals ..... 111
  - see Interior lighting
  - see Replacing the bulbs
  - Loading guidelines** ..... 295
  - Locking**
    - see Central locking
  - Locking (doors)**
    - Automatic ..... 84
    - Emergency locking ..... 84
    - From inside (central locking button) ..... 83
  - Locking centrally**
    - see Central locking
  - Locking verification signal (on-board computer)** ..... 239
  - LOW RANGE**
    - Display message ..... 262
    - Off-road gear ..... 216
  - LOW RANGE off-road gear** ..... 216
  - Low-beam headlamps**
    - Display message ..... 255
    - Replacing bulbs ..... 116
    - Switching on/off ..... 111
  - Lumbar support**
    - Adjusting (on the seat) ..... 101
  - Luxury head restraints** ..... 100
- 
- M**
- M+S tires** ..... 353
  - Malfunction message**
    - see Display messages
  - Matte finish (cleaning instructions)** ..... 328
  - mbrace**
    - Call priority ..... 313
    - Display message ..... 249
    - Downloading destinations (COMAND) ..... 313
    - Downloading routes ..... 316
    - Emergency call ..... 310
    - General notes ..... 310
    - Geo fencing ..... 316
    - Info call button ..... 312
    - Locating a stolen vehicle ..... 315
    - Remote fault diagnosis ..... 315
    - Remote vehicle locking ..... 314
    - Roadside assistance button ..... 311
    - Search & Send ..... 313
    - Self-test ..... 310
    - Speed alert ..... 316
    - System ..... 310
    - Triggering the vehicle alarm ..... 316
    - Vehicle remote unlocking ..... 314
  - Mechanical key**
    - Function/notes ..... 79
    - General notes ..... 79
    - Inserting ..... 79
    - Locking vehicle ..... 84
    - Removing ..... 79
    - Unlocking the driver's door ..... 84
  - Media Interface**
    - USB port in the armrest of the center console ..... 296
    - see Digital Operator's Manual
  - Memory card (audio)** ..... 234
  - Memory function** ..... 108
  - Mercedes-Benz Intelligent Drive**
    - 360° camera ..... 198
    - Active Blind Spot Assist ..... 208
    - Active Lane Keeping Assist ..... 210
    - ATTENTION ASSIST ..... 202
    - Blind Spot Assist ..... 204
    - Distance Pilot DISTRONIC ..... 171
    - Distance Pilot DISTRONIC with Steering Pilot ..... 177
    - General notes ..... 169
    - Lane Keeping Assist ..... 206
    - Parking Assist PARKTRONIC ..... 187
    - Parking Pilot ..... 190
    - PRE-SAFE® PLUS (anticipatory occupant protection PLUS) ..... 59
    - Rear view camera ..... 194
    - Traffic Sign Assist ..... 203
  - Message memory (on-board computer)** ..... 243
  - Mirror**
    - Vanity mirror (sun visor) ..... 305
  - Mirror turn signal**
    - Cleaning ..... 330
  - Mirrors**
    - see Exterior mirrors



see Rear-view mirror  
see Vanity mirror (in the sun visor)

### Mobile phone

Connecting (Bluetooth® inter-  
face) ..... 291  
Connecting (device manager) ..... 292  
Frequencies ..... 381  
Installation ..... 381  
Menu (on-board computer) ..... 235  
Transmission output (maximum) .... 381

### Modifying the programming

(SmartKey) ..... 79

MOExtended tires ..... 336

### Mounting wheels

Lowering the vehicle ..... 375  
Mounting a new wheel ..... 374  
Preparing the vehicle ..... 372  
Raising the vehicle ..... 373  
Removing a wheel ..... 374  
Securing the vehicle against roll-  
ing away ..... 372

### MP3

Operation ..... 234  
see also Digital Operator's Man-  
ual ..... 287

### Multifunction display

Function/notes ..... 230  
Permanent display ..... 238

### Multifunction steering wheel

Operating the on-board computer .. 229  
Overview ..... 38

### Multimedia system

Switching on and off ..... 288

### Music files

see also Digital Operator's Man-  
ual ..... 287

## N

### Navigation

Entering a destination ..... 289  
Menu (on-board computer) ..... 232  
see also Digital Operator's Man-  
ual ..... 287

### Notes on breaking-in a new vehi- cle

..... 134

## O

### Occupant Classification System (OCS)

Conditions ..... 52  
Faults ..... 55  
Operation ..... 52  
System self-test ..... 54

### Occupant safety

Air bags ..... 49  
Automatic measures after an acci-  
dent ..... 59  
Belt warning ..... 48  
Children in the vehicle ..... 59  
Important safety notes ..... 44  
Introduction to the restraint sys-  
tem ..... 44  
Occupant Classification System  
(OCS) ..... 51  
PASSENGER AIR BAG indicator  
lamps ..... 45  
Pets in the vehicle ..... 65  
PRE-SAFE® (anticipatory occu-  
pant protection) ..... 58  
PRE-SAFE® PLUS (anticipatory  
occupant protection PLUS) ..... 59  
Restraint system warning lamp ..... 45  
Seat belt ..... 45

### OCS

Conditions ..... 52  
Faults ..... 55  
Operation ..... 52  
System self-test ..... 54

Odometer ..... 231

### Off-road driving

Approach/departure angle ..... 393  
Checklist after driving off-road ..... 167  
Checklist before driving off-road .... 166  
Fording depth ..... 392  
General information ..... 165  
Important safety notes ..... 165  
Maximum gradient climbing abil-  
ity ..... 393  
Traveling uphill ..... 168

Off-road lights ..... 113

### Off-Road program (vehicles with- out Off-Road Engineering package)

Function/notes ..... 214

- Off-road programs (vehicles with Off-Road Engineering package)**
    - Function/notes ..... 215
    - Off-road drive program ..... 215
    - Offroad Plus drive program ..... 216
  - Off-road programs (vehicles with the Off-Road Engineering package)**
    - Displays in the COMAND display ... 218
  - Off-road system**
    - 4MATIC ..... 213
    - DSR ..... 213
    - LOW RANGE off-road gear ..... 216
    - Off-road 4ETS ..... 70
    - Off-road ABS ..... 67
    - Off-road ESP® ..... 72
    - Off-road program (vehicles without Off-Road Engineering package) ..... 214
    - Off-road programs (vehicles with Off-Road Engineering package) ..... 215
  - Oil**
    - see Engine oil
  - On and Offroad menu (on-board computer)** ..... 240
  - On-board computer**
    - AMG menu ..... 240
    - Assistance menu ..... 236
    - Audio menu ..... 234
    - Convenience submenu ..... 239
    - Display messages ..... 243
    - Displaying a service message ..... 325
    - Distance Pilot DISTRONIC ..... 176
    - Factory settings submenu ..... 240
    - Important safety notes ..... 228
    - Instrument cluster submenu ..... 238
    - Lighting submenu ..... 238
    - Menu overview ..... 231
    - Message memory ..... 243
    - Navigation menu ..... 232
    - On and Offroad menu ..... 240
    - Operation ..... 229
    - RACETIMER ..... 241
    - Service menu ..... 237
    - Settings menu ..... 238
    - Standard display ..... 231
    - Telephone menu ..... 235
    - Trip menu ..... 231
    - Vehicle submenu ..... 239
    - Video DVD operation ..... 234
  - Operating safety**
    - Declaration of conformity ..... 30
    - Important safety notes ..... 30
  - Operating system**
    - see On-board computer
  - Operation**
    - Digital Operator's Manual ..... 26
  - Operator's Manual**
    - Overview ..... 28
    - Vehicle equipment ..... 28
  - Outside temperature display** ..... 228
  - Overhead control panel** ..... 42
  - Override feature**
    - Rear side windows ..... 65
- P**
- Paddle shifters**
    - see Steering wheel paddle shifters
  - Paint code number** ..... 382
  - Paintwork (cleaning instructions)** ... 328
  - Panic alarm** ..... 44
  - Panorama roof with power tilt/sliding panel**
    - Important safety notes ..... 92
    - Opening/closing the roller sun-blind ..... 95
    - Operating ..... 94
    - Operating the roller sunblinds for the sliding sunroof ..... 94
    - Problem (malfunction) ..... 95
    - Reversing feature ..... 93
  - Parking**
    - Important safety notes ..... 156
    - Parking brake ..... 157
    - Position of exterior mirror, front-passenger side ..... 107
    - Rear view camera ..... 194
    - see PARKTRONIC
  - Parking aid**
    - Parking Pilot ..... 190
    - see 360° camera
    - see Exterior mirrors
    - see PARKTRONIC
  - Parking Assist PARKTRONIC**
    - Deactivating/activating ..... 189
    - Driving system ..... 187

- Function/notes ..... 187
- Important safety notes ..... 187
- Problems (malfunctions) ..... 190
- Sensor range ..... 188
- Towing a trailer ..... 187
- Warning display ..... 189
- Parking assistance**  
see Driving system
- Parking brake**  
Applying automatically ..... 158
- Applying or releasing manually ..... 158
- Display message ..... 246
- Electric parking brake ..... 157
- Emergency braking ..... 159
- General notes ..... 157
- Releasing automatically ..... 158
- Warning lamp ..... 282
- Parking lamps**  
Switching on/off ..... 111
- Parking Pilot**  
Canceling ..... 194
- Detecting parking spaces ..... 191
- Display Message ..... 264
- Exiting a parking space ..... 193
- Function/notes ..... 190
- Important safety notes ..... 190
- Parking ..... 192
- PASSENGER AIR BAG**  
Display message ..... 253
- Indicator lamps ..... 45
- Problem (malfunction) ..... 253
- Pets in the vehicle** ..... 65
- Phone book**  
see also Digital Operator's Manual ..... 287
- Plastic trim (cleaning instructions)** ..... 331
- Power locks** ..... 84
- Power washers** ..... 327
- Power windows**  
see Side windows
- PRE-SAFE® (anticipatory occupant protection)**  
Display message ..... 250
- Operation ..... 58
- PRE-SAFE® PLUS (anticipatory occupant protection PLUS)**  
Display message ..... 250
- Operation ..... 59
- Protection against theft**  
ATA (Anti-Theft Alarm system) ..... 75
- Immobilizer ..... 75
- Protection of the environment**  
General notes ..... 27
- Pulling away**  
Automatic transmission ..... 138
- General notes ..... 138
- Hill start assist ..... 139
- Trailer ..... 138
- Q**
- QR code**  
Mercedes-Benz Guide App ..... 1
- Rescue card ..... 32
- Qualified specialist workshop** ..... 31
- R**
- RACE TIMER (on-board computer, Mercedes-AMG vehicles)** ..... 241
- Radiator cover** ..... 322
- Radio**  
Selecting a station ..... 234
- Radio mode**  
see also Digital Operator's Manual ..... 287
- Radio-controlled devices (installing)** ..... 320
- Radio-wave reception/transmission in the vehicle**  
Declaration of conformity ..... 30
- Reading lamp** ..... 114
- Rear bench seat**  
Folding forwards/back ..... 299
- Rear compartment**  
Setting the air vents ..... 133
- Setting the temperature ..... 128
- Rear fog lamp**  
Display message ..... 255
- Switching on/off ..... 111
- Rear Seat Entertainment System**  
AUX jacks ..... 294

- AUX jacks CD/DVD drive ..... 294
- Rear seats**
  - Adjusting ..... 100
- Rear view camera**
  - Cleaning instructions ..... 330
  - Display in the multimedia system .. 195
  - Function/notes ..... 194
  - Switching on/off ..... 195
- Rear window defroster**
  - Problem (malfunction) ..... 131
  - Switching on/off ..... 130
- Rear window wiper**
  - Replacing the wiper blade ..... 120
  - Switching on/off ..... 118
- Rear-view mirror**
  - Anti-glare (manual) ..... 105
  - Dipping (automatic) ..... 107
- Reflective safety jacket** ..... 334
- Refrigerant (air-conditioning system)**
  - Important safety notes ..... 389
- Refueling**
  - Fuel gauge ..... 37
  - Important safety notes ..... 150
  - Refueling process ..... 151
  - see Fuel
- Remote control**
  - Garage door opener ..... 316
- Replacing bulbs**
  - General notes ..... 115
  - High-beam headlamps ..... 116
  - Important safety notes ..... 115
  - Installing/removing the cover (front wheel arch) ..... 116
  - Low-beam headlamps ..... 116
  - Overview of bulb types ..... 115
  - Turn signals (front) ..... 117
- Reporting safety defects** ..... 32
- Rescue card** ..... 32
- Reserve (fuel tank)**
  - see Fuel
- Reserve fuel**
  - Display message ..... 258
  - Warning lamp ..... 283
- Residual heat (climate control)** ..... 131
- Restraint system**
  - Display message ..... 251
  - Introduction ..... 44
- Warning lamp ..... 282
- Warning lamp (function) ..... 45
- Reversing feature**
  - Panorama sliding sunroof ..... 93
  - Roller sunblinds ..... 94
  - Side windows ..... 89
  - Sliding sunroof ..... 93
  - Tailgate ..... 85
- Reversing lamps (display message)** ..... 255
- Roadside Assistance (breakdown)** .... 29
- Roller sunblind**
  - Panorama roof with power tilt/sliding panel ..... 94
  - Rear side windows ..... 306
- Roof carrier** ..... 304
- Roof lining and carpets (cleaning guidelines)** ..... 333
- Roof load (maximum)** ..... 390
- Route (navigation)**
  - see Route guidance (navigation)
- Route guidance**
  - see also Digital Operator's Manual ..... 287
- Route guidance (navigation)** ..... 232
- Route guidance active** ..... 233

## S

- Safety**
  - Children in the vehicle ..... 59
  - see Occupant safety
  - see Operating safety
- Safety system**
  - see Driving safety systems
- SD card**
  - Inserting ..... 293
  - Inserting/removing ..... 293
  - Removing ..... 293
- SD memory card**
  - see also Digital Operator's Manual ..... 287
  - Selecting ..... 234
- Search & Send**
  - see also Digital Operator's Manual ..... 287
- Seat**
  - Correct driver's seat position ..... 97

- Seat belts**
- Adjusting the driver's and front-passenger seat belt ..... 48
  - Adjusting the height ..... 48
  - Cleaning ..... 332
  - Correct usage ..... 47
  - Fastening ..... 48
  - Important safety guidelines ..... 46
  - Introduction ..... 45
  - Releasing ..... 48
  - Switching belt adjustment on/off (on-board computer) ..... 239
  - Warning lamp ..... 274
  - Warning lamp (function) ..... 48
- Seats**
- Adjusting (electrically) ..... 98
  - Adjusting the 4-way lumbar support ..... 101
  - Adjusting the head restraint ..... 99
  - Calling up a stored setting (memory function) ..... 109
  - Cleaning the cover ..... 332
  - Folding the rear bench seat forwards/back ..... 298
  - Important safety notes ..... 97
  - Overview ..... 97
  - Seat heating problem ..... 103
  - Seat ventilation problem ..... 103
  - Storing settings (memory function) ..... 108
  - Switching seat heating on/off ..... 101
  - Switching seat ventilation on/off .. 102
- Section**
- Sliding sunroof ..... 92
- Securing hooks** ..... 300
- Selector lever**
- Cleaning ..... 332
- Sensors (cleaning instructions)** ..... 330
- Service menu (on-board computer)** ..... 237
- Service message**
- see ASSYST PLUS
- Service products**
- Brake fluid ..... 388
  - Coolant (engine) ..... 388
  - DEF special additives ..... 386
  - Engine oil ..... 387
  - Fuel ..... 384
- Important safety notes ..... 383
  - Refrigerant (air-conditioning system) ..... 389
  - Washer fluid ..... 389
- Setting the air distribution** ..... 129
- Setting the airflow** ..... 129
- Setting the date/time format**
- see also Digital Operator's Manual ..... 287
- Setting the language**
- see also Digital Operator's Manual ..... 287
- Setting the time**
- see also Digital Operator's Manual ..... 287
- Settings**
- Factory (on-board computer) ..... 240
  - On-board computer ..... 238
- SETUP (on-board computer, Mercedes-AMG vehicles)** ..... 241
- Side impact air bag** ..... 51
- Side marker lamp (display message)** ..... 255
- Side windows**
- Cleaning ..... 329
  - Convenience closing feature ..... 90
  - Convenience opening feature ..... 89
  - Important safety information ..... 88
  - Opening/closing ..... 89
  - Overview ..... 88
  - Problem (malfunction) ..... 91
  - Resetting ..... 91
  - Reversing feature ..... 89
- SIRIUS services**
- see also Digital Operator's Manual ..... 287
- Sliding sunroof**
- Important safety notes ..... 92
  - Opening/closing ..... 93
  - Problem (malfunction) ..... 95
  - Resetting ..... 93
  - see Panorama roof with power tilt/sliding panel
- SmartKey**
- Changing the battery ..... 80
  - Changing the programming ..... 79
  - Checking the battery ..... 80

- Convenience closing feature ..... 90
- Convenience opening feature ..... 89
- Display message ..... 273
- Door central locking/unlocking ..... 77
- Important safety notes ..... 77
- KEYLESS-GO start function ..... 79
- Loss ..... 81
- Mechanical key ..... 79
- Overview ..... 77
- Positions (ignition lock) ..... 135
- Problem (malfunction) ..... 81
- Starting the engine ..... 137
- Smartphone**
- Starting the engine ..... 137
- SMS**
- see also Digital Operator's Manual ..... 287
- Snow chains**
- Information ..... 353
- Sockets**
- Center console ..... 308
- General notes ..... 308
- Luggage compartment ..... 308
- Rear compartment ..... 308
- Sound**
- Switching on/off ..... 288
- Special seat belt retractor** ..... 60
- Specialist workshop** ..... 31
- Speed, controlling**
- see Cruise control
- Speedometer**
- Digital ..... 232
- In the Instrument cluster ..... 37
- Segments ..... 228
- Selecting the display unit ..... 238
- Standing lamps**
- Display message ..... 255
- Switching on/off ..... 111
- Start/Stop button**
- Starting the engine ..... 137
- Start/stop function**
- see ECO start/stop function
- Starting (engine)** ..... 136
- STEER CONTROL** ..... 75
- Steering**
- Display message ..... 272
- Steering Pilot**
- Activating/deactivating ..... 236
- Display message ..... 266
- Steering wheel**
- Adjusting (electrically) ..... 104
- Adjusting (manually) ..... 103
- Button overview ..... 38
- Buttons (on-board computer) ..... 229
- Cleaning ..... 332
- Important safety notes ..... 103
- Steering wheel heating ..... 104
- Storing settings (memory function) ..... 108
- Steering wheel heating**
- Problem (malfunction) ..... 104
- Switching on/off ..... 104
- Steering wheel paddle shifters** ..... 147
- Stopwatch (RACETIMER)** ..... 241
- Stowage areas** ..... 295
- Stowage compartments**
- Armrest (under) ..... 296
- Center console ..... 297
- Center console (rear) ..... 297
- Cup holders ..... 304
- Eyeglasses compartment ..... 297
- Glove box ..... 296
- Important safety information ..... 295
- Stowage net ..... 297
- Stowage net** ..... 297
- Summer tires**
- In winter ..... 353
- Sun visor** ..... 305
- Suspension setting**
- AIRMATIC ..... 183
- AMG adaptive sport suspension system ..... 186
- Suspension tuning**
- SETUP (on-board computer, Mercedes-AMG vehicles) ..... 241
- SUV**
- (Sport Utility Vehicle) ..... 30
- Switching air-recirculation mode on/off** ..... 131
- Switching on media mode**
- Via the device list ..... 293

## T

**Tachometer** ..... 228

- Tailgate**
- Display message ..... 271
  - Emergency unlocking ..... 88
  - Important safety notes ..... 84
  - Limiting the opening angle ..... 88
  - Opening dimensions ..... 390
  - Opening/closing (automatically from inside) ..... 87
  - Opening/closing (automatically from outside) ..... 86
  - Opening/closing (from outside) ..... 85
  - Power closing ..... 84
- Tank**
- see Fuel tank
- Tank content**
- Fuel gauge ..... 37
- Technical data**
- Capacities ..... 383
  - Information ..... 381
  - Tires/wheels ..... 376
  - Trailer loads ..... 394
  - Vehicle data ..... 390
- Telephone**
- Accepting a call (multifunction steering wheel) ..... 235
  - Authorizing a mobile phone (connecting) ..... 291
  - Authorizing a mobile phone via the device manager (connecting) ..... 292
  - Connecting a mobile phone (device manager) ..... 292
  - Connecting a mobile phone (general information) ..... 291
  - Display message ..... 272
  - Menu (on-board computer) ..... 235
  - Number from the phone book ..... 235
  - Redialing ..... 235
  - Rejecting/ending a call ..... 235
  - see also Digital Operator's Manual ..... 287
- Temperature**
- Coolant (display in the instrument cluster) ..... 229
  - Coolant (on-board computer, Mercedes-AMG vehicles) ..... 240
  - Engine oil (on-board computer, Mercedes-AMG vehicles) ..... 240
  - Outside temperature ..... 228
  - Setting (climate control) ..... 128
  - Transmission oil (on-board computer, Mercedes-AMG vehicles) ..... 240
- Through-loading feature** ..... 298
- Timing (RACETIMER)** ..... 241
- Tire pressure**
- Calling up (on-board computer) ..... 358
  - Checking manually ..... 357
  - Display message ..... 268
  - Maximum ..... 357
  - Not reached (TIREFIT) ..... 338
  - Notes ..... 356
  - Reached (TIREFIT) ..... 339
  - Recommended ..... 354
- Tire pressure loss warning system**
- General notes ..... 357
  - Important safety notes ..... 358
  - Restarting ..... 358
- Tire pressure monitor**
- Checking the tire pressure electronically ..... 360
  - Function/notes ..... 358
  - General notes ..... 358
  - Important safety notes ..... 359
  - Radio type approval for the tire pressure monitor ..... 361
  - Restarting ..... 361
  - Warning lamp ..... 286
  - Warning message ..... 360
- Tire pressure table** ..... 355
- TIREFIT kit**
- Important safety notes ..... 337
  - Storage location ..... 335
  - Tire pressure not reached ..... 338
  - Tire pressure reached ..... 339
  - Using ..... 337
- Tires**
- Aspect ratio (definition) ..... 370
  - Average weight of the vehicle occupants (definition) ..... 369
  - Bar (definition) ..... 369
  - Changing a wheel ..... 371
  - Characteristics ..... 369
  - Checking ..... 351
  - Curb weight (definition) ..... 370
  - Definition of terms ..... 369
  - Direction of rotation ..... 372
  - Display message ..... 268

- Distribution of the vehicle occupants (definition) ..... 371
- DOT (Department of Transportation) (definition) ..... 369
- DOT, Tire Identification Number (TIN) ..... 368
- GAWR (Gross Axle Weight Rating) (definition) ..... 369
- GTW (Gross Trailer Weight) (definition) ..... 370
- GVW (Gross Vehicle Weight) (definition) ..... 370
- GVWR (Gross Vehicle Weight Rating) (definition) ..... 370
- Important safety notes ..... 351
- Increased vehicle weight due to optional equipment (definition) ..... 369
- Information on driving ..... 351
- Kilopascal (kPa) (definition) ..... 370
- Labeling (overview) ..... 366
- Load bearing index (definition) ..... 371
- Load index ..... 368
- Load index (definition) ..... 370
- M+S tires ..... 353
- Maximum load on a tire (definition) ..... 370
- Maximum loaded vehicle weight (definition) ..... 370
- Maximum permissible tire pressure (definition) ..... 370
- Maximum tire load ..... 368
- Maximum tire load (definition) ..... 370
- MOExtended tires ..... 353
- Optional equipment weight (definition) ..... 371
- PSI (pounds per square inch) (definition) ..... 370
- Replacing ..... 371
- Service life ..... 352
- Sidewall (definition) ..... 371
- Snow chains ..... 353
- Speed rating (definition) ..... 370
- Storing ..... 372
- Structure and characteristics (definition) ..... 369
- Summer tires in winter ..... 353
- Temperature ..... 365
- TIN (Tire Identification Number) (definition) ..... 371
- Tire bead (definition) ..... 370
- Tire pressure (definition) ..... 370
- Tire pressures (recommended) ..... 369
- Tire size (data) ..... 376
- Tire size designation, load-bearing capacity, speed rating ..... 366
- Tire tread ..... 352
- Tire tread (definition) ..... 370
- Total load limit (definition) ..... 371
- Traction ..... 365
- Traction (definition) ..... 371
- Tread wear ..... 365
- TWR (permissible trailer drawbar noseweight) (definition) ..... 371
- Uniform Tire Quality Grading Standards ..... 364
- Uniform Tire Quality Grading Standards (definition) ..... 369
- Wear indicator (definition) ..... 371
- Wheel and tire combination ..... 376
- Wheel rim (definition) ..... 369
- see Flat tire
- Top Tether** ..... 62
- Tow-starting**
  - Emergency engine starting ..... 348
  - Important safety notes ..... 345
- Towing a trailer**
  - Axle load, permissible ..... 394
  - Cleaning the trailer tow hitch ..... 331
  - Coupling up a trailer ..... 222
  - Decoupling a trailer ..... 224
  - Driving tips ..... 220
  - Important safety notes ..... 219
  - Installing the ball coupling ..... 221
  - Lights display message ..... 255
  - Mounting dimensions ..... 394
  - Parking Assist PARKTRONIC ..... 187
  - Power supply ..... 225
  - Pulling away with a trailer ..... 138
  - Removing the ball coupling ..... 224
  - Trailer loads ..... 394
- Towing away**
  - Important safety guidelines ..... 345
  - Installing the towing eye ..... 346
  - Notes for 4MATIC vehicles ..... 348
  - Removing the towing eye ..... 346



- Transporting the vehicle ..... 347
  - With both axles on the ground ..... 346
  - Towing eye** ..... 335
  - Traffic reports**
    - see also Digital Operator's Manual ..... 287
  - Traffic Sign Assist**
    - Activating/deactivating the warning function ..... 236
    - Display message ..... 263
    - Function/notes ..... 203
    - Important safety notes ..... 204
    - Instrument cluster display ..... 204
  - Trailer coupling**
    - see Towing a trailer
  - Trailer loads and drawbar nose-weights** ..... 224
  - Trailer towing**
    - Active Blind Spot Assist ..... 210
    - Active Lane Keeping Assist ..... 213
    - Blind Spot Assist ..... 206
    - Permissible trailer loads and drawbar noseweights ..... 224
  - Transfer case** ..... 150
  - Transmission**
    - see Automatic transmission
  - Transmission position display** ..... 145
  - Transporting the vehicle** ..... 347
  - Traveling uphill**
    - Brow of hill ..... 169
    - Driving downhill ..... 169
    - Maximum gradient-climbing capability ..... 168
  - Trim pieces (cleaning instructions)** ..... 332
  - Trip computer (on-board computer)** ..... 231
  - Trip odometer**
    - Calling up ..... 231
    - Resetting (on-board computer) ..... 232
  - Trunk**
    - see Tailgate
  - Turn signals**
    - Display message ..... 255
    - Replacing bulbs (front) ..... 117
    - Switching on/off ..... 111
  - Two-way radio**
    - Frequencies ..... 381
    - Installation ..... 381
    - Transmission output (maximum) .... 381
  - TWR (Tongue Weight Rating) (definition)** ..... 371
  - Type identification plate**
    - see Vehicle identification plate
- ## U
- Unlocking**
    - Emergency unlocking ..... 84
    - From inside the vehicle (central unlocking button) ..... 83
  - Upshift indicator (on-board computer, Mercedes-AMG vehicles)** ..... 240
  - USB devices**
    - Connecting to the Media Interface ..... 294
- ## V
- Vanity mirror (in the sun visor)** ..... 306
  - Vehicle**
    - Correct use ..... 31
    - Data acquisition ..... 32
    - Display message ..... 270
    - Equipment ..... 28
    - Individual settings ..... 238
    - Limited Warranty ..... 32
    - Loading ..... 361
    - Locking (in an emergency) ..... 84
    - Locking (SmartKey) ..... 77
    - Lowering ..... 375
    - Maintenance ..... 29
    - Operating safety ..... 30
    - Parking ..... 156
    - Parking for a long period ..... 159
    - Pulling away ..... 138
    - Raising ..... 373
    - Reporting problems ..... 31
    - Securing from rolling away ..... 372
    - Towing away ..... 345
    - Transporting ..... 347
    - Unlocking (in an emergency) ..... 84
    - Unlocking (SmartKey) ..... 77
    - Vehicle data ..... 390

- Vehicle battery**  
see Battery (vehicle)
- Vehicle data** ..... 390
- Vehicle data (off-road driving)**  
Approach/departure angle ..... 393  
Fording depth ..... 392  
Maximum gradient climbing ability ..... 393
- Vehicle dimensions** ..... 390
- Vehicle emergency locking** ..... 84
- Vehicle identification number**  
see VIN
- Vehicle identification plate** ..... 382
- Vehicle level**  
AIRMATIC ..... 185
- Vehicle level (display message)** ..... 260
- Vehicle tool kit** ..... 335
- Video**  
Operating the DVD ..... 234  
see also Digital Operator's Manual ..... 287
- VIN** ..... 382  
Seat ..... 383  
Type plate ..... 382
- W**
- Warning and indicator lamps**  
ABS ..... 277  
Brakes ..... 276  
Coolant ..... 283  
Distance Pilot DISTRONIC ..... 285  
Distance warning ..... 285  
Engine diagnostics ..... 283  
ESP® ..... 279  
ESP® OFF ..... 280  
Fuel tank ..... 283  
Overview ..... 37  
Parking brake ..... 282  
PASSENGER AIR BAG ..... 45  
Reserve fuel ..... 283  
Restraint system ..... 282  
Seat belt ..... 274  
Tire pressure monitor ..... 286
- Warranty** ..... 28
- Washer fluid**  
Display message ..... 272
- Weather display (COMAND)**  
see also Digital Operator's Manual ..... 287
- Wheel and tire combinations**  
Tires ..... 376
- Wheel bolt tightening torque** ..... 375
- Wheel chock** ..... 372
- Wheels**  
Changing a wheel ..... 371  
Checking ..... 351  
Cleaning ..... 329  
Emergency spare wheel ..... 376  
Important safety notes ..... 351  
Information on driving ..... 351  
Interchanging/changing ..... 371  
Mounting a new wheel ..... 374  
Mounting a wheel ..... 372  
Overview ..... 351  
Removing a wheel ..... 374  
Snow chains ..... 353  
Storing ..... 372  
Tightening torque ..... 375  
Wheel size/tire size ..... 376
- Window curtain air bag**  
Display message ..... 252  
Operation ..... 51
- Windows**  
see Side windows
- Windshield**  
Defrosting ..... 129  
Infrared reflective ..... 320
- Windshield washer fluid**  
see Windshield washer system
- Windshield washer system**  
Adding washer fluid ..... 325  
Important safety notes ..... 389
- Windshield wipers**  
Problem (malfunction) ..... 121  
Rear window wiper ..... 118  
Replacing the wiper blades ..... 118  
Replacing the wiper blades (MAGIC VISION CONTROL) ..... 119  
Switching on/off ..... 117
- Winter driving**  
Slippery road surfaces ..... 164
- Winter operation**  
Overview ..... 353  
Radiator cover ..... 322

**Winter tires**

M+S tires ..... 353

**Wiper blades**

Cleaning ..... 329

Replacing ..... 118

Replacing (rear window) ..... 120

Replacing (windshield) ..... 118

**Wooden trim (cleaning instruc-**

**tions) ..... 332**

**Workshop**

see Qualified specialist workshop

**Z****ZONE function**

Switching on/off ..... 129

## Introduction

The printed Operator's Manual provides information about the safe operation of your vehicle. The Digital Operator's Manual provides comprehensive and specifically adapted information on your vehicle's equipment and multimedia system. You can call up the Digital Operator's Manual via the multimedia system.

- i** You will not incur any costs when calling up the Digital Operator's Manual. The Digital Operator's Manual works without connecting to the Internet.

There are three ways to access the topics of the Digital Operator's Manual:

### • Visual search

The visual search allows you to explore your vehicle "virtually". Starting from either the vehicle exterior view or interior view, you can access many of the different topics covered by the Digital Operator's Manual. To access the vehicle interior section, select the "Vehicle interior" view.

### • Keyword search

The keyword search allows you to search for a keyword by entering characters. Further information can be found in the Digital Operator's Manual in the "Audio 20" or "COMAND" section under the "Character entry (telephony)" keyword.





### • Contents

You can select individual sections in the contents.

- i** The Digital Operator's Manual is deactivated for safety reasons while driving.

## Operation

### Calling up the Digital Operator's Manual

- ▶ Press the  button on the center console. The overview relating to the vehicle appears.
- ▶ Select the "Operator's Manual" menu item by turning  or pressing  the controller.
- ▶ Confirm  the message about the warning and safety notes. The menu for the Digital Operator's Manual appears.

## Operating the Digital Operator's Manual







### General notes

Please observe the information about the operation of the controller (▷ page 288).

### Content pages

The content pages can be accessed by means of a visual search, a keyword search or using the contents.



- ▶ **To scroll forward/back:** turn  the controller.
- ▶ **To display in full-screen or animation:** slide  the controller to the left **1**.
- ▶ **To select information text or save bookmarks:** slide  the controller to the right **2**.
- ▶ **To select a link:** slide  the controller down **3**.
- ▶ **To exit a content page:** select the  symbol **4**.
- ▶ **To call up the menu of the Digital Operator's Manual:** select  symbol **5**.

## Protecting the environment

### General notes

#### Environmental note

Daimler's declared policy is one of comprehensive environmental protection.

The objectives are for the natural resources that form the basis of our existence on this planet to be used sparingly and in a manner that takes the requirements of both nature and humanity into account.

You too can help to protect the environment by operating your vehicle in an environmentally responsible manner.

Fuel consumption and the rate of engine, transmission, brake and tire wear are affected by these factors:

- operating conditions of your vehicle
- your personal driving style

You can influence both factors. You should bear the following in mind:

Operating conditions:

- avoid short trips as these increase fuel consumption.
- always make sure that the tire pressures are correct.
- do not carry any unnecessary weight.
- remove roof racks once you no longer need them.
- a regularly serviced vehicle will contribute to environmental protection. You should therefore adhere to the service intervals.
- always have service work carried out at a qualified specialist workshop.

Personal driving style:

- do not depress the accelerator pedal when starting the engine.
- do not warm up the engine when the vehicle is stationary.
- drive carefully and maintain a safe distance from the vehicle in front.
- avoid frequent, sudden acceleration and braking.

- change gear in good time and use each gear only up to  $\frac{2}{3}$  of its maximum engine speed.
- switch off the engine in stationary traffic.
- keep an eye on the vehicle's fuel consumption.

### Environmental concerns and recommendations

Wherever the operating instructions require you to dispose of materials, first try to regenerate or re-use them. Observe the relevant environmental rules and regulations when disposing of materials. In this way you will help to protect the environment.

## Genuine Mercedes-Benz parts

#### Environmental note

Daimler AG also supplies reconditioned major assemblies and parts which are of the same quality as new parts. They are covered by the same Limited Warranty entitlements as new parts.

**!** Air bags and Emergency Tensioning Devices, as well as control units and sensors for these restraint systems, may be installed in the following areas of your vehicle:

- doors
- door pillars
- door sills
- seats
- cockpit
- instrument cluster
- center console

Do not install accessories such as audio systems in these areas. Do not carry out repairs or welding. You could impair the operating efficiency of the restraint systems.

Have aftermarket accessories installed at a qualified specialist workshop.

You could jeopardize the operating safety of your vehicle if you use parts, tires and wheels as well as accessories relevant to safety which have not been approved by Mercedes-Benz. This could lead to malfunctions in safety-relevant

systems, e.g. the brake system. Use only genuine Mercedes-Benz parts or parts of equal quality. Only use tires, wheels and accessories that have been specifically approved for your vehicle.

Genuine Mercedes-Benz parts are subject to strict quality control. Every part has been specifically developed, manufactured or selected for and adapted to Mercedes-Benz vehicles. Therefore, only genuine Mercedes-Benz parts should be used.

More than 300,000 different genuine Mercedes-Benz parts are available for Mercedes-Benz models.

All authorized Mercedes-Benz Centers maintain a supply of genuine Mercedes-Benz parts for necessary service and repair work. In addition, strategically located parts delivery centers provide quick and reliable parts service.

Always specify the vehicle identification number (VIN) when ordering genuine Mercedes-Benz parts (> page 382).

## Operator's Manual

### Vehicle equipment

**i** This Operator's Manual describes all models and all standard and optional equipment of your vehicle available at the time of going to print. Country-specific differences are possible. Bear in mind that your vehicle may not feature all functions described here. This also applies to safety-relevant systems and functions. The equipment in your vehicle may therefore differ from that shown in the descriptions and illustrations.

The original purchase contract documentation for your vehicle contains a list of all the systems in your vehicle.

Should you have any questions concerning equipment and operation, please consult an authorized Mercedes-Benz Center.

The Operator's Manual and Maintenance Booklet are important documents and should be kept in the vehicle.

## Service and vehicle operation

### Warranty

The Limited Warranty for your vehicle applies in accordance with the warranty terms and conditions in the Service and Warranty Information booklet.

Your authorized Mercedes-Benz Center will replace and repair all factory-installed parts in accordance with the following warranty terms and conditions:

- New Vehicle Limited Warranty
- Emission System Warranty
- Emission Performance Warranty
- California, Connecticut, Maine, Massachusetts, New York, Pennsylvania, Rhode Island and Vermont Emission Control System Warranty
- State warranty enforcement laws (lemon laws)

Replacement parts and accessories are covered by the Mercedes-Benz Parts and Accessories warranties. These are available at any authorized Mercedes-Benz Center.

**i** Should you lose your Service and Warranty Information booklet, have an authorized Mercedes-Benz Center arrange for a replacement. The new Service and Warranty Information booklet will be posted to you.

### Information for customers in California

Under California law you may be entitled to a replacement of your vehicle or a refund of the purchase price or lease price, if after a reasonable number of repair attempts Mercedes-Benz USA, LLC and/or its authorized repair or service facilities fail to fix one or more substantial defects or malfunctions in the vehicle that are covered by its express warranty.

During the period of 18 months from original delivery of the vehicle or the accumulation of 18,000 miles (approximately 29,000 km) on the odometer of the vehicle, whichever occurs first, a reasonable number of repair attempts is presumed for a retail buyer or lessee if one or more of the following occurs:

- (1) the same substantial defect or malfunction results in a condition that is likely to cause

death or serious bodily injury if the vehicle is driven, that defect or malfunction has been subject to repair two or more times, and you have directly notified Mercedes-Benz USA, LLC in writing of the need for its repair.

- (2) the same substantial defect or malfunction of a less serious nature than category (1) has been subject to repair four or more times and you have directly notified Mercedes-Benz in writing of the need for its repair.
- (3) the vehicle is out of service by reason of repair of the same or different substantial defects or malfunctions for a cumulative total of more than 30 calendar days.

Please send your written notice to:  
Mercedes-Benz USA, LLC  
Customer Assistance Center  
One Mercedes Drive  
Montvale, NJ 07645-0350

## Maintenance

### USA only:

Always have the Service and Warranty Booklet with you when you bring the vehicle to an authorized Mercedes-Benz Center. The service advisor will record every service for you in the Service and Warranty Booklet.

### Canada only:

Have every service in a qualified specialist workshop confirmed in the service report.

## Roadside Assistance

The Mercedes-Benz Roadside Assistance Program offers technical help in the event of a breakdown. Calls to the toll-free Roadside Assistance Hotline are answered by our agents 24 hours a day, 365 days a year.

**1-800 FOR-MERCEDES (1-800-367-6372)  
(USA)**

**1-800-387-0100 (Canada)**

For additional information, refer to the Mercedes-Benz Roadside Assistance Program brochure (USA) or the "Roadside Assistance" section in the Service and Warranty Booklet (Canada). You will find both in the vehicle document wallet.

## Change of address or change of ownership

In the event of a change of address, please send us the "Notification of Address Change" in the Service and Warranty Booklet or simply call the Mercedes-Benz Customer Assistance Center (USA) at the hotline number 1-800 FOR-MERCEDES (1-800-367-6372) or Customer Service Center (Canada) at 1-800-387-0100. This will assist us in contacting you in a timely manner should the need arise. If you sell your Mercedes, please leave all literature in the vehicle so that it is available to the next owner.

If you have purchased a used car, please send us the "Notification of Used Car Purchase" in the Service and Warranty Booklet or simply call the Mercedes-Benz Customer Assistance Center (USA) at the hotline number 1-800 FOR-MERCEDES (1-800-367-6372) or Customer Service (Canada) at 1-800-387-0100.

## Vehicle operation outside the USA and Canada

When you are abroad with your vehicle, observe the following points:

- Service facilities or replacement parts may not be readily available.
- Lead-free fuel for vehicles with a catalytic converter may not be available. Leaded fuel can cause damage to the catalytic converter.
- The fuel may have a considerably lower octane number. Unsuitable fuel can cause engine damage.

Some Mercedes-Benz models are available for delivery in Europe through our European Delivery Program. For details, consult an authorized Mercedes-Benz Center or write to one of the following addresses.

### In the USA

Mercedes-Benz USA, LLC  
European Delivery Department  
One Mercedes Drive  
Montvale, NJ 07645-0350

### In Canada

Mercedes-Benz Canada, Inc.  
European Delivery Department  
98 Vanderhoof Avenue  
Toronto, Ontario M4G 4C9

## Sports Utility Vehicle

### WARNING

Due to the high center of gravity, the vehicle may start to skid and roll over in the event of an abrupt steering maneuver and/or when the vehicle's speed is not adapted to the road conditions. There is a risk of an accident.

Always adapt your speed and driving style to the vehicle's driving characteristics and to the prevailing road and weather conditions.

Utility vehicles have a significantly higher roll-over rate than other types of vehicles.

Failure to operate this vehicle safely may result in an accident, rollover of the vehicle, and severe or fatal injury.

In a rollover crash, an unbelted person is significantly more likely to die than a person wearing a seat belt.

You and all vehicle occupants should always wear your seat belts.

## Operating safety

### Important safety notes

#### WARNING

If you do not have the prescribed service/maintenance work or any required repairs carried out, this can result in malfunctions or system failures. There is a risk of an accident. Always have the prescribed service/maintenance work as well as any required repairs carried out at a qualified specialist workshop.

#### WARNING

Flammable material such as leaves, grass or twigs may ignite if they come into contact with hot parts of the exhaust system. There is a risk of fire.

When driving off road or on unpaved roads, check the vehicle's underside regularly. In particular, remove parts of plants or other flammable materials which have become trapped. In the case of damage, contact a qualified specialist workshop.

### WARNING

Modifications to electronic components, their software as well as wiring can impair their function and/or the function of other networked components. In particular, systems relevant to safety could also be affected. As a result, these may no longer function as intended and/or jeopardize the operating safety of the vehicle. There is an increased risk of an accident and injury.

Never tamper with the wiring as well as electronic components or their software. You should have all work to electrical and electronic equipment carried out at a qualified specialist workshop.

 There is a risk of damage to the vehicle if:

- the vehicle becomes stuck, e.g. on a high curb or an unpaved road
- you drive too fast over an obstacle, e.g. a curb, a speed bump or a pothole in the road
- a heavy object strikes the underbody or parts of the chassis

In situations like this, the body, the underbody, chassis parts, wheels or tires could be damaged without the damage being visible. Components damaged in this way can unexpectedly fail or, in the case of an accident, no longer withstand the loads they are designed to.

If the underbody paneling is damaged, combustible materials such as leaves, grass or twigs can gather between the underbody and the underbody paneling. If these materials come in contact with hot parts of the exhaust system, they can catch fire.

In such situations, have the vehicle checked and repaired immediately at a qualified specialist workshop. If on continuing your journey you notice that driving safety is impaired, pull over and stop the vehicle immediately, paying attention to road and traffic conditions. In such cases, consult a qualified specialist workshop.

### Declarations of conformity

**USA:** "The wireless devices of this vehicle comply with Part 15 of the FCC Rules. Operation is subject to the two following two conditions: 1)



These devices may not cause harmful interference, and 2) These devices must accept any interference received, including interference that may cause undesired operation. Changes or modifications not expressly approved by the party responsible for compliance could void the user's authority to operate the equipment."

**Canada:** "The wireless devices of this vehicle comply with Industry Canada license-exempt RSS standard(s). Operation is subject to the following two conditions: (1) These devices may not cause interference, and (2) These devices must accept any interference, including interference that may cause undesired operation of the device."

### Diagnostics connection

The diagnostics connection is only intended for the connection of diagnostic equipment at a qualified specialist workshop.

#### WARNING

If you connect equipment to a diagnostics connection in the vehicle, it may affect the operation of vehicle systems. As a result, the operating safety of the vehicle could be affected. There is a risk of an accident.

Only connect equipment to a diagnostics connection in the vehicle, which is approved for your vehicle by Mercedes-Benz.

#### WARNING

Objects in the driver's footwell can restrict the pedal travel or obstruct a depressed pedal. The operating and road safety of the vehicle is jeopardized. There is a risk of an accident.

Make sure that all objects in the vehicle are stowed correctly, and that they cannot enter the driver's footwell. Install the floor mats securely and as specified in order to ensure sufficient clearance for the pedals. Do not use loose floor mats and do not place floor mats on top of one another.

**!** If the engine is switched off and equipment on the diagnostics connection is used, the starter battery may discharge.

Connecting equipment to the diagnostics connection can lead to emissions monitoring infor-

mation being reset, for example. This may lead to the vehicle failing to meet the requirements of the next emissions test during the main inspection.

### Qualified specialist workshop

An authorized Mercedes-Benz Center is a qualified specialist workshop. It has the necessary specialist knowledge, tools and qualifications to correctly carry out the work required on your vehicle. This is especially the case for work relevant to safety.

Always have the following work carried out at an authorized Mercedes-Benz Center:

- work relevant to safety
- service and maintenance work
- repair work
- alterations, installation work and modifications
- work on electronic components

### Correct use

If you remove any warning stickers, you or others could fail to recognize certain dangers. Leave warning stickers in position.

Observe the following information when driving your vehicle:

- the safety notes in this manual
- the vehicle technical data
- traffic rules and regulations
- laws and safety standards pertaining to motor vehicles

### Problems with your vehicle

If you should experience a problem with your vehicle, particularly one that you believe may affect its safe operation, we urge you to contact an authorized Mercedes-Benz Center immediately to have the problem diagnosed and rectified. If the problem is not resolved to your satisfaction, please discuss the problem again with the Mercedes-Benz Center or, if necessary, contact us at one of the following addresses.

#### In the USA

Customer Assistance Center  
Mercedes-Benz USA, LLC

3 Mercedes Drive  
Montvale, NJ 07645-0350

### In Canada

Customer Relations Department  
Mercedes-Benz Canada, Inc.  
98 Vanderhoof Avenue  
Toronto, Ontario M4G 4C9

## Reporting safety defects

USA only:

The following text is reproduced as required of all manufacturers under Title 49, Code of U.S. Federal Regulations, Part 575 pursuant to the National Traffic and Motor Vehicle Safety Act of 1966.

If you believe that your vehicle has a defect which could cause a crash or could cause injury or death, you should immediately inform the National Highway Traffic Safety Administration (NHTSA) in addition to notifying Mercedes-Benz USA, LLC.

If NHTSA receives similar complaints, it may open an investigation, and if it finds that a safety defect exists in a group of vehicles, it may order a recall and remedy campaign. However, NHTSA cannot become involved in individual problems between you, your dealer, or Mercedes-Benz USA, LLC.

To contact NHTSA, you may call the Vehicle Safety Hotline toll-free at 1-888-327-4236 (TTY: 1-800-424-9153); go to <http://www.safercar.gov>; or write to: Administrator, NHTSA, 400 Seventh Street, SW., Washington, DC 20590.

You can also obtain other information about motor vehicle safety from

<http://www.safercar.gov>

## Limited Warranty

**I** Observe the notes in this Operator's Manual regarding the correct operation of your vehicle and possible damage to the vehicle. Damage to the vehicle which is caused by violation of these notes is not covered by the Mercedes-Benz implied warranty or the new or used-vehicle warranty.

## QR codes for the rescue card

The QR codes are secured in the fuel filler flap and on the opposite side on the B-pillar. In the event of an accident, rescue services can use the QR code to quickly find the appropriate rescue card for your vehicle. The current rescue card contains the most important information about your vehicle in a compact form, e.g. the routing of the electric cables.

You can find more information at [www.mercedes-benz.de/qr-code](http://www.mercedes-benz.de/qr-code).

## Data stored in the vehicle

### Information from electronic control units

There are electronic control units installed in your vehicle. Some of these are necessary for your vehicle to operate safely, while some offer support during driving (driver assistance systems). In addition, your vehicle offers comfort and entertainment functions that are also made possible by electronic control units.

Electronic control units contain data storage systems that can temporarily or permanently save technical information concerning the vehicle's condition, component stress and maintenance requirements as well as technical events and malfunctions.

This information generally documents the condition of a component, a module, a system or the surroundings, for example:

- operating states of system components (e.g. fill levels, battery status, tire pressure)
- status messages concerning the vehicle or its individual components (e.g. wheel rpm/speed, deceleration, lateral acceleration, indication of whether seat belts are fastened)
- malfunctions and defects in important system components (e.g. lights, brakes)
- information about events leading to vehicle damage
- system responses in special driving situations (e.g. air bag deployment, intervention of stability control systems)
- ambient conditions (e.g. temperature, rain sensor)

In addition to performing the actual control unit function, these data are used by manufacturers

to detect and rectify malfunctions and to optimize vehicle functions. Most of these data are volatile and processed only in the vehicle itself. Only a small part of the data is stored in event or malfunction memories.

When you use services, the technical data from the vehicle can be read out by service network employees or third parties. Services can include repair services, maintenance processes, warranty cases and quality assurance measures. The data is read out via the legally prescribed diagnostics connection in the vehicle. The relevant offices in the service network or third parties collect, process and use the data. These data document the vehicle's technical states, are used to help in finding malfunctions and improving quality and are sent to the manufacturer where necessary. In addition, the manufacturer is subject to product liability. The manufacturer needs technical data from vehicles for this purpose.

Malfunction memories in the vehicle can be reset by a service center during repair or service work.

You can incorporate data into the vehicle's comfort and infotainment functions yourself as part of the selected equipment.

These include, for example:

- multimedia data such as music, films or photos for playback in an integrated multimedia system
- address book data for use in conjunction with an integrated hands-free system or an integrated navigation system
- navigation destinations that have been entered
- data about using Internet services

These data can be saved locally in the vehicle or are located on a device that you have connected to the vehicle. If this data is saved in the vehicle, you can delete it at any time. These data are sent to third parties only at your request, particularly when you use online services in accordance with the settings that you have selected.

You can save and change comfort settings/customizations in the vehicle at any time.

Depending on the piece of equipment in question, these can include, for example:

- seat and steering wheel position settings
- suspension and climate control settings
- custom settings such as interior lighting

If your vehicle is equipped appropriately, you can connect your smartphone or another mobile end device to the vehicle. You can control this by means of the control elements integrated in the vehicle. The smartphone's picture and sound can be output via the multimedia system. Specific items of information are also sent to your smartphone.

Depending on the type of integration, this can include:

- general vehicle information
- position data

This allows the use of selected smartphone apps, such as navigation or music player apps. There is no additional interaction between the smartphone and the vehicle, particularly active access to vehicle data. The type of additional data processing is determined by the provider of the app being used. Whether you can configure settings for it and, if so, which ones, depends on the app and your smartphone's operating system.

## Service provider

### Wireless network connection

If your vehicle has a wireless network connection, data can be exchanged between your vehicle and other systems. The wireless network connection is made possible by the vehicle's own transmitter and receiver or by mobile devices that you have brought into the vehicle (e.g. smartphones). Online functions can be used via this wireless network connection. These include online services and applications/Apps provided by the manufacturer or other providers.

### Services provided by the manufacturer

In the case of the manufacturer's online services, the manufacturer describes the functions in a suitable place and the associated information subject to data protection legislation. Personal data can be used in order to provide online services. The data exchange for this takes place via a secure connection, e.g. with the manufacturer's IT systems intended for the purpose. Collecting, processing and using personal data beyond the provision of services is permitted only on the basis of a statutory permit or declaration of consent.

You can usually activate and deactivate the services and functions (some of which are subject to charge). In many cases, this also applies to the vehicle's entire data connection. However, this does not apply in particular to legally prescribed functions and services such as the "eCall" emergency call system.

### Services from third parties

If it is possible to use online services from other providers, these services are the responsibility of the provider in question and subject to that provider's data protection conditions and terms of use. The manufacturer has no influence over the content exchanged here.

For this reason, please ask the service provider for information about the type, extent and purpose of the collection and use of personal data when services are provided by third parties.

### COMAND/mbrace

If the vehicle is equipped with COMAND or mbrace, additional data about the vehicle's operation, the use of the vehicle in certain situations, and the location of the vehicle may be compiled through COMAND or the mbrace system.

For additional information please refer to the COMAND User Manual or the Digital Operator's Manual and/or the mbrace Terms and Conditions.

### Event data recorders

This vehicle is equipped with an event data recorder (EDR). This vehicle is equipped with an event data recorder (EDR). The main purpose of an EDR is to record, in certain crash or near crash-like situations, such as an air bag deployment or hitting a road obstacle, data that will assist in understanding how a vehicle's systems performed. The EDR is designed to record data relating to vehicle dynamics and safety systems for a short period of time, typically 30 seconds or less.

The EDR in this vehicle is designed to record such data as:

- How various systems in your vehicle were operating
- Whether or not the driver and passenger safety belts were buckled/fastened
- How far (if at all) the driver was depressing the accelerator and/or brake pedal and
- How fast the vehicle was traveling

These data can help provide a better understanding of the circumstances in which crashes and injuries occur. **NOTE:** EDR data are recorded by your vehicle only if a non-trivial crash situation occurs; no data are recorded by the EDR under normal driving conditions and no personal data (e.g. name, gender, age and crash location) are recorded. However, other parties, such as law enforcement could combine the EDR data with the type of personally identifying data routinely acquired during a crash investigation.

Access to the vehicle and/or the EDR is needed to read data that is recorded by an EDR, and special equipment is required. In addition to the vehicle manufacturer, other parties that have the special equipment, such as law enforcement, can read the information by accessing the vehicle or the EDR.

EDR data may be used in civil and criminal matters as a tool in accident reconstruction, accident claims and vehicle safety. Since the Crash Data Retrieval CDR tool that is used to extract data from the EDR is commercially available, Mercedes-Benz USA, LLC ("MBUSA") expressly disclaims any and all liability arising from the extraction of this information by unauthorized Mercedes-Benz personnel.

MBUSA will not share EDR data with others without the consent of the vehicle owners or, if the vehicle is leased, without the consent of the lessee. Exceptions to this representation include responses to subpoenas by law enforcement; by federal, state or local government; in connection with or arising out of litigation involving MBUSA or its subsidiaries and affiliates; or, as required by law.

**Warning:** The EDR is a component of the Restraint System Module. Tampering with, altering, modifying or removing the EDR component may result in a malfunction of the Restraint System Module and other systems.

State laws or regulations regarding EDRs that conflict with federal regulation are pre-empted.

This means that in the event of such conflict, the federal regulation governs. As of February 2013, 13 states have enacted laws relating to EDRs.

## Information on copyright

### Free and open-source software

Information on license for free and open-source software used in your vehicle can be found on the data carrier in your vehicle document wallet and, including updates, on the following website:

**<http://www.mercedes-benz.com/opensource>**

## Cockpit

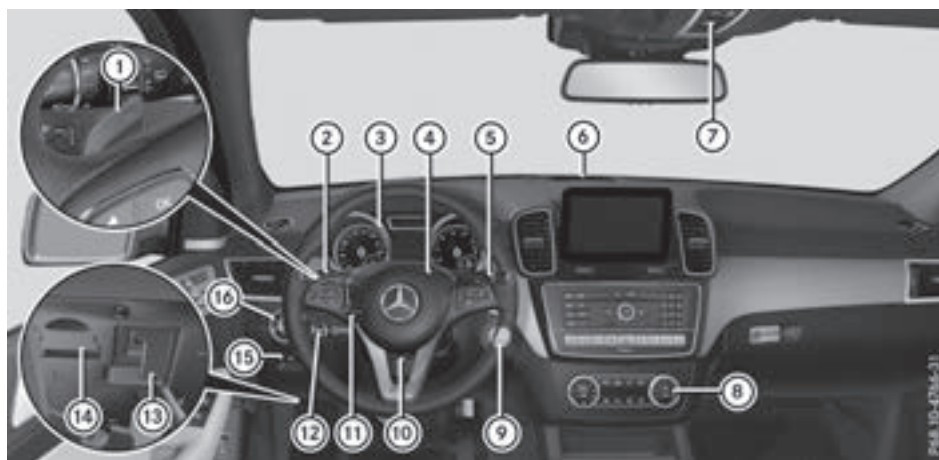

	Function	Page
①	Steering wheel paddle shifter	147
②	Combination switch	111
③	Instrument cluster	37
④	Horn	
⑤	DIRECT SELECT lever	143
⑥	Parking Assist PARKTRONIC warning display	189
⑦	Overhead control panel	42
⑧	Climate control systems	122
⑨	Ignition lock	135
	Start/Stop button	135

	Function	Page
⑩	Adjusts the steering wheel manually	103
⑪	Adjusts the steering wheel electrically	103
	Steering wheel heating	104
⑫	Cruise control lever	170
⑬	Opens the hood	321
⑭	Diagnostics connection	31
⑮	Electric parking brake	157
⑯	Light switch	110

## Instrument cluster



	Function	Page
①	Speedometer with segments Warning and indicator lamps: ESP® OFF 279 ABS 277 Brakes 276 (USA only) (Canada only) Low-beam headlamps 111 Parking lamps 111 ESP® 279 High-beam headlamps 111 Electric parking brake (red) (USA only) (Canada only) Electric parking brake (yellow) 282 Distance warning 285	228
②	Turn signals	111
③	Multifunction display	230

	Function	Page
④	Tachometer Warning and indicator lamps: Rear fog lamp 111 Check Engine 283 Tire pressure monitor 286 Restraint system 45 Seat belts 274 Diesel engine: preglow 137 RBS (Recuperative Brake System)	228
⑤	Coolant temperature gauge Warning and indicator lamps: Coolant	229 283
⑥	Fuel level indicator Warning and indicator lamps: Reserve fuel with fuel filler flap location indicator (right-hand side)	283
⑦	Instrument cluster lighting	228





**i** Information on displaying the outside temperature in the multifunction display can be





found under "Outside temperature display" (> page 228).

Multifunction steering wheel

At a glance



	Function	Page
①	Multifunction display	230
②	Multimedia system display	
③	 Switches on voice-operated navigation or the Voice Control System  Mute  Adjusts the volume  Rejects or ends a call Exits phone book/redial memory  Makes or accepts a call Switches to the redial memory	235

	Function	Page
④	 Selects a menu  Selects a submenu or scrolls through lists  Confirms a selection  Hides display messages  Back Switches off voice-operated navigation or the Voice Control System	229

**i** In vehicles with multimedia system COMAND you can find further information:

- on the multimedia system in the Digital Operator's Manual
- on the DVD changer or single DVD drive in the Digital Operator's Manual
- on the Voice Control System in the separate operating instructions

**i** In vehicles with multimedia system Audio 20 you can find further information:





- on the multimedia system in the Digital Operator's Manual
- on the voice-operated control of the navigation in the manufacturer's operating instructions





## Center console

## Center console, upper section





	Function	Page
①	Multimedia system; see the Digital Operator's Manual	
②	 Seat heating	101
③	 Seat ventilation	102
④	 Parking Assist PARKTRONIC	187
⑤	 ECO start/stop function	139

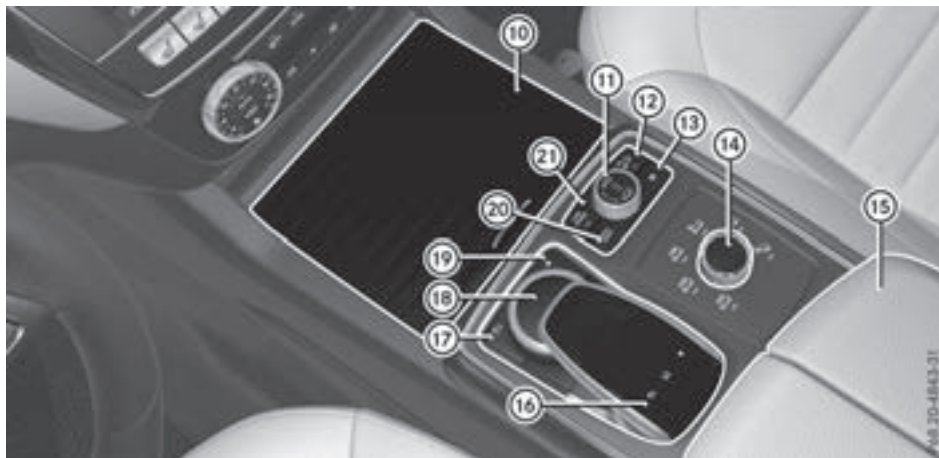

	Function	Page
⑥	 Hazard warning lamps	112
⑦	PASSENGER AIRBAG indicator lamps Anti-theft alarm system indicator lamp	45 75
⑧	 ESP®	70

## Center console, lower section





**i** Vehicles with the Off-Road Engineering package

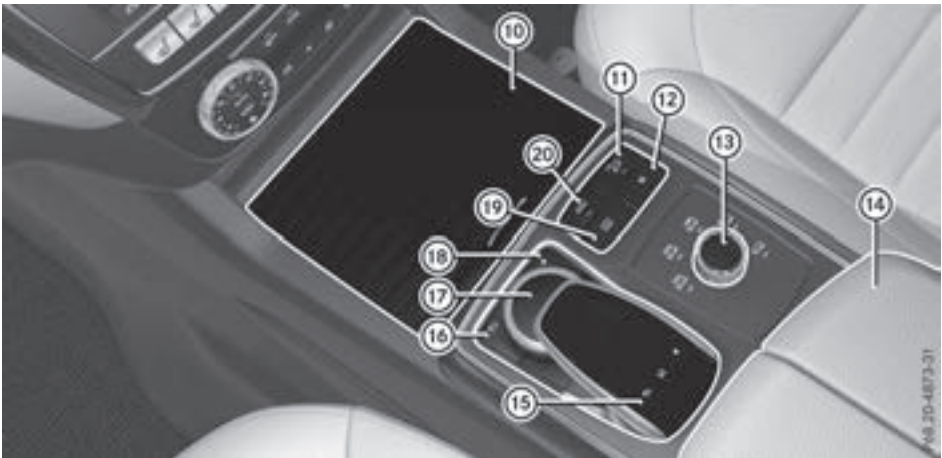

	Function	Page
⑩	Stowage compartment Cup holder Ashtray Cigarette lighter Socket	297 304 307 307 308
⑪	Selector wheel for level control	179
⑫	 DSR (Downhill Speed Regulation)	213
⑬	 Manual gearshifting (permanent setting)	147
⑭	DYNAMIC SELECT controller	142
⑮	Stowage compartment with Media Interface	296

	Function	Page
⑯	Touchpad; see Digital Operator's Manual	
⑰	 Back button (see the Digital Operator's Manual)	
⑱	Multimedia system controller; see Digital Operator's Manual	
⑲	 Switches to the favorites button (see the Digital Operator's Manual)	
⑳	Switches to the vehicle settings display (see the Digital Operator's Manual)	
㉑	 LOW RANGE off-road gear	216







**i** Vehicles with the AIRMATIC package and Mercedes-AMG vehicles

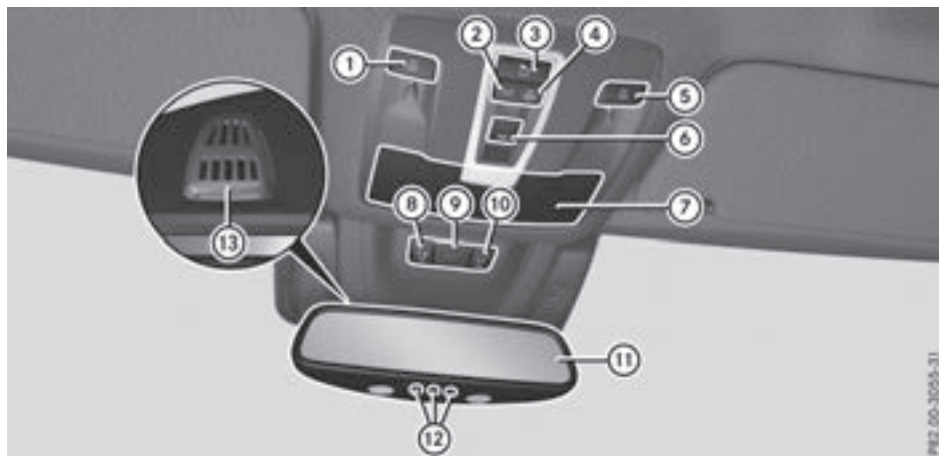

	Function	Page
⑩	Stowage compartment Cup holder Ashtray Cigarette lighter Socket	297 304 307 307 308
⑪	 DSR (Downhill Speed Regulation)	213
⑫	 Manual gearshifting (permanent setting)	147
⑬	DYNAMIC SELECT controller	142
⑭	Stowage compartment with Media Interface	296
⑮	Touchpad; see Digital Operator's Manual	

	Function	Page
⑯	 Back button (see the Digital Operator's Manual)	
⑰	Multimedia system controller; see Digital Operator's Manual	
⑱	 Switches to the favorites button (see the Digital Operator's Manual)	
⑲	Switches to the vehicle settings display (see the Digital Operator's Manual) AMG adaptive sport suspension system (Mercedes-AMG vehicles)	186
⑳	 Level control	185

## Overhead control panel













	Function	Page
①	 Switches the left-hand reading lamp on/off	114
②	 Switches the front interior lighting on	114
③	 Switches the rear interior lighting on or off	114
④	 Switches the front interior lighting/automatic interior lighting control off	114
⑤	 Switches the right-hand reading lamp on/off	114
⑥	 Opens/closes the panorama roof with power tilt/sliding panel and roller sunblinds	94





	Function	Page
⑦	Eyeglasses compartment	297
⑧	 Breakdown assistance call button (mbrace system)	311
⑨	 SOS button (mbrace system)	310
⑩	 Info call button (mbrace system)	312
⑪	Rear-view mirror	105
⑫	Buttons for the garage door opener	319
⑬	Microphone for mbrace (emergency call system), telephone and the Voice Control System <sup>1</sup>	

<sup>1</sup> The Voice Control System is only available in combination with COMAND. Please observe the separate operating instructions.

Door control panel



	Function	Page
①	Opens the door	83
②	  Unlocks/locks the vehicle	83
③	    Stores settings for the seat, exterior mirrors and steering column (memory function)	108
④	Adjusts the seats	97
⑤	    Adjusts and folds the exterior mirrors in/out electrically	105

	Function	Page
⑥	 Opens/closes the side windows	89
⑦	 Opens/closes the tail-gate	87
⑧	 Plug-in hybrid: Unlocks the fuel filler flap	
⑨	 Activates/deactivates the override feature for the side windows in the rear compartment	65

## Panic alarm



- ▶ **To activate:** press **PANIC** button ① for approximately one second.  
A visual and audible alarm is triggered if the alarm system is armed.
- ▶ **To deactivate:** press **PANIC** button ① again.  
or
- ▶ Insert the SmartKey into the ignition lock.  
or, on vehicles with KEYLESS-GO:
- ▶ Press the Start/Stop button.  
The SmartKey must be in the vehicle.

## Occupant safety

### Introduction to the restraint system

The restraint system can reduce the risk of vehicle occupants coming into contact with parts of the vehicle's interior in the event of an accident. The restraint system can also reduce the forces to which vehicle occupants are subjected during an accident.

The restraint system comprises:

- Seat belt system
- Air bags
- Child restraint system
- Child seat securing systems

The components of the restraint system work in conjunction with each other. They can only deploy their protective function if, at all times, all vehicle occupants:

- have fastened their seat belts correctly (▷ page 47)
- have the seat and head restraint adjusted properly (▷ page 97)

As the driver, you also have to make sure that the steering wheel is adjusted correctly. Observe the information relating to the correct driver's seat position (▷ page 97).

You also have to make sure that an air bag can inflate properly if deployed (▷ page 49).

An air bag supplements a correctly worn seat belt. As an additional safety device, the air bag increases the level of protection for vehicle occupants in the event of an accident. For example, if, in the event of an accident, the protection offered by the seat belt is sufficient, the air bags are not deployed. When an accident occurs, only the air bags that increase protection in that particular accident situation are deployed. However, seat belts and air bags generally do not protect against objects penetrating the vehicle from the outside.

Information on restraint system operation can be found under "Triggering of the Emergency Tensioning Devices and air bags" (▷ page 56).

See "Children in the vehicle" for information on children traveling with you in the vehicle as well as on child restraint systems (▷ page 59).

### Important safety notes

#### WARNING

Modifications to the restraint system may cause it to no longer work as intended. The restraint system may then not perform its intended protective function and may fail in an accident or trigger unexpectedly, for example. This poses an increased risk of injury or even fatal injury.

Never modify parts of the restraint system.  
Never tamper with the wiring, the electronic components or their software.

If it is necessary to modify components of the restraint system to accommodate a person with disabilities, contact an authorized Mercedes-Benz Center for details. USA only: for further information contact our Customer Assistance Center at 1-800 FOR-MERCEDES (1-800-367-6372).

Mercedes-Benz recommends that you only use driving aids which have been approved specifically for your vehicle by Mercedes-Benz.

## Restraint system warning lamp

The functions of the restraint system are checked after the ignition is switched on and at regular intervals while the engine is running. Therefore, malfunctions can be detected in good time.

The  restraint system warning lamp on the instrument cluster lights up when the ignition is switched on. It goes out no later than a few seconds after the vehicle is started. The components of the restraint system are in operational readiness.

A malfunction has occurred if the  restraint system warning lamp:

- does not light up after the ignition is switched on
- does not go out after a few seconds with the engine running
- lights up again while the engine is running



### WARNING

If the restraint system is malfunctioning, restraint system components may be triggered unintentionally or may not deploy as intended during an accident. This can affect for example the Emergency Tensioning Device or the air bag. This poses an increased risk of injury or even fatal injury.

Have the restraint system checked and repaired in a qualified specialist workshop as soon as possible.

## PASSENGER AIR BAG indicator lamp



PASSENGER AIR BAG ON indicator lamp  and PASSENGER AIR BAG OFF indicator lamp  are part of the Occupant Classification System (OCS).

The indicator lamps display the status of the front-passenger front air bag.

- PASSENGER AIR BAG ON lights up for 60 seconds, subsequently both indicator lamps are off (PASSENGER AIR BAG ON and OFF): the front-passenger front air bag is able to deploy in the event of an accident.
- PASSENGER AIR BAG OFF lights up: the front-passenger front air bag is deactivated. It will then not be deployed in the event of an accident.

If the PASSENGER AIR BAG ON indicator lamp is off, only the PASSENGER AIR BAG OFF indicator lamp shows the status of the front-passenger front air bag. The PASSENGER AIR BAG OFF indicator lamp may be lit continuously or be off. Depending on the person in the front-passenger seat, the front-passenger front air bag must either be deactivated or enabled; see the following points. You must make sure of this both before and during a journey.

- **Children in a child restraint system:** whether the front-passenger front air bag is enabled or deactivated depends on the installed child restraint system, and the age and size of the child. Therefore, be sure to observe the notes on the "Occupant Classification System (OCS)" ([▷ page 51](#)) and on "Children in the vehicle" ([▷ page 59](#)). There you will also find instructions on rearward and forward-facing child restraint systems on the front-passenger seat.
- **All other persons:** depending on the classification of the person in the front-passenger seat, the front-passenger front air bag is enabled or deactivated ([▷ page 51](#)). Be sure to observe the notes on "Seat belts" ([▷ page 45](#)) and "Air bags" ([▷ page 49](#)). There you can also find information on the correct seat position.

## Seat belts

### Introduction

Seat belts are the most effective means of restricting the movement of vehicle occupants in the event of an accident or the vehicle rolling over. This reduces the risk of vehicle occupants coming into contact with parts of the vehicle interior or being ejected from the vehicle. Furthermore, the seat belt helps to keep the vehicle

occupant in the best position in relation to the air bag.

The seat belt system comprises:

- Seat belts
- Emergency Tensioning Devices for the front seat belts and the outer seat belts in the rear
- Seat belt force limiters

If the seat belt is pulled out of the belt outlet quickly or with a jerky movement, the belt retractor locks. The belt strap cannot be extracted any further.

The Emergency Tensioning Device tightens the seat belt in an accident, pulling the belt close against the body. However it does not pull the vehicle occupant back in the direction of the backrest.

The Emergency Tensioning Device does not correct an incorrect seat position or the routing of an incorrectly fastened seat belt.

When triggered, a seat belt force limiter helps to reduce the force exerted by the seat belt on the vehicle occupant.

The seat belt force limiters for the front seats are synchronized with the front air bags, which absorb part of the deceleration force. This can reduce the force exerted on the vehicle occupants during an accident.

**!** If the front-passenger seat is not occupied, do not engage the seat belt tongue in the buckle on the front-passenger seat. Otherwise, in addition to other systems, the Emergency Tensioning Device could also be triggered in the event of an accident and would need to be replaced.

### Important safety notes

The use of seat belts and child restraint systems is required by law in:

- all 50 states
- the U.S. territories
- the District of Columbia
- all Canadian provinces

Even where this is not required by law, all vehicle occupants should correctly fasten their seat belts before starting the journey.

#### WARNING

If the seat belt is not worn correctly, it cannot perform its intended protective function. An incorrectly fastened seat belt can also cause

injuries, for example, in the event of an accident or when braking or changing direction abruptly. This poses an increased risk of injury or even fatal injury.

Always ensure that all vehicle occupants have their seat belts fastened correctly and are sitting properly.

The components of the restraint system work in conjunction with each other. They can only deploy their protective function if, at all times, all vehicle occupants:

- have fastened their seat belts correctly (▷ page 47)
- have the seat and head restraint adjusted properly (▷ page 97)

#### WARNING

The seat belt does not offer the intended level of protection if you have not moved the backrest to an almost vertical position. When braking or in the event of an accident, you could slide underneath the seat belt and sustain abdomen or neck injuries, for example. This poses an increased risk of injury or even fatal injury.

Adjust the seat properly before beginning your journey. Always ensure that the backrest is in an almost vertical position and that the shoulder section of your seat belt is routed across the center of your shoulder.

#### WARNING

Persons less than 5 ft (1.50 m) tall cannot wear the seat belt correctly without an additional and suitable restraint system. If the seat belt is not worn correctly, it cannot perform its intended protective function. An incorrectly fastened seat belt can also cause injuries, for example, in the event of an accident or when braking or changing direction abruptly. This poses an increased risk of injury or even fatal injury.

For this reason, always secure persons under 5 ft (1.50 m) tall in suitable additional restraint systems.



If a child younger than twelve years old and under 5 ft (1.50 m) in height is traveling in the vehicle:

- always secure the child in a child restraint system suitable for this Mercedes-Benz vehicle. The child restraint system must be appropriate to the age, weight and size of the child
- always observe the instructions and safety notes on "Children in the vehicle" (▷ page 59) in addition to the child restraint system manufacturer's installation and operating instructions
- always observe the instructions and safety notes on the "Occupant classification system (OCS)" (▷ page 51)

### **WARNING**

The seat belts may not perform their intended protective function if:

- they are damaged, modified, extremely dirty, bleached or dyed
- the seat belt buckle is damaged or extremely dirty
- the Emergency Tensioning Devices, belt anchorages or inertia reels have been modified.

Seat belts may be damaged in an accident, although the damage may not be visible, e.g. due to splinters of glass. Modified or damaged seat belts may tear or fail, e.g. in an accident. Modified Emergency Tensioning Devices could accidentally trigger or fail to deploy when necessary. This poses an increased risk of injury or even fatal injury.

Never modify the seat belts, Emergency Tensioning Devices, belt anchorages and inertia reels. Make sure that the seat belts are undamaged, not worn out and clean. Following an accident, have the seat belts checked immediately at a qualified specialist workshop.

Only use seat belts that have been approved for your vehicle by Mercedes-Benz.

## Proper use of the seat belts

Observe the safety notes on the seat belt (▷ page 46).

All vehicle occupants must be wearing the seat belt correctly before beginning the journey. Also make sure that all vehicle occupants are always wearing the seat belt correctly while the vehicle is in motion.

When fastening the seat belt, always make sure that:

- the seat belt buckle tongue is inserted only into the belt buckle belonging to that seat
- the seat belt is pulled tight across your body. Avoid wearing bulky clothing, e.g. a winter coat.

- the seat belt is not twisted

Only then can the forces which occur be distributed over the area of the belt.

- the shoulder section of the belt is routed across the center of your shoulder

The shoulder section of the seat belt should not touch your neck or be routed under your arm or behind your back. Where possible, adjust the seat belt to the appropriate height.

- the lap belt is taut and passes across your lap as low down as possible

The lap belt must always be routed across your hip joints and not across your abdomen. This applies particularly to pregnant women. If necessary, push the lap belt down to your hip joint and pull it tight using the shoulder section of the belt.

- the seat belt is not routed across sharp, pointed or fragile objects

If you have such items located on or in your clothing, e.g. pens, keys or eyeglasses, store these in a suitable place.

- only one person is using a seat belt

Infants and children must never travel sitting on the lap of a vehicle occupant. In the event of an accident, they could be crushed between the vehicle occupant and seat belt.

- objects are never secured with a seat belt if the seat belt is also being used by one of the vehicle's occupants

Also ensure that there are never objects between a person and the seat, e.g. cushions.

Seat belts are only intended to secure and restrain vehicle occupants. Always observe the "Loading guidelines" for securing objects, luggage or loads (▷ page 295).

## Fastening and adjusting the seat belts

Observe the safety notes on the seat belt (> page 46) and the notes on correct use of seat belts (> page 47).



Basic illustration

- ▶ Adjust the seat (> page 97). The seat backrest must be in an almost upright position.
- ▶ Pull the seat belt smoothly from the belt outlet and engage belt tongue ② into belt buckle ①.  
The seat belt on the driver's seat and the front-passenger seat may be tightened automatically, see "Belt adjustment" (> page 48).
- ▶ If necessary, pull up on the shoulder section of the seat belt to tighten the belt across your body.

The shoulder section of the seat belt must always be routed across the center of the shoulder. Adjust the belt outlet if necessary.

- ▶ **To raise:** slide the belt outlet up.  
The belt outlet will engage in various positions.
- ▶ **To lower:** hold belt outlet release ③ and slide the belt outlet down.
- ▶ Let go of belt outlet release ③ in the desired position and make sure that the belt outlet engages.

All seat belts except the driver's seat belt are equipped with a special seat belt retractor to securely fasten child restraint systems in the vehicle. Further information can be found under "Special seat belt retractor" (> page 60).

## Releasing seat belts

- ❗ Make sure that the seat belt is fully rolled up. Otherwise, the seat belt or belt tongue will be trapped in the door or in the seat mechanism. This could damage the door, the door trim panel and the seat belt. Damaged seat belts can no longer fulfill their protective function and must be replaced. Visit a qualified specialist workshop.
- ▶ Press the release button in the belt buckle, hold the belt tongue firmly and guide the belt back.

## Seat belt adjustment

The belt adjustment is a convenience function integrated into PRE-SAFE®. With this function, the driver's and front-passenger seat belts are adjusted to the upper body of the vehicle occupant.

The seat belt strap will slightly tighten if:



- the belt tongue is inserted into the buckle and
- the ignition is switched on

The seat belt adjustment will apply a certain tightening force if any slack is detected between the vehicle occupant and the seat belt. Do not grab hold of the seat belt.

The belt adjustment can be switched on and off using the on-board computer (> page 239).

## Belt warning for the driver and front passenger

The  seat belt warning lamp in the instrument cluster is a reminder that all vehicle occupants must wear their seat belts. It may light up continuously or flash. In addition, there may be a warning tone.

Regardless of whether the driver's seat belt has already been fastened, the  seat belt warning lamp lights up for six seconds each time the engine is started. If the front doors are closed and the driver's or front-passenger seat belt has not been fastened, the  seat belt warning lamp lights up again after the six seconds. As soon as the driver's and front-passenger seat belts are fastened or a front door is opened again, the  seat belt warning lamp goes out. If the driver's seat belt is not fastened after the engine is started, an additional warning tone will sound. The warning tone switches off after six

seconds or once the driver's seat belt is fastened.

If the vehicle's speed exceeds 15 mph (25 km/h) once and the driver's and front-passenger seat belts are not fastened, a warning tone sounds. A warning tone also sounds with increasing intensity for 60 seconds or until the driver or front passenger have fastened their seat belts.

If the driver or front passenger unfasten their seat belts during the journey, the seat belt warning is activated again.

## Air bags

### Introduction

The installation point of an air bag can be recognized by the AIRBAG marking.

An air bag complements the correctly fastened seat belt. It is no substitute for the seat belt. The air bag provides additional protection in applicable accident situations.

Not all air bags are deployed in an accident. The different air bag systems function independently from one another (▷ page 56).

However, no system available today can completely eliminate injuries and fatalities.

It is also not possible to rule out a risk of injury caused by an air bag due to the high speed at which the air bag must be deployed.

### Important safety notes

#### WARNING

If you do not sit in the correct seat position, the air bag cannot protect as intended and could even cause additional injury when deployed. This poses an increased risk of injury or even fatal injury.

To avoid hazardous situations, always make sure that all of the vehicle's occupants:

- have fastened their seat belts correctly, including pregnant women
- are sitting correctly and maintain the greatest possible distance to the air bags
- follow the following instructions

Always make sure that there are no objects between the air bag and the vehicle's occupants.

- Adjust the seats properly before beginning your journey. Always make sure that the seat is in an almost upright position. The center of the head restraint must support the head at about eye level.
- Move the driver's and front-passenger seats as far back as possible. The driver's seat position must allow the vehicle to be driven safely.
- Only hold the steering wheel on the outside. This allows the air bag to be fully deployed.
- Always lean against the backrest while driving. Do not lean forward or lean against the door or side window. You may otherwise be in the deployment area of the air bags.
- Always keep your feet in the footwell in front of the seat. Do not put your feet on the dashboard, for example. Your feet may otherwise be in the deployment area of the air bag.
- For this reason, always secure persons less than 5 ft (1.50 m) tall in suitable restraint systems. Up to this height, the seat belt cannot be worn correctly.

#### **If a child is traveling in your vehicle, also observe the following notes:**

- Always secure children under twelve years of age and less than 5 ft (1.50 m) tall in suitable child restraint systems.
- Child restraint systems should be installed on the rear seats.
- Only secure a child in a rearward-facing child restraint system on the front-passenger seat when the front-passenger front air bag is deactivated. If the PASSENGER AIR BAG OFF indicator lamp is permanently lit, the front-passenger front air bag is deactivated (▷ page 45).
- Always observe the instructions and safety notes on the "Occupant Classification System (OCS)" (▷ page 51) and on "Children in the vehicle" (▷ page 59) in addition to the child restraint system manufacturer's installation and operating instructions.

**Objects in the vehicle interior may prevent an air bag from functioning correctly.** Before starting your journey and to avoid risks resulting from the speed of the air bag as it deploys, make sure that:

- there are no people, animals or objects between the vehicle occupants and an air bag
- there are no objects between the seat, door and B-pillar
- there are no hard objects, e.g. coat hangers, hanging on the grab handles or coat hooks
- no accessories, such as cup holders, are attached to the vehicle within the deployment area of an air bag, e.g. to doors, side windows, rear side trim or side walls
- no heavy, sharp-edged or fragile objects are in the pockets of your clothing. Store such objects in a suitable place

#### WARNING

If you modify the air bag cover or affix objects such as stickers to it, the air bag can no longer function correctly. There is an increased risk of injury.

Never modify an air bag cover or affix objects to it.

#### WARNING

Sensors to control the air bags are located in the doors. Modifications or work not performed correctly to the doors or door paneling, as well as damaged doors, can lead to the function of the sensors being impaired. The air bags might therefore not function properly anymore. Consequently, the air bags cannot protect vehicle occupants as they are designed to do. There is an increased risk of injury.

Never modify the doors or parts of the doors. Always have work on the doors or door paneling carried out at a qualified specialist workshop.

### Front air bags

- !** Do not place heavy objects on the front-passenger seat. This could cause the system to identify the seat as being occupied. In the event of an accident, the restraint systems on

the front-passenger side may be triggered and have to be replaced.



Driver's air bag ① deploys in front of the steering wheel. Front-passenger front air bag ② deploys in front of and above the glove box.

When deployed, the front air bags offer additional head and thorax protection for the occupants in the front seats.

The PASSENGER AIR BAG OFF indicator lamp informs you about the status of the front-passenger front air bag (▷ page 45).

The front-passenger front air bag will only deploy if:

- the system, based on the OCS weight sensor readings, detects that the front-passenger seat is occupied (▷ page 51). The PASSENGER AIR BAG OFF indicator lamp is not lit (▷ page 52)
- the restraint system control unit predicts a high accident severity

### Driver's knee bag



Driver's knee bag ① deploys under the steering column. The driver's knee bag is deployed together with the front air bag.

The driver's knee bag offers additional thigh, knee and lower leg protection for the occupant in the driver's seat.

## Side impact air bags

### WARNING

Unsuitable seat covers can obstruct or prevent deployment of the air bags integrated into the seats. Consequently, the air bags cannot protect vehicle occupants as they are designed to do. In addition, the operation of the occupant classification system (OCS) could be adversely affected. This poses an increased risk of injury or even fatal injury. You should only use seat covers that have been approved for the respective seat by Mercedes-Benz.

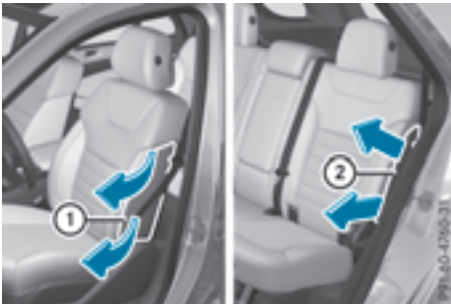

Front side impact air bags ① and rear side impact air bags ② deploy next to the outer bolster of the seat backrest.

When deployed, the side impact air bag offers additional thorax protection. It also offers additional pelvis protection for occupants in the front seats. However, it does not protect the:

- Head
- Neck
- Arms

If the restraint system control unit detects a side impact, the side impact air bag is deployed on the side on which the impact occurs.

The side impact air bag on the front-passenger side deploys under the following conditions:

- the OCS system detects that the front-passenger seat is occupied or
- the seat belt buckle tongue is engaged in the belt buckle of the front-passenger seat

If the belt tongue is engaged in the belt buckle, the side impact air bag on the front-passenger side deploys if an appropriate accident situation occurs. In this case, deployment is independent of whether the front-passenger seat is occupied or not.

## Window curtain air bags



Window curtain air bags ① are integrated into the side of the roof frame and deployed in the area from the A-pillar to the C-pillar.

When deployed, the window curtain air bag enhances the level of protection for the head. However, it does not protect the chest or arms.

If the restraint system control unit detects a side impact, the window curtain air bag is deployed on the side on which the impact occurs.

If the system determines that they can offer additional protection to that provided by the seat belt, a window curtain air bag may be deployed in other accident situations (> page 56).

## Occupant Classification System (OCS)

### Introduction

The Occupant Classification System (OCS) categorizes the person in the front-passenger seat. Depending on that result, the front-passenger front air bag is either enabled or deactivated.

The system does not deactivate:

- the side impact air bag
- the window curtain air bag
- the Emergency Tensioning Devices

In the following situation, the side impact air bag and the Emergency Tensioning Device are deactivated:

- OCS has not categorized the person on the front-passenger seat as an adult or a person of corresponding stature and
- the seat belt buckle tongue of the seat belt is not inserted into the front-passenger seat belt buckle

## Requirements

To be classified correctly, the front passenger must sit:

- with the seat belt fastened correctly
  - in an almost upright position with their back against the seat backrest
  - with their feet resting on the floor, if possible
- If the front passenger does not observe these conditions, OCS may produce a false classification, e.g. because the front passenger:
- transfers their weight by supporting themselves on a vehicle armrest
  - sits in such a way that their weight is raised from the seat cushion

If it is absolutely necessary to install a child restraint system on the front-passenger seat, be sure to observe the correct positioning of the child restraint system. Never place objects under or behind the child restraint system, e.g. a cushion. The entire base of the child restraint system must always rest on the seat cushion of the front-passenger seat. The backrest of the forward-facing child restraint system must lie as flat as possible against the backrest of the front-passenger seat.

The child restraint system must not touch the roof or be subjected to a load by the head restraint. Adjust the angle of the seat backrest and the head restraint position accordingly.

Only then can OCS be guaranteed to function correctly. Always observe the child restraint system manufacturer's installation and operating instructions.

## Occupant Classification System operation (OCS)



- ① PASSENGER AIR BAG ON indicator lamp
- ② PASSENGER AIR BAG OFF indicator lamp

The indicator lamps inform you whether the front-passenger front air bag is deactivated or enabled.

- ▶ Press the Start/Stop button once or twice, or turn the SmartKey to position 1 or 2 in the ignition lock.

The system carries out self-diagnostics.

The PASSENGER AIR BAG OFF and PASSENGER AIR BAG ON indicator lamps must light up simultaneously for approximately six seconds.

The indicator lamps display the status of the front-passenger front air bag.

- PASSENGER AIR BAG ON lights up for 60 seconds, subsequently both indicator lamps are off (PASSENGER AIR BAG ON and OFF): the front-passenger front air bag is able to deploy in the event of an accident.
- PASSENGER AIR BAG OFF lights up: the front-passenger front air bag is deactivated. It will then not be deployed in the event of an accident.

If the PASSENGER AIR BAG ON indicator lamp is off, only the PASSENGER AIR BAG OFF indicator lamp shows the status of the front-passenger front air bag. The PASSENGER AIR BAG OFF indicator lamp may be lit continuously or be off. If the status of the front-passenger front air bag changes while the vehicle is in motion, an air bag display message appears in the instrument cluster (▷ page 253). When the front-passenger seat is occupied, always pay attention to the PASSENGER AIR BAG OFF indicator lamp. Be aware of the status of the front-passenger front air bag both before and during the journey.

 **WARNING**

If the PASSENGER AIR BAG OFF indicator lamp is lit, the front-passenger front air bag is disabled. It will not be deployed in the event of an accident and cannot perform its intended protective function. A person in the front-passenger seat could then, for example, come into contact with the vehicle's interior, especially if the person is sitting too close to the dashboard. This poses an increased risk of injury or even fatal injury.

When the front-passenger seat is occupied, always ensure that:

- the classification of the person in the front-passenger seat is correct and the front-passenger front air bag is enabled or disabled in accordance with the person in the front-passenger seat
- the front-passenger seat has been moved back as far back as possible.
- the person is seated correctly.

Make sure, both before and during the journey, that the status of the front-passenger front air bag is correct.

 **WARNING**

If you secure a child in a rearward-facing child restraint system on the front-passenger seat and the PASSENGER AIR BAG OFF indicator lamp is off, the front-passenger front air bag can deploy in the event of an accident. The child could be struck by the air bag. This poses an increased risk of injury or even fatal injury.

Make sure that the front-passenger front air bag has been deactivated. The PASSENGER AIR BAG OFF indicator lamp must be lit.

NEVER use a rearward-facing child restraint on a seat protected by an ACTIVE FRONT AIR-BAG in front of it; DEATH or SERIOUS INJURY to the child can occur.

If the PASSENGER AIR BAG OFF indicator lamp stays off, do not install a rearward-facing child restraint system on the front-passenger seat. You can find more information on OCS under "Problems with the Occupant Classification System" (▷ page 55).

 **WARNING**

If you secure a child in a forward-facing child restraint system on the front-passenger seat and you position the front-passenger seat too close to the dashboard, the child could, in the event of an accident:

- come into contact with the vehicle's interior if the PASSENGER AIR BAG OFF indicator lamp is lit, for example
- be struck by the air bag if the PASSENGER AIR BAG OFF indicator lamp is off

This poses an increased risk of injury or even fatal injury.

Move the front-passenger seat as far back as possible. Always make sure that the shoulder belt strap is correctly routed from the vehicle belt sash guide to the shoulder belt guide on the child restraint system. The shoulder belt strap must be routed forwards and downwards from the vehicle belt sash guide. If necessary, adjust the vehicle belt sash guide and the front-passenger seat accordingly. Always observe the child restraint system manufacturer's installation instructions.

If OCS determines that:

- The front-passenger seat is unoccupied, the PASSENGER AIR BAG OFF indicator lamp lights up after the system self-test and remains lit. This indicates that the front-passenger front air bag is deactivated.
- The front-passenger seat is occupied by a child of up to twelve months old, in a standard child restraint system, the PASSENGER AIR BAG OFF indicator lamp lights up after the system self-test and remains lit. This indicates that the front-passenger front air bag is deactivated.

But even in the case of a twelve-month-old child, in a standard child restraint system, the PASSENGER AIR BAG OFF indicator lamp can go out after the system self-test. This indicates that the front-passenger front air bag is activated. The result of the classification is dependent on, among other factors, the child restraint system and the child's stature. It is recommended that you install the child restraint system on a suitable rear seat.

- The front-passenger seat is occupied by a person of smaller stature (e.g. a teenager or small adult), the PASSENGER AIR BAG OFF indicator lamp lights up and remains lit after the system self-test depending on the result of the classification or, alternatively, goes out.
  - If the PASSENGER AIR BAG OFF indicator lamp is off, move the front-passenger seat as far back as possible. Alternatively, a person of smaller stature can sit on a rear seat.
  - If the PASSENGER AIR BAG OFF indicator lamp is lit, a person of smaller stature should not use the front-passenger seat.
- The front-passenger seat is occupied by an adult or a person of adult stature, the PASSENGER AIR BAG OFF indicator lamp goes out after the system self-test. This indicates that the front-passenger front air bag is activated.

If children are traveling in the vehicle, be sure to observe the notes on "Children in the vehicle" (▷ page 59).

When the Occupant Classification System (OCS) is malfunctioning, the red  restraint system warning lamp on the instrument cluster and the PASSENGER AIR BAG OFF indicator lamp light up simultaneously. The front-passenger front air bag is deactivated in this case and does not deploy during an accident. Have the Occupant Classification System (OCS) checked and repaired immediately at a qualified specialist workshop. Mercedes-Benz recommends that you use an authorized Mercedes-Benz Center for this purpose.

If the front-passenger seat, the seat cover or the seat cushion are damaged, have the necessary repair work carried out at a qualified specialist workshop. Mercedes-Benz recommends that you use an authorized Mercedes-Benz Center for this purpose.

For safety reasons, Mercedes-Benz recommends that you only use seat accessories that have been approved by Mercedes-Benz.

If the driver's air bag deploys, this does not mean that the front-passenger front air bag will also deploy. The Occupant Classification System (OCS) categorizes the occupant on the front-passenger seat. Depending on that result, the front-passenger front air bag is either enabled or deactivated.

## System self-test

### DANGER

If both the PASSENGER AIR BAG OFF and PASSENGER AIR BAG ON indicator lamps do not light up during the system self-test, the system is malfunctioning. The front-passenger front air bag might be triggered unintentionally or might not be triggered at all in the event of an accident with high deceleration. This poses an increased risk of injury or even fatal injury.

In this case the front-passenger seat may not be used. Do not install a child restraint system on the front-passenger seat. Have the Occupant Classification System (OCS) checked and repaired immediately at a qualified specialist workshop.

### WARNING

If the PASSENGER AIR BAG OFF indicator lamp remains lit after the system self-test, the front-passenger front air bag is disabled. It will not be deployed in the event of an accident. In this case, the front-passenger front air bag cannot perform its intended protective function, e.g. when a person is seated in the front-passenger seat.

That person could, for example, come into contact with the vehicle's interior, especially if the person is sitting too close to the dashboard. This poses an increased risk of injury or even fatal injury.

When the front-passenger seat is occupied, always ensure that:

- the classification of the person in the front-passenger seat is correct and the front-passenger front air bag is enabled or disabled in accordance with the person in the front-passenger seat
- the person is seated properly with a correctly fastened seatbelt
- the front-passenger seat has been moved as far back as possible

If the PASSENGER AIR BAG OFF indicator lamp remains lit when it should not, the front-



passenger seat may not be used. Do not install a child restraint system on the front-passenger seat. Have the Occupant Classification System (OCS) checked and repaired immediately at a qualified specialist workshop.

 **WARNING**

Objects between the seat surface and the child restraint system could affect OCS operation. This could result in the front-passenger air bag not functioning as intended during an accident. This poses an increased risk of injury or even fatal injury.

Do not place any objects between the seat surface and the child restraint system. The entire base of the child restraint system must always rest on the seat cushion of the front-passenger seat. The backrest of the forward-

facing child restraint system must, as far as possible, be resting on the backrest of the front-passenger seat. Always comply with the child restraint system manufacturer's installation instructions.

After the system self-test, the PASSENGER AIR BAG OFF or PASSENGER AIR BAG ON indicator lamp displays the status of the front-passenger front air bag (▷ page 52). If the front-passenger front air bag is enabled, the PASSENGER AIR BAG ON indicator lamp lights up for 60 seconds and then goes out.

If the PASSENGER AIR BAG ON indicator lamp is off, only the PASSENGER AIR BAG OFF indicator lamp shows the status of the front-passenger front air bag. The PASSENGER AIR BAG OFF indicator lamp may be lit continuously or be off.

For more information about the OCS, see "Problems with the Occupant Classification System" (▷ page 55).

## Problems with the Occupant Classification System (OCS)

---

Be sure to observe the notes on "System self-test" (▷ page 54).

Problem	Possible causes/consequences and ► Solutions
<p>The PASSENGER AIR BAG OFF indicator lamp lights up and remains lit, even though the front-passenger seat is occupied by an adult or a person of a stature corresponding to that of an adult.</p>	<p>The classification of the person on the front-passenger seat is incorrect.</p> <ul style="list-style-type: none"> <li>► Make sure the conditions for a correct classification of the person on the front-passenger seat are met (► page 52).</li> <li>► If the PASSENGER AIR BAG OFF indicator lamp remains lit, the front-passenger seat may not be used.</li> <li>► Have OCS checked as soon as possible at an authorized Mercedes-Benz Center.</li> </ul>
<p>The PASSENGER AIR BAG OFF indicator lamp does not light up and/or does not stay on.</p> <p>The front-passenger seat is:</p> <ul style="list-style-type: none"> <li>• unoccupied</li> <li>• occupied by the weight of a child up to twelve months old in a child restraint system</li> </ul>	<p>OCS is malfunctioning.</p> <ul style="list-style-type: none"> <li>► Make sure there is nothing between the seat cushion and the child seat.</li> <li>► Make sure that the entire base of the child restraint system rests on the seat cushion of the front-passenger seat. The backrest of the forward-facing child restraint system must lie as flat as possible against the backrest of the front-passenger seat. If necessary, adjust the position of the front-passenger seat.</li> <li>► When installing the child restraint system, make sure that the seat belt is tight. Do not pull the seat belt tight using the front-passenger seat adjustment. This could result in the seat belt and the child restraint system being pulled too tightly.</li> <li>► Check for correct installation of the child restraint system. Make sure that the head restraint does not apply a load to the child restraint system. If necessary, adjust the head restraint accordingly.</li> <li>► Make sure that no objects are applying additional weight onto the seat.</li> <li>► If the PASSENGER AIR BAG OFF indicator lamp remains off and/or the PASSENGER AIR BAG ON indicator lamp lights up, do not install a child restraint system on the front-passenger seat. It is recommended that you install the child restraint system on a suitable rear seat.</li> <li>► Have OCS checked as soon as possible at an authorized Mercedes-Benz Center.</li> </ul>

### Deployment of Emergency Tensioning Devices and air bags

#### Important safety notes

##### WARNING

The air bag parts are hot after an air bag has been deployed. There is a risk of injury. Do not touch the air bag parts. Have a deployed air bag replaced at a qualified specialist workshop as soon as possible.

##### WARNING

A deployed air bag no longer offers any protection and cannot provide the intended protection in an accident. There is an increased risk of injury.

Have the vehicle towed to a qualified specialist workshop in order to have a deployed air bag replaced.

It is important for your safety and that of your passenger to have deployed air bags replaced and to have any malfunctioning air bags

repaired. This will help to make sure the air bags continue to perform their protective function for the vehicle occupants in the event of a crash.

### WARNING

Emergency Tensioning Devices that have deployed pyrotechnically are no longer operational and are unable to perform their intended protective function. This poses an increased risk of injury or even fatal injury.

Have pyrotechnically triggered Emergency Tensioning Devices replaced immediately at a qualified specialist workshop.

An electric motor is used by PRE-SAFE® to trigger the tightening of the seat belt in hazardous situations. This procedure is reversible.

If Emergency Tensioning Devices are triggered or air bags are deployed, you will hear a bang, and some powder may also be released. The  restraint system warning lamp lights up.

Only in rare cases will the bang affect your hearing. The powder that is released generally does not constitute a health hazard, but it may cause short-term breathing difficulties in people with asthma or other respiratory problems. Provided it is safe to do so, you should leave the vehicle immediately or open the window in order to prevent breathing difficulties.

Air bags and pyrotechnic Emergency Tensioning Devices (ETDs) contain perchlorate material, which may require special handling and regard for the environment. National guidelines must be observed during disposal. In California, see [www.dtsc.ca.gov/HazardousWaste/Perchlorate/index.cfm](http://www.dtsc.ca.gov/HazardousWaste/Perchlorate/index.cfm).

## Method of operation

During the first stage of a collision, the restraint system control unit evaluates important physical data relating to vehicle deceleration or acceleration, such as:

- duration
- direction
- intensity

Based on the evaluation of this data, the restraint system control unit triggers the Emergency Tensioning Devices during a frontal or rear collision.

An Emergency Tensioning Device can only be triggered, if:

- the ignition is switched on
- the components of the restraint system are operational. You can find further information under "Restraint system warning lamp" (> page 45)
- the seat belt buckle tongue has engaged in the belt buckle of the respective front seat

The Emergency Tensioning Devices in the rear compartment are triggered independently of the lock status of the seat belts.

If the restraint system control unit detects a more severe accident, further components of the restraint system are activated independently of each other in certain frontal collision situations:

- Front air bags and driver's knee bag
- Window curtain air bag, if the system determines that deployment can offer additional protection to that provided by the seat belt

The front-passenger front air bag is activated or deactivated depending on the person on the front-passenger seat. The front-passenger front air bag can only deploy in an accident if the PASSENGER AIR BAG OFF indicator lamp is off. Observe the information on the PASSENGER AIR BAG indicator lamps (> page 45).

Your vehicle has two-stage front air bags. In the first deployment stage, the front air bag is filled with propellant gas. The front air bag is fully deployed with the maximum amount of propellant gas if a second deployment threshold is reached within a few milliseconds.

The activation threshold of the Emergency Tensioning Devices and the air bags is determined by evaluating the rate of vehicle deceleration or acceleration which occurs at various points in the vehicle. This process is pre-emptive in nature. Deployment should take place in good time at the start of the collision.

The rate of vehicle deceleration or acceleration and the direction of the force are essentially determined by:

- the distribution of forces during the collision
- the collision angle
- the deformation characteristics of the vehicle
- the characteristics of the object with which the vehicle has collided

Factors which can only be seen and measured after a collision has occurred do not play a decisive role in the deployment of an air bag. Nor do

they provide an indication of air bag deployment.

The vehicle can be deformed considerably, without an air bag being deployed. This is the case if only parts which are relatively easily deformed are affected and the rate of deceleration is not high. Conversely, air bags may be deployed even though the vehicle suffers only minor deformation. This is the case if, for example, very rigid vehicle parts such as longitudinal body members are hit, and sufficient deceleration occurs as a result.

If the restraint system control unit detects a side impact or if the vehicle rolls over, the applicable components of the restraint system are deployed independently of each other depending on the apparent type of accident.

- Side impact air bags on the side where the impact takes place, independently of the Emergency Tensioning Device and the use of the seat belt on the driver's seat and outer seats in the second row

The side impact air bag on the front-passenger side deploys under the following conditions:

- the OCS system detects that the front-passenger seat is occupied or
- the seat belt buckle tongue is engaged in the belt buckle of the front-passenger seat
- Window curtain air bag on the side of impact, independently of the use of the seat belt and independently of whether the front-passenger seat is occupied
- Emergency Tensioning Devices, if the system determines that deployment can offer additional protection in this situation
- Window curtain air bags on the driver's and front-passenger side in certain situations when the vehicle rolls over, if the system determines that deployment can offer additional protection to that provided by the seat belt

**i** Not all air bags are deployed in an accident. The different air bag systems work independently of each other.

How the air bag system works is determined by the severity of the accident detected, especially the vehicle deceleration or acceleration and the apparent type of accident:

- Frontal collision
- Side impact
- Rollover

## PRE-SAFE® (anticipatory occupant protection system)

### Introduction

In certain hazardous situations, PRE-SAFE® takes pre-emptive measures to protect the vehicle occupants.

### Important safety notes

**!** Make sure that there are no objects in the footwell or behind the seats. There is a danger that the seats and/or objects could be damaged when PRE-SAFE® is activated.

Although your vehicle is equipped with PRE-SAFE®, the possibility of injury in the event of an accident cannot be ruled out. Always adapt your driving style to suit the prevailing road and weather conditions and maintain a safe distance from the vehicle in front. Drive carefully.

### Function

PRE-SAFE® intervenes:

- in emergency braking situations, e.g. when BAS is activated
- in critical driving situations, e.g. when physical limits are exceeded and the vehicle understeers or oversteers severely
- on vehicles with the Driving Assistance PLUS package: when Active Brake Assist intervenes powerfully or the radar sensor system detects an imminent danger of collision in certain situations

PRE-SAFE® takes the following measures depending on the hazardous situation detected:

- the front seat belts are pre-tensioned.
- if the vehicle skids, the side windows and the sliding sunroof are closed.
- vehicles with the memory function: the front-passenger seat is adjusted if it is in an unfavorable position.
- vehicles with a multicontour seat: the air pressure in the side bolsters of the seat backrest is increased.

If the hazardous situation passes without resulting in an accident, PRE-SAFE® slackens the belt pre-tensioning. On vehicles with multicontour seats, the air pressure in the side bolsters is reduced again. All settings made by PRE-SAFE® can then be reversed.

If the seat belt pre-tensioning is not reduced:

- Move the seat backrest or seat back slightly when the vehicle is stationary.

The seat belt pre-tensioning is reduced and the locking mechanism is released.

The seat-belt adjustment is an integral part of the PRE-SAFE® convenience function. Information about the convenience function can be found under "Belt adjustment" (► page 48).

## PRE-SAFE® PLUS (anticipatory occupant protection system PLUS)

### Introduction

PRE-SAFE® PLUS is only available in vehicles with the Driving Assistance PLUS package.

Using the radar sensor system, PRE-SAFE® PLUS is able to detect that a head-on or rear-end collision is imminent. In certain hazardous situations, PRE-SAFE® PLUS takes pre-emptive measures to protect the vehicle occupants.

### Important safety notes

The intervention of PRE-SAFE® PLUS cannot prevent an imminent collision.

The driver is not warned about the intervention of PRE-SAFE® PLUS.

PRE-SAFE® PLUS does not intervene if the vehicle is backing up.

When driving, or when parking or exiting a parking space with assistance from Parking Pilot, PRE-SAFE® PLUS will not apply the brakes.

### Function

PRE-SAFE® PLUS intervenes in certain situations if the radar sensor system detects an imminent head-on or rear-end collision.

PRE-SAFE® PLUS takes the following measures depending on the hazardous situation detected:

- if the radar sensor system detects that a head-on collision is imminent, the seat belts are pre-tensioned.
- if the radar sensor system detects that a rear-end collision is imminent:
  - the brake pressure is increased if the driver applies the brakes when the vehicle is stationary.
  - the seat belts are pre-tensioned.

The PRE-SAFE® PLUS braking application is canceled:

- if the accelerator pedal is depressed when a gear is engaged
- if the risk of a collision passes or is no longer detected
- if Distance Pilot DISTRONIC indicates an intention to pull away

If the hazardous situation passes without resulting in an accident, the original settings are restored.

### Automatic measures after an accident

Immediately after an accident, the following measures are implemented, depending on the type and severity of the impact:

- the hazard warning lamps are activated
- the emergency lighting is activated
- the vehicle doors are unlocked
- the front side windows are lowered
- vehicles with a memory function: the electrically adjustable steering wheel is raised when the driver's door is opened
- the engine is switched off and the fuel supply is cut off
- vehicles with mbrace: automatic emergency call

## Children in the vehicle

### Important safety notes

Accident statistics show that children secured in the rear seats are safer than children secured in the front-passenger seat. For this reason, Mercedes-Benz strongly advises that you install

a child restraint system on a rear seat. Children are generally better protected there.

If a child younger than twelve years old and under 5 ft (1.50 m) in height is traveling in the vehicle:

- always secure the child in a child restraint system suitable for Mercedes-Benz vehicles. The child restraint system must be appropriate to the age, weight and size of the child
- be sure to observe the instructions and safety notes in this section in addition to the child restraint system manufacturer's installation instructions
- be sure to observe the instructions and safety notes on the "Occupant classification system (OCS)" (▷ page 51)

#### WARNING

If you leave children unsupervised in the vehicle, they could set it in motion by, for example:

- release the parking brake.
- shift the automatic transmission out of the parking position **P**.
- start the engine.

In addition, they may operate vehicle equipment and become trapped. There is a risk of an accident and injury.

When leaving the vehicle, always take the SmartKey with you and lock the vehicle. Never leave children unsupervised in the vehicle.

#### WARNING

If persons, particularly children are subjected to prolonged exposure to extreme heat or cold, there is a risk of injury, possibly even fatal. Never leave children unattended in the vehicle.

#### WARNING

If the child restraint system is subjected to direct sunlight, parts may get very hot. Children may burn themselves on these parts, particularly on the metal parts of the child restraint system. There is a risk of injury.

If you leave the vehicle, taking the child with you, always ensure that the child restraint system is not exposed to direct sunlight. Pro-

tect it with a blanket, for example. If the child restraint system has been exposed to direct sunlight, let it cool down before securing the child in it. Never leave children unattended in the vehicle.

Always ensure that all vehicle occupants have their seat belts fastened correctly and are sitting properly. Particular attention must be paid to children.

Observe the safety notes on the seat belt (▷ page 46) and the notes on correct use of seat belts (▷ page 47).

A booster seat may be necessary to achieve proper seat belt positioning for children over 40 lbs (18 kg) until they reach a height where a three-point seat belt can be properly fastened without a booster seat.

### Special seatbelt retractor

#### WARNING

If the seat belt is released while driving, the child restraint system will no longer be secured properly. The special seat belt retractor is disabled and the inertia reel draws in a portion of the seat belt. The seat belt cannot be immediately refastened. There is an increased risk of injury, possibly even fatal.

Stop the vehicle immediately, paying attention to road and traffic conditions. Reactivate the special seat belt retractor and secure the child restraint system properly.

All seat belts in the vehicle, except the driver's seat belt, are equipped with a special seat belt retractor. When activated, the special seat belt retractor ensures that the seat belt cannot slacken once the child seat is secured.

Installing a child restraint system:

- ▶ Make sure you observe the child restraint system manufacturer's installation instructions.
- ▶ Pull the seat belt smoothly from the belt outlet.
- ▶ Engage seat belt tongue in belt buckle.

Activating the special seat belt retractor:

- ▶ Pull the seat belt out fully and let the inertia reel retract it again.  
While the seat belt is retracting, you should hear a ratcheting sound. The special seat belt retractor is enabled.
- ▶ Push the child restraint system down so that the seat belt is tight and does not loosen.

Removing the child restraint system and deactivating the special seat belt retractor:

- ▶ Make sure you observe the child restraint system manufacturer's installation instructions.
- ▶ Press the release button of the seat belt buckle and guide the seat belt tongue back towards the belt sash guide.  
The special seat belt retractor is deactivated.

### Child restraint system

The use of seat belts and child restraint systems is required by law in:

- all 50 states
- the U.S. territories
- the District of Columbia
- all Canadian provinces

If you install a rearward-facing child restraint system on the center rear seat, the rear arm rest must be folded back as far as possible.

You can obtain further information about the correct child restraint system from any authorized Mercedes-Benz Center.

#### WARNING

If the child restraint system is installed incorrectly on a suitable seat, it cannot protect as intended. The child cannot then be restrained in the event of an accident, heavy braking or sudden changes of direction. There is an increased risk of injury, possibly even fatal.

Make sure that you observe the child restraint system manufacturer's installation instructions and the notes on use. Please ensure, that the base of the child restraint system is always resting completely on the seat cushion. Never place objects, e.g. cushions, under or behind the child restraint system. Only use child restraint systems with the original cover

designed for them. Only replace damaged covers with genuine covers.

#### WARNING

If the child restraint system is installed incorrectly or is not secured, it can come loose in the event of an accident, heavy braking or a sudden change in direction. The child restraint system could be thrown about, striking vehicle occupants. There is an increased risk of injury, possibly even fatal.

Always install child restraint systems properly, even if they are not being used. Make sure that you observe the child restraint system manufacturer's installation instructions.

You will find further information on stowing objects, luggage or loads under "Loading guidelines" (▶ page 295).

#### WARNING

Child restraint systems or their securing systems which have been damaged or subjected to a load in an accident can no longer protect as intended. The child cannot then be restrained in the event of an accident, heavy braking or sudden changes of direction. There is an increased risk of injury, possibly even fatal.

Replace child restraint systems which have been damaged or subjected to a load in an accident as soon as possible. Have the securing systems on the child restraint system checked at a qualified specialist workshop, before you install a child restraint system again.

The securing systems of child restraint systems are:

- the seat belt system
- the LATCH-type (ISOFIX) securing rings
- the Top Tether anchorages

If it is absolutely necessary to carry a child on the front-passenger seat, be sure to observe the information on the "Occupant Classification System (OCS)" (▶ page 51). There you will also find information on deactivating the front-passenger front air bag.

All child restraint systems must meet the following standards:

- U.S. Federal Motor Vehicle Safety Standards 213 and 225
- Canadian Motor Vehicle Safety Standards 213 and 210.2

Confirmation that the child restraint system corresponds to the standards can be found on an instruction label on the child restraint system. This confirmation can also be found in the installation instructions that are included with the child restraint system.

Observe the warning labels in the vehicle interior and on the child restraint system.

### LATCH-type (ISOFIX) child seat securing system

#### WARNING

For LATCH-type (ISOFIX) child restraint systems in which the child is secured using the safety belt integrated in the child restraint system, the maximum permissible weight of the child and child restraint system together is 73 lbs (33 kg).

If the child and the child restraint system together weigh more than 73 lbs (33 kg), the LATCH-type (ISOFIX) child restraint system with integrated safety belt no longer offers sufficient protection. The LATCH-type (ISOFIX) child seat securing system may be overloaded, and the child may not be restrained in an accident, for example. This poses an increased risk of injury or even fatal injury.

If the child and the child restraint system together weigh more than 73 lbs (33 kg), use only a LATCH-type (ISOFIX) child restraint system in which the child is also secured with the vehicle seat belt. Also secure the child restraint system with the Top Tether belt, if available.

Regularly check that the permissible gross weight of the child together with the child restraint system is still maintained.

Always comply with the manufacturer's installation and operating instructions for the child restraint system used.

Before every trip, make sure that the LATCH-type (ISOFIX) child restraint system is engaged correctly in both LATCH-type (ISOFIX) securing rings

 When installing the child restraint system, make sure that the seat belt for the middle seat does not get trapped. The seat belt could otherwise be damaged.



► Install the LATCH-type (ISOFIX) child restraint system on both LATCH-type (ISOFIX) securing rings ①.

LATCH-type (ISOFIX) is a standardized securing system for specially designed child restraint systems on the rear seats. LATCH-type (ISOFIX) securing rings for two LATCH-type (ISOFIX) child restraint systems are installed on the left and right of the rear seats.

Non-LATCH-type (ISOFIX) child seats may also be used and can be installed using the vehicle's seat belt system. Install the child seat according to the manufacturer's instructions.

### Top Tether

#### Introduction

Top Tether provides an additional connection between the child restraint system secured with a LATCH-type (ISOFIX) system and the vehicle. This helps reduce the risk of injury even further. If the child restraint system is equipped with a Top Tether belt, this should always be used.

#### Important safety notes

##### WARNING

If the rear seat backrests are not locked, they could fold forwards in the event of an accident, heavy braking or sudden changes of



direction. As a result, child restraint systems cannot perform their intended protective function. Rear seat backrests that are not locked can also cause additional injuries, e.g. in the event of an accident. This poses an increased risk of injury or even fatal injury. Always lock rear seat backrests after installing a Top Tether belt. Adjust the rear seat backrests so that they are in an upright position.

Make sure that the backrest in the rear compartment engages fully. To do so, pull firmly on the seat backrest.

### Top Tether anchorages

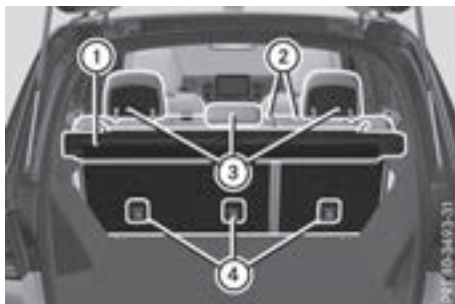

Top Tether anchorages ④ are located on the rear side of the seat backrests.

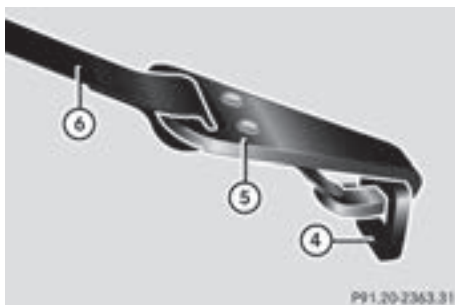

- ▶ Move head restraint ③ upwards (> page 100).
- ▶ Install the LATCH-type (ISOFIX) child restraint system with Top Tether. Always comply with the child restraint system manufacturer's installation instructions when doing so.
- ▶ Route Top Tether belt ⑥ under head restraint ③ between the two head restraint bars.

- ▶ Guide Top Tether belt ⑥ down between cargo compartment cover ① and seat backrest ②.
- ▶ Hook Top Tether hook ⑤ of Top Tether belt ⑥ into Top Tether anchorage ④.

Make sure that:

- Top Tether hook ⑤ is hooked into Top Tether anchorage ④ as shown.
  - Top Tether belt ⑥ is not twisted.
  - Top Tether belt ⑥ is routed between seat backrest ② and cargo compartment cover ① if cargo compartment cover ① is installed.
  - Top Tether belt ⑥ is routed between seat backrest ② and the cargo net if the cargo net is installed.
- ▶ Tension Top Tether belt ⑥. Always comply with the child restraint system manufacturer's installation instructions when doing so.
  - ▶ Move head restraint ③ back down again slightly if necessary (> page 100). Make sure that you do not interfere with the correct routing of Top Tether belt ⑥.

### Child restraint system on the front-passenger seat

#### General notes

Accident statistics show that children secured in the rear seats are safer than children secured in the front-passenger seat. For this reason, Mercedes-Benz strongly advises that you install the child restraint system on a rear seat.

If it is absolutely necessary to install a child restraint system on the front-passenger seat, always observe the instructions and safety notes on the "Occupant Classification System (OCS)" (> page 51).

You can thus avoid the risks that could arise as a result of:

- an incorrectly categorized person in the front-passenger seat
- the unintentional deactivation of the front-passenger front air bag
- the unsuitable positioning of the child restraint system, e.g. too close to the dashboard

## Rearward-facing child restraint system

If it is absolutely necessary to install a rearward-facing child restraint system on the front-passenger seat, always make sure that the front-passenger front air bag is deactivated. Only if the PASSENGER AIR BAG OFF indicator lamp is permanently lit (▷ page 45) is the front-passenger front air bag deactivated.

Always observe the child restraint system manufacturer's installation and operating instructions.

## Forward-facing child restraint system

If it is absolutely necessary to install a forward-facing child restraint system on the front-passenger seat, always move the front-passenger seat as far back as possible. The entire base of the child restraint system must always rest on the seat cushion of the front-passenger seat. The backrest of the child restraint system must lie as flat as possible against the backrest of the front-passenger seat. The child restraint system must not touch the roof or be subjected to a load by the head restraint. Adjust the angle of the seat backrest and the head restraint position accordingly. Always make sure that the shoulder belt strap is correctly routed from the vehicle belt outlet to the shoulder belt guide on the child restraint system. The shoulder belt strap must be routed forward and down from the vehicle belt outlet. If necessary, adjust the vehicle belt outlet and the front-passenger seat accordingly.

Always observe the child restraint system manufacturer's installation and operating instructions.

## Child-proof locks

### Important safety notes

#### WARNING

If children are traveling in the vehicle, they could:

- open doors, thus endangering other people or road users
- exit the vehicle and be caught by oncoming traffic
- operate vehicle equipment and become trapped

There is a risk of an accident and injury.

Always activate the child-proof locks and override feature if children are traveling in the vehicle. When leaving the vehicle, always take the key with you and lock the vehicle. Never leave children unattended in the vehicle.

Override feature for:

- the rear doors (▷ page 65)
- the rear side windows (▷ page 65)

#### WARNING

If you leave children unsupervised in the vehicle, they could set it in motion by, for example:

- release the parking brake.
- shift the automatic transmission out of the parking position **P**.
- start the engine.

In addition, they may operate vehicle equipment and become trapped. There is a risk of an accident and injury.

When leaving the vehicle, always take the SmartKey with you and lock the vehicle. Never leave children unsupervised in the vehicle.

#### WARNING

If persons, particularly children are subjected to prolonged exposure to extreme heat or cold, there is a risk of injury, possibly even fatal. Never leave children unattended in the vehicle.

**⚠ WARNING**

If the child restraint system is subjected to direct sunlight, parts may get very hot. Children may burn themselves on these parts, particularly on the metal parts of the child restraint system. There is a risk of injury.

If you leave the vehicle, taking the child with you, always ensure that the child restraint system is not exposed to direct sunlight. Protect it with a blanket, for example. If the child restraint system has been exposed to direct sunlight, let it cool down before securing the child in it. Never leave children unattended in the vehicle.

**Child-proof locks for the rear doors**

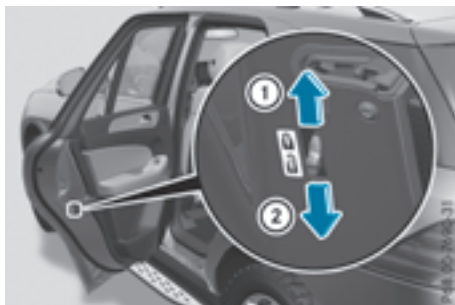

You secure each door individually with the child-proof locks on the rear doors. A door secured with a child-proof lock cannot be opened from inside the vehicle. When the vehicle is unlocked, the door can be opened from the outside.

- ▶ **To activate:** press the child-proof lock lever up in the direction of arrow ①.
- ▶ Make sure that the child-proof locks are working properly.
- ▶ **To deactivate:** press the child-proof lock lever down in the direction of arrow ②.

**Override feature for the rear side windows**



- ▶ **To activate/deactivate:** press button ①. If indicator lamp ② is lit, operation of the rear side windows is disabled. Operation is only possible using the switches in the driver's door. If indicator lamp ② is off, operation is possible using the switches in the rear compartment.

**Pets in the vehicle**

**⚠ WARNING**

If you leave animals unattended or unsecured in the vehicle, they could press buttons or switches, for example.

As a result, they could:

- activate vehicle equipment and become trapped, for example
- activate or deactivate systems, thereby endangering other road users

Unsecured animals could also be flung around the vehicle in the event of an accident or sudden steering or braking, thereby injuring vehicle occupants. There is a risk of an accident and injury.

Never leave animals unattended in the vehicle. Always secure animals properly during the journey, e.g. use a suitable animal transport box.

## Driving safety systems

### Overview of driving safety systems

In this section, you will find information about the following driving safety systems:

- ABS (**A**nti-**l**ock **B**raking **S**ystem) (▷ page 66)
- BAS (**B**rake **A**ssist **S**ystem) (▷ page 67)
- Active Brake Assist (▷ page 67)
- ESP® (**E**lectronic **S**tability **P**rogram) (▷ page 70)
- EBD (**E**lectronic **B**rake force **D**istribution) (▷ page 72)
- ADAPTIVE BRAKE (▷ page 72)
- Active Brake Assist with cross-traffic function (▷ page 72)
- Steering Pilot STEER CONTROL (▷ page 75)

### Important safety notes

If you fail to adapt your driving style or if you are inattentive, the driving safety systems can neither reduce the risk of an accident nor override the laws of physics. Driving safety systems are merely aids designed to assist driving. You are responsible for maintaining the distance to the vehicle in front, for vehicle speed, for braking in good time, and for staying in lane. Always adapt your driving style to suit the prevailing road and weather conditions and maintain a safe distance from the vehicle in front. Drive carefully.

The driving safety systems described only work as effectively as possible when there is adequate contact between the tires and the road surface. Pay particular attention to the information regarding tires, recommended minimum tire tread depths etc. in the "Wheels and tires" section (▷ page 351).

In wintry driving conditions, always use winter tires (M+S tires) and if necessary, snow chains. Only in this way will the driving safety systems described in this section work as effectively as possible.

## ABS (Anti-lock Braking System)

### General information

ABS regulates brake pressure in such a way that the wheels do not lock when you brake. This allows you to continue steering the vehicle when braking.

The  ABS warning lamp in the instrument cluster lights up when the ignition is switched on. It goes out when the engine is running.

ABS works from a speed of about 5 mph (8 km/h), regardless of road-surface conditions. ABS works on slippery surfaces, even when you only brake gently.

### Important safety notes

-  Observe the "Important safety notes" section (▷ page 66).

#### WARNING

If ABS is faulty, the wheels could lock when braking. The steerability and braking characteristics may be severely impaired. Additionally, further driving safety systems are deactivated. There is an increased danger of skidding and accidents.

Drive on carefully. Have ABS checked immediately at a qualified specialist workshop.

When ABS is malfunctioning, other systems, including driving safety systems, will also become inoperative. Observe the information on the ABS warning lamp (▷ page 277) and display messages which may be shown in the instrument cluster (▷ page 244).

### Braking

- ▶ **If ABS intervenes:** continue to depress the brake pedal vigorously until the braking situation is over.
- ▶ **To make a full brake application:** depress the brake pedal with full force.

If ABS intervenes when braking, you will feel a pulsing in the brake pedal.

The pulsating brake pedal can be an indication of hazardous road conditions, and functions as a reminder to take extra care while driving.

## Off-road ABS

An ABS system specifically suited to off-road terrain is activated automatically once the off-road program is activated on:

- Vehicles without the Offroad Engineering package (▷ page 214)
- Vehicles with the Off-Road Engineering package (▷ page 215)

At speeds below 20 mph (30 km/h), the front wheels lock cyclically during braking. The digging-in effect achieved in the process reduces the stopping distance on off-road terrain. This limits steering capability.

## BAS (Brake Assist System)

### General information

BAS operates in emergency braking situations. If you depress the brake pedal quickly, BAS automatically boosts the braking force, thus shortening the stopping distance.

### Important safety notes

- i** Observe the "Important safety notes" section (▷ page 66).

#### WARNING

If BAS is malfunctioning, the braking distance in an emergency braking situation is increased. There is a risk of an accident.

In an emergency braking situation, depress the brake pedal with full force. ABS prevents the wheels from locking.

### Braking

- ▶ Keep the brake pedal firmly depressed until the emergency braking situation is over. ABS prevents the wheels from locking.

The brakes will function as usual once you release the brake pedal. BAS is deactivated.

## Active Brake Assist

### General information

- i** Observe the "Important safety notes" section (▷ page 66).

Active Brake Assist consists of a distance warning function with an autonomous braking function and situation-dependent braking assistance

Active Brake Assist can help you to minimize the risk of a collision with the vehicle traveling in front or reduce the effects of such a collision.

If Active Brake Assist detects that there is a risk of collision, you will be warned visually and acoustically. If you do not react to the visual and audible collision warning, autonomous braking can be initiated in critical situations. If you apply the brake yourself in a critical situation, Adaptive Brake Assist supports you with situation-dependent braking assistance.

Active Brake Assist is only available in certain countries.

### Important safety notes

In particular, the detection of obstacles can be impaired if:

- there is dirt on the sensors or anything else covering the sensors
- there is snow or heavy rain
- there is interference by other radar sources
- there are strong radar reflections, for example in parking garages
- a narrow vehicle is traveling in front, e.g. a motorbike
- a vehicle is traveling in front on a different line
- you are driving a new vehicle or servicing on the Active Brake Assist system has just been carried out

Observe the notes in the section on breaking-in (▷ page 134).

Following damage to the front end of the vehicle, have the configuration and operation of the radar sensor checked at a qualified specialist workshop. This also applies to collisions at slow speeds where there is no visible damage to the front of the vehicle.

### Activating/deactivating

Active Brake Assist is automatically active after switching on the ignition.

You can activate or deactivate Active Brake Assist (▷ page 237) in the on-board computer. When deactivated, the distance warning function and the autonomous braking function are also deactivated.

If Active Brake Assist is deactivated, the  symbol appears in the assistance graphic display.

If DSR (▷ page 213) is activated, Active Brake Assist is deactivated.

### Distance warning function

#### General information

The distance warning function can help you to minimize the risk of a front-end collision with a vehicle ahead or reduce the effects of such a collision. If the distance warning function detects that there is a risk of a collision, you will be warned visually and acoustically.

#### Important safety notes

**i** Observe the "Important safety notes" section for driving safety systems (▷ page 66).

 **WARNING**

The distance warning function does not react:

- to people or animals
- to oncoming vehicles
- to crossing traffic
- when cornering

The distance warning function may not give warnings in all critical situations. There is a risk of an accident.

Always pay careful attention to the traffic situation and be ready to brake.

Always adapt your speed to suit the prevailing road and traffic conditions.

 **WARNING**

The distance warning function cannot always clearly identify objects and complex traffic situations.

In such cases, the distance warning function may:

- give an unnecessary warning
- not give a warning

There is a risk of an accident.

Always pay careful attention to the traffic situation and do not rely solely on the distance warning function.

#### Function

Starting at a speed of around 4 mph (7 km/h), the distance warning function warns you if you rapidly approach a vehicle in front. An intermittent warning tone will then sound, and the  distance warning lamp will light up in the instrument cluster.

▶ Brake immediately in order to increase the distance from the vehicle in front.

or

▶ Take evasive action, provided it is safe to do so.

Due to the nature of the system, particularly complicated but non-critical driving conditions may also cause the system to display a warning. With the help of the radar sensor system, the distance warning function can detect obstacles that are in the path of your vehicle for an extended period of time.

Up to a speed of around 44 mph (70 km/h), the distance warning function can also react to stationary obstacles, such as stopped or parked vehicles.

### Autonomous braking function

If the driver does not react to the distance warning signal in a critical situation, Active Brake Assist can assist the driver with the autonomous braking function.

**Vehicles without Distance Pilot DISTRONIC:** the autonomous braking function is available in the following speed ranges:

- 4 - 65 mph (7 - 105 km/h) for moving objects
- 4 - 31 mph (7 - 50 km/h) for stationary objects

**Vehicles with Distance Pilot DISTRONIC:** the autonomous braking function is available in the following speed ranges:

- 4 - 124 mph (7 - 200 km/h) for moving objects
- 4 - 31 mph (7 - 50 km/h) for stationary objects

Due to the nature of the system, particularly complicated but non-critical driving conditions may also cause the Autonomous Braking Function to intervene.

If the autonomous braking function requires a particularly high braking force, preventative passenger protection measures (PRE-SAFE®) are activated simultaneously (▷ page 58).

## Situation-dependent braking assistance

### General information

**i** Observe the "Important safety notes" section (▷ page 66).

With the help of the radar sensor system, Adaptive Brake Assist can detect obstacles that are in the path of your vehicle for an extended period of time.

If Adaptive Brake Assist detects a risk of collision with the vehicle in front, it calculates the brake pressure necessary to avoid a collision. If you apply the brakes forcefully, situation-dependent braking assistance adapts to the situation and automatically increases the brake pressure to a degree appropriate to the traffic situation.

Situation-dependent braking assistance provides braking assistance in hazardous situations at speeds above 4 mph (7 km/h). It uses radar sensor technology to assess the traffic situation.

Situation-dependent braking assistance is capable of reacting to moving objects that have already been detected as such at least once over the period of observation, up to vehicle speeds of around 155 mph (250 km/h).

Situation-dependent braking assistance reacts to stationary obstacles up to a speed of approximately 44 mph (70 km/h).

If situation-dependent braking assistance demands particularly high brake pressure, preventative passenger protection measures (PRE-SAFE®) are triggered simultaneously (▷ page 58).

► Keep the brake pedal depressed until the emergency braking situation is over. ABS prevents the wheels from locking.

The brakes will work normally again if:

- you release the brake pedal.
- there is no longer any danger of a collision.
- no obstacle is detected in front of your vehicle.

Situation-dependent braking assistance is then deactivated.

### Important safety notes

**i** Observe the "Important safety notes" section for driving safety systems (▷ page 66).

#### WARNING

Adaptive Brake Assist cannot always clearly identify objects and complex traffic situations.

In such cases, Adaptive Brake Assist might:

- intervene unnecessarily
- not intervene

There is a risk of an accident.

Always pay careful attention to the traffic situation and be ready to brake. Terminate the intervention in a non-critical driving situation.

#### WARNING

Adaptive Brake Assist does not react:

- to people or animals
- to oncoming vehicles
- to crossing traffic
- when cornering

As a result, Adaptive Brake Assist may not intervene in all critical conditions. There is a risk of an accident.

Always pay careful attention to the traffic situation and be ready to brake.

Due to the nature of the system, complex but non-critical driving conditions may also cause Active Brake Assist to intervene.

Even if Active Brake Assist is not available due to a malfunction in the radar sensor system, the brake system is still available with full brake boosting effect and BAS.

## ESP® (Electronic Stability Program)

### General notes

**i** Observe the "Important safety notes" section (▷ page 66).

ESP® monitors driving stability and traction, i.e. power transmission between the tires and the road surface.

If ESP® detects that the vehicle is deviating from the direction desired by the driver, one or more wheels are braked to stabilize the vehicle. The engine output is also modified to keep the vehicle on the desired course within physical limits. ESP® assists the driver when pulling away on wet or slippery roads. ESP® can also stabilize the vehicle during braking.

### ETS/4ETS (Electronic Traction System)

ETS traction control is part of ESP®. On vehicles with 4MATIC, 4ETS is part of ESP®.

Traction control brakes the drive wheels individually if they spin. This enables you to pull away and accelerate on slippery surfaces, for example if the road surface is slippery on one side. In addition, more drive torque is transferred to the wheel or wheels with traction.

Traction control remains active, even if you deactivate ESP®.

In appropriate driving situations, activate the offroad program:

- ▶ Vehicles without the Offroad Engineering package (▷ page 214)
- ▶ Vehicles with the Off-Road Engineering package (▷ page 215)

### Offroad 4ETS (Electronic Traction System)

An ETS system specifically suited to off-road terrain is activated automatically once an off-road program is activated:

- Vehicles without the Offroad Engineering package (▷ page 214)
- Vehicles with the Off-Road Engineering package (▷ page 215)

## Important safety notes

### WARNING

If ESP® is malfunctioning, ESP® is unable to stabilize the vehicle. Additionally, further driving safety systems are deactivated. This increases the risk of skidding and an accident.



Drive on carefully. Have ESP® checked at a qualified specialist workshop.

- !** Vehicles with 4MATIC: only operate the vehicle for a maximum of ten seconds on a brake test dynamometer. Switch off the ignition.

Application of the brakes by ESP® may otherwise destroy the brake system.

- !** Vehicles with 4MATIC: function or performance tests may only be carried out on a 2-axle dynamometer. Before you operate the vehicle on such a dynamometer, please consult a qualified workshop. You could otherwise damage the drive train or the brake system.

ESP® is only deactivated if the  warning lamp is lit continuously.

If the  warning lamp and the  warning lamp are lit continuously, ESP® is not available due to a malfunction.

Observe the information on warning lamps (▷ page 279) and display messages which may be shown in the instrument cluster (▷ page 244).

- i** Only use wheels with the recommended tire sizes. Only then will ESP® function properly.

## Characteristics of ESP®

### General information

If the  ESP warning lamp goes out before beginning the journey, ESP® is automatically active.

If ESP® intervenes, the  ESP® warning lamp flashes in the instrument cluster.



If ESP® intervenes:

- ▶ Do not deactivate ESP® under any circumstances.
- ▶ Only depress the accelerator pedal as far as necessary when pulling away.
- ▶ Adapt your driving style to suit the prevailing road and weather conditions.

### ECO start/stop function

The ECO start/stop function switches the engine off automatically when the vehicle stops moving. The engine starts automatically when the driver wants to pull away again. ESP® remains in its previously selected status, e.g. if ESP® was deactivated before the engine was automatically switched off.

### Deactivating/activating ESP®

#### Important safety notes

- ❗ Observe the "Important safety notes" section (▶ page 66).

You can select between the following states of ESP®:

- ESP® is activated.
- ESP® is deactivated.

#### WARNING

If you deactivate ESP®, ESP® no longer stabilizes the vehicle. There is an increased risk of skidding and an accident.

Only deactivate ESP® in the situations described in the following.

It may be best to deactivate ESP® in the following situations:

- when using snow chains
- in deep snow
- on sand or gravel



Spinning the wheels results in a cutting action which provides better grip.

- ❗ Activate ESP® as soon as the situations described above no longer apply. ESP® will otherwise not be able to stabilize the vehicle if the vehicle starts to skid or a wheel starts to spin.

- ❗ Avoid spinning the driven wheels for an extended period with ESP® deactivated. You could otherwise damage the drivetrain.

### Deactivating/activating ESP®



- ▶ **To deactivate:** press button ①.  
The  ESP® OFF warning lamp in the instrument cluster lights up.
- ▶ **To activate:** press button ①.  
The  ESP® OFF warning lamp in the instrument cluster goes out.

### Characteristics when ESP® is deactivated

If ESP® is deactivated and one or more wheels start to spin, the  ESP® warning lamp in the instrument cluster flashes. In such situations, ESP® will not stabilize the vehicle.

If you deactivate ESP®:

- ESP® no longer improves driving stability.
- Engine torque is no longer limited and the drive wheels are able to spin.
- Traction control is still activated.
- Active Brake Assist is no longer available; nor is it activated if you brake firmly with assistance from ESP®
- PRE-SAFE® is no longer available, nor is it activated if you brake firmly and ESP® intervenes.
- Active Brake Assist with cross-traffic function is no longer available; nor is it activated if you brake firmly with assistance from ESP®
- ESP® still provides support when you brake firmly.

## Offroad ESP® (vehicles with Offroad Engineering package)

An ESP® system specifically suited to off-road terrain is activated automatically once the off-road program is activated on:

- Vehicles without the Offroad Engineering package (▷ page 214)
- Vehicles with the Off-Road Engineering package (▷ page 215)

Offroad ESP® intervenes with a delay if there is oversteering or understeering, thus improving traction.

## Crosswind Assist

### General information

Strong crosswind gusts can impair the ability of your vehicle to drive straight ahead. The crosswind driving assistance function integrated in ESP® noticeably reduces these impairments.

ESP® intervenes automatically according to the direction and intensity of the crosswinds affecting your vehicle.

ESP® intervenes with stabilizing braking to assist you in keeping the vehicle in the lane.

Crosswind Assist is active at vehicle speeds above 50 mph (80 km/h) when driving straight ahead or cornering gently.

### Important safety notes

Crosswind Assist does not work if ESP® is switched off or deactivated because of a malfunction.

## EBD (electronic brake force distribution)

### General information

EBD monitors and controls the brake pressure on the rear wheels to improve driving stability while braking.

### Important safety notes

- Observe the "Important safety notes" section for driving safety systems (▷ page 66).

## WARNING

If EBD is malfunctioning, the rear wheels can lock, e.g. under full braking. This increases the risk of skidding and an accident.

You should therefore adapt your driving style to the different handling characteristics. Have the brake system checked at a qualified specialist workshop.

Observe information regarding indicator and warning lamps (▷ page 277) as well as display messages (▷ page 246).

## ADAPTIVE BRAKE

ADAPTIVE BRAKE enhances braking safety and offers increased braking comfort. In addition to the braking function, ADAPTIVE BRAKE also has the HOLD function (▷ page 182) and hill start assist (▷ page 139).

## Active Brake Assist with cross-traffic function

### General information

- Pay attention to the important safety notes in the "Driving safety systems" section (▷ page 66).

Active Brake Assist with cross-traffic function can help you to minimize the risk of a collision with a vehicle in front or a pedestrian and reduce the effects of such a collision. If the Active Brake Assist with cross-traffic function detects a risk of collision, you will be warned visually and acoustically and, if necessary, your brake application will be assisted according to the situation. If you do not react, the system can also react by braking automatically. In the event of a detected risk of collision due to crossing traffic, you will also be visually and acoustically warned as well as assisted by the brake boosting effect according to the situation.

Active Brake Assist with cross-traffic function is only available in vehicles with the Driving Assistance Plus package.

For Active Brake Assist with cross-traffic function to assist you when driving, the radar sensor system and the camera system must be operational.

If the radar sensor system or the camera system is malfunctioning, Active Brake Assist with cross-traffic function is restricted or no longer available. The brake system is still available with complete brake boosting effect and BAS.

The radar sensor system and camera system help Active Brake Assist with cross-traffic function to detect obstacles that are in the path of your vehicle for an extended period of time.

In addition, pedestrians in the path of your vehicle can be detected.

Active Brake Assist with cross-traffic function detects pedestrians using typical characteristics such as body contours and the posture of a person standing upright.

- i** Observe the restrictions described in the "Important safety notes" section (▷ page 73).

### Important safety notes

#### WARNING

Active Brake Assist with cross-traffic function will initially brake your vehicle by a partial application of the brakes if a danger of collision is detected. There may be a collision unless you brake yourself. Even after subsequent full application of the brakes a collision cannot always be avoided, particularly when approaching at too high a speed. There is a risk of an accident.

Always apply the brakes yourself and try to take evasive action, provided it is safe to do so.

In the event of a partial application of the brakes, the vehicle is braked with up to 50% of the full braking pressure.

#### WARNING

Active Brake Assist with cross-traffic function cannot always clearly identify objects and complex traffic situations.

In such cases, Active Brake Assist with cross-traffic function might:

- issue an unnecessary warning or engage
- neither give a warning nor intervene

There is a risk of an accident.

Always pay particular attention to the traffic situation and be prepared to brake, especially if Active Brake Assist with cross-traffic function alerts you. Terminate the intervention in a non-critical driving situation.

#### WARNING

Active Brake Assist with cross-traffic function cannot always clearly identify people, particularly if they are moving. Active Brake Assist with cross-traffic function cannot intervene in these cases. There is a risk of an accident.

Always pay particular attention to the traffic situation and be prepared to brake, especially if Active Brake Assist with cross-traffic function alerts you.

In order to maintain the appropriate distance to the vehicle in front and thus prevent a collision, you must apply the brakes yourself.

#### WARNING

Active Brake Assist with cross-traffic function does not react:

- to small people, e.g. children
- to animals
- to oncoming vehicles
- when cornering

As a result, Active Brake Assist with cross-traffic function may not warn you or engage in all critical situations. There is a risk of an accident.

Always pay careful attention to the traffic situation and be ready to brake.

In the event of snowfall or heavy rain, the recognition can be impaired.

Recognition by the radar sensor system is also impaired if:

- there is dirt on the sensors or anything else covering the sensors
- there is interference by other radar sources
- there are strong radar reflections, for example in parking garages
- a narrow vehicle is traveling in front, e.g. a motorbike

- a vehicle is traveling in front of on a different line relative to the center of your vehicle
- vehicles quickly move into the radar sensor system detection range

Recognition by the camera system is also impaired in the event of:

- dirt on the camera or if the camera is covered
- glare on the camera system, e.g. from the sun being low in the sky
- darkness
- or if:
  - pedestrians move quickly, e.g. into the path of the vehicle
  - the camera system no longer recognizes a pedestrian as a person due to special clothing or other objects
  - a pedestrian is concealed by other objects
  - the typical outline of a person is not distinguishable from the background

Following damage to the front end of the vehicle, have the configuration and operation of the radar sensors checked at a qualified specialist workshop. This also applies to collisions at slow speeds where there is no visible damage to the front of the vehicle.

Following damage to the windshield, have the configuration and operation of the camera system checked at a qualified specialist workshop.

## Function

- ▶ **To activate or deactivate:** activate or deactivate Active Brake Assist with cross-traffic function using the on-board computer (> page 237).

If the Active Brake Assist with cross-traffic function is deactivated, the  symbol appears in the multifunction display.

If you have activated DSR (> page 213), the Active Brake Assist with cross-traffic function is deactivated.

Starting at a speed of around 4 mph (7 km/h), this function warns you if you rapidly approach a vehicle in front. An intermittent warning tone will then sound and the  distance warning lamp will light up in the instrument cluster.

- ▶ Brake immediately to defuse the situation.
- or

- ▶ Take evasive action provided it is safe to do so.

Active Brake Assist with cross-traffic function can also brake the vehicle automatically under the following conditions:

- the driver and front-passenger have their seat belts fastened and
- the vehicle speed is between approximately 4 mph (7 km/h) and 124 mph (200 km/h)

Up to a speed of approximately 44 mph (70 km/h), Active Brake Assist with cross-traffic function may react to:

- stationary objects in the path of your vehicle, e.g. stopped or parked vehicles
- pedestrians in the path of your vehicle

**i** If there is an increased risk of a collision, preventive passenger protection measures (PRE-SAFE®) are triggered (> page 58).

If the risk of collision with the vehicle in front remains and you do not brake, take evasive action or accelerate significantly, the vehicle may perform automatic emergency braking, up to the point of full brake application. Automatic emergency braking is not performed until immediately prior to an imminent accident.

If you apply the brake yourself in a critical situation or during autonomous braking, braking assistance is provided according to the situation. If necessary, this increases the brake pressure up to full brake application.

To avoid a collision, Active Brake Assist with cross-traffic function calculates the brake force necessary if:

- you approach an obstacle, and
- Active Brake Assist with cross-traffic function has detected a risk of a collision

### When driving at a speed under 20 mph

**(30 km/h):** if you depress the brake pedal, Active Brake Assist with cross-traffic function is activated. The increase in brake pressure from Active Brake Assist with cross-traffic function is carried out at the last possible moment.

### When driving at a speed above 20 mph

**(30 km/h):** if you depress the brake pedal sharply, Active Brake Assist with cross-traffic function automatically increases the brake pressure to a degree suited to the traffic situation.

Active Brake Assist with cross-traffic function provides braking assistance in hazardous situations with vehicles in front within a speed range between 4 mph (7 km/h) and 155 mph (250 km/h).

Up to a speed of approximately 44 mph (70 km/h) the Active Brake Assist with cross-traffic function assists you with braking in hazardous situations with:

- stationary obstacles in the path of the vehicle, e.g. stopped or parked vehicles
  - stationary pedestrians in the path of the vehicle
  - obstacles crossing your path that move in the detection range of the sensors and are detected
- Keep the brake pedal depressed until the emergency braking situation is over. ABS prevents the wheels from locking.

You can prevent the intervention of Active Brake Assist with cross-traffic function at any time by:

- depressing the accelerator pedal further
- activating kickdown
- releasing the brake pedal

The braking application of Active Brake Assist with cross-traffic function is ended automatically if:

- you maneuver to avoid the obstacle
- there is no longer a risk of collision
- there is no longer an obstacle detected in front of your vehicle

## STEER CONTROL

### General information

STEER CONTROL helps you by transmitting a noticeable steering force to the steering wheel in the direction required for vehicle stabilization. This steering assistance is provided in particular if:

- both right wheels or both left wheels are on a wet or slippery road surface when you brake
- the vehicle starts to skid

### Important safety notes

- i** Observe the "Important safety notes" section (► page 66).

No steering assistance is provided from STEER CONTROL, if:

- ESP® is deactivated
- ESP® is malfunctioning
- the steering is malfunctioning

If ESP® is malfunctioning, you will be assisted further by the electrical power steering.

## Protection against theft

### Immobilizer

- **To activate with the SmartKey:** remove the SmartKey from the ignition lock.
- **To activate with KEYLESS-GO:** switch the ignition off and open the driver's door.
- **To deactivate:** switch on the ignition.

The immobilizer prevents your vehicle from being started without the correct SmartKey.

When leaving the vehicle, always take the SmartKey with you and lock the vehicle. Anyone can start the engine if a valid SmartKey has been left inside the vehicle.

- i** The immobilizer is always deactivated when you start the engine.

In the event that the engine cannot be started (yet the vehicle's battery is charged), the system is not operational. Contact an authorized Mercedes-Benz Center or call 1-800-FOR-MERCEDES (in the USA) or 1-800-387-0100 (in Canada).

### ATA (anti-theft alarm system)



- ▶ **To arm:** lock the vehicle with the SmartKey or KEYLESS-GO.

Indicator lamp ① flashes. The alarm system is armed after approximately 15 seconds.

- ▶ **To switch off using the SmartKey:** unlock the vehicle with the SmartKey.

or



- ▶ Insert the SmartKey into the ignition lock.
- ▶ **To switch off using KEYLESS-GO:** unlock the vehicle with KEYLESS-GO.

or

- ▶ Press the Start/Stop button on the dashboard. The SmartKey must be inside the vehicle.

A visual and audible alarm is triggered if the alarm system is armed and you open:

- a door
- the vehicle with the mechanical key
- the tailgate
- the hood

- ▶ **To switch the alarm off with the SmartKey:** press the  or  button on the SmartKey.

The alarm is stopped.

or

- ▶ Insert the SmartKey into the ignition lock. The alarm is stopped.

- ▶ **To stop the alarm using KEYLESS-GO:** grasp the outside door handle. The SmartKey must be outside the vehicle. The alarm is stopped.

or

- ▶ Press the Start/Stop button on the dashboard. The SmartKey must be inside the vehicle. The alarm is stopped.

The alarm is not switched off, even if you close the open door that triggered it, for example.

- ▶ **i** If the alarm continues for more than 30 seconds, the mbrace emergency call system automatically notifies the Customer Assistance Center. This is done either by text message or data connection. The emergency call system sends the message or data provided that:

- you have subscribed to the mbrace service.
- the mbrace service has been activated properly.
- the necessary mobile phone network is available.

## SmartKey

### Important safety notes

#### WARNING

If children are left unsupervised in the vehicle, they could:

- open the doors, thus endangering other people or road users.
- get out and disrupt traffic.
- operate the vehicle's equipment.

Additionally, children could set the vehicle in motion if, for example, they:

- release the parking brake.
- shifting the automatic transmission out of park position **P**
- Start the engine.

There is a risk of an accident and injury.

When leaving the vehicle, always take the SmartKey with you and lock the vehicle. Never leave children or animals unattended in the vehicle. Always keep the SmartKey out of reach of children.

#### WARNING

If you attach heavy or large objects to the SmartKey, the SmartKey could be unintentionally turned in the ignition lock. This could cause the engine to be switched off. There is a risk of an accident.

Do not attach any heavy or large objects to the SmartKey. Remove any bulky key rings before inserting the SmartKey into the ignition lock.

- !** Keep the SmartKey away from strong magnetic fields. Otherwise, the remote control function could be affected.

Strong magnetic fields can occur in the vicinity of powerful electrical installations.

Do not keep the SmartKey:

- with electronic devices, e.g. a mobile phone or another SmartKey.
- with metallic objects, e.g. coins or metal foil.
- inside metallic objects, e.g. a metal case.



This can affect the functionality of the SmartKey.

Do not keep the KEYLESS-GO or KEYLESS-GO Start function key in the temperature-controlled cup holder. Otherwise, the KEYLESS-GO or KEYLESS-GO Start function key will not be detected.

**Vehicles with KEYLESS-GO start function:** do not keep the SmartKey in the cargo compartment. Otherwise, the SmartKey may not be detected, e.g. when starting the engine using the Start/Stop button.

### SmartKey functions



- ①  To lock the vehicle
- ②  To open/close the tailgate
- ③  To unlock the vehicle

► **To unlock centrally:** press the  button.

If you do not open the vehicle within approximately 40 seconds of unlocking:

- the vehicle is locked again.
- anti-theft protection is reactivated.

► **To lock centrally:** press the  button.

The SmartKey centrally locks and unlocks the following components:

- the doors
- the tailgate
- the fuel filler flap

The turn signals flash once when unlocking and three times when locking.

You can also set an audible signal to confirm that the vehicle has been locked. The audible signal can be activated and deactivated using the on-board computer (▷ page 239).

You will receive visual and acoustic locking confirmation if all components were able to be locked.

If activated in the multimedia system, the locator lighting also lights up in the dark (see the Digital Operator's Manual).

- ▶ **To open the tailgate automatically from outside the vehicle:** press and hold the  button until the tailgate opens.

Vehicles with KEYLESS-GO:

- ▶ **To close the tailgate automatically from outside the vehicle:** if the SmartKey is located in the immediate vicinity of the vehicle, press the  button on the SmartKey. When the tailgate closes you can then release the button.

## KEYLESS-GO

### General notes

Bear in mind that the engine can be started by any of the vehicle occupants if there is a KEYLESS-GO key in the vehicle (▷ page 137).

### Locking/unlocking centrally

You can start, lock or unlock the vehicle using KEYLESS-GO. To do this, you only need carry the SmartKey with you. You can combine the functions of KEYLESS-GO with those of a conventional SmartKey. Unlock the vehicle by using KEYLESS-GO, for instance, and lock it using the  button on the SmartKey.

The driver's door and the door at which the handle is used, must both be closed. The SmartKey must be outside the vehicle. When locking or unlocking with KEYLESS-GO, the distance between the SmartKey and the corresponding door handle must not be greater than 3 ft (1 m). KEYLESS-GO checks whether a valid SmartKey is in the vehicle by periodically establishing a radio connection between the vehicle and the SmartKey. This happens:

- when starting the engine
- while driving
- when the external door handles are touched
- during convenience closing



- ▶ **To unlock the vehicle:** touch the inner surface of the door handle.
- ▶ **To lock the vehicle:** touch sensor surface ① or ②.  
Make sure that you do not touch the inner surface of the door handle.
- ▶ **Convenience closing feature:** touch recessed sensor surface ② for an extended period.

Further information on the convenience closing feature (▷ page 90).

If you pull on the handle of the tailgate, only the cargo compartment of the vehicle is unlocked.

### Deactivating and activating

If you do not intend to use a SmartKey for an extended period of time, you can deactivate the KEYLESS-GO function of the SmartKey. The SmartKey will then use very little power, thereby conserving battery power. For the purposes of activation/deactivation, the vehicle must not be nearby.

- ▶ **To deactivate:** press the  button on the SmartKey twice in rapid succession. The battery check lamp of the SmartKey flashes twice briefly and lights up once, KEYLESS-GO is deactivated (▷ page 80).
  - ▶ **To activate:** press any button on the SmartKey.
- or
- ▶ Insert the SmartKey into the ignition lock. KEYLESS-GO and all of its associated features are available again.





## KEYLESS-GO start function



### General notes

Bear in mind that the engine can be started by any of the vehicle occupants if there is a SmartKey in the vehicle (▷ page 137).

## Changing the settings of the locking system



You can change the settings of the locking system. This means that only the driver's door and the fuel filler flap are unlocked when the vehicle is unlocked. This is useful if you frequently travel alone.

- ▶ **To change the setting:** press and hold down the  and  buttons simultaneously for about six seconds until the battery indicator lamp flashes twice (▷ page 80).



If the setting of the locking system is changed within the signal range of the vehicle, pressing the  or  button:

- locks or
- unlocks the vehicle

The SmartKey now functions as follows:

- ▶ **To unlock:** press the  button once.
- ▶ **To unlock centrally:** press the  button twice.
- ▶ **To lock centrally:** press the  button.

The KEYLESS-GO function is changed as follows:

- ▶ **To unlock the driver's door:** touch the inner surface of the door handle on the driver's door.
- ▶ **To unlock centrally:** touch the inner surface of the door handle on the front-passenger door or the rear door.
- ▶ **To lock centrally:** touch the outer sensor surface on one of the door handles (▷ page 78).
- ▶ **To restore the factory settings:** press and hold down the  and  buttons simultaneously for approximately six seconds until the battery check lamp flashes twice (▷ page 80).

## Mechanical key

### General notes

If the vehicle can no longer be locked or unlocked with the SmartKey or with KEYLESS-GO, use the mechanical key.

If you use the mechanical key to unlock and open the driver's door, the anti-theft alarm system will be triggered. Switch off the alarm (▷ page 75).

If you unlock the vehicle using the mechanical key, the fuel filler flap will not be unlocked automatically.

- ▶ **To unlock the fuel filler flap:** insert the SmartKey into the ignition lock.

## Removing the mechanical key



- ▶ Push release catch ① in the direction of the arrow and at the same time remove mechanical key ② from the SmartKey.

For further information about:

- Unlocking the driver's door (▷ page 84)
- Unlocking the cargo compartment (▷ page 88)
- Locking the vehicle (▷ page 84)

## Inserting the mechanical key

- ▶ Push mechanical key ② completely into the SmartKey until it engages and release catch ① is back in its basic position.

## SmartKey battery

### Important safety notes

#### WARNING

Batteries contain toxic and corrosive substances. If batteries are swallowed, it can result in severe health problems. There is a risk of fatal injury.

Keep batteries out of the reach of children. If a battery is swallowed, seek medical attention immediately.

#### Environmental note



Batteries contain dangerous substances. It is against the law to dispose of them with the household rubbish. They must be collected separately and recycled to protect the environment.





Dispose of batteries in an environmentally friendly manner. Take discharged batteries to a qualified specialist workshop or a special collection point for used batteries.

The SmartKey batteries contain perchlorate material, which may require special handling and regard for the environment. National guidelines must be observed during disposal. In California, see [www.dtsc.ca.gov/HazardousWaste/Perchlorate/index.cfm](http://www.dtsc.ca.gov/HazardousWaste/Perchlorate/index.cfm).

Mercedes-Benz recommends that you have the batteries replaced at a qualified specialist workshop.



## Checking the battery



► Press the  or  button. The battery is working properly if battery check lamp ① lights up briefly.

The battery is discharged if battery check lamp ① does not light up briefly.

► Change the battery (▷ page 80).

If the SmartKey battery is checked within the signal reception range of the vehicle, pressing the  or  button:

- locks or
- unlocks the vehicle

 You can get a battery at any qualified specialist workshop.

## Replacing the battery

You require a CR 2025 3 V cell battery.

► Take the mechanical key out of the SmartKey (▷ page 79).



► Press mechanical key ② into the SmartKey opening in the direction of the arrow until battery compartment cover ① opens. Do not hold battery compartment cover ① closed while doing so.

► Remove battery compartment cover ①.



- ▶ Insert the front tabs of battery compartment cover ① into the housing first and then press to close it.
- ▶ Insert mechanical key ② into the SmartKey (▷ page 79).
- ▶ Check the function of all SmartKey buttons on the vehicle.

- ▶ Repeatedly tap the SmartKey against your palm until battery ③ falls out.
- ▶ Insert the new battery with the positive terminal facing upwards. Use a lint-free cloth to do so.
- ▶ Make sure that the surface of the battery is free of lint, grease and other contaminants.

### Problems with the SmartKey

Problem	Possible causes/consequences and ▶ Solutions
You can no longer lock or unlock the vehicle using the SmartKey.	The SmartKey battery is discharged or nearly discharged. <ul style="list-style-type: none"> <li>▶ Check the SmartKey battery (▷ page 80) and replace it if necessary (▷ page 80).</li> </ul> If this does not work: <ul style="list-style-type: none"> <li>▶ Unlock (▷ page 84) or lock (▷ page 84) the vehicle using the mechanical key.</li> </ul>
	There is interference from a powerful source of radio waves. <ul style="list-style-type: none"> <li>▶ Unlock (▷ page 84) or lock (▷ page 84) the vehicle using the mechanical key.</li> </ul>
	The SmartKey is faulty. <ul style="list-style-type: none"> <li>▶ Unlock (▷ page 84) or lock (▷ page 84) the vehicle using the mechanical key.</li> <li>▶ Have the SmartKey checked at a qualified specialist workshop.</li> </ul>
You can no longer lock or unlock the vehicle using KEYLESS-GO.	KEYLESS-GO was deactivated. <ul style="list-style-type: none"> <li>▶ Reactivate KEYLESS-GO (▷ page 78).</li> </ul>
	The SmartKey battery is discharged or nearly discharged. <ul style="list-style-type: none"> <li>▶ Check the SmartKey battery (▷ page 80) and replace it if necessary (▷ page 80).</li> </ul> If this does not work: <ul style="list-style-type: none"> <li>▶ Unlock (▷ page 84) or lock (▷ page 84) the vehicle using the mechanical key.</li> </ul>

Problem	Possible causes/consequences and ► Solutions
	<p>There is interference from a powerful source of radio waves.</p> <ul style="list-style-type: none"> <li>► Unlock (▷ page 84) or lock (▷ page 84) the vehicle using the mechanical key.</li> </ul> <p>KEYLESS-GO is malfunctioning.</p> <ul style="list-style-type: none"> <li>► Lock/unlock the vehicle using the remote control function of the SmartKey.</li> <li>► Have the vehicle and SmartKey checked at a qualified specialist workshop.</li> </ul> <p>If the vehicle can also not be locked/unlocked using the remote control function:</p> <ul style="list-style-type: none"> <li>► Unlock (▷ page 84) or lock (▷ page 84) the vehicle using the mechanical key.</li> <li>► Have the vehicle and SmartKey checked at a qualified specialist workshop.</li> </ul>
<p>The engine cannot be started using the SmartKey.</p>	<p>The on-board voltage is too low.</p> <ul style="list-style-type: none"> <li>► Switch off non-essential consumers, e.g. seat heating or interior lighting, and try to start the engine again.</li> </ul> <p>If this does not work:</p> <ul style="list-style-type: none"> <li>► Check the starter battery and charge it if necessary (▷ page 342).</li> </ul> <p>or</p> <ul style="list-style-type: none"> <li>► Jump-start the vehicle (▷ page 342).</li> </ul> <p>or</p> <ul style="list-style-type: none"> <li>► Consult a qualified specialist workshop.</li> </ul>
<p>The engine cannot be started using the Start/Stop button. The SmartKey is in the vehicle.</p>	<p>The vehicle is locked.</p> <ul style="list-style-type: none"> <li>► Unlock the vehicle and try to start the vehicle again.</li> </ul> <p>The SmartKey battery is discharged or nearly discharged.</p> <ul style="list-style-type: none"> <li>► Check the SmartKey battery (▷ page 80) and replace it if necessary (▷ page 80).</li> </ul> <p>If this does not work:</p> <ul style="list-style-type: none"> <li>► Start your vehicle with the SmartKey in the ignition lock.</li> </ul> <p>There is interference from a powerful source of radio waves.</p> <ul style="list-style-type: none"> <li>► Start your vehicle with the SmartKey in the ignition lock.</li> </ul>
<p>You have lost a SmartKey.</p>	<ul style="list-style-type: none"> <li>► Have the SmartKey deactivated at a qualified specialist workshop.</li> <li>► Report the loss immediately to the vehicle insurers.</li> <li>► If necessary, have the locks changed as well.</li> </ul>
<p>You have lost the mechanical key.</p>	<ul style="list-style-type: none"> <li>► Report the loss immediately to the vehicle insurers.</li> <li>► If necessary, have the locks changed as well.</li> </ul>

## Doors

### Important safety notes

#### WARNING

If children are left unsupervised in the vehicle, they could:

- open the doors, thus endangering other people or road users.
- get out and disrupt traffic.
- operate the vehicle's equipment.

Additionally, children could set the vehicle in motion if, for example, they:

- release the parking brake.
- shifting the automatic transmission out of park position **P**
- Start the engine.

There is a risk of an accident and injury.

When leaving the vehicle, always take the SmartKey with you and lock the vehicle. Never leave children or animals unattended in the vehicle. Always keep the SmartKey out of reach of children.

### Unlocking and opening doors from the inside

You can open a door from inside the vehicle even if it has been locked. You can only open the rear doors from inside the vehicle if they are not secured by the child-proof locks (> page 65).

If the vehicle has previously been locked from the outside, opening a door from the inside will trigger the anti-theft alarm system. Switch off the alarm (> page 75).



► **Front door:** pull door handle ②.

If the door is locked, locking knob ① pops up. The door is unlocked and can be opened.

► **Rear door:** pull door handle ②.

If the door is locked, locking knob ① pops up and the door unlocks.

► Pull door handle ② again.

The door can be opened.

### Centrally locking and unlocking the vehicle from the inside

You can centrally lock or unlock the vehicle from the inside. The buttons are located on both front doors.



► **To unlock:** press button ①.

► **To lock:** press button ②.

If the front-passenger door is closed, the vehicle locks.

Meanwhile, the fuel filler flap will not be locked or unlocked.

You cannot unlock the vehicle centrally from the inside if the vehicle has been locked from the outside.

You can open a front door from inside the vehicle even if it has been locked.

If a locked door is opened from the inside, the previous unlock status of the vehicle will be taken into consideration if:

- the vehicle was locked using the locking button for the central locking, or
- if the vehicle was locked automatically

The vehicle will be fully unlocked if it had previously been fully unlocked. If only the driver's door had been previously unlocked, only the door which has been opened from the inside is unlocked.

### Automatic locking feature



- ▶ **To deactivate:** press and hold button ① for about five seconds until a tone sounds.
- ▶ **To activate:** press and hold button ② for about five seconds until a tone sounds.

If you press one of the two buttons and do not hear a tone, the relevant setting has already been selected.

The vehicle is locked automatically when the ignition is switched on and the wheels are turning.

You could therefore be locked out if:

- the vehicle is being pushed.
- the vehicle is being towed.
- the vehicle is on a roller dynamometer.

You can also switch the automatic locking function on and off using the on-board computer (▷ page 239).

### Power closing

Power closing pulls the doors and tailgate into their locks automatically even if they are not completely closed.

- ▶ **To power close a door:** push the door into the lock up to the first detent position. Power closing will pull the door fully closed.
- ▶ **To power close the tailgate:** lightly press the tailgate downwards. Power closing will pull the tailgate fully closed.

### Unlocking/locking the driver's door using the mechanical key

- ❗ If you want to centrally lock the vehicle using the mechanical key, begin by pressing the locking button for the interior locking mechanism while the driver's door is open. Then proceed to lock the driver's door using the mechanical key.

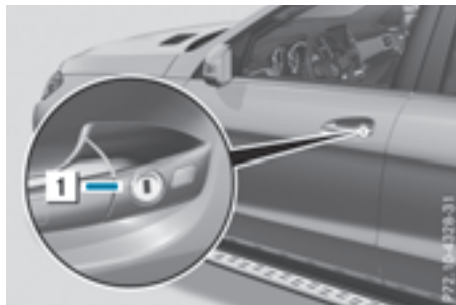

- ▶ Insert the mechanical key into the lock of the driver's door as far as it will go.
- ▶ **To unlock:** turn the mechanical key counter-clockwise to position 1.
- ▶ **To lock:** turn the mechanical key clockwise as far as it will go to position 1.

If you use the mechanical key to unlock and open the driver's door, the anti-theft alarm system will be triggered. Switch off the alarm (▷ page 75).

If you lock the vehicle as described above, the fuel filler flap is not locked. The anti-theft alarm system is not armed.

## Cargo compartment

### Important safety notes

#### ⚠ WARNING

Combustion engines emit poisonous exhaust gases such as carbon monoxide. If the tailgate is open when the engine is running, particularly if the vehicle is moving, exhaust fumes could enter the passenger compartment. There is a risk of poisoning.

Turn off the engine before opening the tailgate. Never drive with the tailgate open.

### WARNING

If objects, luggage or loads are not secured or not secured sufficiently, they could slip, tip over or be flung around and thereby hit vehicle occupants. There is a risk of injury, particularly in the event of sudden braking or a sudden change in direction.

Always store objects so that they cannot be flung around. Secure objects, luggage or loads against slipping or tipping before the journey.

**!** The tailgate swings upwards and to the rear when opened. Therefore, make sure that there is sufficient clearance above and behind the tailgate.

The opening dimensions of the tailgate can be found in the "Vehicle data" section ( $\triangleright$  page 390).

You should preferably place luggage or loads in the cargo compartment. Observe the loading guidelines ( $\triangleright$  page 295).

Do not leave the SmartKey in the cargo compartment. You could otherwise lock yourself out.

**Vehicles without the EASY-PACK tailgate:** the tailgate can be:

- opened and closed manually from outside
- unlocked from inside with the emergency release

**For vehicles with the EASY-PACK tailgate:** you can:

- close the tailgate manually from outside
- open the tailgate automatically from outside
- open and close the tailgate automatically from inside
- unlock the tailgate from inside with the emergency release
- limit the opening angle of the tailgate

### Tailgate reversing feature

On vehicles with the tailgate remote closing feature, the tailgate is equipped with automatic obstacle recognition with a reversing feature. If a solid object blocks or restricts the tailgate when automatically opening or closing, this procedure is stopped. If the tailgate is stopped during the closing procedure, it will open again

automatically. The automatic obstacle recognition with reversing feature is only an aid. It is not a substitute for your attentiveness when opening and closing the tailgate.

### WARNING

The reversing feature does not respond:

- to soft, light and thin objects, e.g. fingers
- over the last  $\frac{1}{3}$  in (8 mm) of the closing movement

The reversing feature cannot prevent someone from becoming trapped in these situations in particular. There is a risk of injury.

Make sure that no body parts are in close proximity during the closing procedure.

If somebody becomes trapped:

- press the  button on the SmartKey, or
- pull or press the remote operating switch on the driver's door or
- press the closing or locking button on the tailgate or
- pull the handle on the tailgate

### Opening and closing manually from outside

#### Opening



- ▶ Press the  button on the SmartKey.
- ▶ Pull handle ①.
- ▶ Raise the tailgate.

**Vehicles with the EASY-PACK tailgate:** if you pull handle ① and then release it, the tailgate opens automatically.

## Closing



- ▶ Pull the tailgate down using recess ①.
- ▶ Allow the tailgate to drop into the lock.
- ▶ Lock the vehicle if necessary with the  button on the SmartKey or with KEYLESS-GO.

**i** If a KEYLESS-GO key is detected in the cargo compartment, the tailgate will not lock.

## Opening/closing automatically from the outside

### Important safety notes

#### WARNING

Parts of the body could become trapped during automatic closing of the tailgate. Moreover, people, e.g. children, may be standing in the closing area or may enter the closing area during the closing process. There is a risk of injury.

Make sure that nobody is in the vicinity of the closing area during the closing process.

Use one of the following options to stop the closing process:

- press the  button on the SmartKey.
- pull or press the remote operating switch on the driver's door.
- press the closing or locking button on the tailgate.
- pull the handle on the tailgate

#### WARNING

Combustion engines emit poisonous exhaust gases such as carbon monoxide. If the tailgate

is open when the engine is running, particularly if the vehicle is moving, exhaust fumes could enter the passenger compartment. There is a risk of poisoning.

Turn off the engine before opening the tailgate. Never drive with the tailgate open.

**!** The tailgate swings upwards and to the rear when opened. Therefore, make sure that there is sufficient clearance above and behind the tailgate.

Two warning tones sound while the tailgate is opening or closing.

The opening dimensions of the tailgate can be found in the "Vehicle data" section (> page 390).

**i** Notes on the automatic reversing feature for the tailgate (> page 85).

## Opening the tailgate automatically

You can open the tailgate automatically with the SmartKey or the handle in the tailgate.

- ▶ Press and hold the  button on the SmartKey until the tailgate opens.

or

- ▶ When the tailgate is unlocked, pull the tailgate handle and let it go again immediately.

or

- ▶ With the tailgate stopped in an intermediate position, pull the tailgate upwards. You can release the tailgate as soon as the tailgate starts to open.

## Closing the tailgate automatically

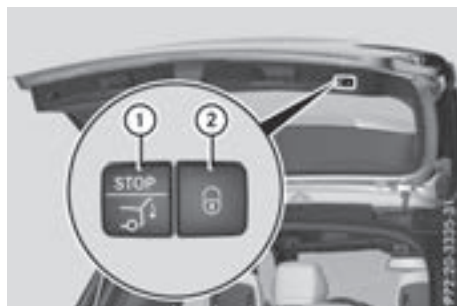



► **To close:** press closing button ① in the tailgate.

or

► Vehicles with KEYLESS-GO or KEYLESS-GO starting function: press and hold the  button on the SmartKey until the tailgate closes.

You can release the button as soon as the tailgate starts to close.

Vehicles with KEYLESS-GO or KEYLESS-GO starting function: you can close and lock the tailgate simultaneously.

► Press locking button ② in the tailgate. If a KEYLESS-GO or KEYLESS-GO starting function key is detected outside the vehicle, the tailgate closes and locks. All the doors must be shut and the SmartKey located in the vicinity of the tailgate.

**i** The tailgate cannot be opened and closed with the SmartKey if there is a SmartKey in the ignition.

If the tailgate touches an object while closing, the closing procedure is interrupted and the tailgate reopens.

If a KEYLESS-GO or KEYLESS-GO starting function key is detected in the cargo compartment, the tailgate will not lock.

### Opening/closing automatically from inside

#### Important safety notes

##### WARNING

Parts of the body could become trapped during automatic closing of the tailgate. In addition, people may be standing in the closing area or may enter the closing area, e.g. children, during the closing procedure. There is a risk of injury.

Make sure that nobody is in the vicinity of the closing area during the closing process.

Release the remote operating switch immediately if somebody becomes trapped. To reopen the tailgate pull on the remote operating switch.

##### WARNING

Combustion engines emit poisonous exhaust gases such as carbon monoxide. If the tailgate is open when the engine is running, particularly if the vehicle is moving, exhaust fumes could enter the passenger compartment. There is a risk of poisoning.

Turn off the engine before opening the tailgate. Never drive with the tailgate open.

**!** The tailgate swings upwards and to the rear when opened. Therefore, make sure that there is sufficient clearance above and behind the tailgate.

Two warning tones sound while the tailgate is opening or closing.

The opening dimensions of the tailgate can be found in the "Vehicle data" section (▷ page 390).

**i** Notes on the automatic reversing feature for the tailgate (▷ page 85).

#### Opening and closing



► **To open:** pull remote operating switch ① for the tailgate until the tailgate opens.

► **To close:** turn the SmartKey to position **1** or **2** in the ignition lock.

► Press remote operating switch for tailgate ① until the tailgate is completely closed.

You can open and close the tailgate from the driver's seat when the vehicle is stationary and unlocked.

## Limiting the opening angle of the tailgate

### General notes

! Make sure there is sufficient clearance to open the tailgate fully when setting the opening angle. The tailgate could otherwise be damaged. Ideally, set the opening angle outside.

### Activating

You can limit the opening angle of the tailgate. This is possible in the top half of its opening range, up to approximately 4 in (10 cm) before the stop.

- ▶ **To open the tailgate:** pull the handle on the tailgate.
- ▶ **To stop the opening procedure at the desired position:** press the closing button in the tailgate or pull the handle on the outside of the tailgate again.
- ▶ **To save the position:** press and hold the closing button in the tailgate until two short tones sound.  
The opening angle limiter is activated. The tailgate will now stop in the stored position when opening.

### Deactivating

- ▶ Press and hold the closing button in the tailgate until you hear a short tone.

## Tailgate emergency release

### General notes

! The tailgate swings upwards and to the rear when opened. Therefore, make sure that there is sufficient clearance above and behind the tailgate.

The opening dimensions of the tailgate can be found in the "Vehicle data" section (> page 390).

If the tailgate can no longer be unlocked:

- using the SmartKey, or
- using the remote operating switch in the door control panel:

Use the emergency release.

## Opening



- ▶ Take mechanical key ② out of the SmartKey (> page 79).
- ▶ Insert mechanical key ② or a suitable tool, e.g. a thin screwdriver, into opening ① in the paneling and push it in.  
The tailgate is released.
- ▶ Open the tailgate.
- ▶ Insert mechanical key ② into the SmartKey (> page 79).

## Side windows

### Important safety notes

#### ⚠ WARNING

While opening the side windows, body parts could become trapped between the side window and the door frame as the side window moves. There is a risk of injury.

Make sure that nobody touches the side window during the opening procedure. If somebody becomes trapped, release the switch or pull the switch to close the side window again.

#### ⚠ WARNING

While closing the side windows, body parts in the closing area could become trapped. There is a risk of injury.

When closing make sure that no parts of the body are in the closing area. If somebody becomes trapped, release the switch or press the switch to open the side window again.

### WARNING

If children operate the side windows they could become trapped, particularly if they are left unsupervised. There is a risk of injury.

Activate the override feature for the rear side windows. When leaving the vehicle, always take the SmartKey with you and lock the vehicle. Never leave children unsupervised in the vehicle.

### Side window reversing feature

The side windows are equipped with an automatic reversing feature. If a solid object blocks or restricts a side window during the closing process, the side window opens again automatically. However, the automatic reversing feature is only an aid and does not relieve you of the responsibility of paying attention when closing a side window.

### WARNING

The reversing feature does not react:

- to soft, light and thin objects, e.g. small fingers
- over the last 1/6 in (4 mm) of the closing movement
- during resetting
- when closing the side window again manually immediately after automatic reversing

This means that the reversing feature cannot prevent someone being trapped in these situations. There is a risk of injury.

Make sure that no body parts are in close proximity during the closing procedure. If someone becomes trapped, press the switch to open the side window again.

### Opening and closing the side windows

The switches for all side windows are located on the driver's door. There is also a switch on each door for the corresponding side window.

The switches on the driver's door take precedence.



- ① Front left
- ② Front right
- ③ Rear right
- ④ Rear left

- ▶ Turn the SmartKey to position **1** or **2** in the ignition lock.
- ▶ **To open manually:** press and hold the corresponding switch.
- ▶ **To open fully:** press the switch beyond the pressure point and release it. Automatic operation is started.
- ▶ **To close manually:** pull the corresponding switch and hold it.
- ▶ **To close fully:** pull the switch beyond the pressure point and release it. Automatic operation is started.
- ▶ **To interrupt automatic operation:** press/pull the corresponding switch again.

If you press the switch beyond the pressure point and release, automatic operation is started in the corresponding direction. You can stop automatic operation by pressing/pulling the switch again.

You can continue to operate the side windows after you switch off the engine or remove the SmartKey. This function is available for up to five minutes or until the driver's or front-passenger door is opened.

The side windows cannot be operated from the rear when the override feature for the side windows is activated (▷ page 65).

### Convenience opening

#### General notes

**Vehicles with KEYLESS-GO or KEYLESS-GO start function:** you can ventilate the vehicle before you start driving.



To do this, the SmartKey is used to carry out the following functions simultaneously:

- unlock the vehicle
- open the side windows
- open the sliding sunroof or the panorama roof with power tilt/sliding panel and the roller sunblinds
- switch on the seat ventilation for the driver's seat

The convenience opening feature can only be operated using the SmartKey. The SmartKey must be close to the vehicle. For vehicles without KEYLESS-GO, the SmartKey must be near the driver's door handle.

The "convenience opening" feature is also available when the vehicle is unlocked.

### Convenience opening

- ▶ **Vehicles without KEYLESS-GO:** point the tip of the SmartKey at the door handle on the driver's door.
- ▶ Press and hold the  button until the side windows and the sliding sunroof or panorama roof with power tilt/sliding panel are in the desired position.  
If the roller sunblinds of the panorama roof with power tilt/sliding panel are closed, the roller sunblinds are opened first.
- ▶ Press and hold the  button again until the panorama roof with power tilt/sliding panel is in the desired position.
- ▶ **To interrupt convenience opening:** release the  button.

### Convenience closing feature

#### Important safety notes

##### WARNING

When the convenience closing feature is operating, parts of the body could become trapped in the closing area of the side window and the sliding sunroof. There is a risk of injury.



Observe the complete closing procedure when the convenience closing feature is operating. Make sure that no body parts are in close proximity during the closing procedure.

When you lock the vehicle, you can simultaneously:

- close the side windows
- close the sliding sunroof or the panorama roof with power tilt/sliding panel

On vehicles with a panorama roof with power tilt/sliding panel, you can then close the roller sunblinds.

Proceed as follows if someone is trapped:

- Release the  button to interrupt the closing procedure.
- Press and hold the  button to open.

Vehicles with KEYLESS-GO:

- Release the sensor surfaces on the exterior door handle to interrupt the closing procedure.
- To open, pull the same door handle immediately and hold it firmly. The door windows and the sliding sunroof will open for as long as the door handle is held but the door is not opened.

Notes on the automatic reversing feature for:



- the side window (▷ page 89)
- the sliding sunroof (▷ page 93)
- the panorama roof with power tilt/sliding panel (▷ page 93)

### Using the SmartKey

The SmartKey must be close to the vehicle. For vehicles without KEYLESS-GO, the SmartKey must be near the driver's door handle.

- ▶ **Vehicles without KEYLESS-GO:** point the tip of the SmartKey at the door handle on the driver's door.
- ▶ Press and hold the  button until the side windows and the sliding sunroof or the panorama roof with power tilt/sliding panel are fully closed.
- ▶ Make sure that all the side windows and the sliding sunroof or panorama roof with power tilt/sliding panel are closed.

On vehicles with a panorama roof with power tilt/sliding panel:

- ▶ Press and hold the  button again until the roller sunblinds of the panorama roof with power tilt/sliding panel close.
- ▶ **To interrupt convenience closing:** release the  button.

## Using KEYLESS-GO



- ▶ Touch recessed sensor surface ① on the door handle until the side windows and the sliding sunroof or the panorama roof with power tilt/sliding panel are fully closed.
- ❗ Make sure you only touch recessed sensor surface ①.
- ▶ Make sure that all the side windows and the sliding sunroof or panorama roof with power tilt/sliding panel are closed.
- ▶ **Vehicles with a panorama roof with power tilt/sliding panel:** touch recessed sensor surface ① on the door handle again

until the roller sunblinds of the panorama roof with power tilt/sliding panel close.

- ▶ **To interrupt convenience closing:** release recessed sensor surface ① on the door handle.

## Resetting the side windows

If a side window can no longer be closed fully, you must reset it.

- ▶ Close all the doors.
- ▶ Turn the SmartKey to position ① or ② in the ignition lock.
- ▶ Pull the corresponding switch on the door control panel until the side window is completely closed (▷ page 89).
- ▶ Hold the switch for an additional second.

If the side window opens again slightly:

- ▶ Immediately pull the corresponding switch on the door control panel until the side window is completely closed (▷ page 89).
- ▶ Hold the switch for an additional second.
- ▶ If the respective side window remains closed after the button is released, then it has been set correctly. If this is not the case, repeat the steps above.

## Problems with the side windows

### WARNING

If you close a side window again immediately after it has been blocked or reset, the side window closes with increased or maximum force. The reversing feature is then not active. Parts of the body could be trapped in the closing area in the process. This poses an increased risk of injury or even fatal injury.

Make sure that no parts of the body are in the closing area. To stop the closing process, release the switch or push the switch again to reopen the side window.

Problem	Possible causes/consequences and ► Solutions
A side window cannot be closed because it is blocked by objects, e.g. leaves in the window guide.	<ul style="list-style-type: none"> <li>► Remove the objects.</li> <li>► Close the side window.</li> </ul>
A side window cannot be closed and you cannot see the cause.	<p>If a side window is obstructed during closing and reopens again slightly:</p> <ul style="list-style-type: none"> <li>► Immediately after the window blocks, pull the corresponding switch again until the side window has closed. The side window is closed with increased force.</li> </ul> <p>If a side window is obstructed again during closing and reopens again slightly:</p> <ul style="list-style-type: none"> <li>► Immediately after the window blocks, pull the corresponding switch again until the side window has closed. The side window is closed without the automatic reversing feature.</li> </ul>
The side windows cannot be opened or closed with convenience opening.	<p>The SmartKey battery is discharged or nearly discharged.</p> <ul style="list-style-type: none"> <li>► Check the SmartKey battery (► page 80) and replace it if necessary (► page 80).</li> </ul>

If a side window will still not open or close due to a malfunction, consult a qualified specialist workshop.

## Sliding sunroof

### Important safety notes

Your vehicle may be equipped with a sliding sunroof or a panorama roof with power tilt/sliding panel. In the following section, the term "sliding sunroof" refers to both sliding sunroof variants.

#### WARNING

While opening and closing the sliding sunroof, body parts in close proximity could become trapped. There is a risk of injury.

Make sure that no body parts are in close proximity during the opening and closing procedures.

If somebody becomes trapped:

- release the switch immediately, or
- during automatic operation, push the switch briefly in any direction

The opening or closing procedure will be stopped.

#### WARNING

If children operate the sliding sunroof they could become trapped, particularly if they are left unsupervised. There is a risk of injury.

When leaving the vehicle, always take the SmartKey with you and lock the vehicle. Never leave children unsupervised in the vehicle.

 Only open the sliding sunroof if it is free of snow and ice. Otherwise, malfunctions may occur.

Do not allow anything to protrude from the sliding sunroof. Otherwise, the seals could be damaged.

 The weather can change abruptly. It could start to rain or snow. Make sure that the sliding sunroof is closed when you leave the vehicle. The vehicle electronics can be damaged if water enters the vehicle interior.

Resonance noises can occur in addition to the usual airflow noises when the sliding sunroof is open. They are caused by minor pressure fluctuations in the vehicle interior. Change the posi-

tion of the sliding sunroof or open a side window. The noise will be reduced or eliminated.

### Sliding sunroof reversing feature

Your vehicle may be equipped with a sliding sunroof or a panorama roof with power tilt/sliding panel. In the following section, the term "sliding sunroof" refers to both sliding sunroof variants.

The sliding sunroof is equipped with an automatic reversing feature. If a solid object blocks or restricts the sliding sunroof during the closing process, the sliding sunroof opens again automatically. However, the automatic reversing feature is only an aid and does not relieve you of the responsibility of paying attention when closing the sliding sunroof.

#### WARNING

The reversing feature does not react:

- to soft, light and thin objects, e.g. small fingers
- over the last 1/6 in (4 mm) of the closing movement
- during resetting
- when closing the sliding sunroof again manually immediately after automatic reversing

This means that the reversing feature cannot prevent someone being trapped in these situations. There is a risk of injury.

Make sure that no body parts are in close proximity during the closing procedure.

If somebody becomes trapped:

- release the switch immediately, or
- press the switch in any direction during the automatic closing process

The closing process is stopped.

## Operating the sliding sunroof

### Opening and closing



- ① To raise
- ② To open
- ③ To close/lower

- ▶ Turn the SmartKey to position ① or ② in the ignition lock.
- ▶ Press or pull the  switch in the corresponding direction.

If you press the  switch beyond the pressure point, an automatic opening/closing process is started in the corresponding direction. You can stop automatic operation by pressing/pulling the switch again.

When opening and raising the roof, automatic operation is only available if the sliding sunroof is in the closed position.

The sun protection cover automatically opens along with the sliding sunroof. You can open or close the sun protection cover manually when the sliding sunroof is raised or closed.

You can continue to operate the sliding sunroof after switching off the engine or removing the SmartKey from the ignition lock. This function is available for up to five minutes or until the driver's or front-passenger door is opened.

### Resetting

- ❗ If the sliding sunroof still cannot be opened or closed fully after resetting, contact a qualified specialist workshop.

Reset the sliding sunroof if it does not move smoothly.

- ▶ Turn the SmartKey to position ① or ② in the ignition lock.
- ▶ Raise the sliding sunroof fully at the rear (> page 93).

- ▶ Keep the  switch pressed for another second.
- ▶ Make sure that the sliding sunroof can be fully opened and closed again (▷ page 93).
- ▶ If this is not the case, repeat the steps above.

### Operating the panorama roof with power tilt/sliding panel

#### Opening and closing



- ① To raise
- ② To open
- ③ To close/lower

The panorama roof with power tilt/sliding panel can only be opened when the roller sunblind is open.

- ▶ Turn the SmartKey to position **1** or **2** in the ignition lock.
- ▶ Press or pull the  switch in the corresponding direction.

If you press/pull the  switch beyond the pressure point, automatic operation is started in the corresponding direction. You can stop automatic operation by pressing/pulling the switch again.

The automatic raising feature is available only when the panorama roof with power tilt/sliding panel is closed.

### Operating the roller sunblinds for the panorama roof with power tilt/sliding panel

#### Important safety notes

##### WARNING

Parts of the body could become trapped between the roller sunblind and frame or sliding sunroof during automatic opening or closing. There is a risk of injury.

When opening or closing, make sure that no body parts are in the sweep of the roller sunblind.

If somebody becomes trapped:

- release the switch immediately, or
- during automatic operation, push the switch briefly in any direction

The opening or closing procedure will be stopped.

The roller sunblinds shield the vehicle interior from sunlight. The roller sunblinds can only be opened and closed together when the panorama roof with power tilt/sliding panel is closed.

#### Roller sunblind reversing feature

The roller sunblinds are equipped with an automatic reversing feature. If a solid object blocks or restricts a roller sunblind during the closing process, the roller sunblind opens again automatically. However, the automatic reversing feature is only an aid and is not a substitute of your attentiveness when closing the roller sunblind.

##### WARNING

The reversing feature does not react in particular to soft, light and thin objects, e.g. small fingers. This means that the reversing feature cannot prevent someone being trapped in these situations. There is a risk of injury.

When closing the roller sunblind, make sure that no body parts are in the sweep area.



If somebody becomes trapped:

- release the switch immediately, or
- press the switch in any direction during the automatic closing process

The closing process is stopped.

## Opening and closing the roller sunblinds



① Opens

② Opens

③ Closes

- ▶ Turn the SmartKey to position ① or ② in the ignition lock.
- ▶ Press or pull the  switch in the corresponding direction.

If you press the  switch beyond the pressure point, an automatic opening/closing process is started in the corresponding direction.

You can stop automatic operation by pressing/pulling the switch again.

## Resetting the panorama roof with power tilt/sliding panel and the roller sunblinds

**!** If the panorama roof with power tilt/sliding panel and the roller sunblinds cannot be fully opened or closed after resetting, contact a qualified specialist workshop.

Reset the panorama roof with power tilt/sliding panel and the roller sunblinds if the panorama roof with power tilt/sliding panel or the roller sunblinds do not move smoothly.

- ▶ Turn the SmartKey to position ① or ② in the ignition lock.
- ▶ Pull the  switch repeatedly to the point of resistance in the direction of arrow ③ until the panorama roof with power tilt/sliding panel is fully closed.
- ▶ Keep the  switch pulled for an additional second.
- ▶ Pull the  switch repeatedly to the point of resistance in the direction of arrow ③ until the roller sunblinds are fully closed.
- ▶ Keep the  switch pulled for an additional second.
- ▶ Make sure that the panorama roof with power tilt/sliding panel and the roller sunblinds can be fully opened again.
- ▶ If this is not the case, repeat the steps above.

## Problems with the sliding sunroof

Your vehicle may be equipped with a sliding sunroof or a panorama roof with power tilt/sliding panel. In the following section, the term "sliding sunroof" refers to both sliding sunroof variants.

### WARNING

If you close the sliding sunroof again immediately after it has been blocked or reset, the sliding sunroof closes with increased or maximum force. The reversing feature is then not active. Parts of the body could be trapped in the closing area in the process. This poses an increased risk of injury or even fatal injury.



Make sure that no parts of the body are in the closing area.

If somebody becomes trapped:

- release the switch immediately, or
- press the switch in any direction during the automatic closing process

The closing process is stopped.

**!** If the sliding sunroof still cannot be opened or closed as a result of a malfunction, contact a qualified specialist workshop.

Problem	Possible causes/consequences and ► Solutions
<p>The sliding sunroof cannot be closed and you cannot see the cause.</p>	<p>If the sliding sunroof is obstructed during closing and reopens again slightly:</p> <ul style="list-style-type: none"> <li>► Immediately after the sliding sunroof blocks, pull the  switch in the overhead control panel down to the point of resistance and hold it until the sliding sunroof is closed. The sliding sunroof is closed with increased force.</li> </ul> <p>If the sliding sunroof is obstructed again during closing and then reopens slightly:</p> <ul style="list-style-type: none"> <li>► Immediately after the sliding sunroof blocks, pull the  switch in the overhead control panel down to the point of resistance and hold it until the sliding sunroof is closed. The sliding sunroof is closed without the automatic reversing feature.</li> </ul>

## Correct driver's seat position

### WARNING

You could lose control of your vehicle if you do the following while driving:

- adjust the driver's seat, head restraint, steering wheel or mirrors
- fasten the seat belt

There is a risk of an accident.

Adjust the driver's seat, head restraint, steering wheel and mirror and fasten your seat belt before starting the engine.



Observe the following when adjusting steering wheel ①, seat belt ② and driver's seat ③:

- you are as far away from the driver's air bag as possible
- you are sitting in a normal upright position
- your thighs are slightly supported by the seat cushion
- your legs are not entirely stretched and you can depress the pedals properly
- the back of your head is supported at eye level by the center of the head restraint
- you can hold the steering wheel with your arms slightly bent
- you can move your legs freely
- you can see all the displays in the instrument cluster clearly

- you should have a good overview of traffic conditions
- the seat belt is pulled snugly against the body and is routed across the center of your shoulder and across your hips in the pelvic area

Further related subjects:

- Electrical seat adjustment (▷ page 98)
- Adjusting the steering wheel mechanically (▷ page 103) or electrically (▷ page 104)
- Fastening the seat belt correctly (▷ page 48).
- Adjusting the rear-view mirror and exterior mirrors (▷ page 105).
- **Vehicles with memory function:** storing the seat, steering wheel, exterior mirror and Head-up display settings with the memory function (▷ page 108)

## Seats

### Important safety notes

#### WARNING

Children could become trapped if they adjust the seats, particularly when unattended. There is a risk of injury.

When leaving the vehicle, always take the SmartKey with you and lock the vehicle. Never leave children unsupervised in the vehicle.

The seats can still be adjusted when there is no SmartKey in the ignition lock.

#### WARNING

When you adjust a seat, you or other vehicle occupants could become trapped, e.g. on the seat guide rail. There is a risk of injury.

Make sure when adjusting a seat that no one has any body parts in the sweep of the seat.

Observe the safety notes on "Air bags" (▷ page 49) and "Children in the Vehicle" (▷ page 59).

**⚠ WARNING**

You could lose control of your vehicle if you do the following while driving:

- adjust the driver's seat, head restraint, steering wheel or mirrors
- fasten the seat belt

There is a risk of an accident.

Adjust the driver's seat, head restraint, steering wheel and mirror and fasten your seat belt before starting the engine.

**⚠ WARNING**

If you adjust the seat height carelessly, you or other vehicle occupants could be trapped and thereby injured. Children in particular could accidentally press the electrical seat adjustment buttons and become trapped. There is a risk of injury.

While moving the seats, make sure that your hands or other body parts do not get under the lever assembly of the seat adjustment system.

**⚠ WARNING**

If the head restraints are not installed or not adjusted correctly, they cannot provide protection as intended. There is an increased risk of injury in the head and neck area, e.g. in the event of an accident or when braking.

Always drive with the head restraints installed. Before driving off, make sure for every vehicle occupant that the center of the head restraint supports the back of the head at about eye level.

**⚠ WARNING**

The seat belt does not offer the intended level of protection if you have not moved the backrest to an almost vertical position. When braking or in the event of an accident, you could slide underneath the seat belt and sustain abdomen or neck injuries, for example. This poses an increased risk of injury or even fatal injury.

Adjust the seat properly before beginning your journey. Always ensure that the backrest is in an almost vertical position and that the shoulder section of your seat belt is routed across the center of your shoulder.

**!** To avoid damage to the seats and the seat heating, observe the following information:

- keep liquids from spilling on the seats. If liquid is spilled on the seats, dry them as soon as possible.
- if the seat covers are damp or wet, do not switch on the seat heating. The seat heating should also not be used to dry the seats.
- clean the seat covers as recommended; see "Interior care".
- do not transport heavy loads on the seats. Do not place sharp objects on the seat cushions, e.g. knives, nails or tools. The seats should only be occupied by passengers, if possible.
- when the seat heating is in operation, do not cover the seats with insulating materials, e.g. blankets, coats, bags, seat covers, child seats or booster seats.

**!** Make sure that there are no objects in the footwell under or behind the seats when moving the seats back. There is a risk that the seats and/or the objects could be damaged.

**i** Further related subjects:

- Cargo compartment enlargement (folding down the rear bench seat) (▷ page 298)

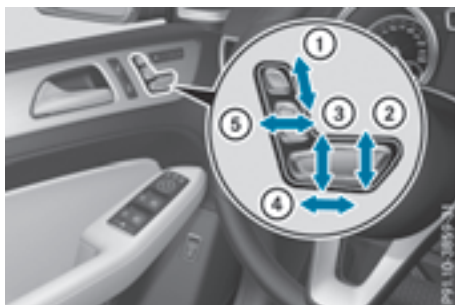
**Adjusting the seats electrically**

- ① Head restraint height
- ② Seat cushion angle
- ③ Seat height

- ④ Seat fore-and-aft adjustment
  - ⑤ Backrest angle
- i** Vehicles with memory function: if PRE-SAFE® has been triggered, the front-passenger seat will be moved to a better position if it was previously in an unfavorable position.
- i** Vehicles with memory function: when the seat is moved forwards or backwards, the headrest is moved up or down automatically.

## Adjusting the head restraints

### Important safety notes

#### WARNING

You could lose control of your vehicle if you do the following while driving:

- adjust the driver's seat, head restraint, steering wheel or mirrors
- fasten the seat belt

There is a risk of an accident.

Adjust the driver's seat, head restraint, steering wheel and mirror and fasten your seat belt before starting the engine.

#### WARNING

If the head restraints are not installed or not adjusted correctly, they cannot provide protection as intended. There is an increased risk of injury in the head and neck area, e.g. in the event of an accident or when braking.

Always drive with the head restraints installed. Before driving off, make sure for every vehicle occupant that the center of the head restraint supports the back of the head at about eye level.

Do not rotate the head restraints of the front and rear seats. Otherwise, you cannot adjust the height and angle of the head restraints to the correct position.

Using the fore-and-aft adjustment, adjust the head restraint so that it is as close as possible to your head.

Observe the important safety notes regarding the seats (▷ page 97).

## Adjusting the head restraints manually

### Adjusting the head restraint height



- ▶ **To raise:** pull the head restraint up to the desired position.
- ▶ **To lower:** press release catch ① in the direction of the arrow and push the head restraint down to the desired position.

### Adjusting the fore/aft position of the head restraint



With this function you can adjust the distance between the head restraint and the back of the seat occupant's head.

- ▶ **To move forwards:** pull the head restraint forwards in the direction of the arrow until it engages.  
There are several notches.
  - ▶ **To move backwards:** press and hold release button ① and push the head restraint backwards.
  - ▶ When the head restraint is in the desired position, release the button and make sure that the head restraint is engaged in position.
- i** Adjust the head restraint so that the back of your head is as close to the head restraint as possible.

## Adjusting the head restraints electrically

- ▶ **To adjust the head restraint height:** slide the switch for the head restraint adjustment (▷ page 98) up or down in the direction of the arrow.

## Adjusting the luxury head restraints

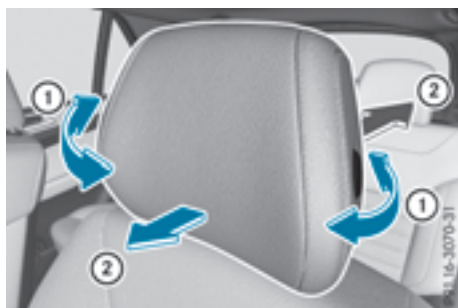

- ▶ **To adjust the side bolsters of the head restraint:** push or pull right and/or left-hand side bolster ① into the desired position.
  - ▶ **To adjust the fore/aft position of the head restraint:** push or pull the head restraint in the direction of arrow ②.
- i** Adjust the head restraint so that the back of your head is as close to the head restraint as possible.

## Rear seat head restraints

### Adjusting the rear seat head restraint height



- ▶ Once the head restraint is fully lowered, press release catch ①.
- ▶ **To raise:** pull the head restraint up to the desired position.
- ▶ **To lower:** press release catch ① and push the head restraint down until it is in the desired position.

## Removing and installing the rear seat head restraints

- ▶ **To remove:** pull the head restraint up to the stop.
- ▶ Press release catch ① and pull the head restraint out of the guides.
- ▶ **To re-install:** insert the head restraint so that the notches on the bar are on the left when viewed in the direction of travel.
- ▶ Push the head restraint down until you hear it engage in position.

## Adjusting the angle of the rear seat backrests



You can adjust the angle of the backrests in the second row of seats. There are several possible detent positions.

- ▶ Pull the left or right release lever ② upwards in the direction of the arrow until relevant backrest ① is fully released.
- ▶ Pull backrest ① forwards in the direction of the arrow and allow it to engage.
- ▶ To ensure that the backrest has engaged, lean firmly against backrest ①.

### Adjusting the multicontour seat

The multicontour seat can be adjusted via the multimedia system (see the Digital Operator's Manual).

- ③ Lowers the backrest contour
- ④ Hardens the backrest contour

You can adjust the contour of the front seat backrests individually to provide optimum support for your back.

### Adjusting the 4-way lumbar support

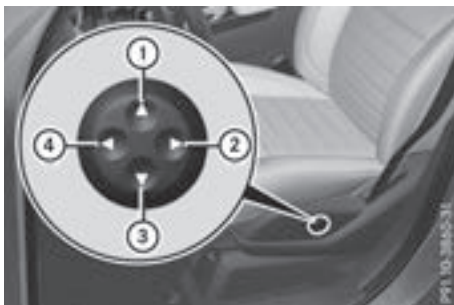

- ① Raises the backrest contour
- ② Softens the backrest contour

### Seat heating and seat ventilation

#### Switching the seat heating on/off

##### WARNING

Repeatedly switching on the seat heating can cause the seat cushion and backrest pads to become very hot. The health of persons with limited temperature sensitivity or a limited ability to react to high temperatures may be affected or they may even suffer burn-like injuries. There is a risk of injury.

Therefore, do not switch the seat heating on repeatedly.



Driver's and front-passenger seat

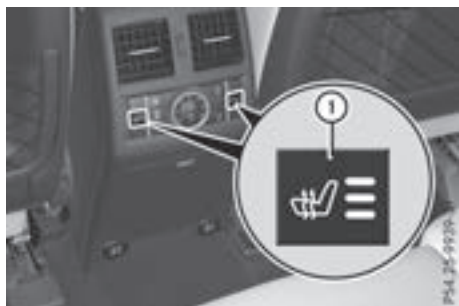

### Rear seats

The three red indicator lamps in the button indicate the heating level you have selected. The system automatically switches down from level **3** to level **2** after approximately eight minutes. The system automatically switches down from level **2** to level **1** after approximately ten minutes. The system automatically switches off approximately 35 minutes after it is set to level **1**.

- ▶ Turn the SmartKey to position **1** or **2** in the ignition lock (▷ page 135).
- ▶ **To switch on:** press button **1** repeatedly until the desired heating level is set.
- ▶ **To switch off:** press button **1** repeatedly until all the indicator lamps go out.

**i** If the battery voltage is too low, the seat heating may switch off.

### Activating/deactivating seat ventilation



The three blue indicator lamps in the buttons indicate the blower setting you have selected.

- ▶ Turn the SmartKey to position **1** or **2** in the ignition lock (▷ page 135).
- ▶ **To switch on:** press button **1** repeatedly until the desired blower setting is set.
- ▶ **To switch off:** press button **1** repeatedly until all the indicator lamps go out.

**i** If the battery voltage is too low, the seat ventilation may switch off.

**i** You can open the side windows and the sliding sunroof using the "Convenience opening" feature (▷ page 89). The seat ventilation of the driver's seat automatically switches to the highest level.



## Problems with the seat heating or seat ventilation

Problem	Possible causes/consequences and ► Solutions
The seat heating or seat ventilation has switched off prematurely or cannot be switched on.	<p>The on-board voltage is too low because too many electrical consumers are switched on.</p> <p>► Switch off electrical consumers that you do not need, such as the rear window defroster or interior lighting. Once the battery is sufficiently charged, the seat heating or seat ventilation will switch back on automatically.</p>

## Steering wheel

### Important safety notes

#### WARNING

You could lose control of your vehicle if you do the following while driving:

- adjust the driver's seat, head restraint, steering wheel or mirrors
- fasten the seat belt

There is a risk of an accident.

Adjust the driver's seat, head restraint, steering wheel and mirror and fasten your seat belt before starting the engine.

#### WARNING

Children could injure themselves if they adjust the steering wheel. There is a risk of injury.

When leaving the vehicle, always take the SmartKey with you and lock the vehicle. Never leave children unsupervised in the vehicle.

The electrically adjustable steering wheel can still be adjusted when there is no SmartKey in the ignition lock.

### Adjusting the steering wheel manually

#### WARNING

If the steering wheel is unlocked while the vehicle is in motion, it could change position unexpectedly. This could cause you to lose

control of the vehicle. There is a risk of an accident.

Before starting off, make sure the steering wheel is locked. Never unlock the steering wheel while the vehicle is in motion.



- ① Release lever
- ② Adjusts the steering wheel height
- ③ Adjusts the steering wheel position (fore-and-aft adjustment)

- Push release lever ① down completely. The steering column is unlocked.
- Adjust the steering wheel to the desired position.
- Push release lever ① up completely. The steering column is locked.
- Check if the steering column is locked. When doing so, try to push the steering wheel up or down or try to move it in the fore-and-aft direction.

### Adjusting the steering wheel electrically

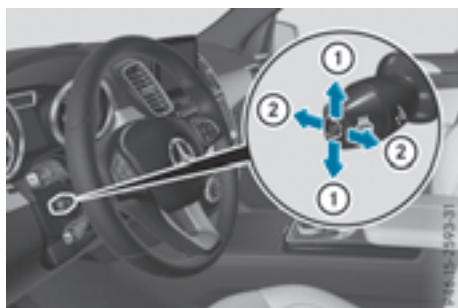

- ① Adjusts the steering wheel height
- ② Adjusts the steering wheel position (fore-and-aft adjustment)

The steering wheel can also be adjusted when the SmartKey is removed from the ignition lock.

#### **i** Further related subjects:

- EASY-ENTRY/EXIT feature (▷ page 104)
- Storing settings (▷ page 108)

### Steering wheel heating

#### Switching on/off

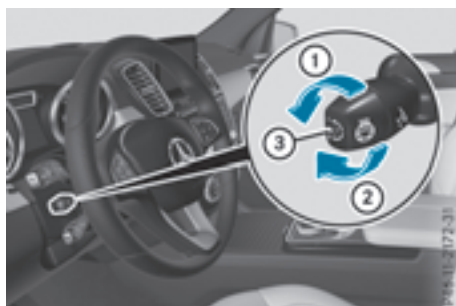

- ▶ Turn the SmartKey to position **2** in the ignition lock (▷ page 135).
- ▶ **To switch on/off:** turn the lever in the direction of arrow **1** or **2**. Indicator lamp **3** lights up or goes out.

Vehicles with KEYLESS-GO: when you switch off the ignition and open the driver's door, the steering wheel heating is deactivated.

Vehicles without KEYLESS-GO: when you remove the SmartKey from the ignition lock, the steering wheel heating is deactivated.

### Problems with the steering wheel heating

Problem	Possible causes/consequences and ▶ Solutions
The steering wheel heating has switched off prematurely or cannot be switched on.	The on-board voltage is too low because too many electrical consumers are switched on. ▶ Switch off electrical consumers that you do not need, such as the rear window defroster or interior lighting.

### EASY-ENTRY/EXIT feature

#### Important safety notes

#### **⚠ WARNING**

When the EASY-ENTRY/EXIT feature adjusts the steering wheel, you and other vehicle occupants – particularly children – could become trapped. There is a risk of injury.

While the EASY-ENTRY/EXIT feature is making adjustments, make sure that no one has any body parts in the sweep of the steering wheel.

Move the steering wheel adjustment lever if there is a risk of entrapment by the steering wheel. The adjustment process is stopped.

Press one of the memory function position buttons. This function is only available on vehicles with memory function.

#### **⚠ WARNING**

If children activate the EASY-ENTRY/EXIT feature, they can become trapped, particularly when unattended. There is a risk of injury.

When leaving the vehicle, always take the SmartKey with you and lock the vehicle. Never leave children unsupervised in the vehicle.

### WARNING

If you drive off while the EASY-ENTRY/EXIT feature is making adjustments, you could lose control of the vehicle. There is a risk of an accident.

Always wait until the adjustment process is complete before driving off.

The EASY-ENTRY/EXIT feature makes getting in and out of your vehicle easier.

You can activate and deactivate the EASY-ENTRY/EXIT feature in the on-board computer (> page 239).

### Position of the steering wheel when the EASY-ENTRY/EXIT feature is active

The steering wheel swings up when you:

- remove the SmartKey from the ignition lock.
- open the driver's door and KEYLESS-GO is in position **1**.
- open the driver's door and the SmartKey is in position **0** or **1** in the ignition lock.

**i** The steering wheel only moves up if it has not already reached the upper stop.

### Position of the steering wheel for driving

The steering wheel is moved to the last selected position when:

- the driver's door is closed
- you insert the SmartKey into the ignition lock or
- you press the Start/Stop button once on vehicles with KEYLESS-GO

When you close the driver's door with the ignition switched on, the steering wheel is also automatically moved to the previously set position.

The last position of the steering column is stored when you:

- switch the ignition off
- save the setting with the memory function (> page 108).

### Crash-responsive EASY-EXIT feature

If the crash-responsive EASY-EXIT feature is triggered in an accident, the steering column will move upwards when the driver's door is opened. This occurs irrespective of the position of the SmartKey in the ignition lock. This makes it easier to exit the vehicle and rescue the occupants. The crash-responsive EASY-EXIT feature is only operational if the EASY-EXIT/ENTRY feature is activated in the on-board computer (> page 239).

## Mirrors

### Rear-view mirror



► **Anti-glare mode:** flick anti-glare lever **1** forwards or back.

### Exterior mirrors

#### Adjusting the exterior mirrors

### WARNING

You could lose control of your vehicle if you do the following while driving:

- adjust the driver's seat, head restraint, steering wheel or mirrors
- fasten the seat belt

There is a risk of an accident.

Adjust the driver's seat, head restraint, steering wheel and mirror and fasten your seat belt before starting the engine.

### WARNING

The exterior mirror on the front-passenger side reduces the size of the image. Visible objects are actually closer than they appear. This means that you could misjudge the distance from road users traveling behind, e.g. when changing lane. There is a risk of an accident.

For this reason, always make sure of the actual distance from the road users traveling behind by glancing over your shoulder.



- ▶ Turn the SmartKey to position **1** or **2** in the ignition lock (▷ page 135).
- ▶ Exterior mirror on the driver's side: press button **1**.  
Exterior mirror on the front-passenger side: press button **2**.  
The indicator lamp in the corresponding button lights up in red.  
The indicator lamp goes out again after some time. You can adjust the selected exterior mirror using button **3** as long as the indicator lamp is lit.
- ▶ Press button **3** up, down, or to the right or left until you have adjusted the exterior mirror to the correct position. You should have a good overview of traffic conditions.

The convex exterior mirrors provide a larger field of vision.

The exterior mirrors are heated automatically if the rear window defroster is switched on and the outside temperature is low.

### Folding the exterior mirrors in or out electrically



- ▶ Turn the SmartKey to position **1** or **2** in the ignition lock (▷ page 135).
- ▶ Briefly press **1**.  
Both exterior mirrors fold in or out.
- i** Make sure that the exterior mirrors are always folded out fully while driving. They could otherwise vibrate.
- i** If you are driving faster than 30 mph (47 km/h), you can no longer fold in the exterior mirrors.

### Resetting the exterior mirrors

If the battery has been disconnected or completely discharged, the exterior mirrors must be reset. Otherwise, the exterior mirrors will not fold in when you select the "Fold in mirrors when locking" function in the on-board computer (▷ page 240).

- ▶ Turn the SmartKey to position **1** in the ignition lock (▷ page 135).
- ▶ Briefly press **1**.

### Folding the exterior mirrors in or out automatically

If the "Fold in mirrors when locking" function is activated in the on-board computer (▷ page 240):

- the exterior mirrors fold in automatically as soon as you lock the vehicle from the outside.
- the exterior mirrors fold out again automatically as soon as you unlock the vehicle and then open the driver's or front-passenger door.

## Exterior mirror pushed out of position

If an exterior mirror has been pushed out of position, proceed as follows:

- ▶ **Vehicles without electrically folding exterior mirrors:** move the exterior mirror into the correct position manually.
- ▶ **Vehicles with electrically folding exterior mirrors:** press and hold mirror-folding button ① until you hear a click and the mirror engages in position audibly.  
The mirror housing is engaged again and you can adjust the exterior mirrors as usual (▷ page 105).

## Automatic anti-glare mirrors

### ⚠ WARNING

Electrolyte may escape if the glass in an automatic anti-glare mirror breaks. The electrolyte is harmful and causes irritation. It must not come into contact with your skin, eyes, respiratory organs or clothing or be swallowed. There is a risk of injury.

If you come into contact with the electrolyte, observe the following:

- Rinse off the electrolyte from your skin immediately with water.
- Immediately rinse the electrolyte out of your eyes thoroughly with clean water.
- If the electrolyte is swallowed, immediately rinse your mouth out thoroughly. Do not induce vomiting.
- If electrolyte comes into contact with your skin or hair or is swallowed, seek medical attention immediately.
- Immediately change out of clothing which has come into contact with electrolyte.
- If an allergic reaction occurs, seek medical attention immediately.

The rear-view mirror and the exterior mirror on the driver's side automatically go into anti-glare mode if the following conditions are met simultaneously:

- the ignition is switched on and
- incident light from headlamps strikes the sensor in the rear-view mirror

The mirrors do not go into anti-glare mode if reverse gear is engaged or if the interior lighting is switched on.

## Parking position for the exterior mirror on the front-passenger side

### Setting and storing the parking position

You can position the front-passenger side exterior mirror in such a way that you can see the rear wheel on that side as soon as you engage reverse gear. You can store this position.

### Using reverse gear



- ① Button for the driver's side exterior mirror
  - ② Button for the front-passenger side exterior mirror
  - ③ Adjustment button
  - ④ Memory button **M**
- ▶ Bring the vehicle to a standstill.
  - ▶ Turn the SmartKey to position ② in the ignition lock (▷ page 135).
  - ▶ Press button ②.

- ▶ Engage reverse gear.  
The exterior mirror on the front-passenger side moves to the default setting parking position.
- ▶ Use button **③** to adjust the exterior mirror to a position that allows you to see the rear wheel and the curb.  
The parking position is stored.
- i** If you shift the transmission to another position, the exterior mirror on the front-passenger side returns to the driving position.

### Using the memory button

You can store the parking position of the exterior mirror on the front-passenger side using memory button **M** **④**. The reverse gear must not be engaged during the process.

- ▶ Turn the SmartKey to position **2** in the ignition lock (▷ page 135).
- ▶ Press button **②**.
- ▶ Use button **③** to adjust the exterior mirror to a position that allows you to see the rear wheel and the curb.
- ▶ Press memory button **M** **④** and one of the arrows on button **③** within three seconds.  
The parking position is stored if the exterior mirror does not move.
- ▶ If the mirror moves out of position, repeat the steps.

### Calling up a stored parking position setting

- ▶ Turn the SmartKey to position **2** in the ignition lock (▷ page 135).
- ▶ Adjust the exterior mirror on the front-passenger side using button **②**.
- ▶ Engage reverse gear.  
The exterior mirror on the front-passenger side moves to the stored parking position.

The exterior mirror on the front-passenger side moves back to its original position:

- as soon as you exceed a speed of 9 mph (15 km/h)
- if you press button **①** for the exterior mirror on the driver's side

## Memory function

### Storing settings

#### WARNING

If you use the memory function on the driver's side while driving, you could lose control of the vehicle as a result of the adjustments being made. There is a risk of an accident.  
Only use the memory function on the driver's side when the vehicle is stationary.

#### WARNING

When the memory function adjusts the seat or steering wheel, you and other vehicle occupants – particularly children – could become trapped. There is a risk of injury.

While the memory function is making adjustments, make sure that no one has any body parts in the sweep of the seat or steering wheel. If somebody becomes trapped, immediately release the memory function position button. The adjustment process is stopped.

#### WARNING

Children could become trapped if they activate the memory function, particularly when unattended. There is a risk of injury.

When leaving the vehicle, always take the SmartKey with you and lock the vehicle. Never leave children unsupervised in the vehicle.

The memory function can be used at any time, e.g. even when the SmartKey isn't in the ignition lock.

With the memory function, you can store up to three different settings, e.g. for three different people.

The following settings are stored as a single memory preset:

- position of the seat, backrest and head restraint
- driver's side: steering wheel position
- driver's side: position of the exterior mirrors on the driver's and front-passenger sides



- ▶ Adjust the seat (▷ page 98).
- ▶ On the driver's side, adjust the steering wheel (▷ page 104) and the exterior mirrors (▷ page 105).
- ▶ Press memory button **M** and then press memory position button **1**, **2** or **3** within three seconds.  
The settings are stored in the selected preset position. A tone sounds when the settings have been completed.

The memory function can still be used if the SmartKey has been removed.

### Calling up a stored setting

- ▶ Press and hold the relevant storage position button **1**, **2** or **3** until the seat, steering wheel and exterior mirrors are in the stored position.

The setting procedure is interrupted as soon as you release the storage position buttons.

## Exterior lighting

### General notes

For reasons of safety, Mercedes-Benz recommends that you drive with the lights switched on even during the daytime. In some countries, operation of the headlamps varies due to legal requirements and self-imposed obligations.

### Setting the exterior lighting

#### Setting options

Exterior lighting can be set using:

- the light switch
- the combination switch (▷ page 111)
- the on-board computer (▷ page 238)

#### Light switch

##### Operation

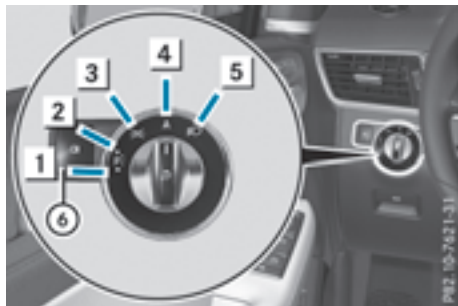

- 1 Left-hand standing lamps
- 2 Right-hand standing lamps
- 3 Parking lamps, license plate and instrument cluster lighting
- 4 Automatic headlamp mode, controlled by the light sensor
- 5 Low-beam/high-beam headlamps
- 6 Rear fog lamp

If you hear a warning tone when you leave the vehicle, the lights may still be switched on.

- ▶ Turn the light switch to .

The exterior lighting (except the parking/standing lamps) switches off automatically if you:

- remove the SmartKey from the ignition lock
- open the driver's door with the SmartKey in position in the ignition lock

### Automatic headlamp mode

is the favored light switch position. The light setting is automatically selected according to the brightness of the ambient light (exception: poor visibility due to weather conditions such as fog, snow or spray):

- SmartKey in position in the ignition lock: the parking lamps are switched on/off automatically depending on the brightness of the ambient light.
- With the engine running (USA only): if you have switched on the **Daytime Running Lights** function in the on-board computer, the daytime running lamps or the parking lamps and low-beam headlamps are switched on or off automatically depending on the brightness of the ambient light.

- ▶ **To switch on automatic headlamp mode:** turn the light switch to .

#### WARNING

When the light switch is set to , the low-beam headlamps may not be switched on automatically if there is fog, snow or other causes of poor visibility due to the weather conditions such as spray. There is a risk of an accident.

In such situations, turn the light switch to .

The automatic headlamp mode is only an aid. The driver is responsible for the vehicle's lighting at all times.

#### Canada only:

The daytime running lamps improve the visibility of your vehicle during the day. The daytime running lamps function is required by law in Canada. It cannot therefore be deactivated.

When the engine is running and the vehicle is stationary: if you move the selector lever from a driving position to **P**, the daytime running lamps/low-beam headlamps go out after three minutes.



When the engine is running, the vehicle is stationary and in bright ambient light: if you turn the light switch to the position, the daytime running lamps and parking lamps switch on.

If the engine is running and you turn the light switch to , the manual settings take precedence over the daytime running lamps.

#### USA only:





The daytime running lamps improve the visibility of your vehicle during the day. To do this, the daytime running lamps function must be switched on using the on-board computer (▷ page 238).

If the engine is running and you turn the light switch to  or , the manual settings take precedence over the daytime running lamps.







### Low-beam headlamps

Even if the light sensor does not detect that it is dark, the parking lamps and low-beam headlamps switch on when the ignition is switched on and the light switch is set to the  position. This is a particularly useful function in the event of rain and fog.



- ▶ **To switch on the low-beam headlamps:** turn the SmartKey to position  in the ignition lock or start the engine.
- ▶ Turn the light switch to . The green  indicator lamp in the instrument cluster lights up.



### Rear fog lamp

The rear fog lamp improves visibility of your vehicle for the traffic behind in the event of thick fog. Please take note of the country-specific regulations for the use of rear fog lamps.

- ▶ **To switch on the rear fog lamp:** turn the SmartKey to position  in the ignition lock or start the engine.
- ▶ Turn the light switch to  or .
- ▶ Press the  button. The yellow  indicator lamp in the instrument cluster lights up.
- ▶ **To switch off the rear fog lamp:** press the  button. The yellow  indicator lamp in the instrument cluster goes out.



### Parking lamps

**!** If the battery charge is very low, the parking lamps or standing lamps are automatically switched off to enable the next engine start. Always park your vehicle safely and in a well lit area, in accordance with the relevant legal stipulations. Avoid using the  parking lamps over a period of several hours. If possible, switch on the right-hand  or left-hand  standing lamps.

- ▶ **To switch on:** turn the light switch to . The green  indicator lamp in the instrument cluster lights up.

### Standing lamps





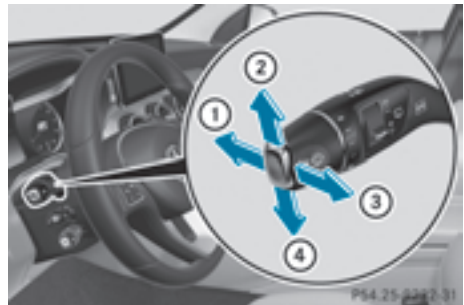

Switching on the standing lamps ensures the corresponding side of the vehicle is illuminated.

- ▶ **To switch on the standing lamps:** the SmartKey should not be in the ignition lock or in key position  in the ignition lock.
- ▶ Turn the light switch to  (left-hand side of the vehicle) or  (right-hand side of the vehicle).

Vehicles towing a trailer: both the right-hand and left-hand standing lamps (tail lamps) are always illuminated on the trailer.

### Combination switch



- ① High-beam headlamps
  - ② Turn signal, right
  - ③ High-beam flasher
  - ④ Turn signal, left
- ▶ **To indicate briefly:** press the combination switch briefly to the pressure point in the direction of arrow  or . The corresponding turn signal flashes three times.
  - ▶ **To indicate:** press the combination switch beyond the pressure point in the direction of arrow  or .
  - ▶ **To switch on the high-beam headlamps:** turn the light switch to  or **AUTO**.
  - ▶ Press the combination switch beyond the pressure point in the direction of arrow . In the **AUTO** position, the high-beam headlamps are only switched on when it is dark and the engine is running.

The blue  indicator lamp in the instrument cluster lights up when the high-beam headlamps are switched on.



- **To switch off the high-beam headlamps:** move the combination switch back to its normal position.

The blue  indicator lamp in the instrument cluster goes out.

**Vehicles with Adaptive Highbeam Assist:** if Adaptive Highbeam Assist is activated, it automatically controls activation and deactivation of the high-beam headlamps (► page 113).

## Hazard warning lamps



- **To switch on the hazard warning lamps:** press button . All turn signals flash. If you now switch on a turn signal using the combination switch, only the turn signal lamp on the corresponding side of the vehicle will flash.
- **To switch off the hazard warning lamps:** press button .

The hazard warning lamps automatically switch on if:

- an air bag is deployed or
- the vehicle decelerates rapidly from a speed of above 45 mph (70 km/h) and comes to a standstill

The hazard warning lamps switch off automatically if the vehicle reaches a speed of above 6 mph (10 km/h) again after a full brake application.

-  The hazard warning lamps still operate if the ignition is switched off.

## Intelligent Light System

### General notes

The Intelligent Light System is a system that adjusts the headlamps automatically to suit the prevailing driving and weather conditions. It offers advanced functions for improved illumination of the road surface, e.g. depending on the vehicle speed or weather conditions. The system includes the active light function, cornering light function, highway mode and extended range fog lamps. The system is only active when it is dark.

You can activate or deactivate the "Intelligent Light System" using the on-board computer (► page 238).

### Active light function

The active light function is a system that moves the headlamps according to the steering movements of the front wheels. In this way, relevant areas remain illuminated while driving. This allows you to recognize pedestrians, cyclists and animals sooner.

**Active:** when the lights are switched on.

Vehicles with Lane Keeping Assist: the active light function evaluates the course of the lane in which you are driving and adjusts the light in advance.

### Cornering light function

The cornering light function improves the illumination of the road over a wide angle in the direction you are turning, enabling better visibility in tight bends, for example. It can only be activated when the low-beam headlamps are switched on.

**Active:**

- if you are driving at speeds below 25 mph (40 km/h) and switch on the turn signal or turn the steering wheel
- if you are driving at speeds between 25 mph (40 km/h) and 45 mph (70 km/h) and turn the steering wheel

The cornering lamp may remain lit for a short time, but is automatically switched off after no more than three minutes.

**Cornering light function with traffic circle function:**

The cornering light function is activated on both sides before entering a traffic circle through an evaluation of the current GPS position of the vehicle. It remains active until after the vehicle has left the traffic circle. In this way, pedestrians crossing the road, for example, are illuminated by your vehicle in good time.

### Highway mode

Highway mode increases the range of the beam.

**Active:** if you are driving at a speed above 110 km/h and do not make any large steering movements for at least 1,000 m or if you are driving at a speed above 130 km/h.

**Not active:** if you are driving at speeds below 80 km/h following activation.

### Extended range fog lamps

The extended range fog lamps reduce the glare experienced by the driver and improve the illumination of the edge of the road.

**Active:** if you are driving at speeds below 40 mph (70 km/h) and you switch on the rear fog lamp.

**Not active:** if, following activation, you are driving at speeds above 60 mph (100 km/h) or if you switch off the rear fog lamp

### Off-road lights

The off-road lights facilitate the early recognition of objects/obstacles when driving off-road thanks to a symmetrical, wider and brighter distribution of light from the low-beam headlamps.

**Active:** when driving at speeds no faster than 30 mph (50 km/h) and the off-road program selector wheel is in position 1 or 2.

**Not active:** when driving at speeds above 30 mph (50 km/h).

When the off-road lights are switched on, the cornering light function is permanently activated, the active light function is deactivated and the headlamp range control is set to static mode.

## Adaptive Highbeam Assist

### General notes

You can use this function to set the headlamps to change between low beam and high beam automatically. The system recognizes vehicles with their lights on, either approaching from the opposite direction or traveling in front of your vehicle, and consequently switches the headlamps from high beam to low beam.

The system automatically adapts the low-beam headlamp range depending on the distance to the other vehicle. Once the system no longer detects any other vehicles, it reactivates the high-beam headlamps.

The system's optical sensor is located behind the windshield near the overhead control panel.

### Important safety notes

#### WARNING

Adaptive Highbeam Assist does not recognize road users:

- who have no lights, e.g. pedestrians
- who have poor lighting, e.g. cyclists
- whose lighting is blocked, e.g. by a barrier

On very rare occasions, Adaptive Highbeam Assist may fail to recognize other road users that have lights, or may recognize them too late. In this, or in similar situations, the automatic high-beam headlamps will not be deactivated or will be activated regardless. There is a risk of an accident.

Always carefully observe the traffic conditions and switch off the high-beam headlamps in good time.

Adaptive Highbeam Assist cannot take into account road, weather or traffic conditions. Adaptive Highbeam Assist is only an aid. You are responsible for adjusting the vehicle's lighting to the prevailing light, visibility and traffic conditions.

In particular, the detection of obstacles can be impaired if:

- poor visibility, e.g. due to fog, heavy rain or snow
- dirt on the sensors or the sensors are obscured

## Switching Adaptive Highbeam Assist on/off



- ▶ **To switch on:** turn the light switch to **AUTO**.
- ▶ Press the combination switch beyond the pressure point in the direction of arrow ①. The  indicator lamp in the multifunction display lights up when it is dark and the light sensor activates the low-beam headlamps. If you are driving at speeds above approximately 16 mph (25 km/h):

The headlamp range is set automatically depending on the distance between the vehicle and other road users.

If you are driving at speeds above approximately 19 mph (30 km/h) and no other road users have been detected:

The high-beam headlamps are switched on automatically. The  indicator lamp in the instrument cluster also lights up.

If you are driving at speeds below approximately 16 mph (25 km/h) or other road users have been detected or the roads are adequately lit:

The high-beam headlamps are switched off automatically. The  indicator lamp in the instrument cluster goes out. The  indicator lamp in the multifunction display remains lit.

- ▶ **To switch off:** move the combination switch back to its normal position or move the light switch to another position. The  indicator lamp in the multifunction display goes out.

## Headlamps fogged up on the inside





Certain climatic and physical conditions may cause moisture to form in the headlamp. This moisture does not affect the functionality of the headlamp.

## Interior lighting

### Overview of interior lighting



Overhead control panel

- ①  Switches the left-hand front reading lamp on/off
- ②  Switches the front interior lighting on
- ③  Switches the rear interior lighting on/off
- ④  Switches the front interior lighting/automatic interior lighting control off
- ⑤  Switches the right-hand front reading lamp on/off
- ⑥ Switches the automatic interior lighting control on

## Interior lighting control

### General notes

The interior light functions are automatically switched off after some time to prevent the vehicle's battery from discharging, unless the SmartKey is in position **2** in the ignition lock.

The color and brightness of the ambient lighting are set using the multimedia system (see Digital Operator's Manual).

### Automatic interior lighting control

- ▶ **To switch on:** set the switch to center position **⑥**.
- ▶ **To switch off:** set the switch to the  position.

The interior lighting automatically switches on if you:

- unlock the vehicle
- open a door
- remove the SmartKey from the ignition lock

The interior lighting is switched on for a set time when the SmartKey is removed from the ignition lock. This delayed switch-off can be adjusted via the multimedia system (see Digital Operator's Manual).

### Crash-responsive emergency lighting

The interior lighting is activated automatically if the vehicle is involved in an accident.

- ▶ **To switch off the crash-responsive emergency lighting:** press the hazard warning lamp button.

or

- ▶ Lock and then unlock the vehicle using the SmartKey.

### Replacing bulbs (vehicles with LED headlamps)

The front and rear light clusters of your vehicle are equipped with light-emitting diodes. Do not replace the vehicle's bulbs yourself. Contact a qualified specialist workshop which has the necessary specialist knowledge and tools to carry out the work required.

Lamps are an important aspect of vehicle safety. You must therefore make sure that these function correctly at all times. Have the headlamp setting checked regularly.

### Replacing bulbs (vehicles with halogen headlamps)

#### Important safety notes

#### WARNING

Bulbs, lamps and connectors can get very hot when operating. If you change a bulb, you could burn yourself on these components. There is a risk of injury.

Allow these components to cool down before changing a bulb.

Do not use a bulb if it has been dropped or if its glass tube has been scratched.

The bulb may explode if:

- you touch it
- it is hot
- you drop it
- you scratch it

Use bulbs only in closed lamps that have been designed for this purpose. Only install spare bulbs of the same type and the specified voltage.

Marks on the glass tube reduce the service life of the bulbs. Do not touch the glass tube with your bare hands. If necessary, clean the glass tube when cold with alcohol or spirit and rub it off with a lint-free cloth.

Protect bulbs from moisture during operation. Do not allow bulbs to come into contact with liquids.

Replace only the bulbs listed (▷ page 115).

Have the bulbs that you cannot replace yourself replaced at a qualified specialist workshop.

If you require assistance replacing bulbs, consult a qualified specialist workshop.

If the new bulb still does not light up, consult a qualified specialist workshop.

Headlamps and lights are an important aspect of vehicle safety. You must therefore make sure that these function correctly at all times. Have the headlamp setting checked regularly.

#### Overview of bulb replacement - bulb types

You can replace the following bulbs. The bulb type can be found in the legend.

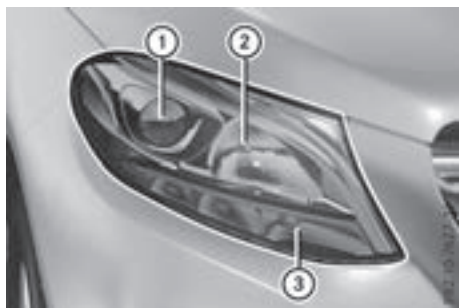

Halogen headlamps

- ① Low-beam headlamp: H7 55 W
- ② High-beam headlamp: H7 55 W
- ③ Turn signal: W 5 W BV

### Removing and installing the cover in the front wheel housing



You must remove the cover from the front wheel housing before you can change the front bulbs.

- ▶ **To remove:** switch off the lights.
- ▶ Turn the front wheel inwards.
- ▶ Remove securing pin ② using a suitable tool.
- ▶ Slide cover ① up and remove it.
- ▶ **To install:** insert cover ① again and slide it down until it engages.
- ▶ Insert securing pin ②.

### Low-beam headlamps

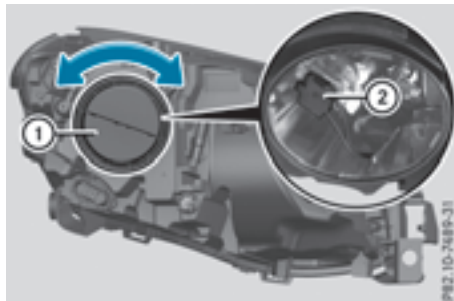

- ▶ Remove the cover in the front wheel housing (▷ page 116).
- ▶ Turn housing cover ① counter-clockwise and remove it.
- ▶ Turn bulb holder ② counter-clockwise and pull out.
- ▶ Pull the bulb out of bulb holder ②.
- ▶ Insert new bulb into bulb holder ②.
- ▶ Insert bulb holder ② and turn it clockwise.
- ▶ Press on housing cover ① and turn it to the right.
- ▶ Replace the cover in the front wheel housing (▷ page 116).

### High-beam headlamps

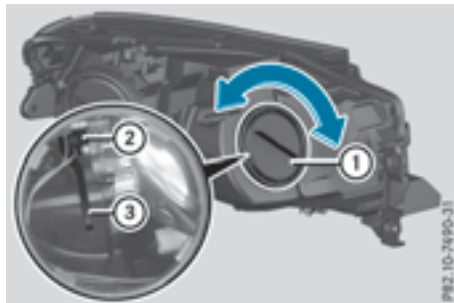

- ▶ Switch off the lights.
- ▶ Open the hood.
- ▶ Turn housing cover ① counter-clockwise and remove it.
- ▶ Pull lever ③ upwards (headlamps on the left in the direction of travel) or push it downwards (headlamps on the right in the direction of travel) and remove bulb holder ②.

- ▶ Remove the bulb from bulb holder ②.
- ▶ Insert the new bulb into bulb holder ②.
- ▶ Simultaneously push down on bulb holder ② and push lever ③ downwards (headlamps on the left in the direction of travel) or pull upwards (headlamps on the right in the direction of travel).
- ▶ Press on housing cover ① and turn it clockwise.

### Turn signals

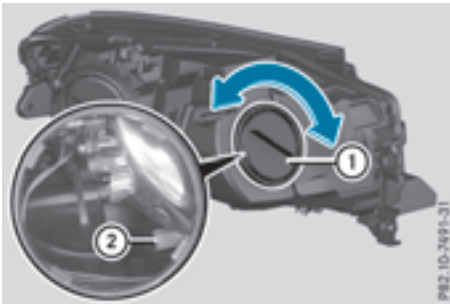

- ▶ Switch off the lights.
- ▶ Open the hood.
- ▶ Turn housing cover ① counter-clockwise and remove it.
- ▶ Turn bulb holder ② counter-clockwise and pull out.
- ▶ Pull the bulb out of bulb holder ②.
- ▶ Insert new bulb into bulb holder ②.
- ▶ Insert bulb holder ② and turn it clockwise.
- ▶ Press on housing cover ① and turn it to the right.

## Windshield wipers

### Switching the windshield wipers on/off

**!** Do not operate the windshield wipers when the windshield is dry, as this could damage the wiper blades. Moreover, dust that has collected on the windshield can scratch the glass if wiping takes place when the windshield is dry.

If it is necessary to switch on the windshield wipers in dry weather conditions, always use

washer fluid when operating the windshield wipers.

**!** If the windshield wipers leave smears on the windshield after the vehicle has been washed in an automatic car wash, wax or other residues may be the reason for this. Clean the windshield using washer fluid after washing the vehicle in an automatic car wash.

**!** Intermittent wiping with rain sensor: due to optical influences and the windshield becoming dirty in dry weather conditions, the windshield wipers may be activated inadvertently. This could then damage the windshield wiper blades or scratch the windshield.

For this reason, you should always switch off the windshield wipers in dry weather.

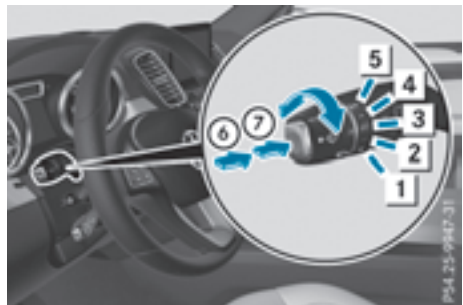

#### Combination switch

- |   |      |   |
|---|------|---|
| 1 | 0    | Windshield wiper off  |
| 2 | ...  | Intermittent wipe, low (rain sensor set to low sensitivity)   |
| 3 | .... | Intermittent wipe, high (rain sensor set to high sensitivity) |
| 4 | —    | Continuous wipe, slow   |
| 5 | ==   | Continuous wipe, fast   |
| 6 |      | Single wipe   |
| 7 |      | To wipe with washer fluid                                     |

▶ Switch on the ignition.

▶ Turn the combination switch to the corresponding position.

In the **...** or **....** position, the appropriate wiping frequency is set automatically according to the intensity of the rain. In the **....** position, the rain sensor is more sensitive than in the **...** position, causing the windshield wiper to wipe more frequently.

Vehicles with MAGIC VISION CONTROL: the washer fluid is fed through the wiper blades and when wiping with washer fluid the washer fluid is emitted directly from the blades.

If the wiper blades are worn, the windshield will no longer be wiped properly. This could prevent you from observing the traffic conditions.

### Switching the rear window wiper on/off



Combination switch

- ① Rear window wiper switch
  - ② Wipes with washer fluid
  - ③ Intermittent wiper on
  - ④ Intermittent wiper off
  - ⑤ Wipes with washer fluid
- ▶ Turn the SmartKey to position **1** or **2** (▷ page 135).
  - ▶ Turn switch **①** on the combination switch to the corresponding position.  
When the rear window wiper is switched on, the icon appears in the instrument cluster.

### Replacing the wiper blades

#### Important safety notes

#### WARNING

If the windshield wipers begin to move while you are changing the wiper blades, you could be trapped by the wiper arm. There is a risk of injury.

Always switch off the windshield wipers and ignition before changing the wiper blades.

- ❗ To avoid damaging the wiper blades, make sure that you touch only the wiper arm of the wiper.

- ❗ Never open the hood/tailgate if a wiper arm has been folded away from the windshield/rear window.

Never fold a windshield wiper arm without a wiper blade back onto the windshield/rear window.

Hold the windshield wiper arm firmly when you change the wiper blade. If you release the wiper arm without a wiper blade and it falls onto the windshield/rear window, the windshield/rear window may be damaged by the force of the impact.

Mercedes-Benz recommends that you have the wiper blades changed at a qualified specialist workshop.

### Changing the windshield wiper blades

#### Moving the wiper arms to a vertical position

##### On vehicles without KEYLESS-GO:

- ▶ Turn the SmartKey to position **0** in the ignition lock (▷ page 135).
- ▶ Set the windshield wiper to position on the combination switch.
- ▶ Turn the SmartKey to position **1** in the ignition lock (▷ page 135).
- ▶ As soon as the wiper arms are vertical to the hood, turn the SmartKey to position **0** in the ignition lock (▷ page 135).
- ▶ Remove the SmartKey.
- ▶ Fold the wiper arms away from the windshield until you feel them snap into place.

##### On vehicles with KEYLESS-GO:

- ▶ Switch off the engine.
- ▶ Remove your foot from the brake pedal.
- ▶ Set the windshield wiper to the position.
- ▶ Press the Start/Stop button repeatedly until the windshield wiper starts.
- ▶ When the wiper arms are vertical to the hood, press the Start/Stop button repeatedly until the windshield wiper stops.
- ▶ Fold the wiper arms away from the windshield until you feel them snap into place.

#### Removing the wiper blades

- ▶ Remove the SmartKey from the ignition lock.
- ▶ Fold the wiper arm away from the windshield.



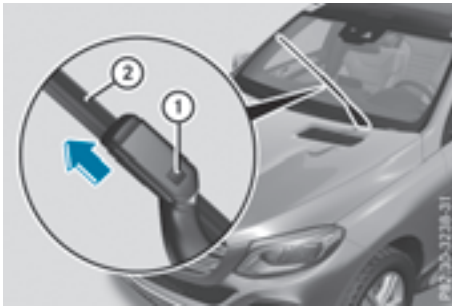

- ▶ Firmly press release knob ① and pull wiper blade ② upwards from the wiper arm in the direction of the arrow.

### Installing the wiper blades



- ▶ Position new wiper blade ① in the retainer on the wiper arm and slide it into place in the direction of the arrow. The wiper blade audibly engages.
- ▶ Make sure that the wiper blade is seated correctly.
- ▶ Fold the wiper arm back onto the windshield.

### Replacing the wiper blades (MAGIC VISION CONTROL)

#### Moving the wiper arms to a vertical position

##### On vehicles without KEYLESS-GO:

- ▶ Turn the SmartKey to position **0** in the ignition lock (▷ page 135).
- ▶ Set the windshield wiper to position **—** on the combination switch.
- ▶ Turn the SmartKey to position **1** in the ignition lock (▷ page 135).

- ▶ As soon as the wiper arms are vertical to the hood, turn the SmartKey to position **0** in the ignition lock (▷ page 135).
- ▶ Remove the SmartKey.
- ▶ Fold the wiper arms away from the windshield until you feel them snap into place.

##### On vehicles with KEYLESS-GO:

- ▶ Switch off the engine.
- ▶ Remove your foot from the brake pedal.
- ▶ Set the windshield wiper to the **—** position.
- ▶ Press the Start/Stop button repeatedly until the windshield wiper starts.
- ▶ When the wiper arms are vertical to the hood, press the Start/Stop button repeatedly until the windshield wiper stops.
- ▶ Fold the wiper arms away from the windshield until you feel them snap into place.

### Removing a wiper blade

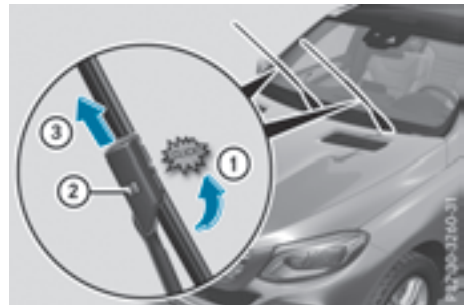

- ▶ **To bring the wiper blade into position to be removed:** hold the wiper arm firmly with one hand. With the other hand, turn the wiper blade in the direction of arrow ① beyond the point of resistance. The wiper blade engages in the removal position with an audible click.
- ▶ **To remove a wiper blade:** firmly press release knob ② and pull the wiper blade upwards ③.

### Installing the wiper blades



- ▶ Push the new wiper blade in the direction of arrow ① onto the wiper arm until lug ② engages.
- ▶ Push the wiper blade out of the removal position in the direction of arrow ③ beyond the point of resistance. The wiper blade disengages with an audible click and is freely movable again.
- ▶ Make sure that the wiper blade is seated correctly.
- ▶ Fold the wiper arm back onto the windshield.

### Replacing the rear window wiper blade

#### Removing a wiper blade



- ▶ Remove the SmartKey from the ignition lock.
- ▶ Fold wiper arm ① away from the rear window until it engages.
- ▶ Position wiper blade ② at a right angle to wiper arm ①.
- ▶ Hold wiper arm ① and press wiper blade ② in the direction of the arrow until it releases.
- ▶ Remove wiper blade ②.

#### Installing a wiper blade

- ▶ Place new wiper blade ② onto wiper arm ①.
- ▶ Hold wiper arm ① and press wiper blade ② in the opposite direction to the arrow until it engages.
- ▶ Make sure that wiper blade ② is seated correctly.
- ▶ Position wiper blade ② parallel to wiper arm ①.
- ▶ Fold wiper arm ① back onto the rear window.

### Problems with the windshield wipers

Problem	Possible causes/consequences and ► Solutions
The windshield wipers are jammed.	<p>Leaves or snow, for example, may be obstructing the windshield wiper movement. The wiper motor has been deactivated.</p> <ul style="list-style-type: none"> <li>► For safety reasons, you should remove the SmartKey from the ignition lock.</li> </ul> <p>or</p> <ul style="list-style-type: none"> <li>► Switch off the engine using the Start/Stop button and open the driver's door.</li> <li>► Remove the cause of the obstruction.</li> <li>► Switch the windshield wipers back on.</li> </ul>
The windshield wipers fail completely.	<p>The windshield wiper drive is malfunctioning.</p> <ul style="list-style-type: none"> <li>► Select another wiper speed on the combination switch.</li> <li>► Have the windshield wipers checked at a qualified specialist workshop.</li> </ul>

## Overview of climate control systems

### General notes

Observe the settings recommended on the following pages. The windows could otherwise fog up.

To prevent the windows from fogging up:

- switch off climate control only briefly
- switch on air-recirculation mode only briefly
- switch on the cooling with air dehumidification function
- switch on the defrost windshield function briefly, if required

Climate control regulates the temperature and the humidity in the vehicle interior and filters undesirable substances out of the air.

The "Cooling with air dehumidification" function is only available when the engine is running. Optimum climate control is only achieved with the side windows and roof closed.

The residual heat function can only be activated or deactivated with the ignition switched off (▷ page 131).

- i** Ventilate the vehicle for a brief period during warm weather, e.g. using the convenience opening feature (▷ page 89). This will speed up the cooling process and the desired interior temperature will be reached more quickly.

If you start the engine using your smartphone, the last selected climate control setting is reactivated (▷ page 137).

- i** The integrated filter filters out most particles of dust and soot and completely filters out pollen. It also reduces gaseous pollutants and odors. A clogged filter reduces the amount of air supplied to the vehicle interior. Depending on the operating conditions and environmental influences, the interval for replacing the filter may be shorter than specified.
- i** **Vehicles with ionization of the interior air and air filter:** in addition to ionization, the vehicle has an air filter with anti-allergenic properties that contribute to improved air filtration.
- i** It is possible that under certain circumstances the residual heat function may be activated automatically an hour after the SmartKey has been removed in order to dry the automatic climate control. The vehicle is then ventilated for 30 minutes.
- i** **Plug-in hybrid vehicles:** observe the notes on climate control in the separate Operator's Manual.

## Control panel for dual-zone automatic climate control

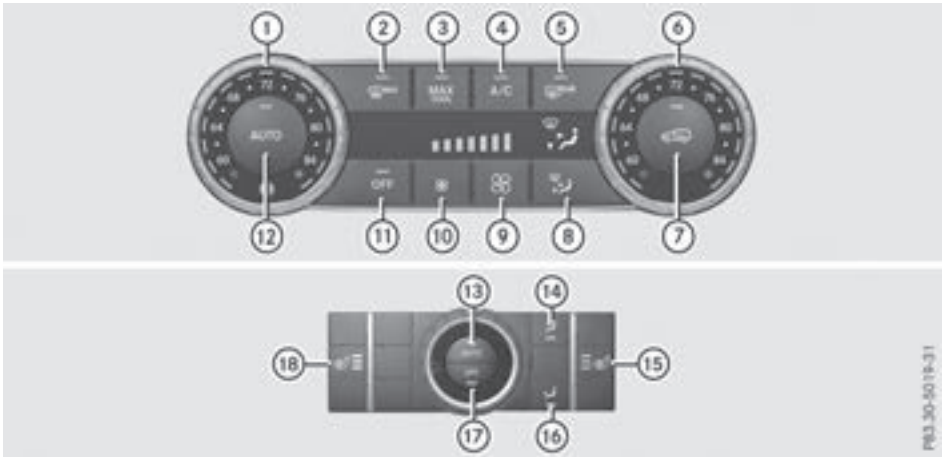

USA only

### Front control panel

- ① Sets the temperature, left (▷ page 128)
- ② Defrosts the windshield (▷ page 129)
- ③ Switches the maximum cooling MAX COOL on or off (▷ page 130)
- ④ Switches cooling with air dehumidification on/off (▷ page 127)
- ⑤ Switches the rear window defroster on/off (▷ page 130)
- ⑥ Sets the temperature, right (▷ page 128)
- ⑦ Switches air-recirculation mode on/off (▷ page 131)
- ⑧ Sets the air distribution (▷ page 129)
- ⑨ Increases the airflow (▷ page 129)
- ⑩ Reduces the airflow (▷ page 129)
- ⑪ Activates/deactivates climate control (▷ page 127)
- ⑫ Sets climate control to automatic (▷ page 128)

### Rear control panel

- ⑬ Sets rear-compartment climate control to automatic (▷ page 128)
- ⑭ Directs the air distribution through the rear air vents (▷ page 129)
- ⑮ Switches the seat heating on the right-hand side on/off (▷ page 101)
- ⑯ Directs the air distribution through the footwell vents (▷ page 129)
- ⑰ Switches the rear climate control on/off (▷ page 127)
- ⑱ Switches the seat heating on the left-hand side on/off (▷ page 101)

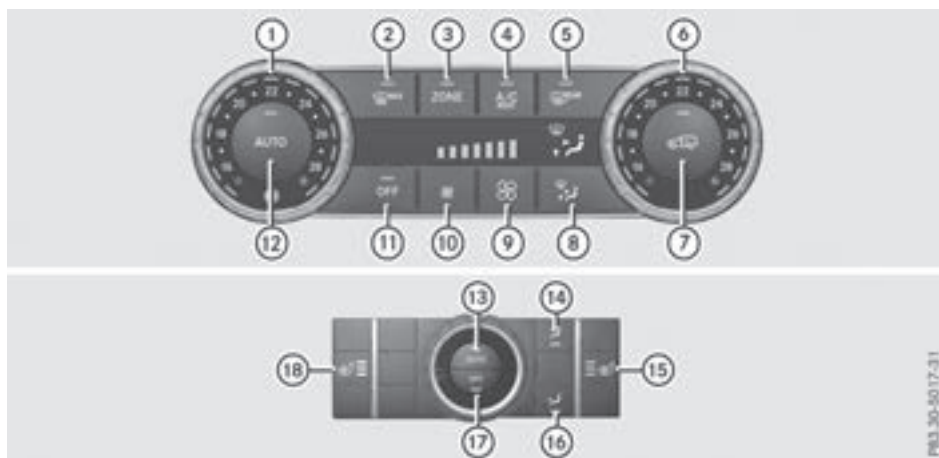

Canada only

### Front control panel

- ① Sets the temperature, left (▷ page 128)
- ② Defrosts the windshield (▷ page 129)
- ③ Switches the ZONE function on/off (▷ page 129)
- ④ Switches cooling with air dehumidification on/off (▷ page 127)  
Switches the residual heat on or off (▷ page 131)
- ⑤ Switches the rear window defroster on/off (▷ page 130)
- ⑥ Sets the temperature, right (▷ page 128)
- ⑦ Switches air-recirculation mode on/off (▷ page 131)
- ⑧ Sets the air distribution (▷ page 129)
- ⑨ Increases the airflow (▷ page 129)
- ⑩ Reduces the airflow (▷ page 129)
- ⑪ Activates/deactivates climate control (▷ page 127)
- ⑫ Sets climate control to automatic (▷ page 128)

### Rear control panel

- ⑬ Sets rear-compartment climate control to automatic (▷ page 128)
- ⑭ Directs the air distribution through the rear air vents (▷ page 129)
- ⑮ Switches the seat heating on the right-hand side on/off (▷ page 101)
- ⑯ Directs the air distribution through the footwell vents (▷ page 129)
- ⑰ Switches the rear climate control on/off (▷ page 127)
- ⑱ Switches the seat heating on the left-hand side on/off (▷ page 101)

## Control panel for 3-zone automatic climate control

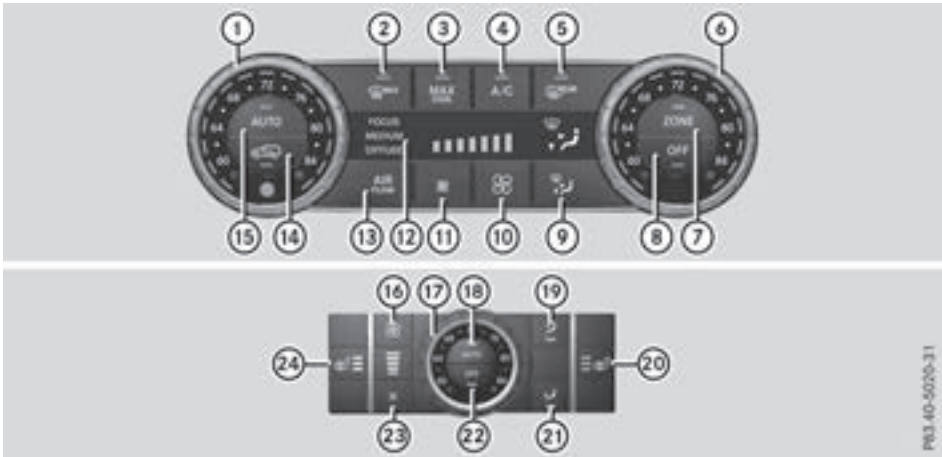

USA only

**Front control panel**

- ① Sets the temperature, left (▷ page 128)
- ② Defrosts the windshield (▷ page 129)
- ③ Switches the maximum cooling MAX COOL on or off (▷ page 130)
- ④ Switches cooling with air dehumidification on/off (▷ page 127)
- ⑤ Switches the rear window defroster on/off (▷ page 130)
- ⑥ Sets the temperature, right (▷ page 128)
- ⑦ Switches the ZONE function on/off (▷ page 129)
- ⑧ Activates/deactivates climate control (▷ page 127)
- ⑨ Sets the air distribution (▷ page 129)
- ⑩ Increases the airflow (▷ page 129)
- ⑪ Reduces the airflow (▷ page 129)
- ⑫ Display
- ⑬ Adjusts the climate mode settings (▷ page 128)
- ⑭ Switches air-recirculation mode on/off (▷ page 131)
- ⑮ Sets climate control to automatic (▷ page 128)

**Rear control panel**

- ⑯ Increases the airflow (▷ page 129)
- ⑰ Sets the temperature (▷ page 128)
- ⑱ Sets rear-compartment climate control to automatic (▷ page 128)
- ⑲ Directs the airflow through the rear air vents (▷ page 129)
- ⑳ Switches the seat heating on the right-hand side on/off (▷ page 101)
- ㉑ Directs the airflow through the footwell vents (▷ page 129)
- ㉒ Switches the rear climate control on/off (▷ page 127)
- ㉓ Reduces the airflow (▷ page 129)
- ㉔ Switches the seat heating on the left-hand side on/off (▷ page 101)

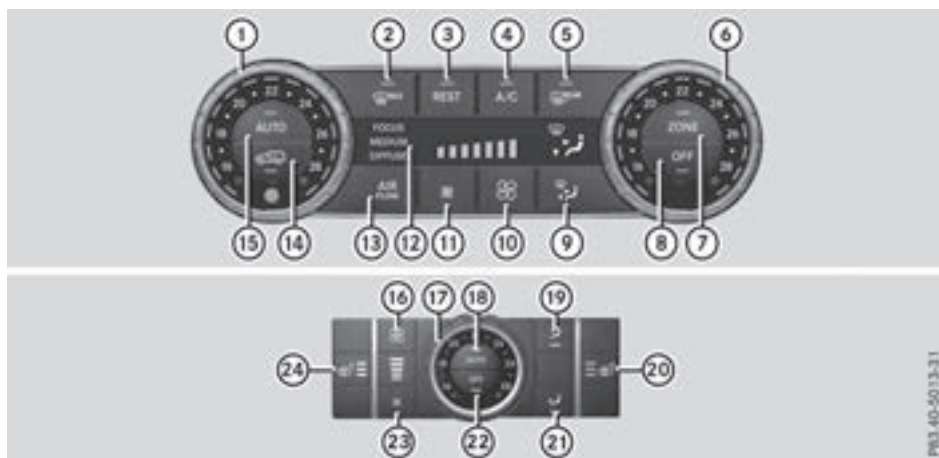

Canada only

### Front control panel

- ① Sets the temperature, left (▷ page 128)
- ② Defrosts the windshield (▷ page 129)
- ③ Switches the residual heat on or off (▷ page 131)
- ④ Switches cooling with air dehumidification on/off (▷ page 127)
- ⑤ Switches the rear window defroster on/off (▷ page 130)
- ⑥ Sets the temperature, right (▷ page 128)
- ⑦ Switches the ZONE function on/off (▷ page 129)
- ⑧ Activates/deactivates climate control (▷ page 127)
- ⑨ Sets the air distribution (▷ page 129)
- ⑩ Increases the airflow (▷ page 129)
- ⑪ Reduces the airflow (▷ page 129)
- ⑫ Display
- ⑬ Adjusts the climate mode settings (▷ page 128)
- ⑭ Switches air-recirculation mode on/off (▷ page 131)
- ⑮ Sets climate control to automatic (▷ page 128)

### Rear control panel

- ⑯ Increases the airflow (▷ page 129)
- ⑰ Sets the temperature (▷ page 128)
- ⑱ Sets rear-compartment climate control to automatic (▷ page 128)
- ⑲ Directs the airflow through the rear air vents (▷ page 129)
- ⑳ Switches the seat heating on the right-hand side on/off (▷ page 101)
- ㉑ Directs the airflow through the footwell vents (▷ page 129)
- ㉒ Switches the rear climate control on/off (▷ page 127)
- ㉓ Reduces the airflow (▷ page 129)
- ㉔ Switches the seat heating on the left-hand side on/off (▷ page 101)



## Optimum use of automatic climate control

The following contains notes and recommendations on optimum use of the dual-zone automatic climate control or 3-zone automatic climate control.

- You can switch on climate control by using the **AUTO** and **A/C** or **AUTO** and **A/C REST** buttons. The indicator lamps in the **AUTO** and **A/C** buttons or the **AUTO** and **A/C REST** buttons light up.
  - Vehicles with 3-zone automatic climate control:** in automatic mode, you can also use the **AIR FLOW** button to set a climate mode (FOCUS/MEDIUM/DIFFUSE). The MEDIUM level is recommended.
  - Set the temperature to 72 °F (22 °C).
  - Only use the "Windshield defrosting" function briefly until the windshield is clear again.
  - Only use air-recirculation mode briefly, e.g. if there are unpleasant outside odors or when in a tunnel. The windows could otherwise fog up, since no fresh air is drawn into the vehicle in air-recirculation mode.
  - Vehicles with 3-zone automatic climate control:** use the ZONE function to adopt the temperature settings on the driver's side for the front-passenger side and the rear compartment as well. The indicator lamp above the **ZONE** button goes out.
  - Vehicles with 3-zone automatic climate control:** use the "residual heat" function if you want to heat or ventilate the vehicle interior when the ignition is switched off. The residual heat function can only be activated or deactivated with the ignition switched off.
  - If you change the settings of the climate control system, the climate status display appears for approximately three seconds at the bottom of the screen in the multimedia system display. You will see the current settings of the various climate control functions.
- During automatic engine switch-off, the climate control system only operates at a reduced capacity. If you require the full climate control output, you can switch off the ECO start/stop function by pressing the ECO button (▷ page 140).

## Operating the climate control systems

### Activating/deactivating climate control

#### General notes

When the climate control is switched off, the air supply and air circulation are also switched off. The windows could fog up. Therefore, switch off climate control only briefly

Activate climate control primarily using the **AUTO** button (▷ page 128).

In the rear compartment, you can also switch climate control on and off using the **AUTO** and **OFF** buttons.

#### Activating/deactivating



- Turn the SmartKey to position **2** in the ignition lock (▷ page 135).
- To activate:** press the **AUTO** button. The indicator lamp in the **AUTO** button lights up. Airflow and air distribution are set to automatic mode.
- To deactivate:** press the **OFF** button. The indicator lamp in the **OFF** button lights up.

### Switching cooling with air dehumidification on/off

#### Activating/deactivating

- To activate:** press the **A/C** or **A/C REST** button. The indicator lamp in the **A/C** or **A/C REST** button lights up.
- To deactivate:** press the **A/C** or **A/C REST** button. The indicator lamp in the **A/C** or **A/C REST** button goes out. The "Cooling with air dehumidification" function has a delayed switch-off feature.

## Problems with the "Cooling with air dehumidification" function

Problem	Possible causes/consequences and ► Solutions
The indicator lamp in the  or  button flashes three times or remains off. The "Cooling with air dehumidification" function cannot be switched on.	Cooling with air dehumidification has been deactivated due to a malfunction. ► Visit a qualified specialist workshop.

### Setting climate control to automatic





#### General notes

In automatic mode, the set temperature is maintained automatically at a constant level. The system automatically regulates the temperature of the dispensed air, the airflow and the air distribution.

The "Cooling with air dehumidification" function is activated automatically in automatic mode.

In the rear compartment, you can also switch climate control for the rear seats to automatic mode using the  button.

#### Automatic control



- Turn the SmartKey to position  in the ignition lock (► page 135).
- Set the desired temperature.
- **To activate:** press the  button.  
The indicator lamp in the  button lights up. Automatic air distribution and airflow are activated.
- **To switch to manual mode:** press the  button.

**3-zone automatic climate control:** when automatic mode is activated, you can select a climate mode (► page 128).

### Adjusting the climate mode settings

You can select the following climate mode settings in automatic mode:



- FOCUS high airflow, slightly cooler setting
- MEDIUM medium airflow, standard setting
- DIFFUSE low airflow, slightly warmer and draft-free setting

- Turn the SmartKey to position  in the ignition lock (► page 135).
- Press the  button.
- Press the  button repeatedly until the desired climate mode appears in the display.

### Setting the temperature





#### Dual-zone automatic climate control

Different temperatures can be set for the driver's and front-passenger sides.

- Turn the SmartKey to position  in the ignition lock (► page 135).
- **To increase or decrease:** turn control  or  counter-clockwise or clockwise (► page 123).  
Only change the temperature setting in small increments. Start at 72 °F (22 °C).

#### 3-zone automatic climate control

You can select different temperature settings for the driver's and front-passenger sides as well as for the rear compartment.

- Turn the SmartKey to position  in the ignition lock (► page 135).
- **To increase or decrease temperature in the front compartment:** turn control  or  counter-clockwise or clockwise (► page 125).  
Only change the temperature setting in small increments. Start at 72 °F (22 °C).
- **To increase or reduce the temperature in the rear compartment using the front control panel:** press the  button.  
The indicator lamp in the  button goes out.







The temperature setting for the driver's side is adopted for the rear compartment and the front-passenger side.

- ▶ Turn thumbwheel ① to the left or right (> page 125).  
Only change the temperature setting in small increments. Start at 72 °F (22 °C).
- ▶ **To increase or decrease the rear compartment temperature using the rear control panel:** turn control ⑰ counter-clockwise or clockwise on the rear control panel (> page 125).  
Only change the temperature setting in small increments. Start at 72 °F (22 °C).



### Setting the air distribution

#### Air distribution settings

##### Front control panel

-  Directs the airflow through the center vents
-  Directs air through the footwell air vents
-  Directs the airflow through the center and footwell vents
-  Directs air through the defroster vents
-  Directs the airflow through the defroster and center vents (Canada only)
-  Directs air through the defroster and footwell vents
-  Directs the airflow through the defroster, center and footwell air vents (Canada only)

##### Rear control panel

-  Directs the airflow through the rear center and B-pillar air vents
-  Directs air through the footwell air vents



**i** Using the rear control panel, you can also activate both air distribution positions simultaneously. In order to do this, press both air distribution buttons. The air is then routed through all rear air vents.

**i** Regardless of the air distribution setting, airflow is always directed through the side air vents. The side air vents can only be closed when the controls on the side air vents are turned downwards.





### Setting

- ▶ Turn the SmartKey to position 2 in the ignition lock (> page 135).
- ▶ Press the  button repeatedly until the desired symbol appears in the display.

#### Setting the airflow

- ▶ Turn the SmartKey to position 2 in the ignition lock (> page 135).
  - ▶ **To increase:** press the  button.
  - ▶ **To reduce:** press the  button.
- i** You can use 3-zone automatic climate control to set the airflow in the rear compartment separately.

#### Switching the ZONE function on/off

- ▶ **To activate:** press the  button.  
The indicator lamp above the  button lights up.  
Dual-zone automatic climate control: the temperature setting for the driver's side is not adopted for the front-passenger side.  
3-zone automatic climate control: the temperature setting for the driver's side is not adopted for the front-passenger side and the rear compartment.
- ▶ **To deactivate:** press the  button.  
The indicator lamp above the  button goes out.  
Dual-zone automatic climate control: the temperature setting for the driver's side is adopted for the front-passenger side.  
3-zone automatic climate control: the temperature setting for the driver's side is adopted for the front-passenger side and the rear compartment.



#### Defrosting the windshield

##### General notes

You can use this function to defrost the windshield or to clear a fogged up windshield or front side windows on the inside.  
Switch off the "Windshield defrosting" function as soon as the windshield is clear again.



## Activating/deactivating

▶ Turn the SmartKey to position **2** in the ignition lock (▷ page 135).

▶ **To activate:** press the  button. The indicator lamp in the  button lights up.

The climate control system switches to the following settings:



- high airflow
- high temperature
- air distribution to the windshield and front side windows
- air-recirculation mode off



▶ **To deactivate:** press the  button. The indicator lamp in the  button goes out. The previously selected settings are restored. Air-recirculation mode remains deactivated.

## MAX COOL maximum cooling

The MAX COOL function is only available in vehicles for the USA.

MAX COOL is only operational when the engine is running.

▶ **To activate:** press the  button. The indicator lamp in the  button lights up.



▶ **To deactivate:** press the  button. The indicator lamp in the  button goes out. The previously selected settings are restored.

When you activate MAX COOL, climate control switches to the following functions:

- maximum cooling
- maximum airflow
- air-recirculation mode on

## Defrosting the windows

### Windows fogged up on the inside

▶ Activate the  or  cooling with air dehumidification function.



▶ Activate automatic mode **AUTO**.

▶ If the windows continue to fog up, activate the "windshield defrosting" function (▷ page 129).

**i** You should only select this setting until the windshield is clear again.

### Windows fogged up on the outside

▶ Activate the windshield wipers.

▶ Press the  button repeatedly until the  or  symbol appears in the display.

**i** You should only select this setting until the windshield is clear again.

**i** If you clean the windows regularly, they do not fog up so quickly.

## Rear window defroster



### General notes

The rear window defroster has a high current draw. You should therefore switch it off as soon as the rear window is clear. Otherwise, the rear window defroster switches off automatically after several minutes.

If the battery voltage is too low, the rear window defroster may switch off.

### Activating/deactivating

▶ Turn the SmartKey to position **2** in the ignition lock (▷ page 135).

▶ Press the  button. The indicator lamp in the  button lights up or goes out.

## Problems with the rear window defroster

Problem	Possible causes/consequences and ► Solutions
The rear window defroster has deactivated prematurely or cannot be activated.	The battery has not been sufficiently charged. ► Switch off any consumers that are not required, e.g. reading lamps, interior lighting or the seat heating. When the battery is sufficiently charged, the rear window defroster can be activated again.

### Switching air-recirculation mode on/off



#### General notes

You can deactivate the flow of fresh air if unpleasant odors are entering the vehicle from outside. The air already inside the vehicle will then be recirculated.



If you switch on air-recirculation mode, the windows can fog up more quickly, in particular at low temperatures. Only use air-recirculation mode briefly to prevent the windows from fogging up.

#### Activating/deactivating

► Turn the SmartKey to position **2** in the ignition lock (► page 135).

► **To activate:** press the  button. The indicator lamp in the  button lights up.

**i** In the event of high pollution levels (3-zone automatic climate control only) or at high outside temperatures, air-recirculation mode is automatically activated. When air-recirculation mode is activated automatically, the indicator lamp in the  button is not lit. Outside air is added after about 30 minutes.

► **To deactivate:** press the  button. The indicator lamp in the  button goes out.

- i** Air-recirculation mode deactivates automatically:
- after approximately five minutes at outside temperatures below approximately 41 °F (5 °C)
  - after approximately five minutes if cooling with air dehumidification is deactivated
  - after approximately 30 minutes at outside temperatures above approximately 41 °F

(5 °C) if the "Cooling with air dehumidification" function is activated





### Switching the residual heat on or off

#### General notes

The residual heat function is only available on vehicles for Canada.





It is possible to make use of the residual heat of the engine to continue heating the stationary vehicle for up to 30 minutes after the engine has been switched off. The heating time depends on the set interior temperature.

#### Activating/deactivating

► **To activate:** press the  or  button. The indicator lamp in the  or  button lights up.

**i** The blower will run at a low speed regardless of the airflow setting.

**i** If you activate the residual heat function at high temperatures, only the ventilation will be activated. The blower runs at medium speed.

► **To deactivate:** press the  or  button. The indicator lamp in the  or  button goes out.

Residual heat is deactivated automatically:

- after approximately 30 minutes
- when the ignition is switched on
- if the battery voltage drops

### Ionization

Ionization is used to purify the air in the vehicle interior and attain an improved interior climate.

The ionization of the interior air is odorless and cannot be perceived directly in the vehicle interior.

You can switch ionization on and off via the multimedia system (see the Digital Operator's Manual).

Ionization can only be operated when the automatic climate control is switched on. The side air vent on the driver's side must be open.

## Setting the air vents

### Important safety notes

#### WARNING

Very hot or very cold air can flow from the air vents. This could result in burns or frostbite in the immediate vicinity of the air vents. There is a risk of injury.

Make sure that all vehicle occupants always maintain a sufficient distance to the air outlets. If necessary, redirect the airflow to another area of the vehicle interior.

In order to ensure the direct flow of fresh air through the air vents into the vehicle interior, please observe the following notes:

- keep the air inlet grille on the hood and in the engine compartment on the front-passenger side free of blockages, such as ice, snow or leaves.
- never cover the air vents or air intake grilles in the vehicle interior.

- i** For virtually draft-free ventilation, adjust the sliders of the air vents to the center position.

## Setting the center air vents



- ① Center air vent, left
- ② Center air vent, right
- ③ Center vent thumbwheel, right
- ④ Center vent thumbwheel, left

► **To open or close:** turn thumbwheels ③ and ④ to the left or right.

## Setting the side air vents

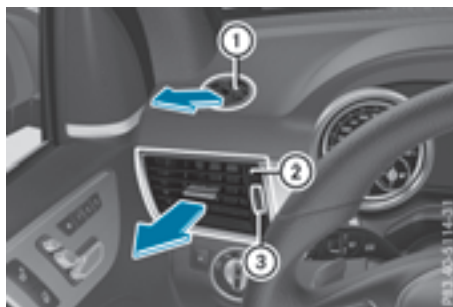

Example

- ① Side window defroster vent
- ② Side air vent, left
- ③ Thumbwheel for side air vent

► **To open or close:** turn thumbwheel ③ up or down.

## Setting the glove box air vent

- !** Close the air vent when heating the vehicle. At high outside temperatures, open the air vent and activate the "cooling with air dehumidification" function. Otherwise, temperature-sensitive items stored in the glove box could be damaged.

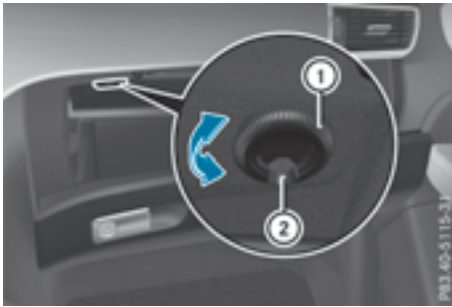

- ① Air vent control
- ② Air vent

When the climate control system is activated, the glove box can be ventilated, for instance to cool its contents. The level of airflow depends on the airflow and air distribution settings.

► **To open or close:** turn thumbwheel ① to the right or left.

### Setting the rear-compartment air vents

#### Setting the center vents in the rear compartment

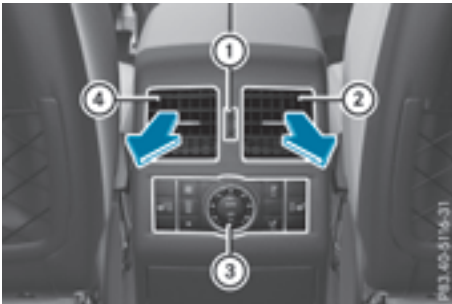

Example: center vents with rear control panel

- ① Rear-compartment air vent thumbwheel
- ② Rear-compartment air vent, right
- ③ Rear control panel
- ④ Rear-compartment air vent, left

► **To open or close:** turn thumbwheel ① up or down.

#### Setting the B-pillar air vent

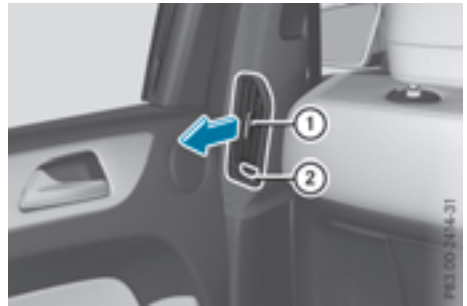

- ① B-pillar air vent
- ② Thumbwheel for B-pillar air vent

► **To open or close:** turn thumbwheel ② to the left or right.

## Notes on breaking-in a new vehicle

### Important safety notes

The sensor system of some driving and driving safety systems adjusts automatically while a certain distance is being driven after the vehicle has been delivered or after repairs. Full system effectiveness is not reached until the end of this teach-in procedure.

New and replaced brake pads and discs only reach their optimum braking effect after several hundred kilometers of driving. Compensate for this by applying greater force to the brake pedal.

### The first 1000 miles (1500 km)

The more you look after the engine when it is new, the more satisfied you will be with its performance in the future.

- You should therefore drive at varying vehicle and engine speeds for the first 1000 miles (1500 km).
- Avoid heavy loads, e.g. driving at full throttle, during this period.
- Change gear in good time, before the tachometer needle is  $\frac{2}{3}$  of the way to the red area of the tachometer.
- Do not manually shift to a lower gear to brake the vehicle.
- Try to avoid depressing the accelerator pedal beyond the point of resistance (kickdown).

Additional breaking-in notes for Mercedes-AMG vehicles:

- Do not drive faster than 85 mph (140 km/h) for the first 1,000 miles (1,500 km).
- Only allow the engine to reach a maximum engine speed of 4,500 rpm briefly.
- Change gear in good time.
- Ideally, for the first 1,000 miles (1,500 km), drive in the **Comfort** drive program.

After 1000 miles (1500 km), you can increase the engine speed gradually and accelerate the vehicle to full speed.

You should also observe these notes on breaking in if the engine or parts of the drive train on your vehicle have been replaced.

Always observe the maximum permissible speed.

## Driving

### Important safety notes

#### WARNING

Objects in the driver's footwell can restrict the pedal travel or obstruct a depressed pedal.

The operating and road safety of the vehicle is jeopardized. There is a risk of an accident.

Make sure that all objects in the vehicle are stowed correctly, and that they cannot enter the driver's footwell. Install the floormats securely and as specified in order to ensure sufficient clearance for the pedals. Do not use loose floormats and do not place floormats on top of one another.

#### WARNING

Unsuitable footwear can hinder correct usage of the pedals, e.g.:

- shoes with thick soles
- shoes with high heels
- slippers

There is a risk of an accident.

Wear suitable footwear to ensure correct usage of the pedals.

#### WARNING

If you switch off the ignition while driving, safety-relevant functions are only available with limitations, or not at all. This could affect, for example, the power steering and the brake boosting effect. You will require considerably more effort to steer and brake. There is a risk of an accident.

Do not switch off the ignition while driving.

#### WARNING

If the parking brake has not been fully released when driving, the parking brake can:

- overheat and cause a fire
- lose its hold function.

There is a risk of fire and an accident. Release the parking brake fully before driving off.



**!** Do not warm up the engine while stationary. Pull away immediately. Avoid high engine speeds and full throttle until the engine has reached its operating temperature.

In vehicles with automatic transmission, engage positions P and R only when the vehicle is stationary.

Where possible, avoid spinning the drive wheels when pulling away on slippery roads. You could otherwise damage the drive train.

**!** **Mercedes-AMG vehicles:** at low engine oil temperatures below 68 °F (+20 °C), the maximum engine speed is restricted in order to protect the engine. To protect the engine and maintain smooth engine operation, avoid driving at full throttle when the engine is cold.

**Plug-in hybrid:** be sure to read the separate Operator's Manual. Otherwise, you may not recognize dangers.

locked. To unlock, remove the SmartKey and reinsert it into the ignition lock.

The steering is locked when you remove the SmartKey from the ignition lock.

▶ Remove the SmartKey when the engine is switched off.  
The starter battery could otherwise be discharged.

If you cannot turn the SmartKey in the ignition lock, the starter battery may not be charged sufficiently.

▶ Check the starter battery and charge it if necessary (▷ page 342).

or

▶ Jump-start the vehicle (▷ page 342).

**i** The SmartKey can be turned in the ignition lock even if it is not the correct SmartKey for the vehicle. The ignition is not switched on. The engine cannot be started.

## Key positions

### SmartKey

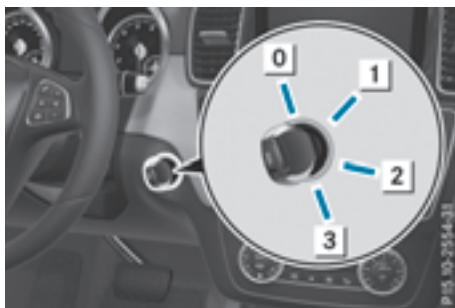

- 0** To remove the SmartKey
- 1** Power supply for some consumers, such as the windshield wipers
- 2** Ignition (power supply for all consumers) and drive position
- 3** To start the engine

As soon as the ignition is switched on, all the indicator lamps in the instrument cluster light up. Further information on situations where an indicator lamp either fails to go out after starting the engine or lights up while driving (▷ page 276).

If the SmartKey is in position **0** in the ignition lock for a longer period, it can no longer be turned in the ignition lock. The steering is then

## KEYLESS-GO

### General notes

Vehicles with KEYLESS-GO are equipped with a SmartKey featuring an integrated KEYLESS-GO function and a detachable Start/Stop button.

A check which periodically establishes a radio connection between the vehicle and the SmartKey determines whether a valid SmartKey is in the vehicle. This occurs, for example, when starting the engine.

When you insert the Start/Stop button into the ignition lock, the system needs approximately two seconds recognition time. You can then use the Start/Stop button.

Pressing the Start/Stop button several times in succession corresponds to the different SmartKey positions in the ignition lock. This is only the case if you are not depressing the brake pedal.

If you depress the brake pedal and press the Start/Stop button, the engine starts immediately.

To start the vehicle without actively using the SmartKey:

- the Start/Stop button must be inserted in the ignition lock
- the SmartKey must be in the vehicle
- the vehicle must not be locked with the SmartKey or KEYLESS-GO (▷ page 78).

Do not keep the SmartKey:

- with electronic devices, e.g. a mobile phone or another SmartKey
- with metallic objects, e.g. coins or metal foil
- inside metallic objects, e.g. a metal case

This can impair the functionality of the KEYLESS-GO key.

Do not keep the KEYLESS-GO key in the temperature-controlled cup holder (▷ page 305). Otherwise, the KEYLESS-GO key will not be recognized.

If you lock the vehicle with the SmartKey remote control or with KEYLESS-GO, after a short time:

- you will not be able to switch on the ignition with the Start/Stop button
- you will not be able to start the engine with the Start/Stop button until the vehicle is unlocked again

If you lock the vehicle centrally using the button on the front door (▷ page 83), you can continue to start the engine with the Start/Stop button.

The engine can be switched off while the vehicle is in motion by pressing and holding the Start/Stop button for three seconds. This function operates independently of the ECO start/stop automatic engine switch-off function.

### Key positions with KEYLESS-GO



- ① Start/Stop button
- ② Ignition lock

As soon as the ignition is switched on, all the indicator lamps in the instrument cluster light up. Further information on situations where an indicator lamp either fails to go out after starting the engine or lights up while driving (▷ page 276).

If Start/Stop button ① has not yet been pressed, this corresponds to the SmartKey being removed from the ignition.

► **To switch on the power supply:** press Start/Stop button ① once.

The power supply is switched on. You can now activate the windshield wipers, for example.

The power supply is switched off again if:

- the driver's door is opened and
- you press Start/Stop button ① twice when in this position

► **To switch on the ignition:** press Start/Stop button ① twice.

The ignition is switched on.

If you press Start/Stop button ① once when in this position, the ignition is deactivated again.

### Removing the Start/Stop button

You can remove the Start/Stop button from the ignition lock and start the vehicle as normal using the SmartKey.

It is possible to switch between KEYLESS-GO mode and key operation only when the transmission is in position **P**.

► Remove Start/Stop button ① from ignition lock ②.

You do not have to remove the Start/Stop button from the ignition lock when you leave the vehicle. You should, however, always take the SmartKey with you when leaving the vehicle. As long as the SmartKey is in the vehicle:

- the vehicle can be started using the Start/Stop button
- the electrically powered equipment can be operated

### Starting the engine

### Important safety notes

#### ⚠ WARNING

If children are left unsupervised in the vehicle, they could:

- open the doors, thus endangering other people or road users.
- get out and disrupt traffic.
- operate the vehicle's equipment.

Additionally, children could set the vehicle in motion if, for example, they:

- release the parking brake.
- shifting the automatic transmission out of park position **P**
- Start the engine.

There is a risk of an accident and injury.

When leaving the vehicle, always take the SmartKey with you and lock the vehicle. Never leave children or animals unattended in the vehicle. Always keep the SmartKey out of reach of children.

### WARNING

Combustion engines emit poisonous exhaust gases such as carbon monoxide. Inhaling these exhaust gases leads to poisoning. There is a risk of fatal injury. Therefore never leave the engine running in enclosed spaces without sufficient ventilation.

### WARNING

Flammable materials introduced through environmental influence or by animals can ignite if in contact with the exhaust system or parts of the engine that heat up. There is a risk of fire.

Carry out regular checks to make sure that there are no flammable foreign materials in the engine compartment or in the exhaust system.

## General notes

**Vehicles with a gasoline engine:** the catalytic converter is preheated for up to 30 seconds after a cold start. The sound of the engine may change during this time.

## Automatic transmission

- ▶ Shift the transmission to position **P** (▷ page 144).  
The transmission position indicator on the multifunction display shows **P** (▷ page 145).

- i** You can start the engine in transmission position **P** and **N**.

## Starting procedure with the SmartKey

- ▶ **To start a diesel engine:** turn the SmartKey to position **2** in the ignition lock (▷ page 135).  
The **00** preglow indicator lamp in the instrument cluster lights up.
- ▶ Turn the SmartKey to position **3** in the ignition lock (▷ page 135) and release it as soon as the engine is running.

- i** **Vehicles with a diesel engine:** you can start the engine without preglow if the engine is warm.

## Using KEYLESS-GO to start the engine

The Start/Stop button can be used to start the vehicle without inserting the SmartKey into the ignition lock. The Start/Stop button must be inserted in the ignition lock and the SmartKey must be in the vehicle. This mode for starting the engine operates independently of the ECO start/stop automatic engine start function.

- ▶ Depress the brake pedal and keep it depressed.
- ▶ Press the Start/Stop button once (▷ page 135).  
**Vehicles with a gasoline engine:** the engine starts.  
**Vehicles with a diesel engine:** preglow is activated and the engine starts.

## Starting procedure via smartphone

Observe the important safety notes on starting the engine (▷ page 136).

You can also start your engine via your smartphone from outside the vehicle. In this case, the previously selected climate control setting is activated. In this way you can cool or heat the interior of the vehicle before starting the journey.

Only start the engine via your smartphone if it is safe to start and run the engine where your vehicle is parked.

Observe the legal stipulations in the area where your vehicle is parked. Engine start via smartphone may be limited to certain countries or regions.

You can execute a maximum of two consecutive starting attempts via your smartphone. If you insert the SmartKey into the ignition lock, you can carry out two more starting attempts.

Once you have started the engine, you can switch the engine off via your smartphone at any time.

You can only start the engine via your smartphone if:

- the SmartKey is in the ignition lock
- park position **P** is selected
- the accelerator pedal is not depressed
- the anti-theft alarm system is not activated
- the panic alarm is not activated
- the hazard warning lamps are switched off
- the hood is closed
- the doors are closed and locked
- the windows and sliding sunroof are closed

Also make sure that:

- the fuel tank is sufficiently filled
- the starter battery is sufficiently charged

#### WARNING

Limbs could be crushed or trapped if the engine is started unintentionally during service or maintenance work. There is a risk of injury.

Always secure the engine against unintentional starting before carrying out maintenance or repair work.

Make sure that the engine cannot be started via your smartphone before carrying out maintenance or repairs. You can prevent an engine start via your smartphone, for example, if you:

- switch on the hazard warning lamps
- do not lock the doors
- open the hood

### Pulling away

#### General notes

#### WARNING

If the engine speed is above the idling speed and you engage transmission position **D** or **R**,

the vehicle could pull away suddenly. There is a risk of an accident.

When engaging transmission position **D** or **R**, always firmly depress the brake pedal and do not simultaneously accelerate.

Depress the accelerator carefully when pulling away.

The vehicle locks centrally once you have pulled away. The locking knobs in the doors drop down. You can open the doors from the inside at any time.

You can also deactivate the automatic locking feature (▷ page 239).

It is only possible to shift the transmission from position **P** to the desired position if you depress the brake pedal. Only then is the parking lock released. If you do not depress the brake pedal, the DIRECT SELECT lever can still be moved but the parking lock remains engaged.

**i** Upshifts take place at higher engine speeds after a cold start. This helps the catalytic converter to reach its operating temperature more quickly.

Information on the automatic release of the electric parking brake (▷ page 158).

### Pulling away with a trailer



To ensure that you do not roll backwards when pulling away on an uphill slope, engage the electric parking brake.

► Press and hold handle ①.

The electric parking brake continues to brake and prevent the vehicle from rolling backwards.

The red **PARK** (USA only) or **(P)** (Canada only) indicator lamp in the instrument cluster remains on.

- ▶ Depress the accelerator pedal.
  - ▶ As soon as the vehicle/trailer combination is held by the driving force of the engine, release lever ①. The electric parking brake is released.
- The red **PARK** (USA only) or **(P)** (Canada only) indicator lamp in the instrument cluster goes out.

### Hill start assist

Hill start assist helps you when pulling away forwards or in reverse on an uphill gradient. It holds the vehicle for a short time after you have removed your foot from the brake pedal. This gives you enough time to move your foot from the brake pedal to the accelerator pedal and to depress it before the vehicle begins to roll.

#### WARNING

After a short time, hill start assist will no longer brake your vehicle and it could roll away. There is a risk of an accident and injury.

Therefore, quickly move your foot from the brake pedal to the accelerator pedal. Never leave the vehicle when it is held by hill start assist.

Hill start assist is not active if:

- you are pulling away on a level road or on a downhill gradient.
- the transmission is in position **N**.
- the electric parking brake is applied.
- ESP® is malfunctioning.

### ECO start/stop function

#### Introduction

**Plug-in hybrid:** observe the notes on the ECO start/stop function in the separate Operator's Manual.

The ECO start/stop function switches the engine off automatically if the vehicle is stopped under certain conditions.

The engine starts automatically when the driver wants to pull away again. The ECO start/stop

function thereby helps you to reduce the fuel consumption and emissions of your vehicle.

### Important safety notes

#### WARNING

If the engine is switched off automatically and you exit the vehicle, the engine is restarted automatically. The vehicle may begin moving. There is a risk of accident and injury.

If you wish to exit the vehicle, always turn off the ignition and secure the vehicle against rolling away.

### General notes



#### ① ECO start/stop display

The ECO start/stop function is activated whenever you start the engine using the SmartKey or the Start/Stop button.

If the engine has been switched off automatically by the ECO start/stop function, the **(A)** ECO symbol is shown in the multifunction display.

**Mercedes-AMG vehicles:** the ECO start/stop function is only available in drive programs **Comfort** and **Slippery**.

### Automatic engine switch-off

If the vehicle is braked to a standstill in **D** or **N**, the ECO start/stop function switches off the engine automatically.

The ECO start/stop function is operational when:

- the indicator lamp in the ECO button is lit green
- the **Sport Plus** drive program is not selected (Mercedes-AMG GLE 43 4MATIC)
- the **Sport Plus** or **Sport** drive program is not selected (Mercedes-AMG vehicles)
- no Off-road program has been selected

- the outside temperature and the atmospheric air pressure is within the range that is suitable for the system
- the engine is at normal operating temperature
- the set temperature for the vehicle interior has been reached
- the battery is sufficiently charged
- the system detects that the windshield is not fogged up when the air-conditioning system is switched on
- the hood is closed
- the driver's door is closed and the driver's seat belt is fastened

All of the vehicle's systems remain active when the engine is stopped automatically.

The HOLD function can also be activated if the engine has been switched off automatically. It is then not necessary to continue applying the brakes during the automatic stop phase. When you depress the accelerator pedal, the engine starts automatically and the braking effect of the HOLD function is deactivated.

**All vehicles (except Mercedes-AMG vehicles):** automatic engine switch-off can take place a maximum of four times in a row (initial stop, then three subsequent stops).

**Mercedes-AMG vehicles:** the number of consecutive automatic engine switch-offs is unlimited.

### Automatic engine start

The engine starts automatically if:

- you switch off the ECO start/stop function by pressing the ECO button
- in transmission position **D** or **N** the brake pedal is released and the HOLD function is not active
- you depress the accelerator pedal
- you engage reverse gear **R**
- you move the transmission out of position **P**
- you switch to the **Sport Plus** drive program (Mercedes-AMG GLE 43 4MATIC)
- you switch to the **Sport Plus** or **Sport** drive program (Mercedes-AMG vehicles)
- you activate manual gearshifting (Mercedes-AMG vehicles)
- you switch to the **Offroad** drive program (vehicles without Off-Road Engineering package)

- you switch to the **Offroad** or **Offroad Plus** drive program (vehicles with Off-Road Engineering package)
- you unfasten your seat belt or open the driver's door
- the vehicle starts to roll
- the brake system requires this
- the temperature in the vehicle interior deviates from the set range
- the system detects moisture on the windshield when the air-conditioning system is switched on
- the battery's condition of charge is too low

Shifting the transmission to position **P** does not start the engine.

### Deactivating or activating the ECO start/stop function

**All vehicles (except Mercedes-AMG vehicles)**



- ▶ **To deactivate:** press ECO button ①. Indicator lamp ② goes out.
- ▶ **To activate:** press ECO button ①. Indicator lamp ② lights up.

If indicator lamp ② is off, the ECO start/stop function has been deactivated manually or as the result of a malfunction.

**Mercedes-AMG vehicles**

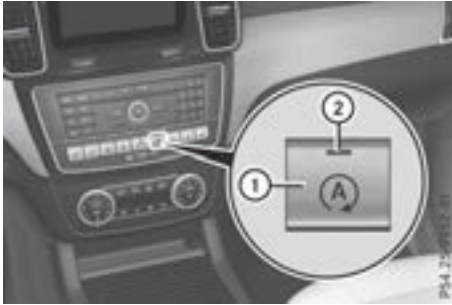

► **To deactivate:** in the **Comfort** drive program, press ECO button ①.  
or

- Activate manual gearshifting (▷ page 147).  
or
- Switch to the **Sport Plus** or **Sport** drive program (▷ page 142).  
Indicator lamp ② goes out.
- **To activate:** press ECO button ①.  
Indicator lamp ② lights up. When the **Sport Plus** or **Sport** drive program is activated, the automatic transmission switches to the **Comfort** drive program.

If indicator lamp ② is off, the ECO start/stop function has been deactivated manually or as the result of a malfunction.

**Problems with the engine**

Problem	Possible causes/consequences and ► Solutions
The engine does not start. The starter motor can be heard.	<ul style="list-style-type: none"> <li>• There is a malfunction in the engine electronics.</li> <li>• There is a malfunction in the fuel supply.</li> </ul> Before attempting to start the engine again: <ul style="list-style-type: none"> <li>► Turn the SmartKey in the ignition lock back to position <b>0</b>.</li> <li>or</li> <li>► Press the Start/Stop button repeatedly until all indicator lamps in the instrument cluster go out.</li> <li>► Try to start the engine again (▷ page 136). Avoid excessively long and frequent attempts to start the engine as these will drain the battery.</li> </ul> If the engine does not start after several attempts: <ul style="list-style-type: none"> <li>► Consult a qualified specialist workshop.</li> </ul>
The engine does not start. You cannot hear the starter motor.	The on-board voltage is too low because the battery is too weak or discharged. <ul style="list-style-type: none"> <li>► Jump-start the vehicle (▷ page 342).</li> </ul> If the engine does not start despite attempts to jump-start it: <ul style="list-style-type: none"> <li>► Consult a qualified specialist workshop.</li> </ul> The starter motor was exposed to a thermal load that was too high. <ul style="list-style-type: none"> <li>► Allow the starter motor to cool down for approximately two minutes.</li> <li>► Try to start the engine again.</li> </ul> If the engine still does not start: <ul style="list-style-type: none"> <li>► Consult a qualified specialist workshop.</li> </ul>

Problem	Possible causes/consequences and ► Solutions
Vehicles with a gasoline engine: The engine is not running smoothly and is misfiring.	There is a malfunction in the engine electronics or in a mechanical component of the engine management system. ► Only depress the accelerator pedal slightly. Otherwise, non-combusted fuel may get into the catalytic converter and damage it. ► Have the cause rectified immediately at a qualified specialist workshop.
The coolant temperature gage shows a value above 248 °F (120 °C).	The coolant level is too low. The coolant is too hot and the engine is no longer being cooled sufficiently. ► Stop as soon as possible and allow the engine and the coolant to cool down. ► Check the coolant level (► page 324). Observe the warning notes as you do so and add coolant if necessary.

## DYNAMIC SELECT controller

**Plug-in hybrid:** observe the notes on the DYNAMIC SELECT controller in the separate Operator's Manual.

Use the DYNAMIC SELECT controller to change the drive program. Depending on the drive program selected the following vehicle characteristics will change:

- the drive (engine and transmission management)
- the transmission
- the suspension
- the steering
- the availability of the ECO start/stop function

Each time you start the engine with the Smart-Key or the Start/Stop button, the **Comfort** drive program is activated. For further information about starting the engine, see (► page 136).

The **Comfort** drive program is recommended in city traffic and stop/start traffic situations.



- **All vehicles (except Mercedes-AMG vehicles):** turn DYNAMIC SELECT controller ① as many times as necessary until the desired drive program is selected.

The selected drive program appears in the multifunction display. After five seconds the display goes out.

In addition, the current drive program settings are displayed in the multimedia system display.

### Drive programs available (all vehicles except Mercedes-AMG vehicles):

<b>Individual</b>	Individual settings
<b>Sport</b>	Sporty driving characteristics
<b>Comfort</b>	Comfortable and economical driving characteristics



<b>Slippery</b>	Optimal driving characteristics on slippery or snow-covered roads
<b>Off-road</b>	Optimal driving characteristics for easily negotiable off-road terrain
<b>Off-road Plus</b> (vehicles with Off-Road Engineering package)	Optimal driving characteristics for rough terrain

Further information on:

- the **Individual**, **Sport**, **Comfort** and **Slippery** drive programs (▷ page 146)
- the **Off-road** drive program (vehicles without Off-Road Engineering package) (▷ page 214)
- the **Off-road** and **Off-road Plus** drive programs (vehicles with Off-Road Engineering package) (▷ page 215)



- ▶ **Mercedes-AMG vehicles:** turn DYNAMIC SELECT controller ① as many times as necessary until the desired drive program is selected.

The selected drive program appears in the multifunction display. After five seconds the display goes out.

In addition, the current drive program settings are displayed in the multimedia system display.

#### Drive programs available (Mercedes-AMG vehicles):

<b>Individual</b>	Individual settings
<b>Comfort</b>	Comfortable and economical driving characteristics

<b>Sport</b>	Sporty driving characteristics
<b>Sport Plus</b>	Particularly sporty driving characteristics
<b>Slippery</b>	Optimal driving characteristics on slippery or snow-covered roads

Additional information for drive programs (▷ page 146).

### Automatic transmission

#### Important safety notes

#### WARNING

The automatic transmission switches to neutral position **N** when you switch off the engine. The vehicle may roll away. There is a risk of an accident.

After switching off the engine, always switch to parking position **P**. Prevent the parked vehicle from rolling away by applying the parking brake.

**Plug-in hybrid:** be sure to read the separate Operator's Manual. Otherwise, you may not recognize dangers.

#### DIRECT SELECT lever

#### Overview of transmission positions



- P** Park position with parking lock
- R** Reverse gear

- N** Neutral
- D** Drive

The DIRECT SELECT lever is on the right of the steering column.

The DIRECT SELECT lever always returns to its original position. The current transmission position **P**, **R**, **N** or **D** is shown on the transmission position display on the multifunction display (▷ page 145).

### Engaging park position P

**!** If the engine speed is too high or the vehicle is coasting, do not shift the automatic transmission directly from **D** to **R**, from **R** to **D** or directly to **P**. Otherwise, the automatic transmission may be damaged.

- ▶ Push the DIRECT SELECT lever switch in the direction of arrow **P**.

### Engaging park position P automatically

Park position **P** is automatically engaged if:

- You switch off the engine using the SmartKey and remove the SmartKey
- You switch off the engine using the SmartKey or using the Start/Stop button and open the driver's door or front-passenger door
- You open the driver's door when the vehicle is stationary or when driving at a very low speed and the transmission is in position **D** or **R**

Under certain conditions, the automatic transmission shifts automatically to transmission position **P** if the HOLD function or Distance Pilot DISTRONIC is activated. Observe the information on the HOLD function (▷ page 182) and on Distance Pilot DISTRONIC (▷ page 174).

### Engaging reverse gear R

**!** Only move the automatic transmission to **R** when the vehicle is stationary.

- ▶ If the transmission is in position **D** or **N**: push the DIRECT SELECT lever up past the first point of resistance.
- ▶ If the transmission is in position **P**: depress the brake pedal and push the DIRECT SELECT lever up past the first point of resistance.

### Shifting to neutral N

#### WARNING

If children are left unsupervised in the vehicle, they could:

- open the doors, thus endangering other people or road users.
- get out and disrupt traffic.
- operate the vehicle's equipment.

Additionally, children could set the vehicle in motion if, for example, they:

- release the parking brake.
- shifting the automatic transmission out of park position **P**
- Start the engine.

There is a risk of an accident and injury.

When leaving the vehicle, always take the SmartKey with you and lock the vehicle. Never leave children or animals unattended in the vehicle. Always keep the SmartKey out of reach of children.

- ▶ If the transmission is in position **D** or **R**: push the DIRECT SELECT lever up or down to the first point of resistance.
- ▶ If the transmission is in position **P**: depress the brake pedal and push the DIRECT SELECT lever up or down to the first point of resistance.

If you switch the engine off with the transmission in position **R** or **D**, the automatic transmission shifts to **N** automatically.

**With the SmartKey:** if you then open the driver's door or the front-passenger door or remove the SmartKey from the ignition lock, the automatic transmission shifts to **P** automatically.

**With the Start/Stop button:** if you then open the driver's door or the front-passenger door, the automatic transmission shifts automatically to **P**.

If you want the automatic transmission to remain in neutral **N**, e.g. when having the vehicle cleaned in an automatic, tow-through car wash:

**With the SmartKey:**

- ▶ Switch on the ignition.
- ▶ Depress the brake pedal and keep it depressed.
- ▶ Shift to neutral **[N]**.
- ▶ Release the brake pedal.
- ▶ Release the electric parking brake.
- ▶ Switch off the ignition and leave the SmartKey in the ignition lock.

**With the Start/Stop button:**

- ▶ Remove the Start/Stop button from the ignition lock.
- ▶ Insert the SmartKey into the ignition lock.
- ▶ Switch on the ignition.
- ▶ Depress the brake pedal and keep it depressed.
- ▶ Shift to neutral **[N]**.
- ▶ Release the brake pedal.
- ▶ Release the electric parking brake.
- ▶ Switch off the ignition and leave the SmartKey in the ignition lock.

**Engaging drive position D**

- ▶ If the transmission is in position **[R]** or **[N]**: push the DIRECT SELECT lever down past the first point of resistance.
- ▶ If the transmission is in position **[P]**: depress the brake pedal and push the DIRECT SELECT lever down past the first point of resistance.

**Transmission position and drive program display**

The current transmission position and drive program appear in the multifunction display.



- ① Transmission position
- ② Gear
- ③ Drive program

The arrows in the transmission position display show how and into which transmission positions you can shift using the DIRECT SELECT lever. If the transmission position display on the multifunction display is not working, you should pull away carefully to check whether the desired transmission position is engaged. Ideally, you should select transmission position **[D]**.

**Transmission positions****[P]****Park position**

Only shift the transmission into position **P** when the vehicle is stationary (▷ page 156). The parking lock should not be used as a brake when parking. Always apply the electronic parking brake in addition to the parking lock in order to secure the vehicle.

If the vehicle electronics are malfunctioning, the transmission may be locked in position **P**. Have the vehicle electronics checked immediately at a qualified specialist workshop.

Park position **P** is automatically engaged if:

- you switch off the engine using the SmartKey and remove the SmartKey
- you switch off the engine using the SmartKey or using the Start/Stop button and open the driver's door or front-passenger door
- the driver's door is opened when the vehicle is stationary or driving at very low speed and the transmission is in position **D** or **R**

**[R]****Reverse gear**

Only shift the transmission into position **R** when the vehicle is stationary.

**N****Neutral**

Do not shift the transmission to **N** while driving. Otherwise, the automatic transmission could be damaged.

No power is transmitted from the engine to the drive wheels.

Releasing the brakes will allow you to move the vehicle freely, e.g. to push it or tow it.

If ESP® is deactivated or faulty: shift the transmission to position **N** if the vehicle is in danger of skidding, e.g. on icy roads.

If you switch the engine off with the transmission in position **R** or **D**, the automatic transmission shifts to **N** automatically.

**!** Coasting in neutral **N** may cause damage to the drive train.

**D****Drive**

The automatic transmission changes gear automatically. All forward gears are available.

**Driving tips****Changing gear**

The automatic transmission shifts through the individual gears automatically when it is in transmission position **D**. This automatic gear shifting behavior is determined by:

- the selected drive program
- the position of the accelerator pedal
- the road speed

**Accelerator pedal position**

Your style of driving influences how the automatic transmission shifts gear:

- little throttle: early upshifts
- more throttle: late upshifts

**Kickdown**

Use kickdown for maximum acceleration.

- ▶ Depress the accelerator pedal beyond the pressure point.  
The automatic transmission shifts to a lower gear depending on the engine speed.
- ▶ Ease off the accelerator pedal once the desired speed is reached.  
The automatic transmission shifts back up.

**Rocking the vehicle free**

Shifting back and forth between transmission positions **D** and **R** can help to free up the vehicle if it gets stuck in mud or snow. The vehicle's engine management system limits the speed to a maximum of 5 mph (9 km/h) when shifting back and forth. To shift repeatedly between transmission positions **D** and **R**, move the DIRECT SELECT lever up and down past the point of resistance.

**Towing a trailer**

- ▶ Drive in the middle of the engine speed range on uphill gradients.
- ▶ Depending on the uphill or downhill gradient, use the left-hand steering wheel paddle shifter (> page 147) to select a lower gear, even if cruise control or Distance Pilot DISTRONIC are activated.

**Drive programs****Slippery drive program**

The **Slippery** drive program has the following characteristics:

- reduced engine and transmission settings for optimum propulsion on slippery or snow-covered roads.
- optimized ESP® stability control on slippery or snow-covered roads.
- the vehicle has improved driving stability on slippery or snow-covered roads, for example.

## Comfort drive program

The **Comfort** drive program has the following characteristics:

- comfort-oriented engine and transmission settings.
- optimal fuel consumption resulting from the automatic transmission shifting up sooner.
- the vehicle pulling away more gently in forward and reverse gears, unless the accelerator pedal is depressed fully.
- the automatic transmission shifting up sooner. This results in the vehicle being driven at lower engine speeds and the wheels being less likely to spin.

## Sport drive program

The **Sport** drive program has the following characteristics:

- sporty engine and transmission settings.
- the automatic transmission shifting up later. the fuel consumption possibly being higher as a result of the later automatic transmission shift points.
- the suspension exhibits sporty damping (vehicles with AIRMATIC).

## Drive program Sport Plus (Mercedes-AMG vehicles)

The **Sport Plus** drive program has the following characteristics:

- the vehicle exhibits particularly sporty driving characteristics.
- the vehicle pulling away in first gear.
- the automatic transmission shifting up later. the fuel consumption possibly being higher as a result of the later automatic transmission shift points.
- the suspension exhibits particularly firm springing and damping settings (vehicles with AIRMATIC).
- the ECO start/stop function is deactivated, it can, however, be activated again using the ECO button (▷ page 140).

## Individual drive program

In the **Individual** drive program, the following properties of the drive program can be selected:

- the drive (engine and transmission management)
- the transmission
- the suspension
- all vehicles (except Mercedes-AMG vehicles): the steering
- all vehicles (except Mercedes-AMG vehicles): availability of the ECO start/stop function

To select the gears in the **Individual** drive program permanently using the steering wheel paddle shifters, select the permanent manual gear-shift program.

Information about configuring the **Individual** drive program with the multimedia system can be found in the Digital Operator's Manual.

## Manual gear shifting

### General notes

You can change gear yourself using the steering wheel paddle shifters. The transmission must be in position **[D]** to do this.

Depending on which steering wheel paddle shifter is pulled, the automatic transmission immediately shifts into the next gear down or up, if permitted.

To use manual shifting, you have two options:

- temporary setting
- permanent setting

If you activate manual gearshifting, the current gear appears in the multifunction display instead of transmission position **[D]**.

If manual gearshifting is deactivated, the gears will be selected automatically.

### Temporary setting



► **To activate:** shift the DIRECT SELECT lever to position **D**.

► Pull steering wheel paddle shifter ① or ②.

The temporary setting is active for a certain amount of time. Under certain conditions, the minimum amount of time is extended, e.g. in the case of lateral acceleration, during overrun mode or when driving on steep terrain.

► **To deactivate:** pull steering wheel paddle shifter ② and hold it in place.

or

► Use the DIRECT SELECT lever to switch the transmission position.

or

► Use the DYNAMIC SELECT controller to change the drive program.

► **To deactivate:** press button ①.

or

► Use the DYNAMIC SELECT controller to change the drive program.

### Permanent setting (Mercedes-AMG vehicles)



► **To activate:** shift the DIRECT SELECT lever to position **D**.

► Press button ①.  
Indicator lamp ② lights up.

► **To deactivate:** press button ①.

or

► Use the DYNAMIC SELECT controller to switch to the **Individual** drive program.  
Indicator lamp ② goes out.

### Permanent setting (all vehicles except Mercedes-AMG vehicles)



► **To activate:** shift the DIRECT SELECT lever to position **D**.

► Press button ①.

### Shifting gears

■ **Mercedes-AMG vehicles:** the automatic transmission does not shift up automatically even when the engine limiting speed for the current gear is reached. When the engine limiting speed is reached, the fuel supply is cut to prevent the engine from overrevving. Always make sure that the engine speed does not reach the red area of the tachometer. There is otherwise a risk of engine damage.



- **To shift up:** pull steering wheel paddle shifter ②.

The automatic transmission shifts up to the next gear.

**All vehicles (except Mercedes-AMG vehicles):** if the maximum engine speed in the gear currently engaged is reached and you continue to accelerate, the automatic transmission automatically shifts up to prevent engine damage.

- **To shift down:** pull steering wheel paddle shifter ①.

The automatic transmission shifts down to the next gear.

Automatic down shifting occurs when coasting.

If the engine were to exceed the maximum engine speed when shifting down, the automatic transmission protects against engine damage by not shifting down.

## Shift recommendation



The gearshift recommendations assist you in adopting an economical driving style. The recommended gear is shown in the multifunction display.

- When the corresponding gearshift recommendation ① appears in the multifunction

display of the instrument cluster, shift to recommended gear ②.

## Upshifting (Mercedes-AMG vehicles)

- ! In manual mode, the automatic transmission does not shift up automatically even when the engine limiting speed for the current gear is reached. When the engine limiting speed is reached, the fuel supply is cut to prevent the engine from overrevving. Always make sure that the engine speed does not reach the red area of the tachometer. There is otherwise a risk of engine damage.



- ① Gear indicator
- ② Upshift indicator

Before the engine speed reaches the red area, an upshift indicator will be shown in the multifunction display.

- When the **UP** message appears in the multifunction display, pull on the right-hand steering wheel paddle shifter.

## Kickdown

**Mercedes-AMG vehicles:** kickdown is only possible in the temporary setting.

- For maximum acceleration, depress the accelerator pedal beyond the pressure point. The automatic transmission shifts to a lower gear depending on the engine speed.
- Shift back up once the desired speed is reached.

During kickdown, you cannot shift gears using the steering wheel paddle shifters.

If you apply full throttle, the automatic transmission shifts up to the next gear when the maximum engine speed is reached. This prevents the engine from overrevving.

## Problems with the transmission

Problem	Possible causes/consequences and ► Solutions
The transmission has problems shifting gear.	The transmission is losing oil. ► Have the transmission checked at a qualified specialist workshop immediately.
<b>7G-TRONIC:</b> The acceleration ability is deteriorating. The transmission no longer changes gear.	The transmission is in emergency mode. It is only possible to shift into <b>second</b> gear and reverse gear. ► Stop the vehicle. ► Shift the transmission to position <b>P</b> . ► Switch off the engine. ► Wait at least ten seconds before restarting the engine. ► Shift the transmission to position <b>D</b> or <b>R</b> . If <b>D</b> is selected, the transmission shifts into <b>second</b> gear; if <b>R</b> is selected, the transmission shifts into reverse gear. ► Have the transmission checked at a qualified specialist workshop immediately.
<b>9G-TRONIC:</b> The acceleration ability is deteriorating. The transmission no longer changes gear.	The transmission is in emergency mode. It is only partly possible to engage the gears or the transmission is in position <b>N</b> . ► Stop the vehicle. ► Shift the transmission to position <b>P</b> . ► Switch off the engine. ► Wait at least ten seconds before restarting the engine. ► Shift the transmission to position <b>D</b> or <b>R</b> . ► Have the transmission checked at a qualified specialist workshop immediately.

## Transfer case

This section is only valid for vehicles with 4-wheel drive (4MATIC). Power is always transmitted to both axles.

! Performance tests may only be carried out on a 2-axle dynamometer. The brake system or transfer case could otherwise be damaged. Contact a qualified specialist workshop for a performance test.

! Because ESP® is an automatic system, the engine and ignition must be switched off (SmartKey in position **0** or **1** or Start/Stop button in position **0** or **1**) when the electric parking brake is being tested on a brake dynamometer (maximum 10 seconds).

Braking triggered automatically by ESP® may seriously damage the brake system.

! Vehicles with 4MATIC must not be towed with either the front or the rear axle raised, as doing so will damage the transmission.

## Refueling

### Important safety notes

#### WARNING

Fuel is highly flammable. If you handle fuel incorrectly, there is a risk of fire and explosion.

You must avoid fire, open flames, creating sparks and smoking. Switch off the engine and, if applicable, the auxiliary heating before refueling.



**⚠ WARNING**

Fuel is poisonous and hazardous to health. There is a risk of injury.

You must make sure that fuel does not come into contact with your skin, eyes or clothing and that it is not swallowed. Do not inhale fuel vapors. Keep fuel away from children.

If you or others come into contact with fuel, observe the following:

- Wash away fuel from skin immediately using soap and water.
- If fuel comes into contact with your eyes, immediately rinse them thoroughly with clean water. Seek medical assistance without delay.
- If fuel is swallowed, seek medical assistance without delay. Do not induce vomiting.
- Immediately change out of clothing which has come into contact with fuel.

**⚠ WARNING**

Electrostatic buildup can create sparks and ignite fuel vapors. There is a risk of fire and explosion.

Always touch the vehicle body before opening the fuel filler flap or touching the fuel pump nozzle. Any existing electrostatic buildup is thereby discharged.

**⚠ WARNING**

Vehicles with a diesel engine:

If you mix diesel fuel with gasoline, the flash point is lower than that of pure diesel fuel. When the engine is running, exhaust system components could overheat without being noticed. There is a risk of fire.

Never refuel with gasoline. Never mix gasoline with diesel fuel.

- !** Do not use gasoline to refuel vehicles with a diesel engine. Do not switch on the ignition if you accidentally refuel with the wrong fuel. Otherwise, the fuel will enter the fuel system. Even small amounts of the wrong fuel could result in damage to the fuel system and the

engine. The repair costs are high. Notify a qualified specialist workshop and have the fuel tank and fuel lines drained completely.

- !** Do not use diesel to refuel vehicles with a gasoline engine. Do not switch on the ignition if you accidentally refuel with the wrong fuel. Otherwise, the fuel will enter the fuel system. Even small amounts of the wrong fuel could result in damage to the fuel system and the engine. Notify a qualified specialist workshop and have the fuel tank and fuel lines drained completely.
- !** Overfilling the fuel tank could damage the fuel system.
- !** Take care not to spill any fuel on painted surfaces. You could otherwise damage the paintwork.
- !** Use a filter when adding fuel from a fuel can. The fuel lines and/or the fuel injection system could otherwise be blocked by particles from the fuel can.

Do not get into the vehicle again during the refueling process. Otherwise, electrostatic charge could build up again.

If you overfill the fuel tank, fuel could spray out when the fuel pump nozzle is removed.

- i** Flexible Fuel vehicles can be recognized by the **Ethanol up to E85** sticker on the inside of the fuel filler flap.

For further information on fuel and fuel quality (> page 384).

**Refueling****General information**

Pay attention to the important safety notes (> page 150).

If you unlock/lock the vehicle from the outside, the fuel filler flap also unlocks/locks.

The position of the fuel filler cap is displayed in the instrument cluster . The arrow next to the filling pump indicates the side of the vehicle.

## Preparing to refuel

- ▶ Switch off the engine.
- ▶ Remove the SmartKey from the ignition lock. or, on vehicles with KEYLESS-GO:
- ▶ Open the driver's door.  
The vehicle electronics now have status **0**. This is the same as the SmartKey having been removed.  
The driver's door can be closed again.

## Opening the fuel filler flap

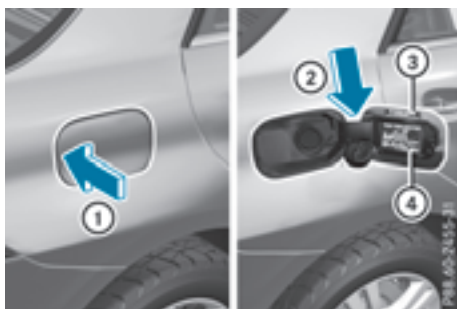

- ① Opens the fuel filler flap
  - ② Insert the fuel filler cap
  - ③ Instruction label for fuel type to be refueled
  - ④ Tire pressure table
- ▶ Press the fuel filler flap in the direction of arrow ①.  
The fuel filler flap swings up.
  - ▶ Turn the fuel filler cap counterclockwise and remove it.
  - ▶ Insert the fuel filler cap into the holder bracket on the inside of the filler flap in the direction of arrow ②.

- ▶ Completely insert the filler neck of the fuel pump nozzle into the tank, hook in place and refuel.
- ▶ Only fill the tank until the pump nozzle switches off.  
Do not add any more fuel after the pump stops filling for the first time. Otherwise, fuel may leak out.

**Vehicles with a diesel engine:** the filler neck is designed for refueling at diesel filling pumps.

## Closing the fuel filler flap

- ▶ Replace the cap on the filler neck and turn clockwise until it engages audibly.
- ▶ Close the fuel filler flap.

Close the fuel filler flap before locking the vehicle.

If you drive at speeds above 1 mph (2 km/h) with the fuel filler flap open, the **Fuel Filler Flap Open** message is shown in the multifunction display.

If you are driving with the fuel filler cap open, the  reserve fuel warning lamp flashes. A message appears in the multifunction display (▷ page 258).

In addition, the  Check Engine warning lamp may light up (▷ page 283).

- i** For further information on warning and indicator lamps in the instrument cluster, see (▷ page 283).

## Problems with fuel and the fuel tank

Problem	Possible causes/consequences and ► Solutions
Fuel is leaking from the vehicle.	<p> <b>WARNING</b></p> <p>The fuel line or the fuel tank is faulty. Risk of explosion or fire.</p> <ul style="list-style-type: none"> <li>► Apply the electric parking brake.</li> <li>► Switch off the engine.</li> <li>► Remove the SmartKey from the ignition lock.</li> </ul> <p>or, in vehicles with KEYLESS-GO start-function or KEYLESS-GO</p> <ul style="list-style-type: none"> <li>► Open the driver's door. The vehicle electronics are now in key position <b>0</b>. This is the same as the SmartKey having been removed.</li> <li>► Do not restart the engine under any circumstances.</li> <li>► Consult a qualified specialist workshop.</li> </ul>
The engine does not start.	<p>The fuel tank of a vehicle with a diesel engine has been run completely dry.</p> <ul style="list-style-type: none"> <li>► Refuel the vehicle with at least 5.3 US qt (5 liters) of diesel.</li> <li>► Turn the ignition on for approximately ten seconds (► page 135).</li> <li>► Start the engine continuously for up to ten seconds until it runs smoothly.</li> </ul> <p>If the engine does not start:</p> <ul style="list-style-type: none"> <li>► Turn the ignition on again for approximately ten seconds (► page 135).</li> <li>► Start the engine again continuously for up to ten seconds until it runs smoothly.</li> </ul> <p>If the engine does not start after three attempts:</p> <ul style="list-style-type: none"> <li>► Consult a qualified specialist workshop.</li> </ul>
The fuel filler flap cannot be opened.	<p>The fuel filler flap is not unlocked.</p> <ul style="list-style-type: none"> <li>► Unlock the vehicle (► page 77).</li> </ul> <p>The SmartKey battery is discharged or nearly discharged.</p> <ul style="list-style-type: none"> <li>► Unlock the vehicle using the mechanical key (► page 79).</li> </ul> <p>The fuel filler flap is unlocked, but the opening mechanism is jammed.</p> <ul style="list-style-type: none"> <li>► Consult a qualified specialist workshop.</li> </ul>

## DEF (BlueTEC vehicles only)

## General notes

To function properly, BlueTEC exhaust gas after-treatment must be operated with the reducing agent DEF. Adding DEF is one of the tasks performed during maintenance.

When the supply of DEF is almost used up, the **Check Additive See Operator's Manual** message is shown in the multifunction display.

If you drive the vehicle faster than 10 mph (16 km/h), the **Check Additive See Operator's Manual** message goes out after approximately one minute.

When the DEF supply drops to a minimum, the **Remaining Starts: 16** message is shown in the multifunction display.

If the **Remaining Starts: 16** message appears in the multifunction display, you can start the engine another 16 times. If DEF is not refilled, you will subsequently be **unable to start the engine**.

- ▶ Add at least 2 gal (7.5 l) of DEF.
- ▶ Switch on the ignition for at least 60 seconds.
- ▶ Start the engine.

**i** Have the DEF tank refilled at a qualified specialist workshop.

Use the special DEF refill bottle when adding DEF between maintenance intervals. You can obtain further information from an authorized Mercedes-Benz Center or, if necessary, contact Roadside Assistance (> page 29).

If the outside temperature is below 12 °F (-11 °C), it may be difficult to top up. If DEF is frozen and there is an active warning indicator, it may not be possible to add DEF. Park the vehicle in a warmer place, e.g. in a garage, until DEF has become fluid again. It will then be possible to add DEF again. Alternatively, have the DEF tank refilled at a qualified specialist workshop.

Further information about BlueTEC exhaust gas aftertreatment and DEF is available at any authorized Mercedes-Benz Center.

### Important safety notes

DEF is a water-soluble fluid for the exhaust gas aftertreatment of diesel engines. It is:

- not poisonous
- colorless and odorless
- not flammable

When you open the DEF container, small amounts of ammonia vapor may be released.

Ammonia vapors have a pungent odor and are particularly irritating to the skin, to mucous membranes and to the eyes. You may experience a burning sensation in your eyes, nose and throat. Coughing and watering of the eyes are possible.

Do not inhale ammonia vapors. Fill the DEF tank only in well-ventilated areas.

DEF must not come into contact with your skin, eyes or clothing and must not be swallowed. Keep DEF away from children.

If you or other persons come into contact with DEF, observe the following:

- Rinse DEF from your skin immediately with soap and water.
- If DEF comes into contact with your eyes, immediately rinse them thoroughly with clean water. Seek medical assistance without delay.
- If DEF has been swallowed, rinse your mouth out immediately. Drink plenty of water. Seek medical assistance without delay.
- Change out of clothing contaminated with DEF immediately.

**!** Only use DEF in accordance with ISO 22241. Do not mix any additives with DEF, and do not dilute DEF with water. This may destroy the BlueTEC exhaust gas aftertreatment system.

**!** The vehicle must be parked on level ground to fill the DEF tank. The DEF tank can only be filled as intended with the vehicle parked on a level surface. This avoids false level readings. Filling the tank is not permitted if the vehicle is not parked on a level surface. There is a danger of overfilling, which could result in damage to components of the BlueTEC exhaust gas aftertreatment.

**!** Immediately rinse off surfaces which come into contact with DEF or remove DEF with a damp cloth and cold water. If DEF has already crystallized, clean using a sponge and cold water. DEF residue crystallizes after a short period and contaminates the affected surfaces. Furthermore, electrical components in the vicinity may be damaged by DEF.

**!** DEF is not a fuel additive and must not be added to the fuel tank. If DEF is added to the fuel tank, this can lead to engine damage.

For further information on DEF, see (> page 386).

## Opening/closing the DEF filler cap

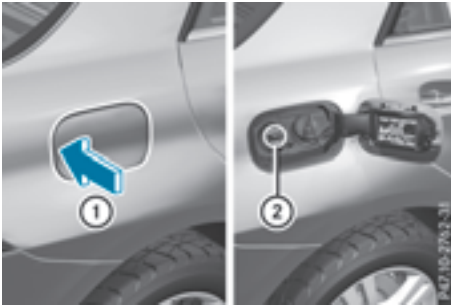

The fuel filler flap is unlocked or locked automatically when you open or close the vehicle with the SmartKey or with KEYLESS-GO.

- ▶ **To open:** switch the ignition off.
- ▶ Press the fuel filler flap in the direction of arrow ①.  
The fuel filler flap swings up.
- ▶ Turn blue DEF fuel filler cap ② counter-clockwise and remove it.  
DEF filler cap ② is secured with a plastic strip.
- ▶ **To close:** place DEF filler cap ② on the filler neck and turn it clockwise.
- ▶ To close the fuel filler flap, press it in the direction of arrow ①.
- ▶ Drive faster than 10 mph (16 km/h).  
The **Check Additive See Operator's Manual** message goes out after approximately one minute.

**i** If the **Check Additive See Operator's Manual** message continues to be shown in the multifunction display, you must add more DEF.

## DEF refill canisters

**!** Do not screw the disposable hose on too tight. The disposable hose could otherwise be damaged and DEF may leak out.

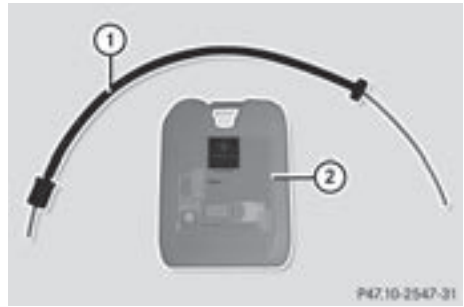

- ▶ Unscrew the cap from the opening on top of DEF refill canister ②.
- ▶ Place disposable hose ① on the opening of DEF refill canister ② and screw it on clockwise until hand-tight.  
Disposable hose ① remains closed until you fasten disposable hose ① to the DEF filler neck of the vehicle.



- ▶ Place disposable hose ① on the filler neck on the vehicle and screw it on clockwise until hand-tight. When you feel resistance, disposable hose ① is sufficiently secured.
- ▶ Lift up and tip DEF refill canister ②.  
Filling stops when the DEF tank is completely filled. Do not fill the DEF tank any further. DEF refill canister ② can be removed when it has been only partially emptied.
- ▶ Turn disposable hose ① on the filler neck of the vehicle counter-clockwise and remove it.
- ▶ Turn disposable hose ① on the opening of DEF refill canister ② counter-clockwise and remove it.
- ▶ Reseal DEF refill canister ② with the cap.

DEF refill canisters are available at many gas stations or at a qualified specialist workshop. DEF refill canisters are often sold with a filler hose. A filler hose that does not exactly fill the vehicle's DEF tank offers no protection against

overfilling. DEF may leak if overfilled. Mercedes-Benz offers a special disposable hose with overflow protection. You can obtain this from any authorized Mercedes-Benz Center. DEF is available in a variety of containers and receptacles. Only use the disposable hose with the Mercedes-Benz DEF refill canisters.

### DEF refill bottle

**!** Only screw on the DEF refill bottle hand-tight. Otherwise, the thread of the DEF refill bottle could be damaged and DEF could leak out.



- ▶ Unscrew the protective cap from DEF refill bottle ①.
- ▶ Place DEF refill bottle ① on the filler neck as shown and screw it on clockwise until hand-tight.
- ▶ Press DEF refill bottle ① towards the filler neck.  
The DEF tank is filled. This may take up to one minute.
- i** When DEF refill bottle ① is no longer pressed, filling stops and the bottle may be taken off again after being only partially emptied.
- ▶ Release DEF refill bottle ①.
- ▶ Turn DEF refill bottle ① counter-clockwise and remove it.
- ▶ Screw the protective cap onto DEF refill bottle ① again.

DEF refill bottles are available at many gas stations or at a qualified specialist workshop. Refill bottles without a threaded cap do not provide overflow protection. DEF may leak if overfilled. Mercedes-Benz offers special refill bottles with a threaded seal. These are available at any authorized Mercedes-Benz Center.

## Parking

### Important safety notes

#### **⚠ WARNING**

Flammable material such as leaves, grass or twigs may ignite if they come into contact with hot parts of the exhaust system or exhaust gas flow. There is a risk of fire.

Park the vehicle so that no flammable materials come into contact with parts of the vehicle which are hot. Take particular care not to park on dry grassland or harvested grain fields.

#### **⚠ WARNING**

If you leave children unsupervised in the vehicle, they could set it in motion by, for example:

- release the parking brake.
- shift the automatic transmission out of the parking position **P**.
- start the engine.

In addition, they may operate vehicle equipment and become trapped. There is a risk of an accident and injury.

When leaving the vehicle, always take the SmartKey with you and lock the vehicle. Never leave children unsupervised in the vehicle.

**!** Always secure the vehicle correctly against rolling away. Otherwise, the vehicle or its drivetrain could be damaged.

To ensure that the vehicle is secured against rolling away unintentionally:

- the electric parking brake must be applied
- the transmission must be in position **[P]** and the SmartKey must be removed from the ignition lock
- the front wheels must be turned towards the curb on steep uphill or downhill gradients
- the empty vehicle must be secured at the front axle with a wheel chock or similar, for example, on uphill or downhill gradients
- a laden vehicle must also be secured at the rear axle with a wheel chock or similar, for example, on uphill or downhill gradients

## Switching off the engine

### WARNING

The automatic transmission switches to neutral position **N** when you switch off the engine. The vehicle may roll away. There is a risk of an accident.

After switching off the engine, always switch to parking position **P**. Prevent the parked vehicle from rolling away by applying the parking brake.

- ▶ Apply the electric parking brake.
- ▶ Shift the transmission to position **P**.
- ▶ **With the SmartKey:** turn the SmartKey to position **O** in the ignition lock and remove it. The immobilizer is activated.
- ▶ **With KEYLESS-GO:**  
Press the Start/Stop button (▷ page 135)  
The engine stops and all the indicator lamps in the instrument cluster go out.

If you switch the engine off with the transmission in position **R** or **D**, the automatic transmission shifts to **N** automatically.

If you then open the driver's or front-passenger door, the automatic transmission shifts to **P** automatically.

If you want the automatic transmission to remain in neutral **N**, e.g. when having the vehicle cleaned in an automatic, tow-through car wash:

- ▶ **Vehicles with a SmartKey:** switch on the ignition.
- ▶ **Vehicles with KEYLESS-GO:** remove the Start/Stop button from the ignition lock.
- ▶ Insert the SmartKey into the ignition lock.
- ▶ Switch on the ignition.
- ▶ **All vehicles:** depress the brake pedal and keep it depressed.
- ▶ Engage neutral **N**.
- ▶ Release the brake pedal.
- ▶ Release the electric parking brake.
- ▶ Switch off the ignition and leave the SmartKey in the ignition lock.

 The engine can be switched off in an emergency while the vehicle is in motion by pressing and holding the Start/Stop button for three seconds.

## Electric parking brake

### General notes

### WARNING

If you leave children unsupervised in the vehicle, they could set it in motion by, for example:

- release the parking brake.
- shift the automatic transmission out of the parking position **P**.
- start the engine.

In addition, they may operate vehicle equipment and become trapped. There is a risk of an accident and injury.

When leaving the vehicle, always take the SmartKey with you and lock the vehicle. Never leave children unsupervised in the vehicle.

The function of the electric parking brake is dependent on the on-board voltage. If the on-board voltage is low or there is a malfunction in the system, it may not be possible to apply the released parking brake.

- ▶ If this is the case, only park the vehicle on level ground and secure it to prevent it rolling away.
- ▶ Shift the automatic transmission to position **P**.

It may not be possible to release an applied parking brake if the on-board voltage is low or there is a malfunction in the system. Contact a qualified specialist workshop.

 The electric parking brake performs a function test at regular intervals while the engine is switched off. The sounds that can be heard while this is occurring are normal.

## Applying or releasing manually



### ▶ To engage: push handle ①.

When the electric parking brake is engaged, the **PARK** (USA only) or **(P)** (Canada only) red indicator lamp lights up in the instrument cluster.

**i** The electric parking brake can also be applied when the SmartKey is removed.

### ▶ To release: pull handle ①.

The red **PARK** (USA only) or **(P)** (Canada only) indicator lamp in the instrument cluster goes out.

**i** The electric parking brake can only be released:

- when the SmartKey is in position **1** in the ignition lock (▷ page 135) or
- if the ignition was switched on using the Start/Stop button

To ensure that you do not roll backwards when pulling away on an uphill slope, engage the electric parking brake (▷ page 138).

## Applying automatically

The electric parking brake is automatically applied when the transmission is in position **P** and

- the engine is switched off or
- the driver is not wearing a seat belt and the driver's door is opened

To prevent the electric parking brake from being automatically applied, pull handle ①.

The electric parking brake is also engaged automatically if:

- Distance Pilot DISTRONIC brings the vehicle to a standstill or
- the HOLD function is keeping the vehicle stationary
- Parking Pilot is keeping the vehicle stationary

In addition, at least one of the following conditions must be fulfilled:

- the engine is switched off
- the driver is not wearing a seat belt and the driver's door is opened
- there is a system malfunction
- the power supply is insufficient
- the vehicle is stationary for a lengthy period

The red **PARK** (USA only) or **(P)** (Canada only) indicator lamp in the instrument cluster lights up.

The electric parking brake is not automatically engaged if the engine is switched off by the ECO start/stop function.

## Releasing automatically

The electric parking brake is released automatically when all of the following conditions are fulfilled:

- The engine is running.
- The seat belt tongue is engaged in the belt buckle.
- The transmission is in position **D** or **R** and you depress the accelerator pedal or, on a level surface, shift from transmission position **P** to **D** or **R**.
- If the transmission is in position **R**, the trunk lid must be closed.

If the seat belt tongue is not engaged in the seat belt buckle, the following conditions must be fulfilled:

- The driver's door is closed.
- You are shifting from transmission position **P** or have previously driven at speeds greater than 2 mph (3 km/h).
- If the transmission is in position **R**, the trunk lid must be closed.

When the electric parking brake is released, the **(P)** indicator lamp goes out in the instrument cluster.



## Emergency braking



The vehicle can also be braked during an emergency by using the electric parking brake.

- ▶ While driving, push handle ① of the electric parking brake.  
The vehicle is braked for as long as the handle of the electric parking brake is pressed. The longer the electric parking brake handle is depressed, the greater the braking force.

During braking:

- a warning tone sounds
- the **Release Park. Brake** message appears
- the red **PARK** (USA only) or **(P)** (Canada only) indicator lamp in the instrument cluster flashes

When the vehicle has been braked to a standstill, the electric parking brake is engaged.

## Parking the vehicle for a long period

If you leave the vehicle parked for longer than four weeks, the battery may be damaged by exhaustive discharging.

If you leave the vehicle parked for longer than six weeks, the vehicle may suffer damage as a result of lack of use.

- ▶ Visit a qualified specialist workshop and seek advice.

**i** You can obtain information about trickle chargers from a qualified specialist workshop.

**Plug-in hybrid vehicles:** observe the notes on the high-voltage battery in the separate Operator's Manual.

## Driving tips

### General notes

### Important safety notes

#### **⚠ WARNING**

If you switch off the ignition while driving, safety-relevant functions are only available with limitations, or not at all. This could affect, for example, the power steering and the brake boosting effect. You will require considerably more effort to steer and brake. There is a risk of an accident.

Do not switch off the ignition while driving.

#### **⚠ WARNING**

If you operate mobile communication equipment when driving, you may be distracted from the traffic situation. You could also lose control of the vehicle. There is a risk of an accident.

Only operate this equipment when the vehicle is stationary.

Observe the legal requirements for the country in which you are driving. Some jurisdictions prohibit the driver from using a mobile phone while driving a vehicle.

If you make a call while driving, always use hands-free mode. Only operate the telephone when the traffic situation permits. If you are unsure, pull over to a safe location and stop before operating the telephone.

Bear in mind that at a speed of only 30 mph (approximately 50 km/h), the vehicle covers a distance of 44 ft (approximately 14 m) per second.

### Drive sensibly – save fuel

Observe the following tips to save fuel:

- ▶ The tires should always be inflated to the recommended tire pressure.
- ▶ Remove unnecessary loads.
- ▶ Remove roof carriers when they are not needed.
- ▶ Warm up the engine at low engine speeds.

- ▶ Avoid frequent acceleration or braking.
- ▶ Have all service and maintenance work carried out at the specified intervals.

Fuel consumption also increases when driving in cold weather, in stop-start traffic and in hilly terrain.

## Drinking and driving

### WARNING

Drinking and driving and/or taking drugs and driving are very dangerous combinations. Even a small amount of alcohol or drugs can affect your reflexes, perceptions and judgment.

The possibility of a serious or even fatal accident is greatly increased when you drink or take drugs and drive.

Do not drink or take drugs and drive or allow anyone to drive who has been drinking or taking drugs.

## Emission control

### WARNING

Combustion engines emit poisonous exhaust gases such as carbon monoxide. Inhaling these exhaust gases leads to poisoning. There is a risk of fatal injury. Therefore never leave the engine running in enclosed spaces without sufficient ventilation.

Certain engine systems are designed to keep the level of poisonous components in exhaust fumes within legal limits.

These systems only work at peak efficiency if they are serviced exactly in accordance with the manufacturer's specifications. Always have work on the engine carried out at a qualified specialist workshop. Mercedes-Benz recommends that you use an authorized Mercedes-Benz Center for this purpose. In particular, work relevant to safety or on safety-related systems must be carried out at a qualified specialist workshop.

The engine settings must not be changed under any circumstances. Furthermore, all specific service work must be carried out at regular intervals and in accordance with the Mercedes-Benz service requirements.

You can obtain current information concerning the servicing of your vehicle at any time from a qualified specialist workshop. This could be an overview of the maintenance work or any additional maintenance work, for example.

## ECO display

The ECO display shows you how economical your driving style is. The ECO display assists you in achieving the most economical driving style for the selected settings and prevailing conditions. Your driving style can significantly influence the vehicle's consumption.



- ① Acceleration
- ② Coasting
- ③ Constant
- ④ Additional range achieved

Range ④ is shown under **Bonus fr. Start** and represents the additional range achieved since the beginning of the journey as a result of an adapted driving style.

If the fuel level has dropped into the reserve range, the **Reserve Fuel** message is shown in the multifunction display instead of range ④. The  warning lamp in the instrument cluster also lights up (▷ page 283).

The ECO display consists of three sections, with an inner and outer area. The sections correspond to the following three categories:

①	<p><b>Acceleration</b> (evaluation of all acceleration processes):</p> <ul style="list-style-type: none"> <li>the outer area fills up and the inner area lights up green: moderate acceleration, especially at higher speeds</li> <li>the outer area empties and the inner area is gray: sporty acceleration</li> </ul>
②	<p><b>Coasting</b> (evaluation of all deceleration processes):</p> <ul style="list-style-type: none"> <li>the outer area fills up and the inner area lights up green: anticipatory driving, keeping your distance and early release of the accelerator. The vehicle can coast without use of the brakes.</li> <li>the outer area empties and the inner area is gray: frequent heavy braking</li> </ul>
③	<p><b>Constant</b> (continuous evaluation over the entire journey):</p> <ul style="list-style-type: none"> <li>the outer area fills up and the inner area lights up green: constant speed and avoidance of unnecessary acceleration and deceleration</li> <li>the outer area empties and the inner area is gray: fluctuations in speed</li> </ul>

The three inner areas display the current driving style and light up green as a result of a particularly economical driving style. Depending on the driving situation, up to two areas may light up simultaneously.

At the beginning of the journey, the three outer areas are empty and fill up as a result of economical driving. A higher level indicates a more economical driving style. If the three outer areas are completely filled at the same time, the driver has adopted the most economical driving style for the selected settings and prevailing conditions. The ECO display border lights up.

The ECO display does not indicate the actual fuel consumption. The additionally achieved range displayed under **Bonus fr. Start** does not indicate a fixed consumption reduction.

In addition to driving style, the actual consumption is affected by other factors, such as:

- load
- tire pressure
- cold start
- choice of route
- electrical consumers switched on

These factors are not included in the ECO display.

An economical driving style specially requires driving at moderate engine speeds.

Achieving a higher value in the categories "Acceleration" and "Constant":

- observe the gearshift recommendations.
- drive the vehicle in the **Comfort** drive program.

On long journeys at a constant speed, e.g. on the highway, only the outer area for "constant" will change.

The ECO display summarizes the driving style from the start of the journey to its completion. Therefore, there are more marked changes in the outer areas at the start of a journey. On longer journeys, there are fewer changes. For more marked changes, perform a manual rest (> page 232).

For further information on the ECO display, see (> page 232).

## Braking

### Important safety notes

#### WARNING

If you shift down on a slippery road surface in an attempt to increase the engine's braking effect, the drive wheels could lose their grip. There is an increased danger of skidding and accidents.

Do not shift down for additional engine braking on a slippery road surface.

### Downhill gradients

-  On long and steep gradients, you must reduce the load on the brakes by shifting to a lower gear in good time. This allows you to take advantage of the engine's braking effect.

This helps you to avoid overheating the brakes and wearing them out excessively.

When you take advantage of engine braking, a drive wheel may not turn for some time, e.g. on a slippery road surface. This could cause damage to the drive train. This type of damage is not covered by the Mercedes-Benz warranty.

Do not depress the brake pedal continuously while the vehicle is in motion, e.g. causing the brakes to rub by constantly applying light pressure to the pedal. This results in excessive and premature wear to the brake pads.

Use the left-hand steering wheel paddle shifter to shift into a lower gear in good time on long and steep downhill gradients. This is especially important if the vehicle is laden.

This also applies if you have activated cruise control, the speed limiter or Distance Pilot DISTRONIC.

This will use the braking effect of the engine, so that less braking will be required to maintain the speed. This relieves the load on the brake system and prevents the brakes from overheating and wearing too quickly.

### Heavy and light loads

#### WARNING

If you rest your foot on the brake pedal while driving, the braking system can overheat. This increases the stopping distance and can even cause the braking system to fail. There is a risk of an accident.

Never use the brake pedal as a footrest. Never depress the brake pedal and the accelerator pedal at the same time.

-  Depressing the brake pedal constantly results in excessive and premature wear to the brake pads.

If the brakes have been subjected to a heavy load, do not stop the vehicle immediately. Drive on for a short while. This allows the airflow to cool the brakes more quickly.

### Wet roads

If you have driven for a long time in heavy rain without braking, there may be a delayed reaction from the brakes when braking for the first

time. This may also occur after the vehicle has been washed or driven through deep water.

You then have to depress the brake pedal more firmly. Maintain a greater distance from the vehicle in front.

After driving on a wet road or having the vehicle washed, brake firmly while paying attention to the traffic conditions. This will warm up the brake discs, thereby drying them more quickly and protecting them against corrosion.

### Limited braking performance on salt-treated roads

If you drive on salted roads, a layer of salt residue may form on the brake discs and brake pads. This can result in a significantly longer braking distance.

- Brake occasionally to remove any possible salt residue. Make sure that you do not endanger other road users when doing so.
- Carefully depress the brake pedal at the beginning and end of a journey.
- Maintain a greater distance to the vehicle ahead.

### Servicing the brakes

-  The brake fluid level may be too low, if:
  - if the red brake warning lamp lights up in the instrument cluster and
  - you hear a warning tone while the engine is running

Observe additional warning messages in the multifunction display.

The brake fluid level may be too low due to brake pad wear or leaking brake lines.

Have the brake system checked immediately. Consult a qualified specialist workshop to arrange this.

-  A function or performance test should only be carried out on a 2-axle dynamometer. If you wish to operate the vehicle on such a dynamometer, please consult a qualified specialist workshop in advance. You could otherwise damage the drive train or the brake system.

-  Because ESP® is an automatic system, the engine and ignition must be switched off (SmartKey in position **0** or **1** or Start/Stop button in position **0** or **1**) when the electric

parking brake is being tested on a brake dynamometer (maximum 10 seconds).

Braking triggered automatically by ESP® may seriously damage the brake system.

All checks and maintenance work on the brake system must be carried out at a qualified specialist workshop.

Have brake pads installed and brake fluid replaced at a qualified specialist workshop.

If the brake system has only been subject to moderate loads, you should test the functionality of your brakes at regular intervals. To do so, depress the brake pedal firmly when driving at a high speed. This improves the grip of the brake pads.

You can find a description of Brake Assist (BAS) on (▷ page 67) or of BAS PLUS on (▷ page 72). Mercedes-Benz recommends that you only have brake pads/linings installed on your vehicle which have been approved for Mercedes-Benz vehicles or which correspond to an equivalent quality standard. Brake pads/linings which have not been approved for Mercedes-Benz vehicles or which are not of an equivalent quality could affect your vehicle's operating safety.

Mercedes-Benz recommends that you only use brake fluid that has been specially approved for your vehicle by Mercedes-Benz, or which corresponds to an equivalent quality standard. Brake fluid which has not been approved for Mercedes-Benz vehicles or which is not of an equivalent quality could affect your vehicle's operating safety.

### High-performance brake system (Mercedes-AMG vehicles)

The high-performance brake system is designed for heavy loads. This may lead to noise when braking. This will depend on:

- Speed
- Braking force
- Environmental conditions, such as temperature and humidity

The wear of individual components of the brake system, such as the brake pads/linings or brake discs, depends on the individual driving style and operating conditions.

For this reason, it is impossible to state a mileage that will be valid under all circumstances. An aggressive driving style will lead to high wear.

You can obtain further information about this from your authorized Mercedes-Benz Center.

New and replaced brake pads and discs only reach their optimum braking effect after several hundred kilometers of driving. Compensate for this by applying greater force to the brake pedal. Keep this in mind, and adapt your driving and braking accordingly during this break-in period.

Excessive heavy braking results in correspondingly high brake wear. Observe the  brake wear warning lamp in the instrument cluster and note any brake status messages in the multi-function display. Especially for high performance driving, it is important to maintain and have the brake system checked regularly.

### Driving on wet roads

#### Hydroplaning

If water has accumulated to a certain depth on the road surface, there is a danger of hydroplaning occurring, even if:

- you drive at low speeds.
- the tires have adequate tread depth.

For this reason, in the event of heavy rain or in conditions in which hydroplaning may occur, you must drive in the following manner:

- lower your speed.
- avoid ruts.
- avoid sudden steering movements.
- brake carefully.

#### Driving on flooded roads

**!** Do not drive through flooded areas. Check the depth of any water before driving through it. Drive slowly through standing water. Otherwise, water may enter the vehicle interior or the engine compartment. This can damage the electronic components in the engine or the automatic transmission. Water can also be drawn in by the engine's air suction nozzles and this can cause engine damage.

**i** **Vehicles with the AIRMATIC package:** select the raised vehicle level before driving through a body of water.

## Off-road fording

**!** Under no circumstances should you accelerate before entering the water. The bow wave could cause water to enter and damage the engine and other assemblies.

**!** Do not open any of the vehicle's doors while fording. Otherwise, water could get into the vehicle interior and damage the vehicle's electronics and interior equipment.

- Establish how deep the water is and the characteristics of the body of water before fording.
- Select the highest possible vehicle level.
- Shift to a lower gear using the left-hand steering wheel paddle shifter.
- Avoid high engine speeds.
- Enter and exit the water at a flat place and at a steady walking pace.
- Drive slowly and at an even speed through the water.
- Ensure that a bow wave does not form as you drive.
- Do not stop and do not switch off the engine. Water offers a high degree of resistance, and the ground is slippery and in some cases unstable. Therefore, it is difficult and dangerous to pull away in the water.
- Clean any mud from the tire tread after fording.
- Apply the brakes to dry them after fording.

Always observe the fording depth values (▷ page 392).

## Winter driving

### WARNING

If you shift down on a slippery road surface in an attempt to increase the engine's braking effect, the drive wheels could lose their grip. There is an increased danger of skidding and accidents.

Do not shift down for additional engine braking on a slippery road surface.

### DANGER

If the exhaust pipe is blocked or adequate ventilation is not possible, poisonous gases

such as carbon monoxide (CO) may enter the vehicle. This is the case, e.g. if the vehicle becomes trapped in snow. There is a risk of fatal injury.

If you leave the engine or the auxiliary heating running, make sure the exhaust pipe and area around the vehicle are clear of snow. To ensure an adequate supply of fresh air, open a window on the side of the vehicle that is not facing into the wind.

**!** When scraping ice off the rear window, take care not to damage the rear-window seal or trim.

Have your vehicle winter-proofed at a qualified specialist workshop at the onset of winter.

Drive particularly carefully on slippery road surfaces. Avoid sudden acceleration, steering and braking maneuvers. Do not use cruise control or Distance Pilot DISTRONIC.

If the vehicle threatens to skid or cannot be stopped when moving at low speed:

- ▶ Shift the transmission to position **N**.
- ▶ Try to bring the vehicle under control using corrective steering.

When driving in snow with or without snow chains, select driving program **Slippery** (▷ page 142).

**i Vehicles with a diesel engine:** do not cover the radiator, e.g. with a protective cover. The measuring function of the on-board diagnosis system may otherwise provide inaccurate values. Some of these values are required by law and must therefore always be accurate.

The outside temperature indicator is not designed to serve as an ice-warning device and is therefore unsuitable for that purpose. Changes in the outside temperature are displayed after a short delay.

Indicated temperatures just above the freezing point do not guarantee that the road surface is free of ice. The road may still be icy, especially in wooded areas or on bridges. You should pay special attention to road conditions when temperatures are around the freezing point.

For more information on driving with snow chains, see (▷ page 353).

For more information on driving with summer tires, see (▷ page 353).

Observe the notes in the "Changing a wheel" section (▷ page 371).

## Off-road driving

### Important safety notes

#### WARNING

If you drive on a steep incline at an angle or turn when driving on an incline, the vehicle could slip sideways, tip and rollover. There is a risk of an accident.

Always drive on a steep incline in the line of fall (straight up or down) and do not turn the vehicle.

#### WARNING

Flammable material such as leaves, grass or twigs may ignite if they come into contact with hot parts of the exhaust system. There is a risk of fire.

When driving off road or on unpaved roads, check the vehicle's underside regularly. In particular, remove parts of plants or other flammable materials which have become trapped. In the case of damage, contact a qualified specialist workshop.

#### WARNING

If the vehicle level is high, the vehicle center of gravity is raised. This could cause the vehicle to tip over more easily on uphill or downhill gradients. There is a risk of an accident.

Select the lowest possible vehicle level.

**!** There is a risk of damage to the vehicle if:

- the vehicle becomes stuck, e.g. on a high curb or an unpaved road
- you drive too fast over an obstacle, e.g. a curb, a speed bump or a pothole in the road
- a heavy object strikes the underbody or parts of the chassis

In situations like this, the body, the underbody, chassis parts, wheels or tires could be damaged without the damage being visible.

Components damaged in this way can unexpectedly fail or, in the case of an accident, no longer withstand the loads they are designed to.

If the underbody paneling is damaged, combustible materials such as leaves, grass or twigs can gather between the underbody and the underbody paneling. If these materials come in contact with hot parts of the exhaust system, they can catch fire.

In such situations, have the vehicle checked and repaired immediately at a qualified specialist workshop. If on continuing your journey you notice that driving safety is impaired, pull over and stop the vehicle immediately, paying attention to road and traffic conditions. In such cases, consult a qualified specialist workshop.

When driving off-road, substances such as sand, mud and water or water mixed with oil may get into the brakes. This could result in a reduced braking effect or in total brake failure and also in increased wear and tear. The braking characteristics change depending on the material entering the brakes. Clean the brakes after driving off-road. If you detect a reduced braking effect or grinding noises, have the brake system checked in a qualified specialist workshop as soon as possible. Adapt your driving style to the different braking characteristics.

Driving off-road increases the likelihood of damage to the vehicle, which, in turn, can lead to failure of the mechanical assembly or systems. Adapt your driving style to suit the terrain conditions. Drive carefully. Have damage to the vehicle rectified immediately at a qualified specialist workshop.

Do not switch to transmission position **N** when driving off-road. If you try to brake the vehicle using the service brake, you could lose control of the vehicle. If the gradient is too steep for your vehicle, drive back down in reverse gear.

### General notes

#### Environmental note

Protection of the environment is of primary importance. Treat nature with respect. Observe all prohibiting signs.

Read this section carefully before driving your vehicle off-road. Practice by driving over more gentle off-road terrain first.

Familiarize yourself with the characteristics of your vehicle and the gear shift operation before driving through difficult terrain.

The following driving systems are specially adapted to off-road driving:

- the **Off-road** drive program (vehicles without Off-Road Engineering package) (▷ page 214)
- **Off-road** and **Off-road Plus** drive programs (vehicles with Off-Road Engineering package) (▷ page 215)
- **LOW RANGE** off-road gear (vehicles with the Off-Road Engineering package) (▷ page 216)
- **Differential lock** (vehicles with the Off-Road Engineering package) (▷ page 216)
- **Off-road ABS** (▷ page 67)
- **Off-road 4ETS** (▷ page 70)
- **Off-road ESP®** (▷ page 72)
- **AIRMATIC** package (vehicle level) (▷ page 183)
- **DSR (Downhill Speed Regulation)** (▷ page 213)

Observe the following notes:

- Stop the vehicle before starting to drive along an off-road route. If necessary, select the off-road program (▷ page 215) or shift to the **LOW RANGE** off-road gear (▷ page 216).
- Select a vehicle level that is suitable for the terrain. To avoid damaging the vehicle, make sure there is always sufficient ground clearance.
- Check that items of cargo and loads are stowed safely and are well secured (▷ page 299).
- Always keep the engine running and in gear when driving on a downhill gradient. Activate **DSR** (▷ page 213).
- Always keep the engine running and in gear when driving down an incline.
- Adapt your speed to the terrain. The rougher, steeper or more ruts on the terrain, the slower your speed should be.
- Do not jump with the vehicle as this will interrupt the vehicle's propulsion.
- Drive with extreme care on unfamiliar off-road routes where visibility is poor. For safety reasons, get out of the vehicle first and survey the off-road route.

- Look out for obstacles, such as rocks, holes, tree stumps and furrows.
- Take care when turning on an uphill or downhill slope or when driving across a slope. The vehicle could otherwise tip over.
- Always keep the doors, the tailgate, the side windows and the sliding sunroof closed while the vehicle is in motion.
- Do not shift the automatic transmission to position **N**.
- Observe the notes on off-road fording (▷ page 164).

**i** Information about retrofitting special all-terrain tires is available from any qualified specialist workshop.

**i** Do not use the **HOLD** function when driving off-road, on steep uphill or downhill gradients or on slippery or loose surfaces. The **HOLD** function cannot hold the vehicle on such surfaces.

### Checklist before driving off-road

**!** If the engine oil warning lamp lights up while the vehicle is in motion, stop the vehicle in a safe place as soon as possible. Check the engine oil level. The engine oil warning lamp warning must not be ignored. Continuing the journey while the symbol is displayed could lead to engine damage.

► **Engine oil level:** check the engine oil level and add oil if necessary.

When driving on steep gradients, the engine oil level must be sufficiently high to ensure a correct oil supply in the vehicle.

► **DEF tank (BlueTEC vehicles):** check the level and add if necessary (▷ page 153).

► **Tire-changing tool kit:** check that the jack is working and make sure you have the lug wrench, a robust tow cable and a folding spade in the vehicle.

► **Wheels and tires:** check the tread depth and pressure of the tires.

► Check for damage and remove any foreign objects, e.g. small stones, from the wheels/tires.

► Replace any missing valve caps.

► Replace dented or damaged wheels.

► **Rims:** dented or bent rims can result in a loss of tire pressure and damage the tire bead.



Before driving off-road, check the wheels and replace them if necessary.

### Checklist after driving off-road

**!** If you detect damage to the vehicle after driving off-road, have the vehicle checked immediately at a qualified specialist workshop.

Driving over rough terrain places greater demands on your vehicle than driving on normal roads. After driving off-road, check the vehicle. This allows you to detect damage promptly and reduce the risk of an accident to yourself and other road users.

- ▶ If the **Offroad** or **Offroad Plus** drive program is selected: select the **Individual**, **Sport**, **Comfort** or **Slippery** drive program (▷ page 142).
- ▶ Deactivate the LOW RANGE off-road gear (▷ page 216).
- ▶ Deactivate DSR (▷ page 213).
- ▶ Lower the vehicle level again to a level suitable to the road conditions, e.g. to the normal level.
- ▶ Clean the headlamps and rear lights and check for damage.
- ▶ Clean the front and rear license plates.
- ▶ Clean the wheels and tires with a water jet and remove any foreign objects.
- ▶ Clean the wheels, wheel housings and the vehicle underside with a water jet; check for any foreign objects and damage.
- ▶ Check whether twigs or other parts of plants have become trapped. These increase the risk of fire and can damage fuel pipes, brake hoses or the rubber bellows of the axle joints and propeller shafts.
- ▶ After the trip, examine without fail the entire undercarriage, wheels, tires, brakes, bodywork structure, steering, chassis and exhaust system for damage.
- ▶ After driving for extended periods across sand, mud, gravel, water or in similarly dirty conditions, have the brake discs, wheels, brake pads/linings and axle joints checked and cleaned.
- ▶ If you detect strong vibrations after off-road travel, check for foreign objects in the wheels and drive train and remove them if necessary. Foreign objects can disturb the balance and cause vibrations.

### Driving on sand

Observe the following rules when driving on sand:

- Select the **Offroad** drive program (vehicles with Off-Road Engineering package) (▷ page 215).
- Select the **Offroad** drive program (vehicles without Off-Road Engineering package) (▷ page 214).
- Select a higher vehicle level.
- Avoid high engine speeds.
- Use the left-hand steering wheel paddle shifter to shift to a lower gear appropriate to the terrain.
- Drive quickly to overcome the rolling resistance. Otherwise the vehicle's wheels could become stuck in loose ground.
- Drive in the tracks of other vehicles if possible. Make sure that:
  - the tire ruts are not too deep.
  - the sand is sufficiently firm.
  - the ground clearance of the vehicle is sufficient.

### Tire ruts and gravel roads

**!** Check that the ruts are not too deep and that your vehicle has sufficient clearance. Otherwise, your vehicle could be damaged or bottom out and get stuck.

Observe the following rules when driving along ruts in off-road terrain or on roads with loose gravel:

- Select the **Offroad** drive program (vehicles with Off-Road Engineering package) (▷ page 215).
- Select the **Offroad** drive program (vehicles without Off-Road Engineering package) (▷ page 214).
- Select a higher vehicle level.
- Avoid high engine speeds.
- Shift to a lower gear using the left-hand steering wheel paddle shifter.
- Drive slowly.
- Where ruts are too deep, drive with the wheels of one side on the center grassy area, if possible.

## Driving over obstacles

**!** Obstacles could damage the floor of the vehicle or components of the chassis. Ask passengers for guidance when driving over large obstacles. The passenger should always keep a safe distance from the vehicle when doing so in order to avoid injury as a result of unexpected vehicle movements. After driving off-road or over obstacles, check the vehicle for possible damage, especially to the underbody and the components of the chassis.



Observe the following rules when driving over tree stumps, large stones and other obstacles:

- Select the **Offroad** drive program (vehicles with Off-Road Engineering package) (▷ page 215).
- Select the **Offroad** drive program (vehicles without Off-Road Engineering package) (▷ page 214).
- Select **LOW RANGE** offroad gear (vehicles with Off-Road Engineering package) (▷ page 216)
- Raise the vehicle level.
- Avoid high engine speeds.
- Shift to a lower gear using the left-hand steering wheel paddle shifter.
- Drive very slowly.
- Drive straight over the center of obstacles.

## Traveling uphill

### Approach/departure angle

#### **WARNING**

If you drive on a steep incline at an angle or turn when driving on an incline, the vehicle

could slip sideways, tip and rollover. There is a risk of an accident.

Always drive on a steep incline in the line of fall (straight up or down) and do not turn the vehicle.

- Observe the rules on off-road driving.
- Do not drive at an angle on slopes, inclines or gradients, but instead follow the direct line of fall.
- When driving down an incline, make use of the engine's braking effect. Observe the engine speed; do not overrev the engine.
- Select the **Offroad** drive program (vehicles with Off-Road Engineering package) (▷ page 215).
- Select the **Offroad** drive program (vehicles without Off-Road Engineering package) (▷ page 214).
- Before driving on extreme uphill and downhill gradients, select the **LOW RANGE** offroad gear (vehicles with Off-Road Engineering package) (▷ page 216).
- Drive slowly.
- Avoid high engine speeds. Drive at appropriate engine speeds (maximum 3,000 rpm).
- Use the left-hand steering wheel paddle shifter to shift into a lower gear in good time on long and steep downhill gradients.
- Check the brakes after prolonged off-road driving.

Hill start assist will aid you when pulling away on a hill. For further information about hill start assist, see (▷ page 139).

Do not switch to transmission position **N** when driving off-road. If you try to brake the vehicle using the service brake, you could lose control of the vehicle. If the gradient is too steep for your vehicle, drive back down in reverse gear.

Always observe the approach/departure angle values (▷ page 393).

## Maximum gradient-climbing capability

Always observe the maximum gradient climbing ability values (▷ page 393).

## Hilltops

When driving up an uphill gradient, slightly reduce pressure on the accelerator immediately before reaching the brow of the hill. Make use of the vehicle's own impetus to travel over the brow.

This style of driving prevents:

- the vehicle from lifting off the ground on the brow of a hill
- the vehicle from traveling too quickly down the other side

## Driving downhill

- Drive slowly.
- Do not drive at an angle down steep inclines. Steer into the line of fall and drive with the front wheels aligned straight. Otherwise, the vehicle could slip sideways, tip and rollover.
- Shift to a lower gear using the left-hand paddle shifter before tackling steep downhill gradients.
- Activate DSR. If this is not sufficient, brake gently. When doing so, make sure that the vehicle is facing in the direction of the line of fall.
- Check that the brakes are working normally after a long downhill stretch.

**i** The special off-road ABS setting enables a precise, brief and repeated locking of the front wheels. This causes them to dig into loose earth. Be aware that the front wheels easily skid across the ground surface if completely braked and therefore lose their ability to steer.

## Driving systems

### Intelligent Drive

Mercedes-Benz Intelligent Drive stands for innovative driver assistance and safety systems which enhance comfort and support the driver in critical situations. With these intelligent co-ordinated systems Mercedes-Benz has set a milestone on the path towards autonomous driving. Mercedes-Benz Intelligent Drive embraces all elements of active and passive safety in one well thought out system – for the safety of the vehicle occupants and that of other road users.

Further information on driving safety systems (> page 66).

### Cruise control

#### General notes

Cruise control maintains a constant road speed for you. It brakes automatically in order to avoid exceeding the set speed. You must select a lower gear in good time on long and steep downhill gradients, especially if the vehicle is laden or towing a trailer. By doing so, you will make use of the braking effect of the engine. This relieves the load on the brake system and prevents the brakes from overheating and wearing too quickly.

Use cruise control only if road and traffic conditions make it appropriate to maintain a steady speed for a prolonged period. You can store any road speed above 20 mph (30 km/h).

**i** Cruise control should not be activated when driving off-road.

#### Important safety notes

If you fail to adapt your driving style, cruise control can neither reduce the risk of an accident nor override the laws of physics. Cruise control cannot take into account the road, traffic and weather conditions. Cruise control is only an aid. You are responsible for the distance to the vehicle in front, for vehicle speed, for braking in good time and for staying in your lane.

Do not use cruise control:

- in road and traffic conditions which do not allow you to maintain a constant speed, e.g. in heavy traffic or on winding roads
- on slippery road surfaces. Braking or accelerating could cause the drive wheels to lose traction and the vehicle could then skid
- when there is poor visibility, e.g. due to fog, heavy rain or snow

If there is a change of drivers, advise the new driver of the speed stored.

## Cruise control lever

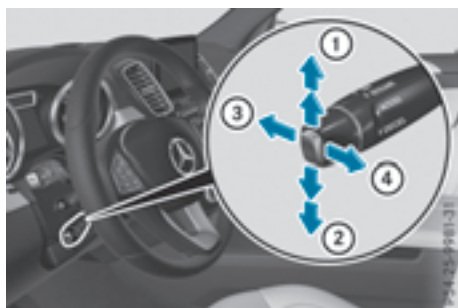

- ① Activates or increases speed
- ② Activates or reduces speed
- ③ Deactivates cruise control
- ④ Activates at the current speed/last stored speed

When you activate cruise control, the stored speed is shown in the multifunction display for five seconds.

### Activation conditions

To activate cruise control, all of the following activation conditions must be fulfilled:

- the electric parking brake must be released.
- you are driving faster than 20 mph (30 km/h).
- ESP® must be active, but not intervening.
- the transmission must be in position **D**.
- DSR must be deactivated.
- the Offroad Plus drive program must be deactivated (vehicles with the Off-Road Engineering package).

### Storing, maintaining and calling up a speed

#### Storing and maintaining a speed

- ▶ Accelerate the vehicle to the desired speed.
- ▶ Briefly press the cruise control lever up ① or down ④.
- ▶ Remove your foot from the accelerator pedal. Cruise control is activated. The vehicle automatically maintains the stored speed.

**i** Cruise control may be unable to maintain the stored speed on uphill gradients. The stored speed is resumed when the gradient evens out. Cruise control maintains the

stored speed on downhill gradients by automatically applying the brakes.

### Storing or calling up a speed

#### **⚠ WARNING**

If you call up the stored speed and it differs from the current speed, the vehicle accelerates or decelerates. If you do not know the stored speed, the vehicle could accelerate or brake unexpectedly. There is a risk of an accident.

Pay attention to the road and traffic conditions before calling up the stored speed. If you do not know the stored speed, store the desired speed again.

- ▶ Briefly pull the cruise control lever towards you ③.
- ▶ Remove your foot from the accelerator pedal. Cruise control is operational and when first activated stores the current speed or regulates the speed of the vehicle to the stored speed.

### Setting a speed

Keep in mind that it may take a brief moment until the vehicle has accelerated or braked to the speed set.

- ▶ Press the cruise control lever up ① for a higher speed or down ② for a lower speed.
- ▶ **To adjust the set speed in 1 mph increments (1 km/h increments):** briefly press the cruise control lever up ① or down ② to the pressure point. Every time the cruise control lever is pressed up ① or down ② the last speed stored is increased or reduced.
- ▶ **To adjust the set speed in 5 mph increments (10 km/h increments):** briefly press the cruise control lever up ① or down ② beyond the pressure point. Every time the cruise control lever is pressed up ① or down ② the last speed stored is increased or reduced.

**i** Cruise control is not deactivated if you depress the accelerator pedal. For example, if you accelerate briefly to overtake, cruise control adjusts the vehicle's speed to the last speed stored after you have finished overtaking.

## Deactivating cruise control

There are several ways to deactivate cruise control:

► Briefly press the cruise control lever forwards ①.

or

► Brake.

Cruise control is automatically deactivated if:

- you engage the electric parking brake
- you are driving at less than 20 mph (30 km/h)
- ESP® intervenes or you deactivate ESP®
- you activate DSR
- you activate the Offroad Plus program (vehicles with the Off-Road Engineering package)
- you shift the transmission to position **N** while driving

If cruise control is deactivated, you will hear a warning tone. You will see the **Cruise Control Off** message in the multifunction display for approximately five seconds.

**i** When you switch off the engine, the last speed stored is cleared.

## Distance Pilot DISTRONIC

### General notes

Distance Pilot DISTRONIC regulates the speed and automatically helps you maintain the distance to the vehicle detected in front. Vehicles are detected with the aid of the radar sensor system. Distance Pilot DISTRONIC brakes automatically so that the set speed is not exceeded.

You must select a lower gear in good time on long and steep downhill gradients, especially if the vehicle is laden or towing a trailer. By doing so, you will make use of the braking effect of the engine. This relieves the load on the brake system and prevents the brakes from overheating and wearing too quickly.

If Distance Pilot DISTRONIC detects that there is a risk of a collision, you will be warned visually and acoustically. Without your intervention, Distance Pilot DISTRONIC cannot prevent a collision. An intermittent warning tone will then sound and the distance warning lamp will light up in the instrument cluster. Brake immediately in order to increase the distance to the vehicle in

front or take evasive action provided it is safe to do so.

For Distance Pilot DISTRONIC to assist you when driving, the radar sensor system must be operational.

Distance Pilot DISTRONIC operates in the range between 0 mph (0 km/h) and 120 mph (200 km/h).

Do not use Distance Pilot DISTRONIC while driving on roads with steep gradients.

Since Distance Pilot DISTRONIC transmits radar waves, it can resemble the radar detectors of the responsible authorities. You can refer to the relevant chapter in the Operator's Manual if questions are asked about this.

**i** USA only:

This device has been approved by the FCC as a "Vehicular Radar System". The radar sensor is intended for use in an automotive radar system only. Removing, tampering with, or altering the device will void any warranties, and is not permitted by the FCC. Do not tamper with, alter, or use in any non-approved way.

Any unauthorized modification to this device could void the user's authority to operate the equipment.

**i** Canada only: This device complies with RSS-210 of Industry Canada. Operation is subject to the following two conditions:

1. This device may not cause harmful interference, and
2. This device must accept any interference received, including interference that may cause undesired operation of the device.

Do not tamper with, alter or use in any non-approved way.

Any unauthorized modification to this device could void the user's authority to operate the equipment.

### Important safety notes

#### WARNING

Distance Pilot DISTRONIC does not react to:

- people or animals
- stationary objects on the road, e.g. stopped or parked vehicles
- oncoming vehicles and crossing traffic

As a result, Distance Pilot DISTRONIC may neither give warnings nor intervene in such situations. There is a risk of an accident.

Always pay careful attention to the traffic situation and be ready to brake.

### WARNING

Distance Pilot DISTRONIC cannot always clearly identify other road users and complex traffic situations.

In such cases, Distance Pilot DISTRONIC may:

- give an unnecessary warning and then brake the vehicle
- neither give a warning nor intervene
- accelerate or brake unexpectedly

There is a risk of an accident.

Continue to drive carefully and be ready to brake, especially if Distance Pilot DISTRONIC warns you.

### WARNING

Distance Pilot DISTRONIC brakes your vehicle with up to 50% of the maximum possible deceleration. If this deceleration is not sufficient, Distance Pilot DISTRONIC alerts you with a visual and acoustic warning. There is a risk of an accident.

Apply the brakes yourself in these situations and try to take evasive action.

**!** When Distance Pilot DISTRONIC or the HOLD function is activated, the vehicle brakes automatically in certain situations.

To avoid damage to the vehicle, deactivate DISTRONIC PLUS and the HOLD function in the following or similar situations:

- when towing the vehicle
- in the car wash

The Distance Pilot DISTRONIC

- can neither reduce the risk of accident nor override the laws of physics if you fail to adapt your driving style.
- cannot take into account road, weather or traffic conditions.
- is only an aid. You are responsible for the distance to the vehicle in front, for vehicle speed,

for braking in good time and for staying in your lane.

Do not use Distance Pilot DISTRONIC:

- in road and traffic conditions which do not allow you to maintain a constant speed, e.g. in heavy traffic or on winding roads
- on slippery road surfaces. Braking or accelerating could cause the drive wheels to lose traction and the vehicle could then skid
- in poor visibility, e.g. due to fog, heavy rain or snow

Distance Pilot DISTRONIC may not detect narrow vehicles driving in front, e.g. motorcycles, or vehicles driving on a different line.

In particular, the detection of obstacles can be impaired if:

- there is dirt on the sensors or anything else covering the sensors
- there is snow or heavy rain
- there is interference by other radar sources
- there are strong radar reflections, for example, in parking garages

If Distance Pilot DISTRONIC no longer detects a vehicle in front, it may unexpectedly accelerate to the speed stored.

This speed may:

- be too high if you are driving in a turning lane or an exit lane
- be so high when driving in the right-hand lane that you overtake vehicles in the left-hand lane
- be so high when driving in the left-hand lane that you overtake vehicles in the right-hand lane

If there is a change of drivers, advise the new driver of the speed stored.

## Cruise control lever

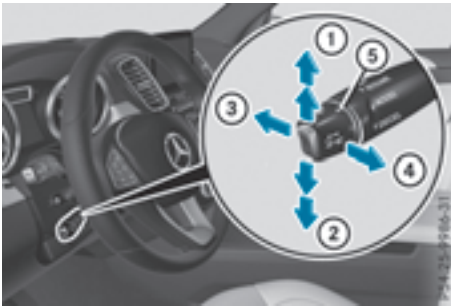

- ① Activates or increases speed
- ② Activates or reduces speed
- ③ Deactivates Distance Pilot DISTRONIC
- ④ Activates at the current speed/last stored speed
- ⑤ Sets a specified minimum distance

## Activating Distance Pilot DISTRONIC

### Activation conditions

To activate Distance Pilot DISTRONIC, the following conditions must be fulfilled:

- the engine must be started. It may take up to two minutes of driving before Distance Pilot DISTRONIC is ready for use.
- the electric parking brake must be released.
- ESP® must be active, but not intervening.
- the transmission must be in position **D**.
- the driver's door must be closed when you shift from **P** to **D** or your seat belt must be fastened.
- the front-passenger door and rear doors must be closed.
- the Offroad Plus drive program must be deactivated (vehicles with the Off-Road Engineering package).
- DSR must be deactivated.
- the vehicle must not skid.

### Activating

- ▶ Briefly pull the cruise control lever towards you ③, up ① or down ④. Distance Pilot DISTRONIC is activated.
- ▶ Remove your foot from the accelerator pedal. Your vehicle adapts its speed to that of the vehicle in front, but only up to the desired stored speed.

- ❗ If you do not fully release the accelerator pedal, the **Distance Pilot Passive** message appears in the multifunction display. The set distance to a slower-moving vehicle in front will then not be maintained. You will be driving at the speed you determine by the position of the accelerator pedal.

You can also activate Distance Pilot DISTRONIC when stationary. The lowest speed that can be set is 20 mph (30 km/h).

- ▶ Briefly pull the cruise control lever towards you ③, up ① or down ④. Distance Pilot DISTRONIC is activated.

## Activating at the current speed/last stored speed

### ⚠ WARNING

If you call up the stored speed and it differs from the current speed, the vehicle accelerates or decelerates. If you do not know the stored speed, the vehicle could accelerate or brake unexpectedly. There is a risk of an accident.

Pay attention to the road and traffic conditions before calling up the stored speed. If you do not know the stored speed, store the desired speed again.

- ▶ Briefly pull the cruise control lever towards you ③.
- ▶ Remove your foot from the accelerator pedal. The first time Distance Pilot DISTRONIC is activated, it stores the current speed or regulates the speed of the vehicle to the stored speed.

## Driving with Distance Pilot DISTRONIC

### Pulling away and driving

- ▶ **If you want to pull away with Distance Pilot DISTRONIC:** remove your foot from the brake pedal.
  - ▶ Briefly pull the cruise control lever towards you ④.
- or
- ▶ Accelerate briefly. Your vehicle pulls away and adapts its speed to that of the vehicle in front. If no vehicle is detected in front, your vehicle accelerates to the set speed.

The vehicle can also pull away when it is facing an unidentified obstacle or is driving on a different line from another vehicle. The vehicle then brakes automatically.

If there is no vehicle in front, Distance Pilot DISTRONIC operates in the same way as cruise control.

If Distance Pilot DISTRONIC detects a slower-moving vehicle in front, it brakes your vehicle. In this way, the distance you have selected is maintained.

If Distance Pilot DISTRONIC detects a faster-moving vehicle in front, it increases the driving speed. However, the vehicle is only accelerated up to the speed you have stored.

### Selecting the drive program

Distance Pilot DISTRONIC supports a sporty driving style if you have selected the **Sport** or **Sport Plus** drive program (▷ page 146). Acceleration behind the vehicle in front or to the set speed is then noticeably more dynamic. If you have selected the **Comfort** drive program, the vehicle accelerates more gently. This setting is recommended in stop-and-start traffic.

### Changing lanes

If you change to the overtaking lane, Distance Pilot DISTRONIC supports you if:

- you are driving faster than 45 mph (70 km/h)
- you switch on the appropriate turn signal
- Distance Pilot DISTRONIC does not currently detect a danger of collision

If these conditions are fulfilled, your vehicle is accelerated. Acceleration will be interrupted if changing lanes takes too long or if the distance between your vehicle and the vehicle in front becomes too small.

- ❗ When you change lanes, Distance Pilot DISTRONIC monitors the right lane (in left-side traffic) or the left lane (in right-side traffic).

### Stopping

#### WARNING

If you leave the vehicle when it is only being braked by Distance Pilot DISTRONIC, it could roll away if:

- there is a malfunction in the system or in the voltage supply.
- Distance Pilot DISTRONIC is switched off using the cruise control lever, e.g. by a vehicle occupant or from outside the vehicle
- the electrical system in the engine compartment, the battery or the fuses are tampered with.
- the battery is disconnected
- the vehicle is accelerated, e.g. by a vehicle occupant.

There is a risk of an accident.

Before leaving the vehicle, always deactivate Distance Pilot DISTRONIC and secure the vehicle against rolling away.

If Distance Pilot DISTRONIC detects that the vehicle in front is stopping, it brakes your vehicle to a stop.

Once your vehicle is stationary, it remains stationary and you do not need to depress the brake.

After a time, the electric parking brake secures the vehicle and relieves the service brake.

Depending on the specified minimum distance, your vehicle will come to a standstill at a sufficient distance behind the vehicle in front. The specified minimum distance is set using the control on the cruise control lever.

The transmission is shifted automatically to position P if, with Distance Pilot DISTRONIC activated and the vehicle stationary:

- the driver's door is open and the driver's seat belt is unfastened.
- the engine is switched off, unless it is automatically switched off by the ECO start/stop function.

The electric parking brake secures the vehicle automatically if, with Distance Pilot DISTRONIC activated and the vehicle stationary:

- a system malfunction occurs.
- the power supply is not sufficient.



On steep uphill or downhill inclines or if there is a malfunction, the transmission may also be automatically shifted into position **P**.

### Setting a speed

Keep in mind that it may take a brief moment until the vehicle has accelerated or braked to the speed set.

- ▶ Press the cruise control lever up ① for a higher speed or down ⑤ for a lower speed
- ▶ **To adjust the set speed in 1 mph increments (1 km/h increments):** briefly press the cruise control lever up ① or down ② to the pressure point.  
Every time the cruise control lever is pressed up ① or down ② the last speed stored is increased or reduced.
- ▶ **To adjust the set speed in 5 mph increments (10 km/h increments):** briefly press the cruise control lever up ① or down ② beyond the pressure point.  
Every time the cruise control lever is pressed up ① or down ②, the last speed stored is increased or reduced.

- ① If you accelerate to overtake, Distance Pilot DISTRONIC adjusts the vehicle's speed to the last speed stored after you have finished overtaking.

### Setting a specified minimum distance

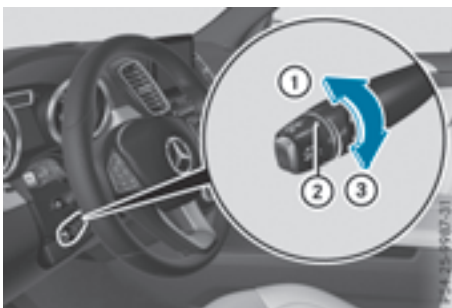

You can set the specified minimum distance for Distance Pilot DISTRONIC by varying the time span between one and two seconds. With this function you can set the minimum distance that Distance Pilot DISTRONIC maintains to the vehicle in front, dependent on vehicle speed. You can see this distance in the multifunction display (▷ page 176).

- ▶ **To increase:** turn control ② in direction ③.  
Distance Pilot DISTRONIC then maintains a greater distance between your vehicle and the vehicle in front.
- ▶ **To decrease:** turn control ② in direction ①.  
Distance Pilot DISTRONIC then maintains a shorter distance between your vehicle and the vehicle in front.

- ① Make sure that you maintain a sufficiently safe distance from the vehicle in front. Adjust the distance to the vehicle in front if necessary.

### Deactivating Distance Pilot DISTRONIC

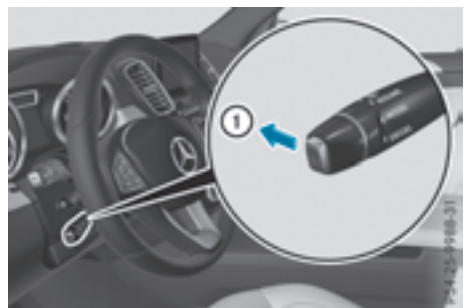

There are several ways to deactivate Distance Pilot DISTRONIC:

- ▶ Briefly press the cruise control lever forwards ①.

or

- ▶ Brake, unless the vehicle is stationary

When you deactivate Distance Pilot DISTRONIC, the **Distance Pilot Off** message appears in the multifunction display for approximately five seconds.

- ① The last speed stored remains stored until you switch off the engine.
- ① Distance Pilot DISTRONIC is not deactivated if you depress the accelerator pedal. If you accelerate to overtake, Distance Pilot DISTRONIC adjusts the vehicle's speed to the last speed stored after you have finished overtaking.

Distance Pilot DISTRONIC is automatically deactivated if:

- you engage the electric parking brake or if the vehicle is automatically secured with the electric parking brake
- ESP® intervenes or you deactivate ESP®
- the transmission is in the **P**, **R** or **N** position
- you pull the cruise control lever towards you in order to pull away and the front-passenger door or one of the rear doors is open
- you activate Parking Pilot
- the vehicle is skidding

A warning tone sounds. The **Distance Pilot Off** message will appear in the multifunction display for approximately five seconds.

Distance Pilot DISTRONIC is automatically deactivated if:

- you activate DSR
- you activate the OFFROAD Program+ (vehicles with the Off-Road Engineering package)

The  DSR symbol appears in the multifunction display.

## Displays in the instrument cluster

### Displays in the speedometer



Example: Distance Pilot DISTRONIC displays in the speedometer

When Distance Pilot DISTRONIC is activated, one or two segments ② in the stored speed range light up.

If Distance Pilot DISTRONIC detects a vehicle in front, segments ② between speed of the vehicle in front ③ and stored speed ① light up.

**i** For design reasons, the speed displayed in the speedometer may differ slightly from the speed stored for Distance Pilot DISTRONIC.

### Display in the assistance graphic when Distance Pilot DISTRONIC is deactivated



- ① Vehicle in front, if detected
- ② Distance indicator, current distance to the vehicle in front
- ③ Specified minimum distance to the vehicle in front; adjustable
- ④ Own vehicle

► Select the **Assistance Graphic** function using the on-board computer (> page 236).

### Display in the assistance graphic when Distance Pilot DISTRONIC is activated



- ① Vehicle in front, if detected
- ② Specified minimum distance to the vehicle in front; adjustable
- ③ Own vehicle
- ④ Distance Pilot DISTRONIC activated

► Select the **Assistance Graphic** function using the on-board computer (> page 236).

You will see the stored speed for approximately five seconds when you activate Distance Pilot DISTRONIC.

## Tips for driving with Distance Pilot DISTRONIC

### General notes

Pay particular attention in the following traffic situations:

- Cornering, entering and exiting a bend: the ability of Distance Pilot DISTRONIC to detect vehicles during cornering is limited. Your vehicle may brake unexpectedly or late.
- Driving on a different line: Distance Pilot DISTRONIC may not detect vehicles which are not driving in the middle of their lane. The distance to the vehicle in front will be too short.
- Other vehicles changing lanes: Distance Pilot DISTRONIC has not detected the vehicle cutting in yet. The distance to this vehicle will be too short.
- Narrow vehicles: Distance Pilot DISTRONIC has not yet detected the vehicle in front on the edge of the road because of its narrow width. The distance to the vehicle in front will be too short.
- Obstacles and stationary vehicles: Distance Pilot DISTRONIC does not brake for obstacles or stationary vehicles. If, for example, the detected vehicle turns a corner and an obstacle or stationary vehicle is then revealed, Distance Pilot DISTRONIC will not brake for them.
- Crossing traffic: Distance Pilot DISTRONIC may mistakenly detect vehicles that are crossing your lane. Activating Distance Pilot DISTRONIC at, for example, a traffic light with crossing traffic, could cause your vehicle to pull away at the wrong time.

In such situations, brake if necessary. Distance Pilot DISTRONIC will then be deactivated.

## Distance Pilot DISTRONIC with Steering Pilot

### General notes

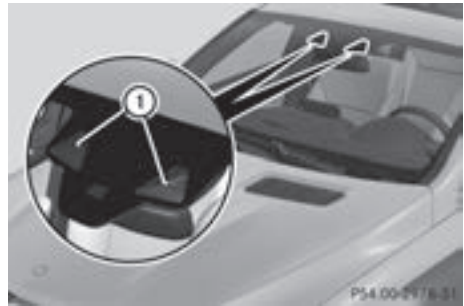

Distance Pilot DISTRONIC with Steering Pilot aids you in keeping the vehicle in the center of the driving lane by means of moderate steering interventions in a speed range from 0 - 125 mph (0 - 200 km/h).

It monitors the area in front of your vehicle by means of camera system ① at the top of the windshield.

In a speed range from 0 - 37 mph (0 - 60 km/h), the extended automatic Re-start in traffic jams focuses on the vehicle in front, taking into account lane markings, e.g. when following vehicles in a traffic jam.

At speeds of more than 37 mph (60 km/h), Steering Pilot focuses on clear lane markings (left and right), only focusing on the vehicle in front if clear lane markings are not present.

If these conditions are not present, Steering Pilot cannot provide assistance.

Distance Pilot DISTRONIC must be active in order for the function to be available.

### Important safety notes

If you fail to adapt your driving style, Distance Pilot DISTRONIC and Steering Pilot can neither reduce the risk of an accident nor override the laws of physics. It cannot take into account road, weather or traffic conditions. Distance Pilot DISTRONIC with Steering Pilot is only an aid. You are responsible for the distance to the vehicle in front, for vehicle speed, for braking in good time and for staying in your lane.

Distance Pilot DISTRONIC with Steering Pilot does not detect road and traffic conditions and does not detect all road users. If you are following a vehicle which is driving towards the edge of the road, your vehicle could come into contact

with the curb or other road boundaries. Be particularly aware of other road users, e.g. cyclists, that are directly next to your vehicle.

Obstacles such as traffic pylons on the lane or projecting out into the lane are not detected.

An inappropriate steering intervention, e.g. after intentionally driving over a lane marking, can be corrected at any time if you steer slightly in the opposite direction.

Distance Pilot DISTRONIC with Steering Pilot cannot continuously keep your vehicle in lane. In some cases, the steering intervention is not sufficient to bring the vehicle back to the lane. In such cases, you must steer the vehicle yourself to ensure that it does not leave the lane.

The support provided by the system can be impaired if:

- there is poor visibility, e.g. due to insufficient illumination of the road, or due to snow, rain, fog or heavy spray
- there is glare, e.g. from oncoming traffic, the sun or reflections (e.g. when the road surface is wet)
- the windshield is dirty, fogged up, damaged or covered, for instance by a sticker, in the vicinity of the camera
- there are no or several unclear lane markings for one lane, e.g. roadworks
- the lane markings are worn away, dark or covered up, e.g. by dirt or snow
- the distance to the vehicle in front is too short and thus the lane markings cannot be detected
- the lane markings change quickly, e.g. lanes branch off, cross one another or merge
- the road is narrow and winding
- there are strong shadows cast on the road

The system is switched to passive and no longer assists you by performing steering interventions if:

- you actively change lane
- you switch on the turn signal
- take your hands off the steering wheel or do not steer for a prolonged period of time

**i** After you have finished changing lanes, Steering Pilot is automatically active once more.

Steering Pilot cannot provide assistance:

- on very sharp corners
- when towing a trailer
- when a loss of tire pressure or a defective tire has been detected and displayed

Observe the important safety notes on Distance Pilot DISTRONIC (> page 171).

The steering interventions are carried out with a limited steering moment. The system requires the driver to keep his hands on the steering wheel and to steer himself.

If you do not steer yourself or if you take your hands off the steering wheel for a prolonged period of time, the system will first alert you with a visual warning. A steering wheel symbol appears in the multifunction display. If you have still not started to steer and have not taken hold of the steering wheel after five seconds at the latest, a warning tone also sounds to remind you to take control of the vehicle. Steering Pilot is then switched to passive. Distance Pilot DISTRONIC remains active.

### Activating Steering Pilot

- ▶ Activate Distance Pilot DISTRONIC with Steering Pilot using the on-board computer (> page 236).

The **Steering Pilot On** message appears on the multifunction display. Steering Pilot is activated.

### Information in the multifunction display



If Steering Pilot is activated but not ready for a steering intervention, steering wheel symbol ① appears in gray. If the system provides you with support by means of steering interventions, symbol ① is shown in green.

### Deactivating Steering Pilot

- ▶ Deactivate Distance Pilot DISTRONIC with Steering Pilot using the on-board computer (> page 236).

The **Steering Pilot Off** message appears on the multifunction display. Steering pilot is deactivated.

When Distance Pilot DISTRONIC is deactivated or not available, Steering Pilot is deactivated automatically.

### Level control (vehicles with the Off-road Engineering package)

#### Important safety notes

Level control adapts the vehicle level automatically to the current operating and driving situation. This results in reduced fuel consumption and improved handling.

Make changes to the vehicle level while the vehicle is in motion. This enables the vehicle to adjust to the new level as quickly as possible.

The vehicle level may change visibly if you park the vehicle and the outside temperature changes. If the temperature drops, the vehicle level is lower; with an increase in temperature, the vehicle level rises.

If you unlock the vehicle or open a door, the vehicle begins to compensate for load discrepancies while still parked. However, for significant level changes, such as after the vehicle has been stationary for a long period, the engine must be on. For safety reasons, the vehicle is only lowered when the doors are closed. Lowering is interrupted if a door is opened, and it continues once the door has been closed.

Further information about "Driving off-road" (▷ page 165).

#### WARNING

When the vehicle is being lowered, people could become trapped if their limbs are between the vehicle body and the wheels or underneath the vehicle. There is a risk of injury.

Make sure no one is underneath the vehicle or in the immediate vicinity of the wheel arches when the vehicle is being lowered.

#### WARNING

When you drive with the vehicle raised, the driving characteristics could be impaired by the vehicle's raised center of gravity. The vehicle could rollover more easily, for example on a bend. There is a risk of an accident.

Always select as low a vehicle level as possible and adjust your driving style.

#### WARNING

When you drive with the chassis lowered or raised, the vehicle's braking and driving characteristics can be significantly impaired. You could also exceed the permissible vehicle height if the chassis is raised. There is a risk of an accident.

Adjust the vehicle level before pulling away.

#### WARNING

Due to the high center of gravity, the vehicle may start to skid and roll over in the event of an abrupt steering maneuver and/or when the vehicle's speed is not adapted to the road conditions. There is a risk of an accident.

Always adapt your speed and driving style to the vehicle's driving characteristics and to the prevailing road and weather conditions.

**!** When driving on extremely rough terrain, select a high vehicle level in good time. Make sure there is always sufficient ground clearance. You will otherwise damage the vehicle.

- Utility vehicles have a significantly higher roll-over rate than other types of vehicles. Failure to operate this vehicle safely may result in an accident, rollover of the vehicle, and severe or fatal injury.
- In a rollover crash, an unbelted person is significantly more likely to die than a person wearing a seat belt. You and all vehicle occupants should always wear your seat belts.

### Basic settings

The extent to which the vehicle is raised or lowered depends on the basic setting selected.

Select:

- the **Comfort** or **Sport** drive program for driving on normal roads
- the **Offroad** drive program for driving on easily negotiable off-road terrain
- the **Offroad Plus** drive program for off-road driving

- offroad level 1 for driving on easily negotiable off-road terrain
- offroad level 2 for driving on normal off-road terrain
- offroad level 3 for freeing the vehicle in particularly rough terrain at low speeds only

The individual vehicle levels differ from the normal level as follows:

- -0.6 in (-15 mm) in the **Sport** drive program
- +/-0 in (+/-0 mm) in the **Comfort** drive program
- + 1.2 in (+ 30 mm) in the **Offroad** drive program
- + 2.4 in (+ 60 mm) in the **Offroad Plus** drive program
- + 1.2 in (+ 30 mm) in offroad level 1
- + 2.4 in (+ 60 mm) in offroad level 2
- + 3.5 in (+ 90 mm) in offroad level 3

### Setting the vehicle level

- !** Make sure that there is enough ground clearance when the vehicle is being lowered. It could otherwise hit the ground, damaging the underbody.



Set the vehicle level using the selector wheel.

- ▶ Start the engine.
- ▶ Press selector wheel ①. Selector wheel ① extends.
- ▶ To raise the vehicle: turn selector wheel ① clockwise ②. The vehicle is raised.
- ▶ To lower the vehicle: turn selector wheel ① counter-clockwise ④. The vehicle is lowered.

During the adjustment, the **Lowering** or **Vehicle Rising** message appears in the multifunction display.

If you press the or button on the multifunction steering wheel, the message will disappear. Once normal level has been reached, all indicator lamps ③ go out.

The vehicle automatically selects normal level if you:

- drive at speeds above 70 mph (112 km/h) or
- drive at speeds between 65 mph (105 km/h) and 70 mph (112 km/h) for approximately 20 seconds

The vehicle is lowered to low level if you are traveling at higher speeds.

### Normal level



Setting the vehicle to normal level:

- ▶ Start the engine.
- ▶ Press selector wheel ①. Selector wheel ① extends.
- ▶ To lower the vehicle: turn selector wheel ① counter-clockwise ④. The vehicle is lowered.

If one or more indicator lamps ③ are on:

- ▶ Turn selector wheel ① counter-clockwise ④ until all indicator lamps ③ that are lit start to flash. The vehicle is lowered to normal level. As soon as the next lowest level is reached, the indicator lamp stops flashing and goes out.

### Offroad levels

#### General notes

Only select an offroad level when this is appropriate for road conditions. Otherwise, fuel consumption increases and handling may be affected.

You can select from the following:

- Offroad level 1 at speeds up to 60 mph (96 km/h)
- Offroad level 2 at speeds up to 40 mph (64 km/h)
- Offroad level 3 at speeds up to 12 mph (20 km/h)

If you select an offroad level when driving at too high a speed, the **Drive More Slowly** message appears in the multifunction display.

Offroad level 3 is only suitable for driving on extremely difficult off-road terrain under particularly rough conditions.

- Adjust your driving style to the altered handling characteristics.
- Do not drive at speeds above 12 mph (20 km/h).



Indicator lamps ③ for the desired offroad level flash:

- the lower indicator lamp flashes, offroad level 1 is selected
- the lower and center indicator lamps flash, offroad level 2 is selected
- all three indicator lamps flash, offroad level 3 is selected

The vehicle adjusts to the offroad level selected. As soon as an offroad level is reached, the corresponding indicator lamp stops flashing and lights up constantly.

### Raising the vehicle

Set the vehicle level using the selector wheel.

- ▶ To raise the vehicle: turn selector wheel ① clockwise ②.

The vehicle is raised to offroad level 1 by 1.2 in (30 mm) compared to the normal level.

During the adjustment, the **Vehicle rising** message, for example, appears in the multifunction display.

If you press the  or **OK** button on the multifunction steering wheel, the message will disappear.

- ❗ Up to offroad level 2, you can hide the messages using the  or **OK** button on the multifunction steering wheel.

While the adjustment from offroad level 2 to offroad level 3 is taking place, you will see a message such as the following in the multifunction display: **Vehicle rising Max. speed 12 mph (20 km/h)**.

The **Max. speed 12 mph (20 km/h)** message draws your attention to the maximum speed permitted for offroad level 3.

If you drive above 12 mph (20 km/h) at offroad level 3, you will see the following message shown in red in the multifunction display: **Lowering Max. speed 12 mph (20 km/h)**.

- ❗ You cannot clear these messages.

You also hear a warning. The vehicle is lowered and offroad level 3 is canceled.

If you continue to increase your speed, the red message continues to be shown in the multifunction display. The newly set level is not displayed until the vehicle has been set to a level suitable for the current speed.

### Lowering the vehicle

If you drive faster than 12 mph (20 km/h) while the vehicle level is being lowered, you will see the following message shown in white in the multifunction display: **Lowering Max. speed 20 km/h**.

The vehicle is lowered to offroad level 2.

You will see a message in the multifunction display, for example: **Lowering**.

Offroad level 2 is canceled and the vehicle is lowered to offroad level 1 if you:

- drive at speeds above 50 mph (80 km/h) or
- drive at speeds between 40 mph (64 km/h) and 50 mph (80 km/h) for longer than 20 seconds

Offroad level 1 is canceled. Depending on the vehicle's speed and the selected drive program, the vehicle is automatically lowered to normal level or low level if you:

- drive at speeds above 70 mph (112 km/h) or
- drive at speeds between 65 mph (105 km/h) and 70 mph (112 km/h) for longer than 20 seconds

## HOLD function

### General notes

The HOLD function can assist the driver in the following situations:

- when pulling away, especially on steep slopes
- when maneuvering on steep slopes
- when waiting in traffic

The vehicle is kept stationary without the driver having to depress the brake pedal.

The braking effect is canceled and the HOLD function deactivated when you depress the accelerator pedal to pull away.

- i** Do not use the HOLD function when driving off-road, on steep uphill or downhill gradients or on slippery or loose surfaces. The HOLD function cannot hold the vehicle on such surfaces.

### Important safety notes

#### **⚠ WARNING**

If the vehicle is only braked using the HOLD function, the vehicle may roll away in the following situations when you leave the vehicle:

- if there is a malfunction in the system or in the voltage supply
- if the HOLD function is deactivated by depressing the accelerator pedal or brake pedal, e.g. by a vehicle occupant
- if the electrical system in the engine compartment, the battery or the fuses are tampered with or the battery is disconnected

There is a risk of an accident.

Always deactivate the HOLD function and secure the vehicle against rolling away before you leave it.

- !** When Distance Pilot DISTRONIC or the HOLD function is activated, the vehicle brakes automatically in certain situations. To avoid damage to the vehicle, deactivate Distance Pilot DISTRONIC and the HOLD function in the following or similar situations:

- when towing the vehicle
- in the car wash

Deactivate the HOLD function (> page 182).

### Activation conditions

You can activate the HOLD function if:

- the vehicle is stationary
- the engine is running or if it has been automatically switched off by the ECO start/stop function
- the driver's door is closed or your seat belt is fastened
- the electric parking brake is released
- the transmission is in position **D**, **R** or **N**
- Distance Pilot DISTRONIC is deactivated

### Activating the HOLD function



- ▶ Make sure that the activation conditions are met.
- ▶ Depress the brake pedal.
- ▶ Quickly depress the brake pedal further until **1** appears in the multifunction display. The HOLD function is activated. You can release the brake pedal.

- i** If depressing the brake pedal the first time does not activate the HOLD function, wait briefly and then try again.

### Deactivating the HOLD function

The HOLD function is deactivated automatically if:

- you depress the accelerator and the transmission is in position **D** or **R**
- you shift the transmission to position **P**
- you depress the brake pedal again with a certain amount of pressure until **1** disappears from the multifunction display
- you secure the vehicle using the electric parking brake
- you activate Distance Pilot DISTRONIC

- i** After a time, the electric parking brake secures the vehicle and relieves the service brake.



When the HOLD function is activated, the transmission is automatically shifted to position **P** if:

- the driver's door is open and the driver's seat belt is unfastened
- the engine is switched off, unless it is automatically switched off by the ECO start/stop function

The electric parking brake secures the vehicle automatically if the HOLD function is activated when the vehicle is stationary and:

- a system malfunction occurs
- the power supply is insufficient

On steep uphill or downhill gradients or if there is a malfunction, the transmission may also be automatically shifted to position **P**.

### AIRMATIC package

#### General notes

AIRMATIC is an air suspension system with variable damping for improved driving comfort. Level control ensures the best possible suspension and constant ground clearance, even with a laden vehicle. When you drive fast, the vehicle is lowered automatically to improve driving safety and to reduce fuel consumption. There is also the option to manually adjust the vehicle level. AIRMATIC consists of:

- level settings
- level control and
- ADS or ADS PLUS (Adaptive Damping System)

**All vehicles (except Mercedes-AMG vehicles):** your vehicle may also be equipped with the ACTIVE CURVE SYSTEM (▷ page 184).

**Mercedes-AMG vehicles:** your vehicle is equipped with the ACTIVE CURVE SYSTEM (▷ page 184).

Observe the notes on driving with a trailer (▷ page 220).

The vehicle level can be set using the DYNAMIC SELECT controller (▷ page 142) or the level button (▷ page 185). The setting always corresponds to the last selected function.

#### Important safety notes

##### WARNING

When the vehicle is being lowered, people could become trapped if their limbs are between the vehicle body and the wheels or underneath the vehicle. There is a risk of injury.

Make sure no one is underneath the vehicle or in the immediate vicinity of the wheel arches when the vehicle is being lowered.

If you unlock the vehicle or open a door, the vehicle begins to compensate for load discrepancies while still parked. However, for significant level changes, such as after the vehicle has been stationary for a long period, the engine must be on. For safety reasons, the vehicle is only lowered when the doors are closed. Lowering is interrupted if a door is opened, and it continues once the door has been closed.

#### ADS and ADS PLUS (Adaptive Damping System)

##### General notes

The Adaptive Damping System automatically controls the calibration of the dampers. The damping characteristics adapt to the current operating and driving situation.

The damping is tuned individually to each wheel and depends on:

- your driving style, e.g. sporty
- the road surface conditions
- the drive program selected
- the vehicle level setting

##### Selecting Comfort mode



In the **Comfort** drive program, the driving characteristics of your vehicle are more comfortable. Therefore, select this mode if you favor a more comfortable driving style. Also select the **Comfort** drive program when driving fast on straight roads, e.g. on straight stretches of highway.

- ▶ Select the **Comfort** drive program using DYNAMIC SELECT controller ①.  
The vehicle is adjusted to normal level

**All vehicles (except Mercedes-AMG vehicles):** in the **Comfort** drive program, the vehicle is lowered by 0.6 in (15 mm) if you:

- drive at speeds above 70 mph (112 km/h) or
- drive at speeds between 60 mph (96 km/h) and 70 mph (112 km/h) for longer than 20 seconds

The vehicle is raised again if you:

- drive at speeds below 25 mph (40 km/h) or
- drive at speeds between 25 mph (40 km/h) and 40 mph (64 km/h) for longer than 20 seconds

**Mercedes-AMG vehicles:** in the **Comfort** drive program, the vehicle is:

- lowered by 0.4 in (10 mm) if you drive at speeds above 112 mph (180 km/h)
- raised again if you drive at speeds below 87 mph (140 km/h)

### Selecting Sport mode



The firmer setting of the suspension tuning in the **Sport** drive program ensures even better contact with the road. Select this drive program when employing a sporty driving style, e.g. on winding country roads.

DSR is not available in the **Sport** drive program. For further information on DSR, see (▷ page 213).

- ▶ Select the **Sport** drive program using DYNAMIC SELECT controller ①.  
**All vehicles (except Mercedes-AMG vehicles):** the vehicle is lowered by 0.6 in (15 mm) compared to the normal level.  
**Mercedes-AMG vehicles:** the vehicle remains at the normal level.

### Selecting Sport Plus tuning (Mercedes-AMG vehicles)



The very firm setting of the suspension setting in the **Sport Plus** drive program ensures the best possible contact with the road. Select this drive program when employing a sporty driving style, e.g. on winding country roads or primarily when driving on race circuits.

DSR is not available in the **Sport Plus** drive program. For further information on DSR, see (▷ page 213).

- ▶ Select the **Sport Plus** drive program using DYNAMIC SELECT controller ①.  
The vehicle is lowered by 0.4 in (10 mm) compared to the normal level.

### ACTIVE CURVE SYSTEM

The ACTIVE CURVE SYSTEM uses active stabilizers to optimize both driving comfort and vehicle dynamics. Depending on the drive program selected (▷ page 146), the ACTIVE CURVE SYSTEM also changes the setting.

If you have selected the **Comfort** drive program:

- rolling movement is reduced in the event of changing surface undulations
- the roll angle when cornering is reduced
- the driving is dynamic

If you have selected the **Sport** drive program:

- the roll angle is reduced significantly
- the driving is even more dynamic

**Mercedes-AMG vehicles:** if you have selected the **Sport Plus** drive program:

- the roll angle is reduced even more significantly
- the driving is designed for maximum dynamism

## Vehicle level

### Important safety notes

#### WARNING

When the vehicle is being lowered, people could become trapped if their limbs are between the vehicle body and the wheels or underneath the vehicle. There is a risk of injury.

Make sure no one is underneath the vehicle or in the immediate vicinity of the wheel arches when the vehicle is being lowered.

#### WARNING

When you drive with the vehicle raised, the driving characteristics could be impaired by the vehicle's raised center of gravity. The vehicle could rollover more easily, for example on a bend. There is a risk of an accident.

Always select as low a vehicle level as possible and adjust your driving style.

#### WARNING

When you drive with the chassis lowered or raised, the vehicle's braking and driving characteristics can be significantly impaired. You could also exceed the permissible vehicle height if the chassis is raised. There is a risk of an accident.

Adjust the vehicle level before pulling away.

#### WARNING

Due to the high center of gravity, the vehicle may start to skid and roll over in the event of an abrupt steering maneuver and/or when the vehicle's speed is not adapted to the road conditions. There is a risk of an accident.

Always adapt your speed and driving style to the vehicle's driving characteristics and to the prevailing road and weather conditions.

**!** When driving on extremely rough terrain, select a high vehicle level in good time. Make sure there is always sufficient ground clearance. You will otherwise damage the vehicle.

- Utility vehicles have a significantly higher rollover rate than other types of vehicles.

Failure to operate this vehicle safely may result in an accident, rollover of the vehicle, and severe or fatal injury.

- In a rollover crash, an unbelted person is significantly more likely to die than a person wearing a seat belt.

You and all vehicle occupants should always wear your seat belts.

### General notes

Only select raised level if this is appropriate for the road conditions. Otherwise, fuel consumption may increase and handling may be affected.

Make changes to the vehicle level while the vehicle is in motion. This enables the vehicle to adjust to the new level as quickly as possible.

The vehicle level may change visibly if you park the vehicle and the outside temperature changes. If the temperature drops, the vehicle level is lower; with an increase in temperature, the vehicle level rises.

If you unlock the vehicle or open a door, the vehicle begins to compensate for load discrepancies while still parked. However, for significant level changes, such as after the vehicle has been stationary for a long period, the engine must be on. For safety reasons, the vehicle is only lowered when the doors are closed. Lowering is interrupted if a door is opened, and it continues once the door has been closed.

**Vehicles with no trailer coupled:** below a speed of 40 mph (64 km/h) you can choose between the normal and raised vehicle level. Select the normal vehicle level for normal road surfaces and the raised vehicle level for driving with snow chains or on particularly poor road surfaces. Your selection remains stored even if you remove the SmartKey from the ignition lock. If you try to select raised level at a speed above 40 mph (64 km/h), the **Drive More Slowly** message appears in the multifunction display.

**Vehicles with a trailer coupled:** below a speed of 19 mph (30 km/h), you can choose between the normal and raised vehicle level.

### Setting the raised vehicle level



▶ Start the engine.

If indicator lamp ② is not lit:

▶ Press button ①.



Indicator lamp ② flashes while the vehicle is being raised, and lights up continuously as soon as the vehicle reaches the desired level.

**All vehicles (except Mercedes-AMG vehicles):** the vehicle is raised by 2.4 in (60 mm) compared to the normal level.

**Mercedes-AMG vehicles:** the vehicle is raised by 2 in (50 mm) compared to the normal level.

The **Vehicle Rising** message appears in the multifunction display.

The message remains until the raised level is reached.

If you press the  or  button on the multifunction steering wheel, the message will disappear.

The raised vehicle level setting is canceled in the following cases:

- **All vehicles (except Mercedes-AMG vehicles):** you are driving faster than 50 mph (80 km/h).
- **Mercedes-AMG vehicles:** you are driving faster than 43 mph (70 km/h).
- **All vehicles (except Mercedes-AMG vehicles):** You drive for approximately 20 seconds between 40 mph (64 km/h) and 50 mph (80 km/h).

- **Mercedes-AMG vehicles:** You drive for approximately 20 seconds between 40 mph (64 km/h) and 43 mph (70 km/h).
- You drive with a trailer at speeds greater than 19 mph (30 km/h).

The raised vehicle level remains saved when you are not driving within these speed ranges.

### Setting the normal vehicle level

**!** Make sure that there is enough ground clearance when the vehicle is being lowered. It could otherwise hit the ground, damaging the underbody.

▶ Start the engine.

If indicator lamp ② is lit:



▶ Press button ①.

Indicator lamp ② flashes while the vehicle is being lowered, and goes out as soon as the desired vehicle level is reached.

**Vehicles with no trailer coupled:** the vehicle is adjusted to the height of the selected drive program (▷ page 142).

**Vehicles with a trailer coupled:** the vehicle is adjusted to normal level regardless of the drive program selected (▷ page 142). The vehicle remains at the normal level, even if the drive program is changed.

During the adjustment, the **Lowering** message appears in the multifunction display.

If you press the  or  button on the multifunction steering wheel, the message will disappear.

## AMG adaptive sport suspension system

### General notes

**i** The AMG adaptive sport suspension system is available for Mercedes-AMG vehicles and for the Mercedes-AMG GLE 43 4MATIC.

The electronically controlled damping system works continuously. This improves driving safety and ride comfort.

The damping is tuned individually to each wheel and depends on:

- your driving style, e.g. sporty
- the road surface condition, e.g. bumps
- your individual selection of Sport, Sport+ or Comfort

The suspension setting can be adjusted using button ① in the center console or the DYNAMIC SELECT controller (▷ page 142).

Each time you start the engine with the ignition SmartKey or the Start/Stop button, Comfort mode is activated. For further information about starting the engine, see (▷ page 136).

### Sport mode



The firmer setting of the suspension tuning in Sport mode ensures even better contact with the road. Select this mode when employing a sporty driving style, e.g. on winding country roads.

- ▶ Press button ① repeatedly until indicator lamp ③ lights up.  
You have selected Sport mode.

The **AMG Suspension System SPORT** message appears in the multifunction display.

### Sport + mode

The very firm setting of the suspension setting in Sport + mode ensures the best possible contact with the road. Select this mode only when driving on race circuits.

If indicator lamps ② and ③ are off:

- ▶ Press button ① repeatedly until indicator lamp ② lights up.  
You have selected Sport + mode.

The **AMG Suspension System SPORT +** message appears in the multifunction display.

In "Sport +" mode, the vehicle is lowered by 10 mm compared to the normal level.

### Comfort mode

In Comfort mode, the driving characteristics of your vehicle are more comfortable. Select this mode if you favor a more comfortable driving style, but also when driving fast on straight roads, e.g. highways.

- ▶ Press button ① repeatedly until indicator lamps ② and ③ go out.  
You have selected Comfort mode.

The **AMG Suspension System COMFORT** message appears in the multifunction display.

### Parking Assist PARKTRONIC

#### Important safety notes

Parking Assist PARKTRONIC is an electronic parking aid with ultrasound. It monitors the area around your vehicle using six sensors in the front bumper and six sensors in the rear bumper. Parking Assist PARKTRONIC visually and audibly indicates the distance between your vehicle and an object.

Parking Assist PARKTRONIC is only an aid. It is not a replacement for your attention to your immediate surroundings. You are always responsible for safe maneuvering, parking and exiting a parking space. When maneuvering, parking or pulling out of a parking space, make sure that there are no persons, animals or objects in the area in which you are maneuvering.

**!** When parking, pay particular attention to objects above or below the sensors, such as flower pots or trailer drawbars. PARKTRONIC does not detect such objects when they are in the immediate vicinity of the vehicle. You could damage the vehicle or the objects.

The sensors may not detect snow and other objects that absorb ultrasonic waves.

Ultrasonic sources such as an automatic car wash, the compressed-air brakes on a truck or a pneumatic drill could cause PARKTRONIC to malfunction.

PARKTRONIC may not function correctly on uneven terrain.

**!** Fold in the ball coupling if the trailer tow hitch is not required. PARKTRONIC measures the minimum detection range to an obstacle from the bumper, not the ball coupling.

Parking Assist PARKTRONIC is deactivated for the rear area when you establish an electrical connection between your vehicle and a trailer.

Parking Assist PARKTRONIC is activated automatically when you:

- switch on the ignition
- shift the transmission to position **D**, **R** or **N**
- release the electric parking brake

Parking Assist PARKTRONIC is deactivated at speeds above 11 mph (18 km/h). It is reactivated at lower speeds.

## Range of the sensors

### General notes

Parking Assist PARKTRONIC does not take into account obstacles located:

- below the detection range, such as persons, animals or objects
- above the detection range, such as overhanging loads, truck overhangs or loading ramps



- ① Sensors in the front bumper, left-hand side (example)

The sensors must be free from dirt, ice or slush. They can otherwise not function correctly. Clean the sensors regularly, taking care not to scratch or damage them (> page 330).

## Range



- ① Approx. 24 in (approx. 60 cm) (corners)  
 ② Approx. 32 in (approx. 80 cm) (corners)  
 ③ Approx. 48 in (approx. 120 cm) (center)  
 ④ Approx. 40 in (approx. 100 cm) (center)

### Minimum distance

Center	Approx. 8 in (approx. 20 cm)
Corners	Approx. 6 in (approx. 15 cm)

If there is an obstacle within this range, the relevant warning displays light up and a warning tone sounds. If the distance falls below the minimum, the distance may no longer be shown.

## Warning displays



- ① Segments on the left-hand side of the vehicle
- ② Segments on the right-hand side of the vehicle
- ③ Segments showing operational readiness

The warning displays show the distance between the sensors and the obstacle. The warning display for the front area is located on the dashboard above the center air vents. The warning display for the rear area is located on the headliner in the rear compartment.

The warning display for each side of the vehicle is divided into five yellow and two red segments. Parking Assist PARKTRONIC is operational if yellow segments showing operational readiness ③ light up.

The selected transmission position and the direction in which the vehicle is rolling determine which warning display is active when the engine is running.

Transmission position	Warning display
D	Front area activated
R, N or the vehicle is rolling backwards	Rear and front areas activated
P	No areas activated

One or more segments light up as the vehicle approaches an obstacle, depending on the vehicle's distance from the obstacle.

From the:

- sixth segment onwards, you will hear an intermittent warning tone for approximately two seconds.
- seventh segment onwards, you will hear a warning tone for approximately two seconds. This indicates that you have now reached the minimum distance.

## Deactivating or activating Parking Assist PARKTRONIC



- ① Indicator lamp
- ② Deactivates or activates Parking Assist PARKTRONIC

If indicator lamp ① lights up, Parking Assist PARKTRONIC is deactivated. Parking Pilot is then also deactivated.

- ⓘ Parking Assist PARKTRONIC is automatically activated when you turn the SmartKey to position ② in the ignition lock.

## Problems with Parking Assist PARKTRONIC

Problem	Possible causes/consequences and ► Solutions
<p>Only the red segments in the Parking Assist PARKTRONIC warning displays are lit. You also hear a warning tone for approximately two seconds.</p> <p>Parking Assist PARKTRONIC is deactivated after approximately five seconds, and the indicator lamp in the Parking Assist PARKTRONIC button lights up.</p>	<p>Parking Assist PARKTRONIC has malfunctioned and has been deactivated.</p> <p>► If problems persist, have Parking Assist PARKTRONIC checked at a qualified specialist workshop.</p>
<p>Only the red segments in the Parking Assist PARKTRONIC warning displays are lit. Parking Assist PARKTRONIC is deactivated after approximately five seconds.</p>	<p>The Parking Assist PARKTRONIC sensors are dirty or there is interference.</p> <p>► Clean the Parking Assist PARKTRONIC sensors (► page 330).</p> <p>► Switch the ignition back on.</p> <p>The problem may be caused by an external source of radio or ultrasound waves.</p> <p>► Check to see if Parking Assist PARKTRONIC works at a different location.</p>

### Parking Pilot

#### General notes

Parking Pilot is an electronic parking aid with ultrasound. It measures the road on both sides of the vehicle. A parking symbol indicates a suitable parking space. Active steering intervention and brake application can assist you during parking. Parking Assist PARKTRONIC is also available (► page 187).

#### Important safety notes

Parking Pilot is only an aid. It is not a replacement for your attention to your immediate surroundings. You are always responsible for safe maneuvering, parking and exiting a parking space. Make sure that no persons, animals or objects are in the path of your vehicle.

When Parking Assist PARKTRONIC is deactivated, Parking Pilot is also unavailable.

### WARNING

While parking or pulling out of a parking space, the vehicle swings out and can drive onto areas of the oncoming lane. This could result in a collision with another road user. There is a risk of an accident.

Pay attention to other road users. Stop the vehicle if necessary or cancel the Parking Pilot parking procedure.

**!** If they cannot be avoided, drive over obstacles such as curbs slowly and at an obtuse angle. Otherwise, you may damage the wheels or tires.

Parking Pilot may show parking spaces which are not suitable for parking, e.g.:

- where parking or stopping is prohibited
- in front of driveways or entrances and exits
- on unsuitable surfaces



### Parking tips:

- On narrow roads, drive as close to the parking space as possible.
- Parking spaces that are littered or overgrown might be identified or measured incorrectly.
- Parking spaces that are partially occupied by trailer drawbars might not be identified as such or be measured incorrectly.
- Snowfall or heavy rain may lead to a parking space being measured inaccurately.
- Pay attention to the warning messages of Parking Assist PARKTRONIC during the parking procedure (▷ page 187).
- You can intervene to correct the steering procedure at any time. Parking Pilot will then be canceled.
- When transporting a load that protrudes from your vehicle, you must not use Parking Pilot.
- Never use Parking Pilot when snow chains are mounted.
- Make sure that the tire pressures are always correct. This has a direct influence on the parking characteristics of the vehicle.

### Use Parking Pilot for parking spaces that are:

- parallel or at right angles to the direction of travel
- on straight roads, not bends
- on the same level as the road, e.g. not on the pavement

## Detecting parking spaces

Objects located above the detection range of Parking Pilot will not be detected when the parking space is measured. These are not taken into account when the parking/exiting procedure is calculated, e.g. overhanging loads, tail sections or loading ramps of trucks. Parking Pilot may therefore guide you into the parking space too early.

### WARNING

If there are objects above the detection range:

- Parking Pilot may steer in too early
- the vehicle may not stop in front of these objects

You may cause a collision as a result. There is a risk of an accident.

If objects are located above the detection range, stop and deactivate Parking Pilot.

Further information about the detection range (▷ page 188).

Parking Pilot does not assist you parking in spaces at a right angle to the direction of travel if:

- two parking spaces are located directly next to one another
- the parking space is directly next to a low obstacle such as a low curb
- you park forwards

Parking Pilot does not assist you parking in spaces parallel with or at a right angle to the direction of travel if:

- the parking space is on a curb
- the system reads the parking space as being blocked, for example by foliage or grass paving blocks
- the area is too small for the vehicle to maneuver into
- the parking space is bordered by an obstacle, e.g. a tree, a post or a trailer



- ① Detected parking space on the left
- ② Parking symbol
- ③ Detected parking space on the right

Parking Pilot is activated automatically when driving forward. The system is operational up to a speed of approximately 22 mph (35 km/h). While in operation, the system independently locates and measures parking spaces on both sides of the vehicle.

Parking Pilot will only detect parking spaces which are:

- parallel or at right angles to the direction of travel
- that are parallel to the direction of travel and at least 59 in (1.5 m) wide
- that are parallel to the direction of travel and at least 39.5 in (1.0 m) longer than your vehicle
- that are at right angles to the direction of travel and at least 39.5 in (1.0 m) wider than your vehicle

- i** Note that Parking Pilot PARKTRONIC cannot measure the depth of parking spaces if they are at right angles to the direction of travel. You will need to judge whether your vehicle will fit into the parking space.

When driving at speeds below 19 mph (30 km/h), you will see parking symbol ② as a status indicator in the instrument cluster. When a parking space has been detected, an arrow towards the right or the left also appears. Parking Pilot only displays parking spaces on the front-passenger side as standard. Parking spaces on the driver's side are displayed as soon as the turn signal on the driver's side is activated. When parking on the driver's side, this must remain activated until you confirm the use of Parking Pilot by pressing the **OK** button on the multifunction steering wheel. The system automatically determines whether the parking space is parallel or at right angles to the direction of travel.

A parking space is displayed while you are driving past it, and until you are approximately 50 ft (15 m) away from it.

## Parking

### WARNING



If you leave the vehicle when it is only being braked by Active Parking Assist it could roll away if:

- there is a malfunction in the system or in the voltage supply.
- the electrical system in the engine compartment, the battery or the fuses have been tampered with.
- the battery is disconnected.
- the accelerator pedal has been depressed, e.g. by a vehicle occupant.

There is a risk of an accident.

Before leaving the vehicle, always secure it against rolling away.

- i** If Parking Assist PARKTRONIC detects obstacles, Parking Pilot brakes automatically whilst the vehicle is being parked. You are responsible for braking in good time.

- ▶ Stop the vehicle when the parking space symbol shows the desired parking space in the instrument cluster.
- ▶ Shift the transmission to position **R**. The **Start Parking Pilot? Yes: OK No:**  message appears in the multifunction display.
- ▶ **To cancel the procedure:** press the  button on the multifunction steering wheel or pull away.

or

- ▶ **To park using Parking Pilot:** press the **OK** button on the multifunction steering wheel. The **Parking Pilot Active Accelerate and Brake Observe Surroundings** message appears in the multifunction display.
- ▶ Let go of the multifunction steering wheel.
- ▶ Back up the vehicle, being ready to brake at all times. When backing up, drive at a speed below approximately 6 mph (10 km/h). Otherwise, Parking Pilot is canceled immediately. Parking Pilot brakes the vehicle to a standstill when the vehicle approaches the rear border of the parking space.

Maneuvering may be required in tight parking spaces.

The **Parking Pilot Active Select D Observe Surroundings** message appears in the multifunction display.

- ▶ Shift the transmission to position **D** while the vehicle is stationary. Parking Pilot immediately steers in the other direction.

The **Parking Pilot Active Accelerate and Brake Observe Surroundings** message appears in the multifunction display.

- i** You will achieve the best results by waiting for the steering procedure to complete before pulling away.
- ▶ Drive forwards and be ready to brake at all times. Parking Pilot brakes the vehicle to a standstill.

The **Parking Pilot Active Select R Observe Surroundings** message appears in the multifunction display.

As soon as the parking procedure is complete, the **Parking Pilot Finished** message appears and a warning tone sounds. The vehicle is now parked. The vehicle is kept stationary without the driver having to depress the brake

pedal. The braking effect is canceled when you depress the accelerator pedal.

Parking Pilot no longer supports you with steering interventions and brake applications. When Parking Pilot is finished, you must steer and brake again yourself. Parking Assist PARKTRONIC is still available.

Parking tips:

- The way your vehicle is positioned in the parking space after parking is dependent on various factors. These include the position and shape of the vehicles parked in front and behind it and the conditions of the location. It may be the case that Parking Pilot guides you too far into a parking space, or not far enough into it. In some cases, it may also lead you across or onto the curb. Cancel the parking procedure with Parking Pilot if necessary.
- You can also select preselect transmission position **D**. The vehicle redirects and does not drive as far into the parking space. Should the transmission change take place too early, the parking procedure will be canceled. A sensible parking position can no longer be achieved from this position.

### Exiting a parking space

In order for Parking Pilot to assist you:

- the border of the parking space must be high enough at the front and the rear. A curb is too small, for example.
- the border of the parking space must not be too wide. Your vehicle can be maneuvered into a position at a maximum of 45° to the starting position in the parking space.
- a maneuvering distance of at least 3.3 ft (1.0 m) must be available.

Parking Pilot can assist you with exiting a parking space only if you have parked the vehicle parallel to the direction of travel using the Parking Pilot.

- ❗ If Parking Assist PARKTRONIC detects obstacles, Parking Pilot brakes automatically whilst the vehicle is exiting the parking space. You are responsible for braking in good time.
- ▶ Start the engine.
- ▶ Release the electric parking brake.
- ▶ Switch on the turn signal in the direction you will drive out of the parking space.

▶ Shift the transmission to position **D** or **R**. The **Start Parking Pilot? Yes: OK No: ** message appears in the multifunction display.

▶ **To cancel the procedure:** press the  button on the multifunction steering wheel or pull away.

or

▶ **To exit a parking space using Parking Pilot:** press the  button on the multifunction steering wheel.

The **Parking Pilot Active Accelerate and Brake Observe Surroundings** message appears in the multifunction display.

- ▶ Let go of the multifunction steering wheel.
- ▶ Pull away, being ready to brake at all times. Do not exceed a maximum speed of approximately 6 mph (10 km/h) when exiting a parking space. Otherwise, Parking Pilot is canceled immediately.
- ▶ Shift the transmission to position **D** or **R** as required or according to the message while the vehicle is stationary. Parking Pilot immediately steers in the other direction. The **Parking Pilot Active Accelerate and Brake Observe Surroundings** message appears in the multifunction display.

❗ You will achieve the best results by waiting for the steering procedure to complete before pulling away.

If you back up after activation, the steering wheel is moved to the straight-ahead position.

- ▶ Drive forwards and back up as prompted by the Parking Assist PARKTRONIC warning displays, several times if necessary.

Once you have exited the parking space completely, the steering wheel is moved to the straight-ahead position. You hear a tone and the **Parking Pilot Finished** message appears in the multifunction display. You will then have to steer and merge into traffic on your own. Parking Assist PARKTRONIC is still available. You can take over the steering before the vehicle has exited the parking space completely. This is useful, for example when you recognize that it is already possible to pull out of the parking space.

## Canceling Parking Pilot

► Stop the movement of the multifunction steering wheel or steer yourself. Parking Pilot is canceled immediately. The **Parking Pilot Canceled** message appears in the multifunction display.

or

► Press the Parking Assist PARKTRONIC button (> page 189). Parking Assist PARKTRONIC is switched off and Parking Pilot is immediately canceled. The **Parking Pilot Canceled** message appears in the multifunction display.

Parking Pilot is canceled automatically when:

- the electric parking brake is engaged
- transmission position **P** is selected
- parking using Parking Pilot is no longer possible
- you are driving faster than 6 mph (10 km/h)
- a wheel spins, ESP® intervenes or fails. The  warning lamp lights up in the instrument cluster

A warning tone sounds. The parking symbol disappears and the multifunction display shows the **Parking Pilot Canceled** message.

When Parking Pilot is canceled, you must steer and brake again yourself.

If a system malfunction occurs, the vehicle is braked to a standstill. To drive on, depress the accelerator again.

## Rear view camera

### General notes



Rear view camera ① is an optical parking and maneuvering aid. It shows the area behind your

vehicle with guide lines in the multimedia system.

The area behind the vehicle is displayed as a mirror image, as in the rear view mirror.

**i** The text shown in the multimedia system display depends on the language setting. The following are examples of rear view camera displays in the multimedia system.

## Important safety notes

The rear view camera is only an aid. It is not a replacement for your attention to your immediate surroundings. You are always responsible for safe maneuvering and parking. Make sure that there are no persons, animals or objects in the maneuvering area while maneuvering and parking in parking spaces.

Under the following circumstances, the rear view camera will not function, or will function in a limited manner:

- if the trunk lid is open
- if there is heavy rain, snow or fog
- at night or in very dark places
- if the camera is exposed to very bright light
- if the area is lit by fluorescent bulbs or LED lighting (the display may flicker)
- if there is a sudden change in temperature, e.g. when driving into a heated garage in winter
- if the camera lens is dirty or obstructed. Observe the notes on cleaning (> page 330)
- if the rear of your vehicle is damaged. In this event, have the camera position and setting checked at a qualified specialist workshop

The field of vision and other functions of the rear view camera may be restricted due to additional accessories on the rear of the vehicle (e.g. license plate holder, bicycle rack).

For technical reasons, leaving the standard height can result in inaccuracies in the guide lines on vehicles with a height-adjustable chassis.

**i** The rear view camera is protected from raindrops and dust by means of a flap. When the rear view camera is activated, this flap opens.

The flap closes again when:

- you have finished the maneuvering process
- you switch off the engine
- you open the cargo compartment

Observe the notes on cleaning (▷ page 330).

For technical reasons, the flap may remain open briefly after the rear view camera has been deactivated.

### Activating/deactivating the rear view camera

► **To activate:** make sure that the SmartKey is in position **2** in the ignition lock.

► Make sure that the **Activation by R gear** function is selected in the multimedia system (see the Digital Operator's Manual).

► Engage reverse gear.

The rear view camera flap opens. The multimedia system shows the area behind the vehicle with guide lines.

The image from the rear view camera is available throughout the maneuvering process.

► **To switch the function mode for vehicles with trailer tow hitch:** using the controller, select symbol **1** for the "Reverse parking" function or symbol **2** for "Coupling up a trailer".

The symbol of the selected function is highlighted.

**To deactivate:** the rear view camera deactivates if you shift the transmission to **P** or after driving forwards a short distance.

### Displays in the multimedia system

The rear view camera may show a distorted view of obstacles, show them incorrectly or not at all. The rear view camera does not show objects in the following positions:

- very close to the rear bumper
- under the rear bumper
- in the area immediately above the tailgate handle

**!** Objects not at ground level may appear to be further away than they actually are, e.g.:

- the bumper of a parked vehicle
- the drawbar of a trailer
- the ball coupling of a trailer tow hitch

- the rear section of an HGV
- a slanted post

Use the guidelines only for orientation.

Approach objects no further than the bottom-most guideline.

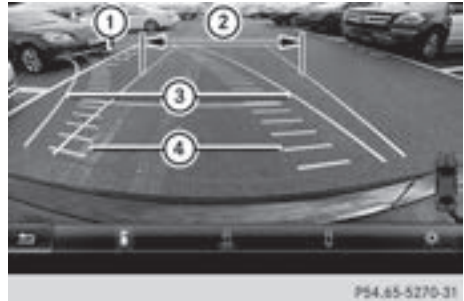

- ① Yellow guide line at a distance of approximately 13 ft (4.0 m) from the rear of the vehicle
- ② White guide line without turning the steering wheel, vehicle width including the exterior mirrors (static)
- ③ Yellow guide line for the vehicle width including the exterior mirrors, for current steering wheel angle (dynamic)
- ④ Yellow lane marking the course the tires will take at the current steering wheel angle (dynamic)



- ⑤ Yellow guide line at a distance of approximately 3 ft (1.0 m) from the rear of the vehicle
- ⑥ Vehicle center axle (marker assistance)
- ⑦ Bumper
- ⑧ Red guide line at a distance of approximately 12 in (0.30 m) from the rear of the vehicle

The guide lines are shown when the transmission is in position **R**.

The distance specifications only apply to objects that are at ground level.



- ① Front warning display
- ② Additional measurement operational readiness indicator for Parking Assist PARKTRONIC
- ③ Rear warning display

#### Vehicles with Parking Assist PARKTRONIC:

when Parking Assist PARKTRONIC is operational (▷ page 188), additional measurement operational readiness indicator ② appears in the multimedia system. If the Parking Assist PARKTRONIC warning displays are active or light up, warning displays ① and ③ are also active or light up correspondingly in the multimedia system.

### "Reverse parking" function

#### Backing up straight into a parking space without steering input



- ① White guide line without steering input – vehicle width including the exterior mirrors (static)
- ② Yellow guide line for the vehicle width including the exterior mirrors, for current steering wheel angle (dynamic)

- ③ Yellow guide line at a distance of approximately 3 ft (1.0 m) from the rear of the vehicle
- ④ Red guide line at a distance of approximately 12 in (0.30 m) from the rear of the vehicle

- ▶ Make sure that the rear view camera is switched on (▷ page 195). The lane and the guide lines are shown.
- ▶ With the help of white guide line ①, check whether the vehicle will fit into the parking space.
- ▶ Using white guide line ① as a guide, carefully back up until you reach the end position. Red guide line ④ is then at the end of the parking space. The vehicle is almost parallel in the parking space.

#### Reverse perpendicular parking with steering input



- ① Parking space marking
- ② Yellow guide line for the vehicle width including the exterior mirrors, for current steering wheel angle (dynamic)

- ▶ Drive past the parking space and bring the vehicle to a standstill.
- ▶ Make sure that the rear view camera is switched on (▷ page 195). The lane and the guide lines are shown.
- ▶ While the vehicle is at a standstill, turn the steering wheel in the direction of the parking space until yellow guide line ② reaches parking space marking ①.
- ▶ Maintain the steering input and reverse carefully.



- ① Yellow guide line for the vehicle width including the exterior mirrors, for current steering wheel angle (dynamic)

- Stop the vehicle when it is almost exactly in front of the parking space. The white lane should be as close to parallel with the parking space marking as possible.



- ① White guide line for current steering input  
② Parking space marking

- Turn the steering wheel to the center position while the vehicle is stationary.



- ① Red guide line at a distance of approximately 12 in (0.30 m) from the rear of the vehicle  
② White guide line without steering input  
③ End of parking space

- Back up carefully until you have reached the final position.

Red guide line ① is then at end of parking space ③. The vehicle is almost parallel in the parking space.

### "Coupling up a trailer" function

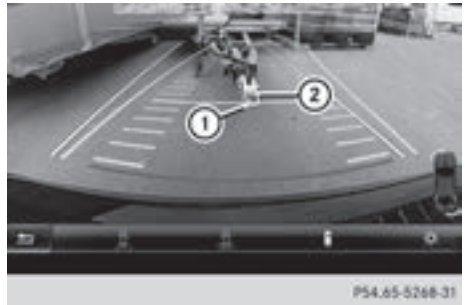

- ① Vehicle center point on the yellow guide line at a distance of approximately 1.0 m from the rear of the vehicle

- ② Trailer drawbar

This function is only available on vehicles with a trailer tow hitch.

- Before coupling up a trailer, set the height of trailer drawbar ② so that it is slightly higher than the ball coupling.

- Position the vehicle centrally in front of trailer drawbar ②.

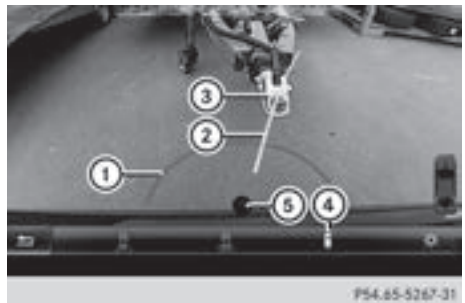

- ① Red guide line at a distance of approximately 0.30 m from the ball coupling

- ② Trailer drawbar marker assistant

- ③ Trailer drawbar

- ④ Symbol for the "Coupling up a trailer" function

- ⑤ Ball coupling

**i** For technical reasons, the ball coupling of the trailer tow hitch in the multimedia system display is either only partially visible or not at all.

- ▶ Select symbol **④** using the controller. The "Coupling up a trailer" function is selected. The distance specifications now only apply to objects that are at the same level as the ball coupling.
- ▶ Back up carefully, making sure that trailer drawbar locating aid **②** points approximately in the direction of trailer drawbar **③**.
- ▶ Back up carefully until trailer drawbar **③** reaches the red guide line. The distance between the trailer drawbar and the red guide line is now approximately 0.30 m.
- ▶ Couple up the trailer (▷ page 220).

### 180° view



- ①** Symbol for the 180° view function
- ②** Your vehicle
- ③** Warning displays for Parking Assist PARKTRONIC

You can also use the rear view camera to select a 180° view.

When Parking Assist PARKTRONIC is operational (▷ page 188), a symbol for your own vehicle appears in the multimedia system. If the Parking Assist PARKTRONIC warning displays are active, warning displays **③** light up in the multimedia system in yellow or red accordingly.

### 360° camera

#### General notes

The 360° camera is a system consisting of four cameras.

The system processes images from the following cameras:

- Rear view camera
- Front camera
- Two cameras in the exterior rear view mirrors

The cameras cover the immediate surroundings of the vehicle. The 360° camera assists you, for instance when parking or at exits with reduced visibility.

You can show pictures from the 360° camera in full-screen mode or in seven different split-screen views on the multimedia system display. A split-screen view also includes a top view of the vehicle. This view is calculated from the data supplied by the installed cameras (virtual camera).

The six split-screen views are:

- Top view and picture from the rear view camera (130° viewing angle)
- Top view and image from the front camera (130° viewing angle without displaying the maximum steering wheel angle)
- Top view and enlarged rear view
- Top view and enlarged front view
- Top view and trailer view (vehicles with trailer tow hitch)
- Top view and rear-view images from the exterior mirror cameras (rear wheel view)
- Top view and forward-view images from the exterior mirror cameras (front wheel view)

When the function is active and you shift the transmission from **D** or **R** to **N**, the dynamic guide lines are hidden.

When you shift between transmission positions **D** and **R**, you see the previously selected front or rear view.

Distances measured by Parking Assist PARKTRONIC will also be optically displayed:

- in split screen view as red or yellow brackets around the vehicle icon in the top view, or
- at the bottom right as red or yellow brackets around the vehicle symbol in full-screen mode

The line thickness and color of the brackets show how far the vehicle is away from an object:



- yellow brackets with thin lines: Parking Assist PARKTRONIC is active
- yellow brackets with normal lines: an object is present in close range of the vehicle
- red line: an object is present in the immediate close range of the vehicle

**i** The camera in the rear area is protected from raindrops and dust by means of a flap. When the camera is activated, this flap opens. The flap closes again in the following situations:

- you have finished the maneuvering process
- you switch the engine off
- you open the cargo compartment

Observe the notes on cleaning (▷ page 330).

For technical reasons, the flap may remain open briefly after the camera has been deactivated.

### Important safety notes

The 360° camera is only an aid and may show a distorted view of obstacles, show them incorrectly or not at all. The 360° camera is not a substitute for attentive driving.

You are always responsible for safe maneuvering and parking. Make sure that there are no persons, animals or objects in the maneuvering area while maneuvering and parking in parking spaces.

You are always responsible for safety and must continue to pay attention to your immediate surroundings when parking and maneuvering. This applies to the areas behind, in front of and beside the vehicle. You could otherwise endanger yourself and others.

The 360° camera will not function or will function in a limited manner in the following situations:

- the doors are open
- the exterior mirrors are folded in
- the tailgate is open
- in heavy rain, snow or fog
- at night or in very dark places
- the cameras are exposed to very bright light
- the area is lit by fluorescent bulbs or LED lighting (the display may flicker)
- there is a sudden change in temperature, such as when driving into a heated garage in winter

- the camera lenses are dirty or covered
- the vehicle components in which the cameras are installed are damaged. In this event, have the camera position and setting checked at a qualified specialist workshop

Do not use the 360° camera under such circumstances. You can otherwise injure others or cause damage to objects or the vehicle.

Guide lines are always shown at road level. In trailer mode, the guide lines are shown at the level of the trailer coupling.

The field of vision and other functions of the camera system may be restricted due to additional accessories on the rear of the vehicle (e.g. license plate holder, bicycle rack).

On vehicles with height-adjustable chassis, depending on technical conditions, leaving the standard height can result in:

- inaccuracies in the guide lines
- inaccuracies in the display of generated images (top view)

### Activation conditions

The 360° camera image can be displayed in the following situations:

- your vehicle is equipped with a 360° camera
- the SmartKey is in key position **[2]** in the ignition lock
- the multimedia system is switched on

### Switching on the 360° camera

▶ Press the  button in the center console for longer than two seconds.

Depending on whether transmission position **[D]** or **[R]** is selected, the following appears:

- a split screen with top view and the image from the front camera or
- a split screen with top view and the image from the rear view camera

or

▶ Press the  button in the center console. The vehicle menu is displayed.

▶ Select **360° Camera** and press  to confirm. Depending on whether transmission position **[D]** or **[R]** is selected, the following appears:

- a split screen with top view and the image from the front camera or
- a split screen with top view and the image from the rear view camera

## Activating the 360° camera using reverse gear

The 360° camera images can be automatically displayed by engaging reverse gear.

- ▶ Make sure that the SmartKey is in position **2** in the ignition lock.
- ▶ Make sure that the **Activation by R gear** function is selected on the multimedia system (see the Digital Operator's Manual).
- ▶ **To show the 360° camera image:** engage reverse gear.  
The multimedia system shows the area behind the vehicle in split-screen mode. You see the top view of the vehicle and the image from the rear view camera.

## Selecting the split-screens or 180° view

Selecting split-screen view

- ▶ To switch to the line with the vehicle icons: slide **↑** the controller.
- ▶ To select one of the vehicle icons: turn **⊙** the controller.
- ▶ **To switch to 180° View:** turn **⊙** the controller to select **180° View** and press **⊙** to confirm.

**i** The **180° View** option is only available in the following views:

- Top view with picture from the rear view camera
- Top view with picture from the front camera

## Displays in the multimedia system

### Important safety notes

The camera system may show a distorted view of obstacles, show them incorrectly or not at all. Obstacles are not shown by the system in the following locations:

- under the front and rear bumpers
- very close to the front and rear bumpers
- in the area immediately above the tailgate handle
- very close to the exterior mirrors
- in the transitional areas between the various cameras in the virtual top view

**!** Objects not at ground level may appear to be further away than they actually are, e.g.:

- the bumper of a parked vehicle
- the drawbar of a trailer
- the ball coupling of a trailer tow hitch
- the rear section of an HGV
- a slanted post

Use the guidelines only for orientation.

Approach objects no further than the bottom-most guideline.

### Top view with picture from the rear view camera



- ① Yellow guide line at a distance of approximately 13 ft (4.0 m) from the rear of the vehicle
- ② Symbol for the split screen setting with top view and rear view camera image
- ③ Guide lines for the maximum steering input
- ④ Yellow lane marking the course the tires will take at the current steering wheel angle (dynamic)
- ⑤ Yellow guide line for the vehicle width including the exterior mirrors, for current steering wheel angle (dynamic)

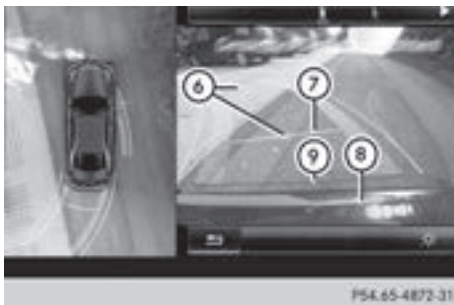

- ⑥ Vehicle center axle (marker assistance)
- ⑦ Yellow guide line at a distance of approximately 3 ft (1.0 m) from the rear of the vehicle
- ⑧ Bumper
- ⑨ Red guide line at a distance of approximately 12 in (0.30 m) from the rear of the vehicle

The guide lines are shown when the transmission is in position **R**.

The distance specifications only apply to objects that are at ground level.

### Top view with picture from the front camera



- ① Symbol for the split screen setting with top view and front camera image
- ② Yellow guide line at a distance of approximately 13 ft (4.0 m) from the front of the vehicle
- ③ Yellow guide line for the vehicle width including the exterior mirrors, for current steering wheel angle (dynamic)
- ④ Yellow lane marking the course the tires will take at the current steering wheel angle (dynamic)

- ⑤ Red guide line at a distance of approximately 12 in (0.30 m) from the front of the vehicle
- ⑥ Yellow guide line at a distance of approximately 3 ft (1.0 m) from the front of the vehicle

### Top view and enlarged rear view

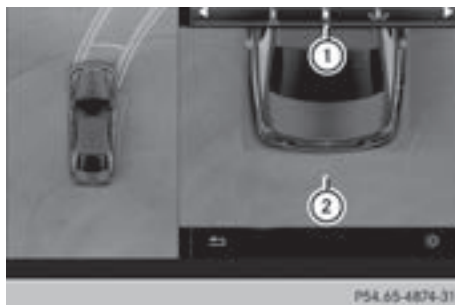

- ① Symbol for the split screen setting with top view and rear view camera image enlarged
- ② Red guide line at a distance of approximately 12 in (0.30 m) from the rear of the vehicle

This view assists you in estimating the distance to the vehicle behind you.

- i** This setting can also be selected as an enlarged front view.

### Top view with image from the camera in the exterior mirrors

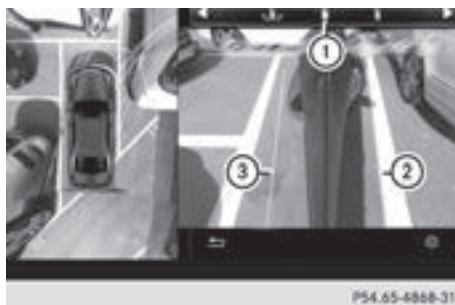

- ① Symbol for setting the top view with image from the forward camera in the exterior mirrors
- ② Yellow guide line for the vehicle width including the exterior mirrors (right side of vehicle)
- ③ Yellow guide line for the vehicle width including the exterior mirrors (left side of vehicle)

- i** You can also select the camera setting in the exterior mirrors for the rear-facing view.

### Top view with trailer view



- ① Symbol for the trailer view setting
- ② Trailer drawbar marker assistant
- ③ Ball coupling
- ④ Red guide line at a distance of approximately 0.30 m from the ball coupling

The lines are shown at the level of the trailer coupling.

- i** For technical reasons, the ball coupling of the trailer tow hitch is only partially visible in the multimedia system display.

### 180° view



- ① Symbol for the full screen setting with rear view camera image
  - ② Your vehicle
  - ③ Warning displays for Parking Assist PARKTRONIC
- i** 180° view can also be selected as front view.

Select this view when you are driving out of an exit and the view of crossing traffic is restricted, for example.

### Exiting 360° camera display mode

The 360° camera display is stopped:

- when you select transmission position **P**, or
- when you are driving at moderate speeds

The previous display appears in the multimedia system. You can also switch the display by selecting the  symbol in the display and pressing the controller to confirm.

### ATTENTION ASSIST

#### General notes

ATTENTION ASSIST helps you during long, monotonous journeys, such as on highways. It is active in the 37 mph (60 km/h) to 125 mph (200 km/h) range. If ATTENTION ASSIST detects typical indicators of fatigue or increasing lapses in concentration on the part of the driver, it suggests taking a break.

#### Important safety notes

ATTENTION ASSIST is only an aid to the driver. It might not always recognize fatigue or increasing inattentiveness in time or fail to recognize them at all. The system is not a substitute for a well-rested and attentive driver.

The functionality of ATTENTION ASSIST is restricted and warnings may be delayed or not occur at all:

- if the length of the journey is less than approximately 30 minutes
- if the road condition is poor, e.g. if the surface is uneven or if there are potholes
- if there is a strong side wind
- if you have adopted a sporty driving style with high cornering speeds or high rates of acceleration
- if you are predominantly driving slower than 37 mph (60 km/h) or faster than 125 mph (200 km/h)
- if you are driving with the Steering Pilot of Distance Pilot DISTRONIC activated
- if the time has been set incorrectly
- in active driving situations, such as when you change lanes or change your speed

The attention level evaluation is deleted and restarts when the journey is continued, if:

- you switch off the engine
- you take off your seat belt and open the driver's door, e.g. for a change of drivers or to take a break

## Displaying the attention level



You can have current status information displayed in the assistance menu (▷ page 236) of the on-board computer.

- ▶ Select the Assistance display for ATTENTION ASSIST using the on-board computer (▷ page 236).

The following information is displayed:

- the length of the journey since the last break.
- the attention level determined by ATTENTION ASSIST, displayed in a bar display in five levels from high to low.
- If ATTENTION ASSIST is unable to calculate the attention level and cannot output a warning, the **System suspended** message appears. The bar display then changes the display, e.g. if you are driving at a speed below 37 mph (60 km/h) or above 125 mph (200 km/h).

## Activating ATTENTION ASSIST

- ▶ Activate ATTENTION ASSIST using the on-board computer (▷ page 237). The system determines the attention level of the driver depending on the setting selected:

**Standard selected:** the sensitivity with which the system determines the attention level is set to normal.

**Sensitive selected:** the sensitivity is set higher. The attention level detected by Attention Assist

is adapted accordingly and the driver is warned earlier.

When ATTENTION ASSIST is deactivated, the  symbol and OFF appear in the multifunction display in the assistance display when the engine is running.

When ATTENTION ASSIST has been deactivated, it is automatically reactivated after the engine has been stopped. The sensitivity selected corresponds to the last selection activated (standard/sensitive).

## Warning in the multifunction display

If fatigue or increasing lapses in concentration are detected, a warning appears in the multifunction display: **Attention Assist: Take a Break!**

In addition to the message shown in the multifunction display, you will then hear a warning tone.

- ▶ If necessary, take a break.
- ▶ Confirm the message by pressing the **OK** button on the steering wheel.

On long journeys, take regular breaks in good time to allow yourself to rest. If you do not take a break, you will be warned again after 15 minutes at the earliest. This will only happen if ATTENTION ASSIST still detects typical indicators of fatigue or increasing lapses in concentration.

**Vehicles with COMAND:** if a warning is issued in the multifunction display, a service station search is performed in COMAND. You can select a service station and navigation to this service station will then begin. This function can be activated and deactivated in COMAND.

## Traffic Sign Assist

### General notes

Traffic Sign Assist displays the maximum speed permitted to the driver in the instrument cluster. The data stored in the navigation system and general traffic regulations are used to determine the current speed limit.

As Traffic Sign Assist is a map-based system, traffic signs put up temporarily (e.g. near road-works) are not detected.

If a traffic sign that is relevant to your vehicle is passed, the display of the speed limits is updated.

Traffic signs with a restriction indicated by an additional sign (e.g. in wet conditions) are also shown.

The traffic signs are only displayed with the restrictions if:

- The regulation must be observed with the restriction, or
- Traffic Sign Assist is unable to determine whether the restriction applies

If Traffic Sign Assist is unable to determine a maximum permitted speed from any of the available sources, no speed limit is displayed in the instrument cluster either.



Traffic Sign Assist is not available in all countries. In this case, symbol ① is shown in the assistance graphic display (▷ page 236).

### Important safety notes

Traffic Sign Assist is only an aid and is not always able to correctly display speed limits. Traffic signs always have priority over the Traffic Sign Assist display.

The system may be either functionally impaired or temporarily unavailable if the information in the digital street map of the navigation system is incorrect or out of date.

### Instrument cluster display

#### Displaying the assistance graphic

- ▶ Call up the assistance graphics display function using the on-board computer (▷ page 236).
- ▶ Select the Traffic Sign Assist display. Detected traffic signs are displayed in the instrument cluster.

### Speed limit with unknown restriction



- ① Maximum permitted speed
- ② Maximum permitted speed for vehicles for which the restriction in the additional sign is relevant
- ③ Additional sign for unknown restriction

A maximum permitted speed of 80 mph (80 km/h) and a speed limit of 60 mph (60 km/h) with an unknown restriction apply.

### Lane Tracking package

#### General notes

The Lane Tracking package consists of Blind Spot Assist (▷ page 204) and Lane Keeping Assist (▷ page 206).

#### Blind Spot Assist

##### General notes

Blind Spot Assist monitors the areas on either side of the vehicle that are not visible to the driver with two lateral, rear-facing radar sensors. A warning display in the exterior mirrors draws your attention to vehicles detected in the monitored area. If you then switch on the corresponding turn signal to change lane, you will also receive an optical and audible warning.

Blind Spot Assist supports you from a speed of approximately 20 mph (30 km/h).

## Important safety notes

### WARNING

Blind Spot Assist does not react to:

- vehicles overtaken too closely on the side, placing them in the blind spot area
- vehicles which approach with a large speed differential and overtake your vehicle

As a result, Blind Spot Assist may not give warnings in such situations. There is a risk of an accident.

Always observe the traffic conditions carefully, and maintain a safe lateral distance.

Blind Spot Assist is only an aid. It may fail to detect some vehicles and is no substitute for attentive driving. Always ensure that there is sufficient distance to the side for other road users and obstacles.

### USA only:

This device has been approved by the FCC as a "Vehicular Radar System". The radar sensor is intended for use in an automotive radar system only. Removing, tampering with, or altering the device will void any warranties, and is not permitted by the FCC. Do not tamper with, alter, or use in any non-approved way.

Any unauthorized modification to this device could void the user's authority to operate the equipment.

## Radar sensors

The radar sensors for Blind Spot Assist are integrated into the rear bumper. Make sure that the bumpers are free from dirt, ice or slush. The sensors must not be covered, for example by cycle racks or overhanging loads. Following a severe impact or in the event of damage to the bumpers, have the function of the radar sensors checked at a qualified specialist workshop. Blind Spot Assist may no longer work properly.

## Monitoring area

In particular, the detection of obstacles can be impaired if:

- there is dirt on the sensors or anything else covering the sensors
- there is poor visibility, e.g. due to fog, heavy rain, snow or spray

- there are narrow vehicles, e.g. motorcycles or bicycles
- the road has very wide lanes
- the road has narrow lanes
- you are not driving in the middle of the lane
- there are barriers or similar lane borders

Vehicles in the monitoring range are then not indicated.

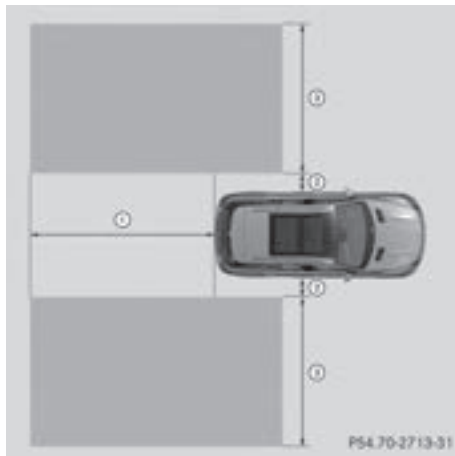

At a distance of around 1.6 ft (0.5 m) ② from the vehicle, Blind Spot Assist monitors the area up to 10 ft (3 m) next to ③ and behind ① your vehicle, as shown in the picture.

If the lanes are narrow, vehicles driving in the lane beyond the lane next to your vehicle may be indicated, especially if the vehicles are not driving in the middle of their lane. This may be the case if there are vehicles driving at the inner edge of their lanes.

Due to the nature of the system:

- warnings may be issued in error when driving close to crash barriers or similar solid lane borders.
- the warning is canceled when driving for an extended period next to long vehicles, such as trucks.

## Warning lamp

Blind Spot Assist is not active at speeds below approximately 20 mph (30 km/h). Vehicles in the monitoring range are then not indicated.



### ① Warning lamp

If Blind Spot Assist is activated, warning lamp ① in the exterior mirrors lights up yellow at speeds of up to 20 mph (30 km/h). At speeds above 20 mph (30 km/h), the warning lamp goes out and Blind Spot Assist is operational.

If a vehicle is detected within the blind spot monitoring range at speeds above 20 mph (30 km/h), warning lamp ① on the corresponding side lights up red. This warning is always emitted when a vehicle enters the blind spot monitoring range from behind or from the side. When you overtake a vehicle, the warning only occurs if the difference in speed is less than 7 mph (12 km/h).

If you select the reverse gear, Blind Spot Assist is not operational.

The brightness of the warning lamps is automatically adapted to the brightness of the surroundings.

### Collision warning

If a vehicle is detected in the monitoring range of Blind Spot Assist and you switch on the corresponding turn signal, a double warning tone sounds. Red warning lamp ① flashes. If the turn signal remains on, detected vehicles are indicated by the flashing of red warning lamp ①. There are no further warning tones.

### Switching on Blind Spot Assist

- ▶ Make sure that Blind Spot Assist is activated in the on-board computer (▷ page 237).
- ▶ Turn the SmartKey to position ② in the ignition lock. Warning lamps ① in the exterior mirrors light up red for approximately 1.5 seconds and then turn yellow.

### Towing a trailer

When you attach a trailer, make sure you have correctly established the electrical connection. This can be accomplished by checking the trailer lighting. In this event, Blind Spot Assist is deactivated. The warning lamp lights up yellow in the exterior mirrors and the **Blind Spot Assist Not Available When Towing a Trailer See Operator's Manual** message appears in the multifunction display.

① You can deactivate the warning lamps in the exterior mirrors.

To do so, switch off Blind Spot Assist when:

- the SmartKey is in position ② in the ignition lock
- the engine is not running

### Lane Keeping Assist

#### General notes



### ① Lane Keeping Assist camera

Lane Keeping Assist monitors the area in front of your vehicle with camera ①, which is mounted at the top of the windshield. Lane Keeping Assist detects lane markings on the road and can warn you before you leave your lane unintentionally. This function is available in the range between 40 mph and 120 mph (60 km/h and 200 km/h). A warning may be given if a front wheel passes over a lane marking. It will warn you by means of intermittent vibration in the steering wheel for up to 1.5 seconds.

### Important safety notes

#### ⚠ WARNING

Lane Keeping Assist cannot always clearly detect lane markings.



In such cases, Lane Keeping Assist can:

- give an unnecessary warning
- not give a warning

There is a risk of an accident.

Always pay particular attention to the traffic situation and keep within the lane, especially if Lane Keeping Assist alerts you.

### **WARNING**

The Lane Keeping Assist warning does not return the vehicle to the original lane. There is a risk of an accident.

You should always steer, brake or accelerate yourself, in particular if warned by Lane Keeping Assist.

If you fail to adapt your driving style, Lane Keeping Assist can neither reduce the risk of an accident nor override the laws of physics. Lane Keeping Assist cannot take into account the road, traffic and weather conditions. Lane Keeping Assist is merely an aid. You are responsible for the distance to the vehicle in front, for vehicle speed, for braking in good time and for staying in your lane.

The Lane Keeping Assist does not keep the vehicle in the lane.

The system may be impaired or may not function if:

- there is poor visibility, e.g. due to insufficient illumination of the road, or due to snow, rain, fog or heavy spray
- there is glare, e.g. from oncoming traffic, the sun or reflection from other vehicles (e.g. if the road surface is wet)
- the windshield is dirty, fogged up, damaged or covered, for instance by a sticker, in the vicinity of the camera
- there are no or several unclear lane markings for one lane, e.g. roadworks
- the lane markings are worn away, dark or covered up, e.g. by dirt or snow
- the distance to the vehicle in front is too short and thus the lane markings cannot be detected
- the lane markings change quickly, e.g. lanes branch off, cross one another or merge
- the road is narrow and winding
- there are strong shadows cast on the road

## Switching on Lane Keeping Assist

- ▶ Switch on Active Lane Keeping Assist using the on-board computer; to do so, select **Standard** or **Adaptive** (▷ page 237). If you drive at speeds above 40 mph (60 km/h) and lane markings are detected, the lines in the assistance graphic are shown in green (▷ page 236). Lane Keeping Assist is ready for use.

### Standard

If **Standard** is selected, no warning vibration occurs if:

- you switch on the turn signals. In this event, the warnings are suppressed for a certain period of time
- a driving safety system intervenes, such as ABS, BAS or ESP®

### Adaptive

When **Adaptive** is selected, no warning vibration occurs if:

- you switch on the turn signals. In this event, the warnings are suppressed for a certain period of time
- a driving safety system intervenes, e.g. ABS, BAS or ESP®
- you accelerate hard, e.g. kickdown
- you brake hard
- you steer actively, e.g. swerve to avoid an obstacle or change lanes quickly
- you cut the corner on a sharp bend

To ensure that you are warned only when necessary and in good time if you cross the lane markings, the system detects certain conditions and warns you accordingly.

The warning vibration occurs earlier if:

- you approach the outer lane marking on a bend
- the road has very wide lanes, e.g. a freeway
- the system detects solid lane markings

The warning vibration occurs later if:

- the road has narrow lanes
- you cut the corner on a bend

## Driving Assistance Plus package

### General notes

The Driving Assistance Plus package consists of Distance Pilot DISTRONIC (▷ page 171), Active Blind Spot Assist (▷ page 208) and Active Lane Keeping Assist (▷ page 210).

### Active Blind Spot Assist

#### General notes

Active Blind Spot Assist monitors the areas on either side of the vehicle that are not directly visible to the driver with two lateral, rear-facing radar sensors. A warning lamp lights up in the exterior mirrors and draws your attention to vehicles detected in the monitored area. If you then switch on the corresponding turn signal to change lanes, you will also receive a visual and audible collision warning. If a risk of lateral collision is detected, corrective braking may help you avoid a collision. Before a course-correcting brake application, Active Blind Spot Assist evaluates the space in the direction of travel and at the sides of the vehicle. For this, Active Blind Spot Assist uses the forward-facing radar sensors.

Active Blind Spot Assist supports you from a speed of approximately 20 mph (30 km/h).

#### Important safety notes

Active Blind Spot Assist is only an aid and is not a substitute for attentive driving.

#### WARNING

Active Blind Spot Assist does not react to:

- vehicles overtaken too closely on the side, placing them in the blind spot area
- vehicles which approach with a large speed differential and overtake your vehicle

As a result, Active Blind Spot Assist may neither give warnings nor intervene in such situations. There is a risk of an accident.

Always observe the traffic conditions carefully, and maintain a safe lateral distance.

- i** USA only: This device has been approved by the FCC as a "Vehicular Radar System". The radar sensor is intended for use in an automotive radar system only. Removal, tampering, or altering of the device will void any war-

ranties, and is not permitted by the FCC. Do not tamper with, alter, or use in any non-approved way.

Any unauthorized modification to this device could void the user's authority to operate the equipment.

- i** Canada only: This device complies with RSS-210 of Industry Canada. Operation is subject to the following two conditions:

1. This device may not cause interference, and
2. This device must accept any interference received, including interference that may cause undesired operation of the device.

Removal, tampering, or altering of the device will void any warranties, and is not permitted. Do not tamper with, alter, or use in any non-approved way.

Any unauthorized modification to this device could void the user's authority to operate the equipment.

### Radar sensors

The Active Blind Spot Assist radar sensors are integrated into the front and rear bumpers and behind a cover in the radiator trim. Make sure that the bumpers and the cover in the radiator grill are free of dirt, ice or slush. The sensors must not be covered, for example by cycle racks or overhanging loads. Following an accident or in the event of damage to the bumpers, have the function of the radar sensors checked at a qualified specialist workshop. Active Blind Spot Assist may otherwise no longer work properly.

### Monitoring area

#### WARNING

Active Blind Spot Assist does not detect all traffic situations and road users. There is a risk of an accident.

Always make sure that there is sufficient distance on the side for other traffic or obstacles.



At a distance of approximately 1.6 ft (0.5 m) ② from the vehicle, Active Blind Spot Assist monitors the area up to 10 ft (3 m) next to ③ and behind ① your vehicle, as shown in the picture. In particular, the detection of obstacles can be impaired if:

- there is dirt on the sensors or anything else covering the sensors
- poor visibility, e.g. due to rain, snow or spray

Vehicles in the monitoring range are then not reliably indicated.

Active Blind Spot Assist may not detect narrow vehicles, such as motorcycles or bicycles, or may only detect them too late.

If the lanes are narrow, vehicles driving in the lane beyond the lane next to your vehicle may be indicated, especially if the vehicles are not driving in the middle of their lane. This may be the case if there are vehicles at the inner edge of your lane.

On very wide lanes, vehicles in the adjacent lane may not be shown if they are too far away.

Due to the nature of the system:

- warnings may be issued in error when driving close to crash barriers or similar solid lane borders.
- warnings may be interrupted when driving alongside particularly long vehicles, e.g. trucks, for a prolonged time.

## Warning lamp



### ① Warning lamp

Active Blind Spot Assist is not operational at speeds below approximately 20 mph (30 km/h). Vehicles in the monitoring range are then not indicated.

If Active Blind Spot Assist is activated, warning lamp ① in the exterior mirrors lights up yellow at speeds of up to 20 mph (30 km/h). At speeds above 20 mph (30 km/h), the warning lamp goes out and Active Blind Spot Assist is operational.

If a vehicle is detected within the monitoring range at speeds above approximately 20 mph (30 km/h), warning lamp ① on the corresponding side lights up red. This warning lamp always lights up when a vehicle enters the blind spot monitoring range from behind or from the side. When you overtake a vehicle, the warning only occurs if the difference in speed is less than 7 mph (12 km/h).

If you select the reverse gear, Active Blind Spot Assist is not operational.

The brightness of the warning lamps is automatically adapted to the brightness of the surroundings.

## Visual and acoustic collision warning

If you switch on the turn signals to change lanes and a vehicle is detected in the side monitoring range, you receive a visual and acoustic collision warning. You then hear a double warning tone and red warning lamp ① flashes. If the turn signal remains on, detected vehicles are indicated by the flashing of red warning lamp ①. There are no further warning tones.

### Course-correcting brake application

If Active Blind Spot Assist detects a risk of a lateral collision in the monitoring range, a course-correcting brake application is carried out. This is meant to assist you in avoiding a collision.

#### WARNING

A course-correcting brake application cannot always prevent a collision. There is a risk of an accident.

Always steer, brake or accelerate yourself, especially if Active Blind Spot Assist warns you or makes a course-correcting brake application. Always maintain a safe distance at the sides.

If a course-correcting brake application occurs, red warning lamp  flashes in the exterior mirror and a double warning tone sounds. In addition, a display underlining the danger of a side collision appears in the multifunction display.

In very rare cases, the system may make an inappropriate brake application. A course-correcting brake application may be interrupted at any time by countersteering slightly or accelerating.



The course-correcting brake application is available in the speed range between 20 mph (30 km/h) and 120 mph (200 km/h).

Either no braking application, or a course-correcting brake application adapted to the driving situation occurs if:

- there are vehicles or obstacles, e.g. crash barriers, located on both sides of your vehicle.
- a vehicle approaches you too closely at the side.
- you have adopted a sporty driving style with high cornering speeds.
- you clearly brake or accelerate.
- a driving safety system intervenes, e.g. ESP® or PRE-SAFE® Brake.
- ESP® is switched off.
- the offroad program is activated (vehicles without the Offroad Engineering package).
- the Offroad or Offroad Plus drive program is activated (vehicles with the Off-Road Engineering package).

- the LOW RANGE offroad gear is activated (vehicles with the Offroad Engineering package).
- a loss of tire pressure or a defective tire is detected.

### Switching on Active Blind Spot Assist

- ▶ Make sure that Active Blind Spot Assist (▷ page 237) is activated in the on-board computer.
- ▶ Turn the SmartKey to position  in the ignition lock.  
Warning lamps  in the exterior mirrors light up red for approximately 1.5 seconds and then turn yellow.

### Towing a trailer

When you attach a trailer, make sure you have correctly established the electrical connection. This can be accomplished by checking the trailer lighting. Active Blind Spot Assist is then deactivated. The indicator lamp lights up yellow in the exterior mirrors and the **Active Blind Spot Asst. Not Available When Towing a Trailer** See Operator's Manual message appears in the multifunction display.

### Active Lane Keeping Assist

#### General notes

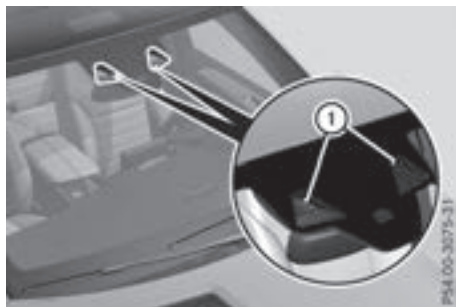

Active Lane Keeping Assist monitors the area in front of your vehicle by means of multifunction camera  at the top of the windshield. Various different areas to the front, rear and side of your vehicle are also monitored with the aid of the radar sensor system. Active Lane Keeping Assist detects lane markings on the road and can warn you before you leave your lane unintentionally. If you do not react to the warning, a

lane-correcting application of the brakes can bring the vehicle back into the original lane.

This function is available in a speed range between 40 mph and 120 mph (60 km/h and 200 km/h).

For Active Lane Keeping Assist to assist you when driving, the radar sensor system must be operational.

### Important safety notes

If you fail to adapt your driving style, Active Lane Keeping Assist can neither reduce the risk of accident nor override the laws of physics. Active Lane Keeping Assist cannot take into account road, weather or traffic conditions. Active Lane Keeping Assist is only an aid. You are responsible for the distance to the vehicle in front, for vehicle speed, for braking in good time and for staying in your lane.

Active Lane Keeping Assist cannot continuously keep your vehicle in its lane.

#### WARNING

Active Lane Keeping Assist cannot always clearly detect lane markings.

In such cases, Active Lane Keeping Assist can:

- give an unnecessary warning and then make a course-correcting brake application to the vehicle
- not give a warning or intervene

There is a risk of an accident.

Always pay particular attention to the traffic situation and keep within the lane, especially if Active Lane Keeping Assist alerts you. Terminate the intervention in a non-critical driving situation.

The system may be impaired or may not function if:

- there is poor visibility, e.g. due to insufficient illumination of the road, or due to snow, rain, fog or heavy spray
- there is glare, e.g. from oncoming traffic, the sun or reflection from other vehicles (e.g. if the road surface is wet)
- the windshield is dirty, fogged up, damaged or covered, for instance by a sticker, in the vicinity of the camera

- there are no or several unclear lane markings for one lane, e.g. roadworks
- the lane markings are worn away, dark or covered up, e.g. by dirt or snow
- the distance to the vehicle in front is too short and thus the lane markings cannot be detected
- the lane markings change quickly, e.g. lanes branch off, cross one another or merge
- the road is narrow and winding
- there are highly variable shade conditions on the roadway
- no vehicle is detected in the adjacent lane and there are broken lane markings

### Warning vibration in the steering wheel

A warning may be given if a front wheel passes over a lane marking. It will warn you by means of intermittent vibration in the steering wheel for up to 1.5 seconds.

In order that you are warned only when necessary and in good time if you cross the lane marking, the system detects certain conditions and warns you accordingly.

The warning vibration occurs earlier if:

- you approach the outer lane marking on a bend
- the road has very wide lanes, e.g. a freeway
- the system detects solid lane markings

The warning vibration occurs later if:

- the road has narrow lanes
- you cut the corner on a bend

### Lane-correcting brake application

#### WARNING

A lane-correcting brake application cannot always bring the vehicle back into the original lane. There is a risk of an accident.

Always steer, brake or accelerate yourself, especially if Active Lane Keeping Assist warns you or makes a lane-correcting brake application.

#### WARNING

Active Lane Keeping Assist does not detect traffic conditions or road users. In very rare cases, the system may make an inappropriate brake application, e.g. after intentionally driv-

ing over a solid lane marking. There is a risk of an accident.

An inappropriate brake application may be interrupted at any time if you steer slightly in the opposite direction. Always make sure that there is sufficient distance on the side for other traffic or obstacles.



If you leave your lane, under certain circumstances the vehicle will brake briefly on one side. This is meant to assist you in bringing the vehicle back to the original lane.

If a lane-correcting brake application occurs, display ① appears in the multifunction display.

A lane-correcting brake application can be made after driving over a solid or broken lane marking. Before this, a warning must be given by means of intermittent vibration in the steering wheel. In addition, a lane with lane markings on both sides must have been detected.

In the case of a broken lane marking being detected, a lane-correcting brake application can only be made if a vehicle has been detected in the adjacent lane. The following vehicles can have an influence on brake application: oncoming traffic, vehicles that are overtaking and vehicles that are driving parallel to your vehicle.

- ① A further lane-correcting brake application can only occur after your vehicle has returned to the original lane.

No lane-correcting brake application occurs if:

- you clearly and actively steer, brake or accelerate.
- you cut the corner on a sharp bend
- you have switched on the turn signal
- a driving safety system intervenes, e.g. ESP®, PRE-SAFE® Brake or Active Blind Spot Assist

- you have adopted a sporty driving style with high cornering speeds or high rates of acceleration
- ESP® is switched off
- the transmission is not in position **D**
- on vehicles with a trailer tow hitch, the electrical connection to the trailer has been correctly established
- the Off-road program is activated (vehicles without the Off-Road Engineering package)
- the Off-road or Off-road Plus drive program is activated (vehicles with the Off-Road Engineering package)
- the LOW RANGE off-road gear is activated (vehicles with the Off-Road Engineering package)
- an obstacle has been detected in the lane in which you are driving
- when a loss of tire pressure or a defective tire has been detected and displayed

There is a possibility that the Active Lane Keeping Assist could misjudge the given traffic situation. An inappropriate brake application may be interrupted at any time if you:

- steer slightly in the opposite direction
- switch on the turn signal
- clearly brake or accelerate

A lane-correcting brake application is interrupted automatically if:

- a driving safety system intervenes, e.g. ESP®, PRE-SAFE® Brake or Active Blind Spot Assist
- lane markings are no longer detected

### Switching on Active Lane Keeping Assist

- Switch on Active Lane Keeping Assist using the on-board computer; to do so, select **Standard** or **Adaptive** (▷ page 237).

If you drive at speeds above 40 mph (60 km/h) and lane markings are detected, the lines in the assistance graphic are shown in green (▷ page 236). Active Lane Keeping Assist is ready for use.

If **Standard** is selected, no warning vibration occurs if:

- you switch on the turn signals. In this event, the warnings are suppressed for a certain period of time
- a driving safety system intervenes, such as ABS, BAS or ESP®

When **Adaptive** is selected, no warning vibration occurs if:

- you switch on the turn signals. In this event, the warnings are suppressed for a certain period of time
- a driving safety system intervenes, e.g. ABS, BAS or ESP®
- you accelerate hard, e.g. kickdown
- you brake hard
- you steer actively, e.g. swerve to avoid an obstacle or change lanes quickly
- you cut the corner on a sharp bend

### Towing a trailer

When you attach a trailer, make sure you have correctly established the electrical connection. This can be accomplished by checking the trailer lighting. Lane-correcting brake application does not take place when towing a trailer. Active Lane Keeping Assist is not activated and the lines in the assistance graphic are gray.

## Off-road driving systems

### 4MATIC (permanent four-wheel drive)

4MATIC ensures that all four wheels are permanently driven. Together with ESP® and 4ETS, it improves the traction of your vehicle whenever a drive wheel spins due to insufficient grip.

If you fail to adapt your driving style, 4MATIC can neither reduce the risk of accident nor override the laws of physics. 4MATIC cannot take account of road, weather and traffic conditions. 4MATIC is only an aid. You are responsible for the distance to the vehicle in front, for vehicle speed, for braking in good time and for staying in your lane.

**!** Never tow the vehicle with one axle raised. This may damage the transfer case. Damage of this sort is not covered by the Mercedes-Benz Limited Warranty. All wheels must remain either on the ground or be fully raised. Observe the instructions for towing the vehicle with all wheels in full contact with the ground.

**!** A function or performance test should only be carried out on a two-axle dynamometer. Before you operate the vehicle on such a dynamometer, please consult a qualified

workshop. You could otherwise damage the drive train or the brake system.

- i** In wintry driving conditions, the maximum effect of 4MATIC can only be achieved if you use winter tires (M+S tires), with snow chains if necessary.

Further information about "Driving off-road" (▷ page 165).

## DSR (Downhill Speed Regulation)

### General notes

DSR is an aid to assist you when driving downhill. It keeps the speed of travel at the speed selected on the on-board computer. The steeper the downhill gradient, the greater the DSR braking effect on the vehicle. When driving on flat stretches of road or on an uphill gradient, the DSR braking effect is minimal or nonexistent. DSR controls the vehicle's speed when it is activated and the transmission is in position **D**, **R** or **N**. You can drive at a higher or a lower speed than that set on the on-board computer at any time by accelerating or braking.

### Important safety notes

#### WARNING

If the speed driven and the set speed deviate and you activate DSR on a slippery road surface, the wheels may lose traction. There is an increased danger of skidding and accidents. Before switching DSR on, please take into consideration the road surface and the difference between driving speed and the set speed.

If you fail to adapt your driving style, DSR can neither reduce the risk of accident nor override the laws of physics. DSR cannot take account of road, weather and traffic conditions. DSR is only an aid. You are responsible for the distance to the vehicle in front, for vehicle speed, for braking in good time and for staying in your lane.

You are always responsible for keeping control of the vehicle and for assessing whether the downhill gradient can be managed. DSR may not always be able to keep to the set speed, depending on road surface and tire conditions. Select a set speed suitable for the prevailing conditions and when necessary, apply the brakes manually.

## Activating DSR



- ▶ Press button ①.  
Indicator lamp ② lights up.  
The  DSR symbol appears in the multifunction display.

You can only activate DSR when driving at speeds below 25 mph (40 km/h).

If the current vehicle speed is too high, the  DSR symbol appears in the multifunction display with the **Max. speed 25 mph** message (Canada: **40 km/h**).

If you have activated DSR and you change the drive program, DSR is deactivated. If you switch between the offroad and offroad plus drive programs, DSR remains activated.

## Deactivating DSR

- ▶ Press button ①.  
Indicator lamp ② goes out.  
The  DSR symbol appears in the multifunction display with the **Off** message.

On vehicles with the Offroad Engineering package, if you select a different drive program, DSR is also deactivated. If you switch between the Offroad programs, DSR remains activated.

DSR switches off automatically if you drive faster than 28 mph (Canada: 45 km/h). The  DSR symbol appears in the multifunction display with the **Off** message. The status indicator in the multifunction display goes out. You also hear a warning. On vehicles with the Offroad Engineering package, if you select a different onroad/offroad program, DSR is also deactivated.

## Changing the set speed

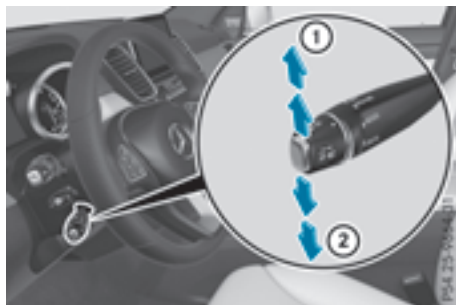

- ▶ **To increase or reduce the set speed in 1 mph increments (Canada: 1 km/h increments):** briefly press the cruise control lever up ① for a higher set speed or down ② for a lower set speed.  
The set speed appears in the multifunction display with the  DSR symbol.

When DSR is activated, you can change the set speed to a value between 1 mph and 11 mph (Canada: between 2 km/h and 18 km/h).

- ① The DSR set speed is always changed in 1 mph increments (Canada: 1 km/h increments). This is regardless of whether you press the cruise control lever to or beyond the pressure point.

## Offroad program (vehicles without the Offroad Engineering package)

### General notes

Select the **Offroad** program for easily negotiable off-road terrain, e.g. dirt tracks, gravel or sandy surfaces. The engine's torque is restricted to a limited degree and the drive wheels can spin. The spinning wheels produce a cutting effect for better traction. ABS, ESP® and 4ETS programs especially adapted to off-road driving are activated. A gentle accelerator pedal curve is also selected, i.e. the accelerator pedal must be depressed much further in order to accelerate.

You can select the **Offroad** drive program at speeds below 60 mph (96 km/h). The **Drive program "Offroad" Max. Speed 60 mph** message appears in the multifunction display. If you drive at speeds of more than 60 mph (96 km/h) and select the **Offroad** drive program, the **Drive More Slowly** message



appears in the multifunction display. The last active drive program is selected again.

Do not use the **Offroad** program on roads that are snow-covered or icy or if you have installed your vehicle with snow chains.

### Selecting the Offroad program



Selecting the Offroad program

- To select drive program: turn DYNAMIC SELECT controller ① until indicator lamp ② lights up.

The **Drive Program "Offroad1" Max. Speed 60 mph** message appears in the multifunction display.

The vehicle is raised by +2.4 in (60 mm).

The vehicle is lowered to normal level again if you:

- drive at speeds above 50 mph (80 km/h) (all vehicles except Mercedes-AMG vehicles)
- drive at speeds above 43 mph (70 km/h) (Mercedes-AMG vehicles)
- drive between 40 mph (64 km/h) and 50 mph (80 km/h) for approximately 20 seconds (all vehicles except Mercedes-AMG vehicles).
- drive at speeds between 40 mph (64 km/h) and 43 mph (70 km/h) for approximately 20 seconds (Mercedes-AMG vehicles)

The vehicle changes from the **Offroad** drive program to the **Comfort** drive program if you drive faster than 70 mph (112 km/h).

The **Drive More Slowly** message appears in the multifunction display.

Further information about "Driving off-road" (▷ page 165).

## Offroad programs (vehicles with Off-road Engineering package)

### General notes

The **Offroad** and **Offroad Plus** drive programs assist you when driving off-road. The engine's performance characteristics and the gearshifting characteristics of the automatic transmission are adapted for this purpose. ABS, ESP® and 4ETS programs especially adapted to off-road driving are activated. An accelerator pedal curve suitable for the terrain is selected, i.e. the accelerator pedal must be depressed further to accelerate.

Do not use the **Offroad** or **Offroad Plus** drive programs on roads that are snow-covered or icy, or if you have installed your vehicle with snow chains.

### Offroad drive program



- ① DYNAMIC SELECT controller
- ② **Offroad** program indicator lamp

Select the **Offroad** program for easily negotiable off-road terrain, e.g. dirt tracks, gravel or sandy surfaces. The engine's torque is restricted to a limited degree and the drive wheels can spin. The spinning wheels produce a cutting effect for better traction. ABS, ESP® and 4ETS programs especially adapted to off-road driving are activated. A gentle accelerator pedal curve is also selected, i.e. the accelerator pedal must be depressed much further in order to accelerate.

You can select the **Offroad** drive program at speeds below 60 mph (96 km/h). The **Drive Program "Offroad" Max. Speed 60 mph** message appears in the multifunction display. If you drive at speeds above 60 mph (96 km/h) and select the **Offroad** drive program, the **Drive More Slowly** message appears in the

multifunction display. The last active drive program is selected again.

### Selecting the Offroad program

- ▶ To select a drive program: turn DYNAMIC SELECT controller ① until indicator lamp ② lights up.

The **Drive program "Offroad" Max. speed 60 mph** message appears in the multifunction display.

The vehicle is raised by +1.2 in (30 mm).

The vehicle changes from the **Offroad** drive program to the **Comfort** drive program if you drive faster than 70 mph (112 km/h).

The **Drive more slowly** message appears in the multifunction display.

### Offroad Plus drive program



- ① DYNAMIC SELECT controller
- ② **Offroad Plus** drive program indicator lamp

Select the **Offroad Plus** drive program for rough terrain, e.g. for steep and/or uneven terrain or for driving on rocky terrain.

Your vehicle has an automatically activated differential lock for the transfer case. It controls the balance between the front and rear axles.

The differential lock improves the vehicle's traction. 4ETS (> page 70) controls the balance between both wheels on an axle.

### Selecting the Offroad Plus drive program

- ▶ To select drive program: turn DYNAMIC SELECT controller ① until indicator lamp ② lights up.

The **Drive program "Offroad Plus" Max. speed 25 mph** message appears in the multifunction display.

- The **Offroad Plus** program is selected and the vehicle is raised by +1.2 in (30 mm) compared with the **Offroad** drive program.
- DSR is switched on.
- The differential lock is closed.

You can select the Offroad Plus drive program at speeds below 25 mph (40 km/h).

The Offroad Plus drive program automatically switches to the Offroad drive program if you drive faster than 30 mph (45 km/h). The **Drive more slowly** message appears in the multifunction display.

Further information about "Driving off-road" (> page 165).

## LOW RANGE off-road gear (vehicles with the Off-Road Engineering package)

### Important safety notes

#### WARNING

If you select the LOW RANGE off-road gear on a slippery road surface, the wheels could lose traction:

- if you remove your foot from the accelerator pedal when driving
- if off road ABS intervenes when braking

If the wheels lose traction, the vehicle can no longer be steered. There is an increased danger of skidding and accidents.

Never select the LOW RANGE off-road gear when driving on slippery road surfaces.

#### WARNING

If you do not wait for the transfer case gear change process to complete, the transfer case could remain in the neutral position. The power transmission to the driven wheels is then interrupted. There is a danger of the vehicle rolling away unintentionally. There is a risk of an accident.

Wait until the transfer case shift process is completed.

Do not turn off the engine while changing gear and do not shift the automatic transmission to another position.

## General notes



- ① LOW RANGE offroad gear button  
 ② LOW RANGE offroad gear indicator lamp

<b>HIGH RANGE</b>	Position for all normal on-road driving conditions
<b>LOW RANGE</b>	<p>Offroad position for driving off-road and fording</p> <p>The transmission ratio between the engine and wheels is only approximately one third of that in the HIGH RANGE road position. Drive torque is thus proportionately higher.</p> <p>Do not use LOW RANGE:</p> <ul style="list-style-type: none"> <li>• on slippery road surfaces, e.g. in the case of slush</li> <li>• on snow or ice-covered roads</li> <li>• if you have mounted snow chains to your vehicle</li> </ul>

The LOW RANGE offroad gear assists you in driving off-road and when fording. When LOW RANGE is engaged, the engine's performance characteristics and the gearshifting characteristics of the automatic transmission are adapted for this purpose.

Further information about "Driving off-road" (▷ page 165). You will find information about driving safety systems in conjunction with LOW RANGE in the "Safety" section (▷ page 66).

## From HIGH RANGE to LOW RANGE

- ! Only change from LOW RANGE to HIGH RANGE if:
- the engine is running.
  - the transmission is in position **N**
  - you are driving at a speed below 40 km/h

- ▶ Press LOW RANGE button ①. Indicator lamp ② flashes. When the gear change is complete, indicator lamp ② lights up. LOW RANGE indicator appears in the multifunction display and in the status indicator.

While indicator lamp ② is flashing, you can cancel the gear change by pressing LOW RANGE button ① again.

- i You cannot activate LOW RANGE if the **SPORT** drive program is activated. The **LOW RANGE Not in Drive Program "Sport"** message then appears in the multifunction display.

## From LOW RANGE to HIGH RANGE

- ! Only change from LOW RANGE to HIGH RANGE if:
- the engine is running.
  - the transmission is in position **N**
  - you are driving at a speed below 70 km/h



- ▶ Press LOW RANGE button ①. Indicator lamp ② flashes. When the gear change is complete, indicator lamp ② goes out. In the multifunction display, the **LOW RANGE Off** message appears and the status indicator goes out.

While indicator lamp ② is flashing, you can cancel the gear change by pressing LOW RANGE button ① again.

### Messages in the multifunction display

If a gear change process has not been successful, the following messages may be displayed in the multifunction display:

Display messages	Possible causes/consequences and ► Solutions
LOW RANGE Max. Speed 24 mph	You have been driving faster than 24 mph (40 km/h). Additionally, the indicator lamp on the button in the center console is flashing. ► Slow down to change gear.
LOW RANGE Shift to Position N Briefly	The transmission is in position <b>D</b> and you are driving at below 40 km/h. ► Shift the transmission to <b>N</b> to complete the gear change process.
LOW RANGE Shifting Canceled Please Reactivate	The gear change process was not carried out. ► Ensure that all gear change conditions are fulfilled and carry out the gear change process again.
LOW RANGE Stop Apply Parking Brake	A warning tone also sounds. The gear change process has not been completed. LOW RANGE is in the neutral position. There is no connection between the engine and the drive wheels. <b>!</b> Do not drive any further. You could otherwise damage the vehicle's drive train. ► Stop the vehicle. Take into account the road and traffic conditions when doing this. ► Depress the electric parking brake (▷ page 157). ► Carry out the gear change process again. If the gear change process has been carried out, the <b>LOW RANGE Stop Apply Parking Brake</b> message disappears.

### Driving dynamics display in the COMAND display (vehicles with the Off-Road Engineering package)

#### General notes

The driving dynamics display allows you to see the selected drive program and additional information about the vehicle's operating status in the COMAND display.



- ① Drive program selected
- ② Status of the differential lock for the transfer case
- ③ Accelerator pedal position shown in %
- ④ Brake pedal position shown in %
- ⑤ Condition of the LOW RANGE offroad gear
- ⑥ Angle of inclination
- ⑦ Steering angle
- ⑧ Uphill or downhill gradient in percentage

- ⑨ Level control
- ⑩ Compass with angle scale

### Activating the driving dynamics display



- ▶ Switch on COMAND (see the Digital Operator's Manual).
- ▶ Press button ①.  
The driving dynamics display appears in the COMAND display.

## Towing a trailer

### Important safety notes

#### WARNING

Installing an unsuitable ball coupling may result in overloading of the trailer tow hitch and the rear axle. This applies especially if the ball coupling in question is longer or angled differently. This could seriously impair the driving characteristics and the trailer can come loose. There is a risk of an accident.

You should only ever install a ball coupling that has the permissible dimensions and that is designed to meet your trailer-towing requirements. Do not modify the ball coupling or the trailer tow hitch.

You will find the values approved by the manufacturer on the vehicle identification plates and those for the towing vehicle under "Technical data" (> page 394).

#### WARNING

If the ball coupling is not installed correctly or not secured with the bolt provided and the

corresponding spring cotter, the trailer may come loose. There is a risk of an accident.

Always install and secure the ball coupling as described. Before every journey, ensure that the ball coupling is secured with the bolt and the corresponding spring cotter.

#### WARNING

When the vehicle/trailer combination begins to lurch, you could lose control of it. The vehicle/trailer combination could even rollover. There is a risk of an accident.

On no account should you attempt to straighten up the vehicle/trailer combination by increasing the speed. Reduce vehicle speed and do not countersteer. Apply the brake as necessary.

Please observe the manufacturer's operating instructions for the trailer coupling if a detachable trailer coupling is used.

Couple and uncouple the trailer carefully. If you do not couple the trailer to the towing vehicle correctly, the trailer could become detached.

Make sure that the following values are not exceeded:

- the permissible trailer drawbar noseweight
- the permissible trailer load
- the permissible rear axle load of the towing vehicle
- the maximum permissible gross vehicle weight of both the towing vehicle and the trailer

The applicable permissible values, which must not be exceeded, can be found:

- in the vehicle documents
- on the identification plates for the trailer tow hitch and the trailer
- on the vehicle identification plate

If the values differ, the lowest value applies.

When towing a trailer, your vehicle's handling characteristics will be different in comparison with when driving without a trailer.

The vehicle/trailer combination:

- is heavier
- is restricted in its acceleration and gradient-climbing capability
- has an increased braking distance

- is affected more by strong crosswinds
- demands more sensitive steering
- has a larger turning circle

This could impair the handling characteristics.

When towing a trailer, always adjust your speed to the current road and weather conditions. Do not exceed the maximum permissible speed for your vehicle/trailer combination.

### Notes on towing a trailer

#### General notes

**!** If you have a trailer tow hitch retrofitted, changes to the cooling system and drive train may be necessary, depending on the vehicle type.

If you have a trailer tow hitch retrofitted, observe the anchorage points on the chassis frame.

- Do not exceed the legally prescribed maximum speed for vehicle/trailer combinations in the relevant country.

This lowers the risk of an accident.

- Only install an approved trailer coupling on your vehicle.

More information on availability and installation can be obtained at any qualified specialist workshop.

- The bumpers of your vehicle are not suitable for installing detachable trailer couplings.
- Do not install hired trailer couplings or other detachable trailer couplings on the bumpers of your vehicle.
- If you no longer need the ball coupling, remove it from the ball coupling recess. This will reduce the risk of damage to the ball coupling.

When towing a trailer, set the tire pressure on the rear axle of the towing vehicle for the maximum load. You will find the values in the tire pressure table in the fuel filler flap of the vehicle (▷ page 369).

Please note that when towing a trailer, the following driving systems have limited availability or are not available at all:

- Parking Assist PARKTRONIC (▷ page 187)
- Blind Spot Assist (▷ page 204)
- Active Lane Keeping Assist (▷ page 210)

On vehicles without level control, the height of the ball coupling will alter according to the load placed on the vehicle. If necessary, use a trailer with a height-adjustable drawbar.

You will find installing dimensions and loads under "Technical data" (▷ page 394).

#### Driving tips

Also observe the notes on pulling away with a trailer (▷ page 138).

The maximum permissible speed for vehicle/trailer combinations depends on the type of trailer. Before beginning the journey, check the trailer's documents to see what the maximum permissible speed is for your trailer. Observe the legally permissible maximum speed in the relevant country.

For certain Mercedes-Benz vehicles, the maximum permissible rear axle load is increased when towing a trailer. See "Technical data" to find out whether this applies to your vehicle (▷ page 394). If you utilize any of the added maximum rear axle load when towing a trailer, the vehicle/trailer combination may not exceed a maximum speed of 60 mph (100 km/h) for reasons concerning the operating permit. This also applies in countries in which the maximum permissible speed for car/trailer combinations is greater than 60 mph (100 km/h).

When towing a trailer, your vehicle's handling characteristics will be different in comparison with when driving without a trailer.

Use the left-hand steering wheel paddle shifter to shift into a lower gear in good time on long and steep downhill gradients.

This also applies if you have activated cruise control or Distance Pilot DISTRONIC.

This will use the braking effect of the engine, so that less braking will be required to maintain the speed. This relieves the load on the brake system and prevents the brakes from overheating and wearing too quickly. If you need additional braking, depress the brake pedal repeatedly rather than continuously.

#### Driving tips

If the trailer swings from side to side:

- ▶ Do not accelerate.
- ▶ Do not counter-steer.
- ▶ Brake if necessary.

- Maintain a greater distance from the vehicle in front than when driving without a trailer.
- Avoid braking abruptly. If possible, brake gently at first to allow the trailer to run on. Then, increase the braking force rapidly.
- The values given for gradient-climbing capabilities from a standstill refer to sea level. When driving in mountainous areas, note that the power output of the engine and, consequently, the vehicle's gradient-climbing capability, decreases with increasing altitude.

### Installing the ball coupling

#### WARNING

If the ball coupling is not correctly installed and secured, it can come loose during the journey and endanger other road users. There is a risk of an accident and injury.

Always install and secure the ball coupling as described. Before every journey, ensure that the ball coupling is secured with the bolt and the corresponding spring cotter.

#### WARNING

If the ball coupling is not installed correctly or not secured with the bolt provided and the corresponding spring cotter, the trailer may come loose. There is a risk of an accident.

Always install and secure the ball coupling as described. Before every journey, ensure that the ball coupling is secured with the bolt and the corresponding spring cotter.

#### WARNING

If the ball coupling is not installed and secured correctly the trailer may come loose. There is a risk of an accident.

Install and secure the ball coupling as described in the ball coupling installation instructions. Make sure that the ball coupling is installed and secured correctly before every journey.

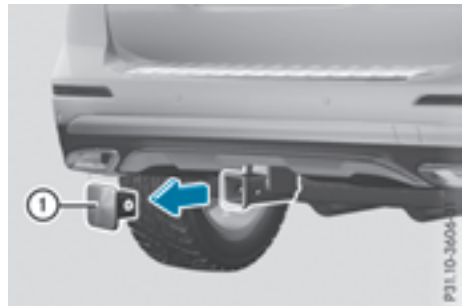

- ▶ Pull protective cap ① in the direction of the arrow, out of the ball coupling recess.
- ▶ Stow protective cap ① so that it cannot be thrown around.

Observe the loading guidelines (▷ page 295) and the safety notes regarding stowage spaces (▷ page 295).

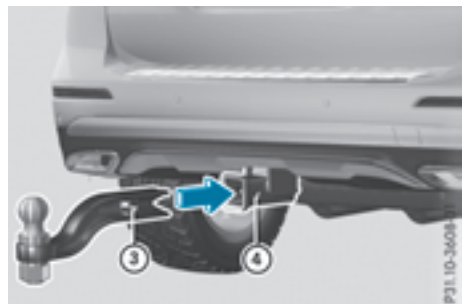
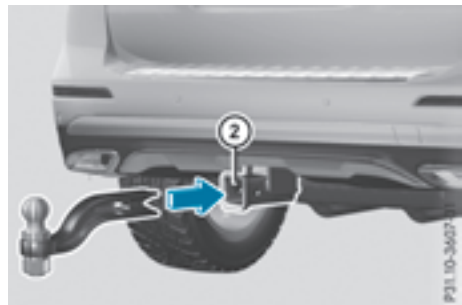

- ▶ Insert the ball coupling horizontally into ball coupling recess ② in the direction of the arrow until the holes in ball coupling ③ are in line with the holes in ball coupling recess ④.

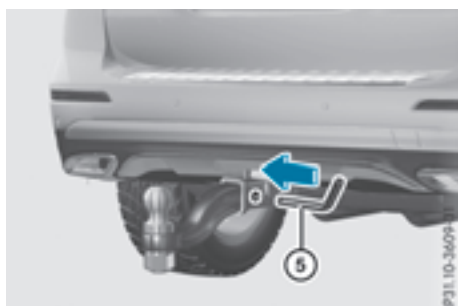

- ▶ Slide bolt ⑤ into the hole in the ball coupling recess and the ball coupling to the stop.

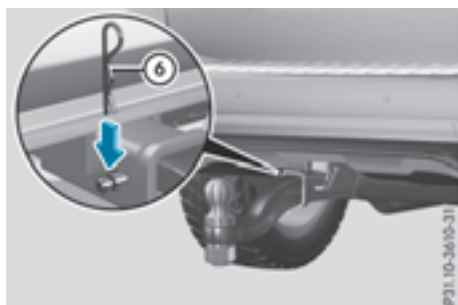

- ▶ Secure the bolt using spring cotter ⑥.



- ▶ Check the ball coupling, bolt and spring cotter for correct installation.

If the ball coupling cannot be correctly mounted, remove the ball coupling. Under these circumstances, the ball coupling must not be used for trailer towing.

Have the entire trailer tow hitch checked at a qualified specialist workshop.

## Coupling up a trailer

**!** Do not connect the trailer's brake system (if featured) to the hydraulic brake system of the towing vehicle, as the latter is equipped with an anti-lock brake system. Doing so will result in a loss of function of the brake systems of both the vehicle and the trailer.

- ▶ Shift the transmission to position **P**.
- ▶ Apply the vehicle's electric parking brake.
- ▶ Start the engine.
- ▶ **Vehicles with AIRMATIC package:** select normal level and the **Comfort** drive program.
- ▶ Switch off the engine.
- ▶ Close the doors and tailgate.
- ▶ Couple up the trailer.
- ▶ Establish the electrical connection between the vehicle and the trailer.
- ▶ Check that the trailer lighting system is working.
- ▶ Push the combination switch upwards/downwards and check whether the corresponding turn signal on the trailer flashes.

A trailer that is connected is recognized only when the electrical connection is established correctly and when the lighting system is working properly. The function of other systems also depends on this, for example:

- ESP®
- Parking Assist PARKTRONIC
- Parking Pilot
- Active Blind Spot Assist
- Active Lane Keeping Assist

**i** Vehicles with the AIRMATIC package: if you couple up a trailer, the vehicle always remains at normal level. When coupling up a trailer, please observe the following:

- If the normal level has not been set manually, the vehicle is automatically lowered to normal level. This is the case if a speed of 5 mph (8 km/h) is reached.
- The **Sport** drive program is not available.

These restrictions apply to all accessories powered through a connection to the trailer power socket of your vehicle, e.g. a bicycle carrier.

Observe the maximum permissible trailer dimensions (width and length).



Most U.S. states and all Canadian provinces require by law:

- Safety chains between the towing vehicle and the trailer. The chains should be cross-wound under the trailer drawbar. They must be fastened to the vehicle's trailer coupling, not to the bumper or the axle.  
Leave enough play in the chains to make tight cornering possible.
- A separate brake system for certain types of trailer.
- Safety switch for braked trailers. Check the specific legal requirements applicable to your state.

If the trailer becomes detached from the towing vehicle, the safety feature triggers the trailer brakes.

### Towing a trailer

There are numerous legal requirements concerning the towing of a trailer, e.g. speed restrictions. Make sure that your car/trailer combination complies with the local regulations:

- in your place of residence
- in the location to which you are driving

The police and local authorities can provide reliable information.

Observe the following when towing a trailer:

- To gain driving experience and to become accustomed to the new handling characteristics, you should practice the following in a traffic-free location:
  - cornering
  - stopping
  - backing up
- Before driving, check:
  - trailer tow hitch
  - safety switch for braked trailers
  - safety chains
  - electrical connections
  - lights
  - wheels
- Adjust the exterior mirrors to provide an unobstructed view of the rear section of the trailer.
- If the trailer has electronically controlled brakes, pull away carefully. Brake manually

using the brake controller and check whether the brakes function correctly.

- Secure any objects on the trailer to prevent the cargo from slipping when the vehicle is in motion.
- When you couple up a trailer, check at regular intervals that the load is firmly secured. If the trailer is equipped with trailer lights and brakes, check the trailer to ensure that these are working.
- Bear in mind that the handling will be less stable when towing a trailer than when driving without one. Avoid sudden steering movements.
- The vehicle/trailer combination is heavier, accelerates more slowly, has a decreased gradient climbing capability and a longer braking distance.

It is more susceptible to side winds and requires more careful steering.

- If possible, do not brake suddenly, but instead depress the brake pedal moderately at first so that the trailer can activate its brakes. Then increase the pressure on the brake pedal.
- If the automatic transmission repeatedly shifts between gears on uphill or downhill gradients, shift to a lower gear using the left-hand steering wheel paddle shifter.

A lower gear and lower speed reduce the risk of engine failure.

- When driving downhill, shift to a lower gear to utilize the engine's braking effect.  
Avoid continuous brake application as this may overheat the vehicle brakes and, if installed, the trailer brakes.
- If the coolant temperature increases dramatically while the air-conditioning system is switched on, switch off the air-conditioning system.  
Coolant heat can also be dissipated by opening the windows and switching the ventilation blower and the interior temperature to the highest level.
- When overtaking, pay particular attention to the extended length of your vehicle/trailer combination.

Due to the length of the vehicle/trailer combination, you require additional road space in relation to the vehicle you are overtaking before you can change back to the original lane.

### Decoupling a trailer

#### WARNING

If you uncouple a trailer with the overrun brake engaged, you could trap your hand between the vehicle and the trailer drawbar. There is a risk of injury.

Do not uncouple a trailer if the overrun brake is engaged.

#### WARNING

Vehicles with level control:

The vehicle is lowered as soon as you disconnect the trailer cable. This could result in your limbs or those of other people that are between the vehicle body and tires or underneath the vehicle being trapped. There is a risk of injury.

Make sure that nobody is in the immediate vicinity of the wheel housings or under the vehicle when you disconnect the trailer cable.

**!** Do not disconnect a trailer with an engaged overrun brake. Otherwise, your vehicle could be damaged by the rebounding of the overrun brake.

- ▶ Shift the transmission to position **P**.
- ▶ Apply the vehicle's electric parking brake.
- ▶ Start the engine.
- ▶ Close the doors and tailgate.
- ▶ Apply the trailer's parking brake.
- ▶ Detach the trailer cable and decouple the trailer.
- ▶ Switch off the engine.

### Permissible trailer loads and drawbar loads

#### Weight specifications

##### Maximum allowable gross mass

The gross vehicle weight of the trailer is calculated by adding the weight of the trailer to the weight of the load and equipment on the trailer.

You will find installing dimensions and loads under "Technical data" (▷ page 394).

### Permissible noseweight

You will find installing dimensions and loads under "Technical data" (▷ page 394).

### Loading a trailer

- When loading the trailer, make sure that neither the permissible gross weight of the trailer nor the gross vehicle weight are exceeded. The permissible gross vehicle weight is indicated on the identification plate located on the B-pillar on the driver's side of the vehicle. You can find the maximum permissible values on the type plates of your vehicle and the trailer. When calculating how much weight the vehicle and trailer may carry, pay attention to the respective lowest values.
- The trailer drawbar load on the ball coupling must be added to the rear axle load to avoid exceeding the permissible gross axle weight. The permissible gross vehicle weight is indicated on the identification plate located on the B-pillar on the driver's side of the vehicle.

**i** Mercedes-Benz recommends a trailer load where the trailer drawbar noseweight accounts for 8 % to 15 % of the trailer's permissible gross weight.

**i** The weight of additional accessories, passengers, and cargo reduces the permissible trailer load and drawbar load for your vehicle.

### Checking the vehicle and trailer weight

- To check that the weights of the towing vehicle and the trailer comply with the maximum permissible values, have the vehicle/trailer combination (including the driver, passengers, and cargo with a fully laden trailer) weighed on a calibrated weighbridge.
- Check the gross axle weight rating of the front and rear axles, the gross weight of the trailer and the trailer drawbar noseweight.

### Removing the ball coupling

- ▶ Remove the spring cotter.
- ▶ Remove the bolt from the ball coupling recess.
- ▶ Remove the ball coupling from the ball coupling recess.

- ▶ Clean the ball coupling if it is dirty.
- ▶ Stow the ball coupling so that it cannot be thrown around.

Observe the loading guidelines (▷ page 295) and the safety notes regarding stowage spaces (▷ page 295).

Information on cleaning and care of the trailer tow hitch (▷ page 331).

### Trailer power supply

**!** Accessories with a maximum power consumption of 180 W can be connected to the permanent power supply.

You must not charge a trailer battery using the power supply.

The trailer socket of your vehicle is equipped at the factory with a permanent power supply.

The permanent power supply is supplied via trailer socket pin 4.

The trailer's permanent power supply is switched off in the event of low vehicle supply voltage and after six hours at the latest.

A qualified specialist workshop can provide more information about installing the trailer electrics.

### Bicycle rack

#### General notes



Trailer tow hitch (example with additional guide pin)

Depending on the bicycle rack's design, you can transport up to four bicycles on it:

- When attached by clamping onto ball coupling ①, the maximum payload is 75 kg. You can transport up to three bicycles.
- When attached to ball coupling ① and also guide pin ②, the maximum payload is 100 kg. You can transport up to three bicycles.

The payload is calculated from the weight of the bicycle rack and the load of the bicycle rack.

To transport bicycles with a gross weight between 75 kg and 100 kg, use only bicycle racks with additional anchorage on guide pin ②.

### Important safety notes

#### **⚠** WARNING

The bicycle rack can detach from the vehicle if you

- exceed the permissible payload of the trailer tow hitch
- use the bicycle rack incorrectly
- attach the bicycle rack to the ball coupling beneath the ball head

There is a risk of an accident.

For your safety and that of other road users, observe the following:

- Always observe the permissible payload of the trailer tow hitch.
- Use the bicycle rack only to transport bicycles.
- Always attach the bicycle rack correctly by clamping onto the ball head and, if possible, to the guide pin on the ball coupling as well.
- To transport four bicycles, always use bicycle racks with additional support on the ball coupling's guide pin.
- Use only bicycle racks approved by Mercedes-Benz.
- Always comply with the bicycle rack's operating manual.

**!** Using unsuitable bicycle racks or using them incorrectly can cause damage to and fractures in the trailer tow hitch.

Use only bicycle racks approved by Mercedes-Benz.

Bicycle racks cause your vehicle's driving characteristics to change. The vehicle:

- is heavier
- is restricted in its acceleration and gradient-climbing capability
- has an increased braking distance

This could impair the handling characteristics. Adapt your driving style accordingly. Maintain a safe distance and drive carefully.

When using bicycle racks, set the tire pressure on the rear axle of the vehicle for the maximum load. Further information on tire pressure can be found on the tire pressure table (▷ page 354).

### Loading instructions

The greater the distance between the load's center of gravity and the ball head, the higher the load exerted on the trailer tow hitch.

Therefore, observe the following notes:

- Attach heavy bicycles as close as possible to the vehicle.
- Always distribute the load on the bicycle rack as symmetrically as possible to the vehicle longitudinal axis.

Before loading the bicycle rack, Mercedes-Benz advises you to remove all add-on parts from the bicycles, e.g. bicycle baskets, child seats or batteries. This will allow you to improve the aerodynamic resistance and the bicycle rack's center of gravity.

Always secure bicycles against slipping and check that they are firmly seated at regular intervals. Do not use tarpaulins or other covers. This could impair the driving characteristics and rear visibility. The aerodynamic resistance would also rise, and so would the load exerted on the trailer tow hitch as a result.

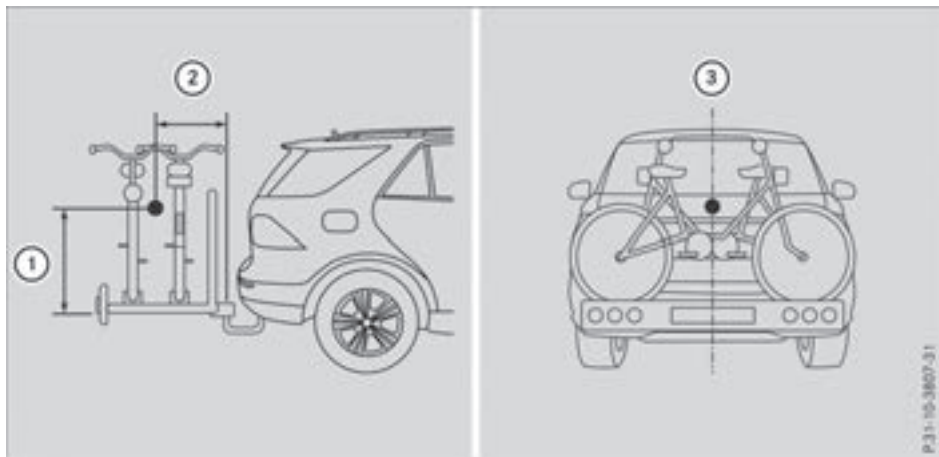

Load distribution on the bicycle rack

- ① Distance in height between the center of gravity and the ball coupling
- ② Distance to the rear between the center of gravity and the ball coupling
- ③ The center of gravity is located on the central axis of the vehicle

When loading the bicycle rack, comply with the following notes:

Number of bicycles	Gross weight of bicycle rack and load	Max. distance ①	Max. distance ②
3	up to 75 kg	420 mm	300 mm
4 <sup>2</sup>	up to 100 kg <sup>2</sup>	420 mm	400 mm

<sup>2</sup> When transporting four bicycles or a gross weight between 75 kg and 100 kg, use only bicycle racks with additional support on the guide pin of the trailer tow hitch.

## Important safety notes

### WARNING

If you operate information systems and communication equipment integrated in the vehicle when driving, you may be distracted from the traffic situation. You could also lose control of the vehicle. There is a risk of an accident.

Only operate this equipment when the traffic situation permits. If you are not sure that this is possible, park the vehicle paying attention to traffic conditions and operate the equipment when the vehicle is stationary.

You must observe the legal requirements for the country in which you are currently driving when operating the on-board computer.

### WARNING

If the instrument cluster has failed or malfunctioned, you may not recognize function restrictions in systems relevant to safety. The operating safety of your vehicle may be impaired. There is a risk of an accident.

Pull over as soon as it is safe to do so and consult a qualified specialist workshop.

The on-board computer only shows messages or warnings from certain systems in the multifunction display. You should therefore make sure your vehicle is operating safely at all times.

For an overview, see the instrument panel illustration (▷ page 37).

**Plug-in hybrid:** be sure to read the separate Operator's Manual. Otherwise, you may not recognize dangers.



## Displays and operation

### Instrument cluster lighting

The lighting in the instrument cluster, in the displays and the controls in the vehicle interior can be adjusted using the brightness control knob.

The brightness control knob is located on the bottom left of the instrument cluster (▷ page 37).

► Turn the brightness control knob clockwise or counter-clockwise.

If you turn the light switch to ,  or , the brightness is dependent upon the brightness of the ambient light.

**i** The light sensor in the instrument cluster automatically controls the brightness of the multifunction display.

In daylight, the displays in the instrument cluster are not illuminated.

### Speedometer with segments

The segments in the speedometer indicate which speed range is available.

- Cruise control activated (▷ page 169):  
The segments light up from the stored speed to the maximum speed.
- Distance Pilot DISTRONIC is activated (▷ page 171):  
One or two segments in the set speed range light up.
- Distance Pilot DISTRONIC detects a vehicle in front moving more slowly than the stored speed:  
The segments between the speed of the vehicle in front and the stored speed light up.

### Tachometer

**!** Do not drive in the overrevving range, as this could damage the engine.

The red band in the tachometer indicates the engine's overrevving range.

The fuel supply is interrupted to protect the engine when the red band is reached.

### Outside temperature display

You should pay special attention to road conditions when temperatures are around freezing point.

Bear in mind that the outside temperature display indicates the temperature measured and does not record the road temperature.

The outside temperature display is in the multifunction display (▷ page 230).

There is a short delay before a change in outside temperature appears in the multifunction display.

### Coolant temperature gauge

#### WARNING

Opening the hood when the engine is overheated or when there is a fire in the engine compartment could expose you to hot gases or other service products. There is a risk of injury.

Let an overheated engine cool down before opening the hood. If there is a fire in the engine compartment, keep the hood closed and contact the fire department.

**!** A display message is shown if the coolant temperature is too high.

If the coolant temperature is over 248 °F (120 °C), do not continue driving. The engine will otherwise be damaged.

**All vehicles except PLUG-IN HYBRID:** the coolant temperature display is on the instrument cluster on the right-hand side (▷ page 37). Under normal operating conditions and with the specified coolant level, the coolant temperature may rise to 248 °F (120 °C).

## Operating the on-board computer

### Overview



- ① Multifunction display
- ② Right control panel
- ③ Left control panel









► **To activate the on-board computer:** turn the SmartKey to position  in the ignition lock.

You can control the multifunction display and the settings in the on-board computer using the buttons on the multifunction steering wheel.





Vehicles with the COMAND multimedia system: you can find further information on the Voice Control System in the separate operating instructions.

Vehicles with the Audio 20 multimedia system: you can find further information on voice-operated control for navigation in the manufacturer's operating instructions.

## Left control panel

	<ul style="list-style-type: none"> <li>• Calls up the menu and menu bar</li> </ul>
	
	<p><b>Press briefly:</b></p> <ul style="list-style-type: none"> <li>• Scrolls in lists</li> <li>• Selects a submenu or function</li> <li>• In the <b>Audio</b> menu: selects the previous or next station, when the preset list or station list is active, or the previous or next audio track or video scene</li> <li>• In the <b>Te1</b> (Telephone) menu: switches to the phone book and selects a name or telephone number</li> </ul>
	
	<p><b>Press and hold:</b></p> <ul style="list-style-type: none"> <li>• In the <b>Audio</b> menu: selects a preset list or a station list in the desired frequency range or an audio track or video scene using rapid scrolling</li> <li>• In the <b>Te1</b> (Telephone) menu: starts rapid scrolling if the phone book is open</li> </ul>
	
	<ul style="list-style-type: none"> <li>• Confirms the selection or display message</li> <li>• In the <b>Te1</b> (Telephone) menu: switches to the phone book and starts dialing the selected number</li> </ul>
	<p><b>Press briefly:</b></p> <ul style="list-style-type: none"> <li>• Back</li> <li>• Switches off voice-operated control for navigation or the Voice Control System</li> <li>• Hides display messages or calls up the last <b>Trip</b> menu function used</li> <li>• Exits the telephone book/redial memory</li> </ul>
	<p><b>Press and hold:</b></p> <ul style="list-style-type: none"> <li>• Calls up the standard display in the <b>Trip</b> menu</li> </ul>



## Right control panel

	<ul style="list-style-type: none"> <li>• Rejects or ends a call</li> <li>• Exits the telephone book/redial memory</li> </ul>
	<ul style="list-style-type: none"> <li>• Makes or accepts a call</li> <li>• Switches to the redial memory</li> </ul>
	<ul style="list-style-type: none"> <li>• Adjusts the volume</li> </ul>
	<ul style="list-style-type: none"> <li>• Mute</li> </ul>
	<ul style="list-style-type: none"> <li>• Switches on voice-operated control for navigation or the Voice Control System</li> </ul>

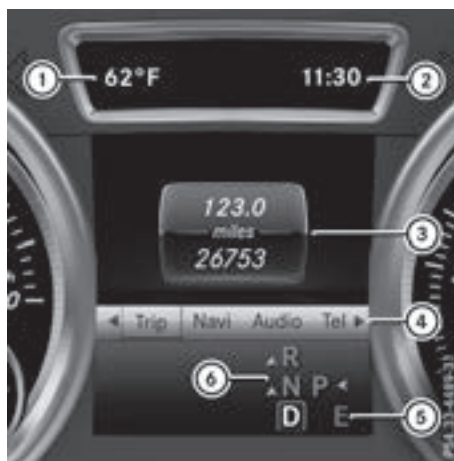
## Multifunction display



- ① Permanent display: outside temperature or speed (▷ page 238)
- ② Time
- ③ Text field
- ④ Menu bar
- ⑤ Drive program (▷ page 145)
- ⑥ Transmission position (▷ page 145)

► **To display menu bar** ④: press the  or  button on the steering wheel. If you do not press any other button, menu bar ④ fades out after a few seconds. Text field ③ shows the selected menu or submenu as well as display messages.



**i** Set the time using the multimedia system; see the Digital Operator's Manual.

**Possible displays in the multifunction display:**

- **↑** Gearshift recommendation, when shifting manually (▷ page 147)
- **P** Parking Pilot (▷ page 190)
- **CRUISE** Cruise control (▷ page 169)
- **Adaptive Highbeam Assist** (▷ page 114)
- **ECO** start/stop function (▷ page 139)
- **HOLD** HOLD function (▷ page 182)
- **Distance Pilot DISTRONIC Steering Pilot** (▷ page 236)
- **DSR** Downhill Speed Regulation (▷ page 213)

**Menus and submenus**

**Menu overview**

Press the **◀** or **▶** button on the steering wheel to call up the menu bar and select a menu. Operating the on-board computer (▷ page 229). Depending on the equipment installed in the vehicle, you can call up the following menus:

- **Trip** menu (▷ page 231)
- **Navi** menu (navigation instructions) (▷ page 232)
- **Audio** menu (▷ page 234)
- **Tel** menu (telephone) (▷ page 235)
- **DriveAssist** menu (assistance) (▷ page 236)
- **Serv.** menu (▷ page 237)
- **Sett.** menu (settings) (▷ page 238)
- **ON&OFFROAD** menu (▷ page 240)
- **AMG** menu (Mercedes-AMG vehicles) (▷ page 240)

**Trip menu**

**Standard display**



▶ Press and hold the **⏪** button on the steering wheel until the **Trip** menu with trip odometer ① and odometer ② appears.

**Trip computer "From Start" or "From Reset"**



- ① Distance
- ② Driving time
- ③ Average speed
- ④ Average fuel consumption

▶ Press the **◀** or **▶** button on the steering wheel to select the **Trip** menu.

▶ Press the **▲** or **▼** button to select **From start** or **From reset**.

The values in the **From Start** submenu are calculated from the start of a journey, while the values in the **From Reset** submenu are calculated from the last time the submenu was reset (▷ page 232).

The **From Start** trip computer is automatically reset if:

- the ignition has been switched off for more than four hours.
- 999 hours have been exceeded.
- 9,999 miles have been exceeded.

The **From reset** trip computer is automatically reset if the value exceeds 9,999 hours or 99,999 miles.

## ECO display

The ECO display is not available for Mercedes-AMG vehicles.

- ▶ Press the ◀ or ▶ button on the steering wheel to select the **Trip** menu.
- ▶ Press the ▲ or ▼ button to select **ECO DISPLAY**.

If the ignition remains switched off for longer than four hours, the ECO display will be automatically reset.

For more information on the ECO display, see (▷ page 160).

## Displaying the range and current fuel consumption

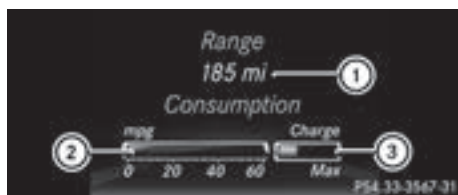

**Mercedes-AMG vehicles:** the menu displays only the approximate range ①.

- ▶ Press the ◀ or ▶ button on the steering wheel to select the **Trip** menu.

## Digital speedometer

- ▶ Press the ◀ or ▶ button on the steering wheel to select the **Trip** menu.
- ▶ Press the ▲ or ▼ button to select the digital speedometer.

A gear shift recommendation † can also appear.

Observe the information on gearshift recommendation † when shifting manually (▷ page 147).

Mercedes-AMG vehicles: a gearshift recommendation is shown in the status bar of the multifunction display and not in the digital speedometer display.

## Resetting values

- ▶ Press the ◀ or ▶ button on the steering wheel to select the **Trip** menu.
- ▶ Press the ▲ or ▼ button to select the function that you wish to reset.

- ▶ Press **OK** to confirm your selection.
- ▶ Press ▼ to select **Yes** and press **OK** to confirm.

You can reset the values of the following functions:

- Trip odometer
- "From Start" trip computer
- "From Reset" trip computer
- ECO display

If you reset the values in the ECO display, the values in the "From Start" trip computer are also reset. If you reset the values in the "From Start" trip computer, the values in the ECO display are also reset.

## Navigation system menu

### Displaying navigation instructions

In the **Navi** menu, the multifunction display shows navigation instructions.

You can find further information on navigation in the Digital Operator's Manual in the multimedia system.

- ▶ Switch on the multimedia system (see the Digital Operator's Manual)
- ▶ Press the ◀ or ▶ button on the steering wheel to select the **Navi** menu.

### Route guidance not active



- ① Direction of travel
- ② Current road

## Route guidance active

### No change of direction announced



- ① Distance to destination
- ② Distance to the next change of direction
- ③ Current road
- ④ "Follow the road's course" symbol

### Change of direction announced without a lane recommendation



- ① Road into which the change of direction leads
- ② Distance to change of direction and visual distance display
- ③ Change-of-direction symbol

When a change of direction is to be made, you will see symbol ③ for the change of direction and distance graphic ②. The distance indicator shortens towards the top of the display as you approach the point of the announced change of direction. The change of direction starts once the distance display reaches zero.

### Change of direction announced with a lane recommendation



- ① Road into which the change of direction leads
- ② Distance to change of direction and visual distance display

- ③ Lanes not recommended
- ④ Recommended lane and new lane during a change of direction
- ⑤ Change-of-direction symbol

On multilane roads, lane recommendations can be displayed for the next change of direction if the digital map supports this data. During the change of direction, new lanes may be added.

Lane not recommended ③: you will not be able to complete the next change of direction if you stay in this lane.

Recommended lane and new lane during a change of direction ④: in this lane you will be able to complete the next two changes of direction without changing lane.

### Other status indicators of the navigation system



The navigation system displays additional information and the vehicle status.

Possible displays:

- **New Route... or Calculating Route...**  
A new route is calculated.
- **Road Not Mapped**  
The vehicle position is inside the area of the digital map but the road is not recognized, e.g. newly built streets, car parks or private land.
- **No Route**  
No route could be calculated to the selected destination.
-   
You have reached the destination or an intermediate destination.

## Audio menu

### Selecting a radio station



- ① Active station list
- ② Station frequency with memory position

The multifunction display shows station ② with station frequency or station name. The preset position is only displayed along with station ② if this has been stored. You can store TV channels ② in the multimedia system.

- ▶ Switch on the multimedia system and select radio (see the Digital Operator's Manual).
  - ▶ Press the ◀ or ▶ button on the steering wheel to select the **Audio** menu.
  - ▶ **To select a preset list or station list:** press and briefly hold the ▲ or ▼ button until the preset list or station list in the desired frequency range is shown in the multifunction display.
  - ▶ **To select a station:** briefly press ▲ or ▼.
- i** SIRIUS XM satellite radio functions like a normal radio.

For more information on radio operation, see "Satellite radio" in the Digital Operator's Manual.

### Operating an audio player or audio media



Audio data from various audio devices or media can be played, depending on the equipment installed in the vehicle.

- ▶ Switch on the multimedia system and select CD or MP3 mode (see the Digital Operator's Manual).
- ▶ Press the ◀ or ▶ button on the steering wheel to select the **Audio** menu.
- ▶ **To select the next/previous track:** briefly press the ▲ or ▼ button.
- ▶ **To select a track from the track list (rapid scrolling):** press and hold the ▲ or ▼ button until desired track ① has been reached.

If you press and hold ▲ or ▼, the rapid scrolling speed is increased. Not all audio drives or data carriers support this function.

If track information is stored on the audio device or medium, the multifunction display will show the number and title of the track. The current track does not appear in audio AUX mode (**Auxiliary** audio mode: external audio source connected).

### Video DVD operation



- ▶ Switch on the multimedia system and select video DVD (see the Digital Operator's Manual).
- ▶ Press the ◀ or ▶ button on the steering wheel to select the **Audio** menu.
- ▶ **To select the next or previous scene:** briefly press the ▲ or ▼ button.
- ▶ **To select a scene from the scene list (rapid scrolling):** press and hold the ▲ or ▼ button until desired scene ① has been reached.

## Telephone menu



### Introduction

#### WARNING

If you operate information systems and communication equipment integrated in the vehicle when driving, you may be distracted from the traffic situation. You could also lose control of the vehicle. There is a risk of an accident.

Only operate this equipment when the traffic situation permits. If you are not sure that this is possible, park the vehicle paying attention to traffic conditions and operate the equipment when the vehicle is stationary.

When telephoning, you must observe the legal requirements for the country in which you are currently driving.

- ▶ Switch on the mobile phone (see the manufacturer's operating instructions).
- ▶ Switch on the multimedia system (see the Digital Operator's Manual)
- ▶ Establish a Bluetooth® connection to the multimedia system (see the Digital Operator's Manual).
- ▶ Press the  or  button on the steering wheel to select the **TeI** menu.

You will see one of the following display messages in the multifunction display:

- **Phone READY** or the name of the network provider: the mobile phone has found a network and is ready to receive.
- **Phone No Service**: there is no network available or the mobile phone is searching for a network.

### Accepting a call

If someone calls you when you are in the **TeI** menu, a display message appears in the multifunction display.

You can accept a call at any time regardless of the menu selected.







- ▶ Press the  button on the steering wheel to accept an incoming call.

### Rejecting or ending a call



You can end or reject a call even if you are not in the **TeI** menu.

- ▶ Press the  button on the steering wheel to reject or end a call.

### Selecting an entry from the phone book

- ▶ Press the  or  button on the steering wheel to select the **TeI** menu.
- ▶ Press the ,  or  button to switch to the phone book.
- ▶ Authorize access to the phone book on the phone.
- ▶ Press the  or  button to select the desired name.



or

- ▶ **To start rapid scrolling:** press and hold the  or  button for longer than one second.

Rapid scrolling stops when you release the button or reach the end of the list.

- ▶ **If only one telephone number is stored for a name:** press the  or  button to start dialing.

or

- ▶ **If there is more than one number for a particular name:** press the  or  button to display the numbers.

- ▶ Press the ,  button to select the number you want to dial.





- ▶ Press the  or  button to start dialing.





or

- ▶ **To exit the telephone book:** press the  or  button.

### Redialing

The on-board computer saves the last names or numbers dialed in the redial memory.

- ▶ Press the  or  button on the steering wheel to select the **TeI** menu.
- ▶ Press the  button to switch to the redial memory.
- ▶ Press the ,  button to select the desired name or number.

- ▶ Press the  or  button to start dialing, or
- ▶ **To exit the redial memory:** press the  or  button.

## Assistance menu





### Introduction

Depending on the equipment installed in the vehicle, you have the following options in the **DriveAssist** menu:

- Displaying the assistance graphic (▷ page 236)
- Activating/deactivating the Traffic Sign Assist display (▷ page 236)
- Activating or deactivating Steering Pilot (▷ page 236)
- Activating or deactivating Active Brake Assist (▷ page 237)
- Activating or deactivating Active Brake Assist with cross-traffic function (▷ page 237)
- Activating/deactivating ATTENTION ASSIST (▷ page 237)
- Activating/deactivating Blind Spot Assist or Active Blind Spot Assist (▷ page 237)
- Activating/deactivating Lane Keeping Assist or Active Lane Keeping Assist (▷ page 237)

### Displaying the assistance graphic









- ▶ Press the  or  button on the steering wheel to select the **DriveAssist** menu.
- ▶ Press  or  to select **Assistance Graphic**.
- ▶ Confirm by pressing  on the steering wheel.  
The multifunction display shows the Distance Pilot DISTRONIC distance display in the assistance graphic display.  
The assistance graphic displays the status of and information from the following driving systems or driving safety systems:

- Traffic Sign Assist (▷ page 203)
  - Distance Pilot DISTRONIC (▷ page 171)
  - Active Brake Assist (▷ page 67)
  - Active Brake Assist with cross-traffic function (▷ page 73)
  - ATTENTION ASSIST (▷ page 202)
  - Lane Keeping Assist (▷ page 206) or Active Lane Keeping Assist (▷ page 210)
  - DSR (▷ page 213)
  - Off-road program (vehicles with Off-Road Engineering package) (▷ page 215)
  - Rear window wiper (▷ page 118)
- ▶ Press  to display the ATTENTION ASSIST assessment.







### Traffic Sign Assist

You can switch the Traffic Sign Assist message function on or off in the **Traffic Sign Assist** menu. When the function is activated, detected traffic signs and information appear in the multifunction display for five seconds.

- ▶ Press the  or  button on the steering wheel to select the **DriveAssist** menu.
- ▶ Press the  or  button to select **Traffic Sign Assist**.
- ▶ Confirm by pressing  on the steering wheel.  
The current selection appears.
- ▶ **To activate/deactivate the message function:** press the  button again.

For further information about Traffic Sign Assist, see (▷ page 203).

### Activating or deactivating Steering Pilot

- ▶ Press the  or  button on the steering wheel to select the **DriveAssist** menu.
- ▶ Press  or  to select **Steering Pilot**.
- ▶ Confirm by pressing  on the steering wheel.  
The current selection appears.
- ▶ **To activate/deactivate:** press the  button again.  
When the Steering Pilot is activated, the multifunction display displays a **Steering Pilot On** message.

Further information about Distance Pilot DISTRONIC with Steering Pilot (▷ page 177).

## Activating/deactivating Active Brake Assist

You can use these functions to activate/deactivate Active Brake Assist or, on vehicles with the Driving Assistance package, to activate or deactivate Active Brake Assist with cross-traffic function.

- ▶ Press the ◀ or ▶ button on the steering wheel to select the **DriveAssist** menu.
- ▶ Press the ▲ or ▼ button to select **Brake Assist**.
- ▶ Press **OK** to confirm.  
The current selection appears.
- ▶ **To activate/deactivate:** press the **OK** button again.  
When Active Brake Assist or Active Brake Assist with cross-traffic function is deactivated, the  symbol appears in the multifunction display in the assistance graphic display.

Further information on Active Brake Assist (▷ page 67) and Active Brake Assist with cross-traffic function (▷ page 72).

## Activating/deactivating ATTENTION ASSIST

- ▶ Press the ◀ or ▶ button on the steering wheel to select the **DriveAssist** menu.
- ▶ Press the ▲ or ▼ button to select **Attention Assist**.
- ▶ Press the **OK** button.  
The current selection appears.
- ▶ Press **OK** to confirm.
- ▶ Press the ▼ or ▲ button to set **Off**, **Standard** or **Sensitive**.
- ▶ Press the **OK** button to save the setting.  
When ATTENTION ASSIST is deactivated, the  symbol appears in the multifunction display in the assistance graphics display.

For further information about ATTENTION ASSIST, see (▷ page 202).

## Activating/deactivating Blind Spot Assist

- ▶ Press the ◀ or ▶ button on the steering wheel to select the **DriveAssist** menu.
- ▶ Press the ▲ or ▼ button to select **Blind Spot Assist**.

- ▶ Confirm by pressing **OK** on the steering wheel.

The current selection appears.

- ▶ **To activate/deactivate:** press the **OK** button again.

For further information about Blind Spot Assist, see (▷ page 204).

For further information about Active Blind Spot Assist, see (▷ page 208).

## Activating/deactivating Lane Keeping Assist

- ▶ Press the ◀ or ▶ button on the steering wheel to select the **DriveAssist** menu.
- ▶ Press the ▲ or ▼ button to select **Lane Keeping Assist**.
- ▶ Press **OK** to confirm.  
The current selection appears.
- ▶ Press **OK** to confirm.
- ▶ Press the ▼ or ▲ button to set **Off**, **Standard** or **Adaptive**.  
When Lane Keeping Assist or Active Lane Keeping Assist is activated, the multifunction display shows the lane markings as bright lines in the assistance graphic.
- ▶ Press the **OK** button to save the setting.

For further information about Lane Keeping Assist, see (▷ page 206).

For further information about Active Lane Keeping Assist, see (▷ page 210).

## Service menu

### Introduction

Depending on the equipment installed in the vehicle, you have the following options in the **Serv.** menu:

- calling up display messages in message memory (▷ page 243)
- restarting the tire pressure loss warning system (▷ page 358) or checking the tire pressure electronically (▷ page 360)
- calling up the service due date (▷ page 325).

## Settings menu

### Introduction







Depending on the equipment installed in the vehicle, in the **Sett.** menu you have the following options:

- Changing the instrument cluster settings (▷ page 238)
- Changing the light settings (▷ page 238)
- Changing the vehicle settings (▷ page 239)
- Changing the convenience settings (▷ page 239)
- Restoring the factory settings (▷ page 240)

### Instrument cluster submenu

#### Selecting the distance unit

The **Display Unit Speedometer / Odometer**: function allows you to choose whether certain displays appear in kilometers or miles in the multifunction display.

- ▶ Press the  or  button on the steering wheel to select the **Sett.** menu.
  - ▶ Press the  or  button to select the **Instrument Cluster** submenu.
  - ▶ Press **OK** to confirm.
  - ▶ Press the  or  button to select the **Display Unit Speedometer / Odometer** function.
- You will see the selected setting: **km** or **miles**.
- ▶ Press the **OK** button to save the setting.







The selected unit of measurement for distance applies to:

- Digital speedometer in the **Trip** menu
- Odometer and the trip odometer
- Trip computer
- Current consumption and the range
- Navigation instructions in the **Navi** menu
- Cruise control
- Distance Pilot DISTRONIC
- ASSYST PLUS service interval display

#### Selecting permanent display

The **Permanent Display**: function allows you to choose whether the multifunction display always shows the outside temperature or the speed.







The speed display is inverse to the speedometer.

- ▶ Press the  or  button on the steering wheel to select the **Sett.** menu.
- ▶ Press the  or  button to select the **Instrument Cluster** submenu.
- ▶ Confirm by pressing **OK** on the steering wheel.
- ▶ Press the  or  button to select the **Permanent Display**: function.  
The current setting, **Outside Temperature**, **Speedometer [km/h]** or **Speedometer [mph]** appears.
- ▶ **To change the setting**: press **OK** again.

### Light submenu







#### Setting the daytime running lamps

This function is not available in Canada.

- ▶ Press the  or  button on the steering wheel to select the **Sett.** menu.
- ▶ Press the  or  button to select the **Light** submenu.
- ▶ Press **OK** to confirm.
- ▶ Press  or  to select the **Daytime Running Lights** function.  
If the **Daytime Running Lights** function has been switched on, the cone of light and the  symbol in the multifunction display are shown in orange.
- ▶ Press the **OK** button to save the setting.

Further information on daytime running lamps (▷ page 110).

#### Switching the Intelligent Light System on/off

- ▶ Press the  or  button on the steering wheel to select the **Sett.** menu.
- ▶ Press the  or  button to select the **Light** submenu.
- ▶ Press **OK** to confirm.
- ▶ Press the  or  button to select the **Intell. Light System** function.  
If the **Intell. Light System** function has been switched on, the cone of light and the  symbol in the multifunction display are shown in orange.
- ▶ Press the **OK** button to save the setting.

When you activate **Intell. Light System**, you activate the following functions:



- Highway mode
- Active light function
- Cornering light function
- Extended range fog lamps
- Off-road lights

Further information on the Intelligent Light System (▷ page 112).

## Vehicle submenu

### Activating/deactivating the automatic door locking mechanism

If you activate the **Automatic Door Lock** function, the vehicle is centrally locked above a speed of approximately 9 mph (15 km/h).

- ▶ Press the or button on the steering wheel to select the **Sett.** menu.
- ▶ Press the or button to select the **Vehicle** submenu.
- ▶ Press to confirm.
- ▶ Press the or button to select the **Automatic Door Lock** function.  
When the **Automatic Door Lock** function is activated, the vehicle doors are displayed in orange in the multifunction display.
- ▶ Press the button to save the setting.

For further information on the automatic locking feature, see (▷ page 84).

### Activating/deactivating the acoustic locking verification signal

If you switch on the **Acoustic Lock** function, an acoustic signal sounds when you lock the vehicle.

- ▶ Press the or button on the steering wheel to select the **Settings** menu.
- ▶ Press the or button to select the **Vehicle** submenu.
- ▶ Press to confirm.
- ▶ Press the or button to select the **Acoustic Lock** function.  
If the **Acoustic Lock** function is activated, the symbol in the multifunction display lights up orange.
- ▶ Press the button to save the setting.

## Convenience submenu

### Activating/deactivating the EASY-ENTRY/EXIT feature

#### WARNING

When the EASY-ENTRY/EXIT feature adjusts the steering wheel, you and other vehicle occupants – particularly children – could become trapped. There is a risk of injury.

While the EASY-ENTRY/EXIT feature is making adjustments, make sure that no one has any body parts in the sweep of the steering wheel.

If somebody becomes trapped:

- press one of the memory function position buttons, or
- move the switch for steering wheel adjustment in the opposite direction to that in which the steering wheel is moving.

The adjustment process is stopped.

- ▶ Press the or button on the steering wheel to select the **Sett.** menu.
- ▶ Press the or button to select the **Convenience** submenu.
- ▶ Press to confirm.
- ▶ Using or , select the **Easy Entry/Exit** function.  
If the **Easy Entry/Exit** function is activated, the vehicle steering wheel is displayed in orange in the multifunction display.
- ▶ Press the button to save the setting.

Further information on the EASY-ENTRY/EXIT feature (▷ page 104).

### Switching the seat belt adjustment on/off

- ▶ Press the or button on the steering wheel to select the **Settings** menu.
- ▶ Press the or button to select the **Convenience** submenu.
- ▶ Press to confirm.
- ▶ Press the or button to select the **Belt Adjustment** function.  
If the **Belt Adjustment** function is activated, the vehicle seat belt is shown in orange in the multifunction display.
- ▶ Press the button to save the setting.

For further information on belt adjustment, see (> page 48).

### Switching the fold-in mirrors when locking feature on/off

This function is only available when the vehicle is equipped with the electrical fold-in function.

When you activate the **Auto. Mirror Folding** function, the exterior mirrors are folded in when the vehicle is locked. The exterior mirrors fold out automatically again as soon as you unlock the vehicle.

- ▶ Press the or button on the steering wheel to select the **Sett.** menu.
- ▶ Press the or button to select the **Convenience** submenu.
- ▶ Press **OK** to confirm.
- ▶ Press the or button to select the **Auto. Mirror Folding** function. If the **Auto. Mirror Folding** function is switched on, the multifunction display shows the exterior mirror in orange.
- ▶ Press the **OK** button to save the setting.



If you have switched the **Auto. Mirror Folding** on and you fold the exterior mirrors in using button ①, they will not fold out automatically (> page 106).

You can then only fold out the exterior mirrors using button ①.

### Restoring the factory settings

- ▶ Press the or button on the steering wheel to select the **Sett.** menu.
- ▶ Press the or button to select the **Factory Setting** submenu.
- ▶ Press **OK** to confirm. The **Reset All Settings?** message appears.

- ▶ Press the or button to select **No** or **Yes**.
- ▶ Press **OK** to confirm the selection. If you select **Yes**, the multifunction display shows a confirmation message.

If you want to reset the **Daytime Running Lights** function in the **Light** submenu, you must turn the SmartKey to position ① in the ignition lock.

### ON&OFFROAD menu

- ▶ Press the or button on the steering wheel to select the **ON&OFFROAD** menu.

You can view the current off-road program settings in the **ON&OFFROAD** menu:

- Vehicles with the Off-Road Engineering package (> page 215)
- Vehicles without the Offroad Engineering package (> page 214)

### AMG menu (Mercedes-AMG vehicles)

#### Warm-up



- ① Digital speedometer
  - ② Gear indicator
  - ③ Upshift indicator
  - ④ Engine oil temperature
  - ⑤ Coolant temperature
  - ⑥ Transmission oil temperature
- ▶ Press the or button on the steering wheel to select the **AMG** menu.
    - Upshift indicator:** upshift indicator **Up** ③ indicates that the engine has reached the overrevving range when in the manual drive program.
    - Engine/transmission oil temperature:** when the engine and transmission are at normal operating temperature, oil temperature ④ and ⑥ are displayed in white in the multifunction display.

If the multifunction display shows oil temperature ④ or ⑥ in blue, the engine or the transmission are not yet at normal operating temperature. Avoid driving at full engine output during this time.

## SETUP



- ① Engine mode (Comfort/Sport/Sport +)
- ② Suspension setting Comfort/Sport/Sport +
- ③ Transmission position D/M
- ④ ESP® mode (ON/OFF)

SETUP displays the following information/functions:

- the digital speedometer
- the gear indicator
- the engine mode
- the suspension mode
- the transmission position
- the ESP® (Electronic Stability Program) mode
- ▶ Press the ◀ or ▶ button on the steering wheel to select the AMG menu.
- ▶ Press the ▲ button repeatedly until SETUP is displayed.

## RACE TIMER

### Displaying and starting RACETIMER

The RACETIMER is only intended for use on a closed race circuit. Do not use the function on public roads.



- ① Lap
- ② RACETIMER

You can start the RACETIMER when the engine is running or if the SmartKey is in position 2 in the ignition lock.

- ▶ Press the ◀ or ▶ button on the steering wheel to select the AMG menu.
- ▶ Press the ▲ button repeatedly until the RACETIMER is shown.
- ▶ **To start:** press the OK button to start the RACETIMER.

### Displaying the intermediate time

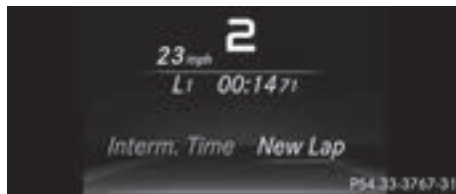

- ▶ Press the ◀ or ▶ button to select Interm. Time.
- ▶ Press OK to confirm. The intermediate time is displayed for five seconds.

### Starting a new lap



- ① RACETIMER
- ② Fastest lap time (best lap)
- ③ Lap
- ▶ Press OK to confirm New Lap.

**i** It is possible to store a maximum of sixteen laps. The 16th lap can only be completed with Finish Lap.

### Stopping the RACETIMER

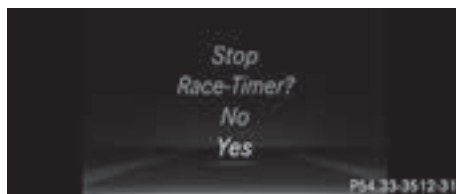

- ▶ Press the button on the steering wheel.
- ▶ Confirm **Yes** with .

The RACETIMER interrupts timing if you stop the vehicle and turn the SmartKey to position **1** in the ignition lock. If you turn the SmartKey to position **3** and then press to confirm **Start** timing is continued.

### Resetting the current lap

- ▶ Stop the RACETIMER.
- ▶ Press the or button to select **Reset Lap**.
- ▶ Press to reset the lap time to "0".

### Deleting all laps

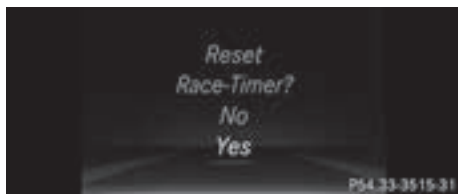

If you switch off the engine, the RACETIMER is reset to "0" after 30 seconds. All laps are deleted.

You cannot delete individual stored laps. If you have stopped 16 laps, the current lap does not have to be reset.

- ▶ Reset the current lap.
- ▶ Press to confirm **Reset**. **Reset Race Timer?** appears in the multi-function display.
- ▶ Press the button to select **Yes** and press the button to confirm. All laps are deleted.

### Overall statistics



- ① RACETIMER overall evaluation
- ② Total time driven

- ③ Average speed
- ④ Distance covered
- ⑤ Maximum speed

This function is shown if you have stored at least one lap and stopped the RACETIMER.

- ▶ Press the or button on the steering wheel to select the **AMG** menu.
- ▶ Press the button repeatedly until the overall evaluation is shown.

### Lap statistics



- ① Lap
- ② Lap time
- ③ Average lap speed
- ④ Lap length
- ⑤ Top speed during lap

This function is only available if you have stored at least two laps and have stopped the RACETIMER.

- ▶ Press the or button on the steering wheel to select the **AMG** menu.
- ▶ Press the button repeatedly until the lap evaluation is shown. Each lap is shown in a separate submenu. The fastest lap is indicated by flashing symbol ①.
- ▶ Press the or button to select a different lap evaluation.

## Display messages

### Introduction

#### General notes

---

Display messages appear in the multifunction display.

Display messages with graphic displays may be shown in simplified form in the Operator's Manual and may therefore differ from the multifunction display.

Please respond in accordance with the display messages and follow the additional notes in this Operator's Manual.



Certain display messages are accompanied by an audible warning tone or a continuous tone.

When you stop and park the vehicle, please observe the notes on:

- HOLD function (▷ page 182)
- Parking (▷ page 156)

#### Hiding display messages

---

- ▶ Press the  or  button on the steering wheel.  
The multifunction display hides the display message.







High-priority display messages are shown in red in the multifunction display. Some high-priority display messages cannot be hidden.

The multifunction display shows these messages continuously until the causes for the messages have been remedied.

#### Message memory

---

The on-board computer saves certain display messages in the **message memory**. You can call up the display messages:

- ▶ Press  or  on the steering wheel to select the **Serv.** menu.  
If there are display messages, the multifunction display shows **2 Messages**, for example.
- ▶ Press the  or  button to select the entry, e.g. **2 messages**.
- ▶ Press  to confirm.
- ▶ Press the  or  button to scroll through the display messages.

When the ignition is switched off, all display messages are deleted, apart from some high-priority display messages. Once the causes of the high-priority display messages have been rectified, the corresponding display messages are also deleted.

## Safety systems

## Display messages



Currently Unavailable See Operator's Manual

## Possible causes/consequences and ► Solutions

ABS (Anti-lock Braking System) and ESP® (Electronic Stability Program) are temporarily not available. Other driving systems and driving safety systems may also malfunction.

In addition, the ,  and  warning lamps light up in the instrument cluster.

Possible causes are:

- self-diagnosis is not yet complete
- the on-board voltage may be insufficient

 **WARNING**

The brake system continues to function normally, but without the functions listed above. The wheels could therefore lock if you brake hard, for example.

The steerability and braking characteristics may be severely affected. The braking distance in an emergency braking situation can increase.

If ESP® is not operational, ESP® is unable to stabilize the vehicle.

There is an increased risk of skidding and an accident.

- Carefully drive a suitable distance, making slight steering movements at a speed above 12 mph (20 km/h).  
If the display message disappears, the functions mentioned above are available again.

If the multifunction display still shows the display message:





- Drive on carefully.
- Visit a qualified specialist workshop immediately.



Inoperative See Operator's Manual

ABS and ESP® are malfunctioning.

Other driving systems and driving safety systems may also malfunction.

The  (USA only) or  (Canada only), ,  and  warning lamps in the instrument cluster also light up.

 **WARNING**







The brake system continues to function normally, but without the functions listed above. The wheels could therefore lock if you brake hard, for example.





















The steerability and braking characteristics may be severely affected. The braking distance in an emergency braking situation can increase.

If ESP® is not operational, ESP® is unable to stabilize the vehicle.









There is an increased risk of skidding and an accident.













- Drive on carefully.
- Visit a qualified specialist workshop immediately.













Display messages	Possible causes/consequences and ► Solutions
 <p data-bbox="115 220 348 296">Currently Unavailable See Operator's Manual</p>	<p data-bbox="370 172 684 199">ESP® is temporarily unavailable.</p> <p data-bbox="370 204 1028 255">Other driving systems and driving safety systems may also malfunction.</p> <p data-bbox="370 260 1025 311">In addition, the  and  warning lamps light up in the instrument cluster.</p> <p data-bbox="370 316 986 343">The self-diagnosis function might not be complete, for example. ATTENTION ASSIST is deactivated.</p> <p data-bbox="381 387 535 414"><b>▲ WARNING</b></p> <p data-bbox="370 427 1025 504">The brake system continues to function normally, but without the functions listed above. The wheels could therefore lock if you brake hard, for example.</p> <p data-bbox="370 509 997 560">The braking distance in an emergency braking situation can thus increase.</p> <p data-bbox="370 564 1001 624">If ESP® is not operational, ESP® is unable to stabilize the vehicle. There is an increased risk of skidding and an accident.</p> <ul style="list-style-type: none"> <li data-bbox="370 628 1012 679">► Carefully drive a suitable distance, making slight steering movements at a speed above 12 mph (20 km/h).</li> </ul> <p data-bbox="393 684 1031 735">If the display message disappears, the functions mentioned above are available again.</p> <p data-bbox="370 740 945 767">If the multifunction display still shows the display message:</p> <ul style="list-style-type: none"> <li data-bbox="370 772 568 799">► Drive on carefully.</li> <li data-bbox="370 804 869 831">► Visit a qualified specialist workshop immediately.</li> </ul>
 <p data-bbox="115 911 320 962">Inoperative See Operator's Manual</p>	<p data-bbox="370 863 600 890">ESP® is malfunctioning.</p> <p data-bbox="370 895 1028 946">Other driving systems and driving safety systems may also malfunction.</p> <p data-bbox="370 951 1025 1002">In addition, the  and  warning lamps light up in the instrument cluster.</p> <p data-bbox="381 1015 535 1042"><b>▲ WARNING</b></p> <p data-bbox="370 1054 1025 1131">The brake system continues to function normally, but without the functions listed above. The wheels could therefore lock if you brake hard, for example.</p> <p data-bbox="370 1136 997 1187">The braking distance in an emergency braking situation can thus increase.</p> <p data-bbox="370 1192 1001 1251">If ESP® is not operational, ESP® is unable to stabilize the vehicle. There is an increased risk of skidding and an accident.</p> <ul style="list-style-type: none"> <li data-bbox="370 1256 568 1283">► Drive on carefully.</li> <li data-bbox="370 1287 869 1315">► Visit a qualified specialist workshop immediately.</li> </ul>

Display messages	Possible causes/consequences and ► Solutions
   <p>Inoperative See Operator's Manual</p>	<p>EBD (electronic brake force distribution), ABS and ESP<sup>®</sup> are malfunctioning.</p> <p>Other driving systems and driving safety systems may also malfunction.</p> <p>In addition, the ,  and  warning lamps light up in the instrument cluster and a warning tone sounds.</p> <p><b>⚠ WARNING</b></p> <p>The brake system continues to function normally, but without the functions listed above. The wheels could therefore lock if you brake hard, for example.</p> <p>The steerability and braking characteristics may be severely affected. The braking distance in an emergency braking situation can increase. If ESP<sup>®</sup> is not operational, ESP<sup>®</sup> is unable to stabilize the vehicle. There is an increased risk of skidding and an accident.</p> <ul style="list-style-type: none"> <li>► Drive on carefully.</li> <li>► Visit a qualified specialist workshop immediately.</li> </ul>
 (USA only)  (Canada only) <p>Turn On the Ignition to Release the Parking Brake</p>	<p>The red  (USA only) or  (Canada only) indicator lamp lights up.</p> <p>You attempted to release the electric parking brake while the ignition was switched off.</p> <ul style="list-style-type: none"> <li>► <b>SmartKey</b> : insert the SmartKey into the ignition lock and turn to position <b>1</b>.</li> <li>► <b>KEYLESS-GO</b>: switch on the ignition.</li> </ul>
 (USA only)  (Canada only) <p>Please Release Parking Brake</p>	<p>The red  (USA only) or  (Canada only) indicator lamp flashes and a warning tone sounds. A condition for automatic release of the electric parking brake is not fulfilled (▷ page 157).</p> <p>You are driving with the electric parking brake applied.</p> <ul style="list-style-type: none"> <li>► Release the electric parking brake manually.</li> </ul> <p>The red  (USA only) or  (Canada only) indicator lamp flashes and a warning tone sounds.</p> <p>You are using the electric parking brake for emergency braking (▷ page 157).</p>
 (USA only)  (Canada only) <p>Parking Brake See Operator's Manual</p>	<p>The yellow  warning lamp lights up.</p> <p>The electric parking brake is malfunctioning.</p> <p><b>To apply:</b></p> <ul style="list-style-type: none"> <li>► Switch the ignition off.</li> <li>► Press the electric parking brake handle for at least ten seconds.</li> <li>► Shift the transmission to position  .</li> <li>► Consult a qualified specialist workshop.</li> </ul>















Display messages	Possible causes/consequences and ► Solutions
	<p>The yellow  warning lamp and the red  (USA only) or  (Canada only) indicator lamp light up. The electric parking brake is malfunctioning.</p> <p><b>To release:</b></p> <ul style="list-style-type: none"> <li>► Switch off the ignition and turn it back on.</li> <li>► Release the electric parking brake manually.</li> </ul> <p>or</p> <ul style="list-style-type: none"> <li>► Release the electric parking brake automatically (▷ page 157).</li> </ul> <p>If the electric parking brake still cannot be released:</p> <ul style="list-style-type: none"> <li>► Do not drive on.</li> <li>► Consult a qualified specialist workshop.</li> </ul>
	<p>The red  (USA only) or  (Canada only) indicator lamp flashes and the yellow  warning lamp lights up. The electric parking brake is malfunctioning.</p> <p><b>To release:</b></p> <ul style="list-style-type: none"> <li>► Switch off the ignition and turn it back on.</li> <li>► Release the electric parking brake manually.</li> </ul> <p><b>To apply:</b></p> <ul style="list-style-type: none"> <li>► Switch off the ignition and turn it back on.</li> <li>► Apply the electric parking brake manually.</li> </ul> <p>If the red  (USA only) or  (Canada only) indicator lamp continues to flash:</p> <ul style="list-style-type: none"> <li>► Do not drive on.</li> <li>► Secure the vehicle against rolling away (▷ page 372).</li> <li>► Shift the transmission to position .</li> <li>► Turn the front wheels towards the curb.</li> <li>► Consult a qualified specialist workshop.</li> </ul>

Display messages	Possible causes/consequences and ► Solutions
	<p>The yellow  warning lamp lights up. The red  (USA only) or  (Canada only) indicator lamp flashes for about ten seconds after the electric parking brake has been applied or released. It then goes out or remains lit.</p> <p>The electric parking brake is malfunctioning.</p> <ul style="list-style-type: none"> <li>► Switch off the ignition and turn it back on.</li> <li>► Apply the electric parking brake.</li> </ul> <p>If it is not possible to engage the electric parking brake:</p> <ul style="list-style-type: none"> <li>► Shift the transmission to position .</li> <li>► Visit a qualified specialist workshop.</li> </ul> <p>If it is not possible to release the electric parking brake:</p> <ul style="list-style-type: none"> <li>► Release the electric parking brake automatically (&gt; page 157).</li> </ul> <p>If the electric parking brake still cannot be released:</p> <ul style="list-style-type: none"> <li>► Consult a qualified specialist workshop.</li> </ul> <p>The yellow  warning lamp lights up. If you manually apply or release the electric parking brake, the red  (USA only) or  (Canada only) indicator lamp flashes.</p> <p>The electric parking brake is malfunctioning. It is not possible to apply the electric parking brake manually.</p> <ul style="list-style-type: none"> <li>► Shift the transmission to position .</li> <li>► Visit a qualified specialist workshop.</li> </ul>
<p> (USA only)  (Canada only)</p> <p><b>Parking Brake Inoperative</b></p>	<p>The yellow  warning lamp lights up. The red  (USA only) or  (Canada only) indicator lamp flashes for about ten seconds after the electric parking brake has been applied or released. It then goes out or remains lit.</p> <p>The electric parking brake is malfunctioning, e.g. because of overvoltage or undervoltage.</p> <ul style="list-style-type: none"> <li>► Remove the cause for the overvoltage or undervoltage, e.g. by charging the battery or restarting the engine.</li> <li>► Engage or release the electric parking brake.</li> </ul> <p>If it remains impossible to apply or release the electric parking brake:</p> <ul style="list-style-type: none"> <li>► Switch off the ignition and turn it back on.</li> <li>► Engage or release the electric parking brake.</li> </ul> <p>If the electric parking brake still cannot be released:</p> <ul style="list-style-type: none"> <li>► Consult a qualified specialist workshop.</li> </ul> <p>If the electric parking brake still cannot be applied:</p> <ul style="list-style-type: none"> <li>► Visit a qualified specialist workshop.</li> </ul>

Display messages	Possible causes/consequences and ► Solutions
	<p>The yellow  warning lamp lights up and the red  (USA only) or  (Canada only) indicator lamp flashes.</p> <p>It is not possible to apply the electric parking brake manually.</p> <ul style="list-style-type: none"> <li>► Shift the transmission to position .</li> <li>► Visit a qualified specialist workshop.</li> </ul>
<p> (USA only)   (Canada only)                      Check Brake Fluid Level</p>	<p>There is not enough brake fluid in the brake fluid reservoir. In addition, the  (USA only) or  (Canada only) warning lamp lights up in the instrument cluster and a warning tone sounds.</p> <p> <b>WARNING</b></p> <p>The braking effect may be impaired.                      There is a risk of an accident.</p> <ul style="list-style-type: none"> <li>► Pull over and stop the vehicle safely as soon as possible, paying attention to road and traffic conditions. Do not continue driving under any circumstances.</li> <li>► Secure the vehicle against rolling away (▷ page 156).</li> <li>► Consult a qualified specialist workshop.</li> <li>► Do not add brake fluid. This does not correct the malfunction.</li> </ul>
<p>                      Check Brake Pad Wear</p>	<p>The brake pads/linings have reached their wear limit.</p> <p>USA only: the  red brake system warning lamp is lit while the engine is running.</p> <ul style="list-style-type: none"> <li>► Visit a qualified specialist workshop.</li> </ul>
<p>                      Inoperative</p>	<p>One or more main features of the mbrace system are malfunctioning.</p> <ul style="list-style-type: none"> <li>► Visit a qualified specialist workshop.</li> </ul>
<p>Active Brake Assist Functions Currently Limited See Operator's Manual</p>	<p>Active Brake Assist with cross-traffic function is temporarily inoperative.</p> <p>Possible causes are:</p> <ul style="list-style-type: none"> <li>• The radar sensor system is temporarily inoperative, e.g. due to electromagnetic radiation emitted by nearby TV or radio stations or other sources of electromagnetic radiation.</li> <li>• The system is outside the operating temperature range.</li> <li>• The on-board voltage is too low.</li> </ul> <p>When the causes stated above no longer apply, the display message disappears.</p> <p>Active Brake Assist with cross-traffic function or PRE-SAFE® PLUS is functional again.</p> <p>If the display message does not disappear:</p> <ul style="list-style-type: none"> <li>► Pull over and stop the vehicle safely as soon as possible, paying attention to road and traffic conditions.</li> <li>► Secure the vehicle against rolling away (▷ page 156).</li> <li>► Restart the engine.</li> </ul>

Display messages	Possible causes/consequences and ► Solutions
Active Brake Assist Functions Currently Limited See Operator's Manual	<p>Active Brake Assist is unavailable due to a malfunction. Adaptive Brake Assist may also have failed.</p> <p>► Visit a qualified specialist workshop immediately.</p>
PRE-SAFE Inoperative See Operator's Manual	<p>Important functions of PRE-SAFE® have failed. All other occupant safety systems, e.g. air bags, remain available.</p> <p>► Visit a qualified specialist workshop immediately.</p>
Active Brake Assist Functions Currently Limited See Operator's Manual	<p>Active Brake Assist or PRE-SAFE® PLUS is temporarily inoperative. Possible causes are:</p> <ul style="list-style-type: none"> <li>• Function is impaired due to heavy rain or snow.</li> <li>• The radar sensor system is temporarily inoperative, e.g. due to electromagnetic radiation emitted by nearby TV or radio stations or other sources of electromagnetic radiation.</li> <li>• Mercedes-AMG vehicles: ESP® is deactivated.</li> <li>• The system is outside the operating temperature range.</li> <li>• The on-board voltage is too low.</li> </ul> <p>When the causes stated above no longer apply, the display message disappears.</p> <p>Active Brake Assist or PRE-SAFE® PLUS is operative again.</p> <p>If the display message does not disappear:</p> <ul style="list-style-type: none"> <li>► Pull over and stop the vehicle safely as soon as possible, paying attention to road and traffic conditions.</li> <li>► Secure the vehicle against rolling away (▷ page 156).</li> <li>► Restart the engine.</li> <li>► Mercedes-AMG vehicles: switch ESP® on again (▷ page 71).</li> </ul>
Active Brake Assist Functions Limited See Operator's Manual	<p>Active Brake Assist with cross-traffic function or PRE-SAFE® PLUS is not available due to a malfunction.</p> <p>► Visit a qualified specialist workshop immediately.</p>

Display messages	Possible causes/consequences and ► Solutions
<p>Radar Sensors Dirty See Operator's Manual</p>	<p>The radar sensor system is malfunctioning. Possible causes are:</p> <ul style="list-style-type: none"> <li>• dirt on sensors</li> <li>• heavy rain or snow</li> <li>• when driving on inter-urban roads without traffic or infrastructure, e.g. in desert-like areas</li> </ul> <p>At least one driving system or driving safety system is malfunctioning or is temporarily unavailable:</p> <ul style="list-style-type: none"> <li>• PRE-SAFE® PLUS</li> <li>• Active Brake Assist</li> <li>• Active Lane Keeping Assist</li> <li>• Active Blind Spot Assist</li> <li>• Distance Pilot DISTRONIC</li> </ul> <p>If the radar sensor system in front is dirty, Active Blind Spot Assist will not perform a course-correcting brake application. A warning tone also sounds.</p> <p>Once the cause of the problem is no longer present, the driving and drive safety systems will be available again. The display message disappears.</p> <p>If the display message does not disappear:</p> <ul style="list-style-type: none"> <li>► Pull over and stop the vehicle safely as soon as possible, paying attention to road and traffic conditions.</li> <li>► Secure the vehicle against rolling away (▷ page 156).</li> <li>► Switch off the engine.</li> <li>► Clean all sensors (▷ page 330).</li> <li>► Restart the engine. The display message disappears.</li> </ul>
<p> SRS Malfunction Service Required</p>	<p>The restraint system is malfunctioning. The  warning lamp also lights up in the instrument cluster.</p> <p> <b>WARNING</b></p> <p>The air bags or Emergency Tensioning Devices may either be triggered unintentionally or, in the event of an accident, may not be triggered. There is an increased risk of injury.</p> <ul style="list-style-type: none"> <li>► Visit a qualified specialist workshop immediately.</li> </ul> <p>For further information about the restraint system, see (▷ page 44).</p>
<p> Front Left Malfunction Service Required or Front Left Malfunction Service Required</p>	<p>The restraint system has malfunctioned at the front on the left or right. The  warning lamp also lights up in the instrument cluster.</p> <p> <b>WARNING</b></p> <p>The air bags or Emergency Tensioning Devices may either be triggered unintentionally or, in the event of an accident, may not be triggered. There is an increased risk of injury.</p> <ul style="list-style-type: none"> <li>► Visit a qualified specialist workshop immediately.</li> </ul>

Display messages	Possible causes/consequences and ► Solutions
 <p>Rear Left Malfunction Service Required or Rear Left Malfunction Service Required</p>	<p>The rear left-hand or right-hand restraint system is malfunctioning. The  warning lamp also lights up in the instrument cluster.</p> <p><b>⚠ WARNING</b></p> <p>The air bags or Emergency Tensioning Devices may either be triggered unintentionally or, in the event of an accident, may not be triggered. There is an increased risk of injury.</p> <p>► Visit a qualified specialist workshop immediately.</p>
 <p>Rear Center Malfunction Service Required</p>	<p>The rear center restraint system is malfunctioning. The  warning lamp also lights up in the instrument cluster.</p> <p><b>⚠ WARNING</b></p> <p>The air bags or Emergency Tensioning Devices may either be triggered unintentionally or, in the event of an accident, may not be triggered. There is an increased risk of injury.</p> <p>► Visit a qualified specialist workshop immediately.</p>
 <p>Left Side Curtain Airbag Malfunction Service Required or Right Side Curtain Airbag Malfunction Service Required</p>	<p>The left-hand or right-hand window curtain air bag is malfunctioning. The  warning lamp also lights up in the instrument cluster.</p> <p><b>⚠ WARNING</b></p> <p>The left or right window curtain air bag may either be triggered unintentionally or, in the event of an accident, may not be triggered. There is an increased risk of injury.</p> <p>► Visit a qualified specialist workshop immediately.</p>

Display messages	Possible causes/consequences and ► Solutions
<p><a href="#">Front Passenger Air-bag Disabled See Operator's Manual</a></p>	<p>The front-passenger front air bag is deactivated during the journey, even though:</p> <ul style="list-style-type: none"> <li>• an adult</li> <li>or</li> <li>• a person of the corresponding stature is on the front-passenger seat</li> </ul> <p>If additional forces are applied to the seat, the system may interpret the occupant's weight as lower than it actually is.</p> <p> <b>WARNING</b></p> <p>The front-passenger air bag does not deploy during an accident. There is an increased risk of injury.</p> <ul style="list-style-type: none"> <li>► Pull over and stop the vehicle safely as soon as possible, paying attention to road and traffic conditions.</li> <li>► Secure the vehicle against rolling away (► page 156).</li> <li>► Switch the ignition off.</li> <li>► Have the occupant on the front-passenger seat get out of the vehicle.</li> <li>► Keep the seat unoccupied, close the front-passenger door and switch on the ignition.</li> <li>► Observe the PASSENGER AIR BAG indicator lamps in the center console and the multifunction display and check the following: Seat unoccupied and ignition switched on: <ul style="list-style-type: none"> <li>• a self-diagnosis is carried out. The PASSENGER AIR BAG OFF and PASSENGER AIR BAG ON indicator lamps must light up simultaneously for approximately six seconds.</li> <li>• the PASSENGER AIR BAG OFF indicator lamp must then light up and remain lit after the self-diagnosis. If the indicator lamp is on, OCS (Occupant Classification System) has deactivated the front-passenger front air bag (► page 52)</li> <li>• the <a href="#">Front Passenger Airbag Enabled See Operator's Manual</a> or <a href="#">Front Passenger Airbag Disabled See Operator's Manual</a> display messages must not be shown on the multifunction display.</li> </ul> </li> <li>► Wait for a period of at least 60 seconds until the necessary system checks have been completed.</li> <li>► Make sure that the display messages do not appear in the multifunction display.</li> </ul> <p>If these conditions are fulfilled, the front-passenger seat can be occupied again. Whether the PASSENGER AIR BAG OFF or ON indicator lamp remains lit or goes out depends on how OCS classifies the occupant.</p> <p>If the conditions are not fulfilled, the system is not operating correctly.</p> <ul style="list-style-type: none"> <li>► Visit a qualified specialist workshop immediately.</li> </ul> <p>For further information about the Occupant Classification System, see (► page 52).</p>

Display messages	Possible causes/consequences and ► Solutions
<p>Front Passenger Airbag Enabled See Operator's Manual</p>	<p>The front-passenger front air bag is enabled during the journey, even though:</p> <ul style="list-style-type: none"> <li>• a child, a small adult or an object weighing less than the system's weight threshold is located on the front-passenger seat or</li> <li>• the front-passenger seat is unoccupied</li> </ul> <p>The system may detect objects or forces applying additional weight on the seat.</p> <p> <b>WARNING</b></p> <p>The front-passenger front air bag may deploy unintentionally. There is an increased risk of injury.</p> <ul style="list-style-type: none"> <li>► Pull over and stop the vehicle safely as soon as possible, paying attention to road and traffic conditions.</li> <li>► Secure the vehicle against rolling away (▷ page 156).</li> <li>► Switch the ignition off.</li> <li>► Open the front-passenger door.</li> <li>► Remove the child and the child restraint system from the front-passenger seat.</li> <li>► Make sure that there are no objects on the seat adding to the weight. The system might otherwise detect the additional weight and interpret the seat occupant's weight as greater than it actually is.</li> <li>► Keep the seat unoccupied, close the front-passenger door and switch on the ignition.</li> <li>► Observe the PASSENGER AIR BAG indicator lamps in the center console and the multifunction display and check the following: Seat unoccupied and ignition switched on: <ul style="list-style-type: none"> <li>• a self-diagnosis is carried out. The PASSENGER AIR BAG OFF and PASSENGER AIR BAG ON indicator lamps must light up simultaneously for approximately six seconds.</li> <li>• the PASSENGER AIR BAG OFF indicator lamp must then light up and remain lit after the self-diagnosis. If the indicator lamp is on, OCS has disabled the front-passenger front air bag (▷ page 52)</li> <li>• the <a href="#">Front Passenger Airbag Enabled See Operator's Manual</a> or <a href="#">Front Passenger Airbag Disabled See Operator's Manual</a> display messages must not be shown on the multifunction display.</li> </ul> </li> <li>► Wait for a period of at least 60 seconds until the necessary system checks have been completed.</li> <li>► Make sure that the display messages do not appear in the multifunction display.</li> </ul> <p>If these conditions are fulfilled, the front-passenger seat can be occupied again. Whether the PASSENGER AIR BAG OFF or ON indicator lamp remains lit or goes out depends on how OCS classifies the occupant.</p> <p>If the conditions are not fulfilled, the system is not operating correctly.</p>











Display messages	Possible causes/consequences and ► Solutions
	<ul style="list-style-type: none"> <li>► Visit a qualified specialist workshop immediately.</li> </ul> <p>For further information about the Occupant Classification System, see (► page 52).</p>

## Lights



**i** Vehicles with LED bulbs in the light clusters:



The display message for the corresponding lamp only appears when all of the LEDs in the lamp have failed.







Display messages	Possible causes/consequences and ► Solutions
 <p>Check Left Low Beam (Example)</p>	<p>The bulb in question is malfunctioning.</p> <ul style="list-style-type: none"> <li>► Visit a qualified specialist workshop.</li> </ul> <p>or</p> <ul style="list-style-type: none"> <li>► Check whether you are permitted to replace the bulb yourself (► page 115).</li> </ul>
 <p>Active Headlamps Inoperative</p>	<p>The active light function is faulty.</p> <ul style="list-style-type: none"> <li>► Visit a qualified specialist workshop.</li> </ul>
 <p>Intell. Light System Inoperative</p>	<p>The Intelligent Light System is faulty. The lights remain available without the Intelligent Light System.</p> <ul style="list-style-type: none"> <li>► Visit a qualified specialist workshop.</li> </ul>
 <p>Malfunction See Operator's Manual</p>	<p>The exterior lighting is malfunctioning.</p> <ul style="list-style-type: none"> <li>► Visit a qualified specialist workshop.</li> </ul> <p>Vehicles with trailer tow hitch: a fuse may have blown.</p> <ul style="list-style-type: none"> <li>► Pull over and stop the vehicle safely as soon as possible, paying attention to road and traffic conditions.</li> <li>► Secure the vehicle against rolling away (► page 156).</li> <li>► Check the fuses (► page 348).</li> <li>► If necessary, replace the blown fuse. Observe the warning notes.</li> </ul> <p>If the multifunction display still shows the display message:</p> <ul style="list-style-type: none"> <li>► Visit a qualified specialist workshop.</li> </ul>
 <p>Malfunction See Operator's Manual</p>	<p>The exterior lighting is malfunctioning.</p> <ul style="list-style-type: none"> <li>► Visit a qualified specialist workshop.</li> </ul>
 <p>Auto Lamp Function Inoperative</p>	<p>The light sensor is defective.</p> <ul style="list-style-type: none"> <li>► Visit a qualified specialist workshop.</li> </ul>







Display messages	Possible causes/consequences and ► Solutions
 <p>Switch Off Lights</p>	<p>You leave the vehicle and the lights are switched on. A warning tone also sounds.</p> <p>► Turn the light switch to the <b>AUTO</b> position.</p>
 <p>Switch On Headlamps</p>	<p>You are driving with low-beam headlamps switched off.</p> <p>► Turn the light switch to the  or <b>AUTO</b> position.</p>
<p>Adaptive Highbeam Assist Currently Unavailable See Operator's Manual</p>	<p>Adaptive Highbeam Assist is deactivated and temporarily inoperative. Possible causes are:</p> <ul style="list-style-type: none"> <li>• The windshield in the camera's field of vision is dirty.</li> <li>• Visibility is impaired due to heavy rain, snow or fog.</li> </ul> <p>► Clean the windshield.</p> <p>If the system detects that the camera is fully operational, the <b>Adaptive Highbeam Assist Now Available</b> message is displayed. Adaptive Highbeam Assist is operational again.</p>
<p>Adaptive Highbeam Assist Inoperative</p>	<p>Adaptive Highbeam Assist is faulty.</p> <p>► Visit a qualified specialist workshop.</p>





## Engine



Display messages	Possible causes/consequences and ► Solutions
 <p>Check Coolant Level See Operator's Manual</p>	<p>The coolant level is too low.</p> <p><b>!</b> Avoid making long journeys with too little coolant in the engine cooling system. The engine will otherwise be damaged.</p> <p>► Add coolant, observing the warning notes before doing so (► page 324).</p> <p><b>If you have to add coolant frequently:</b></p> <p>► Contact a qualified specialist workshop and have the engine cooling system checked.</p>
	<p>The fan motor is malfunctioning.</p> <p>► At coolant temperatures below 248 °F (120 °C), drive to the nearest qualified specialist workshop.</p> <p>► Avoid heavy loads on the engine as you do so, e.g. driving in mountainous terrain and stop-and-go traffic.</p>



Display messages	Possible causes/consequences and ► Solutions
 <p data-bbox="116 220 322 296">Coolant Too Hot Stop Vehicle Turn Engine Off</p>	<p data-bbox="372 172 645 225">The coolant is too hot. A warning tone also sounds.</p> <p data-bbox="384 240 535 268"> <b>WARNING</b></p> <p data-bbox="372 284 1028 357">Do not drive when your engine is overheated. This can cause some fluids which may have leaked into the engine compartment to catch fire.</p> <p data-bbox="372 368 1031 416">Steam from the overheated engine can also cause serious burns which can occur just by opening the hood.</p> <p data-bbox="372 424 598 448">There is a risk of injury.</p> <ul style="list-style-type: none"> <li data-bbox="372 456 1031 504">► Pull over and stop the vehicle safely and switch off the engine, paying attention to road and traffic conditions.</li> <li data-bbox="372 512 908 536">► Secure the vehicle against rolling away (▷ page 156).</li> <li data-bbox="372 544 768 568">► Wait until the engine has cooled down.</li> <li data-bbox="372 576 1031 624">► Make sure that the air supply to the engine radiator is not blocked, e.g. by snow, slush or ice.</li> <li data-bbox="372 632 1031 705">► Do not start the engine again until the display message goes out and the coolant temperature is below 248 °F (120 °C). Otherwise, the engine could be damaged.</li> <li data-bbox="372 713 857 737">► Pay attention to the coolant temperature gauge.</li> </ul> <p data-bbox="372 745 740 769"><b>If the temperature increases again:</b></p> <ul style="list-style-type: none"> <li data-bbox="372 785 869 809">► Visit a qualified specialist workshop immediately.</li> </ul> <p data-bbox="372 817 1005 865">Under normal operating conditions and with the specified coolant level, the coolant temperature may rise to 248 °F (120 °C).</p>
 <p data-bbox="116 938 344 986">See Operator's Manual</p>	<p data-bbox="372 890 689 914">The battery is not being charged.</p> <p data-bbox="372 922 645 946">A warning tone also sounds.</p> <p data-bbox="372 954 568 978">Possible causes are:</p> <ul style="list-style-type: none"> <li data-bbox="384 986 602 1010">• a defective alternator</li> <li data-bbox="384 1018 563 1042">• a torn poly-V-belt</li> <li data-bbox="384 1050 701 1074">• a malfunction in the electronics</li> </ul> <p data-bbox="372 1090 1009 1114"><b>!</b> Do not continue driving. The engine could otherwise overheat.</p> <ul style="list-style-type: none"> <li data-bbox="372 1121 1031 1169">► Pull over and stop the vehicle safely and switch off the engine, paying attention to road and traffic conditions.</li> <li data-bbox="372 1177 908 1201">► Secure the vehicle against rolling away (▷ page 156).</li> <li data-bbox="372 1209 779 1233">► Consult a qualified specialist workshop.</li> </ul>

Display messages	Possible causes/consequences and ► Solutions
 <p>Stop Vehicle See Operator's Manual</p>	<p>The battery is no longer being charged and the condition of charge is too low. A warning tone also sounds.</p> <ul style="list-style-type: none"> <li>► Pull over and stop the vehicle safely and switch off the engine, paying attention to road and traffic conditions.</li> <li>► Secure the vehicle against rolling away (▷ page 156).</li> <li>► Observe the instructions in the  See Operator's Manual display message.</li> <li>► Consult a qualified specialist workshop.</li> </ul>
 <p>Check Engine Oil At Next Refueling</p>	<p>The engine oil level has dropped to the minimum level. A warning tone also sounds.</p> <p><b>!</b> Avoid long journeys with too little engine oil. The engine will otherwise be damaged.</p> <ul style="list-style-type: none"> <li>► Check the oil level when next refueling, at the latest (▷ page 323).</li> <li>► If necessary, add engine oil (▷ page 323).</li> </ul> <p><b>If the engine oil needs topping up more often:</b></p> <ul style="list-style-type: none"> <li>► Contact a qualified specialist workshop and have the engine checked.</li> </ul> <p>Information on approved engine oils can be obtained from any qualified specialist workshop or on the Internet at <a href="http://bevo.mercedes-benz.com">http://bevo.mercedes-benz.com</a>.</p>
 <p>Check Engine Oil Level (Add 1 quart)</p>	<p>Mercedes-AMG vehicles: the engine oil level is too low.</p> <p><b>!</b> Avoid long journeys with too little engine oil. The engine will otherwise be damaged.</p> <ul style="list-style-type: none"> <li>► Check the oil level when next refueling, at the latest (▷ page 323).</li> <li>► If necessary, add engine oil (▷ page 323).</li> </ul> <p><b>If the engine oil needs topping up more often:</b></p> <ul style="list-style-type: none"> <li>► Contact a qualified specialist workshop and have the engine checked.</li> </ul> <p>Information on approved engine oils can be obtained from any qualified specialist workshop or on the Internet at <a href="http://bevo.mercedes-benz.com">http://bevo.mercedes-benz.com</a>.</p>
 <p>Engine Oil Level Low Stop Vehicle Turn Engine Off</p>	<p>Mercedes-AMG vehicles: the engine oil level is too low. There is a risk of engine damage.</p> <ul style="list-style-type: none"> <li>► Pull over and stop the vehicle safely and switch off the engine, paying attention to road and traffic conditions.</li> <li>► Secure the vehicle against rolling away (▷ page 156).</li> <li>► Check the engine oil level (▷ page 323).</li> <li>► If necessary, add engine oil (▷ page 323).</li> </ul>
 <p>Fuel Level Low</p>	<p>The fuel level has dropped into the reserve range.</p> <ul style="list-style-type: none"> <li>► Refuel at the nearest gas station.</li> </ul>

Display messages	Possible causes/consequences and ► Solutions
	<p>There is only a very small amount of fuel in the fuel tank.</p> <ul style="list-style-type: none"> <li>► Refuel at the nearest gas station without fail.</li> </ul>
 <p>Gas Cap Loose</p>	<p>The fuel filler cap is not closed correctly or the fuel system is leaking.</p> <ul style="list-style-type: none"> <li>► Check that the fuel filler cap is correctly closed.</li> </ul> <p><b>If the fuel filler cap is not correctly closed:</b></p> <ul style="list-style-type: none"> <li>► Close the fuel filler cap.</li> </ul> <p><b>If the fuel filler cap is correctly closed:</b></p> <ul style="list-style-type: none"> <li>► Visit a qualified specialist workshop.</li> </ul>
 <p>Ultra Low-sulfur Diesel Fuel Only</p>	<p>Vehicles with a diesel engine: the fuel level has fallen below the reserve range.</p> <ul style="list-style-type: none"> <li>► Refuel at the nearest gas station.</li> <li>► Only use commercially available vehicular ULTRA-LOW SULFUR HIGHWAY DIESEL FUEL (ULSD, 15 ppm SULFUR MAXIMUM).</li> </ul>
 <p>Replace Air Filter</p>	<p>Vehicles with a diesel engine: the engine air filter is dirty and must be replaced.</p> <ul style="list-style-type: none"> <li>► Visit a qualified specialist workshop.</li> </ul>
 <p>Check Fuel Filter</p>	<p>Vehicles with a diesel engine: there is water in the fuel filter. The water must be drained off.</p> <ul style="list-style-type: none"> <li>► Visit a qualified specialist workshop.</li> </ul>
 <p>Check Additive See Operator's Manual</p>	<p>The DEF tank is almost empty.</p> <ul style="list-style-type: none"> <li>► Have the DEF tank filled immediately at a qualified specialist workshop (► page 153).</li> </ul> <p>The DEF system is malfunctioning.</p> <ul style="list-style-type: none"> <li>► Visit a qualified specialist workshop.</li> </ul>
 <p>Remaining Starts: 16</p>	<p>The DEF level has fallen to a minimum. You can start the engine a further 16 times.</p> <ul style="list-style-type: none"> <li>► Have the DEF tank filled immediately at a qualified specialist workshop (► page 153).</li> </ul> <p><b>i</b> You can start the engine a further 16 times. If DEF is not added, it will then not be possible to restart the engine. Refill the DEF tank with approximately 2 gal (7.5 l) of DEF (► page 153).</p> <p>If the 'ten starts' message appears in the display and a warning tone sounds, the DEF system is malfunctioning.</p> <ul style="list-style-type: none"> <li>► Visit a qualified specialist workshop.</li> </ul>



Driving systems	
Display messages	Possible causes/consequences and ► Solutions
 <p>Attention Assist: Take a Break!</p>	<p>Based on certain criteria, ATTENTION ASSIST has detected fatigue or a lack of concentration on the part of the driver. A warning tone also sounds.</p> <ul style="list-style-type: none"> <li>► If necessary, take a break.</li> </ul> <p>During long journeys, take regular breaks in good time so you get enough rest.</p>
 <p>Attention Assist Inoperative</p>	<p>ATTENTION ASSIST is inoperative.</p> <ul style="list-style-type: none"> <li>► Visit a qualified specialist workshop.</li> </ul>
 <p>Drive More Slowly</p>	<p>You cannot change the vehicle level.</p> <p>Possible causes are:</p> <ul style="list-style-type: none"> <li>• You are driving too fast for the selected vehicle level</li> <li>• You are driving too fast with a trailer or the trailer-coupling socket is being used, e.g. for a bicycle rack</li> </ul> <ul style="list-style-type: none"> <li>► Drive more slowly and then select the desired vehicle level again. <ul style="list-style-type: none"> <li>• Vehicles with the Off-Road Engineering package (► page 179)</li> <li>• Vehicles with the AIRMATIC package (► page 185)</li> </ul> </li> <li>► Observe the notes on towing a trailer (► page 220).</li> </ul>
 <p>Compressor Is Cooling</p>	<p>You have selected a higher vehicle level. The compressor first needs to cool down because of frequent level changes.</p> <ul style="list-style-type: none"> <li>► Drive in a manner appropriate for the current vehicle level.</li> <li>► Make sure that there is sufficient ground clearance.</li> <li>► Allow the compressor to cool down.</li> </ul> <p>When the compressor has cooled down, the display message disappears. The vehicle then continues rising to the selected level.</p>
 <p>Malfunction</p>	<p>AIRMATIC is malfunctioning.</p> <ul style="list-style-type: none"> <li>► Drive as appropriate for the current vehicle level, but do not exceed 50 mph (80 km/h).</li> <li>► Make sure that there is sufficient ground clearance.</li> <li>► Visit a qualified specialist workshop.</li> </ul>

Display messages	Possible causes/consequences and ► Solutions
 <p>Max. Speed 12 mph</p>	<p>You are exceeding the speed permissible for the selected off-road level.</p> <p>In addition, the vehicle level display appears above the display message, and a warning tone sounds.</p> <p><b>▲ WARNING</b></p> <p>The vehicle could tip and rollover. There is a risk of an accident.</p> <ul style="list-style-type: none"> <li>► Adjust your driving style to the altered handling characteristics.</li> <li>► Only make slight steering movements and avoid fast steering movements.</li> <li>► Do not exceed 12 mph (20 km/h) until the vehicle has reached off-road level 2.</li> </ul>
 <p>Raising Max. Speed 12 mph</p>	<p>The vehicle is being adjusted to off-road level 3.</p> <p>In addition, the vehicle level display appears above the display message.</p> <p>The display message refers to the maximum speed permissible (depending on the model type) for off-road level 3.</p> <ul style="list-style-type: none"> <li>► Do not drive at speeds above 12 mph (20 km/h).</li> </ul>
 <p>Lowering Max. Speed 12 mph</p>	<p>The vehicle is being lowered from off-road level 3 to off-road level 2.</p> <p>In addition, the vehicle level display appears above the display message.</p> <p>The display message refers to the maximum speed permissible (depending on the model type) for off-road level 3.</p> <ul style="list-style-type: none"> <li>► Do not exceed 12 mph (20 km/h) until the vehicle has reached off-road level 2.</li> </ul>
<p>ACTIVE CURVE SYSTEM Malfunction</p>	<p>The ACTIVE CURVE SYSTEM is faulty. The vehicle's handling characteristics may be affected.</p> <ul style="list-style-type: none"> <li>► Do not drive at speeds above 50 mph (80 km/h).</li> <li>► Visit a qualified specialist workshop.</li> </ul>
<p>ACTIVE CURVE SYSTEM Malfunction see Operator's Manual</p>	<p>The ACTIVE CURVE SYSTEM is faulty. The vehicle's handling characteristics are severely impaired. A warning tone also sounds.</p> <p><b>▲ WARNING</b></p> <p>There is a risk of an accident.</p> <ul style="list-style-type: none"> <li>► Drive on carefully.</li> <li>► Adjust your driving style to the altered handling characteristics.</li> <li>► Avoid sudden acceleration around tight corners and fast steering movements.</li> <li>► Do not drive at speeds above 50 mph (80 km/h).</li> <li>► Visit a qualified specialist workshop immediately.</li> </ul>

Display messages	Possible causes/consequences and ► Solutions
 <p>Different. Lock Sys. Malfunction</p>	<p>The differential lock is faulty.</p> <ul style="list-style-type: none"> <li>► Do not drive at speeds above 50 mph (80 km/h).</li> <li>► Visit a qualified specialist workshop.</li> </ul>
 <p>Different. Locking Sys. Cooling Down Please Wait</p>	<p>The differential lock is too hot and has been disengaged.</p> <ul style="list-style-type: none"> <li>► Drive on carefully.</li> <li>► Allow the differential lock to cool down. The differential lock re-engages as soon as it has cooled down.</li> </ul>
<p>LOW RANGE Stop Apply Parking Brake</p>	<p>A gearshift process has been canceled. LOW RANGE is in the neutral position. There is no connection between the engine and the drive wheels.</p> <ul style="list-style-type: none"> <li>► Pull over and stop the vehicle safely as soon as possible, paying attention to road and traffic conditions.</li> <li>► Apply the electric parking brake. Do not continue driving under any circumstances.</li> <li>► Repeat the gearshift process.</li> </ul>
<p>LOW RANGE Malfunction To Park. Apply Brake</p>	<p>LOW RANGE is malfunctioning.</p> <ul style="list-style-type: none"> <li>► Do not drive at speeds above 50 mph (80 km/h).</li> <li>► When parking, secure the vehicle against rolling away (▷ page 156).</li> <li>► Visit a qualified specialist workshop.</li> </ul>
<p>LOW RANGE Max. Speed 25 mph</p>	<p>You have exceeded the maximum speed for the gearshift process.</p> <ul style="list-style-type: none"> <li>► Drive more slowly. The gear change is made.</li> </ul>
<p>LOW RANGE Max. Speed 40 mph</p>	<p>You have exceeded the maximum speed for the gearshift process.</p> <ul style="list-style-type: none"> <li>► Drive more slowly. The gear change is made.</li> </ul>
<p>LOW RANGE Shift to Position N Briefly</p>	<p>You have reduced the vehicle speed, but the automatic transmission is not in position <b>N</b>.</p> <ul style="list-style-type: none"> <li>► Briefly shift the automatic transmission to <b>N</b>.</li> </ul>
<p>LOW RANGE Shifting Canceled Please Reactivate</p>	<p>The gearshift process has been canceled.</p> <ul style="list-style-type: none"> <li>► Repeat the gearshift process.</li> </ul>
 <p>Inoperative</p>	<p>DSR (Downhill Speed Regulation) is deactivated due to a malfunction.</p> <ul style="list-style-type: none"> <li>► Have DSR checked at a qualified specialist workshop.</li> </ul>



Display messages	Possible causes/consequences and ► Solutions
<p>Traffic Sign Assist Currently Unavailable See Operator's Manual</p>	<p>Traffic Sign Assist is temporarily inoperative. Possible causes are:</p> <ul style="list-style-type: none"> <li>• The windshield in the camera's field of vision is dirty.</li> <li>• Visibility is impaired due to heavy rain, snow or fog.</li> </ul> <p>► Clean the windshield.</p> <p>If the system detects that the camera is fully operational, the display message disappears. Traffic Sign Assist is operational again.</p>
<p>Traffic Sign Assist Inoperative</p>	<p>Traffic Sign Assist is malfunctioning. ► Visit a qualified specialist workshop.</p>
<p><b>HOLD</b> Off</p>	<p>The HOLD function is deactivated. The vehicle is skidding. A warning tone also sounds. ► Reactivate the HOLD function later (▷ page 182).</p>
<p>Lane Keeping Assist Currently Unavailable See Operator's Manual or Active Lane Keeping Assist Currently Unavailable See Operator's Manual</p>	<p>Lane Keeping Assist or Active Lane Keeping Assist is deactivated and temporarily inoperative. Possible causes are:</p> <ul style="list-style-type: none"> <li>• The windshield in the camera's field of vision is dirty.</li> <li>• Visibility is impaired due to heavy rain, snow or fog.</li> <li>• There have been no lane markings for an extended period.</li> <li>• The lane markings are worn away, dark or covered up, e.g. by dirt or snow.</li> </ul> <p>When the causes stated above no longer apply, the display message disappears. Lane Keeping Assist or Active Lane Keeping Assist is operational again.</p> <p>If the display message does not disappear:</p> <ul style="list-style-type: none"> <li>► Pull over and stop the vehicle safely as soon as possible, paying attention to road and traffic conditions.</li> <li>► Secure the vehicle against rolling away (▷ page 156).</li> <li>► Clean the windshield.</li> </ul>
<p>Lane Keeping Assist Inoperative or Active Lane Keeping Assist Inoperative</p>	<p>Lane Keeping Assist or Active Lane Keeping Assist is malfunctioning. ► Visit a qualified specialist workshop.</p>



Display messages	Possible causes/consequences and ► Solutions
<p>Blind Spot Assist Currently Unavailable See Operator's Manual or Active Blind Spot Assist Currently Unavailable See Operator's Manual</p>	<p>Blind Spot Assist or Active Blind Spot Assist is temporarily inoperative. Possible causes are:</p> <ul style="list-style-type: none"> <li>• The radar sensor system is outside the operating temperature range.</li> <li>• The radar sensor system is temporarily inoperative, e.g. due to electromagnetic radiation emitted by nearby TV or radio stations or other sources of electromagnetic radiation.</li> </ul> <p>The yellow  indicator lamps also light up in the exterior mirrors. When the causes stated above no longer apply, the display message disappears.</p> <p>Blind Spot Assist or Active Blind Spot Assist is operational again.</p> <p>If the display message does not disappear:</p> <ul style="list-style-type: none"> <li>► Pull over and stop the vehicle safely as soon as possible, paying attention to road and traffic conditions.</li> <li>► Secure the vehicle against rolling away (▷ page 156).</li> <li>► Restart the engine.</li> </ul>
<p>Blind Spot Assist Not Available When Towing a Trailer See Operator's Manual or Active Blind Spot Assist Not Available When Towing a Trailer See Operator's Manual</p>	<p>Blind Spot Assist or Active Blind Spot Assist is deactivated while towing a trailer.</p> <p>You have established the electrical connection between the trailer and your vehicle.</p> <ul style="list-style-type: none"> <li>► Press  on the steering wheel to confirm the display message.</li> </ul>
<p>Blind Spot Assist Inoperative or Active Blind Spot Assist Inoperative</p>	<p>Blind Spot Assist or Active Blind Spot Assist is malfunctioning.</p> <p>The yellow  indicator lamps also light up in the exterior mirrors.</p> <ul style="list-style-type: none"> <li>► Visit a qualified specialist workshop.</li> </ul>
<p>Parking Pilot Canceled</p>	<p>The driver's door is open.</p> <ul style="list-style-type: none"> <li>► Repeat the parking gap measurement and parking process with the driver's door closed.</li> </ul> <p>You have inadvertently touched the multifunction steering wheel while steering intervention was active.</p> <ul style="list-style-type: none"> <li>► While steering intervention is active, make sure that the multifunction steering wheel is not touched unintentionally.</li> </ul> <p>The vehicle has started to skid and ESP® has intervened.</p> <ul style="list-style-type: none"> <li>► Use Parking Pilot again later (▷ page 190).</li> </ul>

Display messages	Possible causes/consequences and ► Solutions
<b>Parking Pilot Inoperative</b>	<p>Parking Assist PARKTRONIC is malfunctioning or faulty.</p> <p>► Follow the instructions and helpful hints in the "Problems with Parking Assist PARKTRONIC" section (▷ page 190).</p> <p>If the multifunction display still shows the display message:</p> <p>► Visit a qualified specialist workshop.</p> <p>Parking Pilot is unavailable or malfunctioning.</p> <p>► Switch off the ignition and restart the engine.</p> <p>If the Parking Pilot continues to be unavailable (the <b>P</b> symbol does not appear in the multifunction display):</p> <p>► Visit a qualified specialist workshop.</p>
<b>Parking Pilot Finished</b>	<p>The vehicle is parked. A warning tone also sounds. The display message disappears automatically.</p>
<b>Distance Pilot Off</b>	<p>Distance Pilot DISTRONIC is deactivated.</p> <p>If a warning tone also sounds, Distance Pilot has deactivated automatically (▷ page 171).</p>
<b>Distance Pilot Now Available</b>	<p>Distance Pilot DISTRONIC is operational again after having been temporarily unavailable. You can now reactivate Distance Pilot DISTRONIC (▷ page 171).</p>
<b>Distance Pilot Currently Unavailable See Operator's Manual</b>	<p>Distance Pilot DISTRONIC is temporarily inoperative. Steering Pilot is also temporarily inoperative.</p> <p>Possible causes are:</p> <ul style="list-style-type: none"> <li>• The radar sensor system is temporarily inoperative, e.g. due to electromagnetic radiation emitted by nearby TV or radio stations or other sources of electromagnetic radiation.</li> <li>• The system is outside the operating temperature range.</li> <li>• The on-board voltage is too low.</li> </ul> <p>A warning tone also sounds.</p> <p>When the causes stated above no longer apply, the display message disappears.</p> <p>Distance Pilot DISTRONIC is operational again.</p> <p>If the display message does not disappear:</p> <p>► Pull over and stop the vehicle safely as soon as possible, paying attention to road and traffic conditions.</p> <p>► Secure the vehicle against rolling away (▷ page 156).</p> <p>► Restart the engine.</p>

Display messages	Possible causes/consequences and ► Solutions
Distance Pilot Inoperative	<p>Distance Pilot DISTRONIC is malfunctioning.</p> <p>The following may have also failed:</p> <ul style="list-style-type: none"> <li>• Active Brake Assist</li> <li>• Active Brake Assist with cross-traffic function</li> </ul> <p>A warning tone also sounds.</p> <p>► Visit a qualified specialist workshop.</p>
Distance Pilot Passive	<p>You have depressed the accelerator pedal. Distance Pilot DISTRONIC is no longer controlling the speed of the vehicle.</p> <p>► Remove your foot from the accelerator pedal.</p>
Distance Pilot - - - mph	<p>A condition for activating Distance Pilot DISTRONIC has not been met.</p> <p>► Check the activation conditions for Distance Pilot DISTRONIC (▷ page 171).</p>
Steering Pilot Currently Unavailable See Operator's Manual	<p>Steering Pilot is temporarily inoperative.</p> <p>Possible causes are:</p> <ul style="list-style-type: none"> <li>• The windshield in the camera's field of vision is dirty.</li> <li>• Visibility is impaired due to heavy rain, snow or fog.</li> <li>• There have been no lane markings for an extended period.</li> <li>• The lane markings are worn away, dark or covered up, e.g. by dirt or snow.</li> </ul> <p>When the causes stated above no longer apply, the display message disappears.</p> <p>Steering Pilot is operational again.</p> <p>If the display message does not disappear:</p> <ul style="list-style-type: none"> <li>► Pull over and stop the vehicle safely as soon as possible, paying attention to road and traffic conditions.</li> <li>► Secure the vehicle against rolling away (▷ page 156).</li> <li>► Clean the windshield.</li> </ul>
Steering Pilot Inoperative	<p>Steering Pilot is malfunctioning.</p> <p>However, the Distance Pilot DISTRONIC functions are still available.</p> <p>A warning tone also sounds.</p> <p>► Visit a qualified specialist workshop.</p>
Cruise Control Inoperative	<p>Cruise control is malfunctioning.</p> <p>► Visit a qualified specialist workshop.</p>

Display messages	Possible causes/consequences and ► Solutions
<b>Cruise Control</b> --- mph	<ul style="list-style-type: none"><li>• A condition for activating cruise control has not been met. You have tried to store a speed below 20 mph (30 km/h), for example.</li><li>• ESP® is deactivated. The yellow ESP® OFF warning lamp is lit.</li></ul> <p>► If conditions permit, drive faster than 20 mph (30 km/h) and store the speed.</p> <p>or</p> <p>► Check the activation conditions for cruise control (► page 169).</p> <p>or</p> <p>► Reactivate ESP® (► page 71).</p>
<b>Cruise Control Off</b>	Cruise control has been deactivated. If a warning tone also sounds, cruise control has deactivated automatically (► page 169).

Tires	
Display messages	Possible causes/consequences and ► Solutions
Check Tire Pressure Soon	<p>The tire pressure loss warning system has detected a significant loss in pressure.</p> <p>A warning tone also sounds.</p> <p>Possible causes:</p> <ul style="list-style-type: none"> <li>• you have changed the positions of the wheels and tires or installed new wheels and tires.</li> <li>• the tire pressure in one or more tires has dropped significantly</li> </ul> <p> <b>WARNING</b></p> <p>Tire pressures that are too low pose the following hazards:</p> <ul style="list-style-type: none"> <li>• they may burst, especially as the load and vehicle speed increase.</li> <li>• they may wear excessively and/or unevenly, which may greatly impair tire traction.</li> <li>• the driving characteristics, as well as steering and braking, may be greatly impaired.</li> </ul> <p>There is a risk of an accident.</p> <ul style="list-style-type: none"> <li>► Stop the vehicle without making any sudden steering or braking maneuvers. Pay attention to the traffic conditions as you do so.</li> <li>► Secure the vehicle against rolling away (▷ page 156).</li> <li>► Check the tires and, if necessary, follow the instructions for a flat tire (▷ page 335).</li> <li>► Check the tire pressures and, if necessary, correct the tire pressure.</li> <li>► Restart the tire pressure loss warning system when the tire pressure is correct (▷ page 358).</li> </ul>
Check Tire Pressure Then Restart Run Flat Indicator	<p>The tire pressure loss warning system generated a display message and has not been restarted since.</p> <ul style="list-style-type: none"> <li>► Set the correct tire pressure in all four tires.</li> <li>► Restart the tire pressure loss warning system (▷ page 358).</li> </ul>
Run Flat Indicator Inoperative	<p>The tire pressure loss warning system is faulty.</p> <ul style="list-style-type: none"> <li>► Visit a qualified specialist workshop.</li> </ul>
Please Correct Tire Pressure	<p>The tire pressure is too low in at least one of the tires, or the tire pressure difference between the wheels is too great.</p> <ul style="list-style-type: none"> <li>► Check the tire pressures at the next opportunity (▷ page 358).</li> <li>► If necessary, correct the tire pressure.</li> <li>► Restart the tire pressure monitor (▷ page 361).</li> </ul>

Display messages	Possible causes/consequences and ► Solutions
<p>Check Tires</p>	<p>The tire pressure in one or more tires has dropped significantly. The wheel position is displayed in the multifunction display. A warning tone also sounds.</p> <p> <b>WARNING</b></p> <p>Tire pressures that are too low pose the following hazards:</p> <ul style="list-style-type: none"> <li>• they may burst, especially as the load and vehicle speed increase.</li> <li>• they may wear excessively and/or unevenly, which may greatly impair tire traction.</li> <li>• the driving characteristics, as well as steering and braking, may be greatly impaired.</li> </ul> <p>There is a risk of an accident.</p> <ul style="list-style-type: none"> <li>► Stop the vehicle without making any sudden steering or braking maneuvers. Pay attention to the traffic conditions as you do so.</li> <li>► Secure the vehicle against rolling away (▷ page 156).</li> <li>► Check the tires and, if necessary, follow the instructions for a flat tire (▷ page 335).</li> <li>► Check the tire pressure (▷ page 358).</li> <li>► If necessary, correct the tire pressure.</li> </ul>
<p>Warning Tire Malfunction</p>	<p>The tire pressure in one or more tires has dropped suddenly. The wheel position is shown in the multifunction display.</p> <p> <b>WARNING</b></p> <p>Driving with a flat tire poses a risk of the following hazards:</p> <ul style="list-style-type: none"> <li>• a flat tire affects the ability to steer or brake the vehicle.</li> <li>• you could lose control of the vehicle.</li> <li>• continued driving with a flat tire will cause excessive heat build-up and possibly a fire.</li> </ul> <p>There is a risk of an accident.</p> <ul style="list-style-type: none"> <li>► Stop the vehicle without making any sudden steering or braking maneuvers. Pay attention to the traffic conditions as you do so.</li> <li>► Secure the vehicle against rolling away (▷ page 156).</li> <li>► Check the tires and, if necessary, follow the instructions for a flat tire (▷ page 335).</li> </ul>
<p>Tire Press. Monitor Currently Unavailable</p>	<p>Because there is interference from a strong source of radio waves, no signals from the tire pressure sensors are detected. The tire pressure monitor is temporarily malfunctioning.</p> <ul style="list-style-type: none"> <li>► Drive on. The tire pressure monitor restarts automatically as soon as the problem has been resolved.</li> </ul>
<p>Tire Press. Sensor(s) Missing</p>	<p>There is no signal from the tire pressure sensor of one or several wheels. The pressure of the affected tire is not displayed in the multifunction display.</p> <ul style="list-style-type: none"> <li>► Have the faulty tire pressure sensor replaced at a qualified specialist workshop.</li> </ul>







Display messages	Possible causes/consequences and ► Solutions
Tire Pressure Monitor Inoperative No Wheel Sensors	The wheels mounted do not have a suitable tire pressure sensor. The tire pressure monitor is deactivated. ► Mount wheels with suitable tire pressure sensors. The tire pressure monitor is activated automatically after driving for a few minutes.
Tire Press. Monitor Inoperative	The tire pressure monitor is faulty. ► Visit a qualified specialist workshop.







## Vehicle

Display messages	Possible causes/consequences and ► Solutions
Shift to 'P' or 'N' to Start Engine	You attempted to start the engine with the transmission in position <b>R</b> or <b>D</b> . ► Shift the transmission to position <b>P</b> or <b>N</b> .
Apply Brake to Shift from 'P'	You attempted to shift the transmission to position <b>D</b> , <b>R</b> or <b>N</b> without depressing the brake pedal. ► Depress the brake pedal.
To Deselect P or N, Depress Brake and Start Engine	You attempted to shift the transmission out of position <b>P</b> or <b>N</b> into another transmission position with the engine switched off. ► Depress the brake pedal. ► Start the engine.
Apply Brake to Select R	You have attempted to shift from position <b>D</b> to position <b>R</b> without applying the brakes. ► Depress the brake pedal. ► Shift the transmission to position <b>R</b> .
Transmission Not in P Risk of Vehicle Rolling Away	The driver's door is open or not fully closed and the transmission is in position <b>R</b> , <b>N</b> or <b>D</b> . A warning tone also sounds.  <b>WARNING</b> The vehicle may roll away. There is a risk of an accident. ► Shift the transmission to position <b>P</b> . ► Secure the vehicle against rolling away (▷ page 156). ► Close the driver's door completely.
Only Shift to 'P' when Vehicle is Stationary	The vehicle is moving. ► Stop the vehicle safely as soon as possible, paying attention to road and traffic conditions. ► Shift the transmission to position <b>P</b> .



Display messages	Possible causes/consequences and ► Solutions
<p>Service Required Do Not Shift Gears Visit Dealer</p>	<p>You cannot change the transmission position due to a malfunction. A warning tone also sounds.</p> <p>If transmission position <b>D</b> is selected:</p> <ul style="list-style-type: none"> <li>► Drive to a qualified specialist workshop without shifting the transmission from position <b>D</b>.</li> </ul> <p>If position <b>R</b>, <b>N</b> or <b>P</b> is selected:</p> <ul style="list-style-type: none"> <li>► Secure the vehicle against rolling away (▷ page 156).</li> <li>► Notify a qualified specialist workshop or breakdown service.</li> </ul>
<p>Reversing Not Possible Service Required</p>	<p>You can no longer shift to transmission position <b>R</b> due to a malfunction.</p> <p>Transmission positions <b>P</b>, <b>N</b> or <b>D</b> continue to be available. A warning tone also sounds.</p> <ul style="list-style-type: none"> <li>► Visit a qualified specialist workshop.</li> </ul>
<p>Transmission Malfunction Stop</p>	<p>A malfunction has occurred in the mechanical transmission components. A warning tone also sounds. The transmission shifts automatically to position <b>N</b>.</p> <ul style="list-style-type: none"> <li>► Pull over and stop the vehicle safely as soon as possible, paying attention to road and traffic conditions.</li> <li>► Shift the transmission to position <b>P</b>.</li> <li>► Secure the vehicle against rolling away (▷ page 156).</li> <li>► Notify a qualified specialist workshop or breakdown service.</li> </ul>
<p>Auxiliary Battery Malfunction</p>	<p>The auxiliary battery for the automatic transmission is no longer being charged.</p> <ul style="list-style-type: none"> <li>► Visit a qualified specialist workshop.</li> <li>► Until then, always set the automatic transmission to position <b>P</b> before switching off the engine.</li> <li>► Before leaving the vehicle, apply the electric parking brake.</li> </ul>
	<p>The tailgate is open</p> <p><b>⚠ WARNING</b></p> <p>When the engine is running, exhaust gases can enter the vehicle interior if the tailgate is open. There is a risk of poisoning.</p> <ul style="list-style-type: none"> <li>► Close the tailgate.</li> </ul>

Display messages	Possible causes/consequences and ► Solutions
	<p>The hood is open.</p> <p> <b>WARNING</b></p> <p>The open hood may block your view when the vehicle is in motion. There is a risk of an accident.</p> <ul style="list-style-type: none"> <li>► Pull over and stop the vehicle safely as soon as possible, paying attention to road and traffic conditions.</li> <li>► Secure the vehicle against rolling away (▷ page 156).</li> <li>► Close the hood.</li> </ul>
	<p>At least one door is open. A warning tone also sounds.</p> <ul style="list-style-type: none"> <li>► Close all the doors.</li> </ul>
 <p>Power Steering Malfunction See Operator's Manual</p>	<p>The power steering is malfunctioning. A warning tone also sounds.</p> <p> <b>WARNING</b></p> <p>You will need to use more force to steer. There is a risk of an accident.</p> <ul style="list-style-type: none"> <li>► Check whether you are able to apply the extra force required.</li> </ul> <p><b>If you are able to steer safely:</b></p> <ul style="list-style-type: none"> <li>► Drive on carefully.</li> <li>► Visit a qualified specialist workshop immediately.</li> </ul> <p><b>If you are unable to steer safely:</b></p> <ul style="list-style-type: none"> <li>► Do not drive on.</li> <li>► Consult a qualified specialist workshop.</li> </ul>
<p>Phone No Service</p>	<p>Your vehicle is outside the network provider's transmitter/receiver range.</p> <ul style="list-style-type: none"> <li>► Wait until the mobile phone operational readiness symbol appears in the multifunction display.</li> </ul>
 <p>Check Washer Fluid</p>	<p>The washer fluid level in the washer fluid reservoir has dropped below the minimum.</p> <ul style="list-style-type: none"> <li>► Add washer fluid (▷ page 325).</li> </ul>
<p>Wiper Malfunctioning</p>	<p>The windshield wipers are malfunctioning.</p> <ul style="list-style-type: none"> <li>► Visit a qualified specialist workshop.</li> </ul>
<p>Hazard Warning Flashers Malfunctioning</p>	<p>The hazard warning lamps are faulty.</p> <ul style="list-style-type: none"> <li>► Visit a qualified specialist workshop.</li> </ul>

SmartKey	
Display messages	Possible causes/consequences and ► Solutions
 Key Does Not Belong to Vehicle	You have put the wrong SmartKey in the ignition lock. ► Use the correct SmartKey.
 Take Your Key from Ignition	The SmartKey is in the ignition lock. A warning tone also sounds. ► Remove the SmartKey.
 Obtain a New Key	The SmartKey needs to be replaced. ► Visit a qualified specialist workshop.
 Replace Key Battery	The SmartKey battery is discharged. ► Change the battery (▷ page 80).
 Don't Forget Your Key	The SmartKey is not in the ignition lock. You have opened the driver's door with the engine switched off. A warning tone also sounds. This display message is displayed for a maximum of 60 seconds and is simply a reminder. ► Take the SmartKey with you when you leave the vehicle.
 Key Not Detected (white display message)	The SmartKey is currently undetected. ► Change the location of the SmartKey in the vehicle. If the SmartKey still cannot be detected: ► Operate the vehicle with the SmartKey in the ignition lock.
 Key Not Detected (red display message)	The SmartKey is not in the vehicle. A warning tone also sounds. If the engine is switched off, you can no longer lock the vehicle centrally or start the engine. ► Pull over and stop the vehicle safely as soon as possible, paying attention to road and traffic conditions. ► Secure the vehicle against rolling away (▷ page 156). ► Locate the SmartKey.

Display messages	Possible causes/consequences and ► Solutions
	<p>Because there is interference from a strong source of radio waves, the SmartKey is not detected whilst the engine is running. A warning tone also sounds.</p> <ul style="list-style-type: none"> <li>► Pull over and stop the vehicle safely as soon as possible, paying attention to road and traffic conditions.</li> <li>► Secure the vehicle against rolling away (▷ page 156).</li> <li>► Insert the SmartKey into the ignition lock and drive in SmartKey mode.</li> </ul>
 <p>Remove 'Start' Button and Insert Key</p>	<ul style="list-style-type: none"> <li>• The SmartKey detection function has a temporary malfunction or is faulty.</li> <li>• The SmartKey is continually undetected.</li> </ul> <p>A warning tone also sounds.</p> <ul style="list-style-type: none"> <li>► Insert the SmartKey into the ignition lock and turn it to the desired position.</li> <li>► Visit a qualified specialist workshop.</li> </ul>



## Warning and indicator lamps in the instrument cluster



### General notes

Some systems carry out a self-diagnosis when the ignition is switched on. Therefore, some indicator and warning lamps may light up or flash temporarily. This behavior is non-critical. These indicator and warning lamps only indicate a malfunction if they light up or flash after starting the engine or whilst driving.

### Safety

#### Seat belts

Warning/indicator lamp	▷ Signal type Possible causes/consequences and ► Solutions
	<p>▷ After starting the engine, the red seat belt warning lamp lights up for 6 seconds. The seat belt warning lamp reminds the driver and front passenger to fasten their seat belts.</p> <ul style="list-style-type: none"> <li>► Fasten your seat belt (▷ page 48).</li> </ul>
	<p>▷ After starting the engine, the red seat belt warning lamp lights up. In addition, a warning tone sounds for up to 6 seconds. The driver's seat belt is not fastened.</p> <ul style="list-style-type: none"> <li>► Fasten your seat belt (▷ page 48). The warning tone ceases.</li> </ul>

Warning/ indicator lamp	▷ Signal type Possible causes/consequences and ▶ Solutions
	<p>▷ The red seat belt warning lamp lights up after the engine starts, as soon as the driver's or the front-passenger door is closed. The driver or front passenger has not fastened their seat belt.</p> <ul style="list-style-type: none"> <li>▶ Fasten your seat belt (▷ page 48). The warning lamp goes out.</li> </ul> <p>There are objects on the front-passenger seat.</p> <ul style="list-style-type: none"> <li>▶ Remove the objects from the front-passenger seat and stow them in a secure place. The warning lamp goes out.</li> </ul>
	<p>▷ The red seat belt warning lamp flashes and an intermittent audible warning sounds.</p> <p>The driver or front passenger has not fastened their seat belt. The vehicle is being driven faster than 15 mph (25 km/h) or has briefly been driven faster than 15 mph (25 km/h).</p> <ul style="list-style-type: none"> <li>▶ Fasten your seat belt (▷ page 48). The warning lamp goes out and the intermittent warning tone ceases.</li> </ul> <p>There are objects on the front-passenger seat. The vehicle is being driven faster than 15 mph (25 km/h) or has briefly been driven faster than 15 mph (25 km/h).</p> <ul style="list-style-type: none"> <li>▶ Remove the objects from the front-passenger seat and stow them in a secure place. The warning lamp goes out and the intermittent warning tone ceases.</li> </ul>



## Safety systems

Warning/  
indicator  
lamp

## ▷ Signal type

## Possible causes/consequences and ► Solutions



▷  (USA only),  (Canada only): the red brake system warning lamp is lit while the engine is running.  
A warning tone also sounds.



 **WARNING**

The brake boosting effect is malfunctioning and the braking characteristics may be affected.

There is a risk of an accident.

- ▶ Pull over and stop the vehicle safely as soon as possible, paying attention to road and traffic conditions. Do not continue driving under any circumstances.
- ▶ Secure the vehicle against rolling away (▷ page 156).
- ▶ Consult a qualified specialist workshop.
- ▶ Observe the additional display messages in the multifunction display.



▷  (USA only),  (Canada only): the red brake system warning lamp is lit while the engine is running.  
A warning tone also sounds.

 **WARNING**

There is not enough brake fluid in the brake fluid reservoir.





There is a risk of an accident.

- ▶ Pull over and stop the vehicle safely as soon as possible, paying attention to road and traffic conditions. Do not continue driving under any circumstances.
- ▶ Secure the vehicle against rolling away (▷ page 156).
- ▶ Do not add brake fluid. Adding more will not correct the malfunction.
- ▶ Consult a qualified specialist workshop.
- ▶ Observe the additional display messages in the multifunction display.



▷ USA only: the red brake system warning lamp is lit while the engine is running. The multifunction display also shows a display message with the  symbol. The brake pads/linings have reached their wear limit.

- ▶ Visit a qualified specialist workshop.

Warning/ indicator lamp	▶ Signal type Possible causes/consequences and ▶ Solutions
	<p>▶ The yellow ABS warning lamp is lit while the engine is running. ABS (Anti-lock Braking System) is deactivated due to a malfunction. Other driving systems and driving safety systems may also malfunction. In addition, the  and  warning lamps may light up in the instrument cluster. ATTENTION ASSIST is deactivated.</p> <p> <b>WARNING</b></p> <p>The brake system continues to function normally, but without the functions listed above. The wheels could therefore lock if you brake hard, for example. The steerability and braking characteristics may be severely affected. The braking distance in an emergency braking situation can increase. If ESP® is not operational, ESP® is unable to stabilize the vehicle. There is an increased risk of skidding and an accident.</p> <ul style="list-style-type: none"> <li>▶ Observe the additional display messages in the multifunction display.</li> <li>▶ Drive on carefully.</li> <li>▶ Visit a qualified specialist workshop immediately.</li> </ul> <p>If the ABS control unit is faulty, there is also a possibility that other systems, such as the navigation system or the automatic transmission, will not be available.</p>

Warning/  
indicator  
lamp



## ▷ Signal type

## Possible causes/consequences and ► Solutions



▷ The yellow ABS warning lamp is lit while the engine is running. ABS is temporarily unavailable.

Other driving systems and driving safety systems may also malfunction.

In addition, the  and  warning lamps may light up in the instrument cluster.

ATTENTION ASSIST is deactivated.

Possible causes are:

- self-diagnosis is not yet complete
- the on-board voltage may be insufficient

 **WARNING**

The brake system continues to function normally, but without the functions listed above. The front and rear wheels could therefore lock if you brake hard, for example.

The steerability and braking characteristics may be severely affected. The braking distance in an emergency braking situation can increase.

If ESP® is not operational, ESP® is unable to stabilize the vehicle.

There is a risk of an accident.

- ▶ Carefully drive a suitable distance, making slight steering movements at a speed above 12 mph (20 km/h).

The functions mentioned above are available again when the warning lamp goes out.



If the warning lamp is still on:

- ▶ Observe the additional display messages in the multifunction display.
- ▶ Drive on carefully.
- ▶ Visit a qualified specialist workshop immediately.



Warning/ indicator lamp	▷ Signal type Possible causes/consequences and ▶ Solutions
-------------------------------	---



▷ The yellow ABS warning lamp is lit while the engine is running. EBD is not available due to a malfunction. Other driving systems and driving safety systems may also malfunction. In addition, the  and  warning lamps may light up in the instrument cluster. ATTENTION ASSIST is deactivated.

### WARNING

The brake system continues to function normally, but without the functions listed above. The front and rear wheels could therefore lock if you brake hard, for example.



The steerability and braking characteristics may be severely affected. The braking distance in an emergency braking situation can increase.

If ESP® is not operational, ESP® is unable to stabilize the vehicle.

There is an increased risk of skidding and an accident.

- ▶ Observe the additional display messages in the multifunction display.
- ▶ Drive on carefully.
- ▶ Visit a qualified specialist workshop immediately.



▷  (USA only),  (Canada only): the red brake warning lamp and the yellow ESP®, ESP® OFF and ABS warning lamps are lit while the engine is running.

ABS and ESP® are malfunctioning.

Other driving systems and driving safety systems may also malfunction.

ATTENTION ASSIST is deactivated.

### WARNING

The brake system continues to function normally, but without the functions listed above. The front and rear wheels could therefore lock if you brake hard, for example.

The steerability and braking characteristics may be severely affected. The braking distance in an emergency braking situation can increase.

If ESP® is not operational, ESP® is unable to stabilize the vehicle.

There is an increased risk of skidding and an accident.

- ▶ Observe the additional display messages in the multifunction display.
- ▶ Drive on carefully.
- ▶ Visit a qualified specialist workshop immediately.

**Warning/  
indicator  
lamp****▷ Signal type****Possible causes/consequences and ▶ Solutions**

▷ The yellow ESP® warning lamp flashes while the vehicle is in motion. ESP® or traction control has intervened because there is a risk of skidding or at least one wheel has started to spin.

Cruise control or Distance Pilot DISTRONIC is deactivated.

- ▶ When pulling away, only depress the accelerator pedal as far as necessary.
- ▶ Ease off the accelerator pedal while the vehicle is in motion.
- ▶ Adapt your driving style to suit the road and weather conditions.
- ▶ Do not deactivate ESP®.

In rare cases (▷ page 71), it may be best to deactivate ESP®.

Observe the important safety notes on ESP® (▷ page 70).



▷ The yellow ESP® OFF warning lamp is lit while the engine is running. ESP® is deactivated.

**⚠ WARNING**

If ESP® is switched off, ESP® is unable to stabilize the vehicle.

Further driving systems or driving safety systems are thus restricted, e.g. Active Blind Spot Assist. The system does not perform course-correcting brake applications.

There is an increased risk of skidding and an accident.

- ▶ Reactivate ESP®.

In rare cases (▷ page 71), it may be best to deactivate ESP®.

Observe the important safety notes on ESP® (▷ page 70).

- ▶ Adapt your driving style to suit the road and weather conditions.

If ESP® cannot be activated:

- ▶ Drive on carefully.
- ▶ Contact a qualified specialist workshop and have ESP® checked.

**Warning/  
indicator  
lamp****▷ Signal type****Possible causes/consequences and ► Solutions**

▷ The yellow ESP<sup>®</sup> and ESP<sup>®</sup> OFF warning lamps are lit while the engine is running. ESP<sup>®</sup>, BAS, Active Brake Assist, Active Brake Assist with cross-traffic function, ESP<sup>®</sup> trailer stabilization, PRE-SAFE<sup>®</sup>, PRE-SAFE<sup>®</sup> PLUS, the HOLD function, hill start assist, Crosswind Assist, STEER CONTROL, Active Lane Keeping Assist and Active Blind Spot Assist are not available due to a malfunction. ATTENTION ASSIST is deactivated.

**WARNING**

The brake system continues to function normally, but without the functions listed above.

The braking distance in an emergency braking situation can thus increase.

If ESP<sup>®</sup> is not operational, ESP<sup>®</sup> is unable to stabilize the vehicle.

There is an increased risk of skidding and an accident.

- ▶ Observe the additional display messages in the multifunction display.
- ▶ Drive on carefully.
- ▶ Visit a qualified specialist workshop immediately.



▷ The yellow ESP<sup>®</sup> and ESP<sup>®</sup> OFF warning lamps are lit while the engine is running. ESP<sup>®</sup>, BAS, Active Brake Assist, Active Brake Assist with cross-traffic function, ESP<sup>®</sup> trailer stabilization, PRE-SAFE<sup>®</sup>, PRE-SAFE<sup>®</sup> PLUS, the HOLD function, hill start assist, Crosswind Assist, STEER CONTROL, Active Lane Keeping Assist and Active Blind Spot Assist are not available due to a malfunction. ATTENTION ASSIST is deactivated.

Self-diagnosis is not yet complete

**WARNING**

The brake system continues to function normally, but without the functions listed above.

The braking distance in an emergency braking situation can thus increase.

If ESP<sup>®</sup> is not operational, ESP<sup>®</sup> is unable to stabilize the vehicle.

There is an increased risk of skidding and an accident.

- ▶ Carefully drive a suitable distance, making slight steering movements at a speed above 12 mph (20 km/h).  
The functions mentioned above are available again when the warning lamp goes out.

If the warning lamp is still on:

- ▶ Observe the additional display messages in the multifunction display.
- ▶ Drive on carefully.
- ▶ Visit a qualified specialist workshop immediately.

Warning/  
indicator  
lamp

## ▷ Signal type

## Possible causes/consequences and ► Solutions



▷ (USA only), (Canada only): the red indicator lamp for the electric parking brake flashes or is lit and/or the yellow warning lamp for the electric parking brake is lit.

► Observe the additional display messages in the multifunction display.



▷ The red restraint system warning lamp is lit while the engine is running. The restraint system is malfunctioning.

**WARNING**

The air bags or Emergency Tensioning Devices may either be triggered unintentionally or, in the event of an accident, may not be triggered.

There is an increased risk of injury.

- Observe the additional display messages in the multifunction display.
- Drive on carefully.
- Contact a qualified specialist workshop and have the restraint system checked.

For further information about the restraint system, see (▷ page 44).

## Engine

Warning/  
indicator  
lamp

## ▷ Signal type

## Possible causes/consequences and ▶ Solutions



▷ The yellow Check Engine warning lamp lights up while the engine is running. There may be a malfunction, for example:

- in the engine management
- in the fuel injection system
- in the exhaust system
- in the ignition system (for vehicles with gasoline engines)
- in the fuel system

The emission limit values may be exceeded and the engine may be in emergency mode.

▶ Visit a qualified specialist workshop immediately.

Vehicles with a diesel engine: the fuel tank has been run dry (▷ page 153).

▶ Start the engine three to four times after refueling.

If the yellow Check Engine warning lamp goes out, emergency running mode is canceled. The vehicle need not be checked.

In some states, you must immediately visit a qualified specialist workshop as soon as the yellow Check Engine warning lamp lights up. This is due to the legal requirements in effect in these states. If in doubt, check whether such legal regulations apply in the state in which you are currently driving.



▷ The yellow reserve fuel warning lamp lights up while the engine is running. The fuel level has dropped into the reserve range.

▶ Refuel at the nearest gas station.



▷ The yellow reserve fuel warning lamp flashes while the vehicle is in motion. In addition, the  Check Engine warning lamp may light up.

The fuel filler cap is not closed correctly or the fuel system is leaking.

- ▶ Check that the fuel filler cap is correctly closed.
- ▶ **If the fuel filler cap is not correctly closed:** close the fuel filler cap.
- ▶ **If the fuel filler cap is closed:** visit a qualified specialist workshop.



▷ The red coolant warning lamp lights up while the engine is running and the coolant temperature gauge is at the start of the scale.

The temperature sensor for the coolant temperature gauge is malfunctioning.

The coolant temperature is no longer being monitored. There is a risk of engine damage if the coolant temperature is too high.

- ▶ Pull over and stop the vehicle safely and switch off the engine, paying attention to road and traffic conditions. Do not continue driving under any circumstances.
- ▶ Secure the vehicle against rolling away (▷ page 156).
- ▶ Consult a qualified specialist workshop.

Warning/  
indicator  
lamp

## ▷ Signal type

## Possible causes/consequences and ► Solutions



▷ The red coolant warning lamp comes on while the engine is running.

The coolant level is too low.

If the coolant level is correct, the airflow to the engine radiator may be blocked or the electric engine radiator fan may be defective.

The coolant is too hot and the engine is no longer being cooled sufficiently.

- ▶ Observe the additional display messages in the multifunction display.
- ▶ Pull over and stop the vehicle safely and switch off the engine, paying attention to road and traffic conditions.
- ▶ Secure the vehicle against rolling away (▷ page 156).
- ▶ Leave the vehicle and keep a safe distance from the vehicle until the engine has cooled down.
- ▶ Check the coolant level and add coolant, observing the warning notes (▷ page 324).
- ▶ If you have to add coolant frequently, have the engine cooling system checked.
- ▶ Make sure that the air supply to the engine radiator is not blocked, e.g. by snow, slush or ice.
- ▶ Do not start the engine again until the coolant temperature is below 248 °F (120 °C). Otherwise, the engine could be damaged.
- ▶ Drive to the nearest qualified specialist workshop.
- ▶ Avoid heavy loads on the engine as you do so, e.g. driving in mountainous terrain and stop-and-go traffic.



▷ The red coolant warning lamp comes on while the engine is running.

The coolant temperature has exceeded 248 °F (120 °C). The airflow to the engine radiator may be blocked or the coolant level may be too low.

**WARNING**

The engine is not being cooled sufficiently and may be damaged.

Do not drive when your engine is overheated. This can cause some fluids which may have leaked into the engine compartment to catch fire.

Steam from the overheated engine can also cause serious burns which can occur just by opening the hood.

There is a risk of injury.

- ▶ Observe the additional display messages in the multifunction display.
- ▶ Pull over and stop the vehicle safely and switch off the engine, paying attention to road and traffic conditions.
- ▶ Secure the vehicle against rolling away (▷ page 156).
- ▶ Leave the vehicle and keep a safe distance from the vehicle until the engine has cooled down.
- ▶ Check the coolant level and add coolant, observing the warning notes (▷ page 324).
- ▶ If you have to add coolant frequently, have the engine cooling system checked.
- ▶ Make sure that the air supply to the engine radiator is not blocked, e.g. by snow, slush or ice.

Warning/ indicator lamp	▷ Signal type Possible causes/consequences and ▶ Solutions
	<ul style="list-style-type: none"> <li>▶ At coolant temperatures below 248 °F (120 °C), drive to the nearest qualified specialist workshop.</li> <li>▶ Avoid heavy loads on the engine as you do so, e.g. driving in mountainous terrain and stop-and-go traffic.</li> </ul>

## Driving systems

Warning/ indicator lamp	▷ Signal type Possible causes/consequences and ▶ Solutions
	<p>▷ The red distance warning lamp lights up while the vehicle is in motion. A warning tone also sounds.</p> <p>You are approaching a vehicle, a pedestrian or a stationary obstacle in your line of travel at too high a speed.</p> <ul style="list-style-type: none"> <li>▶ Be prepared to brake immediately.</li> <li>▶ Pay careful attention to the traffic situation. You may have to brake or take evasive action.</li> </ul> <p>Further information on Distance Pilot DISTRONIC (▷ page 171).</p> <p>Further information on the distance warning function of Active Brake Assist (▷ page 67).</p> <p>Further information on the distance warning function of Active Brake Assist with cross-traffic function (▷ page 72).</p>

## Tires

Warning/  
indicator  
lamp

## ▷ Signal type

## Possible causes/consequences and ► Solutions



▷ The yellow tire pressure monitor warning lamp (pressure loss/malfunction) is lit. The tire pressure monitor has detected a loss of pressure in at least one of the tires.

 **WARNING**

Tire pressures that are too low pose the following hazards:

- they may burst, especially as the load and vehicle speed increase.
  - they may wear excessively and/or unevenly, which may greatly impair tire traction.
  - the driving characteristics, as well as steering and braking, may be greatly impaired.
- There is a risk of an accident.

- ▶ Stop the vehicle without making any sudden steering or braking maneuvers. Pay attention to the traffic conditions as you do so.
- ▶ Secure the vehicle against rolling away (▷ page 156).
- ▶ Observe the additional display messages in the multifunction display.
- ▶ Check the tires and, if necessary, follow the instructions for a flat tire (▷ page 335).
- ▶ Check the tire pressure (▷ page 358).
- ▶ If necessary, correct the tire pressure.



▷ The yellow tire pressure monitor warning lamp (pressure loss/malfunction) flashes for approximately one minute and then remains lit.

The tire pressure monitor is faulty.

 **WARNING**

The system is possibly unable to recognize or register low tire pressure. There is a risk of an accident.

- ▶ Observe the additional display messages in the multifunction display.
- ▶ Visit a qualified specialist workshop immediately.



## General notes

The multimedia system section in this Operator's Manual describes the basic principles for operation. More information can be found in the Digital Operator's Manual.

## Important safety notes

### WARNING

If you operate information systems and communication equipment integrated in the vehicle when driving, you may be distracted from the traffic situation. You could also lose control of the vehicle. There is a risk of an accident.

Only operate this equipment when the traffic situation permits. If you are not sure that this is possible, park the vehicle paying attention to traffic conditions and operate the equipment when the vehicle is stationary.

You must observe the legal requirements for the country in which you are currently driving when operating the multimedia system.

The multimedia system calculates the route to the destination without taking the following into account, for example:

- traffic lights
- stop and yield signs
- parking or stopping restrictions
- road narrowing
- other road and traffic rules and regulations

The multimedia system may give incorrect navigation recommendations if the actual street/traffic situation does not correspond with the digital map's data.

For example:

- a diverted route
- the road layout or the direction of a one-way street has been changed

For this reason, you must always observe road and traffic rules and regulations during your journey. Road and traffic rules and regulations always have priority over multimedia system driving recommendations.

Navigation announcements are intended to direct you while driving without diverting your attention from the road and driving.

Please always use this feature instead of consulting the map display for directions. Looking at the icons or map display can distract you from traffic conditions and driving, and increase the risk of an accident.

This equipment complies with FCC radiation exposure limits set forth for uncontrolled equipment and meets the FCC radio frequency (RF) Exposure Guidelines in Supplement C to OET65.

This equipment has very low levels of RF energy that is deemed to comply without maximum permissive exposure evaluation (MPE). However, it is recommended to install it at a distance of at least 8 inches (approx. 20 cm) between the radiation source and a person's body (not including limbs such as hands, wrists, feet and legs).

### WARNING

Modifications to electronic components, their software as well as wiring can impair their function and/or the function of other networked components. In particular, systems relevant to safety could also be affected. As a result, these may no longer function as intended and/or jeopardize the operating safety of the vehicle. There is an increased risk of an accident and injury.

Never tamper with the wiring as well as electronic components or their software. You should have all work to electrical and electronic equipment carried out at a qualified specialist workshop.

## Function restrictions

For safety reasons, some functions are restricted or unavailable while the vehicle is in motion. You will notice this, for example, because either you will not be able to select certain menu items or a message will appear to this effect.

## Operating system

### Overview

#### General notes

**!** Do not use the space in front of the display for storage. Objects placed here could damage the display or impair its function. Avoid any direct contact with the display surface. Pressure on the display surface may result in impairments to the display, which could be irreversible.

Wearing polarized sunglasses may impair your ability to read the display.

The display has an automatic temperature-controlled switch-off feature. The brightness is automatically reduced if the temperature is too high. The display may temporarily switch off completely.

#### Cleaning instructions

**!** Do not touch the display. The display has a very sensitive high-gloss surface; there is a risk of scratching. If you have to clean the screen, however, use a mild cleaning agent and a soft, lint-free cloth.

The display must be switched off and have cooled down before you start cleaning. Do not apply pressure to the display surface when cleaning it, as this could cause irreversible damage to the display.

#### Switching the multimedia system on/off

▶ Press the  control knob.



#### Adjusting the volume

▶ Turn the  control knob.

The volume is adjusted:

- for the currently selected media source
- during traffic or navigation announcements
- in hands-free mode during an active call

#### Switching the sound on or off

▶ Press the  button on the control panel. If the audio output is switched off, the status line will show the  symbol. If you switch

the media source or set the volume, the sound is automatically switched on.

**i** Navigation announcements will be heard even if the sound is muted.

#### Functions

The multimedia system has the following functions:





- Radio mode
- Media mode with media search
- Sound systems
- Navigation system  
COMAND: navigation via the hard drive  
Audio 20: navigation via SD card
- Communication functions
- SIRIUS Weather (COMAND)
- Vehicle functions with system settings
- Favorites functions

#### Controller

The controller in the center console lets you:

- select menu items on the display
- enter characters
- select a destination on the map
- save entries

The controller can be:

- turned 
- slid left or right 
- slid forwards or back 
- slid diagonally 
- pressed briefly or pressed and held 

#### Back button

You can use the  button to exit a menu or to call up the main menu of the current operating mode.

▶ **To exit the menu:** briefly press the  button.

The multimedia system changes to the next higher menu level in the current operating mode.



▶ **To call up the main menu:** press the  button for longer than two seconds. The multimedia system changes to the main menu of the current operating mode.

## Favorites button

You can assign predefined functions using the  favorites button and call them up by pressing the button (▷ page 289).







### Favorites

#### Calling up and exiting favorites

- ▶ **To call up:** press the  button on the controller.
- ▶ Select a favorite, e.g. **Vehicle**.  
The favorites are displayed.
- ▶ **To exit:** press the  button again.

#### Adding favorites

##### Adding predefined favorites

- ▶ Press the  button.
- ▶ **COMAND:** slide  the controller.
- ▶ **Audio 20:** slide  or  the controller.  
The menu bar is displayed.
- ▶ Select **Reassign**.  
The categories are displayed.
- ▶ Select a category.  
The favorites are displayed.
- ▶ Select a favorite.
- ▶ **COMAND:** to add the favorite to the desired position, turn and press the controller.  
If a favorite has already been added at this position, it will be overwritten.
- ▶ **Audio 20:** to add the favorite to the desired position, turn, slide  or  and press the controller.  
If a favorite has already been added at this position, it will be overwritten.

##### Adding your own favorites

You can add climate control as a favorite, for example.

- ▶ Select **Vehicle** → **Vehicle Settings**.
- ▶ Press and hold the  button until the favorites are displayed.
- ▶ Add a favorite to the desired position.  
If a favorite has already been added at this position, it will be overwritten.

## Navigation mode

### Important safety notes

#### WARNING

If you operate information systems and communication equipment integrated in the vehicle when driving, you may be distracted from the traffic situation. You could also lose control of the vehicle. There is a risk of an accident.

Only operate this equipment when the traffic situation permits. If you are not sure that this is possible, park the vehicle paying attention to traffic conditions and operate the equipment when the vehicle is stationary.

You must observe the legal requirements for the country in which you are currently driving when operating the navigation system.

### General notes

Among other things, correct functioning of the navigation system depends on GPS reception. In certain situations, GPS reception may be impaired, there may be interference or there may be no reception at all, e.g. in tunnels or parking garages.

Audio 20 is equipped with Garmin® MAP PILOT (see the manufacturer's operating instructions). The Garmin® MAP PILOT operating instructions are stored on the SD card as a PDF file. The SD card box contains a quick guide.

The following descriptions apply to navigation with COMAND. Further information can be found in the Digital Operator's Manual.

### Selecting a route type and route options

Multimedia system:

- ▶ Select **Navi** → **Navigation**.  
The map shows the vehicle's current position.
- ▶ Slide  the controller.
- ▶ Select **Options** → **Route Settings**.

Notes for route types:

- **Eco Route**
- **Dynamic Traffic Route**

Traffic reports on the route for the route guidance are taken into account (not available in all countries).

- **Dynamic TRF. Route After Request**

You can decide whether or not current traffic reports should be included in the route calculation (not available in all countries).

- **Calculate Alternative Routes**

Different routes are being calculated. In order to do so, instead of **Start**, select the menu item **Continue**.

- ▶ **To avoid/use route options:** select **Avoid Options**.

- ▶ Select a route option.

Notes for route options:

- **Use Toll Roads**

The route calculation includes roads which require you to pay a usage fee (toll).

- **Number of Occupants in the Vehicle:** (only available in the USA)

Prerequisite: your vehicle meets the access conditions for carpool lanes.

Carpool lanes will be included if the carpool lanes option is activated.

- ▶ Select the location.

If available, the ZIP code is shown. If there are different ZIP codes available for the location, the corresponding digits are displayed with an X.

- ▶ Enter the street and house number. The address is in the menu.

#### Further options for destination entry:

- search for a keyword

The keyword search finds destinations using fragments of words.

- select the last destination

- select a contact

- select a POI

You can search for a POI by location, name or telephone number.

- select destination on the map

- enter intermediate destination

You can map the route to the destination yourself with up to four intermediate destinations.

- select destinations from Mercedes-Benz Apps

- select geo-coordinates

## Entering an address

Multimedia system:

- ▶ Select **Navi** → **Navigation**.

The map shows the vehicle's current position.

- ▶ Slide  the controller.

- ▶ Select **Destination** → **Address Entry**.

Enter an address, e.g. as follows:

- city or ZIP code, street, house number

- state/province, city or ZIP code

- city or ZIP code, center

- street, city or ZIP code, intersection

- ▶ Select **City**.

The city in which the vehicle is currently located (current vehicle position) is at the top.

Below this, you will see locations for which route guidance has already been carried out.

- ▶ Enter the city.

The  symbol: the location is contained on the digital map multiple times.

- ▶ **To switch to the list:** slide  the controller.

## Calculating the route

Prerequisite: the address has been entered and is in the menu.

- ▶ Select **Start** or **Continue**.

The route is calculated with the selected route type and the selected route options.

If route guidance has already been activated, a prompt will appear asking whether you wish to end the current route guidance.

- ▶ Select **Cancel Active Route Guidance** or **Set as Intermediate Destination**. **Cancel Active Route Guidance** cancels the current route guidance and starts route calculation to the new destination.

**Set as Intermediate Destination** adds the new destination in addition to the existing destination and opens the intermediate destinations list.

## Connecting a mobile phone (COMAND)

### Requirements

For telephony via the Bluetooth® interface, you require a Bluetooth®-capable mobile phone. The mobile phone must support Hands-Free Profile 1.0 or above.

Multimedia system:

- ▶ Select **Vehicle** → **System Settings** → **Activate Bluetooth**.
- ▶ Activate Bluetooth® .

Mobile phone:

- ▶ Activate Bluetooth® and, if necessary, Bluetooth® visibility for other devices (see the manufacturer's operating instructions).

The Bluetooth® device names for all of one manufacturer's products might be identical. To make it possible to clearly identify your mobile phone, change the device name (see the manufacturer's operating instructions).

If the mobile phone supports the PBAP (Phone Book Access Profile) and MAP (Message Access Profile) Bluetooth® profiles, the following information will be transmitted after you connect:

- Phone book
- Call lists
- Text messages and e-mail

**i** Further information on suitable mobile phones can be found at: **http://www.mercedes-benz.com/connect**

**i** In the USA, you can get in touch with the Mercedes-Benz Customer Assistance Center on 1-800-FOR-MERCEdes (1-800-367-6372). In Canada, you can get in touch with the Customer Relations Center on 1-800-387-0100.

### Searching for and authorizing (connecting) a mobile phone

Before using your mobile phone with the multimedia system for the first time, you will need to search for the phone and then authorize (connect) it. Depending on the mobile phone, authorization either takes place by means of Secure Simple Pairing or by entering a passkey. The multimedia system automatically makes the

procedure that is relevant for your mobile phone available. The mobile phone is always connected automatically after authorization. Further information on using a mobile phone with the multimedia system (see the Digital Operator's Manual).

If the multimedia system does not detect your mobile phone, this may be due to particular security settings on your mobile phone (see the manufacturer's operating instructions).

Only one mobile phone can be connected to the multimedia system at any one time.



### Searching for a mobile phone

Multimedia system:

- ▶ Select **TeL**/ → **Conn. Device** → **Search for Phones** → **Start Search**.

The available mobile phones are displayed.

### Symbols in the device list

Symbol	Explanation
	New mobile phone found, not yet authorized.
	Mobile phone is authorized, but is not connected.

### Connecting a mobile phone

Authorization using Secure Simple Pairing:

- ▶ Select mobile phone.  
A code is displayed in the multimedia system and on the mobile phone.
- ▶ **If codes match:** select **Yes** on the multimedia system.
- ▶ Confirm code on the mobile phone. Depending on the mobile phone used, confirm the connection to the multimedia system and for the PBAP and MAP Bluetooth® profiles. The prompt to confirm may take up to two minutes to be displayed (see the manufacturer's operating instructions).
- ▶ **If the codes are different:** select **No** on the multimedia system.  
The process is canceled.  
Repeat authorization.

Authorization by entering a passkey (passcode):

- ▶ Select the Bluetooth® name of the mobile phone.  
The input menu for the passkey is displayed.
- ▶ Choose a one to sixteen-digit number combination as a passkey.
- ▶ Enter the passkey on the multimedia system.
- ▶ Press **OK** to confirm.
- ▶ Enter and confirm the passkey on the mobile phone. Depending on the mobile phone used, confirm the connection to the multimedia system and for the PBAP and MAP Bluetooth® profiles. The prompt to confirm may take up to two minutes to be displayed (see the manufacturer's operating instructions).

### Connecting a mobile phone (Audio 20)

#### Requirements

For telephony via the Bluetooth® interface, you require at least one Bluetooth®-capable mobile phone depending on use of **one-telephone mode** or **two-telephone mode**. The mobile phone must support Hands-Free Profile 1.0 or above.

In **two-telephone mode** you can use all the functions of the multimedia system with the **main telephone**. With the **additional telephone**, you can receive incoming calls.

Multimedia system:

- ▶ Select **Vehicle** → **System Settings** → **Activate Bluetooth**.
- ▶ Activate Bluetooth® .

Mobile phone:

- ▶ Activate Bluetooth® and, if necessary, Bluetooth® visibility for other devices (see the manufacturer's operating instructions).

The Bluetooth® device names for all of one manufacturer's products might be identical. To make it possible to clearly identify your mobile phone, change the device name (see the manufacturer's operating instructions).

If the mobile phone supports the PBAP (Phone Book Access Profile) and MAP (Message Access Profile) Bluetooth® profiles, the following information is transmitted after you connect the main telephone:

- Phone book
- Call lists
- Text messages and e-mail

**i** Further information on suitable mobile phones can be found at: **http://www.mercedes-benz.com/connect**

**i** In the USA, you can get in touch with the Mercedes-Benz Customer Assistance Center on 1-800-FOR-MERcedes (1-800-367-6372). In Canada, you can get in touch with the Customer Relations Center on 1-800-387-0100.

#### Searching for and authorizing (connecting) a mobile phone

Before using your mobile phone with the multimedia system for the first time, you will need to search for the phone and then authorize (connect) it. Depending on the mobile phone, authorization either takes place by means of Secure Simple Pairing or by entering a passkey. The multimedia system automatically makes the procedure that is relevant for your mobile phone available. The mobile phone is always connected automatically after authorization. Further information on using a mobile phone with the multimedia system (see the Digital Operator's Manual).

If the multimedia system does not detect your mobile phone, this may be due to particular security settings on your mobile phone (see the manufacturer's operating instructions).

#### Searching for a mobile phone

Multimedia system:

- ▶ Select **TeL**  → **Conn. Device** → **Connect New Device**.
- ▶ Select **Connect via Vehicle**.
- ▶ Select mobile phone.

#### Connecting a mobile phone

- ▶ **One-telephone mode:** select **Connect as New Main Phone**.
- ▶ **Two-telephone mode:** select **Connect as Additional Phone** when a mobile phone is already connected.

### ► Authorization using Secure Simple Pairing:

A code is displayed in the multimedia system and on the mobile phone.



- Confirm code on the mobile phone. Depending on the mobile phone used, confirm the connection to the multimedia system and for the PBAP and MAP Bluetooth® profiles. The prompt to confirm may take up to two minutes to be displayed (see the manufacturer's operating instructions).
- If the codes are different: select **No** on the multimedia system.  
The process is canceled.  
Repeat authorization.

or

- **Authorization by entering a passkey (passcode):** enter any one- to sixteen-digit number sequence which you have chosen yourself into the passkey input menu.
- Press  to confirm.
- Enter and confirm the passkey on the mobile phone. Depending on the mobile phone used, confirm the connection to the multimedia system and for the PBAP and MAP Bluetooth® profiles. The prompt to confirm may take up to two minutes to be displayed (see the manufacturer's operating instructions).

### Symbols in the device manager

The symbols are shown in color depending on their use.

Symbol	Explanation
	Mobile phone connected to the multimedia system
	Main telephone with full range of functions
	Additional telephone for incoming calls in two telephone mode

### Media mode

#### General notes

If you wish to play external media sources, the appropriate media mode must already be turned on. Further information on media mode (see the Digital Operator's Manual).

The following external media sources can be used:

- Apple® devices (e.g. iPhone®)
- USB devices (e.g. USB stick, MP3 player) (> page 294)
- CD
- DVD (COMAND)
- SD cards
- via devices connected by Bluetooth®

**i** Information on single CD/DVD drive or DVD changer (see the Digital Operator's Manual).

### Selecting using the device list

Multimedia system:

- Select **Media** → **Devices**.  
The available media sources will be shown.  
The • dot indicates the current setting.
- Select the media source.  
Playable files are played.

### Inserting/removing an SD card

#### Important safety notes

##### **WARNING**

SD cards are small parts. They can be swallowed and cause choking. This poses an increased risk of injury or even fatal injury.

Keep the SD card out of the reach of children. If a SD card is swallowed, seek medical attention immediately.

- !** If you are no longer using the SD card, you should remove it and store it outside the vehicle. High temperatures can damage the card.

#### Inserting an SD card

The SD card slot is located on the control panel.

- Insert the SD card into the SD card slot until the SD card engages. The side with the contacts must face down.

#### Removing an SD card

- Press the SD card.  
The SD card is ejected.
- Remove the SD card.

## Connecting USB devices



- ▶ Connect the USB device to the USB port.  
There are two USB ports in the stowage space under the armrest.
- ▶ Select the media source (▷ page 293).

## CD/DVD drive and AUX jacks (Rear Seat Entertainment System)



- ① Disc slot
- ② AUX, right-hand (R) jack for audio signal (red)
- ③ AUX, left-hand (L) jack for audio signal (white)
- ④ AUX, video (V) jack (yellow)
- ⑤ Disc eject button

The AUX jacks shown are for the AUX drive. Identical jacks can be found on the right-hand side of the rear-compartment screens (AUX display).



## Stowage areas

### Loading guidelines

#### WARNING

If objects, luggage or loads are not secured or not secured sufficiently, they could slip, tip over or be flung around and thereby hit vehicle occupants. There is a risk of injury, particularly in the event of sudden braking or a sudden change in direction.

Always store objects so that they cannot be flung around. Secure objects, luggage or loads against slipping or tipping before the journey.

#### WARNING

Combustion engines emit poisonous exhaust gases such as carbon monoxide. If the tailgate is open when the engine is running, particularly if the vehicle is moving, exhaust fumes could enter the passenger compartment. There is a risk of poisoning.

Turn off the engine before opening the tailgate. Never drive with the tailgate open.

#### WARNING

The exhaust tail pipe and tail pipe trim can become very hot. If you come into contact with these parts of the vehicle, you could burn yourself. There is a risk of injury.

Always be particularly careful around the exhaust tail pipe and the tail pipe trim. Allow these components to cool down before touching them.

The gross vehicle weight (GVW) is the vehicle weight including fuel, vehicle tool kit, spare wheel, installed accessories, vehicle occupants and luggage/cargo.

Do not exceed the load limit or permitted gross vehicle weight rating (GVWR) for your vehicle. The gross load limit and the GVWR are specified on the vehicle identification plate on the B-pillar of the driver's door (▷ page 361).

The load must also be distributed so that the weight on each axle never exceeds the gross axle weight rating (GAWR) for the front and rear axles. The specifications for GVWR and GAWR

are on the vehicle identification plate on the B-pillar of the driver's door (▷ page 361).

Observe the notes on loading the vehicle (▷ page 361).

The handling characteristics of a laden vehicle are dependent on the distribution of the load within the vehicle. For this reason, you should observe the following notes when transporting a load:

- Never exceed the maximum permissible gross vehicle mass or the gross axle weight rating for the vehicle (including occupants).
- The cargo compartment is the preferred place to carry objects.
- Position heavy loads as far forward as possible and as low down in the cargo compartment as possible.
- The load must not protrude above the upper edge of the seat backrests.
- Always place the load against the rear or front seat backrests. Make sure that the seat backrests are securely locked into place.
- Always place the load behind unoccupied seats if possible.
- Use the cargo tie-down rings and the parcel nets to transport loads and luggage.
- Use cargo tie-down rings and fastening materials appropriate for the weight and size of the load.
- Secure the load with sufficiently strong and wear-resistant tie-downs. Pad sharp edges for protection.

### Stowage spaces

#### Important safety notes

#### WARNING

If you transport objects in the vehicle interior and these are not adequately secured, they could slip or be flung around and thereby strike vehicle occupants. In addition, cup holders, open stowage spaces and mobile phone brackets may not always be able to hold the objects placed in them in the event of an accident. There is a risk of injury, particularly in the event of sharp braking or sudden changes of direction.

- Always stow objects in such a way that they cannot be tossed about in these or similar situations.
- Always make sure that objects do not protrude out of the stowage spaces, luggage nets or stowage nets.
- Ensure that closable stowage spaces are shut before beginning your journey.
- Always stow and secure heavy, hard, pointed, sharp-edged, fragile or large objects in the cargo compartment.

Observe the loading guidelines (▷ page 295).

### Glove box



- ▶ **To open:** pull handle ① and open glove box flap ②.
- ▶ **To close:** fold glove box flap ② up until it engages.

**i** The glove box can be cooled (▷ page 132).



- 1 Glove box unlocked
- 2 Glove box locked

The glove box can be locked and unlocked using the mechanical key.



Partition ① for stowing flat objects is located in the upper section of the glove box. It can be removed to increase the stowage space in the glove box.

- ▶ **To remove:** pull out partition ①.
- ▶ **To install:** insert partition ① and push it back until it engages.

### Stowage compartment under the armrest



Vehicles without touchpad

- ▶ **To open:** pull handle ① up. The armrest folds out.



Vehicles with touchpad and COMAND

- ▶ **To open:** press button ① at the front. Armrest ② folds out.

Depending on the vehicle equipment, there is a multimedia connector unit with two USB ports, e.g. for iPod®, iPhone® or MP3 player in the stowage compartment.

- ❗ There is a removable stowage tray in the storage compartment, in which objects such as an iPod® can be stored.

### Eyeglasses compartment



- ▶ **To open:** press marking ①. The eyeglasses compartment opens down.
- ▶ **To close:** press marking ① again and the eyeglasses compartment moves up and engages.

Make sure that the eyeglasses compartment is always closed while the vehicle is in motion.

### Stowage compartment in the front center console



- ▶ **To open:** slide cover ① forwards. Stowage compartment ② appears.
- ▶ **To close:** pull cover ① back as far as it will go.

### Stowage compartment in the rear center console



- ▶ **To open:** briefly press the stowage compartment marking. The stowage compartment opens.
- ❗ Depending on the vehicle's equipment, there may be open stowage spaces above and below the stowage compartment.

### Stowage net

#### ⚠ WARNING

Vehicles with the Occupant Classification System (OCS):

If the gross weight of the objects in the stowage net on the back of the front-passenger seat is greater than 4.4 lb (2 kg), OCS cannot correctly assess the occupant's weight category. The front-passenger front air bag could deploy without cause, or may fail to deploy in the event of an accident. This poses an increased risk of injury or even fatal injury. Always observe the permissible gross weight of 4.4 lb (2 kg). Stow and secure heavy objects in the cargo compartment.

Stowage nets are located in the front-passenger footwell and on the back of the driver's and the front-passenger seat.

Observe the loading guidelines (▷ page 295) and the safety notes regarding stowage spaces (▷ page 295).

### Through-loading facility in the rear

There is a through-loading facility above the armrest in the rear for transporting longer objects. You can continue to use both of the outer rear seats.

If objects or loads are not secured when being transported in the through-loading facility, they could slip or be thrown around and thereby hit vehicle occupants.

Observe the loading guidelines (▷ page 295) and the safety notes regarding stowage spaces (▷ page 295).

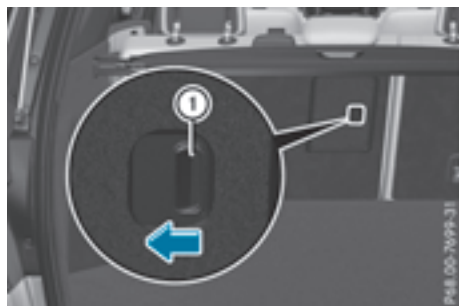

The through-loading facility is opened from the cargo compartment.

- ▶ Fold down the rear seat armrest.
- ▶ Pull the center head restraint on the rear bench seat into the uppermost position (▷ page 99).
- ▶ Slide release catch ① to the left and swing flap ② to the left until it is lying on the rear side of the rear bench seat.

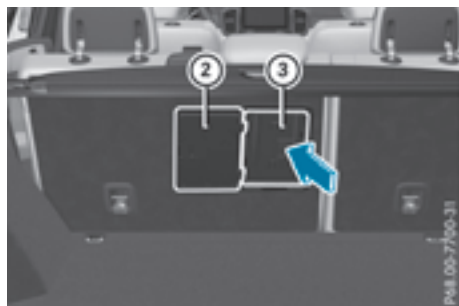

- ▶ Push cover ③ forward until it is lying on the rear seat armrest.

### Cargo compartment enlargement

#### Important safety notes

##### WARNING

If the rear bench seat/rear seat and seat backrest are not engaged they could fold forwards, e.g. when braking suddenly or in the event of an accident.

- The vehicle occupant would thereby be pushed into the seat belt by the rear bench seat/rear seat or by the seat backrest. The seat belt can no longer offer the intended level of protection and could even cause injuries.
- Objects or loads in the trunk/cargo compartment cannot be restrained by the seat backrest.

There is an increased risk of injury.

Before every trip, make sure that the seat backrests and the rear bench seat/rear seat are engaged.

Make sure that the seat backrest and the seat cushion are correctly engaged in position. To do so, pull firmly on the seat backrest.

- !** Fold the seat cushion upwards before folding the rear bench seat forward. Otherwise, the backrests may be damaged.

When the backrest is folded forwards, the front seats should not be moved to their rear-most position. Otherwise, the front seats and the rear bench seat could be damaged.

- !** The backrest is heavy. Therefore, take care when folding it down. Make sure that the head restraints are pushed all the way in so that the backrests and seat cushions are not damaged.

Observe the loading guidelines (▷ page 295).

The left-hand and right-hand rear seat backrests can be folded forward separately to increase the cargo compartment capacity.

### Folding the rear bench seat forward



If the driver's or front-passenger seat is set for a larger person, it may not be possible to fold the rear bench seat forward. In this case, move the front seats as far forward as possible.

- ▶ Move the head restraints to the lowest position (▶ page 100).
- ▶ Fold seat cushion ① up.



- ▶ Pull release handle ② up in the direction of the arrow until the backrest is fully released.
- ▶ Fold the backrest forward until it reaches the cargo compartment position.

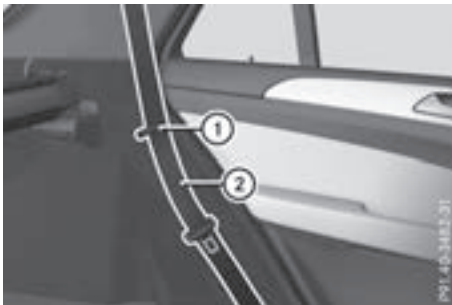

- ▶ Guide seat belts ② under respective clips ①.

### Folding the rear bench seat back



- ▶ Fold seat backrest ② back until it engages. Make sure not to trap the seat belt while doing so.
- ▶ Swing seat cushion ① back.
- ▶ Pull up and adjust the head restraints if necessary (▶ page 100).

### Securing loads

#### Cargo tie-down rings

#### WARNING

The Top Tether anchorages cannot secure a load. If you secure a load with the Top Tether anchorages, the Top Tether anchorages could be pulled out during braking, abrupt changes in direction or in the event of an accident. The load could slip, tip over or be flung around and thereby hit vehicle occupants. There is a risk of injury.

Only use the cargo tie down rings when securing a load.

Observe the following notes on securing loads:

- Secure the load using the cargo tie-down rings.
- Distribute the load on the cargo tie-down rings evenly.
- Do not use elastic straps or nets to secure a load, as these are only intended as an anti-slip protection for light loads.
- Do not route tie-downs across sharp edges or corners.
- Pad sharp edges for protection.



There are four cargo tie-down rings ① in the cargo compartment.

The parcel net must be pushed down before using the cargo tie-down rings on the front right-hand side of the cargo compartment.

### Bag hook

#### WARNING

The bag hooks cannot restrain heavy objects or items of luggage. Objects or items of luggage could be flung around and thereby hit vehicle occupants when braking or abruptly changing directions. There is a risk of injury. Only hang light objects on the bag hooks. Never hang hard, sharp-edged or fragile objects on the bag hooks.

**!** The bag hook can bear a maximum load of 6.6lbs (3kg) and should not be used to secure a load.



There is a bag hook in the cargo compartment on the left-hand side.

- ▶ Press bag hook marking ①.
- ▶ Turn bag hook ① until it engages.

### Securing hooks



There is a securing hook ① on each side of the cargo compartment.

Only secure lightweight luggage items on the securing hooks (maximum 9 lbs (4 kg)).

### Cargo compartment cover

#### Important safety notes

#### WARNING

On its own, the cargo compartment cover cannot secure or restrain heavy objects, items of luggage and heavy loads. You could be hit by an unsecured load during sudden changes in direction, braking or in the event of an accident. There is an increased risk of injury or even fatal injury.

Always store objects so that they cannot be flung around. Secure objects, luggage or loads against slipping or tipping over, e.g. by using tie downs, even if you are using the cargo compartment cover.

**!** When loading the vehicle, make sure that you do not stack the load in the cargo compartment higher than the lower edge of the side windows. Do not place heavy objects on top of the cargo compartment cover.

A cargo compartment cover or a combined cargo cover and net (cargo compartment cover with cargo net) is installed, depending on equipment, behind the rear bench seat backrest.

### Extending/retracting the cargo compartment cover

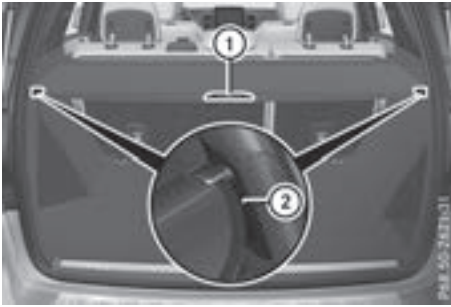

- ▶ **To extend:** pull the cargo compartment cover back by grab handle ① and clip it into retainers ② on the left and right.
- ▶ **To retract:** unhook the cargo compartment cover from left-hand and right-hand retainers ②.
- ▶ Guide cargo compartment cover forwards by grab handle ① until it is completely rolled up.

### Removing/installing the cargo compartment cover (without integrated cargo net)

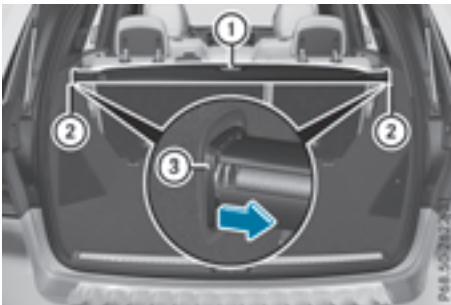

- ▶ **To remove:** make sure that cargo compartment cover ① is rolled up.
- ▶ Push end cap ③ of cargo compartment cover ① in the direction of the arrow on the right or left-hand side.
- ▶ Push cargo compartment cover ① into opposite anchorage ②.
- ▶ Remove cargo compartment cover ①.

- ▶ **To install:** place cargo compartment cover ① into anchorage ② on the right or left-hand side.
- ▶ Push in opposite end cap ③ of cargo compartment cover ① in the direction of the arrow and insert cargo compartment cover ① into opposite anchorage ②.

### Cargo net in combined cargo cover and net

#### Important safety notes

##### ⚠ WARNING

On its own, the cargo net cannot secure or restrain heavy objects, items of luggage and heavy loads. You could be hit by an unsecured load during sudden changes in direction, braking or in the event of an accident. There is an increased risk of injury or even fatal injury. Always store objects so that they cannot be flung around. Secure objects, luggage or loads against slipping or tipping over, e.g. by using tie downs, even if you are using the cargo net.

It is important to use a cargo net if you load the vehicle with small objects above the seat backrests. For safety reasons, always use a cargo net when transporting loads.

Damaged cargo nets can no longer fulfill their protective function and must be replaced. Visit a qualified specialist workshop.

#### Attaching the cargo net



- ▶ Pull the cargo net up by tab ① and hook it into eyelets ② using both hands.

### Coat hooks on the tailgate



- ① Coat hook

### EASY-PACK load-securing kit

#### General notes

The EASY-PACK load-securing kit allows you to use your cargo compartment for a variety of purposes. The following accessory parts are located under the cargo compartment floor:

- a telescopic rod
- two mounting elements
- two brackets

#### Important safety notes

##### WARNING

If you drive when the cargo compartment floor is open, objects could be flung around, thus striking vehicle occupants. There is a risk of injury, particularly in the event of sudden braking or a sudden change in direction.



Always close the cargo compartment floor before a journey.

### Installation



- ▶ Open cargo compartment floor ② (▷ page 302).
- ▶ Attach brackets ① in the desired position on the side of cargo compartment floor ②.
- ▶ Close cargo compartment floor ②.



- ▶ Turn mounting elements ③ to .
- ▶ Insert mounting elements ③ into brackets ①.
- ▶ Pull telescopic rod ④ apart.
- ▶ Insert telescopic rod ④ into mounting elements ③.
- ▶ Turn both mounting elements ③ to  until you feel them engage.

### Stowage well under the cargo compartment floor

#### Important safety notes

##### WARNING

If you drive when the cargo compartment floor is open, objects could be flung around, thus striking vehicle occupants. There is a risk of



injury, particularly in the event of sudden braking or a sudden change in direction. Always close the cargo compartment floor before a journey.

The accessory parts of the EASY-PACK load-securing kit, as well as TIREFIT and the tire-changing tools are located in the removable insert in the stowage well.

### Opening/closing the cargo compartment floor



- ▶ **To open:** holding the ribbing, press handle ① down ②. Handle ① folds up.
- ▶ Swing the cargo compartment floor up using handle ① until it rests against the cargo compartment cover.



- ▶ Fold out hook ③ on the underside of the cargo compartment floor in the direction of the arrow.

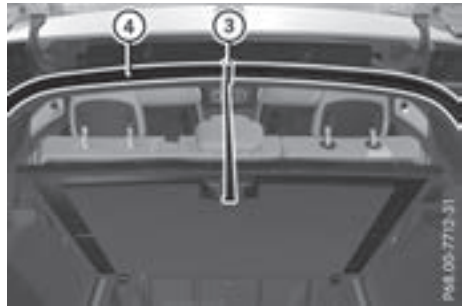

- ▶ Attach hook ③ to the cargo compartment's upper seal ④.
- ▶ **To close:** detach hook ③ from the cargo compartment's upper seal ④.
- ▶ Fasten hook ③ to the retainer on the underside of the cargo compartment floor.
- ▶ Fold the cargo compartment floor down.
- ▶ Press the cargo compartment floor down ② until it engages.

**i** To remove the cargo compartment floor, undo the press studs below the cargo compartment floor. When you re-install the cargo compartment floor, fasten it with the press studs.

### Locking/unlocking the cargo compartment floor



- 1 Cargo compartment floor unlocked
- 2 Cargo compartment floor locked

The cargo compartment floor can be locked and unlocked using the mechanical key.

## Roof carrier

### Important safety notes

#### WARNING

When you load the roof, the center of gravity of the vehicle rises and the driving characteristics change. If you exceed the maximum roof load, the driving characteristics, as well as steering and braking, will be greatly impaired. There is a risk of an accident.

Never exceed the maximum roof load and adjust your driving style.

**!** Mercedes-Benz recommends that you only use roof carriers that have been tested and approved for Mercedes-Benz vehicles. This helps to prevent damage to the vehicle.

Position the load on the roof carrier in such a way that the vehicle will not sustain damage even when it is in motion.

Depending on the vehicle equipment, ensure that when the roof carrier is installed you can:

- raise the sliding sunroof fully
- open the panorama roof with power tilt/sliding panel fully
- open the tailgate fully

You will find information on the maximum roof load in the "Technical data" section (▷ page 390).

An incorrectly secured roof carrier or roof load may become detached from the vehicle. You must therefore ensure that you observe the roof carrier manufacturer's installation instructions.

### Attaching the roof carrier



- ▶ Secure the roof carrier to roof rails . In doing so, observe the manufacturer's installation instructions.

## Features

### Cup holder

### Important safety notes

#### WARNING

If you transport objects in the vehicle interior and these are not adequately secured, they could slip or be flung around and thereby strike vehicle occupants. In addition, cup holders, open stowage spaces and mobile phone brackets may not always be able to hold the objects placed in them in the event of an accident. There is a risk of injury, particularly in the event of sharp braking or sudden changes of direction.

- Always stow objects in such a way that they cannot be tossed about in these or similar situations.
- Always make sure that objects do not protrude out of the stowage spaces, luggage nets or stowage nets.
- Ensure that closable stowage spaces are shut before beginning your journey.
- Always stow and secure heavy, hard, pointed, sharp-edged, fragile or large objects in the cargo compartment.

Observe the loading guidelines (▷ page 295).

**!** Only use the cup holders for containers of the right size and which have lids. The drinks could otherwise spill.

**!** Do not expose drinks bottles in the cup holder in the center console to continuous, strong and direct sunlight. The passenger compartment in the area of the center console can otherwise be damaged by the concentrated and reflected sunlight.

Do not keep the KEYLESS-GO key in the temperature-controlled cup holder (▷ page 305). Otherwise, the KEYLESS-GO key will not be recognized.

The stowage compartments in the doors provide space for bottles with a capacity of up to 34 fl. oz. (1.0 l).

The bottles are not secured or prevented from tipping over. Therefore, do not place any open drink containers in the stowage compartments.

### Cup holder in the front center console

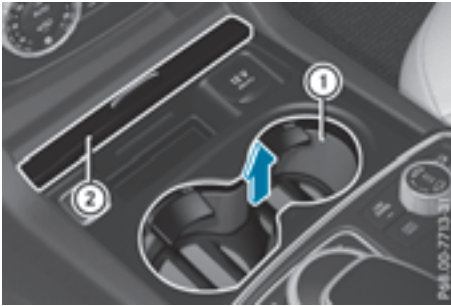

- ① Cup holder
- ② Cover

► **To open:** slide cover ② to its foremost position.

► **To close:** pull cover ② back as far as it will go.

You can remove the cup holder's rubber mat for cleaning. Clean with clear, lukewarm water only.

### Temperature-controlled cup holder in the front-compartment center console



- ① Cup holder
- ② Residual heat indicator lamp
- ③ Switch

The temperature-controlled cup holder can be used to keep cold drinks cool and warm drinks warm.

► Turn the SmartKey to position ② in the ignition lock.

► **To switch on the cooling function:** press and hold button ③ until the blue indicator lamp on the button lights up.

► **To switch on the heating function:** press and hold button ③ until the red indicator lamp on the button lights up.

► **To switch off the function:** press and hold button ③ until the indicator lamp on the button goes out.

When the heating function is used, the metal insert of the cup holder is heated. Once a certain temperature is reached, residual heat indicator lamp ② lights up. This means that the metal insert of the cup holder is hot. For this reason, you must not reach into the cup holder metal insert.

Do not use hard or sharp objects to clean the cup holder. Use only a soft cloth to clean it.

### Cup holder in the rear seat armrest

! Do not sit on or support your body weight on the rear seat armrest when it is folded down, as you could otherwise damage it.



► Fold down the rear seat armrest. Cup holder ① is located in the rear seat armrest.

### Sun visors

### Overview

#### ⚠ WARNING

If the mirror cover of the vanity mirror is folded up when the vehicle is in motion, you could be

blinded by incident light. There is a risk of an accident.

Always keep the mirror cover folded down while driving.

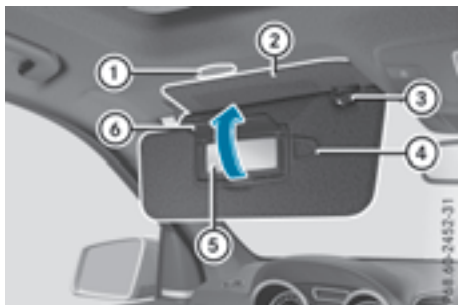

- ① Mirror light
- ② Additional sun visor
- ③ Retainer
- ④ Retaining clip, e.g. for a car park ticket
- ⑤ Vanity mirror
- ⑥ Mirror cover

### Vanity mirror in the sun visor

Mirror light ① only functions if the sun visor is clipped into retainer ③ and mirror cover ⑥ has been folded up.

### Glare from the side



- ▶ Fold down sun visor ①.
- ▶ Pull sun visor ① out of retainer ③.
- ▶ Swing sun visor ① to the side.

Vehicles with additional sun visor:

- ▶ Slide sun visor ① horizontally as required.
- ▶ Fold down additional sun visor ② to the windshield.

### Roller sunblinds on the rear side windows

▶ Always guide the roller sunblind by hand. Do not let it snap back suddenly as this would damage the automatic roller mechanism.

▶ Do not drive the vehicle with the roller sunblind hooked in and the side windows opened simultaneously. The roller sunblind can jump out of the retainers and spring back suddenly when driving at high speeds, e.g. when driving on the freeway. This could damage the inertia reel. Therefore, either close the side window or retract the roller sunblind before driving at high speeds.



- ▶ **To extend:** pull the roller sunblind out by tab ① and hook it onto retainers ② at the back of the window.

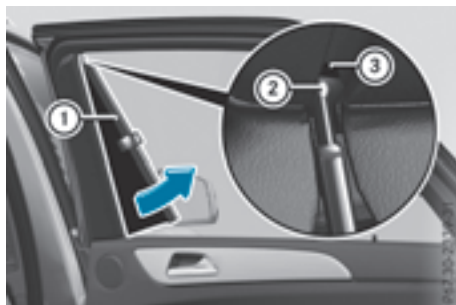

The roller sunblind can be hooked back into place should it pop out from the top of the guide rail.

- ▶ Tilt pull-out profile ① as illustrated.
- ▶ Slip guide bush ② into open area of guide rail ③.
- ▶ Straighten up pull-out profile ① again.

## Ashtray

### Front ashtray

**!** The holder under the ashtray is not heat resistant. Before placing lit cigarettes in the ashtray, make sure that the ashtray is properly engaged. Otherwise, the holder could be damaged.

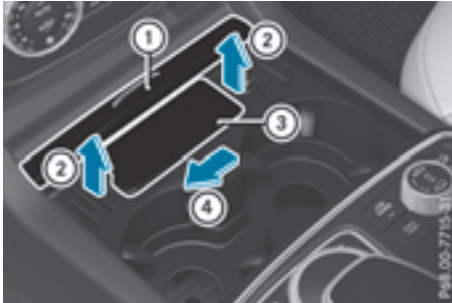

- ▶ **To open:** slide cover ① to its foremost position.
- ▶ Fold cover ③ of the insert upwards.
- ▶ **To remove the insert:** push insert ③ to the left ④.
- ▶ Insert ③ slides out slightly to the right.
- ▶ Lift insert ③ up ② and out.
- ▶ **To re-install the insert:** place insert ③ into the holder and press it down on the right until it engages.
- ▶ **To close:** pull cover ① back as far as it will go.

### Rear-compartment ashtray

**!** Close the ashtray when it is not in use and before you fold the rear seats forward. You can otherwise damage the ashtray.

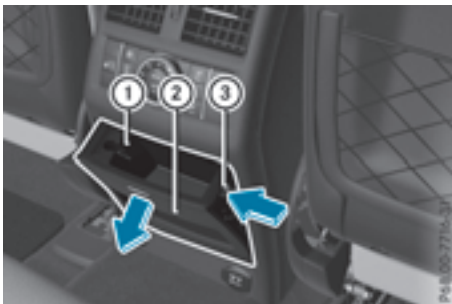

Vehicles without a Rear Seat Entertainment System have an ashtray in the center console in the rear compartment.

- ▶ **To open:** briefly press cover ② at the top. The ashtray opens.
- ▶ **To remove the insert:** push into recess ③ from the right. Ashtray insert ① slides out slightly to the right.
- ▶ Lift insert ① up and out.
- ▶ **To re-install the insert:** place insert ① into the holder and press down on the right until it engages.

### Cigarette lighter

#### **⚠ WARNING**

You can burn yourself if you touch the hot heating element or the socket of the cigarette lighter.

In addition, flammable materials can ignite if:

- the hot cigarette lighter falls
- a child holds the hot cigarette lighter to objects, for example

There is a risk of fire and injury.

Always hold the cigarette lighter by the knob. Always make sure that the cigarette lighter is out of reach of children. Never leave children unsupervised in the vehicle.

**!** The cigarette lighter in the center console in the front compartment is not intended for operating the tire inflation compressor.



Your attention must always be focused on the traffic conditions. Only use the cigarette lighter when road and traffic conditions permit.

- ▶ Turn the SmartKey to position **2** in the ignition lock (▶ page 135).
- ▶ **To open:** slide cover **1** to its foremost position.
- ▶ Press in cigarette lighter **2**.  
Cigarette lighter **2** will pop out automatically when the heating element is red-hot.
- ▶ **To close:** pull cover **1** back as far as it will go.

## 12 V sockets

### General notes

- ▶ Turn the SmartKey to position **1** in the ignition lock (▶ page 135).

With the exception of the socket in the front center console, all sockets can be used for accessories with a maximum current draw of 240 W (20 A). The socket in the front center console can be used for accessories with a maximum current draw of 180 W (15 A). Accessories include such items as chargers for mobile phones.

If you use the sockets for long periods when the engine is switched off, the battery may discharge.

- i** An emergency cut-out ensures that the on-board voltage does not drop too low. If the on-board voltage is too low, the power to the sockets is automatically cut. This ensures that there is sufficient power to start the engine.

### Socket in the front center console

- !** The socket is not suitable for operating the tire inflation compressor.
- ▶ **To open:** slide the cover to its foremost position.
- ▶ Lift up the cover of the socket.
- ▶ **To close:** pull the cover back as far as it will go.

### Socket in the rear compartment center console

Vehicles with the Rear Seat Entertainment System have two sockets in the center console in the rear compartment.

- ▶ Lift up the cover of the socket.

### Socket in the cargo compartment



- ▶ Lift up the cover of socket **1**.

## 115 V socket

### Important safety notes

#### **⚠ DANGER**

When a suitable device is connected, the 115 V power socket will be carrying a high voltage. You could receive an electric shock if the connector cable or the 115 V power socket is pulled out of the trim or is damaged or wet. There is a risk of fatal injury.

- Use only connector cables that are dry and free of damage.
- When the ignition is off, make sure that the 115 V power socket is dry.
- Have the 115 V power socket checked or replaced immediately at a qualified specialized workshop if it is damaged or has been pulled out of the trim.
- Never plug the connector cable into a 115 V power socket that is damaged or has been pulled out of the trim.

#### **⚠ DANGER**

If you reach into the power socket or plug inappropriate devices into the power socket, you could receive an electric shock. There is a risk of fatal injury.

Only connect appropriate devices to the power socket.

**!** Note that work and repairs on the 115 V power socket should only be carried out by qualified specialist personnel.

### General notes

The 115 V power socket provides an alternating voltage of 115 V so that small electronic devices can be connected. These devices, such as games consoles, chargers and laptops, must not consume more than a maximum of 150 watts altogether.

Requirements for operation of these devices:

- the electronic device that you connect has a suitable connector and conforms to standards specific to the country you are in.
- the plug of the electronic device is plugged correctly into 115 V power socket.
- the maximum wattage of the device to be connected must not exceed 150 watts.
- the on-board power supply is within a permissible voltage range.
- the 12 V sockets in the rear compartment and the cargo compartment are operational.

### Using the 115 V power socket

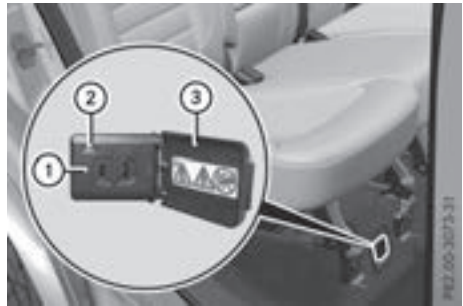

- ▶ **To switch on:** switch the ignition on.
- ▶ Open flap (3).
- ▶ Insert the plug of the electronic device into 115 V power socket (1). Indicator lamp (2) lights up.
- ▶ **To switch off:** disconnect the plug from 115 V power socket (1). Ensure that you do not pull on the cord.

### Problems with the 115 V power socket

Problem	Possible causes/consequences and ▶ Solutions
The warning lamp on the 115 V power socket is not lit.	The on-board voltage is too low because the battery is too weak. <ul style="list-style-type: none"> <li>▶ Start the engine.</li> <li>or</li> <li>▶ Charge the battery (▷ page 342).</li> </ul> If the indicator lamp still does not light up: <ul style="list-style-type: none"> <li>▶ Visit a qualified specialist workshop.</li> </ul>
	The temperature of the DC/AC converter is temporarily too high. <ul style="list-style-type: none"> <li>▶ Remove the electronic device connector from the 115 V socket.</li> <li>▶ Let the DC/AC converter cool down.</li> </ul> If the indicator lamp still does not light up after cooling down the converter: <ul style="list-style-type: none"> <li>▶ Visit a qualified specialist workshop.</li> </ul>
	You have connected an electronic device that has a constant nominal power of less than 150 watts, but has a very high switch-on current. This device will not work. If you connect such a device, the 115 V power socket will not supply it with power. <ul style="list-style-type: none"> <li>▶ Connect a suitable electronic device.</li> </ul>

## mbrace

### General notes

The mbrace system is only available in the USA. A license agreement must be in place in order to activate the mbrace service. Make sure that your system is activated and operational. To register, press the  Info call button. If any of the steps mentioned are not carried out, the system may not be activated.

If you have questions about the activation, contact one of the following telephone hotlines:

Mercedes-Benz Customer Assistance Center at 1-800 FOR-MERCEDES (1-800-367-6372) or 1-866-990-9007

Shortly after successfully registering with the mbrace service, a user ID and password will be sent to you by mail. You can use this password to log onto the mbrace area under "Owners Online" at <http://www.mbusa.com>.

The system is available if:

- it has been activated and is operational
- the corresponding mobile phone network is available for transmitting data to the Customer Center

- a service subscription is available

Determining the location of the vehicle on a map is only possible if:

- GPS reception is available
- the vehicle position can be forwarded to the Customer Assistance Center

### The mbrace system

To adjust the volume during a call, proceed as follows:

- ▶ Press the  or  button on the multi-function steering wheel.

or

- ▶ Use the multimedia system volume control.

The system offers various services, e.g.:





- Automatic and manual emergency call
- Roadside Assistance call
- Info call

You can find information and a description of all available features under "Owners Online" at <http://www.mbusa.com>.

### System self-test

After you have switched on the ignition, the system carries out a self-diagnosis.

A malfunction in the system has been detected if one of the following occurs:

- The indicator lamp in the SOS button does not come on during the system self-test.
- The indicator lamp in the  Roadside Assistance button does not light up during self-diagnosis of the system.
- The indicator lamp in the  Info call button does not light up during the system self-diagnosis.
- The indicator lamp in one or more of the following buttons continues to light up red after the system self-diagnosis:
  - SOS button
  -  Roadside Assistance call button
  -  Info call button
- The **Inoperative** or the **Service Not Activated** message appears in the multi-function display after the system self-diagnosis.

If a malfunction is indicated as outlined above, the system may not operate as expected. In the event of an emergency, help will have to be summoned by other means.

Have the system checked at the nearest authorized Mercedes-Benz Center or call the following telephone assistance services:

Mercedes-Benz Customer Assistance Center at 1-800 FOR-MERCEDES (1-800-367-6372) or 1-866-990-9007.

### Emergency call

#### Important safety notes

##### WARNING

It can be dangerous to remain in the vehicle, even if you have pressed the SOS button in an emergency if:

- you see smoke inside or outside of the vehicle, e.g. if there is a fire after an accident
- the vehicle is on a dangerous section of road
- the vehicle is not visible or cannot easily be seen by other road users, particularly when dark or in poor visibility conditions



There is a risk of an accident and injury.

Leave the vehicle immediately in this or similar situations as soon as it is safe to do so.

Move to a safe location along with other vehicle occupants. In such situations, secure the vehicle in accordance with national regulations, e. g. with a warning triangle.

### General notes

Observe the notes on system activation (▷ page 310).

The emergency call is triggered automatically if an air bag is deployed or an Emergency Tensioning Device is triggered. You cannot end an automatically triggered emergency call yourself.

An emergency call can also be initiated manually.

As soon as the emergency call has been initiated, the indicator lamp in the SOS button flashes. The **Connecting Call** message appears in the multifunction display.

The audio output is muted.

Once the connection has been made, the **Call Connected** message appears in the multifunction display.

All important information on the emergency is transmitted, for example:

- Current location of the vehicle (as determined by the GPS system)
- Vehicle identification number
- Information on the severity of the accident

Shortly after the emergency call has been initiated, a voice connection is automatically established between the Customer Assistance Center and the vehicle occupants.

- If the vehicle occupants respond, the Mercedes-Benz Customer Assistance Center attempts to get more information on the emergency.
- If there is no response from the vehicle occupants, an ambulance is immediately sent to the vehicle.
- If the relevant mobile phone network is not available, no emergency call can be initiated. The indicator lamp in the SOS button flashes continuously.

No voice connection can be established to the Mercedes-Benz Customer Assistance Center.

The **Call Failed** message appears on the multifunction display and must be confirmed.

In this case, summon assistance by other means.

### Making an emergency call



- ▶ **To initiate an emergency call manually:** press cover ① briefly to open.
- ▶ Press and hold the SOS button for at least one second ②.
- ▶ The indicator lamp in SOS button ② flashes until the emergency call is concluded.
- ▶ Wait for a voice connection to the Mercedes-Benz Customer Assistance Center.
- ▶ After the emergency call, close cover ①.

If the mobile phone network is unavailable, mbrace will not be able to make the emergency call. If you leave the vehicle immediately after pressing SOS button ②, you do not know if mbrace has successfully made the emergency call. In this case, always summon assistance by other means.

### Breakdown assistance button



- ▶ **To call:** press Roadside Assistance button ①. This initiates a call to the Mercedes-Benz Customer Assistance Center.

The indicator lamp in Roadside Assistance button ① flashes while the call is active. The **Connecting Call** message appears in the multifunction display. The audio output is muted.

If a connection can be established, the **Call Connected** message appears in the multifunction display.

If a mobile phone network and GPS reception are available, the system transfers data to the Mercedes-Benz Customer Assistance Center, for example:

- Current location of the vehicle
- Vehicle identification number

The multimedia system display indicates that a call is active. During the call, you can change to the navigation menu by pressing the NAVI button on the multimedia system, for example.

Voice output is not available in this case.

A voice connection is established between the Mercedes-Benz Customer Assistance Center and the vehicle occupants.

From the remote malfunction diagnosis, the Mercedes-Benz Customer Assistance Center can ascertain the nature of the problem (> page 315).

The Mercedes-Benz Customer Assistance Center either sends a qualified Mercedes-Benz technician or makes arrangements for your vehicle to be transported to the nearest Mercedes-Benz Service Center.

You may be charged for services such as repair work and/or towing.

You can find more information in the separate mbrace manual.

The system has not been able to initiate a Roadside Assistance call, if:

- the  indicator lamp for the Roadside Assistance call button is flashing continuously.
- no voice connection to the Mercedes-Benz Customer Assistance Center was established.

This can occur if the relevant mobile phone network is not available, for example.

The **Call Failed** message appears in the multifunction display.

► **To end a call:** press the  button on the multifunction steering wheel.

or

► Press the corresponding multimedia system button for ending a phone call.

### Info call button



► **To call:** press Info call button ①.

This initiates a call to the Mercedes-Benz Customer Assistance Center.

The indicator lamp in Info call button ① flashes while the connection is being made.

The **Connecting Call** message appears in the multifunction display. The audio output is muted.

If a connection can be established, the **Call Connected** message appears in the multifunction display.

If a mobile phone network and GPS reception are available, the system transfers data to the Mercedes-Benz Customer Assistance Center, for example:

- Current location of the vehicle
- Vehicle identification number

The multimedia system display indicates that a call is active. During the call, you can change to the navigation menu by pressing the NAVI button on COMAND, for example.

Voice output is not available in this case.

A voice connection is established between the Mercedes-Benz Customer Assistance Center and the vehicle occupants.

You receive information about operating your vehicle, about the nearest Mercedes-Benz Service Center and about other products and services from Mercedes-Benz.

You can find further information on the mbrace system under "Owners Online" at <http://www.mbusa.com>.

The system was unable to initiate an Info call if:

- the indicator lamp in the  Info call button is flashing continuously.
- no voice connection to the Mercedes-Benz Customer Assistance Center has been established.

This can occur if the relevant mobile phone network is not available, for example.

The **Call Failed** message appears in the multifunction display.

► **To end a call:** press the  button on the multifunction steering wheel.

or

► Press the corresponding multimedia system button for ending a phone call.

## Call priority

When service calls are active, e.g. Roadside Assistance or Info calls, an emergency call can still be initiated. In this case, an emergency call will take priority and override all other active calls.

The indicator lamp of the respective button flashes until the call is ended.

An emergency call can only be terminated by the Mercedes-Benz Customer Assistance Center.

All other calls can be ended by pressing:

- the  button on the multifunction steering wheel
- the corresponding button in the multimedia system to end the voice call

When a call is initiated, the audio system is muted.

The mobile phone is no longer connected to the multimedia system.

However, if you want to use your mobile phone, do so only when the vehicle is stationary and in a safe location.

## Downloading destinations in COMAND



### Downloading destinations

Downloading destinations gives you access to a database with over 15 million points of interest (POIs). These can be downloaded on the navigation system in your vehicle. If you know the

destination, the address can be downloaded. Alternatively, you can obtain the location of Points of Interest (POIs)/important destinations in the vicinity.

Furthermore, you can download routes with up to four way points.

You are prompted to confirm route guidance to the address entered.

► Select **Yes** by turning  or sliding  the controller and confirm with .

The system calculates the route and subsequently starts the route guidance with the address entered.

If you select **No** the address can be stored in the address book.

The destination download function is available if:

- the vehicle is equipped with a navigation system.
- the relevant mobile phone network is available and data transfer is possible.

## Route Assistance

This service is part of the mbrace PLUS Package and cannot be purchased separately.

You can use the Route Assistance function even if the vehicle is not equipped with a navigation system.

Within the framework of this service, you receive a professional and reliable form of navigation support without having to leave your vehicle.

The customer service representative finds a suitable route depending on your vehicle's current position and the desired destination. You will then be guided live through the current route section.

## Search and Send

### General notes

To use "Search & Send", your vehicle must be equipped with mbrace and a navigation system. Additionally, an mbrace service subscription must be completed.

"Search & Send" is a service for entering destinations in the navigation system. A destination address which is found on Google Maps® can be transferred via mbrace directly to your vehicle's navigation system.

### Specifying and sending the destination address

► Go to the website <http://maps.google.com> and enter a destination address into the entry field.

► **To send the destination address to the e-mail address of your mbrace account:** click on the corresponding button on the website.

Example:

If you select "Send to vehicle" and then "Mercedes-Benz", the destination address will be sent to your vehicle.

► When the "Send" dialog window appears:

Enter the e-mail address you specified when setting up your mbrace account into the corresponding field.

► Click "Send".

Information on specific commands such as "Address entry" or "Send" can be found on the website.

### Calling up a transmitted destination address

► Turn the SmartKey to position **2** in the ignition lock (▷ page 135).

The transmitted destination address is loaded into the vehicle's navigation system.

A display message appears, asking whether navigation should be started.

► Select **Yes** by turning **(⊙)** or sliding **←⊙→** the controller and confirm with **(⊙)**.

The system calculates the route and subsequently starts the route guidance with the address entered.

If you select **No** the address can be stored in the address book.

If you have sent more than one destination address, each individual destination must be confirmed separately.

Destination addresses are loaded in the same order as the order in which they were sent.

If you have multiple Mercedes-Benz vehicles with mbrace and active mbrace accounts:

If multiple vehicles are registered under the same e-mail address, the destination will be sent to all the vehicles.

### Vehicle remote opening

You can use the vehicle remote unlocking if you have unintentionally locked your vehicle and a replacement SmartKey is not available.

The vehicle can then be unlocked by the Mercedes-Benz Customer Assistance Center.

The vehicle can be immediately unlocked remotely within four days of the ignition being turned off. After this time, the remote unlocking may be delayed by 15 to 60 minutes. After 30 days, the vehicle can no longer be unlocked remotely.

The vehicle remote unlocking feature is available if the relevant mobile phone network is available and a data connection is possible.

► Contact the following service hotlines:

Mercedes-Benz Customer Assistance Center at 1-800 FOR-MERCEDES (1-800-367-6372) or 1-866-990-9007

You will be asked for your password.

► Return to your vehicle at the time agreed upon with the Mercedes-Benz Customer Assistance Center.

Alternatively, the vehicle can be opened via:

- the Internet, under the "Owners Online" section
- telephone applications (e.g. for iPhone®, Android™)

To do this, you will need your identification number and password.

### Vehicle remote closing

The vehicle remote closing feature can be used when you have forgotten to lock the vehicle and you are no longer nearby.

The vehicle can then be locked by the Mercedes-Benz Customer Assistance Center.

The vehicle can be immediately remotely locked within four days of the ignition being turned off. After this time, remote closing may be delayed by 15 to 60 minutes. After 30 days the vehicle can no longer be locked remotely.

The vehicle remote closing feature is available if the relevant mobile phone network is available and a data connection is possible.

► Contact the following service hotlines:

Mercedes-Benz Customer Assistance Center at 1-800-FOR-MERCEDES (1-800-367-6372) or 1-866-990-9007

You will be asked for your password.

The next time you are inside the vehicle and you switch on the ignition, the **Doors Locked Remotely** message appears in the multifunction display.

Alternatively, the vehicle can be locked via:

- the Internet, under the "Owners Online" section
- telephone applications (e.g. for iPhone®, Android™)

To do this, you will need your identification number and password.

### Stolen vehicle recovery service

If your vehicle has been stolen:

- ▶ Notify the police.  
The police will issue a numbered incident report.
- ▶ Forward this number to the Mercedes-Benz Customer Assistance Center along with your PIN.  
The Mercedes-Benz Customer Assistance Center then tries to locate the system. The Mercedes-Benz Customer Assistance Center contacts you and the local law enforcement agency if the vehicle is located.  
However, only the law enforcement agency is informed of the location of the vehicle.

If the anti-theft alarm system is activated for longer than 30 seconds, mbrace automatically notifies the Mercedes-Benz Customer Assistance Center.

### Vehicle Health Check

With the Vehicle Health Check, the Customer Assistance Center can provide improved support for problems with your vehicle. During an existing call, vehicle data is transferred to the Customer Assistance Center.

The customer service representative can use the received data to decide what kind of assistance is required. You are then, for example, guided to the nearest Mercedes-Benz Service Center or a recovery vehicle is called.

If vehicle data need to be transferred during an Info call or a Roadside Assistance call, this is initiated by the Customer Assistance Center.

The **Roadside Assistance Connected** message appears in the display. If the Vehicle Health Check can be started, the **Request for Vehicle Diagnostics Received Start vehicle diagnostics?** message appears in the display.

- ▶ Press the **Yes** button to confirm the message.
- ▶ If the **Vehicle Diagnostics Please Start Ignition** message appears: turn the SmartKey to key position **2** in the ignition lock (▷ page 135).
- ▶ If the **Please follow the instructions received by phone and move your vehicle to a safe position.** message appears: please follow the instructions received by phone and move your vehicle to a safe position.  
The message in the display disappears.  
The vehicle operating state check begins.  
During this procedure, you will see the **Vehicle Diagnostics Active** message.  
If you select **Cancel**, the Vehicle Health Check is canceled completely.

When the check is complete, the **Sending vehicle diagnostics data. (Voice connection may be interrupted during data transfer)** message appears. The vehicle data can now be sent.

- ▶ Press the **OK** button to confirm the message.  
The voice connection with the Customer Assistance Center is terminated.  
The **Vehicle Diagnostics: Transferring Data...** message appears.  
The vehicle data is sent to the Customer Assistance Center.

Depending on what the customer service representative agreed with you, the voice connection is re-established after the transfer is complete. If necessary, you will be contacted at a later time by another means, e.g. by e-mail or phone.

Another function of the Vehicle Health Check is the transfer of service data to the Customer Assistance Center. If a service is due, the display shows a message to this effect together with information about any special offers at your workshop.

This information can also be called up under "Owners Online" at <http://www.mbusa.com>.

Information on the data stored in the vehicle (▷ page 32).

Information on Roadside Assistance  
(▷ page 29).

### Downloading routes

Downloading routes allows you to transfer and save predefined routes in the navigation system.

A route can be prepared and sent either by a customer service representative or under "Owners Online" at <http://www.mbusa.com>.

Each route can include up to four way points.

Once a route has been received by the navigation system, you will see the **Do you want to start route guidance? Destination Received destination has been saved in "Previous destinations"**. message on the multimedia system display.

The route is saved.

► **To start route guidance:** select **Yes**.

An overview of the route is shown in the display.

If you select **No**, the saved route can be called up later in the navigation menu.

► Select **Start**.

Route guidance starts.

Downloaded and saved routes can be called up again.

### Speed alert

You can define the upper speed limit, which must not be exceeded by the vehicle.

If the vehicle exceeds the set speed, a message is sent to the Customer Assistance Center. The Customer Assistance Center then forwards this information to you.

You can select the way in which you receive this information beforehand. Possible options include text message, e-mail or an automated call.

The data you receive contains the following information:

- the location where the speed limit was exceeded
- the time at which the speed limit was exceeded
- the selected speed limit which was exceeded

### Geo fencing

Geo fencing allows you to select areas which the vehicle should not enter or leave. You will be informed if the vehicle crosses the boundaries of the selected areas. You can select the way in which you receive this information beforehand. Possible options include text message, e-mail or an automated call.

The area can be determined as either a circle or a polygon with a maximum of ten corners. You can specify up to ten areas simultaneously. Different settings are possible for each area.

These settings can be called up under "Owners Online" at <http://www.mbusa.com>.

Alternatively, you can also trigger an Info call and notify the customer service representative that you wish to activate geo-fencing.

Currently inactive areas can be activated by text message.

### Triggering the vehicle alarm

With this function, you can trigger the vehicle's panic alarm via text message. An alarm sounds and the exterior lighting flashes. Depending on the setting, the panic alarm lasts five or ten seconds. Afterwards, the alarm switches off.

### Garage door opener

#### General notes

The HomeLink® garage door opener integrated in the rear-view mirror allows you to operate up to three different door and gate systems.

Use the integrated garage door opener only on garage doors that:

- have safety stop and reverse features and
- meet current U.S. federal safety standards

Once programmed, the integrated garage door opener in the rear-view mirror will assume the function of the garage door system's remote control. Please also read the operating instructions for the garage door system.

When programming a garage door opener, park the vehicle outside the garage. Do not run the engine while programming.

Certain garage door drives are incompatible with the integrated garage door opener. If you have difficulty programming the integrated garage

door opener, contact a Mercedes-Benz Service Center.

Alternatively, you can call the following telephone assistance services:

- **USA:** Mercedes-Benz Customer Assistance Center at 1-800 FOR-MERCEDES
- **Canada:** Customer Service at 1-800-387-0100
- HomeLink® hotline 1-800-355-3515 (free of charge)

More information on HomeLink® and/or compatible products is also available online at <http://www.homelink.com>.

Notes on the declaration of conformity (▷ page 30).

USA: FCC ID: CB2HMIHL4

Canada: IC: 279B-HMIHL4

## Important safety notes

### ⚠ WARNING

When you operate or program the garage door with the integrated garage door opener, persons in the range of movement of the garage door can become trapped or struck by the garage door. There is a risk of injury.

When using the integrated garage door opener, always make sure that nobody is within the range of movement of the garage door.

### ⚠ WARNING

Combustion engines emit poisonous exhaust gases such as carbon monoxide. Inhaling these exhaust gases leads to poisoning. There is a risk of fatal injury. Therefore never leave the engine running in enclosed spaces without sufficient ventilation.

## Programming

### Programming the buttons

Pay attention to the "Important safety notes" (▷ page 317).



Garage door remote control ⑤ is not included with the integrated garage door opener.

- ▶ Turn the SmartKey to position ② in the ignition lock (▷ page 135).
- ▶ Select one of buttons ② to ④ to use to control the garage door drive.

- ▶ **To start programming mode:** press and hold one of buttons ② to ④ on the integrated garage door opener.

The garage door opener is now in programming mode. After a short time, indicator lamp ① lights up yellow.

Indicator lamp ① lights up yellow as soon as button ②, ③ or ④ is stored for the first time. If the selected button has already been programmed, indicator lamp ① will only light up yellow after ten seconds have elapsed.

- ▶ Release button ②, ③ or ④. Indicator lamp ① flashes yellow.
- ▶ **To program the remote control:** point garage door remote control ⑤ towards buttons ② to ④ on the rear-view mirror at a distance of 2 to 8 in (5 to 20 cm).
- ▶ Press and hold button ⑥ on remote control ⑤ until indicator lamp ① lights up green. When indicator lamp ① lights up green: programming is finished.

When indicator lamp ① flashes green: programming was successful. The next step is to synchronize the rolling code (▷ page 318).

- ▶ Release button ⑥ on remote control ⑤ for the garage door drive system. If indicator lamp ① lights up red: repeat the programming procedure for the corresponding button on the rear-view mirror. When doing so, vary the distance between remote control ⑤ and the rear-view mirror.

The required distance between remote control ⑤ and the integrated garage door opener depends on the garage door drive system.

Several attempts might be necessary. You should test every position for at least 25 seconds before trying another position.

### Synchronizing the rolling code

Pay attention to the "Important safety notes" (▷ page 317).

If the garage door system uses a rolling code, you will also have to synchronize the garage door system with the integrated garage door opener in the rear-view mirror. To do this you will need to use the programming button on the door drive control panel. The programming button may be located in different places depending on the manufacturer. It is usually located on the door drive unit on the garage ceiling.

Familiarize yourself with the garage door drive operating instructions, e.g. under "Programming additional remote controls", before carrying out the following steps.

Your vehicle must be within reach of the garage door or gate opener drive. Make sure that neither your vehicle nor any persons/objects are present within the sweep of the door or gate.

▶ Turn the SmartKey to position **2** in the ignition lock (▷ page 135).

▶ Get out of the vehicle.

▶ Press the programming button on the door drive unit.

You now have 30 seconds to initiate the next step.

▶ Get into the vehicle.

▶ Press previously programmed button **2**, **3** or **4** on the integrated garage door opener repeatedly until the door closes.

The rolling code synchronization is then complete.

### Notes on programming the remote control

Canadian radio frequency laws require a "break" (or interruption) of the transmission signals after broadcasting for a few seconds. Therefore, these signals may not last long enough for the integrated garage door opener. The signal is not recognized during programming. Comparable with Canadian law, some U.S. garage door openers also feature a "break".

Proceed as follows:

- if you live in Canada.
  - if you have difficulties programming the garage door opener (regardless of where you live) when following the programming steps.
- ▶ Press and hold one of buttons **2** to **4** on the integrated garage door opener.  
After a short time, indicator lamp **1** lights up yellow.
- ▶ Release the button.  
Indicator lamp **1** flashes yellow.
- ▶ Press button **6** of garage door remote control **5** for two seconds, then release it for two seconds.
- ▶ Press button **6** again for two seconds.
- ▶ Repeat this sequence on button **6** of remote control **5** until indicator lamp **1** lights up green.  
When indicator lamp **1** lights up green: programming is finished.  
When indicator lamp **1** flashes green: programming was successful. The next step is to synchronize the rolling code.
- ▶ Release button **6** of remote control **5** of the garage door drive.  
When indicator lamp **1** lights up red: repeat the programming process for the corresponding button on the rear-view mirror. When doing so, vary the distance between remote control **5** and the rear-view mirror.  
The required distance between remote control **5** and the integrated garage door opener depends on the garage door drive system. Several attempts might be necessary. You should test every position for at least 25 seconds before trying another position.

### Problems when programming

If you are experiencing problems programming the integrated garage door opener on the rear-view mirror, take note of the following instructions:

- Check the transmitter frequency used by garage door drive remote control **5** and whether it is supported. The transmitter frequency can usually be found on the back of remote control **5** for the garage door drive.  
The integrated garage door opener is compatible with devices that have units which



operate in the frequency range of 280 to 433 MHz.

- ▶ Replace the batteries in garage door remote control ⑤. This increases the likelihood that garage door remote control ⑤ will transmit a strong and precise signal to the integrated garage door opener.
- ▶ When programming, hold remote control ⑤ at varying distances and angles from buttons ② to ④ which you are programming. Try various angles at a distance between 2 and 8 inches (5 to 20 cm) or at the same angle but at varying distances.
- ▶ If a further remote control ⑤ is available for the same garage door drive, repeat the same programming steps with this remote control ⑤. Before performing these steps, make sure that new batteries have been installed in garage door drive remote control ⑤.
- ▶ Note that some remote controls only transmit for a limited amount of time (the indicator lamp on the remote control goes out). Press button ⑥ on remote control ⑤ again before transmission ends.
- ▶ Align the antenna cable of the garage door opener unit. This can improve signal reception/transmission.

### Opening/closing the garage door

After it has been programmed, the integrated garage door opener performs the function of the garage door system remote control. Please also read the operating instructions for the garage door system.

- ▶ Turn the SmartKey to position 2 in the ignition lock (▷ page 135).
- ▶ Press button ②, ③ or ④ which you programmed to operate the garage door.  
Garage door system with a fixed code: indicator lamp ① lights up green.  
Garage door system with a rolling code: indicator lamp ① flashes green.  
The transmitter will transmit a signal as long as the button is pressed. The transmission is halted after a maximum of ten seconds and indicator lamp ① lights up yellow.
- ▶ Press button ②, ③ or ④ again if necessary.

### Clearing the memory

Make sure that you clear the memory of the integrated garage door opener before selling the vehicle.

- ▶ Turn the SmartKey to position 2 in the ignition lock (▷ page 135).
- ▶ Press and hold buttons ② and ④. Indicator lamp ① initially lights up yellow and then green.
- ▶ Release buttons ② and ④. The memory of the integrated garage door opener in the rear-view mirror is cleared.

### Floormats

#### ⚠ WARNING

Objects in the driver's footwell can restrict the pedal travel or obstruct a depressed pedal. The operating and road safety of the vehicle is jeopardized. There is a risk of an accident.

Make sure that all objects in the vehicle are stowed correctly, and that they cannot enter the driver's footwell. Install the floormats securely and as specified in order to ensure sufficient clearance for the pedals. Do not use loose floormats and do not place floormats on top of one another.

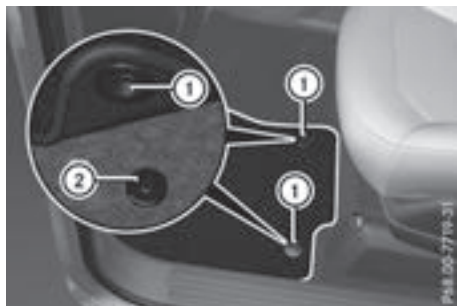

- ▶ **Driver's seat/front-passenger seat:** slide the respective seat back.
- ▶ **Rear seats:** slide the corresponding front seat forwards.
- ▶ **To install:** place the floormat in the footwell.
- ▶ Press studs ① onto retainers ②.

- ▶ **To remove:** pull the floormat from retainers ②.
- ▶ Remove the floormat.

### Infrared reflective windshield

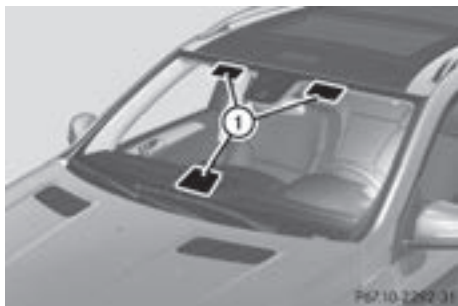

The infrared reflecting glass prevents the vehicle interior from becoming too hot. It also blocks radio waves up into the gigahertz range.

To enable operation of radio-controlled equipment, e.g. toll recording systems, areas on the windshield are permeable to radio waves ①. In these areas, you can install radio-controlled systems.

These areas can best be seen from outside the vehicle by observing the light reflected off the windshield.

## Engine compartment

### Hood

#### Important safety notes

##### WARNING

If the hood is unlatched, it may open up when the vehicle is in motion and block your view. There is a risk of an accident.

Never unlatch the hood while driving. Before every trip, ensure that the hood is locked.

##### WARNING

When opening and closing the hood, it may suddenly fall into the closed position. There is a risk of injury to persons within range of movement of the hood.

Open and close the hood only when no one is within its range of movement.

##### WARNING

Opening the hood when the engine is overheated or when there is a fire in the engine compartment could expose you to hot gases or other service products. There is a risk of injury.

Let an overheated engine cool down before opening the hood. If there is a fire in the engine compartment, keep the hood closed and contact the fire department.

##### WARNING

The engine compartment contains moving components. Certain components, such as the radiator fan, may continue to run or start again suddenly when the ignition is off. There is a risk of injury.

If you need to do any work inside the engine compartment:

- switch off the ignition
- never reach into the area where there is a risk of danger from moving components, such as the fan rotation area

- remove jewelry and watches
- keep items of clothing and hair, for example, away from moving parts

##### WARNING

The ignition system and the fuel injection system work under high voltage. If you touch components which are under voltage, you could get an electric shock. There is a risk of injury.

Never touch components of the ignition system or fuel injection system when the ignition is switched on.

Electrically live components include ignition coils, spark plug connectors and the test socket.

**Plug-in hybrid:** be sure to read the separate Operator's Manual. You could otherwise fail to recognize dangers, e.g. due to high voltage.

#### Opening the hood

##### WARNING

Certain components in the engine compartment, such as the engine, radiator and parts of the exhaust system, can become very hot. Working in the engine compartment poses a risk of injury.

Where possible, let the engine cool down and touch only the components described in the following.

##### WARNING

When the hood is open and the windshield wipers are set in motion, you can be injured by the wiper linkage. There is a risk of injury.

Always switch off the windshield wipers and the ignition before opening the hood.

- ❗ Make sure that the windshield wipers are not folded away from the windshield. You could otherwise damage the windshield wipers or the hood.



- ▶ Make sure that the windshield wipers are turned off.
- ▶ Pull release lever ① on the hood. The hood is released.



- ▶ Reach into the gap, pull hood catch handle ② up and lift the hood. If you lift the hood by approximately 15 in (40 cm), the hood is opened and held open automatically by the gas-filled strut.

### Closing the hood

- ▶ Lower the hood and let it fall from a height of approximately 8 in (20 cm).
- ▶ Check that the hood has engaged properly. If the hood can be raised slightly, it is not properly engaged. Open it again and close it with a little more force.

### Radiator

**Vehicles with a diesel engine:** do not cover the radiator, such as with a thermal mat or insect protection cover. Otherwise, the values of the European on-board diagnostics may be affected. Some of these readings are required by law and must be accurate at all times.

### Engine oil

#### Important safety notes

##### WARNING

Certain components in the engine compartment, such as the engine, radiator and parts of the exhaust system, can become very hot. Working in the engine compartment poses a risk of injury.

Where possible, let the engine cool down and touch only the components described in the following.

##### WARNING

Opening the hood when the engine is overheated or when there is a fire in the engine compartment could expose you to hot gases or other service products. There is a risk of injury.

Let an overheated engine cool down before opening the hood. If there is a fire in the engine compartment, keep the hood closed and contact the fire department.

##### WARNING

If engine oil comes into contact with hot components in the engine compartment, it may ignite. There is a risk of fire and injury.

Make sure that engine oil is not spilled next to the filler neck. Let the engine cool down and thoroughly clean the engine oil off the components before starting the engine.

**Plug-in hybrid:** be sure to read the separate Operator's Manual. You could otherwise fail to recognize dangers, e.g. due to high voltage.

### General notes

Depending on your driving style, the vehicle consumes up to 0.9 US qt (0.8 liters) of oil per 600 miles (1,000 km). The oil consumption may be higher than this when the vehicle is new or if you frequently drive at high engine speeds.

Depending on the engine, the oil dipstick may be in a different location.

When checking the oil level:

- park the vehicle on a level surface.
- the engine should be switched off for approximately five minutes if the engine is at normal operating temperature.
- if the engine is not at normal operating temperature, e.g. if the engine was only started briefly, wait about 30 minutes before carrying out the measurement.

### Checking the oil level using the oil dipstick



Example: vehicles with a gasoline engine

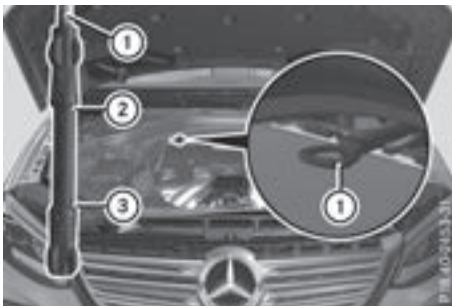

Example: vehicles with a diesel engine

- ▶ Pull oil dipstick ① out of the dipstick tube.
- ▶ Wipe off oil dipstick ①.
- ▶ Slowly slide oil dipstick ① into the guide tube to the stop, and take it out again. If the level is between MIN mark ③ and MAX mark ②, the oil level is correct.
- ▶ If the oil level has dropped to MIN mark ③ or below, add 1.1 US qt (1.0 liter) engine oil.

### Adding engine oil

#### Environmental note

When adding oil, take care not to spill any. If oil enters the soil or waterways, it is harmful to the environment.

- ! Use only engine oils and oil filters that are approved for vehicles with a service system. A list of the engine oils and oil filters that have been tested and approved in accordance with Mercedes-Benz Specifications for Service Products is available at any authorized Mercedes-Benz Center.

The following cause engine failure or damage to the exhaust system:

- Use of engine oils and oil filters that have not been expressly approved for the service system
- Replacement of engine oil and oil filter after the replacement interval specified by the service system has expired
- Use of engine oil additives

- ! Do not add too much oil. adding too much engine oil can result in damage to the engine or to the catalytic converter. Have excess engine oil siphoned off.



Example: engine oil cap

- ▶ Turn cap ① counter-clockwise and remove it.
- ▶ Add engine oil. If the oil level is at or below the MIN mark on the oil dipstick, add 1.1 US qt (1.0 liter) of engine oil.
- ▶ Replace cap ① on the filler neck and tighten clockwise. Ensure that the cap locks into place securely.
- ▶ Check the oil level again with the oil dipstick (▷ page 323).

Further information on engine oil (▷ page 387).

### Additional service products

### Important safety notes

#### WARNING

Certain components in the engine compartment, such as the engine, radiator and parts of the exhaust system, can become very hot. Working in the engine compartment poses a risk of injury.

Where possible, let the engine cool down and touch only the components described in the following.

#### WARNING

The cooling system is pressurized, particularly when the motor is warm. If you open the cap, you could be scalded if hot coolant sprays out. There is a risk of injury.

Let the engine cool down before you open the cap. Wear gloves and eye protection. Slowly open the cap to relieve pressure.

The coolant level may only be checked and coolant refilled when the engine and engine cooling system have cooled down.

#### WARNING

Windshield washer concentrate could ignite if it comes into contact with hot engine components or the exhaust system. There is a risk of fire and injury.

Make sure that no windshield washer concentrate is spilled next to the filler neck.

### Checking coolant level

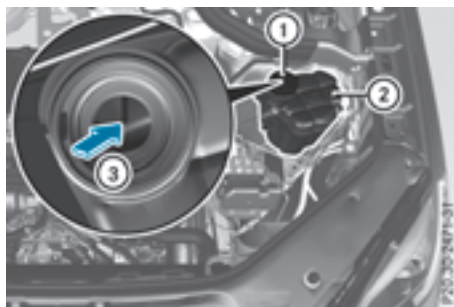

- ▶ Park the vehicle on a level surface.
  - Only check the coolant level when the vehicle is on a level surface and the engine has cooled down.
- ▶ Turn the SmartKey to position **2** in the ignition lock (▷ page 135).
  - On vehicles with KEYLESS-GO, press the Start/Stop button twice (▷ page 137).
- ▶ Check the coolant temperature gauge in the multifunction display.
  - The coolant temperature must be below 158 °F (70 °C).
- ▶ Turn the SmartKey to position in the ignition lock **0** (▷ page 135).
- ▶ On vehicles with KEYLESS-GO, press the Start/Stop button (▷ page 137).
- ▶ Press the Start/Stop button (▷ page 137).
- ▶ Slowly turn cap **1** half a turn counter-clockwise and allow excess pressure to escape.
- ▶ Turn cap **1** further counter-clockwise and remove it.
  - If the coolant is at the level of marker bar **3** in the filler neck when cold, there is enough coolant in coolant expansion tank **2**.
  - If the coolant level is approximately 0.6 in (1.5 cm) above marker bar **3** in the filler neck when warm, there is enough coolant in expansion tank **2**.
- ▶ If necessary, add coolant that has been tested and approved by Mercedes-Benz.
- ▶ Replace cap **1** and turn it clockwise as far as it will go.

For further information on coolant, see (▷ page 388).

## Adding washer fluid to the windshield washer system



Example: washer fluid reservoir

- ▶ **To open:** pull cap ① upwards by the tab.
- ▶ Add the premixed washer fluid.
- ▶ **To close:** press cap ① onto the filler neck until it engages.

If the washer fluid level drops below the recommended minimum of 1 liter, a message appears in the multifunction display prompting you to add washer fluid (▷ page 272).

Further information on windshield washer fluid (▷ page 389).

## ASSYST PLUS

### Service message

**i** If the scheduled service intervals are exceeded, this may result in damage to the vehicle.

You can obtain up-to-date information concerning the servicing of your vehicle from a qualified specialist workshop, e.g. an authorized Mercedes-Benz Center or at <http://www.mbusa.com> (USA only).

**i** The ASSYST PLUS service interval display does not show any information on the engine oil level. Observe the notes on the engine oil level (▷ page 322).

The multifunction display shows a service message for several seconds, e.g.:

- Service A in .. Days
- Service A Due
- Service A Exceeded by .. Days

Depending on the operating conditions of the vehicle, the remaining time or distance until the next service due date is displayed.

The letter **A** or **B**, possibly in connection with a number or another letter, shows the type of service. **A** stands for a minor service and **B** for a major service.

Further information can be obtained at a qualified specialist workshop.

The ASSYST PLUS service interval display does not take into account any periods of time during which the battery is disconnected.

Maintaining the time-dependent service schedule:

- ▶ Note down the service due date displayed in the multifunction display before disconnecting the battery.

or

- ▶ After reconnecting the battery, subtract the battery disconnection periods from the service date shown on the display.

### Hiding a service message

- ▶ Press the or button on the steering wheel.

### Displaying service messages

- ▶ Switch on the ignition.
- ▶ Press the or button on the steering wheel to select the **Serv.** menu.
- ▶ Press the or button to select the **ASSYST PLUS** submenu and confirm by pressing the button.  
The service due date appears in the multifunction display.

### Information about Service

#### Resetting the ASSYST PLUS service interval display

**!** If the ASSYST PLUS service interval display has been inadvertently reset, this setting can be corrected at a qualified specialist workshop.

Have service work carried out as described in the Maintenance Booklet. This may otherwise lead to increased wear and damage to the major assemblies or the vehicle.

A qualified specialist workshop will reset the ASSYST service interval display after the service work has been carried out. You can also obtain further information on maintenance work, for example.

### Special service requirements

The specified maintenance interval takes only the normal operation of the vehicle into account. Under increased load on the vehicle, maintenance work must be carried out more frequently, for example:

- Regular city driving with frequent intermediate stops
- If the vehicle is primarily used to travel short distances
- Use in mountainous terrain or on poor road surfaces
- If the engine is often left idling for long periods

Under these or similar conditions, have, for example, the air filter, engine oil and oil filter replaced or changed more frequently. Under arduous operating conditions, the tires must be checked more often. Further information can be obtained at a qualified specialist workshop.

### Driving abroad

An extensive Mercedes-Benz Service network is also available in other countries. You can obtain further information from any authorized Mercedes-Benz Center.

## Care

### General notes

#### 🌱 Environmental note

Dispose of empty packaging and cleaning cloths in an environmentally responsible manner.

❗ When cleaning your car, do not use:

- dry, coarse or hard cloths
- abrasive cleaning agents
- solvents
- cleaning agents containing solvents

Do not scrub.

Do not touch the surfaces and films with hard objects, e.g. rings or ice scrapers. Otherwise,

you may scratch or damage the surfaces and films.

❗ Do not park your vehicle for a long period of time directly after cleaning, particularly after cleaning the wheel rim with wheel cleaner. Wheel cleaner can lead to the increased corrosion of the brake discs and pads. Therefore, drive for a few minutes after cleaning. By heating up the brakes, the brake discs and pads dry. The vehicle can then be parked for a long period of time.

Regular care of your vehicle is a condition for retaining the quality in the long term.

Use care products and cleaning agents recommended and approved by Mercedes-Benz.

### Washing the vehicle and cleaning the paintwork

#### Automatic car wash

#### ⚠️ WARNING

Braking efficiency is reduced after washing the vehicle. There is a risk of an accident.

After the vehicle has been washed, brake carefully while paying attention to the traffic conditions until full braking power is restored.

❗ Before driving into an automatic car wash, make sure that it is suitable for the dimensions of the vehicle. In particular, make sure that:

- there is enough ground clearance between the vehicle underbody and the guide rails of the automatic car wash.
- the clearance width of the automatic car wash is sufficient, particularly the width of the guide rails.
- you enter the automatic car wash straight and in the center of the guide rails in order to avoid damaging the tires or wheel rims.

Fold in the exterior mirrors before the vehicle is washed. The exterior mirrors could otherwise be damaged.

❗ When Distance Pilot DISTRONIC or the HOLD function is activated, the vehicle brakes automatically in certain situations.



To avoid damage to the vehicle, deactivate Distance Pilot DISTRONIC and the HOLD function in the following or similar situations:

- when towing the vehicle
- in the car wash

**!** Never clean your vehicle in a Touchless Automatic Car Wash as these use special cleaning agents. These cleaning agents can damage the paintwork or plastic parts.

**!** Make sure that:

- the side windows and the sliding sunroof are fully closed.
- that the blower of the ventilation/heating system is switched off (OFF button has been pressed).
- the windshield wiper switch is at position **0**.

The vehicle may otherwise be damaged.

**!** In car washes with a towing mechanism, make sure that the automatic transmission is in transmission position **N**; otherwise, the vehicle could be damaged.

- Vehicles with a SmartKey:

Do not remove the SmartKey from the ignition lock. Do not open the driver's door or front-passenger door when the engine is switched off. Otherwise, the automatic transmission selects park position **P** automatically and locks the wheels. You can prevent this by shifting the automatic transmission to **N** beforehand.

- Vehicles with KEYLESS-GO:

Do not open the driver's door or front-passenger door when the engine is switched off. Otherwise, the automatic transmission selects park position **P** automatically and locks the wheels.

Observe the following to make sure that the automatic transmission stays in position **N**:

- ▶ Make sure the vehicle is stationary and the ignition is switched off.
- ▶ Turn the SmartKey to position in the ignition lock **2** (▷ page 135).  
Use the SmartKey instead of the Start/Stop button on vehicles with KEYLESS-GO.
- ▶ Depress and hold the brake pedal.
- ▶ Shift the automatic transmission to position **N**.
- ▶ Release the brake pedal.

- ▶ Release the electric parking brake.
- ▶ Switch off the ignition and leave the SmartKey in the ignition lock.

You can wash the vehicle in an automatic car wash from the very start.

If the vehicle is very dirty, pre-wash it before cleaning it in an automatic car wash.

After using an automatic car wash, wipe off wax from the windshield and the wiper blades. This will prevent smears and reduce wiping noises caused by residue on the windshield.

## Washing by hand

In some countries, washing by hand is only allowed at specially equipped washing bays. Observe the legal requirements in all countries concerned.

- ▶ Do not use hot water and do not wash the vehicle in direct sunlight.
- ▶ Use a soft sponge to clean.
- ▶ Use a mild cleaning agent, such as a car shampoo approved by Mercedes-Benz.
- ▶ Thoroughly hose down the vehicle with a gentle jet of water.
- ▶ Do not point the water jet directly towards the air inlets.
- ▶ Use plenty of water and rinse out the sponge frequently.
- ▶ Rinse the vehicle with clean water and dry thoroughly with a chamois.
- ▶ Do not let the cleaning agent dry on the paintwork.

When using the vehicle in winter, remove all traces of road salt deposits carefully and as soon as possible.

## Power washers

### WARNING

The water jet from a circular jet nozzle (dirt blasters) can cause invisible exterior damage to the tires or chassis components. Components damaged in this way may fail unexpectedly. There is a risk of an accident.

Do not use power washers with circular jet nozzles to clean the vehicle. Have damaged tires or chassis components replaced immediately.

**!** Always maintain a distance of at least 11.8 in (30 cm) between the vehicle and the power washer nozzle. Information about the correct distance is available from the equipment manufacturer.

Move the power washer nozzle around when cleaning your vehicle.

Do not aim directly at any of the following:

- tires
- door gaps, roof gaps, joints, etc.
- electrical components
- battery
- plug-type couplings
- lights
- seals
- trim
- ventilation slots

Damaged seals or electrical components can lead to leaks or failures.

**!** Vehicles with decorative foil: parts of your vehicle are covered with decorative foil. Maintain a distance of at least 27.5 in (70 cm) between the foil-wrapped parts of the vehicle and the nozzle of the high pressure cleaner. Information about the correct distance is available from the equipment manufacturer. Move the power washer nozzle around when cleaning your vehicle.

The water temperature of the high-pressure cleaner must not exceed 140 °F (60 °C).

## Cleaning the paintwork

**!** Do not affix:

- stickers
  - films
  - magnetic plates or similar items
- to painted surfaces. You could otherwise damage the paintwork.

Scratches, corrosive deposits, areas affected by corrosion and damage caused by inadequate care cannot always be completely repaired. In such cases, visit a qualified specialist workshop.

- ▶ Remove dirt immediately, where possible, while avoiding rubbing too hard.
- ▶ Soak insect remains with insect remover and rinse off the treated areas afterwards.
- ▶ Soak bird droppings with water and rinse off the treated areas afterwards.

▶ Remove coolant, brake fluid, tree resin, oils, fuels and greases by rubbing gently with a cloth soaked in petroleum ether or lighter fluid.

▶ Use tar remover to remove tar stains.

▶ Use silicone remover to remove wax.

If water no longer forms "beads" on the paint surface, use the paint care products recommended and approved by Mercedes-Benz. This is the case approximately every three to five months, depending on the climate conditions and the care product used.

If dirt has penetrated the paint surface or if the paint has become dull, the paint cleaner recommended and approved by Mercedes-Benz should be used.

Do not use these care products in the sun or on the hood while the hood is hot.

▶ Use a suitable touch-up stick, e.g. MB Touch-Up Stick, to repair slight damage to the paintwork quickly and provisionally.

## Matte finish care

**!** Never polish the vehicle or the light alloy wheels. Polishing causes the finish to shine.

**!** The following can give the paint a glossy appearance and thus reduce the matt effect:

- Rubbing hard with unsuitable agents
- Washing the vehicle in direct sunlight

**!** Never use paint cleaner, buffing or polishing products, or gloss preserver, e.g. wax, for the purpose of paintwork care. These products are only suitable for high-gloss surfaces. Their use on vehicles with matte paintwork leads to considerable surface damage or, more specifically, to shiny, spotted areas.

Always have paintwork repairs carried out at a qualified specialist workshop.

**!** Only use automatic car washes which correspond to the latest technological standards. Never use wash programs which finish by treating the vehicle with hot wax.

Observe these notes if your vehicle has a clear matte finish. This will help you to avoid damage to the paintwork due to incorrect treatment.

These notes also apply to light alloy wheels with a clear matt finish.

- i** Use only insect remover and car shampoo from the range of recommended and approved Mercedes-Benz care products.

## Cleaning the vehicle parts

### Cleaning the wheels

#### WARNING

The water jet from a circular jet nozzle (dirt blasters) can cause invisible exterior damage to the tires or chassis components. Components damaged in this way may fail unexpectedly. There is a risk of an accident.

Do not use power washers with circular jet nozzles to clean the vehicle. Have damaged tires or chassis components replaced immediately.

- !** Do not use acidic wheel cleaning products to remove brake dust. This could damage wheel bolts and brake components.
- !** Do not park your vehicle for a long period of time directly after cleaning, particularly after cleaning the wheel rim with wheel cleaner. Wheel cleaner can lead to the increased corrosion of the brake discs and pads. Therefore, drive for a few minutes after cleaning. By heating up the brakes, the brake discs and pads dry. The vehicle can then be parked for a long period of time.

### Cleaning the windows

#### WARNING

You could become trapped by the windshield wipers if they start moving while cleaning the windshield or wiper blades. There is a risk of injury.

Always switch off the windshield wipers and the ignition before cleaning the windshield or wiper blades.

- !** Do not use dry cloths, abrasive products, solvents or cleaning agents containing solvents to clean the inside of the windows. Do not touch the insides of the windows with hard objects, e.g. an ice scraper or ring. There is otherwise a risk of damaging the windows.

- !** Clean the water drainage channels of the windshield and the rear window at regular intervals. Deposits such as leaves, petals and pollen may under certain circumstances prevent water from draining away. This can lead to corrosion damage and damage to electronic components.

- ▶ Clean the inside and outside of the windows with a damp cloth and a cleaning product that is recommended and approved by Mercedes-Benz.

### Cleaning wiper blades

#### WARNING

You could become trapped by the windshield wipers if they start moving while cleaning the windshield or wiper blades. There is a risk of injury.

Always switch off the windshield wipers and the ignition before cleaning the windshield or wiper blades.

- !** Do not pull the wiper blade. Otherwise, the wiper blade could be damaged.
- !** Do not clean wiper blades too often and do not rub them too hard. Otherwise, the graphite coating could be damaged. This could cause wiper noise.
- !** Hold the wiper arm securely when folding back. The windshield could be damaged if the wiper arm smacks against it suddenly.
- ▶ Fold the windshield wiper arms away from the windshield (▷ page 118).
- ▶ Carefully clean the wiper blades with a damp cloth.
- ▶ Fold the windshield wiper arms back again before switching on the ignition.

### Cleaning the exterior lighting

- !** Only use cleaning agents or cleaning cloths which are suitable for plastic light lenses. Unsuitable cleaning agents or cleaning cloths could scratch or damage the plastic light lenses.
- ▶ Clean the plastic lenses of the exterior lighting using a wet sponge and a mild cleaning agent, e.g. Mercedes-Benz car shampoo or cleaning cloths.

### Cleaning the mirror turn signals

- ❗ Only use cleaning agents or cleaning cloths that are suitable for plastic lenses. Unsuitable cleaning agents or cleaning cloths could scratch or damage the plastic lenses of the mirror turn signals.
- ▶ Clean the plastic lenses of the mirror turn signals in the exterior mirror housing using a wet sponge and mild cleaning agent, e.g. Mercedes-Benz car shampoo or cleaning cloths.

### Cleaning the side running board

- ❗ Do not clean the aluminum inserts of the side running board with alkaline or acidic cleaners, such as wheel cleaner. Do not use acidic wheel cleaners to remove brake dust. The aluminum inserts could otherwise be damaged.

### Cleaning the sensors

- ❗ If you clean the sensors with a power washer, make sure that you keep a distance of at least 11.8 in (30 cm) between the vehicle and the power washer nozzle. Information about the correct distance is available from the equipment manufacturer.

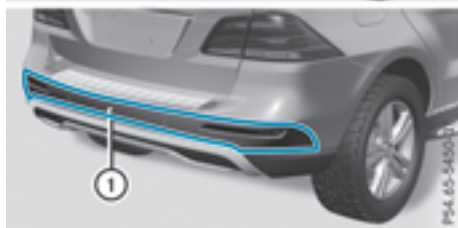

- ▶ Clean sensors ① of the driving systems with water, car shampoo and a soft cloth.

### Cleaning the rear view camera and 360° camera

- ❗ Do not clean the camera lens and the area around the rear view camera or 360° camera with a power washer.



- ▶ Make sure that the vehicle is stationary and the SmartKey is in position ② in the ignition lock.
- ▶ Open the camera cover for cleaning via the multimedia system (see Digital Operator's Manual).
- ▶ **To clean the camera:** use clean water and a soft cloth to clean the camera lens ①.

**360° camera:** if you drive at speeds above 20 mph (30 km/h) or with the SmartKey in position ① or ② in the ignition lock, the cover of the 360° camera closes.

### Cleaning the exhaust pipe

#### ⚠ WARNING

The exhaust tail pipe and tail pipe trim can become very hot. If you come into contact with these parts of the vehicle, you could burn yourself. There is a risk of injury.

Always be particularly careful around the exhaust tail pipe and the tail pipe trim. Allow these components to cool down before touching them.

- ❗ Vehicles with black exhaust pipes: black chromed screens should not be polished with a chrome polish. They will otherwise lose their black shine. For optimal care, the screens should be rubbed with a lightly oiled cloth after every car wash. Commercially available engine and care oils are suitable for this.

For heavier soiling, you can apply a fine paintwork polish with a microfiber cloth. Remove the excess polish residue after polishing.

Impurities combined with the effects of road grit and corrosive environmental factors may cause flash rust to form on the surface. You can restore the original shine of the exhaust pipe by cleaning it regularly, especially in winter and after washing.

- ▶ Clean the exhaust pipe with a chrome care product tested and approved by Mercedes-Benz.

## Cleaning the trailer tow hitch



### Environmental note

Dispose of rags soaked in oil and grease in an environmentally responsible manner.

- ❗ Do not clean the ball coupling with a power washer. Do not use solvents.
- ❗ Please note the care instructions in the trailer coupling manufacturer's operating instructions.



The ball coupling must be cleaned if it becomes dirty or corroded.

- ▶ Remove rust on the ball of the ball coupling, e.g. with a wire brush.
  - ▶ Remove dirt with a clean, lint-free cloth or a brush.
  - ▶ After cleaning, lightly oil or grease ball coupling ①.
  - ▶ Check that the vehicle's trailer tow hitch is working properly.
- ① You can also have the maintenance work on the ball coupling and the trailer tow hitch carried out by a qualified specialist workshop.

## Interior care

### Cleaning the display

- ❗ For cleaning, do not use any of the following:
  - alcohol-based thinner or gasoline
  - abrasive cleaning agents
  - commercially-available household cleaning agents

These may damage the display surface. Do not put pressure on the display surface when cleaning. This could lead to irreparable damage to the display.

- ▶ Before cleaning the display, make sure that it is switched off and has cooled down.
- ▶ Clean the display surface using a commercially available microfiber cloth and TFT/LCD display cleaner.
- ▶ Dry the display surface using a dry microfiber cloth.

### Cleaning the plastic trim

#### WARNING

Care products and cleaning agents containing solvents cause surfaces in the cockpit to become porous. As a result, plastic parts may come loose in the event of air bag deployment. There is a risk of injury.

Do not use any care products and cleaning agents to clean the cockpit.

- ❗ Never attach the following to plastic surfaces:
  - stickers
  - films
  - perfume oil container or similar
 You could otherwise damage the plastic.
- ❗ Do not allow cosmetics, insect repellent or sunscreen to come into contact with the plastic trim. This maintains the high-quality look of the surfaces.
- ▶ Wipe the plastic trim with a damp, lint-free cloth, e.g. a microfiber cloth.
- ▶ **Heavy soiling:** use care and cleaning products recommended and approved by Mercedes-Benz. The surface may change color temporarily. Wait until the surface is dry again.

## Cleaning the steering wheel and gear or selector lever

- ▶ Thoroughly wipe with a damp cloth or use leather care agents that have been recommended and approved by Mercedes-Benz.

## Cleaning genuine wood and trim elements

❗ Do not use solvent-based cleaning agents such as tar remover, wheel cleaners, polishes or waxes. There is otherwise a risk of damaging the surface.

❗ Do not use chrome polish on trim pieces. The trim pieces have a chrome look but are mostly made of anodized aluminum and can lose their shine if chrome polish is used. Use a damp, lint-free cloth instead when cleaning the trim pieces.

If the chrome-plated trim pieces are very dirty, you can use a chrome polish. If you are unsure as to whether the trim pieces are chrome-plated or not, consult an authorized Mercedes-Benz Center.

- ▶ Wipe the wooden trim and trim pieces with a damp, lint-free cloth, e.g. a microfiber cloth.
- ▶ **Heavy soiling:** use car care and cleaning products recommended and approved by Mercedes-Benz.

## Cleaning the seat covers

### General notes

❗ Do not use a microfiber cloth to clean covers made out of real leather, artificial leather or DINAMICA. If used often, these can damage the cover.

i Note that regular care is essential to ensure that the appearance and comfort of the covers is retained over time.

## Genuine leather seat covers

❗ To retain the natural appearance of the leather, observe the following cleaning instructions:

- Clean genuine leather covers carefully with a damp cloth and then wipe the covers down with a dry cloth.
- Make sure that the leather does not become soaked. It may otherwise become rough and cracked.
- Only use leather care agents that have been tested and approved by Mercedes-Benz. You can obtain these from a qualified specialist workshop.

Leather is a natural product.

It exhibits natural surface characteristics, for example:

- differences in the texture
- marks caused by growth and injury
- slight nuances of color

These are characteristics of leather and not material defects.

### Seat covers of other materials

❗ Observe the following when cleaning:

- clean artificial leather covers with a cloth moistened with a solution containing 1% detergent (e.g. dish washing liquid).
- clean cloth covers with a microfiber cloth moistened with a solution containing 1% detergent (e.g. dish washing liquid). Rub carefully and always wipe entire seat sections to avoid leaving visible lines. Leave the seat to dry afterwards. Cleaning results depend on the type of dirt and how long it has been there.
- clean DINAMICA covers with a damp cloth. Make sure that you wipe entire seat sections to avoid leaving visible lines.

## Cleaning the seat belts

### WARNING

Seat belts can become severely weakened if bleached or dyed. This could cause the seat belts to tear or fail, for instance, in the event of an accident. This poses an increased risk of injury or fatal injury.

Never bleach or dye the seat belts.

**!** Do not clean the seat belts using chemical cleaning agents. Do not dry the seat belts by heating at temperatures above 176 °F (80 °C) or in direct sunlight.

- ▶ Use clean, lukewarm water and soap solution.

### **Cleaning the headliner and carpets**

---

- ▶ **Headliner:** if it is very dirty, use a soft brush or dry shampoo.
- ▶ **Carpets:** use the carpet and textile cleaning agents recommended and approved by Mercedes-Benz.

## Where will I find...?

## Reflective safety jacket

## Removing/replacing the reflective safety jacket



The reflective safety jackets are located in front door stowage compartments ①. Reflective safety jackets can also be stored in the rear door stowage compartments.

- ▶ **To remove:** pull out the safety jacket bag containing the reflective safety jacket.
- ▶ Open the safety jacket bag and pull out the reflective safety jacket.
- ▶ **To stow:** fold the reflective safety jacket, roll it up and stow it in the safety jacket bag.
- ▶ Replace the safety jacket bag in stowage compartment ①.

**i** Remove a new reflective safety jacket from its packaging material before sliding it into the stowage compartment. The packaging material may otherwise cause it to slip out or make removing it difficult.

Observe the legal requirements in each country.

## Information on reflective safety jackets



- ① Maximum number of washes
- ② Maximum wash temperature
- ③ Do not bleach
- ④ Do not iron
- ⑤ Do not use a laundry dryer
- ⑥ Do not dry-clean
- ⑦ This is a class 2 vest

- The reflective safety jackets meet the requirements defined by the legal standard only:
  - if the correct size is used and
  - if the reflective safety jackets are correctly fastened
- Before use, ensure that the reflective safety jackets are clean and intact. The special properties may otherwise be compromised.
- The reflective safety jackets should be stored in their original packaging in a dry place away from sources of heat and light.
- The maximum number of washes specified is not the only factor influencing the life span of the reflective safety jackets. Their life span also depends on use, care, storage, etc.
- The reflective safety jackets should be disposed of and replaced with new ones:
  - after 15 washes, and/or
  - if the reflective strips have become scratched, and/or
  - if the backing material and/or reflective strips have become soiled and cannot be cleaned off, and/or
  - if the fluorescence has faded e.g. due to the effects of sunlight
- Dispose of reflective safety jackets in an environmentally responsible manner. To do so, contact your local waste disposal company.



## Vehicle tool kit

### General notes

The vehicle tool kit can be found in the stowage well under the cargo compartment floor.

Apart from certain country-specific variations, the vehicles are not equipped with a tire-change tool kit. Some tools for changing a wheel are specific to the vehicle. For more information on which tools are required to perform a wheel change on your vehicle, consult a qualified specialist workshop.

Necessary tire-changing tools can include, for example:

- jack
- wheel chock
- lug wrench
- ratchet wrench
- alignment bolt

### Vehicles with a TIREFIT kit

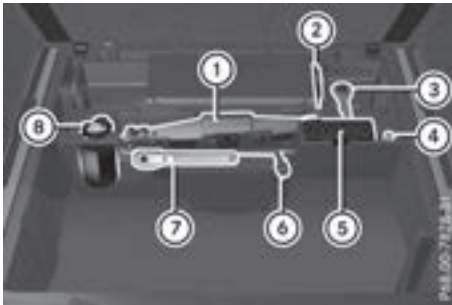

- ① Jack
  - ② Folding wheel chock
  - ③ Towing eye
  - ④ Alignment bolt
  - ⑤ Tire inflation compressor
  - ⑥ Lug wrench
  - ⑦ Ratchet wrench
  - ⑧ Tire sealant filler bottle
- ▶ Open the tailgate.
  - ▶ Lift the cargo compartment floor up (> page 303).
  - ▶ Use the TIREFIT kit (> page 337).

### Vehicles with a "Minispare" emergency spare wheel

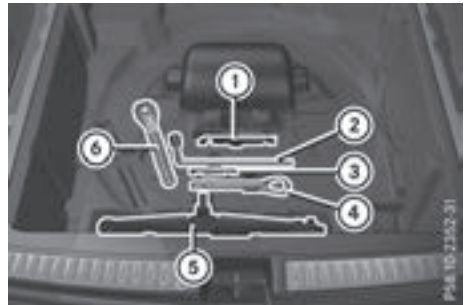

- ① Folding wheel chock
  - ② Lug wrench
  - ③ Alignment bolt
  - ④ Towing eye
  - ⑤ Jack
  - ⑥ Ratchet wrench
- ▶ Open the tailgate.
  - ▶ Lift the cargo compartment floor up (> page 303).
  - ▶ Remove the "Minispare" emergency spare wheel (> page 377).

## Flat tire

### Preparing the vehicle

Your vehicle may be equipped with:

- MOExtended tires (tires with run-flat properties)
- a TIREFIT kit (> page 335)
- an emergency spare wheel (only for certain countries)

Information on changing and mounting wheels (> page 371).

- ▶ Stop the vehicle on solid, non-slippery and level ground, as far away as possible from traffic.
- ▶ Switch on the hazard warning lamps.
- ▶ Secure the vehicle against rolling away (> page 156).
- ▶ If possible, bring the front wheels into the straight-ahead position.

- ▶ **Vehicles with the AIRMATIC package:** make sure that the normal vehicle level is selected (▷ page 185).
- ▶ **Vehicles with the Off-Road Engineering package:** make sure that the normal vehicle level is selected (▷ page 179).
- ▶ Switch off the engine.
- ▶ **Vehicles without KEYLESS-GO:** remove the SmartKey from the ignition lock.
- ▶ **Vehicles with KEYLESS-GO:** open the driver's door.  
The vehicle electronics are now in position **[O]**. This means no SmartKey is in the ignition lock.
- ▶ **Vehicles with KEYLESS-GO:** remove the Start/Stop button from the ignition lock (▷ page 135).
- ▶ Make sure that the engine cannot be started via your smartphone (▷ page 137).
- ▶ Make sure that the passengers are not endangered as they do so. Make sure that no one is near the danger area while a wheel is being changed. Anyone who is not directly assisting in the wheel change should, for example, stand behind the barrier.
- ▶ Get out of the vehicle. Pay attention to traffic conditions when doing so.
- ▶ Close the driver's door.
- ▶ Unload heavy luggage.

**i** Only operate the tire inflation compressor using a 12 V socket, even if the ignition is turned off (▷ page 308).

An emergency cut-out ensures that the on-board voltage does not drop too low. If the on-board voltage is too low, the power to the sockets is automatically cut. This ensures that there is sufficient power to start the engine.

### MOExtended tires (tires with run-flat properties)

#### General notes

With MOExtended tires (tires with run flat characteristics), you can continue to drive your vehicle even if there is a total loss of pressure in one or more tires. The affected tire must not show any clearly visible damage.

You can recognize a MOExtended tire by the MOExtended marking which appears on the

sidewall of the tire. You will find this marking next to the tire size designation, the load-bearing capacity and the speed index (▷ page 366). MOExtended tires may only be used in conjunction with an active tire pressure loss warning system or with an active tire pressure monitor.

#### If a pressure loss warning message appears in the multifunction display:

- observe the instructions in the display messages (▷ page 268).
- check the tire for damage
- if driving on, observe the following notes

The driving distance possible in run-flat mode is approximately 50 miles (80 km) when the vehicle is partially laden and approximately 18 miles (30 km) when the vehicle is fully laden.

In addition to the vehicle load, the driving distance possible depends upon:

- Vehicle speed
- Road condition
- Outside temperature

The driving distance possible in run-flat mode may be reduced by extreme driving conditions or maneuvers, or it can be increased through a moderate style of driving.

The driving distance possible in run-flat mode is counted from the moment the tire pressure loss warning appears in the multifunction display.

You must not exceed a maximum permissible speed of 50 mph (80 km/h).

**i** When replacing one or all tires, please observe the following specifications for your vehicle's tires:

- size
- type and
- the "MOExtended" mark

If a tire has gone flat and cannot be replaced with a MOExtended tire, a standard tire may be used as a temporary measure. Make sure that you use the proper size and type (summer or winter tire).

**i** Vehicles equipped with MOExtended tires are not equipped with a TIREFIT kit at the factory. It is therefore recommended that you additionally equip your vehicle with a TIREFIT kit if you mount tires that do not feature run-flat properties, e.g. winter tires. A TIREFIT kit may be obtained from a qualified specialist workshop.

## Important safety notes

### ⚠ WARNING

When driving in emergency mode, the driving characteristics deteriorate, e.g. when cornering, accelerating quickly and when braking. There is a risk of an accident.

Do not exceed the stated maximum speed. Avoid abrupt steering and driving maneuvers, and driving over obstacles (curbs, potholes, off-road). This applies in particular to a laden vehicle.

Stop driving in emergency mode if:

- you hear banging noises.
- the vehicle starts to shake.
- you see smoke and smell rubber.
- ESP® is intervening constantly.
- there are tears in the sidewalls of the tire.

After driving in emergency mode, have the wheel rims checked at a qualified specialist workshop with regard to their further use. The defective tire must be replaced in every case.

## TIREFIT kit

## Important safety notes

TIREFIT is a tire sealant.

You can use TIREFIT to seal punctures of up to 0.16 in (4 mm), particularly those in the tire tread. You can use TIREFIT at outside temperatures down to -4 °F (-20 °C).

### ⚠ WARNING

In the following situations, the tire sealant is unable to provide sufficient breakdown assistance, as it is unable to seal the tire properly:

- there are cuts or punctures in the tire larger than those mentioned above.
- the wheel rim is damaged.
- you have driven at very low tire pressures or on a flat tire.

There is a risk of an accident.

Do not drive the vehicle. Contact a qualified specialist workshop.

### ⚠ WARNING

The tire sealant is harmful and causes irritation. It must not come into contact with your skin, eyes or clothing or be swallowed. Do not inhale TIREFIT fumes. Keep tire sealant away from children. There is a risk of injury.

If you come into contact with the tire sealant, observe the following:

- Rinse off the tire sealant from your skin immediately with water.
- If the tire sealant comes into contact with your eyes, immediately rinse them thoroughly with clean water.
- If tire sealant is swallowed, immediately rinse your mouth out thoroughly and drink plenty of water. Do not induce vomiting, and seek medical attention immediately.
- Immediately change out of clothing which has come into contact with tire sealant.
- If an allergic reaction occurs, seek medical attention immediately.

❗ Do not operate the tire inflation compressor for longer than eight minutes at a time without a break. It may otherwise overheat.

The tire inflation compressor can be operated again once it has cooled down.

Comply with the manufacturer's safety instructions on the sticker on the tire inflation compressor.

## Using the TIREFIT kit

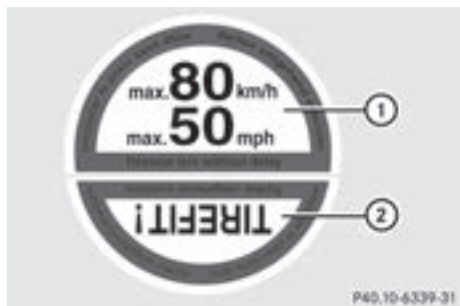

- ▶ Do not remove any foreign objects which have penetrated the tire, e.g. screws or nails.
- ▶ Remove the tire sealant bottle, the accompanying TIREFIT sticker and the tire inflation

compressor from the stowage well underneath the cargo compartment floor (▷ page 335).

- ▶ Affix part ① of the TIREFIT sticker to the instrument cluster within the driver's field of vision.
- ▶ Affix part ② of the TIREFIT sticker near the valve on the wheel with the defective tire.

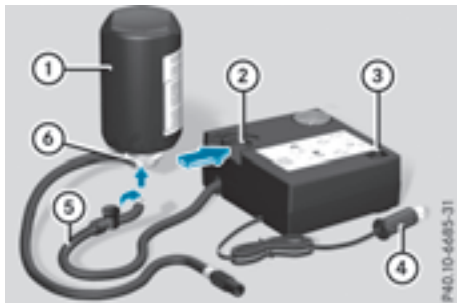

- ▶ Pull connector ④ with the cable and hose ⑤ out of the tire inflation compressor housing.
- ▶ Screw hose ⑤ onto flange ⑥ of tire sealant bottle ①.
- ▶ Place tire sealant bottle ① head down into recess ② of the tire inflation compressor.

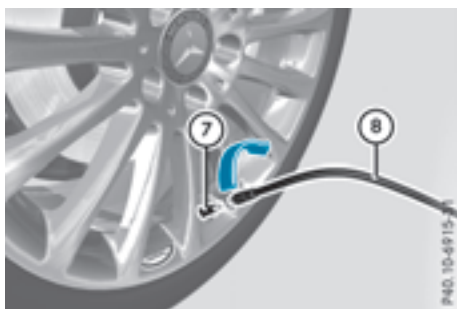

- ▶ Remove the cap from valve ⑦ on the faulty tire.
- ▶ Screw filler hose ⑧ onto valve ⑦.
- ▶ Insert connector ④ into a socket in your vehicle.  
Cigarette lighter socket: (▷ page 307)  
12 V sockets: (▷ page 308)  
Observe the notes on the cigarette lighter (▷ page 307). Observe the notes on sockets (▷ page 308).
- ▶ Turn the SmartKey to position ① in the ignition lock (▷ page 135).

- ▶ Press on and off switch ③ on the tire inflation compressor to I.  
The tire inflation compressor is switched on. The tire is inflated.

First, tire sealant is pumped into the tire. The pressure may briefly rise to approximately 500 kPa (5 bar/73 psi).

**Do not switch off the tire inflation compressor during this phase.**

- ▶ Let the tire inflation compressor run for a maximum of five minutes. The tire should then have attained a pressure of at least 180 kPa (1.8 bar/26 psi).

If a pressure of 180 kPa (1.8 bar/26 psi) has been attained after five minutes, see "Tire pressure reached" (▷ page 339).

If a tire pressure of 180 kPa (1.8 bar/26 psi) has not been attained after five minutes, see "Tire pressure not reached" (▷ page 338).

If tire sealant has escaped, clean it off affected areas as quickly as possible. It is preferable to use clean water.

If your clothes are soiled with tire sealant, have them cleaned with perchloroethylene at a dry cleaner as soon as possible.

### Tire pressure not reached

If a pressure of 180 kPa (1.8 bar/26 psi) has not been attained after five minutes:

- ▶ Switch off the tire inflation compressor.
- ▶ Unscrew the filler hose from the valve of the faulty tire.

Note that tire sealant may escape when you unscrew the filler hose.

- ▶ Very slowly drive forwards or reverse approximately 30 ft (10 m).
- ▶ Pump up the tire again.

After a maximum of five minutes the tire pressure must be at least 180 kPa (1.8 bar/26 psi).

### WARNING

If the required tire pressure is not reached after the specified time, the tire is too badly damaged. The tire sealant cannot repair the tire in this instance. Damaged tires and a tire pressure that is too low can significantly impair the vehicle's braking and driving characteristics. There is a risk of accident.

Do not continue driving. Contact a qualified specialist workshop.

## Tire pressure reached

### WARNING

A tire temporarily sealed with tire sealant impairs the driving characteristics and is not suitable for higher speeds. There is a risk of accident.

You should therefore adapt your driving style accordingly and drive carefully. Do not exceed the specified maximum speed with a tire that has been repaired using tire sealant.

The maximum permissible speed for a tire sealed with tire sealant is 50 mph (80 km/h). The upper part of the TIREFIT sticker must be affixed to the instrument cluster in the driver's field of vision.

 Residue from the tire sealant may come out of the filler hose after use. This could cause stains.

Therefore, place the filler hose in the plastic bag which contained the TIREFIT kit.

### Environmental note

Have the used tire sealant bottle disposed of professionally, e.g. at a qualified specialist workshop.

If a tire pressure of 180 kPa (1.8 bar/26 psi) has been attained after five minutes:

- ▶ Switch off the tire inflation compressor.
- ▶ Unscrew the filler hose from the valve of the faulty tire.
- ▶ Stow the tire sealant bottle and the tire inflation compressor.
- ▶ **Pull away immediately.**
- ▶ Stop after driving for approximately ten minutes and check the tire pressure with the tire inflation compressor. The tire pressure must now be at least 130 kPa (1.3 bar/19 psi).

### WARNING

If the required tire pressure is not reached after driving for a short period, the tire is too badly damaged. The tire sealant cannot repair



the tire in this instance. Damaged tires and a tire pressure that is too low can significantly impair the vehicle's braking and driving characteristics. There is a risk of accident.

Do not continue driving. Contact a qualified specialist workshop.

 In cases such as the one mentioned above, contact an authorized Mercedes-Benz Center. Or call 1-800-FOR-MERCEDES (in the USA) or 1-800-387-0100 (in Canada).

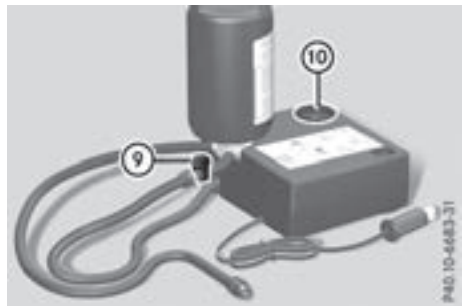
- ▶ Correct the tire pressure if it is still at least 130 kPa (1.3 bar/19 psi). See the Tire and Loading Information placard on the driver's side B-pillar or the tire pressure table in the fuel filler flap for values.
- ▶ **To increase the tire pressure:** switch on the tire inflation compressor.



- ▶ **To reduce the tire pressure:** press pressure release button  on the filler hose.
- ▶ The tire pressure is shown on pressure gauge .
- ▶ When the tire pressure is correct, unscrew the filler hose from the valve of the sealed tire.
- ▶ Screw the valve cap onto the tire valve of the sealed tire.
- ▶ Pull the tire sealant bottle out of the tire inflation compressor. The filler hose remains attached to the tire sealant bottle.
- ▶ Drive to the nearest qualified specialist workshop and have the tire changed there.
- ▶ Have the tire sealant bottle replaced as soon as possible at a qualified specialist workshop.
- ▶ Have the tire sealant bottle replaced every four years at a qualified specialist workshop.

## Battery (vehicle)

### 12 V battery - important safety notes

**Plug-in hybrid:** be sure to read the separate operating instructions. You could otherwise fail to recognize dangers, e.g. due to high voltage.

Special tools and expert knowledge are required when working on the battery, e.g. removal and installation. You should therefore have all work involving the battery carried out at a qualified specialist workshop.

#### WARNING

Work carried out incorrectly on the battery can lead, for example, to a short circuit and thus damage the vehicle electronics. This can lead to function restrictions applying to safety-relevant systems, e.g. the lighting system, the ABS (anti-lock braking system) or the ESP® (Electronic Stability Program). The operating safety of your vehicle may be restricted. You could lose control of the vehicle, for example:

- when braking
- in the event of abrupt steering maneuvers and/or when the vehicle's speed is not adapted to the road conditions

There is a risk of an accident.

In the event of a short circuit or a similar incident, contact a qualified specialist workshop immediately. Do not drive any further. You should have all work involving the battery carried out at a qualified specialist workshop.

For further information about ABS and ESP®, see (> page 66) and (> page 70).

#### WARNING

Electrostatic build-up can lead to the creation of sparks, which could ignite the highly explosive gases of a battery. There is a risk of an explosion.

Before handling the battery, touch the vehicle body to remove any existing electrostatic build-up.

The highly flammable gas mixture forms when charging the battery as well as when jump-starting.

Always make sure that neither you nor the battery is electrostatically charged. A build-up of electrostatic charge can be caused, for example:

- by wearing clothing made from synthetic fibers
- due to friction between clothing and seats
- if you push or pull the battery across the carpet or other synthetic materials
- if you wipe the battery with a cloth

#### WARNING

During the charging process, a battery produces hydrogen gas. If a short circuit occurs or sparks are created, the hydrogen gas can ignite. There is a risk of an explosion.

- Make sure that the positive terminal of a connected battery does not come into contact with vehicle parts.
- Never place metal objects or tools on a battery.
- It is important that you observe the described order of the battery terminals when connecting and disconnecting a battery.
- When jump-starting, make sure that the battery poles with identical polarity are connected.
- It is particularly important to observe the described order when connecting and disconnecting the jumper cables.
- Never connect or disconnect the battery terminals while the engine is running.

#### WARNING

Battery acid is caustic. There is a risk of injury. Avoid contact with skin, eyes or clothing. Do not inhale any battery gases. Do not lean over the battery. Keep children away from batteries. Wash away battery acid immediately with plenty of clean water and seek medical attention.



**Environmental note**



Batteries contain dangerous substances. It is against the law to dispose of them with the household rubbish. They must be collected separately and recycled to protect the environment.



Dispose of batteries in an environmentally friendly manner. Take discharged batteries to a qualified specialist workshop or a special collection point for used batteries.

**!** Have the battery regularly checked at a qualified specialist workshop.  
For more information, please contact a qualified specialist workshop.

**!** Always have work on batteries carried out at a qualified specialist workshop.  
Should it, in exceptional circumstances, be absolutely necessary to disconnect the 12-volt battery yourself, please observe the following:

- Secure the vehicle to prevent it from rolling away.
- Switch off the ignition.
- Disconnect the negative terminal first and then the positive terminal.

The transmission is locked in position **P** after disconnecting the battery.

After the work has been done, install the battery and replace the cover of the positive terminal clamp firmly.

Comply with safety precautions and take protective measures when handling batteries.



Risk of explosion.



Fire, open flames and smoking are prohibited when handling the battery. Avoid creating sparks.



Battery acid is caustic. Avoid contact with skin, eyes or clothing.

Wear suitable protective clothing, especially gloves, apron and face-guard.

Rinse any acid spills immediately with clear water. Contact a physician if necessary.



Wear eye protection.



Keep children away.



Observe this Operator's Manual.

For safety reasons, Mercedes-Benz recommends that you only use batteries which have been tested and approved for your vehicle by Mercedes-Benz. These batteries provide increased impact protection to prevent vehicle occupants from suffering acid burns should the battery be damaged in the event of an accident. In order for the battery to achieve the maximum possible service life, it must always be sufficiently charged.

Like other batteries, the vehicle battery may discharge over time if you do not use the vehicle. In this case, have the battery disconnected at a qualified specialist workshop. However, you can also charge the battery with a charger recommended by Mercedes-Benz. Contact a qualified specialist workshop for further information.

Have the battery condition of charge checked more frequently if you use the vehicle mainly for short trips or if you leave it standing idle for a lengthy period. Consult a qualified specialist workshop if you wish to leave your vehicle parked for a long period of time.

Remove the SmartKey if you park the vehicle and do not require any electrical consumers. The vehicle will then use very little energy, thus conserving battery power.

If the power supply has been interrupted, e.g. if you reconnect the battery, you will have to:

- set the clock; see the Digital Operator's Manual

On vehicles with a multimedia system and navigation system, the clock is set automatically.

- reset the function for folding the exterior mirrors in/out automatically, by folding the mirrors out once (▷ page 106)

### Charging the 12 V battery

#### WARNING

During charging and jump-starting, explosive gases can escape from the battery. There is a risk of an explosion.

Particularly avoid fire, open flames, creating sparks and smoking. Ensure there is sufficient ventilation while charging and jump-starting. Do not lean over a battery.



#### WARNING

Battery acid is caustic. There is a risk of injury. Avoid contact with skin, eyes or clothing. Do not inhale any battery gases. Do not lean over the battery. Keep children away from batteries. Wash away battery acid immediately with plenty of clean water and seek medical attention.

#### WARNING

A discharged battery can freeze at temperatures below freezing point. When jump-starting the vehicle or charging the battery, gases can escape from the battery. There is a risk of an explosion.

Allow the frozen battery to thaw out before charging it or jump-starting.

-  Only use battery chargers with a maximum charging voltage of 14.8 V.
-  Only charge the battery using the jump-starting connection point.

The jump-starting connection point is in the engine compartment (▷ page 342).

- ▶ Open the hood.
- ▶ Connect the battery charger to the positive terminal and ground point in the same order as when connecting the donor battery in the jump-starting procedure (▷ page 342).

Keep away from fire and open flames. Do not lean over a battery. Never charge the battery if it is still installed in the vehicle, unless you use a battery charger which has been tested and approved by Mercedes-Benz. A battery charger unit specially adapted for Mercedes-Benz vehicles and tested and approved by Mercedes-Benz is available as an accessory. It permits the charging of the battery in its installed position. Contact an authorized Mercedes-Benz Center for further information and availability. Read the battery charger's operating instructions before charging the battery.

If, at low temperatures, the indicator lamps/warning lamps in the instrument cluster do not light up, it is highly likely that the discharged battery has frozen. In this case you may neither jump-start the vehicle nor charge the battery. The service life of a thawed-out battery may be shorter. The starting characteristics can be impaired, particularly at low temperatures. Have the thawed-out battery checked at a qualified specialist workshop.

## Jump-starting

**Plug-in hybrid:** be sure to read the separate Operator's Manual. You could otherwise fail to recognize dangers, e.g. due to high voltage.

For the jump-starting procedure, use only the jump-starting connection point in the engine compartment, consisting of a positive terminal and a ground point.

#### WARNING

Battery acid is caustic. There is a risk of injury.

Avoid contact with skin, eyes or clothing. Do not inhale any battery gases. Do not lean over the battery. Keep children away from batteries. Wash away battery acid immediately with plenty of clean water and seek medical attention.



 **WARNING**

During charging and jump-starting, explosive gases can escape from the battery. There is a risk of an explosion.

Particularly avoid fire, open flames, creating sparks and smoking. Ensure there is sufficient ventilation while charging and jump-starting. Do not lean over a battery.

 **WARNING**

During the charging process, a battery produces hydrogen gas. If a short circuit occurs or sparks are created, the hydrogen gas can ignite. There is a risk of an explosion.

- Make sure that the positive terminal of a connected battery does not come into contact with vehicle parts.
- Never place metal objects or tools on a battery.
- It is important that you observe the described order of the battery terminals when connecting and disconnecting a battery.
- When jump-starting, make sure that the battery poles with identical polarity are connected.
- It is particularly important to observe the described order when connecting and disconnecting the jumper cables.
- Never connect or disconnect the battery terminals while the engine is running.

 **WARNING**

A discharged battery can freeze at temperatures below freezing point. When jump-starting the vehicle or charging the battery, gases can escape from the battery. There is a risk of an explosion.

Allow the frozen battery to thaw out before charging it or jump-starting.

**!** **Vehicles with a gasoline engine:** avoid repeated and lengthy starting attempts. Otherwise, the catalytic converter could be damaged by non-combusted fuel.

If the indicator/warning lamps do not light up at low temperatures, it is very likely that the discharged battery has frozen. In this case you may neither jump-start the vehicle nor charge the battery. The service life of a thawed-out battery may be shorter. The starting characteristics can be impaired, particularly at low temperatures. Have the thawed-out battery checked at a qualified specialist workshop.

Do not start the vehicle using a rapid charging device. If your vehicle's battery is discharged, the engine can be jump-started from another vehicle or from a donor battery using jumper cables. Observe the following points:

- The battery is not accessible in all vehicles. If the other vehicle's battery is not accessible, jump-start the vehicle using a donor battery or a jump-starting device.
- **Vehicles with a gasoline engine:** only jump-start the vehicle when the engine and exhaust system are cold.
- Do not start the engine if the battery is frozen. Let the battery thaw first.
- Only jump-start from batteries with a 12 V voltage rating.
- Only use jumper cables which have a sufficient cross-section and insulated terminal clamps.
- If the battery is fully discharged, leave the battery that is being used to jump-start connected for a few minutes before attempting to start. This charges the battery slightly.
- Make sure that the two vehicles do not touch.

Make sure that:

- The jumper cables are not damaged.
- Bare parts of the terminal clamp do not come into contact with other metal parts while the jumper cables are connected to the battery.
- The jumper cables cannot come into contact with parts which can move when the engine is running, such as the V-belt pulley or the fan.
- ▶ Secure the vehicle by applying the electric parking brake.
- ▶ Shift the transmission to position **P**.
- ▶ Make sure that the ignition is switched off. All indicator lamps in the instrument cluster must be off. When using the SmartKey, turn the SmartKey to position **0** in the ignition lock and remove it (▷ page 135).
- ▶ Switch off all electrical consumers, e.g. rear window defroster, lighting, etc.
- ▶ Open the hood.

**i Right-hand-drive vehicle:** the jump-starting connection points may be located on the other side of the vehicle.

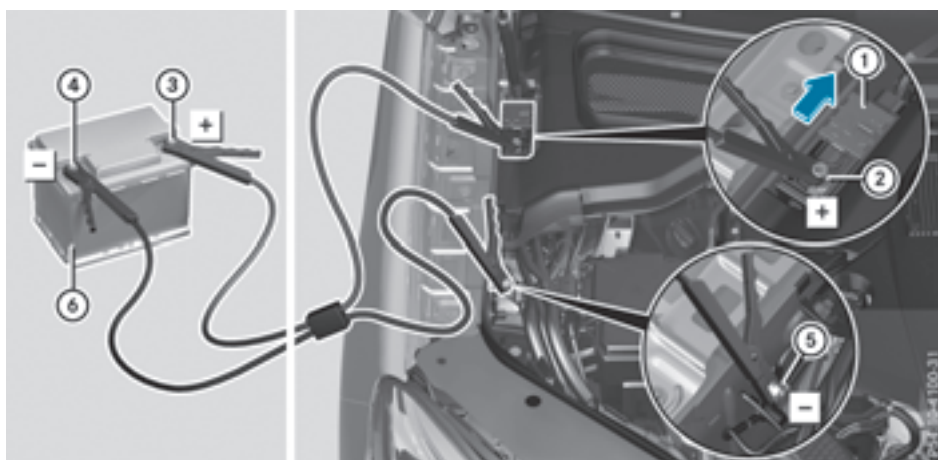

Position number ⑥ identifies the charged battery of the other vehicle or an equivalent jump-starting device.

- ▶ Slide cover ① of positive terminal ② in the direction of the arrow.
- ▶ Connect positive terminal ② on your vehicle to positive terminal ③ of donor battery ⑥ using the jumper cable, always begin with positive terminal ② on your own vehicle first.
- ▶ Start the engine of the donor vehicle and run it at idling speed.
- ▶ Connect negative terminal ④ of donor battery ⑥ to ground point ⑤ of your vehicle using the jumper cable, beginning with donor battery ⑥ first.
- ▶ Start the engine.
- ▶ Before disconnecting the jumper cables, let the engine run for several minutes.
- ▶ First, remove the jumper cables from ground point ⑤ and negative terminal ④, then from positive terminal ② and positive terminal ③. Begin each time at the contacts on your own vehicle first.
- ▶ Close cover ① of positive terminal ② after removing the jumper cables.
- ▶ Have the battery checked at a qualified specialist workshop.

Jump-starting is not considered to be a normal operating condition.

**i** Jumper cables and further information regarding jump-starting can be obtained at any qualified specialist workshop.

## Towing and tow-starting

### Important safety notes

**Plug-in hybrid:** be sure to read the separate Operator's Manual. You could otherwise fail to recognize dangers, e.g. due to high voltage.

#### WARNING

Functions relevant to safety are restricted or no longer available if:

- the engine is not running.
- the brake system or the power steering is malfunctioning.
- there is a malfunction in the voltage supply or the vehicle's electrical system.

If your vehicle is being towed, much more force may be necessary to steer or brake. There is a risk of an accident.

In such cases, use a tow bar. Before towing, make sure that the steering moves freely.

#### WARNING

When towing or tow-starting another vehicle and its weight is greater than the permissible gross weight of your vehicle, the:

- the towing eye could detach itself
- the vehicle/trailer combination could roll-over.

There is a risk of an accident.

When towing or tow-starting another vehicle, its weight should not be greater than the permissible gross weight of your vehicle.

Details on the permissible gross vehicle weight of your vehicle can be found on the vehicle identification plate (▷ page 382).

**!** When Active Brake Assist, Distance Pilot DISTRONIC or the HOLD function is activated, the vehicle brakes automatically in certain situations.

To avoid damage to the vehicle, deactivate these systems in the following or similar situations:

- when towing the vehicle
- in the car wash

**!** Make sure that the electric parking brake is released. If the electric parking brake is faulty, visit a qualified specialist workshop.

**!** Only secure the tow rope or tow bar at the towing eyes, or the trailer tow hitch, if available. You could otherwise damage the vehicle.

**!** Observe the following points when towing with a tow rope:

- Secure the tow rope on the same side on both vehicles.
- Make sure that the tow rope is not longer than legally permitted. Mark the tow rope in the middle, e.g. with a white cloth (11.8 x 11.8 in). This will make other road users aware that a vehicle is being towed.
- Only secure the tow cable to the towing eyes or, if available, to the trailer tow hitch.
- Observe the brake lamps of the towing vehicle while driving. Always maintain a distance a distance so that the tow rope does not sag.
- Do not use steel cables or chains to tow your vehicle. You could otherwise damage the vehicle.

**!** Do not use the trailer tow hitch for recovery or towing. Do not use the towing eye for recovery. this could damage the vehicle. If in doubt, have the vehicle recovered using a crane.

**!** When towing, pull away slowly and smoothly. Pull the towed vehicle as straight as possible and not at an acute angle. Excessive tractive power could damage the vehicles.

When towing, it is preferable to use a rigid towing bar as opposed to a tow rope. A rigid towing bar helps to keep the tractive power low.

**!** When towing away vehicles with KEYLESS-GO, use the key instead of the Start/Stop button. The automatic transmission may otherwise shift to position **P** when you open the

driver's or front-passenger door, which could damage the transmission.

**!** Do not tow with sling-type equipment. This could damage the vehicle.

**!** Vehicles with differential locks: make sure the differential locks are in automatic mode. When towing, the differential locks must not be switched on. The transmission may otherwise be damaged.

**!** The vehicle can be towed a maximum of 30 miles (50km). The towing speed of 30 mph (50 km/h) must not be exceeded.

If the vehicle has to be towed more than 30 miles (50km), the entire vehicle must be raised and transported.

It is better to have the vehicle transported than to have it towed away.

If the vehicle has suffered transmission damage, have it transported on a transporter or trailer.

The automatic transmission must be in position **N** when the vehicle is being towed.

The battery must be connected and charged. Otherwise, you:

- cannot turn the SmartKey to position **2** in the ignition lock
- cannot release the electric parking brake
- cannot shift the automatic transmission to position **N**

Disarm the automatic locking feature before the vehicle is towed (▷ page 239). You could otherwise be locked out when pushing or towing the vehicle.

If the vehicle is in a dangerous area, it can be towed out of that area with both axles on the ground. In this case, the towing distance must not be greater than 165 ft (50 m) and must not exceed a towing speed of 6 mph (10 km/h). For longer distances, have the vehicle loaded and transported.

## Installing/removing the towing eye

### Installing the towing eye

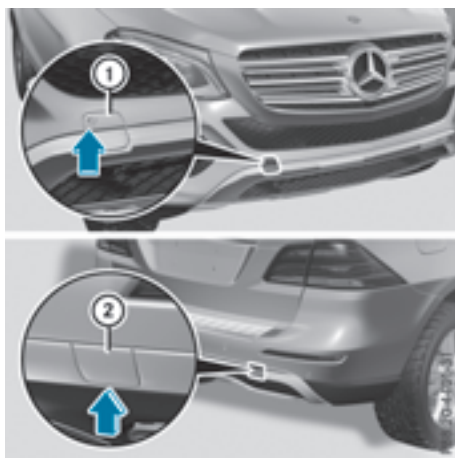

The brackets for the screw-in towing eye are located in the bumpers. They are at the front and rear behind covers ①②.

- ▶ Remove the towing eye from the vehicle tool kit (▷ page 335).
- ▶ **To open the cover at the front:** press the mark on cover ① inwards in the direction of the arrow.
- ▶ **To open the cover at the rear:** insert a flat, blunt object into the cutout and lever cover ② out of the bumper.
- ▶ Take cover ① or ② off the opening.
- ▶ Screw in the towing eye clockwise as far as it will go and tighten it.

### Removing the towing eye

- ▶ Unscrew and remove the towing eye.
- ▶ Position cover ① or ② in the bumper and press the cover on until it engages.
- ▶ Place the towing eye in the vehicle tool kit.

## Towing a vehicle with both axles on the ground

The automatic transmission shifts to position **P** automatically when you open the driver's or front-passenger door or when you remove the SmartKey from the ignition lock.

In order to ensure that the automatic transmission stays in position **N** when towing away the vehicle, you must observe the following points:

- ▶ Make sure that the vehicle is stationary.
- ▶ Turn the SmartKey to position **2** in the ignition lock.
- ▶ Depress and hold the brake pedal.
- ▶ Shift the automatic transmission to position **N**.
- ▶ Leave the SmartKey in position **2** in the ignition lock.
- ▶ Release the brake pedal.
- ▶ Release the electric parking brake.
- ▶ Switch on the hazard warning lamps (▷ page 112).

In order to signal a change of direction when towing the vehicle with the hazard warning lamps switched on, use the combination switch as usual. In this case, only the indicator lamps for the direction of travel flash. After resetting the combination switch, the hazard warning lamp starts flashing again.

### Transporting the vehicle

#### 4MATIC vehicles/vehicles with automatic transmission

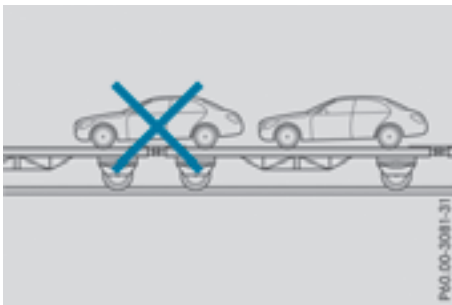

- ! When the vehicle is loaded for transport, the front and rear axles must be stationary and on the same transportation vehicle. Positioning over the connection point of the transport vehicle is not permitted. The drive train may otherwise be damaged.

### All vehicles

- ! You may only secure the vehicle by the wheels, not by parts of the vehicle such as axle or steering components. Otherwise, the vehicle could be damaged.

The towing eye can be used to pull the vehicle onto a trailer or transporter for transporting purposes.

- ▶ Turn the SmartKey to position **2** in the ignition lock.
- ▶ Shift the automatic transmission to position **N**.

#### As soon as the vehicle has been loaded:

- ▶ Prevent the vehicle from rolling away by applying the electric parking brake.
- ▶ Shift the automatic transmission to position **P**.
- ▶ Turn the SmartKey to position **0** in the ignition lock and remove it.
- ▶ Secure the vehicle.

### Securing the vehicle

- ! After loading, the vehicle must be secured at all four wheels. Otherwise, the vehicle could be damaged.

A minimum distance of 8 in (20 cm) up and 4 in (10 cm) down must be maintained to the transport platform.

- ▶ Secure all four wheels after loading the vehicle.

### Vehicles with ADS PLUS (Adaptive Damping System PLUS)

#### Important safety notes

##### **WARNING**

The weaker damping forces of the vehicle to be transported can cause the vehicle/trailer combination to swing.

As a result, when transporting vehicles with Adaptive Damping System PLUS, the vehicle/trailer combination may start to skid. Consequently, you could lose control of the vehicle.

There is a risk of accident and injury.

When transporting, make sure that:

- the vehicle is has been loaded onto the transporter correctly
- the vehicle is secured at all four wheels with suitable tensioning straps
- you do not exceed the maximum permissible speed of 35 mph (60 km/h)

### Securing the vehicle

**!** After loading, the vehicle must be secured at all four wheels. Otherwise, the vehicle could be damaged.

A minimum distance of 8 in (20 cm) up and 4 in (10 cm) down must be maintained to the transport platform.

- ▶ Secure all four wheels after loading the vehicle.

### Information on 4MATIC vehicles

**!** Vehicles with 4MATIC must not be towed with either the front or the rear axle raised, as doing so will damage the transmission.

Vehicles with 4MATIC may either be towed away with both axles on the ground or be loaded up and transported.

If the vehicle's transmission, front, or rear axle is damaged, have the vehicle transported on a truck or trailer.

**In the event of damage to the electrical system:** if the battery is defective, the automatic transmission will be locked in position **P**. To shift the automatic transmission to position **N**, you must provide power to the vehicle's electrical system in the same way as when jump-starting (▷ page 342).

Have the vehicle transported on a transporter or trailer.

### Tow-starting (emergency engine starting)

**!** Vehicles with automatic transmission must not be tow-started. You could otherwise damage the automatic transmission.

You can find information on "Jump-starting" under (▷ page 342).

## Fuses

### Important safety notes

#### WARNING

If you manipulate or bridge a faulty fuse or if you replace it with a fuse with a higher amperage, the electric cables could be overloaded. This could result in a fire. There is a risk of an accident and injury.

Always replace faulty fuses with the specified new fuses having the correct amperage.

**!** For the fuse boxes in the engine compartment and under the rear bench seat, only use fuses with the suffix "S". Otherwise, components or systems could be damaged.

**!** Make sure that no moisture can enter the fuse box when the cover is open.

**!** When closing the cover, make sure that it is lying correctly on the fuse box. Moisture seeping in or dirt could otherwise impair the operation of the fuses.

The fuses in your vehicle serve to close down faulty circuits. If a fuse blows, all the components on the circuit and their functions stop operating.

Blown fuses must be replaced with fuses of the same rating, which you can recognize by the color and value. The fuse ratings are listed in the fuse allocation chart.

The fuse allocation chart is located in the fuse box under the rear bench seat (▷ page 350).

If a newly inserted fuse also blows, have the cause traced and rectified at a qualified specialist workshop, e.g. an authorized Mercedes-Benz Center.

### Before changing a fuse

Observe the important safety notes (▷ page 348)

- ▶ Switch off the engine.
- ▶ Switch off all electrical consumers.

- ▶ Remove the SmartKey from the ignition lock. Or, on vehicles with KEYLESS-GO start function or KEYLESS-GO:
- ▶ Open the driver's door.  
The vehicle electronics are now in key position [0]. This is the same as the SmartKey having been removed.  
The driver's door can be closed again.
- ▶ Secure the vehicle against rolling away (> page 156).

All indicator lamps in the instrument cluster must be off.

The fuses are located in various fuse boxes:

- Fuse box on the front-passenger side of the dashboard
- Fuse box in the engine compartment on the right-hand side of the vehicle, when viewed in the direction of travel
- Fuse box under the rear bench seat

### Dashboard fuse box

**!** Do not use a pointed object such as a screwdriver to open the cover in the dashboard. You could damage the dashboard or the cover.

Mercedes-Benz recommends that you have this work performed at a qualified specialist workshop, e.g. at an authorized Mercedes-Benz Center.



- ▶ Open the front-passenger door.
- ▶ **To open:** pull cover ① outwards in the direction of the arrow and remove it.
- ▶ **To close:** clip in cover ① on the front of the dashboard.
- ▶ Fold cover ① inwards until it engages.

### Fuse box in the engine compartment

#### WARNING

When the hood is open and the windshield wipers are set in motion, you can be injured by the wiper linkage. There is a risk of injury. Always switch off the windshield wipers and the ignition before opening the hood.

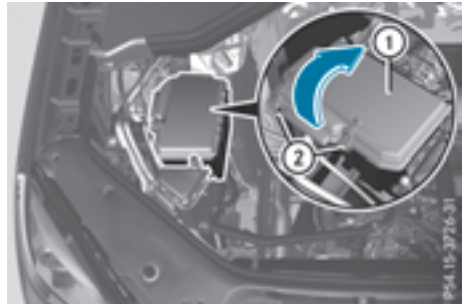

- ▶ Open the hood (> page 321).
- ▶ Use a dry cloth to remove any moisture from the fuse box.
- ▶ **To open:** open clamps ②.
- ▶ Fold up cover ① in the direction of the arrow and remove it.
- ▶ **To close:** check whether the seal is seated correctly in cover ①.
- ▶ Insert cover ① at the side of the fuse box into the retainers.
- ▶ Fold down cover ① and close clamps ②.
- ▶ Close the hood.

### Fuse box under the rear bench seat



- ▶ Fold the right-hand rear bench seat forward (▷ page 298).
- ▶ **To open:** lift and fold out carpet ① in the direction of the arrow.



- ▶ Release clamps ② by pressing them in the direction of the arrow.
- ▶ Fold cover ③ up in the direction of the arrow and remove it.

**i** The fuse allocation chart is located under cover ③.

- ▶ **To close:** insert cover ③ into the retainers on the side of the fuse box.
- ▶ Fold down cover ③ until clamps ② engage audibly.
- ▶ Fold the right-hand rear bench seat back (▷ page 298).



## Important safety notes

### WARNING

If wheels and tires of the wrong size are used, the wheel brakes or suspension components may be damaged. There is a risk of an accident.

Always replace wheels and tires with those that fulfill the specifications of the original part.

When replacing wheels, make sure to use the correct:

- designation
- model

When replacing tires, make sure to use the correct:

- designation
- manufacturer
- model

### WARNING

A flat tire severely impairs the driving, steering and braking characteristics of the vehicle. There is a risk of accident.

Tires without run-flat characteristics:

- do not drive with a flat tire.
- immediately replace the flat tire with your emergency spare wheel or spare wheel, or consult a qualified specialist workshop.

Tires with run-flat characteristics:

- pay attention to the information and warning notices on MOExtended tires (tires with run-flat characteristics).

Accessories that are not approved for your vehicle by Mercedes-Benz or are not being used correctly can impair the operating safety.

Before purchasing and using non-approved accessories, visit a qualified specialist workshop and inquire about:

- suitability
- legal stipulations
- factory recommendations

Further information regarding wheels and tires can be found under "Wheel/tire combinations" (> page 376).

You can ask for information regarding permitted wheel-tire combinations at an authorized Mercedes-Benz Center.

Tire pressure information can be found:

- on the Tire and Loading Information placard on the B-pillar on the driver's side
- in the tire pressure table in the fuel filler flap
- in the "Tire pressure" section

## Operation

### Information on driving

Check the tire pressure when the vehicle is heavily laden and adjust prior to a trip.

While driving, pay attention to vibrations, noises and unusual handling characteristics, e.g. pulling to one side. This may indicate that the wheels or tires are damaged. If you suspect that a tire is defective, reduce your speed immediately. Stop the vehicle as soon as possible to check the wheels and tires for damage. Hidden tire damage could also be causing the unusual handling characteristics. If you find no signs of damage, have the tires and wheels checked at a qualified specialist workshop.

When parking your vehicle, make sure that the tires do not get deformed by the curb or other obstacles. If it is necessary to drive over curbs, speed humps or similar elevations, try to do so slowly and at an obtuse angle. Otherwise, the tires, particularly the sidewalls, may be damaged.

### Regular checking of wheels and tires

#### WARNING

Damaged tires can cause tire inflation pressure loss. As a result, you could lose control of your vehicle. There is a risk of accident.

Check the tires regularly for signs of damage and replace any damaged tires immediately.

Check wheels and tires for damage at least once a month. Check wheels and tires after driving off-road or on rough roads. Damaged wheels can cause a loss of tire pressure.

Pay particular attention to damage such as:

- Cuts in the tires
- Punctures in the tires
- Tears in the tires
- Bulges on tires
- Deformation or severe corrosion on wheels

Regularly check the tire tread depth and the condition of the tread across the whole width of all tires (▷ page 352). If necessary, turn the front wheels to full lock in order to inspect the inner side of the tire surface.

All wheels must have a valve cap to protect the valve against dirt and moisture. Do not mount anything onto the valve other than the standard valve cap or other valve caps approved by Mercedes-Benz for your vehicle. Do not use any other valve caps or systems, e.g. tire pressure monitoring systems.

Regularly check the pressure of all the tires particularly prior to long trips. Adjust the tire pressure as necessary (▷ page 354).

Observe the notes on the emergency spare wheel (▷ page 376).

The service life of tires depends, among other things, on the following factors:

- Driving style
- Tire pressure
- Distance covered

### Notes on tire tread

#### WARNING

Insufficient tire tread will reduce tire traction. The tire is no longer able to dissipate water. This means that on wet road surfaces, the risk of hydroplaning increases, in particular where speed is not adapted to suit the driving conditions. There is a risk of accident.

If the tire pressure is too high or too low, tires may exhibit different levels of wear at different locations on the tire tread. Thus, you should regularly check the tread depth and the condition of the tread across the entire width of all tires.

Minimum tire tread depth for:

- Summer tires:  $\frac{1}{8}$  in (3 mm)
- M+S tires:  $\frac{1}{6}$  in (4 mm)

For safety reasons, replace the tires before the legally prescribed limit for the minimum tire tread depth is reached.

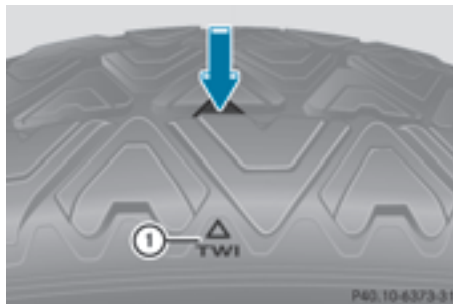

Marking ① shows where the bar indicator (arrow) for tread wear is integrated into the tire tread.

Treadwear indicators (TWI) are required by law. Six indicators are positioned on the tire tread. They are visible once a tread depth of approximately  $\frac{1}{16}$  in (1.6 mm) has been reached. If this is the case, the tire is so worn that it must be replaced.

### Selecting, mounting and replacing tires

- Only mount tires and wheels of the same type and make.  
Exception: it is permissible to mount a different type or make in the event of a flat tire. Observe here the "MOExtended tires (tires with run-flat characteristics)" section (▷ page 336).
- Only mount tires of the correct size onto the wheels.
- Break in new tires at moderate speeds for the first 60 miles (100 km). The new tires only reach their full performance after this distance.
- Do not drive with tires which have too little tread depth. This significantly reduces the traction on wet roads (hydroplaning).
- Replace the tires after six years at the latest, regardless of wear.

Observe the notes on the emergency spare wheel (▷ page 376).

## MOExtended tires (tires with run-flat properties)

With MOExtended tires (tires with run flat characteristics), you can continue to drive your vehicle even if there is a total loss of pressure in one or more tires.

MOExtended tires may only be used in conjunction with an active tire pressure loss warning system or with an active tire pressure monitor and on wheels specifically tested by Mercedes-Benz.

Notes on driving with MOExtended tires with a flat tire (▷ page 336).

- i** Vehicles equipped with MOExtended tires are not equipped with a TIREFIT kit at the factory. It is therefore recommended that you additionally equip your vehicle with a TIREFIT kit if you mount tires that do not feature run-flat properties, e.g. winter tires. A TIREFIT kit may be obtained from a qualified specialist workshop.

## Winter operation

### General notes

Have your vehicle winter-proofed at a qualified specialist workshop at the onset of winter.

Observe the notes in the "Changing a wheel" section (▷ page 371).

### Driving with summer tires

At temperatures below 45 °F (+7 °C), the elasticity of summer tires and therefore also the traction and braking capability are reduced considerably. Change the tires on your vehicle to M+S tires. Using summer tires at very cold temperatures could cause cracks to form, thereby damaging the tires permanently. Mercedes-Benz cannot accept responsibility for this type of damage.

#### WARNING

Damaged tires can cause tire inflation pressure loss. As a result, you could lose control of your vehicle. There is a risk of accident.

Check the tires regularly for signs of damage and replace any damaged tires immediately.

## M+S tires

#### WARNING

M+S tires with a tire tread depth of less than 1/8 in (4 mm) are not suitable for use in winter and do not provide sufficient traction. There is a risk of an accident.

M+S tires with a tread depth of less than 1/8 in (4 mm) must be replaced immediately.

At temperatures below 45 °F (+7 °C), use winter tires or all-season tires. Both types of tire are identified by the M+S marking.

Only winter tires bearing the  snowflake symbol in addition to the M+S marking provide the best possible grip in wintry road conditions. Only these tires will allow driving safety systems such as ABS and ESP® to function optimally in winter. These tires have been developed specifically for driving in snow.

Use M+S tires of the same make and tread on all wheels to maintain safe handling characteristics.

Always observe the maximum permissible speed specified for the M+S tires you have mounted.

Once the winter tires are mounted:

- ▶ Check the tire pressures (▷ page 357).
- ▶ Restart the tire pressure monitor (▷ page 358).
- ▶ **Vehicles for Canada:** restart the tire pressure loss warning system (▷ page 358).

Information about driving with an emergency spare wheel (▷ page 376).

## Snow chains

#### WARNING

If snow chains are installed to the front wheels, they may drag against the vehicle body or chassis components. This could cause damage to the vehicle or the tires. There is a risk of an accident.

To avoid hazardous situations:

- never install snow chains to the front wheels
- always install snow chains in pairs to the rear wheels.

**!** Check the snow chains for damage before mounting them. Damaged or worn snow chains may snap and damage the following components:

- wheel
- wheel housing
- wheel suspension

For this reason, you must use only snow chains that are free of defects. Observe the manufacturer's mounting instructions.

**!** You must drive at raised vehicle level (height 1) if snow chains have been installed. The vehicle may otherwise be damaged.

**!** **Vehicles with ADS (Adaptive Damping System):** do not use the sport mode when driving with snow chains mounted. The vehicle may otherwise be damaged.

For safety reasons, Mercedes-Benz recommends that you only use snow chains that have been specially approved for your vehicle by Mercedes-Benz, or are of a corresponding standard of quality. For more information, please contact a qualified specialist workshop.

Install the snow chains on all driven wheels for maximum tractive power and driving stability. If you own snow chains for two driven wheels only, install the snow chains to the wheels on the rear axle. The vehicle then remains more stable under braking.

If you intend to mount snow chains, please bear the following points in mind:

- Snow chains may not be mounted on all wheel/tire combinations. Permissible wheel/tire combinations (▷ page 376).
- Only use snow chains when driving on roads completely covered by snow. Remove the snow chains as soon as possible when you come to a road that is not snow-covered.
- Local regulations may restrict the use of snow chains. Observe the appropriate regulations if you wish to mount snow chains.

- Do not exceed the maximum permissible speed of 30 mph (50 km/h).
- Never use Parking Pilot when snow chains are installed (▷ page 190).

You may wish to deactivate ESP® (▷ page 71) when pulling away with snow chains mounted. You can thereby allow the wheels to spin in a controlled manner, achieving an increased driving force (cutting action).

Information about driving with an emergency spare wheel (▷ page 376).

## Tire pressure

### Tire pressure specifications

#### Important safety notes

##### WARNING

Underinflated or overinflated tires pose the following risks:

- the tires may burst, especially as the load and vehicle speed increase.
- the tires may wear excessively and/or unevenly, which may greatly impair tire traction.
- the driving characteristics, as well as steering and braking, may be greatly impaired.

There is a risk of an accident.

Follow recommended tire inflation pressures and check the pressure of all the tires including the spare wheel:

- monthly, at least
- if the load changes
- before beginning a long journey
- under different operating conditions, e.g. off-road driving

If necessary, correct the tire pressure.

Details on tire pressure can be found at the following positions in the vehicle:

- Tire and Loading Information placard on the B-pillar on the driver's side
- table for tire pressure on the inside of the fuel filler flap

The tire pressure monitor does not warn you of:

- incorrectly set tire pressure
- sudden loss of tire pressure, e.g. from a foreign object that has penetrated the tire

The data on the Tire and Loading Information placard and tire pressure table shown here are examples. Tire pressure specifications are vehicle-specific and may deviate from the data shown here. The tire pressure specifications that are valid for your vehicle can be found on the Tire and Loading Information placard and tire pressure table on the vehicle.

### General notes

The recommended tire pressures for the tires mounted at the factory can be found on the labels described here.

**Operation with emergency spare wheel:** information on operation with the emergency spare wheel can be found under "Emergency spare wheel" (▷ page 377).

**Operation with a trailer:** the applicable value for the rear axle is the maximum tire pressure value stated in the table inside the fuel filler flap. Further information on tire pressures can be obtained at a qualified specialist workshop.

### Tire and Loading Information placard



#### ① Recommended tire pressures

The Tire and Loading Information placard is on the B-pillar on the driver's side (▷ page 361).

The Tire and Loading Information placard contains the recommended tire pressures for cold tires. The recommended tire pressures are valid for the maximum permissible load and up to the maximum permissible vehicle speed.

### Tire pressure table

The tire pressure table is on the inside of the fuel filler flap. It shows the tire pressure for all tires permitted at the factory for this vehicle; see illustration (example).



The tire pressure table contains the recommended pressures for cold tires for various operating conditions, i.e. differing load and speed conditions.

If a tire size precedes a tire pressure, the following tire pressure information is only valid for that tire size; see illustration (example).

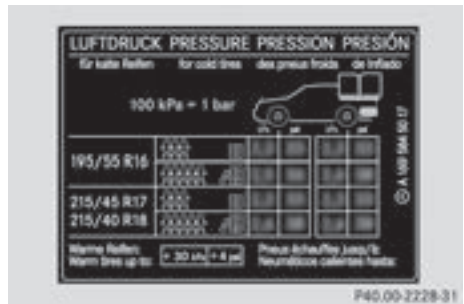

The load conditions "partially laden" and "fully laden" are defined in the table for different numbers of occupants and amounts of luggage. The actual number of seats may differ.

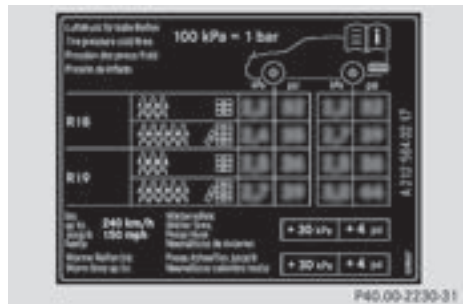

Some tire pressure tables show only the rim diameters instead of the full tire size, e.g. **R18**. The rim diameter is part of the tire size and can be found on the tire sidewall (▷ page 366).

If the tire pressures have been set to the lower values for lighter loads and/or lower road speeds, the pressures should be reset to the higher values:

- if you want to drive with an increased load and/or
- if you want to drive at higher road speeds

The tire pressures for increased loads and/or higher road speeds, shown in the tire pressure table, may have a negative effect on driving comfort.

If the tire pressure is not set correctly, this can lead to an excessive build up of heat and a sudden loss of pressure.

For more information, contact a qualified specialist workshop.

### Important notes on tire pressure

#### WARNING

If the tire pressure drops repeatedly, the wheel, valve or tire may be damaged. Tire pressure that is too low may result in a tire blow-out. There is a risk of an accident.

- Check the tire for foreign objects.
- Check whether the wheel is losing air or the valve is leaking.

If you are unable to rectify the damage, contact a qualified specialist workshop.

#### WARNING

If you fit unsuitable accessories onto tire valves, the tire valves may be overloaded and malfunction, which can cause tire pressure loss. Due to their design, retrofitted tire pressure monitors keep the tire valve open. This can also result in tire pressure loss. There is a risk of an accident.

Only screw the standard valve cap or other valve caps approved by Mercedes-Benz for your vehicle onto the tire valve.

Use a suitable pressure gauge to check the tire pressure. The outer appearance of a tire does

not permit any reliable conclusion about the tire pressure. On vehicles equipped with the electronic tire pressure monitor, the tire pressure can be checked in the on-board computer.

The tire temperature and pressure increase when the vehicle is in motion. This is dependent on the driving speed and the load.

Therefore, you should only correct tire pressures when the tires are cold.

The tires are cold:

- if the vehicle has been parked with the tires out of direct sunlight for at least three hours and
- if the vehicle has not been driven further than 1 mile (1.6 km)

The tire temperature changes depending on the outside temperature, the vehicle speed and the tire load. If the tire temperature changes by 18 °F (10 °C), the tire pressure changes by approximately 10 kPa (0.1 bar/1.5 psi). Take this into account when checking the pressure of warm tires. Only correct the tire pressure if it is too low for the current operating conditions. If you check the tire pressure when the tires are warm, the resulting value will be higher than if the tires were cold. This is normal. Do not reduce the tire pressure to the value specified for cold tires. The tire pressure would otherwise be too low.

Observe the recommended tire pressures for cold tires:

- on the Tire and Loading Information placard on the B-pillar on the driver's side
- in the tire pressure table in the fuel filler flap (▷ page 152)
- printed in yellow on the rim of the emergency/collapsible spare wheel (depending on vehicle equipment)

### Underinflated or overinflated tires

#### Underinflated tires

#### WARNING

Tires with pressure that is too low can overheat and burst as a consequence. In addition, they also suffer from excessive and/or irregular wear, which can severely impair the braking properties and the driving characteristics. There is a risk of an accident.

Avoid tire pressures that are too low in all the tires, including the spare wheel.

Underinflated tires may:

- overheat, leading to tire defects
- adversely affect handling
- wear excessively and/or unevenly
- have an adverse effect on fuel consumption

## Overinflated tires

### WARNING

Tires with excessively high pressure can burst because they are damaged more easily by road debris, potholes etc. In addition, they also suffer from irregular wear, which can severely impair the braking properties and the driving characteristics. There is a risk of an accident.

Avoid tire pressures that are too high in all the tires, including the spare wheel.

Overinflated tires may:

- increase the braking distance
- adversely affect handling
- wear excessively and/or unevenly
- have an adverse effect on ride comfort
- be more susceptible to damage

## Maximum tire pressures

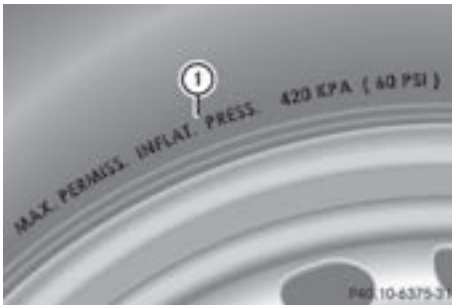

① Example: maximum permissible tire pressure

Never exceed the maximum permissible tire inflation pressure. Always observe the recommended tire pressure for your vehicle when adjusting the tire pressure (▷ page 354).

 The actual values for tires are vehicle-specific and may deviate from the values in the illustration.

## Checking the tire pressures

### Important safety notes

Observe the notes on tire pressure (▷ page 354).

Information on air pressure for the tires on your vehicle can be found:

- on the Tire and Loading Information placard on the B-pillar on the driver's side
- in the tire pressure table in the fuel filler flap
- in the "Tire pressure" section

### Checking tire pressures manually

To determine and set the correct tire pressure, proceed as follows:

- ▶ Remove the valve cap of the tire that is to be checked.
- ▶ Press the tire pressure gage securely onto the valve.
- ▶ Read the tire pressure and compare it to the recommended value on the Tire and Loading Information placard or the tire pressure table (▷ page 354).
- ▶ If the tire pressure is too low, increase the tire pressure to the recommended value.
- ▶ If the tire pressure is too high, release air. To do so, press down the metal pin in the valve, using the tip of a pen for example. Then check the tire pressure again using the tire pressure checker.
- ▶ Screw the valve cap onto the valve.
- ▶ Repeat these steps for the other tires.

## Tire pressure loss warning system

### General notes

While the vehicle is in motion, the tire pressure loss warning system monitors the set tire pressure using the rotational speed of the wheels. This enables the system to detect significant pressure loss in a tire. If the speed of rotation of a wheel changes as a result of a loss of pressure,

a corresponding warning message will appear in the multifunction display.

You can recognize the tire pressure loss warning by the **Run Flat Indicator Active Press 'OK' to Restart** message which appears in the **Service** menu of the multifunction display. Information on the message display can be found in the "Restarting the tire pressure loss warning system" section (▷ page 358).

### Important safety notes

The tire pressure warning system does not warn you of an incorrectly set tire pressure. Observe the notes on the recommended tire pressure (▷ page 354).

The tire pressure loss warning does not replace the need to regularly check the tire pressure. An even loss of pressure on several tires at the same time cannot be detected by the tire pressure loss warning system.

The tire pressure monitor is not able to warn you of a sudden loss of pressure, e.g. if the tire is penetrated by a foreign object. In the event of a sudden loss of pressure, bring the vehicle to a halt by braking carefully. Avoid abrupt steering movements.

The function of the tire pressure loss warning system is limited or delayed if:







- snow chains are mounted on your vehicle's tires.
- road conditions are wintry.
- you are driving on sand or gravel.
- you adopt a very sporty driving style (cornering at high speeds or driving with high rates of acceleration).
- you are driving with a heavy load (in the vehicle or on the roof).

### Restarting the tire pressure loss warning system





Restart the tire pressure loss warning system if you have:

- changed the tire pressure
- changed the wheels or tires
- mounted new wheels or tires
- ▶ Before restarting, make sure that the tire pressures are set properly on all four tires for the respective operating conditions.  
The recommended tire pressure can be found on the Tire and Loading Information placard





on the B-pillar. Additionally, a tire pressure table is attached to the fuel filler flap. The tire pressure loss warning system can only give reliable warnings if you have set the correct tire pressure. If an incorrect tire pressure is set, these incorrect values will be monitored.

- ▶ Also observe the notes in the section on tire pressures (▷ page 354).
- ▶ Make sure that the SmartKey is in position  in the ignition lock (▷ page 135).
- ▶ Press the  or  button on the steering wheel to select the **Service** menu.
- ▶ Press the  or  button to select **Tire Pressure**.
- ▶ Press the  button.  
The **Run Flat Indicator Active Press 'OK' to Restart** message appears in the multifunction display.

#### If you wish to confirm the restart:

- ▶ Press the  button.  
The **Tire Pressure Now OK?** message appears in the multifunction display.
- ▶ Press the  or  button to select **Yes**.
- ▶ Press the  button.  
The **Run Flat Indicator Restarted** message appears in the multifunction display.  
After a teach-in period, the tire pressure loss warning system will monitor the set tire pressures of all four tires.

#### If you wish to cancel the restart:

- ▶ Press the  button.
- or
- ▶ When the **Tire Pressure Now OK?** message appears, press the  or  button to select **Cancel**.
- ▶ Press the  button.  
The tire pressure values stored at the last restart will continue to be monitored.

### Tire pressure monitor

#### General notes

If a tire pressure monitor is installed, the vehicle's wheels have sensors that monitor the tire pressures in all four tires. The tire pressure monitor warns you if the pressure drops in one or more of the tires. The tire pressure monitor only functions if the corresponding sensors are installed in all wheels.



Information on tire pressures is displayed in the multifunction display. After a few minutes of driving, the current tire pressure of each tire is shown in the **Serv.** menu of the multifunction display, see illustration (example).



For information on the message display, refer to the "Checking the tire pressure electronically" section (▷ page 360).

### Important safety notes

#### WARNING

Each tire, including the spare (if provided), should be checked at least once a month when cold and inflated to the pressure recommended by the vehicle manufacturer on the Tire and Loading Information placard on the driver's door B-pillar or the tire pressure label on the inside of the fuel filler flap. If your vehicle has tires of a different size than the size indicated on the Tire and Loading Information placard or the tire pressure label, you should determine the proper tire pressure for those tires.

As an added safety feature, your vehicle has been equipped with a tire pressure monitoring system (TPMS) that illuminates a low tire pressure telltale when one or more of your tires are significantly underinflated. Accordingly, when the low tire pressure telltale illuminates, you should stop and check your tires as soon as possible, and inflate them to the proper pressure. Driving on a significantly underinflated tire causes the tire to overheat and can lead to tire failure. Underinflation also reduces fuel efficiency and tire tread life, and may affect the vehicle's handling and stopping ability.

Please note that the TPMS is not a substitute for proper tire maintenance, and it is the driver's responsibility to maintain correct tire

pressure, even if underinflation has not reached the level to trigger illumination of the TPMS low tire pressure telltale.

USA only:

Your vehicle has also been equipped with a TPMS malfunction indicator to indicate if the system is not operating properly. The TPMS malfunction indicator is combined with the low tire pressure telltale. When the system detects a malfunction, the warning lamp will flash for approximately a minute and then remain continuously illuminated. This sequence will be repeated every time the vehicle is started as long as the malfunction exists.

When the malfunction indicator is illuminated, the system may not be able to detect or signal low tire pressure as intended. TPMS malfunctions may occur for a variety of reasons, including the mounting of incompatible replacement or alternate tires or wheels on the vehicle that prevent the TPMS from functioning properly. Always check the TPMS malfunction telltale after replacing one or more tires or wheels on your vehicle to ensure that the replacement or alternate tires and wheels allow the TPMS to continue to function properly.

It is the driver's responsibility to set the tire pressure to that recommended for cold tires which is suitable for the operating situation (▷ page 354). Note that the correct tire pressure for the current operating situation must first be taught-in to the tire pressure monitor. If a substantial loss of pressure occurs, the warning threshold for the warning message is aligned to the taught-in reference values. Restart the tire pressure monitor after adjusting the pressure of the cold tires (▷ page 361). The current pressures are saved as new reference values. As a result, a warning message will appear if the tire pressure drops significantly.

The tire pressure monitor does not warn you of an incorrectly set tire pressure. Observe the notes on the recommended tire pressure (▷ page 354).

The tire pressure monitor is not able to warn you of a sudden loss of pressure, e.g. if the tire is penetrated by a foreign object. In the event of a

sudden loss of pressure, bring the vehicle to a halt by braking carefully. Avoid abrupt steering movements.

The tire pressure monitor has a yellow warning lamp in the instrument cluster for indicating pressure loss or a malfunction. Whether the warning lamp flashes or lights up indicates whether a tire pressure is too low or the tire pressure monitor is malfunctioning:

- if the warning lamp is lit continuously, the tire pressure on one or more tires is significantly too low. The tire pressure monitor is not malfunctioning.
- if the warning lamp flashes for approximately a minute and then remains lit constantly, the tire pressure monitor is malfunctioning.



In addition to the warning lamp, a message appears in the multifunction display. Observe the information on display messages (▷ page 268).

It may take up to ten minutes for a malfunction of the tire pressure monitor to be indicated. A malfunction will be indicated by the tire pressure warning lamp flashing for approximately one minute and then remaining lit. When the malfunction has been rectified, the tire pressure warning lamp goes out after a few minutes of driving.

The tire pressure values indicated by the on-board computer may differ from those measured at a gas station with a pressure gage. The tire pressures shown by the on-board computer refer to those measured at sea level. At high altitudes, the tire pressure values indicated by a pressure gage are higher than those shown by the on-board computer. In this case, do not reduce the tire pressures.

The operation of the tire pressure monitor can be affected by interference from radio transmitting equipment (e.g. radio headphones, two-way radios) that may be being operated in or near the vehicle.

### Checking the tire pressure electronically

- ▶ Make sure that the SmartKey is in position  (▷ page 135) in the ignition lock.
- ▶ Press the  or  button on the steering wheel to select the **Serv.** menu.

- ▶ Press the  or  button to select **Tire Pressure**.

- ▶ Press .

The current tire pressure of each tire is shown in the multifunction display.

If the vehicle has been parked for longer than 20 minutes, the **Tire pressure will be displayed after driving a few minutes** message appears.

After a teach-in process, the tire pressure monitor automatically detects new wheels or new sensors. As long as a clear allocation of the tire pressure value to the individual wheels is not possible, the **Tire Pressure Monitor Active** display message is shown instead of the tire pressure display. The tire pressures are already being monitored.

If an emergency spare wheel is mounted, the system may continue to show the tire pressure of the wheel that has been removed for a few minutes. If this occurs, note that the value displayed for the position where the spare wheel is mounted is not the same as the current tire pressure of the emergency spare wheel.

### Tire pressure monitor warning messages

If the tire pressure monitor detects a pressure loss in one or more tires, a warning message is shown in the multifunction display. The yellow tire pressure warning lamp then lights up.

- If the **Please Correct Tire Pressure** message appears in the multifunction display, the tire pressure in at least one tire is too low. The tire pressure must be corrected when the opportunity arises.
- If the **Check Tires** message appears in the multifunction display, the tire pressure in at least one tire has dropped significantly. The tires must be checked.
- If the **Warning Tire Malfunction** message appears in the multifunction display, the tire pressure in at least one tire has dropped suddenly. The tires must be checked.

Be sure to observe the instructions and safety notes in the display messages in the "Tires" section (▷ page 268).







If the wheel positions on the vehicle are rotated, the tire pressures may be displayed for the wrong positions for a short time. This is rectified after a few minutes of driving, and the tire pressures are displayed for the correct positions.

## Restarting the tire pressure monitor

When you restart the tire pressure monitor, all existing warning messages are deleted and the warning lamps go out. The monitor uses the currently set tire pressures as the reference values for monitoring. In most cases, the tire pressure monitor will automatically detect the new reference values after you have changed the tire pressure. However, you can also set reference values manually as described here. The tire pressure monitor then monitors the new tire pressure values.

- ▶ Set the tire pressure to the value recommended for the corresponding driving situation on the Tire and Loading Information placard on the driver's side B-pillar (▷ page 354).

You can find more tire pressure values for various operating conditions in the tire pressure table inside the fuel filler flap (▷ page 355).

- ▶ Make sure that the tire pressure is correct on all four wheels.
- ▶ Make sure that the SmartKey is in position  in the Ignition lock.
- ▶ Press the  or  button on the steering wheel to select the **Serv.** menu.
- ▶ Press the  or  button to select **Tire Pressure**.
- ▶ Press .
 

The multifunction display shows the current tire pressure for the individual tires or the **Tire pressure will be displayed after driving a few minutes** message.
- ▶ Press the  button.
 

The **Use Current Pressures as New Reference Values** message appears in the multifunction display.

### If you wish to confirm the restart:

- ▶ Press the  button.
 

The **Tire Press. Monitor Restarted** message appears in the multifunction display.

After driving for a few minutes, the system checks whether the current tire pressures are within the specified range. The new tire pressures are then accepted as reference values and monitored.

### If you wish to cancel the restart:

- ▶ Press the  button.
 

The tire pressure values stored at the last restart will continue to be monitored.

## Radio type approval for the tire pressure monitor

Country	Radio type approval number
USA	FCC ID: MRXMW2433A FCC ID: MRXGG4 FCC ID: MRXMC34MA4
Canada	IC: 2546A-MW2433A IC: 2546A-GG4 IC: 2546A-MC34MA4

## Loading the vehicle

### Instruction labels for tires and loads

#### WARNING

Overloaded tires can overheat, causing a blowout. Overloaded tires can also impair the steering and driving characteristics and lead to brake failure. There is a risk of accident.

Observe the load rating of the tires. The load rating must be at least half of the GAWR of your vehicle. Never overload the tires by exceeding the maximum load.

Two instruction labels on your vehicle show the maximum possible load.

- (1) The Tire and Loading Information placard is on the B-pillar on the driver's side. The Tire and Loading Information placard shows the maximum permissible number of occupants and the maximum permissible vehicle load. It also contains details of the tire sizes and corresponding pressures for tires mounted at the factory.
- (2) The vehicle identification plate is on the B-pillar on the driver's side. The vehicle identification plate informs you of the gross vehicle weight rating. It is made up of the vehicle weight, all vehicle occupants, the fuel and the cargo. You can also find information about the maximum gross axle weight rating on the front and rear axle.
 

The maximum gross axle weight rating is the maximum weight that can be carried by one axle (front or rear axle). Never exceed the maximum load or the maximum gross axle weight rating for the front or rear axle.



① B-pillar, driver's side

### Maximum permissible gross vehicle weight rating

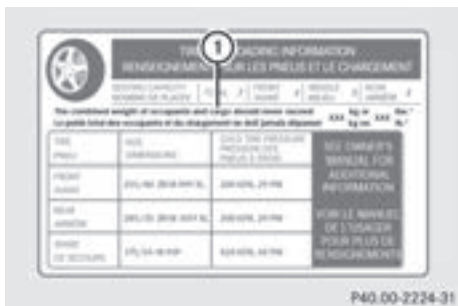

- Specification for maximum gross vehicle weight (①) is listed in the Tire and Loading Information placard: "The combined weight of occupants and cargo should never exceed XXX kilograms or XXX lbs."

The gross weight of all vehicle occupants, load and luggage must not exceed the specified value.

- ① The specifications shown on the Tire and Loading Information placard in the illustration are examples. The maximum permissible gross vehicle weight rating is vehicle-specific and may differ from that in the illustration. You can find the valid maximum permissible gross vehicle weight rating for your vehicle on the Tire and Loading Information placard.

### Number of seats

TIRE AND LOADING INFORMATION RENSEIGNEMENTS SUR LES PNEUS ET LE CHARGEMENT			
The combined weight of occupants and cargo should never exceed XXX kg or XXX lbs. (The combined weight of occupants and cargo should never exceed XXX kg or XXX lbs.)			
SEAT	MAX. OCCUPANTS	LOADS AND PASSENGERS PERMITTED BY SEAT	SEE OWNER'S MANUAL FOR ADDITIONAL INFORMATION
FRONT PASSENGER	1 (150 kg / 330 lbs)	1 (150 kg / 330 lbs)	
FRONT DRIVER	1 (150 kg / 330 lbs)	1 (150 kg / 330 lbs)	
REAR PASSENGER	3 (450 kg / 990 lbs)	3 (450 kg / 990 lbs)	
REAR DRIVER	3 (450 kg / 990 lbs)	3 (450 kg / 990 lbs)	

P40-00-2225-31

Maximum number of seats (①) indicates the maximum number of occupants allowed to travel in the vehicle. This information can be found on the Tire and Loading Information placard.

- ① The specifications shown on the Tire and Loading Information placard in the illustration are examples. The number of seats is vehicle-specific and can differ from the details shown. The number of seats in your vehicle can be found on the Tire and Loading Information placard.

### Determining the correct load limit

#### Step-by-step instructions

The following steps have been developed as required of all manufacturers under Title 49, Code of U.S. Federal Regulations, Part 575 pursuant to the "National Traffic and Motor Vehicle Safety Act of 1966".

- **Step 1:** Locate the statement "The combined weight of occupants and cargo should never exceed XXX kg or XXX lbs." on your vehicle's Tire and Loading Information placard.
- **Step 2:** Determine the combined weight of the driver and passengers that will be riding in your vehicle.
- **Step 3:** Subtract the combined weight of the driver and passengers from XXX kilograms or XXX lbs.
- **Step 4:** The resulting figure equals the available amount of cargo and luggage load capacity. For example, if the "XXX" amount equals 1400 lbs and there will be five 150-lb passengers in your vehicle, the amount of avail-

able cargo and luggage load capacity is 650 lbs (1400 - 750 (5 x 150) = 650 lbs).

- **Step 5:** Determine the combined weight of luggage and cargo being loaded on the vehi-

cle. That weight may not safely exceed the available cargo and luggage load capacity calculated in step 4.

### Example: steps 1 to 3

The following table shows examples on how to calculate total and cargo load capacities with varying seating configurations and number and size of occupants. The following examples use a load limit of 1500 lbs (680 kg). **This is for illustration purposes only.** Make sure you are using the actual load limit for your vehicle stated on your vehicle's Tire and Loading Information placard (▷ page 361).

The greater the combined weight of the occupants, the lower the maximum luggage load.

Additional information when towing a trailer (▷ page 220).

#### Step 1

	Example 1	Example 2	Example 3
<b>Combined maximum weight of occupants and cargo (data from the Tire and Loading Information placard)</b>	1500 lbs (680 kg)	1500 lbs (680 kg)	1500 lbs (680 kg)

#### Step 2

	Example 1	Example 2	Example 3
<b>Number of people in the vehicle (driver and occupants)</b>	5	3	1
<b>Distribution of the occupants</b>	Front: 2 Rear: 3	Front: 1 Rear: 2	Front: 1
<b>Weight of the occupants</b>	Occupant 1: 150 lbs (68 kg) Occupant 2: 180 lbs (82 kg) Occupant 3: 160 lbs (73 kg) Occupant 4: 140 lbs (63 kg) Occupant 5: 120 lbs (54 kg)	Occupant 1: 200 lbs (91 kg) Occupant 2: 190 lbs (86 kg) Occupant 3: 150 lbs (68 kg)	Occupant 1: 150 lbs (68 kg)
<b>Gross weight of all occupants</b>	750 lbs (340 kg)	540 lbs (245 kg)	150 lbs (68 kg)

## Step 3

	Example 1	Example 2	Example 3
<b>Permissible load (maximum gross vehicle weight rating from the Tire and Loading Information placard minus the gross weight of all occupants)</b>	1500 lbs (680 kg) - 750 lbs (340 kg) = 750 lbs (340 kg)	1500 lbs (680 kg) - 540 lbs (245 kg) = =960 lbs (435 kg)	1500 lbs (680 kg) - 150 lbs (68 kg) = 1350 lbs (612 kg)

### Vehicle identification plate

Even if you have calculated the total cargo carefully, you should still make sure that the gross vehicle weight rating and the gross axle weight rating are not exceeded. Details can be found on the vehicle identification plate on the B-pillar on the driver's side of the vehicle (▷ page 361).

**Permissible Gross Vehicle Weight Rating (GVWR):** the gross weight of the vehicle, all passengers, load and trailer load/noseweight (if applicable) must not exceed the permissible gross vehicle weight.

**Gross Axle Weight Rating (GAWR):** the maximum permissible weight that can be carried by one axle (front or rear axle).

To ensure that your vehicle does not exceed the maximum permissible values (gross vehicle weight and maximum gross axle weight rating), have your loaded vehicle (including driver, occupants, cargo, and full trailer load if applicable) weighed on a suitable vehicle weighbridge.

### Trailer load/noseweight

The trailer load/noseweight affects the gross weight of the vehicle. If a trailer is attached, the trailer load/noseweight is included in the load along with occupants and luggage. The trailer load/noseweight is usually approximately 8% of the gross weight of the trailer and its cargo.

## All about wheels and tires

### Uniform Tire Quality Grading Standards

#### Overview of Tire Quality Grading Standards

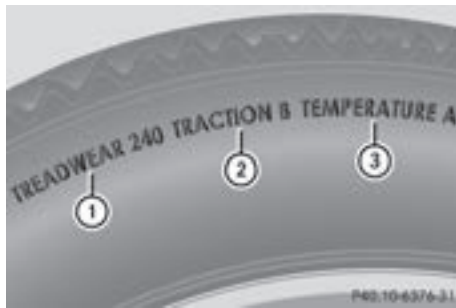

Uniform Tire Quality Grading Standards are U.S. government specifications. Their purpose is to provide drivers with uniform reliable information on tire performance data. Tire manufacturers have to grade tires using three performance factors: ① tread wear grade, ② traction grade and ③ temperature grade. These regulations do not apply to Canada. Nevertheless, all tires sold in North America are provided with the corresponding quality grading markings on the sidewall of the tire.

Quality grades can be found, where applicable, on the tire sidewall between tread shoulder and maximum section width.

Example:

- **Treadwear grade:** 200
- **Traction grade:** AA
- **Temperature grade:** A

All passenger car tires must conform to the statutory safety requirements in addition to these grades.

- i** The actual values for tires are vehicle-specific and may deviate from the values in the illustration.

### Treadwear

The treadwear grade is a comparative rating based on the wear rate of the tire when tested under controlled conditions on a specified U.S. government course. For example, a tire graded 150 would wear one and one-half times as well on the government course as a tire graded 100. The relative performance of tires depends upon the actual conditions of their use, however, and may depart significantly from the norm due to variations in driving habits, service practices and differences in road characteristics and climate.

### Traction

#### WARNING

The traction grade assigned to this tire is based on straight-ahead braking traction tests, and does not include acceleration, cornering, hydroplaning, or peak traction characteristics.

- !** Avoid wheelspin. This can lead to damage to the drive train.

The traction grades – from highest to lowest – are AA, A, B and C. Those grades represent the tire's ability to stop on wet pavement as measured under controlled conditions on specified government test surfaces of asphalt and concrete. A tire marked C may have poor traction performance.

The safe speed on a wet, snow covered or icy road is always lower than on dry road surfaces. You should pay special attention to road conditions when temperatures are around freezing point.

Mercedes-Benz recommends a minimum tread depth of  $\frac{1}{8}$  in (4 mm) on all four winter tires. Observe the legally required minimum tire tread depth (▷ page 352). Winter tires can reduce the braking distance on snow-covered surfaces in comparison with summer tires. The braking distance is still much further than on surfaces that

are not icy or covered with snow. Take appropriate care when driving.

Further information on winter tires (M+S tires) (▷ page 353).

### Temperature

#### WARNING

The temperature grade for this tire is established for a tire that is properly inflated and not overloaded. Excessive speed, underinflation, or excessive loading, either separately or in combination, can cause excessive heat build-up and possible tire failure.

The temperature grades are A (the highest), B, and C, representing the tire's resistance to the generation of heat and its ability to dissipate heat when tested under controlled conditions on a specified indoor laboratory test wheel. Sustained high temperature can cause the material of the tire to degenerate and reduce tire life, and excessive temperature can lead to sudden tire failure. The grade C corresponds to a level of performance which all passenger car tires must meet under the Federal Motor Vehicle Safety Standard No. 109. Grades B and A represent higher levels of performance on the laboratory test wheel than the minimum required by law.

## Tire labeling

### Overview

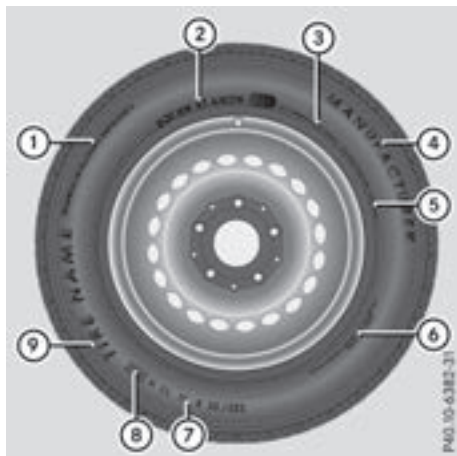

- ① Uniform Tire Quality Grading Standards (▷ page 369)
- ② Department of Transportation, Tire Identification Number (▷ page 368)
- ③ Maximum load rating (▷ page 368)
- ④ Maximum tire pressures (▷ page 357)
- ⑤ Manufacturer
- ⑥ Tire material (▷ page 369)
- ⑦ Tire size designation, load-bearing capacity and speed rating (▷ page 366)
- ⑧ Load index (▷ page 368)
- ⑨ Tire name

The markings described above are on the tire in addition to the tire name (sales designation) and the manufacturer's name.

- ⓘ Tire data is vehicle-specific and may deviate from the data in the example.

### Tire size designation, load-bearing capacity and speed rating

#### ⚠ WARNING

Exceeding the stated tire load-bearing capacity and the approved maximum speed could lead to tire damage or the tire bursting. There is a risk of accident.

Therefore, only use tire types and sizes approved for your vehicle model. Observe the

tire load rating and speed rating required for your vehicle.



- ① Tire width
- ② Nominal aspect ratio in %
- ③ Tire code
- ④ Rim diameter
- ⑤ Load bearing index
- ⑥ Speed rating

**General:** depending on the manufacturer's standards, the size imprinted in the tire wall may not contain any letters or may contain one letter that precedes the size description.

If there is no letter preceding the size description (as shown above): these are passenger vehicle tires according to European manufacturing standards.

If "P" precedes the size description: these are passenger vehicle tires according to U.S. manufacturing standards.

If "LT" precedes the size description: these are light truck tires according to U.S. manufacturing standards.

If "T" precedes the size description: compact emergency wheels with high tire pressure that are only designed for temporary use in an emergency.

**Tire width:** tire width ① shows the nominal tire width in millimeters.

**Height-width ratio:** aspect ratio ② is the size ratio between the tire height and tire width and is shown in percent. The aspect ratio is calculated by dividing the tire width by the tire height.

**Tire code:** tire code ③ specifies the tire type. "R" represents radial tires; "D" represents diagonal tires; "B" represents diagonal radial tires.

Optionally, tires with a maximum speed of over 149 mph (240 km/h) may have "ZR" in the size



description, depending on the manufacturer (e.g. 245/40 ZR 18).

**Rim diameter:** rim diameter ④ is the diameter of the bead seat, not the diameter of the rim flange. The rim diameter is specified in inches (in).

**Load-bearing index:** load-bearing index ⑤ is a numerical code that specifies the maximum load-bearing capacity of a tire.

Do not overload the tires by exceeding the specified load limit. The maximum permissible load can be found on the vehicle's Tire and Loading Information placard on the B-pillar on the driver's side (▷ page 361).

Example:

Load-bearing index 91 indicates a maximum load of 1,356 lb (615 kg) that the tires can bear. For further information on the maximum tire load in kilograms and lbs, see (▷ page 368).

For further information on the load bearing index, see "Load index" (▷ page 368).

**Speed rating:** speed rating ⑥ specifies the approved maximum speed of the tire.

**i** Tire data is vehicle-specific and may deviate from the data in the example.

Regardless of the speed rating, always observe the speed limits. Drive carefully and adapt your driving style to the traffic conditions.

### Summer tires

Index	Speed rating
Q	up to 100 mph (160 km/h)
R	up to 106 mph (170 km/h)
S	up to 112 mph (180 km/h)
T	up to 118 mph (190 km/h)
H	up to 130 mph (210 km/h)
V	up to 149 mph (240 km/h)
W	up to 168 mph (270 km/h)
Y	up to 186 mph (300 km/h)
ZR...Y	up to 186 mph (300 km/h)
ZR...(..Y)	over 186 mph (300 km/h)
ZR	over 149 mph (240 km/h)

- Optionally, tires with a maximum speed of over 149 mph (240 km/h) may have "ZR" in the size description, depending on the manufacturer (e.g. 245/40 ZR18).

The service specification is made up of load-bearing index ⑤ and speed rating ⑥.

- If the size description of your tire includes "ZR" and there are no service specifications, ask the tire manufacturer in order to find out the maximum speed.

If a service specification is available, the maximum speed is limited according to the speed rating in the service specification. Example: 245/40 ZR18 97 Y. In this example, "97 Y" is the service specification. The letter "Y" represents the speed rating. The maximum speed of the tire is limited to 186 mph (300 km/h).

- The size description for all tires with maximum speeds of over 186 mph (300 km/h) must include "ZR", **and** the service specification must be given in parentheses. Example: 275/40 ZR 18 (99 Y). Speed rating "Y" indicates that the maximum speed of the tire is over 186 mph (300 km/h). Ask the tire manufacturer about the maximum speed.

### All-weather tires and winter tires

Index	Speed rating
Q M+S <sup>3</sup>	up to 100 mph (160 km/h)
T M+S <sup>3</sup>	up to 118 mph (190 km/h)
H M+S <sup>3</sup>	up to 130 mph (210 km/h)
V M+S <sup>3</sup>	up to 149 mph (240 km/h)

- i** Not all tires with the M+S marking provide the driving characteristics of winter tires. In addition to the M+S marking, winter tires also have the  snowflake symbol on the tire wall. Tires with this marking fulfill the requirements of the Rubber Manufacturers Association (RMA) and the Rubber Association of Canada (RAC) regarding the tire traction on snow. They have been especially developed for driving on snow.

<sup>3</sup> Or M+S  for winter tires.

An electronic speed limiter prevents your vehicle from exceeding the following speeds:

- All vehicles (except Mercedes-AMG GLE 63): 130 mph (210 km/h)
- Mercedes-AMG GLE 63 vehicles: 155 mph (250 km/h)
- Mercedes-AMG GLE 63 with increased top speed: 174 mph (280 km/h)

The speed rating of tires mounted at the factory may be higher than the maximum speed that the electronic speed limiter permits.

Make sure that your tires have the required speed rating, e.g. when buying new tires. The required speed rating for your vehicle can be found in the "Tires" section (▷ page 376).

Further information about reading tire data can be obtained from any qualified specialist workshop.

### Load index



In addition to the load bearing index, load index ① may be imprinted after the letters that identify speed index ⑥ on the sidewall of the tire (▷ page 366).

- If no specification is given: no text (as in the example above), represents a standard load (SL) tire
- XL or Extra Load: represents a reinforced tire
- Light Load: represents a light load tire
- C, D, E: represents a load range that depends on the maximum load that the tire can carry at a certain pressure

**i** Tire data is vehicle-specific and may deviate from the data in the example.

### Maximum load rating

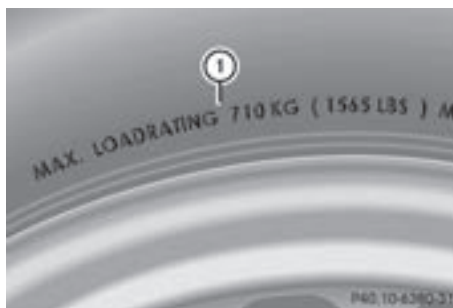

Maximum tire load ① is the maximum permissible weight for which the tire is approved.

Do not overload the tires by exceeding the specified load limit. The maximum permissible load can be found on the vehicle's Tire and Loading Information placard on the B-pillar on the driver's side (▷ page 361).

**i** The actual values for tires are vehicle-specific and may deviate from the values in the illustration.

### DOT, Tire Identification Number (TIN)

US tire regulations stipulate that every tire manufacturer or retreader must imprint a TIN in or on the sidewall of each tire produced.



The TIN is a unique identification number. The TIN enables the tire manufacturers or retreaders to inform purchasers of recalls and other safety-relevant matters. It makes it possible for the purchaser to easily identify the affected tires.

The TIN is made up of manufacturer identification code ②, tire size ③, tire type code ④ and manufacturing date ⑤.

**DOT (Department of Transportation):** tire symbol ① marks that the tire complies with the

requirements of the U.S. Department of Transportation.

**Manufacturer identification code:** manufacturer identification code ② provides details on the tire manufacturer. New tires have a code with two symbols. Retreaded tires have a code with four symbols.

For further information about retreaded tires, see (> page 376).

**Tire size:** identifier ③ describes the tire size.

**Tire type code:** tire type code ④ can be used by the manufacturer as a code to describe specific characteristics of the tire.

**Date of manufacture:** date of manufacture ⑤ provides information about the age of a tire. The first and second positions represent the week of manufacture, starting with "01" for the first calendar week. Positions three and four represent the year of manufacture. For example, a tire that is marked "3214" was manufactured in week 32 in 2014.

- ① Tire data is vehicle-specific and may deviate from the data in the example.

## Tire characteristics



This information describes the type of tire cord and the number of layers in sidewall ① and under tire tread ②.

- ① Tire data is vehicle-specific and may deviate from the data in the example.

## Definition of terms for tires and loading

### Tire ply composition and material used

Describes the number of plies or the number of layers of rubber-coated fabric in the tire tread and sidewall. These are made of steel, nylon, polyester and other materials.

### Bar

Metric unit for tire pressure. 14.5038 pounds per square inch (psi) and 100 kilopascals (kPa) are the equivalent of 1 bar.

### DOT (Department of Transportation)

DOT-marked tires fulfill the requirements of the U S Department of Transportation.

### Normal occupant weight

The number of occupants for which the vehicle is designed multiplied by 68 kilograms (150 lbs).

### Uniform Tire Quality Grading Standards

A uniform standard to grade the quality of tires with regards to tread quality, tire traction and temperature characteristics. The quality grading assessment is made by the manufacturer following specifications from the U.S. government. The ratings are molded into the sidewall of the tire.

### Recommended tire pressures

The recommended tire pressure applies to the tires mounted at the factory.

The Tire and Loading Information placard contains the recommended tire pressures for cold tires on a fully loaded vehicle and for the maximum permissible vehicle speed.

The tire pressure table contains the recommended pressures for cold tires for various operating conditions, i.e. differing load and speed conditions.

### Increased vehicle weight due to optional equipment

The combined weight of all standard and optional equipment available for the vehicle, regardless of whether it is actually installed on the vehicle or not.

### Rim

This is the part of the wheel on which the tire is mounted.

### GAWR (Gross Axle Weight Rating)

The GAWR is the maximum gross axle weight rating. The actual load on an axle must never exceed the gross axle weight rating. The gross axle weight rating can be found on the vehicle identification plate on the B-pillar on the driver's side.

### Speed rating

The speed rating is part of the tire identification. It specifies the speed range for which the tire is approved.

### GTW (Gross Trailer Weight)

The GTW is the weight of a trailer including the weight of the load, luggage, accessories etc. on the trailer.

### GVW (Gross Vehicle Weight)

The gross vehicle weight includes the weight of the vehicle including fuel, tools, the spare wheel, accessories installed, occupants, luggage and the drawbar noseweight, if applicable. The gross vehicle weight must not exceed the gross vehicle weight rating GVWR as specified on the vehicle identification plate on the B-pillar on the driver's side.

### GVWR (Gross Vehicle Weight Rating)

The GVWR is the maximum permissible gross weight of a fully loaded vehicle (the weight of the vehicle including all accessories, occupants, fuel, luggage and the drawbar noseweight, if applicable). The gross vehicle weight rating is specified on the vehicle identification plate on the B-pillar on the driver's side.

### Maximum loaded vehicle weight

The maximum weight is the sum of:

- the curb weight of the vehicle
- the weight of the accessories
- the load limit
- the weight of the factory installed optional equipment

### Kilopascal (kPa)

Metric unit for tire pressure. 6.9 kPa corresponds to 1 psi. Another unit for tire pressure is bar. 100 kilopascals (kPa) are the equivalent of 1 bar.

### Load index

In addition to the load-bearing index, the load index may also be imprinted on the sidewall of the tire. This specifies the load-bearing capacity more precisely.

### Curb weight

The weight of a vehicle with standard equipment including the maximum capacity of fuel, oil and coolant. It also includes the air-conditioning sys-

tem and optional equipment if these are installed in the vehicle, but does not include passengers or luggage.

### Maximum load rating

The maximum tire load is the maximum permissible weight in kilograms or lbs for which a tire is approved.

### Maximum permissible tire pressure

Maximum permissible tire pressure for one tire.

### Maximum load on one tire

Maximum load on one tire. This is calculated by dividing the maximum axle load of one axle by two.

### PSI (pounds per square inch)

A standard unit of measure for tire pressure.

### Aspect ratio

Relationship between tire height and tire width in percent.

### Tire pressure

This is pressure inside the tire applying an outward force to each square inch of the tire's surface. The tire pressure is specified in pounds per square inch (psi), in kilopascal (kPa) or in bar. The tire pressure should only be corrected when the tires are cold.

### Cold tire pressure

The tires are cold:

- if the vehicle has been parked with the tires out of direct sunlight for at least three hours and
- if the vehicle has not been driven further than 1 mile (1.6 km)

### Tread

The part of the tire that comes into contact with the road.

### Bead

The tire bead ensures that the tire sits securely on the wheel. There are several steel wires in the bead to prevent the tire from coming loose from the wheel rim.

## Sidewall

The part of the tire between the tread and the bead.

## Weight of optional extras

The combined weight of those optional extras that weigh more than the replaced standard parts and more than 2.3 kg (5 lbs). These optional extras, such as high-performance brakes, level control, a roof rack or a high-performance battery, are not included in the curb weight and the weight of the accessories.

## TIN (Tire Identification Number)

This is a unique identifier which can be used by a tire manufacturer to identify tires, for example for a product recall, and thus identify the purchasers. The TIN is made up of the manufacturer's identity code, tire size, tire type code and the manufacturing date.

## Load bearing index

The load bearing index (also load index) is a code that contains the maximum load bearing capacity of a tire.

## Traction

Traction is the result of friction between the tires and the road surface.

## TWR (Tongue Weight Rating)

The TWR specifies the maximum permissible weight that the ball coupling of the trailer tow hitch can support.

## Treadwear indicators

Narrow bars (tread wear bars) that are distributed over the tire tread. If the tire tread is level with the bars, the wear limit of  $\frac{1}{16}$  in (1.6 mm) has been reached.

## Occupant distribution

The distribution of occupants in a vehicle at their designated seating positions.

## Total load limit

Nominal load and luggage load plus 68 kg (150 lbs) multiplied by the number of seats in the vehicle.

## Changing a wheel

### Flat tire

The "Breakdown assistance" section (> page 335) contains information and notes on how to deal with a flat tire. Information on driving with MOExtended tires in the event of a flat tire can be found under "MOExtended tires (tires with run-flat characteristics)" (> page 336).

**Vehicles with an emergency spare wheel:** in the event of a flat tire, mount the emergency spare wheel according to the description under "Mounting a wheel" (> page 372).

### Rotating the wheels

#### WARNING

Interchanging the front and rear wheels may severely impair the driving characteristics if the wheels or tires have different dimensions. The wheel brakes or suspension components may also be damaged. There is a risk of accident.

Rotate front and rear wheels only if the wheels and tires are of the same dimensions.

**!** On vehicles equipped with a tire pressure monitor, electronic components are located in the wheel.

Tire-mounting tools should not be used near the valve. This could damage the electronic components.

Only have tires changed at a qualified specialist workshop.

Always observe the instructions and safety notes in the "Mounting a wheel" section (> page 372).

The wear patterns on the front and rear tires differ, depending on the operating conditions. Rotate the wheels before a clear wear pattern has formed on the tires. Front tires typically wear more on the shoulders and the rear tires in the center.

On vehicles that have the same size front and rear wheels, you can rotate the wheels according to the intervals in the tire manufacturer's warranty book in your vehicle documents. If no warranty book is available, the tires should be rotated every 3,000 to 6,000 miles (5,000 to 10,000 km). Depending on tire wear, this may

be required earlier. Do not change the direction of wheel rotation.

Clean the contact surfaces of the wheel and the brake disc thoroughly every time a wheel is rotated. Check the tire pressure and, if necessary, restart the tire pressure loss warning system or the tire pressure monitor (▷ page 358).

### Direction of rotation

Tires with a specified direction of rotation have additional benefits, e.g. if there is a risk of hydroplaning. These advantages can only be gained if the tires are installed corresponding to the direction of rotation.

An arrow on the sidewall of the tire indicates its correct direction of rotation.

### Storing wheels

Store wheels that are not being used in a cool, dry and preferably dark place. Protect the tires from oil, grease, gasoline and diesel.

### Mounting a wheel

#### Preparing the vehicle

- ▶ **Vehicle with emergency spare wheel:** when mounting the emergency spare wheel in the event of a flat tire, follow the additional notes on vehicle preparation under "Flat tire" (▷ page 335).
- ▶ Stop the vehicle on solid, non-slippery and level ground.
- ▶ Apply the electric parking brake manually.
- ▶ Bring the front wheels into the straight-ahead position.
- ▶ **Vehicles with automatic transmission:** shift the transmission to position **[P]**.
- ▶ **Vehicles with the AIRMATIC package:** make sure that the normal vehicle level is selected (▷ page 185).
- ▶ **Vehicles with the Off-Road Engineering package:** make sure that the normal vehicle level is selected (▷ page 179).
- ▶ Switch off the engine.
- ▶ **Vehicles without KEYLESS-GO:** remove the SmartKey from the ignition lock.

▶ **Vehicles with KEYLESS-GO:** open the driver's door.  
The vehicle electronics are now in position **[0]**. This means no SmartKey is in the ignition lock.

- ▶ **Vehicles with KEYLESS-GO:** remove the Start/Stop button from the ignition lock (▷ page 135).
- ▶ Make sure that the engine cannot be started via your smartphone (▷ page 137).
- ▶ If included in the vehicle equipment, remove the tire-change tool kit from the vehicle.
- ▶ Safeguard the vehicle against rolling away.

**i** Apart from certain country-specific variations, vehicles are not equipped with a tire-change tool kit. For more information on which tools are required to perform a wheel change on your vehicle, consult a qualified specialist workshop.

Necessary tire-changing tools can include, for example:

- Jack
- Wheel chock
- Lug wrench

#### Securing the vehicle to prevent it from rolling away

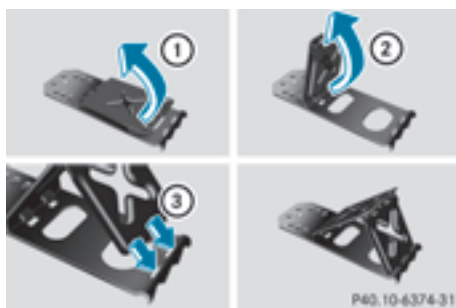

If your vehicle is equipped with a wheel chock, it can be found in the tire-change tool kit (▷ page 335).

The folding wheel chock is an additional safety measure to prevent the vehicle from rolling away, for example when changing a wheel.

- ▶ Fold both plates upwards ①.
- ▶ Fold out lower plate ②.
- ▶ Guide the lugs on the lower plate fully into the openings in base plate ③.



- ▶ Place chocks or other suitable items under the front and rear of the wheel that is diagonally opposite the wheel you wish to change.

### Raising the vehicle

#### WARNING

If you do not position the jack correctly at the appropriate jacking point of the vehicle, the jack could tip over with the vehicle raised. There is a risk of injury.

Only position the jack at the appropriate jacking point of the vehicle. The base of the jack must be positioned vertically, directly under the jacking point of the vehicle.

- ❗ Only position the jack at the appropriate jacking point of the vehicle. Otherwise, you could damage the vehicle.

#### Observe the following when raising the vehicle:

- To raise the vehicle, only use the vehicle-specific jack that has been tested and approved by Mercedes-Benz. If used incorrectly, the jack could tip over with the vehicle raised.
- The jack is designed only to raise and hold the vehicle for a short time while a wheel is being changed. It must not be used for performing maintenance work under the vehicle.
- Avoid changing the wheel on uphill and downhill slopes.
- Before raising the vehicle, secure it from rolling away by applying the parking brake and inserting wheel chocks. Do not disengage the parking brake while the vehicle is raised.
- The jack must be placed on a firm, flat and non-slip surface. On a loose surface, a large, flat, load-bearing underlay must be used. On a

slippery surface, a non-slip underlay must be used, e.g. rubber mats.

- Do not use wooden blocks or similar objects as a jack underlay. Otherwise, the jack will not be able to achieve its load-bearing capacity due to the restricted height.
- Make sure that the distance between the underside of the tires and the ground does not exceed 1.2 in (3 cm).
- Do not place your hands or feet under the raised vehicle.
- Do not lie under the vehicle.
- Do not start the engine when the vehicle is raised.
- Never open or close a door or the tailgate when the vehicle is raised.
- Make sure that no persons are present in the vehicle when the vehicle is raised.



- ▶ Using lug wrench ①, loosen the bolts on the wheel you wish to change by about one full turn. Do not unscrew the bolts completely.



The jacking points are located just behind the front wheel housings and just in front of the rear wheel housings (arrows).

- ▶ Take the ratchet wrench out of the vehicle tool kit and place it on the hexagon nut of the jack so that the letters **AUF** are visible.

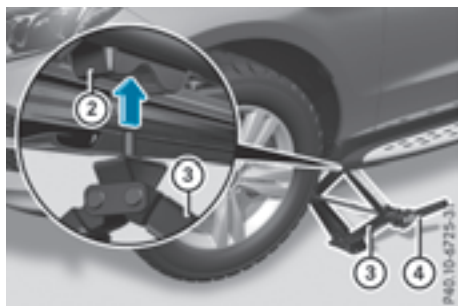

- ▶ Position jack (3) at jacking point (2). The alignment bolt on the jack must be inserted into the intended opening on the jacking point.

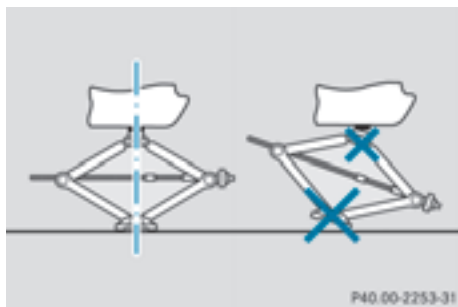

- ▶ Make sure the foot of the jack is directly beneath the jacking point.
- ▶ Turn ratchet wrench (4) until jack (3) sits completely on jacking point (2) and the base of the jack lies evenly on the ground.
- ▶ Turn ratchet wrench (4) until the tire is raised a maximum of 1.2 in (3 cm) from the ground.

### Removing a wheel

- ! Do not place wheel bolts in sand or on a dirty surface. The bolt and wheel hub threads could otherwise be damaged when you screw them in.

When mounting/removing wheels, and for as long as the wheels are removed, avoid applying any external force on the brake disks. This could impair the level of comfort when braking.



- ▶ Unscrew the uppermost wheel bolt completely.
- ▶ Screw alignment bolt (1) into the thread instead of the wheel bolt.
- ▶ Unscrew the remaining wheel bolts fully.
- ▶ Remove the wheel.

### Mounting a new wheel

#### ⚠ WARNING

Oiled or greased wheel bolts or damaged wheel bolts/hub threads can cause the wheel bolts to come loose. As a result, you could lose a wheel while driving. There is a risk of accident.

Never oil or grease wheel bolts. In the event of damage to the threads, contact a qualified specialist workshop immediately. Have the damaged wheel bolts or hub threads replaced/renewed. Do not continue driving.

#### ⚠ WARNING

If you tighten the wheel bolts or wheel nuts when the vehicle is raised, the jack could tip over. There is a risk of injury.

Only tighten the wheel bolts or wheel nuts when the vehicle is on the ground.

- ! To prevent damage to the paintwork, hold the wheel securely against the wheel hub while screwing in the first wheel bolt.

Always pay attention to the instructions and safety notes in the "Changing a wheel" section (▷ page 371).

Only use wheel bolts that have been designed for the wheel and the vehicle. For safety reasons, Mercedes-Benz recommends that you



only use wheel bolts which have been approved for Mercedes-Benz vehicles and the respective wheel.

**!** Always use wheel bolts ② to mount the "Minispare" emergency spare wheel. Using other wheel bolts to mount the "Minispare" emergency spare wheel could damage the brake system.

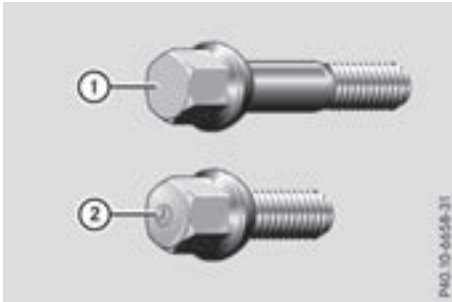

- ① Wheel bolts for all wheels supplied by the factory and for the collapsible spare wheel (Mercedes-AMG GLE 63 4MATIC)
- ② Wheel bolts for the collapsible spare wheel



- ▶ Clean the wheel and wheel hub contact surfaces.
- ▶ Slide the wheel to be mounted onto the alignment bolt and push it on.
- ▶ Tighten the wheel bolts until they are finger-tight.
- ▶ Unscrew the alignment bolt.
- ▶ Tighten the last wheel bolt until it is finger-tight.
- ▶ **Mercedes-AMG vehicles with a collapsible spare wheel:** inflate the collapsible spare wheel (▷ page 379).  
Only then lower the vehicle.

### Lowering the vehicle

#### **!** WARNING

The wheels could work loose if the wheel nuts and bolts are not tightened to the specified tightening torque. There is a risk of accident. Have the tightening torque immediately checked at a qualified specialist workshop after a wheel is changed.

**!** **Mercedes-AMG vehicles with a collapsible spare wheel:** before lowering the vehicle, inflate the collapsible spare wheel with the tire inflation compressor. The wheel rim could otherwise be damaged.

- ▶ Place the ratchet wrench onto the hexagon nut of the jack so that the letters **AB** are visible.
- ▶ Turn the ratchet wrench until the vehicle is once again standing firmly on the ground.
- ▶ Place the jack to one side.



- ▶ Tighten the wheel bolts evenly in a crosswise pattern in the sequence indicated (① to ⑤). The tightening torque must be **110 lb-ft (150 Nm)**.
- ▶ Turn the jack back to its initial position.
- ▶ Stow the jack and the rest of the tire-change tool kit in the stowage well under the cargo compartment floor again.
- ▶ Check the tire pressure of the newly mounted wheel and adjust it if necessary. Observe the recommended tire pressure (▷ page 354).

When you are driving with the collapsible spare wheel mounted, the tire pressure loss warning system or the tire pressure monitor cannot function reliably. Only restart the tire pressure loss warning system or tire pressure monitor when

the defective wheel has been replaced with a new wheel.

**Vehicles with a tire pressure control system:** all installed wheels must be equipped with functioning sensors.

### Wheel and tire combinations

Information regarding permitted wheel/tire combinations can be found at an authorized Mercedes-Benz Center.

**!** For safety reasons, Mercedes-Benz recommends that you only use tires and wheels which have been approved by Mercedes-Benz specifically for your vehicle.

These tires have been specially adapted for use with the control systems, such as ABS or ESP®, and are marked as follows:

- MO = Mercedes-Benz Original
- MOE = Mercedes-Benz Original Extended (tires featuring run-flat characteristics)
- MO1 = Mercedes-Benz Original (only certain AMG tires)

Mercedes-Benz Original Extended tires may only be used on wheels that have been specifically approved by Mercedes-Benz.

Only use tires, wheels or accessories tested and approved by Mercedes-Benz. Certain characteristics, e.g. handling, vehicle noise emissions or fuel consumption, may otherwise be adversely affected. In addition, when driving with a load, tire dimension variations could cause the tires to come into contact with the bodywork and axle components. This could result in damage to the tires or the vehicle.

Mercedes-Benz accepts no liability for damage resulting from the use of tires, wheels or accessories other than those tested and approved.

Information on tires, wheels and approved combinations can be obtained from any qualified specialist workshop.

**!** Retreaded tires are neither tested nor recommended by Mercedes-Benz, since previous damage cannot always be detected on retreaded tires. As a result, Mercedes-Benz cannot guarantee vehicle safety if retreaded tires are mounted. Do not mount used tires if

you have no information about their previous usage.

The recommended pressures for various operating conditions can be found:

- on the Tire and Loading Information placard on the B-pillar on the driver's side
- in the tire pressure table in the fuel filler flap

Observe the notes on recommended tire pressures under various operating conditions (> page 354).

Check tire pressures regularly, and only when the tires are cold. Comply with the maintenance recommendations of the tire manufacturer in the vehicle document wallet.

Notes on the vehicle equipment – always equip the vehicle:

- with tires of the same size on a given axle (left and right)
- with the same type of tires at a given time (summer tires, winter tires, MOExtended tires)

**i** Vehicles equipped with MOExtended tires are not equipped with a TIREFIT kit at the factory. It is therefore recommended that you additionally equip your vehicle with a TIREFIT kit if you mount tires that do not feature run-flat properties, e.g. winter tires. A TIREFIT kit may be obtained from a qualified specialist workshop.

### Emergency spare wheel

#### Important safety notes

##### WARNING

The wheel or tire size as well as the tire type of the spare wheel or emergency spare wheel and the wheel to be replaced may differ.

Mounting an emergency spare wheel may severely impair the driving characteristics. There is a risk of an accident.

To avoid hazardous situations:

- adapt your driving style accordingly and drive carefully.
- never mount more than one spare wheel or emergency spare wheel that differs in size.

- only use a spare wheel or emergency spare wheel of a different size briefly.
- do not switch ESP® off.
- have a spare wheel or emergency spare wheel of a different size replaced at the nearest qualified specialist workshop. Observe that the wheel and tire dimensions as well as the tire type must be correct.

**I Mercedes-AMG vehicles with "Minispare" emergency spare wheel:** only use the "Minispare" emergency spare wheel **on the rear axle**. If you mount the "Minispare" emergency spare wheel on the front axle, this could result in damage to the brake system.

If a tire on the front axle is defective, an intact wheel from the rear axle must first be replaced with the "Minispare" emergency spare wheel. The damaged wheel on the front axle can then be replaced by the undamaged wheel from the rear axle.

Make sure to note the placard on the "Minispare" emergency spare wheel.

When using an emergency spare wheel or spare wheel of a different size, you must not exceed the maximum speed of 50 mph (80 km/h).

You should regularly check the pressure of the emergency spare wheel, particularly prior to long trips, and correct the pressure as necessary (▷ page 354). The value on the wheel is valid.

Snow chains must not be mounted on emergency spare wheels.

### General notes

Information regarding permitted emergency spare wheels can be found at an authorized Mercedes-Benz Center.

Mounting the emergency spare wheel is described under "Mounting a wheel" (▷ page 372).

An emergency spare wheel may also be mounted against the direction of rotation. Observe the time restriction on use as well as the speed limitation specified on the emergency spare wheel.

Replace the tires after six years at the latest, regardless of wear. This also applies to the emergency spare wheel.

When you are driving with the collapsible spare wheel mounted, the tire pressure loss warning system or the tire pressure monitor cannot function reliably. Only restart the tire pressure loss warning system or tire pressure monitor when the defective wheel has been replaced with a new wheel.

**Vehicles with tire pressure monitor:** after mounting an emergency spare wheel, the system may still display the tire pressure of the removed wheel for a few minutes. The value displayed for the mounted emergency spare wheel is not the same as the current tire pressure of the emergency spare wheel.

### Removing/stowing the emergency spare wheel

#### Vehicles with a "Minispare" emergency spare wheel under the cargo compartment floor

Always observe the instructions and safety notes in the "Mounting a wheel" section (▷ page 372).

The "Minispare" emergency spare wheel can be found in the stowage well under the cargo compartment floor.



#### Removing the emergency spare wheel

- ▶ Lift the cargo compartment floor upwards (▷ page 303).
- ▶ **Vehicle without a lockable cargo compartment floor:** turn emergency spare wheel retainer ② counter-clockwise and remove it.
- ▶ Remove "Minispare" emergency spare wheel ①.

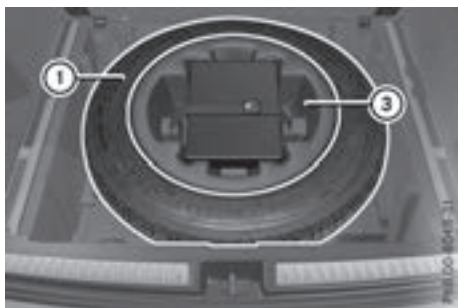

- ▶ **Vehicle with a lockable cargo compartment floor:** remove the contents of stowage tray ③.
- ▶ Turn the central retaining screw in stowage tray ③ and in "Minispare" emergency spare wheel ① counter-clockwise and remove it.
- ▶ Remove stowage well ③.
- ▶ Remove "Minispare" emergency spare wheel ①.

### Vehicles with a "Minispare" emergency spare wheel in the emergency spare wheel bag

Always observe the instructions and safety notes in the "Mounting a wheel" section (> page 372).

On vehicles with a Bang & Olufsen sound system, the "Minispare" emergency spare wheel is packed in an emergency spare wheel bag. The emergency spare wheel bag is secured to the cargo tie-down rings in the cargo compartment.



Removing the emergency spare wheel

- ▶ Detach the fastening straps ②.
- ▶ Unhook retaining spring hooks ① and ③ of fastening straps ② from the cargo tie-down rings.

- ▶ Remove the emergency spare wheel bag with the "Minispare" emergency spare wheel.
- ▶ Open the emergency spare wheel bag and remove the "Minispare" emergency spare wheel.

Stowing the emergency spare wheel

- ▶ Place the "Minispare" emergency spare wheel into the emergency spare wheel bag and close the emergency spare wheel bag.
- ▶ Place the emergency spare wheel bag with the "Minispare" emergency spare wheel into the cargo compartment with the carrying strap at the back.
- ▶ Hook retaining spring hooks ① and ③ of fastening straps ② into the cargo tie-down rings.
- ▶ Tighten fastening straps ②.

### Mercedes-AMG vehicles with a collapsible spare wheel under the cargo compartment floor

- ▶ Only place the collapsible spare wheel in the vehicle when it is dry. Otherwise, moisture may get into the vehicle.

Always observe the instructions and safety notes in the "Mounting a wheel" section (> page 372).

The collapsible spare wheel can be found in the stowage well under the cargo compartment floor.



Removing the emergency spare wheel

- ▶ Lift the cargo compartment floor upwards (> page 303).
- ▶ Unscrew retaining screw ② counter-clockwise.
- ▶ Remove collapsible spare wheel ① from the spare wheel well.

Inflating the collapsible spare wheel  
(▷ page 379).

Take the following steps to stow a used collapsible spare wheel. Otherwise, it will not fit into the spare wheel well. Mercedes-Benz recommends that you have this work performed at a qualified specialist workshop, e.g. at an authorized Mercedes-Benz Center.

Stowing the emergency spare wheel

- ▶ Unscrew the valve cap from the valve.
- ▶ If possible, unscrew the valve insert from the valve and release the air.

**i** Fully deflating the tires can take a few minutes.

- ▶ Screw the valve insert back into the valve.
- ▶ Screw the valve cap back on.
- ▶ Lay collapsible spare wheel ① in the emergency spare wheel well.
- ▶ Screw in retaining screw ② clockwise in the collapsible spare wheel to the stop.
- ▶ Swing the cargo compartment floor down (▷ page 303).

### Mercedes-AMG vehicles with a collapsible spare wheel in the emergency spare wheel bag

Always observe the instructions and safety notes in the "Mounting a wheel" section (▷ page 372).

On Mercedes-AMG vehicles with a Bang & Olufsen sound system, the collapsible spare wheel is packed in an emergency spare wheel bag. The emergency spare wheel bag is secured to the cargo tie-down rings in the cargo compartment.

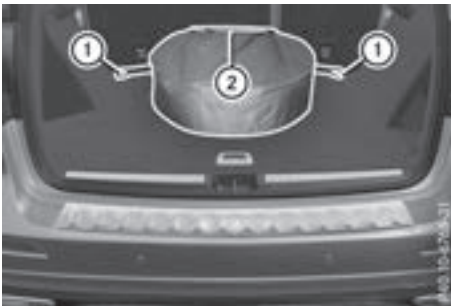

Removing the emergency spare wheel

- ▶ Unhook retaining spring hooks ① of fastening strap ② from the cargo tie-down rings.
- ▶ Remove the emergency spare wheel bag with the emergency collapsible spare wheel.
- ▶ Open the bag and remove the emergency collapsible spare wheel.

Inflating the collapsible spare wheel  
(▷ page 379).

Stowing the emergency spare wheel

- ▶ Place the collapsible spare wheel into the emergency spare wheel bag and close the emergency spare wheel bag.
- ▶ Place the emergency spare wheel bag with the collapsible spare wheel into the cargo compartment with the carrying strap at the back.
- ▶ Hook retaining spring hooks ① of fastening strap ② into the cargo tie-down rings.
- ▶ Tighten fastening strap ②.

### Inflating the collapsible spare wheel (Mercedes-AMG GLE 63 4MATIC)

**!** Inflate the collapsible spare wheel using the tire inflation compressor before lowering the vehicle. The wheel rim could otherwise be damaged.

**!** Do not operate the tire inflation compressor for longer than eight minutes at a time without a break. It may otherwise overheat.

The tire inflation compressor can be operated again once it has cooled down.

Comply with the manufacturer's safety instructions on the tire inflation compressor label and on the tire sealant bottle.

- ▶ Mount the collapsible spare wheel as described (▷ page 372).  
The collapsible spare wheel must be mounted before it is inflated.
- ▶ Remove the tire inflation compressor from the stowage space under the cargo compartment floor (▷ page 335).

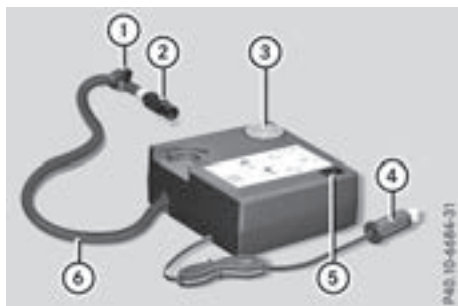

- ▶ Stow connector ④ and hose ⑥ in the lower section of the tire inflation compressor.
- ▶ Stow the tire inflation compressor in the vehicle.

- ▶ Pull connector ④ and hose ⑥ out of the housing.
- ▶ Remove the cap from the valve on the collapsible spare wheel.
- ▶ Screw union nut ② of hose ⑥ onto the valve.
- ▶ Make sure on/off switch ⑤ of the tire inflation compressor is set to **0**.
- ▶ Insert connector ④ into a socket in your vehicle.

Cigarette lighter socket: (▷ page 307)

12 V sockets: (▷ page 308)

Observe the notes on the cigarette lighter (▷ page 307). Observe the notes on sockets (▷ page 308).

- ▶ Turn the SmartKey to position **1** in the ignition lock (▷ page 135).
- ▶ Press on and off switch ⑤ on the tire inflation compressor to **I**.  
The tire inflation compressor is switched on.  
The tire is inflated. The tire pressure is shown on pressure gauge ③.
- ▶ Inflate the tire to the specified tire pressure.  
The specified tire pressure is printed on the yellow label of the emergency spare wheel.
- ▶ When the specified tire pressure has been reached, press on and off switch ⑤ on the tire inflation compressor to **0**.  
The tire inflation compressor is switched off.
- ▶ Turn the SmartKey to position **0** in the ignition lock.
- ▶ If the tire pressure is higher than the specified pressure, press pressure release valve button ① until the correct tire pressure has been reached.
- ▶ Unscrew union nut ② on hose ⑥ from the valve.
- ▶ Screw the cap onto the valve of the collapsible spare wheel again.

**Information regarding technical data**

**Plug-in hybrid:** be sure to read the separate Operator's Manual. Otherwise, you may not recognize dangers.

**i** The data stated here specifically refers to a vehicle with standard equipment. Consult an authorized Mercedes-Benz Center for the data for all vehicle variants and trim levels.

**Vehicle electronics**

**Installing two-way radios and mobile phones (RF transmitters)**

**⚠ WARNING**

The electromagnetic radiation from two-way radios can interfere with the vehicle electronics if two-way radios are manipulated or retrofitted incorrectly. This could jeopardize the operating safety of the vehicle. There is a risk of an accident.

You should have all work on electrical and electronic components carried out at a qualified specialist workshop.

**⚠ WARNING**

If you incorrectly operate two-way radios in the vehicle, the electromagnetic radiation may interfere with the vehicle electronics, for example if:

- the two-way radio is not connected to an exterior antenna
- the exterior antenna is not correctly mounted or is not low-reflection

This could jeopardize the operating safety of the vehicle. There is a risk of an accident.

Have the low-reflection exterior antenna installed at a qualified specialist workshop. Always connect two-way radios to the low-reflection exterior antenna when operating in the vehicle.

**!** The operating permit may be invalidated if the instructions for installation and use of two-way radios are not observed.

In particular, the following conditions must be complied with:

- only approved wavebands may be used
- observe the maximum permissible output in these wavebands
- only approved antenna positions may be used

Excessive levels of electromagnetic radiation may cause damage to your health and the health of others. Using an exterior antenna takes into account current scientific discussions relating to the possible health hazards that may result from electromagnetic fields.

The following antenna positions may be used for the correct installation of two-way radios:

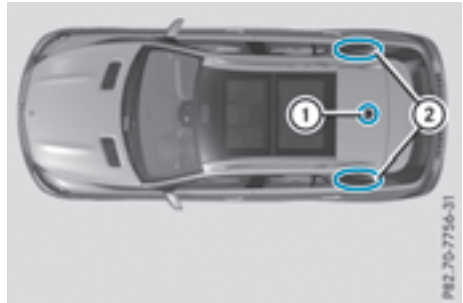

Approved antenna positions

- ① Rear roof area
- ② Rear fender

**i** On the rear fenders, it is recommended to position the antenna on the side of the vehicle closest to the center of the road.

Use Technical Specification ISO/TS 21609 (Road Vehicles - "EMC guidelines for installation of aftermarket radio frequency transmitting equipment") when installing wireless devices. Observe the legal requirements for accessory parts.

If your vehicle has installations for two-way radio equipment, use the power supply or antenna connections intended for use with the basic wiring. Be sure to observe the manufacturer's Supplement when installing.

Deviations with respect to frequency bands, maximum transmission outputs or antenna positions must be approved by Mercedes-Benz.

The maximum transmission output (PEAK) at the base of the antenna must not exceed the following values:

Frequency band	Maximum transmission output
Short wave 3 - 54 MHz	100 W
4 m waveband 74 - 88 MHz	30 W
2 m waveband 144 - 174 MHz	50 W
Trunked radio system/ Tetra 380 - 460 MHz	10 W
70 cm waveband 400 - 460 MHz	35 W
Mobile communications (2G/3G/4G)	10 W

The following can be used in the vehicle without restrictions:

- Two-way radios with a maximum transmission output of up to 100 mW
- Two-way radios with transmitter frequencies in the 380 - 410 MHz waveband and a maximum transmission output of up to 2 W (trunked radio/Tetra)
- Mobile phones (2G/3G/4G)

There are no restrictions when positioning the antenna on the outside of the vehicle for the following wavebands:

- Trunked radio system/Tetra
- 70 cm waveband
- 2G/3G/4G

## Identification plates

### Vehicle identification plate with vehicle identification number (VIN)



- Open the driver's door.  
You will see vehicle identification plate ①.

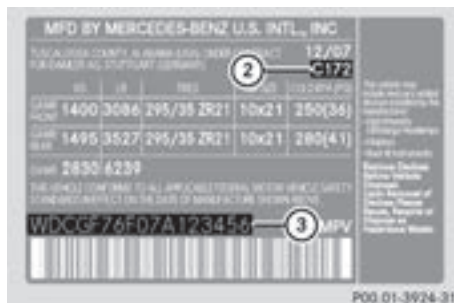

Example: vehicle identification plate (USA only)

- ② Paint code
- ③ VIN



Example: vehicle identification plate (Canada only)

- ② Paint code
- ③ VIN

**i** The data shown on the vehicle identification plate is used only as an example. This data is different for every vehicle and can deviate



from the data shown here. You can find the data applicable to your vehicle on the vehicle identification plate.

### Vehicle identification number (VIN)



- ▶ Open the front right-hand door.
- ▶ Open cover ① in the direction of the arrow and remove it. You will see the VIN.

The VIN can also be found in the following locations:

- on the lower edge of the windshield (▷ page 383)
- on the vehicle identification plate (▷ page 382)

### Engine number



- ① Emission control information plate, including the certification of both federal and Californian emissions standards
- ② Engine number (stamped into the crankcase)
- ③ VIN (on the lower edge of the windshield)

## Service products and filling capacities

### Important safety notes

#### WARNING

Service products may be poisonous and hazardous to health. There is a risk of injury.

Comply with instructions on the use, storage and disposal of service products on the labels of the respective original containers. Always store service products sealed in their original containers. Always keep service products out of the reach of children.

#### Environmental note

Dispose of service products in an environmentally responsible manner.

Service products include the following:

- Fuels
- Exhaust gas aftertreatment additives, e.g. DEF
- Lubricants (e.g. engine oil, transmission oil)
- Coolant
- Brake fluid
- Windshield washer fluid
- Climate control system refrigerant

Components and service products must match. You should therefore only use products that have been tested and approved by Mercedes-Benz.

You can identify service products approved by Mercedes-Benz by the following inscriptions on the container:

- MB-Freigabe (e.g. MB-Freigabe 229.51)
- MB-Approval (e.g. MB-Approval 229.51)

Other designations or recommendations indicate a level of quality or a specification in accordance with an MB Sheet Number (e.g. MB 229.5). They have not necessarily been approved by Mercedes-Benz.

Other identifications, for example:

- 0 W-30
- 5 W-30
- 5 W-40

## Fuel

### Important safety notes

#### WARNING

Fuel is highly flammable. If you handle fuel incorrectly, there is a risk of fire and explosion.

You must avoid fire, open flames, creating sparks and smoking. Switch off the engine and, if applicable, the auxiliary heating before refueling.

#### WARNING

Fuel is poisonous and hazardous to health. There is a risk of injury.

You must make sure that fuel does not come into contact with your skin, eyes or clothing and that it is not swallowed. Do not inhale fuel vapors. Keep fuel away from children.

If you or others come into contact with fuel, observe the following:

- Wash away fuel from skin immediately using soap and water.
- If fuel comes into contact with your eyes, immediately rinse them thoroughly with clean water. Seek medical assistance without delay.
- If fuel is swallowed, seek medical assistance without delay. Do not induce vomiting.
- Immediately change out of clothing which has come into contact with fuel.

### Tank capacity

Model	Total capacity
GLE 550 e 4MATIC	21.1 US gal (80.0 l)
All other models	24.6 US gal (93.0 l)

Model	Of which reserve
Mercedes-AMG GLE 43 4MATIC	Approx. 3.2 US gal (12.0 l)
Mercedes-AMG vehicles	Approx. 3.7 US gal (14.0 l)
All other models	Approx. 3.2 US gal (12.0 l)

## Gasoline

### Fuel grade

 Do not use diesel to refuel vehicles with a gasoline engine. Do not switch on the ignition if you accidentally refuel with the wrong fuel. Otherwise, the fuel will enter the fuel system. Even small amounts of the wrong fuel could result in damage to the fuel system and the engine. Notify a qualified specialist workshop and have the fuel tank and fuel lines drained completely.

 Only refuel using unleaded premium grade gasoline with at least 91 AKI/95 RON.

 E10 fuel contains up to 10% bioethanol. Your vehicle is E10-compatible. You can refuel your vehicle using E10 fuel.

 Only use the fuel recommended. Operating the vehicle with other fuels can lead to damage to the fuel system, engine and exhaust system.

 Do not use the following:

- Gasoline with more than 10% ethanol
- E100 (100% ethanol)
- Gasoline with methanol
- M100 (100% methanol)
- Gasoline with metalliferous additives
- Diesel

Do not mix such fuels with the fuel recommended for your vehicle.

 To ensure the longevity and full performance of the engine, only premium-grade unleaded gasoline must be used.

If standard unleaded gasoline is unavailable and you have to refuel with unleaded gasoline of a lower grade, observe the following precautions:

- Only fill the fuel tank to half full with regular unleaded gasoline and fill the rest with premium-grade unleaded gasoline as soon as possible.
- Do not drive at the maximum speed.
- Avoid sudden acceleration and engine speeds over 3,000 rpm.

You will usually find information about the fuel grade on the fuel pump. If you cannot find the label on the fuel pump, ask the gas station staff.

**i** For more information, please contact a qualified specialist workshop or visit <http://www.mbusa.com> (USA only).

As a temporary measure, if the recommended fuel is not available, you may also use regular unleaded gasoline with an octane rating of 87 AKI/91 RON. This may reduce engine performance and increase fuel consumption. Avoid driving at full throttle and sudden acceleration. Never refuel using gasoline with a lower AKI. Information on refueling (▷ page 151).

### Additives

**!** Operating the engine with fuel additives added later can lead to engine failure. Do not mix fuel additives with fuel. This does not include additives for the removal and prevention of residue buildup. Gasoline must only be mixed with additives recommended by Mercedes-Benz. Comply with the instructions for use on the product label. More information about recommended additives can be obtained from any authorized Mercedes-Benz Center.

Mercedes-Benz recommends that you use branded fuels that have additives.

The fuel quality available in some countries may not be sufficient. Residue could build up in the fuel injection system as a result. In such cases, and in consultation with an authorized Mercedes-Benz Center, the fuel may be mixed with the cleaning additive recommended by Mercedes-Benz. You must observe the notes and mixing ratios specified on the container.

## Diesel

### Fuel grade

#### WARNING

If you mix diesel fuel with gasoline, the flash point is lower than that of pure diesel fuel. When the engine is running, exhaust system components could overheat without being noticed. There is a risk of fire.

Never refuel with gasoline. Never mix gasoline with diesel fuel.

**!** Only use Ultra Low Sulfur Diesel (ULSD), otherwise it may lead to increased wear and damage to the fuel system, engine and exhaust system.

**!** Do not use the following:

- gasoline
- diesel with a bio-diesel content greater than 5% (e.g. B20)
- bio-diesel
- vegetable oil
- paraffin
- kerosene
- marine diesel
- heating oil

Do not mix such fuels with diesel fuel and do not use any special additives. Otherwise, engine damage may occur.

**!** In countries outside USA and Canada, only use sulfur-free diesel with a sulfur content under 50 ppm. Otherwise, the emission control system could be damaged.

You will usually find information about the fuel grade on the pump. If you cannot find the label on the pump, ask the staff for assistance.

Information on refueling (▷ page 151).

### Low outside temperatures

**i** Diesel fuel with improved cold flow properties is available during the winter months. Further information about fuel properties can be obtained from oil companies, e.g. at gas stations.

## Flexible Fuel vehicles

### Important safety notes

#### WARNING

Fuel is highly flammable. If you handle fuel incorrectly, there is a risk of fire and explosion.

You must avoid fire, open flames, creating sparks and smoking. Switch off the engine and, if applicable, the auxiliary heating before refueling.

#### WARNING

Fuel is poisonous and hazardous to health. There is a risk of injury.

You must make sure that fuel does not come into contact with your skin, eyes or clothing and that it is not swallowed. Do not inhale fuel vapors. Keep fuel away from children.

If you or others come into contact with fuel, observe the following:

- Wash away fuel from skin immediately using soap and water.
- If fuel comes into contact with your eyes, immediately rinse them thoroughly with clean water. Seek medical assistance without delay.
- If fuel is swallowed, seek medical assistance without delay. Do not induce vomiting.
- Immediately change out of clothing which has come into contact with fuel.

Flexible Fuel vehicles can be refueled with the following fuel types:

- premium-grade unleaded gasoline
- E85 fuel
- a mixture of E85 fuel and premium-grade unleaded gasoline

 Flexible Fuel vehicles can be recognized by the **Ethanol up to E85** sticker on the inside of the fuel filler flap.

## Fuel consumption

The energy content of E85 fuel is less than that of the same amount of premium-grade gasoline. The amount of fuel consumed when operating the vehicle with E85 fuel is therefore higher than with premium-grade gasoline.

## Maintenance

Inform your authorized Mercedes-Benz Center that you are operating or have operated the vehicle with E85 fuel.

## Low outside temperatures

If the outside temperature is below 32 °F (0 °C), the starting procedure can take noticeably longer when operating with E85 fuel.

E85 fuel is not suitable for use at outside temperatures under -4 °F (-20 °C).

## DEF

### Important safety notes

Comply with the important safety notes for service products when handling DEF (▷ page 383). DEF is a water-soluble fluid for the exhaust gas aftertreatment of diesel engines. It is:

- not poisonous
- colorless and odorless
- not flammable

When you open the DEF container, small amounts of ammonia vapor may be released. Ammonia vapors have a pungent odor and are particularly irritating to the skin, to mucous membranes and to the eyes. You may experience a burning sensation in your eyes, nose and throat. Coughing and watering of the eyes are possible.

Do not inhale ammonia vapors. Fill the DEF tank only in well-ventilated areas.

## Low outside temperatures

DEF freezes at a temperature of approximately 12 °F (-11 °C). The vehicle is delivered from the factory equipped with a DEF preheating system. Winter operation can thus be guaranteed even at temperatures below 12 °F (-11 °C).

## Additives

**!** Only use DEF in accordance with ISO 2224 1. Do not use additives with DEF and do not dilute DEF with water. This may destroy the BlueTEC exhaust gas aftertreatment system.

## Purity

**!** Impurities in DEF (e.g. due to other service products, cleaning agents or dust) lead to:

- increased emission values
- damage to the catalytic converter
- engine damage
- malfunctions in the BlueTEC exhaust gas aftertreatment system

Assuring the purity of DEF is particularly important with respect to avoiding malfunctions in the BlueTEC exhaust gas aftertreatment system.

If DEF is pumped out of the DEF tank, e.g. during repair work, it must not be returned to the tank. The purity of the fluid can no longer be guaranteed.

## Filling capacities

Model	Total capacity
All models	8.5 US gal (32.0 l)

## Engine oil

### General notes



**!** Do not use engine oil or an oil filter with specifications deviating from those expressly required for the prescribed service intervals.

Do not change the engine oil or oil filter in order to set replacement intervals longer than those prescribed. This could otherwise cause damage to the engine or exhaust gas aftertreatment.

Follow the instructions on the service interval display for changing the engine oil. This could otherwise cause damage to the engine or exhaust gas aftertreatment.

When handling engine oil, observe the important safety notes on service products (▷ page 383).

The engine oils are matched to the performance of Mercedes-Benz engines and service intervals. You should therefore only use engine oils and oil filters that are approved for vehicles with maintenance systems.

For a list of approved engine oils and oil filters, consult an authorized Mercedes-Benz Center.

Alternatively, visit the website <http://bevo.mercedes-benz.com>.

The table shows which engine oils have been approved for your vehicle.

Gasoline engines	MB-Freigabe or MB-Approval
All models	229.5, 229.6
Mercedes-AMG vehicles	229.5

Diesel engines	MB-Freigabe or MB-Approval
All models	229.52

**Mercedes-AMG vehicles:** only use SAE 0W-40 or SAE 5W-40 engine oils.

**i** MB approval is indicated on the oil containers.

## Filling capacities

The following values refer to an engine oil change, including the oil filter.

Model	Capacity
GLE 300 d 4MATIC	6.9 US qt (6.5 l)
GLE 350 d 4MATIC	8.5 US qt (8.0 l)
Mercedes-AMG GLE 43 4MATIC	7.4 US qt (7.0 l)

Model	Capacity
GLE 550 4MATIC Mercedes-AMG GLE 63 4MATIC Mercedes-AMG GLE 63 S 4MATIC	9.0 US qt (8.5 l)
All other models	7.4 US qt (7.0 l)

### Additives

- !** Do not use any additives in the engine oil. This could damage the engine.

### Brake fluid

#### WARNING

The brake fluid constantly absorbs moisture from the air. This lowers the boiling point of the brake fluid. If the boiling point of the brake fluid is too low, vapor pockets may form in the brake system when the brakes are applied hard. This would impair braking efficiency. There is a risk of an accident.

You should have the brake fluid renewed at the specified intervals.

Comply with the important safety notes for service products when handling brake fluid (▷ page 383).

Only use brake fluid approved for Mercedes-Benz according to MB-Freigabe or MB-Approval 331.0.

Information about approved brake fluid can be obtained at any qualified specialist workshop or on the Internet at

<http://bevo.mercedes-benz.com>.

- i** Have the brake fluid regularly replaced at a qualified specialist workshop in accordance with the replacement intervals and the replacement confirmed in the service report.

### Coolant

#### Important safety notes

#### WARNING

If antifreeze comes into contact with hot components in the engine compartment, it may ignite. There is a risk of fire and injury.

Let the engine cool down before you add antifreeze. Make sure that antifreeze is not spilled next to the filler neck. Thoroughly clean the antifreeze from components before starting the engine.

- !** Only add coolant that has been premixed with the desired antifreeze protection. You could otherwise damage the engine.

Further information on coolants can be found in the Mercedes-Benz Specifications for Service Products, MB BeVo 310.1, e.g. on the Internet at

<http://bevo.mercedes-benz.com>. Or contact a qualified specialist workshop.

- !** Always use a suitable coolant mixture, even in countries where high temperatures prevail. Otherwise, the engine cooling system is not sufficiently protected from corrosion and overheating.

- i** Have the coolant regularly replaced at a qualified specialist workshop and the replacement confirmed in the service report.

Comply with the important safety notes for service products when handling coolant (▷ page 383).

The coolant is a mixture of water and antifreeze/corrosion inhibitor. It is responsible for the following:

- anti-corrosion protection
- antifreeze protection
- raising the boiling point

If the coolant has antifreeze protection down to -35 °F (-37 °C), the boiling point of the coolant during operation is approximately 266 °F (130 °C).

The antifreeze concentrate/corrosion inhibitor concentration in the engine cooling system should:

- be at least 50%. This will protect the engine cooling system against freezing down to approximately -35 °F (-37 °C).
- not exceed 55% (antifreeze protection down to -49 °F [-45 °C]). Otherwise, heat will not be dissipated as effectively.

Mercedes-Benz recommends an antifreeze/corrosion inhibitor concentrate in accordance with MB Specifications for Service Products 310.1.

- i** When the vehicle is first delivered, it is filled with a coolant mixture that ensures adequate antifreeze and anti-corrosion protection.
- i** The coolant is checked at specified intervals at a qualified specialist workshop.

### Filling capacities

Missing values were not available at time of going to print.

Model	Capacity
<b>Mercedes-AMG vehicles</b>	Approx. 11.9 US qt (11.3 l)
<b>GLE 300 d 4MATIC</b>	Approx. 10.7 US qt (10.1 l)
<b>GLE 350</b>	Approx. 11.1 US qt (10.5 l)
<b>GLE 350 4MATIC</b>	Approx. 11.1 US qt (10.5 l)
<b>GLE 350 d 4MATIC</b>	Approx. 12.2 US qt (11.5 l)
<b>GLE 400 4MATIC</b>	Approx. 10.3 US qt (9.7 l)
<b>Mercedes-AMG GLE 43 4MATIC</b>	Approx. 10.3 US qt (9.7 l)
<b>GLE 550 4MATIC</b>	
<b>All other models</b>	Approx. 10.3 US qt (9.7 l)

### Windshield washer system

#### Important safety notes

##### WARNING

Windshield washer concentrate could ignite if it comes into contact with hot engine components or the exhaust system. There is a risk of fire and injury.

Make sure that no windshield washer concentrate is spilled next to the filler neck.

- !** Only MB SummerFit and MB WinterFit washer fluid should be mixed together. The spray nozzles may otherwise become blocked.

Do not use distilled or de-ionized water. Otherwise, the level sensor may give a false reading. When handling washer fluid, observe the important safety notes on service products (> page 383).

At temperatures above freezing:

- ▶ Fill the washer fluid reservoir with a mixture of water and windshield washer fluid, e.g. MB SummerFit.

Add 1 part MB SummerFit to 100 parts water.

At temperatures below freezing:

- ▶ Fill the washer fluid reservoir with a mixture of water and washer fluid, e.g. MB WinterFit. For the correct mixing ratio refer to the information on the antifreeze reservoir.

- i** Add windshield washer fluid, e.g. MB SummerFit or MB WinterFit, to the washer fluid all year round.

### Climate control system refrigerant

#### Important safety notes

The climate control system of your vehicle is filled with refrigerant R-134a.

The instruction label regarding the refrigerant type used can be found on the radiator cross member.

- !** Only the refrigerant R-134a and the PAG oil approved by Mercedes-Benz may be used. The approved PAG oil may not be mixed with any other PAG oil that is not approved for

R-134a refrigerant. Otherwise, the climate control system may be damaged.

Service work, such as refilling with refrigerant or replacing component parts, may only be carried out by a qualified specialist workshop. All applicable regulations, as well as SAE standard J639, must be adhered to.

Always have work on the climate control system carried out at a qualified specialist workshop.

### Refrigerant instruction label



Example: refrigerant instruction label

- ① Warning symbol
- ② Refrigerant filling capacity
- ③ Applicable standards
- ④ PAG oil part number
- ⑤ Type of refrigerant

Warning symbol ① advises you about:

- Possible dangers
- Having service work carried out at a qualified specialist workshop

### Filling capacities

Refrigerant	Capacity
All models	37.0 ± 0.4 oz (1050 ± 10 g)

PAG oil	Capacity
All models	3.9 ± 0.4 oz (110 ± 10 g)

## Vehicle data

### General notes

Please note that for the specified vehicle data:

- the heights specified may vary as a result of:
  - tires
  - load
  - condition of the suspension
  - optional equipment
- optional equipment reduces the maximum payload

Observe the information relating to level control:

- AIRMATIC package (> page 185)
- Offroad Engineering package (> page 215)

### Dimensions and weights



Model	① Opening height	② Max. headroom
Mercedes-AMG G vehicles	85 in 2157 mm - 2159 mm	76.8 in 1949 mm - 1950 mm



All other models with:	① Opening height	② Max. headroom
Steel suspension	86.4 in (2195 mm)	78.2 in (1987 mm)
AIRMATIC package	84.3 in - 87.2 in (2140 mm - 2215 mm)	76.0 in - 79.0 in (1931 mm - 2006 mm)
ON&OFFROAD package	84.3 in - 88.4 in (2140 mm - 2245 mm)	76.0 in - 80.2 in (1931 mm - 2036 mm)

Missing values were not available at time of going to print.

Mercedes-AMG vehicles	
Vehicle length	191.0 in (4852 mm)
Vehicle width including exterior mirrors	84.3 in (2141 mm)
Maximum vehicle height	69.4 in (1762 mm)
Maximum vehicle height (Mercedes-AMG GLE 63 S 4MATIC)	69.3 in (1760 mm)
Wheelbase	114.8 in (2915 mm)
Maximum ground clearance	7.1 in (180 mm)
Turning circle	38.7 ft (11.80 m)
Maximum roof load	220 lb (100 kg)

Mercedes-AMG GLE 43 4MATIC	
Vehicle length	189.6 in (4816 mm)
Vehicle width including exterior mirrors	84.3 in (2141 mm)
Vehicle width without exterior mirrors, without side running board	76.2 in 1935 mm
Vehicle width without exterior mirrors, with side running board	
Maximum vehicle height (steel suspension)	69.4 in (1762 mm)
Maximum vehicle height (AIRMATIC package)	71.6 in (1818 mm)
Maximum vehicle height (ON&OFFROAD package)	72.8 in (1848 mm)
Minimum vehicle height (AIRMATIC package, ON&OFFROAD package)	69.2 in (1758 mm)
Wheelbase	114.8 in (2915 mm)
Maximum ground clearance (steel suspension)	8.0 in (202 mm)
Maximum ground clearance (AIRMATIC package)	10.0 in (255 mm)
Maximum ground clearance (ON&OFFROAD package)	11.2 in (285 mm)
Minimum ground clearance (AIRMATIC package, ON&OFFROAD package)	7.1 in (180 mm)
Maximum roof load	220 lbs (100 kg)

All other models	
Vehicle width including exterior mirrors	84.3 in (2141 mm)
Maximum vehicle height (steel suspension)	70.7 in (1796 mm)
Maximum vehicle height (AIRMATIC package)	71.6 in (1818 mm)
Maximum vehicle height (ON&OFFROAD package)	72.8 in (1848 mm)
Minimum vehicle height	69.2 in (1758 mm)
Wheelbase	114.8 in (2915 mm)
Maximum ground clearance (steel suspension)	8.0 in (202 mm)
Maximum ground clearance (AIRMATIC package)	10.0 in (255 mm)
Maximum ground clearance (ON&OFFROAD package)	11.2 in (285 mm)
Minimum ground clearance	7.1 in (180 mm)
Turning circle	38.7 ft (11.80 m)
Maximum roof load	220 lb (100 kg)

Model	Vehicle length
GLE 400 4MATIC	189.5 in (4813 mm)
GLE 550 4MATIC	189.5 in (4813 mm)
All other models	189.7 in (4819 mm)

## Vehicle data for off-road driving

### Fording depth

**!** The depth of water must not exceed the value specified in the table. Note that the possible fording depth is less in flowing water.



#### ① Fording depth

On vehicles with the AIRMATIC package or the Off-Road Engineering package, loads up to the maximum permissible load have no influence on fording capability.

Missing values were not available at the time of going to print.

	Fording depth
<b>Steel-sprung vehicles</b>	19.7 in (50 cm)
<b>Vehicles with the AIRMATIC package</b>	
Raised level	19.7 in (50 cm)
<b>Vehicles with the Off-Road Engineering package</b>	
Off-road level 1	19.7 in (50 cm)
Off-road level 2	19.7 in (50 cm)
Off-road level 3	23.6 in (60 cm)
<b>Mercedes-AMG vehicles</b>	
Raised level	19.7 in (50 cm)

For more information about off-road fording, see (▷ page 164).

### Approach/departure angle



All vehicles (except vehicles with AMG body-styling)

	①	②
<b>Steel-sprung vehicles</b>	26°	26°
<b>Vehicles with the AIRMATIC package</b>		
Normal level	23°	24°
Raised level	29°	28°
<b>Vehicles with the Off-Road Engineering package</b>		
Normal level	23°	24°
Off-road level 1	26°	26°
Off-road level 2	29°	28°
Off-road level 3	30°	29°
<b>Mercedes-AMG vehicles</b>		
Normal level (in sport mode with AMG adaptive sport suspension system activated)	21°	24°
Raised level	23°	24°

### Vehicles with AMG bodystyling

	①	②
<b>Steel-sprung vehicles</b>	23°	26°
<b>Vehicles with the AIRMATIC package</b>		
Normal level	22°	24°
Raised level	26°	28°
<b>Vehicles with the Off-Road Engineering package</b>		
Normal level	22°	24°
Off-road level 1	24°	26°
Off-road level 2	26°	28°
Off-road level 3	28°	29°

For further information about approach/departure angles, see (▷ page 168).

### Maximum gradient-climbing capability

Note that the vehicle's gradient-climbing capability depends on the off-road conditions and the road surface conditions.

**Vehicles with the Off-Road Engineering package:** the maximum gradient climbing ability is 100 % when the LOW RANGE off-road gear is selected.

**Mercedes-AMG vehicles:** the maximum gradient climbing ability is 80 %.

**Vehicles without the Off-Road Engineering package:** the maximum gradient climbing ability is 80 %.

**GLE 550 e 4MATIC:** the maximum gradient climbing ability is 50 %.

Accelerate carefully and make sure that the wheels do not spin when driving on steep terrain.

**i** If the load on the front axle is reduced when pulling away on a steep uphill slope, the front wheels have a tendency to spin. 4ETS recognizes this and brakes the wheels accordingly. The rear wheel torque is increased, making it easier to drive off.

For further information about the maximum gradient climbing ability, see (▷ page 168).

## Trailer tow hitch

### Mounting dimensions

**I** If you have a trailer tow hitch retrofitted, changes to the cooling system and drive train may be necessary, depending on the vehicle type.

If you have a trailer tow hitch retrofitted, observe the anchorage points on the chassis frame.

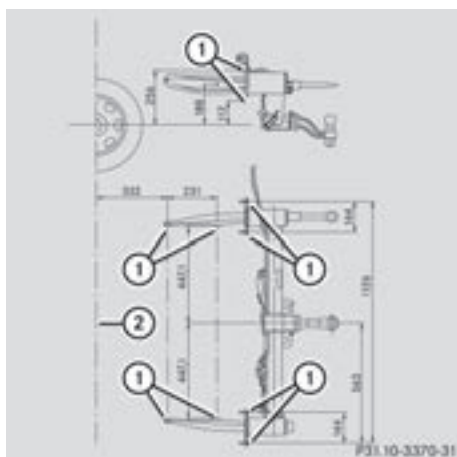

- ① Anchorage points for the trailer tow hitch
- ② Rear axle center line

### Trailer loads

#### Permissible trailer load, braked (at a minimum gradient-climbing capability of 12% from a standstill)

Missing values were not available at the time of going to print.

<b>All models</b>	7200 lbs (3265 kg)
<b>GLE 300 d 4MATIC</b>	6615 lbs (3000 kg)
<b>GLE 350</b>	6615 lbs (3000 kg)

#### Mercedes-AMG GLE 43 4MATIC

<b>GLE 550 e 4MATIC</b>	4410 lbs (2000 kg)
-------------------------	--------------------

#### Maximum drawbar noseweight (the drawbar noseweight is not included in the trailer load)

Missing values were not available at the time of going to print.

<b>All models</b>	575 lbs (261 kg)
<b>GLE 300 d 4MATIC</b>	530 lbs (240 kg)
<b>GLE 350</b>	530 lbs (240 kg)
<b>Mercedes-AMG GLE 43 4MATIC</b>	
<b>GLE 550 e 4MATIC</b>	355 lbs (160 kg)

The actual noseweight may not be higher than the value which is given. The value can be found on the trailer tow hitch or trailer identification plates. The lowest weight applies.

The maximum permissible trailer drawbar noseweight is the maximum weight with which the trailer drawbar can be loaded. Limit for Mercedes-Benz-approved trailer couplings.

#### Gross rear axle weight rating when towing a trailer

Missing values were not available at the time of going to print.

<b>All models</b>	3527 lbs (1600 kg)
<b>GLE 300 d 4MATIC</b>	3638 lbs (1650 kg)
<b>GLE 350 d 4MATIC</b>	3638 lbs (1650 kg)
<b>Mercedes-AMG GLE 43 4MATIC</b>	

GLE 550 e 4MATIC	3704 lbs (1680 kg)
Mercedes-AMG GLE 63 4MATIC	3858 lbs (1750 kg)
Mercedes-AMG GLE 63 S 4MATIC	

### Ball position of the ball coupling

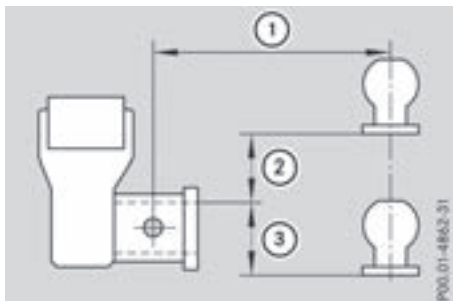

- ① 7.5"
- ② 2"
- ③ 2.75"

When choosing a ball coupling, the dimensions stated in the illustration must not be exceeded.

