



VOLVO S80

OWNERS MANUAL

Web Edition



Volvo. for life



DEAR VOLVO OWNER

THANK YOU FOR CHOOSING VOLVO

We hope you will enjoy many years of driving pleasure in your Volvo. The car has been designed for the safety and comfort of you and your passengers. Volvo is one of the safest cars in the world. Your Volvo has also been designed to satisfy all current safety and environmental requirements.

In order to increase your enjoyment of the car, we recommend that you familiarise yourself with the equipment, instructions and maintenance information contained in this owner's manual.



00 Introduction

Important information.....	6
Volvo and the environment.....	11

00



01 Safety

Seatbelts	16
Airbags.....	19
Activating/deactivating the airbag*.....	22
Side airbags (SIPS bags)	24
Inflatable Curtain (IC)	26
WHIPS	27
When the systems deploy	29
Safety mode.....	30
Child safety.....	31

01



02 Locks and alarm

Remote control key/key blade.....	44
Privacy locking*.....	49
Battery replacement, remote control key/ PCC*.....	50
Keyless drive*.....	52
Locking/unlocking.....	55
Child safety locks.....	60
Alarm*.....	61

02



03 Your driving environment

Instruments and controls.....	66
Instruments and controls - Executive	75
Volvo Sensus	76
Key positions.....	77
Seats.....	79
Seats - Executive.....	83
Steering wheel.....	85
Lighting.....	86
Wipers and washing.....	96
Windows, rearview and door mirrors.....	98
Compass*.....	104
Power sunroof*.....	105
Alcoguard*.....	107
Starting the engine.....	111
Starting the engine – Flexifuel.....	113
Starting the engine – external battery.....	115
Gearboxes.....	116
Eco Start/Stop DRIVE*.....	122
All-wheel drive – AWD*.....	129
Foot brake.....	130
Parking brake.....	132
HomeLink® *.....	136



04 Comfort and driving pleasure

Menus and messages.....	142
Menu source MY CAR.....	144
Climate control.....	152
Fuel-driven engine block heater and passenger compartment heater*.....	162
Additional heater*.....	165
Trip computer.....	166
DSTC – Stability and traction control system.....	168
Adapting driving characteristics.....	170
Cruise control*.....	171
Adaptive cruise control*.....	173
Distance Warning*.....	183
City Safety™.....	186
Collision Warning with Auto Brake & Pedestrian Protection*.....	190
Driver Alert System – DAC*.....	197
Driver Alert System - LDW*.....	200
Park assist syst*.....	203
Park assist camera*.....	206
BLIS* – Blind Spot Information System. .	209
Comfort inside the passenger compartment.....	213
Comfort inside the passenger compartment - Executive.....	217



05 Infotainment system

General information on infotainment.....	220
Quick start.....	222
General infotainment functions.....	227
Radio.....	230
Media player.....	237
External audio source via AUX/USB* input.....	241
Media Bluetooth®*.....	244
TV*.....	247
Remote control*.....	250
Bluetooth® handsfree*.....	252
Voice recognition* mobile phone.....	260
RSE - Rear Seat Entertainment system*.....	264
Menu navigation, Infotainment.....	273



06 During your journey

Recommendations during driving.....	280
Refuelling.....	283
Fuel.....	284
Loading.....	288
Cargo area	290
Driving with a trailer.....	291
Towing and recovery.....	297

06



07 Wheels and tyres

General	302
Changing wheels	306
Tyre pressure	309
Warning triangle and first-aid kit*.....	310
Emergency puncture repair (TMK)*	311

07



08 Maintenance and service

Engine compartment.....	318
Lamps.....	325
Wiper blades and washer fluid.....	332
Battery.....	334
Fuses.....	339
Car care.....	350

08

01 10
00 11

09 Specifications

Type designations.....	358
Dimensions and weights.....	360
Engine specifications.....	364
Engine oil.....	366
Fluids and lubricants.....	368
Fuel.....	370
Wheel and tyres, dimensions and pressure	373
Electrical system.....	375
Type approval.....	376
Symbols in the display.....	388

A-Z

10 Alphabetical Index

Alphabetical Index.....	392
-------------------------	-----



Important information

Reading the Owner's Manual

Introduction

A good way of getting to know your new car is to read the owner's manual, ideally before your first journey. This will give you the opportunity to familiarise yourself with new functions, to see how best to handle the car in different situations, and to make the best use of all the car's features. Please pay attention to the safety instructions contained in the manual.

The specifications, design features and illustrations in this owner's manual are not binding. We reserve the right to make modifications without prior notice.

© Volvo Car Corporation

Option

All types of option/accessory are marked with an asterisk*.

In addition to standard equipment, this manual also describes options (factory fitted equipment) and certain accessories (retrofitted extra equipment).

The equipment described in the owner's manual is not available in all cars - they have different equipment depending on adaptations for the needs of different markets and national or local laws and regulations.

In the event of uncertainty over what is standard or an option/accessory, contact a Volvo dealer.

Special texts

WARNING

Warning texts advise of a risk of personal injury.

IMPORTANT

Important texts advise of a risk of material damage.

NOTE

NOTE texts give advice or tips that facilitate the use of features and functions for example.

Footnote

There is footnote information in the owner's manual that is located at the bottom of the page. This information is an addition to the text that it refers to via a number. If the footnote refers to text in a table then letters are used instead of numbers for referral.

Message texts

There are displays in the car that show text messages. These text messages are high-

lighted in the owner's manual by means of the text being slightly larger and printed in grey. Examples of this are in menu texts and message texts on the information display (e.g. **Audio settings**).

Decals

The car contains different types of decal which are designed to convey important information in a simple and clear manner. The decals in the car have the following descending degree of importance for the warning/information.

Warning for personal injury

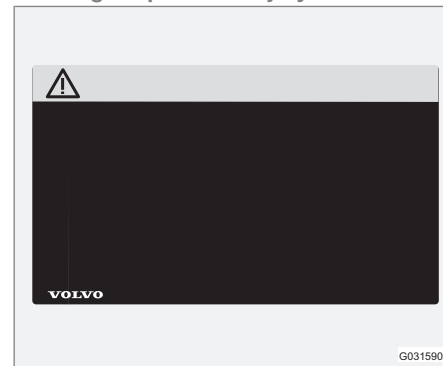

Black ISO symbols on yellow warning field, white text/image on black message field. Used to indicate the presence of danger which, if the



Important information

warning is ignored, may result in serious personal injury or fatality.

Risk of property damage

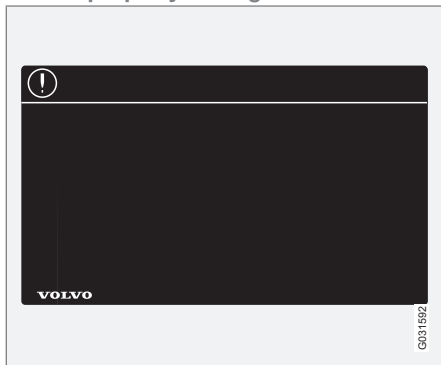

White ISO symbols and white text/image on black or blue warning field and message field. Used to indicate the presence of danger which, if the warning is ignored, may result in damage to property.

Information

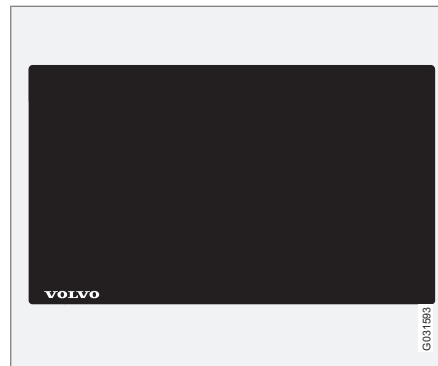

White ISO symbols and white text/image on black message field.

NOTE

The labels shown in the owner's manual are not provided as exact reproductions of those in the car. The purpose is to show their approximate appearance and location in the car. The information that applies to your car in particular is available on the label in question in your car.

Procedure lists

Procedures where action must be taken in a certain sequence are numbered in the owner's manual.

- 1 When there is a series of illustrations for step-by-step instructions each step is numbered in the same way as the corresponding illustration.
- A There are numbered lists with letters adjacent to the series of illustrations where the order of the instructions is not significant.
- ➔ Arrows appear numbered and unnumbered and are used to illustrate a movement.

If there is no series of illustrations for step-by-step instructions then the different steps are numbered with normal numbers.

Position lists

- 1 Red circles containing a number are used in overview images where different components are pointed out. The number recurs in the position list featured in connection with the illustration that describes the item.

Bulleted lists

A bulleted list is used when there is a list of points in the owner's manual.

Example:



Important information

- Coolant
- Engine oil

To be continued

▶▶ This symbol is located furthest down to the right when a section continues on the following page.

Recording data

Your vehicle contains a number of computers whose function is to continuously check and monitor the vehicle's operation and functionality. Some of the computers can record information during normal driving if they detect an error. In addition, information is recorded in the event of a crash or incident. Parts of the recorded information are required so that technicians can diagnose and rectify faults in the vehicle during servicing and maintenance and so that Volvo can fulfil legal requirements and other regulations. In addition to this, the information is used for research purposes by Volvo in order to continually develop quality and safety, as the information can contribute to a better understanding of the factors that cause accidents and injuries. The information includes details of the status and functionality of various systems and modules in the vehicle with regard to engine, throttle, steering and brake systems, amongst other things. This information may include details regarding the

way the driver drives the vehicle, such as vehicle speed, brake and accelerator pedal use, steering wheel movement and whether or not the driver and passengers have used their seatbelts. For the reasons given this information may be stored in the vehicle's computers for a certain length of time, but also as a result of a collision or incident. This information may be stored by Volvo as long as it can help to further develop and further enhance safety and quality and as long as there are legal requirements and other regulations that Volvo needs to consider.

Volvo will not contribute to the above-described information being disclosed to third parties without the vehicle owner's consent. However, due to national legislation and regulations Volvo may be required to disclose such information to authorities such as police authorities, or others who may assert a legal right to have access to it.

To be able to read and interpret the information recorded by the computers in the vehicle requires special technical equipment that Volvo, and workshops that have entered into agreements with Volvo, have access to. Volvo is responsible that the information, which is transferred to Volvo during servicing and maintenance, is stored and handled in a secure manner and that the handling complies with

applicable legal requirements. For further information - contact a Volvo dealer.

Accessories and extra equipment

The incorrect connection and installation of accessories can negatively affect the car's electrical system. Certain accessories only function when their associated software is installed in the car's computer system. Volvo therefore recommends that you always contact an authorised Volvo workshop before installing accessories which are connected to or affect the electrical system.

Change of ownership for cars with Volvo On Call*

Volvo On Call is a supplemental service that consists of safety, security and comfort services. If the car has Volvo On Call and there is a change of owner, it is very important that these services are discontinued so that the former owner cannot access the services in the car. Contact the call centre by pressing the **ON CALL** button in the car or contact an authorised Volvo workshop. See also "Changing the security code" in the owner's manual for Volvo On Call.



Important information

Laser sensor

This vehicle is equipped with a sensor which transmits laser light. It is absolutely essential to follow the prescribed instructions when handling the laser sensor.

The following two labels in English are fitted directly on the laser sensor unit:

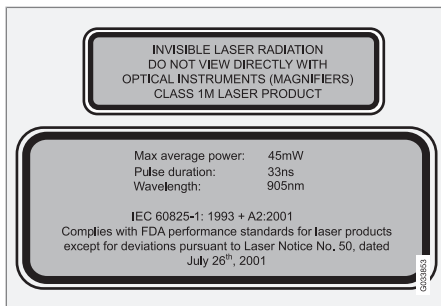

The upper label in the figure describes the laser beam's classification:

- Laser radiation - Do not look into the laser beam with optical instruments - Class 1M laser product.

The lower label in the figure describes the laser beam's physical data:

- IEC 60825-1:1993 + A2:2001. Complies with FDA (U.S. Food Administration) standards for laser product design with the

exception of deviations in accordance with "Laser Notice No. 50" from 26 July 2001.

Radiation data for the laser sensor

The following table specifies the laser sensor's physical data.

Maximum pulse energy	2.64 μ J
Maximum average output	45 mW
Pulse duration	33 ns
Divergence (horizontal x vertical)	28° x 12°



WARNING

If any of these instructions are not followed then there is a risk of eye injury!

- Never look into the laser sensor (which emits spreading invisible laser radiation) at a distance of 100 mm or closer with magnifying optics such as a magnifying glass, microscope, lens or similar optical instruments.
- Testing, repair, removal, adjustment and/or replacement of the laser sensor's spare parts must only be carried out by a qualified workshop - we recommend an authorised Volvo workshop.
- To avoid exposure to harmful radiation, do not carry out any readjustments or maintenance other than those specified here.
- The repairer must follow specially drawn up workshop information for the laser sensor.
- Do not remove the laser sensor (this includes removing the lenses). A removed laser sensor does not fulfil laser class 3B as per standard IEC 60825-1. Laser class 3B is not eye-safe and therefore entails a risk of injury.



Important information

- The laser sensor's connector must be unplugged before removal from the windscreen.
- The laser sensor must be fitted onto the windscreen before the sensor's connector is plugged in.
- The laser sensor transmits laser light when the remote control key is in position II and also with the engine switched off (see page 77 on key positions).

For more information on the laser sensor, see page 186.

Information on the Internet

At www.volvocars.com there is further information concerning your car.



Volvo and the environment

Volvo Cars' environmental philosophy



Environmental care is one of Volvo Car Corporation's core values which influence all operations. We also believe that our customers share our consideration for the environment.

Your Volvo complies with strict international environmental standards and is also manufactured in one of the cleanest and most resource-efficient plants in the world. Volvo Car Corporation has global ISO certification, which includes the environmental standard ISO 14001 covering all factories and several of our other units. We also set requirements for our partners so that they work systematically with environmental issues.

Fuel consumption

Volvo cars have competitive fuel consumption in each of their respective classes. Lower fuel consumption generally results in lower emission of the greenhouse gas, carbon dioxide.

It is possible for the driver to influence fuel consumption. For more information read under the heading, **Reducing environmental impact**.

Efficient emission control

Your Volvo is manufactured following the concept "Clean inside and out" – a concept that encompasses a clean interior environment as well as highly efficient emission control. In

many cases the exhaust emissions are well below the applicable standards.

Clean air in the passenger compartment

A passenger compartment filter prevents dust and pollen from entering the passenger compartment via the air intake.

A sophisticated air quality system, IAQS* (Interior Air Quality System) ensures that the incoming air is cleaner than the air in the traffic outside.

The system consists of an electronic sensor and a carbon filter. The incoming air is monitored continuously and if there is an increase in

* Option/accessory, for more information, see Introduction.



Volvo and the environment

the level of certain unhealthy gases such as carbon monoxide then the air intake is closed. Such a situation may arise in heavy traffic, queues and tunnels for example.

The entry of nitrous oxides, ground-level ozone and hydrocarbons is prevented by the carbon filter.

Interior

The interior of a Volvo is designed to be pleasant and comfortable, even for people with contact allergies and for asthma sufferers. Extreme attention has been given to choosing environmentally-compatible materials.

Volvo workshops and the environment

Regular maintenance creates the conditions for a long service life and low fuel consumption for your car. In this way you contribute to a cleaner environment. When Volvo's workshops are entrusted with the service and maintenance of your car it becomes part of our system. Volvo makes clear demands regarding the way in which our workshops are designed in order to prevent spills and discharges into the environment. Our workshop staff have the knowledge and the tools required to guarantee good environmental care.

Reducing environmental impact

You can easily help reduce environmental impact - here are a few tips:

- Avoid letting the engine idle - switch off the engine when stationary for longer periods. Pay attention to local regulations.
- Drive economically - think ahead.
- Perform service and maintenance in accordance with the owner's manual's instructions - follow the Service and Warranty Booklet's recommended intervals.
- If the car is equipped with an engine block heater*, use it before starting from cold - it improves starting capacity and reduces wear in cold weather and the engine reaches normal operating temperature more quickly, which lowers consumption and reduces emissions.
- High speed increases consumption considerably due to increased wind resistance - a doubling of speed increases wind resistance 4 times.
- Always dispose of environmentally hazardous waste, such as batteries and oils, in an environmentally safe manner. Consult a workshop in the event of uncertainty about how this type of waste should be discarded - an authorised Volvo workshop is recommended.

Following this advice can save money, the planet's resources are saved, and the car's durability is extended. For more information and further advice, see the pages 280 and 370.

Recycling

As a part of Volvo's environmental work, it is important that the car is recycled in an environmentally sound manner. Almost all of the car can be recycled. The last owner of the car is therefore requested to contact a dealer for referral to a certified/approved recycling facility.

The owner's manual and the environment

The Forest Stewardship Council® symbol shows that the paper pulp in this publication comes from FSC® certified forests or other controlled sources.





Seatbelts	16
Airbags.....	19
Activating/deactivating the airbag*	22
Side airbags (SIPS bags)	24
Inflatable Curtain (IC)	26
WHIPS	27
When the systems deploy	29
Safety mode.....	30
Child safety.....	31



01

SAFETY





Seatbelts

General information



Heavy braking can have serious consequences if the seatbelts are not used. Ensure that all passengers use their seatbelts.

It is important that the seatbelt lies against the body so it can provide maximum protection. Do not lean the backrest too far back. The seatbelt is designed to protect in a normal seating position.

Putting on a seatbelt

Pull the belt out slowly and secure it by pressing its locking tab into the seatbelt buckle. A loud "click" indicates that the belt has locked.

The buckles only fit the intended lock in the rear seat¹.

Releasing the seatbelt

Press the red button on the seatbelt buckle and then let the belt retract. If the seatbelt does not retract fully, feed it in by hand so that it does not hang loose.

The seatbelt locks and cannot be withdrawn:

- if it is pulled out too quickly
- during braking and acceleration
- if the car leans heavily.

Make sure that you:

- do not use clips or anything else that can prevent the seatbelt from fitting properly
- ensure that the seatbelt is not twisted or caught on anything
- the hip strap must be positioned low down (not over the abdomen)
- tension the hip strap over the lap by pulling the diagonal shoulder belt up towards the shoulder.

! WARNING

Each seatbelt is designed for only one person.

! WARNING

Never modify or repair the seatbelts yourself. Volvo recommends that you contact an authorised Volvo workshop.

If a seatbelt has been subjected to a major load, such as in conjunction with a collision, the entire seatbelt must be replaced. Some of the protective characteristics of the seatbelt may have been lost, even if it appears to be undamaged. In addition, replace the seatbelt if the belt is worn or damaged. The new seatbelt must be type-approved and intended for installation in the same position as the replaced seatbelt.

! WARNING

The seatbelts and airbags interact. If a seatbelt is not used or is used incorrectly, this may diminish the protection provided by the airbag in the event of a collision.

¹ Certain markets.



Seatbelts

Seatbelts and pregnancy



The seatbelt should always be worn during pregnancy. But it is then crucial that it be worn in the correct way. The diagonal section should wrap over the shoulder then be routed between the breasts and to the side of the abdomen.

The lap section should lay flat over the thighs and as low as possible under the abdomen. – It must never be allowed to ride upward. Remove the slack from the seatbelt and ensure that it fits as close to the body as possible. In addition, check that there are no twists in the seatbelt.

As the pregnancy progresses, pregnant drivers should adjust their seats and steering wheel such that they can easily maintain control of the vehicle as they drive (which means that they must be able to easily operate the foot pedals

and steering wheel). The aim should be to position the seat with as large a distance as possible between abdomen and steering wheel.

Seatbelt reminder



Unbelted occupants will be reminded to fasten their seatbelts by means of an audio and visual reminder. The audio reminder is speed dependent, and in some cases time dependent. The visual reminder is located in the roof console and the combined instrument panel.

Child seats are not covered by the seatbelt reminder system.

Rear seat

The seatbelt reminder in the rear seat has two subfunctions:

- Provides information on which seatbelts are being used in the rear seat. A message appears in the information display when the seatbelts are in use, or if one of the rear doors has been opened. The message is cleared automatically after driving for approximately 30 seconds or after pressing the indicator stalk's **READ** button.
- Provides a warning if one of the rear seatbelts is unfastened during travel. This warning takes the form of a message on the information display along with the audio/visual signal. The warning stops when the seatbelt is re-fastened, or it can also be acknowledged manually by pressing the **READ** button.

The message on the information display showing which seatbelts are in use is always available. Press the **READ** button to see stored messages.



Seatbelts

Certain markets

An acoustic signal and indicator lamp remind the driver and front seat passenger to use a seatbelt if either of them is not wearing one. At low speed, the audio reminder will sound for the first 6 seconds.

Seatbelt tensioner

All the seatbelts are equipped with belt tensioners. A mechanism in the seatbelt tensioner tightens the seatbelt in the event of a sufficiently violent collision. The seatbelt then provides more effective restraint for the occupants.



WARNING

Never insert the tongue of the passenger's seatbelt into the buckle on the driver's side. Always insert the tongue of the seatbelt into the buckle on the correct side. Do not make any damages on seatbelts nor insert any foreign objects into a buckle. The seatbelts and buckles would then possibly not function as intended in the event of a collision. There is a risk of serious injury.



Airbags

Warning symbol on the combined instrument panel

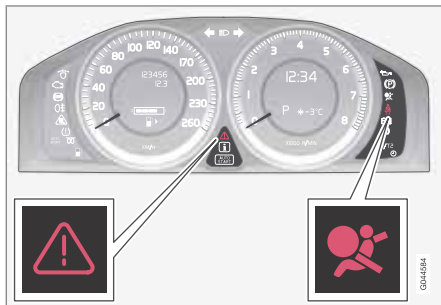

The warning symbol in the combined instrument panel illuminates when the remote control key is in key position II or III. The symbol clears after approx. 6 seconds provided the airbag system is fault-free.

WARNING

If the warning symbol for the airbag system remains illuminated or illuminates while driving, it means that the airbag system does not have full functionality. The symbol indicates a fault in the seatbelt tensioner system, SIPS, the IC system or some other fault in the system. Volvo recommends that you contact an authorised Volvo workshop immediately.

As well as the warning symbol, a message may appear on the information display in appropriate cases. If the warning symbol malfunctions, the warning triangle illuminates and **SRS Airbag Service required** or **SRS Airbag Service urgent** appears in the display. Volvo recommends that you contact an authorised Volvo workshop immediately.

Airbag system

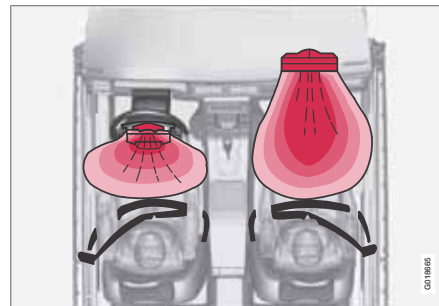

Airbag system, left-hand drive car.

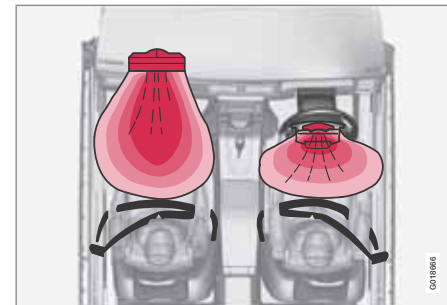

Airbag system, right-hand drive car.

The system consists of airbags and sensors. A sufficiently violent collision trips the sensors and the airbag(s) are inflated with hot gas. To cushion the impact, the airbag deflates when compressed. When this occurs, smoke escapes into the car. This is completely normal. The entire process, including inflation and deflation of the airbag, occurs within tenths of a second.

WARNING

Volvo recommends that you contact an authorised Volvo workshop for repair. Defective work in the airbag system could cause malfunction and result in serious personal injury.



Airbags

NOTE

The sensors react differently depending on the course of the collision and whether or not the seatbelts on the driver and passenger side are used.

It is therefore possible that only one (or none) of the airbags may inflate in a collision. The airbag system senses the force of the collision on the car and adapts accordingly so that one or more airbags are deployed.

The capacity of the airbags is also adapted to the collision force to which the vehicle is subjected.



Location of the front passenger airbag in a left-hand drive car.



Location of the front passenger airbag in a right-hand drive car.

Airbag on the driver's side

The car has an airbag to supplement the protection afforded by the seatbelt on the driver's side. It is folded up into the centre of the steering wheel. The steering wheel is marked **AIRBAG**.

WARNING

The seatbelts and airbags interact. If a seatbelt is not used or is used incorrectly, this may diminish the protection provided by the airbag in the event of a collision.

Passenger airbag

The car has an airbag to supplement the protection afforded by the seatbelt on the passenger side. It is folded up into a compartment above the glovebox. Its cover panel is marked **AIRBAG**.

WARNING

To minimise the risk of injury if the airbag deploys, passengers must sit as upright as possible with their feet on the floor and backs against the backrest. Seatbelts must be secured.

WARNING

Do not put objects in front of or above the dashboard where the passenger airbag is located.

** WARNING**

Never place a child in a child seat or on a booster cushion in the front seat if the airbag is activated.

Never allow anybody to stand or sit in front of the front passenger seat.

No one shorter than 140 cm should ever sit in the front passenger seat if the airbag is activated.

Failure to follow the advice given above can endanger life.



Activating/deactivating the airbag*

Key switch off - PACOS*

General information

The airbag for the front passenger seat can be deactivated if the car is equipped with a switch, PACOS (Passenger Airbag Cut Off Switch). For information on how to activate/deactivate, see under the heading Activating/deactivating.

Key switch off/switch

The switch for the passenger airbag (PACOS) is located on the passenger end of the instrument panel and is accessible when the passenger door is open (see under the heading below, Activating/deactivating).

Check that the switch is in the required position. Volvo recommends that the remote control key's key blade be used to change position.

For information on the key blade, see page 47.

WARNING

Failure to follow the advice given above could endanger the life of passengers in the car.

WARNING

If the car is equipped with a front passenger airbag, but does not have a PACOS switch (Passenger Airbag Cut Off Switch), then the airbag will always be activated.

WARNING

Never place a child in a child seat or on a booster cushion in the front seat if the airbag is activated and the symbol  in the roof console is illuminated. Failure to follow this advice could endanger the life of the child.

WARNING

Do not allow anyone to sit in the front passenger seat if the message in the roof console (see page 23) indicates that the airbag is deactivated and if the warning symbol for the airbag system is also displayed in the combined instrument panel. This indicates that there has been a severe malfunction. Visit a workshop as soon as possible. Volvo recommends that you contact an authorised Volvo workshop.

Activating/deactivating



Switch location

- A** The airbag is activated. With the switch in this position, persons taller than 140 cm can sit in the front passenger seat, but never children in a child seat or on a booster cushion.
- B** The airbag is deactivated. With the switch in this position, children in a child seat or on a booster cushion can sit in the front passenger seat, but never persons taller than 140 cm.



Activating/deactivating the airbag*

! WARNING**Activated airbag (passenger seat):**

Never place a child in a child seat or on a booster cushion on the front passenger seat when the airbag is activated. This applies to everyone shorter than 140 cm.

Deactivated airbag (passenger seat):

No one taller than 140 cm should ever sit in the front passenger seat when the airbag is deactivated.

Failure to follow the advice given above can endanger life.

Messages

Indicator showing that the passenger airbag is deactivated.

A text message and a symbol in the roof console indicate that the airbag for the front passenger seat is deactivated (see preceding illustration).



Indicator showing that the passenger airbag is activated.

A warning symbol in the roof console indicates that the airbag for the front passenger seat is activated (see preceding illustration).

i NOTE

When the remote control key is in key position II or III the warning symbol for the airbag is displayed on the combined instrument panel for approx. 6 seconds (see page 19).

Following which, the indicator in the roof console is illuminated showing the correct status for the front passenger seat airbag. For more information about the different key positions for the remote control key, see page 77.



Side airbags (SIPS bags)

Side airbag



In a side impact collision a large proportion of the collision force is transferred by the SIPS (Side Impact Protection System) to beams, pillars, the floor, the roof and other structural parts of the body. The side airbags at the driver's and front passenger seats protect the chest area and the hip and are an important part of the SIPS.

The SIPS bag system consists of two main components, side airbag and sensors. The side airbags are located in the front seat backrests.

WARNING

- Volvo recommends that repairs are only carried out by an authorised Volvo workshop. Defective work in the SIPS-bag system could cause malfunction and result in serious personal injury.
- Do not put objects in the area between the outside of the seat and the door panel, since this area is required by the side airbag.
- Volvo recommends the use only of car seat covers approved by Volvo. Other seat covers may impede the operation of the side airbags.
- The side airbag is a supplement to the seatbelts. Always use a seatbelt.

Child seats and side airbags

The protection provided by the car to children seated in a child seat or on a booster cushion is not diminished by the side airbag.

A child seat or booster cushion can be placed on the front passenger seat provided that the car does not have an activated¹ passenger airbag.

Location

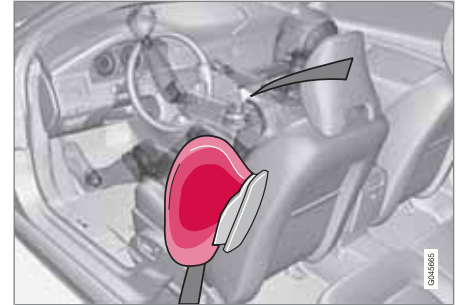

Driver's seat, left-hand drive.

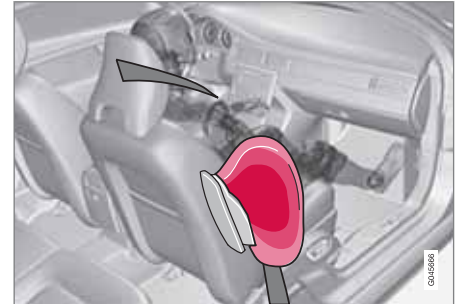

Front passenger seat, left-hand drive.

The SIPS bag system consists of side airbags and sensors. A sufficiently violent collision trips

¹ For information on activating/deactivating the airbag, see page 22.

**Side airbags (SIPS bags)**

the sensors and the side airbags are inflated. The airbag inflates between the occupant and the door panel and thereby cushions the initial impact. The airbag deflates when compressed by the collision. The side airbag is normally only deployed on the side of the collision.



Inflatable Curtain (IC)

Properties

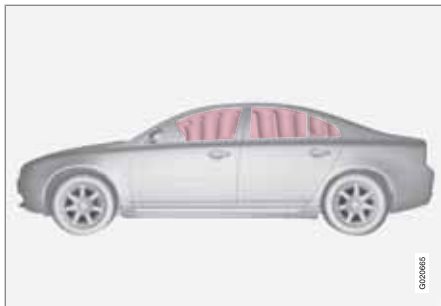

The inflatable curtain IC (Inflatable Curtain) is a part of SIPS and the airbags. It is fitted in the headlining along both sides of the roof and protects the car's occupants sitting in the outer seats. A sufficiently violent collision trips the sensors and the inflatable curtain is inflated. The inflatable curtain helps to prevent the driver and passengers from striking their heads on the inside of the car during a collision.

WARNING

Never hang or attach heavy items onto the handles in the roof. The hook is only designed for light clothing (not for solid objects such as umbrellas for example).

Do not screw or install anything onto the car's headlining, door pillars or side panels. This could compromise the intended protection. Volvo recommends that you only ever use Volvo genuine parts that are approved for placement in these areas.

WARNING

Do not load the car higher than 50 mm under the top edge of the door windows. Otherwise, the intended protection of the inflatable curtain, which is concealed in the headlining, may be compromised.

WARNING

The inflatable curtain is a supplement to the seatbelts.

Always use a seatbelt.

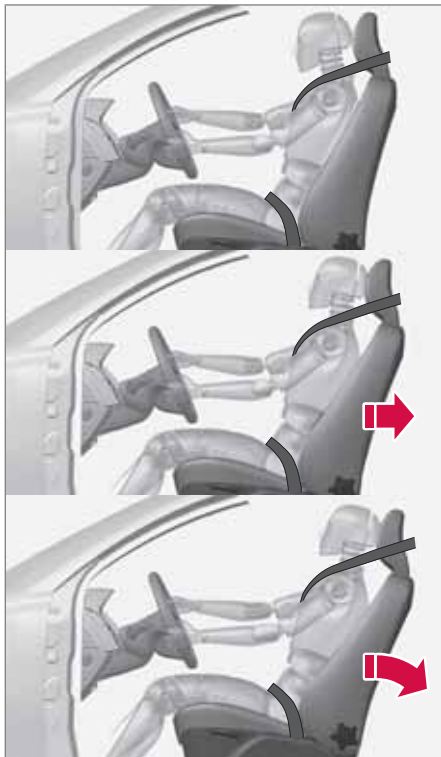
**WHIPS****Protection against whiplash injury – WHIPS**

The whiplash protection system (WHIPS) consists of energy absorbing backrests and specially designed head restraints in the front seats. The system is actuated by a rear-end collision, where the angle and speed of the collision, and the nature of the colliding vehicle all have an influence.

WARNING

The WHIPS system is a supplement to the seatbelts. Always use a seatbelt.

Properties of the seat

When the WHIPS system is deployed, the front seat backrests are lowered backward to alter the seating position of the driver and front seat passenger. This reduces the risk of whiplash injury.

WARNING

Never modify or repair the seat or WHIPS system yourself. Volvo recommends that you contact an authorised Volvo workshop.

WHIPS system and child seats/booster cushions

The protection provided by the car to children seated in a child seat or on a booster cushion is not diminished by the WHIPS system.

Correct seating position

For the best possible protection, the driver and front seat passenger should sit in the centre of the seat with as little space as possible between the head and the head restraint.

Do not obstruct the WHIPS system

Do not leave any objects on the floor behind the driver's seat/passenger seat that may prevent the WHIPS system from functioning.

WARNING

Do not squeeze rigid objects between the rear seat cushion and the front seat backrest. Make sure you do not obstruct the function of the WHIPS system.



WHIPS



Do not place objects on the rear seat that may prevent the WHIPS system from functioning.

WARNING

If a rear seat backrest is folded down, the corresponding front seat must be moved forward so that it does not touch the folded backrest.

WARNING

If a seat has been subjected to extreme forces, such as due to a rear-end collision, the WHIPS system must be checked. Volvo recommends that it is checked by an authorised Volvo workshop.

Part of the WHIPS system's protective capacity may have been lost even if the seats appear to be undamaged.

Volvo recommends that you contact an authorised Volvo workshop to have the system checked even after a minor rear-end collision.



When the systems deploy

When the systems deploy

System	Triggered
Seatbelt tensioner, front seat	In a frontal collision and/or side-impact accident and/or rear-end collision
Seatbelt tensioner, rear seat	In a frontal collision
Airbags (SRS)	In a frontal collision ^A
Side airbags (SIPS)	In a side-impact accident ^A
Inflatable Curtain IC	In a side-impact accident ^A
Whiplash protection WHIPS	In a rear-end collision

^A The bodywork of the car could be greatly deformed in a collision without airbag deployment. A number of factors such as the rigidity and weight of the object hit, the speed of the car, the angle of the collision etc. affects how the different safety systems of the car are activated.

If the airbags have deployed, the following is recommended:

- Recovering the car. Volvo recommends that you have it conveyed to an authorised

Volvo workshop. Do not drive with deployed airbags.

- Volvo recommends that you engage an authorised Volvo workshop to handle the replacement of components in the car's safety systems.
- Always contact a doctor.

**NOTE**

The SRS, SIPS, IC and belt tensioner systems are deployed only once during a collision.

**WARNING**

The airbag control module is located in the centre console. If the centre console is drenched with water or other liquid, disconnect the battery cables. Do not attempt to start the car since the airbags may deploy. Recovering the car. Volvo recommends that you have it conveyed to an authorised Volvo workshop.

**WARNING**

Never drive with deployed airbags. They can make steering difficult. Other safety systems may also be damaged. The smoke and dust created when the airbags are deployed can cause skin and eye irritation/injury after intensive exposure. In case of irritation, wash with cold water. The rapid deployment sequence and airbag fabric may cause friction and skin burns.



Safety mode

Driving after a collision

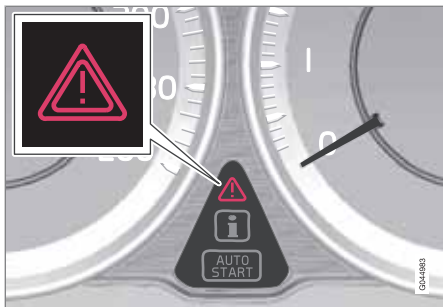

If the car is involved in a collision, the text **Safety mode See manual** may appear on the information display. This means that the car has reduced functionality. Safety mode is a protective state that is enforced when the collision may have damaged any of the car's vital functions, such as the fuel lines, sensors for one of the safety systems, or the brake system.

Attempting to start the car

First, check that no fuel is leaking from the car. There must be no smell of fuel either.

If everything seems normal and you have checked for indications of fuel leakage, you may attempt to start the car.

Remove the remote control key and open the driver's door. If a message is now shown to the

effect that the ignition is on, press the start button. Then close the door and reinsert the remote control key. The car's electronics will now try to reset themselves to normal mode. Then try to start the car.

If the message **Safety mode See manual** is still shown on the display then the car must not be driven or towed, but a vehicle recovery service used instead. Even if the car appears to be driveable, hidden damage may make the car impossible to control once moving.

Moving the car

If **Normal mode** is shown after **Safety mode See manual** has been reset, the car can be moved carefully out of a dangerous position. Do not move the car further than necessary.

WARNING

Never attempt to repair your car or reset the electronics yourself if the car has been in safety mode. This could result in personal injury or the car not functioning as normal. Volvo recommends that you engage an authorised Volvo workshop to check and restore the car to normal status after **Safety mode See manual** has been displayed.

WARNING

Never, under any circumstances, attempt to restart the car if it smells of fuel when the **Safety mode See manual** message is displayed. Leave the car at once.

WARNING

If the car is in safety mode it must not be towed. It must be transported from its location. Volvo recommends that it is transported to an authorised Volvo workshop.



Child safety

Children should sit comfortably and safely

Volvo recommends that children travel in rear-facing child seats until as late an age as possible, at least until 3-4 years of age, and then front-facing booster cushions/child seats until up to 10 years of age.

The position of a child in the car and the choice of equipment are dictated by the child's weight and size, for more information, see page 33.

i NOTE

Regulations regarding the placement of children in cars vary from country to country. Check what does apply.

Children of all ages and sizes must always sit correctly secured in the car. Never allow a child to sit on the knee of a passenger.

Volvo has child safety equipment (child seats, booster cushions & attachment devices) which is designed for your particular car. Using Volvo's child safety equipment provides you with optimum conditions for your child to travel safely in the car. Furthermore, the child safety equipment fits and is easy to use.

i NOTE

In the event of questions when fitting child safety products, contact the manufacturer for clearer instructions.

Child seats

Child seats and airbags are not compatible.

i NOTE

When using child safety products it is important to read the installation instructions included.

Do not attach the straps for the child seat to the horizontal adjustment bar, springs, rails or

beams under the seat. Sharp edges can damage the straps.

Look in the installation instructions for the child seat for the correct fitting.

Location of child seats

You may place:

- a child seat/booster cushion on the passenger seat, provided the passenger airbag is not activated¹.
- one or more child seats/booster cushions in the rear seat.

Always fit child seats/booster cushions in the rear seat if the passenger airbag is activated. If a child is sitting on the front passenger seat then he/she could suffer serious injury if the airbag deploys.

¹ For information on activated/deactivated airbag, see page 22.



Child safety

WARNING

Never place a child in a child seat or on a booster cushion in the front seat if the airbag (SRS) is activated.

No one shorter than 140 cm should ever sit in the front passenger seat if the airbag (SRS) is activated.

Failure to follow the advice given above can endanger life.

WARNING

Booster cushions/child seats with steel braces or some other design that could rest on the seatbelt buckle's opening button must not be used, as they could cause the seatbelt buckle to open accidentally.

Do not allow the upper section of the child seat to rest against the windscreen.

Label Airbag



Label fitted on the end face of the instrument panel on the passenger side, see the illustration on page 22.



Child safety

Recommended child seats²

Weight	Front seat (with deactivated air-bag)	Outer rear seat	Centre rear seat
Group 0 max 10 kg Group 0+ max 13 kg		Volvo infant seat (Volvo Infant Seat) - rear-facing child seat, secured with the ISOFIX fixture system. Type approval: E1 04301146 (L)	
	Volvo infant seat (Volvo Infant Seat) - rear-facing child seat, secured with the car's seatbelt. Type approval: E1 04301146 (U)	Volvo infant seat (Volvo Infant Seat) - rear-facing child seat, secured with the car's seatbelt. Type approval: E1 04301146 (U)	Volvo infant seat (Volvo Infant Seat) - rear-facing child seat, secured with the car's seatbelt. Type approval: E1 04301146 (U)
	Rear-facing child seat (Child Seat) - rear-facing child seat, secured with the car's seatbelt and straps. Use a protective cushion between the child seat and the dashboard. Type approval: E5 03135 (L)	Rear-facing child seat (Child Seat) - rear-facing child seat, secured with the car's seatbelt and straps. Type approval: E5 03135 (L)	Rear-facing child seat (Child Seat) - rear-facing child seat, secured with the car's seatbelt and straps. Type approval: E5 03135 (L)
	Child seats which are universally approved. (U)	Child seats which are universally approved. (U)	Child seats which are universally approved. (U)

² With regard to other child seats your car should be included in the manufacturer's enclosed list of vehicles or be universally approved in accordance with the ECE R44 legal requirement.



Child safety

Weight	Front seat (with deactivated air-bag)	Outer rear seat	Centre rear seat
Group 1 9-18 kg	Volvo rear-facing/turnable child seat (Volvo Convertible Child Seat) - rear-facing child seat, secured with the car's seatbelt and straps. Type approval: E5 04192 (L)	Volvo rear-facing/turnable child seat (Volvo Convertible Child Seat) - rear-facing child seat, secured with the car's seatbelt and straps. Type approval: E5 04192 (L)	
	Rear-facing child seat (Child Seat) - rear-facing child seat, secured with the car's seatbelt and straps. Use a protective cushion between the child seat and the dashboard. Type approval: E5 03135 (L)	Rear-facing child seat (Child Seat) - rear-facing child seat, secured with the car's seatbelt and straps. Use a protective cushion between the child seat and the dashboard. Type approval: E5 03135 (L)	Rear-facing child seat (Child Seat) - rear-facing child seat, secured with the car's seatbelt and straps. Use a protective cushion between the child seat and the dashboard. Type approval: E5 03135 (L)
		Britax Fixway – rear-facing child seat, secured with the ISOFIX fixture system and straps. Type approval: E5 03171 (L)	
	Child seats which are universally approved. (U)	Child seats which are universally approved. (U)	Child seats which are universally approved. (U)



Child safety

Weight	Front seat (with deactivated air-bag)	Outer rear seat	Centre rear seat
Group 2 15-25 kg	Volvo rear-facing/turnable child seat (Volvo Convertible Child Seat) - rear-facing child seat, secured with the car's seatbelt and straps Type approval: E5 04192 (L)	Volvo rear-facing/turnable child seat (Volvo Convertible Child Seat) - rear-facing child seat, secured with the car's seatbelt and straps Type approval: E5 04192 (L)	
	Volvo rear-facing/turnable child seat (Volvo Convertible Child Seat) - front-facing child seat, secured with the car's seatbelt. Type approval: E5 04191 (L)	Volvo rear-facing/turnable child seat (Volvo Convertible Child Seat) - front-facing child seat, secured with the car's seatbelt. Type approval: E5 04191 (L)	Volvo rear-facing/turnable child seat (Volvo Convertible Child Seat) - front-facing child seat, secured with the car's seatbelt. Type approval: E5 04191 (L)



Child safety

Weight	Front seat (with deactivated air-bag)	Outer rear seat	Centre rear seat
Group 2/3 15-36 kg	Booster cushion with and without backrest (Booster Cushion with and without backrest). Type approval: E5 03139 (UF)	Booster cushion with and without backrest (Booster Cushion with and without backrest). Type approval: E5 03139 (UF)	Booster cushion with and without backrest (Booster Cushion with and without backrest). Type approval: E5 03139 (UF)
	Volvo booster seat with backrest (Volvo Booster Seat with backrest). Type approval: E1 04301169 (UF)	Volvo booster seat with backrest (Volvo Booster Seat with backrest). Type approval: E1 04301169 (UF)	Volvo booster seat with backrest (Volvo Booster Seat with backrest). Type approval: E1 04301169 (UF)
			Volvo integrated booster cushion (Integrated Booster Cushion). Type approval: E5 03140 (B)

L: Suitable for specific child seats. These child seats may be intended for use in a special car model, limited or semi-universal categories.

U: Suitable for universally approved child seats in this weight class.

UF: Suitable for front-facing universally approved child seats in this weight class.

B: Built-in child seats approved for this weight class.



Child safety

Child safety locks, rear doors

The controls for operating the rear door power windows and the rear door opening handles can be blocked from opening from the inside. For more information, see page 60.

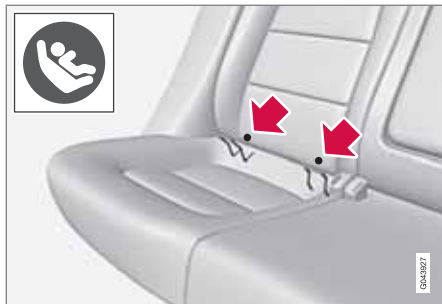
ISOFIX fixture system for child seats

Mounting points for the ISOFIX fixture system are concealed behind the lower section of the rear seat backrest, in the outer seats.

The location of the mounting points is indicated by symbols in the backrest upholstery (see preceding illustration).

Press the seat cushion down to access the mounting points.

Always follow the manufacturer's installation instructions when connecting a child seat to the ISOFIX mounting points.

Size classes

Child seats are in different sizes – cars are in different sizes. This means that not all child seats are suitable for all seats in all car models.

Consequently, there is a size classification for child seats using the ISOFIX fixture system in order to assist users in choosing the correct child seat (see the following table).

Size class	Description
A	Full size, front-facing child seat
B	Reduced size (alt. 1), front-facing child seat
B1	Reduced size (alt.2), front-facing child seat
C	Full size, rear-facing child seat
D	Reduced size, rear-facing child seat

Size class	Description
E	Rear-facing infant seat
F	Transverse infant seat, left-hand
G	Transverse infant seat, right-hand

WARNING

Never place a child in the passenger seat if the car is equipped with an activated airbag.

NOTE

If an ISOFIX child seat has no size classification then the car model must be included on the child seat's vehicle list.

NOTE

Volvo recommends that you contact an authorised Volvo dealer for recommendations about which ISOFIX child seats Volvo recommends.



Child safety

Types of ISOFIX child seat

Type of child seat	Weight	Size class	Passenger seats for ISOFIX installation of child seats	
			Front seat	Outer rear seat
Infant seat transverse (0 – 9 months)	max 10 kg	F	X	X
		G	X	X
Infant seat, rear-facing (0 – 9 months)	max 10 kg	E	X	OK (IL)
Infant seat, rear-facing (0 – 12 months)	max 13 kg	E	X	OK (IL)
		D	X	OK (IL)
		C	X	OK (IL)
Child seat, rear-facing	9-18 kg (9-36 months)	D	X	OK (IL)
		C	X	OK (IL)



Child safety

Type of child seat	Weight	Size class	Passenger seats for ISOFIX installation of child seats	
			Front seat	Outer rear seat
Front-facing child seat	9-18 kg (9-36 months)	B	X	OK ^A (IUF)
		B1	X	OK ^A (IUF)
		A	X	OK ^A (IUF)

X: The ISOFIX position is not suitable for ISOFIX child seats in this weight class and/or size class.

IL: Suitable for specific ISOFIX child seats. These child seats may be intended for use in a special car model, limited or semi-universal categories.

IUF: Suitable for front-facing ISOFIX child seats that are universally approved in this weight class.

^A Volvo recommends rear-facing child seats for this group.



Child safety

Upper mounting points for child seats



The car is equipped with upper mounting points for child seats. These mounting points are located on the parcel shelf and are concealed by plastic covers. Bend aside the plastic covers to access each respective mounting point.

For cars with folding head restraints on the outside seats the head restraints should be folded to facilitate installation.

The upper mounting points are primarily intended for use with front-facing child seats. Volvo recommends that small children should sit in rear-facing child seats for as long as possible.

For detailed information on how the child seat should be tensioned in the upper mounting

points, see the seat manufacturer's instructions.



WARNING

The child seat's straps must always be drawn through the hole in the head restraint leg before they are tensioned at the attachment point.



[Empty rectangular box]

Remote control key/key blade.....	44
Privacy locking*.....	49
Battery replacement, remote control key/PCC*.....	50
Keyless drive*.....	52
Locking/unlocking.....	55
Child safety locks.....	60
Alarm*.....	61



02

LOCKS AND ALARM





Remote control key/key blade

General

The car is supplied with 2 remote control keys or PCCs (Personal Car Communicator). They are used to start the car and for locking and unlocking.

More remote control keys can be ordered – up to 6 can be programmed and used for the same car.

The PCC has increased functionality compared with the remote control key. The continuation of this chapter describes the functions available in both the PCC and the remote control key.

WARNING

If there are children in the car:

Always remember to switch off the power supply to power windows and sunroof by removing the remote control key if the driver leaves the car.

Loss of a remote control key

If you lose a remote control key then new ones can be ordered at a workshop - an authorised Volvo workshop is recommended. The remaining remote control keys must then be taken to the workshop. The code of the missing remote

control key must be erased from the system as a theft prevention measure.

The current number of keys registered to the car can be checked in the menu system **MY CAR** under **Information** → **Number of keys**. For a description of the menu system, see page 144.

Key memory¹ – door mirrors and driver's seat

The settings are automatically connected to each respective remote control key, see pages 80 and 101.

The function can be activated/deactivated in the menu system **MY CAR** under **Settings** → **Car settings** → **Car key memory**.

For a description of the menu system, see page 144.

For cars with Keyless drive system, see page 52.

Indicator for locking/unlocking

When the car is locked or unlocked using the remote control key, the direction indicators confirm that locking/unlocking was correctly performed.

- Locking - one flash and the door mirrors are folded² in.
- Unlocking - two flashes and the door mirrors are folded² out.

After locking the indication is only given if all locks have been activated once the doors have been closed.

Selecting the function

Different options for indicating locking/unlocking with light can be set in the car's menu system, see page 144.

Search in the menu system **MY CAR** for **Settings** → **Car settings** → **Light settings** and select **Lock confirmation light** and/or **Unlock confirmation light**.

Immobiliser

Each remote control key has a unique code. The car can only be driven with the correct remote control key with the correct code.

The following error messages in the combined instrument panel's information display are related to the electronic immobiliser:

¹ Only in combination with power driver's seat and power mirrors.

² Only for cars with retractable power door mirrors.



Remote control key/key blade

Message	Specification
Insert car key	Error when reading the remote control key during starting - Remove the key from the ignition switch, press it in again and make a new start attempt.
Car key not found (Only applies to Keyless drive with PCC.)	Error reading the PCC during starting - Try to start again. If the error persists: Insert the remote key into the ignition switch and try to start again.
Immobiliser Try start again	Error in immobiliser system during starting. If the error persists: Contact a workshop - an authorised Volvo workshop is recommended.

For starting the car, see page 111.

Functions



Remote control key, standard version.

- Locking
- Unlocking
- Approach light duration
- Boot lid
- Panic function



Remote control key with PCC* - Personal Car Communicator.

Information

Function buttons

Locking – Locks the doors and boot lid while the alarm is activated.

Press and hold (at least 2 seconds) to close all the windows and sunroof* simultaneously.

WARNING

If the sunroof and windows are closed using the remote control key, check that no one is in danger of getting hands caught.

Unlocking – Unlocks the doors and boot lid while the alarm is deactivated.

* Option/accessory, for more information, see Introduction.



02 Locks and alarm

Remote control key/key blade

Press and hold (at least 4 seconds) to open all windows simultaneously.

The function can be changed from unlocking all doors simultaneously, to unlocking the driver's door only with one press of the button and, after a further press of the button - within 10 seconds - unlocking the remaining doors.

The function can be changed in the menu system **MY CAR** under **Settings** → **Car settings** → **Lock settings** → **Doors unlock** with both the alternatives **All doors** and **Driver door, then all**. For a description of the menu system, see page 144.

 **Approach light duration** – Used to switch on the car's lighting at a distance. For more information, see page 91.

 **Boot lid** – Unlocks and disarms the alarm for the boot lid only. For more information, see page 56.

 **Panic function** – Used to attract attention in an emergency.

Press and hold the button for at least 3 seconds or press it twice within 3 seconds to activate the direction indicators and the horn.

The function can be turned off with the same button once it has been active for at least 5 seconds. Otherwise the function switches off automatically after 2 minutes and 45 seconds.

Range

The remote key's functions have a range of about 20 m from the car.

If the car does not verify a button being pressed - move closer and try again.

NOTE

The remote control key functions can be disrupted by surrounding radio waves, buildings, topographical conditions etc. The car can always be locked/unlocked using the key blade, see page 47.

Unique PCC functions*



Remote control key with PCC* - Personal Car Communicator.

- 1** Information button
- 2** Indicator lamps

Using the information button enables access to certain information from the car via the indicator lamps.

Using the information button

- Press the information button .
 - > All indicator lamps flash for approximately 7 seconds and the light travels around on the PCC. This indicates that information from the car has been read.



If any of the other buttons are pressed during this time then the reading is interrupted.

i NOTE

i If none of the indicator lamps illuminates with repeated use of the information button and in different locations (as well as after 7 seconds and after the light has travelled around on the PCC), contact a workshop - an authorised Volvo workshop is recommended.

Indicator lamps display information in accordance with the following illustration:

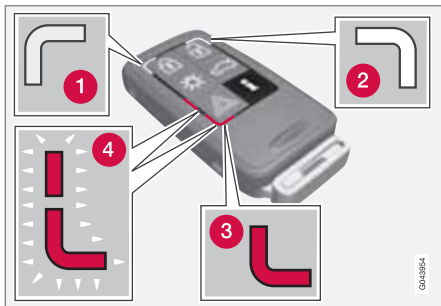

- 1** Green continuous light – the car is locked.
- 2** Yellow continuous light – the car is unlocked.

- 3** Red continuous light – the alarm has been triggered since the car was locked.
- 4** Red light flashing alternately in both indicator lamps – The alarm was triggered less than 5 minutes ago.

Range PCC

The PCC's range for locking, unlocking and boot lid is about 20 m from the car - for other functions up to about 100 m.

If the car does not verify a button being pressed - move closer and try again.

i NOTE

The information button functions can be disrupted by surrounding radio waves, buildings, topographical conditions etc.

Out of PCC range

If the PCC is too far away from the car for the information to be read then the status the car was last left in is shown, without the light travelling around on the PCC.

If several PCCs are used for the car then it is only the PCC last used for locking/unlocking that shows correct status.

Remote control key/key blade

i NOTE

i If no indicator lamps illuminate when the information button is used within range then this may be because the last communication between the PCC and the car was disrupted by surrounding radio waves, buildings, topographical conditions etc.

Detachable key blade

A remote control key contains a detachable key blade of metal with which some functions can be activated and some operations carried out.

The key blade's unique code is provided by authorised Volvo workshops, which are recommended when ordering new key blades.

Key blade functions

Using the remote control key's detachable key blade:

- the driver's door can be opened manually if central locking cannot be activated with the remote control key, see page 53.
- the rear doors' mechanical child safety locks can be activated/deactivated, see page 60.
- access to the glovebox and cargo area (privacy locking*) is blocked, see page 49.



Remote control key/key blade

- the boot lid can be opened manually if the car is de-energised, see page 57.
- the airbag for front passenger seat (PACOS)* can be activated/deactivated, see page 22.

Removing the key blade



- 1 Slide the spring-loaded catch to the side.
- 2 At the same time pull the key blade straight out backwards.

Attaching the key blade

Carefully refit the key blade into its location in the remote control key.

1. Hold the remote control key with the slot pointed up and lower the key blade into its slot.

2. Lightly press the key blade. You should hear a "click" when the key blade is locked in.

Unlocking doors with the key blade

If central locking cannot be activated with the remote control key - e.g. if the batteries are discharged - then the driver's door can be opened as follows:

1. Unlock the driver's door with the key blade in the door handle's lock cylinder.

See also the figure and further information on page see page 53.



NOTE

When the door has been unlocked using the key blade and is opened, the alarm is triggered.

2. Deactivate the alarm by inserting the remote control key in the ignition switch.

For a car with the Keyless system, see page 53.



Privacy locking*

General information on privacy locking

Active locks for remote control key **with** key blade.Active locks for remote control key, **without** key blade and privacy locking **activated**.

The privacy locking function is intended for when the car is left for service, with a hotel parking valet or similar. The glovebox is then

locked and the boot lid lock is disconnected from the central locking - the boot lid cannot be opened with either the central locking button in the front doors or the remote control key.

This means that the remote control key without key blade can only be used to activate/deactivate the alarm, to open the doors and to drive the car.

The remote control key without key blade can then be handed over to the service or hotel staff - the loose key blade is retained by the car owner.

Activate/deactivate



Activating privacy locking.

To activate privacy locking:

- ➡ Insert the key blade in the glovebox lock cylinder.

- ➡ Turn the key blade 180 degrees clockwise. The keyhole is vertical in the locked position for privacy locking.
- ➡ Pull out the key blade. The information display shows a message at the same time.

The glovebox is then locked and the boot lid can no longer be unlocked with the remote control key or the central locking button.

i NOTE

Do not reinsert the key blade into the remote control key but keep it in a safe place instead.

- Deactivation takes place in reverse order. For information on locking the glovebox only, see page 56.



Battery replacement, remote control key/PCC*

Replacing the battery

The batteries should be replaced if:

- the information symbol is illuminated and the display shows **Low battery in remote control**. Please change batteries.
- the locks repeatedly do not react to signals from the remote control key within 20 metres from the car.

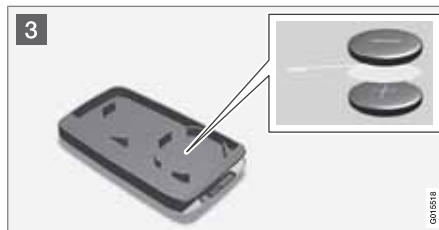

Opening

- Slide the spring-loaded catch to the side.
- At the same time pull the key blade straight out backwards.
- Insert a 3 mm slot screwdriver in the hole behind the spring-loaded catch and gently prize the remote control key up.

NOTE

Turn the remote control key over with the buttons facing up, this is to avoid the batteries falling out when it is opened.

IMPORTANT

Avoid touching the battery and its terminals with your fingers, as this could damage their functionality.

Battery replacement

- Closely study how the battery/batteries are secured on the inside of the cover, with regard to their (+) and (-) sides.

Remove control key (1 battery)

- Carefully prize out the battery.
- Install a new one with the (+) side down.

PCC* (2 batteries)

- Carefully prize out the batteries.
- First install one new one with the (+) side up.
- Position the white plastic tab in between and finally install a second new battery with the (+) side down.

Battery type

Use batteries with the designation CR2430, 3V - one in the remote control key and two in the PCC.

Assembly

- Press the remote control key together.
- Hold the remote control key with the slot pointed up and lower the key blade into its slot.
- Lightly press the key blade. You should hear a "click" when the key blade is locked in.



Battery replacement, remote control key/PCC*

 **IMPORTANT**

Make sure that you dispose of old batteries in an environmentally-friendly way.

02



Keyless drive*

Keyless lock and ignition system (only PCC¹)

General

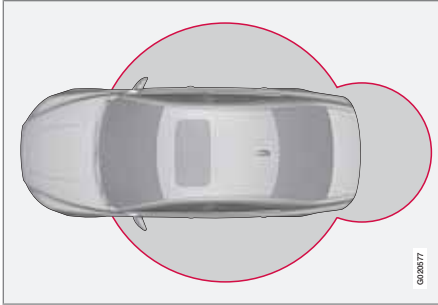

The keyless drive function in the PCC allows the car to be unlocked, driven and locked without the need for a key. You simply have to have the PCC with you. The system makes it easier and more convenient to open the car, e.g. when your hands are full.

Both of the car's PCCs incorporate the Keyless function. Additional PCCs can be ordered, see page 44.

PCC range

In order to open a door or the boot lid, a PCC must be no more than approx. 1.5 metres from

the car door handle or boot lid. This means that the person who wishes to lock or unlock a door must have the PCC with him or her. It is not possible to lock or unlock a door if the PCC is on the opposite side of the car.

The red rings in the preceding illustration indicate the range covered by the system's antennas.

If all PCCs are removed from the car when the engine is running or key position I or II is active (see page 77) and if all doors are closed, then a warning message is shown in the information display and an audible reminder signal sounds at the same time.

The warning message clears and the audio reminder signal stops when the PCC is brought back to the car after:

- a door has been opened and closed
- the PCC is inserted into the ignition switch
- the **READ** button has been pressed.

Handling the PCC safely

If a PCC with keyless drive function is left in the car, it is deactivated temporarily when the car is locked. This prevents unauthorised entry.

However, if someone breaks into the car, opens the door and finds the PCC, it can be

reactivated. It is therefore important to handle all PCCs with great care.



IMPORTANT

Never leave a PCC behind in the car.

Interference to PCC function

Electromagnetic fields and screening can interfere with the keyless drive system.



NOTE

Do not place/store the PCC near a mobile phone or metal object - no closer than 10-15 cm.

If interference is experienced nonetheless, use the PCC and the key blade as a remote control key, see page 45.

¹ Personal Car Communicator, see page 46.

* Option/accessory, for more information, see Introduction.

**Keyless drive*****Locking**

Cars with the keyless system have a button on the outside door handles.

Lock the doors and the boot lid by pressing the lock button on one of the door handles on the outside.

All doors and the boot lid must be closed before the car can be locked - otherwise the car is not locked.

i NOTE

On cars with automatic transmission, the gear selector must be set in the **P** position - otherwise the car cannot be locked or the alarm armed.

Unlocking

Unlocking takes place when a hand grasps a door handle or the boot lid's rubberised pressure plate is actuated - open the door or boot lid as normal.

Unlocking with the key blade

Hole for key blade - to loosen the cover.

If central locking cannot be activated with the PCC, e.g. if the batteries are discharged, then the driver's door can be opened with the PCC's detachable key blade (see page 47).

To access the lock cylinder, the door handle's plastic cover must be removed - this is also done with the key blade:

1. Press the key blade approx. 1 cm straight up into the hole on the underside of the door handle/cover - do not prize.
 - > The plastic cover loosens automatically by means of the torque when the blade is pushed straight up and into the opening.
2. Then insert the key blade in the lock cylinder and unlock the door.
3. Refit the plastic cover after unlocking.

i NOTE

When the driver's door is unlocked using the key blade and is opened, the alarm is triggered. It is switched off by inserting the PCC in the ignition switch, see page 62.

Key memory² - driver's seat and door mirrors**PCC memory function**

If several people each with a PCC approach the car, then the settings for seat and mirrors are implemented for the person who opens the driver's door.

After the driver's door has been opened by person A with PCC-A, but person B with PCC-

² Only in combination with power driver's seat and power mirrors.



Keyless drive*

B shall drive, the settings can be changed in three ways:

- Standing by the driver's door, or sitting behind the steering wheel, person B presses their PCC's unlock button, see page 45.
- Select one of three possible memories for seat adjustment with seat button 1-3, see page 80.
- Adjust seat and mirrors manually, see page 80 and 101.

Lock settings

The Keyless function can be adapted by indicating in the menu system **MY CAR** which doors shall be unlocked, under **Car settings** → **Lock settings** → **Keyless entry** - there select between **All doors unlock**, **Any door**, **Doors on same side** and **Both front doors**.

For a description of the menu system, see page 144.

Antenna location

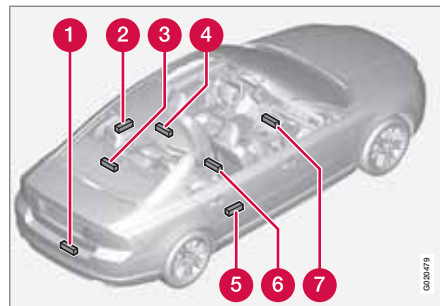

The keyless system has a number of integrated antennae located around the car:

- 1 Rear bumper, centre
- 2 Door handle, left rear
- 3 Parcel shelf, centre, underside
- 4 Roof, centre above rear seat
- 5 Door handle, right rear
- 6 Centre console, under the rear section
- 7 Centre console, under the front section.



WARNING

People with pacemaker operations should not come closer than 22 cm to the keyless system's antennae with their pacemaker. This is to prevent interference between the pacemaker and the keyless system.



Locking/unlocking

From the outside

The remote control key can lock/unlock all doors and the boot lid simultaneously. Different sequences for unlocking can be selected, see "Unlocking with the remote control key" page 45.

In order that the lock sequence can be activated, the driver's door must be closed - if any of the other doors or the boot lid is open, then it/they is/are locked and the alarm is activated only when it/they are closed. With the Keyless* system all the doors and boot lid must be closed.

NOTE

Be aware of the risk of locking the remote control key in the car.

If it is not possible to lock/unlock with the remote control key, the battery may be discharged - lock or unlock the driver's door with the detachable key blade, see page 47.

NOTE

Remember that the alarm is triggered when the door is opened after being unlocked with the key blade - the alarm is switched off when the remote control key is inserted into the ignition switch.

WARNING

Be aware of the risk of being locked in the car when it is locked from the outside using the remote control key - it is then not possible to open any of the doors from the inside with the door controls. Read more about this in the section "Deadlocks" later on.

Automatic relocking

If none of the doors or the boot lid is opened within 2 minutes of unlocking, all are locked again automatically. This function reduces the risk that the car is left unlocked unintentionally. (For cars with alarm, see page 61.)

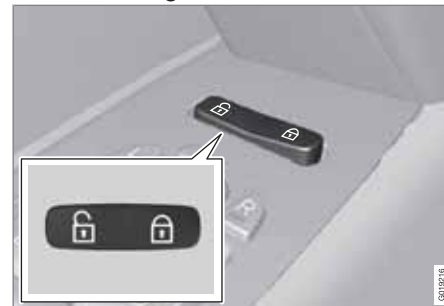
From the inside**Central locking**

Central locking.

All of the doors and the boot lid can be locked or unlocked simultaneously using the central locking button on either front door.

- Press one side  of the button to lock - the other side  to unlock.

Unlocking

A door can be unlocked from the inside in two different ways:

- Press the central locking button .

Press and hold (at least 4 seconds) to also open all the side windows* simultaneously.

* Option/accessory, for more information, see Introduction.



Locking/unlocking

- Pull the door handle once and release - the door is unlocked. Pull the door handle again to open the door.

Locking

- Press the central locking button  after the front doors have been closed.

Press and hold (at least 2 seconds) to also close all the side windows and the sunroof* simultaneously.

All doors can also be individually locked manually with their lock buttons - the door in question must then be closed.

Global opening

Press and hold the central locking button  (at least 4 seconds) to also open all the windows simultaneously - for example, to quickly ventilate the passenger compartment during hot weather.

Automatic locking

The doors and boot lid are locked automatically when the car starts to move.

The function can be activated/deactivated in the menu system **MY CAR** under **Settings** →

Car settings → **Lock settings** → **Doors automatic lock**. For a description of the menu system, see page 144.

Glovebox

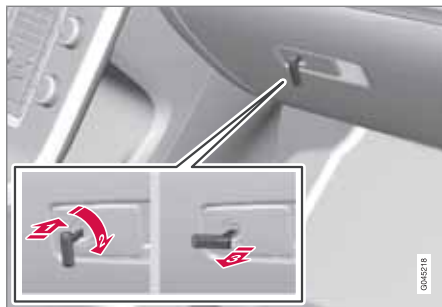

The glovebox can only be locked/unlocked using the remote control key's detachable key blade. For information on the key blade, see page 47.

Locking the glovebox:

- Insert the key blade in the glovebox lock cylinder.
- Turn the key blade 90 degrees clockwise. The keyhole is horizontal in the locked position.
- Pull out the key blade.

- Unlock by carrying this out in reverse order.

For information on privacy locking, see page 49.

Boot lid

Unlocking with the remote control key



The alarm for the boot lid can be disarmed* and the boot lid unlocked and opened on its own by using the remote control key's  button.

If the car is equipped with an alarm* the alarm indicator on the instrument panel stops to show that alarm for the whole of the car is not armed. The alarm's level and movement sensors and the sensors for opening the boot lid are disconnected.

The doors remain locked and armed.

The boot lid can be opened in two different ways

One press - The boot lid is unlocked, but remains closed - press lightly on the rubberised



Locking/unlocking

pressure plate under the outer handle and lift the boot lid.

If the tailgate is not opened within 2 minutes then it is relocked and the alarm is re-armed.

Two presses - The boot lid is unlocked and the lock is disengaged at which the boot lid opens about a centimetre - lift the outer handle to open. Rain, cold, frost or snow could however prevent the tailgate from disengaging from the lock.

NOTE

- When the boot lid/tailgate is unlocked with 2 presses, automatic relocking does not take place because the boot lid/tailgate is open - it must be closed manually.
- After the boot lid/tailgate has been closed it is unlocked and the alarm is not armed - relock it and re-arm the alarm with the remote control key's lock button .

Unlocking with the key blade

The boot lid can be opened manually with the key blade if the car's battery has drained - the boot lid cannot then be opened with the lighting panel button.

1. Prize loose the lock cylinder's cover.
2. Unlock the boot lid by turning the key blade one half turn anticlockwise as illustrated.
3. Refit the cover.

Locking with the remote control key

- Press the remote control key's button for locking, , see page 45.

If the car is equipped with an alarm* the alarm indicator on the instrument panel starts to flash, which means that the alarm is armed.

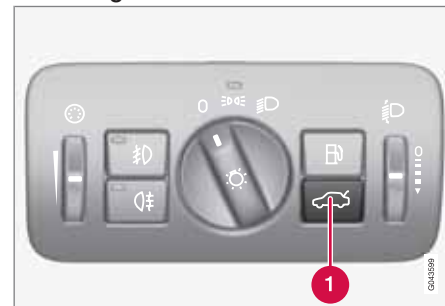
Unlocking the car from inside

To unlock/open the boot lid:

- Press the lighting panel button (1) - the lock releases and the boot lid is opened a few centimetres.



Locking/unlocking

Deadlocks*¹

Deadlocks means that all lock buttons and door handles are mechanically disengaged, which prevents doors being opened from the inside.

The deadlocks are activated with the remote control key and are set after an approximately 10 second delay after the doors have been locked.



NOTE

If a door is opened within the delay time then the sequence is interrupted and the alarm is deactivated.

The car can only be unlocked from a deadlock state with the remote control key. The driver's door can also be unlocked with the detachable key blade.



WARNING

Do not allow anyone to remain in the car without first deactivating the deadlocks in order to avoid the risk of anyone being locked in.

Temporary deactivation



Active menu options are indicated with a cross.

- 1 MY CAR
- 2 OK MENU
- 3 TUNE knob control
- 4 EXIT

If someone is going to stay in the car but the doors must be locked from the outside, then the deadlocks function can be temporarily switched off. This is carried out as follows:

1. Access the menu system **MY CAR** under **Settings** → **Car settings** → **Reduced guard** (for a detailed description of the menu system, see page 144).

2. Select **Activate once**.
 - > The instrument panel display shows the message **Reduced guard See manual** and the deadlocks function is switched off when the car is locked.

or

- Select **Ask on exit**.
 - > Each time the engine is switched off the centre console display screen shows the message **Activate Reduced Guard until engine has started again?** followed by the alternatives **Confirm with OK** and **Cancel with EXIT**.

If the deadlocks function shall be switched off

- Press **OK/MENU** and lock the car. (Note that the alarm's movement and tilt detectors* are switched off at the same time, see page 62.)
 - > The next time the engine is started, the system is reset to zero and the instrument panel display shows the message **Full guard** at which the deadlocks function and the alarm's movement and tilt detectors are re-engaged.

¹ Only in combination with alarm.

* Option/accessory, for more information, see Introduction.

**Locking/unlocking****If the locking system shall not be changed**

- Press **EXIT** and lock the car.

 NOTE

- Remember that the alarm is activated when the car is locked.
- If any of the doors are opened from the inside then the alarm is triggered.



Child safety locks

Manual blocking of the rear doors

The child safety locks prevent children from opening a rear door from the inside.

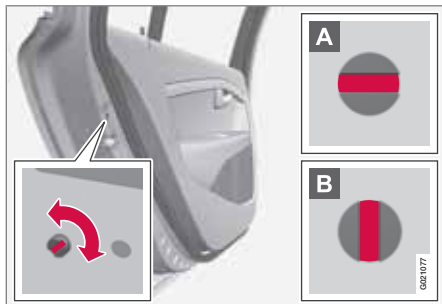

The child safety locks are located on the trailing edge of the rear doors and are only accessible when the doors are open.

To activate/deactivate the child safety locks:

- Use the remote control key's detachable key blade to turn the knob - see page 47.

- A** The door is blocked against opening from the inside.
- B** The door can be opened from both the outside and the inside.

NOTE

- A door's knob control only blocks that particular door - not both rear doors simultaneously.
- Cars with an electric child safety lock do not have a manual child lock.

Electrical locking of the rear doors* and power windows



Control panel driver's door.

The child safety locks can be activated/deactivated in all key positions higher than **0** - see page 77. Activation/deactivation can be performed up to 2 minutes after switching off the engine, provided that no door is opened.

To activate the child safety locks:

1. Start the engine or choose a key position higher than **0**.
2. Press the button in the driver's door control panel.
 - > The information display shows the message **Rear child locks Activated** and the button's lamp illuminates - the locks are active.

When the electric child safety lock is active then the rear:

- windows can only be opened with the driver's door control panel
- doors cannot be opened from inside.

The current setting is stored when the engine is switched off - if the child safety locks are activated at engine shutdown, the function will remain activated the next time the engine is started.



Alarm*

General

Activated alarm is triggered if:

- a door, the bonnet or the boot lid is opened
- a movement is detected in the passenger compartment (if fitted with a movement detector*)
- the car is raised or towed away (if fitted with a tilt detector*)
- the battery's cable is disconnected
- the siren is disconnected.

If there is a fault in the alarm system, the information display shows a message. In which case, contact a workshop - an authorised Volvo workshop is recommended.

i NOTE

The movement sensors trigger an alarm in the event of movement in the passenger compartment - air currents are also registered. For this reason the alarm is triggered if the car is left with a window or the sunroof open or if the passenger compartment heater is used.

To avoid this: Close the window/sunroof when leaving the car. If the car's integrated passenger compartment heater (or a portable electric heater) shall be used - direct the airflow from the air vents so that they are not pointing upwards in the passenger compartment.

i NOTE

Do not attempt to repair or modify alarm system components. All such attempts could affect the terms of insurance.

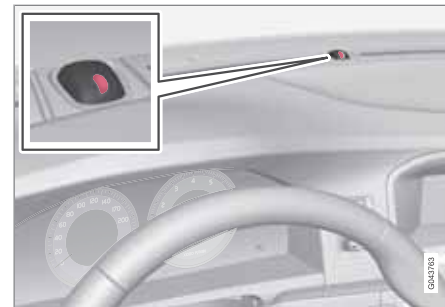
Alarm indicator

A red LED on the instrument panel indicates the alarm system's status:

- LED not lit – Alarm not armed
- The LED flashes once every other second – Alarm is armed
- The LED flashes rapidly after disarming the alarm (and until the remote control key is inserted in the ignition switch and key position I is selected) – Alarm has been triggered.

Arming the alarm

- Press the remote control key lock button.

Deactivate the alarm

- Press the remote control key unlock button.



Alarm*

Deactivating a triggered alarm

- Press the remote control key unlock button or insert the remote control key in the ignition switch.

Other alarm functions

Automatic re-arming of the alarm

This function prevents the car being left with the alarm disarmed unintentionally.

If the car is unlocked with the remote control key (and the alarm is disarmed) but none of the doors or the boot lid is opened within 2 minutes, then the alarm is automatically re-armed. The car is relocked at the same time.

Remote control key not working

If the alarm cannot be deactivated with the remote control key, e.g. if the key's battery is discharged - the car can be unlocked, disarmed and the engine started as follows:

1. Open the driver's door with the detachable key blade - see page 53.
 - > The alarm is triggered, the alarm indicator flashes rapidly and the siren sounds.



2. Insert the remote control key in the ignition switch.
 - > The alarm is deactivated and the alarm indicator goes out.
3. Start the engine.

Alarm signals

When the alarm is triggered, the following happens:

- A siren sounds for 30 seconds or until the alarm is switched off. The siren has its own battery and works independently of the car battery.
- The direction indicators flash for 5 minutes or until the alarm is switched off.

Reduced alarm level

To avoid accidental triggering of the alarm - e.g. if a dog is left in a locked car or during transport on a car train or car ferry - the movement and tilt detectors should be temporarily deactivated.

The procedure is the same as with the temporary disengaging of deadlocks, see page 58.



Instruments and controls.....	66
Instruments and controls - Executive	75
Volvo Sensus	76
Key positions.....	77
Seats.....	79
Seats - Executive.....	83
Steering wheel.....	85
Lighting.....	86
Wipers and washing.....	96
Windows, rearview and door mirrors.....	98
Compass*	104
Power sunroof*.....	105
Alcoguard*.....	107
Starting the engine.....	111
Starting the engine – Flexifuel.....	113
Starting the engine – external battery.....	115
Gearboxes.....	116
Eco Start/Stop DRIVE*	122
All-wheel drive – AWD*.....	129
Foot brake.....	130
Parking brake.....	132
HomeLink® *	136



G041142

03

YOUR DRIVING ENVIRONMENT





03 Your driving environment

Instruments and controls

Instrument overview

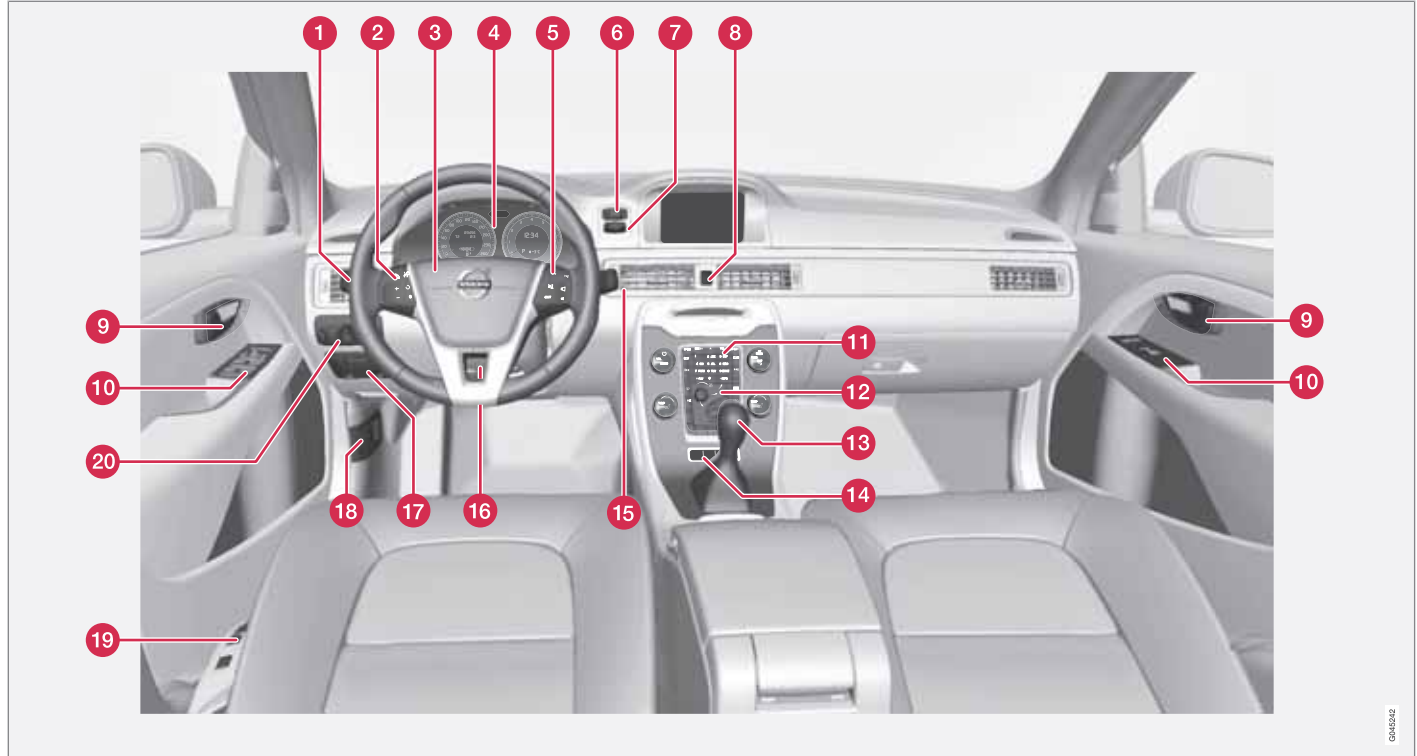

Left-hand drive.

046524

03



Instruments and controls

	Function	Page
1	Menus and messages, direction indicators, main/dipped beam, trip computer	86, 89, 142, 166
2	Cruise control	171, 173
3	Horn, airbags	20, 85
4	Combined instrument panel	69, 73
5	Menu, audio and phone control	144, 224, 252, 273
6	START/STOP ENGINE key	111
7	Ignition switch	77
8	Hazard warning flashers	89
9	Door handle	–
10	Control panel	55, 60, 98, 101
11	Menu control and audio system	144, 224, 273

	Function	Page
12	Control panel for climate control	152
13	Gear selector	116
14	Controls for active chassis (Four-C)*	170
15	Wipers and washing	96, 97
16	Steering wheel adjustment	85
17	Parking brake	132
18	Bonnet opener	318
19	Seat adjustment*	79
20	Headlamp control, opener for fuel filler flap and boot lid	56, 86, 283



03 Your driving environment

Instruments and controls

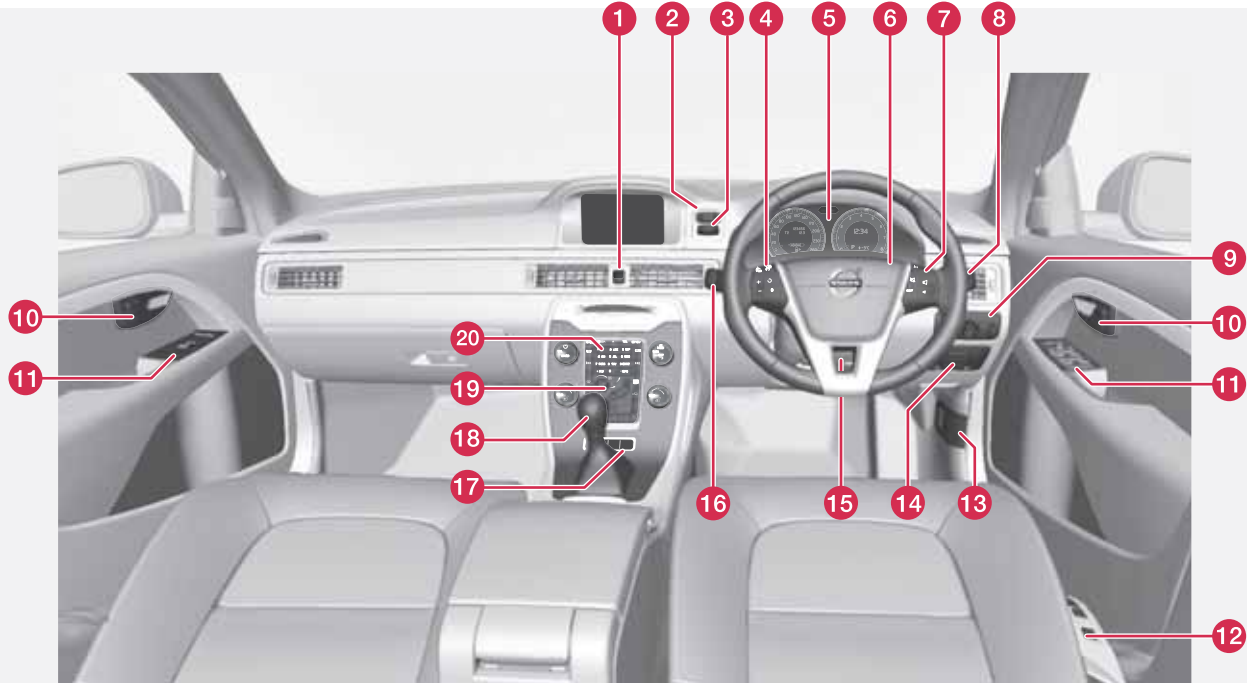

Right-hand drive.

006524



Instruments and controls

	Function	Page
1	Hazard warning flashers	89
2	START/STOP ENGINE key	111
3	Ignition switch	77
4	Cruise control	171, 173
5	Combined instrument panel	69, 73
6	Horn, airbags	20, 85
7	Menu, audio and phone control	144, 224, 252, 273
8	Wipers and washing	96, 97
9	Headlamp control, opener for fuel filler flap and boot lid	56, 86, 283
10	Door handle	–
11	Control panel	55, 60, 98, 101
12	Seat adjustment*	79
13	Bonnet opener	318

	Function	Page
14	Parking brake	132
15	Steering wheel adjustment	85
16	Menus and messages, direction indicators, main/dipped beam, trip computer	86, 89, 142, 166
17	Controls for active chassis (Four-C)*	170
18	Gear selector	116
19	Control panel for climate control	152
20	Menu control and audio system	144, 224, 273

Information displays

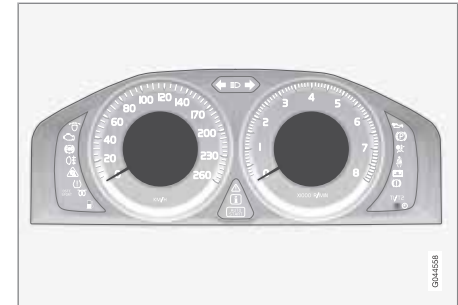

The information displays show information on some of the car's functions, e.g. cruise control, trip computer and messages. The information is shown with text and symbols.

There are further descriptions under the functions that use the information displays.

Instruments and controls

Meters

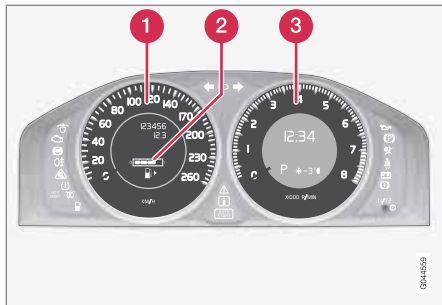

Meters in the combined instrument panel.

- 1 Speedometer
- 2 Fuel gauge. See also Trip computer, page 166, and Refuelling, page 283.
- 3 Tachometer. The meter indicates engine speed in thousands of revolutions per minute (rpm).

Indicator, information and warning symbols

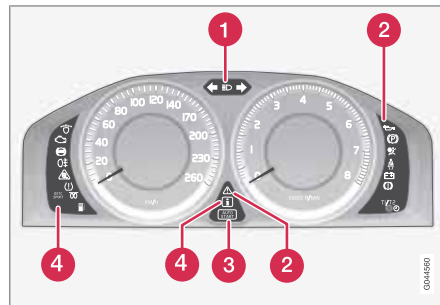

Indicator and warning symbols.

- 1 Main beam and direction indicator symbol
- 2 Indicator and warning symbols¹
- 3 Symbol for DRIVE - Start/Stop*, see page 122
- 4 Indicator and information symbols

Functionality check

All indicator and warning symbols illuminate in key position II or when the engine is started. When the engine has started, all the symbols should go out except the parking brake symbol, which only goes out when the brake is disengaged.

If the engine does not start or if the functionality check is carried out in key position II then all symbols go out after 5 seconds except the symbol for faults in the car's emissions system and the symbol for low oil pressure.

Indicator and information symbols

Symbol	Specification
	ABL fault
	Emissions system
	ABS fault
	Rear fog lamp on
	Stability system
	Stability system, sport mode
	Engine preheater (diesel)
	Low level in fuel tank
	Information, read display text

¹ For certain engine variants, the symbol for low oil pressure is not used. Warnings are made via display text. For information on checking the oil level, see page 319.

Instruments and controls

Symbol	Specification
	Main beam On
	Left-hand direction indicators
	Right-hand direction indicators
	DRIVE - Start/Stop*

ABL fault

The symbol illuminates if a fault has arisen in the ABL function (Active Bending Lights).

Emissions system

If the symbol illuminates then it may be due to a fault in the car's emissions system. Drive to a workshop for checking. Volvo recommends that you seek assistance from an authorised Volvo workshop.

ABS fault

If this symbol illuminates then the system is not working. The car's regular brake system continues to work, but without the ABS function.

1. Stop the car in a safe place and turn off the engine.
2. Restart the engine.
3. If the symbol remains illuminated, drive to a workshop to have the ABS system

checked. Volvo recommends that you seek assistance from an authorised Volvo workshop.

Rear fog lamp on

This symbol illuminates when the rear fog lamp is on. There is only one fog lamp. It is located on the driver's side.

Stability system

A flashing symbol indicates that the stability system is operating. If the symbol illuminates with constant glow then there is a fault in the system.

Stability system, Sport mode

Sport mode allows for a more active driving experience. The system then detects whether the accelerator pedal, steering wheel movements and cornering are more active than in normal driving and then allows controlled skidding of the rear section up to a certain level before it intervenes and stabilises the car.

Engine preheater (diesel)

This symbol illuminates during engine preheating. Preheating occurs when the temperature is below -2 °C. The car can be started once the symbol goes out.

Low level in fuel tank

When the symbol illuminates the level in the fuel tank is low, refuel as soon as possible.

Information, read display text

When one of the car's systems does not behave as intended, this information symbol illuminates and a text appears on the information display. The message text is cleared with the **READ** button, see page 142, or it disappears automatically after a time (time depending on which function is indicated). The information symbol can also illuminate in conjunction with other symbols.

**NOTE**

When a service message is shown, the symbol and message are cleared using the **READ** button, or clear automatically after a while.

Main beam On

The symbol illuminates when main beam is on and with main beam flash.

Left/right-hand direction indicators

Both direction indicator symbols flash when the hazard warning flashers are used.



Instruments and controls

Indicator and warning symbols

Symbol	Specification
	Low oil pressure ^A
	Parking brake applied
	Airbags – SRS
	Seatbelt reminder
	Alternator not charging
	Fault in brake system
	Warning

^A For certain engine variants, the symbol for low oil pressure is not used. Warnings are made via display text, see pages 319 and 321.

Low oil pressure

If this symbol illuminates during driving then the engine's oil pressure is too low. Stop the engine immediately and check the engine oil level, top up if necessary. If the symbol illuminates and the oil level is normal, contact a workshop. Volvo recommends that you seek assistance from an authorised Volvo workshop.

Parking brake applied

This symbol illuminates with a constant glow when the parking brake is applied. The symbol flashes during application, and then changes over to a constant glow.

A flashing symbol means that a fault has arisen. Read the message on the information display.

Airbags – SRS

If this symbol remains illuminated or illuminates while driving, it means a fault has been detected in the seatbelt buckle, SRS, SIPS, or IC systems. Drive immediately to a workshop to have the system checked. Volvo recommends that you seek assistance from an authorised Volvo workshop.

Seatbelt reminder

This symbol illuminates if someone in a front seat has not put on their seatbelt or if someone in a rear seat has taken off their seatbelt.

Alternator not charging

This symbol illuminates during driving if a fault has occurred in the electrical system. Visit a workshop. Volvo recommends that you seek assistance from an authorised Volvo workshop.

Fault in brake system

If this symbol illuminates, the brake fluid level may be too low. Stop the car in a safe place

and check the level in the brake fluid reservoir, see page 323.

If the brake and ABS symbols illuminate at the same time, there may be a fault in the brake force distribution system.

1. Stop the car in a safe place and turn off the engine.
2. Restart the engine.
 - If both symbols extinguish, continue driving.
 - If the symbols remain illuminated, check the level in the brake fluid reservoir, see page 323. If the brake fluid level is normal but the symbols are still illuminated, the car can be driven, with great care, to a workshop to have the brake system checked. Volvo recommends that you seek assistance from an authorised Volvo workshop.



WARNING

If the brake fluid is under the **MIN** level in the brake fluid reservoir, do not drive further before topping up the brake fluid.

The loss of brake fluid must be investigated by a workshop. Volvo recommends that you contact an authorised Volvo workshop.



Instruments and controls

! WARNING

If the brake and ABS symbols are illuminated at the same time, there is a risk that the rear end will skid during heavy braking.

Warning

The red warning symbol illuminates when a fault has been indicated which could affect the safety and/or driveability of the car. An explanatory text is shown on the information display at the same time. The symbol remains visible until the fault has been rectified but the text message can be cleared with the **READ** button, see page 142. The warning symbol can also illuminate in conjunction with other symbols.

Action:

1. Stop in a safe place. Do not drive the car further.
2. Read the information on the information display. Implement the action in accordance with the message in the display. Clear the message using the **READ** button.

Reminder – doors not closed

If one of the doors, the bonnet² or boot lid is not closed properly then the information or warning symbol illuminates together with an

explanatory text message in the combined instrument panel. Stop the car in a safe place as soon as possible and close the door, bonnet or boot lid, whichever is open.

 If the car is driven at a speed lower than approx. 7 km/h then the information symbol illuminates.

 If the car is driven at a speed higher than approx. 7 km/h then the warning symbol illuminates.

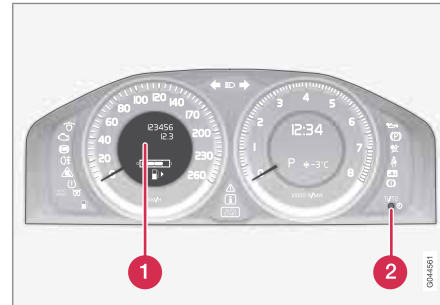
Trip meter

Trip meter and controls.

- 1 Display for trip meter
- 2 Controls for switching between trip meters **T1** and **T2**, as well as resetting the trip meters.

The meters are used to measure short distances.

One short press on the control switches between the two trip meters **T1** and **T2**. A long press (more than 2 seconds) resets an active trip meter to zero. The distance is shown in the display.

03

² Only cars with alarm*.

Instruments and controls

Clock

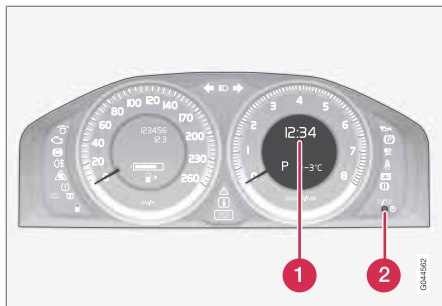

Clock and setting knob.

- 1 Display for showing the time.
- 2 Controls for setting the clock.

Turn the knob clockwise/anticlockwise to set the clock. Turn first to the end position and then turn past/over the end position a further approx. 1 mm - a "click" sounds and is felt in the button. Each "click" scrolls 1 minute. In order to change quickly - hold in the "click position".

In connection with a message the clock can be temporarily replaced by a symbol, see page 142.

Setting the clock in MY CAR

In addition to the previous manual/mechanical method the clock can also be set in the menu

group **MY CAR**, for more information see page 144.



1. Locate **Settings** → **System options** → **Time**.
2. The cursor is located in the first box for Hour: Press **OK** - the box is activated.
3. Turn **TUNE** to set the correct hour and press **OK** - the box is deactivated.
4. Turn **TUNE** to select the box for Minute (A) and press **OK** - the box is activated (B).
5. Turn **TUNE** to set the correct minute and press **OK** - the box is deactivated.
6. Turn **TUNE** to select the box for **OK** and press **OK** - the setting is complete.

The menu option **Settings** → **System options** → **Time format** selects the 24h or 12h system (AM/PM).



Instruments and controls - Executive

Analogue clock



Analogue clock.

- 1 Button for setting indicator backwards in time.
- 2 Button for setting indicator forwards in time.

The analogue clock is located in the instrument panel above the glovebox.

To set the time:

- Use the appropriate button to move the indicators either forward or back in time. Setting can be made by means of two methods:
 - Hold the button depressed - the indicator is first moved slowly in time, equivalent to about 5 minutes, then faster.

Release the button when the clock shows the correct time.

- Press the button again - the indicator is moved about 10 seconds in time.



03 Your driving environment

Volvo Sensus

General

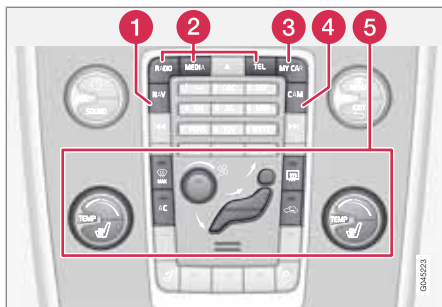

Control panel in centre console

- 1 Navigation* - **NAV**, see separate owner's manual (Road and Traffic Information System - RTI).
- 2 Infotainment (**RADIO, MEDIA, TEL***), see page 222.
- 3 Car settings - **MY CAR**, see page 144.
- 4 Park assist camera - **CAM***, see page 206.
- 5 Climate control, see page 152.

Volvo Sensus is the car's operating system, the heart of your personal Volvo experience. Volvo Sensus combines and presents many functions in several of the car's systems on the centre console TV screen. With Volvo Sensus

the car can be personalised by means of an intuitive user interface. Settings can be made in Car settings, Infotainment, Climate, etc.

With the centre console buttons and controls or the steering wheel's right-hand keypad* functions can be activated or deactivated and many different settings can be made.

With a press on **MY CAR** all settings related to the driving and control of the car are presented, such as City Safety, Locks and alarm, setting the clock, etc.

With a press on the respective function: **RADIO, MEDIA, TEL***, **NAV*** and **CAM*** other sources, systems and functions can be activated, e.g. AM, FM1, CD, DVD*, TV*, Bluetooth*, navigation* and park assist camera*.

For more information on all functions/systems, see the respective section in the owner's manual.



Key positions

Insert and remove the remote control key



Ignition switch with remote control key extracted/inserted.

i NOTE

For cars with the Keyless* function the key does not need to be inserted into the ignition switch but can be stored in e.g. a pocket. For more information on Keyless functions - see page 52.

Insert the key

1. Hold the end of the remote control key with the detachable key blade and insert the key in the ignition switch.
2. Then press the key in the lock up to its end position.

! IMPORTANT

Foreign objects in the ignition switch may jeopardise the function or destroy the lock.

Do not press the remote control key incorrectly turned - Hold the end with the detachable key blade, see page 47.

Withdraw the key

- Push in the remote control key, allow it to eject, then pull it out from the ignition switch.

Functions at different levels

To enable the use of a limited number of functions with the engine switched off, the car's electrical system can be set in 3 different levels (key positions) - **0**, **I** and **II** - with the remote control key. This owner's manual describes these levels throughout using the denomination "key positions".

The following table shows the functions available in each key position/level.

Level	Functions
0	<p>Odometer, clock and temperature gauge are illuminated.</p> <p>Electrically operated seats can be adjusted.</p> <p>The audio system can be used for a limited time - see page 220.</p>
I	<p>Sunroof, power windows, 12 V socket in the passenger compartment, RTI, phone, ventilation fan and windscreen wipers can be used.</p>
II	<p>The headlamps come on.</p> <p>Warning/indicator lamps illuminate for 5 seconds.</p> <p>Several other systems are activated. However, electric heating in seat cushions and the rear window can only be activated after starting the engine.</p> <p>This key position consumes a lot of current from the battery and should therefore be avoided!</p>



03 Your driving environment

Key positions

Selecting key position/level

Key position 0

- Unlock the car - at which point the car's electrical system is at level **0**.

Key position I

- With the remote control key fully inserted into the ignition switch - Briefly press **START/STOP ENGINE**.

NOTE

To reach level **I** or **II** **without** starting the engine - do **not** depress the brake/clutch pedal when these key positions are due to be selected.

Key position II

- With the remote control key fully inserted into the ignition switch - Give one long¹ press on **START/STOP ENGINE**.

Back to key position 0

- To return to key position **0** from position **II** and **I** - Briefly press on **START/STOP ENGINE**.

Audio system

For information on the audio system's functions with remote control key removed - see page 220.

Starting and stopping the engine

For information about starting/switching off the engine - see page 111.

Towing

For important information about the remote control key during towing - see page 297.

¹ Approx. 2 seconds.



Seats

Front seats



- 1 Lumbar support adjustment, turn the wheel¹.
- 2 Forward/backward: lift the handle to adjust the distance to the steering wheel and pedals. Check that the seat is locked after changing position.
- 3 Raise/lower* front edge of seat cushion, pump up/down.
- 4 Adjust backrest rake, turn the wheel.
- 5 Raise/lower the seat, pump up/down.
- 6 Control panel for power seat*.

¹ Also applies to power seat.

⚠ WARNING

Adjust the position of the driver's seat before setting off, never while driving. Make sure that the seat is in locked position in order to avoid personal injury in the event of sudden braking or an accident.

Lowering the front seat backrest

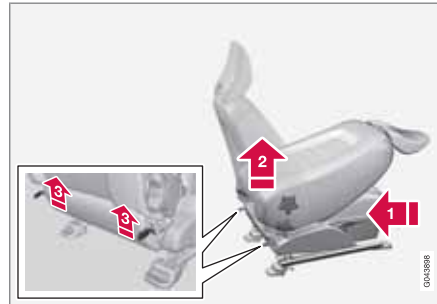

The passenger seat backrest can be folded forward to make room for long loads.

- 1 Move the seat as far back/down as possible.
- 2 Adjust the backrest to an upright position.

- 3 Lift the catches on the rear of the backrest and fold it forward.

4. Push the seat forward so that the head restraint "locks" in under the glovebox.

Raising takes place in reverse order.

⚠ WARNING

Grasp the backrest and make sure that it is properly locked after being folded up in order to avoid personal injury in the event of sudden braking or an accident.



Seats

Power seat*



- 1 Front edge of seat cushion up/down
- 2 Seat forward/backward and up/down
- 3 Backrest rake

The power front seats have overload protection which is tripped if a seat is blocked by an object. If this happens, go to key position **I** or **0** and wait a short time before adjusting the seat again.

Only one movement (forward/back/up/down) can be made at a time.

Preparations

The seats can be adjusted for a certain time after unlocking the door with the remote con-

trol key without the key in the ignition switch. Seat adjustment is normally made in key position **I** and can always be made when the engine is running.

Seat with memory function*

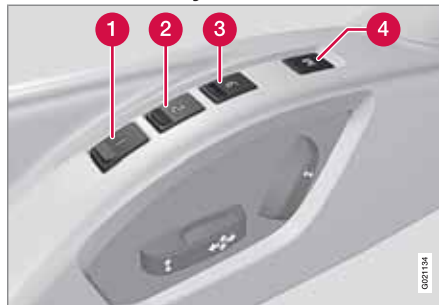

Store setting

- 1 Memory button
- 2 Memory button
- 3 Memory button
- 4 Button for storing settings

1. Adjust the seat and the door mirrors.

2. Hold the button depressed to store settings while depressing one of the memory buttons.

Using a stored setting

Hold one of the memory buttons depressed until the seat and the door mirrors stop. If you release the button then the movement of the seat will stop.

Key memory* in remote control key²

The positions of the driver's seat and the door mirrors³ are stored in the key memory when the car is locked with the remote control key.



When the car is unlocked with the same remote control key it was locked with and the driver's

² For key memory for keyless drive, see page 53.

³ Only if the car is equipped with power seat with memory and retractable power door mirrors.

door is opened, the driver's seat and also the door mirrors automatically adopt the positions stored in the key memory.

i NOTE

The seat and the door mirrors do not move if they are already set the relevant position.

It is also possible to use the key memory by pressing the unlock button on the remote control key when the driver's door is open.

The key memory can be activated/deactivated in the menu system **MY CAR** under **Settings** → **Car settings** → **Car key memory**. For a description of the menu system, see page 144.

i NOTE

In order that the key memory for the driver's seat, and rearview and door mirrors, should work with several remote control keys, the key memory must be activated for each one of the remote control keys.

Each one of the remote control keys must be inserted into the ignition switch when the key memory is activated for each respective remote control key.

i NOTE

The key memory in the remote control keys and the seat's three memories are completely independent of each other.

Emergency stop

If the seat accidentally begins to move, press one of the setting buttons for the seat or memory buttons in order to stop the seat.

Restarting to reach the seat position stored in the key memory is performed by pressing the unlock button on the remote control key. The driver's door must then be open.

! WARNING

Risk of crushing! Make sure that children do not play with the controls. Check that there are no objects in front of, behind or under the seat during adjustment. Ensure that none of the backseat passengers will be trapped.

Heated/ventilated seats*

For heated/ventilated seats, see page 157.

Rear seats

Lowering the rear seat backrest

! IMPORTANT

There must be no objects on the rear seat when the backrest is to be folded down. The seat belts must not be connected either. Otherwise there is a risk of damaging the rear seat upholstery.



The backrest is in two parts. The parts can be folded forward, together or separately.

1. Pull the handle(s). First raise the head restraints if they are lowered.

Seats

2. Fold the backrest forward. Lower the centre head restraint fully if the backrest's wide section shall be lowered.

WARNING

Take hold of the backrests and make sure they are locked properly after opening them out in order to prevent injury under hard braking or in the event of an accident.

Head restraint, centre seat, rear



The head restraint can be adjusted vertically to suit the height of the passenger. The upper edge of the head restraint should be aligned with middle of the back of the head. Slide it up as required.

To lower the head restraint again the button on the left-hand shaft must be pressed in while the head restraint is pressed down.

Electrical lowering of the rear seat's outer head restraints*



1. The remote control key must be in position I or II.
2. Press the button to lower the rear outer head restraints to improve rearward visibility.

WARNING

Do not lower the outer head restraints if there are any passengers using of the outer seats.

Move the head restraint back manually until a click is heard.

WARNING

The head restraints must be in locked position after being raised.



Seats - Executive

Comfort seats, front



- 1 Adjusting the seat, front - rear.
- 2 Control panel for massage and lumbar.

Massage



Button for activating massage.

- 1 Hard massage
- 2 Soft massage

Each front seat has massage in the backrest. The massage is performed by air cushions that can massage with either a hard or soft setting. When one of the settings is selected the massage is carried out in accordance with the cycle: massage 6 minutes - pause 4 minutes - massage 6 minutes etc.

When the button is in the centre position, or when the remote control key is in position 0, massage is not activated.

Setting lumbar

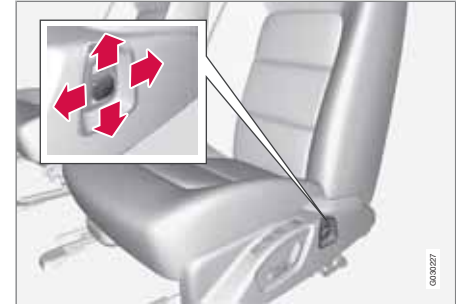

Button for setting lumbar.

The lumbar support is set with the same air cushions used for massage. Adjustment can be made steplessly both in terms of depth and height using the control button, see the illustration above.

Lumbar support can be set when massage is not active.

A memory function recalls the lumbar setting when massage is stopped or when the pressure in the air cushions has decreased, e.g. after a longer period of parking.



Seats - Executive

Adjusting the seat, front - rear



The illustration above shows a left-hand drive car.

The passenger seat can be adjusted front - rear. The seat can be moved forward or backward as long as the front or rear part of the button respectively is held depressed, see illustration above. The angle of the backrest is not changed.



Steering wheel

Adjusting

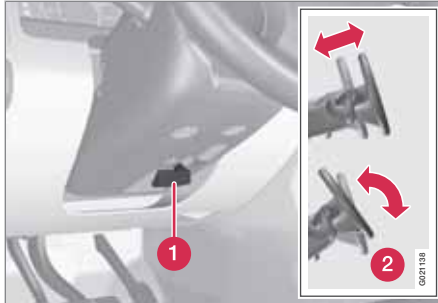

Adjusting the steering wheel.

- 1 Lever - releasing the steering wheel
- 2 Possible steering wheel positions

The steering wheel can be adjusted for both height and depth:

1. Pull the lever towards you to release the steering wheel.
2. Adjust the steering wheel to the position that suits you.
3. Push back the lever to fix the steering wheel in place. If the lever is stiff, press the steering wheel lightly at the same time as you push the lever back.

WARNING

Adjust and secure the steering wheel before driving.

With speed related power steering* the level of steering force can be adjusted, see page 170.

Keypads*



Keypads in the steering wheel.

- 1 Cruise control, see page 171
 - Adaptive cruise control*, see page 173
- 2 Audio and phone control, see page 222

Horn



Horn.

Press the centre of the steering wheel to signal.

* Option/accessory, for more information, see Introduction.

Lighting

Light switches

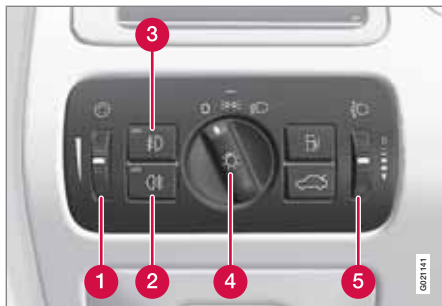

Overview, light switches.

- 1 Thumbwheel¹ for adjusting display and instrument lighting
- 2 Rear fog lamp
- 3 Front fog lamps*
- 4 Light switches
- 5 Thumbwheel² for headlamp levelling

Instrument lighting

Different display and instrument lighting is switched on depending on key position, see page 77.

The display lighting is automatically subdued in darkness - the sensitivity is set with the thumbwheel.

The intensity of the instrument lighting is adjusted with the thumbwheel.

Headlamp levelling

The load in the car changes the vertical alignment of the headlamp beam, which could dazzle oncoming motorists. Avoid this by adjusting the height of the beam. Lower the beam if the car is heavily laden.

1. Allow the engine to run or have the remote control key in position I.
2. Roll the thumbwheel up/down to raise/lower beam alignment.

Cars with Xenon headlamps* have automatic headlamp levelling and therefore do not have the thumbwheel.

Main/dipped beam



Headlamp control and stalk switch.

- 1 Position for main beam flash
- 2 Position for main beam

¹ The thumbwheel also adjusts brightness for auxiliary lighting in handles, storage compartment in the door, analogue clock*, cup holder in the tunnel console and front floor lighting.

² Not available for cars equipped with Xenon headlamps*.

Lighting

Position	Specification
0	Automatic dipped beam. Main beam and main beam flash work in this position ^A /Deactivated dipped beam.
	Position/parking lamps
	Dipped beam. Main beam and main beam flash work in this position.

^A Applies to certain markets.

Main beam flash

Move the stalk switch gently towards the steering wheel to the position for main beam flash. Main beam comes on until the stalk switch is released.

Dipped beam

When the engine is started, dipped beam is activated automatically³ if the headlamp control is in position **0**. If necessary, automatic dipped beam for this position can be deactivated by a workshop. Volvo recommends that you contact an authorised Volvo workshop.

³ Applies to certain markets.

In position dipped beam is always activated automatically when the engine is running or when the remote control key is in position II.

Main beam

Main beam can be activated when the headlamp control is in position **0**³ or . Activate/deactivate main beam by moving the stalk switch towards the steering wheel to the end position and release.

When main beam has been activated the symbol illuminates in the combined instrument panel.

Active Xenon headlamps - ABL*

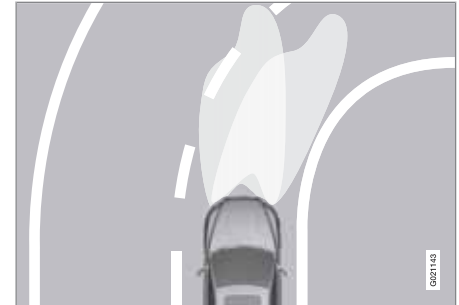

Headlamp pattern with function deactivated (left) and activated (right) respectively.

If the car is equipped with active Xenon headlamps (Active Bending Lights - ABL) the light from the headlamps follows the steering wheel movement in order to provide maximum lighting in bends and junctions and so provide increased safety.

The function is activated automatically when the car is started. In the event of a fault in the function the symbol illuminates in the combined instrument panel at the same time as the information display shows an explanatory text and a further illuminated symbol.

Lighting

Symbol	Display	Specification
	Headlamp failure Service required	The system is disengaged. Visit a workshop if the message remains. Volvo recommends that you contact an authorised Volvo workshop.

The function is only active in twilight or darkness and only when the car is moving.

The function⁴ can be deactivated/activated in the menu system **MY CAR** under **My S80** →

Active bending lights or under **Settings** → **Car settings** → **Light settings** → **Active bending lights**. For a description of the menu system, see page 145.

For headlamp pattern adjustment, see page 91.

⁴ Activated on delivery from the factory.

⁵ Auxiliary lamps must be connected to the electrical system by a workshop. Volvo recommends that you contact an authorised Volvo workshop.

Auxiliary lamps*

If the car has auxiliary lamps, the driver can use the **MY CAR** menu system to choose whether they should be deactivated or switched on/off simultaneously with the main beam⁵, see page 146.

Position/parking lamps



Headlamp control in position for position/parking lamps.

Turn the headlamp control to the centre position (number plate lighting comes on at the same time).

When it is dark outside and the boot lid is opened the rear position lamps illuminate to alert traffic behind. This takes place irrespec-

tive of what position the headlamp control is in or what position the ignition is in.

Brake lights

The brake light automatically comes on during braking. For information on the Emergency brake lights and automatic hazard warning flashers, see page 130.

Front fog lamps



Button for front fog lamps.

The front fog lamps* can be switched on along with main/dipped beam or position/parking lamps.



Lighting

Press the button for on/off. The light in the button illuminates when the fog lamps are on.

i NOTE

Regulations for using front fog lamps vary between different countries.

Rear fog lamp

Button for rear fog lamp.

The rear fog lamp consists of one rear lamp and can only be switched on in combination with main/dipped beam or the front fog lamps.

Press the button for On/Off. The rear fog lamp indicator symbol  on the combined instrument panel and the light in the button illuminate when the rear fog lamp is switched on.

The rear fog lamp is switched off automatically when the engine is switched off.

i NOTE

Regulations for using rear fog lamps vary between different countries.

Hazard warning flashers

Button for hazard warning flashers.

Press the button to activate the hazard warning flashers. Both direction indicator symbols in the combined instrument panel flash when the hazard warning flashers are in use.

The hazard warning flashers are activated automatically when the car brakes so suddenly that the emergency brake lights are activated and speed is below 30 km/h. They remain on when the car has stopped and are deactivated

automatically when the car is driven off again or the button is depressed. For more information on Emergency brake lights and automatic hazard warning flashers, see page 130.

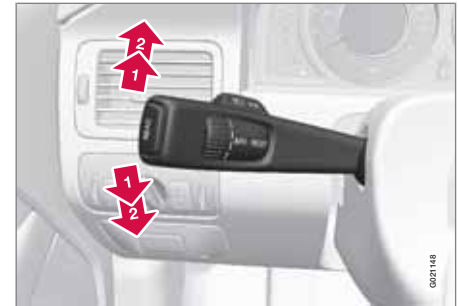
Direction indicators/flashers

Direction indicators/flashers.

Short flash sequence

-  Move the stalk switch up or down to the first position and release. The direction indicators flash three times. The function can be activated/deactivated in the menu system **MY CAR** under **Settings** → **Car settings** → **Light settings** → **Triple turn signal**. For a description of the menu system, see page 145.



Lighting

Continuous flash sequence

➔ Move the stalk switch up or down to the outer position.

The stalk switch remains in its position and is moved back manually, or automatically by the steering wheel movement.

Direction indicator symbols

For direction indicator symbols, see page 70.

Interior lighting



Controls in roof console for the front reading lamps and passenger compartment lighting.

- ➊ Reading lamp, left-hand side
- ➋ Reading lamp, right-hand side
- ➌ Passenger compartment lighting

All lighting in the passenger compartment can be switched on and off manually within 30 minutes from when:

- the engine has been switched off and the remote control key is in position **0**
- the car has been unlocked but the engine has not been started.

Front roof lighting

The front reading lamps are switched on or off by pressing the relevant button in the roof console.

Rear roof lighting



Rear roof lighting.

The lamps are switched on or off by pressing each respective button.

Courtesy lighting

Courtesy lighting (and passenger compartment lighting) is switched on and off respectively when a side door is opened or closed, see page 86

Glovebox lighting

Glovebox lighting is switched on and off respectively when the lid is opened or closed.

Vanity mirror

The lighting for the vanity mirror, see page 215, is switched on and off respectively when the cover is opened or closed.

Automatic lighting

The switch for passenger compartment lighting has three positions for the lighting in the passenger compartment:

- **Off** – right-hand side pressed in, automatic lighting deactivated.
- **Neutral position** – automatic lighting activated.
- **On** – left-hand side pressed in, passenger compartment lighting switched on.

Neutral position

When the button is in neutral position the passenger compartment lighting is switched on and off automatically in accordance with the following.

The passenger compartment lighting is switched on and remains on for 30 seconds if:

- the car is unlocked with the remote control key or key blade, see pages 45 or 48
- the engine has been switched off and the remote control key is in position **0**.

Passenger compartment lighting is switched off when:

- the engine is started
- the car is locked.

The passenger compartment lighting comes on and remains on for two minutes if one of the doors is open.

If any lighting is switched on manually and the car is locked then it will be switched off automatically after two minutes.

Comfort lighting

When the normal passenger compartment lighting is switched off and the engine is running some of the LEDs illuminate, including one in the ceiling lighting, in order to provide a low-light and increase comfort while driving. This lighting goes out for a little while after the normal passenger compartment lighting when the car is locked.

Home safe light duration

Some of the exterior lighting can be kept switched on to work as home safe lighting after the car has been locked.

1. Remove the remote control key from the ignition switch.
2. Move the left-hand stalk switch toward the steering wheel to the end position and release it. The function can be activated in the same way as with main beam flash, see page 86.
3. Get out of the car and lock the door.

When the function is activated, dipped beam, parking lamps, door mirror lamps, number plate lighting, interior roof lamps and courtesy lighting are switched on.

The length of time for which the home safe lighting should be kept on can be set in the menu system **MY CAR** under **Settings** → **Car settings** → **Light settings** → **Home safe light duration**. For a description of the menu system, see page 145.

Approach light duration

Approach lighting is switched on with the remote control key, see page 45, and is used to switch on the car's lighting at a distance.

When the function is activated with the remote control, parking lamps, door mirror lamps, number plate lighting, interior roof lamps and courtesy lighting are switched on.

The length of time for which the approach lighting should be kept on can be set in the menu system **MY CAR** under **Settings** → **Car settings** → **Light settings** → **Approach light duration**. For a description of the menu system, see page 145.

Adjusting headlamp pattern

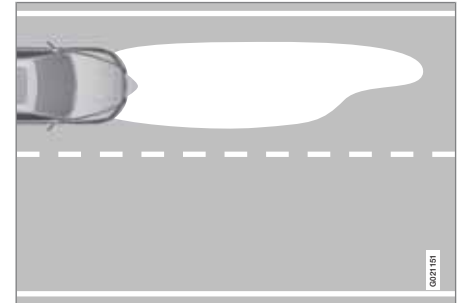

Headlamp pattern, left-hand traffic.

Lighting

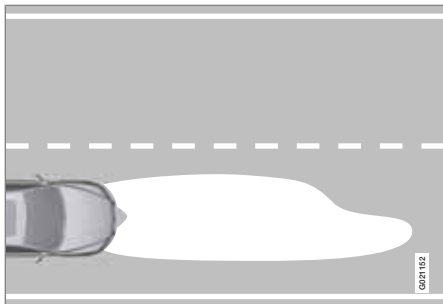

Headlamp pattern, right-hand traffic.

The headlamp pattern must be adjusted to avoid dazzling oncoming motorists and can be set for right or left-hand traffic. The correct pattern will also better illuminate the verge.

Active Xenon headlamps*

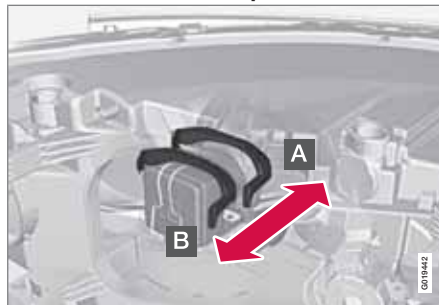

Headlamp control for adjusting headlamp pattern.

- A** Normal position – the headlamp pattern is correct for the country in which the car was delivered.
- B** Adapted position – designed for opposite headlamp pattern.

WARNING

The headlamps must be handled with extreme care due to the Xenon lamp being supplied from a high-voltage unit.

The country in which the car is delivered determines whether normal position is designed for right or left-hand traffic.

Example 1

If a car that is delivered in Sweden shall be driven in the UK then the headlamps must be set to the adjusted position, see preceding illustration.

Example 2

A car that is delivered in the UK is designed for left-hand traffic and is driven there with the headlamps in normal position, see preceding illustration.

Halogen headlamps

The headlamp pattern for halogen headlamps is readjusted by masking the headlamp lens. The headlamp pattern may not be as good.

Masking the headlamps

1. Copy the A and B templates for left-hand drive cars or the C and D templates for right-hand drive cars with a scale of 1:2, see page 95. Use a photocopier with a zoom function for example:
 - A = LHD Right (left-hand drive, right lens)
 - B = LHD Left (left-hand drive, left lens)
 - C = RHD Right (right-hand drive, right lens)
 - D = RHD Left (right-hand drive, left lens)
2. Transfer the template to a self-adhesive waterproof material and cut it out.

**Lighting**

3. Start from the design line on the headlamp lenses, see the dotted line on the side 94. Position the self-adhesive templates at the right distance from each design line using the illustration and the dimensions in the following list:
- A = LHD Right - approx. 86 mm
 - B = LHD Left - approx. 40 mm
 - C = RHD Right - 0 mm
 - D = RHD Left - approx. 96 mm



03 Your driving environment

Lighting

Aligning the templates



Upper row: left-hand drive cars, templates A and B. Lower row: right-hand drive cars, templates C and D.



Lighting

Templates for halogen headlamps

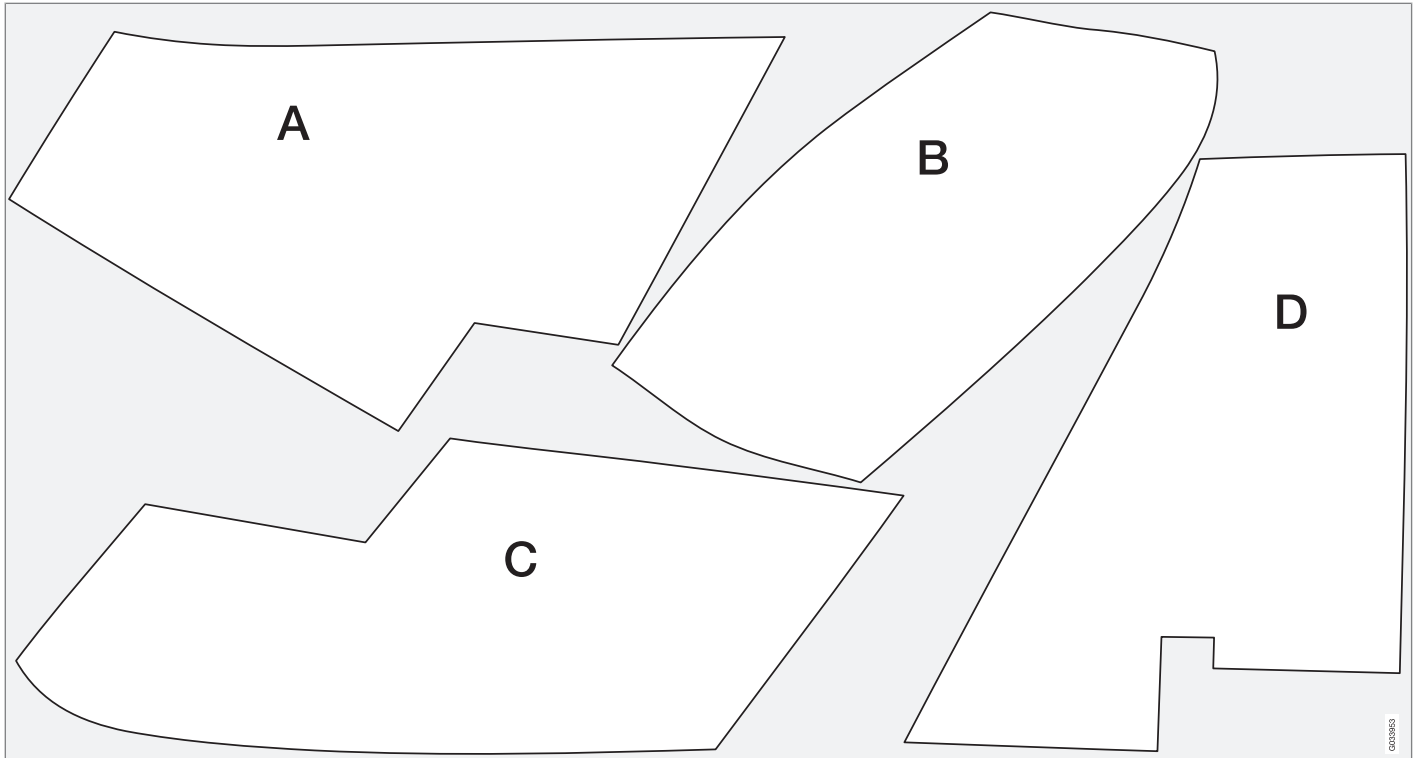

Wipers and washing

Windscreen wipers¹



Windscreen wipers and windscreen washers.

- 1** Rain sensor, on/off
- 2** Thumbwheel sensitivity/frequency

Windscreen wipers off

0 Move the stalk switch to position **0** to switch off the windscreen wipers.

Single sweep

Raise the stalk switch and release to make one sweep.

Intermittent wiping

INT Set the number of sweeps per time unit with the thumbwheel when intermittent wiping is selected.

Continuous wiping

The wipers sweep at normal speed.

The wipers sweep at high speed.

! IMPORTANT

Before activating the wipers during winter - ensure that the wiper blades are not frozen in, and that any snow or ice on the windscreen is scraped away.

! IMPORTANT

Use plenty of washer fluid when the wipers are cleaning the windscreen. The windscreen must be wet when the windscreen wipers are operating.

Service position wiper blade

For cleaning the windscreen/wiper blades and replacement of wiper blades see see page 332 and 350.

Rain sensor*

The rain sensor automatically starts the windscreen wipers based on how much water it detects on the windscreen. The sensitivity of

the rain sensor can be adjusted using the thumbwheel.

When the rain sensor is activated a light in the button the rain sensor symbol is shown in the right-hand display in the combined instrument panel.

Activating and setting the sensitivity

When activating the rain sensor, the car must be running or the remote control key in position **I** or **II** while the windscreen wiper stalk switch must be in position **0** or in the position for a single sweep.

Activate the rain sensor by pressing the button

. The windscreen wipers make one sweep.

Press the stalk switch up for the wipers to make an extra sweep.

Turn the thumbwheel upward for higher sensitivity and downward for lower sensitivity. (An extra sweep is made when the thumbwheel is turned upward.)

deactivate

Deactivate the rain sensor by pressing the button or move the stalk switch down to another wiper program.

¹ Replacing the wiper blades see page 332, service position, wiper blade see page 332 and filling washer fluid see page 333.



Wipers and washing

The rain sensor is automatically deactivated when the remote control key is removed from the ignition switch or five minutes after the engine has been switched off.

! IMPORTANT

The windscreen wipers could start and be damaged in an automatic car wash. Deactivate the rain sensor while the car is running or the remote control key is in position I or II. The symbol in the combined instrument panel and the lamp in the button go out.

Washing the headlamps and windows



Washing the windscreen

Move the stalk switch toward the steering wheel to start the windscreen and headlamp washers.

The windscreen wipers will make several more sweeps and the headlamps are washed once the stalk switch has been released.

Heated washer nozzles*

The washer nozzles are heated automatically in cold weather to prevent the washer fluid freezing solid.

High-pressure headlamp washing*

High-pressure headlamp washing consumes a large quantity of washer fluid. To save fluid, the headlamps are washed automatically at every fifth windscreen wash cycle.



03 Your driving environment

Windows, rearview and door mirrors

General

Laminated glass



The glass is reinforced which provides better protection against break-ins and improved sound insulation in the passenger compartment.

The windscreen and the side windows* have laminated glass.

Water and dirt-repellent coating*



The front side windows are treated with a coating that improves the view in difficult weather conditions. Maintenance, see page 351.

! IMPORTANT

Do not use a metal ice scraper to remove ice from the windows. Use the defroster to remove ice from the mirrors, see page 102.

Heat-reflecting windscreen*

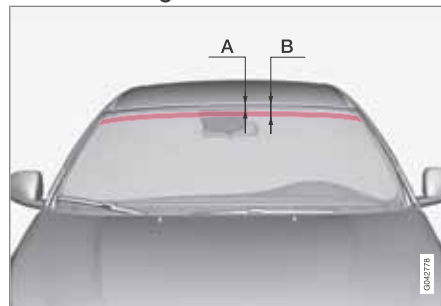

Areas where IR film is not applied.

	Dimensions
A	47 mm
B	87 mm

The windscreen is equipped with a heat-reflecting film (IR) that reduces the solar heat radiation into the passenger compartment.

The positioning of electronic equipment, such as a transponder, behind a glass surface with heat-reflecting film may affect its function and performance.

For the optimal function of electronic equipment, it should be positioned on the part of the

windscreen with no heat-reflecting film (see the highlighted area in the above illustration).

Power windows



Driver's door control panel.

- 1 Switch for electric child safety locks* and disengaging rear power window buttons, see page 60.
- 2 Rear window controls
- 3 Front window controls

! WARNING

Check that none of the rear seat passengers is in danger of becoming trapped in any way when closing the windows from the driver's door.



Windows, rearview and door mirrors

WARNING

Make sure that children or other passengers are not in danger of becoming trapped in any way when closing the windows, in particular when the remote control key is used.

WARNING

If there are children in the car - remember to always switch off the power supply to the power windows by selecting key position **0** and then take the remote control key with you when leaving the car. For information on key positions - see page 78.

Operating



Operating the power windows.

1 Operating without auto

2 Operating with auto

All power windows can be operated using the control panel for the driver's door - the control panels for the other doors can only each operate their respective power window. Only one control panel can be operated at a time.

In order for the power windows to be used the key position must be at least **I** - see page 77.

The power windows can be operated for a few minutes after the engine has been switched off and after the remote control key has been removed - although not after a door has been opened.

Closing of the windows is stopped and the window is opened if anything prevents its movement. It is possible to force the pinch protection when closing has been interrupted, e.g. with ice, by continuously holding the button up until the window is closed. The pinch protection is reactivated after a brief pause.

NOTE

One way to reduce the pulsating wind noise when the rear windows are open is to also open the front windows slightly.

Operating without auto

Move one of the controls up/down gently. The power windows move up/down as long as the control is held in position.

Operating with auto

Move one of the controls up/down to the end position and release it. The window runs automatically to its end position.

Operating with the remote control key and central locking

To remotely operate the power windows from the outside with the remote control key or from inside with central locking, see pages 45 and 55

Windows, rearview and door mirrors

Resetting

If the battery is disconnected then the function for automatic opening must be reset so that it can work correctly.

1. Gently raise the front section of the button to raise the window to its end position and hold it there for one second.
2. Release the button briefly.
3. Raise the front section of the button again for one second.

WARNING

Resetting must be carried out to ensure that pinch protection works.

Sun blinds*

Rear door



Hook with associated catch

Sun blinds are built into the panel on each rear door.

1. Pull up the sun blind and hook it into the hook in the upper door frame.
2. Lock the sun blind by moving the catch upwards.

The window can also be opened and closed when the sun blind is pulled up.

Rear window



There is a sun blind built into the rear parcel shelf.

- Pull up the sun blind and hook it into the roof clip using the two hooks for the blind.
 - > The spring force in the blind keeps the hooks in position.

When the sun blind is not in use - unhook it, hold onto the handle and allow the blind to roll up slowly.



Windows, rearview and door mirrors

Door mirrors



Door mirror controls.

Adjusting

1. Press the **L** button for the left-hand door mirror or the **R** button for the right-hand door mirror. The light in the button illuminates.
2. Adjust the position with the joystick in the centre.
3. Press the **L** or **R** button again. The light should no longer be illuminated.

WARNING

The mirror on the driver's side is the wide-angle type to provide optimal vision. Objects may appear further away than they actually are.

Storing the position¹

The mirror positions are stored in the key memory when the car has been locked with the remote control key. When the car is unlocked with the same remote control key the mirrors and the driver's seat adopt the stored positions when the driver's door is opened.

The function can be activated/deactivated in the menu system **MY CAR** under **Settings** → **Car settings** → **Car key memory** → **Position of door mirrors and driver's seat in key**. For a description of the menu system, see page 145.

Angling the door mirror when parking¹

The door mirror can be angled down for the driver to view the side of the road when parking for example.

- Engage reverse gear and press the **L** or **R** button.

When reverse gear is disengaged the mirror automatically returns to its original position

after approx. 10 seconds, or sooner by pressing the **L** and **R** button.

Automatic angling of the door mirror when parking¹

When reverse gear is engaged the door mirror is automatically angled down so that the driver can see the side of the road when parking for example. When reverse gear is disengaged the mirror automatically returns to its original position after a short time.

The function can be activated/deactivated in the menu system **MY CAR** under **Settings** → **Car settings** → **Side mirror settings** → **Tilt left mirror** or **Tilt right mirror**. For a description of the menu system, see page 145.

Automatic retraction when locking¹

When the car is locked/unlocked with the remote control key the door mirrors are automatically retracted/extended.

The function can be activated/deactivated in the menu system **MY CAR** under **Settings** → **Car settings** → **Side mirror settings** → **Fold mirrors**. For a description of the menu system, see page 145.

¹ Only in combination with power seat with memory, see page 80.

Windows, rearview and door mirrors

Resetting to neutral

Mirrors that have been moved out of position by an external force must be reset electrically to the neutral position for electric retracting/extending to work correctly:

1. Retract the mirrors with the **L** and **R** buttons.
2. Fold them out again with the **L** and **R** buttons.
3. Repeat the above procedure as necessary.

The mirrors are now reset in neutral position.

Retractable power door mirrors*

The mirrors can be retracted for parking/driving in narrow spaces:

1. Depress the **L** and **R** buttons simultaneously (key position must be at least **I**).
2. Release them after approximately 1 second. The mirrors automatically stop in the fully retracted position.

Fold out the mirrors by pressing down the **L** and **R** buttons simultaneously. The mirrors automatically stop in the fully extended position.

Home safe and approach lighting

The light on the door mirrors illuminates when approach lighting or home safe lighting is selected, see page 91.

Rear window and door mirror defrosters

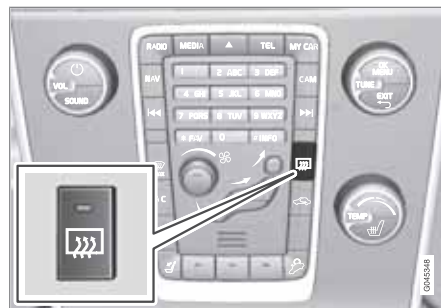

Use the defroster to quickly remove misting and ice from the rear window and the door mirrors.

One press of the button starts the heating. The light in the button indicates that the function is active. Disconnect the heating as soon as the ice/misting is cleared in order not to load the battery unnecessarily. However, the heating is switched off automatically after a certain time. Following which, the heating is switched on

and off automatically as long as the outside temperature is below +7 °C.

The rear window is demisted/defrosted automatically if the car is started in an outside temperature lower than +9 °C. Automatic defrosting can be selected in the menu system **MY CAR** under **Settings** → **Climate settings** → **Automatic rear defroster**. Select between **On** or **Off**. For a description of the menu system, see page 145.

Interior rearview mirror



- 1 Control for dimming

Manual dimming

Bright light from behind could be reflected in the rearview mirror and dazzle the driver. Use



Windows, rearview and door mirrors

dimming with the dimming control when lights from behind are distracting:

1. Use dimming by moving the control in towards the passenger compartment.
2. Return to normal position by moving the control towards the windscreen.

Automatic dimming*

Bright light from behind is automatically dimmed by the rearview mirror. The control is not available in mirrors with automatic dimming.

The compass* can only be specified for rearview mirrors with automatic dimming, see page 104.



03 Your driving environment

Compass*

Operation



Rearview mirror with compass.

The upper right-hand corner of the rearview mirror has an integrated display that shows the compass direction in which the front of the car is pointing. Eight different directions are shown with English abbreviations: **N** (north), **NE** (north east), **E** (east), **SE** (south east), **S** (south), **SW** (south west), **W** (west) and **NW** (north west).

The compass is activated automatically when the car is started or in key position **II**, see page 77. To deactivate/activate the compass - press in the button on the rear side of the mirror using a paper clip for example.

Calibration

The compass may need calibrating to work correctly. **C** is shown in the mirror's display if the compass needs calibrating.

1. Stop the car in a large open area free from steel structures and high-voltage power lines.
2. Start the car.

NOTE

For optimum calibration - switch off all electrical equipment (climate control system, wipers etc.) and make sure that all doors are closed.

3. Press and hold the button on the rear of the rearview mirror (use a paper clip or similar) until **C** is shown again (approx. 6 seconds).
4. Drive off as usual. **C** disappears from the display when calibration is complete.

Alternative calibration method: Drive slowly in a circle at a speed of no more than 8 km/h until **C** disappears from the display when calibration is complete.

Selecting the zone

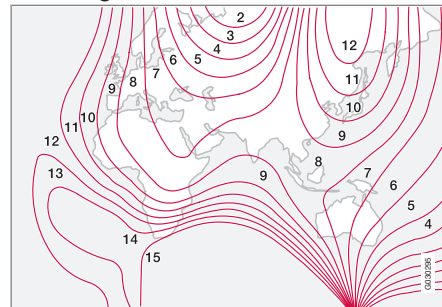

Magnetic zones.

The earth is divided into 15 magnetic zones. The correct zone must be selected for the compass to work correctly.

1. The remote control key should be in position **II**, see page 77.
2. Press and hold the button on the rear of the rearview mirror (use a paper clip or similar) for at least 3 seconds. The number for the current area is shown.
3. Press the button repeatedly until the number for the required geographic area (**1-15**) is shown.
4. The display will revert to showing the compass direction after a few seconds.



Power sunroof*

General

The sunroof controls are located in the roof panel. The sunroof can be opened vertically at the rear edge and horizontally. Key position I or II is required for the sunroof to be opened.

Horizontal opening

Horizontal opening, backward/forward.

- 1 Opening, automatic
- 2 Opening, manual
- 3 Closing, manual
- 4 Closing, automatic

Opening

For maximum sunroof opening, move the control back to the position for automatic opening and release.

Open manually by pulling the control backwards to the point of resistance for manual opening. The sunroof moves to maximum open position as long as the button is kept depressed.

Closing

Close manually by pushing the control forwards to the point of resistance for manual closing. The sunroof moves to closed position as long as the button is kept depressed.

WARNING

Risk of crushing when sunroof is closed. The sunroof's pinch-protection function only operates during automatic closing, not manual.

Close automatically by pressing the control to the position for automatic closing and then release it.

The power supply to the sunroof is switched off by selecting key position 0 and removing the remote control key from the ignition switch.

WARNING

If there are children in the car:

Remember to always switch off the power supply to the sunroof by selecting key position 0 and then take the remote control key with you when leaving the car. For information on key positions - see page 78.

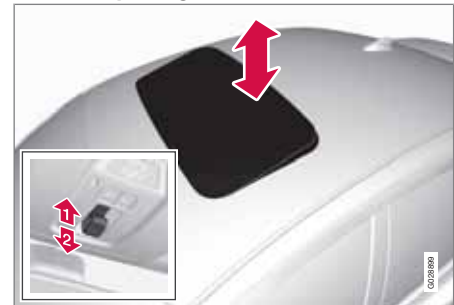
Vertical opening

Vertical opening, raised at the rear edge.

- 1 Open by pressing the rear edge of the control upward.
- 2 Close by pulling the rear edge of the control down.



Power sunroof*

Closing using the remote control key or central locking button



One long press on the lock button closes the sunroof and all the windows, see pages 45 and 55. The doors and the boot lid are locked. To interrupt closing, press the lock button again.

WARNING

If the sunroof is closed using the remote control key, check that no one is in danger of becoming trapped in any way.

Sunscreen

The sunroof features a manual, sliding interior sunscreen. The sunscreen slides back automatically when the sunroof is opened. Grip the handle and slide the screen forward to close it.

Pinch protection

The sunroof's pinch protection function is triggered if it is blocked by an object during automatic closing. If blocked, the sunroof will stop and automatically open to the previous position.

Wind deflector



The sunroof has a wind deflector that is folded up when the sunroof is in the open position.

03

**Alcolock*****General information on the alcolock**

The function of the Alcolock is to prevent the car from being driven by individuals under the influence of alcohol. Before the engine can be started the driver must take a breath test that verifies that he/she is not under the influence of alcohol. Alcolock calibration takes place in accordance with each market's limit value in force for driving legally.

WARNING

The Alcolock is an aid and does not exempt the driver from responsibility. It is always the responsibility of the driver to be sober and to drive the car safely.

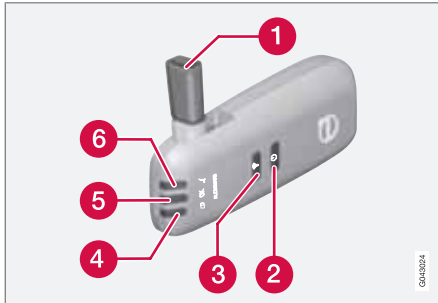
Functions

1. Nozzle for breath test.
2. Switch.
3. Transmission button.
4. Lamp for battery status.
5. Lamp for result of breath test.
6. Lamp indicates ready for breath test.

Operation**Battery**

Alcolock indicator lamp (4) shows battery status:

Indicator lamp (4)	Battery status
Green flashing	Charging in progress
Green	Fully charged
Yellow	Semi-charged
Red	Discharged - fit the charger in the holder or connect the power supply cable from the glovebox.

NOTE

Store the Alcolock in its holder. This will keep the built-in battery fully charged and the Alcolock is activated automatically when the car is opened.

Before starting the engine

The Alcolock is activated automatically and is then ready for use when the car is opened.

1. When the indicator lamp (6) is green the Alcolock is ready for use.
2. Withdraw the Alcolock from its holder. If the Alcolock is outside the car when it is unlocked then it must first be activated with the switch (2).
3. Fold up the nozzle (1), take a deep breath and blow with an even pressure until a "click" is heard after approx. 5 seconds. The result will be one of the alternatives in the following table **Result after breath test**.
4. If no message is shown then the transmission to the car may have failed - in which case, press the button (3) to transmit the result to the car manually.
5. Fold down the nozzle and refit the Alcolock in its holder.
6. Start the engine following an approved breath test within 5 minutes - otherwise it must be repeated.

* Option/accessory, for more information, see Introduction.



03 Your driving environment

Alcoguard*

Result after breath test

Indicator lamp (5) + Display text	Specification
Green lamp + Alcoguard Approved test	Start the engine - no alcohol content measured.
Yellow lamp + Alcoguard Approved test	Engine starting possible - measured alcohol content is above 0.1 promille but below the limit value in force ^A .
Red lamp + Disapproved test Wait 1 minute	Engine starting not possible - measured alcohol content is above the limit value in force ^A .

^A Limits vary between countries, so find out what limits apply. See also the section entitled General information on the Alcolock on page 107

i NOTE

After a completed period of driving, the engine can be restarted within 30 minutes without a new breath test.

To bear in mind

Before the breath test

In order to obtain correct function and as accurate a measurement result as possible:

- Avoid eating or drinking approx. 5 minutes before the breath test.
- Avoid excess windscreen washing - the alcohol in the washer fluid may result in an incorrect measurement result.

Change of driver

In order to ensure that a new breath test is carried out in the event of a change of driver - depress the switch (2) and the send button (3) simultaneously for approx. 3 seconds. At which point the car returns to start inhibition mode and a new approved breath test is required before starting the engine.

Calibration and service

The Alcolock must be checked and calibrated at a workshop¹ every 12 months.

30 days before recalibration is necessary the display shows **Alcoguard Calibr. required**. If calibration is not carried out within these 30 days then normal engine starting will be blocked - only starting with the Bypass func-

tion will then be possible, see page 109 section Emergency situation.

The message can be cleared by pressing the send button (3) once. Otherwise it goes out by its own after approx. 2 minutes but then reappears each time the engine is started - only recalibration at a workshop¹ can clear the message permanently.

Cold or hot weather

The colder the weather the longer it takes before the Alcolock is ready for use:

Temperature (°C)	Maximum heating time (seconds)
+10 - +85	10
-5 - +10	60
-40 - -5	180

At temperatures below -20 °C or above +60 °C the Alcolock requires additional power supply. The display shows **Alcoguard insert power cable**. In which case, connect the power supply cable from the glovebox and wait until indicator lamp (6) is green.

¹ An authorised Volvo workshop is recommended.

* Option/accessory, for more information, see Introduction.



Alcoguard*

In extremely cold weather the heating time can be reduced by taking the Alcolock indoors.

Emergency situation

In the event of an emergency situation, or if the Alcolock is out of order or has been removed, it is possible to bypass the Alcolock in order to drive the car.



NOTE

All Bypass activation is logged and saved in memory, see page 8 in the section, Recording data.

After the Bypass function has been activated the display shows **Alcoguard Bypass enabled** the whole time while driving and can only be reset by a workshop¹.

The Bypass function can be tested without the error message being logged - in which case, carry out all the steps without starting the car. The error message is cleared when the car is locked.

When the Alcolock is installed, either the Bypass or Emergency function is selected as the bypassing option. This setting can be changed afterwards at a workshop¹.

Activating the Bypass function

- Depress and hold the left-hand stalk switch **READ** button and the button for hazard warning flashers simultaneously for approx. 5 seconds - the display first shows **Bypass activated Wait 1 minute** and then **Alcoguard Bypass enabled** - after which the engine can be started.

This function can be activated several times. The error message shown during driving can only be cleared at a workshop¹.

Activating the Emergency function

- Depress and hold the left-hand stalk switch **READ** button and the button for hazard warning flashers simultaneously for approx. 5 seconds - the display shows **Alcoguard Bypass enabled** and the engine can be started.

This function can be used once, after which a reset must be made at a workshop¹.

Symbols and display messages

In addition to the previously described messages, the combined instrument panel's display can also show the following:

Display text	Meaning/Action
Alcoguard Restart possible	The engine has been switched off for less than 30 minutes - engine starting possible without new test.
Alcoguard Service required	Contact a workshop ¹ .
Alcoguard No signal	Transmission failed - send manually with button (3) or take a new breath test.
Alcoguard Invalid test	Test failed - take a new breath test.
Alcoguard Blow longer	Blowing too short - blow for longer.
Alcoguard Blow softer	Blowing too hard - blow more gently.

¹ An authorised Volvo workshop is recommended.



03 Your driving environment

Alcoguard*

Display text	Meaning/Action
Alcoguard Blow harder	Blowing too weak - blow harder.
Alcoguard wait Preheating	Heating not finished - wait for text Alcoguard Blow 5 seconds.

03



Starting the engine

Petrol and diesel engines



Ignition switch with remote control key extracted/inserted, and **START/STOP ENGINE** button.

! IMPORTANT

Do not press in the remote control key incorrectly turned - Hold the end with the detachable key blade, see page 47.

1. Insert the remote control key in the ignition switch and press it in to its end position. Note that if the car is equipped with an alcolock then a breath test must first be approved before the engine can be started - see page 107.

2. Hold the clutch pedal fully depressed¹. (For cars with automatic gearbox - Depress the brake pedal.)
3. Press the **START/STOP ENGINE** button and then release it.

i NOTE

For diesel-engined cars, there may be a slight delay before the engine can be started - **Engine Preheating** is displayed in the meantime.

The starter motor works until the engine starts or until its overheating protection triggers.

! IMPORTANT

If the engine fails to start after 3 attempts - wait for 3 minutes before making a further attempt. Starting capacity increases if the battery is allowed to recover.

! WARNING

Always remove the remote control key from the ignition switch when leaving the car, and make sure that the key position is **0** - in particular if there are children in the car. For information on how this works - see page 78.

i NOTE

The idling speed can be noticeably higher than normal for certain engine types during cold starting. This is so that the emissions system can reach normal operating temperature as quickly as possible, which minimises exhaust emissions and protects the environment.

Keyless drive*

Follow steps 2–3 for starting petrol and diesel engines. For more information on Keyless drive - see page 52.

i NOTE

A prerequisite for the car to start is that one of the car's remote control keys with the Keyless drive* function is in the passenger compartment or cargo area.

! WARNING

Never remove the remote control key from the car while driving or during towing.

Stop the engine

To switch off the engine:

¹ If the car is moving then it is enough to press the **START/STOP ENGINE** button to start the car.



Starting the engine

- Press **START/STOP ENGINE** - the engine stops.
- If the car has an automatic gearbox and the gear selector is not in a position **P** or if the car is moving - Press twice or hold the **START/STOP ENGINE** button depressed until the engine stops.

Steering lock

A mechanical noise can be perceived when the steering lock unlocks or locks.

- The steering lock unlocks when the remote control key is in the ignition switch² and the **START/STOP ENGINE** button is depressed.
- The steering lock locks when the driver's door is opened after the engine has been switched off.

Key positions

For information on the remote control key's different key positions - see page 77

² Cars with Keyless drive must have a remote control key inside the passenger compartment.



Starting the engine – Flexifuel

General information about starting with Flexifuel

The engine is started in the same way as in a petrol-engined car.

In the event of starting difficulties

If the engine does not start at the first start attempt:

- Make further attempts to start with the **START/STOP ENGINE** button.

If the engine still does not start

The outside temperature is lower than +5 °C:

1. Connect the engine block heater for at least 1 hour.
2. Make further attempts to start with the **START/STOP ENGINE** button.

! IMPORTANT

If the engine does not start despite repeated start attempts, you are recommended to contact an authorised Volvo workshop.

Engine block heater*



Electrical input to the engine block heater.

When the temperature is expected to be lower than -10 °C and the car has been refuelled with bioethanol E85, an engine block heater should be used for about 2 hours to facilitate the quick starting of the engine.

The lower the temperature, the longer the time required with the engine block heater. At -20 °C the heater should be used for approx. 3 hours.

Cars intended for E85 have an electric engine block heater*. Starting and driving with a pre-heated engine involves significantly lower emissions and reduced fuel consumption. For this reason you should aim to use the engine block heater throughout the winter months.

! WARNING

The engine block heater is powered by high voltage. Fault tracing and repair of an electric engine block heater and its electrical connections must only be carried out by a workshop – an authorised Volvo workshop is recommended.

i NOTE

Points to remember for carrying reserve fuel:

- In the event of stalling due to an empty fuel tank, bioethanol E85 from a reserve fuel can may make the engine difficult to start in extreme cold. This is avoided by filling the reserve fuel can with 95 octane petrol.

For more information on Flexifuel's bioethanol E 85 fuel, see page 285 and 370.



Starting the engine – Flexifuel

Fuel adaptation

Flexifuel engines can be driven on both 95 octane unleaded petrol and bioethanol E85. Both fuels are filled in the common fuel tank so that any variations of mixing ratios between these two fuels is possible.

If the fuel tank is filled with petrol after the car has been driven on bioethanol E85 (or vice versa) then the engine may run slightly unevenly for a time. For this reason it is important to allow the engine to accustom itself (adapt) to the new fuel mixture.

Adaptation takes place automatically when the car is driven for a short period at an even speed.

IMPORTANT

After the fuel mixture in the tank has been changed an adaptation should be made by driving at an even speed for about 15 minutes.

If the battery has been discharged or disconnected then a slightly longer period of driving is required for the adaptation as the memory for the electronics has been cleared.

Starting the engine – external battery

Jump starting

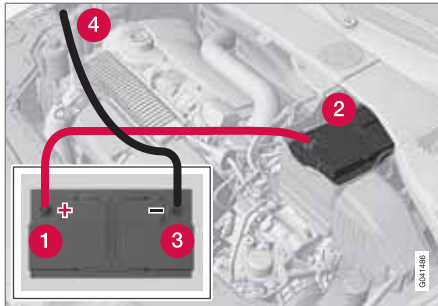

If the battery is flat then the car can be started with current from another battery.

When jump starting the car, the following steps are recommended to avoid short circuits or other damage:

1. Insert the remote control key in key position 0, see page 77.
2. Check that the donor battery has a voltage of 12 V.
3. If the donor battery is installed in another car - switch off the donor car's engine and make sure that the two cars do not touch each other.
4. Connect one of the red jump lead's clamps to the donor battery's positive terminal (1).

IMPORTANT

Connect the start cable carefully to avoid short circuits with other components in the engine compartment.

IMPORTANT

Do not touch the crocodile clips during the start procedure. There is a risk of sparks forming.

12. Remove the jump leads in reverse order - first the black and then the red.
 - > Make sure that none of the black jump lead's clamps comes into contact with the battery's positive terminal or the clamp connected to the red jump lead!

WARNING

- The battery can generate oxyhydrogen gas, which is highly explosive. A spark can be formed if a jump lead is connected incorrectly, and this can be enough for the battery to explode.
- The battery contains sulphuric acid, which can cause serious burns.
- If sulphuric acid comes into contact with eyes, skin or clothing, flush with large quantities of water. If acid splashes into the eyes - seek medical attention immediately.

For more information on the car's battery - see page 334.



Gearboxes

Manual gearbox



Gearshift pattern 5-speed gearbox.

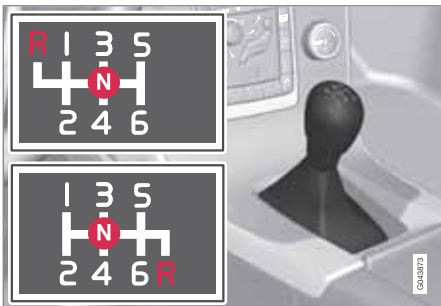

Gearshift pattern 6-speed gearbox.

The 6-speed box is available in two versions - reverse gear position differs between them.

Look at the actual gearshift pattern imprinted on the gear lever.

- Depress the clutch pedal fully during each gear change.
- Take your foot off the clutch pedal between gear changes.

⚠ WARNING

Get into the habit of always applying the parking brake when parking on a slope - an engaged gear is not sufficient to hold the car in all situations.

Reverse gear inhibitor

The reverse gear inhibitor hinders the possibility of mistakenly attempting to engage reverse gear during normal forward travel.

- Start from neutral position **N** and only engage reverse gear **R** when the car is stationary.

i NOTE

With the upper variant of the shifting pattern for 6-speed gearbox (see previous illustration) - **first press down** the gear lever in the **N** position in order to engage reverse gear.

Automatic gearbox Geartronic*



D: Automatic gear positions. **M (+/-):** Manual gear positions.

The information display shows the position of the gear selector using the following indications: **P, R, N, D, S, 1, 2, 3, 4, 5** or **6**, see page 69.

Gear positions

Parking position (P)

Select **P** when starting the engine or when the car is parked. The brake pedal must be depressed to disengage the gear selector from the **P** position.

The gearbox is mechanically blocked when the **P** position is engaged. Apply the parking brake as well, as a precaution - see page 132.



Gearboxes

IMPORTANT

The car must be stationary when position **P** is selected.

WARNING

Get into the habit of always applying the parking brake when parking on a slope - the automatic transmission's **P** position is not sufficient to hold the car in all situations.

Reverse (R)

The car must be stationary when position **R** is selected.

Neutral position (N)

No gear is engaged and the engine can be started. Apply the parking brake if the car is stationary with the gear selector in position **N**.

Drive (D)

D is the normal driving position. Shifting up and down takes place automatically based on the level of acceleration and speed. The car must be stationary when the gear selector is moved to position **D** from position **R**.

Geartronic – Manual gear positions (+/-)

The driver can also change gear manually using the Geartronic automatic gearbox. The

car engine-brakes when the accelerator pedal is released.

Manual gearshift mode is obtained by moving the lever to the side from position **D** to the end position at +/- . The information display shifts the indication from **D** to one of the figures 1 – 6, which is equivalent to the gear that is engaged just then, see page 69.

- Move the lever forwards towards + (plus) to change up a gear and release the lever, which returns to its rest position between + and –.

or

- Pull the lever back towards – (minus) to change down a gear and release it.

The manual gearshift mode (+/-) can be selected at any time while driving.

Geartronic automatically shifts down if the driver allows the speed to decrease lower than a level suitable for the selected gear, in order to avoid jerking and stalling.

To return to automatic driving mode:

- Move the lever to the side to the end position at **D**.

NOTE

If the gearbox has a Sport programme then the gearbox will only become manual after the lever has been moved forwards or backwards in its (-+/-) position. The information display then shifts the indication from **S** to show which of the gears 1-6 is engaged.

Geartronic - Sport mode (S)¹

The Sport programme provides sportier characteristics and allows higher engine speed for the gears. At the same time it responds more quickly to acceleration. During active driving, the use of a lower gear is prioritised, leading to a delayed upshift.

Sport mode is obtained by moving the lever to the side from **D** position to the end position at +/- . The information display shifts the indication from **D** to **S**.

Sport mode can be selected at any time while driving.

Geartronic - Winter mode

It can be easier to pull away on slippery roads if 3rd gear is engaged manually.

1. Depress the brake pedal and move the gear lever from the **D** position to the end position at +/- - the instrument panel dis-

¹ Only models D5 and T6.

Gearboxes

play shifts the indication from **D** to the figure 1.

2. Scroll up to gear 3 by pushing the lever forward towards + (plus) twice - the display shifts the indication from 1 to 3.
3. Release the brake and accelerate carefully.

The gearbox "winter mode" means that the car moves off with a lower engine speed and reduced engine power on the drive wheels.

Kick-down

When the accelerator pedal is pressed all the way to the floor (beyond the position normally regarded as full acceleration) a lower gear is immediately engaged. This is known as kick-down.

If the accelerator is released from the kick-down position, the gearbox automatically changes up.

Kick-down is used when maximum acceleration is needed, such as for overtaking.

Safety function

To prevent overrevving the engine, the gearbox control program has a protective downshift inhibitor which prevents the kick-down function.

Geartronic does not permit downshifting/kick-down which would result in an engine speed high enough to damage the engine. Nothing

happens if the driver still tries to shift down in this way at high engine speed – the original gear remains engaged.

When kick-down is activated the car can change one or more gears at a time depending on engine speed. The car changes up when the engine reaches its maximum speed in order to prevent damage to the engine.

Mechanical gear selector inhibitor

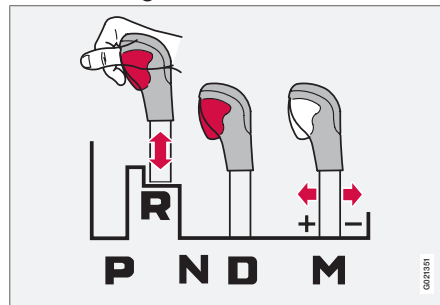

The gear selector can be moved forward and back freely between **N** and **D**. Other positions are locked with a latch that is released with the inhibitor button on the gear selector.

With the inhibitor button depressed the lever can be moved forwards or backwards between **P**, **R**, **N** and **D**.

Automatic gear selector inhibitor

The automatic gearbox has special safety systems:

Parking position (P)

Stationary car with engine running:

Keep your foot on the brake pedal when moving the gear selector to another position.

Electric gear inhibitor – Shiftlock Parking position (P)

To be able to move the gear selector from **P** to other gear positions, the brake pedal must be depressed and the remote control key must be in position **II**, see page 77.

Shiftlock – Neutral (N)

If the gear selector is in the **N** position and the car has been stationary for at least 3 seconds (irrespective of whether the engine is running) then the gear selector is locked.

To be able to move the gear selector from **N** to other gear positions, the brake pedal must be depressed and the remote control key must be in position **II**, see page 77.



Gearboxes

Deactivate automatic gear selector inhibitor



If the car cannot be driven, e.g. due to a flat battery, the gear selector must be moved from the **P** position so that the car can be moved.

- 1 Lift the rubber mat in the compartment behind the centre console and open the hatch.
- 2 Fully insert the key blade. Press the key blade down and hold (For information on the key blade, see page 47.)
- 3 Move the gear selector from the **P** position.

Automatic gearbox Powershift*



D: Automatic gear positions. M (+/-): Manual gear positions.

Powershift is a six-stage automatic gearbox that has double mechanical clutch discs in contrast to a conventional automatic gearbox. A conventional automatic gearbox has a hydraulic torque converter instead that transfers power from engine to gearbox.

Powershift transmission operates in the same way and has similar controls and functions as the Geartronic automatic transmission, described in the previous section.

Powershift or Geartronic?

In the event of uncertainty as to whether or not the car is equipped with Powershift transmission, this can be verified by checking the designation on the decal number (5) under the

bonnet - see page 358. The designation "MPS6" means that it is Powershift transmission - otherwise it is Geartronic automatic transmission.

HSA

The HSA (Hill Start Assist) function means that the pressure in the brake system remains for several seconds while the foot is moved from the brake pedal to the accelerator pedal before setting off or reversing uphill.

The temporary braking effect releases after several seconds or when the driver accelerates.

To bear in mind

The transmission's double clutch has overload protection that is activated if it becomes too hot, e.g. if the car is held stationary with the accelerator pedal on an uphill gradient for a long time.

Overheated transmission causes the car to shake and vibrate, and the warning symbol illuminates and the information display shows a message. The transmission can also overheat during slow driving in queues (10 km/h or slower) on an uphill gradient, or with a trailer hitched. The transmission cools down when the car is stationary, with foot brake depressed and the engine running at idling speed.



03 Your driving environment

Gearboxes

Overheating during slow driving in queues can be avoided by driving in stages: Stop the car and wait with your foot on the brake pedal until there is a moderate distance to the traffic ahead, drive forward a short distance, and then wait another moment with your foot on the brake pedal.

IMPORTANT

Use the foot brake to hold the car stationary on an uphill gradient - do not hold the car with the accelerator pedal. The gearbox could then overheat.

For important information regarding Powershift transmission and towing - see page 297.

Text message and action
In some situations the display may show a message at the same time as a symbol is illuminated.

03

Symbol	Display	Driving characteristics	Action
	Transm. overheat brake to hold	Difficulty in maintaining even speed at constant engine speed.	Transmission overheated. Keep the car stationary using the foot brake. ^A
	Transm. overheat park safely	Significant pulling in the car's traction.	Transmission overheated. Park the car immediately in a safe manner. ^A
	Transm. cooling let engine run	No drive due to overheated gearbox.	Transmission overheated. For fastest cooling: Run the engine at idling speed with the gear lever in the N or P position until the message clears.

^A For fastest cooling: run the engine at idling speed with the gear lever in the **N** or **P** position, until the message clears.

The table shows three steps with an increased degree of seriousness should the transmission become too hot. In parallel with the display text the driver is also advised that the car's electronics are temporarily changing the driving characteristics. Follow the instructions on the information display where appropriate.

NOTE

The table's examples are no indication that the car is defective but instead show that a safety function has been activated intentionally to prevent damage to one of the car's components.

WARNING

If a warning symbol combined with the text **Transm. overheat park safely** is ignored then the heat in the gearbox may become so high that the power transmission between engine and gearbox is temporarily



Gearboxes

halted in order to prevent the clutch from malfunctioning - the car then loses drive and is stationary until gearbox temperature has cooled to an acceptable level.

For more possible display messages with their respective proposals for solutions concerning automatic transmission, see page 142.

A display text clears automatically after the action has been carried out or after one press on the indicator stalk **READ** button.



Eco Start/Stop DRIVE*

Quieter and cleaner



Environmental care is one of Volvo Car Corporation's core values and it influences all of our operations. This target-orientation has resulted in the DRIVE vehicle series whose concept consists of an interaction between several separate energy-saving functions, all with the common purpose of reducing fuel consumption, which in turn contributes to reduced exhaust emissions.

General information on Start/Stop



The engine is switched off - it becomes quieter and cleaner....

Some combinations of engine and gearbox are equipped with a Start and Stop function which engages in the event of e.g. stationary traffic or waiting at traffic lights - the engine is then switched off temporarily and restarts automatically when the journey is due to continue.

The Start/Stop function gives the driver the opportunity for a more active environmentally conscious way of driving the car by means of being able to allow the engine to stop automatically, whenever appropriate.

Manual or Automatic

Note that there are differences in the Start/Stop function depending on whether the gearbox is manual or automatic.

Function and operation

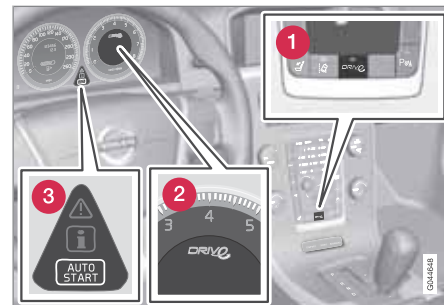

- 1 Start/Stop On/Off.
- 2 Illuminates briefly on activation and for text messages.
- 3 The engine is auto-stopped.

DRIVE Start/StopThe function is activated automatically when the engine is started with the key. The driver is alerted to the function by means of this symbol on the instrument panel illuminating briefly, the display text **Auto Start-Stop ON** is shown and the green lamp for the On/Off button illuminates.



Eco Start/Stop DRIVE*

i NOTE

After starting with the key and each auto-stop the car must first reach 5 km/h before the automatic Start/Stop function is re-activated - following which certain conditions must also be fulfilled, refer to these under the heading "The engine does not auto-stop".

All of the car's normal systems such as lighting, radio, etc. work as normal even with an engine that has stopped automatically, except that some equipment may have the function temporarily reduced, e.g. the climate control system's fan speed or extremely high volume on the audio system.

Auto-stopping the engine

In order that the engine should stop automatically the car must be completely stationary:

Conditions	M/A ^A
Declutch, set the gear lever in neutral position and release the clutch pedal - the engine is switched off.	M
Stop the car with the foot brake and then keep your foot on the pedal - the engine stops automatically.	A

^A M = Only manual gearbox, A = Only automatic gearbox and model D3.

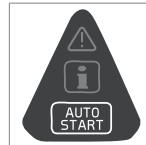

The **AUTO START** symbol on the information display illuminates as verification and reminder that the engine is has stopped automatically.

Auto-starting the engine

Conditions	M/A ^A
With the gear lever in neutral position: Depress the clutch pedal - the engine starts. Engage a suitable gear and continue the journey.	M
With the gear lever in neutral position: Depress the accelerator pedal - the engine starts. Engage a suitable gear and continue the journey.	M
The following option is also available on a downhill gradient: Release the foot brake and let the car move off - the engine starts automatically when the speed exceeds normal walking pace.	M
Release the foot pressure on the foot brake - the engine starts automatically and the journey can continue.	A

^A M = Only manual gearbox, A = Only automatic gearbox and model D3.



03 Your driving environment

Eco Start/Stop DRIVE*

Start assistance HSA

The foot brake can also be released on an uphill gradient to start the engine automatically - the HSA function means that the car does not roll backwards.

HSA (Hill Start Assist) means that the pressure in the brake system remains temporarily available while the driver moves his/her foot from the brake pedal to the accelerator pedal for driving off with the engine having stopped automatically. The temporary braking effect releases after a couple of seconds or when the driver accelerates.

There is more information available on HSA on page 119.

Gear indicator¹

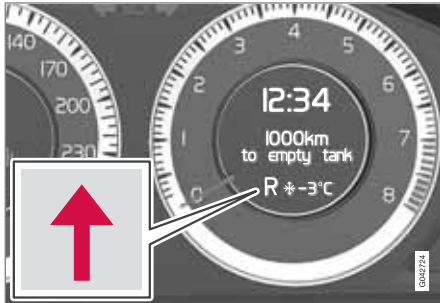

An essential detail in connection with environmental driving is to drive in the right gear and change gear in time.

The driver is assisted by an indicator which notifies the driver when it is most advantageous to engage the next higher or lower gear - GSI (Gear Shift Indicator).

Indication is made with an up or down arrow in the combined instrument panel's right-hand display.

Deactivating the Start/Stop function



In certain situations, it may be advisable to temporarily switch off the automatic Start/Stop function - this is carried out by pressing this button once, at which point the button's lamp goes out.

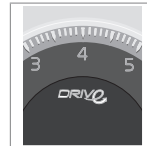

Disengaged Start/Stop function is indicated by the information display's symbol going out and the message **Auto Start-Stop OFF** being displayed for about 5 seconds - while the button's lamp goes out at the same time.



The Start/Stop function is disengaged until it is reactivated with the button or until the next time the engine is started with the key.

Limitations

The engine does not auto-stop

Even if the Start/Stop function is activated, the engine does not stop automatically if:

Conditions	M/A ^A
the driver has opened the seat-belt's buckle.	A
the car does not stop completely.	
the capacity of the battery is below the minimum permissible level.	
the engine does not have normal operating temperature.	
outside temperature is below freezing point or above approx. 30 °C.	

¹ Only manual gearbox for the DRIVE model.

* Option/accessory, for more information, see Introduction.



Eco Start/Stop DRIVE*

Conditions	M/A ^A
the environment in the passenger compartment differs from the preset values - indicated by the ventilation fan running at a high speed.	
the car is reversed.	
battery temperature is below freezing point or above approx. 55 °C.	
the driver makes sudden steering wheel movements.	
the exhaust system's particulate filter is full - the temporarily disengaged Start/Stop function is reactivated once an automatic cleaning cycle has been performed (see page 286).	
Queue Assistant is activated - see also the section "Adaptive cruise control" page 173.	A

Conditions	M/A ^A
if the road is very steep.	A
the atmospheric air pressure is less than equivalent to approx. 1500 metres above sea level - the current air pressure varies with the prevailing weather conditions.	A

^A M = Only manual gearbox, A = Only automatic gearbox and model D3.

The engine auto-starts without driver intervention

An engine that has stopped automatically may restart in some cases without the driver having decided that the journey should continue. In the following cases the engine also starts automatically if the driver has not depressed the clutch pedal (manual gearbox) or takes his/her foot off the brake pedal (automatic gearbox):

Conditions	M/A ^A
The driver's seatbelt buckle is opened.	
Misting forms on the windows.	

Conditions	M/A ^A
The environment in the passenger compartment deviates from the preset values.	
The outside temperature falls below freezing point or exceeds approx. 30 °C.	
There is a temporarily high current take-off or battery capacity drops below the lowest permissible level.	
Repeated pumping of the brake pedal.	
The car starts to roll - faster than the equivalent normal walking pace.	M
The gear selector is moved from the D position to "+/-" or R .	A

^A M = Only manual gearbox, A = Only automatic gearbox and model D3.

Eco Start/Stop DRIVE*

! WARNING

Do not open the bonnet when the engine has stopped automatically - the engine may suddenly start automatically. First switch off the engine as normal using the **START/STOP ENGINE** button before opening the bonnet.

The engine does not auto-start²

In the following cases the engine does not auto-start after having auto-stopped:

Conditions

A gear is engaged without declutching - a display text prompts the driver to set the gear lever in neutral position in order to enable automatic starting.

Involuntary engine stop²

In the event that a start-up fails and the engine stops, proceed as follows:

1. Depress the clutch pedal again - the engine starts automatically after the gear lever has been set in neutral position. Prior to this the information display showed the text **Put gear in neutral**.

Trailer

- The Start/Stop function is deactivated if a trailer is electrically connected to the car's electrical system.

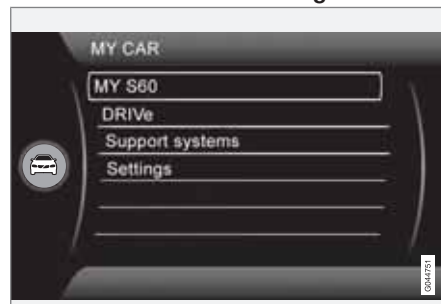
More information and settings

The **MY CAR** menu system in the car includes instructions which explain parts of the DRIVE concept along with several possible settings and options - see page 145.

Text message







In combination with this indicator lamp the Start/Stop function may display text messages on the information display for certain situations. For some of them there is a recommended action that should be performed. The following table shows some examples.

² Only manual gearbox.

* Option/accessory, for more information, see Introduction.





Eco Start/Stop DRIVE*

Symbol	Message	Info/Action	M/A ^A
	Auto Start-Stop ON	Illuminates for about 5 seconds after Start/Stop has been activated.	
	Auto Start-Stop OFF	Illuminates for about 5 seconds after Start/Stop has been switched off.	
	Auto Start-Stop serv. required	Start/Stop is not operational. A workshop should be contacted - in which case an authorised Volvo workshop is recommended.	
	Emission management	Start/Stop is temporarily disengaged. The function is reactivated after an automatic system check.	
AUTO-STOP	Engine in Auto Start	The engine is ready to start automatically - waiting for the brake pedal to be released.	A
	Select P or N to start	Start/Stop has been deactivated - move the gear selector to N or P position and start the engine as normal with the START/STOP ENGINE button.	A
	Press Start button	The engine will not start automatically - start the engine as normal with the START/STOP ENGINE button and the gear selector in P or N .	A
AUTO-STOP	Engine in Auto Start	The engine is ready to start automatically - waiting for the brake or clutch pedal to be depressed.	M
	Press Start button	The engine will not start automatically - start the engine as normal with the START/STOP ENGINE button.	M
	Depress clutch pedal to start	The engine is ready to auto-start - waiting for the clutch pedal to be depressed.	M



03 Your driving environment

Eco Start/Stop DRIVE*

Symbol	Message	Info/Action	M/A ^A
	Depress the foot brake to start	The engine is ready to auto-start - waiting for the brake pedal to be depressed.	M
	Press brake and clutch to start	The engine is ready to auto-start - waiting for the brake or clutch pedal to be depressed.	M
	Put gear in neutral	Gear is engaged without declutching - disengage and set the gear lever in neutral position.	M

A M = Only manual gearbox, A = Only automatic gearbox and model D3.

If a message does not go out following completion of the action then a workshop should be contacted - an authorised Volvo workshop is recommended.

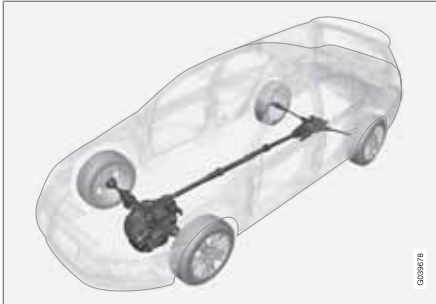
**All-wheel drive – AWD*****All Wheel Drive is always available**

All Wheel Drive means that the car is driving all four wheels at the same time.

The power is automatically distributed between the front and rear wheels. An electronically controlled clutch system distributes the power to the wheels that have the best grip on the current road surface. This provides the best traction and prevents wheel spin. Under normal driving conditions, the majority of power is transmitted to the front wheels.

All Wheel Drive improves driving safety in rain, snow and icy conditions.



Foot brake

General

The car is equipped with two brake circuits. If one brake circuit is damaged then this will mean that the brakes engage at a deeper level and harder pressure on the pedal is needed to produce the normal braking effect.

The driver's brake pedal pressure is assisted by a brake servo.

WARNING

The brake servo only works when the engine is running.

If the brake is used when the engine is switched off then the pedal will feel stiff and more force must be used to brake the car.

In very hilly terrain or when driving with a heavy load the brakes can be relieved by using engine braking. Engine braking is most efficiently used if the same gear is used downhill as up.

For more general information on heavy loads on the car, see page 366.

Anti-lock braking system

The car is equipped with ABS (Anti-lock Braking System) which prevents the wheels from locking during braking. This means the ability to steer is maintained and it is easier to swerve to avoid a hazard for example. Vibration

may be felt in the brake pedal when this is engaged and this is normal.

A short test of the ABS system is made automatically after the engine has been started when the driver releases the brake pedal. A further automatic test of the ABS system may be made when the car reaches 10 km/h. The test may be experienced as pulses in the brake pedal.

Emergency brake lights and automatic hazard warning flashers

Emergency brake lights are activated to alert vehicles behind about sudden braking. The function means that the brake light flashes instead of - as in normal braking - shining with a constant glow.

Emergency brake lights are activated at speeds above 50 km/h if the ABS system is working and/or in the event of sudden braking. After the car's speed has been slowed below 10 km/h the brake light returns from flashing to the normal constant glow - while at the same time the hazard warning flashers are activated, and they flash until the driver changes engine speed with the accelerator pedal or they are deactivated with their button, see page 89.

Cleaning the brake discs

Coatings of dirt and water on the brake discs may result in delayed brake function. This delay is minimised by cleaning the brake linings.

Manual cleaning is advisable with wet road surfaces, prior to long-stay parking and after the car has been washed. Carry this out by braking gently during a short period while en route.

Emergency Brake Assistance



Emergency Brake Assistance EBA (Emergency Brake Assist) helps to increase brake force and so reduce braking distance. EBA detects the driver's braking style and increases brake force as necessary. The brake force can be reinforced up to the level when the ABS system is engaged. The EBA function is interrupted when the pressure on the brake pedal is reduced.

NOTE



When EBA is activated the brake pedal lowers slightly more than usual, depress (hold) the brake pedal as long as necessary. If the brake pedal is released then all braking ceases.



Symbols in the combined instrument panel

Symbol	Specification
	Constant glow – Check the brake fluid level. If the level is low, fill with brake fluid and check for the cause of the brake fluid loss.
	Constant glow for 2 seconds when the engine is started – There was a fault in the brake system's ABS function when the engine was last running.

WARNING

If  and  illuminate at the same time, there may be a fault in the brake system.

If the level in the brake fluid reservoir is normal at this stage, drive carefully to the nearest workshop and have the brake system checked - an authorised Volvo workshop is recommended.

If the brake fluid is under the **MIN** level in the brake fluid reservoir, do not drive further before topping up the brake fluid.

The reason for the loss of brake fluid must be investigated.



03 Your driving environment

Parking brake

General



Function

A faint electric motor noise can be heard when the electrical parking brake is being applied. The noise can also be heard during the automatic function checking of the parking brake.

If the car is stationary when the parking brake is applied then it only acts on the rear wheels. If it is applied when the car is moving then the normal foot brake is used, i.e. the brake acts on all four wheels. Brake function changes over to the rear wheels when the car is almost stationary.

Low battery voltage

If the battery voltage is too low then the parking brake can neither be released nor applied. Connect a donor battery if the battery voltage is too low, see page 115.

Applying the parking brake



Parking brake control - apply.

1. Press the foot brake pedal down firmly.
2. Press the control.
 - > The combined instrument panel symbol  starts flashing - once there is a constant glow it is applied.
3. Release the foot brake pedal and make sure that the car is at a standstill position.
 - When parking the vehicle, always engage 1st gear (for manual gearbox) or put the gear selector in position **P** (for automatic gearbox).

In an emergency the parking brake can be applied when the vehicle is moving by depressing the control. When the control is released or

the accelerator pedal is depressed the braking is interrupted.

NOTE

In the event of emergency braking at speeds above 10 km/h a signal sounds during the braking procedure.

Parking on a hill

If the car is parked facing uphill:

- Turn the wheels **away from** the kerb.

If the car is parked facing downhill:

- Turn the wheels **towards** the kerb.

WARNING

Get into the habit of always applying the parking brake when parking on a slope - leaving the car in gear, or in **P** if it has automatic transmission, is not sufficient to hold the car in all situation.



Parking brake

Disengaging the parking brake



Parking brake control - release.

Cars with manual gearbox

Releasing manually

1. Insert the remote control key in the ignition switch.¹
2. Press the foot brake pedal down firmly.
3. Pull the control.
 - > The parking brake releases and the combined instrument panel symbol  goes out.

NOTE

The parking brake can also be released manually by depressing the clutch pedal instead of the brake pedal. Volvo recommends the use of the brake pedal.

Releasing automatically

1. Start the engine.
2. Engage 1st gear or reverse gear.
3. Ease up the clutch and depress the accelerator.
 - > The parking brake releases and the combined instrument panel symbol  goes out.

Cars with automatic gearbox

Releasing manually

1. Insert the remote control key in the ignition switch¹.
2. Press the foot brake pedal down firmly.
3. Pull the control.
 - > The parking brake releases and the combined instrument panel symbol  goes out.

Releasing automatically

1. Put the seatbelt on.
2. Start the engine.
3. Press the foot brake pedal down firmly.
4. Move the gear selector to position **D** or **R** and depress the accelerator.
 - > The parking brake releases and the combined instrument panel symbol  goes out.

NOTE

For safety reasons, the parking brake is only released automatically if the engine is running and the driver is wearing a seatbelt. The parking brake is released immediately on cars with automatic gearbox when the accelerator pedal is depressed and the gear selector is in position **D** or **R**.

Heavy load uphill

A heavy load, such as a trailer, can cause the car to roll backward when the parking brake is released automatically on a steep incline. Avoid this by depressing the control while driving off. Release the control when the engine achieves traction.

¹ For a car with the Keyless system: Press **START/STOP ENGINE**.



03 Your driving environment



Parking brake

Replacing the brake linings

The rear brake linings must be replaced at a workshop due to the design of the electric

parking brake - an authorised Volvo workshop is recommended.

Symbols and messages in the display

Symbol	Message	Meaning/Action
	"Message"	Read the message on the information display.
		A flashing symbol indicates that the parking brake is applied. If the symbol flashes in any other situation then this means that a fault has arisen. Read the message on the information display.
	Park brake not fully released	A fault is preventing the parking brake from being released - Try to apply and release the brake. If the fault persists after a few attempts: Visit a workshop - an authorised Volvo workshop is recommended. Note: A warning signal sounds if the journey is continued with this error message.



Parking brake

Symbol	Message	Meaning/Action
	Parking brake not applied	<p>A fault is preventing the parking brake from being applied - Try to release and apply the brake.</p> <p>If the fault persists after a few attempts: Visit a workshop - an authorised Volvo workshop is recommended.</p> <p>The message is also illuminated on cars with manual gearbox when the car is driven at low speed with the door open in order to alert the driver that the parking brake may have been unintentionally disengaged.</p>
	Parking brake Service required	<p>A fault has arisen - Try to apply and release the brake.</p> <p>If the fault persists after a few attempts: Visit a workshop - an authorised Volvo workshop is recommended.</p>

- If the car has to be parked before the fault has been rectified then the wheels must be turned as if parking on a hill and 1st gear engaged (manual gearbox) or the gear selector must be in position **P** (automatic gearbox).



03 Your driving environment

HomeLink® *

General



HomeLink® is a programmable remote control which can control up to three different devices (e.g. garage door, alarm system, outdoor lighting and indoor lighting etc.) and in doing so replace their remote controls. HomeLink® is supplied built into the left-hand sun visor.

The HomeLink® panel consists of three programmable buttons and one indicator lamp.

NOTE

HomeLink® is designed not to work if the car is locked from the outside.

Save the original remote controls for future programming (e.g. when switching to another car).

Delete the button programming when the car is to be sold.

Metallic sun visors should not be used in cars fitted with HomeLink®. This may have an adverse effect on its function.

Operation

When HomeLink® is fully programmed it can be used in place of the separate original remote controls.

Depress the programmed button to activate the garage door, alarm system etc. The indicator lamp illuminates for the time that the button is kept depressed.

NOTE

If the ignition is not activated, HomeLink® will work for 30 minutes after the driver's door has been opened.

The original remote controls can of course be used in parallel with HomeLink®.

WARNING

If HomeLink® is used to operate a garage door or gate, ensure that nobody is in the vicinity of the door or gate while it is in motion.

Do not use the HomeLink® remote control for any garage door that does not have safety stop and safety reverse. The garage door must react immediately when it detects that something is preventing its movement, and stop directly and reverse. A garage door without these characteristics could cause personal injury. For further information - contact the supplier via the Internet: www.homelink.com.

Programming for the first time

The first step erases the memory in HomeLink® and must not be carried out when only one individual button is being reprogrammed.

1. Depress the two outer buttons and do not release until the indicator lamp starts to flash after approx. 20 seconds. The flashing indicates that HomeLink® is set in "learn mode" and is ready to be programmed.
2. Position the original remote control 5-30 cm from HomeLink®. Monitor the indicator lamp.



The particular distance that is required between the original remote control and HomeLink® depends on the programming of the device in question. Perhaps several attempts will be required at different distances. Maintain each position for approx. 15 seconds before trying a new one.

3. Depress the button for the original remote control and the button to be programmed on HomeLink® simultaneously. Do not release the buttons until the indicator lamp has changed over from slow to rapid flashing. The rapid flashing indicates successful programming.
4. Test the programming by depressing the programmed button on HomeLink® and watching the indicator lamp:
 - **Constant glow:** The indicator lamp illuminates with a constant glow when the button is kept depressed, this indicates that the programming is complete. The garage door, gate or similar should now be activated when the programmed HomeLink® button is depressed.
 - **Glow not constant:** The indicator lamp flashes quickly for approx. 2 seconds and then changes over to a constant glow for approx. 3 seconds. This proc-

ess is repeated for approx. 20 seconds and indicates that the device has a "rolling code". The garage door, gate or similar is not activated when the programmed HomeLink® button is depressed. Continue the programming in accordance with the following.

5. Locate the "programming button"¹ on the receiver for the garage door for example, normally located close to the antenna's bracket on the receiver. If you have difficulty in finding the button - consult the supplier's manual, or contact the supplier via the Internet: www.homelink.com.
6. Depress and release the "programming button". The button flashes for approx. 30 seconds and the next step must be carried out within this period.
7. Depress the programmed button on HomeLink®, while the "programming button" is still flashing, keep it depressed for approx. 3 seconds and then release. Repeat the press/hold/release sequence up to 3 times to conclude the programming.

Programming individual buttons

To reprogram an individual button, proceed in accordance with the following:

1. Depress the required button on HomeLink® and do not release until step 3 has been completed.
2. When the indicator lamp on HomeLink® starts to flash, after approx. 20 seconds, position the original remote control 5-30 cm from HomeLink®. Monitor the indicator lamp.

The particular distance that is required between the original remote control and HomeLink depends on the programming of the device in question. Perhaps several attempts will be required at different distances. Maintain each position for approx. 15 seconds before trying a new one.

3. Depress the button on the original remote control. The indicator lamp will start to flash. When the flashing has changed over from a slow to a rapid flashing - release both buttons. The rapid flashing indicates successful programming.
4. Test the programming by depressing the programmed button on HomeLink and watching the indicator lamp:

¹ Button designation and colour vary depending on manufacturer.



03 Your driving environment

HomeLink® *

- **Constant glow:** The indicator lamp illuminates with a constant glow when the button is kept depressed, this indicates that the programming is complete. The garage door, gate or similar should now be activated when the programmed HomeLink® button is depressed.
 - **Glow not constant:** The indicator lamp flashes quickly for approx. 2 seconds and then changes over to a constant glow for approx. 3 seconds. This process is repeated for approx. 20 seconds and indicates that the device has a "rolling code". The garage door, gate or similar is not activated when the programmed HomeLink® button is depressed. Continue the programming in accordance with the following.
5. Locate the "programming button²" on the receiver for the garage door for example, normally located close to the antenna's bracket on the receiver. If you have difficulty in finding the button - consult the supplier's manual, or contact the supplier via the Internet: www.homelink.com.
 6. Depress and release the "programming button". The button flashes for approx. 30 seconds and the next step must be carried out within this period.
 7. Depress the programmed button on HomeLink®, while the "programming button" is still flashing, keep it depressed for approx. 3 seconds and then release. Repeat the press/hold/release sequence up to 3 times to conclude the programming.

Erasing programming

It is only possible to erase the programming for all the buttons on HomeLink®, not for individual buttons.

- Depress the two outer buttons and do not release until the indicator lamp starts to flash after approx. 20 seconds.
 - > HomeLink® is now set in so-called "learn mode" and is ready to be programmed once more, see page 136.

² Button designation and colour vary depending on manufacturer.

* Option/accessory, for more information, see Introduction.



Menus and messages.....	142
Menu source MY CAR.....	144
Climate control.....	152
Fuel-driven engine block heater and passenger compartment heater*.....	162
Additional heater*.....	165
Trip computer.....	166
DSTC – Stability and traction control system.....	168
Adapting driving characteristics.....	170
Cruise control*.....	171
Adaptive cruise control*.....	173
Distance Warning*.....	183
City Safety™.....	186
Collision Warning with Auto Brake & Pedestrian Protection*.....	190
Driver Alert System – DAC*.....	197
Driver Alert System - LDW*.....	200
Park assist syst*.....	203
Park assist camera*.....	206
BLIS* – Blind Spot Information System.....	209
Comfort inside the passenger compartment.....	213
Comfort inside the passenger compartment - Executive.....	217



04

COMFORT AND DRIVING PLEASURE





Menus and messages

Combined instrument panel

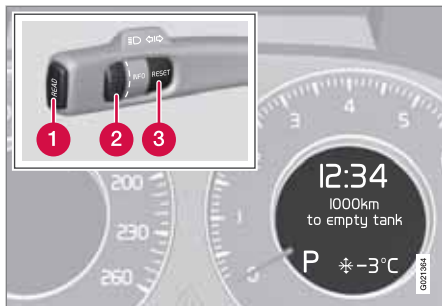

Information display and controls for menus.

- 1 **READ** – access to message list and message confirmation.
- 2 Thumbwheel – browse between menu options.
- 3 **RESET** – reset the active function. Used in certain cases to select/activate a function, see the explanation under each respective function.

The menus shown on the information displays in the combined instrument panel are controlled with the left-hand stalk switch. The menus shown depend on key position, see page 77. If a message appears then this must

be acknowledged with **READ** for the menus to be shown.

Menu overview

Some of the following menu options require the function and hardware to be installed in the car.

- km to empty tank
- I/100km average
- I/100km instantaneous
- km/h average speed
- km/h current speed¹

Engine oil level Wait...*

Tyre pressure Calibration*

Park heat timer --:-- ---*²

Direct start Park heat ON*³

Additional heat auto ON*

Lane Depart Warn *

Driver Alert *

Message



Text message in the information display.

When a warning, information or indicator symbol illuminates, a corresponding message appears on the information display. An error message is stored in a memory list until the fault has been rectified.

Press **READ** to acknowledge and browse between the messages.

¹ Only certain markets.

² Programming is only possible when the engine is switched off.

³ Cannot be selected when the additional heater is operating.



Menus and messages

 NOTE

If a warning message appears while you are using the trip computer, the message must be read (press **READ**) before the previous activity can be resumed.

Message	Specification
Stop safely ^A	Stop and switch off the engine. Serious risk of damage - consult a workshop ^B .
Stop engine ^A	Stop and switch off the engine. Serious risk of damage - consult a workshop ^B .
Service urgent ^A	Contact a workshop ^B to check the car immediately.
Service required ^A	Contact a workshop ^B to check the car as soon as possible.
See manual ^A	Read the owner's manual.
Book time for maintenance	Time to book regular service - contact a workshop ^B .

Message	Specification
Time for regular maintenance	Time for regular service - contact a workshop ^B . The timing is determined by the number of kilometres driven, number of months since the last service, engine running time and oil grade.
Maintenance overdue	If the service intervals are not followed then the warranty does not cover any damaged parts - contact a workshop ^B .
Transmission oil Change needed	Contact a workshop ^B to check the car as soon as possible.
Transmission performance low	The gearbox cannot handle full capacity. Drive carefully until the message clears ^C . If shown repeatedly - contact a workshop ^B .

Message	Specification
Transmission hot Reduce speed	Drive more smoothly or stop the car in a safe manner. Disengage the gear and run the engine at idling speed until the message clears ^C .
Transmission hot Stop safely	Critical fault. Stop the car immediately in a safe manner and contact a workshop ^B .
Temporarily OFF ^A	A function has been temporarily switched off and is reset automatically while driving or after starting again.
Low battery Power save mode	The audio system is switched off to save energy. Charge the battery.

^A Part of message, shown together with information on where the problem has arisen.

^B An authorised Volvo workshop is recommended.

^C For more messages concerning automatic transmission, see page 120.



Menu source MY CAR

General information about MY CAR



Many of the car's features are handled in this menu source, e.g. setting the clock, door mirrors and locks.

Navigation in the menus is carried out using buttons in the centre console or with the steering wheel's right-hand keypad.

Certain functions are standard, others are optional - the range also varies depending on the market.

Operation

Centre console controls



Centre console controls for menu navigation.

- 1 Press **MY CAR** to open the menus under **MY CAR**.
- 2 Press **OK MENU** to select/tick in the highlighted menu option or to store the selected function in the memory.
- 3 Turn the **TUNE** knob to scroll up/down among the menu options.
- 4 **EXIT**

EXIT functions

Use **EXIT** to go back in the menu structure or to undo the most recent selection. Depending on the menu level the cursor is on, with a press on **EXIT**, the cursor is moved different "lengths".

Short and long presses also produce varying results.

- Short **EXIT** presses go back one step in the current menu structure.
- One long **EXIT** press leads to the **MY CAR** source menu.
- One long **EXIT** press while in the **MY CAR** source menu, leads out of **MY CAR** to the menu system's main menu (Parent view), from where all the car's functions/ menu sources can be accessed, see page 224.



Menu source MY CAR

Steering wheel keypad*



The keypad may vary depending on market.

- 1 Turn the thumbwheel to scroll up/down among the menu options.
- 1 Press the thumbwheel to select/tick in the highlighted menu option or to store the selected function in the memory.
- 2 EXIT (see heading "EXIT functions" page 144).

Search paths

Current menu level is shown at the top right of the centre console display screen. Search paths to the menu system functions are described in this manual in the following form:

Settings → Car settings → Lock settings
→ Doors unlock → Driver door, then all.

The following is an example of how a function can be accessed and adjusted using the steering wheel keypad:

1. Press the centre console button **MY CAR**.
2. Scroll to the desired menu, e.g. **Settings**, with the thumbwheel (1) and then **press** the thumbwheel - a submenu opens.
3. Scroll to the desired menu, e.g. **Car settings** and press the thumbwheel - a submenu opens.
4. Scroll to **Lock settings** and press the thumbwheel - a new submenu opens.
5. Scroll to **Doors unlock** and press the thumbwheel - a submenu of selectable functions opens.
6. Choose between the options **All doors** and **Driver door**, then all and press the thumbwheel - a cross is marked in the option's empty box.
7. Exit the programming by backing out of the menus incrementally with short presses on **EXIT** (2) or with one long press.

The procedure is the same as with the centre console's buttons - see page 144: **OK MENU** (2), **EXIT** (4) and the **TUNE** knob (3).

MY CAR

The following options are available in menu source **MY CAR**:



- My S80
- DRiVe*
- Support systems (Support systems)
- Settings (Settings)



Menu source MY CAR

My S80



MY CAR → My S80

The display screen shows a grouping of all of the car's driver support systems - these can be activated or deactivated here.

My DRIVE*

Parts of Volvo's DRIVE concept are described here, amongst other things.

- **Start/Stop**
- **ECO driving guide**

For more information - see page 122.

Driver support system

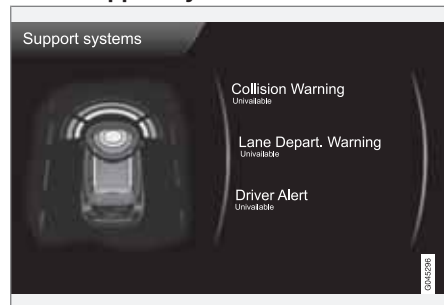

MY CAR → Support systems

(MY CAR > Support systems)

The display screen shows a summary of the current status of the car's driver support systems.

Setup - menus

Shown here are the 4 first menu levels under **MY CAR → Settings**. Some menus have further submenus - these are then described in detail in their respective sections.

When selecting whether a function should be activated/**On** or deactivated/**Off** a square is displayed:

On: Selected square.

Off: Empty square.

- Select **On/Off** with **OK** - then back out of the menu with **EXIT**.

Car settings	
Car key memory	p. 80 and 101
On	
Off	
Lock settings	p. 45, 54 and 56
Doors automatic lock	
On	
Off	
Doors unlock	
All doors	
Driver door, then all	
Keyless entry	
All doors	
Any door	
Doors on same side	
Both front doors	



Menu source MY CAR

Reduced Guard Activate once Ask on exit	p. 58 and 62
Side mirror settings Fold mirrors Tilt left mirror Tilt right mirror	p. 101
Light settings Lock confirmation light On Off Unlock confirmation light On Off Approach light duration Off 30 sec 60 sec 90 sec	p. 44 p. 45 and 91

Home safe light duration 30 sec 60 sec 90 sec	p. 91
Triple turn signal On Off	p. 89
Active bending lights On Off	p. 87
Auxiliary lights On Off	p. 86
Steering wheel force Low Medium High	p. 170

Reset car settings All menus in Car settings are given original factory settings.	
Driving support systems	
Collision Warning Collision Warning On Off Warning distance Long Normal Short Warning sound On Off	p. 190



04 Comfort and driving pleasure

Menu source MY CAR

04

Lane Departure Warning	p. 200
Lane Departure Warning	
On	
Off	
On at start up	
On	
Off	
Increased sensitivity	
On	
Off	
DSTC	p. 168
On	
Off	
City Safety	p. 9 and 186
On	
Off	
BLIS	p. 209
On	
Off	

Distance Alert	p. 183
On	
Off	
Driver Alert	p. 197
On	
Off	
System options	
Time	p. 74
The instrument panel clock is set here.	
Time format	p. 74
12h	
24h	

Screen saver	p. 144
On	
Off	
The TV screen's current content fades out after a period of inactivity and is replaced by a blank screen if this option is selected.	
The current screen content returns if any of the TV screen's buttons or controls are actuated.	
Language	
Selects language for menu texts.	
Show help text	
On	
Off	
Explanatory text for the display screen's current content is shown with this option selected.	
Distance and fuel unit	p. 166
MPG (UK)	
MPG (US)	
km/l	
l/100km	



Menu source MY CAR

<p>Temperature unit</p> <p>Celsius Fahrenheit</p> <p>Selects the unit for the display of outside temperature and setting of the climate control system.</p>		<p>Voice command list</p> <p>Phone commands</p> <p>Phone Phone call contact Phone dial number</p> <p>Navigation commands</p> <p>Navigation Navigation repeat instruction Navigation go to address</p> <p>General commands</p> <p>Help Cancel Voice tutorial</p> <p>The menu options under Phone commands show several examples of available voice commands - only with a Bluetooth®-enabled mobile phone installed. For more</p>		<p>and detailed information - see page 252.</p> <p>The menu options under Navigation commands show several examples of available voice commands - only with Volvo's navigation system RTI* installed.</p> <p>Voice user setting</p> <p>Default setting User 1 User 2</p> <p>Here there is the option to create a second user profile - an advantage if more than one person shall use the car/system regularly. Default setting gives factory settings.</p>	
<p>Volumes</p> <p>Voice output volume Park assist front volume Park assist rear volume Phone ringing volume</p>					
<p>Reset system options</p> <p>All menus in System options are given original factory settings.</p>					
<p>Voice settings</p>					
<p>Voice tutorial</p> <p>This menu option + OK provides spoken information about how the system works.</p>					



Menu source MY CAR

04

<p>Voice training</p> <p>User 1 User 2</p> <p>With Voice training the voice recognition system is taught to recognise the driver's voice and pronunciation. A number of phrases are presented on the screen for the driver to read aloud. When the system has learnt how the driver talks, the presentation of the phrases stops. Following which e.g. User 1 can be selected in Voice user setting in order that the system shall listen to the right user.</p>		<p>Voice POI list</p> <p>Edit list</p> <p>The number of facilities is extensive and varies depending on market. Maximum 30 favourite facilities can be stored in this list.</p> <p>Menu option Voice POI list is only shown if Volvo's navigation system RTI* is installed. For more information on Facilities and Voice recognition - see the Navigation system's owner's manual.</p>		<p>Automatic blower adjust</p> <p>Normal High Low</p> <p>Recirculation timer</p> <p>On Off</p> <p>Automatic rear defroster</p> <p>On Off</p> <p>Interior air quality system</p> <p>On Off</p>	<p>p. 152</p>
<p>Voice output volume</p> <ul style="list-style-type: none"> A volume control appears on the screen - at which point, proceed as follows: <ol style="list-style-type: none"> Adjust the volume with the thumbwheel. Test-listen using OK. Use EXIT to store the setting and the menu is switched off. 		<p>Audio settings</p> <p>Climate settings</p>	<p>p. 220</p>	<p>Reset climate settings</p> <p>All menus in Climate settings are given original factory settings.</p> <p>Favourites (FAV)</p> <p>Volvo On Call</p> <p>Described in a separate manual.</p> <p>Information</p>	<p>p. 227</p>



Menu source MY CAR

Number of keys	p. 44
VIN number	p. 358
DivX® VOD code	p. 240
Bluetooth software version in car	p. 246
Map and software version* Only in cars with Volvo GPS navigator - see separate manual.	



Climate control

General

Climate control

The car is equipped with electronic climate control. The climate control system cools or heats as well as dehumidifies the air in the passenger compartment.

i NOTE

The air conditioning system (AC) can be switched off, but to ensure the best possible climate comfort in the passenger compartment and to prevent the windows from misting, it should always be on.

Actual temperature

The temperature you select corresponds to the physical experience with reference to factors such as air speed, humidity and solar radiation etc. in and around the car.

The system includes a sun sensor¹ which detects on which side the sun is shining into the passenger compartment. This means that the temperature can differ between the right and left-hand air vents despite the controls being set for the same temperature on both sides.

¹ Only applies to ECC.

Sensor location

- The sun sensor¹ is located on the top side of the dashboard.
- The temperature sensor for the passenger compartment is located below the climate control panel.
- The outside temperature sensor is located on the door mirror.
- The humidity sensor* is located by the interior rearview mirror.

i NOTE

Do not cover or block the sensors with clothing or other objects.

Side windows and sunroof*

To ensure that the air conditioning works optimally, the side windows, and sunroof* if specified, should be closed.

Misting windows

Remove misting on the insides of the windows by primarily using the defroster function.

To reduce the risk of misting, keep the windows clean and use window cleaner.

Vents in the parcel shelf

i NOTE

To avoid misting, do not block the vents furthest back on the parcel shelf with clothing or other objects.

Temporary shut-off of the air conditioning

When the engine requires full power, e.g. for full acceleration or driving uphill with a trailer, the air conditioning can be temporarily switched off. There may then be a temporary increase in temperature in the passenger compartment.

Condensation

In warm weather, condensation from the air conditioning may drip under the car. This is normal.

Ice and snow

Remove ice and snow from the climate control system air intake (the grille between the bonnet and the windscreen).

Fault tracing and repair

Engage a workshop that has authorisation for the fault tracing and repair of the climate control system. Volvo recommends that you contact an authorised Volvo workshop.

* Option/accessory, for more information, see Introduction.



Refrigerant

The air conditioning system contains a refrigerant. This refrigerant contains no chlorine, which means that it is harmless to the ozone layer. Engage a workshop that has authorisation for filling/changing refrigerant to carry out the work. Volvo recommends that you contact an authorised Volvo workshop.

Total airing function

The function opens/closes all side windows simultaneously and can be used for example to quickly air the car during hot weather, see page 56.

Passenger compartment filter

All air entering the car's passenger compartment is cleaned with a filter. This must be replaced at regular intervals. Follow the Volvo Service Programme for the recommended replacement intervals. If the car is used in a severely contaminated environment, it may be necessary to replace the filter more often.

NOTE

There are different types of passenger compartment filter. Make sure that the correct filter is fitted.

Clean Zone Interior Package (CZIP)*

This option keeps the passenger compartment clear of allergy and asthma inducing substances. For more information on CZIP, see the brochure included with the purchase of the car.

The following is included:

- An enhanced fan function that means that the fan starts when the car is opened with the remote control key. The fan fills the passenger compartment with fresh air. The function starts when required and is disengaged automatically after a time or when one of the passenger compartment doors is opened. The amount of time the fan runs is reduced gradually due to reduced need up until the car is 4 years old.
- The air quality system IAQS is a fully automatic system that cleans the air in the passenger compartment from contaminants such as particles, hydrocarbons, nitrous oxides and ground-level ozone.

NOTE

To keep the CZIP standard in cars with CZIP the IAQS filter must be changed after 15 000 km or once per year depending on whichever occurs first. However, up to 75 000 km over 5 years. In cars without CZIP and where the customer does not want to keep the CZIP standard the IAQS filter must be changed at a regular service.

Use of tested materials in the interior equipment.

The materials have been developed in order to minimise the quantity of dust in the passenger compartment and they contribute to making the passenger compartment easier to keep clean. The carpets in both the passenger compartment and the cargo area are removable and easy to remove and clean. Use cleaning agents and car care products recommended by Volvo, see page 352.

Menu settings

It is possible to activate/deactivate or change the default settings for four of the climate control system's functions via the centre console. For general information about menu navigation, see page 145:

- Fan speed in automatic mode*, see page 159.
- Recirculation timer for passenger compartment air, see page 160.
- Automatic rear window defrosting, see page 102.
- Air quality system IAQS*, see page 160

The climate control system's functions can be reset to the default settings via the menu system in **MY CAR** and this is carried out under: **Settings → Climate settings → Reset climate settings.**



Climate control

Air distribution

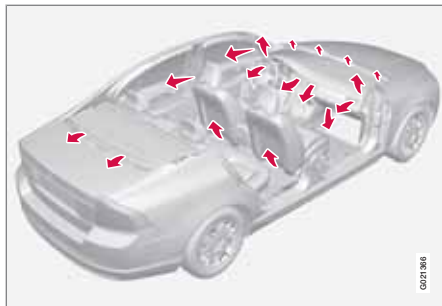

The incoming air is divided between a number of different vents in the passenger compartment.

Air distribution is fully automatic in **AUTO** mode*.

If necessary it can be controlled manually, see page 161.

Air vents in the dashboard

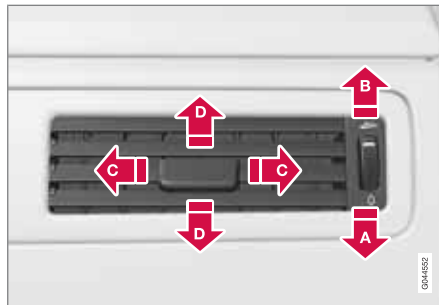

- A** Closed
- B** Open
- C** Lateral airflow
- D** Vertical airflow

Aim the outer vents at the side windows to remove misting.

Air vents in the door pillars

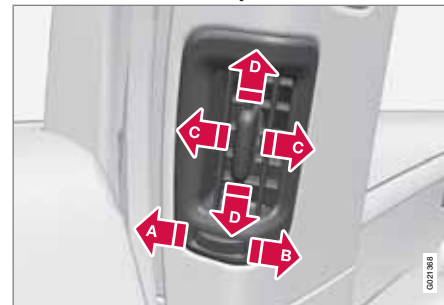

- A** Closed
- B** Open
- C** Lateral airflow
- D** Vertical airflow

Aim the vents at the windows to remove misting in cold weather.

Aim the vents into the passenger compartment to maintain a comfortable climate in the rear seat in hot weather.



NOTE

Remember that small children may be sensitive to air flows and draughts.



Climate control

Electronic climate control, ECC*

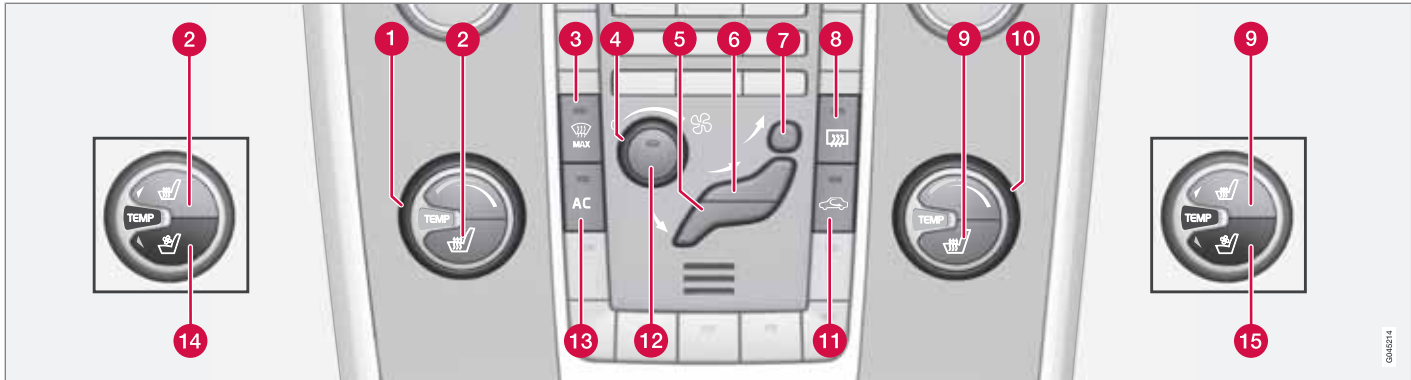

- | | | |
|---|---|---|
| <p>1 Temperature control, left-hand side</p> <p>2 Electrically heated front seat, left-hand side²</p> <p>3 Max. defroster</p> <p>4 Fan</p> <p>5 Air distribution - ventilation floor</p> | <p>6 Air distribution - air vent instrument panel</p> <p>7 Air distribution - defroster windscreen</p> <p>8 Rear window and door mirror defrosters, see page 102</p> <p>9 Electrically heated front seat, right-hand side²</p> | <p>10 Temperature control, right-hand side</p> <p>11 Recirculation</p> <p>12 AUTO</p> <p>13 AC – – Air conditioning on/off</p> <p>14 Ventilated front seat*, left-hand side</p> <p>15 Ventilated front seat*, right-hand side</p> |
|---|---|---|

² The button has a different location depending on whether or not the car is equipped with ventilated front seat*.



Climate control

Electronic Temperature Control, ETC

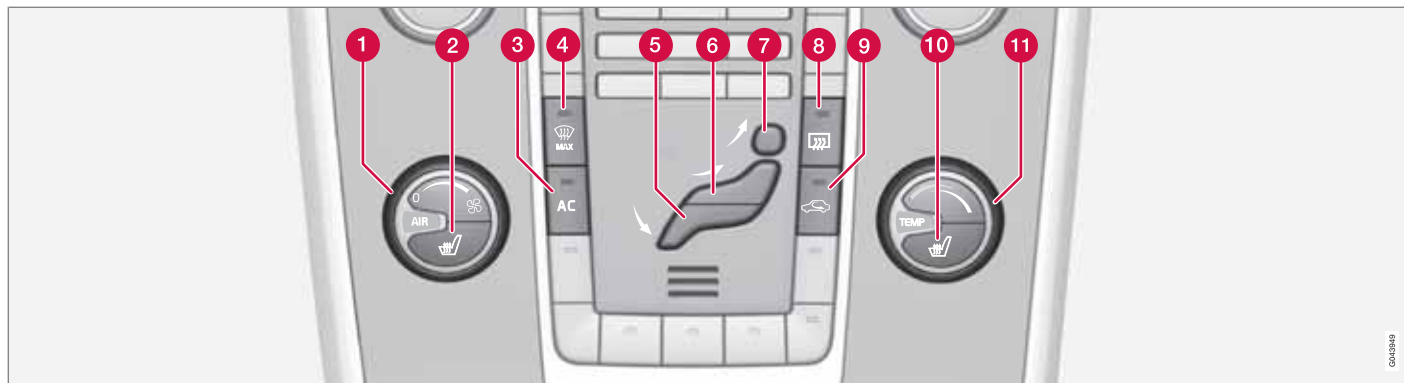

- 1 Fan
- 2 Electrically heated front seat, left-hand side
- 3 AC -- Air conditioning on/off
- 4 Max. defroster
- 5 Air distribution - ventilation floor
- 6 Air distribution - air vent instrument panel
- 7 Air distribution - defroster windscreen
- 8 Rear window and door mirror defrosters, see page 102
- 9 Recirculation
- 10 Electrically heated front seat, right-hand side
- 11 Temperature control



Climate control

Operating the controls

Heated seats*

Front seats

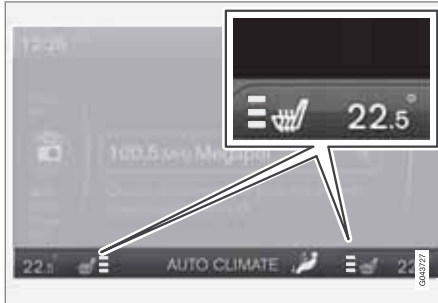

Current heat level is shown in the centre console TV screen.



One press on the button gives the highest heat level - three orange lamps illuminate in the centre console TV screen (see figure above).

Press the button twice for a lower heat level – two orange lamps illuminate in the TV screen.

Press the button three times for the lowest heat level – one orange lamp illuminates in the TV screen.

Press the button four times to switch off the heat – no lamps illuminate.

WARNING

The heated seat should not be used by people who find it difficult to perceive temperature increase because of sensory loss or for any reason have difficulty in managing to use the control of the heated seat. Otherwise, burn injuries may arise.

Rear seat



Press the button once for the highest heat level – three lamps illuminate.

Press the button twice for a lower heat level – two lamps illuminate.

Press the button three times for the lowest heat level – one lamp illuminates.

Press the button four times to switch off the heat – no lamps illuminate.

Ventilated front seats*

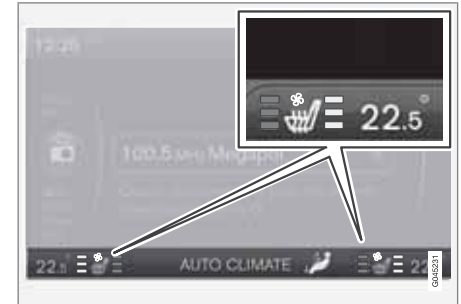

Current comfort level is shown in the centre console TV screen.



Ventilated front seats can only be specified when ECC is installed in the car. The ventilation system consists of fans in the seats and backrests that draw air through the seat upholstery. The cooling effect

increases the cooler the passenger compartment air becomes.

The ventilation is regulated from the climate control and takes seat temperature, solar radiation and outside temperature into consideration.



Climate control

The ventilation can be used at the same time as seat heating. For example, the function can be used to dry damp from clothing.

The ventilation system can be activated when the engine is running. There are three comfort levels that produce different cooling and dehumidification outputs:

- **Comfort Level III:** press the button once for the highest output - three blue lamps illuminate in the centre console TV screen (see illustration above).
- **Comfort level II:** press the button twice for lower output – two blue lamps illuminate in the TV screen.
- **Comfort level I:** press the button three times for the lowest output – one blue lamp illuminates in the TV screen.

Press the button four times to switch off the function – no lamps illuminate.

i NOTE

The seat ventilation should be used carefully by people sensitive to draughts. Comfort level I is recommended for long-term use.

! IMPORTANT

The seat ventilation cannot be started when passenger compartment temperature is below 5 °C. This is to avoid chilling anyone sitting in the seat.

Fan

i NOTE

If the fan is fully switched off then the air conditioning is not engaged - which can cause a risk of misting on the windows.

Fan knob for ECC*



Turn the knob to increase or decrease fan speed. If **AUTO** is selected then fan speed is regulated automatically. The previously set fan speed is disengaged.

Fan knob for ETC



Turn the knob to increase or decrease fan speed.

Air distribution

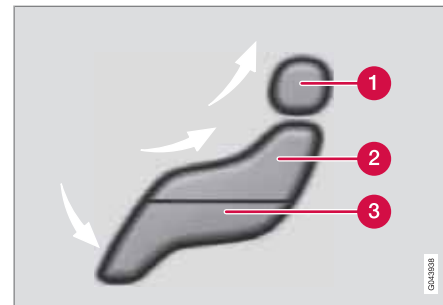

- 1 Air distribution - defroster windscreen
- 2 Air distribution - air vent instrument panel
- 3 Air distribution - ventilation floor

The figure consists of three buttons. When pressing the buttons the corresponding figure is illuminated in the TV screen (see figure below) and an arrow in front of each part of the figure shows the air distribution that is selected. For more information on air distribution, see page 161.



Climate control



The selected air distribution is shown in the centre console TV screen.

AUTO¹

The Auto function automatically regulates temperature, air conditioning, fan speed, recirculation, and air distribution.

If you select one or more manual functions, the other functions continue to be controlled automatically. All manual settings are disengaged when **AUTO** is pressed. The TV screen shows **AUTO CLIMATE**.

Fan speed in automatic mode can be set in the menu system **MY CAR** under: **Settings** →

Climate settings → **Automatic blower adjust**. Choose between **Low**, **Normal** or **High**:

- **Low** - Automatic fan control. Low airflow is prioritised.
- **Normal** - Automatic fan control.
- **High** - Automatic fan control. A more intense airflow is prioritised.

For a description of the menu system, see page 145.

Temperature control

The temperature can be adjusted with the knob. For ECC* the temperature for the driver's side and the passenger side can be set separately.

When the car is started, the most recent setting is resumed.

NOTE

Heating or cooling cannot be hastened by selecting a higher/lower temperature than the actual temperature required.

AC – Air conditioning on/off

When the lamp in the **AC** button illuminates, the air conditioning is controlled by the system's automatic function. This way, incoming air is cooled and dehumidified.

When the lamp in the **AC** button is switched off the air conditioning is disconnected. Other functions are still controlled automatically. When the max. defroster function is activated the air conditioning is switched on automatically, so that the air is dehumidified at the maximum setting.

Max. defroster

Used to quickly remove misting and ice from the windshield and side windows. Air flowing to the windows. The light in the defroster button illuminates when the function is active.

The following also takes place in order to provide maximum dehumidification in the passenger compartment:

¹ Only applies to ECC.



04 Comfort and driving pleasure

Climate control

- the air conditioning is automatically engaged
- recirculation and the air quality system are automatically disengaged.

NOTE

The noise level increases as the fan is operating at max.

When the defroster is switched off the climate control returns to the previous settings.

Recirculation

Recirculation



When recirculation is engaged the orange lamp in the button illuminates. The function is selected to shut out bad air, exhaust gases etc. from the passenger compartment. The air in the pas-

senger compartment is recirculated, i.e. no outside air is taken into the car when this function is activated.

IMPORTANT

If the air in the car recirculates for too long, there is a risk of misting on the insides of the windows.

Timer

With the timer function activated the system will exit manually activated recirculation mode according to a time that depends on the outside temperature. This reduces the risk of ice, misting and bad air. Activate/deactivate the function in the menu system **MY CAR** under **Settings → Climate settings →**

Recirculation timer. For a description of the menu system, see page 145.

NOTE

When max. defroster is selected, recirculation is always deactivated.

Air quality system IAQS*

The air quality system separates gases and particles to reduce the levels of odours and pollution in the passenger compartment. If the outside air is contaminated then the air intake is closed and the air is recirculated.

Activate/deactivate the function in the menu system **MY CAR** under **Settings → Climate settings → Interior air quality system.** For a description of the menu system, see page 145.

NOTE

The air quality sensor should always be engaged in order to obtain the best air in the passenger compartment.

Recirculation is limited in cold weather to avoid misting.

If the insides of the windows start misting up, disengage the air quality sensor, and the defroster functions for the windscreen, the side and the rear windows should also be used to demist the windows.









Cars with Eco Start/Stop DRIVE*

With an auto-stopped engine certain equipment has its function temporarily reduced, e.g. climate control fan speed. For more information, see page 122.



Climate control

Air distribution table

	Air distribution	Use		Air distribution	Use
	Air to windows. Some air flows from the air vents. The air is not recirculated. Air conditioning is always engaged.	to remove ice and misting quickly.		Air to the floor and windows. Some air flows from the dashboard air vents.	to ensure comfortable conditions and good demisting in cold or humid weather.
	Air to windscreen, via defroster vent, and side windows. Some air flows from the air vents.	to prevent misting and icing in a cold and humid climate, (not at too low fan speed to enable this).		Air to floor and from dashboard air vents.	in sunny weather with cool outside temperatures.
	Airflow to windows and from dashboard air vents.	to ensure good comfort in warm, dry weather.		Air to floor. Some air flows to the dashboard air vents and windows.	to direct heat or cold to the floor.
	Airflow to the head and chest from the dashboard air vents.	to ensure efficient cooling in warm weather.		Airflow to windows, from dashboard air vents and to the floor.	to provide cooler air along the floor or warmer air higher up in cold weather or hot, dry weather.



Fuel-driven engine block heater and passenger compartment heater*

Fuel-driven heater

General information about the parking heater

The parking heater heats the engine and passenger compartment and can be started directly or with the timer.

Two different times can be selected using the timer. Here, time refers to the time when the car is heated and ready. The car's electronic system calculates when heating should be started based on the outside temperature.

The heater cannot start if the outside temperature exceeds 15 °C. At -5 °C or lower the maximum running time of the parking heater is 50 minutes.

WARNING

The car must be outdoors when the parking heater is used.

NOTE

When the parking heater is active there may be smoke from the right-hand wheel housing, which is perfectly normal.

Refuelling



Warning label on fuel filler flap.

WARNING

Fuel which spills out can be ignited. Switch off the fuel-driven heater before starting to refuel.

Check the information display to see that the parking heater is switched off. When it is running, the information display shows **Park heat ON**.

Parking on a hill

If the car is parked on a steep hill, the front of the car should point downhill to ensure that there is a supply of fuel to the parking heater.

Battery and fuel

If the battery has insufficient charge or the fuel level is too low, the parking heater will be switched off automatically and a message appears on the information display. Acknowledge the message by pressing the indicator stalk **READ** button once, see page 163.

IMPORTANT

Repeated use of the parking heater combined with short journeys may discharge the battery and impair starting.

The car should be driven for the same time as the heater is used to ensure that the car's battery is recharged adequately to replace the energy consumed by the heater when it is used on a regular basis.



Fuel-driven engine block heater and passenger compartment heater*

Operation

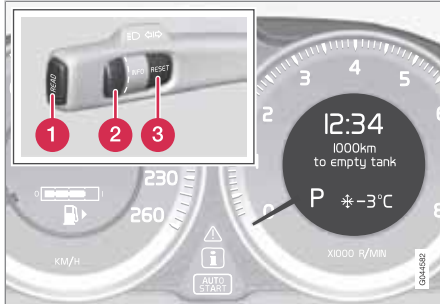

- 1** **READ** button
- 2** Thumbwheel
- 3** **RESET** - resets/selects



For more information on the information display and **READ**, see page 142.





Symbols and display messages

 When one of the timer's settings or **Direct start** is activated, the information symbol in the combined instrument panel illuminates while the information display shows an explanatory text and a further illuminated symbol. The table shows symbols and display texts that appear.

i **NOTE**

 - Figure 2 in the symbol means the second climate control system in the car, where the normal climate control system is the first. The figure 2 has nothing to do with **TIMER 1** or **TIMER 2**.

Symbol	Display	Specification
	Fuel heater ON	The heater is switched on and running.
	Timer is set for Fuel heater	The heater's timer is activated after the remote control key has been removed from the ignition switch and leaving the car - the engine and passenger compartment are heated at the set time.

Symbol	Display	Specification
 	Heater stopped Low battery	The heater has been stopped by the car's electronics in order to facilitate starting the engine.
 	Heater unavailable. Low fuel level	Setting the heater is not possible due to fuel level being too low (approx. 7 litres) - this is in order to facilitate starting the engine as well as approx. 50 km driving.
	Park heater Service required	Heater not working. Contact a workshop for repair. Volvo recommends that you contact an authorised Volvo workshop.

* Option/accessory, for more information, see Introduction.



Fuel-driven engine block heater and passenger compartment heater*

A display text clears automatically after a time or after one press on the indicator stalk **READ** button.

Direct start and immediate stop

1. Scroll with the thumbwheel to **Direct start Park heat**.
2. Press **RESET** to select between **ON** and **OFF**.

ON: Parking heater switched on manually or with programmed timer.

OFF: Parking heater switched off.

Following the direct start of the heater it will be activated for 50 minutes.

Heating of the passenger compartment will begin as soon as the engine coolant has reached the correct temperature.

NOTE

The car can be started and driven while the parking heater is running.

Setting the timer

The time when the car shall be used and heated is specified with the timer.

Select between **TIMER 1** and **TIMER 2**.

NOTE

The timer can only be programmed when the remote control key is in key position **I**, see page 77 - programming must therefore be carried out before starting the engine.

1. Scroll with the thumbwheel to **Park heat timer 1**.
2. Briefly press **RESET** to move to the flashing hours setting.
3. Select the required hour using the thumbwheel.
4. Briefly press **RESET** to move to the flashing minutes setting.
5. Select the required minute using the thumbwheel.
6. Briefly press **RESET** to confirm the setting.
7. Press **RESET** to activate the timer.

After setting **Park heat timer 1** a second start time can be programmed with **Park heat timer 2** by scrolling to it with the thumbwheel.

Set the alternative time in the same way as **Park heat timer 1**.

Deactivating a timer-started heater

A timer-started heater can be switched off manually before the set time has elapsed. Proceed as follows:

1. Press **READ**.
2. Use the thumbwheel to scroll to the text **Park heat timer 1** or **2**.
 - > The text **ON** flashes on the display.
3. Press **RESET**.
 - > The text **OFF** is shown with a constant glow and the heater is switched OFF.

A timer-started heater can be switched off in accordance with the instructions in the section "Direct start and immediate stop", see page 164.

Clock/timer

The heater's time is connected to the car's clock.

NOTE

All timer programming will be cleared if the car's clock is reset.



Additional heater*

General information about the additional heater

In cold climate zones¹ an additional heater may be required to obtain the correct operating temperature in the engine and to obtain sufficient heating in the passenger compartment.

Fuel-driven additional heater

A fuel-driven additional heater is fitted in cars with diesel engines.

The heater starts automatically when extra heat is required when the engine is running.

The heater is switched off automatically when the correct temperature is reached or when the engine is switched off.

i NOTE

When the additional heater is active there may be smoke from the right-hand wheel housing which is perfectly normal.

Auto mode or shutdown

The additional heater's automatic start sequence can be switched off if required.

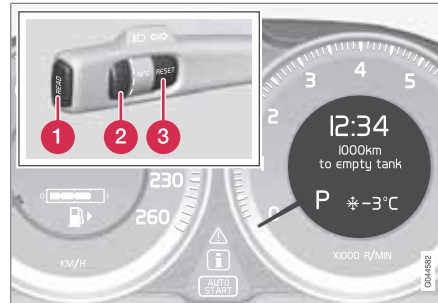

- 1** READ button
- 2** Thumbwheel
- 3** RESET button

1. Before starting the engine: Select key position **I**, see page 77.
2. Scroll with the thumbwheel to **Additional heat auto**.
3. Press **RESET** to select between **ON** and **OFF**.

i NOTE

The menu options are only visible in key position **I** - any adjustments must therefore be made before starting the engine.

Passenger compartment heater*

If the additional heater is supplemented with timer function then it can be used as a fuel-driven passenger compartment heater, see page 162.

Electric additional heater

Cars with certain petrol engines² have an electric additional heater integrated into the car's climate control system.

In a semi-cold¹ climate zone diesel-driven cars have an electric additional heater instead of a fuel-driven version.

The heater cannot be controlled manually but is instead activated automatically after the engine has been started in outside temperatures below 14 °C and is switched off after the set passenger compartment temperature has been reached.

¹ An authorised Volvo dealer has information regarding the geographical areas concerned.

² An authorised Volvo dealer has information regarding the engines concerned.



Trip computer

General

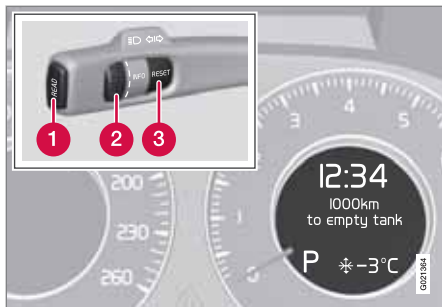

Information display and controls.

- 1 **READ** - confirms.
- 2 Thumbwheel – browse between menus and options in the trip computer list.
- 3 **RESET** – resets.

The trip computer's menu is in a variable loop. One of the menu options is a blank display - it also marks the beginning/end of the loop.

Functions

i NOTE

If a warning message appears when the trip computer is used then the message must first be acknowledged before the trip computer can be reactivated. Acknowledge the warning message by pressing **READ**.

To change unit for distance and speed - go to **MY CAR → Settings → System options → Distance and fuel unit**, see page 144.

Average speed

Average speed is calculated from the last resetting. Reset using **RESET**.

Instantaneous

Current fuel consumption is calculated every second. The information on the display is updated every couple of seconds. When the car is stationary, "----" appears on the display.

Average

Average fuel consumption is calculated from the last resetting. Reset using **RESET**.

i NOTE

There may be a slight error in the reading if a fuel-driven supplementary and/or parking heater* has been used.

Km to empty tank

The calculation is based on the average fuel consumption over the last 30 km and the remaining driveable fuel quantity. The display shows the approximate distance that can be driven with the fuel quantity remaining in the tank.

An economic driving style generally results in a longer driving distance. For more information on how fuel consumption can be influenced, see page 11.

No guaranteed range remains when the display shows "---- **km to empty tank**". Refuel as soon as possible.

i NOTE

There may be a slight error in the reading if the driving style has been changed.

Resetting

1. Select --- **km/h average speed** or --.- **l/100km average**.



Trip computer

2. Press and hold **RESET** for approx. 1 second to reset the selected function. If **RESET** is kept depressed for at least 3 three seconds then Average speed and Average are reset simultaneously.

Current speed*¹

The instrument panel display changes to show current speed in mph (miles per hour) if the speedometer is graduated in km/h. If the speedometer is graduated in mph then the display changes to km/h.

¹ Only certain markets.



DSTC – Stability and traction control system

General information on DSTC

The stability and traction control system, DSTC (Dynamic Stability & Traction Control) helps the driver to avoid skidding and improves the car's traction.

The activation of the system during braking may be noticed as a throbbing sound. The car may accelerate slower than expected when the accelerator pedal is depressed.

Active Yaw Control

The function limits the driving and brake force of the wheels individually in order to stabilise the car.

Spin Control

The function prevents the driving wheels from spinning against the road surface during acceleration.

Traction control system

The function is active at low speed and transfers power from the driving wheel that is spinning to the one that is not.

Operation

Selection of level - Sport mode

The DSTC system is always activated - it cannot be deactivated.

However, the driver can select the **Sport** mode, which allows for a more active driving experience. In **Sport** mode the system detects whether the accelerator pedal, steering wheel movements and cornering are more active than in normal driving and then allows controlled skidding with the rear section up to a certain level before it intervenes and stabilises the car.

If the driver stops a controlled skid by releasing the accelerator pedal then the DSTC system intervenes and stabilises the car.

With **Sport** mode, maximum traction is obtained if the car has become stuck, or when driving on a loose surface - e.g. sand or deep snow.

Proceed as follows to select **Sport** mode:







1. Press the centre console button **MY CAR** and search in the display screen's menu system and locate **My S80 → DSTC**. (For information on the menu system, see page 144).
2. Uncheck the box and back out of the menu system with **EXIT**.
 - > The system then allows a more sporty driving style.

The **Sport** mode is active until the driver deselects it or until the engine is switched off - after the engine is started the next time the DSTC system is back in its normal mode again.



DSTC – Stability and traction control system

Symbols and messages in the display

Symbol	Message	Specification
	DSTC Temporarily OFF	DSTC system temporarily reduced due to excessive brake disc temperature. - The function is reactivated automatically when the brakes have cooled.
	DSTC Service required	DSTC system disengaged. <ul style="list-style-type: none"> • Stop the car in a safe place, switch off the engine and start it again. • Visit a workshop if the message remains - an authorised Volvo workshop is recommended.
 and 	"Message"	There is a message on the speedometer's display - Read it!
	Constant glow for 2 seconds.	System check when the engine is started.
	Flashing light.	DSTC system is being activated.
DSTC SPORT		Sport mode is activated.



Adapting driving characteristics

Active chassis - Four-C*

Active chassis, Four-C (Continuously Controlled Chassis Concept), regulates the characteristics of the shock absorbers so that the car's driving characteristics can be adjusted. There are three settings: **Comfort**, **Sport** and **Advanced**.

Comfort

This setting means that the car is perceived as being more comfortable on rough and uneven road surfaces. Shock absorption is soft and the movement of the body is smooth and gentle.

Sport

This setting means that the car is perceived as being more sporty and is recommended for more active driving. Steering response is faster than in the Comfort mode. Shock absorption is harder and the body follows the road in order to reduce rolling during cornering.

Advanced

This setting is only recommended on very even and smooth road surfaces.

The shock absorbers are optimised for maximum roadholding and rolling in bends is further minimised.

Operation



Chassis settings.

Use the buttons in the centre console to change setting. The setting in use when the engine is switched off is activated next time the engine is started.

Speed related power steering*

Steering force increases with the speed of the car to give the driver enhanced sensitivity. The steering is firmer and more immediate on motorways. Steering is light and requires no extra effort when parking and at low speed.

The driver can choose between three different levels of steering force for road responsiveness or steering sensitivity. Go to the menu system **MY CAR** and locate **Settings** → **Car settings**

→ **Steering wheel force** and select **Low**, **Medium** or **High**.

For a description of the menu system, see page 144. This menu cannot be accessed while the car is in motion.



Cruise control*

Operation

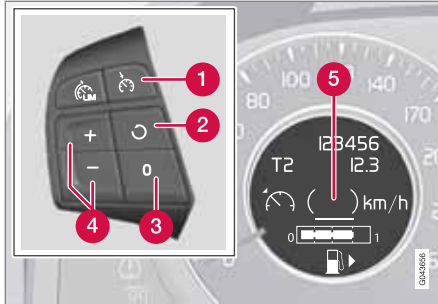

Steering wheel keypad and display.

- 1 Cruise control - On/Off.
- 2 Standby mode ceases and the stored speed is resumed.
- 3 Standby mode
- 4 Activate and adjust the speed.
- 5 Selected speed (in brackets = Standby mode).

Activating and setting the speed

Switch on the cruise control with one press on the steering wheel button - the symbol is illuminated in the display (5) and the brackets around (---) km/h show that the cruise control is set in standby mode.

The cruise control is then activated with or , after which the current speed is stored in the memory - the display text (---) km/h changes to show the selected speed, e.g. 100 km/h.

NOTE

Cruise control cannot be engaged at speeds below 30 km/h.

Changing the speed

In active mode the speed is adjusted with long or short presses on or - the last press is stored in the memory.

A temporary increase in speed with the accelerator pedal, e.g. during overtaking, does not affect the cruise control setting - the car returns to the set speed when the accelerator pedal is released.

NOTE

If any cruise control button is held depressed for more than approx. 1 minute then cruise control is disengaged. The engine must be switched off in order to reset cruise control.

Temporary deactivation - standby mode

Press to temporarily disengage the cruise control and set it in standby mode - set speed is shown in brackets in the display (5), e.g. (100) km/h.

Automatic standby mode

Cruise control is temporarily disengaged and set in standby mode if:

- wheels lose traction
- the foot brake is used
- speed falls below approx. 30 km/h
- the clutch pedal is depressed
- the gear selector is moved to neutral position (automatic gearbox)
- the driver maintains a speed higher than the set speed for longer than 1 minute.

The driver must then regulate the speed.

Resume set speed

Cruise control in standby mode is re-activated with one press on the steering wheel button - the speed is then set to the last stored speed.



NOTE

A significant increase in speed may arise after the speed has been resumed with .



Cruise control*

Deactivate

The cruise control is switched off with the steering wheel button  or by switching off the engine - the set speed is deleted from the memory and cannot be resumed with the  button.



Adaptive cruise control*

General information on ACC¹

The adaptive cruise control (ACC – Adaptive Cruise Control) helps the driver maintain a safe distance from the vehicle ahead. The cruise control provides a more relaxing driving experience on long journeys on motorways and long straight main roads in smooth traffic flows.

The driver sets the desired speed and time interval to the car in front. When the radar detector detects a slower vehicle in front of the car, the speed is automatically adapted to that. When the road is clear again the car returns to the selected speed.

If the adaptive cruise control is switched off or set to the standby mode and the car comes too close to a vehicle in front, then the driver is warned by Distance Warning (see page 183) about the short distance.

WARNING

The driver must always be observant with regard to the traffic conditions and intervene when the adaptive cruise control is not maintaining a suitable speed or suitable distance.

The adaptive cruise control cannot handle all traffic, weather and road conditions.

Read the whole of this section for information on the limitations of the adaptive cruise control. The driver must be familiar with this information before using the adaptive cruise control.

The driver always bears responsibility for maintaining the correct distance and speed, even when the adaptive cruise control is being used.

IMPORTANT

Maintenance of adaptive cruise control components must only be performed at a workshop - an authorised Volvo workshop is recommended.

Automatic gearbox

Cars with automatic gearbox have enhanced functionality with the adaptive cruise control's Queue Assistant, see page 177.

Function

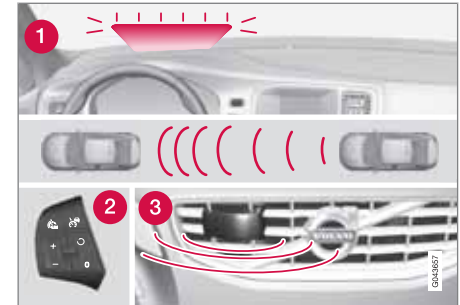

Function overview².

- 1** Warning lamp, braking by driver required
- 2** Steering wheel keypad
- 3** Radar sensor

Adaptive cruise control consists of a cruise control system and a coordinated spacing system.

¹ Not available as an option for the 2.5T.

² NOTE: The illustration is schematic - details may vary depending on car model.



Adaptive cruise control*

WARNING

Adaptive cruise control is not a collision avoidance system. The driver must intervene if the system does not detect a vehicle in front.

The adaptive cruise control does not brake for humans or animals, and not for small vehicles such as bicycles and motorcycles. Nor for oncoming, slow or stationary vehicles and objects.

Do not use the adaptive cruise control, for example, in city traffic, in dense traffic, at junctions, on slippery surfaces, with a lot of water or slush on the road, in heavy rain/snow, in poor visibility, on winding roads or on slip roads.

The distance to the vehicle ahead is mainly measured by a radar sensor. Cruise control regulates the speed with acceleration and braking. It is normal for the brakes to emit a low sound when they are being used by cruise control.

WARNING

The brake pedal moves when the cruise control brakes. Do not rest your foot under the brake pedal as it could become trapped.

The adaptive cruise control aims to follow the vehicle ahead in the same lane at a time interval set by the driver. If the radar sensor cannot see any vehicle in front then the car will instead maintain the cruise control's set speed. This also happens if the speed of the vehicle in front exceeds the cruise control's set speed.

The cruise control aims to control the speed in a smooth way. In situations that demand sudden braking the driver must brake himself/herself. This applies with large differences in speed, or if the vehicle in front brakes heavily. Due to limitations in the radar sensor, braking may come unexpectedly or not at all, see page 178.

The adaptive cruise control can be activated to follow another vehicle at speeds from 30 km/h³ up to 200 km/h. If the speed falls below 30 km/h or if the engine speed becomes too low, the cruise control is set in standby mode at which automatic braking ceases - the driver must then take over himself/herself to maintain a safe distance to the vehicle ahead.

Warning lamp - braking by driver required

Adaptive cruise control has a braking capacity that is equivalent to more than 40% of the car's braking capacity.

If the car needs to be braked more heavily than cruise control capacity and the driver does not brake, then the cruise control uses the collision warning system's warning lamp and warning sound (see page 191) to alert the driver that immediate intervention is required.

NOTE

The warning lamp may be difficult to notice in strong sunlight or when sunglasses are being worn.

WARNING

Cruise control only warns of vehicles detected by the radar sensor. Consequently there may be no warning or it may be subject to a delay. Do not wait for a warning but brake when it is necessary.

Steep roads and/or heavy load

Bear in mind that the adaptive cruise control is primarily intended for use when driving on level road surfaces. The cruise control may have difficulty in keeping the correct distance from the vehicle ahead when driving on steep roads, with a heavy load or with a trailer - in which case, be extra attentive and ready to slow down.

³ Queue Assistant (in cars with automatic gearbox) can operate in the range of 0-200 km/h, see page 177.

* Option/accessory, for more information, see Introduction.



Adaptive cruise control*

Operation

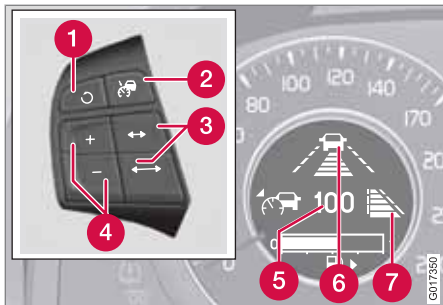

Steering wheel keypad and display.

- 1 Standby mode ceases and the stored speed is resumed.
- 2 Cruise control - On/Off or Standby mode.
- 3 Time interval - Increase/decrease.
- 4 Activate and adjust the speed.
- 5 Selected speed (in brackets = Standby mode).
- 6 Time interval⁴ - On, during adjustment.
- 7 Time interval⁴ - On, after adjustment.

Activating and setting the speed

Switch on cruise control with one press on the steering wheel button - the symbol is illuminated in the display. The brackets (6) at (---) mean that cruise control is set in standby mode.

The cruise control is then activated with or , after which the current speed is stored in the memory - the display text (---) changes to show the selected speed, e.g. 100 without brackets.

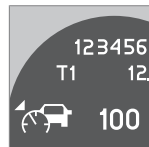

When the symbol changes to the radar sensor has detected a vehicle.

Only when the symbol (with car) is illuminated, is the distance to the vehicle in front regulated by the cruise control.

Changing the speed

In active mode the speed is adjusted 5 km/h with each press on or . In active mode the button has the same function as but results in a lower increase in speed. The last press is stored in the memory.

NOTE

If any cruise control button is held depressed for more than approx. 1 minute then cruise control is disengaged. The engine must be switched off in order to reset cruise control.

In certain situations, cruise control cannot be activated. Then the display shows **Cruise control Unavailable**, see page 180.

Set time interval

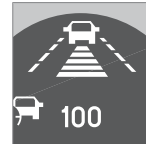

Different time intervals to the vehicle in front can be selected and shown in the display as 1-5 horizontal lines - the more lines the longer the time distance. One line corresponds to approximately

1 second, 5 lines approximately 2.5 seconds.

The time interval is increased or decreased with the buttons / .

At low speed, when the distances are short, the adaptive cruise control increases the time interval slightly.

The adaptive cruise control allows the time interval to vary noticeably in certain situations

⁴ The display shows either "dash" symbol [6] or [7] - they are never shown simultaneously.



Adaptive cruise control*

in order to allow the car to follow the vehicle in front smoothly and comfortably.

Note that a short time interval only allows the driver a short time to react and take action if any unforeseen traffic problem should arise.



The number of lines for the selected time interval is shown during the setting itself and for several seconds afterwards. Then a smaller scale version of the symbol is shown to the right of the display.

The same symbol is also shown when Distance Warning is activated, see page 183.

NOTE

Only use the time interval that is allowed in accordance with local traffic regulations.

If cruise control does not seem to react to activation the reason may be that the time interval to the closest vehicle prevents an increase in speed.

The higher the speed, the longer the calculated distance in metres for a specific time interval.

Temporary deactivation - standby mode

Press the steering wheel button  to temporarily disengage the cruise control and set it in standby mode - set speed is shown in brackets in the display, e.g. (100).

Standby mode due to driver intervention

Cruise control is temporarily disengaged and set in standby mode if:

- the foot brake is used
- the clutch pedal is depressed for longer than 1 minute⁵
- the gear selector is moved to **N** position (automatic gearbox)
- the driver maintains a speed higher than the set speed for longer than 1 minute

The driver must then regulate the speed.

A temporary increase in speed with the accelerator pedal, e.g. during overtaking, does not affect the cruise control setting - the car returns to the last stored speed when the accelerator pedal is released.

Automatic standby mode

Adaptive cruise control is dependent on other systems e.g. stability and traction control (DSTC). If any of these systems stop working

then cruise control is automatically deactivated.

In the event of automatic deactivation a signal will sound and the message **Cruise control Cancelled** is shown in the display. The driver must then intervene and adapt the speed and distance to the vehicle ahead.

An automatic deactivation can be due to:

- engine speed is too low/high
- speed falls below 30 km/h⁶
- wheels lose traction
- brake temperature is high
- the radar sensor is covered e.g. by wet snow or heavy rain (radar waves blocked).

Resume set speed

Cruise control in standby mode is re-activated with one press on the steering wheel button  - the speed is then set to the last stored speed.

NOTE

A significant increase in speed may arise after the speed has been resumed with .



⁵ Disengaging and selecting a higher or lower gear does not involve standby mode.

⁶ Does not apply to a car with Queue Assistant - it manages right down to stationary.



Adaptive cruise control*

Deactivate

The cruise control is switched off with a short press on the steering wheel button  in standby mode - or with one long press in active mode. The set speed is cleared and cannot be resumed with the  button.

Queue Assistant

In cars with automatic gearbox the adaptive cruise control has the Queue Assistant function (sometimes also referred to as "Queue Assist").

Queue Assistant has the following functions:

- Extended speed range
- Change of target
- Automatic braking ceases when stationary
- Automatic activation parking brake.

Note that the lowest programmable speed for the cruise control is 30 km/h - even though the cruise control is capable of following another vehicle down to a standstill, a lower speed **cannot** be selected.

Extended speed range

NOTE

In order to activate the cruise control the driver's door must be closed and the driver must be wearing the seatbelt.

- With the automatic gearbox the cruise control can follow another vehicle within the range of 0-200 km/h - right down to stationary and up to 200 km/h.

NOTE

Activation of the cruise control below 30 km/h requires a vehicle in front within a reasonable distance.

For shorter stops in connection with inching in slow traffic or at traffic lights driving is automatically resumed if the stops do not exceed about 3 seconds - if it takes longer before the car in front starts moving again then the cruise control is set in standby mode. The driver must then re-activate the cruise control in one of the following ways:

- Press the steering wheel button .

or

- Press the accelerator pedal and accelerate up to at least about 4 km/h (normal walking pace).

The cruise control will then resume following the vehicle in front.

NOTE

The cruise control can hold the car stationary for a maximum of 2 minutes - then the parking brake is applied and the cruise control is disengaged.

- The driver has to release the parking brake before the cruise control can be reactivated.

Change of target

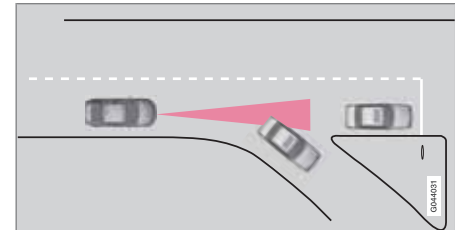

If the target vehicle in front suddenly turns then there may be stationary traffic in front.

When the cruise control is following another vehicle at speeds **below** 30 km/h and changes target from a moving to a stationary vehicle, the



Adaptive cruise control*

cruise control will slow down for the stationary vehicle.

WARNING

When the cruise control is following another vehicle at speeds **in excess of 30 km/h** and the target is changed from a moving vehicle to a stationary vehicle, the cruise control will ignore the stationary vehicle and instead select the stored speed.

- The driver must intervene him/herself and brake.

Automatic standby mode with change of target

Cruise control is disengaged and set in standby mode:

- when the speed is below 15 km/h and cruise control is not sure whether the target object is a stationary vehicle or some other object, e.g. a speed bump.
- when the speed is below 15 km/h and the vehicle in front turns off so the cruise control no longer has a vehicle to follow.

Automatic braking ceases when stationary

In certain situations the cruise control interrupts braking when stationary. This means that

the foot brake is released and the driver must brake himself/herself.

Cruise control releases the foot brake and is set in standby mode when:

- the driver puts his/her foot on the brake pedal
- the parking brake is applied
- the gear selector is moved to **P, N or R** position
- the driver sets the cruise control in standby mode.

Automatic activation parking brake

In some situations the cruise control applies the parking brake in order to keep a stationary car remaining stationary.

This takes place if:

- the driver opens the door or takes off his/her seatbelt
- DSTC is changed from **Normal** to **Sport** mode
- cruise control has held the car stationary for more than 2 minutes
- the engine is switched off
- the brakes have overheated.

The radar sensor and its limitations

Apart from the adaptive cruise control, the radar sensor is also used by the Collision Warning with Auto Brake function (see page 190) and the Distance Warning function (see page 183). The function of the radar sensor is to detect cars or larger vehicles in the same direction, in the same lane.

Modification of the radar sensor could result in it being illegal to use.

WARNING

The driver must always be observant with regard to the traffic conditions and intervene when the adaptive cruise control is not maintaining a suitable speed or suitable distance.

The adaptive cruise control cannot handle all traffic, weather and road conditions.

Read the whole of this section for information on the limitations of the adaptive cruise control. The driver must be familiar with this information before using the adaptive cruise control.

The driver always bears responsibility for maintaining the correct distance and speed, even when the adaptive cruise control is being used.



Adaptive cruise control*

WARNING

Accessories or other objects such as auxiliary lamps must not be installed in front of the grille.

WARNING

Adaptive cruise control is not a collision avoidance system. The driver must intervene if the system does not detect a vehicle in front.

The adaptive cruise control does not brake for humans or animals, and not for small vehicles such as bicycles and motorcycles. Nor for oncoming, slow or stationary vehicles and objects.

Do not use the adaptive cruise control, for example, in city traffic, in dense traffic, at junctions, on slippery surfaces, with a lot of water or slush on the road, in heavy rain/snow, in poor visibility, on winding roads or on slip roads.

The capacity of the radar sensor to detect vehicles in front is reduced significantly:

- if the radar sensor becomes blocked and cannot detect other vehicles e.g. in heavy rain or slush, or if other objects have collected in front of the radar sensor.

NOTE

Keep the surface in front of the radar sensor clean.

- if the speed of vehicles in front is significantly different from your own speed.

Examples where the cruise control does not work optimally

The radar sensor has a limited field of vision. In some situations another vehicle is not detected, or the detection is made later than expected.

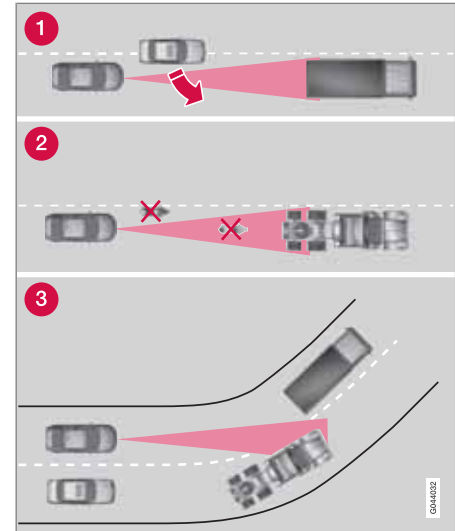

ACC field of vision.



04 Comfort and driving pleasure

Adaptive cruise control*

- 1 Sometimes the radar sensor is late at detecting vehicles at close distances, e.g. a vehicle that drives in between the car and vehicles in front.
- 2 Small vehicles, such as motorcycles, or vehicles not driving in the centre of the lane can remain undetected.

- 3 In bends the radar sensor may detect the wrong vehicle or lose a detected vehicle from view.

Fault tracing and action

If the display shows the message **Radar blocked** See manual this means that the radar signals from the radar sensor are blocked

and that vehicles in front of the car could not be detected.

In turn this means that the Adaptive Cruise Control, Distance Warning and Collision Warning with Auto Brake functions are not operating either.

The following table presents possible causes for a message being shown along with the appropriate action.

Cause	Action
The radar surface in the grille is dirty or covered with ice or snow.	Clean the radar surface in the grille from dirt, ice and snow.
Heavy rain or snow blocking the radar signals.	No action. Sometimes the radar does not work during heavy rain or snowfall.
Water or snow from the road surface swirls up and blocks the radar signals.	No action. Sometimes the radar does not work on a very wet or snowy road surface.
The radar surface has been cleaned but the message remains.	Wait. It could take several minutes for the radar to sense that it is no longer blocked.





Symbols and messages in the display

Symbol	Message	Specification
		Standby mode or active mode without detected vehicle.
		Active mode with detected vehicle to which cruise control adapts the speed.

* Option/accessory, for more information, see Introduction.



Adaptive cruise control*

Symbol	Message	Specification
		Time interval activated, during adjustment.
		Time interval activated, after adjustment.
	DSTC Normal to enable Cruise	Cruise control cannot be activated until the Stability and Traction Control system (DSTC) has been set in Normal mode - see page 168.
	Cruise control Cancelled	The cruise control has been deactivated - the driver has to regulate the speed.
	Cruise control Unavailable	Cruise control cannot be activated. This could be due to: <ul style="list-style-type: none"> • brake temperature is high • the radar sensor is blocked by e.g. wet snow or rain.
	Radar blocked See manual	Cruise control temporarily disengaged. <ul style="list-style-type: none"> • The radar sensor is blocked and cannot detect other vehicles. For example, in the event that heavy rain or if slush has collected in front of the radar sensor. Read about the limitations of the radar sensor, see page 178.
	Cruise control Service required	Cruise control disengaged. <ul style="list-style-type: none"> • Contact a workshop - an authorised Volvo workshop is recommended.



04 Comfort and driving pleasure

Adaptive cruise control*

Symbol	Message	Specification
	Press Brake To hold + acoustic alarm (Only with Queue Assistant)	The car is stationary and the cruise control will release the foot brake to allow the parking brake to take over and hold the car, but a fault in the parking brake means the car will shortly begin to roll. <ul style="list-style-type: none">• The driver must brake himself/herself. The message remains and the alarm sounds until the driver depresses the brake pedal or uses the accelerator pedal.
	Below 30 km/h Only following (Only with Queue Assistant)	Shown with attempts to activate the cruise control at speeds below 30 km/h without a vehicle in front within the activation distance (approx. 30 metres).

04



Distance Warning*

General¹

Distance Warning (Distance Alert) is a function that informs the driver about the time interval to vehicles in front.

Distance Warning is active at speeds above 30 km/h and only reacts to vehicles driving in front of the car, in the same direction. No distance information is provided for oncoming, slow or stationary vehicles.

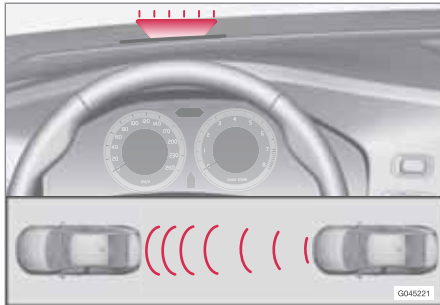

Orange warning lamp².

An orange warning lamp in the windscreen illuminates with a constant glow if the distance to the vehicle in front is shorter than the set time interval.

NOTE

Distance warning is deactivated during the time the adaptive cruise control is active.

WARNING

Distance warning only reacts if the distance to the vehicle ahead is shorter than the pre-set value - the speed of the driver's vehicle is not affected.

Operation



Press the button in the centre console to switch the function on or off. The function is switched on if one lamp is illuminated in the button.

Some combinations of the selected equipment leave no vacant space for a button in the centre console - in which case the function is handled by the car's menu system **MY CAR** under **Settings → Car settings → Warning distance**. For a description of the menu system - see page 144.)

¹ Not available as an option for the 2.5T.

² NOTE: The illustration is schematic - details may vary depending on car model.



Distance Warning*

Set time interval

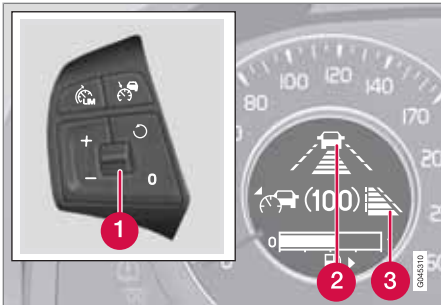

Controls and display for time interval.

- 1 Time interval - Increase/decrease. Press up to increase, down to decrease.
- 2 Time interval³ - On (during adjustment).
- 3 Time interval³ - On (after adjustment).



Different time intervals to the vehicle in front can be selected and shown in the display as 1-5 horizontal lines - the more lines the longer the time interval. One line corresponds to approximately

1 second to the vehicle in front, 5 lines approximately 2.5 seconds.

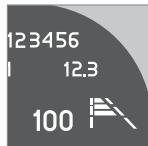

The number of lines for the selected time interval is shown during the setting itself and for several seconds afterwards. Then a smaller scale version of the symbol is shown to the right of the display. The same symbol is also shown when adaptive cruise control is activated.

NOTE

The higher the speed, the longer the calculated distance in metres for a specific time interval.

The set time interval is also used by the adaptive cruise control function, see page 175.

Only use the time interval that is allowed in accordance with local traffic regulations.

Limitations

The function uses the same radar sensor as adaptive cruise control and the collision warning system. For more information on the radar sensor and its limitations, see page 178.

NOTE

Strong sunlight, reflections or strong variations in light intensity, as well as wearing sunglasses, could mean that the warning light in the windscreen cannot be seen.

Poor weather or winding roads could affect the radar sensor's capacity to detect vehicles in front.

The size of other vehicles could also affect detection capacity, e.g. motorcycles. This could mean that the warning lamp illuminates at a shorter distance than the setting or that the warning is temporarily absent.

Extremely high speeds can also cause the lamp to illuminate at a shorter distance than that set due to limitations in sensor range.





³ The display shows either "dash" symbol [2] or [3] - they are never shown simultaneously.

* Option/accessory, for more information, see Introduction.



Distance Warning*

Symbols and messages in the display

Symbol	Message	Specification
		Set time interval, during adjustment.
		Set time interval, after adjustment.
	Radar blocked See manual	Distance Warning temporarily disengaged. The radar sensor is blocked and cannot detect other vehicles, e.g. in the event of heavy rain or if slush has collected in front of the radar sensor. Read about the limitations of the radar sensor, see page 178.
 	Collision warn. Service required	Distance Warning and Collision Warning with Auto Brake fully or partially disengaged. Visit a workshop if the message remains - an authorised Volvo workshop is recommended.



04 Comfort and driving pleasure

City Safety™

General

City Safety™ is a function for helping the driver to avoid a collision when driving in queues, amongst other things, when changes in the traffic ahead, combined with a lapse in attention, could lead to an incident.

The function is active at speeds below 30 km/h and it helps the driver by automatically braking the car in the event of imminent risk of collision with vehicles in front, should the driver not react in time by braking and/or steering away.

City Safety™ is activated in situations where the driver should have started braking earlier, which is why it cannot help the driver in every situation.

City Safety™ is designed to be activated as late as possible in order to avoid unnecessary intervention.

City Safety™ must not be used as an excuse for the driver to change his/her driving style. If the driver solely relies on City Safety™ to do the braking, there will be a collision sooner or later.

The driver or passengers normally only notice City Safety™ if a situation arises where the car is extremely close to being in a collision.

If the car is also equipped with a Collision Warning function with Auto Brake*, these two systems complement each other. For more information on Collision Warning function with Auto Brake, see page 190.

! IMPORTANT

Maintenance and replacement of City Safety™ components must only be performed by a workshop - an authorised Volvo workshop is recommended.

! WARNING

City Safety™ does not engage in all driving situations or traffic, weather or road conditions.

City Safety™ does not react to vehicles driving in a different direction from the car, to small vehicles, motorcycles and bicycles or to humans and animals.

City Safety™ can prevent collision at a speed difference of less than 15 km/h - at a higher speed difference, it is only possible to reduce collision speed. In order to obtain full brake function, the driver must depress the brake pedal.

Never wait for City Safety™ to engage. The driver always bears responsibility for maintaining the proper distance and speed.

Function

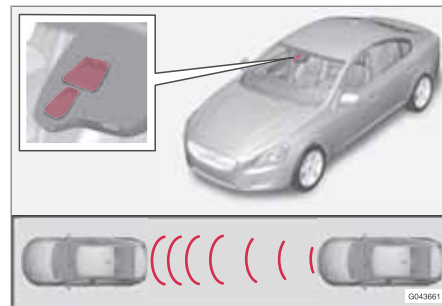

Laser sensor transmitter and receiver window¹.

City Safety™ detects the traffic in front of the car with a laser sensor fitted in the top edge of the windscreen. If there is an imminent risk of collision, City Safety™ will automatically brake the car, which may be experienced as sudden braking.

If the speed difference is 4-15 km/h in relation to the vehicle in front then City Safety™ can completely prevent a collision.

City Safety™ activates a short, sharp braking and stops the car in normal circumstances, just behind the vehicle in front. For most drivers this is well outside normal driving style and may be experienced as being uncomfortable.

¹ NOTE: The illustration is schematic - details may vary depending on car model.

* Option/accessory, for more information, see Introduction.



City Safety™

If the difference in speed between the vehicles is greater than 15 km/h then City Safety™ may not prevent the collision on its own. To obtain full brake force, the driver must depress the brake pedal. This could then make it possible to prevent a collision, even at speed differences above 15 km/h.

When the function is activated and brakes, the instrument panel display shows a message to the effect that the function is/has been active.

NOTE

The brake lights come on when City Safety™ brakes the car.

Operation**NOTE**

The City Safety™ function is always enabled after the engine has been started via key position **I** and **II** (see page 77 on key positions).

On and Off

In certain situations, it may be advisable to disable City Safety™, e.g. where leafy branches could sweep over the bonnet and/or windscreen.

After starting the engine City Safety™ can be deactivated as follows:

Using **MY CAR** on the centre console display screen with its menu system, search and locate **Settings** → **Car settings** → **Driving support systems** → **City Safety**. Select the **Off** option. For more information on the menu system **MY CAR**, see page 144).

However, the function will be enabled the next time the engine is started, regardless of whether the system was enabled or disabled when the engine was switched off.

WARNING

The laser sensor also transmits laser light when City Safety™ is disabled manually.

To enable City Safety™ again:

- Follow the same procedure as for disabling, but select the **On** option.

Limitations

The sensor in City Safety™ is designed to detect cars and other large vehicles in front of the car irrespective of whether it is day or night.

However, the sensor has limitations and has poorer functionality in e.g. heavy snowfall or rain, dense fog, dust storms or snow flurries. Mist, dirt, ice or snow on the windscreen may disrupt the function.

Low-hanging objects, e.g. a flag/pennant for projecting load, or accessories such as auxiliary lamps and bull bars that are higher than the bonnet limit the function.

The infrared light from the sensor in City Safety™ measures how the light is reflected. The sensor cannot detect objects with low reflection capacity. The rear sections of the vehicle generally reflect the light sufficiently thanks to the number plate and rear light reflectors.

On slippery road surfaces the braking distance is extended, which may reduce the capacity of City Safety™ to avoid a collision. In such situations the ABS and DSTC systems will provide best possible braking force with maintained stability.

When the car is reversing City Safety™ cannot be activated.

City Safety™ is not activated at low speeds - under 4 km/h, which is why the system does not intervene in situations where a vehicle in front is being approached very slowly, e.g. when parking.

Driver commands are always prioritised, which is why City Safety™ does not intervene in situations where the driver is steering, braking or accelerating in a clear manner, even if a collision is unavoidable.



04 Comfort and driving pleasure

City Safety™

When City Safety™ has prevented a collision with a stationary object the car remains stationary for a maximum of 1.5 seconds. If the car is braked for a vehicle in front that is moving, then speed is reduced to the same speed as that maintained by the vehicle in front.

On a car with manual gearbox the engine stops when City Safety™ has stopped the car, unless the driver manages to depress the clutch pedal beforehand.

NOTE

- Keep the windscreen surface in front of the laser sensor free from ice, snow and dirt (see the illustration for sensor location, page 186).
- Do not affix or mount anything on the windscreen in front of the laser sensor
- Remove ice and snow from the bonnet - snow and ice must not exceed a height of 5 cm.

Fault tracing and action

If the message **Windscreen Sensors blocked** is shown on the instrument panel display, it indicates that the laser sensor is blocked and cannot detect vehicles in front of the car. This means that City Safety™ is not operational.

The **Windscreen Sensors blocked** message is not shown for all situations in which the laser sensor is blocked. The driver must therefore be diligent about keeping the windscreen and area in front of the laser sensor clean.

The following table presents possible causes for the message being shown, along with suggestions for appropriate action.

Cause	Action
The windscreen surface in front of the laser sensor is dirty or covered with ice or snow.	Clean the windscreen surface in front of the sensor from dirt, ice and snow.
The laser sensor field of vision is blocked.	Remove the blocking object.

IMPORTANT

If there are cracks, scratches or stone chips in the windscreen in front of either of the laser sensor's "windows" and they cover a surface of approx. 0.5 x 3.0 mm (or larger), then a workshop must be contacted for repair or replacement of the windscreen (see the illustration for sensor location, page 186) - an authorised Volvo workshop is recommended.

Failure to take action may result in reduced performance for City Safety™.

To avoid the risk of reducing City Safety™ performance the following also applies:

- The same type or a Volvo-approved windscreen must be fitted during replacement
- The same type or Volvo-approved windscreen wipers must be fitted during replacement.

Laser sensor

The City Safety™ function includes a sensor which transmits laser light. Contact a qualified workshop in the event of a fault or if the laser sensor needs servicing - an authorised Volvo workshop is recommended.



City Safety™

! WARNING







Never look into the laser sensor (which emits spreading invisible laser radiation) at a distance of 100 mm or closer with magnifying optics such as a magnifying glass, microscope, lens or similar optical instruments - this would involve a risk of eye injury (the illustration on page 186 shows sensor location).

For more information on the laser sensor, see page 9.

Symbols and messages in the display

In conjunction with automatic braking by the City Safety™ system, one or more symbols may illuminate on the instrument panel and a message may appear on its display.

A text message can be acknowledged by briefly pressing the **READ** button on the direction indicator stalk.

Symbol	Message	Meaning/Action
 	Auto braking by City Safety	City Safety™ is braking or has automatically braked.
 	Windscreen Sensors blocked	The laser sensor is temporarily non-operational because something is blocking it. <ul style="list-style-type: none"> Remove the object blocking the sensor and/or clean the windscreen in front of the sensor. Read about the limitations of the laser sensor, see page 187.
 	City Safety Service required	City Safety™ is not operational. <ul style="list-style-type: none"> Visit a workshop if the message remains - an authorised Volvo workshop is recommended.



Collision Warning with Auto Brake & Pedestrian Protection*

General¹

Collision Warning with Auto Brake and Pedestrian Detection is designed to assist the driver when there is a risk of colliding with a pedestrian or vehicles in front that are stationary or moving in the same direction.

The collision warning system has the following three functions.

- **Collision Warning** – Warns the driver of a potentially imminent collision.
- **Brake Support** – Assists the driver to brake effectively in a critical situation.
- **Auto Brake** - Brakes the car automatically in the event of an imminent risk of collision with a pedestrian or vehicle in front, if the driver does not himself/herself react in time by braking and/or steering away. The Auto Brake function can prevent a collision or reduce collision speed.

The collision warning system is activated in situations where the driver should have started braking a lot earlier, which is why the function cannot help the driver in every situation.

Collision Warning with Auto Brake is designed to be activated as late as possible in order to avoid unnecessary intervention.

The collision warning system must not be used as an excuse for the driver to change his/her driving style. If the driver solely relies on Collision Warning with Auto Brake to do the braking, there will be a collision sooner or later.

The collision warning system and City Safety™ complement each other. For more information on City Safety™, see page 186.

IMPORTANT

Maintenance of collision warning system components must only be performed at a workshop - an authorised Volvo workshop is recommended.

WARNING

No automatic system can guarantee 100 % correct function in all situations. Therefore, never try out the Auto brake system by driving towards people - this may cause serious injuries or risk death.

WARNING

The collision warning system does not engage in all driving situations or traffic, weather or road conditions. The collision warning system does not react to vehicles driving in another direction to the car or to animals.

Warning only activated in the event of a high risk for collision. The Function section and the section after advise about limitations of which the driver should be aware before using Collision Warning with Auto Brake.

Warnings and brake interventions for pedestrians are switched off at vehicle speeds exceeding 80 km/h.

Warnings and brake interventions for pedestrians do not work in darkness and tunnels - not even when streetlights are lit.

The auto-brake function can prevent a collision or reduce collision speed. To ensure full brake performance, the driver should always depress the brake pedal - even when the car auto-brakes.

Never wait for a collision warning. The driver is always responsible that the correct distance and speed are maintained - even when the collision warning system with auto-brake is used.

¹ Not available as an option for the 2.5T.



Collision Warning with Auto Brake & Pedestrian Protection*

Function

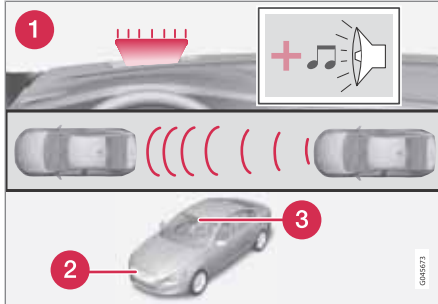

Function overview².

- 1 Audio-visual warning signal in the event of a collision risk.
- 2 Radar sensor
- 3 Camera sensor

Collision warning

Together with a camera sensor, the radar sensor detects pedestrians, stationary vehicles as well as vehicles driving in the same direction in front of the car.

In the event of there being a risk of collision with a pedestrian or such a vehicle your attention is drawn with a red flashing warning signal and a warning sound.

Brake support

If the risk of collision still increases after the collision warning then the brake support is activated. The brake support prepares the brake system for rapid braking and the brakes are applied gently, which may be noticed as a slight jerk.

If the brake pedal is depressed sufficiently quickly then full brake function is implemented.

Brake support also reinforces the driver's braking if the system considers that the braking is not sufficient to avoid a collision.

Auto Brake

If in this situation the driver has not yet started to take evasive action and the risk of collision is imminent then the automatic braking function is deployed, irrespective of whether or not the driver brakes. Braking then takes place with full brake force in order to reduce collision speed, or with limited brake force if it is sufficient to avoid collision.

Operation

Settings are made from **MY CAR** via the centre console display screen and menu system. For information on how the menu system is used, see page 144.

NOTE

The Brake Support and Auto Brake functions are always enabled - they cannot be deactivated.

On and Off

To select whether the collision warning system should be switched on or off: Search with the menu system **MY CAR** via the centre console display screen and locate **Settings → Car settings → Driving support systems → Collision Warning**. For information on the menu system, see page 144.

An activated function is tested at each engine start by briefly illuminating the warning lamp's separate points of light.

When starting the engine, the setting that was selected when the engine was switched off is obtained automatically.

² NOTE: The illustration is schematic - details may vary depending on car model.



Collision Warning with Auto Brake & Pedestrian Protection*

Activating/deactivating warning signals

The warning lamp is activated automatically when the engine is started if the system is switched on.

The warning sound can be activated/deactivated separately using the options for **On** or **Off** in the menu system **MY CAR** under **Settings → Car settings → Driving support systems → Warning sound if risk of collision**.

Set warning distance

The warning distance regulates the distance at which the visual and acoustic warnings are deployed. Select one of the options from **Long**, **Normal** or **Short** in the menu system **MY CAR** under **Settings → Car settings → Driving support systems → Collision Warning → Warning distance**.

The warning distance determines the system's sensitivity. Warning distance **Long** provides an earlier warning. First test with **Long** and if this setting produces too many warnings, which could be perceived as irritating in certain situations, then change to warning distance **Normal**.

Only use warning distance **Short** in exceptional cases, e.g. for dynamic driving.

NOTE

When the adaptive cruise control is in use the warning lamp and warning sound will be used by the cruise control even if the collision warning system is switched off.

The collision warning system warns the driver in the event of a risk of a collision, but the function cannot shorten driver reaction time.

In order for the collision warning system to be effective, always drive with the Distance Alert set at time interval 4 – 5. see page 183.

NOTE

Even if the warning distance has been set to **Long** warnings could be perceived as being late in certain situations, e.g. when there are large differences in speed or if vehicles in front brake heavily.

Checking settings

The settings required can be controlled on the centre console display screen. Search with the menu system **MY CAR** under **Settings → Car settings → Driving support systems → Collision Warning**, see page 144.

Limitations

The collision warning system is active from and including approx. 4 km/h.

The visual warning signal may be difficult to notice in the event of strong sunlight, reflections, when sunglasses are being worn or if the driver is not looking straight ahead. The warning sound should therefore always be activated.

On slippery road surfaces the braking distance is extended, which may reduce the capacity to avoid a collision. In such situations the ABS and DSTC systems will provide best possible braking force with maintained stability.

NOTE

The visual warning signal can be temporarily disengaged in the event of high passenger compartment temperature caused by strong sunlight for example. If this occurs then the warning sound is activated even if it is deactivated in the menu system.

- Warnings may not appear if the distance to the vehicle in front is small or if steering wheel and pedal movements are large, e.g. a very active driving style.

**Collision Warning with Auto Brake & Pedestrian Protection*****⚠ WARNING**

Warnings and brake interventions could be implemented late or not at all if the traffic situation or external influences mean that the radar or camera sensor cannot detect a pedestrian or a vehicle in front correctly.

The sensor system has a limited range for pedestrians and the system therefore provides effective warnings and brake interventions at vehicle speeds up to 50 km/h. For stationary or slow-moving vehicles, warnings and brake interventions are effective at vehicle speeds up to 70 km/h.

Warnings for stationary or slow-moving vehicles could be disengaged due to darkness or poor visibility.

The collision warning system uses the same radar sensors as adaptive cruise control. For more information on the radar sensor and its limitations, see page 178.

If warnings are perceived as being too frequent or disturbing then the warning distance can be reduced. This would lead to the system warning at a later stage, which reduces the total number of warnings.

When the car is reversing Collision Warning with Auto Brake cannot be activated.

Collision Warning with Auto Brake is not activated at low speeds - under 4 km/h, which is

why the system does not intervene in situations where the car is approaching a vehicle in front very slowly, e.g. when parking.

Driver commands are always prioritised, which is why Collision Warning with Auto Brake does not intervene in situations where the driver is steering, braking or accelerating in a clear manner, even if a collision is unavoidable.

When Auto Brake has prevented a collision with a stationary object the car remains stationary for a maximum of 1.5 seconds. If the car is braked for a vehicle in front that is moving, then speed is reduced to the same speed as that maintained by the vehicle in front.

On a car with manual gearbox the engine stops when Auto Brake has stopped the car, unless the driver manages to depress the clutch pedal beforehand.

Camera sensor limitations

The car's camera sensor is used by the three functions - Collision Warning with Auto Brake, Driver Alert Control, see page 197 and Lane Departure Warning, see page 200.

i NOTE

Keep the windscreen surface in front of the camera sensor clean from ice, snow, mist and dirt.

Do not attach or fit anything to the windscreen in front of the camera sensor, as this could reduce or prevent the function of one or more camera-dependent systems.

The camera sensors have limitations similar to the human eye, i.e. they "see" worse in darkness, heavy snowfall or rain and in thick fog for example. Under such conditions the functions of camera-dependent systems could be significantly reduced or temporarily disengaged.

Strong oncoming light, reflections in the carriageway, snow or ice on the road surface, dirty road surfaces or unclear lane markings could also significantly reduce camera sensor function when it is used to scan the carriageway and detect pedestrians and other vehicles.

During very high temperatures the camera is temporarily switched off for about 15 minutes after the engine is started in order to protect camera functionality.



Collision Warning with Auto Brake & Pedestrian Protection*

Detection of pedestrians

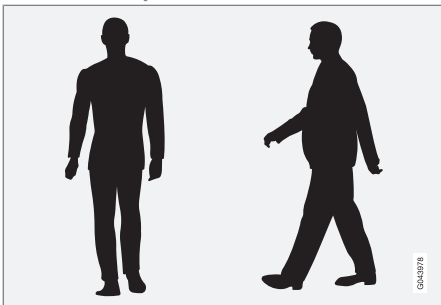

Optimal examples of what the system regards as pedestrians with clear body contours.

Optimal performance of the system requires that the system function that detects pedestrians receives as unambiguous information as possible about the contours of the body - this implies the opportunity to identify the head, arms, shoulders, legs, upper and lower body combined with a normal human pattern of movement.

If large parts of the body are not visible to the camera then the system cannot detect a pedestrian.

- In order for a pedestrian to be detected he/she must appear full-length and have a height of at least 80 cm.
- The system cannot detect a pedestrian carrying larger items.
- The camera sensor's ability to see pedestrians at dusk and dawn is limited - just like the human eye.
- The camera sensor's capacity to detect pedestrians is deactivated when driving in darkness and tunnels - even when street-lights are lit.



WARNING

Collision Warning with Auto Brake & Pedestrian Detection is a means of assistance.

It cannot detect all pedestrians in all situations and it cannot see e.g. partially obscured pedestrians, people in clothing that hides the contours of the body or pedestrians shorter than 80 cm.

- The driver is always responsible that the vehicle is driven properly and with a safety distance adapted to the speed.

Fault tracing and action

If the display shows the message **Windscreen Sensors blocked** then this means that the camera sensor is blocked and cannot detect pedestrians, vehicles or road markings in front of the car.

In turn this means that the Collision Warning with Auto Brake, Lane Departure Warning and Driver Alert Control functions are not operating with full functionality.

The following table presents possible causes for a message being shown along with the appropriate action.

Cause	Action
The windscreen surface in front of the camera is dirty or covered with ice or snow.	Clean the windscreen surface in front of the camera from dirt, ice and snow.
Thick fog, heavy rain or snow means that the camera does not work sufficiently well.	No action. At times the camera does not work during heavy rain or snowfall.





Collision Warning with Auto Brake & Pedestrian Protection*

Cause	Action
The windscreen surface in front of the camera has been	Wait. It may take several minutes for

Cause	Action
cleaned but the message remains.	the camera to measure the visibility.

Cause	Action
Dirt has appeared between the inside of the windscreen and the camera.	Visit a workshop to have the windscreen inside the camera cover cleaned - an authorised Volvo workshop is recommended.





Symbols and messages in the display

Symbol	Message	Specification
	Collis'n warning OFF	Collision warning system switched off. Shown when the engine is started. The message clears after about 5 seconds or after one press of the READ button.
	Collision warn. Unavailable	The collision warning system cannot be activated. Shown when the driver attempts to activate the function. The message clears after about 5 seconds or after one press of the READ button.
	Auto braking was activated	Auto Brake has been active. The message clears after one press of the READ button.



04 Comfort and driving pleasure

Collision Warning with Auto Brake & Pedestrian Protection*

Symbol	Message	Specification
	Wind-screen Sensors blocked	<p>The camera sensor is temporarily disengaged.</p> <p>Shown in the event of snow, ice or dirt on the windscreen for example.</p> <ul style="list-style-type: none"> Clean the windscreen surface in front of the camera sensor. <p>Read about the limitations of the camera sensor, see page 193.</p>
	Radar blocked See manual	<p>Collision Warning with Auto Brake is temporarily disengaged.</p> <p>The radar sensor is blocked and cannot detect other vehicles. For example, in the event of heavy rain or if slush has collected in front of the radar sensor.</p> <p>Read about the limitations of the radar sensor, see page 178.</p>
 	Collision warn. Service required	<p>Collision Warning with Auto Brake is fully or partially disengaged.</p> <ul style="list-style-type: none"> Visit a workshop if the message remains - an authorised Volvo workshop is recommended.

04



Driver Alert System – DAC*

General information on Driver Alert System¹

The Driver Alert System is intended to assist drivers whose driving ability is deteriorating or who are inadvertently leaving the lane they are driving on.

The Driver Alert System consists of two different functions, which can either be switched on at the same time or individually:

- Driver Alert Control (DAC)
- Lane Departure Warning (LDW), see page 200.

A switched-on function is set in standby mode and is not activated automatically until speed exceeds 65 km/h.

The function is deactivated again when speed decreases to below 60 km/h.

Both functions use a camera which is dependent on the lane having side markings painted on each side.

WARNING

The Driver Alert System does not work in all situations but is instead only intended to be of supplementary assistance.

The driver always has ultimate responsibility that the car is driven safely.

General information on Driver Alert Control - DAC

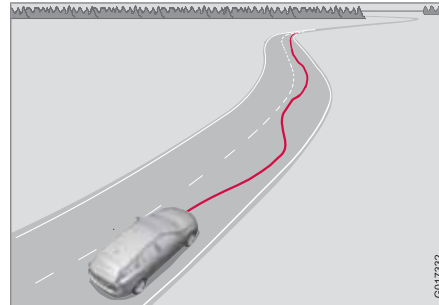

The function is intended to attract the driver's attention when he/she starts to drive less consistently, e.g. if he/she becomes distracted or starts to fall asleep.

A camera detects the side markings painted on the carriageway and compares the section of the road with the driver's steering wheel movements. The driver is alerted if the vehicle does not follow the carriageway evenly.

NOTE

The camera sensor has certain limitations, see page 193.

The objective for DAC is to detect slowly deteriorating driving ability and it is primarily intended for major roads. The function is not intended for city traffic.

In some cases driving ability is not affected despite driver fatigue. In which case there may not be any warning issued for the driver. For this reason it is always important to stop and take a break in the event of any signs of driver fatigue, irrespective of whether or not DAC issues a warning.

NOTE

The function must not be used to extend a driving stint. Always plan breaks at regular intervals and ensure that you are fully rested.

Limitation

In some cases the system may issue a warning despite driving ability not deteriorating, for example:

- if the driver tests the LDW function.
- in strong side winds.
- on rutted road surfaces.

¹ Not available as an option for the 2.5T.



Driver Alert System – DAC*

Operation

Some settings are made from the centre console display screen and its menu system. For information on how the menu system is used, see page 144.

The current status of Driver Alert can be checked on the trip computer display with the thumbwheel on the left-hand stalk switch.



- 1 Thumbwheel. Turn until the display shows **Driver Alert**. On the second row the options **Driver Alert Standby <65 km/h**, **Driver Alert Unavailable** or level mark  can be shown.
- 2 **READ** confirms or clears a warning in the memory.

On/Off

To set Driver Alert in standby mode:

- Search on the centre console's display screen with its **MY CAR** menu system and locate **Car settings** → **Driving support systems** → **Driver Alert** and tick the box.
- No tick in the box: Function disengaged.

Function



Driver Alert is activated when speed exceeds 65 km/h and remains active as long as the speed is over 60 km/h.

The display shows a level mark with 1-5 bars, where a low number of bars indicates inconsistent driving style. Many bars indicates stable driving.

If the vehicle is driven inconsistently then the driver is alerted by an acoustic signal as well as the text message **Driver Alert Time for a break**. The warning is repeated after a time if driving ability does not improve.



WARNING

An alarm should be taken very seriously, as a sleepy driver is often not aware of his/her own condition.





In the event of an alarm or a feeling of tiredness; stop the car in a safe manner as soon as possible and rest.

Studies have shown that it is equally as dangerous to drive while tired as it is under the influence of alcohol.



Driver Alert System – DAC*

Symbols and messages in the display

Symbol	Message	Specification
	Driver Alert OFF	The function is disengaged.
	Driver Alert Standby <65 km/h	The function is set in standby mode due to speed being lower than 65 km/h.
	Driver Alert Unavailable	The carriageway does not have clear side markings or the camera sensor is temporarily disengaged. Read about the limitations of the camera sensor, see page 193.
	Driver Alert	The function analyses the driver's driving style. The number of bars can vary in the range 1-5, where a low number of bars indicates inconsistent driving ability. A high number of bars indicates stable driving.
	Driver Alert Time for a break	The vehicle has been driven inconsistently - the driver is alerted by an acoustic warning signal + text.
	Windscreen Sensors blocked	The camera sensor is temporarily disengaged. Shown in the event of snow, ice or dirt on the windscreen for example. <ul style="list-style-type: none"> Clean the windscreen surface in front of the camera sensor. Read about the limitations of the camera sensor, see page 193.
 	Driver Alert Sys Service required	The system is disengaged. <ul style="list-style-type: none"> Visit a workshop if the message remains - an authorised Volvo workshop is recommended.



Driver Alert System - LDW*

General information on Lane Departure Warning - LDW¹

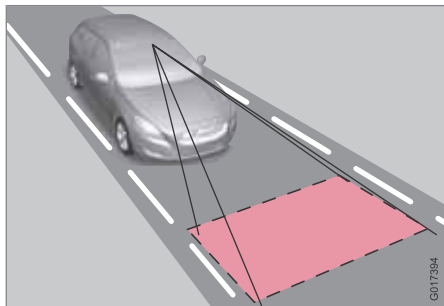

The function is intended to reduce the risk for single-vehicle accidents – accidents where, in certain situations, the vehicle leaves the carriageway and is in danger of driving either into a ditch or into oncoming traffic.

LDW consists of a camera that detects the side markings painted on the carriageway. The driver is alerted by an acoustic signal if the vehicle crosses a side marking.

Operation and function



The function is switched on or off by means of a switch on the centre console. An indicator lamp in the button illuminates when the function is switched on.

The trip computer display shows **Lane Depart Warn Standby <65 km/h** when the function is in standby mode due to speed being below 65 km/h.

The LDW function is activated automatically from standby mode after the camera has scanned in the carriageway's side markings and speed exceeds 65 km/h. The trip computer display then shows **Lane Depart Warn Available**.

If the camera can no longer detect the carriageway's side markings the display shows **Lane Depart Warn Unavailable**.

If speed decreases to below 60 km/h then the function resumes standby mode and the display shows **Lane Depart Warn Standby <65 km/h**.

If the vehicle crosses the left or right-hand side marking of the carriageway without due cause then the driver is alerted by an acoustic signal.

No warning is given in the following situations:

- Direction indicators activated
- The driver has his/her foot on the brake pedal²
- In the event of the accelerator pedal being depressed rapidly²
- In the event of rapid steering wheel movements²
- In the event of a sudden turn so that the car rolls.

The camera sensor also has certain limitations. For more information, see page 193.

¹ Not available as an option for the 2.5T.

² A warning is still given when Increased sensitivity is selected, see page 202.



Driver Alert System - LDW*

NOTE

The driver is only warned once each time the wheels cross a line. So there is no acoustic alarm when there is a line between the car's wheels.

Symbols and messages in the display

Symbol	Message	Specification
	Lane departure warning ON/Lane departure warning OFF	The function is switched on/off. Shown at switch-on/off. The text disappears after 5 seconds.
	Lane Depart Warn Standby <65 km/h	The function is set in standby mode due to speed being lower than 65 km/h.
	Lane Depart Warn Unavailable	The carriageway does not have clear side markings or the camera sensor is temporarily disengaged. Read about the limitations of the camera sensor, see page 193.
	Lane Depart Warn Available	The function scans the carriageway's side markings.



04 Comfort and driving pleasure

Driver Alert System - LDW*

Symbol	Message	Specification
	Windscreen Sensors blocked	<p>The camera sensor is temporarily disengaged.</p> <p>Shown in the event of snow, ice or dirt on the windscreen for example.</p> <ul style="list-style-type: none"> Clean the windscreen surface in front of the camera sensor. <p>Read about the limitations of the camera sensor, see page 193.</p>
 	Driver Alert Sys Service required	<p>The system is disengaged.</p> <ul style="list-style-type: none"> Visit a workshop if the message remains - an authorised Volvo workshop is recommended.

04

Personal preferences

Settings are made from the centre console's display screen via the menu system in **MY CAR**. From there, search and locate **Settings** → **Car settings** → **Driving support systems** → **Lane Departure Warning**. For information on how the menu system is used - see page 144.

Select from the options:

- On at start up** - This option sets the function in standby mode each time the engine is started. Otherwise the same value as

when the engine was switched off is obtained.

- Increased sensitivity** – This option increases sensitivity, an alarm is triggered earlier and fewer limitations apply.



Park assist syst*

General

Parking assistance is used as an aid to parking. An acoustic signal as well as symbols on the centre console's display screen indicate the distance to the detected obstacle.

Parking assistance sound level can be adjusted during the ongoing acoustic signal using the centre console's **VOL** knob or in the car's menu system **MY CAR** - see page 144.

Parking assistance is available in two variants:

- Rear only
- Both front and rear.

 **WARNING**

- Parking assistance does not relinquish the driver's own responsibility during parking.
- The sensors have blind spots where obstacles cannot be detected.
- Be aware of e.g. people or animals near the car.

Function



The system is automatically activated when the engine is started - the switch's On/Off lamp is illuminated. If parking assistance is switched off with the button, the lamp goes out.

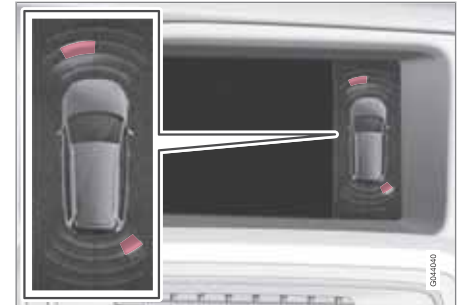

Display screen view - showing an obstacle left front and right rear.

The centre console's display screen shows an overview of the relationship between the car and detected obstacle.

Marked sectors show which of the four sensor(s) detected an obstacle. The closer to the car symbol a selected sector box is, the shorter the distance between the car and a detected obstacle.

The frequency of the signal increases the shorter the distance to an obstacle, in front of or behind the car. Other sound from the audio system is muted automatically.

When the distance is within 30 cm the tone is constant and the active sensor's field nearest the car is filled in. If the detected obstacle is within the distance for the constant tone both



04 Comfort and driving pleasure

Park assist syst*

behind and in front of the car, then the tone sounds alternately from the loudspeakers.

! IMPORTANT

Certain objects e.g. chains, thin glossy poles or low barriers may be in the "signal shadow" and are then temporarily not detected by the sensors - the pulsating tone may then unexpectedly stop instead of changing over to the expected constant tone.

- In which case, pay extra attention and manoeuvre/reposition the car particularly slowly or stop the current parking manoeuvre - there may be a high risk of damage to vehicles or other objects since the sensors are unable to function optimally.

Rear parking assistance

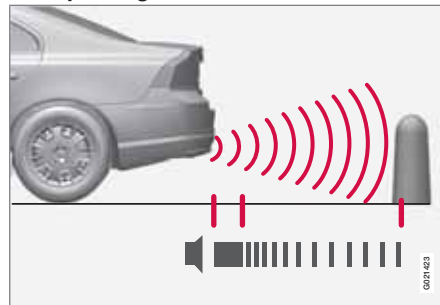

The distance covered to the rear of the car is about 1.5 metres. The acoustic signal for obstacles behind comes from one of the rear loudspeakers.

Rear parking assistance is activated when reverse gear is engaged.

The system must be deactivated when reversing with a trailer or bike carrier on the towbar or similar - otherwise they would trigger the sensors.

i NOTE

Rear parking assistance is deactivated automatically when towing a trailer if Volvo genuine trailer wiring is used.

Front parking assistance

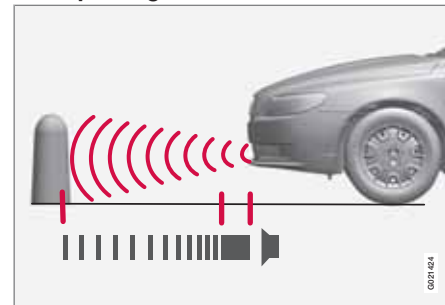

The distance covered in front of the car is about 0.8 metres. The acoustic signal for obstacles in front comes from one of the front loudspeakers.

Front parking assistance is active up to 15 km/h. The lamp in the button is illuminated in order to indicate that the system is activated. When the speed is below 10 km/h the system is reactivated.

i NOTE

Front parking assistance is deactivated when the parking brake is applied or **P** mode is selected in a car with an automatic gear-box.



Park assist syst*

! IMPORTANT

When fitting auxiliary lamps: Remember that they must not obscure the sensors – the auxiliary lamps could then be detected as obstacles.

Fault indicator

 If the information symbol illuminates with constant glow and the information display shows **Park assist syst Service required** then parking assistance is disengaged.

! IMPORTANT

In certain conditions the parking assistance system may produce incorrect warning signals that are caused by external audio sources that emit the same ultrasonic frequencies that the system works with.

Examples of such sources include horns, wet tyres on asphalt, pneumatic brakes and exhaust noises from motorcycles etc.

Cleaning the sensors

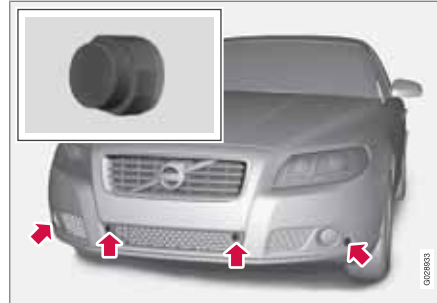

Sensor location, front.



Sensor location, rear.

The sensors must be cleaned regularly to ensure that they work properly. Clean them with water and car shampoo.

i NOTE

Dirt, ice and snow covering the sensors may cause incorrect warning signals.



Park assist camera*

General

The parking camera is an assist system and is activated when reverse gear is engaged (can be changed in the settings menu, see page 144).

The camera image is shown on the centre console's screen.

WARNING

- The parking camera serves as an aid. It does not relieve the driver of responsibility when reversing.
- The camera has blind spots, where obstacles cannot be detected.
- Be aware of people and animals in the vicinity of the car.



CAM button location.

The camera shows what is behind the car and if something appears from the sides.

The camera shows a wide area behind the car and part of the bumper and any towbar.

Objects on the screen may appear to tilt slightly - this is normal.

NOTE

Objects on the display screen may be closer to the car than they appear to be on the screen.

If another view is active the parking camera system takes over automatically and the camera image is displayed on the screen.

When reverse gear is engaged two unbroken lines are shown graphically which illustrate where the car's rear wheels will roll with the current steering wheel angle, this facilitates tight parking, reversing into tight spaces and for hitching a trailer. The car's approximate exterior dimensions are also illustrated by two dashed lines, the park assist lines can be deactivated in the settings menu.

If the car is also equipped with parking assistance sensors* then their information is displayed graphically as coloured fields in order to illustrate the distance to detected obstacles, see page 203.

The camera is active approx. 5 seconds after reverse gear has been disengaged or until the car's speed exceeds 10 km/h.



Camera location next to the opening handle.



Park assist camera*

Light conditions

The camera image is adjusted automatically according to prevailing light conditions. Because of this, the image may vary slightly in brightness and quality. Poor light conditions can result in a slightly reduced image quality.

NOTE

Keep camera lenses clear of dirt, snow and ice to ensure the best possible function. This is particularly important in poor light.

Park assist lines

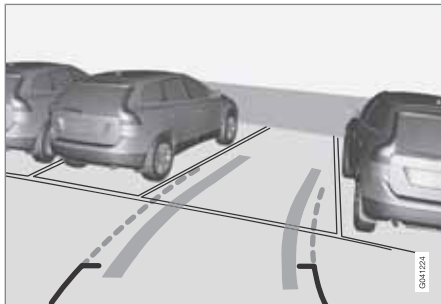

Examples of how the park assist lines can be displayed for the driver.

The lines on the screen are projected as if they were at ground level behind the car and are directly related to steering wheel movement,

which shows the driver the path the car will take, even when turning.

NOTE

- When reversing with a trailer which is not connected electrically to the car, the lines on the display show the route the car will take - not the trailer.
- The screen shows no lines when a trailer is connected electrically to the car's electrical system.
- The parking camera is deactivated automatically when towing a trailer if a Volvo genuine trailer cable is used.

IMPORTANT

Bear in mind that the screen only shows the area behind the car - pay attention to the sides and front of the car when manoeuvring during reversing.

Boundary lines

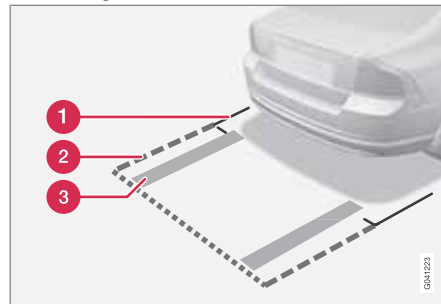

The system's lines.

- 1 Boundary line, 30 cm zone backwards from the car
- 2 Boundary line, free reversing zone
- 3 "Wheel tracks"

The unbroken line (1) frames in a zone that is within about 30 cm from the bumper.

The dashed line (2) frames in a zone up to about 1.5 m back from the bumper. It is also the limit of the car's most protruding parts, such as door mirrors and corners - also during turning.

The wide "wheel tracks" (3) between the side lines indicate where the wheels will roll and can extend about 3.2 m back from the bumper if no obstacle is in the way.



Park assist camera*

Cars with reversing sensors*

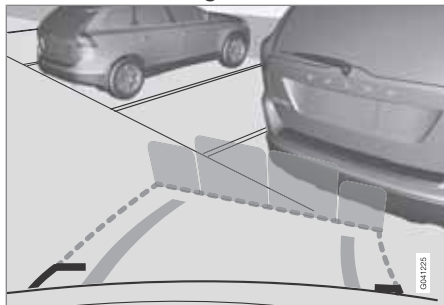

Coloured areas (x 4, one per sensor) show distance.

If the car is also equipped with parking assistance sensors (see page 203) the distance indication will be more precise and the coloured areas show which of the 4 sensors is/are registering an obstacle.

The colour of the areas changes with decreasing distance to the obstacle - from yellow to orange to red.

Colour / paint	Distance (metres)
Yellow	1.5–
Orange	0.3–1.5
Red	0–0.3

Settings

Press **OK/MENU** when a camera view is shown. Make the settings as desired.

Miscellaneous

- The default setting is that the camera is activated when reverse gear is engaged.
- One press on **CAM** activates the camera even if reverse gear is not engaged.
- Change between normal and zoomed image by turning **TUNE** or by pressing **CAM**.
- If the car has more cameras* installed then the camera in use is changed by turning **TUNE**.

Limitations



NOTE

A bike carrier or other accessory mounted on the rear of the car could obscure the camera's view.

Pay attention to the possibility that, even if it only looks like a relatively small part of the image is obscured, it could be a relatively large sector that is hidden from view. Obstacles could thereby go undetected until they are very close to the car.

To bear in mind

- Keep the camera lens free from dirt, ice and snow.
- Clean the camera lens regularly with luke-warm water and car shampoo - take care not to scratch the lens.



BLIS* – Blind Spot Information System

General information on BLIS

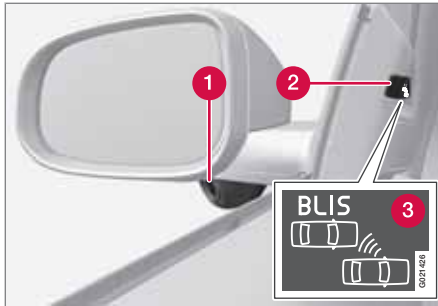

- 1 BLIS camera¹
- 2 Indicator lamp
- 3 BLIS symbol

BLIS is an information system based on camera technology that under certain conditions can help the driver to notice vehicles moving in the same direction as the host vehicle in the so-called "blind spot".

! WARNING

The system is a supplement to, not a replacement for, a safe driving style and use of the rearview mirrors. It can never replace the driver's attention and responsibility. The responsibility for changing lanes safely always rests with the driver.

The system is designed to work most effectively when driving in dense traffic on multi-lane highways.

When a camera (1) has detected a vehicle inside the blind spot zone the indicator lamp (2) illuminates with a constant glow.

i NOTE

The lamp illuminates on the side of the car where the system has detected the vehicle. If the car is overtaken on both sides at the same time then both lamps illuminate.

BLIS advises the driver with a message if a fault arises in the system. If for example the system's cameras are obscured then the BLIS indicator lamp flashes and a message is shown on the information display. In such cases, check and clean the lenses.

If necessary, the system can be switched off temporarily, see the section "Activate/deactivate".

Blind spots

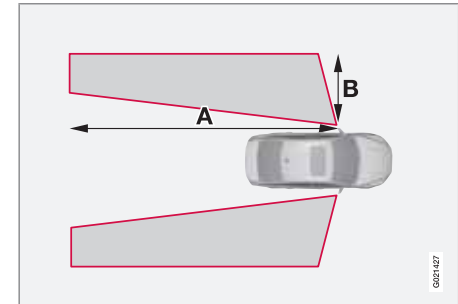

A = approx. 9.5 m and B = approx. 3.0 m.

¹ NOTE: The illustration is schematic - details may vary depending on car model.



BLIS* – Blind Spot Information System

Activate/deactivate



Button for activating/deactivating.

BLIS is activated when the engine is started. The indicator lamps in the door panels flash three times when BLIS is activated.

The system can be deactivated/activated after starting the engine with one press on the **BLIS** button.

Some combinations of the selected equipment leave no vacant space for a button in the centre console - in which case the function is handled by the car's menu system **MY CAR** under **Settings** → **Car settings** → **BLIS**. (For a description of the menu system - see page 144).

When BLIS is deactivated, the lamp in the button goes out and a message is shown in the instrument panel display.

When BLIS is activated the light in the button illuminates, a new text message is shown on the display and the indicator lamps in the door panels flash 3 times. Press the **READ** button to delete the text message. (For a description of messages - see page 142).

When BLIS operates

The system operates when the car is driven at a speed above 10 km/h.

Overtaking

The system is designed to react if:

- you overtake another vehicle at a speed of up to 10 km/h faster than the other vehicle
- you are overtaken by a vehicle travelling up to 70 km/h faster than you are travelling.

Daylight and darkness

In daylight the system reacts to the shape of the surrounding vehicles. The system is designed to detect motor vehicles such as cars, trucks, buses and motorcycles.

In darkness the system reacts to the headlamps of surrounding vehicles. If the headlamps of surrounding vehicles are not switched on then the system does not detect the vehicles. This means for example that the system does not react to a trailer without headlamps which is towed behind a car or truck.



WARNING

The system does not react to cyclists or moped riders.

The BLIS cameras have limitations similar to those of the human eye, i.e. they do not "see" as well e.g. in heavy snowfall, against strong light or in thick fog.



WARNING

BLIS does not work in sharp bends.

BLIS does not work when the car is reversing.

A wide trailer coupled to the car can conceal other vehicles in adjacent lanes. It can prevent the vehicle in the screened area from being detected by BLIS.



BLIS* – Blind Spot Information System

Cleaning

In order to work most effectively the BLIS camera lenses must be clean. The lenses can be cleaned with a soft cloth or damp sponge. Clean the lenses carefully so that they are not scratched.

! IMPORTANT

The lenses are electrically heated to melt ice or snow. If necessary, brush snow away from the lenses.

Messages on the display

Message	Specification
Blind-spot info system ON	The BLIS system is activated.
Blind spot syst. Service required	Blind spot syst. disengaged - contact a workshop.
Blind spot syst. Camera blocked	The BLIS camera is blocked by dirt, snow or ice - clean the lenses.

Message	Specification
Blind spot syst. Reduced function	Reduced function in the data transmission between the BLIS system's camera and the car's electrical system. The camera resets itself when the data transmission between the BLIS system's camera and the car's electrical system returns to normal.
Blind-spot info system OFF	The BLIS system is deactivated.

! IMPORTANT

Repair of the BLIS system components must only be performed by a workshop - an authorised Volvo workshop is recommended.

Limitations

In some situations the BLIS indicator lamp may illuminate despite there being no other vehicle within the blind spot.

i NOTE

If the BLIS indicator lamp illuminates on isolated occasions despite there being no other vehicle within the blind spot then this does not mean that a fault has arisen in the system.

In the event of a fault in the BLIS system the display shows the text **Blind spot syst. Service required.**

The following illustrations show examples of situations where the BLIS indicator lamp may illuminate even if there is no other vehicle within the blind spot.

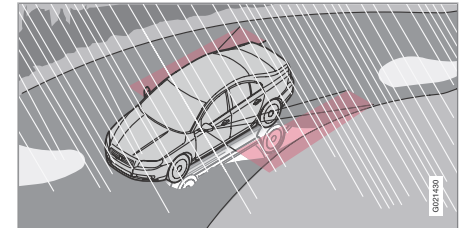

Reflection from shiny wet road surface.



04 Comfort and driving pleasure

BLIS* – Blind Spot Information System

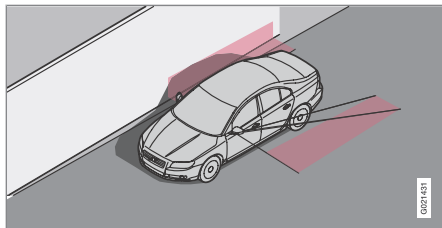

Own shadow on large light smooth surface, e.g. noise barrier or concrete road surface.

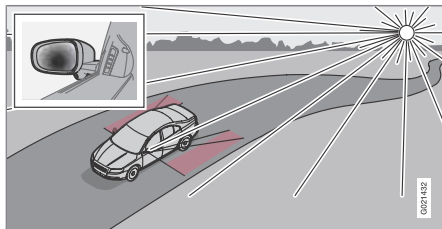

Low stationary sunlight shining into the camera.

04



Comfort inside the passenger compartment

Storage spaces

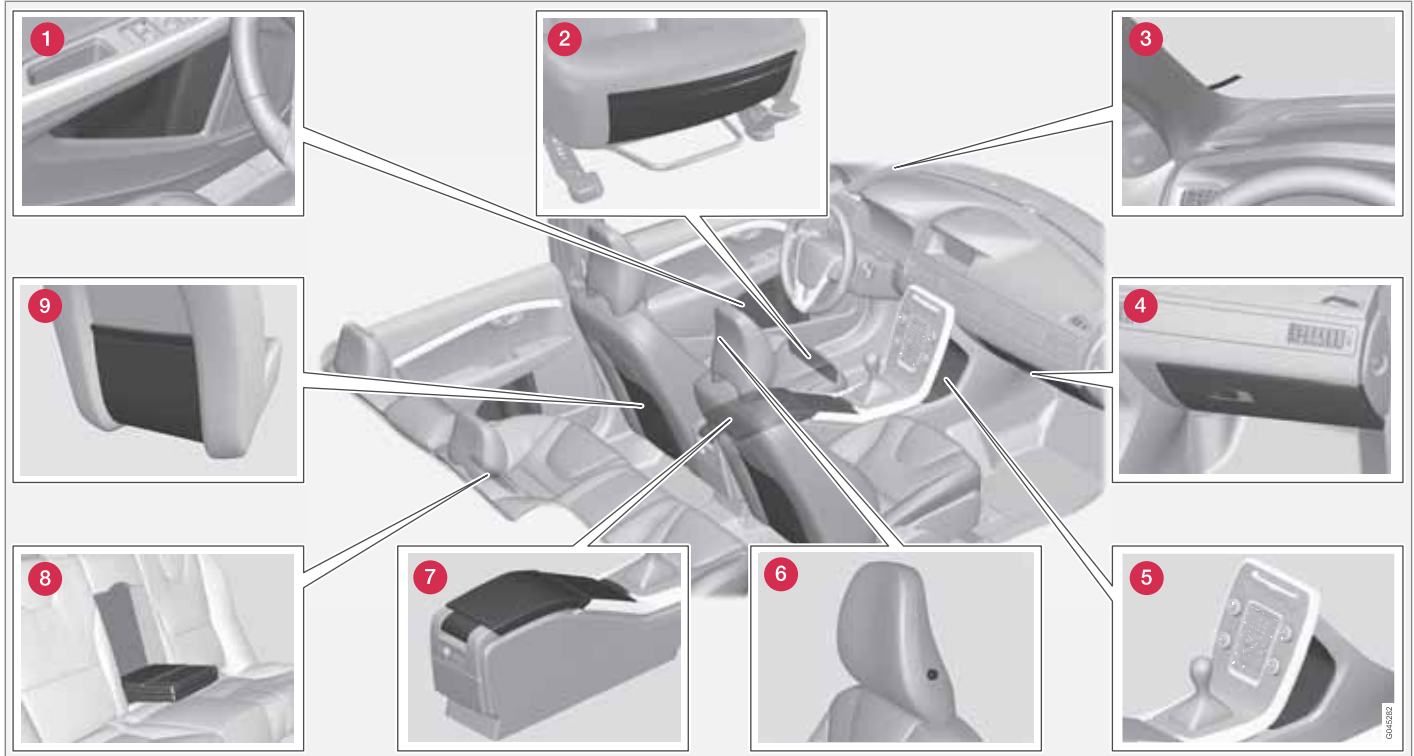



Comfort inside the passenger compartment

- 1 Storage compartment in door panel
- 2 Storage pocket* on front edge of front seat cushions
- 3 Ticket clip
- 4 Glovebox
- 5 Storage compartment
- 6 Jacket holder
- 7 Storage compartment, cup holder
- 8 Cup holder* in armrest, rear seat
- 9 Storage pocket

Jacket holder

The jacket holder is only designed for light clothing.

WARNING

Keep loose objects such as mobile phones, cameras, remote controls for accessories, etc. in the glove compartment or other compartments. Otherwise they may injure people in the car in the event of sudden braking or a collision.

Tunnel console

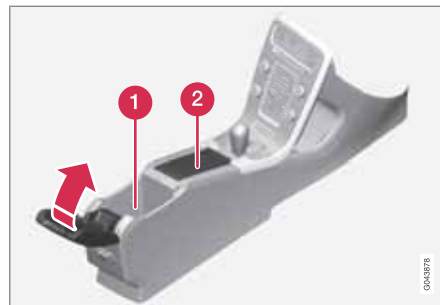

- 1 Storage compartment (e.g. for CDs) and USB*/AUX input under the armrest.
- 2 Includes cup holder for driver and passenger. (If ashtray and cigarette lighter are specified then there is a cigarette lighter in the 12 V socket for the front seat, see page 215, and a detachable ashtray in the cup holder.)

Cigarette lighter and ashtray*

The ashtray in the tunnel console is detached by lifting the tray straight up.

Activate the lighter by pushing in the button. The button pops out when the lighter is hot. Pull out the lighter and light a cigarette on the heated coils.

Glovebox



The owner's manual and maps can be kept here for example. There are also holders for pens on the inside of the lid. The glovebox can be locked with the key blade, see page 47.

Inlay mats*

Volvo supplies specially manufactured inlay mats.

WARNING

Before setting off check that the inlaid mat in the driver area is firmly affixed and secured in the pins in order to avoid getting caught adjacent to and under the pedals.



Comfort inside the passenger compartment

Vanity mirror



Vanity mirror with lighting.

The light illuminates automatically when the cover is lifted.

12 V socket



12 V socket in tunnel console, front seat.



12 V socket in tunnel console, rear seat.

The electrical socket can be used for various accessories designed for 12 V, e.g. TV screens, music players and mobile phones. For the

socket to supply current, the remote control key must be in at least key position I, see page 77.

! IMPORTANT

Max. socket is 10 A (120 W) if one socket is used at a time. If both sockets are used simultaneously, 7.5 A (90 W) per socket is applicable.

! WARNING

Always leave the plug in the socket when the socket is not in use.

i NOTE

Optional equipment and accessories - e.g. TV screens, music players and mobile phones - which are connected to one of the passenger compartment's 12V electrical sockets, could be activated by the climate control system, even when the remote control key has been removed or when the car is locked, for example, when the parking heater is activated at a preset time.

For this reason remove the plugs from the electrical sockets for optional equipment or accessories when not in use because the battery could be drained in the event of such an occurrence!



04 Comfort and driving pleasure

Comfort inside the passenger compartment

Electrical socket in cargo area*

For more information, see page 289.



Comfort inside the passenger compartment - Executive

Cooler box



There is a cooler box behind the armrest in the rear seat. The cooler box works when the engine is running or the remote control key is in position II.

⚠ WARNING

Store bottles well sealed in the cooler box and make sure that the door is closed for the journey.

i NOTE

The cooler box needs to have free circulation of air for optimum function. For this reason you should leave at least 5 cm of space at the air intake for the cooler box in the cargo area.

Mat in cargo area



i NOTE

The rear seat must be folded forward slightly in cars with refrigerator before the cargo area mat can be removed. Fold the backrest forward by pulling the handle, see page 81.

Glass



There is a storage compartment for two glasses and a bottle opener under the cover in the armrest.

⚠ WARNING

Store glasses in the storage compartment or in cup holders and make sure that the armrest cover is closed for the journey.

General information on infotainment.....	220
Quick start.....	222
General infotainment functions.....	227
Radio.....	230
Media player.....	237
External audio source via AUX/USB* input.....	241
Media Bluetooth®*	244
TV*	247
Remote control*	250
Bluetooth® handsfree*.....	252
Voice recognition* mobile phone.....	260
RSE - Rear Seat Entertainment system*	264
Menu navigation, Infotainment.....	273



05

INFOTAINMENT SYSTEM





General information on infotainment

General

The infotainment system in your car has one of the following four levels:

Performance

- 5" TV screen TFT
- Steering wheel keypad* without thumb-wheel
- AM/FM radio
- CD
- AUX input
- 6 speakers
- 4x20W amplifier

High Performance

- 5" TV screen TFT
- Steering wheel keypad* with thumbwheel
- AM/FM radio
- CD
- AUX and USB input (for e.g. iPod®)
- Bluetooth® handsfree/streaming audio
- 8 speakers
- 4x40W amplifier

High Performance Multimedia

- 7" TV screen TFT
- Steering wheel keypad* with thumbwheel

- AM/FM radio
- CD/DVD
- AUX and USB input (for e.g. iPod®)
- Bluetooth® handsfree/streaming audio
- 8 speakers
- 4x40W amplifier

Premium Sound Multimedia

- 7" TV screen TFT
- Steering wheel keypad* with thumbwheel
- AM/FM radio
- CD/DVD
- AUX and USB input (for e.g. iPod®)
- Bluetooth® handsfree/streaming audio
- 12 speakers
- 5x130W amplifier

Dolby, Pro Logic

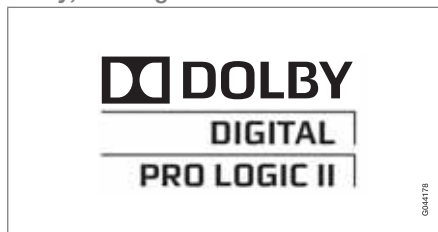

Made under license from Dolby Laboratories. Dolby, Pro Logic and the double-D symbol are trademarks of Dolby Laboratories.

Audyssey MultEQ¹

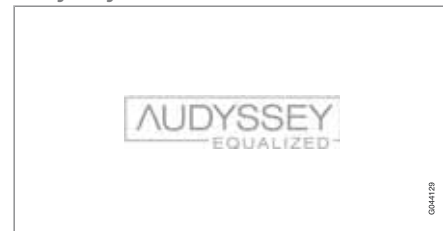

The Audyssey MultEQ system has been used in the development and tuning of the sound to ensure a world-class sound experience.

Other

If the Infotainment System is active when the engine is switched off then it is automatically activated the next time the key is inserted into position I or higher, and it continues with the same source (e.g. radio) as before the engine was switched off (the driver's door must be closed on cars with Keyless systems*).

The infotainment system can be used for 15 minutes at a time without the remote control

¹ Only applies to Premium Sound Multimedia.

* Option/accessory, for more information, see Introduction.

**General information on infotainment**

key being in the ignition switch by pressing the On/Off button.

While the engine is being started the infotainment system is switched off temporarily and continues once the engine has started.

**NOTE**

Avoid using the Infotainment system when the engine is switched off as this loads the battery.



05 Infotainment system

Quick start

Overview, Infotainment

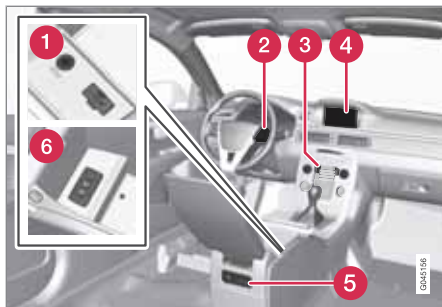

- 1 A/V-AUX input for external audio sources (e.g. iPod®)
- 2 Steering wheel keypad*
- 3 Centre console control panel
- 4 TV screen. The TV screen is available in two sizes, 5" (applies to Performance and High Performance) and 7" (applies to High Performance Multimedia and Premium Sound Multimedia). The manual shows the 7" TV screen.
- 5 Rear control panel with headphones socket*
- 6 A/V-AUX input*

Operating the system

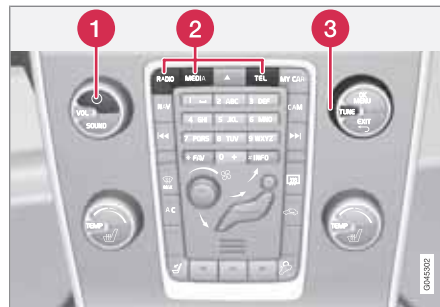

- 1 **Short press** starts the system and **long press** switches off. Briefly press to mute the sound (MUTE) or restore the sound if it had been switched off.
- 2 Select a source by pressing one of the buttons (e.g. **RADIO**, **MEDIA** etc.). Press repeatedly in order to scroll down among the options on the TV screen (e.g. **FM1**), release and wait a second and the selection is accepted automatically. Alternatively, it is possible to turn **TUNE** and confirm with **OK/MENU**.
- 3 **TUNE** - turn to fast-scroll among disc tracks/folders, radio and TV* stations, phone contacts* or navigate through options on the TV screen (e.g. **FM1**, **Disc**).

Source buttons

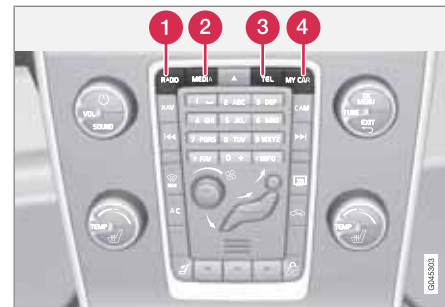

Control panel with buttons for source selection.

- 1 **RADIO** - Select, for example, **AM**, **FM1**, **FM2**, **DAB1***, **DAB2***
- 2 **MEDIA** - Select, for example, **Disc**, **USB***, **iPod**, **AUX**, **Bluetooth***, **TV***.
- 3 **TEL** - Bluetooth® handsfree*
- 4 **MY CAR** - See page 144.

¹ USB only applies to High Performance, High Performance Multimedia and Premium Sound Multimedia.

* Option/accessory, for more information, see Introduction.



Quick start

Basic functions, Infotainment

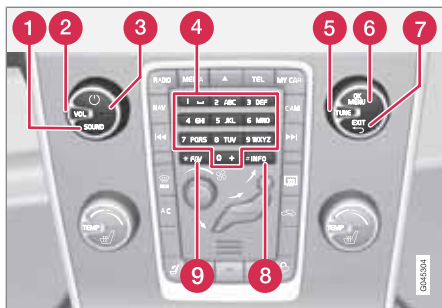

Centre console with controls for basic functions.

- 1 **SOUND** - leads to the audio settings menu (bass, treble, etc.). For more information, see page 227.
- 2 **VOL** - turn to raise or lower the volume.
- 3 **⏻** - **short press** starts the system and **long press** switches off. Briefly press to mute the sound (MUTE) or restore the sound if it had been switched off.
- 4 Preset buttons, input of numbers and letters.
- 5 **TUNE** - turn to fast-scroll among disc tracks/folders, radio and TV* stations, phone contacts* or navigate through options on the TV screen.

- 6 **OK/MENU** - accepts selections in menus. Lead to submenus in selected source (e.g. RADIO or MEDIA).
- 7 **EXIT** - leads up in the menu system, interrupts the current function, rejects calls and deletes input characters. One long press leads to the highest menu level (parent view), see page 224.
- 8 **INFO** - press the button to see more information about a function, song, etc. For more information, see page 227
- 9 **FAV** - shortcut to a favourite setting. The button can be programmed for a commonly used function in AM, FM, etc. For more information, see page 227.

Views in the TV screen

General information about views in the TV screen

The system contains four different types of views. A top-level menu, so-called Parent view, common to all sources, see page 224. For each source there are three different basic types of views:

- Normal view - normal mode for the source
- Quick view - fast mode when **TUNE** is turned, e.g. for changing disc tracks, radio station, etc.
- Menu view - for menu navigation

The views have different appearances depending on the source, in-car equipment, settings, etc.



Example of normal view (Radio).

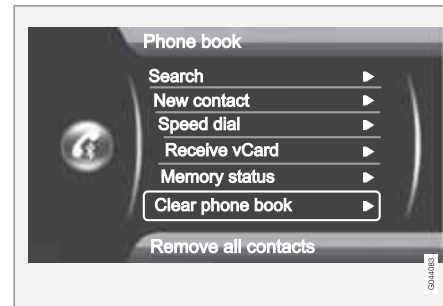

Example of menu view (Bluetooth® handsfree).



Quick start

Parent view

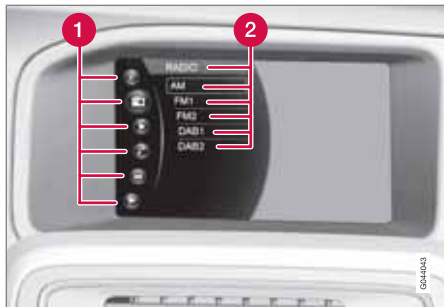

Example of parent view (Radio).

- 1 Sources (e.g. RADIO, MEDIA, etc.), see table.
- 2 Source menu, e.g. (FM1, DISC, etc.).

A long press on **EXIT** on the steering wheel keypad* leads to the highest menu level, called parent view (see illustration above). The function is a quick way to choose or change the source (e.g. **RADIO**, **MEDIA** etc.) directly from the steering wheel keypad* without taking your hands off the steering wheel. The function is also available from the control panel buttons in the centre console.

- Select source (1) by turning the thumbwheel on the steering wheel keypad*, press the thumbwheel to confirm the selection.
- Turn the thumbwheel to one of the options (2) on the TV screen (e.g. **FM1**), press the thumbwheel to confirm the selection.

This then leads to the desired source (e.g. **RADIO/FM1**).

A long press on **EXIT** leads back.

	NAV - Volvo's navigation system (RTI)*
	RADIO - Radio
	MEDIA - Media
	TEL - Bluetooth® handsfree*
	MY CAR - Car settings
	CAM - Park Assist Camera*

Steering wheel keypad*

The keypad is available in three different versions depending on the options and the equipment level of the car.

Keypad without thumbwheel



- 1 **Short presses** scroll between disc tracks or scan for the next available radio station². **Long presses** are used to fast forward and rewind disc tracks.
- 2 Volume

² Does not apply to DAB.

* Option/accessory, for more information, see Introduction.



Quick start

Keypad with thumbwheel

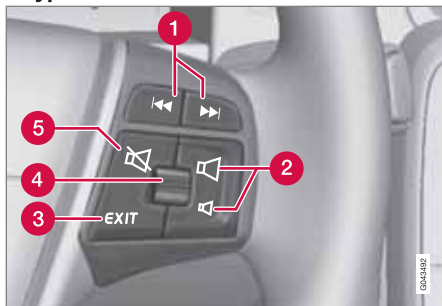

- 1 **Short presses** scroll between disc tracks or preset radio stations². **Long presses** are used to fast forward and rewind disc tracks.
- 2 Volume
- 3 **EXIT** – leads up in the menu system. Interrupt current function, end/refuse phone calls, clear entered characters. One long press leads to the highest menu level (parent view), see page 224.
- 4 Thumbwheel - turn up/down to scroll up and down in the menu system. One press on the thumbwheel leads to the menu (equivalent to MENU), or confirms a selection (OK) in the menu system, and accepts phone calls.

- 5 **MUTE** - switches off the sound

Keypad with thumbwheel, for voice recognition³

- 1 **Short presses** scroll between disc tracks or preset radio stations². **Long presses** are used to fast forward and rewind disc tracks.
- 2 Volume
- 3 **EXIT** – leads up in the menu system. Interrupt current function, end/refuse phone calls, clear entered characters. One long press leads to the highest menu level (parent view), see page 224.
- 4 Thumbwheel - turn up/down to scroll up and down in the menu system. One press on the thumbwheel leads to the menu (equivalent to MENU), or confirms a selection (OK) in the menu system, and accepts phone calls.
- 5 **MUTE** - switches off the sound

press leads to the highest menu level (parent view), see page 224.

- 4 Thumbwheel - turn up/down to scroll up and down in the menu system. One press on the thumbwheel leads to the menu (equivalent to MENU), or confirms a selection (OK) in the menu system, and accepts phone calls.
- 5 Voice recognition (for Bluetooth®-connected mobile phone and navigation system*)

Rear control panel with headphones socket*

Headphones with an impedance of 16-32 ohm and sensitivity of 102 dB or higher are recommended for best sound reproduction.

² Does not apply to DAB.

³ Only cars with navigation.



Quick start

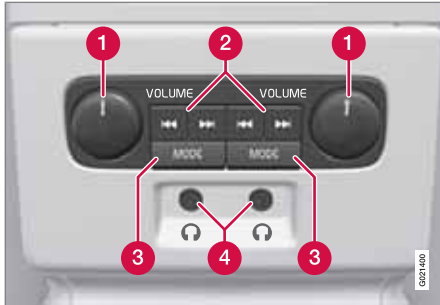

- 1 VOLUME** – Volume, left and right.
- 2** Scroll/search forward and backward.
- 3 MODE** - Select between **AM**, **FM1**, **FM2**, **DAB1***, **DAB2***, **Disc**, **USB***, **iPod***, **Bluetooth***, **AUX**, **TV*** and On/Off. For connection via **USB*** or **AUX**, see page 241 or via **Bluetooth®***, see page 245.
- 4** Headphones sockets (3.5 mm).

Activate/deactivate

The control panel is activated with **MODE**. Deactivation is possible via a long press on **MODE** or when the engine is switched off.

Scroll/search forward and backward

Pressing (2) scrolls between disc tracks/audio files or seeks the next available radio station.

Limitations

i NOTE

The audio source (e.g. **FM1**, **AM**, **Disc** etc.) being played back through the speakers cannot be controlled from the rear control panel.

i NOTE

In order that an audio source can be selected with **MODE** and listened to it is required that the audio source is available and connected in the car.



General infotainment functions

FAV - store a preset



The **FAV** button can be used to store functions that are used frequently so that the function can be started simply by pressing **FAV**. You can select a favourite (e.g. **Equalizer**) for each function as follows:

In **RADIO** mode:

- AM
- FM1/FM2
- DAB1*/DAB2*

In **MEDIA** mode:

- DISC
- USB*
- iPod*

- Bluetooth*
- AUX
- TV*

It is also possible to select and store a favourite for **TEL***, **MY CAR**, **CAM*** and **NAV***. Favourites can also be selected and stored under **MY CAR**. For more information on the menu system **MY CAR**, see page 144.

To store a function in the **FAV** button:

1. Select an infotainment source (e.g. **RADIO**, **MEDIA** etc.).
2. Select a wavelength or source (**AM**, **Disc**, etc.).
3. Press and hold the **FAV** button until the "favourites menu" is shown.
4. Turn **TUNE** to select an option from the list and press **OK/MENU** to save.
 - > When the source (e.g. **RADIO**, **MEDIA** etc.) is active the stored function is available by means of a short press on **FAV**.

INFO - shows additional information

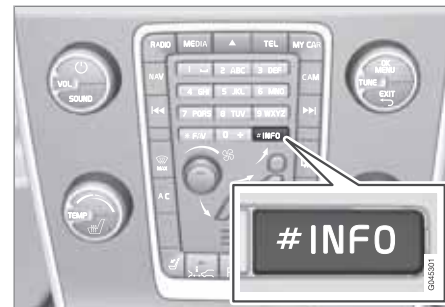

In some cases there is more information available (on a radio station, song, artist, etc.) than can be shown in the TV screen. To see more information, press the **INFO** button.

General audio settings

Press **SOUND** to access the audio settings menu (**Bass**, **Treble**, etc.). Scroll forward with **SOUND** or **OK/MENU** to your selection (e.g. **Treble**).

Adjust the setting by turning **TUNE** and save the setting with **OK/MENU**.

Continue pressing **SOUND** or **OK/MENU** to access other options:



General infotainment functions

- **Surround**¹ - Can be set to the On/Off position. When On is selected, the system selects the setting for optimal sound reproduction. Normally DPLII and then appear in the TV screen. If the recording is made with Dolby Digital technology then playback will take place with this setting, then appears in the TV screen. When Off is selected, 3-channel stereo is available.
- **Bass** - Bass level.
- **Treble** - Treble level.
- **Fader** - Balance between the front and rear speakers.
- **Balance** - Balance between the left and right-hand speakers.
- **DPL II center level**³ **channel center level**¹ - Volume for centre speaker.
- **DPL II surround level**^{1, 2} - Level for surround.

Advanced audio settings

Equalizer³

The volume level can be adjusted separately for different wavelengths.

1. Press **OK/MENU** to access **Audio settings** and select **Equalizer**.
2. Select wavelength by turning **TUNE** and confirm with **OK/MENU**.
3. Adjust the volume level by turning **TUNE** and confirm with **OK/MENU**. Continue in the same way with other wavelengths.
4. When you are finished with the settings, turn **TUNE OK** and confirm by pressing **OK/MENU** or **EXIT**.

For general information on menu navigation and menu structures, see page 273.

Sound stage¹

The sound experience can be optimised for the driver's seat, both front seats or the rear seat. If there are passengers in both the front and rear seats then the option recommended is; both front seats. The options can be selected under **Audio settings** → **Sound stage**.

For general information on menu navigation and menu structures, see page 273.

Audio volume and automatic volume control

The audio system compensates for disrupting noises in the passenger compartment by increasing the volume in relation to the speed of the car. The compensation level can be set to low, medium, high or off. Select the level under **Audio settings** → **Volume compensation**.

For general information on menu navigation and menu structures, see page 273.

External audio source audio volume

If an external audio source (e.g. an MP3 player or iPod®) is connected to the AUX input then the audio source that is connected can have a different volume than the audio system's internal volume (e.g. radio). Correct this by adjusting the volume of the input:

1. Press the **MEDIA** button and turn **TUNE** to **AUX** and wait a few seconds or press **OK/MENU**.

¹ Only Premium Sound Multimedia.

² Only when Surround is activated.

³ Not Performance.



General infotainment functions

2. Press **OK/MENU** and then turn **TUNE** to **AUX input volume**. Confirm with **OK/MENU**.
 3. Turn **TUNE** to adjust the volume for the AUX input.
- able to adapt the sound reproduction according to personal taste.

NOTE

If the external audio source's volume is too high or too low, the quality of the sound may deteriorate. The audio quality may also be impaired if the player is charged while the infotainment system is in AUX mode. In which case, avoid charging the player via the 12 V socket.

Optimum sound reproduction

The audio system is pre-calibrated for optimum sound reproduction by means of digital signal processing.

This calibration takes into account loudspeakers, amplifiers, passenger compartment acoustics, listener position etc. for each combination of car model and audio system.

There is also a dynamic calibration that takes into account the position of the volume control, radio reception and vehicle speed.

The controls explained in these operating instructions, e.g. **Bass**, **Treble** and **Equalizer**, are only intended for the user to be



Radio

Radio functions, general

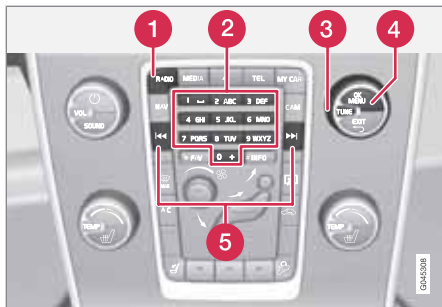

Centre console, controls for radio functions.

- 1 **RADIO** button for selecting the wavelength (AM, FM1, FM2, DAB1*, DAB2*).
- 2 Station presets (0-9)
- 3 Select the desired frequency/station or navigate in the radio menu by turning **TUNE**.
- 4 Confirm your selection or go to the radio menu by pressing **OK/MENU**.
- 5 Hold in the button for next/previous available station. Short press for preset.

NOTE

If the car is equipped with a steering wheel keypad* and/or remote control* then in many cases these can be used instead of the buttons in the centre console. For a description of the buttons in the steering wheel, see page 224. For a description of the remote control, see page 250.

Menus

The menus in **RADIO** are controlled from the centre console and the steering wheel keypad*. For general information on menu navigation and menu structures, see page 273.

Radio AM/FM

Tuning

Automatic tuning

1. Repeatedly press on the **RADIO** button until the desired wavelength (**AM**, **FM1** etc.) is shown, release and wait a second or press **OK/MENU**.
2. Hold in **⏮** / **⏭** in the centre console (or in the steering wheel keypad*). The radio searches for the next/previous available station.

Station list¹

The radio automatically compiles a list of the strongest FM stations whose signals it is currently receiving. This enables you to find a station when you drive into an area where you do not know the radio stations and their frequencies.

To go to the list and select a station:

1. Select the desired wavelength (**FM1** or **FM2**).
2. Turn **TUNE** one step in either direction. This displays the list of all stations in the area. The currently tuned station is indicated with enlarged text in the list.
3. Turn **TUNE** again in either direction to select a station from the list.

¹ Only applies to FM1/FM2.



Radio

i NOTE

- The list only shows the frequencies of stations that are currently being received, **not** a complete list of all radio frequencies on the selected wavelength.
- If the signal from the currently received station is weak, this may prevent the radio from updating the station list. If this occurs, press the **#INFO** button (while the station list is shown in the display screen) in order to change to manual tuning and set a frequency. If the station list is no longer shown, turn **TUNE** one step in either direction to show the list again, and press **#INFO** to switch.

The list disappears from the TV screen after a few seconds.

If the station list is no longer shown, turn **TUNE** one step in either direction and press the **#INFO** button in the centre console to change to manual tuning (or to return from manual tuning to the function for "Station list").

Manual tuning

The preset from the factory is that the radio shows the station list of the strongest stations

in the area when you turn **TUNE** (see the section "Station list", page 230). When the station list is shown, press the **#INFO** button in the centre console to change to manual tuning. This allows you to select a frequency from the list of all available radio frequencies in the selected wavelength. In other words, if turn **TUNE** one step in a manual search the frequency is changed from e.g. 93.3 to 93.4 MHz, etc.

To manually select a station:

1. Repeatedly press on the **RADIO** button until the desired wavelength (**AM**, **FM1** etc.) is shown, release and wait a second or press **OK/MENU**.
2. Turn **TUNE** to select a frequency.

i NOTE

The preset from the factory is that the radio automatically searches for the stations in the area where you are driving (see previous section "Station list" above).

But if you have changed over to manual tuning (by pressing the **#INFO** button in the centre console when the station list was shown), then the radio remains set in the function for manual tuning the next time you switch on the radio. To change back to the function for "Station list", turn **TUNE** one step (to show the complete list of stations) and press the button **#INFO**.

Note that if you press **#INFO** when the station list is not shown then **INFO** is activated. For more information on this function, see page 227.

Preset

10 presets can be stored per wavelength (**AM**, **FM1** etc.).

The stored presets are selected using the preset buttons.

1. Tune into a station (see "Tuning", page 230).
2. Hold in one of the preset buttons for a few seconds, the sound disappears during this



Radio

time and returns when the station is stored. The preset button can now be used.

A list of pre-selected channels can be shown² in the TV screen. The function is activated/deactivated in FM/AM mode under **FM menu** → **Show presets** or **AM menu** → **Show presets**.

Scan wavelength

The function automatically searches the current wavelength for strong stations. When a station is found, it is played for approx. 8 seconds before scanning is resumed. When a station is playing back it can be saved as a preset in the usual way, see the section "Pre-set" above.

- To start scanning go in FM/AM mode to **FM menu** → **Scan** or **AM menu** → **Scan**.

NOTE

Scanning stops if a station is saved.

RDS functions

RDS (Radio Data System) links FM transmitters into a network. An FM transmitter in such a network sends information that gives an RDS radio the following functions:

- Automatically switches to a stronger transmitter if reception in the area is poor.
- Searches for programme type, such as traffic information or news.
- Receives text information on current radio programme.

NOTE

Some radio stations do not use RDS or only some if its functionality.

If a required programme type is located the radio can switch stations interrupting the audio source currently in use. For example, if the CD player is in use, it is paused. The interrupting transmission is played at a preset volume, see page 234. The radio returns to the previous audio source and volume when the set programme type is no longer broadcast.

The programme functions alarm (**ALARM!**), traffic information (**TP**), news (**NEWS**), and programme types (**PTY**) interrupt one another in order of priority, where alarm has the highest priority and programme types has the lowest. For additional settings of programming interruptions (**EON Distant** and **EON Local**), see the section "Enhanced Other Networks – EON" below. Press **EXIT** to return to the inter-

rupted audio source, press the **OK/MENU** to clear the message.

Alarm

This function is used to warn of serious accidents and catastrophes. The alarm cannot be temporarily interrupted or deactivated. The message **ALARM!** appears on the TV screen when an alarm message is transmitted.

Traffic information – TP

This function allows traffic information sent within a set station's RDS network to break through. The **TP** symbol indicates that the function is activated. If the preset station can send traffic information then this is shown by **TP** glowing brightly in the TV screen, otherwise **TP** will be grey.

- Activate/deactivate in FM mode under **FM menu** → **TP**.

Enhanced Other Networks – EON

This function is useful in urban areas with many regional radio stations. It allows the distance between the car and the radio station transmitter to determine when programme functions should interrupt the current audio source.

² Only applies to High Performance Multimedia and Premium Sound Multimedia.



Radio

- Activate/deactivate in FM mode by selecting one of the options under **FM menu** → **Advanced settings** → **EON**:
- Go in FM mode to **FM menu** → **News settings** → **Set news favourite** to change.

- **Local** – interrupts only if the radio station transmitter is close.
- **Distant**³ – interrupts if the station transmitter is far away, even if there is a lot of static.

TP from selected station/all stations

The radio can only interrupt for traffic information from the selected station or all stations within the RDS network.

- Go in FM mode to **FM menu** → **Advanced settings** → **Set TP favourite** to change.

News

This function allows news broadcasts sent within a set station's RDS network to break through. The **NEWS** symbol indicates that the function is active.

- Activate/deactivate in FM mode under **FM menu** → **News settings** → **News**.

News from selected station/all stations

The radio can only interrupt for news from the selected station or all stations in the RDS network.

Programme types – PTY

The PTY function can be used to select one or more programme types, such as pop music and serious classic. The PTY symbol indicates that the function is active. This function allows programme types broadcast within a set station's RDS network to break through.

1. Activate in FM mode by first selecting the programme types under **FM menu** → **Advanced settings** → **PTY settings** → **Select PTY**.
2. Then the PTY function must be activated under **FM menu** → **Advanced settings** → **PTY settings** → **Receive traffic bulletins from other networks**.

An indicator is shown in the TV screen when PTY is activated.

Deactivation of the PTY function is performed in FM mode under **FM menu** → **Advanced settings** → **PTY settings** → **Receive traffic bulletins from other networks**. Selected programme types (PTY) are not reset.

Resetting and removing PTY are performed under **FM menu** → **Advanced settings** → **PTY settings** → **Select PTY** → **Clear all**.

PTY search

This function searches the entire wavelength for the selected programme type.

1. In FM mode select one or more PTY under **FM menu** → **Advanced settings** → **PTY settings** → **Select PTY**.
2. Go to **FM menu** → **Advanced settings** → **PTY settings** → **Seek PTY**.

To finish searching, press **EXIT**.

- To continue searching for another broadcast of the selected programme types, press on **◀◀** or **▶▶**.

Display of programme type

The programme type of the current station can be shown on the TV screen.

- Activate/deactivate in FM mode under **FM menu** → **Advanced settings** → **PTY settings** → **Show PTY text**.

³ Factory settings.



Radio

Radio text

Some RDS stations transmit information on programme content, artists, etc. This information can be shown on the TV screen.

- Activate/deactivate in FM mode under **FM menu** → **Show radio text**.

Automatic frequency update – AF

The function selects the strongest transmitter for the set station. In order to find a strong transmitter the function may, in exceptional cases, need to search the entire FM wavelength.

- Activate/deactivate in FM mode under **FM menu** → **Advanced settings** → **Alternative frequency**.

Regional radio programmes – REG

This function causes the radio to continue with a regional transmitter even if its signal strength is low. The symbol **REG** shows that the function is active.

- Activate/deactivate in FM mode under **FM menu** → **Advanced settings** → **REG**.

Resetting RDS functions

All radio settings can be reset to the original factory settings.

- The reset is carried out in FM mode under **FM menu** → **Advanced settings** → **Reset all FM settings**.

Volume control, programme types

The interrupting programme types, e.g. **NEWS** or **TP**, are heard at the volume selected for each respective programme type. If the volume level is adjusted during the programme interruption, the new level is saved until the next programme interruption.

Radio system - DAB*

General

DAB (Digital Audio Broadcasting) is a digital broadcasting system for radio.

NOTE

This system does not support DAB+.

NOTE

Coverage for DAB is not available in all locations. If there is no coverage then the message **No reception** is shown in the display screen.

Service and Ensemble

- **Service** - Channel, radio channel (only audio services are supported by the system).
- **Ensemble** - A collection of radio channels on the same frequency.

Storing channel groups (Ensemble learn)

When the vehicle is moved to a new broadcasting area, programming of existing channel groups in the area may be necessary.

Programming of channel groups creates an updated list of all available channel groups. The list is not updated automatically.

Programming is carried out in the menu system in DAB mode under **DAB menu** → **Ensemble learn**. Programming can also take place as follows:

1. Turn **TUNE** one step in either direction.
 - > **Ensemble learn** is shown in the list of available channel groups.
2. Press **OK/MENU**.
 - > New programming is started.

Programming can be cancelled with **EXIT**.

It can take up to a minute to program a channel group if both **Band III** and **LBand** are selected. For more information on wavelength, see page 236.



Radio

Navigation in channel group list (Ensemble)

To navigate in and access the channel group list turn **TUNE**. The name of the Ensemble is shown in the upper part of the TV screen. When scrolling to the new Ensemble the name changes to the new one. A thick grey line separates the two channel groups from each other.

- **Service** - Shows channels irrespective of the channel group to which they are allocated. The list can also be filtered using the selection of programme type (**PTY filtering**), see below.

Scanning

The function automatically searches the current wavelength for strong stations. When a station is found, it is played for approx. 8 seconds before scanning is resumed. When a station is playing back it is saved as a preset in the usual way. For more information on presets, see "Preset" below.

- Go in DAB mode to **DAB menu** → **Scan** to start scanning.

i NOTE

Scanning stops if a station is saved.

Scanning can also be selected in DAB-PTY mode. In which case only channels of the pre-selected programme type are played.

Programme type (PTY)

Various types of radio programmes can be selected using the programme type function. There are a number of different programme types which also include different programme categories. After selecting a programme type, navigation only takes place within the channels that are broadcasting that type.

Programme type is selected in DAB mode under **DAB menu** → **PTY filtering**. Exit this mode as follows:

- Press **EXIT**.
 - > An indicator is shown in the TV screen when PTY is activated.

In certain cases DAB radio will exit PTY mode when DAB to DAB linking (see below) is implemented.

Preset

10 station presets can be stored per wavelength. DAB has 2 memories for presets: **DAB1** and **DAB2**. Storing of presets is performed in the usual way, for more information see page 231. The stored presets are selected using the preset buttons.

A preset contains one channel but no sub-channels. If a subchannel is being played and a preset is saved then only the main channel is registered. This is because subchannels are temporary. At the next attempt to retrieve the preset, the channel which contained the sub-channel will be played. The preset is not dependent on the channel list.

A list of pre-selected channels can be shown⁴ in the TV screen. The function is activated/deactivated in DAB mode under **DAB menu** → **Show presets**.

i NOTE

The audio system's DAB system does not support all functions available in the DAB standard.

Radio text

Some radio stations transmit information on programme content, artists, etc. This information is shown on the TV screen.

The function is deactivated/activated in DAB mode under **DAB menu** → **Show radio text**.

⁴ Only applies to High Performance Multimedia and Premium Sound Multimedia



Radio

NOTE

Only one of the functions "Show radio text" and "Show presets" can be activated at a time. If one of them is activated when the other is already activated, then the previously activated function is deactivated automatically. Both functions can be deactivated.

Advanced settings

DAB to DAB link

It is possible to exit a channel with poor or no reception to the same channel in another channel group with better reception. There may be a certain delay when changing channel group. There may be a period of silence between the current channel no longer being available to the new channel becoming available.

The function can be activated/deactivated in DAB mode under **DAB menu → Advanced settings → DAB linking**.

Wavelength

DAB can be transmitted on two⁵ wavelengths:

- **Band III** - covers areas outside big cities
- **LBand** - mainly in large cities

By selecting for example **Band III** on its own, channel programming takes place more

quickly than if both **Band III** and **LBand** have been selected. It is not certain that all channel groups will be found. Wavelength selection does not affect the stored memories.

Wavelengths can be deactivated/activated in DAB mode under **DAB menu → Advanced settings → DAB band**.

Subchannel

Secondary components are usually named subchannels. These are temporary and can contain e.g. translations of the main programme into other languages.

If one or more subchannels are broadcast then the > symbol is shown to the left of the channel name in the TV screen. A subchannel is indicated by the - symbol appearing to the left of the channel name in the TV screen.

Subchannels can only be accessed on the selected main channel and not on any other channel without selecting it.

Display of subchannels can be deactivated/activated in DAB mode under **DAB menu → Advanced settings → Sub channels**

Programme type text

Some radio stations broadcast information about programme type and programme cate-

gory. This information is shown on the TV screen.

The function is activated/deactivated in DAB mode under **DAB menu → Advanced settings → Show PTY text**.

Resetting the DAB settings

All DAB settings can be reset to the original factory settings.

- The reset is carried out in DAB mode under **DAB menu → Advanced settings → Reset all DAB settings**.

⁵ Not all areas/countries use both wavelengths.

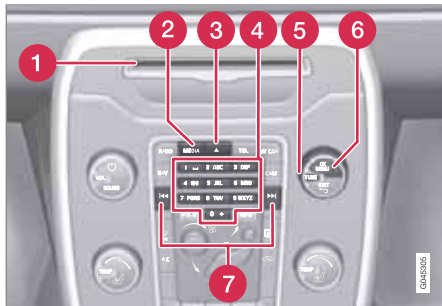

Media player

CD/DVD¹ functions

Centre console control panel.

- 1 Disc insert and eject slot
- 2 **MEDIA** key
- 3 Disc eject
- 4 Input of numbers and letters.
- 5 Select the disc tracks/folders, or navigate through menu options by turning **TUNE**.
- 6 Confirm your selection or go to the menu for the selected media source by pressing **OK/MENU**.
- 7 Fast forward/reverse and change disc track or chapter².

The media player supports and can play the following main types of discs and files:

- Pre-recorded CD discs (CD Audio).
- Burned CD discs with audio and/or video files¹.
- Pre-recorded DVD video discs¹.
- Burned DVD discs¹ with audio and/or video files.

For more information about the supported formats, see page 240.

i NOTE

If the car is equipped with a steering wheel keypad* and/or remote control* then in many cases these can be used instead of the buttons in the centre console. For a description of the buttons in the steering wheel, see page 224. For a description of the remote control, see page 250.

Menus

The menus in **MEDIA** are controlled from the centre console and the steering wheel keypad*. For general information on menu navigation and menu structures, see page 273.

Starting playback of a disc

Repeatedly press on the **MEDIA** button until **Disc** is shown, release and wait a second or press **OK/MENU**. If there is a disc in the media player then the disc starts playing back automatically, otherwise **Insert disc** is shown in the TV screen. Then insert a disc, with text side up. The disc starts to play back automatically.

If a disc with audio/video files is inserted into the player then the disc's folder structure needs to be loaded. Depending on the quality of the disc and the quantity of information there may be a certain delay before playback starts.

Disc eject

A disc remains in the ejected position for about 12 seconds, after which it is inserted back into the player for safety reasons.

Pause

When the volume is turned down completely the media player is paused. When the volume is increased, it starts again.

Playback and navigation

CD audio discs

Turn **TUNE** to access the disc's playlist and navigate in the list. Use **OK/MENU** to confirm the selection of the disc track and start play-

¹ Only applies to High Performance Multimedia and Premium Sound Multimedia.

² Only applies to DVD discs.



Media player

back. Press **EXIT** to cancel and exit the playlist. A long press on **EXIT** leads to the playlist's root level.

Disc tracks can also be changed by pressing on / on the centre console or the steering wheel keypad*.

Burned discs audio/video files¹

Turn **TUNE** to access the disc's playlist/folder structure and navigate in the list/structure. Use **OK/MENU** to confirm either selection of sub-folder or start of playback of the selected audio/video file. Press **EXIT** to either stop and exit the playlist or go up (back) in the folder structure. A long press on **EXIT** leads to the playlist's root level.

Audio/video files can also be changed by pressing / on the centre console or the steering wheel keypad*.

Audio files have the symbol , video files¹ have the symbol and folders have the symbol .

When playback of a file is complete the playback of the other files (of the same type) in that particular folder continues. Change³ of folder takes place automatically when all the files in

the current folder have been played back. The system automatically detects and changes setting when a disc containing only audio files or only video files is loaded into the media player and then plays back these files. However, the system does not change setting if a disc containing a mixture of audio and video files is loaded into the media player, but instead the player continues to play back the previous file type.

NOTE

A video film is only shown when the car is stationary. When the car is moving at a speed of over about 8 km/h no picture is shown and **No visual media available during driving** appears on the display screen, although the audio is heard during this time. The picture is shown again as soon as the car's speed falls below about 6 km/h.

NOTE

Some audio files that are copy-protected by record companies or privately copied audio files cannot be loaded by the player.

DVD video discs¹

For playback of DVD video discs, see page 239.

Fast forward/reverse

Hold in the buttons / to fast forward/rewind. Audio files are fast forwarded/rewound at one speed, while video files are fast forwarded/rewound at several speeds. Repeatedly press the buttons / to increase the fast forward/rewind speed for video files. Release the button to return to viewing at normal speed.

Music recognition, Gracenote®

If the car is equipped with navigation* then there is a hard drive in the car that contains a database for music recognition of CD audio discs. The database contains the most popular songs at the moment. If the media player gets a hit in the database then the album title and artist name for the media are displayed, and each track shows track title, artist and album. If the current CD audio disc is not found in the database then the CD text on the disc is used. If there is no CD text on the disc then only Track 1, Track 2 etc. is displayed.

¹ Only applies to High Performance Multimedia and Premium Sound Multimedia.

³ If Repeat folder is activated then this does not take place.

* Option/accessory, for more information, see Introduction.



Media player

Scan⁴

This function plays the first ten seconds of each disc track/audio file. To scan:

1. Press **OK/MENU**
2. Turn **TUNE** to **Scan**
 - > The first 10 seconds of each disc track or audio file are played.
3. Cancel the scan with **EXIT**, the disc track or audio file being played back will continue playing.

Random⁴

This function plays the tracks in random order. To listen to the tracks in random order:

1. Press **OK/MENU**
2. Turn **TUNE** to **Random**
3. Press **OK/MENU** to activate/deactivate the function.

Disc tracks/audio files can be changed by pressing **◀▶** / **▶▶** on the centre console or the steering wheel keypad*.

Repeat folder⁵

This function makes it possible to play files in a folder over and over again. When the last file

has been played out, playback of the first file starts again.

1. Press **OK/MENU**
2. Turn **TUNE** to **Repeat folder**
3. Press **OK/MENU** to activate/deactivate the function.

Playback of DVD video discs¹**Playback**

When playing back a DVD video disc a disc menu may appear on the display screen. The disc menu gives access to additional functions and settings, such as selecting subtitles, language and scene selection.

i NOTE

A video film is only shown when the car is stationary. When the car is moving at a speed of over about 8 km/h no picture is shown and **No visual media available during driving** appears on the display screen, although the audio is heard during this time. The picture is shown again as soon as the car's speed falls below about 6 km/h.

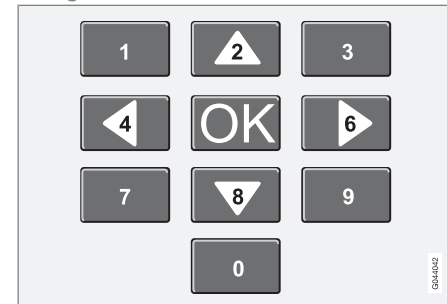
Navigation in the DVD video disc's menu

Navigation in the DVD video disc's menu is performed using the number keys in the centre console as illustrated above.

Changing chapter or title

Turn **TUNE** to access the list of chapters and navigate through them (if the film is being played back then it is paused). Press **OK/MENU** to select the chapter, this also leads back to the original position (if the film was being played back then it is restarted). Press **EXIT** to access the title list.

Titles are selected in the title list by turning **TUNE** and the selection is confirmed with **OK/MENU**, this also leads back to the chapter list.

⁴ Does not apply to DVD video discs.

⁵ Only applies to audio/video files on burned discs or USB.

¹ Only applies to High Performance Multimedia and Premium Sound Multimedia.



Media player

Press **OK/MENU** to activate the selection and return to the start position. Use **EXIT** to cancel the selection and this leads back to the original position (without any selection being made).

The chapter can also be changed by pressing on **◀** / **▶** on the centre console or the steering wheel keypad*.

Advanced settings⁶

Angle

If the DVD video disc supports it, the function can be used to choose from which camera position a particular scene should be shown. Go in disc mode to **Disc menu** → **Advanced settings** → **Angle**.

DivX® Video On Demand

The media player can be registered in order to play DivX VOD type files from burned discs or USB. The code for registration can be found in the menu system **MY CAR Settings** →

Information → **DivX® VOD code**. For general information on menus, see under **MY CAR**, see page 144.

For more information visit www.divx.com/vod.

Picture settings⁶

You can adjust the settings (when the car is stationary) for brightness and contrast.

1. Press **OK/MENU** and select **Image settings**, confirm with **OK/MENU**.
2. Turn **TUNE** to the adjustment option and confirm with **OK/MENU**.
3. Adjust the setting by turning **TUNE** and confirm with **OK/MENU**.

To return to the settings list, press the **OK/MENU** or **EXIT**.

The picture settings can be reset to factory settings with the **Reset** option.

Compatible file formats

The media player can play back a variety of file types and is compatible with the formats in the following table.

Audio format ^A	CD audio, mp3, wma
Audio format ^B	CD audio, mp3, wma, aac, m4a
Video format ^C	CD video, DVD video, divx, avi, asf

^A Applies to Performance.

^B Does not apply to Performance.

^C Only applies to High Performance Multimedia and Premium Sound Multimedia.

NOTE

Dual format, double-sided discs (DVD Plus, CD-DVD format) are thicker than regular CD discs and therefore playback cannot be guaranteed and malfunction may arise.

If a CD contains a mixture of MP3 and CDDA tracks, all MP3s will be ignored.

⁶ Applies to High Performance Multimedia and Premium Sound Multimedia.

* Option/accessory, for more information, see Introduction.



External audio source via AUX/USB* input

AUX, USB¹ and external audio source

General

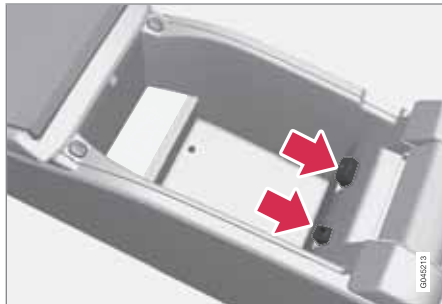

Connection points for external audio sources.

An external audio source, e.g. an iPod® or MP3 player, can be connected to the audio system via any of the connections in the centre console. An audio source connected to the USB input can then be handled² with the car's audio controls. A device connected via the AUX input cannot be controlled via the car.

There is a recess in the right-hand rear edge of the tunnel console where cables can be routed so that the hatch can be closed without cables being pinched.

i NOTE

If the car is equipped with a steering wheel keypad* and/or remote control* then in many cases these can be used instead of the buttons in the centre console. For a description of the buttons in the steering wheel, see page 224. For a description of the remote control, see page 250.

An iPod® or MP3 player with rechargeable batteries is recharged (when the ignition is on or the engine is running) if the device is plugged into the USB connection.

To connect the audio source:

1. Repeatedly press on **MEDIA** to reach the desired audio source **USB**, **iPod** or **AUX**, release and wait a second or press **OK/MENU**.
 - > If USB is selected then **Connect USB** is shown in the TV screen.
2. Connect your audio source to one of the connections in the centre console's storage compartment (see previous illustration).

The text **Reading USB** is shown in the TV screen when the system is loading the storage media's file structure. Depending on the file structure and number of files there may be some delay before loading is finished.

i NOTE

The system supports most iPod® models produced in 2005 or later.

i NOTE

To prevent damage to the USB connection, this is shut off if the USB connection is short-circuited or if a connected USB unit is taking too much power (this may happen if the unit connected does not meet the USB standard). The USB connection is reactivated automatically the next time the ignition is turned on, unless the fault persists.

Menus

The menus in **MEDIA** are controlled from the centre console and the steering wheel keypad*. For general information on menu navigation and menu structures, see page 273.

¹ Applies to High Performance, High Performance Multimedia and Premium Sound Multimedia.



² Only applies to the media source connected via the USB connection.





External audio source via AUX/USB* input

Playback and navigation³

Turn **TUNE** to access the playlist/folder structure and navigate in the list/structure. Use **OK/MENU** to either confirm selection of subfolder or start of playback of the selected audio/video file. Press **EXIT** to either stop and exit the playlist or go up (back) in the folder structure. A long press on **EXIT** leads to the playlist's root level.

Audio/video files can also be changed by pressing  /  on the centre console or the steering wheel keypad*.

Audio files have the symbol , video files⁴ have the symbol  and folders have the symbol .

When playback of a file is complete the playback of the other files (of the same type) in that particular folder continues. Change⁵ of folder takes place automatically when all the files in the current folder have been played back. The system automatically detects and changes setting when a device containing only audio files or only video files is connected to the USB port and then it plays back these files. However, the system does not change setting if a device containing a mixture of audio and video files is connected to the USB port, but instead

the player continues to play back the previous file type.

Fast forward/reverse³

See page 238.

Scan³

See page 239.

Random³

See page 239.

Search function³

The keypad on the control panel in the centre console can be used to find a filename in the current folder.

The search function is accessed either by turning **TUNE** (to access the folder structure) or by pressing one of the letter keys. As a letter or character in a search string is entered you get closer to your search target.

Start playback of a file by pressing **OK/MENU**.

Repeat folder⁶

See page 239.

Audio sources

USB memory

To facilitate the use of a USB memory stick, only store music files on it. It takes a lot longer for the system to load storage media that contains anything other than compatible music files.

NOTE

The system supports mobile media compliant with USB 2.0 and the FAT32 file system and can handle 1000 folders with a maximum of 254 subfolders/files in every folder. The top level, which can handle up to 1000 subfolders/files, is an exception to this.

NOTE

When using a longer model USB memory stick the use of a USB adapter cable is recommended. This is to avoid mechanical wear to the USB input and the connected USB memory stick.

USB hub

It is possible to connect a USB hub to the USB connection and thereby connect multiple USB devices simultaneously. Selection of USB

³ Only applies to USB and iPod®.

⁴ Applies to High Performance Multimedia and Premium Sound Multimedia.

⁵ If Repeat folder is activated then this does not take place.

⁶ Only applies to USB.

**External audio source via AUX/USB* input**

device is made in **USB** mode under **USB menu**
→ **Select USB device.**

MP3 player

Many MP3 players have their own file systems that are not supported by the audio system. For use in the system, an MP3 player must be set in **USB Removable device/Mass Storage Device** mode.

iPod®

An iPod® is charged and supplied with power by the USB connection* via the player's connection cable.

NOTE

The system only supports the playback of audio files from iPod®.

NOTE

When an iPod® is used as audio source, the car's infotainment system has a menu structure that is similar to the iPod® player's own menu structure.

Audio format	mp3, wma, aac, m4a
Video format ^A	divx, avi, asf

^A Only applies to High Performance Multimedia and Premium Sound Multimedia.

Compatible file formats via the USB connection

Audio and video files in the following table are supported by the system for playback via the USB connection.



Media Bluetooth®*

Streaming audio

General

The car's media player is equipped with Bluetooth®¹ and can wirelessly play streaming audio files from external devices with Bluetooth®, such as mobile phones and PDAs. Navigation and control of the sound can be carried out via the centre console buttons or via the steering wheel keypad*. In some external devices it is also possible to change tracks from the device.

To play back the audio the car's media player must first be set in **Bluetooth** mode.

i NOTE

The Bluetooth® media player must support the Audio/Video Remote Control Profile (AVRCP) and Advanced Audio Distribution Profile (A2DP). The player should use AVRCP version 1.3, A2DP 1.2. Otherwise some functions may not work.

Not all mobile phones and external media players available in the market are fully compatible with the Bluetooth® function in the car's media player. Volvo recommends that you contact an authorised Volvo dealer or visit www.volvocars.com for information on compatible phones and external media players.

i NOTE

The car's media player can only play the audio files via the Bluetooth® function.

Overview

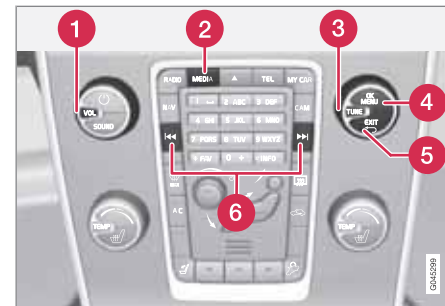

Centre console control panel.

- 1** VOL – volume
- 2** MEDIA key
- 3** Navigate in the menu by turning **TUNE**.
- 4** Confirm your selection or go to the menu by pressing **OK/MENU**.
- 5** **EXIT** - leads up in the menu system, stops the function in progress.
- 6** **Short presses** are used to scroll between audio files. **Long presses** are used to fast forward and rewind audio files.

¹ Applies to High Performance, High Performance Multimedia and Premium Sound Multimedia.

* Option/accessory, for more information, see Introduction.

**Media Bluetooth®*****i NOTE**

If the car is equipped with a steering wheel keypad* and/or remote control* then in many cases these can be used instead of the buttons in the centre console. For a description of the buttons in the steering wheel, see page 224. For a description of the remote control, see page 250.

Menus

The menus in **MEDIA** are controlled from the centre console and the steering wheel keypad*. For general information on menu navigation and menu structures, see page 273.

Pair and connect external device

The connection of an external device takes place in different ways depending on whether or not it has been previously paired. A maximum of 10 external devices can be paired. Pairing takes place once per external device. To connect a device for the first time, follow the instructions below:

1. Repeatedly press on **MEDIA** until **Bluetooth** is shown, release and wait a second or press **OK/MENU**.
2. Press **OK/MENU**.
3. When **Add device** is shown, press **OK/MENU**.

4. Check that the external device is searchable/visible via Bluetooth®, see the manual for the external device.
5. Press **OK/MENU**.
 - > The infotainment system searches for external devices in the vicinity. The search may take a little while. The devices detected are specified with their respective Bluetooth® name in the centre console TV screen.
6. Select the external device you want to pair with and press **OK/MENU**.
7. Enter the series of numbers that is shown in the centre console TV screen via the external device's keypad and press the external device's button to confirm the selection.

The external device is paired and connected automatically to the infotainment system.

Change audio file by pressing **⏮ / ⏭** on the centre console or the steering wheel keypad*.

Automatic connection

When the Bluetooth® function is active and the last external device connected is in range it is connected automatically. When the infotainment system searches for the last device connected its name is shown in the TV screen. To connect to another device, press **EXIT**. Con-

nect a new external device, see "Change to another external device" below.

Change to another external device

It is possible to change a connected device with another device if there are several devices in the car. However, the device must first have been paired, see "Pair and connect external device" above. To change to another device:

1. Repeatedly press on **MEDIA** until **Bluetooth** is shown, release and wait a second or press **OK/MENU**.
2. Check that the external device is searchable/visible via Bluetooth®, see the manual for the external device.
3. Press **OK/MENU**.
4. Turn **TUNE** to **Change device**, and confirm with **OK/MENU**.
 - > After a while, the external device's name is shown in the TV screen. If several external devices have been paired then these are also shown.
5. Select the device to be connected by turning **TUNE** and confirm with **OK/MENU**.
 - > Connection of the external device takes place.

Change audio file by pressing **⏮ / ⏭** on the centre console or the steering wheel keypad*.



Media Bluetooth®*

Remove the connected device

1. Press Bluetooth mode on **OK/MENU**.
2. Turn **TUNE** to **Remove Bluetooth device** and confirm with **OK/MENU**.
3. Select the device to be removed by turning **TUNE**, and confirm with **OK/MENU**.
 - > A prompt asking whether or not you want to remove the connection is shown in the TV screen.
4. Press **OK/MENU** to confirm.

EXIT cancels.

Disconnecting the device

Automatic disconnection takes place if the external device moves out of the infotainment system's range. For more information on connection, see page 245.

Random

This function plays back the audio files on the external device in random order. Activate/deactivate the random function in Bluetooth mode under **Bluetooth menu** → **Random**.

Change audio file by pressing **⏮** / **⏭** on the centre console or the steering wheel keypad*.

Scanning of audio files in external device

This function play backs the first ten seconds of each audio file. Activate/deactivate the func-

tion in Bluetooth mode under **Bluetooth menu** → **Scan**.

Cancel scanning with **EXIT**.

Version information Bluetooth®

The car's current Bluetooth® version can be seen in Bluetooth mode under **Bluetooth menu** → **Bluetooth software version in car**.



TV*

TV*

General

NOTE

This system only supports TV transmissions in countries which transmit signals in mpeg-2 format and follow the DVB-T standard. The system does not support TV transmissions in mpeg-4 format or analogue transmissions.

NOTE

The TV picture is only shown when the car is stationary. When the car is moving at a speed over about 6 km/h the picture disappears, **No visual media available during driving** appears on the display screen, although the audio is heard during this time. The picture reappears when the car has stopped.

NOTE

The reception is dependent both on how good the signal strength and signal quality are. The transmission may be disturbed by various factors such as tall buildings or the TV transmitter being far away. Coverage level can also vary depending on where in the country you are located.

IMPORTANT

A TV licence is required for this product in some countries.

Overview

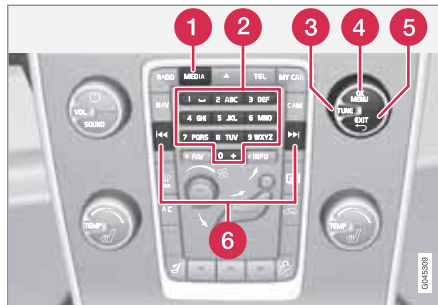

Centre console control panel.

- 1 **MEDIA** key.
- 2 Station presets, numeric input
- 3 Navigate in channel lists or menus by turning **TUNE**.
- 4 Confirm your selection or go to the menu by pressing **OK/MENU**.
- 5 **EXIT** - leads up in the menu system, stops the function in progress.
- 6 The next available channel is shown by pressing **◀▶** / **▶▶**.

NOTE

If the car is equipped with a steering wheel keypad* and/or remote control* then in many cases these can be used instead of the buttons in the centre console. For a description of the buttons in the steering wheel, see page 224. For a description of the remote control, see page 250.

Menus

The menus in **MEDIA** are controlled from the centre console and the steering wheel keypad*. For general information on menu navigation and menu structures, see page 273.

Watch TV

If this is the first time the TV function is used or the country of residence has changed then the setting of TV channels must first be carried out. To set the TV channels see the section "Searching TV channels/Presets list" page 248.

- Repeatedly press on **MEDIA** until **TV** is shown in the TV screen, release the button and wait a second or press **OK/MENU**.
 - > A search starts and after a short while the most recently used channel is shown.

Changing channel

It is possible to change channel as follows:

* Option/accessory, for more information, see Introduction.



TV*

- Turn **TUNE**, a list of all available channels in the area is shown. If any of these channels is already saved as a preset then its preset number is shown to the right of the channel name. Continue turning **TUNE** to reach the desired channel and press **OK/MENU**.
- By pressing the preset buttons (0-9).
- Via a short press on the **◀◀ / ▶▶** buttons the next available channel in the area is shown.

NOTE

If the car has been moved within the country, for example, from one city to another, it is not certain that the presets are available at the new location as the frequency range may have changed. In which case, carry out a new search and save a new preset list, see the function "Save the available TV channels as presets", page 249.

NOTE

If no reception is available on the preset buttons, it may be because the car is at a location other than where the scan of TV channels was run, for example, if the car was driven from Germany to France. A new selection of country and a new search may then need to be carried out.

Searching TV channels/Preset list

1. Press TV mode on **OK/MENU**.
2. Turn **TUNE** to **TV menu** and press **OK/MENU**.
3. Turn **TUNE** to **Select country** and press **OK/MENU**.
 - > If one or more countries have previously been selected then they are shown in a list.
4. Turn **TUNE** to either **Other countries** or one of the previously selected countries. Press **OK/MENU**.
 - > A list of all available countries is shown.
5. Turn **TUNE** to the desired country (e.g. Sweden) and press **OK/MENU**.
 - > An automatic scan for available TV channels starts, this scan takes a little while. During this time the figure for each channel found and added as a preset is shown. When the scan is complete a message is shown and the picture is shown. A preset list (max. 30 presets) has now been created and is available. To change channel, see page 247.

The scan and preset storage can be cancelled with **EXIT**.

NOTE

If the country of residence has changed, a new scan of TV channels must be run.

Channel management

The preset list can be edited. You can change the order of the channels that are shown in the preset list. A TV channel can have more than one place in the preset list. The TV channel positions can also vary in the preset list.

To change the order in the preset list, go in TV mode to **TV menu** → **Reorganize presets**.

1. Turn **TUNE** to the channel you want to move in the list and confirm with **OK/MENU**.
 - > The selected channel is highlighted.
2. Turn **TUNE** to the new location in the list and confirm with **OK/MENU**.
 - > The channels change places with each other.

After the preset channels (max. 30) come all the other channels available in the area. It is possible to move a channel up to a place in the preset list.



Save the available TV channels as presets

If the car has been moved within the country, for example, from one city to another, it is not certain that the presets are available at the new location as the frequency range may have changed. In which case, carry out another scan and save a new preset list.

1. Press TV mode on **OK/MENU**.
2. Turn **TUNE** to **TV menu** and press **OK/MENU**.
3. Turn **TUNE** to **Autostore** and press **OK/MENU**.

> An automatic scan for available TV channels starts, this scan takes a little while. During this time the figure for each channel found and added as a preset is shown. When the scan is complete a message is shown and the picture is shown. A preset list (max. 30 presets) has now been created and is available. To change channel, see page 247.

Scanning the TV channels

This function automatically scans through the frequency range for all channels available in the area where you are. When a channel is found, it is shown for approx. 10 seconds before scanning is resumed. Scanning is stopped with



EXIT, then the channel that you just watched continues to be shown. Scanning does not affect the preset list.

Activate scanning in TV mode under **TV menu** → **Scan**.

Teletext

It is possible to read Teletext. Follow these steps:

1. Press the  button on the remote control.
2. Enter the page number (3 digits) with the number keys (0-9) to select page.
 - > The page is shown automatically.

Enter new page number, or press the remote control buttons  /  to go to the next page.

Return to TV screen with **EXIT** or by pressing the  button on the remote control.

It is also possible to control the teletext with the coloured buttons on the remote control.

Information about the current programme

Press the **INFO** button in order to display the information about the current programme, the next programme and its start time. If the **INFO** button is pressed once more then additional information on the current programme

can sometimes be displayed, such as start and end times and a brief description of the current programme. For more information on the **INFO** button, see page 227.

To return to the TV picture, wait several seconds or press **EXIT**.

Picture settings

The settings for brightness and contrast can be adjusted. For more information, see page 240.

The reception is lost

If the reception for the TV channel that is being shown disappears then the picture will freeze. Shortly after this a message appears informing that the reception has been lost for the current TV channel, and a new search for the channel continues. When the reception returns the display of the TV channel starts immediately. It is possible to change channel at any time when the message is shown.

If the message **Reception lost, searching** is shown then this is because the system has detected that there is no reception for all TV channels. One possible reason may be that a border has been crossed and that the system is set to the wrong country. In which case, change to the right country in accordance with "Searching TV channels/Preset list", see page 248.



Remote control*

Remote control*



1 Scroll wheel, corresponds to **TUNE** in the centre console.

The remote control can be used for all functions in the infotainment system. The remote control's buttons have the same functions as the buttons in the centre console or steering wheel keypad*.

When using the remote control, first press the remote control's button $L \begin{matrix} F \\ \text{TV} \\ R \end{matrix}$ to position **F**. Then aim the remote control at the IR receiver, which is located to the right of the **INFO** button (see page 227) in the centre console.

If the car is fitted with rear TV screens* and you want to operate one of these, select the required TV screen with the button $L \begin{matrix} F \\ \text{TV} \\ R \end{matrix}$ on the remote control. Then aim the remote control at the IR receiver for the TV screen to be operated, see page 264.

WARNING

Keep loose objects such as mobile phones, cameras, remote controls for accessories, etc. in the glove compartment or other compartments. Otherwise they may injure people in the car in the event of sudden braking or a collision.

NOTE

Do not expose the remote control to direct sunlight (e.g. on the instrument panel) - otherwise problems may arise with the batteries.

Key	Function
$L \begin{matrix} F \\ \text{TV} \\ R \end{matrix}$	Change between: L = Rear left TV screen* F = Front TV screen R = Rear right TV screen*
NAV	Change to navigation*
RADIO	Change to radio source (AM , FM1 etc.)
MEDIA	Change to media source (Disc , TV* etc.)
TEL	Change to Bluetooth® hands-free*
	Scroll/fast rewind, change track/song.
	Play/pause



Remote control*

Key	Function
	Stop
	Scroll/fast forward, change track/song.
DVD MENU	Menu
EXIT 	To previous, cancels function, deletes input characters
	Navigate up/down
	Navigate right/left
OK MENU	Confirm selection or go to the menu system for the selected source
	Volume, decrease
	Volume, increase
0-9	Preset channels, number and letter input
FAV *	Shortcuts for favourite setting.

Key	Function
INFO #	Information about the current programme, song, etc. Also used when there is more information available than can be shown in the TV screen.
	Selection of language for soundtrack
	Subtitles, selection of language for text
	Teletext*, On/Off

Replacing the battery in the remote control

NOTE

Battery life is normally 1-4 years and depends on how much the remote control is used.

The remote control is powered by four batteries of the AA/LR6 type.

Take along extra batteries for a long journey.

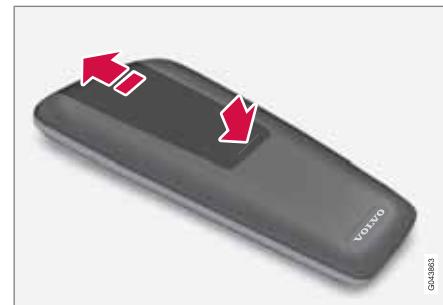

1. Push down the catch on the battery cover and slide the battery cover in the direction of the infrared lens.
2. Remove the used batteries, turn the new batteries in accordance with the symbols in the battery compartment and fit them.
3. Refit the cover.

NOTE

Be sure to dispose of the exhausted batteries in an environmentally safe manner.



05 Infotainment system

Bluetooth® handsfree*

General



System overview.

- 1 Mobile phone
- 2 Microphone
- 3 Steering wheel keypad
- 4 Centre console control panel

Bluetooth®¹

A mobile phone equipped with Bluetooth® can be connected wirelessly to the Infotainment system. The infotainment system then works handsfree, with the option to control a range of the mobile phone's functions remotely. The microphone used is located by the driver's sun visor (2). The mobile phone can be operated by

its own keys irrespective of whether or not it is connected.

NOTE

Only a selection of mobile phones are fully compatible with the handsfree function. Volvo recommends that you seek assistance from an authorised Volvo dealer or visit www.volvocars.com for information on compatible phones.

Menus

The menus in **TEL** are controlled from the centre console and the steering wheel keypad*. For general information on menu navigation and menu structures, see page 273.

Phone functions, controls overview

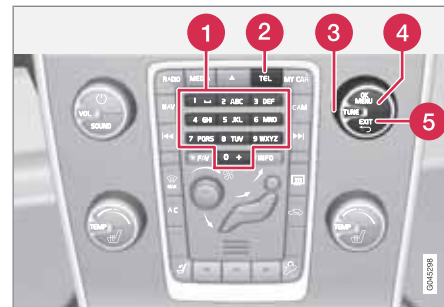

Centre console control panel.

- 1 Number and letter buttons
- 2 **TEL** - Activate/Disconnect
- 3 **TUNE** - Turn in normal view to the right to access the phone book, and to the left for the call register for all calls; also used for navigation among the options on the TV screen.
- 4 Accept incoming calls, confirm your selection or go to the Phone menu by pressing **OK/MENU**.
- 5 **EXIT** - Cancels/rejects phone calls, deletes input characters, leads up in the menu system and cancels the current function.

¹ Applies to High Performance, High Performance Multimedia and Premium Sound Multimedia.

* Option/accessory, for more information, see Introduction.

**Bluetooth® handsfree*****i NOTE**

If the car is equipped with a steering wheel keypad* and/or remote control* then in many cases these can be used instead of the buttons in the centre console. For a description of the buttons in the steering wheel, see page 224. For a description of the remote control, see page 250.

Remember**Activate/deactivate**

A short press on **TEL** activates the handsfree function. The  symbol indicates that the handsfree function is active.

Connect mobile phone

A mobile phone is connected in different ways depending on whether or not it has been connected previously. To connect a mobile phone for the first time, follow the instructions below:

There are two options for connecting a mobile phone, either via the car's menu system or via the mobile phone's menu system. If one option does not work then try with the other.

Alternative 1 - via the car's menu system

1. Make the mobile phone detectable/visible via Bluetooth®, see the mobile phone's manual or www.volvocars.com.

2. Activate the vehicle's handsfree function by pressing **TEL**. Continue by pressing **OK/MENU**.
3. Select, **Change phone**, press **OK/MENU**.
 - > The menu option **Add phone** is shown on the TV screen. If one or more mobile phones have already been paired then these are also shown. Press **OK/MENU**.
4. Check that the mobile phone's Bluetooth® function is switched on and press **OK/MENU**.
 - > The audio system searches for mobile phones in the vicinity. The search takes approximately 30 seconds. The mobile phones detected are specified with their respective Bluetooth® name in the TV screen. The handsfree function's Bluetooth® name is shown in the mobile phone as **My Volvo Car**.
5. Choose one of the mobile phones in the centre console TV screen.
6. Enter the series of numbers that is shown in the centre console TV screen via the mobile phone's keypad and press the mobile phone's button to confirm the selection.

Alternative 2 - via the mobile phone's menu system

1. Activate the handsfree function by pressing **TEL** in the centre console. If there is a phone connected, disconnect the connected phone.
2. Make the car detectable/visible via Bluetooth®, press **OK/MENU** and activate the **Phone settings** → **Discoverable** option.
3. Search with the mobile phone's Bluetooth® function, see the mobile phone manual.
4. Select **My Volvo Car** in the list of units detected in your mobile phone.
5. Enter an optional PIN code on your mobile phone via the mobile phone's keypad when prompted to enter the PIN code. Then key in the same PIN code via the car's keypad.
6. Select to connect to **My Volvo Car** from the mobile phone.

The mobile phone is paired (registered) and connects automatically to the audio system. For more information about how mobile phones are paired, see page 255.

When the connection is established the mobile phone's Bluetooth® name is shown in the TV



Bluetooth® handsfree*

screen. Now the mobile phone can be controlled from the audio system.

To call

1. Make sure that the  symbol appears at the top of the TV screen and that the handsfree function is in phone mode.
2. Dial either the desired number or speed dial number, see page 259. Or in normal view turn **TUNE** to the right to access the phone book, and to the left for the call register for all calls. For information on the phone book, see page 256.
3. Press **OK/MENU**.

The call is interrupted with **EXIT**.

Disconnecting the mobile phone

Automatic disconnection takes place if the mobile phone moves out of the audio system's range. The connection to the mobile phone can be interrupted manually via a long press on **TEL** or in phone mode under **Phone menu** → **Disconnect phone**. For more information on connection, see page 255.

The handsfree function is deactivated when the engine is switched off or when a door is opened².

When the mobile phone has been disconnected an ongoing call can be continued by using the mobile phone's built-in microphone and speaker.

NOTE

Even when your mobile phone has been manually disconnected, some mobile phones may automatically couple up to the last handsfree unit connected, e.g. when a new call begins.

Making and receiving calls

Incoming call

- Press **OK/MENU** to answer the call, even if the audio system is in e.g. **RADIO** or **MEDIA** mode.

Refuse or end with **EXIT**.

Automatic answer

The automatic answer function means that calls are accepted automatically.

- Activate/deactivate in phone mode under **Phone menu** → **Call options** → **Auto answer**.

In call menu

Press **OK/MENU** during an ongoing call to access the following functions:

- **Mute** - audio system microphone is muted.
- **Mobile phone** - the call is transferred from handsfree to the mobile phone. For some mobile phones the connection is interrupted. This is normal. The handsfree function asks if you want to reconnect.
- **Dial number** - option to call a third party using the number keys (current call set in standby).

Call lists

The call lists are copied to the handsfree function at each new connection and are then updated during the connection. In normal view, turn to the left with **TUNE** to see the call register for **All calls** .

In phone mode it is possible to see all the call lists under **Phone menu** → **All calls**:

- **All calls**
- **Missed calls**
- **Answered calls**
- **Dialled calls**
- **Call duration**

² Only Keyless Drive.

* Option/accessory, for more information, see Introduction.

**Bluetooth® handsfree*****NOTE**

Certain mobile phones show a list of the last dialled numbers in reverse order.

Voice mailbox

In normal view a speed dial number for the voice mailbox can be programmed in and then accessed later via a long press on **1**.

Voice mailbox number is changed in phone mode under **Phone menu → Call options → Voicemail number → Change number**. If there is no number stored then this menu can be reached with one long press on **1**.

Audio settings**Phone call volume**

The phone call volume can only be changed during a call. Use the steering wheel keypad* or turn the **VOL** control.

Audio system volume

Providing there is no ongoing call taking place, the audio system volume is controlled as usual by turning **VOL**.

If an audio source is active during an incoming call then it can be muted automatically. Activate/deactivate in phone mode under **Phone**

menu → Phone settings → Sounds and volume → Mute radio/media.

Ring volume

In phone mode go to **Phone menu → Phone settings → Sounds and volume → Ring volume** and adjust by turning **VOL**. Press **EXIT** to save.

Ring signals

The handsfree function has integrated ring signals that can be selected in phone mode under **Phone menu → Phone settings → Sounds and volume → Ring signals → Ring signal 1** etc.

NOTE

For some mobile phones, the ringtone on the phone connected will not be switched off when one of the inbuilt signals for the handsfree system is used.

In order to select the connected phone's ring signal³, go in phone mode to **Phone menu → Phone settings → Sounds and volume → Ring signals → Mobile phone ring signal**.

More on pairing and connecting

A maximum of ten mobile phones can be paired (registered). Pairing is performed once per phone. After pairing the phone no longer needs to be visible/detectable. A maximum of one mobile phone can be connected at a time.

Automatic connection

When the handsfree function is active and the last mobile phone connected is in range it is connected automatically. If the last connected mobile phone is not available then the system will try to connect a mobile phone that was paired earlier. When the audio system searches for the last phone connected its name is shown in the TV screen.

Manual connection

If you want to change the connected mobile phone, go in phone mode to **Phone menu → Change phone**.

Remove the device

A connected mobile phone can be deregistered and removed. This is performed in phone mode under **Phone menu → Remove Bluetooth device**.

³ Not supported by all mobile phones.



Bluetooth® handsfree*

Version information Bluetooth®

The car's current Bluetooth® version can be seen in phone mode under **Phone menu** →

Phone settings → **Bluetooth software version in car**.

Phone book

There are two phone books. These are merged into one in the car and are displayed as a single phone book in the car.

- The car downloads the mobile phone's phone book and only displays this phone book when the mobile phone from which this phone book was downloaded is connected.
- The car also has a built-in phone book. This contains all the contacts stored in the car irrespective of which phone was connected when saving them. These contacts are visible for all users, regardless of the mobile phone that is connected to the car. If a contact is saved in the car then the symbol  is shown in front of the contact in the phone book.

NOTE

Changes made from the car to a record in the mobile phone's telephone book will result in a new record in the car's telephone book, i.e. changes will not be saved to the phone. From the car, this will now look like you have double records, with different icons. Note also that when a shortcut number is saved or a change to a contact is made, this will result in a new record in the car's phone book.

All use of the phone book requires that the  symbol appears at the top of the TV screen and that the handsfree function is in phone mode.

The audio system stores a copy of the phone book from each paired mobile phone. The phone book can be copied automatically to the audio system during each connection.

- Activate/deactivate the function in phone mode under **Phone menu** → **Phone settings** → **Phonebook download**.

If the phone book contains a ringing caller's contact information then this is shown in the TV screen.

Quick search for contacts

In normal view turn **TUNE** to the right to obtain a list of contacts. Turn **TUNE** to select and press **OK/MENU** to call.

Under the name of the contact is the phone number that is selected by default. If the symbol **#** appears to the right of the contact then there are several phone numbers stored for the contact. Change and dial a different number than the one that is selected by default by pressing the button **#INFO** on the control panel in the centre console. Then turn **TUNE** to select and press **OK/MENU** to call.

Search in the list of contacts by using the centre console's keypad to key in the start of the contact's name (see "Character table keypad in centre console" for button functions).

The list of contacts can also be accessed from normal view by pressing and holding the button on the centre console's keypad with the letter that the contact searched for starts with. For example, a long press on the button for **6** gives instant access to that part of the list where the contacts with the letter **M** are located.



Bluetooth® handsfree*

Character table keypad in centre console

Key	Function
1	Space . , - ? @ : ; / () 1
2 ABC	A B C Å Ä È À Ç 2
3 DEF	D E F È É 3
4 GHI	G H I Ì 4
5 JKL	J K L 5
6 MNO	M N O Ö Ø Ñ Ò 6
7 PQRS	P Q R S ß 7
8 TUV	T U V Ü Û 8
9 WXYZ	W X Y Z 9
* FAV	Shift between upper and lower case letter.

Key	Function
0 +	+ 0 p w
#INFO	# *

Searching for contacts

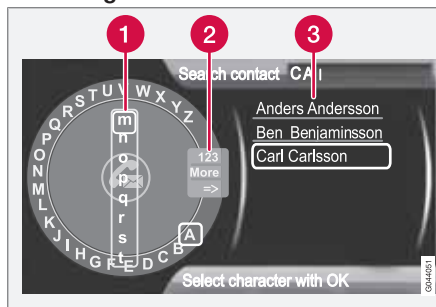

Search contacts using the text wheel.

- 1 Character list
- 2 Changing the input mode (see table below)
- 3 Phone book

To search for or edit a contact, go in phone mode to **Phone menu** → **Phone book** → **Search**.

NOTE

There is no text wheel for High Performance, so **TUNE** cannot be used there to input characters: only the digit and letter buttons on the control panel in the centre console can be used for this.

1. Turn **TUNE** to the desired letter, press **OK/MENU** to confirm. The number and letter buttons on the control panel in the centre console can also be used.
2. Continue with the next letter and so on. The result of the search is shown in the phone book (3).
3. To change the input mode to numbers or special characters, or to go to the phone book, turn **TUNE** to one of the options (see explanation in the table below) in the list for changing the input mode (2), press **OK/MENU**.

⁴ Only applies to High Performance Multimedia and Premium Sound Multimedia.



Bluetooth® handsfree*

123/ ABC	Change between letters and numbers with OK/MENU .
More	Change to special characters with OK/MENU .
=>	Leads to the phone book (3). Turn TUNE to select a contact, press OK/MENU to see the saved numbers and other information.

A short press on **EXIT** deletes an input character. A long press on **EXIT** will clear all entered characters.

By pressing a number key in the centre console when the text wheel is shown (see illustration above), a new character list (1) appears in the TV screen. Continue repeatedly pressing the number key to the desired letter and then release. Continue with the next letter and so on. When a button is depressed the entry is confirmed when another button is depressed.

To enter a number, hold in the corresponding number key.

New contact

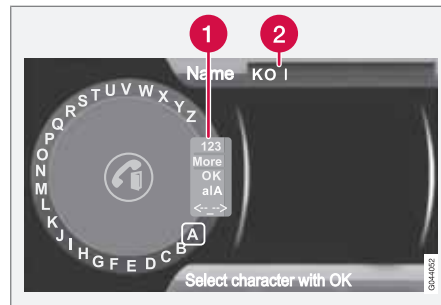

Entering letters for New contact.

- 1 Changing the input mode (see table below)
- 2 Input field

New contacts can be added in phone mode under **Phone menu** → **Phone book** → **New contact**.

i NOTE

There is no text wheel for High Performance, so **TUNE** cannot be used there to input characters: only the digit and letter buttons on the control panel in the centre console can be used for this.

1. When the **Name** row is selected, press **OK/MENU** to reach the input mode (illustration above).
2. Turn⁴ **TUNE** to the desired letter, press **OK/MENU** to confirm. The number and letter buttons on the control panel in the centre console can also be used.
3. Continue with the next letter and so on. The name entered is shown in the input field (2) in the TV screen.
4. To change the input mode to numbers, special characters, change between uppercase/lowercase letters, etc., turn **TUNE** to one of the options (see explanation in the table below) in the list (1) and then press **OK/MENU**.

When the name has been fully entered, select **OK** in the list on the TV screen (1) and press **OK/MENU**. Now continue with the telephone number in the same way as above.

When the telephone number has been entered, press **OK/MENU** and select a telephone number type (**Mobile**, **Home**, **Work** or **General**). Press **OK/MENU** to confirm.

When all details have been filled in, select **Save contact** in the menu to save the contact.

⁴ Only applies to High Performance Multimedia and Premium Sound Multimedia.



Bluetooth® handsfree*

123/ ABC	Change between letters and numbers with OK/MENU .
More	Change to special characters with OK/MENU .
OK	Save and go back to Add contact with OK/MENU .
a A	Change between uppercase and lowercase letters with OK/MENU .
<-- -->	Press OK/MENU , the cursor moves to the input field (2) at the top of the TV screen. The cursor can now be moved, with TUNE , to the appropriate place to e.g. insert new letters or delete with EXIT . To be able to insert new letters first go back to the input mode, by pressing OK/MENU .

Speed dial numbers

Use phone mode to add speed dial numbers under **Phone menu** → **Phone book** → **Speed dial**.

Dialling with speed dial numbers can be performed in phone mode using the number keys on the keypad in the centre console, by pressing a number key and then pressing **OK/MENU**. If there is no contact stored on the

speed dial number then an option is shown to save a contact to the selected speed dial number.

Receiving a vCard

It is possible to receive a vCard to the car's phone book from other mobile phones (other than the one currently connected to the car). In order to allow this the car is set to visible mode for Bluetooth®. The function is activated in phone mode under **Phone menu** → **Phone book** → **Receive vCard**.

Memory status

Memory status of the car's phone book and the connected mobile phone's phone book can be seen in phone mode under **Phone menu** → **Phone book** → **Memory status**.

Delete phone book

The car's phone book can be deleted, this is carried out in phone mode under **Phone menu** → **Phone book** → **Clear phone book**.

**NOTE**

Deleting the car's telephone book only deletes contacts in the car's telephone book. Contacts in the mobile phone's phone book are not deleted.



Voice recognition* mobile phone

Introduction

The infotainment system's voice recognition¹ allows the driver to voice-activate certain functions in a Bluetooth®-connected mobile phone or in Volvo's navigation system - RTI (Road and Traffic Information System).

NOTE

- The information in this section describes the use of voice commands to control a **mobile phone connected using Bluetooth®**. For detailed information on using a mobile phone connected using Bluetooth® with the car's Infotainment system see page 252.
- The Volvo navigation system RTI (Road and Traffic Information System) has a separate user manual which contains more information on voice control and voice commands to control that system.

Voice commands offer convenience and help the driver to avoid being distracted, and instead concentrate on driving and focus attention on the road and traffic conditions.

WARNING

The driver always holds overall responsibility for driving the vehicle in a safe manner and complying with all applicable rules of the road.

The voice recognition system allows the driver to voice-activate certain functions of a Bluetooth®-connected mobile phone and in Volvo's navigation system - RTI (Road and Traffic Information System), while the driver can keep his/her hands on the wheel at the same time. The input data are in dialogue form with spoken commands from the user and verbal replies from the system. The voice recognition system uses the same microphone as the Bluetooth® handsfree system (see illustration on page 252) and the voice recognition system's replies come via the car's speakers.

Language



Language list.

Voice recognition is not possible for all languages. Languages available for voice recognition are marked with an icon in the language list - . Changing the language is performed in the menu system **MY CAR**, see page 146.

¹ Only applies to vehicles equipped with Volvo's navigation system - RTI (Road and Traffic Information System).

* Option/accessory, for more information, see Introduction.



Voice recognition* mobile phone

Remember



Steering wheel keypad.

- 1 Button for voice recognition

To activate the system

Before voice commands to a mobile phone can be used the mobile phone must be paired and connected via Bluetooth® handsfree. If a telephone command is given and no mobile phone is paired, then the system will provide information about this. For information on pairing and connecting a mobile phone, see page 253.

- Press the button for voice recognition (1) in order to activate the system and initiate a dialogue with voice commands. The system will then display commonly used commands in the TV screen in the centre console.

Keep the following things in mind when you use the voice recognition system:

- For a command - speak after the tone, with normal voice at normal speed.
- Do not speak while the system is replying (the system cannot understand commands during this time).
- The car's doors, windows and sunroof* must be closed.
- Avoid background noise in the passenger compartment.

NOTE

If the driver is unsure of which command to use, he (she) can say "Help" - the system then responds with a few different commands which can be used in the current situation.

Voice commands can be disabled by:

- saying "Cancel"
- not speaking
- a long press on the steering wheel button for Voice recognition
- Press **EXIT** or another source button (e.g. **MEDIA**).

Help functions for voice recognition

- Instructions:** A function that helps you get familiar with the system and the procedure for giving commands.
- Voice training:** A function that enables the voice recognition system to learn to know your voice and your accent. The function provides an opportunity to voice train two user profiles.

The help functions can be accessed by pressing the **MY CAR** button on the control panel in the centre console and then turning **TUNE** to the desired menu option.

Instructions

The instructions can be started in two ways:

NOTE

This instruction and voice training can only be started when the car is parked.

- Press the button for Voice recognition and say "Voice instructions".
- Activate the instructions in the menu system **MY CAR** under **Settings** → **Voice settings** → **Voice tutorial**. For a description of the menu system, see page 144.

The instructions are divided into 3 lessons, which take around 5 minutes in total to complete. The system starts with the first lesson.

* Option/accessory, for more information, see Introduction.



Voice recognition* mobile phone

To skip a lesson and go to the next one, press the button for voice recognition and say "Next". Go back to the previous lesson by saying "Previous".

Exit the instructions by means of a long press on the button for voice recognition.

Voice training

The system displays up to fifteen phrases for you to say. Voice training can be started in the menu system **MY CAR** under **Settings** →

Voice settings → **Voice training**. Choose between **User 1** or **User 2**. For a description of the menu system, see page 144.

After voice training has been completed, remember to set your user profile under **Voice user setting**.

Additional settings in MY CAR

- **User setting** - Two user profiles can be set, the function is activated in the menu system **MY CAR** under **Settings** → **Voice settings** → **Voice user setting**. Choose between **User 1** or **User 2**. For a description of the menu system, see page 144.
- **Voice volume** - Can be changed in the menu system **MY CAR** under **Settings** → **Voice settings** → **Voice output volume**. For a description of the menu system, see page 144.

Using voice commands

The driver initiates a dialogue with the voice commands by pressing the button for voice recognition (see illustration on page 261).

Once a dialogue has been started, commonly used commands will be shown in the TV screen. Greyed-out text or text within brackets is not included in the spoken command.

When the driver becomes accustomed to the system, he/she can speed up the command dialogue and skip the prompts from the system, by briefly pressing the button for voice recognition.

Commands can be given in several ways

The command "Phone call contact" can be pronounced as e.g.:

- "Phone > Call contact" - Say "Phone", wait for the system's reply, and then continue by saying "Call contact."
- or
- "Phone call contact" - Say the whole command in one sequence.

Quick commands

Quick commands for the phone can be found in the menu system **MY CAR** under **Settings** → **Voice settings** → **Voice command list** → **Phone commands** and **General**

commands. For a description of the menu system, see page 144.

Dial a number

The system understands the numbers **0** (zero) to **9** (nine). These numbers can be pronounced individually, in groups of several numbers at a time, or the whole number all at once. Numbers greater than **9** (nine) cannot be handled by the system, e.g. **10** (ten) or **11** (eleven) are not possible.

The following is an example of a dialogue with voice commands. The system's reply will vary depending on the situation.

The user starts the dialogue by saying:

Phone > call number

or

Phone call number

System reply

Number?

User action

Start saying the numbers (as individual units, i.e. six-eight-seven, etc.) in the phone number. If you say several numbers and pause, the system will repeat them, and then say "Continue".

Continue to say the numbers. When finished, finish the command by saying "Call".

- You can also change the number by saying the commands "Correct" (which deletes

**Voice recognition* mobile phone**

the last spoken group of numbers) or "Delete" (which deletes the whole spoken phone number).

Dialling from the call register

The following dialogue allows you to make a phone call from one of your mobile phone's call registers.

The user starts the dialogue by saying:

Phone > call from the call register

or

Phone call from the call register

Continue by responding to the system's prompts.

Call a contact

The following dialogue allows you to call your pre-defined contacts in the mobile phone.

The user starts the dialogue by saying:

Phone > call contact

or

Phone call contact

Continue by responding to the system's prompts.

Consider the following when you call a contact:

- If there are several contacts with similar names, they will be presented in the dis-

play in the numbered rows and the system prompts you to select a row number.

- If there are more rows in the list than can be displayed simultaneously, saying "Down" allows you to scroll down in the list (and saying "Up" allows you to scroll up in the list).

Calling voice mailbox

The following dialogue allows you to call your voice mailbox to check if you have received any messages. The phone number for your voice mailbox must be registered in the Bluetooth® function, see page 255.

The user starts the dialogue by saying:

Phone > call voice mailbox

or

Phone call voice mailbox

Continue by responding to the system's prompts.



RSE - Rear Seat Entertainment system*

Overview

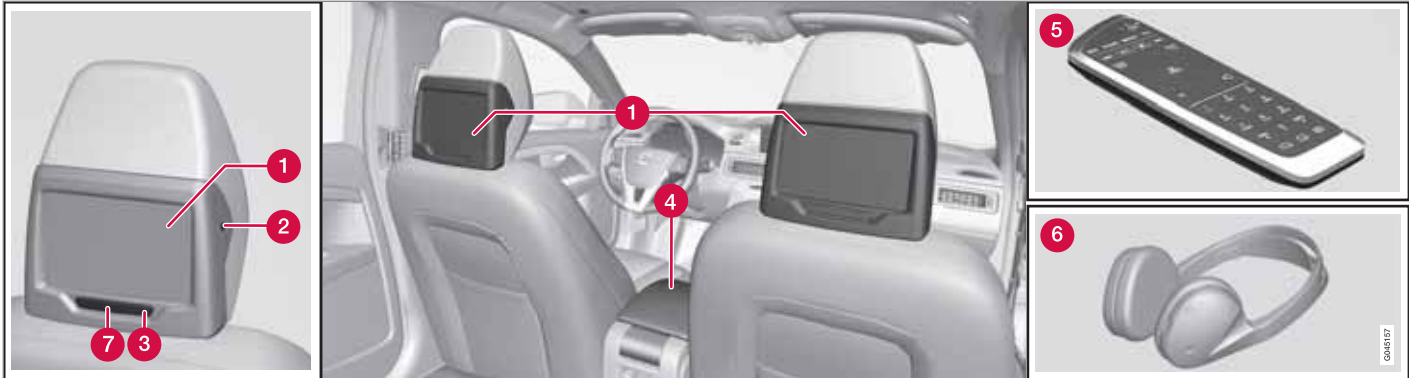

- 1 TV screen
- 2 Headphones socket
- 3 On/Off button
- 4 AV-AUX input
- 5 Remote control
- 6 Headphones
- 7 IR receiver/transmitter

General

The RSE system is a system for rear-seat entertainment that makes it possible to e.g. watch video, play music, listen to the radio, watch TV* or connect other external devices (e.g. a games console).

The RSE system is fully integrated with the car's infotainment system and can be used simultaneously with other functions of the infotainment system.

When the rear seat passengers are using e.g. AV-AUX or watching TV* while listening with headphones, the driver and front seat passenger can still use the car's radio or media player.

However, only one disc at a time can be played in the media player. It is possible to play back music from e.g. an iPod® or steaming audio files via Bluetooth®.

The RSE system can be controlled from the front TV screen (parental control).

It is possible to display or play back various media from different sources on each TV screen. It is also possible to display or play back media from the same source on one or more of the TV screens (front, right rear and left rear). It is not possible to play back video from

0616157



RSE - Rear Seat Entertainment system*

USB while a CD or DVD disc is being played back.

! IMPORTANT

When loading luggage and large objects in the vehicle, ensure that sufficient space is left for the TV screens in the head restraints, so that the TV screens are not scratched or damaged. Cover the TV screens with appropriate covering material during loading.

i NOTE

The TV screens and remote control do not work at very low or high temperatures - they only "come alive" after the climate control system has created an acceptable operating temperature in the passenger compartment.

i NOTE

Clean the lens on the IR receiver regularly with a damp cloth, a dirty lens affects remote control function.

Power consumption, ignition positions

The system can be activated in ignition position **I** or **II** and while the engine is running. When the car is being started the film stops temporarily and continues when the engine has started.

i NOTE

For prolonged use (more than 10 minutes) with the engine switched off, the capacity of the vehicle's battery may fall to such a low level that it is not possible to start the engine.

In this case a message will be displayed on the screen.

Menus

The menus for RSE are controlled using the remote control. For general information on menu navigation and menu structures, see page 270.

Remote control

The RSE system is equipped with a remote control. Using this it is possible to control the functions for each TV screen. The remote control can also be used to control other functions in the infotainment system, even from the rear seat.

For information on the remote control, see page 250.

Wireless headphones



- 1 Control for channel A (**CH.A**) or channel B (**CH.B**)
- 2 On/Off button
- 3 Volume
- 4 Indicator lamp On/Off

The RSE system includes two wireless headphones.

The wireless headphones are activated with the On/Off button (2), an indicator lamp illuminates (4). Select **CH.A** (channel A) or **CH.B** (channel B) using the control (1). Adjust the volume using the volume control (3).

The headphones are automatically switched off after about 3 minutes if they are not used.



RSE - Rear Seat Entertainment system*

Battery replacement in wireless headphones

The headphones are powered by two batteries of the AAA model.

Take along extra batteries for a long journey.



Wireless headphones.

1. Unscrew the screw and detach the battery cover.
2. Remove the used batteries, turn the new batteries in accordance with the symbols in the battery compartment and insert them.
3. Fit the cover and screw in the screw.

Environmental care

Be sure to dispose of the exhausted batteries in an environmentally safe manner.

Headphones socket

It is possible to connect external headphones via the headphones socket (3.5 mm) on the side of the head restraints, see the illustration on page 264. The volume is controlled using the remote control.

A/V-AUX input, Electrical socket 12 V

The input allows you to connect other equipment. Always follow the instructions included with the external equipment, or from the manufacturer or reseller, when connecting. Equipment connected via the A/V-AUX input can use the TV screens, wireless headphones, headphones sockets and the car's speakers.



NOTE

The customer is responsible that equipment connected to the A/V-AUX input or headphones socket does not cause interference in the vehicle's RSE system.

Connection of A/V-AUX input

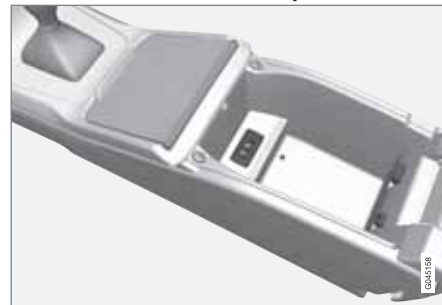

The A/V-AUX input is located under the armrest in the tunnel console.

1. Connect the video cable to the yellow socket.
2. Connect the left-hand audio cable to the white socket and the right-hand one to the red socket.
3. Connect the power cable to the electrical socket if your equipment is designed for 12 V.

Always follow the instructions for the external equipment when connecting.

There is a recess in the right-hand rear edge of the tunnel console where cables can be routed so that the hatch can be closed without cables being pinched.



RSE - Rear Seat Entertainment system*

For electrical socket location, see page 215

Playing back audio/video via the A/V-AUX input

1. Switch on the rear TV screen by means pressing the On/Off button on the TV screen.
2. Aim the remote control at the IR receiver on the TV screen and press repeatedly on **MEDIA** to the source **A/V AUX**, release and wait a few seconds and the selection is accepted.
3. Switch on the connected device and press **PLAY** or equivalent on the connected device.

Input volume

The input volume is adjusted in the menu under **A/V AUX input volume**.

To activate the system

The RSE system can be activated from either the front or rear TV screen.

From the front TV screen, press **MEDIA** and select **RSE**.

From the rear TV screen, by means of pressing the On/Off button on the rear TV screen and then pressing **MEDIA** or **RADIO** on the remote control and selecting a source (e.g. **Disc**).

Settings from the front TV screen

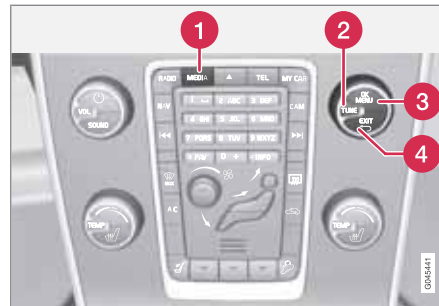

- 1 **MEDIA**
- 2 **TUNE**
- 3 **OK/MENU**
- 4 **EXIT**

Selection of source in the rear TV screens

From the front TV screen it is possible to select the source (what shall be displayed or played back) for the right and left-hand rear TV screens respectively. It is possible select the same source for both or different sources for the right and left-hand TV screens respectively.

1. Press on **MEDIA**, press repeatedly in order to scroll to **RSE** on the TV screen, release

and wait a second and the selection is accepted automatically.

2. Turn **TUNE** to select the right, left-hand or both TV screens, and confirm with **OK/MENU**.
3. Turn **TUNE** to select **RADIO**, **MEDIA** (or **RSE settings**). Press **OK/MENU** to confirm.
4. Turn **TUNE** to the desired source (e.g. **Disc**) and confirm with **OK/MENU**. The selected source will start automatically (if e.g. a disc is in the media player).

Cancel and go back with **EXIT**.

The remote control can also be used for settings. For more information on the remote control, see page 250.

Parental control for the TV*

It is possible to set a permitted age limit for the TV, so that only programmes for the appropriate age can be viewed. The setting is activated for both TV screens.

Activate under **RSE settings** → **TV parental control**, in accordance with point 2-4 in the section "Selection of source in the rear TV screens", see page 267. Choose between **Age 0-6**, **Age 7-13**, **Age 14-18** and **No parental control**.



RSE - Rear Seat Entertainment system*

Audio off

It is possible to mute the two rear TV screens from the front TV screen. The function is activated under **RSE settings** → **Mute**, in accordance with point 2-4 in the section "Selection of source in the rear TV screens", see page 267.

TV screen off

It is possible to switch off the video for the two rear TV screens from the front TV screen. The function is activated under **RSE settings** → **Display off**, in accordance with point 2-4 in the section "Selection of source in the rear TV screens", see page 267.

Press one of the remote control's numeric keys (**0 - 9**) to switch on the TV screen again. The TV screen is also switched to the **On** mode when the ignition is switched on.

Switching off the remote control (front)

It is possible to switch off the IR receiver for the front TV screen, which means that the remote control cannot be used for the front TV screen. The function is activated under **RSE settings** → **Disable remote control (front)**, in accordance with point 2-4 in the section "Selection of source in the rear TV screens", see page 267.

TV screen settings¹ rear TV screen

When playing back video files and displaying TV* a pop-up menu is available by means of pressing **OK MENU** on the remote control. The pop-up menu has different content depending on what is being played back or displayed.

Day/Night mode

The TV screen can be set in three different modes for different light conditions. Choose between **Auto**, **Day** and **Night**.

Press **OK MENU** on the remote control and change the mode under **Day/Night mode** on the TV screen. For general information on menu navigation and menu structures, see page 270.

Picture settings

You can adjust the settings for brightness, contrast, shade and colour.

Press **OK MENU** on the remote control and change the mode under **Image settings** on the TV screen. For general information on menu navigation and menu structures, see page 270.

Display format

It is possible to choose between display formats **Normal**, **Zoom** and **Screen fit**.

Normal - The image is shown in its normal mode (normally 4:3 or 16:9 format).

Zoom - Full screen used but parts of the image are cut off.

Screen fit - Full screen used but image proportions may be slightly distorted.

Unless otherwise stated the image is displayed in the screen format **Normal**.

Press **OK MENU** on the remote control and change the mode under **Screen format** on the TV screen. For general information on menu navigation and menu structures, see page 270.

Source menu

What is shown in the pop-up menu for the source menu depends on what is being played back or displayed, it can be e.g. **Disc menu** or **USB menu**. For general information on menu navigation and menu structures, see page 270.

DVD disc's menu²

If a DVD video disc is played back then this menu option is shown in the pop-up menu. For general information on menu navigation and menu structures, see page 270.

¹ Only available for playing back video files and displaying TV*.

² Only applies to DVD video discs.

**RSE - Rear Seat Entertainment system*****Menu settings from the rear TV screen**

For general information on menu navigation and menu structures, see page 270.

Random³

See page 239.

Repeat folder⁴

See page 239.

DivX® Video On Demand⁴

The media player can be registered in order to play DivX VOD type files from burned discs or USB. The code for registration is available in disc mode or USB mode under **DivX® VOD code**. For more information visit www.divx.com/vod.

USB hub

It is possible to connect a USB hub to the USB connection, see page 242.

TV settings***Searching TV channels/Preset list**

See page 248.

Save the available TV channels as presets

See page 249.

Scanning the TV channels

See page 249.

Music, video, radio and TV***Playing back music**

It is possible to play back music from disc tracks/audio files via the car's media player, USB port/AUX input or via streaming audio files from a Bluetooth®-connected phone.





**NOTE**

The system only supports one iPod® user at a time in the navigation mode (playlist).

For more information about media players, USB/AUX and Media Bluetooth®, see the pages 237, 241 and 244.

1. Switch on the wireless headphones, select **CH.A** for left-hand screen or **CH.B** for right-hand screen.
2. Aim the remote control at the IR receiver on the TV screen, press repeatedly on **MEDIA** to the desired source (**Disc**, **USB**, **AUX** etc.), release and wait a few seconds and the selection is accepted.
3. Insert a CD disc in the car's media player or connect an external audio source via the car's USB port/AUX input or via Bluetooth®.

Playback and navigation in playlists

Rotate the scroll wheel on the remote control to access the playlist/folder structure.  either gives confirmation of subfolder selection or starts playing back the selected disc track/audio file. It is also possible to play back the disc track/audio file using  on the remote control and change the disc tracks/audio file using  / . Stop playback using .

For more information, see page 237.

³ Applies to CD-Audio, CD/DVD discs, USB and iPod®.

⁴ Applies to CD/DVD discs and USB.



RSE - Rear Seat Entertainment system*





Watching video

It is possible to watch video from disc tracks/video files via the car's media player or USB port.







For more information about media players and USB, see the pages 237 and 241.





1. Switch on the wireless headphones, select **CH.A** for left-hand screen or **CH.B** for right-hand screen.
2. Aim the remote control at the IR receiver on the TV screen, press repeatedly on **MEDIA** to the desired source (**Disc** or **USB**), release and wait a few seconds and the selection is accepted.
3. Insert a DVD disc in the car's media player or connect an external source via the car's USB port.

Playback and navigation

Play back disc track/video file using  on the remote control and change disc track/video file using  /  . Stop playback using  . For more information about playback and navigation of DVD video discs, see page 239 and for video files, see page 237.



Fast forward/reverse

Start fast forward/rewind by means of a long press on the buttons  /  . Then increase fast forward/rewind speed by short presses the buttons. Audio files are fast forward/reward at one speed, while video files can be fast forwarded/rewound at four different speeds. Fast forward/rewind is stopped by pressing  -,  - or the equivalent opposite  /  button.

warded/reward at one speed, while video files can be fast forwarded/rewound at four different speeds. Fast forward/rewind is stopped by pressing  -,  - or the equivalent opposite  /  button.

Listening to radio



It is possible to listen to radio via the car's radio.

1. Switch on the wireless headphones, select **CH.A** for left-hand screen or **CH.B** for right-hand screen.
2. Aim the remote control at the IR receiver on the TV screen, press repeatedly on **RADIO** to the desired source (**AM**, **FM1**, **DAB1*** etc.), release and wait a few seconds and the selection is accepted.
3. Select a station with one of the preset buttons (**0 - 9**) on the remote control or press  /  , the radio will search for the next/previous available station.

For more information on the radio, see page 230.

Watching TV*

It is possible to watch TV via the car's media player.

1. Switch on the wireless headphones, select **CH.A** for left-hand screen or **CH.B** for right-hand screen.
2. Aim the remote control at the IR receiver on the TV screen, press repeatedly on **MEDIA** to **TV**, release and wait a few seconds and the selection is accepted.
3. Select a channel with one of the preset buttons (**0 - 9**) on the remote control or press  /  , the next/previous channel available in the area is displayed.

For more information on the TV, see page 247.

Menu navigation RSE

General

The RSE menus are operated both from the front TV screen, and from either of the rear TV screens. From the front TV screen it is possible to both activate a source for a rear TV screen, and to make certain settings for the two rear TV screens.

**RSE - Rear Seat Entertainment system*****RSE menus front TV screen**

To access the menu **RSE** must first be selected under **MEDIA** via the front TV screen. Then press **OK/MENU** to access the menu. Turn **TUNE** to the desired selection and confirm with **OK/MENU**. The remote control and steering wheel keypad can also be used.

It is possible to make settings for either right or left-hand TV screen or both TV screens.

Left RSE screen menu, Right RSE screen menu and Both RSE screen menus:

- Power off/Power on
- RADIO
- MEDIA
- RSE settings
 - Mute
 - Display off
 - Disable remote control (front)
 - TV parental control
 - Reset all RSE settings

Pop-up menu RSE⁵

Press **OK/MENU** on the remote control when a video file is being played back or the TV* is being displayed in order to access the pop-up menu. Menu selections are made using the scroll wheel and the buttons on the remote control. For information on the remote control, see page 250.

- Screen format
- Image settings
- Day/Night mode
- Source menu⁶
- DVD disc menu⁷

RSE menus rear TV screens

Press **OK/MENU** on the remote control when a source (e.g. **Disc**) is selected in order to access the RSE menu for the rear TV screen.

Menu selections are made using the scroll wheel and the buttons on the remote control. For information on the remote control, see page 250.

RADIO

Menu valid for **AM, FM1, FM2, DAB1*** and **DAB2***:

- Day/Night mode
- Display off
- Reset all RSE settings

MEDIA**RSE CD Audio menu****Disc menu**

- Random
- Day/Night mode
- Display off
- Reset disc settings

RSE CD/DVD Data menu**Disc menu**

- Random
- Repeat folder
- DivX® VOD code
- Day/Night mode

⁵ Only applies when playing back videos or displaying TV*.

⁶ What is shown in the pop-up menu for the source menu depends on what is being played back or displayed, it can be e.g. Disc menu or USB menu.

⁷ Only applies to DVD video discs.





RSE - Rear Seat Entertainment system*

- Display off
- Reset disc settings

RSE DVD Video menu

Disc menu

- DVD disc menu
- Subtitles
- Audio tracks
- Advanced settings
- Day/Night mode
- Display off
- Reset disc settings

RSE USB menu

USB menu

- Random
- Repeat folder
- DivX® VOD code
- Select USB device
- Day/Night mode
- Display off
- Reset USB settings

RSE AUX menu

AUX menu

- AUX input volume
- Day/Night mode
- Display off
- Reset AUX settings

RSE A/V-AUX menu

A/V AUX menu

- A/V AUX input volume
- Day/Night mode
- Display off
- Reset AUX settings

RSE iPod menu

iPod menu

- Random
- Day/Night mode
- Display off
- Reset iPod settings

RSE Bluetooth® menu

Bluetooth menu

- Random
- Day/Night mode

- Display off
- Reset Bluetooth settings

RSE TV menu*

TV menu

- Select country
- Autostore
- Scan
- Day/Night mode
- Display off
- Reset TV settings



Menu navigation, Infotainment

To navigate in the menus

The infotainment system's functions are controlled via the system's menus. Each source in the infotainment system (e.g. **RADIO**, **MEDIA**) has its own separate menus. In order to access the menus and activate a function a source must first have been selected (e.g. **RADIO/FM1**). Then press **OK/MENU** for access into the menu for the selected source.

The menu options are selected by means of the buttons in the centre console or via the steering wheel keypad*. The functions are described under their respective sections.

Controls in the centre console



- 1 **RADIO**
- 2 **MEDIA**
- 3 **TEL**
- 4 **TUNE**
- 5 **OK/MENU**

Search paths

The search paths to the menu functions are specified in the owner's manual with the form:

Audio settings → **Equalizer**, which requires that the following is carried out beforehand:

1. Select a source by pressing one of the buttons (e.g. **RADIO**, **MEDIA** etc.). Continue to press in order to scroll down among the options on the TV screen (e.g. **FM1**), release and wait a second and the selection is accepted automatically. Alternatively, turn **TUNE** and confirm with **OK/MENU**.
2. Press **OK/MENU** and turn **TUNE**, or use the thumbwheel* on the steering wheel keypad to reach the desired menu option e.g. **Audio settings** and press **OK/MENU**.
3. Turn **TUNE** again to reach the desired sub-menu, e.g. **Equalizer**, and press **OK/MENU**.

Menus **RADIO**

Main menu **AM** AM menu

Show presets¹

Scan

¹ Only applies to High Performance Multimedia and Premium Sound Multimedia.



Menu navigation, Infotainment

- Audio settings²
 - Sound stage³
 - Equalizer⁴
 - Volume compensation
 - Reset all audio settings

Main menu FM1/FM2

FM menu

- TP
- Show radio text
- Show presets¹
- Scan
- News settings
- Advanced settings
 - REG
 - Alternative frequency
 - EON
 - Set TP favourite
 - PTY settings

Reset all FM settings

Audio settings⁵

Main menu DAB1*/DAB2*

DAB menu

- Ensemble learn
- PTY filtering
 - Turn off PTY filtering
- Show radio text
- Show presets¹
- Scan
- Advanced settings
 - DAB linking
 - DAB band
 - Sub channels
 - Show PTY text
 - Reset all DAB settings
- Audio settings⁵

Menus MEDIA

Main menu CD Audio

Disc menu

- Random
- Scan
- Audio settings⁵

Main menu CD/DVD¹ Data

Disc menu

- Play/Pause
- Stop
- Random
- Repeat folder
- Change subtitle
- Change audio track
- Scan
- Audio settings⁵

² The menu options for audio settings are the same for all audio sources.

³ Only applies to Premium Sound Multimedia.

⁴ Does not apply to Performance.

¹ Only applies to High Performance Multimedia and Premium Sound Multimedia.

⁵ For submenus, see "Main menu AM".



Menu navigation, Infotainment

Main menu DVD¹ Video**Disc menu**

- DVD disc menu
- Play/Pause/Continue
- Stop
- Subtitles
- Audio tracks
- Advanced settings
 - Angle
 - DivX[®] VOD code
- Audio settings⁵

Main menu iPod⁴**iPod menu**

- Random
- Scan
- Audio settings⁵

Main menu USB⁴**USB menu**

- Play/Pause
- Stop
- Random
- Repeat folder
- Select USB device
- Change subtitle
- Change audio track
- Scan
- Audio settings⁵

Main menu Media Bluetooth⁴**Bluetooth menu**

- Random
- Change device
- Remove Bluetooth device
- Scan
- Bluetooth software version in car

Audio settings⁵**Main menu AUX****AUX menu**

- AUX input volume
- Audio settings⁵

Main menu TV***TV menu**

- Select country
- Reorganize presets
- Autostore
- Scan
- Audio settings⁵

Pop-up menu⁶ video and TV*

Press **OK/MENU** when a video file is being played back or TV* is being shown in order to access the pop-up menu.

Image settings

¹ Only applies to High Performance Multimedia and Premium Sound Multimedia.

⁵ For submenus, see "Main menu AM".

⁴ Does not apply to Performance.

⁶ Only applies when playing back videos or displaying TV*.





Menu navigation, Infotainment

Source menu⁷

DVD video menu⁸

DVD disc TOP menu⁸

Menus TEL

Main menu Bluetooth® handsfree⁴

Phone menu

All calls

All calls

Missed calls

Answered calls

Dialled calls

Call duration

Phone book

Search

New contact

Speed dials

Receive vCard

Memory status

Clear phone book

Change phone

Remove Bluetooth device

Phone settings

Discoverable

Sounds and volume

Phonebook download

Bluetooth software version in car

Call options

Auto answer

Voicemail number

Disconnect phone

⁷ What is shown in the pop-up menu for the source menu depends on what is being played back or displayed, it can be e.g. Disc menu or USB menu.

⁸ Only applies to DVD video discs.

⁴ Does not apply to Performance.



Recommendations during driving.....	280
Refuelling.....	283
Fuel.....	284
Loading.....	288
Cargo area	290
Driving with a trailer.....	291
Towing and recovery.....	297



06

DURING YOUR JOURNEY





Recommendations during driving

General

Economical driving

Driving economically means driving smoothly while thinking ahead and adjusting your driving style and speed to the prevailing conditions.

- Drive in the highest gear possible, adapted to the current traffic situation and road - lower engine speeds result in lower fuel consumption.
- Avoid driving with open windows.
- Avoid sudden unnecessary acceleration and heavy braking.
- Remove unnecessary items from the car - the greater the load the higher the fuel consumption.
- Use engine braking to slow down, when it can take place without risk to other road users.
- A roof load and ski box increase air resistance, leading to higher fuel consumption - remove the load carriers when not in use.
- Do not run the engine to operating temperature at idling speed, but rather drive with a light load as soon as possible - a cold engine consumes more fuel than a warm one.
- Cars with the D5 engine and 6-speed manual transmission or DRIVe engine and 6-speed manual transmission are started in

2nd gear under normal conditions on level ground.

For more information and further advice, see the pages 12 and 370.

WARNING

Never switch off the engine while moving, such as downhill, this deactivates important systems such as the power steering and brake servo.

Driving in water

The car can be driven through water at a maximum depth of 25 cm at a maximum speed of 10 km/h. Extra caution should be exercised when passing through flowing water.

During driving in water, maintain a low speed and do not stop the car. When the water has been passed, depress the brake pedal lightly and check that full brake function is achieved. Water and mud for example can make the brake linings wet resulting in delayed brake function.

- Clean the electric contacts of the electric engine block heater and trailer coupling after driving in water and mud.
- Do not let the car stand with water over the sills for any long period of time - this could cause electrical malfunctions.

IMPORTANT

Engine damage can occur if water enters the air filter.

In depths greater than 25 cm, water could enter the transmission. This reduces the lubricating ability of the oils and shortens the service life of these systems.

In the event of the engine stalling in water, do not try restart - tow the car from the water to a workshop - an authorised Volvo workshop is recommended. Risk of engine breakdown.

Engine, gearbox and cooling system

Under special conditions, for example hard driving in hilly terrain and hot climate, there is a risk that the engine and drive system may overheat - in particular with a heavy load.

For information about overheating when driving with a trailer, see page 291.

- Remove any auxiliary lamps from in front of the grille when driving in hot climates.
- If the temperature in the engine's cooling system is too high the instrument panel's warning symbol is illuminated and there is a text message displayed there **High engine temp Stop safely** - stop the car in a safe way and allow the engine to run at idling speed for several minutes to cool down.



Recommendations during driving

- If the text message **High engine temp Stop engine** or **Coolant level low, Stop engine** is shown then the engine must be switched off after stopping the car.
- In the event of overheating in the gearbox a built-in protection function is activated which, amongst other things, illuminates the instrument panel's warning symbol and there is a text message displayed there **Transmission hot Reduce speed** or **Transmission hot Stop safely** - follow the recommendation given and lower the speed and stop the car in a safe way and allow the engine to run at idling speed for a few minutes to allow the gearbox to cool down.
- If the car overheats, the air conditioning may be switched off temporarily.
- Do not turn the engine off immediately you stop after a hard drive.

NOTE

It is normal for the engine's cooling fan to operate for a while after the engine has been switched off.

Open boot lid

WARNING

Do not drive with the boot lid open. Toxic exhaust fumes can be drawn into the car through the cargo area.

Do not overload the battery

The electrical functions in the car load the battery to varying degrees. Avoid using the key position **II** when the engine is switched off. Instead use the **I** mode - which uses less power.

Also, be aware of different accessories that load the electrical system. Do not use functions which use a lot of power when the engine is switched off. Examples of such functions are:

- ventilation fan
- headlamps
- windscreen wiper
- audio system (high volume).

If the battery voltage is low the information display shows the text **Low battery Power save mode**. The energy-saving function then shuts down certain functions or reduces certain functions such as the ventilation fan and/or audio system.

- In which case, charge the battery by starting the engine and then running it for at

least 15 minutes - battery charging is more effective during driving than running the engine at idling speed while stationary.

Before a long journey

- Check that the engine is working normally and that fuel consumption is normal.
- Make sure that there are no leaks (fuel, oil or other fluid).
- Check all bulbs and tyre tread depths.
- Carrying a warning triangle is a legal requirement in certain countries.

Winter driving

Check the following in particular before the cold season:

- The engine coolant must contain at least 50% glycol. This mixture protects the engine against frost erosion down to approximately -35°C . To achieve optimum antifreeze protection, different types of glycol must not be mixed.
- The fuel tank must be kept filled to prevent condensation.
- Engine oil viscosity is important. Oils with lower viscosity (thinner oils) facilitate starting in cold weather and also reduce fuel consumption while the engine is cold. For more information on suitable oils, see page 367.



Recommendations during driving

IMPORTANT

Low viscosity oil must not be used for hard driving or in hot weather.

- The condition of the battery and charge level must be inspected. Cold weather places great demands on the battery and its capacity is reduced by the cold.
- Use washer fluid to avoid ice forming in the washer fluid reservoir.

To achieve optimum roadholding Volvo recommends using winter tyres on all wheels if there is a risk of snow or ice.

NOTE

The use of winter tyres is a legal requirement in certain countries. Studded tyres are not permitted in all countries.

Slippery driving conditions

Practise driving on slippery surfaces under controlled conditions to learn how the car reacts.



Refuelling

Refuelling

Opening/closing the fuel filler flap



Open the fuel filler flap using the button on the lighting panel - the flap opens when the button is released.

 The arrow on the information display's symbol reminds which side of the car the fuel filler cap is located.

- Close the fuel filler flap by pressing it in until a click confirms that it is closed.

Opening the fuel filler flap manually



The fuel filler flap can be opened manually when electric opening from the passenger compartment is not possible.

1. Open/remove the side hatch in the cargo area (same side as fuel filler flap) and locate the green cord with handle.
2. Pull the cord gently straight back until the fuel filler flap folds out with a "click".

 **IMPORTANT**

Pull the wire gently - minimal force is required to disengage the hatch lock.

Opening/closing the fuel cap

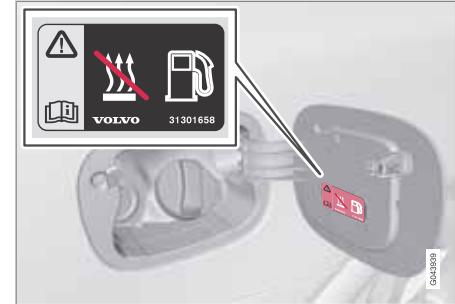

A certain overpressure may arise in the tank in the event of high outside temperatures. Open the cap slowly.

- After refuelling - refit the cap and turn it until one or more clicking sounds are heard.

Filling up with fuel

- Do not overfill the tank but fill until the pump nozzle cuts out.

 **NOTE**

Excess fuel in the tank can overflow in hot weather.



Fuel

General information on fuel

Fuel of a lower quality than that recommended by Volvo must not be used as engine power and fuel consumption is negatively affected.

WARNING

Always avoid inhaling fuel vapour and getting fuel splashes in the eyes.

In the event of fuel in the eyes, remove any contact lenses and rinse the eyes in plenty of water for at least 15 minutes and seek medical attention.

Never swallow fuel. Fuels such as petrol, bioethanol and mixtures of them and diesel are highly toxic and could cause permanent injury or be fatal if swallowed. Seek medical attention immediately if fuel has been swallowed.

WARNING

Fuel which spills onto the ground can be ignited.

Switch off the fuel-driven heater before starting to refuel.

Never carry an activated mobile phone when refuelling. The ring signal could cause spark build-up and ignite petrol fumes, leading to fire and injury.

IMPORTANT

Mixing different types of fuel or the use of fuel not recommended invalidates Volvo's guarantees, and any associated service agreement. This applies to all engines. NOTE: It does not apply to cars with engines that are adapted to run on ethanol fuel (E85).

NOTE

Extreme weather conditions, driving with a trailer or driving at high altitudes in combination with fuel grade are factors that could affect the car's performance.

Catalytic converters

The purpose of the catalytic converters is to purify exhaust gases. They are located close to the engine so that operating temperature is reached quickly.

The catalytic converters consist of a monolith (ceramic or metal) with channels. The channel walls are lined with a thin layer of platinum/rhodium/palladium. These metals act as catalysts, i.e. they participate in and accelerate a chemical reaction without being used up themselves.

Lambda-sond™ oxygen sensor

The Lambda-sond is part of a control system intended to reduce emissions and improve fuel economy.

An oxygen sensor monitors the oxygen content of the exhaust gases leaving the engine. This value is fed into an electronic system that continuously controls the injectors. The ratio of fuel to air directed to the engine is continuously adjusted. These adjustments create optimal conditions for efficient combustion, and together with the three-way catalytic converter reduce harmful emissions (hydrocarbons, carbon monoxide and nitrous oxides).

Petrol

Petrol must fulfil the EN 228 standard. Most engines can be run with octane ratings of 95 and 98 RON. Only in exceptional cases should 91 RON be used.

- 95 RON can be used for normal driving.
- 98 RON is recommended for optimum performance and minimum fuel consumption.

When driving in temperatures above +38 °C, fuel with the highest possible octane rating is recommended for optimum performance and fuel economy.

**Fuel****! IMPORTANT**

- Always refuel with unleaded petrol so as not to damage the catalytic converter.
- Do not use additives not recommended by Volvo.

Bioethanol E85

Do not modify the fuel system or its components, and do not replace components with parts that are not specifically designed for use with bioethanol.

! WARNING

Methanol must not be used. A decal on the inside of the fuel filler flap shows the correct alternative fuel.

The use of components not designed for bioethanol engines could cause fire, injury or engine damage.

Reserve fuel can

The reserve fuel can should be filled with petrol, see the NOTE box, page 113.

! IMPORTANT

Make sure the reserve fuel can is securely fastened and that its cap is sealed.

! WARNING

Ethanol is sensitive to sparks, and explosive gases could form in the reserve fuel can if it is refuelled with ethanol.

Diesel

Only use diesel fuel from well-known producers. Never use diesel of dubious quality. Diesel should fulfil the EN 590 or JIS K2204 standards. Diesel engines are sensitive to contaminants in the fuel, such as excessively high volumes of sulphur particles for example.

At low temperatures (-6 °C to -40 °C), a paraffin precipitate may form in the diesel fuel, which may lead to ignition problems. Special diesel fuel designed for low temperatures around freezing point is available from the major oil companies. This fuel is less viscous at low temperatures and reduces the risk of paraffin precipitate.

The risk of condensation in the fuel tank is reduced if the tank is kept well filled. When

refuelling, check that the area around the fuel filler pipe is clean. Avoid spilling fuel onto the paintwork. Wash off any spillage with detergent and water.

! IMPORTANT

Only ever use fuel that fulfils the European diesel standard.

The sulphur content must be a maximum of 50 ppm.

! IMPORTANT

Diesel type fuels that must not be used:

- Special additives
- Marine diesel fuel
- Heating oil
- FAME¹ (Fatty Acid Methyl Ester) and vegetable oil.

These fuels do not fulfil the requirements in accordance with Volvo recommendations and generate increased wear and engine damage that is not covered by the Volvo warranty.

Empty tank

The design of the fuel system in a diesel engine means that if the vehicle runs out of fuel, the

¹ Diesel fuel may contain a certain amount of FAME, but further amounts must not be added.



Fuel

tank may need to be vented in the workshop in order to restart the engine after fuelling.

Once the engine has stopped due to fuel starvation, the fuel system needs a few moments to carry out a check. Do this before starting the engine, once the fuel tank has been filled with diesel:

1. Insert the remote control key in the ignition switch and push it in to the end position (see page 77).
2. Press the **START** button **without** depressing the brake and/or clutch pedal.
3. Wait approx. 1 minute.
4. To start the engine: Depress the brake and/or clutch pedal and then press the **START** button again.

NOTE

Before filling with fuel in the event of fuel shortage:

- Stop the car on as flat/level ground as possible - if the car is tilting there is a risk of air pockets in the fuel supply.

Draining condensation from the fuel filter

The fuel filter separates condensation from the fuel. Condensation can disrupt engine operation.

The fuel filter must be drained at the intervals specified in the Service and Warranty Booklet or if you suspect that the car has been filled with contaminated fuel.

IMPORTANT

Certain special additives remove the water separation in the fuel filter.

Diesel particle filter (DPF)

Diesel cars are equipped with a particle filter, which results in more efficient emission control. The particles in the exhaust gases are collected in the filter during normal driving. So-called "regeneration" is started in order to burn away the particles and empty the filter. This requires the engine to have reached normal operating temperature.

Regeneration of the filter is automatic and normally takes 10-20 minutes. It may take a little longer at a low average speed. Fuel consumption may increase slightly during regeneration.

Regeneration in cold weather

If the car is frequently driven short distances in cold weather then the engine does not reach normal operating temperature. This means that regeneration of the diesel particle filter does not take place and the filter is not emptied.

When the filter has become approximately 80% full of particles, a warning triangle on the instrument panel illuminates, and the message **Soot filter full** See manual is shown on the instrument panel display.

Start regeneration of the filter by driving the car until the engine reaches normal operating temperature, preferably on a main road or motorway. The car should then be driven for approximately 20 minutes more.

NOTE

A smaller reduction of engine power may be noticed temporarily during regeneration.

When regeneration is complete the warning text is cleared automatically.

Use the parking heater* in cold weather so that the engine reaches normal operating temperature more quickly.

IMPORTANT

If the filter fills up with particles then it can be difficult to start the engine and the filter will be incapable of functioning. Then there is a risk that the filter will have to be replaced.



Fuel consumption and emissions of carbon dioxide

Fuel consumption figures may change if the car is equipped with extra equipment that affects the car's weight. See information on weights page 361 and table page 370.

The manner in which the car is driven, and other non-technical factors can also affect fuel consumption.

Consumption is higher and power output lower for fuel with an octane rating of 91 RON.



NOTE

Extreme weather conditions, driving with a trailer or driving at high altitudes in combination with fuel grade are factors that could affect the car's performance.



Loading

General information on loading

Payload depends on the car's kerb weight. The total of the weight of the passengers and all accessories reduces the car's payload by a corresponding weight. For more detailed information on weights, see page 361.



The boot lid is opened via a button on the lighting panel or the remote control key, see page 56.

WARNING

The car's driving characteristics change depending on the weight and distribution of the load.

To bear in mind when loading

- Position the load firmly against the rear seat's backrest.

Note that objects must not prevent the function of the WHIPS system for the front seats if any of the rear seat's backrests is folded down, see page 27.

- Centre the load.
- Heavy objects should be placed as low as possible. Avoid placing heavy loads on lowered backrests.
- Cover sharp edges with something soft to avoid damaging the upholstery.

- Secure all loads to the load retaining eyelets with straps or web lashings.

WARNING

A loose object weighing 20 kg can, in a frontal collision at a speed of 50 km/h, carry the impact of an item weighing 1000 kg.

WARNING

The protection provided by the inflatable curtain in the headlining may be compromised or eliminated by high loads.

- Never load cargo above the backrest.

WARNING

Always secure the load. During heavy braking the load may otherwise shift, causing injury to the car's occupants.

Cover sharp edges and sharp corners with something soft.

Switch off the engine and apply the parking brake when loading/unloading long items. Otherwise you may accidentally knock the gear lever or gear selector with the load into a drive position - and the car could then move off.

Front seat

The passenger seat backrest can also be folded for an extra long load, see page 79.

Roof load

Using load carriers

To avoid damaging the car and for maximum possible safety while driving, the load carriers designed by Volvo are recommended.

Carefully follow the installation instructions supplied with the carriers.

- Check periodically that the load carriers and load are properly secured. Lash the load securely with retaining straps.
- Distribute the load evenly over the load carriers. Put the heaviest objects at the bottom.
- The size of the area exposed to the wind, and therefore fuel consumption, increase with the size of the load.
- Drive gently. Avoid quick acceleration, heavy braking and hard cornering.

WARNING

The car's centre of gravity and driving characteristics are altered by roof loads. For information on maximum permitted roof load, including load carriers and any space box, see page 361.



Loading

Lowering the rear seat backrest

If the rear seat backrest needs to be lowered, see page 81.

Load retaining eyelets



The folding load retaining eyelets¹ are used to fasten straps in order to anchor items in the cargo area.

! WARNING

Hard, sharp and/or heavy objects that are loose or protrude could cause injury during heavy braking. Always secure large and heavy objects with a seatbelt or cargo retaining straps.

¹ Number of eyes and their location varies depending on market.

Bag holder*



Bag holder under folding hatch in the floor.

The bag holder keeps carrier bags in place and prevents them from overturning and spreading their contents across the cargo area.

1. Fold up the holder, which is part of the floor hatch.
2. Fasten the bags with strap and secure the carrying handle in the hooks.

12 V electrical socket*



Raise the cover to access the electrical socket.

- The socket also provides voltage when the remote control key is not in the ignition switch.

i NOTE

Remember that using the electrical socket with the engine switched off involves the risk of discharging the car's battery.



Cargo area

Ski hatch

The hatch in the backrest can be opened to transport long narrow items.



- 1 Fold the right-hand backrest forward.
- 2 Release the hatch in the rear seat backrest by sliding the bolt up while pressing the hatch down/forward.
- 3 Fold back the backrest with the hatch open.

Use the seatbelt to prevent the load from moving.

WARNING

Stop the engine and apply the parking brake when loading and unloading. Otherwise the gear lever/selector can accidentally be knocked and moved to a driving position.

Removing the hatch

After the hatch has been released and the backrest folded backwards, open the hatch approx. 30 degrees and pull it straight up.

Attaching the hatch

Refit the hatch in the grooves behind the upholstery and close the hatch.



Driving with a trailer

General

Payload depends on the car's kerb weight. The total of the weight of the passengers and all accessories, e.g. towbar, reduces the car's payload by a corresponding weight. For more detailed information on weights, see page 361.

If the towing bracket is mounted by Volvo, then the car is delivered with the necessary equipment for driving with a trailer.

- The car's towing bracket must be of an approved type.
- If the towbar is retrofitted, check with your Volvo dealer that the car is fully equipped for driving with a trailer.
- Distribute the load on the trailer so that the weight on the towing bracket complies with the specified maximum towball load.
- Increase the tyre pressure to the recommended pressure for a full load. For tyre pressure label location, see page 309.
- The engine is loaded more heavily than usual when driving with a trailer.
- Do not tow a heavy trailer when the car is brand new. Wait until it has been driven at least 1000 km.
- The brakes are loaded much more than usual on long and steep downhill slopes. Downshift to a lower gear and adjust your speed.

- For safety reasons, the maximum permitted speed for the car when coupled with a trailer should not be exceeded. Follow the regulations in force for the permitted speeds and weights.
- Maintain a low speed when driving with a trailer up long, steep ascents.
- Avoid driving with a trailer on inclines of more than 12%.

Trailer cable

An adapter is required if the car's towing bracket has 13 pin electrics and the trailer has 7 pin electrics. Use an adapter cable approved by Volvo. Make sure the cable does not drag on the ground.

Direction indicators and brake lights on the trailer

If any of the trailer's lamps for direction indicators are broken, then the combined instrument panel's symbol for direction indicators flashes faster than normal and the display shows the text **Bulb fail - Ind. signal trailer**.

If any of the trailer's lamps for the brake light are broken then the **Bulb fail - Stop lamp trailer** text is shown.

Level control*

The rear shock absorbers maintain a constant height irrespective of the car's load (up to the maximum permissible weight). When the car is

stationary the rear of the car lowers slightly, which is normal.

Trailer weights

For information on Volvo's permitted trailer weights, see page 361.

NOTE

The stated maximum permitted trailer weights are those permitted by Volvo. National vehicle regulations can further limit trailer weights and speeds. Towbars can be certified for higher towing weights than the car can actually tow.

WARNING

Follow the stated recommendations for trailer weights. Otherwise, the car and trailer may be difficult to control in the event of sudden movement and braking.

Manual gearbox

Overheating

When driving with a trailer in hilly terrain in a hot climate there may be a risk of overheating.

- Do not run the engine at higher revolutions than 4500 rpm (diesel engines: 3500 rpm) - otherwise the oil temperature may become too high.



Driving with a trailer

Diesel engine 5-cyl

- In the event of a risk of overheating the optimal speed for the engine is 2300-3000 rpm for optimal circulation of the coolant.

Automatic gearbox

Overheating

When driving with a trailer in hilly terrain in a hot climate there may be a risk of overheating.

- An automatic gearbox selects the optimum gear related to load and engine speed.
- In the event of overheating a warning symbol illuminates on the instrument panel combined with a text message - follow the recommendation given.

Steep inclines

- Do not lock the automatic transmission in a higher gear than the engine "can cope with" - it is not always a good idea to drive at a high gear with low engine revolutions.

IMPORTANT

See also the specific information on slow driving with trailer for cars with the Powershift automatic transmission on page 119.

Parking on a hill

1. Depress the foot brake.

2. Activate the parking brake.
3. Move the gear selector to position **P**.
4. Release the foot brake.
 - Move the gear selector to park position **P** when parking an automatic car with a hitched trailer. Always use the parking brake.
 - Block the wheels with chocks when parking a car with hitched trailer on a hill.

Starting on a hill

1. Depress the foot brake.
2. Move the gear selector to driving position **D**.
3. Release the parking brake.
4. Release the foot brake and start driving off.

Towing bracket

If the car is equipped with a detachable towbar, the installation instructions for the loose section must be followed carefully, see page 294.

WARNING

If the car is fitted with a Volvo detachable towbar:

- Follow the installation instructions carefully.
- The detachable section must be locked with the key before setting off.
- Check that the indicator window shows green.

Important checks

- The towbar's towball must be cleaned and greased regularly.

NOTE

If a towball hitch with vibration damper is used, it is not necessary to grease the towball.



Driving with a trailer

Storing the detachable towbar



Towbar storage space.

! **IMPORTANT**

Always remove the towbar after use and store it in the appointed location in the car, firmly fastened with its strap.

Specifications

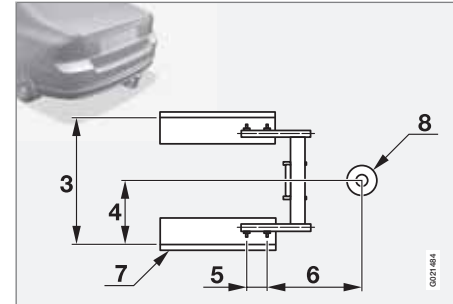
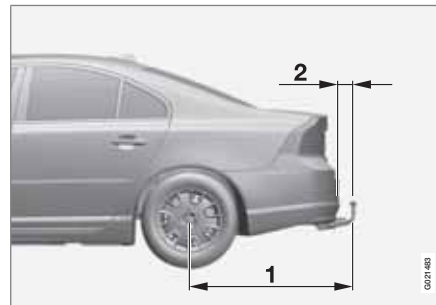

Dimensions, mounting points (mm)

1	1127
2	93
3	855
4	428
5	112
6	360
7	Side member
8	Ball centre



Driving with a trailer

Attaching the towbar



1 Remove the protective cover by first pressing in the catch **1** and then pulling the cover straight back **2**.



2 Ensure that the mechanism is in the unlocked position by turning the key clockwise.



3 The indicator window must show red.



4 Insert the towbar until you hear a click.



5 The indicator window must show green.



6 Turn the key anticlockwise to locked position. Remove the key from the lock.



Driving with a trailer



- 7 Check that the towbar is secure by pulling it up, down and back.

! WARNING

If the towbar is not fitted correctly then it must be detached and reattached in accordance with the previous instructions.

! IMPORTANT

Only grease in the ball for the towing hitch, the remainder of the towbar should be clean and dry.



- 8 Safety cable.

! WARNING

Be sure to attach the trailer's safety cable to the correct place.

Removing the towbar



- 1 Insert the key and turn it clockwise to the unlocked position.



- 2 Push in the locking wheel **1** and turn it anticlockwise **2** until you hear a click.



- 3 Turn the locking wheel down fully, until it comes to a stop. Hold it in this position while pulling the towbar rearward and upward.

! WARNING

Secure the towbar safely if it is stored in the car, see page 293.



Driving with a trailer



- 4 Push the protective cover until it snaps tight.

**Towing and recovery****Towing**

Find out the statutory maximum speed limit for towing before towing begins.

1. Unlock the steering lock by inserting the remote control key in the ignition switch and giving a long press on the **START/STOP ENGINE** button - key position **II** is activated, see page 77 for more information on key positions.
2. The remote control key must remain in the ignition switch while the car is being towed.
3. Keep the towline taut when the towing vehicle reduces speed by holding your foot gently pressed on the brake pedal - thereby avoiding unnecessary jerking.
4. Be prepared to brake to stop.

WARNING

- Check that the steering lock is unlocked before towing.
- The remote control key must be in key position **II** - in position **I** all airbags are deactivated.
- Never remove the remote control key from the ignition switch when the car is being towed.

WARNING

The brake servo and power steering do not work when the engine is switched off - the brake pedal needs to be depressed about 5 times more heavily and the steering is considerably heavier than normal.

Manual gearbox

Prior to towing:

- Move gear lever into neutral and release the parking brake.

Automatic gearbox Geartronic**IMPORTANT**

Note that the car must always be towed with the wheels rolling forward.

- Cars with automatic gearbox must not be towed at speeds above 80 km/h or further than 80 km.

Prior to towing:

- Move the gear selector to position **N** and release the parking brake.

Automatic gearbox Powershift

The model with Powershift transmission should not be towed as it is dependent on the engine running in order to receive sufficient

lubrication. If towing still has to take place, the route must be as short as possible and then with very low speed.

In the event of uncertainty as to whether or not the car is equipped with Powershift transmission, this can be verified by checking the designation on the decal number (5) under the bonnet - see page 358. The designation "MPS6" means that it is Powershift transmission - otherwise it is Geartronic automatic transmission.

IMPORTANT

Avoid towing.

- However, the car can be towed for a short distance at low speed to move it from a dangerous position - not further than 10 km and not faster than 10 km/h. Note that the car must always be towed with the wheels rolling forward.
- In the event of moving a longer distance than 10 km, the car must be transported with the drive wheels raised from the road - professional recovery is recommended.

Prior to towing:

- Move the gear selector to position **N** and release the parking brake.



Towing and recovery

Jump starting

Do not tow the car to bump start the engine. Use a donor battery if the battery is discharged and the engine does not start, see page 115.

! IMPORTANT

The catalytic converter may be damaged during attempts to tow-start the engine.

Towing eye

The towing eye is screwed into a threaded socket behind a cover on the right-hand side of the bumper, front or rear.

Attaching the towing eye

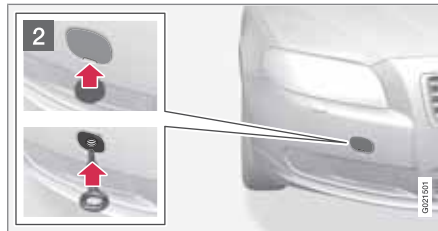
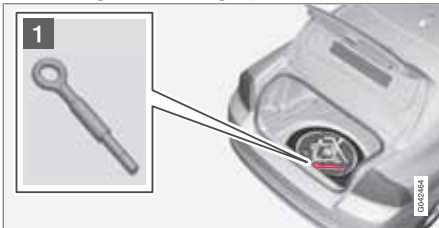

- 1 Take out the towing eye that is located under the floor hatch in the cargo area.
- 2 The cover for the towing eye's attachment point is available in two variants which must be opened in different ways:
 - Open the variant with a recess using a coin or similar inserted in the recess, turning it outwards. Then turn out the cover completely and remove it.
 - The second variant has a marking along one side or in a corner: Press the marking with a finger and fold out the opposite side/corner at the same time using a coin or similar - the cover turns around its axis and can then be removed.

Screw the towing eye right in up to its flange. Turn in the towing eye firmly e.g. using the wheel wrench.

After use, unscrew the towing eye and return it to its place.

Finish by refitting the cover onto the bumper.

! IMPORTANT

The towing eye is only designed for towing on roads - **not** for pulling the car unstuck or out of a ditch. Call a recovery service for recovery assistance.

i NOTE

On certain cars with towbar fitted the towing eye cannot be attached in the rear bracket. Attach the towrope in the towbar.

For this reason it is advisable to store the detachable towbar's towball in the car.

Recovery

Call a recovery service for recovery assistance.

! IMPORTANT

Note that the car must always be transported with the wheels rolling forward.

- An All Wheel Drive car (AWD) with raised front suspension must not be towed at speeds above 70 km/h. It should not be towed further than 50 km.



General	302
Changing wheels	306
Tyre pressure	309
Warning triangle and first-aid kit*	310
Emergency puncture repair (TMK)*	311

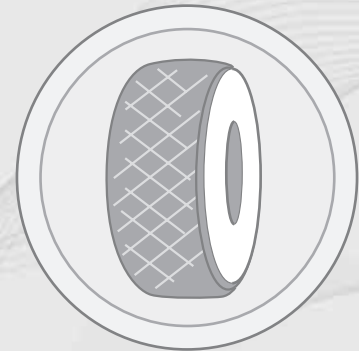

07

WHEELS AND TYRES

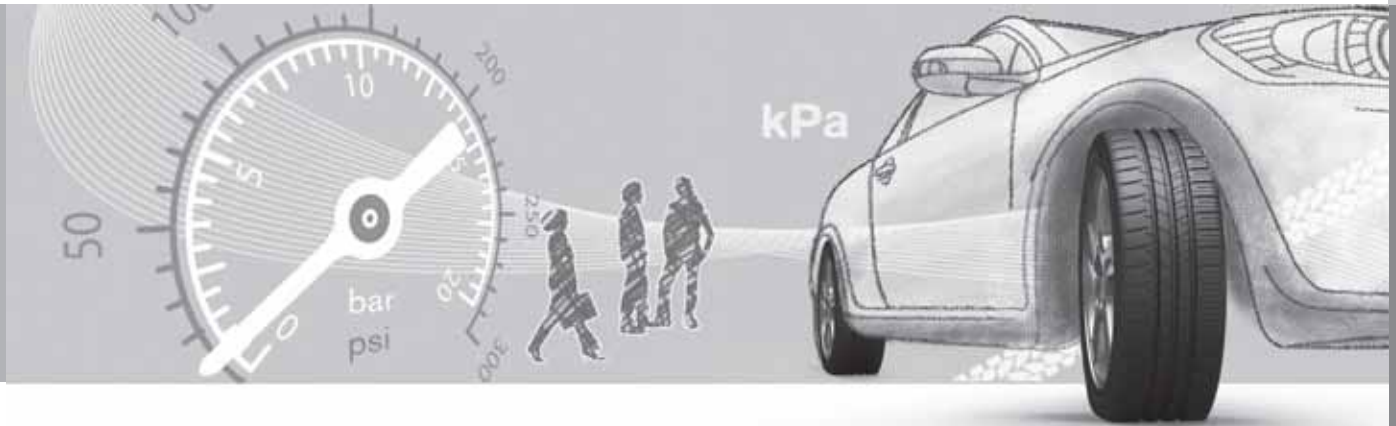



General

Driving characteristics

Tyres greatly affect the car's driving characteristics. The type of tyre, dimensions, tyre pressure and speed rating are important for how the car performs.

Direction of rotation

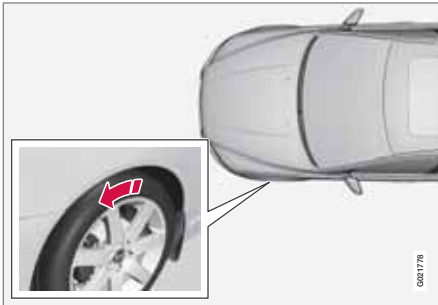

The arrow shows the tyre's direction of rotation.

Tyres with a tread pattern which are designed to only turn in one direction have the direction of rotation marked with an arrow. The tyre must always rotate in the same direction throughout its lifespan. Tyres should only be switched between front and rear positions, never between left and right-hand sides, or vice versa. If the tyres are fitted incorrectly, the car's braking characteristics and capacity to force rain and slush out of the way are adversely affected.

Tyres with the greatest tread depth should always be fitted to the rear of the car (to decrease the risk of skidding).

i NOTE

Ensure that tyres of the same type and dimensions, and also the same make, are fitted to all four wheels.

Follow the recommended tyre pressures specified in the tyre pressure table, see page 373.

Tyre care

Tyre age

All tyres older than 6 years old should be checked by an expert even if they seem undamaged. Tyres age and decompose, even if they are hardly ever or never used. The function can therefore be affected. This applies to all tyres that are stored for future use. Examples of external signs which indicate that the tyre is unsuitable for use are cracks or discoloration.

New tyres

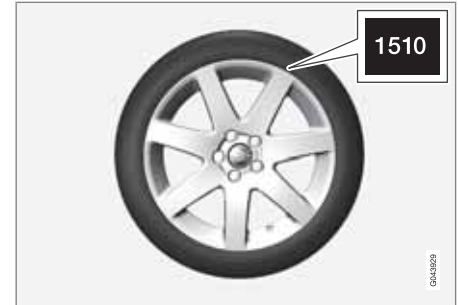

Tyres are perishable. After a few years they begin to harden at the same time as the friction capacity/characteristics gradually deteriorate. For this reason, aim to get as fresh tyres as possible when you replace them. This is especially important with regard to winter tyres. The last four digits in the sequence mean the week and year of manufacture. This is the tyre's DOT marking (Department of Transportation), and this is stated with four digits, for example 1510. The tyre in the illustration was manufactured in week 15 of 2010.

Summer and winter tyres

When summer and winter wheels are changed the wheels should be marked with which side of the car they were mounted on, for example **L** for left and **R** for right.



General

Wear and maintenance

The correct tyre pressure results in more even wear, see page 309. Driving style, tyre pressure, climate and road condition affect how quickly your tyres age and wear. To avoid differences in tread depth and to prevent wear patterns arising, the front and rear wheels can be switched with each other. A suitable distance for the first change is approx. 5000 km and then at 10 000 km intervals. Volvo recommends that you contact an authorised Volvo workshop for checking if you are uncertain about tread depth. If significant differences in wear (>1 mm difference in tread depth) between tyres have already occurred, the least worn tyres must always be placed on the rear. Understeer is normally easier to correct than oversteer, and leads to the car continuing forwards in a straight line rather than having the rear end skidding to one side, resulting in possible complete loss of control over the car. This is why it is important for the rear wheels never to lose grip before the front wheels.

Wheels should be stored lying down or hanging up - and not standing up.

WARNING

A damaged tyre can lead to loss of control of the car.

Tyres with tread wear indicators

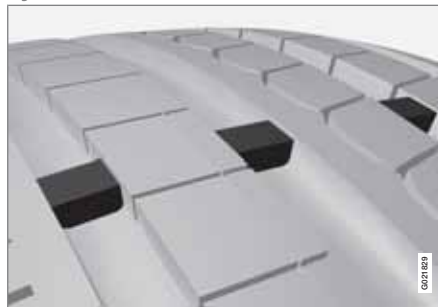

Tread wear indicators.

Tread wear indicators are narrow treadless bands across the width of the tread. On the side of the tyre are the letters **TWI** (Tread Wear Indicator). When the tyre's tread depth is down to 1.6 mm, the tread depth will be level in height with the tread wear indicators. Change to new tyres as soon as possible. Remember that tyres with little tread depth provide very poor grip in rain and snow.

Rims and wheel bolts

IMPORTANT

The wheel bolts must be tightened to 140 Nm. Overtightening can damage the nuts and the bolts.

Only use rims that are tested and approved by Volvo and which are Volvo genuine accessories. Check the torque with a torque wrench.

Locking wheel bolts*

Locking wheel bolts* can be used on both aluminium and steel rims. Under the cargo area floor there is space for the sleeve for the lockable wheel bolts.

Tools

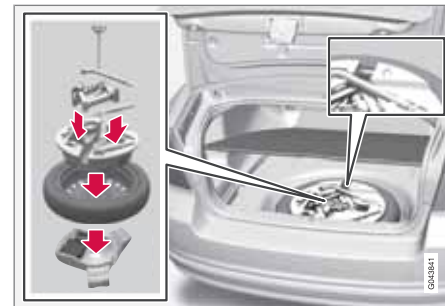

Located under the cargo area floor are the car's towing eye, jack* and wheel wrench*. There is also space for the sleeve for the lockable wheel bolts.

* Option/accessory, for more information, see Introduction.



07 Wheels and tyres

General

Jack*

The original jack should only be used for changing to the spare wheel. The jack's thread must always be well greased.

Tools - returning into place

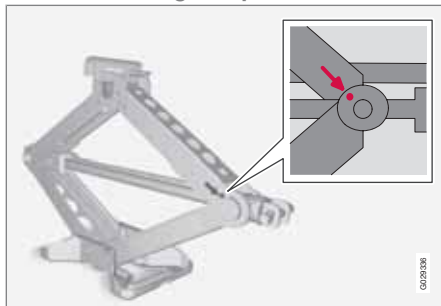

The tools and jack* must be returned to their correct places after use. The jack needs to be cranked together to the correct position in order to have space.

The foam block and spare wheel are replaced in the reverse order to taking out.

Note that there is an arrow on the upper foam block. It must point forwards in the car.

! IMPORTANT

The tools and jack* must be stored in the intended location in the car's cargo area when not in use.

Winter tyres

Volvo recommends winter tyres with particular dimensions. Tyre dimensions are dependent on engine variant. When driving on winter tyres, the correct type of tyres must be fitted to all four wheels.

i NOTE

Volvo recommends that you consult a Volvo dealer about which wheel rim and tyre types are most suitable.

Studded tyres

Studded winter tyres should be run in gently for 500-1000 km so the studs settle properly into the tyres. This gives the tyre, and especially the studs, a longer service life.

i NOTE

The legal provisions for the use of studded tyres vary from country to country.

Tread depth

Road conditions with ice, slush and low temperatures place considerably higher demands on tyres than summer conditions. Volvo therefore recommends not to drive on winter tyres that have a tread depth of less than 4 millimetres.

Using snow chains

Snow chains may only be used on the front wheels (also applies to all-wheel drive cars).

Never drive faster than 50 km/h with snow chains. Avoid driving on bare ground as this wears out both the snow chains and tyres.

! WARNING

Use Volvo genuine snow chains or equivalent chains designed for the car model, and tyre and rim dimensions. In the event of uncertainty Volvo recommends that you consult an authorised Volvo workshop. The wrong snow chains may cause serious damage to your car and lead to an accident.

Specifications

The car has whole vehicle approval. This means that certain combinations of wheels and tyres are approved. For the permissible combinations, see page 373



General

Wheel (rim) dimensions

Wheels (rims) have a designation of dimensions, for example: 7Jx16x50.

7	Rim width in inches
J	Rim flange profile
16	Rim diameter in inches
50	Off-set in mm (distance from wheel centre to wheel contact surface against the hub)

Tyre dimensions

The dimensions are stated on all car tyres. Example of designation:

225/50R17 98W.

225	Tyre width (mm)
50	Ratio between tyre wall height and tyre width (%)
R	Radial ply
17	Rim diameter in inches (")

98	Codes for the maximum permitted tyre load, tyre load index (LI)
W	Speed rating for maximum permitted speed, speed rating (SS). (In this case 270 km/h).

Load index

Each tyre has a certain capacity to carry a load, a load index (LI). The car's weight determines the load capacity required of the tyres. Minimum permitted index is specified in the table, see page 373.

Speed ratings

Each tyre can withstand a certain maximum speed, a speed rating (Speed Symbol; SS).

Tyre speed class must at least correspond with the car's top speed. Minimum permitted speed rating is specified in the table, see page 373.

The only exception to these conditions is winter tyres (both those with metal studs and those without), where a lower speed rating may be used. If such a tyre is chosen, the car must not be driven faster than the speed rating of the tyre (for example, class Q can be driven at a maximum of 160 km/h).

Traffic regulations determine how fast a car can be driven, not the speed rating of the tyres.

**NOTE**

It is the maximum permitted speed that is stated in the table.

Q	160 km/h (used only on winter tyres)
T	190 km/h
H	210 km/h
V	240 km/h
W	270 km/h
Y	300 km/h

**WARNING**

The car must be fitted with tyres which have the same or a higher load index (LI) and speed rating (SS) than specified. If a tyre with too low a load index or speed rating is used, it may overheat.



Changing wheels

Removing

Set up the warning triangle, see page 310 if a wheel must be replaced at a busy location. The car and jack* must be on a firm horizontal surface.

1. Apply the parking brake and engage reverse gear, or position **P** if the car has an automatic gearbox.

WARNING

Check that the jack is not damaged, that the threads are thoroughly lubricated and that it is free from dirt.

NOTE

Volvo recommends only using the jack* that belongs to the car model in question, which is indicated on the jack's label.

The label also indicates the jack's maximum lift capacity at a specified minimum lifting height.

2. Take out the jack*, wheel wrench* and removal tool for wheel covers* located under the cargo floor in the cargo area. If another jack is selected, see page 318.
3. Place chocks in front of and behind the wheels which will remain on the ground.

Use heavy wooden blocks or large stones for example.

4. Cars with steel rims have removable wheel covers. Use the removal tool to hook in and pull off any full-wheel wheel covers. Alternatively, the wheel covers can be pulled away by hand.

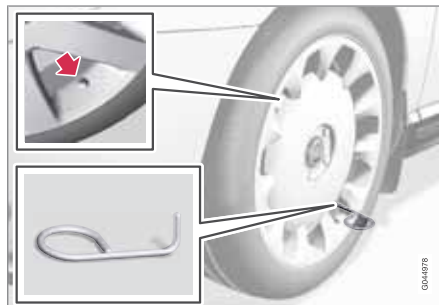

5. Screw together the towing eye with the wheel wrench* until the stop position as illustrated below.

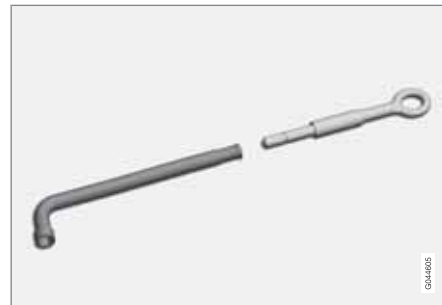

IMPORTANT

The towing eye must be screwed into all threads in the wheel bolt wrench.

6. Loosen the wheel bolts ½-1 turn anticlockwise with the wheel wrench.

WARNING

Never position anything between the ground and the jack, nor between the jack and the car's jacking point.

7. There are two jacking points on each side of the car. There is a recess in the plastic cover at each point. Crank the foot of the



Changing wheels

jack down so it is pressed squarely on the ground.

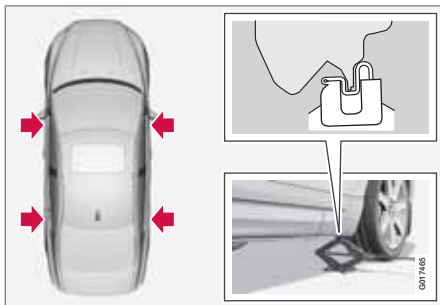

! IMPORTANT

The ground must be firm, smooth and level.

- Lift the car so that the wheel is free. Remove the wheel bolts and lift off the wheel.

Installation

- Clean the contact surfaces between wheel and hub.
- Put on the wheel. Tighten the wheel bolts thoroughly.

- Lower the car so that the wheels cannot rotate.



- Tighten the wheel bolts crosswise. It is important that the wheel bolts are tightened properly. Tighten to 140 Nm. Check the torque with a torque wrench.
- Refit any full wheel covers.

i NOTE

The wheel cover outlet for the valve must be positioned over the valve on the wheel rim during fitting.

! WARNING

Never crawl under the car when it is raised on the jack.

Passengers must leave the car when it is raised on the jack.

Park the car so that passengers have the car - or preferably a crash barrier - between them and the road.

Spare wheel*

The spare wheel (Temporary spare) is only intended for use temporarily and must be replaced by an ordinary wheel as soon as possible. The car's handling may be altered by the use of the spare wheel. The spare wheel is smaller than the normal wheel. The car's ground clearance is affected accordingly. Pay attention to high kerbs and do not machine wash the car. If the spare wheel is fitted on the front axle, you cannot use snow chains at the same time. On all-wheel drive cars the drive on the rear axle can be disconnected. The spare wheel must not be repaired. The correct tyre pressure for the spare wheel is stated in the tyre pressure table, see page 373.



Changing wheels

IMPORTANT

Never drive faster than 80 km/h with a spare wheel on the car.

IMPORTANT

The car must never be driven fitted with more than one temporary spare wheel.

The spare wheel is located in the spare wheel well with the outside down. The same bolt runs through to secure the spare wheel and the foam block. The foam block contains all the tools.

Taking out the spare wheel

1. Fold up the cargo area floor, from the rear and forwards.
2. Undo the retaining screw.
3. Lift out the foam block with its tools.
4. Lift out the spare wheel.



Tyre pressure

Tyre pressure



The tyre pressure decal on the driver's side door pillar (between frame and rear door) shows which pressures the tyres should have at different loads and speed conditions. This is also specified in the tyre pressure table, see page 373.

- Tyre pressure for the car's recommended tyre dimension
- ECO pressure¹
- Spare wheel tyre pressure (Temporary Spare)

i NOTE

Temperature differences change the tyre pressure.

¹ ECO pressure results in improved fuel economy.

Fuel economy, ECO pressure

At speeds under 160 km/h, the general tyre pressure is recommended (applies for both full load and light load) in order to obtain optimum fuel economy.

Checking the tyre pressure

The tyre pressures must be checked every month.

This also applies to the car's spare wheel.

Check tyre pressures on cold tyres. "Cold tyres" means the tyres are the same temperature as the ambient temperature. After several kilometres of driving, the tyres warm up and the pressure increases.

Inadequate tyre pressure increases fuel consumption, shortens tyre lifespan and impairs the car's roadholding. Driving on tyres with tyre pressure that is too low could result in the tyres overheating and being damaged. Tyre pressure affects travelling comfort, road noise and steering characteristics.

i NOTE

Tyre pressure decreases over time, this is a natural phenomenon. Tyre pressure also varies depending on ambient temperature.



Warning triangle and first-aid kit*

Warning triangle

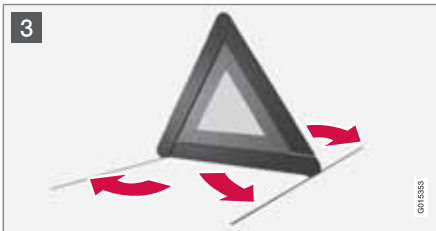
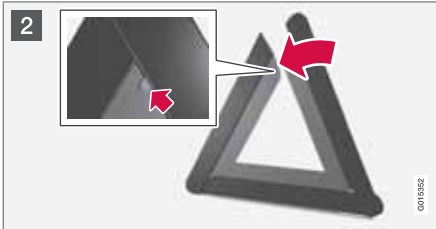

The warning triangle is fitted on the inside of the boot lid with two clips.

- 1 Detach the warning triangle case by pulling both of the snap latches outwards.
- 2 Take the warning triangle from the case, fold out and assemble the two loose sides.
- 3 Fold out the warning triangle's support legs.

Follow the regulations for the use of a warning triangle. Position the warning triangle in a suitable place with regard to traffic.

Ensure the warning triangle and its case are properly secured in the cargo area after use.

First aid kit*

A case with first aid equipment is located in the cargo area.



Emergency puncture repair (TMK)*

General



Emergency puncture repair (TMK; Temporary Mobility Kit) is used to seal a puncture and check and adjust tyre pressure. It consists of a compressor and a bottle of sealing fluid. The kit works as a temporary repair. The sealing fluid bottle must be replaced before its expiration date and after use.

The sealing fluid effectively seals tyres punctured in the tread.

i NOTE

The emergency puncture repair kit is only intended for sealing tyres with a puncture in the tread.

The emergency puncture repair kit has limited capacity to seal tyres which have punctures in

the wall. Do not seal tyres with the emergency puncture repair kit if they have larger slits, cracks or similar damage.

For connecting the compressor there are 12 V sockets in the centre console and by the rear seat, as well as a 12 V socket in the cargo area*. Choose the electrical socket that is nearest the punctured tyre.

Location of the emergency puncture repair kit

Set up the warning triangle if a tyre is being sealed in a trafficked location. The emergency puncture repair kit is located under the floor in the cargo area.

⚠ WARNING

You should not drive faster than 80 km/h after the emergency tyre repair kit has been used. Volvo recommends that you visit an authorised Volvo workshop for inspection of the sealed tyre (maximum driving distance is 200 km). The staff there can determine whether or not the tyre can be repaired or if it needs to be replaced.

Overview

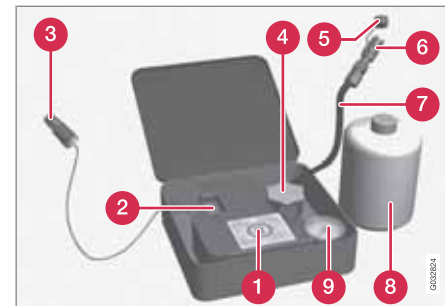

- 1 Label, maximum permitted speed
- 2 Switch
- 3 Cable
- 4 Bottle holder (orange cap)
- 5 Protective cap
- 6 Pressure reducing valve
- 7 Air hose
- 8 Sealing fluid bottle
- 9 Pressure gauge

* Option/accessory, for more information, see Introduction.



Emergency puncture repair (TMK)*

Sealing punctured tyres

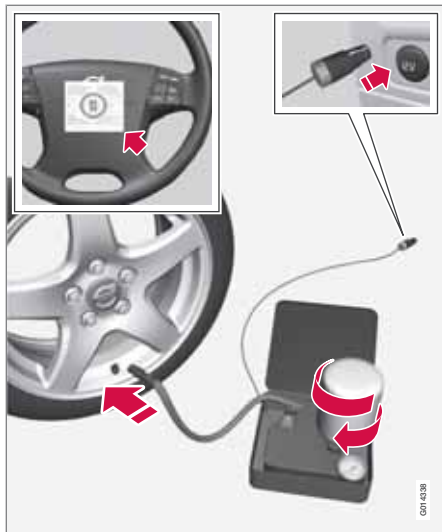

For information on the function of the parts, see preceding illustration.

1. Open the lid of the emergency puncture repair kit.
2. Detach the label for maximum permitted speed and affix it to the steering wheel.

! WARNING

The sealing fluid can irritate the skin. In the case of contact with skin, wash away the fluid with soap and water.

3. Check that the switch is in position **0** and locate the cable and the air hose.

i NOTE

Do not break the bottle's seal before use. The seal is broken automatically when the bottle is screwed in.

4. Unscrew the orange cap and unscrew the bottle's stopper.
5. Screw the bottle into its holder.

! WARNING

Do not unscrew the bottle, it is equipped with a reverse catch to prevent leakage.

6. Unscrew the wheel's dust cap and screw in the air hose valve connection to the bottom of the thread on the tyre's air valve.
7. Plug the cable into the 12 V socket and start the car.

! WARNING

Do not leave children in the car without supervision when the engine is running.

8. Flick the switch to position **I**.

! WARNING

Never stand next to the tyre when the compressor is running. If cracks or unevenness arise then the compressor must be switched off immediately. The journey should not be continued. Contacting an authorised tyre centre is recommended.

i NOTE

When the compressor starts, the pressure can increase up to 6 bar but the pressure drops after approximately 30 seconds.

9. Inflate the tyre for 7 minutes.

! IMPORTANT

Risk of overheating. The compressor must not run for more than 10 minutes.

10. Switch off the compressor to check the pressure on the pressure gauge. Minimum

**Emergency puncture repair (TMK)***

pressure is 1.8 bar and maximum 3.5 bar. (Release air with the pressure reducing valve if the tyre pressure is too high.)

! WARNING

If the pressure is below 1.8 bar then the hole in the tyre is too big. The journey should not be continued. Contacting an authorised tyre centre is recommended.

11. Switch off the compressor and unplug the cable from the 12 V socket.
12. Detach the hose from the tyre valve and fit the valve cap.
13. As soon as possible, drive approximately 3 km at a maximum speed of 80 km/h so that the sealing fluid can seal the tyre.

Rechecking the repair and pressure

1. Reconnect the equipment.
2. Read the tyre pressure on the pressure gauge.
 - If it is below 1.3 bar then the tyre is insufficiently sealed. The journey should not be continued. Contact a tyre centre.
 - If the tyre pressure is higher than 1.3 bar, the tyre must be inflated to the pressure specified in accordance with the

tyre pressure table, see page 373 (1 bar=100 kPa). Release air using the pressure reducing valve if the tyre pressure is too high.

! WARNING

Do not unscrew the bottle, it is equipped with a reverse catch to prevent leakage.

3. Make sure the compressor is switched off. Detach the air hose and cable. Refit the dust cap.

i NOTE

The sealing fluid bottle and the hose must be replaced after use. Volvo recommends that this replacement is performed by an authorised Volvo workshop.

! WARNING

Check the tyre pressure regularly.

Volvo recommends that you drive to the nearest authorised Volvo workshop for the replacement/repair of the damaged tyre. Advise the workshop that the tyre contains sealing fluid.

! WARNING

You should not drive faster than 80 km/h after the emergency tyre repair kit has been used. Volvo recommends that you visit an authorised Volvo workshop for inspection of the sealed tyre (maximum driving distance is 200 km). The staff there can determine whether or not the tyre can be repaired or if it needs to be replaced.

Inflating the tyres

The car's original tyres can be inflated by the compressor.

1. The compressor must be switched off. Make sure that the switch is in position **0** and locate the cable and air hose.
2. Unscrew the wheel's dust cap and screw in the air hose valve connection to the bottom of the thread on the tyre's air valve.

! WARNING

Inhaling car exhaust fumes can result in danger to life. Never leave the engine running in sealed areas or areas that lack sufficient ventilation.



Emergency puncture repair (TMK)*

WARNING

Do not leave children in the car without supervision when the engine is running.

3. Connect the cable to one of the car's 12 V sockets and start the car.
4. Start the compressor by flicking the switch to position I.

IMPORTANT

Risk of overheating. The compressor must not run for more than 10 minutes.

5. Inflate the tyre to the pressure specified in accordance with the tyre pressure table, see page 373. (Release air using the pressure reducing valve if the tyre pressure is too high.)
6. Switch off the compressor. Detach the air hose and cable.
7. Refit the dust cap.

Replacing the sealing fluid canister

Replace the bottle when the expiration date has passed. Treat the old bottle as environmentally hazardous waste.

WARNING

The bottle contains 1.2-Ethanol and natural rubber-latex.

Harmful if ingested. Could result in allergic reaction in the event of skin contact.

Avoid contact with the skin and eyes.

Store out of the reach of children.



Engine compartment.....	318
Lamps.....	325
Wiper blades and washer fluid.....	332
Battery.....	334
Fuses.....	339
Car care.....	350



08

MAINTENANCE AND SERVICE

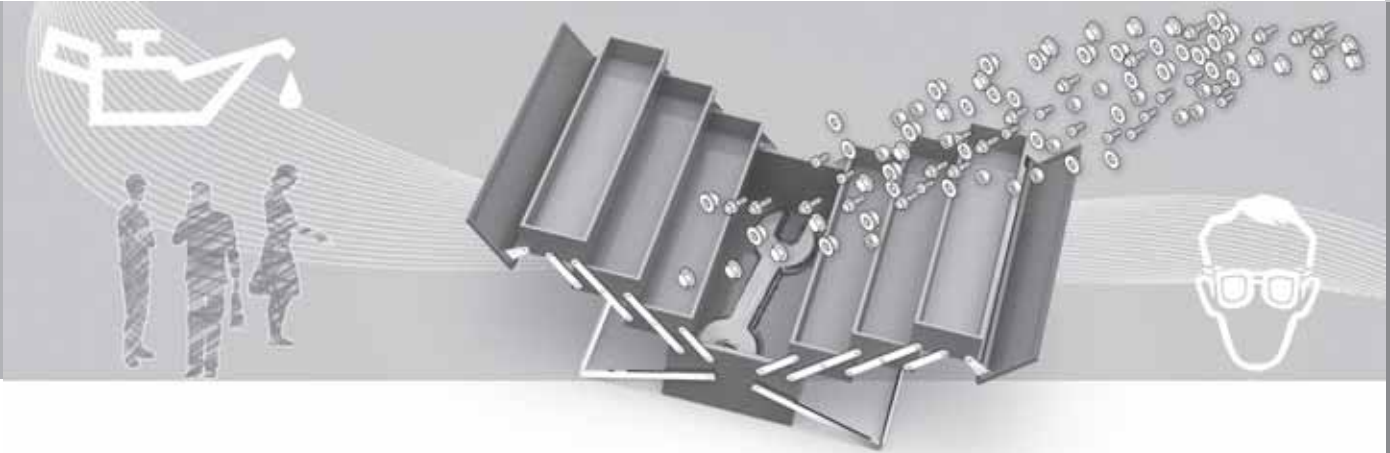



Engine compartment

General

Volvo service programme

To keep the car as safe and reliable as possible, follow the Volvo service programme as specified in the Service and Warranty Booklet. Volvo recommends engaging an authorised Volvo workshop to perform the service and maintenance work. Volvo workshops have the personnel, special tools and service literature to guarantee the highest quality of service.

! IMPORTANT

For the Volvo warranty to apply, check and follow the instructions in the Service and Warranty Booklet.

Check regularly

Check the following oils and fluids at regular intervals, e.g. when refuelling:

- Coolant
- Engine oil
- Power steering fluid
- Washer fluid

! WARNING

Remember that the radiator fan (located at the front of the engine compartment, behind the radiator) may start automatically some after the engine has been switched off.

Always have the engine cleaned by a workshop. There is a risk of fire if the engine is hot.

Raising the car

i NOTE

Volvo recommends only using the jack that belongs to the car model in question. If a jack is selected other than the one recommended by Volvo, follow the instructions for use supplied with the equipment.

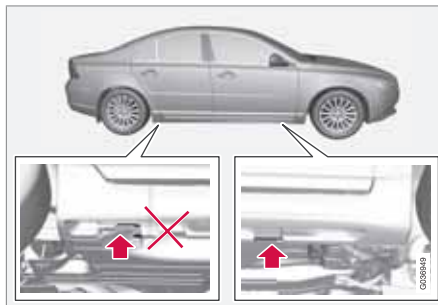

If the car is raised with a workshop jack; position the jack against the front edge on the engine's subframe.

Do not damage the splashguard under the engine. Ensure that the workshop jack is positioned so that the car cannot slide off the jack. Always use axle stands or similar.

If you raise the car using a two-pillar workshop lift, ensure that the front and rear lift arms are fixed under the lifting points. See preceding illustration.

Opening and closing the bonnet





Engine compartment



- 1 Pull the handle by the pedals. You will hear when the catch releases.
- 2 Move the catch to the left and open the bonnet. (The catch hook is located between the headlamp and grille, see illustration.)

WARNING

Check that the bonnet locks properly when closed.

Engine compartment, overview

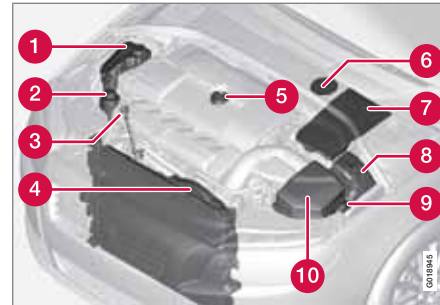

The appearance of the engine compartment may vary depending on engine variant.

- 1 Coolant expansion tank
- 2 Power steering fluid reservoir
- 3 Engine oil dipstick¹
- 4 Radiator
- 5 Filling engine oil
- 6 Reservoir for brake and clutch fluid (located on the driver's side)
- 7 Battery
- 8 Relay and fuse box

- 9 Filling washer fluid
- 10 Air filter

WARNING

The ignition system has very high voltage and output. The voltage in the ignition system is highly dangerous. The remote control key must always be in **0** position when work is being done in the engine compartment, see page 77.

Do not touch the spark plugs or ignition coil when the remote control key is in **II** position or when the engine is hot.

Checking the engine oil



¹ Engines with electronic oil level sensor have no dipstick (5-cyl. diesel).



Engine compartment

Volvo recommends Castrol oil products.

When driving under adverse conditions, see page 366.

! IMPORTANT

In order to fulfil the requirements for the engine's service intervals all engines are filled with a specially adapted synthetic engine oil at the factory. The choice of oil has been made very carefully with regard to service life, starting characteristics, fuel consumption and environmental impact.

An approved engine oil must be used in order that the recommended service intervals can be applied. Only use a prescribed grade of oil for both filling and oil change, otherwise you will risk affecting service life, starting characteristics, fuel consumption and environmental impact.

Volvo Car Corporation disclaims all warranty liability if engine oil of the prescribed grade and viscosity is not used.

Volvo recommends that oil changes are carried out at an authorised Volvo workshop.

Volvo uses different systems for warning of low/high oil level or low/high oil pressure. Certain variants have an oil pressure sensor, and then the lamp for oil pressure is used. Other variants have an oil level sensor, and then the

driver is informed via the warning symbol in the centre of the instrument unit as well as by display texts. Certain models have both variants. Contact a Volvo dealer for more information.

Change the engine oil and oil filter in accordance with the intervals specified in the Service and Warranty Booklet.

Using oil of a higher than specified grade is permitted. If the car is driven in adverse conditions, Volvo recommends using an oil of a higher grade, see page 366.

For capacities, see page 367 and onwards.

Engine with oil dipstick²



Dipstick and filler pipe.

Checking the oil level in a new car is especially important before the first scheduled oil change.

Volvo recommends checking the oil level every 2 500 km. The most accurate measurements are made on a cold engine before starting. The measurement will be inaccurate if taken immediately after the engine is switched off. The dipstick will indicate that the level is too low because the oil has not had time to flow down into the oil sump.

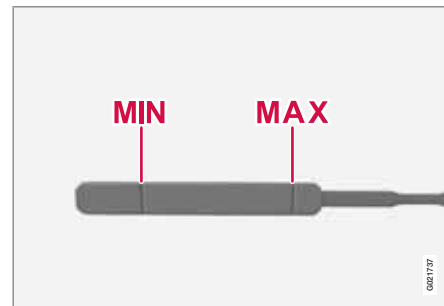

The oil level must be between the **MIN** and **MAX** marks.

Measurement and filling if required

1. Ensure that the car is level. After switching off the engine it is important to wait

² Only applies to petrol and 4-cyl. diesel.



Engine compartment

5 minutes to allow the oil time to run back to the sump.

2. Pull up and wipe the dipstick.
3. Re-insert the dipstick.
4. Pull it out and check the level.
5. If the level is close to **MIN** then 0.5 litres should be added. If the level is significantly below, then an additional amount is required.
6. If required, check the level again, do it after driving a short distance. Then repeat steps 1 - 4.

WARNING

Never fill above the **MAX** mark. The level should never be above **MAX** or below **MIN** as this could lead to engine damage.

WARNING

Do not spill oil onto the hot exhaust manifold due to the risk of fire.

Engine with electronic oil level sensor³



Filler pipe.⁴

You do not need to take action with respect to the engine oil level before a message is shown in the display, see the illustration below.

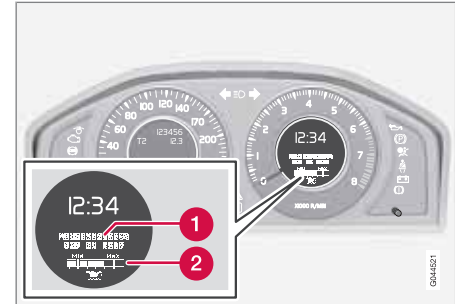

Message and graph in the display.

- 1 Message
- 2 Engine oil level

The oil level is checked using the electronic oil level gauge with the thumbwheel when the engine is switched off, see page 142.

WARNING

If the message **Oil service required** is shown, visit a workshop. The oil level may be too high.

³ Only applies to 5-cyl. diesel.

⁴ Engines with electronic oil level sensor have no dipstick (5-cyl. diesel).



Engine compartment

! IMPORTANT

In the event of the message **Oil level low Refill 0,5 Ltr**, only fill with 0.5 litres.

i NOTE

The oil level is only detected by the system during driving. The system cannot directly detect changes when the oil is filled or drained. The car must be driven about 30 km before the oil level display is correct.

! WARNING

Do not fill more oil if filling level (3) or (4) appears as shown in the illustration below. The level must never be above **MAX** or below **MIN**, as this could lead to engine damage.

! WARNING

Do not spill oil onto the hot exhaust manifold due to the risk of fire.

Measuring the oil level

If the oil level needs to be checked then it should be carried out in accordance with the sequence below.

1. Activate key position **II**, see page 77.
2. Rotate the thumbwheel on the left-hand stalk switch to position **Engine oil level Wait....**
 - > You will then see information displayed about the engine oil level.

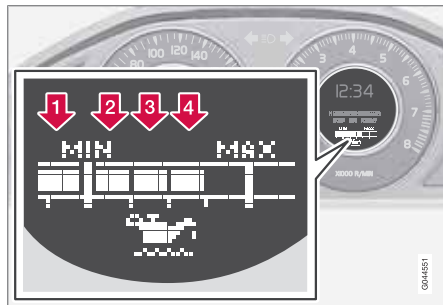

The figures 1-4 represent filling level. Do not fill more oil if filling level (3) or (4) is shown. Recommended filling level is 4.

Coolant

Checking the level and topping up



When topping up the coolant, follow the instructions on the packaging. It is important that the mixture of coolant concentrate and water is correct for the prevailing weather conditions. Never top up with water only. The risk of freezing increases with both too little and too much coolant concentrate.

! WARNING

Coolant can be very hot. If the coolant requires topping up when the engine is at operating temperature, unscrew the expansion tank cap slowly to gently release the overpressure.

**Engine compartment**

For capacities and for standards regarding water quality, see page 368.

Check the coolant regularly

The level must lie between the **MIN** and **MAX** marks on the expansion tank. If the system is not filled sufficiently, high temperatures could occur, causing a risk of damage to the engine.

**IMPORTANT**

- A high content of chlorine, chlorides and other salts may cause corrosion in the cooling system.
- Always use coolant with anti-corrosion agent as recommended by Volvo.
- Ensure that the coolant mixture is 50% water and 50% coolant.
- Mix the coolant with approved quality tap water. In the event of any doubt about water quality, used ready-mixed coolant in accordance with Volvo recommendations.
- When changing coolant/replacing cooling system components, flush the cooling system clean with approved quality tap water or flush with ready-mixed coolant.
- The engine must only be run with a well-filled cooling system. Otherwise, temperatures that are too high may occur resulting in the risk of damage (cracks) in the cylinder head.

Brake and clutch fluid**Checking the level**

Brake and clutch fluid have a common reservoir. The level must be between the **MIN** and **MAX** marks that are visible inside the reservoir. Check the level regularly.

Change the brake fluid every other year or at every other regular service.

For capacities and recommended fluid grade, see page 368. The fluid should be changed annually on cars driven in conditions requiring hard, frequent braking, such as driving in mountains or tropical climates with high humidity.

**WARNING**

If the brake fluid is under the **MIN** level in the brake fluid reservoir, do not drive further before topping up the brake fluid. Volvo recommends that the reason for the loss of brake fluid is investigated by an authorised Volvo workshop.



Engine compartment

Filling

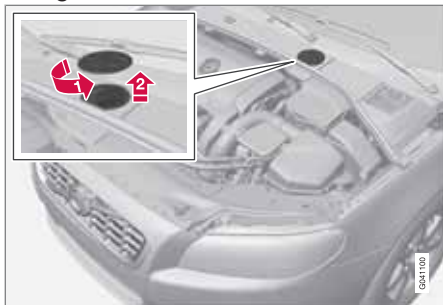

The fluid reservoir is located on the driver's side.

The fluid reservoir is protected under the cover over the cold zone in the engine compartment. The round cover must be removed first before the reservoir cap can be reached.

1. Turn and open the cover located on the covering.
2. Unscrew the reservoir cap and fill the fluid. The level must be between the **MIN** and **MAX** marks, which are located on the inside of the reservoir.

IMPORTANT

Do not forget to refit the cap.

Power steering fluid



IMPORTANT

Keep the area around the power steering fluid reservoir clean when checking. The cover must not be opened.

Check the level frequently. The fluid does not require changing. The fluid level must be between the **MIN** and **MAX** marks. For capacities and recommended fluid grade, see page 368.

NOTE

If a fault should arise in the power steering system or if the engine is switched off and the car must be towed, it can still be steered.



Lamps

General

All bulbs are specified, see page 331. The following list contains locations of bulbs and other light sources that are specialised or unsuitable for changing except at a workshop:

- Active Xenon headlamps - ABL (Xenon lamps)
- Direction indicators, door mirrors
- Approach lighting, door mirrors
- Courtesy lighting
- Glovebox lighting
- General interior lighting in the roof
- Reading lamps
- Brake light
- LED lights, general

WARNING

On cars with Xenon headlamps, the replacement of Xenon lamps must be carried out at a workshop - an authorised Volvo workshop is recommended. Working with Xenon lamps demands extreme caution because the headlamp is equipped with a high voltage unit.

IMPORTANT

Never touch the glass part of the bulbs with your fingers. Grease and oils from your fingers are vaporised by the heat, coating the reflector and then causing damage.

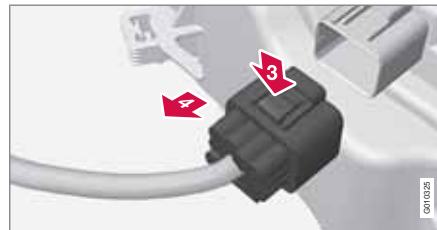
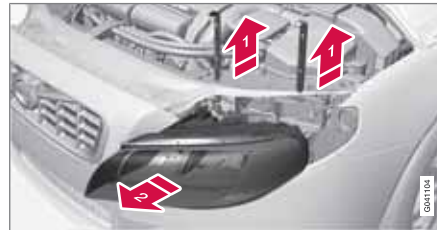
Headlamps front

All of the headlamp bulbs are replaced via the engine compartment. Loosen and remove the whole headlamp.

WARNING

The remote control key must not be turned to key position I or II during bulb replacement.

See the section "Key positions" - for a description of the remote control key's 3 key positions.

Removing the headlamp

1. Make sure the remote control key is in key position 0, see page 77:
2. (First illustration)
 - 1 Pull out the headlamp's locking pins.
 - 2 Pull the headlamp straight forward.

IMPORTANT

Do not pull the electrical cable, only the connector.

3. (Second illustration)
 - 3 Detach the headlamp connector by pressing down the clip with your thumb.
 - 4 At the same time, guide out the connector with your other hand.
4. Lift out the headlamp and place it on a soft surface to avoid scratching the lens.



Lamps

5. Replace the bulb in question.

Securing the headlamp

1. Plug in the connector, a clicking sound should be heard.
2. Reinstall the headlamp and locking pins. Check that they are correctly inserted.
3. Check the lighting.

The headlamp must be mounted and the connector correctly installed before the lighting is switched on or the remote control key is inserted into the ignition switch.

Removing the cover

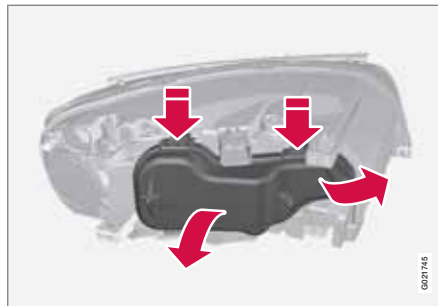

Before starting to replace a bulb, see page 325.

1. Open the lock clamp by pressing up/out.
2. Press down the clips on the cover and remove it.

Reinstall the cover in reverse order.

Dipped beam, halogen

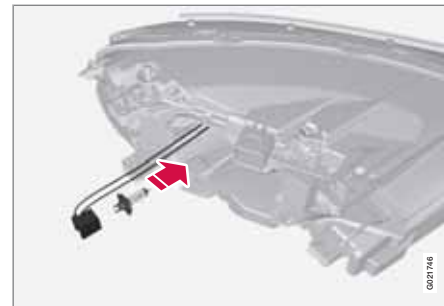

1. Detach the headlamp, see page 325.
2. Remove the cover.
3. Unplug the connector from the bulb.
4. Detach the bulb by pressing the holder downwards.
5. Fit the new bulb in the socket and snap it in. It can be secured in one position.

Reinstall the parts in reverse order.



Lamps

Main beam, Halogen

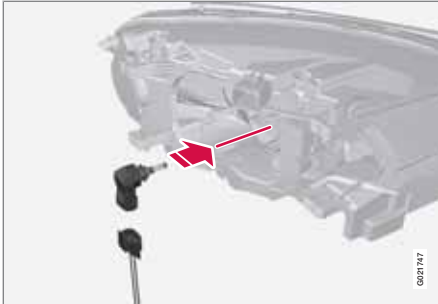

1. Detach the headlamp.
2. Remove the cover, see page 326
3. Detach the bulb by turning anticlockwise and then pulling straight out
4. Unplug the connector from the bulb.
5. Replace the bulb and align it in the socket and turn clockwise in order to secure it. It can be secured in one position.

Reinstall the parts in reverse order.

Extra main beam, ABL headlamps*

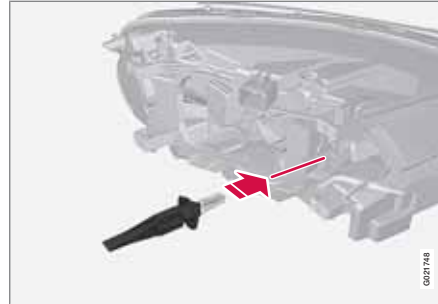

1. Detach the headlamp.
2. Remove the cover, see page 326.
3. Detach the bulb by pressing the holder downwards.
4. Unplug the connector from the bulb.
5. Fit the new bulb in the socket and snap it in. It can only be secured in one position.

Reinstall the parts in reverse order.

Position/parking lamps

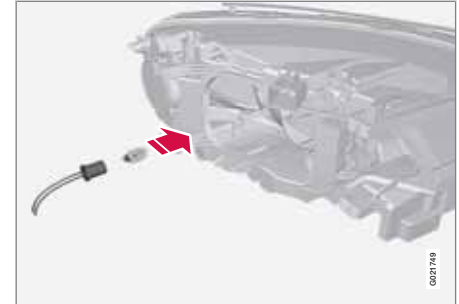

1. Detach the headlamp.
2. Remove the cover, see page 326.
3. For better access, detach the main beam bulb first.
4. Pull the cable in order to withdraw the bulb holder.
5. Remove the blown bulb and fit a new one. It can only be secured in one position.
6. Fit the bulb holder in the socket and press until a clicking sound is heard.

Reinstall the parts in reverse order.



Lamps

Direction indicators/flashers

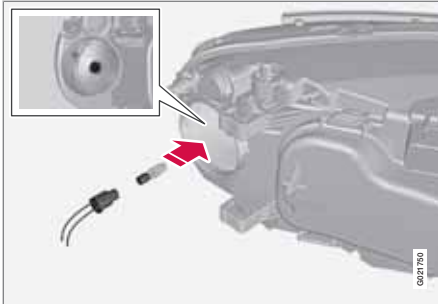

1. Detach the headlamp.
2. Remove the small round cover.
3. Pull the bulb holder in order to extract the bulb.
4. Remove the blown bulb and fit a new one. It can only be installed in one way.
5. Fit the bulb holder in the socket and press until a clicking sound is heard.
6. Refit the cover. It must be fitted and pressed in until a clicking sound is heard.

Reinstall the parts in reverse order.

Side marker lamps

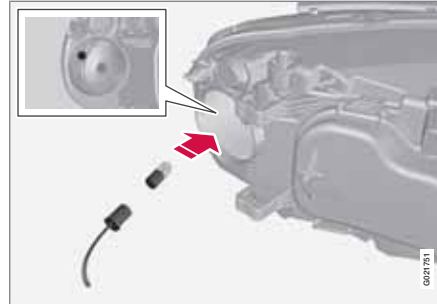

Before starting to replace a bulb, see page 325.

1. Detach the headlamp.
2. Remove the small round cover.
3. Pull the cable in order to withdraw the bulb holder.
4. Remove the blown bulb and fit a new one. It can only be installed in one way.
5. Fit the bulb holder in the socket and press until a clicking sound is heard.
6. Refit the cover. It must be fitted and pressed in until a clicking sound is heard.

Reinstall the parts in reverse order.

Front fog lamps

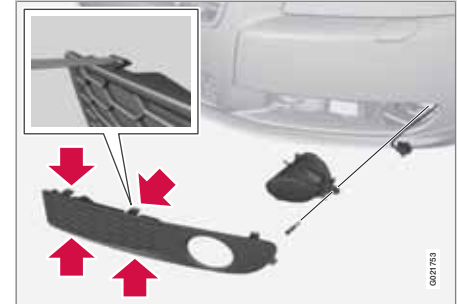

1. Remove the cover by pressing in the 4 clips with a thin blade and pulling straight out.
2. Unscrew the lamp housing screw and pull it out.
3. Turn the bulb anticlockwise and remove it.
4. Fit a new bulb by turning clockwise.
5. Refit the bulb. (The profile of the bulb holder corresponds to the profile of the foot of the bulb).
6. Refit the bulb holder. The **TOP** mark on the bulb holder must always be upward.



Lamps

Lamp housing, rear



The bulbs in the rear light cluster are replaced from inside the cargo area (not the LED lamps).

1. Remove the covers in the left/right-hand panel to access the bulbs. The bulbs are located in separate bulb holders.
2. Press the catches together and pull out the bulb holder.
3. Replace the bulb.
4. Plug in the connector.
5. Press the bulb holder into place and refit the cover.

NOTE

If an error message remains after the broken bulb has been replaced then we recommend that you visit an authorised Volvo workshop.

Location of rear bulbs



Lamp lens, right-hand side

- 1 Position/parking lights (LED)
- 2 Direction indicators
- 3 Side position lights (LED)
- 4 Brake light
- 5 Rear fog lamp (one side)
- 6 Reversing lamp

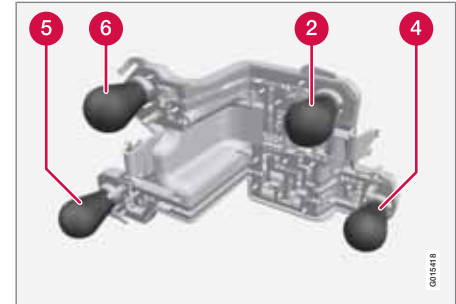

Rear lamp bulb holder

- 2 Direction indicators
- 4 Brake light
- 5 Rear fog lamp (one side)
- 6 Reversing lamp



Lamps

Number plate lighting



1. Remove the screws with a screwdriver.
2. Carefully detach the whole lamp housing and withdraw it.
3. Replace the bulb.
4. Refit the whole lamp housing and screw it into place.

Lighting, cargo area



1. Insert a screwdriver and gently prize so that the lamp housing comes loose.
2. Replace the bulb.
3. Check that the bulb illuminates and press back the lamp housing.

Vanity mirror lighting

Removing the mirror glass

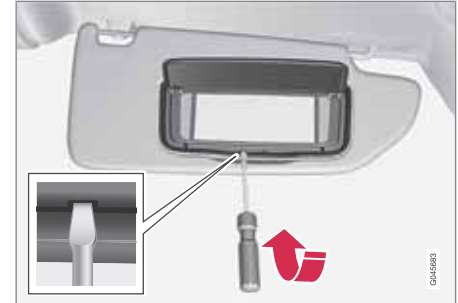

1. Insert a screwdriver in one of the two recesses and carefully prize up the lug on the edge.
2. Insert the screwdriver along the edge on the left and right-hand sides and prize carefully close to the black rubber sections so that the mirror glass comes loose in the lower edge.
3. Carefully detach and lift aside the entire mirror glass and cover.
4. Replace the bulb.

Securing the mirror glass

1. Press the three lugs at top edge of the mirror glass back into position.



Lamps

2. Then press the three lower lugs back into position.

Specification, bulbs

Lighting	W ^A	Type
Dipped beam, halogen	55	H7 LL
Main beam, Halogen	65	H9
Extra main beam, ABL	55	H7 LL
Front direction indicators	21	H21W LL
Position/parking lamps front	5	W5W LL
Side marker lamps front	5	W5W LL
Front fog lamps	35	H8
Direction indicators side, door mirrors	5	WY5W LL
Glovebox lighting	5	Socket SV8.5 Length 43 mm

Lighting	W ^A	Type
Vanity mirror lighting	1.2	Socket SV5.5 Length 35 mm
Cargo area lighting	5	Socket SV8.5 Length 38 mm
Number plate lighting	5	C5W LL
Direction indicators, rear	21	PY21W LL
Brake light	21	P21W LL
Reversing lamp	21	P21W LL
Rear fog lamp	21	P21W LL

^A Watt



Wiper blades and washer fluid

Wiper blades

Service position



In order to change, clean or lift the wiper blades (for scraping off ice from the windscreen) they must be in service position.

1. Turn the remote control key to key position **0**, see page 77, and keep the remote control key in the ignition switch.
2. Move the right-hand stalk switch up for about 1 second. The wipers then move to standing straight up.

The wipers return to the starting position when the car is started.

Replacing the wiper blades

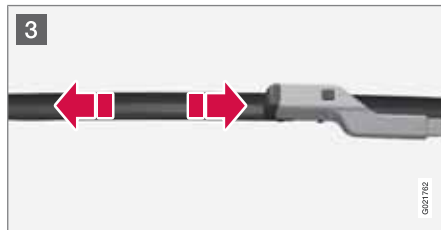
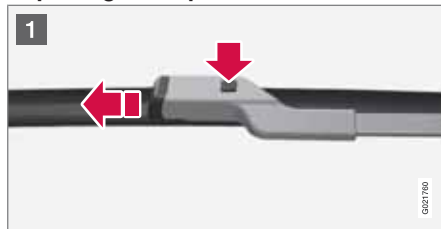

- 1 Lift up the wiper arm. Press the button located on the wiper blade mounting and pull straight out parallel with the wiper arm.
- 2 Slide in the new wiper blade until a "click" is heard.
- 3 Check that the blade is firmly installed.

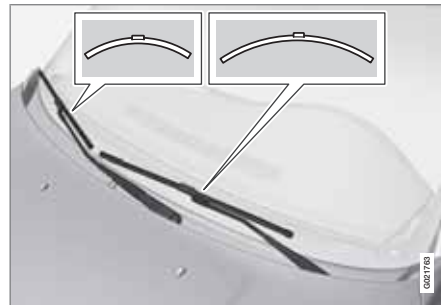

NOTE

The wiper blades are different lengths. The blade on the driver's side is longer than the blade on the passenger side.

Cleaning

For cleaning wiper blades and windscreen, see page 350 and onwards.



Wiper blades and washer fluid

! IMPORTANT

Check the wiper blades regularly. Neglected maintenance shortens the service life of the wiper blades.

Filling washer fluid



The windscreen and headlamp washers share a common reservoir.

! IMPORTANT

Use washer fluid with antifreeze during the winter to avoid freezing in the pump, reservoir and hoses.

For capacities, see page 368.



Battery

Operation

The service life and function of the battery is influenced by factors such as the number of starts, discharging, driving style, driving conditions, climatic conditions etc.

- Never disconnect the battery when the engine is running.
- Check that the cables to the battery are correctly connected and properly tightened.

WARNING

- The battery can generate oxyhydrogen gas, which is highly explosive. A spark can be formed if a jump lead is connected incorrectly, and this can be enough for the battery to explode.
- The battery contains sulphuric acid, which can cause serious burns.
- If sulphuric acid comes into contact with eyes, skin or clothing, flush with large quantities of water. If acid splashes into the eyes - seek medical attention immediately.

NOTE

The life of the battery is shortened if it becomes discharged repeatedly.

The life of the battery is affected by several factors, including driving conditions and climate. Battery starting capacity decreases gradually with time and therefore needs to be recharged if the car is not used for a longer time or when it is only driven short distances. Extreme cold further limits starting capacity.

To maintain the battery in good condition, at least 15 minutes of driving/week is recommended or that the battery is connected to a battery charger with automatic trickle charging.

A battery that is kept fully charged has a maximum service life.

IMPORTANT

Never use a quick charger to charge the battery.

IMPORTANT

If the following instruction is not observed then the energy saving function for infotainment may be temporarily disengaged, and/or the message in the information display about the main battery's state of charge may be temporarily inapplicable, following the connection of an external battery or battery charger:





- The negative battery terminal on the car's main battery must **never** be used for connecting an external battery or battery charger - only the **car chassis** may be used as the grounding point.

See the section "Start assistance" - for a description of how the cable clamps must be attached.



Battery

Symbols on the battery

	Use protective goggles.
	Further information in the owner's manual.
	Store the battery out of the reach of children.
	The battery contains corrosive acid.

	Avoid sparks and naked flames.
	Risk of explosion.
	Must be taken for recycling.

i **NOTE**
An expended battery must be recycled in an environmentally responsible manner - it contains lead.

Replacing the main battery

Removal

First of all: Take the remote control key from the ignition switch and wait at least 5 minutes before any electrical connections are touched - this is because the car's electrical system needs to store the necessary information to control modules.





Battery



1 Open the clips on the front cover and remove the cover.

2 Release the rubber moulding so that the rear cover is free.

3 Remove the rear cover by screwing one quarter turn and lifting it away.

WARNING

Connect and remove the positive and negative cables in the correct order.

4

1 Detach the black negative cable.

2 Detach the red positive cable.

3 Detach the ventilation hose from the battery.

4 Loosen the screw holding the battery clamp.

5 Move the battery to the side and lift it up.

Fitting



1. Lower the battery into the battery box.

2. Move the battery inward and to the side until it reaches the rear edge of the box.

3. Tighten the clamp that holds the battery.

4. Connect the ventilation hose.

> Check that it is correctly connected to both battery and outlet in the body.

5. Connect the red positive cable.

6. Connect the black negative cable.

7. Press in the rear cover. (See Removal).

8. Fit the rubber moulding. (See Removal).

9. Align the front cover and secure it with the clips. (See removal).

For more information on the car's main battery - see page 375



Battery

Eco Start/Stop DRIVE*

Cars with the Start/Stop function are equipped with two 12 V batteries - one extra powerful battery for starting and one standby battery that helps during the Eco Start/Stop DRIVE function's starting sequence.

For more information on Start/Stop - see page 122.

For more information on the car's main battery - see page 115 and 375.

Battery	Start	Support
Cold start capacity ^A , CCA (A)	760	120 ^B 180 ^C
Size ^D , L×W×H (mm)	278×175×190	150×90×106 ^B 150×90×130 ^C
Capacity (Ah)	70	8 ^B 10 ^C

^A In accordance with the SAE standard.

^B Right-hand drive or left-hand drive cars with manual gearbox.

^C Left-hand drive D3 with automatic gearbox.

^D Largest possible size.

! IMPORTANT

When replacing batteries in cars with the Start/Stop function, the AGM¹ type batteries must be fitted.

i NOTE

- The higher the current take-off in the car (extra cooling/heating, etc.) the more the batteries must be charged = increased fuel consumption.
- When the capacity of the battery has fallen below the lowest permissible level then the Start/Stop function is disengaged.

Temporarily reduced Start/Stop function due to high current take-off means:

- The engine starts automatically² without the driver depressing the clutch pedal (manual gearbox).
- The engine starts automatically without the driver lifting his/her foot off the foot brake pedal (automatic gearbox).

¹ Absorbed Glass Mat

² Automatic starting can only take place if the gear lever is in neutral position.



Battery

Location of the batteries

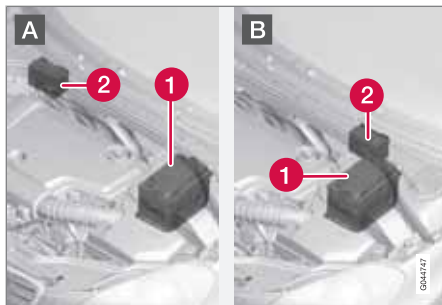

A: Left-hand drive car. B: Right-hand drive car. 1. Battery for starting³ 2. Support battery.

The support battery normally requires no more service than the normal battery that is used for starting. A workshop should be contacted in the event of questions or problems - an authorised Volvo workshop is recommended.

! IMPORTANT

If the following instruction is not observed then the Start/Stop function may temporarily cease to work after the connection of an external battery or battery charger:

- The negative battery terminal on the car's main battery must **never** be used for connecting an external battery or battery charger - only the **car chassis** may be used as the grounding point.

See the section "Start assistance" - for a description of how the cable clamps must be attached.

i NOTE

If the battery has become so discharged that everything is "black" and in principle the car does not have all the normal electrical functions and the engine is subsequently started using an external battery or battery charger, then the Start/Stop function will be activated. It will then be possible for the engine to be auto-stopped but in the event of an auto-stop the Start/Stop function may fail to auto-start the engine due to inadequate capacity in the battery.

The battery must first be charged in order to ensure a successful auto-start after an auto-stop. At an outside temperature of +15 °C the battery needs to be charged for at least 1 hour. At a lower outside temperature a charging time of 3-4 hours is recommended. The recommendation is that the battery is charged using an external battery charger.

If this is not possible then the recommendation is to temporarily deactivate the Start/Stop function until the battery has been adequately recharged.

For more information about recharging the battery, see the section "Battery" in the chapter "Maintenance and service".

³ The battery for starting is described in detail on page 335.



General

All electrical functions and components are protected by a number of fuses in order to protect the car's electrical system from damage by short circuiting or overloading.

If an electrical component or function does not work, it may be because the component's fuse was temporarily overloaded and failed. If the same fuse fails repeatedly then there is a fault in the circuit. Volvo recommends that you visit an authorised Volvo workshop for checking.

Changing

1. Look in the fuse diagram to locate the fuse.
2. Pull out the fuse and check from the side to see whether the curved wire has blown.
3. If this is the case, replace it with a new fuse of the same colour and amperage.



WARNING

Never use a foreign object, or a fuse with an amperage higher than that specified when replacing a fuse. This could cause significant damage to the electrical system and possibly lead to fire.

Location, fuse boxes

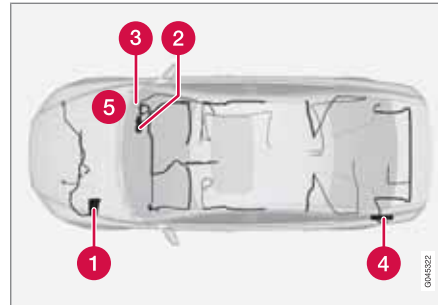

Central electrical unit locations in a left-hand drive car. In a right-hand drive car the central electrical units under the glovebox change sides.

- 1 Engine compartment
- 2, 3 Under the glovebox
- 4 Cargo area
- 5 Engine compartment cold zone (only Start/Stop*)



Fuses

Engine compartment

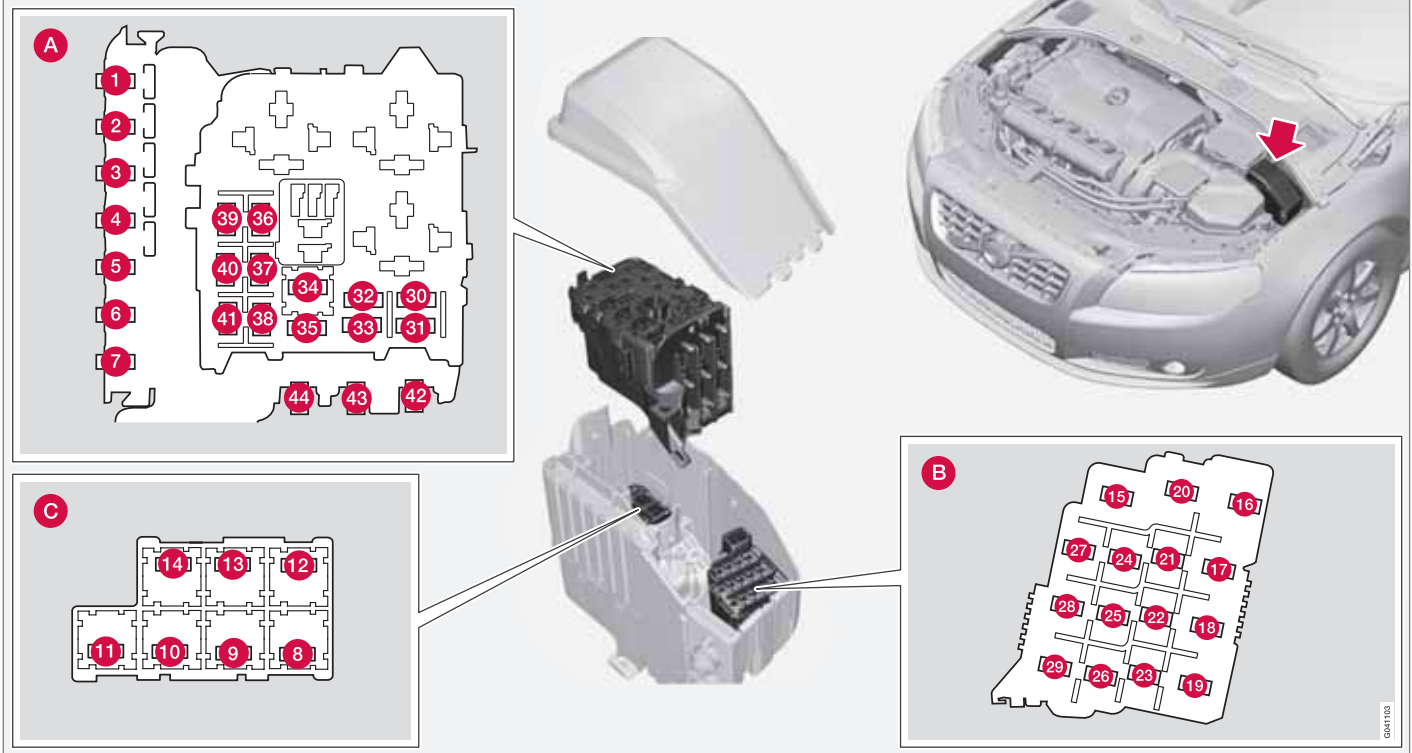

0001103



Fuses

General fuses, engine compartment

On the inside of the cover there are tweezers that facilitate the procedure for the removal and fitting of fuses.

Positions (see preceding illustration)

- A** Engine compartment, upper
- B** Engine compartment, front
- C** Engine compartment, lower

These fuses are all located in the engine compartment box. The fuses in (C) are located under (A).

On the inside of the cover is a label that shows the location of the fuses.

- Fuses 1-7 and 42-44 are of the "Midi Fuse" type and must only be replaced by a workshop¹.
- Fuses 8-15 and 34 are of the "JCASE" type and should be replaced by a workshop¹.
- Fuses 16-33 and 35-41 are of the "Mini Fuse" type.

	Function	A
1	Primary fuse for the central electronic module (CEM) with fuse box B under the glovebox ^A	50
2	Primary fuse for the central electronic module (CEM) with fuse box B under the glovebox	50
3	Primary fuse for central electrical unit in cargo area ^A	60
4	Primary fuse for central electrical unit in passenger compartment with fuse box A under the glovebox ^A	60
5	Primary fuse for central electrical unit in passenger compartment with fuse box A under the glovebox ^A	60
6	-	-
7	PTC element, air preheater ^{*A}	100
8	Headlamp washers*	20
9	Windscreen wipers	30

	Function	A
10	Parking heater*	25
11	Ventilation fan ^A	40
12	-	-
13	ABS pump	40
14	ABS valves	20
15	-	-
16	Headlamp levelling*, Active Xenon headlamps - ABL*	10
17	Primary fuse for the central electronic module (CEM) with fuse box B under the glovebox	20
18	ABS	5
19	Speed related power steering*	5
20	Engine control module, Transmission control module, Airbags	10
21	Heated washer nozzles*	10

¹ An authorised Volvo workshop is recommended.





Fuses

	Function	A
22	Relay coil, relay, vacuum pump (5-cyl. petrol)	5
23	Headlamp control	5
24	-	-
25	-	-
26	-	-
27	Internal relay coils	5
28	Auxiliary lamps*	20
29	Horn	15
30	Relay coil, main relay, engine management system, Engine control module (5, 6-cyl. petrol)	10
31	Transmission control module	15
32	Compressor A/C (not 5-cyl. diesel), Coolant pump (5-cyl. diesel Start/Stop)	15

	Function	A
33	Relay coil, relay, compressor A/C (not 5-cyl. diesel), Relay coil, relay, coolant pump (5-cyl. diesel Start/Stop) Relay coils in central electrical unit in engine compartment cold zone Start/Stop	5
34	Actuator solenoid, starter motor ^A	30
35	Ignition coils (4-cyl. petrol), Glow control module (5-cyl. diesel)	10
	Ignition coils (5, 6-cyl. petrol), Capacitor (6-cyl.)	20
36	Engine control module (petrol)	10
	Engine control module (diesel)	15

	Function	A
37	Valves (1.6 l petrol), Mass air flow sensor (1.6 l petrol) Mass air flow sensor (D4162T), Control valve, fuel flow (D4162T)	10
	Mass air flow sensor (5, 6-cyl.), Control valves (5-cyl. diesel), Injectors (5, 6-cyl. petrol), Engine control module (6-cyl.)	15
38	Compressor A/C (5, 6-cyl.), Engine valves, Engine control module (6-cyl.) Solenoids (6-cyl. without turbo), Actuator motors, intake manifold (6-cyl. without turbo), Mass air flow sensor (4-cyl. 2.0 l petrol), Oil level sensor (5-cyl. diesel) Coolant pump (D4162T)	10
	Lambda-sonds (4-cyl. petrol), Lambda-sond (diesel), Control module, radiator roller cover (manual 5-cyl. 2.0 l diesel) EVAP valve (5, 6-cyl. petrol), Lambda-sonds (5, 6-cyl. petrol)	10 15



Fuses

	Function	A
40	Coolant pump (1.6 l petrol Start/Stop)	10
	Vacuum pump (5-cyl. petrol), Crankcase ventilation heater (5-cyl. petrol), Diesel filter heater	20
41	Crankcase ventilation heater (5-cyl. diesel)	10
42	Glow plugs (diesel)	70
43	Cooling fan (4-cyl., 5-cyl. petrol)	60
	Cooling fan (6-cyl. petrol, 5-cyl. diesel)	80
44	Electro-hydraulic power steering	100

^A For cars with the Start/Stop function this fuse location is empty - see instead page 348.



Fuses

Under the glovebox

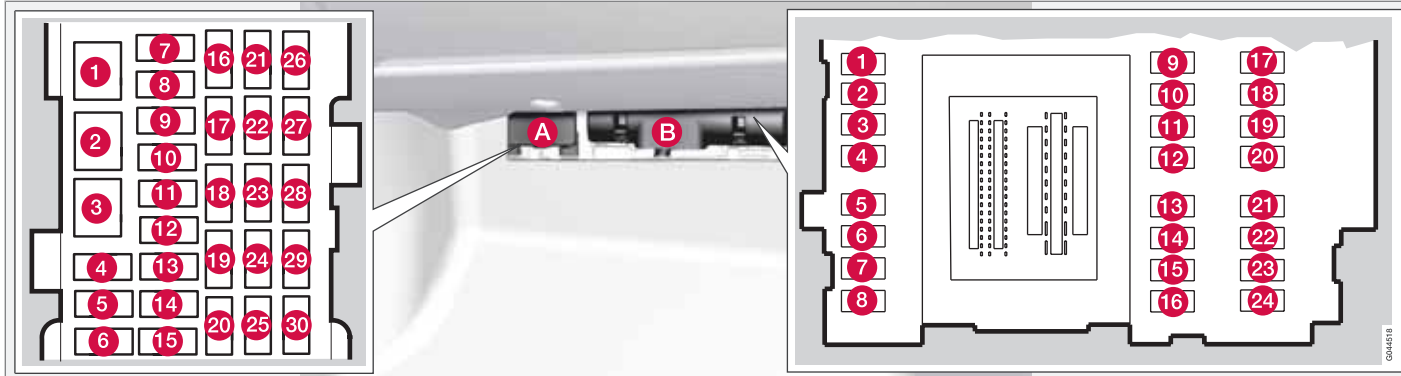

Positions

On the inside of the cover is a label that shows the location of the fuses in fuse box A.

Box A	Function	A
1	Primary fuse for audio control module*, Primary fuse for fuses 16-20	40
2	-	-
3	-	-

Box A	Function	A
4	-	-
5	Analogue clock*	5
6	-	-
7	12 V socket cargo area*, Refrigerator*	15
8	Control panel, driver's door	20

Box A	Function	A
9	Control panel, front passenger door	20
10	Control panel, rear passenger door, right	20
11	Control panel, rear passenger door, left	20
12	Keyless*	20
13	Power seat driver's side*	20



Fuses

Box A	Function	A
14	Power seat passenger side*	20
15	Folding head restraint*	15
16	Infotainment control module	5
17	Audio control module* Digital radio*, TV*	10
18	Audio	15
19	Telematics*, Bluetooth*	5
20	Rear Seat Entertainment (RSE)*	7.5
21	Sun roof*, Interior lighting roof, Climate sensor	5
22	12 V socket, tunnel console	15
23	Seat heating, rear right*	15
24	Seat heating, rear left*	15
25	Massage seats, front*, Arm-rest lighting*, Refrigerator lighting*, Relay coil, relay, refrigerator*	15

Box A	Function	A
26	Seat heating (passenger side)	15
27	Seat heating (driver's side)	15
28	Parking assistance*, Parking camera*, Towbar control module *	5
29	AWD control module*	10
30	Active chassis Four-C*	10

Box B	Function	A
1	-	-
2	-	-
3	Interior lighting, Driver's door control panel, power windows, Power seats, front*, Remote controlled garage door opener*	7.5
4	Information display (DIM)	5
5	Adaptive cruise control, ACC*, collision warning system*	10

Box B	Function	A
6	Interior lighting, Rain sensor	7.5
7	Steering wheel module	7.5
8	Central locking system, fuel filler flap	10
9	-	-
10	Windscreen washers	15
11	Unlocking, boot lid	10
12	-	-
13	Fuel pump	20
14	Climate panel	5
15	Steering lock	15
16	Siren alarm*, Data link connector OBDII	5
17	-	-
18	Airbags	10
19	Collision warning system	5

* Option/accessory, for more information, see Introduction.





Fuses

Box B	Function	A
20	Accelerator pedal, PTC element air preheater*, Dimming, interior rearview mirror*, Seat heating, rear*	7.5
21	-	-
22	Brake light	5
23	Sunroof*	20
24	Immobiliser	5

NOTE

For any fuse replacement the recommendation is that the car is taken into an authorised Volvo workshop.

	Function	A
1	Analogue clock	5

At dashboard - Executive*



The fuse is located behind the side panel on the passenger side.



Fuses

Cargo area

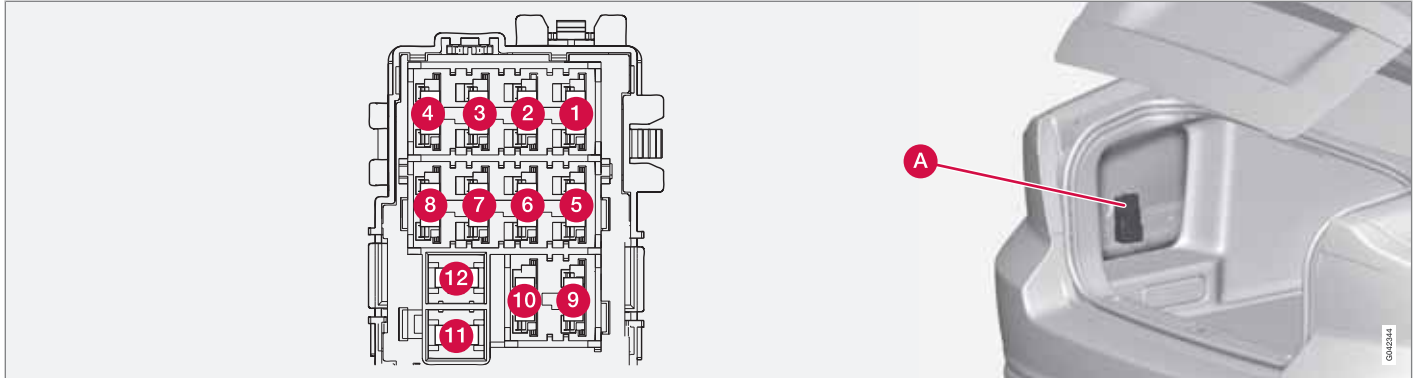

The fuse box is located behind the upholstery on the left-hand side.

Positions

	Function	A
1	Electric parking brake, left	30
2	Electric parking brake, right	30
3	Rear window defroster	30
4	Trailer socket 2*	15

	Function	A
5	-	-
6	-	-
7	-	-
8	-	-

	Function	A
9	-	-
10	-	-
11	Trailer socket 1*	40
12	-	-





Fuses

Engine compartment, cold zone - Start/Stop*

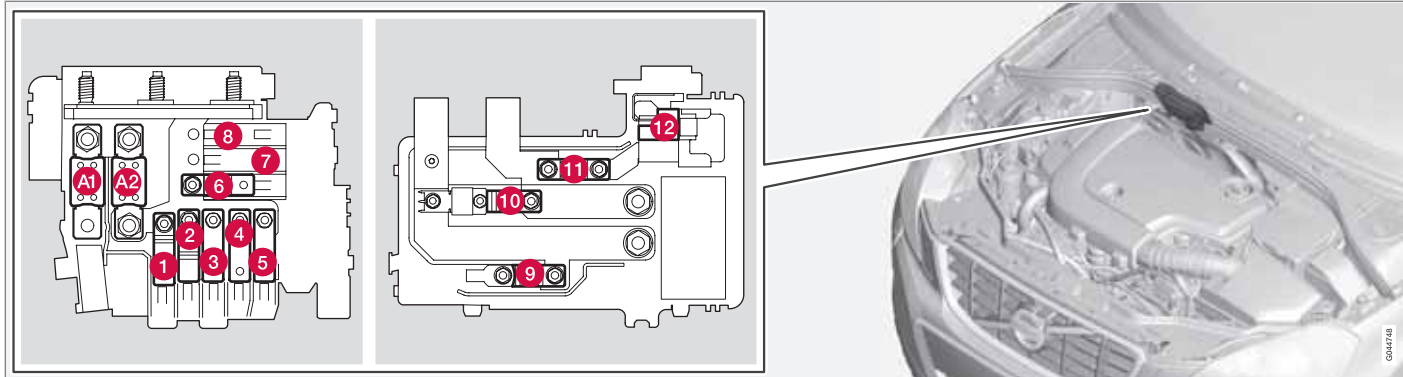

Location of fuses for the Start/Stop function.

- Fuses A1 and A2 are of the "MEGA Fuse" type and must only be replaced by a workshop².
- Fuses 1-11 are of the "Midi Fuse" type and must only be replaced by a workshop².
- Fuse 12 is of the "Mini Fuse" type.

For more information on Start/Stop - see page 122.

Positions

	Function	A
A1	Main fuse for central electrical unit in the engine compartment	175

	Function	A
A2	Main fuse for central electronic module (CEM) with fuse box B under the glovebox, central electrical unit in passenger compartment with fuse box A under the glovebox, central electrical unit in cargo area	175
1	PTC element, air preheater*	100

² An authorised Volvo workshop is recommended.

* Option/accessory, for more information, see Introduction.



Fuses

	Function	A
2	Primary fuse for the central electronic module (CEM) with fuse box B under the glovebox	50
3	Primary fuse for central electrical unit in passenger compartment with fuse box A under the glovebox	60
4	Primary fuse for central electrical unit in passenger compartment with fuse box A under the glovebox	60
5	Primary fuse for central electrical unit in cargo area	60
6	Ventilation fan	40
7	-	-
8	-	-
9	Actuator solenoid, starter motor	30
10	Internal diode	50

	Function	A
11	Support battery	70
12	Central electronic module (CEM) (Reference voltage standby battery)	15



Car care

Washing the car

Wash the car as soon as it becomes dirty. Wash the car in a car wash with oil separator. Use car shampoo.

- Remove bird droppings from the paintwork as soon as possible. Bird droppings contain chemicals that affect and discolour paintwork very quickly. An authorised Volvo workshop is recommended for the removal of any discoloration.
- Hose down the underbody.
- Rinse the entire car to remove loose dirt. Do not spray directly onto the locks.
- Wash using a sponge, car shampoo and plenty of lukewarm water.
- Clean the wiper blades with a lukewarm soap solution or car shampoo.
- Use cold degreasing agent on very dirty surfaces.
- Dry the car using a clean, soft chamois or a water scraper.

WARNING

Always have the engine cleaned by a workshop. There is a risk of fire if the engine is hot.

IMPORTANT

Dirty headlamps have impaired functionality. Clean them regularly, when refuelling for example.

NOTE

Outside lighting such as headlamps, fog lamps and rear lamps may temporarily have condensation on the inside of the lens. This is normal, all exterior lighting is designed to withstand this. Condensation is normally vented out of the lamp housing when the lamp has been switched on for a time.

Cleaning the wiper blades

Asphalt, dust and salt residue on wiper blades, as well as insects, ice etc. on the windscreen, impair the service life of wiper blades.

For cleaning:

- Set the wiper blades in service position, see page 332.

NOTE

Wash the wiper blades and windscreen regularly with lukewarm soap solution or car shampoo.

Do not use any strong solvents.

Automatic car washes

An automatic car wash is a simple and quick way of washing the car, but it cannot reach everywhere. Handwashing the car is recommended for achieving optimum results.

NOTE

During the first few months a new car must only be handwashed. This is because the paintwork is more sensitive when it is new.

High-pressure washing

When using high-pressure washing, use sweeping movements and make sure that the nozzle does not come closer than 30 cm to the surface of the car (the distance applies to all exterior parts). Do not spray directly onto the locks.

Testing the brakes

WARNING

Always test the brakes after washing the car, including the parking brake, to ensure that moisture and corrosion do not attack the brake linings and reduce braking performance.

Lightly depress the brake pedal now and then when driving long distances in rain or slush. The heat from the friction causes the brake lin-



ings to warm up and dry. Do the same thing after starting in very damp or cold weather.

Exterior plastic, rubber and trim components

A special cleaning agent available from Volvo dealers is recommended for the cleaning and care of coloured plastic parts, rubber and trim components, such as glossy trim mouldings. When using such a cleaning agent the instructions must be followed carefully.

IMPORTANT

Avoid waxing and polishing on plastic and rubber.

When using degreasant on plastic and rubber, only rub with light pressure if it is necessary. Use a soft washing sponge.

Polishing glossy trim mouldings could wear away or damage the glossy surface layer.

Polishing agent that contains abrasive must not be used.

Rims

Only use rim cleaning agent recommended by Volvo.

Strong rim cleaning agents can damage the surface and cause stains on chrome-plated aluminium rims.

Polishing and waxing

Polish and wax the car if the paintwork is dull or to give the paintwork extra protection.

The car does not need to be polished until it is at least one year old. However, the car can be waxed during this time. Do not polish or wax the car in direct sunlight.

Wash and dry the car thoroughly before you begin polishing or waxing. Clean off asphalt and tar stains using tar remover or white spirit. More stubborn stains can be removed using fine rubbing paste designed for car paintwork.

Polish first with a polish and then wax with liquid or solid wax. Follow the instructions on the packaging carefully. Many preparations contain both polish and wax.

IMPORTANT

Only paint treatment recommended by Volvo should be used. Other treatment such as preserving, sealing, protection, lustre sealing or similar could damage the paintwork. Paintwork damage caused by such treatments is not covered by Volvo warranty.

Water-repellent coating*



Never use products such as car wax, degreaser or similar on glass surfaces as this could ruin their water-repellent properties.

Take care when cleaning so as not to damage the glass surface.

To avoid damaging glass surfaces when removing ice – only use plastic ice scrapers.

There is natural wear of the water-repellent coating.

Treatment with a special finishing agent available from Volvo dealers is recommended in order to maintain the water-repellent properties. This should be used first after three years and then each year.

Rustproofing – inspection and maintenance

The car received a thorough and complete rustproofing at the factory. Parts of the body are made of galvanised sheet metal. The underbody is protected by a wear-resistant anti-corrosion compound. A thin, penetrating rustproofing fluid was sprayed into the exposed members, cavities, closed sections and side doors.

* Option/accessory, for more information, see Introduction.



Car care

Under normal conditions the rustproofing does not require treatment for approximately 12 years. After this period, it should be treated at three-year intervals. Volvo recommends that you engage an authorised Volvo workshop for assistance if the car needs further treatment.

Dirt and road salt can lead to corrosion so it is important to keep the car clean. The car's rustproofing needs to be checked regularly and touched-up if necessary in order for it to be maintained.

Cleaning the interior

Only use cleaning agents and car care products recommended by Volvo. Clean regularly and follow the instructions included with the car care product.

Vacuuming is important prior to using cleaning agents.

Carpets and cargo area

Remove inlaid carpets for separate cleaning of the floor carpet and the inlaid carpets. Use a vacuum cleaner to remove dust and dirt.

Each inlay mat is secured with pins.

- Take hold of the inlay mat at each pin and lift the mat straight up.

Fit the inlay mat in place by pressing it in at each pin.

WARNING

Before setting off check that the inlaid mat in the driver area is firmly affixed and secured in the pins in order to avoid getting caught adjacent to and under the pedals.

A special textile cleaner is recommended for stains on the floor mat after vacuuming. Floor mats should be cleaned with agents recommended by your Volvo dealer!

Stains on fabric upholstery and roof upholstery

A special fabric cleaning agent, available from authorised Volvo dealers, is recommended to avoid impairing the fire retardant qualities of the upholstery.

IMPORTANT

Sharp objects and Velcro may damage the fabric upholstery.

Treating stains on leather upholstery

Volvo's leather upholstery is chromium-free and is treated to preserve its original appearance.

Leather upholstery ages and acquires a beautiful patina over time. The leather is refined and processed so that it retains its natural characteristics. It is given a protective coating, but

regular cleaning is required in order to maintain both characteristics and appearance. Volvo offers a comprehensive product for the cleaning and treatment of leather upholstery which, when used in accordance with the instructions, preserves the leather's protective coating. After a period of use the natural appearance of the leather will nevertheless emerge, depending more or less on the surface texture of the leather. This is a natural maturing of the leather and shows that it is a natural product.

To achieve best results Volvo recommends cleaning and the application of protective cream once to four times per year (or more if necessary). The Volvo Leather Care kit is available from your Volvo dealer.

IMPORTANT

- Certain items of coloured clothing (for example, jeans and suede garments) may stain the upholstery.
- Never use strong solvents. Such products may damage fabric, vinyl and leather upholstery.

Washing instructions for leather upholstery

1. Pour the leather cleaner on the dampened sponge and squeeze out a strong foam.



2. Work the dirt away with gentle circular movements.
3. Dab accurately with the sponge on the stains. Allow the sponge to absorb the stain. Do not rub.
4. Wipe off with soft paper or a cloth and allow the leather to dry completely.

Protective treatment of leather upholstery

1. Pour a small amount of the protective cream on the felted cloth and massage in a thin layer of cream with gentle circular movements on the leather.
2. Allow the leather to dry for 20 minutes before use.

The leather has now been given improved protection against stains and improved UV protection.

Washing instructions for the leather steering wheel

- Remove dirt and dust with a soft pre-moistened sponge and neutral soap.
- Leather needs to breathe. Never cover the leather steering wheel with protective plastic.
- Use natural oils. Volvo's leather care agents are recommended for best results.

If the steering wheel has stains:

Group 1 (ink, wine, coffee, milk, sweat and blood)

- Use a soft cloth or sponge. Mix a 5% ammonia solution. (For blood stains, use a solution of 2 dl water and 25g salt.)

Group 2 (fats, oils, sauces and chocolate)

1. Same procedure as group 1.
2. Polish with an absorbent paper or cloth.

Group 3 (dry dirt, dust)

1. Use a soft brush to remove the dirt.
2. Same procedure as group 1.

Treating stains on interior plastic, metal and wood parts

A fibrillated fibre or microfibre cloth, lightly moistened with water, available from Volvo dealers, is recommended for cleaning interior parts and surfaces.

Do not scrape or rub stains. Never use strong stain removers. A special cleaning agent available from Volvo dealers can be used for more difficult cleaning.

Cleaning seatbelts

Use water and a synthetic detergent. A special textile cleaning agent is available from your

Volvo dealer. Make sure the seatbelt is dry before allowing it to retract.

Touching up minor paintwork damage

Paint is an important part of the car's rust-proofing and should therefore be checked regularly. To avoid the onset of rust, damaged paintwork should be rectified immediately. The most common types of paintwork damage are stone chips, scratches, and marks on the edges of wings and doors.

Materials

- primer in a can
- spray can or touch-up pen¹
- masking tape

¹ Follow the instructions that are included with the package for the touch-up pen.





Car care

Colour code

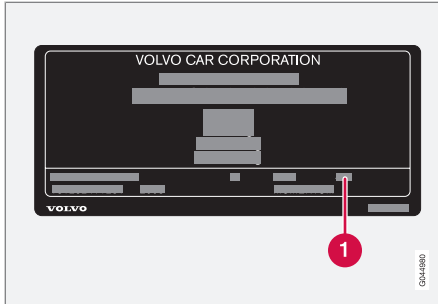

1 Car colour code

It is important that the correct colour is used. For product decal location, see page 358.

Repairing stone chips

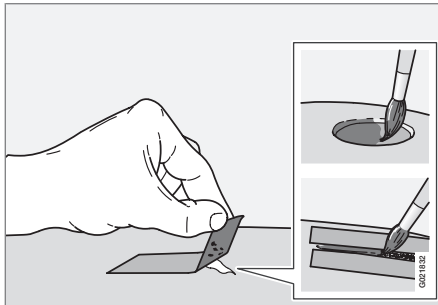

Before work is begun, the car must be clean and dry and at a temperature above 15 °C.

1. Apply a piece of masking tape over the damaged surface. Then remove the tape to remove any loose paint.
2. Stir the primer well and apply using a fine brush or a matchstick. Apply paint using a brush once the primer is dry.
3. For scratches, proceed as above, but mask around the damaged area to protect the undamaged paintwork.
4. After a few days, polish the touched-up areas. Use a soft rag and a small amount of lapping paste.

NOTE

If the stone chip has not penetrated to the bare metal and there is an undamaged colour coat, you can paint straight after cleaning the damaged surface.



Type designations.....	358
Dimensions and weights.....	360
Engine specifications.....	364
Engine oil.....	366
Fluids and lubricants.....	368
Fuel.....	370
Wheel and tyres, dimensions and pressure	373
Electrical system.....	375
Type approval.....	376
Symbols in the display.....	388



09

SPECIFICATIONS

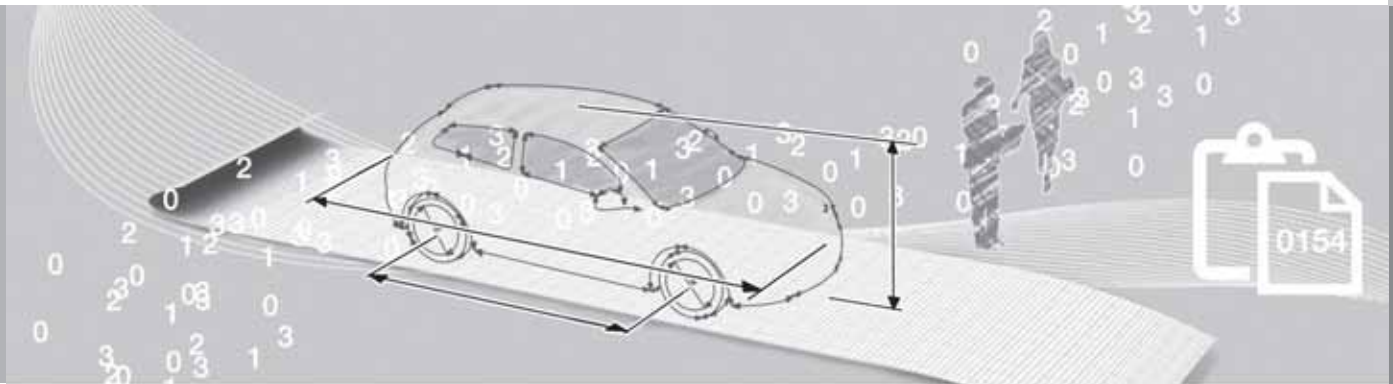

Type designations

Label location

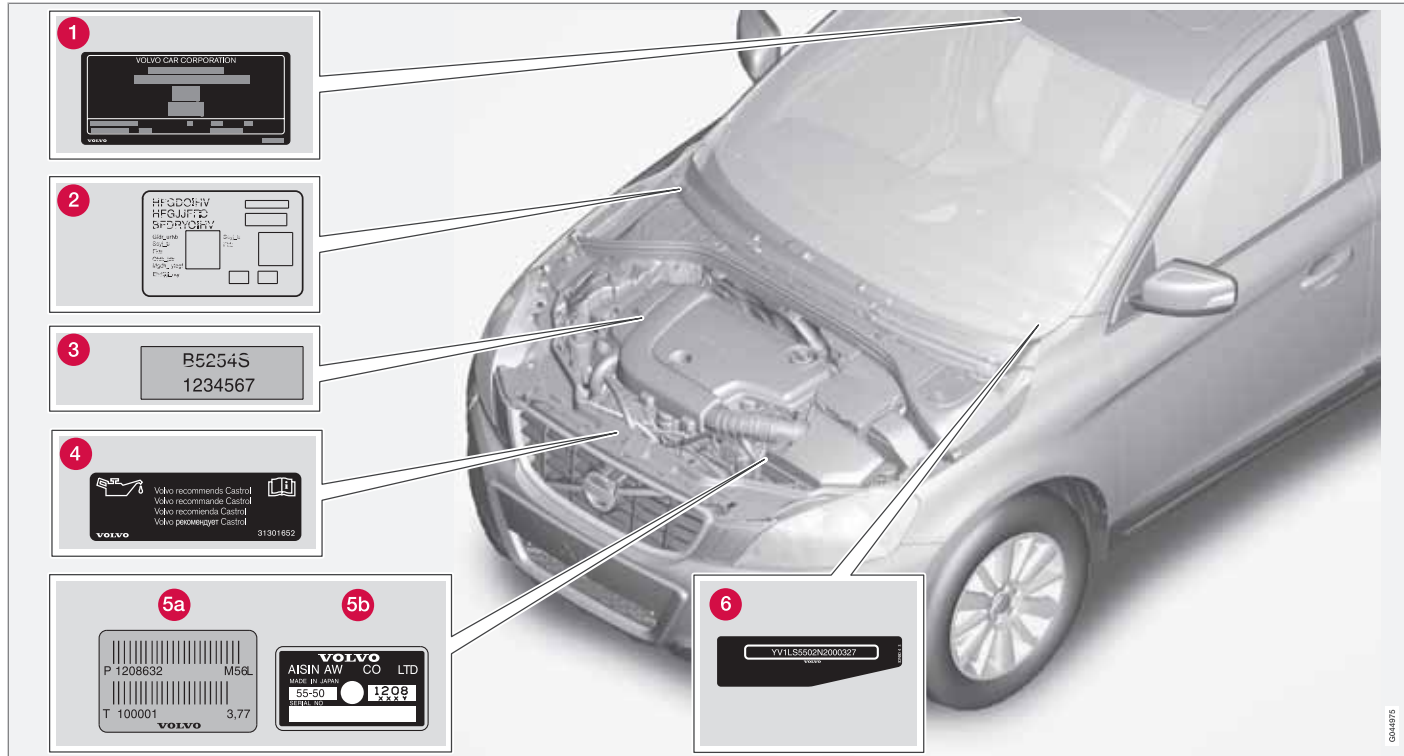

Type designations

Knowing the car's type designation, vehicle identification and engine numbers can facilitate all contact with an authorised Volvo dealer regarding the car and when ordering spare parts and accessories.

- 1 Type designation, vehicle identification number, maximum permissible weights, codes for colour and upholstery and type approval number. The label is visible when the right rear door is opened.
- 2 Label for parking heater.
- 3 Engine code, component and serial numbers.
- 4 Label for engine oil.
- 5 Gearbox type designation and serial number.
 - A Manual gearbox
 - B Automatic gearbox
- 6 Car's identification number. (VIN Vehicle Identification Number)

Further information on the car is presented in the registration document.

i NOTE

The labels shown in the owner's manual are not provided as exact reproductions of those in the car. The purpose is to show their approximate appearance and location in the car. The information that applies to your car in particular is available on the label in question in your car.

Dimensions and weights

Dimensions

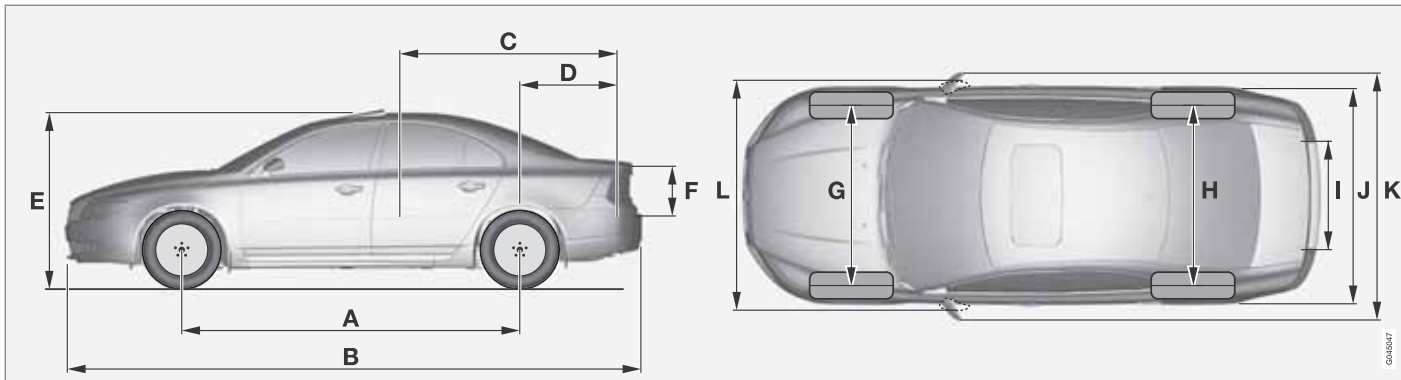

048657

	Dimensions	mm
A	Wheelbase	2835
B	Length	4851
C	Load length, floor, folded seat	1927
D	Load length, floor	1094
E	Height	1493
F	Load height	368

	Dimensions	mm
G	Front track	1588 ^A
		1578 ^B
H	Rear track	1585 ^A
		1575 ^B
I	Load width, floor	1130
J	Width	1861 (1876 ^C)

	Dimensions	mm
K	Width including door mirrors	2106
L	Width including folded-in door mirrors	1907

A with 16" wheel
 B with 17" wheel
 C with Keyless drive*

Dimensions and weights

Weights

Kerb weight includes the driver, the fuel tank 90% full and all fluids.

The weight of passengers and accessories, and towball load (when a trailer is hitched, see table page 361) influences the payload and is not included in the kerb weight.

Permitted max. load = Gross vehicle weight - Kerb weight.

NOTE

The documented kerb weight applies to cars in the standard version - i.e. a car without extra equipment or accessories. This means that for every accessory added the loading capacity of the car is reduced correspondingly by the weight of the accessory.

Examples of accessories that reduce loading capacity are the Kinetic/Momentum/Summum equipment levels, as well as other accessories such as Towbar, Load carriers, Space box, Audio system, Auxiliary lamps, GPS, Fuel-driven heater, Safety grille, Carpets, Cargo cover, Power seats, etc.

Weighing the car is a certain way of ascertaining the kerb weight of your own particular car.

WARNING

The car's driving characteristics change depending on how heavily it is loaded and how the load is distributed.

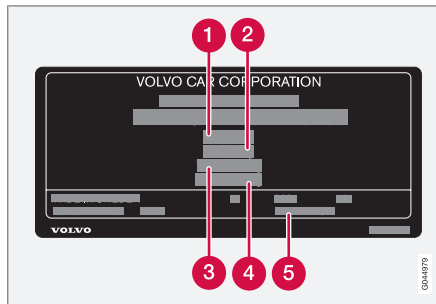

For information on decal location, see page 358.

- 1 Max. gross vehicle weight
- 2 Max. train weight (car+trailer)
- 3 Max. front axle load
- 4 Max. rear axle load
- 5 Equipment level

Max. load: See registration document.

Max. roof load: 100 kg.

Towing capacity and towball load

NOTE

The use of a stabiliser hitch on the towing bracket is recommended for trailers heavier than 1800 kg.

Dimensions and weights

Engine	Gearbox	Max. weight braked trailer (kg)	Max. towball load (kg)
All	All	1200	50
2.0T ^A	Automatic, MPS6	1800	90
2.5T ^A	Manual, M66	1600	75
2.5T ^A	Automatic, TF-80SC	1800	90
T4 ^B	Manual, MMT6	1600	75
T4 ^B	Automatic, MPS6	1600	75
T4F	Manual, MMT6	1600	75
T4F	Automatic, MPS6	1600	75
T5	Manual, MMT6	1800	90
T5	Automatic, MPS6	1800	90
3.2	Automatic, TF-80SC	1800	90
3.2 AWD	Automatic, TF-80SC	1800	90
T6 AWD	Automatic, TF-80SC	2000	90
DRIVE	Manual, MMT6	1300	75
D3	Manual, M66	1600	75
D3	Automatic, TF-80SC ^C	1600	75
D3	Automatic, TF-80SD ^D	1600	75

Dimensions and weights

Engine	Gearbox	Max. weight braked trailer (kg)	Max. towball load (kg)
D5	Manual, M66	1600	75
D5	Automatic, TF-80SC	2000	90
D5 AWD	Automatic, TF-80SC	2000	90

A Certain markets.

B DRIVe for certain markets.

C Without Start/Stop.

D With Start/Stop.

Max. weight unbraked trailer (kg)	Max. towball load (kg)
750	50

09 Engine specifications

Engine specifications



NOTE

Not all engines are available in all markets.

Engine	Engine code ^A	Output (kW/rpm)	Output (hp/rpm)	Torque (Nm/rpm)	No. of cylinders	Bore (mm)	Stroke (mm)	Swept volume (litres)	Compression ratio
2.0T ^B	B4204T6	149/6000	203/6000	300/1750-4000	4	87.5	83.1	1.999	10.0:1
2.5T ^B	B5254T10	170/4800	231/4800	340/1700-4800	5	83.0	93.2	2.521	9.0:1
T4 ^C	B4164T	132/5700	180/5700	240/1600-5000	4	79	81.4	1.596	10.0:1
T4F	B4164T2	132/5700	180/5700	240/1600-5000	4	79	81.4	1.596	10.0:1
T5	B4204T7	177/5500	240/5500	320/1800-5000	4	87.5	83.1	1.999	10.0:1
3.2	B6324S5	179/6400	243/6400	320/3200	6	84	96	3.192	10.8:1
T6	B6304T4	224/5600	304/5600	440/2100-4200	6	82.0	93.2	2.953	9.3:1
DRIVE	D4162T	84/3600	115/3600	270/1750-2500	4	75	88.3	1.560	16.0:1
D3	D5204T3	120/3500	163/3500	400/1500-2750	5	81.0	77	1.984	16.5:1

Engine specifications

Engine	Engine code ^A	Output (kW/rpm)	Output (hp/rpm)	Torque (Nm/rpm)	No. of cylinders	Bore (mm)	Stroke (mm)	Swept volume (litres)	Compression ratio
D5	D5244T11 ^D	158/4000	215/4000	420/1500–3250	5	81.0	93.15	2.400	16.5:1
D5	D5244T15 ^E	158/4000	215/4000	440/1500–3000	5	81.0	93.15	2.400	16.5:1

A Engine code, component and serial number can be read on the engine, see page 358.

B Certain markets.

C DRIVe for certain markets.

D Manual gearbox

E Automatic gearbox

Engine oil

Adverse driving conditions

Adverse driving conditions can lead to abnormally high oil temperature or oil consumption. Below are some examples of adverse driving conditions.

Check the oil level more frequently for long journeys:

- towing a caravan or trailer
- in mountainous regions
- at high speeds
- in temperatures colder than $-30\text{ }^{\circ}\text{C}$ or hotter than $+40\text{ }^{\circ}\text{C}$

The above also apply to shorter driving distances at low temperatures.

Choose a fully synthetic engine oil for adverse driving conditions. It provides extra protection for the engine.

Volvo recommends Castrol oil products.



IMPORTANT

In order to fulfil the requirements for the engine's service intervals all engines are filled with a specially adapted synthetic engine oil at the factory. The choice of oil has been made very carefully with regard to service life, starting characteristics, fuel consumption and environmental impact.

An approved engine oil must be used in order that the recommended service intervals can be applied. Only use a prescribed grade of oil for both filling and oil change, otherwise you will risk affecting service life, starting characteristics, fuel consumption and environmental impact.

Volvo Car Corporation disclaims all warranty liability if engine oil of the prescribed grade and viscosity is not used.

Volvo recommends that oil changes are carried out at an authorised Volvo workshop.

Engine oil

Engine oil grade

Engine	Engine code	Recommended oil grade	Volume, incl. oil filter (litres)
2.5T ^A	B5254T10	Oil grade: ACEA A5/B5 Viscosity: SAE 0W-30	approx 5.5
3.2	B6324S5		approx 6.8
T6	B6304T4		approx 6.8
D3	D5204T3		approx. 5.9
D5	D5244T11 ^B		approx. 5.9
D5	D5244T15 ^C		approx. 5.9
2.0T ^A	B4204T6	Oil grade: ACEA A5/B5 Viscosity: SAE 5W-30 When driving under adverse conditions, use ACEA A5/B5 SAE 0W-30.	approx. 5.4
T5	B4204T7		approx. 5.4
DRIVE	D4162T		approx. 3.8
T4 ^D	B4164T	Certified and factory-filled oil: Oil grade WSS-M2C925-A options for service: Oil grade: ACEA A5/B5 Viscosity: SAE 5W-30	approx. 4.1
T4F	B4164T2		approx. 4.1

^A Certain markets.

^B Manual gearbox.

^C Automatic gearbox.

^D DRIVE for certain markets.

For filling engine oil, see page 319.

09 **Fluids and lubricants****Other fluids and lubricants**

Manual gearbox	Volume (litres)	Prescribed transmission fluid
MMT6	1.7	BOT 350M3
M66	1.9	

Automatic gearbox	Volume (litres)	Prescribed transmission fluid
MPS6	7.3	BOT 341
TF-80SC	7.0	AW1
TF-80SD	7.0	AW1

Fluid	System	Volume (litres)	Prescribed grade
Coolant	2.0T, T5	10.5	Coolant recommended by Volvo mixed with 50% water ^A , see the packaging.
	2.5T, 3.2 and T6	8.9	
	D3 and D5	8.9	
	T4 ^{B, C} and T4 ^{FC}	9.2	
	T4 ^{B, D} and T4 ^{FD}	9.8	
	DRIVE	10.5	
Brake fluid	Brake system	0.6	DOT 4+
Power steering fluid	Power steering	-	WSS M2C204-A2 or equivalent product.

Fluids and lubricants

Fluid	System	Volume (litres)	Prescribed grade
Washer fluid	Cars with headlamp washing	6.5	Washer fluid recommended by Volvo - with frost protection during cold weather and below freezing point.
	Cars without headlamp washing	4.5	
Fuel	Petrol engine	approx. 70	Petrol: see page 284
	Diesel engine	approx. 70	Diesel: see page 285

A Water quality must fulfil the standard STD 1285.1.

B DRIVE for certain markets.

C Manual gearbox





D Automatic gearbox

 **NOTE**







Under normal driving conditions, the gearbox oil does not need to be changed during its service life. However, this may be necessary under adverse driving conditions, see page 368.

Fuel

CO₂ emissions and fuel consumption

		A		B		C	
		CO ₂		CO ₂		CO ₂	
2.5T	man	299	12.8	151	6.5	206	8.8
2.5T	aut	339	14.5	166	7.1	229	9.8
T4F ^A	man	-	-	-	-	-	-
T4F ^A	aut	-	-	-	-	-	-
T4 ^B	man	-	-	-	-	-	-
T4 ^B	aut	-	-	-	-	-	-
T5	man	256	11.0	142	6.1	184	7.9
T5	aut	265	11.4	152	6.5	193	8.3
3.2	aut	305	13.1	153	6.6	208	8.9
3.2 AWD	aut	319	13.7	163	7.0	219	9.4

Fuel

		A		B		C	
		 CO ₂		 CO ₂		 CO ₂	
T6 AWD	aut	337	14.5	170	7.3	231	9.9
DRIVe	man	140	5.3	106	4.0	119	4.5
D3	man	162	6.2	110	4.2	129	4.9
D3 ^C	aut	214	8.1	126	4.8	158	6.0
D3 ^D	aut	187	7.1	125	4.7	148	5.6
D5	man	160	6.1	111	4.2	129	4.9
D5	aut	219	8.4	124	4.7	159	6.1
D5 AWD	aut	224	8.6	134	5.1	167	6.4

A Flexifuel engines can be driven on both 95 octane unleaded petrol and bioethanol E85. Both fuels are filled in the common fuel tank so that any variations of mixing ratios between these two fuels is possible. For more information, see page 114.

B DRIVe for certain markets.

C Without Start/Stop.

D With Start/Stop.

 : gram/km

 : litre/100 km

A = urban driving

B = extra-urban driving

Fuel

C = combined driving



NOTE

If the consumption and emission data is missing then it is included in the enclosed supplement.

Fuel consumption and emissions of carbon dioxide

Fuel consumption and emission values in the table above are based on specific EU cycles¹, that apply to cars with kerb weight in the basic version and without extra equipment. The car's weight may increase depending on equipment. This, as well as how heavily the car is loaded, increases fuel consumption and carbon dioxide emissions.

There are several reasons for increased fuel consumption compared with the table's values. Examples of this are:

- The driver's driving style.
- If the customer has specified wheels larger than those fitted as standard on the model's basic version, then resistance increases.

- High speed results in increased wind resistance.
- Fuel quality, road and traffic conditions, weather and the condition of the car.

Even a combination of the above-mentioned examples can result in significantly improved consumption. For further information, please refer to the regulations referred to¹.

Large deviations in fuel consumption may arise in a comparison with the EU driving cycles¹ which are used in the certification of the car and on which the consumption figures in the table are based.

To bear in mind

Tips that the driver can use in order to reduce consumption:

- Drive gently and avoid unnecessary acceleration as well as braking too hard.
- Drive with the correct air pressure in the tyres and check this regularly - select ECO tyre pressure for best results, see the tyre pressure table on page 373.
- Choice of tyres can affect fuel consumption - seek advice on suitable tyres from a dealer.

See further information and more advice on pages 12 and 280.

See page 284 for general information on fuel.

¹ Official fuel consumption figures are based on two standardised driving cycles in a laboratory environment ("EU driving cycles") all in accordance with EU Directive 80/1268/EEC (Euro 4), EU Regulation no 692/2008 (Euro 5) and UN ECE Regulation no 101. The regulations cover the driving cycles for urban driving and extra-urban driving. - Urban driving - the measurement starts with cold starting the engine. The driving is simulated. - Extra-urban driving - the car is accelerated and braked at speeds between 0-120 km/h. The driving is simulated. - Cars with the D5 engine and 6-speed manual transmission or DRIVE engine and 6-speed manual transmission, are started in 2nd gear. The value for combined driving, which is given in the table, according to legislation, is a combination of urban driving and extra-urban driving. CO₂ emission - to calculate the carbon dioxide emissions from the two driving cycles, the exhaust gases are collected. These are then analysed and give the value for CO₂ emissions.

Wheel and tyres, dimensions and pressure

Approved tyre pressures

Engine	Tyre size	Speed (km/h)	Load, 1-3 persons		Max. load		ECO pressure ^A
			Front (kPa) ^B	Rear (kPa)	Front (kPa)	Rear (kPa)	Front/rear (kPa)
3.2 T6	225/55 R 16	0-160	230	210	260	260	260
	225/50 R 17	160 +	280	280	290	290	-
	245/45 R 17						
	245/40 R 18	0-160	230	210	260	260	260
		160 +	270	270	290	290	-
D5	225/55 R 16	0-160	220	210	260	260	260
	225/50 R 17	160 +	260	260	270	270	-
	245/45 R 17						
	245/40 R 18	0-160	230	210	260	260	260
		160 +	260	260	270	270	-

Wheel and tyres, dimensions and pressure

Engine	Tyre size	Speed (km/h)	Load, 1-3 persons		Max. load		ECO pressure ^A
			Front (kPa) ^B	Rear (kPa)	Front (kPa)	Rear (kPa)	Front/rear (kPa)
T4	225/55 R 16	0-160	220	210	260	260	260
T4F	225/50 R 17	160 +	260	260	270	270	-
2.0T ^C	245/45 R 17						
2.5T ^C	205/60 R 16	0-160	230	210	260	260	260
T5		160 +	260	260	270	270	-
DRIVE D3							
Temporary Spare Tyre		max. 80	420	420	420	420	-

^A Economical driving.

^B In certain countries there is the "bar" unit beside the SI unit "Pascal": 1 bar = 100 kPa.

^C Certain markets.



NOTE

All engines, tyres or combinations of these are not always available in all markets.

Electrical system

Electrical system

The car has a voltage-regulated AC alternator. The electrical system is single-pole and uses the chassis and engine casing as a conductor.

The battery capacity is dependent upon the equipment level in the vehicle.

IMPORTANT

If the battery is replaced, replace it with a battery of the same cold start capacity and reserve capacity as the original (see the decal on the battery).

Battery

Engine	Voltage (V)	Cold start capacity, CCA - Cold Cranking Amperes (A)	Reserve capacity (minutes)
Petrol (Ethanol)	12	520–800	100–160
Diesel	12	700–800	135–160
Petrol/Diesel with Start/Stop function	12	760 ^A	135

^A Battery type AGM (Absorbed Glass Mat) must be used in cars with the Start/Stop function.

NOTE

- The battery's container size should be consistent with the original battery's dimensions.
- The battery's height is different depending on size.

Eco Start/Stop DRIVE*

For information on batteries in cars with Eco Start/Stop DRIVE, see page 337.

Type approval

Remote control system

Country	
A, B, CY, CZ, D, DK, E, EST, F, FIN, GB, GR, H, I, IRL, L, LT, LV, M, NL, P, PL, S, SK, SLO	 Delphi hereby certifies that this remote control key system conforms to the essential characteristic requirements and other relevant regulations of directive 1999/5/EC.
IS, LI, N, CH	
HR	
ROK	Delphi 2003-07-15, Germany R-LPD1-03-0151

Country	
BR	
RC	 CCAB06LP1940T4

Radar system

Country	
Singapore	<div style="border: 1px solid black; padding: 5px;">Complies with IDA standards DA105753</div> <p>IDA: Infocomm Development Authority of Singapore.</p>
Brazil	

Type approval

Bluetooth®**Declaration of Conformity (Declaration of Conformity)**

Country	
Countries in the EU:	 Exporting country: Japan Manufacturer: Alpine Electronics Inc. Type of equipment: Bluetooth® device For further information visit http://ec.europa.eu/enterprise/rte/faq.htm #informing

Type approval

Country	
	<div data-bbox="248 244 667 770" style="border: 1px solid black; padding: 10px;"> <p style="text-align: center;">ALPINE <small>ALPINE ELECTRONICS, INC. 20-1 Yamanashi-Appocho1 Bunkyo-ku, Maebashi 370-1002 Japan Phone: (81)283-34111 Fax: (81)283-34000</small></p> <p style="text-align: center;">DECLARATION of CONFORMITY</p> <p>We, Alpine Electronics, Inc. of the above address, hereby declare, at our sole responsibility, that the following product conforms to the Essential Requirements of the Radio and Telecommunications Terminal Equipment Directive 1999/5/EC in accordance with the tests conducted to the appropriate requirements of the relevant standards, as listed herewith.</p> <p>Product : Bluetooth Module</p> <p>Model/ Type Number : IAM 2.1 BT PWB EU</p> <p>Directive and Standards used : Radio: EN 300 328 V1.7.1: 2006-10 EMC: EN 301 489-1 V1.3.2: 2008-04 EN 301 489-1 V1.8.1: 2008-04 ISO7637-2: 2004 Safety: IEC 60065 Ed.7: 2001 + Amd.1: 2005 EN 60065: 2002 + Amd.1: 2006</p> <p>Year of affixing CE marking : 2009</p> <p>Signature : <i>S. Asuke</i></p> <p>Name : Shimichi Asuke</p> <p>Date : November 12, 2009</p> <p style="text-align: center;">CE</p> <p style="text-align: right; font-size: small;">0043092</p> </div>
Czech Republic:	Alpine Electronics, Inc. tímto prohlašuje, že tento Bluetooth ® Module je ve shodě se základními požadavky a dalšími příslušnými ustanoveními směrnice 1999/5/ES.
Denmark:	Undertegnede Alpine Electronics, Inc. erklærer herved, at følgende udstyr Bluetooth ® Module overholder de væsentlige krav og øvrige relevante krav i direktiv 1999/5/EF.
Germany:	Hiermit erklärt Alpine Electronics, Inc., dass sich das Gerät Bluetooth ® Module in Übereinstimmung mit den grundlegenden Anforderungen und den übrigen einschlägigen Bestimmungen der Richtlinie 1999/5/EG befindet.

Type approval

09

Country	
Estonia:	Käesolevaga kinnitab Alpine Electronics, Inc. seadme Bluetooth ® Module vastavust direktiivi 1999/5/EÜ põhinõuetele ja nimetatud direktiivist tulenevatele teistele asjakohastele sätetele.
UK	Hereby, Alpine Electronics, Inc., declares that this Bluetooth ® Module is in compliance with the essential requirements and other relevant provisions of Directive 1999/5/EC.
Spain:	Por medio de la presente Alpine Electronics, Inc. declara que el Bluetooth ® Module cumple con los requisitos esenciales y cualesquiera otras disposiciones aplicables o exigibles de la Directiva 1999/5/CE.
Greece:	ΜΕ ΤΗΝ ΠΑΡΟΥΣΑ Alpine Electronics, Inc. ΔΗΛΩΝΕΙ ΟΤΙ Bluetooth ® Module ΣΥΜΜΟΡΦΩΝΕΤΑΙ ΠΡΟΣ ΤΙΣ ΟΥΣΙΩΔΕΙΣ ΑΠΑΙΤΗΣΕΙΣ ΚΑΙ ΤΙΣ ΛΟΙΠΕΣ ΣΧΕΤΙΚΕΣ ΔΙΑΤΑΞΕΙΣ ΤΗΣ ΟΔΗΓΙΑΣ 1999/5/EK.
France:	Par la présente Alpine Electronics, Inc. déclare que l'appareil Bluetooth ® Module est conforme aux exigences essentielles et aux autres dispositions pertinentes de la directive 1999/5/CE.
Italy:	Con la presente Alpine Electronics, Inc. dichiara che questo Bluetooth ® Module è conforme ai requisiti essenziali ed alle altre disposizioni pertinenti stabilite dalla direttiva 1999/5/CE.
Latvia:	Ar šo Alpine Electronics, Inc. deklarē, ka Bluetooth ® Module atbilst Direktīvas 1999/5/EK būtiskajām prasībām un citiem ar to saistītajiem noteikumiem.
Lithuania:	Šiuo Alpine Electronics, Inc. deklaruoja, kad šis Bluetooth ® Module atitinka esminius reikalavimus ir kitas 1999/5/EB Direktyvos nuostatas.
Netherlands:	Hierbij verklaart Alpine Electronics, Inc. dat het toestel Bluetooth ® Module in overeenstemming is met de essentiële eisen en de andere relevante bepalingen van richtlijn 1999/5/EG.
Malta:	Hawnhekk, Alpine Electronics, Inc., jiddikjara li dan Bluetooth ® Module jikkonforma mal-htigijiet essenzjali u ma provvedimenti oħrajn relevanti li hemm fid-Dirrettiva 1999/5/EC.
Hungary:	Alulírott, Alpine Electronics, Inc. nyilatkozom, hogy a Bluetooth ® Module megfelel a vonatkozó alapvető követelményeknek és az 1999/5/EC irányelv egyéb előírásainak.



Type approval

Country	
Poland:	Niniejszym Alpine Electronics, Inc. oświadcza, że Bluetooth ® Module jest zgodny z zasadniczymi wymogami oraz pozostałymi stosownymi postanowieniami Dyrektywy 1999/5/EC.
Portugal:	Alpine Electronics, Inc. declara que este Bluetooth ® Module está conforme com os requisitos essenciais e outras disposições da Directiva 1999/5/CE.
Slovenia:	Alpine Electronics, Inc. izjavlja, da je ta Bluetooth ® Module v skladu z bistvenimi zahtevami in ostalimi relevantnimi določili direktive 1999/5/ES.
Slovakia:	Alpine Electronics, Inc. týmto vyhlasuje, že Bluetooth ® Module spĺňa základné požiadavky a všetky príslušné ustanovenia Smernice 1999/5/ES.
Finland:	Alpine Electronics, Inc. vakuuttaa täten että Bluetooth ® Module tyyppinen laite on direktiivin 1999/5/EY oleellisten vaatimusten ja sitä koskevien direktiivin muiden ehtojen mukainen.
Sweden:	Härmed intygar Alpine Electronics, Inc. att denna Bluetooth ® Module står i överensstämmelse med de väsentliga egenskapskrav och övriga relevanta bestämmelser som framgår av direktiv 1999/5/EG.
Iceland:	Alpine Electronics, Inc. hereby certifies that this Bluetooth ® Module conforms to the essential characteristic requirements and other relevant regulations of directive 1999/5/EC.
Norway:	Alpine Electronics, Inc. erklærer herved at utstyret Bluetooth ® Module er i samsvar med de grunnleggende krav og øvrige relevante krav i direktiv 1999/5/EF.

Country	
China:	<p>第十三条 进口和生产厂商在其产品的说明书或使用手册中，应刊印下述有关内容：</p> <ol style="list-style-type: none"> 1. 标明附件中所规定的技术指标和使用范围，说明所有控制、调整及开关等使用方法； <ul style="list-style-type: none"> ■ 使用频率：2.4 - 2.4835 GHz ■ 等效全向辐射功率(EIRP)：天线增益 < 10dBi 时：≤100 mW 或 ≤20 dBm ① ■ 最大功率谱密度：天线增益 < 10dBi 时：≤20 dBm / MHz (EIRP) ① ■ 载频容限：20 ppm ■ 杂散发射(辐射)功率(对应载波±2.5 倍信道带宽以外)： <ul style="list-style-type: none"> • ≤-36 dBm / 100 kHz (30 - 1000 MHz) • ≤-33 dBm / 100 kHz (2.4 - 2.4835 GHz) • ≤-40 dBm / 1 MHz (3.4 - 3.53 GHz) • ≤-40 dBm / 1 MHz (5.725 - 5.85 GHz) • ≤-30 dBm / 1 MHz (其它 1 - 12.75 GHz) 2. 不得擅自更改发射频率、加大发射功率(包括额外加装射频功率放大器)，不得擅自外接天线或改用其它发射天线； 3. 使用时不得对各种合法的无线电通信业务产生有害干扰；一旦发现有害干扰现象时，应立即停止使用，并采取措施消除干扰后方可继续使用； 4. 使用微功率无线电设备，必须忍受各种无线电业务的干扰或工业、科学及医疗应用设备的辐射干扰； 5. 不得在飞机和机场附近使用。

Type approval

Country	
Taiwan:	<p data-bbox="225 244 587 266">低效率電波輻射性電機管理辦法第十條</p> <p data-bbox="225 281 309 303">第十二條</p> <p data-bbox="225 318 1449 340">經型式認證合格之低功率射頻電機，非經許可，公司、商號或使用者均不得擅自 變更頻率、加大功率或變更原設計之特性及功能。</p> <p data-bbox="225 355 309 377">第十四條</p> <p data-bbox="225 392 1489 440">低功率射頻電機之使用不得影響飛航安全及干擾合法通信；經發現有干擾現象時，應立即停用，並改善至無干擾時方得繼續使用。前項合法通信，指依電信法規定 作業之無線電通信。低功率射頻電機須忍受合法通信或工業、科學及醫療用電波 輻射性電機設備之干擾。</p> <div data-bbox="225 454 368 600"></div> <p data-bbox="225 605 395 628">CCAB10LP0230T7</p>

Type approval

Country	
South Korea:	<p>제품 정보</p> <p>Volvo Car Korea 신청자 코드: N25-IAM2101V 제품 명: Bluetooth Audio Navigation Radio 모델 명: IAM2.1 산 날짜: March/2010 Alpine Electronics, Inc Made in Japan</p> <p>고객 정보</p> <p>Volvo Car Korea 불보자동차코리아 서울시 용산구 한남 2 동 726-173 불보빌딩 4 층 불보자동차 고객센터 1588-1777 http://www.volvocars.com/kr</p> <p>사용자 주의사항</p> <p>※당해 무선설비는 전파혼신 가능성이 있으므로 인명안전과 관련된 서비스는 할 수 없습니다</p>

Type approval

Country	
Singapore:	<div data-bbox="225 244 368 393" style="border: 1px solid black; padding: 5px; width: fit-content;"><p data-bbox="252 311 341 362">Complies with IDA Standards DA100925X</p></div>
The United Arab Emirates:	<div data-bbox="225 415 663 779" style="border: 3px double black; padding: 10px; width: fit-content;"><p data-bbox="261 449 344 482">TRA</p><p data-bbox="261 497 520 530">REGISTERED No:</p><p data-bbox="261 549 464 583">0020557/09</p><p data-bbox="261 605 424 639">DEALER No:</p><p data-bbox="261 661 469 695">0014517/08</p></div>
Jordan:	<p data-bbox="225 807 1177 829">The product that contains the Bluetooth module is approved with the following certification number.</p> <p data-bbox="225 844 708 866">BT module certification number: TRC/LPD/2010/4.</p> <p data-bbox="225 881 584 903">BT module name: IAM2.1BT PWB EU</p>

Type approval

Country

South Africa:



Uruguay: This product contains URSEC approved transmitter [module name and model name (IAM2.1 BT PWB EU + BVJG905A, BVVE905A, BVLV905A)]



09 Type approval

Country	
Jamaica:	Approved for use in Jamaica SMA EI: IAM2.1
Thailand:	This telecommunication equipment conforms to NTC technical requirement.
Nigeria:	<div style="border: 1px solid black; padding: 5px; text-align: center;"> <p><u>Connection and use of this communications</u> equipment is permitted by the Nigerian <u>Communications Commission</u></p> </div>
Mexico:	<p>Warning</p> <p>"Este equipo opera a título secundario, consecuentemente, debe aceptar interferencias perjudiciales incluyendo equipos de la misma clase y puede no causar interferencias a sistemas operando a título primario."</p> <p>Bluetooth® module installation information</p> <p>This module board is to be installed only by the professional line operator and used only for car audio produced by ALPINE ELECTRONICS, INC. When this Bluetooth® Module Board is installed in the Car Audio, we shall consider the following points: 1. Since "IAM2.1 BT PWB US" owns its FCC ID/IC Number, we shall affix an exterior label on the outside of the product if the FCC ID is not visible. The exterior label shall use wording such as either "Contains Transmitter Module Board FCC ID: A269ZUA130 / IC: 700B-IAM2101" or "Contains FCC ID: A269ZUA130 / IC: 700B-IAM2101". 2. "IAM2.1 BT PWB US" complies with requirements of subsections 15.19(a)(3) in FCC Rules Part 15 Subpart C. The manual statement 15.19 (a)(3) is included in User Guide of the product.</p> <p>COFETEL No. RCPALIA10-0353</p>

Type approval

09

Country

Botswana:

BTA
REGISTERED No:
BTA/TA/2010/220

0044549

Croatia:



POTVRDA O SUKLADNOSTI
CERTIFICATE OF CONFORMITY

Broj: 087110

Proizvođač: **Siemens AG, Power Line Division**
Adresa: **Waldweg 1, 91074 Erlangen, Germany**

Proizvodni broj: **6ES7 311-1CG03-0AB0**

Proizvodni datum: **01/2010**

Proizvođač: **Siemens AG, Power Line Division**

Model	Opis proizvoda	Opis materijala	Opis pakiranja
6ES7 311-1CG03-0AB0	Power Line Converter	Aluminum	1000000000





0044000

Symbols in the display

General







There are a variety of different symbols in the display in the car. The symbols are divided into warning, indicator and information symbols. Shown below are the most common symbols with their meanings and a reference to where in the manual further information can be found. For more information on symbols and text messages, see pages 70, 72 and 142.

 - Red warning symbol, illuminates when a fault has been indicated which could affect the safety and/or driveability of the car. At the same time an explanatory text is displayed in the information display.











 - Yellow information symbol, illuminates in combination with text in the information display, when a deviation in any of the car's systems has occurred. The yellow symbol information can also illuminate in combination with other symbols.

Symbols in the display



Indicator and warning symbols in the combined instrument panel

Symbol	Meaning	Page
	Low oil pressure	72
	Parking brake	72, 132, 134
	Airbags - SRS	19, 72
	Seatbelt reminder	16, 72
	Alternator not charging	72
	Fault in the brake system	72, 131
	Warning, safety mode	19, 30, 72, 73, 120





Indicator and information symbols in the combined instrument panel







Symbol	Meaning	Page
	Fault in the ABL system*	70, 87
	Emissions system	70
	Fault in the ABS system	70, 131
	Rear fog lamp on	70, 89
	Stability system, DSTC	70, 169
	Stability system, sport mode	70, 169
	Engine preheater (diesel)	70
	Low level in fuel tank	70, 163
	Information, read display text	70
	Main beam on	70, 87
	Left-hand direction indicators	70









Symbols in the display

Symbol	Meaning	Page
	Right-hand direction indicators	70
	DRIVE - Start/Stop*	70, 126



Other information symbols in the combined instrument panel

Symbol	Meaning	Page
	Adaptive cruise control*	171, 175, 180
	Adaptive cruise control*	180
	Adaptive cruise control*, Distance Warning* (Distance Alert)	180, 185
	Adaptive cruise control*, Distance Warning* (Distance Alert)	180, 185
	Adaptive cruise control*	180



Symbol	Meaning	Page
	Adaptive cruise control*, Distance Warning* (Distance Alert)	175, 184
	Adaptive cruise control*, Distance Warning* (Distance Alert)	175, 184
	Adaptive cruise control*	175
	Radar sensor*	180, 185, 195
	Start/Stop*, Adaptive cruise control*	126, 180
-	-	-
	Camera sensor*, Laser sensor*	189, 195, 199, 201

Symbol	Meaning	Page
	Auto Brake*, Distance Warning* (Distance Alert), City Safety™, Collision warning system*	185, 189, 195
	Fuel-driven engine block heater and passenger compartment heater*	163
	ABL system*	87
	Fuel filler flap, right-hand side	283
	Low battery	163
	(P)!	134
	Rain sensor*	96
	Driver Alert System*	198

Symbols in the display

Symbol	Meaning	Page
	Driver Alert System*, Lane Departure Warning*	199, 201
	Driver Alert System*, Lane Departure Warning*	201
	Driver Alert System*, Time for a break	199

Information symbols in the roof console display

Symbol	Meaning	Page
	Seatbelt reminder	17
	Airbag, passenger seat, activated	22, 23
	Airbag, passenger seat, deactivated	23

A

A/V-AUX input.....	266	Air conditioning.....	159	audio system	222
ACC – Adaptive cruise control.....	173	general.....	152	Audio system.....	220
Active Bending Lights (ABL).....	87	Air conditioning, AC.....	159	functions.....	227
Active chassis – FOUR-C.....	170	Air distribution.....	154, 161	overview.....	222
Active Xenon headlamps.....	87	Air quality system IAQS	160	Audio volume	223
Adaptation.....	114	Air vents.....	154	phone.....	255
Adapting driving characteristics.....	170	Alarm.....	61	phone/media player.....	255
Adaptive cruise control.....	173	alarm indicator.....	61	ring signal, phone.....	255
fault tracing.....	180	alarm signals.....	62	Auto	
radar sensor.....	178	arming.....	61	climate control settings.....	159
Adaptive cruise control fault tracing.....	180	checking the alarm.....	46	Automatic car washes.....	350
Additional heater (Diesel).....	165	deactivate.....	61	Automatic gearbox.....	116
Adjusting headlamp pattern.....	91	deactivating a triggered alarm.....	62	manual gear positions (Geartronic)....	117
halogen headlamp.....	92	reduced alarm level.....	62	towing and recovery.....	297
Adjusting the steering wheel.....	85	Alcolock.....	107	trailer.....	292
Airbag		Allergy and asthma inducing sub- stances.....	153	Automatic locking.....	56
activating/deactivating, PACOS.....	22	All-wheel drive, AWD.....	129	Automatic relocking.....	55
driver's and front passenger side.....	20	All Wheel Drive (AWD).....	129	Auxiliary heater.....	165
key switch off.....	22	Approach light, duration.....	45, 91	AUX input.....	222, 241
AIRBAG	20	Audio		AWD, All-wheel drive.....	129
Airbag system	19	headphones socket.....	225		
		rear control panel.....	225		
		settings.....	227, 228		
		surround.....	220, 228		

B

-
- Backrest..... 79
 - front seat, lowering..... 79
 - Backrest rear seat, lowering..... 81
 - Bag holder 289
 - Battery..... 334, 375
 - headphones..... 266
 - maintenance..... 334
 - remote control 251
 - remote control key/PCC..... 50
 - start assistance..... 115
 - symbols on the battery..... 335
 - warning symbols..... 335
 - Bioethanol E85..... 285
 - Blind spot (BLIS)..... 209
 - Blind Spot Information System, BLIS..... 209
 - Bluetooth®
 - handsfree 252
 - media 244
 - microphone off 254
 - streaming audio 244
 - transfer call to mobile 254
 - Bonnet, opening..... 318
 - Boot lid
 - locking/unlocking..... 56
 - Brake and clutch fluid..... 323
 - Brake light..... 88
 - Brakes..... 130
 - anti-lock braking system, ABS..... 130
 - brake light..... 88
 - brake system..... 130
 - electric parking brake..... 132
 - Emergency Brake Assistance, EBA ... 130
 - emergency brake lights..... 88
 - filling brake fluid..... 324
 - symbols in the combined instrument panel..... 131
 - Bulbs, see Lighting..... 325
-
- C**
-
- Calls
 - incoming..... 254
 - operation..... 254
 - Camera sensor..... 187, 193
 - Car care..... 350
 - Car care, leather upholstery..... 352
 - Cargo area
 - loading..... 288
 - load retaining eyelets..... 289
 - mat..... 217
 - Car upholstery..... 352
 - Car wash..... 350
 - Catalytic converter..... 284
 - recovery..... 298
 - CD 237
 - Centre console..... 144
 - Chassis settings..... 170
 - Checking and topping up the coolant.... 322
 - Checking the engine oil level..... 319
 - Children..... 31
 - child safety locks..... 37
 - child seats and side airbags..... 24
 - location in the car..... 31
 - safety..... 31
 - Child safety locks..... 60
 - Child seat..... 31
 - Child seats..... 31
 - ISOFIX fixture system for child seats. . 37
 - recommended..... 33

- size classes for child seats with the ISO-FIX fixture system..... 37
 upper mounting points for child seats.. 40
- Cigarette lighter socket..... 214
- City Safety™..... 186
- Cleaning
 automatic car washes..... 350
 car wash..... 350
 rims..... 351
 seatbelts..... 353
 upholstery..... 352
- Clean Zone Interior Package (CZIP)..... 153
- Climate control..... 152
 general..... 152
 sensors..... 152
- Clock
 analogue..... 75
- Clock, setting..... 74
- CO₂ emissions 370
- Collision..... 30
- Collision warning..... 190, 191
- Collision warning system
 radar sensor..... 178, 186, 191
- Collision Warning with Auto Brake*..... 190
- Colour code, paint..... 354
- Combined instrument panel..... 142
- Comfort inside the passenger compartment..... 213
- Comfort lighting..... 91
- Compass..... 104
 calibration..... 104
 setting the zone..... 104
- Condensation in headlamps..... 350
- controls
 centre console 223, 273
- Controls
 centre console..... 144
- Controls, lights..... 86
- Cooler box..... 217
- Cooling system..... 280
- Crash, see Collision..... 30
- Cruise control..... 171
- CZIP (Clear Zone Interior Package)..... 153
-
- ## D
- DAB Radio..... 234
- Deadlock
 deactivation..... 58
 temporary deactivation..... 58
- Deadlocks..... 58
- Defroster..... 159
- Diesel..... 285
- Diesel particle filter..... 286
- Dipstick, electronic..... 321
- Direction indicators..... 89
- Disengaging the gear selector inhibitor... 119
- Display lighting..... 86
- Distance Warning..... 183
- Dolby Surround Pro Logic II..... 220
- Door mirrors..... 101
- Driver Alert Control..... 197
- Driver Alert System..... 197
- Driving..... 280
 cooling system..... 280
 with the boot lid open..... 281
 with trailer..... 291
- Driving in water..... 280

- Driving with a trailer
 towball load..... 361
 towing capacity..... 361
- DSTC, see also Stability control system.. 169
- DVD 237
- E**
-
- ECC, electronic climate control..... 155
- Economical driving..... 280
- ECO pressure..... 309
- Eco Start/Stop DRIVE..... 122
- Electrical socket..... 215
 cargo area..... 289
 front seat..... 215
- Electric parking brake..... 132
 low battery voltage..... 132
 releasing automatically..... 133
 releasing manually..... 133
- Emergency equipment
 warning triangle..... 310
- Emergency puncture repair..... 311
- Emissions of carbon dioxide..... 287
- Engine
 overheating..... 291
 starting..... 111
- Engine block heater..... 113
 fuel-driven..... 162
- Engine compartment
 coolant..... 322
 oil..... 319
 overview..... 319
 power steering fluid..... 324
- Engine oil..... 319, 366
 adverse driving conditions..... 366
 capacities..... 366
 filter..... 319
 oil grade..... 366
- Engine specifications..... 364
- Environmental labelling, FSC, owner's
 manual..... 12
- Error messages
 Driver Alert Control..... 199
 Lane Departure Warning..... 201
 see Messages and symbols..... 134, 180
- Error messages in BLIS..... 211
- Error messages in Distance Alert..... 185
- Error messages in the Adaptive cruise con-
 trol..... 180
- ETC, electronic temperature control 156
- Expectant mothers, seatbelt..... 17
- External dimensions..... 360
- F**
-
- Fan..... 158
- Fault tracing for the camera sensor. 188, 194
- First aid equipment..... 310
- First aid kit 310
- Flexifuel..... 113
 adaptation..... 114
- Fluids, capacities..... 368
- Fluids and oils..... 368
- Fog lamp
 front..... 88
- Fog lamps
 rear..... 89
- Fog lamps, on/off..... 88
- Foot brake..... 130
- FOUR-C – Active chassis..... 170

Front seat			
adjusting front - rear.....	84		
lumbar.....	83		
massage.....	83		
FSC, environmental labelling.....	12		
Fuel.....	284		
fuel consumption.....	370		
fuel economy.....	309		
fuel filter.....	286		
Fuse box.....	339		
glovebox.....	344		
Fuses.....	339		
box in cargo area.....	347		
by the dashboard - Executive.....	346		
changing.....	339		
cold zone.....	348		
general.....	339		
relay/fuse box in engine compart- ment.....	340		
Start/Stop.....	348		
Fuse table			
fuses in engine compartment.....	341		
G			
Gearbox.....	116		
automatic.....	116		
manual.....	116		
Gear selector inhibitor.....	118		
Gear selector inhibitor, mechanical disen- gagement.....	119		
Geartronic.....	117		
Glass.....	217		
laminated/reinforced.....	98		
Global opening.....	153		
Glovebox.....	214		
locking.....	56		
Gross vehicle weight.....	361		
GSI - Gear selector assistance.....	124		
H			
Hazard warning flashers.....	89		
Headlamp levelling.....	86		
Headlamp pattern, adjusting.....	91		
Headlamp pattern adjustment			
Active Bending Lights	92		
Headlamps.....	325		
Headphones			
battery replacement.....	266		
wireless.....	265		
Headphones socket.....	225, 264, 266		
Head restraint			
centre seat, rear.....	82		
lowering.....	82		
Heated washer nozzles.....	97		
Heating.....	159		
rearview and door mirrors.....	102		
rear window.....	102		
seats.....	157		
Heat-reflecting windscreen.....	98		
High engine temperature.....	291		
High-pressure headlamp washing.....	97		
HomeLink®	136		
Home safe lighting.....	91		
Hoot.....	85		
Horn.....	85		

I	
IAQS – Interior Air Quality System.....	153
IC – Inflatable Curtain.....	26
Ignition keys.....	77
Immobiliser.....	44
Indicator lamps, PCC.....	46
Inflatable curtain.....	26
Information and warning symbols.....	70
Information button, PCC.....	46
Information displays.....	69
Infotainment system	220
basic functions	223
menus	273
overview	222
source buttons	222
voice control.....	260
Inlaid mats.....	214
Instrument lighting, see Lighting.....	86
Instrument overview	
left-hand drive.....	66
right-hand drive.....	68
Instruments and controls.....	66
Interior lighting, see Lighting.....	90
Interior rearview mirror.....	102
automatic dimming.....	103
Intermittent wiping.....	96
iPod®, connection.....	241
J	
Jack.....	307
K	
Kerb weight.....	361
Key.....	44
Key blade.....	47
Keyless drive.....	52, 111
Keyless start (keyless drive).....	52, 111
Keypad in the steering wheel.....	85, 145, 171, 224
Key positions.....	77

L	
Labels.....	358
Laminated glass.....	98
Lamps, see Lighting.....	325
Lane Departure Control.....	200
Laser sensor.....	9
Leather upholstery, washing instructions	352
Lighting.....	325
Active Xenon headlamps.....	87
approach light, duration.....	45, 91
automatic lighting, passenger compart- ment.....	90
bulbs, specifications.....	331
controls.....	90
display lighting.....	86
front fog lamps.....	88
headlamp levelling.....	86
home safe lighting.....	91
in passenger compartment.....	90
instrument lighting.....	86
main/dipped beam.....	86
position/parking lamps.....	88
rear fog lamp.....	89
Lighting, bulb replacement.....	325
bulb holder, rear.....	329

- bulb holder, rear, direction indicators. 329
 cargo area..... 330
 dipped beam halogen..... 326
 direction indicators..... 328
 fog lamp..... 328
 main beam, Xenon lamp..... 327
 main beam halogen..... 327
 number plate lighting..... 330
 parking lamps..... 327
 side marker lamps..... 328
 vanity mirror..... 330
- Light switches..... 86
- Loading
 cargo area..... 288
 general..... 288
 load retaining eyelets..... 289
 roof load..... 288
- Lock confirmation 44
- Locking/unlocking
 inside..... 55
- Locks
 automatic locking..... 55
 boot lid..... 56
 locking..... 55
 unlocking..... 55
- Lubricants..... 368
- Lubricants, capacities..... 368
- M**
-
- Main/dipped beam, see Lightning..... 86
- Maintenance
 rustproofing..... 351
- Making calls..... 254
- Manual gearbox..... 116
 GSI - Gear selector assistance..... 124
 towing and recovery..... 297
- Manual gear positions (Geartronic)..... 117
- Massage
 front seat..... 83
- Max. roof load 361
- Media, Bluetooth® 244
- media player 237
- Memory function in seats..... 80
- Menu navigation, Infotainment 273
- Menu navigation RSE..... 270
- Menus/Functions..... 146
- Menus and messages..... 142
- Menu structure, Infotainment 273
- Menu structures RSE..... 271
- Menu system MY CAR..... 144
- Messages and symbols
 Collision Warning with Auto
 Brake..... 189, 195
 Distance Alert..... 185
 Driver Alert Control..... 199
 Lane Departure Warning..... 201
- Messages and symbols in the Adaptive
 cruise control..... 180
- Messages in BLIS..... 211
- Messages in the combined instrument
 panel..... 142
- Messages in the information display..... 169
- Meters in the combined instrument panel
 fuel gauge..... 70
 speedometer..... 70
 tachometer..... 70
- Misting..... 159
 attending to the windows..... 152
 condensation in headlamps..... 350
 remove with the air vents..... 161
 timer function..... 160
- Mobile phone
 connect..... 255
 handsfree..... 252

register phone.....	253
voice control.....	260
MY CAR.....	144

O

Oil, see also Engine oil.....	366
Oil level low.....	319
Overheating.....	291
Owner's manual, environmental labelling..	12

P

PACOS.....	22
PACOS, switch.....	22
Paintwork	
colour code.....	354
damage and touch-up.....	353
Panel lighting.....	86
Panic function.....	45
Park assist camera.....	206
Parking assistance.....	203
parking assistance sensors.....	205

Parking brake.....	132
Parking heater.....	162
battery and fuel.....	162
parking on a hill.....	162
time setting.....	164
Passenger compartment.....	213
Passenger compartment filter.....	153
Passenger compartment heater	
fuel-driven.....	162
PCC – Personal Car Communicator	
functions.....	45
range.....	46, 47
Pedestrian protection.....	190
Petrol grade.....	284
Phone	
connect.....	255
handsfree.....	252
incoming calls.....	254
making calls.....	254
phone book.....	256
phone book, shortcut.....	256
receiving a call.....	254
register phone.....	253
voice control.....	260
Pinch protection, sunroof.....	106
Polishing.....	351

Position/parking lamps.....	88
Power seat.....	80
Powershift gearbox.....	119, 297
Power sunroof.....	105
Power windows.....	98
Privacy locking.....	49
Puncture, see Tyres.....	307

Q

Queue Assist.....	177
Queue Assistant.....	177

R

Radar sensor.....	173
limitations.....	178
Radio	230
AM/FM	230
DAB	234
menu structure	273
Rain sensor.....	96

Rear bulbs		Remote control	250	S	
location.....	329	battery replacement	251		
Rear control panel		Remote control, HomeLink®			
audio system.....	225	programmable	136		
Rear-seat entertainment.....	264	Remote control key.....	44		
Rear TV screens.....	264	battery replacement.....	50		
Rearview and door mirrors		detachable key blade.....	47		
compass.....	104	functions.....	45		
door.....	101	range.....	46		
electrically retractable.....	102	Remote control key system, type appro-			
heating.....	102	val.....	376		
interior.....	102	Resetting the door mirrors.....	102		
Rear window, defrosting.....	102	Resetting the power windows.....	100		
Recirculation.....	160	Retractable power door mirrors.....	102		
Recommendations during driving.....	280	Reverse gear inhibitor.....	116		
Recommended child seats, table.....	33	Rims			
Recovery.....	298	cleaning.....	351		
Refrigerant.....	153	Roof load, max. weight	361		
Refuelling.....	283	RSE - Rear Seat Entertainment system...	264		
fuel cap.....	283	Rustproofing.....	351		
fuel filler flap, electrical opening.....	283				
fuel filler flap, manual opening.....	283				
refuelling.....	283				
Relay/fuse box: see Fuses.....	339				
				Safety mode.....	30
				Seat, see Seats.....	79
				Seatbelt	
				rear seat.....	17
				seatbelt tensioner.....	18
				Seatbelt reminder.....	17
				Seatbelts.....	16
				Seats.....	79
				head restraints, rear.....	82
				heating.....	157
				lowering the front backrest.....	79
				lowering the rear backrest.....	81
				power seats.....	80
				ventilated front seats.....	157
				Sensus.....	76
				Service programme.....	318
				Set time interval.....	184
				Side airbags.....	24
				Signal input, external.....	222, 241
				SIPS bags.....	24
				Ski hatch.....	290
				Soot filter.....	286
				Soot filter full.....	286

- Spare wheel..... 307
 temporary spare..... 307
- Spin control..... 168
- Spin control function..... 168
- Stability and traction control system..... 168
- Stability system..... 168
- Stains..... 352
- Start assistance..... 115
- Steering force, speed related..... 170
- Steering force level, see Steering force... 170
- Steering lock..... 112
- Steering wheel..... 85
 keypad..... 85, 145, 171, 224
 keypad, adaptive cruise control..... 175
 steering wheel adjustment..... 85
- Stone chips and scratches..... 353
- Storage compartment..... 217
- Storage spaces in the passenger compart-
 ment..... 213
- Sun blind..... 100
- Sunroof
 opening and closing..... 105
 pinch protection..... 106
- sunscreen..... 106
 ventilation position..... 105
- Sunscreen, sunroof..... 106
- Surround..... 220, 228
- Symbols..... 169
 indicator symbols..... 70
 information symbols..... 70
 warning symbols..... 70
- Symbols and messages
 Collision Warning with Auto
 Brake..... 189, 195
 Distance Alert..... 185
 Driver Alert Control..... 199
 Lane Departure Warning..... 201
- Symbols and messages in the Adaptive
 cruise control..... 180
- T**
-
- Temperature
 actual temperature..... 152
- Temperature control..... 159
- Theatre lighting..... 91
- Timer..... 160
- Tools..... 307
- Total airing function..... 56, 153
- Towbar
 detachable, attachment 294
 detachable, removal 295
- Towbar, see Towing equipment..... 292
- Towing..... 297
 towing eye..... 298
- Towing capacity..... 361
- Towing equipment..... 292
 specifications..... 293
- Towing eye..... 298
- Trailer..... 291
 cable..... 291
 driving with a trailer..... 291
- Transmission..... 116
- Transponder..... 98
- Trip computer..... 166
- Trip meter..... 73
- TV..... 247
- Type approval, remote control key sys-
 tem..... 376
- Type designation..... 358

Tyres

direction of rotation.....	302
driving characteristics.....	302
maintenance.....	302
pressure.....	309
puncture repair.....	311
specifications.....	304
speed ratings.....	305
tread wear indicators.....	303
winter tyres.....	304

U

Unlocking

from the inside.....	55
from the outside.....	55

USB, connection.....	241
----------------------	-----

V

Vanity mirror.....	90, 215
Ventilation.....	154
Vibration damper.....	292
Voice control, mobile phone.....	260
Volvo Sensus.....	76

W

Warning lamp

adaptive cruise control.....	173
collision warning system.....	191
stability and traction control system. .	168

Warning lamps

airbags SRS.....	72
alternator not charging.....	72
fault in brake system.....	72
low oil pressure.....	72
parking brake applied.....	72
seatbelt reminder.....	72
warning.....	72

Warning sound

collision warning system.....	191
-------------------------------	-----

Warning symbol, airbag system.....	19
------------------------------------	----

Warning triangle.....	310
-----------------------	-----

Washer fluid, filling.....	333
----------------------------	-----

Washer nozzles, heated.....	97
-----------------------------	----

Washers

washer fluid, filling.....	333
windscreen.....	97

Water and dirt-repellent coating.....	98
---------------------------------------	----

Water-repellent surface, cleaning.....	351
--	-----

Waxing.....	351
-------------	-----

Weights

kerb weight.....	361
------------------	-----

Wheels

changing.....	306
installation.....	307
rims.....	303
snow chains.....	304
spare wheel.....	307

Wheels and tyres.....	302
-----------------------	-----

Whiplash injury, WHIPS.....	27
-----------------------------	----

WHIPS

child seat/booster cushion.....	27
whiplash injury.....	27

Windows, rearview and door mirrors.....	98
---	----

Windscreen washing.....	97
-------------------------	----

Windscreen wipers.....	96
rain sensor.....	96

Winter driving.....	281
---------------------	-----

Winter tyres.....	304
-------------------	-----

Wiper blades.....	332
-------------------	-----

changing.....	332
cleaning.....	332
service position.....	332

Wipers and washing.....	96
-------------------------	----

Wireless headphones.....	265
--------------------------	-----

Volvo. for life

VOLVO

Volvo Car Corporation TP 14063 (English), AT 1146, Printed in Sweden, Göteborg 2011, Copyright © 2000-2011 Volvo Car Corporation