



Contents A-Z

**Owner's Manual for the vehicle.
With a quick reference guide
for your convenience.**





740i
740iL
750iL

Congratulations, and thank you for choosing a BMW.

Thorough familiarity with your vehicle will provide you with enhanced control and security when you drive it. We therefore have this request:

Please take the time to read this Owner's Manual and familiarize yourself with the information that we have compiled for you before starting off in your new car. It contains important data and instructions intended to assist you in gaining maximum use and satisfaction from the unique range of technical features on your BMW. The manual also contains information on care and maintenance designed to enhance operating safety and contribute to maintaining the value of your BMW throughout an extended service life.

This Owner's Manual should be considered a permanent part of this vehicle. It should stay with the vehicle when sold to provide the next owner with important operating, safety and maintenance information.

This manual is supplemented by a Service and Warranty Information Booklet (US models) or a Warranty and Service Guide Booklet (Canadian models). We recommend that you read this publication thoroughly.

Your BMW is covered by the following warranties:

- ▷ New Vehicle Limited Warranty
- ▷ Limited Warranty Rust Perforation
- ▷ Federal Emissions System Defect Warranty
- ▷ Federal Emissions Performance Warranty
- ▷ California Emission Control System Limited Warranty

Detailed information about these warranties is listed in the Service and Warranty Information Booklet (US models) or in the Warranty and Service Guide Booklet (Canadian models).

We wish you an enjoyable driving experience.

BMW AG

Notes on the Owner's Manual

We have made every effort to ensure that you are able to find what you need in this Owner's Manual as quickly as possible. The fastest way to find certain topics is by using the detailed index at the end. If you desire an initial overview of your vehicle, this can be found in the first chapter. The detailed list of contents that directly follows the summary of contents is intended to stimulate your curiosity regarding your BMW and to encourage you to read the manual.

Should you wish to sell your BMW at some time in the future, please remember to hand over the Owner's Manual to the new owner; it is part of the vehicle.

If you have any additional questions, an authorized BMW center will be glad to advise you.

© 1998 BMW AG

Munich, Germany

Reprinting, including excerpts, only with the written consent of BMW AG, Munich.

Order no. 01 41 9 791 187

US English VIII/98

Printed in Germany

Printed on environmentally friendly paper

(bleached without chlorine, suitable for recycling).

Symbols used



These sections contain vital information – please read the accompanying text passages carefully, both for your own safety and to prevent damage to your BMW. ◀



These passages contain information on special and unique features of your vehicle. ◀



Indicates special information on recycling. ◀

◀Indicates the end of a note.

* Indicates special equipment, country-specific equipment and optional extras.



Indicates that you should consult the relevant section of this Owner's Manual for information on a particular part or assembly.



Alerts you to functions which can be adjusted for individual drivers by your authorized BMW center ("Car Memory" or "Key Memory"). Refer to page 53. ◀

The individual vehicle

On buying your BMW, you have decided in favor of a model with individualized equipment and features. This Owner's Manual describes all models and equipment that BMW offers within the same group.

We hope you will understand that equipment and features are included which you might not have chosen for your vehicle. Any differences can easily be identified, since all optional accessories and special equipment are marked with an asterisk *.

If your BMW features equipment which is not described in this Owner's Manual (car radio or telephone, for instance), Supplementary Owner's Manuals are enclosed. We ask you to read these manuals as well.

Status at time of printing

BMW pursues a policy of continuous, ongoing development that is conceived to ensure that our vehicles continue to embody the highest quality and safety standards combined with advanced, state-of-the-art technology. For this reason, it is possible that the features described in this Owner's Manual could differ from those on your vehicle. Nor can errors and omissions be entirely ruled out. You are therefore asked to appreciate that no legal claims can be entertained on the basis of the data, illustrations or descriptions in this manual.

For your own safety

 Use unleaded gasoline only. Fuels containing up to 10% ethanol or other oxygenates with up to 2.8% oxygen by weight (i.e., 15% MTBE or 3% methanol plus an equivalent amount of co-solvent) will not void the applicable warranties with respect to defects in materials or workmanship. Field experience has indicated significant differences in fuel quality (i.e., volatility, composition, additives, etc.) among gasolines offered for sale in the United States and Canada. The use of poor-quality fuels may result in driveability, starting and stalling problems, especially under certain environmental conditions, such as high ambient temperature and high altitude. Should you encounter driveability problems that you suspect could be related to the fuel you are using, we recommend that you respond by switching to a recognized high-quality brand. Failure to comply with these recommendations may result in unscheduled maintenance. Follow the relevant safety rules when you are handling gasoline. ◀



Important safety information! For your own safety, use genuine parts and accessories approved by BMW.

When you purchase accessories tested and approved by BMW and Original BMW Parts, you simultaneously acquire the assurance that they have been thoroughly tested by BMW to ensure optimum performance when installed on your vehicle.

BMW warrants these parts to be free from defects in material and workmanship.

BMW will not accept any liability for damage resulting from installation of parts and accessories not approved by BMW.

BMW cannot test every product from other manufacturers to verify if it can be used on a BMW safely and without risk to either the vehicle, its operation, or its occupants.

Original BMW Parts, BMW Accessories and other products approved by BMW, together with professional advice on using these items, are available from all BMW centers.

Installation and operation of non-BMW approved accessories such as alarms, radios, amplifiers, radar detectors, wheels, suspension components, brake dust shields, telephones (including operation of any portable cellular phone from within the vehicle without using an externally-mounted antenna) or transceiver equipment (C.B., walkie-talkie, ham radio, for instance) may cause extensive damage to the vehicle, compromise its safety, interfere with the vehicle's electrical system, or affect the validity of the BMW Limited Warranty. See your authorized BMW center for additional information. ◀



Maintenance, replacement, or repair of the emission control devices and systems may be performed by any automotive repair establishment or individual using any certified automotive part. ◀

The following only applies to vehicles owned and operated in the US.

REPORTING SAFETY DEFECTS

If you believe that your vehicle has a defect which could cause a crash or could cause injury or death, you should immediately inform the National Highway Traffic Safety Administration (NHTSA) in addition to notifying BMW of North America, Inc., P.O. Box 1227, Westwood, New Jersey 07675-1227, Telephone (201) 307-4000.

If NHTSA receives similar complaints, it may open an investigation, and if it finds that a safety defect exists in a group of vehicles, it may order a recall and remedy campaign. However, NHTSA cannot become involved in individual problems between you, your dealer, or BMW of North America, Inc.

To contact NHTSA, you may either call the Auto Safety Hotline toll-free at 1-800-424-9393 (or 366-0123 in Washington, D.C. area) or write to: NHTSA, U.S. Department of Transportation, Washington, D.C. 20590. You can also obtain other information about motor vehicle safety from the Hotline.



Overview

Controls and features

Operation, care
and maintenance

Owner service procedures

Advanced technology

Technical data

Index



Contents

Overview

- Cockpit 16
- Instrument cluster 18
- Indicator and warning lamps 20
- Multifunction steering wheel (MFL) 23
- Hazard warning flashers 24
- Warning triangle 24
- First-aid kit 24
- Refueling 25
- Fuel specifications 25
- Tire inflation pressure 26

Controls and features

Locks and security systems:

- Keys 30
- Electronic vehicle immobilizer 31
- Central locking system 32
- Door locks – outside 32
- Radio remote control 33
- Door locks – inside 36
- Luggage compartment lid 37
- Luggage compartment 39
- Alarm system 40
- Electric power windows 42
- Security glass 43
- Sliding/Tilt sunroof 44

Adjustments:

- Seats 46
- Steering wheel 49
- Mirrors 50
- Seat, mirror and steering wheel memory 51
- Car Memory, Key Memory 53

Passenger safety systems:

- Safety belts 54
- Airbags 55
- Child restraints 57
- Child restraint installation 58
- Child-safety locks 58

Driving:

- Steering/Ignition lock 59
- Starting engine 59
- Switching off engine 60

- Parking brake 61
- Automatic transmission 62
- Automatic transmission with Steptronic 65
- Turn signal/Headlamp flasher 68
- Washer/Wiper system/Rain sensor 68
- Rear window defroster 70
- Cruise control 70

Everything under control:

- Odometer, outside temperature display 72
- Tachometer 72
- Energy control 73
- Fuel gauge 73
- Temperature gauge 74
- Service Interval Display 74
- Check Control 75
- Multi-Information Display (MID) 78
- Digital clock 79
- Onboard computer 84

Technology for safety and convenience:

- Park Distance Control PDC 90
- Automatic Stability Control plus Traction (ASC+T)/Dynamic Stability Control (DSC) 92
- Electronic Damper Control (EDC) 93
- Tire Pressure Control (RDC) 94

- Controls and features**
- Lamps:**
 - Parking lamps/Low beams 96
 - Instrument panel lighting 96
 - High beams/Parking lamps 97
 - Fog lamps 97
 - Interior lamps 97
 - Reading lamps 98
 - Controlling the climate for pleasant driving:**
 - Automatic climate control 100
 - Rear passenger-area air conditioning 105
 - Seat heating 106
 - Steering wheel heating 106
 - Roller sun blind 107
 - Independent ventilation system 107
 - Cabin convenience:**
 - Integrated Universal Remote Control 108
 - Glove compartment 110
 - Center armrests 111
 - Additional storage areas 113
 - Cup holder 113
 - Cellular phone 113
 - Ashtray 114
 - Cigarette lighter 115
 - Rear footrests 115
 - Loading and transporting cargo:**
 - Ski bag 116
 - Cargo loading 118
 - Roof-mounted luggage rack 118
- Operation, care and maintenance**
- Special operating instructions:**
 - Break-in procedure 122
 - Driving notes 123
 - Catalytic converter 124
 - Antilock Brake System (ABS) 125
 - Disc brakes 126
 - Brake system 128
 - Winter operation 128
 - Power steering 130
 - Level control system 130
 - Cellular phone 131
 - Radio reception 131
 - Wheels and tires:**
 - Tire inflation pressure 132
 - Tire condition 132
 - Tire replacement 133
 - Tire rotation 133
 - Wheel and tire combinations 134
 - Winter tires 135
 - Snow chains 135
 - Approved wheel and tire specifications 136
 - Under the hood:**
 - Hood 137
 - Engine compartment 138
 - Washer fluids 142
 - Washer nozzles 142
 - Engine oil 143
 - Coolant 146
 - Brake fluid 147
 - Oil for power steering/Level control system 148
 - Vehicle Identification Number 148
 - Care and maintenance:**
 - The BMW Maintenance System 149
 - Caring for your car 150
 - Airbags 156
 - Vehicle storage 156
 - Laws and regulations:**
 - Technical modifications to the vehicle 157
 - OBD connector 158

Contents

Owner service procedures

Replacement procedures:

- Onboard tool kit [162](#)
- Windshield wiper blades [162](#)
- Lamps and bulbs [163](#)
- Remote control [168](#)
- Changing tires [170](#)
- Battery [173](#)
- Fuses [176](#)

In case of electrical malfunction:

- Fuel filler door [178](#)
- Sliding/Tilt sunroof [178](#)

Assistance, giving and receiving:

- Jump-starting [179](#)
- Towing the vehicle [180](#)

Advanced technology

- Airbags [184](#)
- Adaptive Transmission Control (ATC) [184](#)
- Automatic Stability Control plus Traction (ASC+T)/Dynamic Stability Control (DSC) [185](#)
- Radio reception [186](#)
- BMW Active Seat [186](#)
- Safety belt tensioner [187](#)
- DSP sound system [187](#)
- Interior rearview mirror with automatic dimming feature [188](#)
- Tire Pressure Control (RDC) [189](#)
- Xenon lamps [190](#)
- Water and dirt repelling windshield [191](#)

Technical data

- Engine specifications [194](#)
- Dimensions [195](#)
- Weights [196](#)
- Capacities [197](#)
- Electrical system [198](#)
- Drive belts [198](#)

Index

Everything from A to Z [202](#)
Owner service procedures from
A to Z [207](#)



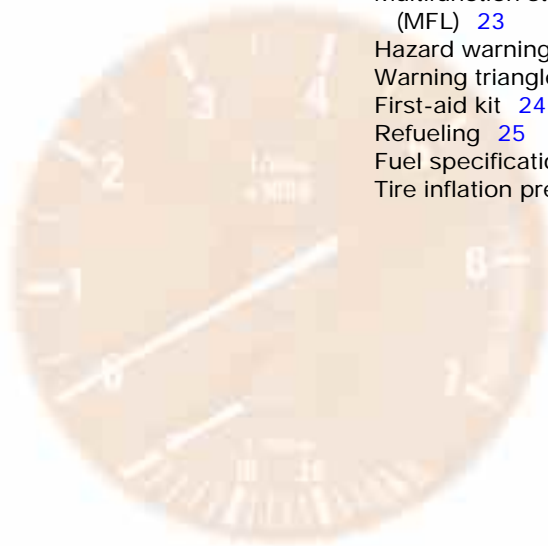

Cockpit 16
 Instrument cluster 18
 Indicator and warning lamps 20
 Multifunction steering wheel
 (MFL) 23
 Hazard warning flashers 24
 Warning triangle 24
 First-aid kit 24
 Refueling 25
 Fuel specifications 25
 Tire inflation pressure 26

Overview

Controls and features

Operation, care and maintenance

Owner service procedures

Advanced technology

Technical data

Index

16 Cockpit

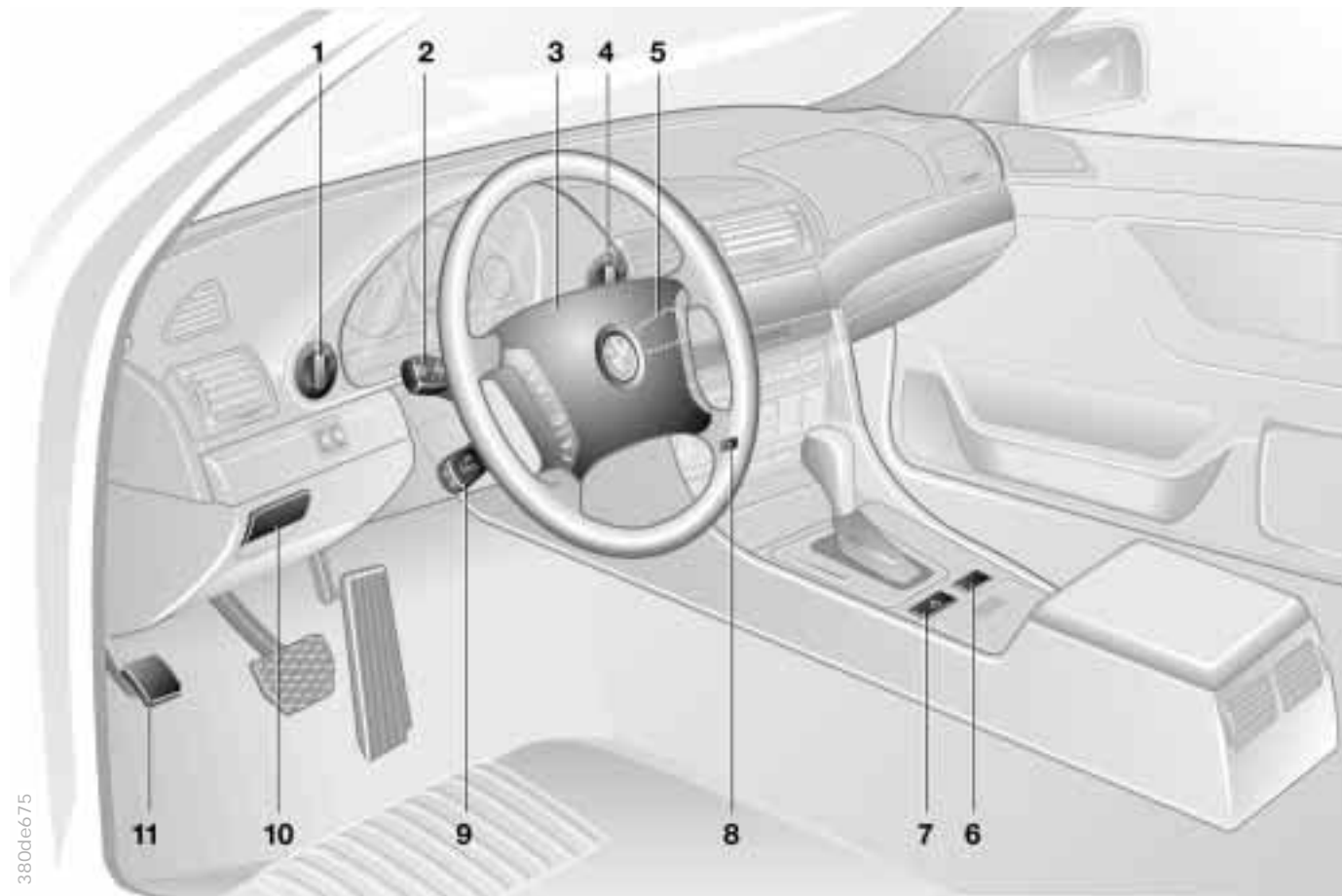

- 1 Parking lamps/Low beams [96](#)
- 2 ▷ Turn signal [68](#)
 - ▷ Parking lamp [97](#)
 - ▷ High beams [97](#)
 - ▷ Headlamp flasher [68](#)
 - ▷ Onboard computer [89](#)
- 3 Horn: The entire surface
- 4 Fog lamps [97](#)
- 5 Wiper/Washer lever [68](#)
- 6 Central locking system [32](#)
- 7 Hazard warning system [24](#)
- 8 Rear window defroster [70](#)
- 9 Electric steering wheel adjustment [49](#)
- 10 Parking brake release handle [61](#)
- 11 Parking brake pedal [61](#)

18 Instrument cluster



Instrument cluster

- 1 Fuel gauge with lamp for fuel reserve range [73](#)
- 2 Turn signal indicators [22](#)
- 3 Speedometer
- 4 Indicator lamp for high beam headlamps [22](#)
- 5 Tachometer and Energy Control [72](#), [73](#)
- 6 Coolant temperature gauge [74](#)
- 7 Indicator and warning lamps for
 - ▷ Parking brake [21](#)
 - ▷ Hydraulic brake system/Dynamic Brake Control (DBC)* [20](#), [21](#)
 - ▷ ABS [21](#)
 - ▷ Airbag [21](#)
 - ▷ Please fasten safety belts [21](#)
 - ▷ Cruise control [22](#)
- 8 Check button [75](#)
- 9 Program display for automatic transmission [64](#), [67](#)
- 10 Outside temperature display [72](#)
- 11 Indicator lamp for Automatic Stability Control plus Traction (ASC+T)/Dynamic Stability Control (DSC)* [21](#)
- 12 Trip odometer [72](#)
- 13 Check Control display [75](#)
- 14 Odometer [72](#)
- 15 Service Interval Display [74](#), [149](#)
- 16 Reset button for trip odometer [72](#)
- 17 Indicator and warning lamps for
 - ▷ Fog lamps [22](#)
 - ▷ Battery charge current [20](#)
 - ▷ Engine oil pressure [20](#)
 - ▷ Check Engine lamp [21](#)



You can display the outside temperature and distance driven in different units of measurement. ◀

20 Indicator and warning lamps

Technology that monitors itself

Many of the systems of your BMW monitor themselves automatically, both during engine starts and while you are driving. Indicator and warning lamps that are identified by "●" are tested for proper functioning whenever the ignition key is turned. They each light up once for different periods of time.

If a fault should occur in one of these systems, the corresponding lamp does not go out after the engine is started or it lights up while the vehicle is moving. You will see how to react to this below.

Red: Stop immediately



Battery charge current ●
The battery is no longer being charged. There is a malfunction of the alternator ribbed V-belt or in the charging circuit of the alternator. Please contact the nearest BMW center.



If the V-belt is defective, do not continue driving. The engine could be damaged due to overheating. If the ribbed V-belt is defective, increased steering effort is also required. ◀



Engine oil pressure ●
Comes on while the engine is running and the "Stop! ENGINE OILPRESS" message appears in the Check Control:
Stop vehicle and switch off engine immediately. Check level of oil in engine, top up as required. If oil level is correct: Please contact the nearest BMW center.



Do not continue driving. The engine could be damaged because of inadequate lubrication. ◀



Brake hydraulic system ●
The brake fluid level is too low. Before driving further, be sure to read the notes on pages 128 and 147. Also comes on with the message "Check brake pads" in the Check Control.



Brake hydraulic system warning lamp for Canadian models.

Red: An important reminder



Parking brake

Comes on when you engage the parking brake.

For additional information: Refer to page [61](#).



Parking brake warning lamp for Canadian models.



Please fasten safety belts* ●

An acoustic signal and message in the Check Control for 4 to 8 seconds. The acoustic signal ends after the safety belts are fastened.

For additional information: Refer to page [54](#).



Airbags ●

Please have the system checked by your authorized BMW center as soon as possible.

For additional information: Refer to page [55](#).

Yellow: Check as soon as possible



Dynamic Brake Control (DBC)* ●
Fault in the DBC System. Conventional braking efficiency is available without limitations.

For additional information: Refer to page [127](#).



Warning lamp, Dynamic Brake Control (DBC)* for Canadian models.



Antilock Brake System (ABS) ●
The ABS system has been deactivated because of a system fault. Conventional braking efficiency is available without limitations. Please have the system inspected by your authorized BMW center.

For additional information: Refer to page [125](#).



ABS warning lamp for Canadian models.



Automatic Stability Control plus Traction (ASC+T)/Dynamic Stability Control (DSC)* ●

The ASC+T/DSC has been switched off or has been deactivated because of a malfunction. In the event of a malfunction, have the system checked by your authorized BMW center. For additional information: Refer to page [92](#).



Check Engine lamp ●

If the indicator lamp comes on either continuously or intermittently, this indicates a fault in the emissions-related electronic systems. Although the vehicle remains operational, you should have the systems checked by your BMW center at the earliest possible opportunity.

For additional information: Refer to OBD connector on page [158](#).

22 Indicator and warning lamps

Green: For your information



Turn signal

Flashes when the turn signals are in operation. Rapid flashing indicates a system malfunction.

For additional information: Refer to page [68](#).



Cruise control

Lights up when the cruise control is activated. Available for operation via the multi-function steering wheel.

For additional information: Refer to page [70](#).



Fog lamps

Lights up whenever you switch on the fog lamps.

For additional information: Refer to page [97](#).

Blue: For your information



High beam

Lights up when the high beams are on or the headlamp flasher is actuated.

For additional information: Refer to pages [68](#), [97](#).

Multifunction steering wheel (MFL)

The controls integrated in the multifunction steering wheel are provided so that you can operate a number of accessories quickly and without being distracted from traffic conditions. You may operate:

- ▷ Some of the functions of the radio, the CD and cassette modes
- ▷ The recirculated-air mode of the air conditioner or
- ▷ The steering wheel heating
- ▷ The cruise control and
- ▷ Selected cellular phone functions.

 In order to operate a system via the MFL, the corresponding system controls must be switched on. ◀

The illustration shows the maximum possible number of controls, corresponding to a full range of optional equipment. Refer to the individual accessory manuals for more detailed descriptions.



- 1 Cellular phone: Receive an incoming call, initiate dialing and end a call. Pressing and holding the key for a longer period activates or deactivates the voice input*
- 2 Radio/Telephone: Selection
- 3 Radio/Telephone: Search backward or station keys or scroll in the phone book. Fast forward and reverse for CD and cassette modes
- 4 Radio/Telephone: Volume
- 5 Radio/Telephone: Search forward or station keys or scroll in the phone book. Fast forward and reverse for CD and cassette modes
- 6 Horn: The entire surface
- 7 Cruise control: Activate stored setting (resume)
- 8 Cruise control: Store and accelerate (+); decelerate and store (-)
- 9 Cruise control: Activate/Interrupt/Deactivate
- 10 Recirculated-air mode and AUC or steering wheel heating: Switch on and off

24 Hazard warning flashers



The push-button flashes rhythmically when the hazard flashers are on.

To help you to locate the switch, the button is also lighted whenever the car lamps are on.

Warning triangle*

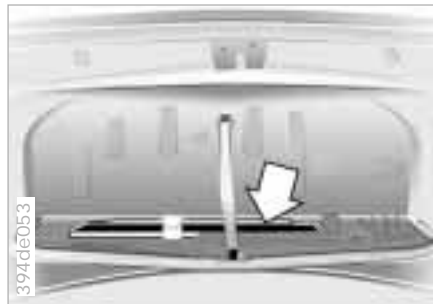

The hazard warning triangle is stored underneath the luggage compartment lid in the onboard tool holder where it is quickly available.

 Comply with legal requirements which cover the availability of a hazard warning triangle in the car. ◀

First-aid kit



Stored between the rear seats. Pull the lever (arrow) and fold the cover forward.

 Some of the articles in the first-aid kit may be used within a limited time only. For this reason, check the expiration dates of each of the items regularly, and replace any whose expiration dates have passed. You can acquire replacements in any drugstore or pharmacy.

Comply with legal requirements which cover availability of a first-aid kit in the car. ◀



⚠ Before filling the tank, shut off the engine. If you do not, fuel cannot flow into the tank and the "Check Engine" warning lamp may come on. ◀

To open the fuel filler door, press against its forward edge.

To unlock the fuel filler door if there is a malfunction of the central locking system, refer to page [178](#).

⚠ When handling fuels, comply with all of the applicable safety precautions and regulations pertaining to fuels. Never carry spare fuel containers in your vehicle. Whether empty or full, these containers can leak, cause an explosion, or lead to fire in the event of a collision. ◀



⚠ Open the filler cap carefully to prevent fuel from spraying out. Fuel spray may cause injury. Do not top off. Topping off may cause fuel spillage. ◀

Keep the filler cap in the bracket attached to the fuel filler door.

When refueling, insert the filler nozzle completely into the filler pipe. Pulling the nozzle out of the pipe during refueling

- ▷ results in premature pump shutoff
- ▷ and will reduce the effect of the recovery vapor system on the pump.

⚠ Close the fuel cap carefully after refueling. A loose or missing cap will activate the "Check Engine" lamp. ◀

Use unleaded gasoline only.

Minimum octane requirement: 91 AKI. BMW engines are equipped with knock sensors and will adapt automatically to different octane ratings, provided that the minimum octane requirement (87 AKI) is met.

Fuels with higher octane ratings will provide enhanced performance and lower fuel consumption, while the use of fuels with lower octane ratings will have the opposite effect.

⚠ Do not use leaded fuels. The use of leaded fuels will cause permanent damage to the system's oxygen sensor and the catalytic converter. ◀

AKI = Anti Knock Index

26 Tire inflation pressure



The inflation pressures are indicated on a sticker attached to the B-pillar behind the driver's door (visible with door open).

Check tire pressures

All pressure specifications are indicated in psi (kilopascal) with cold tires (cold = ambient temperature).

For vehicles with Tire Pressure Control (RDC)*:

After a correction of the tire inflation pressure, reactivate the system. Refer to page [94](#).



Check tire inflation pressures regularly - at least every two weeks and before beginning a longer trip. Incorrect tire pressure can otherwise lead to tire damage and accidents. Also check the inflation pressure of the spare tire. Inflate the spare tire to the highest inflation of any tire on your vehicle. ◀

Comply with tire approval specifications

The inflation pressures in the table apply to tires from BMW-approved manufacturers. Your BMW center is familiar with these pressures. Higher pressures may be specified for tires from other manufacturers. You will find a list of approved tires beginning on page [136](#).

Your vehicle is equipped with tires that not only meet US standards, but also European standards. We recommend the exclusive use of BMW-approved tires.

Tire inflation pressure

Tires

Tire inflation pressures in
psi (kilopascal)



235/60 R 16 100 H M + S

235/60 R 16 100 W

245/55 R 16 100 W

235/50 ZR 18

Rear: 255/45 ZR 18

215/65 R 16 98 Q M + S

235/60 R 16 100 Q M + S

245/55 R 16 100 Q M + S

US/CDN:

33 (230) 41 (280) 33 (230) 41 (280)

outside of the US/Canada:

29 (200) 33 (230) 33 (230) 41 (280)

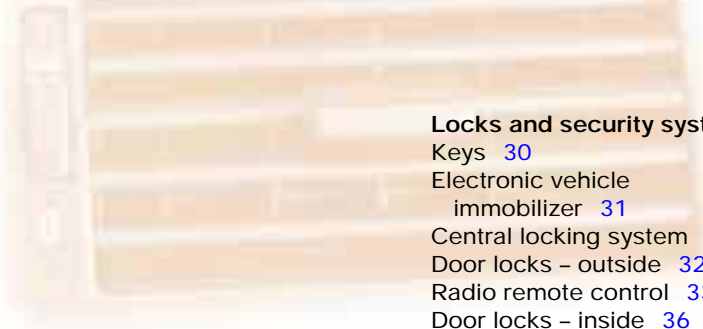
**Locks and security systems:**

Keys 30

Electronic vehicle
immobilizer 31

Central locking system 32

Door locks – outside 32

Radio remote control 33

Door locks – inside 36

Luggage compartment lid 37

Luggage compartment 39

Alarm system 40

Electric power windows 42

Security glass 43

Sliding/Tilt sunroof 44

Adjustments:

Seats 46

Steering wheel 49

Mirrors 50

Seat, mirror and steering wheel
memory 51

Car Memory, Key Memory 53

Passenger safety systems:

Safety belts 54

Airbags 55

Child restraints 57

Child restraint installation 58

Child-safety locks 58

Driving:

Steering/Ignition lock 59

Starting engine 59

Switching off engine 60



Overview

Parking brake 61
 Automatic transmission 62
 Automatic transmission with
 Steptronic 65
 Indicator/Headlamp flasher 68
 Washer/Wiper system/Rain
 sensor 68
 Rear window defroster 70
 Cruise control 70

Everything under control:

Odometer, outside temperature
 display 72
 Tachometer 72
 Energy control 73
 Fuel gauge 73
 Temperature gauge 74
 Service Interval Display 74
 Check Control 75
 Multi-Information Display
 (MID) 78
 Digital clock 79
 Onboard computer 84

Technology for safety and convenience:

Park Distance Control (PDC) 90
 Automatic Stability Control plus
 Traction (ASC+T)/Dynamic Sta-
 bility Control (DSC) 92
 Electronic Damper Control
 (EDC) 93
 Tire Pressure Control (RDC) 94

Lamps:

Parking lamps/Low beams 96
 Instrument panel rheostat 96
 High beams/Parking lamps 97
 Fog lamps 97
 Interior lamps 97
 Reading lamps 98

Controlling the climate for pleasant driving:

Automatic climate control 100
 Rear passenger-area air
 conditioning 105
 Seat heating 106
 Steering wheel heating 106
 Rear window blind 107
 Independent ventilation
 system 107

Cabin convenience:

Integrated Universal
 Remote control 108
 Glove compartment 110
 Center armrests 111
 Additional storage areas 113
 Cup holder 113
 Cellular phone 113
 Ashtray 114
 Cigarette lighter 115
 Rear footrests 115

Loading and transporting cargo:

Ski bag 116
 Cargo loading 118
 Roof-mounted luggage rack 118

Controls and features

Operation, care and maintenance

Owner service procedures

Advanced technology

Technical data

Index



Replacement keys

Replacement keys are available exclusively through your authorized BMW center. Your BMW center is obligated to ensure that a person requesting a key is authorized to do so since the keys belong to a security system (refer to "Electronic vehicle immobilizer" on page 31).

Key with radio remote control

- 1 Master key with transmitter for radio remote control.
- 2 Spare key for storage in a safe place, such as your wallet. This key is not intended for continuous use.
- 3 Door and ignition key
The locks for the luggage compartment lid and glove compartment cannot be operated with this key – this is useful for valet parking, for instance.

Electronic vehicle immobilizer

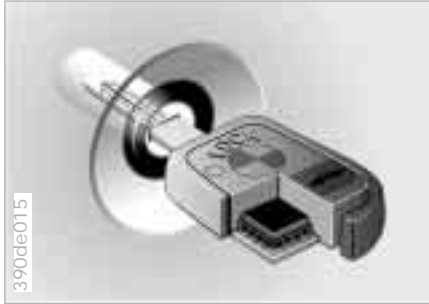

The key to security

Your BMW is equipped with a passive anti-theft system. This electronic immobilization system is designed to reduce the susceptibility of your vehicle to theft by making it impossible to start the engine using any means other than the special keys furnished with the vehicle. Your BMW center can cancel the electronic system authorization for individual keys (for instance, in the event of loss). A deactivated key can no longer be used to start the engine.

How the electronics work

At the heart of this system is an electronic chip which is integrated into the key. The lock mechanism itself is actually a dual-function device, simultaneously serving as a communications interface designed to allow the security system to maintain a continuous stream of variable, vehicle-specific signals with the electronic circuitry in the key. The system will not release the ignition, fuel injection and starter unless it recognizes an "authorized" key.

 Force applied to the key can damage the integrated electronic circuitry. A damaged key can no longer be used to start the engine. ◀

The concept

The central locking system is ready for operation as soon as you close the driver's door. The system engages and releases the locks on the

- ▷ doors
- ▷ luggage compartment lid
- ▷ fuel filler door.

The central locking system can be operated

- ▷ from outside via the driver's door or luggage compartment lock and with the remote control
- ▷ from inside via the central locking button.

The fuel filler door remains unlocked when you activate the system from inside the vehicle.

The anti-theft system is automatically armed whenever you activate the central locking system from outside the vehicle. The alarm system is also activated or deactivated.

In the event of an accident, the central locking system unlocks automatically (only those doors which were not locked separately with the safety lock buttons). Refer to page 36. In addition, the hazard warning flashers and interior lamps come on.

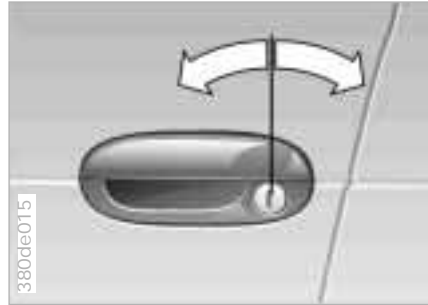
**To engage and release locks**

One turn of the key in the driver's door lock unlocks the driver's door only. Turning the key a second time unlocks all of the remaining doors, the luggage compartment lid and the fuel filler door.

- ▷ When a door is opened, the interior lamps and the exterior door handle illumination are switched on. Switching off is automatic. ◀

Convenience operating mode

You can also use your remote control transmitter to open and close the electric power windows and the sliding/tilt sunroof.

- ▷ To open: With the door closed, turn the key to the "Unlock" position and hold it.
- ▷ To close: With the door closed, turn the key to the "Lock" position and hold it.



Watch the closing process carefully and be sure that no one is trapped by the closing motion. The movement stops when you release the key. ◀

Manual operation

(in the event of an electrical failure)

Turn the key all the way to the extreme left or right to unlock/lock the door.

Radio remote control

The remote control makes opening and locking the doors of your vehicle very convenient. Furthermore, it provides three additional functions which can only be executed by means of the remote control:

- ▷ Switching on the interior lamps and illuminating the exterior door handles. With this function, you can also "search for" your vehicle, when parked in an underground garage, for instance
- ▷ To open luggage compartment lid
The luggage compartment lid will open slightly, regardless of whether the lid was previously locked or unlocked
- ▷ Panic Mode
In case of danger, you can trigger an alarm.

The anti-theft system is also deactivated/activated simultaneously with the unlocking or locking of the vehicle, and the alarm system is disarmed/armed.

When the vehicle is unlocked, the interior lamps and the exterior door handle illumination are switched on.



Master keys

Keys with a transmitter for remote control are master keys. Refer to page 30.



Since children might be able to lock the doors from the inside, take the vehicle's keys with you so that the vehicle can be opened again from the outside at any time. ◀

Every transmission is indicated by a light signal. If the signal no longer lights up when a button is pressed and locking with the remote control no longer functions:

Change the battery. Refer to page 168.



Unlocking and convenience opening mode

To release: Press button 1.

Press the button once to unlock the driver's door only; press a second time to unlock all remaining doors as well as the luggage compartment and fuel filler door.

Convenience opening mode: Press and hold button 1. The electric power windows and the sliding/tilt sunroof are opened.



If you desire, you can have this feature set so that it is related to specific keys. ◀

34 Radio remote control



To lock and secure

Press button 2.



The interior lamps and illuminated exterior door handles switch on; the tilt sensor alarm system switches off

To switch on the interior lamps and illuminating the exterior door handles: After locking the car, press button 2. With this function – keeping the range of the remote control in mind – you can "search for" your car (in a large parking lot, for instance).

To deactivate the tilt sensor alarm system:

Press button 2 again briefly after the system is locked.

This also deactivates the interior motion sensor of the alarm system (refer to page 41).



Opening the luggage compartment lid - Panic Mode

To open the luggage compartment: Press button 3.

 Before beginning a trip, be sure that the luggage compartment lid was not opened unintentionally. ◀

Panic Mode: By pressing and holding button 3 for 2 to 5 seconds, you can trigger the alarm system if there is an impending danger if the system has been armed.

The alarm is deactivated by pressing button 1.

Radio remote control

Same-frequency interference

Operation of the remote control system may be affected by other units or equipment employing the same transmission frequency in the immediate vicinity of your car.

For US owners only

The transmitter and receiver units comply with part 15 of the FCC (Federal Communications Commission) regulations. Operation is governed by the following:

FCC ID: LX8EWS
LX8FZVS
LX8FZVE

Compliance statement:

This device complies with part 15 of the FCC Rules. Operation is subject to the following two conditions:

- ▷ This device may not cause harmful interference, and
- ▷ this device must accept any interference received, including interference that may cause undesired operation.

 Any unauthorized modifications to these devices could void the user's authority to operate the equipment. ◀

36 Door locks – inside



Use this button to operate the central locking system when the front doors are closed. With this button, only the doors and luggage compartment lid are unlocked or locked. The anti-theft system is not activated.

The fuel filler door also remains unlocked to allow refueling.

-  If only the driver's door was unlocked from the outside and you press the button
 - ▷ all other doors, the luggage compartment lid and the fuel filler door will be unlocked if the driver's door is open
 - ▷ the driver's door will be locked again if it is closed. ◀

To unlock and open the doors

- ▷ Either unlock the doors together with the button for the central locking system and then pull each of the release handles above the armrests or
- ▷ pull the release handle for each door twice: The first pull unlocks the door, and the second one opens it.

To engage locks

- ▷ Use the central locking system button to locks all doors at once, or
- ▷ press down the individual door lock buttons. As an added design feature to prevent the driver from being inadvertently locked out of the vehicle, the driver's door lock button will not engage as long as the door is open.



When the vehicle is moving, do not lock the doors with safety lock buttons since the doors would not then open automatically in the event of an accident.

Children might be able to lock the doors from the inside. For this reason, take the vehicle's keys with you so that the vehicle can be opened again from the outside at any time. ◀



When the low beams are switched on, the interior door handles are lighted. The brightness is controlled by the instrument panel lighting. Refer to page 96. ◀

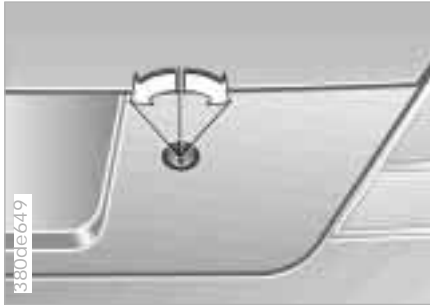

The lock

Only the master key (refer to page 30) fits in the lock of the luggage compartment.

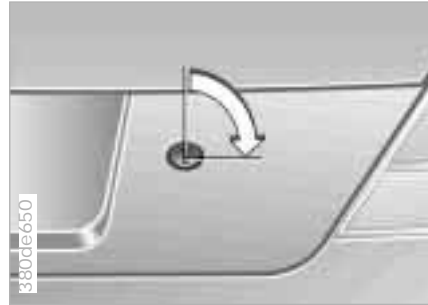

Secure separately

Turn the master key to the right past the resistance point and then pull it out in the horizontal position.

This locks the luggage compartment lid and disconnects it from the central locking system. This feature can be used to prevent unauthorized access to the luggage compartment when you surrender the door and ignition key (refer to page 30) for valet parking, for instance.

Manual operation

(in the event of electrical failure)

Turn the master key to the left in the luggage compartment lock clear to the stop – the luggage compartment lid will open.

The luggage compartment is locked again as soon as you close the lid.

38 Luggage compartment lid



Opening from inside the car

If the luggage compartment lid has not been locked separately, you can open it with this button when the vehicle is stationary.



Closing

The handle recess in the interior trim panel of the luggage compartment lid (arrow) makes it easier to pull the lid down.

Automatic Soft-Close feature

To close the luggage compartment lid, merely press it down gently. The closing process will then be carried out automatically.

 To avoid injuries, be sure that the travel path of the luggage compartment lid is clear when it is closed, as with all closing procedures.

Operate the vehicle only when the luggage compartment lid is completely closed. Otherwise, exhaust fumes could penetrate the interior of the vehicle. Should it be absolutely necessary to operate the vehicle with the luggage compartment lid open:

- ▷ Close all windows. Shut the sliding/tilt sunroof
- ▷ Increase the airflow of the automatic climate control to a high level. Refer to page [104](#). ◀

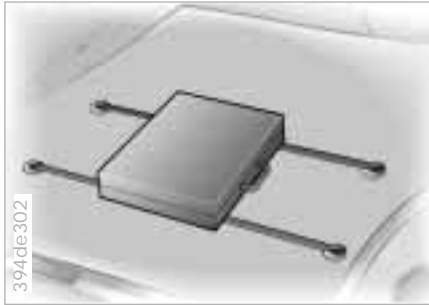

Luggage straps

Use the straps on the floor of the luggage compartment to secure smaller suitcases.

Movement is reduced, when objects are placed on the straps.

Lashing eyes located at the front corners and the rear wall of the luggage compartment provide you with a convenient means of attaching draw straps to secure luggage.

Refer also to "Cargo Loading" on page [118](#).



Nets

To secure your luggage, you may either hook nets

- ▷ into the lashing eyes on the front corners and rear wall of the luggage compartment or
- ▷ into the rear wall of the luggage compartment and the mounting points under the rear parcel tray.

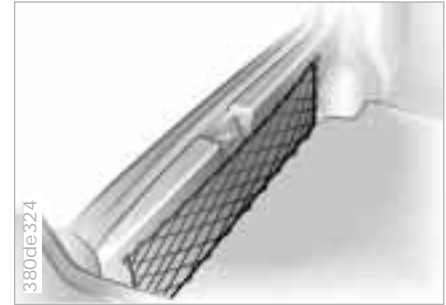

You can store smaller articles in the net on the rear wall of the luggage compartment.

40 Alarm system

The vehicle alarm system responds:

- ▷ When a door, the hood or the luggage compartment lid is opened
- ▷ To movement inside the vehicle (interior motion sensor)
- ▷ To variations in the vehicle tilt sensor such as occur during attempts to steal the wheels or tow the vehicle
- ▷ To interruption of battery voltage.

The system responds to unauthorized vehicle entry and attempted theft by simultaneously activating the following:

- ▷ Sounding an acoustical alarm for 30 seconds
- ▷ The hazard warning flashers are activated for approx. five minutes
- ▷ The high beams flash on and off in the same rhythm.

To arm and disarm the alarm system

When the vehicle is locked or unlocked by using a key or with the remote control, the alarm system is also simultaneously armed or disarmed.

The interior motion sensor is activated approx. 30 seconds after you have finished locking the car.

The system indicates that it has been correctly armed by switching on the hazard flashers for a single cycle and by emitting an acoustical signal.

When the system is active, you can still gain access to the luggage compartment by pressing button 3 on the remote control transmitter. When the lid is closed, it is armed once again.

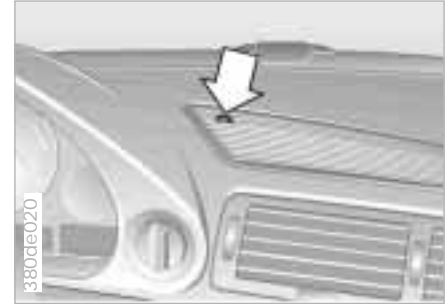

Indicator lamp displays

- ▷ The indicator lamp on the top of the instrument panel flashes continuously: The system is armed
- ▷ The indicator lamp flashes during arming: door(s), the hood or luggage compartment lid are not completely closed. Even if you do not close the alerted area, the system begins to monitor the remaining areas, and the indicator lamp flashes continuously after 10 seconds. However, the interior motion sensor is not activated
- ▷ If the indicator lamp goes out when the system is disarmed: No unauthorized entries have been detected in the period since the system was armed

Alarm system

- ▷ If the indicator lamp flashes for 10 seconds when the system is disarmed: An attempted entry has been detected in the period since the system was armed.

Following triggering of an alarm, the indicator lamp will flash continuously.

Tilt alarm sensor

The tilt alarm sensor and interior motion sensor may be switched off at the same time. By doing this, you can prevent false alarms on garage ramps or when the vehicle is transported by trailer or train, for instance.

Lock the vehicle twice (= arm the system). In other words, press button 2 of the remote control twice in succession or lock the vehicle twice with the key.

The indicator lamp lights up briefly and then flashes continuously. The tilt alarm sensor and the interior motion sensor are deactivated for as long as the system remains armed.



Interior motion sensor

The transmitter and receiver of the interior motion sensor are located in a trim panel in the vehicle's headliner.

In order for the interior motion sensor to function properly, the windows and sliding/tilt sunroof must be completely closed.

Nevertheless, you should deactivate the interior motion sensor whenever

- ▷ children or animals are left in the vehicle
- ▷ the windows and/or sunroof are left open.

Emergency deactivation procedure

If the car is locked and it is not possible to disarm the system in the normal manner, proceed as follows:

- 1 Use the key to unlock the door (the alarm sounds for 30 seconds when opening the door)
- 2 Turn the key to ignition key position 1; the central locking system unlocks the remaining doors.

The alarm system is now disarmed. Refer the problem to your BMW center.



Open and close windows

In ignition key position 1 or 2:

- ▷ Depress the rocker switch until you feel resistance:
The window continues moving for as long as you maintain pressure on the switch
- ▷ Press the rocker switch beyond the resistance point:
The window moves automatically. Press the switch a second time to stop the window

After the ignition has been switched off:

- ▷ You can continue to operate the power windows as long as one of the front doors has not been opened. To open a window, press the rocker switch past the resistance point.



Remove the ignition key when you leave the vehicle and close the doors so that children can no longer operate the power windows, possibly injuring themselves, for instance. ◀

For the convenience operating mode via the door lock or the remote control, refer to page 32 or page 33.

Safety feature

A contact strip is integrated into each of the upper window frame sections. If pressure is exerted against this contact strip while a window is being raised, the system will respond by stopping the window and then retracting it a small distance.



Despite this safety feature, be extremely careful that the closing path of the window is not obstructed whenever it is closed. Otherwise, an object might not touch the contact strip in some situations (with very thin objects, for instance). You can override this safety feature by pressing the switch beyond the resistance point and holding it.

Because the power windows are sealed at high pressure to prevent wind noise when closed, a powerful motor is required for efficient closing. When closing the windows, always ensure that they are not obstructed in any way. Unsupervised use of these systems can result in serious personal injury. Remove the ignition key to deactivate the electric power windows whenever you leave the car. Never leave the keys in the car with unsupervised children. Never place anything that could obstruct the driver's vision on or next to the windows. ◀



Safety switch

You can use the safety switch (arrow) to deactivate the rear window switches (when children are riding in the rear seats, for instance).

 Press the safety switch whenever children are riding in the rear of the vehicle. Careless use of the power windows can lead to injury. ◀

Break-resistant security glass

The glass installed on all side windows and the rear window is designed to offer resistance to breakage and vandalism. Each break-resistant window contains several layers of clear synthetic plastic film sandwiched between the inner and outer glass panes. In addition, another film is applied to the inner surface of the glass (facing the passenger compartment). This film prevents the glass, if shattered, from spreading into the passenger compartment.

Please note the following precautions regarding this inner glass surface film:

- 1 The film is not scratch-resistant. Avoid contact with sharp objects which may break through or cut the film
- 2 Clean the glass with water. If ineffective, you may use regular household window cleaner; wipe the cleaner off immediately.
Do not use window cleaners containing solvents or abrasives, as these may scratch the film

- 3 Do not apply any self-adhesive labels, or labels with tape to the inner surface
- 4 Do not apply window tint film to the inner window surface
- 5 If frost or ice builds up on the inner surface in cold, high-humidity climates, do not use a scraper or an "ice-removing spray." Start the engine and refer to the instructions on defrosting the door windows.

44 Sliding/Tilt sunroof

 To prevent injuries, exercise care when closing the sliding/tilt sunroof and keep it in your field of vision until it is shut.

Before leaving the car, switch off the electric sunroof mechanism by taking out the ignition key. Do not leave children unattended in the vehicle with access to vehicle keys. Use of the key can result in starting of the engine and operation of vehicle systems such as power sunroof, etc. Unsupervised use of these systems can result in serious personal injury. ◀

To avoid pressure or drafts in the passenger compartment when the sunroof is open or lifted, keep the air vents in the dashboard open and increase the air supply if necessary. Refer to pages [100](#), [104](#).

For the convenience operating mode via the door lock or the radio remote control, refer to page [32](#) or page [33](#).

Safety feature

If the sliding/tilt sunroof encounters resistance at a point roughly past the middle of its travel when it is closing, the closing cycle is interrupted and the sunroof will open again slightly.

 Despite this safety feature, be extremely careful that the closing path of the sunroof is not obstructed whenever it is closed. Otherwise, triggering the closing-force limitation may not be ensured in some situations (with very thin objects, for instance). You can override this safety feature by pressing the switch beyond the resistance point and holding it. ◀

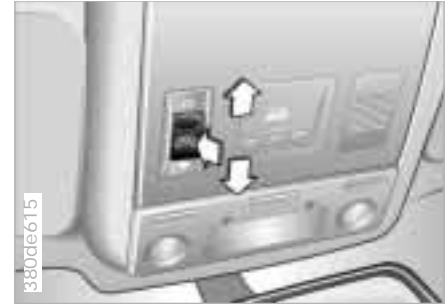

Lifting – opening – closing

From ignition key position 1 press the switch or slide it to the desired direction until you feel resistance.

When lifting, the headliner retracts several inches.

You can continue to operate the sunroof after the ignition has been switched off as long as one of the front doors has not been opened.

Sliding/Tilt sunroof

Automatic* opening and closing

Press the switch past the resistance point briefly: The sunroof travels to either the fully-closed or fully-open position.

Other automatic operations are:

- ▷ With the sunroof open, press the switch briefly toward "Lift:"
The sunroof automatically extends to its fully raised position
- ▷ With the sunroof lifted, press the switch briefly toward "Open:" The sunroof automatically opens all the way.

Pressing the switch again briefly stops the motion immediately.

Sliding/Tilt sunroof with glass moonroof*

The options and control procedures are essentially the same as those previously described for the sliding/tilt sunroof. In order to open the raised roof, press the control switch towards "Open" until the roof has reached the desired position.

The headliner insert slides back somewhat when you raise the roof. When the roof is opened, the headliner retracts with it. The headliner will then automatically remain in its retracted position, but can be repositioned as desired.



Power loss or malfunction

After interruptions in electrical supply (when the battery is disconnected, for instance), the sunroof will only lift. To reinitialize the mechanism:

- 1 Raise the sliding/tilt sunroof all the way
- 2 Continue to hold the switch for approx. five seconds.

In the event of an electrical system malfunction, the sliding/tilt sunroof can be manually operated. Refer to page [178](#).

46 Seat adjustment

For maximum safety when adjusting the seat position, please observe the following:

 Never try to adjust your seat while operating the vehicle. The seat could respond with unexpected movement, and the ensuing loss of vehicle control could lead to an accident. Wear the safety belt firmly against your body at all times. In the event of a frontal impact, a loose lap belt could slide over your hips, leading to abdominal injury. In addition, the safety belt's restraint effectiveness is reduced if the belt is worn loosely.

Never ride with the backrest reclined to an extreme horizontal angle (especially important for front passengers to remember). Keep the backrest relatively upright to minimize the risk of "sliding under" the safety belt and sustaining injury in an accident.

Do not slide the seats to the rear when the vehicle is at an extreme angle (on garage ramps or steep slopes, for instance), to prevent the shoulder strap's automatic height adjustment mechanism from disengaging. ◀

Electric power seats



- 1 Tilt angle
- 2 Forward - backward adjustment
- 3 Cushion height
- 4 Backrest angle
- 5 Head restraint height

Adjust the head restraint manually by tilting it in the desired direction.

 Head restraints reduce the risk of spinal injury in the event of an accident.

Adjust the head restraint so that its center is approximately at the height of the ear.

For maximum safety, read carefully and comply with the adjustment instructions presented here. ◀

Correct sitting posture

To reduce strain on the spinal column, sit all the way back in the seat and rest your back fully against the backrest. Ideal sitting posture is achieved with your head extending from your spine in a straight line.

For long-distance driving, you may wish to increase the backrest tilt-angle slightly to reduce muscular tension. Please remember that you should always remain able to grasp the entire periphery of the steering wheel without straightening your arms.

Lumbar support

Refer to the BMW comfort seat in the following column.



This seat allows you to make additional adjustments for

- 1 Lumbar support
- 2 Shoulder support

Lumbar support

You can adjust the backrest's contour for additional support in the curvature of your spine's lumbar region.

The upper hips and spinal column receive supplementary support to help you maintain a relaxed, upright posture.

- ▷ Press front/rear of switch: Increase/decrease curvature.
- ▷ Press the upper/lower end of the switch: Increase the upper/lower curvature.



Shoulder support

Press the rocker switch: The support angle of the upper backrest section is adjusted.

You can use the adjustable upper backrest for supplementary support in the shoulder region. This provides a relaxed driving position and helps relieve stress on the shoulder muscles.

To obtain an optimal seating posture, we recommend:

Driver's side and front passenger's side:

- 1 Adjust the upper backrest section to its extreme rear position
- 2 Adjust to the optimal seat position as described on page 46
- 3 Bring the upper backrest section forward until your shoulders enjoy firm support.

Front passenger's seat adjusted for relaxed traveling:

- 1 Adjust the upper backrest section to its extreme rear position
- 2 Increase the seat cushion tilt
- 3 Tilt the backrest more
- 4 Bring the upper backrest section forward.

 Make corrections in the forward-backward adjustment of the seat to ensure that the safety belt still fits firmly against your body. If you do not do this, the protection provided by the safety belt may be reduced. ◀

When you are adjusting the seat, select a position in which you remain as far from the instrument panel as possible.

48 BMW contour seat*



In addition to the adjustments offered by the electric power seat, there are adjustments for thigh support, shoulder support and lumbar support.

Thigh support

Press the switch (arrow) to make adjustments.

Shoulder support

Refer to BMW comfort seat on the previous page.

Lumbar support

Refer to BMW comfort seat on page [47](#).

BMW active seat*

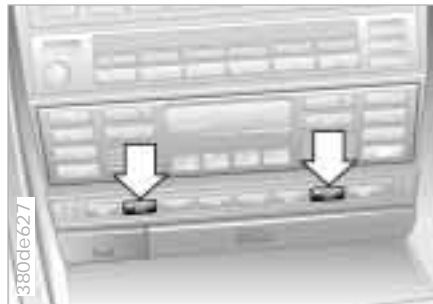

Actively changing the surface of the seat helps to prevent muscle tension, back pain in the lumbar region, and symptoms of fatigue.

To activate this feature, press the button (arrow).

For more details, please refer to the section headed "Advanced technology" on page [186](#).

Rear power seat*



- 1 Backrest angle
- 2 Head restraint height
- 3 Lumbar support

The head restraint extends automatically whenever a passenger fastens the safety belt at one of the rear seating positions.

Correct head restraint height with switch 2.

For information on the lumbar support, refer to the BMW comfort seat on page [47](#).

Adjusting the steering wheel



The steering wheel can be moved in any of four directions. Adjust by moving the control lever in the desired direction.



Do not adjust the steering wheel while the vehicle is moving. There is a risk of accident from unexpected movement. ◀

To store the steering wheel setting, refer to "Seat, mirror and steering wheel memory" on page [51](#).

Electric steering wheel adjustment

In order to make it easier to get into and out of the car, the steering wheel automatically moves into the top position and returns to the driving (memory) position.

This automatic feature is controlled by the position of the ignition key and by the driver's door.



You can make the settings of your vehicle in such a manner that, when you unlock the car with your personalized remote control, your own personalized steering wheel adjustment is initiated. ◀



The mirror on the passenger's side features a lens with a more convex surface than the mirror installed on the driver's side. When estimating the distance between yourself and other traffic, bear in mind that the objects reflected in the mirror are closer than they appear. This means that estimations of the distance to following traffic should not be regarded as precise. ◀



Exterior mirrors

- 1 Switch for 4-way adjustment
- 2 Left/right selection switch.

You can also adjust the mirrors manually by pressing against the outer edges of their lenses.

To store the mirror angles: Refer to "Seat, mirror and steering wheel memory" on page [51](#).



You can make the settings of your vehicle in such a manner that, when you unlock the car with your personalized remote control, your own personalized mirror adjustment is initiated. ◀

Electric heaters

Depending on the outside temperature, both mirrors are automatically defrosted when the ignition key is in position 2.

Inside rearview mirror with automatic dimming feature

This mirror automatically responds to light (ambient light and headlamp glare) by dimming through an infinitely variable range.

The mirror automatically reverts to its clear, undimmed setting whenever you move the selector lever to Reverse.

To ensure that the mirror continues to operate properly, keep the two photocells clean and unobstructed. One photocell is integrated in the mirror glass, the other somewhat offset on the back of the mirror.

For an explanation of the electro-chromic technology used in this mirror, refer to page [188](#).



Lighted vanity mirror

Fold down the sun visor and slide the cover panel to the side as required.

The mirror lamps operate in ignition key positions 1 and 2.

Sun visors

These can be folded down toward the windshield or swiveled out against the side windows.



You can store and call up three different seat, exterior mirror and steering wheel positions.

The illustration shows the buttons on the driver's door, for making these position adjustments.

 The adjustment for the lumbar support is not stored in the memory. ◀

To store

- 1 Turn the ignition key to position 1 or 2
- 2 Adjust for the preferred seat, exterior mirror and steering wheel positions
- 3 Press the **MEMORY** button: The indicator lamp in the button lights up
- 4 Press memory button 1, 2 or 3, as desired: The indicator lamp goes out.

To select a stored setting

Driver's door open after unlocking or ignition key in position 1:

- ▷ Briefly press memory button 1, 2 or 3, as desired.
Movement stops immediately when one of the seat-adjustment or memory buttons is activated during the adjustment process.

With driver's door closed and ignition key either removed or in position 0 or 2:

- ▷ Maintain pressure on desired memory button 1, 2 or 3 until the adjustment process is completed.

If you press the **MEMORY** button accidentally: Press the button a second time, the indicator lamp goes out.

 Do not call up a position from the memory while the vehicle is moving. There is a risk of accident from unexpected movement of the seat or steering wheel. ◀

52 Seat, mirror and steering wheel memory



You can make the settings of your vehicle in such a manner that, when you unlock the car with your personalized remote control, your own personalized settings for the seat position and the mirror and steering wheel adjustments are initiated. ◀



When you make use of this feature, be sure that the footwell behind the driver's seat is not obstructed before unlocking the car. Otherwise, any objects which are behind the seat might be damaged by any rearward movement of the seat. ◀



Passenger side exterior mirror tilt function

(automatic curb monitor)

- 1 Move the mirror selector switch (arrow) to the "driver's mirror" position
- 2 When the selector lever is placed in "Reverse," the passenger-side mirror tilts downward to help the driver monitor the area directly adjacent to the car during parking (curbs, etc.).

You can deactivate this automatic feature: Set the mirror selector switch to the passenger's mirror position.

Car Memory, Key Memory



How the system functions

You have probably frequently wished that you could configure individual functions of your vehicles to reflect your own personal requirements. In engineering your vehicle, BMW has included several user-defined functions in the vehicle's design. Your authorized BMW center can make these settings for you.

There are settings related to the vehicle ("Car Memory") and settings related to individuals ("Key Memory"). You can have two different basic settings adjusted for two different persons. The only requirement is that each person uses his or her own remote control key.

When your vehicle is unlocked with the remote control, the vehicle recognizes the individual user by means of a data exchange with the key, and makes adjustments accordingly.

In order for you to distinguish between different keys, colored decals are supplied together with the keys.

What the system can do

Your authorized BMW center can provide you with details on the capabilities of the Car Memory and Key Memory systems.

Memory functions are available for

- ▷ driver's seat
- ▷ steering wheel
- ▷ exterior mirrors
- ▷ automatic climate control.



You will see this symbol throughout the Owner's Manual. It is to remind you at appropriate places of the settings that are available to you. ◀

An example of Key Memory is the automatic adjustment of the power driver's seat with stored settings for the individual person when the vehicle is unlocked.



Fasten your safety belt before starting off.

To fasten: Make sure you hear the catch engage in the belt buckle.

To release: Press the red button in the buckle. Hold the belt and guide it back into its reel.

The shoulder belt anchor automatically adjusts to continue providing an optimum fit when you move the seat forward or back.

 For your safety, comply with the following instructions for wearing safety belts. If you do not, the safety belts may not be able to provide their maximum protection. All passengers in the vehicle should be aware of and comply with this information: Never allow more than one person to wear a single safety belt. Never allow infants or small children to ride in a passenger's lap.

Avoid twisting the belt while routing it firmly across the hips and shoulder. Do not allow the belt to rest against hard or fragile objects in your pockets. Never route the belt across your neck, do not run it across sharp edges. Be sure that the belt does not become caught or jammed.

Wear the safety belt as firmly as possible against your body at all times. For this reason, avoid wearing bulky clothing which will prevent proper belt fit. Pull the safety belt across your shoulders frequently to re-tension it. In the event of a frontal impact, a loose lap belt could slide over your hips, leading to abdominal injury. In addition, the safety belt's restraint effectiveness is reduced if the belt is worn loosely.

Expectant mothers should always wear their safety belts, taking care to position the lap belt against the lower hips, where it will not exert pressure against the abdominal area. ◀

For securing child restraints, refer to the next page.

For care instructions, refer to page [154](#).

 If the safety belt system has been subjected to the stresses involved in an accident or damaged in any other way, have the belt system, including the safety belt tensioner replaced by an authorized BMW center. Have the safety belt anchorages checked also. ◀

Child restraint systems*

 Never install a rear-facing child restraint device on the front passenger seat. Otherwise, injuries could occur when the airbag is triggered in the event of an accident. Children should always ride in the rear.

Do not attempt to modify child restraint systems. If you do this, the protection provided by these systems could be impaired. ◀

Airbags

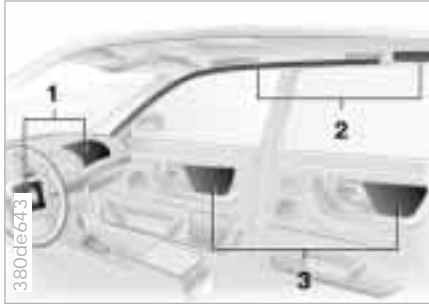

- 1 Front airbags for driver and front passenger
- 2 Side impact head protection system (front and rear*)
- 3 Side airbags (front and rear side*)

Protective effect

The front airbags supplement the three-point safety belts by helping to provide additional protection for the front-seat occupants in the event of a severe frontal collision in which the protection afforded by the belts alone may no longer be sufficient. The head protection and side airbags help provide protection in the event of a severe collision from the side. Each of the side airbags is designed to help support the upper body.

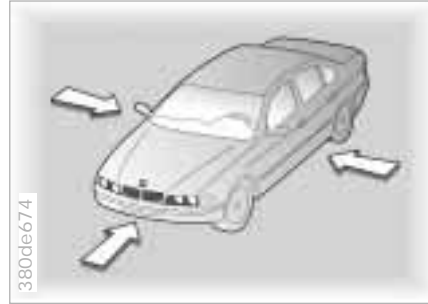

The illustration depicts schematically the primary directions of vehicle impact which initiate an airbag deployment.

Indicator lamp



The indicator lamp indicates the operational readiness of the airbag system from ignition key positions 1 and 2.

System operational:

- ▷ The indicator lamp comes on briefly then goes out.

System malfunction:

- ▷ The indicator lamp fails to come on
- ▷ The indicator lamp comes on briefly before going out and then lighting up again.

A system malfunction could prevent the system from responding to an impact occurring within its normal response range.

Please have your authorized BMW center inspect and repair the system as soon as possible.

 For your safety, comply with the following instructions for the airbags. If you do not, the airbags may not be able to provide their maximum protection. All passengers in the vehicle should be aware of and comply with this information:

The airbags are supplemental restraint devices designed to provide extra protection; they are not a substitute for safety belts. Wear your safety belt at all times. The airbags will not be triggered in the event of a minor accident, a vehicle roll-over, or collisions from the rear. In these situations, the safety belts provide optimal protection.

Adjust your seat to a position that provides maximum distance between you and the steering wheel, the instrument panel and the door while still allowing comfortable and safe access to all vehicle controls.

Hold the steering wheel at the rim (hands at the "9 o'clock and 3 o'clock" positions) in order to avoid injuries to the hands or arms if the airbag is triggered.

Never allow any objects to obstruct the area between the airbag and the driver/passenger.

Do not use the cover panel above the passenger-side airbag as a storage area.

Do not apply tape or stickers or other material over the padded steering wheel hub, the instrument panel, the side trim panels of the front or rear doors and the roof pillars or the sides of the headliner, or modify them in any other way.

Do not install a rear-facing child-restraint device on the front passenger seat.

If your vehicle is equipped with side airbags in the rear, be sure that child seats are installed correctly and with the greatest possible distance from the door. Do not allow children to lean out of the child's seat in the direction of the door. Otherwise, serious injuries could occur if the airbag is triggered. ◀

Even when all these guidelines are followed, there is still a small residual risk of injuries to the face, hands and arms occurring in isolated instances. The ignition and inflation noise may provoke a mild temporary hearing loss in extremely sensitive individuals.

Airbag warning information is also provided on the sun visors.

For additional information concerning the airbag system, refer to pages [156](#), [184](#).



This is the right way a child should sit in a child restraint when rear side bags (arrow) are installed.



This is the right way a larger child should sit wearing the safety belt when rear side airbags (arrow) are installed.

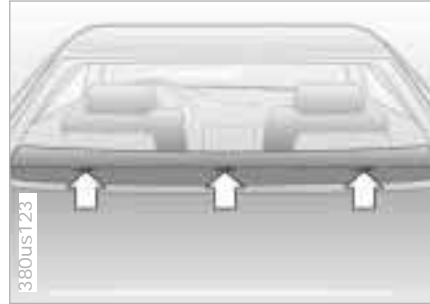

All occupants – especially children – should be restrained whenever riding in cars.

Infants or small children should never be held on the lap of a passenger.

Children should always sit in the rear and, depending on age, use either a child restraint system or the existing safety belts. Accident statistics have shown that children are safer when properly restrained in the rear seats than in the front seating positions.

Infants or toddlers should be secured with a child restraint system appropriate for their size.

Commercially-available child restraint systems are designed to be secured with a lap belt or with the lap belt portion of a combination lap/shoulder belt. Improperly or inadequately installed restraint systems can increase the risk of injury to children. Always read and follow the instructions that come with the system.

If the child restraint of your choice requires the use of a tether strap, three fastening points (arrows) have been provided on the rear shelf for attachment. Ask your BMW center principal to perform the necessary work.

 Before installing any child-restraint device or child seat, please read the following:

Never install a rear-facing child restraint system in the front passenger seat of this car.

Your car is equipped with an airbag supplemental restraint system for the front passenger. Because the backrest on any rear-facing child restraint system (of the kind designed for infants under 1 year and 20 lbs.) would be within the airbag's deployment range, you should never mount such a device in the front passenger seat, as the impact of the airbag against the child restraint's

backrest could lead to serious or fatal injuries.

If it is necessary for a child (not an infant) to ride in the front seat, certain precautions should be taken. First, move the passenger seat as far away from the dashboard as possible. This important precaution is intended to maximize the distance between the air-bag and the child. Older children should be tightly secured with the safety belt. Younger children should be secured in an appropriate forward-facing child restraint system that has first been properly secured with a safety belt. Never install a rear-facing child restraint system in the front passenger seat.

We strongly urge you to carefully read and observe the instructions for installation and use provided by the child restraint's manufacturer whenever you use such a device.

Be sure that all occupants (of all ages) remain properly and securely restrained at all times. ◀

All rear seating positions in your vehicle meet the recommendations of SAE J1819, an industry recommended practice for securing child restraint systems in motor vehicles.

Child restraint installation **Child-safety locks**



To allow you to use the safety belts to secure child-restraint systems, the belts at all rear positions feature a special locking mode.

A label with operating instructions is attached to the belt next to the latch plate (except the middle belt in the rear).

Lock the safety belt

Extract the entire length of the belt from the inertia reel mechanism. Allow the belt to retract somewhat and engage the buckle. Then tighten the belt around the child restraint. The belt is now locked. Comply with the instructions provided by the manufacturer of the child restraint.

Unlock the safety belt

Release the safety belt, remove the child's seat and retract the safety belt to its end position on the belt retractor.



Insert the key into a rear door lock and turn it outward:

The door can now be opened from the outside only.



0 Steering lock engaged

This is the only position in which the ignition key can be inserted and removed.

An acoustic warning sounds when you fail to remove the ignition key before opening the driver's door.

After removing the key, turn the steering wheel slightly to the left or right until you hear the lock engage.

Your vehicle is equipped with an interlock. For this reason, the ignition key cannot be turned to position 0 and removed until the selector lever is in position P.

In addition, the selector lever is locked in position P when the ignition key is in position 0 or removed from the ignition switch.

To move the selector lever out of P, the ignition key must be turned at least to position 2.

1 Steering lock disengaged

You will find that it is often easier to turn the ignition key from position 0 to position 1 when you move the steering wheel slightly to help disengage the lock.

Individual electrical equipment and accessories are available for use.

2 Ignition on

All electrical equipment and accessories are available for use.

3 Starting engine

Before starting

- ▷ Press the parking brake pedal
- ▷ Place the selector lever of the automatic transmission in P or N.

 Do not allow the engine to run in enclosed spaces. The exhaust gases contain carbon monoxide, an odorless and colorless, but highly toxic gas. Breathing the exhaust gases poses an extreme health risk, and can lead to unconsciousness and death. Never leave the car unattended with the engine running, as such a vehicle represents a potential safety hazard. ◀

Starting engine

- ▷ Start the engine. Do not press the accelerator pedal.

 Your BMW is equipped with the convenience starting feature. Simply turn the key to position 3 (starter) and then release it immediately. The starter continues to operate automatically until the engine starts.

60 Starting engine

If the battery's voltage is not adequate, the automatic starting procedure is not initiated, or it is interrupted. Should this condition arise, it remains possible to jump-start the engine (refer to page 179). Do not allow the engine to warm up by leaving it running while the vehicle remains stationary. Instead, begin driving immediately at a moderate engine speed. ◀

Should the engine fail to start on the first attempt (if it is very hot or cold, for instance):

- ▷ Press the accelerator pedal halfway down while engaging the starter.

BMW 740i/L:

Cold starts at extremely low temperatures, from approx. +5°F (-15°C) and at elevations above 3300 feet (1000 meters):

- ▷ Press the accelerator pedal halfway down while engaging the starter.

Engine idle speed is controlled by the engine computer system. Increased speeds at start-up are normal and should decrease as the engine warms up. If engine speed does not decrease, service is required.

To prevent the battery from discharging, always switch off any electrical devices not in use, as well as the ignition when the vehicle is not being driven.

Switching off engine

Turn the ignition key to position 1 or 0.



The vehicle must be stationary and the selector lever in "Park" before you can remove the ignition key. Always remove the ignition key and engage the steering lock before leaving the vehicle. ◀



Depress the pedal. The "PARK BRAKE" (in Canada "P") indicator lamp in the instrument cluster comes on when the ignition key is in position 2.



To release the brake, pull the handle. Please remember that the brakes disengage immediately. The parking brake is primarily designed to prevent the vehicle from rolling while parked, and operates against the rear wheels.

 If, in exceptional circumstances, it should be necessary to engage the parking brake while the vehicle is in motion, depress the pedal cautiously and slowly while continuing to pull on the release handle.

Excessive pressure on the pedal can lead to overbraking and loss of traction at the rear.

The brake lamps do not come on when the parking brake is applied. ◀

You can prevent corrosion from forming on the separate parking brake drums with an occasional gentle application of the parking brake when stopping at traffic lights.



Selector lever positions

P R N D 4 3 2

Shift programs

Lever positions:

- ▷ A (Adaptive/Economy)
- ▷ M (Manual)

Selector lever in position 4:

- ▷ S (Sport program)

For an explanation of the programs, refer to the next page.

Starting engine

The engine can only be started in positions "Park" or "Neutral."



Changing the selector lever position

A detent prevents inadvertent shifts into some selector lever positions. To release the shift-lock mechanism, press the button on the front side of the selector handle (arrow).

- ▷ While the vehicle is stationary and before shifting out of "Park" or "Neutral," depress the footbrake in order to disengage the selector lever's lock mechanism (shift-lock). Hold the footbrake down until starting off. The vehicle will otherwise "creep" when a drive position is engaged. ◀

 Before exiting the vehicle when the engine is running, place the selector lever in the "Park" or "Neutral" position and apply the parking brake. If you do not, the vehicle can move. Do not leave the car unattended with the engine running. An unattended vehicle with a running engine represents a potential safety hazard. ◀

P - Park

Select "Park" only when the vehicle is stationary. The transmission locks to prevent the rear wheels from turning.

R - Reverse

Select "Reverse" only when the vehicle is stationary.

N - Neutral

Select "Neutral" only if your journey is interrupted for a longer period.

D - Drive (automatic shift program)

This position is designed for driving under all normal operating conditions. All forward gears are available; the Adaptive Transmission Control (ATC) is fully operational.

Automatic transmission

4 - Sport program

This position is recommended if your driving style is performance-oriented.

3 and 2 - Shift limiter

Select this range when you wish to limit gear changes (on steep uphill or downhill slopes, for instance). The transmission upshifts only as far as the selected gear.

"Kickdown" (automatic downshift)

In the "Kickdown" mode, you achieve maximum performance. Press the accelerator pedal past the increased resistance point at the full-throttle position.

Shift programs

The automatic transmission of your BMW is equipped with the Adaptive Transmission Control (ATC) as standard equipment.

When you select program A, the ATC system automatically adapts to individual driving styles and road conditions to provide optimal performance with the selector lever at position D.

Because of this, the remaining selector lever positions for forward driving are only required in extreme situations such as those listed in the description of position 2.

A - Adaptive program

This is the initial position that the transmission selects at every start. In the positions for forward driving, the ATC (Adaptive Transmission Control) automatically selects the optimal gear from different shift programs. To achieve this, the system constantly adapts to driver characteristics (such as a moderate or performance-oriented driving style), road condition factors (slick roads or extreme slopes, for instance) as well as the current driving situation (winding roads or mountain travel, for instance).

For details concerning ATC, please refer to the chapter titled "Advanced Technology" on page [184](#).

M - Manual program

This program is for driving in one gear (4th gear when D has been selected). The transmission then remains in the selected gear both when underway and when starting off. For instance, when you make a steep ascent with the selector lever in position 2, the transmission does not make undesired upshifts. The same principle applies during operation on ice-covered roads: By placing the selector lever in position 3 you can move off gradually, and the transmission will also suppress subsequent shifts into higher gears.

Selector lever positions

Positions 4, 3 and 2 have the function of enhanced control over shifting – control which is desired and intentionally selected.

The ATC also functions in these selector lever positions – of course with limitations for gear selection imposed by the lever position.

Special functions

In program A, the Adaptive Transmission Control influences several special functions in the selection of the drive gear.

With the system active, some shifts that would be made in other modes will be suppressed. The system also reacts to special situations by executing shifts that would not occur with a conventional transmission.

Control of the winter program

A winter program is automatically selected when the vehicle is operated on slippery road surfaces (snow and ice). When this program is active, the transmission starts in 2nd gear and shifts into the higher gears earlier. This program improves response under winter driving conditions by providing enhanced traction and vehicle stability.

ATC leaves the winter program when it registers a high-traction road surface, when the Sport program is selected and when ASC+T/DSC is deactivated.

Electronic transmission control module

If the message "TRANS. FAILSAFE PROG" appears in the Check Control, there is a fault in the gearshift electronic system or in the transmission itself.

You can still place the selector lever in all positions. However, it is possible that not all gears are available for the vehicle's forward drive.

If this happens, avoid extreme engine loads and consult the nearest authorized BMW center.



Do not work in the engine compartment when a drive gear (forward or reverse) is engaged. If you do this, the vehicle could move. ◀

For towing, tow-starting or jump-starting the vehicle, refer to pages [179](#), [180](#).

You may drive your vehicle as with a typical automatic transmission, but you may also shift manually.

When you move the selector lever to the left from position "D" and into the M/S shift level, the performance-oriented shift programs of the automatic transmission are activate. As soon as you move the selector lever in the "+" or "-" direction, Steptronic changes the gear and the manual mode is active. If you wish to utilize automatic shifting once again, move the selector lever to the right and into the D position.

The automatic transmission of your BMW is equipped with an Adaptive Transmission Control (ATC). This system reacts with precision to your individual driving style and the current driving conditions. Different shift programs are utilized to achieve this.

For details concerning ATC, please refer to the chapter describing "Advanced technology" on page [184](#).



Selector lever positions

P R N D M/S + -

Starting engine

The engine can only be started in selector lever positions P ("Park") or N ("Neutral").

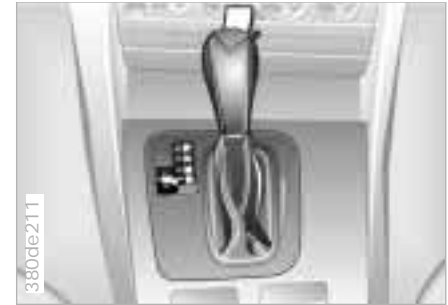

Range selection

A detent prevents inadvertent shifts into some selector lever positions. To release the shift-lock mechanism, press the button on the front side of the selector handle (arrow).

 While the vehicle is stationary and before shifting out of "Park" or "Neutral," depress the footbrake in order to disengage the selector lever's lock mechanism (shift-lock). Hold the footbrake down until starting off. The vehicle will otherwise "creep" when a drive position is engaged. ◀



Before exiting the vehicle when the engine is running, place the selector lever in the "Park" or "Neutral" position and apply the parking brake. If you do not, the vehicle can move.

Do not leave the car unattended with the engine running. An unattended vehicle with a running engine represents a potential safety hazard. ◀

P - Park

Select "Park" only when the vehicle is stationary. The transmission locks to prevent the rear wheels from turning.

R - Reverse

Select "Reverse" only when the vehicle is stationary.

N - Neutral

Select "Neutral" only if your journey is interrupted for a longer period.

D - Drive (automatic shift program)

This position is designed for driving under all normal operating conditions. All forward gears are available; the Adaptive Transmission Control (ATC) is fully operational.

"Kickdown" (automatic downshift)

In the "Kickdown" mode, you achieve maximum performance.

Press the accelerator pedal past the increased resistance point at the full-throttle position.



M/S - Manual mode and Sport Program

When you change from "D" to M/S, the Sport program is activated. This is indicated by "D S" in the gear display. This position is recommended if your driving style is performance-oriented.

With the first brief touch, the automatic transmission shifts from the Sport program to manual mode.

When you move the selector lever forward in the "+" direction, the transmission shifts up. When moved back in the "-" direction, the transmission shifts down.

Depending on the version, "1 to 5" or "M1 to M5" appears in the gear display.

The ATC will execute upshifts or downshifts only at appropriate engine and road speeds. For example, the transmission does not shift down when the engine speed is too high. The selected gear will appear briefly in the instrument cluster, followed by the current gear.

 In the manual mode for rapid acceleration – when passing, for example – manually or a shifting down to the kickdown point. ◀

You can only change from M/S to the selector lever positions "P," "R" and "N" via the "D" position.

In the following situations, the Steptronic "thinks" for you in the manual mode:

- ▷ In order to prevent engine over-speeding, the transmission shifts automatically to the next higher gear shortly before the RPM cutoff point
- ▷ At low speeds, the transmission shifts down automatically - you do not have to act
- ▷ In the kickdown mode, the transmission shifts down to the lowest gear which is possible, depending on the engine speed.

Electronic transmission control module

If the "TRANS. FAILSAFE PROG" message appears in the Check Control, there is a malfunction in the transmission system.

You can still place the selector lever in all positions. However, it is possible that not all gears are available for the vehicle's forward drive.

If this happens, avoid extreme engine loads and consult the nearest authorized BMW center.

 Do not work in the engine compartment when a drive gear (forward or reverse) is engaged. If you do this, the vehicle could move. ◀

For towing, tow-starting and jump-starting, refer to pages [179](#), [180](#).



- 1 High beam (blue indicator)
- 2 Headlamp flasher (blue indicator)
- 3 Turn signal (green indicator accompanied by a rhythmic clicking sound from the relay).

If the indicator lamp and the clicking from the relay are both faster than normal, one of the turn indicators has failed.

To signal briefly

Press the lever up to but not beyond the detent. It then returns to the center position when released.



- 0 Wipers retracted
- 1 Intermittent wipe
- 2 Normal wipe
- 3 Fast wipe
- 4 Brief wipe
- 5 Automatic windshield washer
- 6 Rotary dial for control of the interval time or the sensitivity of the rain sensor

0 Wipers retracted

The wipers are partially hidden behind the hood. To bring the wipers up into their vertical position (important when changing the blades, or folding up when frost is expected):

With the control lever in position 1, switch off the ignition when the wipers are in the parked position.



Fold the wipers down onto the windshield before you turn the ignition key to position 1 or 2. ◀

For changing the wiper blades, refer to page 162.

1 Interval time or rain sensor*

You can set the wipe interval to 4 stages with rotary dial 6. In addition, the wipe interval automatically adapts to variations in road speed.

Rain sensor:

When the rain sensor is activated, the windshield wiper is controlled automatically, depending on the degree of wetness of the windshield (in both snow and rain). You do not have to be concerned with switching the windshield wiper on or off or adjusting the wipe interval between intermittent and full wipe. Instead, you can concentrate fully

Wiper/Washer system

on the traffic conditions. This is especially important under adverse weather conditions.

To activate the rain sensor:

From ignition key position 1 and up, move the lever to position 1. The wipers travel once across the windshield, regardless of the weather.

You can leave the lever permanently in position 1. It is then only necessary to activate the rain sensor from ignition key position 1 and up. To do this

- ▷ turn rotary dial 7 briefly or
- ▷ use either the automatic windshield washer 5 or the automatic intensive washer 6.

To modify the sensitivity of the rain sensor:

Turn rotary dial 7.



Turn the rain sensor off in automatic car washes.

If you do not, damage may occur if the wipers switch on unintentionally. ◀

2 Normal wiper speed

When the vehicle is stationary, the wipers switch automatically to intermittent wipe (not on vehicles with rain sensor).

3 Fast wiper speed

When the vehicle is stationary, the wipers operate at normal speed (not on vehicles with rain sensor).

5 Automatic windshield washer

The system sprays washer fluid against the windshield and activates the wipers for a brief period.

If you only pull the lever briefly, the system sprays washer fluid onto the windshield without activating the wipers.

Headlamp washers*

If they are on, the headlamps will also be cleaned every fifth time you activate the automatic windshield washer.



Do not use the washers if there is any danger that the fluid will freeze on the windshield, otherwise vision could be obscured. For this reason, use an antifreeze agent. Refer to page 142.

Do not use the washers when the reservoir is empty, since this could cause damage to the washer pump. ◀

Windshield washer jets

The windshield washer jets and the windshield in the wiper sweep area are defrosted automatically when the ignition key is in position 2.

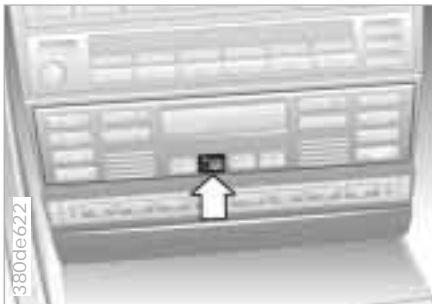

To activate

Press the button: The rear window defroster continues high-output operation for as long as the indicator lamp remains on (rapid thaw).

After the indicator lamp goes out, the defroster continues operating at reduced power for a limited period before deactivating automatically.

To deactivate

If the indicator lamp is on, press the button.



You can store and automatically maintain any desired vehicle speed above approx. 20 mph (30 km/h).

To activate the system

In ignition key positions 1 and 2: Press button 4, the indicator lamp in the instrument cluster comes on. You can now use the cruise control.

To store and maintain speed or to accelerate

Press button 1 briefly: The system records and maintains the current vehicle speed. Every time you tap the button, the speed increases by 0.6 mph (1 km/h).

Press and hold button 1: The vehicle accelerates without pressure on the accelerator pedal. When you release the button, the system records and maintains the current speed.

 If, on a downhill gradient, the engine braking effect is not sufficient, the controlled speed can be exceeded. Speed may not be maintained on uphill grades if the engine output is insufficient. ◀

To decelerate

Press button 2 briefly: When the cruise control is active, vehicle speed is reduced by approx. 0.6 mph (approx. 1 km/h) every time you briefly press the button.

Press and hold button 2: With the cruise control active, the system automatically reduces the throttle opening to slow the vehicle. When you release the button, the system records and maintains the current speed.

Cruise control

To cancel the cruise control

When the system is activated, press and hold button 4. The indicator lamp stays on. You can use the cruise control again as desired.

In addition, cruise control is canceled automatically:

- ▷ When you apply pressure to the brake pedal
- ▷ If the automatic transmission selector lever is moved from "D" to "N"
- ▷ If you exceed or fall below the programmed speed for an extended period (by depressing the accelerator, for example).

To resume the stored setting

Press button 3:

The vehicle accelerates to and maintains the last speed stored. When you turn the ignition key to position 0, the stored speed is deleted from the system's memory and the system is deactivated.

To deactivate the system

When the cruise control has been canceled, press button 4 again. The indicator lamp goes off and the memorized speed is canceled.



Do not use cruise control on twisting roads, when high traffic density prevents driving at a constant speed, when the road surface is slick (snow, rain, ice), or when the road surface is loose (rocks or gravel, sand). ◀



1 Odometer

You can activate the displays shown in the illustration with the ignition key in position 0 by pressing the button in the instrument cluster (arrow).

2 Trip odometer

To reset the trip odometer to zero, press the button (arrow) with the ignition key in position 1 or 2.

3 Outside temperature display

The outside temperature appears in the display panel as soon as you turn the ignition key to position 1.

You can change the units of measure (°C/°F) by

- 1 pressing and holding down the button (arrow) with the ignition key in position 1
- 2 while turning the ignition key to 0.

Ice warning

If the outside temperature drops to approx. +37.5°F (+3°C), a warning signal sounds and the display flashes briefly.

The warning is repeated whenever the temperature goes to at least +43°F (+6°C), and then drops to +37.5°F (+3°C) again.



The ice warning does not alter the fact that surface ice can form at temperatures above +37.5°F (+3°C), on bridges or shaded road surfaces, for instance. ◀



Never allow the engine to operate with the needle in the red overspeed zone of the gauge.

To protect the engine, the engine-management system automatically interrupts the fuel supply in this range; the resulting effect resembles that associated with a sudden loss of power.



Indicates current fuel consumption in mpg (in liters per 100 km on Canadian vehicles). This instrument clearly shows whether your current driving style is conducive to economy and minimum exhaust emissions.

When the vehicle is stationary, the display goes to "Maximum" (zero on Canadian models).



When you switch on the ignition, the indicator lamp comes on briefly to confirm that the system is operational.

If the indicator lamp stays on, there are approx.

- ▷ BMW 740i/L 2.6 gallons (10 liters)
- ▷ BMW 750iL 3.2 gallons (12 liters)

remaining in the tank.

Tank capacity: Refer to page [197](#).

Certain operating conditions (such as those encountered in mountainous areas) may cause the needle to fluctuate slightly.



Please refuel early, since driving to the last drop of fuel can result in damage to the engine and/or catalytic converter. ◀

74 Temperature gauge



Blue

The engine is still cold. Drive at moderate engine and vehicle speeds.

Red

When you switch on the ignition, the warning lamp comes on briefly to confirm that the system is operational.

Lights up while driving, or the message "COOLANT TEMPERATURE" appears in the Check Control: the engine is overheated. Switch the engine off immediately and allow it to cool down.

Between the blue and red zones

Normal operating range. It is not unusual for the needle to rise as far as the edge of the red zone in response to high outside temperatures or severe operating conditions.

Checking coolant level: Refer to page [146](#).

Service Interval Display



Green lamps

The number of illuminated lamps decreases as the time for your next maintenance visit approaches.

Yellow lamp

This field appears together with OILSERVICE or INSPECTION.

Maintenance is due. Please contact your BMW center for an appointment.

Red lamp

Maintenance is overdue.



System malfunctions are reported in text form and alerts or warnings are each reported by a gong when the ignition key is in position 2.

- 1 CHECK button
- 2 Status report symbol
- 3 Display

Messages concerning system faults are differentiated based on two priorities:

Priority 1

These defects are immediately indicated by a gong and a flashing warning symbol (2). Several simultaneous defects will be displayed consecutively. These messages remain active until the malfunction is corrected. They cannot be cleared with CHECK button (1).

- ▷ **RELEASE PARKING BRAKE**
This message appears together with an acoustic signal any time you begin to drive and the parking brake is applied.
- ▷ **COOLANT TEMPERATURE**
Coolant overheated. Stop the vehicle and switch off the engine immediately. Refer to pages [74](#), [146](#).

- ▷ **STOP! ENGINE OILPRESS**
Oil pressure too low. Stop the vehicle and switch off the engine immediately. Refer to page [20](#).
- ▷ **CHECK BRAKE FLUID**
Indicates that brake fluid is down to roughly minimum level. Top up the brake fluid as soon as possible. Refer to page [147](#). Have the cause of the brake fluid loss corrected by your BMW center.
- ▷ **FLAT TIRE***
Reduce vehicle speed immediately and stop the vehicle. Avoid hard brake applications. Do not oversteer. Refer to page [95](#).
- ▷ **LEVEL CONTROL INACTIVE***
Please consult the nearest authorized BMW center. Refer to page [130](#).
- ▷ **SPEED LIMIT***
This is displayed if the programmed speed limit is exceeded.

76 Check Control

Priority 2

These alerts for problems are reported for 20 seconds when the ignition key is in position 2. The status reports remain after the message disappears. You can view the message again by pressing the CHECK button.

▷ TRUNK LID OPEN

This message is given only when initially starting off.

▷ DOOR OPEN

This is displayed after a minimum vehicle speed is exceeded.

▷ FASTEN SEAT BELTS*

In addition, the indicator lamp with the safety belt symbol appears and an acoustic signal is heard.

▷ WASHER FLUID LOW

The washer fluid is too low. Top up the fluid at the earliest opportunity. Refer to page 142.

▷ CHECK ENGINE OIL

Add engine oil as soon as possible. Refer to page 143.

▷ OUTSIDE TEMPERATURE 24 °F (-5.0 °C)

This display is only an example. The current reading appears at an outside temperature of 37.5 °F (+3 °C) and below. Refer also to page 72.

▷ TIRE PRESSURE SET*

The RDC has imported the current inflation pressure in the tires as the target values which the system will monitor.

Refer to page 94.

▷ CHECK TIRE PRESSURE*

Check and correct the tire inflation pressure to specifications at the earliest opportunity (next stop for fuel).

Refer to page 94.

▷ TIRE CHECK INACTIVE*

A temporary interference of the RDC or a system fault. Refer to page 95

▷ BRAKE LAMP CIRCUIT

A bulb has failed or the circuit has a malfunction. Refer to pages 163, 176 or consult an authorized BMW center.

▷ CHECK LOWBEAMS

CHECK SIDE LAMPS

CHECK REAR LAMPS

CHECK FRONT FOGLAMPS

CHECK LICPLATE LAMP

CHECK TRAILER LIGHTS

CHECK HIGHBEAMS

CHECK BACKUP LAMPS

Defective bulb or circuit. Refer to pages 163, 176 or consult an authorized BMW center.

▷ TRANS. FAILSAFE PROG

Please consult the nearest authorized BMW center. Refer to pages 64, 67.

▷ CHECK BRAKE LININGS

Have the brake pads inspected by your BMW center. Refer to page 126.

▷ REMOTE KEY BATTERY

Change the battery. Refer to page 168.

▷ CHECK COOLANT LEVEL

The coolant is too low. Top up at the next opportunity. Refer to page 146.

▷ ENGINE FAILSAFE PROG

Fault in the Electronic Engine Power Control EML. When braking, higher brake application pressure may be necessary and brake pedal travel may be significantly longer.

Please have the system inspected by your authorized BMW center.

Check Control

Displays after completion of trip

All of the malfunctions registered during the trip appear consecutively when the ignition key is turned to position 0.

One of the following displays may appear:

- ▷ LIGHTS ON
- ▷ KEY IN IGNITION LOCK
- ▷ CHECK ENGINE OIL LEV

Add engine oil at the next opportunity (next stop for fuel). Refer to page [143](#).

This message appears when you open the driver's door after parking the vehicle. A supplementary gong is also heard.

Even if the ignition key has been removed and the display has gone off, you can still retrieve these messages with CHECK button (1) for approx. three minutes after completion of your trip. If there are multiple messages, continue to press the CHECK button.

To monitor the Check Control

With the ignition key in position 2, press CHECK button (1):

CHECK CONTROL OK appears in the display.

In this case, there are no faults in the systems which are monitored.

78 Multi-Information Display (MID)

The MID serves as a central control and display unit for the following vehicle systems:

- ▷ Digital clock (time, date, independent ventilation system)
- ▷ Sound system (radio, cassette, CD player*)
- ▷ Onboard computer (such as fuel consumption, cruising range)
- ▷ Cellular phone* (dialing, for instance)



Sound system, digital clock, onboard computer and cellular phone

On the following pages you will find explanations and information on how to use the digital clock and the onboard computer. Information on using the sound system and the telephone are contained in the Supplementary Owner's Manual.



Implausible numbers will not be accepted.

Any interruption in current supply will result in the loss of all stored data. After the current supply is restored, you will need to reset the time as well as any additional program data for the independent ventilation system, distance or speed warning threshold. ◀



From ignition switch position 1, you can make use of the following functions:

- ▷ Time and date
- ▷ Program an hourly reminder (memo), for instance, to remind you of news broadcasts
- ▷ Independent ventilation system.

- 1 Sound system display (refer to the Supplementary Owner's Manual)
- 2 Display for time and date
- 3 Tone symbol for active memo function
- 4 Sound system function key
- 5 Function key for the digital clock and onboard computer
- 6 Entry and data-request keys for sound system, digital clock and onboard computer
- 7 Display for entry and data-request keys.

To display the time and date

Press the digital clock function key.

When the ignition key is in position 0 or removed, the time appears for eight seconds; from ignition key position 1, the time remains in the display.

Press the DATE key with the time activated to display the date.

To display the time again, press the digital clock function key.

You can display the time in either a 12- or 24-hour scale. To change setting:

- 1 Press the digital clock function key
- 2 Press the scale selection key (12H/24H).

When you select the 12-hour mode, AM or PM will appear on the right-hand side of the display panel.

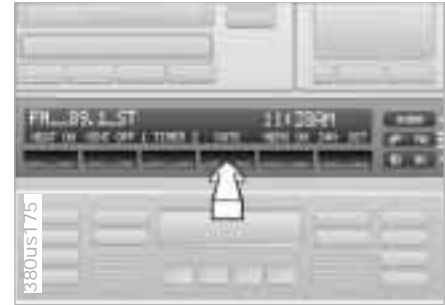
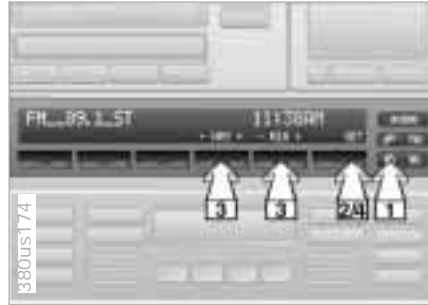
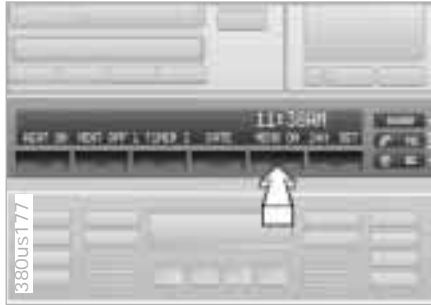

Programming a reminder signal

- 1 Press the digital clock function key
- 2 Press MEMO ON/OFF to activate/de-activate the hourly signal.

When MEMO ON is active, a tone symbol appears in the display and an acoustic signal is provided 15 seconds before each full hour.

To reset the time

- 1 Press the digital clock function key
- 2 Press the SET key; the dots in the display start to flash
- 3 Enter the correct time with the - HRS + and - MIN + input keys
- 4 Confirm your entry by pressing the SET key.

To reset the date

- 1 Press the digital clock function key
- 2 Press the DATE key.

The dots in the display and the word DATE start to flash.



To enter the time and date after a power loss

- 1 Press the digital clock function key
The dots in the display start to flash.
- 2 Enter the correct time with the
- HRS + and - MIN + input keys
- 3 Press the SET key. The clock starts
- 4 Enter the date with the - DAY+,
- MONTH + and - YEAR+ input keys
- 5 Press the SET key.

- 3 Enter the date with the - DAY+,
- MONTH + and - YEAR+ input keys
- 4 Confirm your entry by pressing the
SET key.

Leap years are programmed into the system and therefore need not be taken into account.



Independent ventilation system

To enter activation times

You can preselect two different activation times for the independent ventilation system. The system switches off automatically after 30 minutes.

Refer to page 107 for important information on using the independent ventilation system.



To enter the first activation time

Before you can enter data, the ignition key must be at position 1 and the digital clock must be visible in the display.

- 1 Press the keys as shown in the illustration
- 2 Press the SET key.

TIME 1 flashes in the display.

- 3 Use the - HRS + and - MIN + keys to enter the correct time
- 4 Confirm your entry by pressing the SET key.

An asterisk appears next to the time and the LED to the right of the BC key comes on.

To enter the second activation time

The procedure is the same as that for setting the first activation time, except you will press TIME 2 for your selection.

To correct the time

To enter a different time, press the keys in the sequence described for the first/second activation times.

Calling up a preselected time

- ▷ For the first activation time, press the keys in the sequence shown in the illustration on the left
- ▷ For the second activation time, follow the same key sequence and press TIME 2 key for your selection.

Activating/deactivating switch-on times

After pressing the digital-clock function key, the entered activation times can be activated and deactivated by pressing the keys TIME 1 or TIME 2.

When active, the LED to the right of the BC key comes on and an asterisk appears at the left next to the time.

The times remain stored until they are replaced by subsequent entries.

Digital clock

Ventilation mode

During ventilation, the LED to the right of the BC key flashes and AIR OFF appears in the display. Pressing this key switches off the ventilation mode and the LED goes out.

 When a preselected activation time is set, the independent ventilation system is operational at outside temperatures above 60°F (16°C), or by direct switch activation. It cannot be switched on when the vehicle is moving. ◀

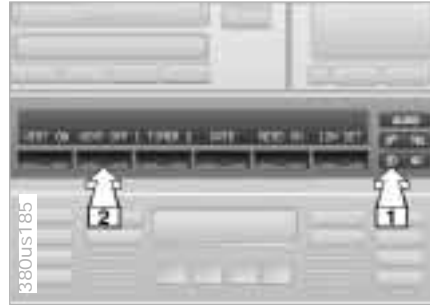

Direct control

Available only with ignition key at position 1.

Press the keys (AIR ON/AIR OFF) in the sequence shown in the illustration.



The onboard computer operates at ignition key positions 1 and 2.

Information for safe and economical driving can be called up for display.

You can use the key with the clock symbol to

- ▷ display the time and date
- ▷ program an hourly reminder signal (Memo), to remind you of the next news broadcast, for instance
- ▷ operate the independent ventilation system.

Refer to page 79 for information and details on using the digital clock.

- 1 Sound system display (refer to the Supplementary Owner's Manual)
- 2 Sound system function key
- 3 Function key for digital clock and onboard computer
- 4 Entry and data-request keys for sound system, digital clock and onboard computer
- 5 Display for entry and data-request keys

Standard displays (no previous data entries required)

		Page
1 CONSUM	Two different average fuel consumption calculations	85
RANGE	Estimated cruising range	85
SPEED	Average speed	86

With previous data entries:

DISTANCE-ARR	The remaining distance to the destination with the estimated time of arrival	86
LIMIT	Speed warning threshold	87
CODE	Code	88

In the interest of driving safety, you should always enter data with the vehicle parked/stationary. The onboard computer starts its calculations as soon as the vehicle starts to move.

You can also use the remote control unit to select information for display. Refer to page 89.



Average fuel consumption

The computer can calculate average fuel consumption rates for two different distances at the same time (simultaneous data for an entire journey and for a single segment of it, for instance).

To start calculations for distance 1:
Press the keys in the sequence shown in the diagram.

To start calculations for distance 2:
The procedure is the same as that for the first distance, except you will press CONSUM 2 for your selection.

The computer starts calculating fuel consumption as soon as you start driving.

Data request:

Press the BC key and CONSUM 1 or 2.

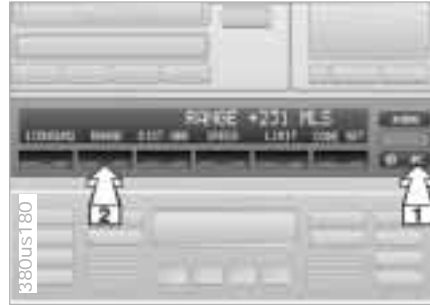

Estimated cruising range

Displays the estimated travel range available with the remaining fuel. The system calculates the cruising range based on operating conditions and the amount of fuel remaining in the tank. The computer uses the average rate of fuel consumption over the preceding 18 miles (30 kilometers) as a reference.

Data request:

Press the keys in the sequence shown in the illustration.

A range of under 31 miles (50 kilometers) is displayed in the Check Control in the instrument cluster.

Please respond to this warning by refueling at once to avoid serious damage to the engine and catalytic converter.

When you refuel, the onboard computer registers the additional fuel only when more than 1.5 gallons (5 liters) are added.

86 Onboard computer

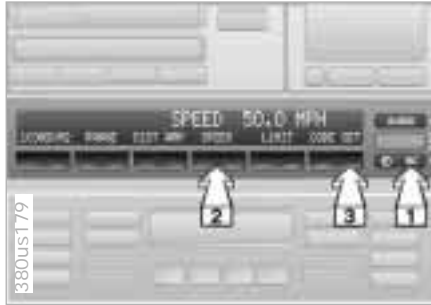

Average speed

To start calculations:

Press the keys in the sequence shown in the illustration.

Calculations begin after you start off.

Data request: Press BC and SPEED key.

The display shows your average speed since the last time the SET key was pressed. Calculations are interrupted whenever you shut down the engine.

At speeds below 100 mph (100 km/h) the display includes decimals.



Distance remaining to destination

Data request:

Press BC and DIST.

Displays the distance to the destination. Available only if the total distance was entered before the start of the journey.



To enter the distance

Press the keys in the sequence shown in the illustration on the left.

The miles flash in the display.

Enter the distance with keys 0 – 9 and confirm with the SET key.

Use the CLR key to make corrections. Press once to delete the final digit.

Any additional mileage extending beyond the total defined in the initial entry is indicated by a minus sign.



Estimated time of arrival

Data request:

Press the keys in the sequence shown in the illustration.

Shows the estimated arrival time based on current driving speed.

Functions only when you enter the trip distance (DIST) before the start of the journey.

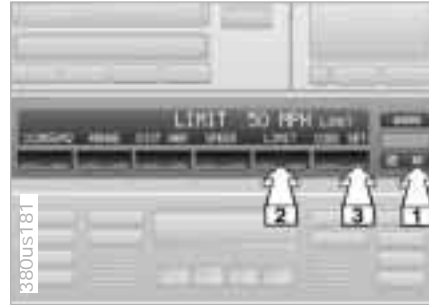

Speed warning threshold (Limit)

Entry of a speed warning threshold (Limit) will be indicated by the word LIMIT at the right in the display.

Alerts you when you exceed the maximum speed that you entered earlier (for instance, posted speed limit). Triggers an acoustic signal, LIMIT flashes on the right-hand side of the display, and the stored limit appears in the instrument cluster Check Control display panel for approximately 3 seconds.

Vehicle speed must drop back to at least 3 mph (5 km/h) below the programmed speed warning threshold to reset the system for repeat warnings.

To enter the speed warning threshold

Press the keys in the sequence shown in the illustration on the left.

The word MPH flashes in the display.

Enter the speed warning threshold with the 0 – 9 keys and confirm with the SET key.

Use the CLR key to make corrections. Press once to delete the final digit.

To deactivate the speed warning

▷ Press BC and then press LIMIT twice.

The word LIMIT on the right side of the display disappears, however the value remains stored and can be reactivated using the LIMIT key.

To adopt the current speed as the limit

Press BC, LIMIT and SET twice.



Code

You can program a code into the onboard computer for supplementary protection against unauthorized attempts to start the engine or tamper with the vehicle. This feature provides you with an extra measure of security extending beyond that furnished by the vehicle immobilization system (refer to page 31).

The system prevents the engine from starting.

A code number is used to arm the system. The code is then required for subsequent starting attempts. Therefore: Always remember the code number.

With the ignition key in position 1, press the keys in the sequence shown in the illustration.

"CODE - - - -" will appear in the display.



Turn the ignition key to position 1 to set

- 1 Use the 0 – 9 keys to enter the code
- 2 Press the SET key
- 3 Turn the ignition key to position 0 or remove it.

If you press a different key of the onboard computer before you turn the ignition key to the 0 position, or if you turn the key to position 2, the code which has been entered will be deleted.

Code numbers from "0000" to "9999" can be entered.

The code must be re-entered each time the system is armed.

You can make corrections of the entered numbers with the CLR key.

To cancel with the ignition key at position 1 or 2

A gong and the "CODE - - - -" display prompt the code entry.

- 1 Use the keys to enter the code number
- 2 Press the SET key.

The system responds to attempts to start the vehicle using an incorrect/no code by preventing the engine from starting.

The time automatically appears after you enter the correct code and then confirm it by pressing SET.

Three incorrect entries will cause the alarm to sound for 30 seconds.

Onboard computer



If you wish to display all data:

- 1 Press the control in the turn signal lever until "Prog 1" appears in the display
- 2 Press the SET key.

Data request:

Briefly press the switch in the turn signal lever for each data request.

Remote control

You can display all information for the onboard computer and digital clock with the switch in the turn signal lever. You can also display selected information in the Check Control in the instrument cluster following specific entries.

To enter:

- 1 Press the control in the turn signal lever until "Prog 1" appears in the display
- 2 Press the buttons on the MID in the sequence in which you want the information to be displayed.
The program number is counted in the display every time information is stored
- 3 Press the SET key.

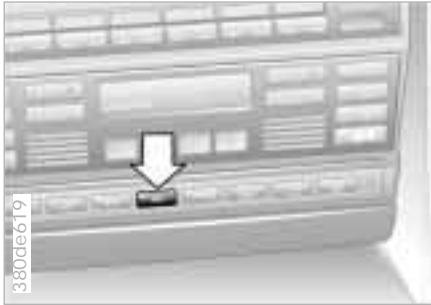

The PDC assists you when you are parking. Acoustic signals warn you of the distance to an obstacle. In addition, four ultrasonic sensors in each the front and rear bumpers measure the distance from the nearest object. The monitoring range for the four front sensors and that of the two rear corner sensors ends approx. 2 feet (60 cm) beyond the respective bumper. The two center sensors cover a distance of approx. 5 feet (1.50 m).

The system starts to operate automatically about one second after you move the selector lever to "R" when the ignition key is in position 2. It is similarly deactivated when you move the selector lever position from the "R" position. The indicator lamp in the button (arrow) comes on to signal the active status.

Manual activation/deactivation is possible using the button in the center console (arrow) (indicator lamp comes on/goes out). The system deactivates once the vehicle travels approximately 160 ft (50 m) or exceeds a speed of about 18 mph (30 km/h). It must then be switched on again as desired.

Acoustical signals

The distance to an obstruction in the front is indicated by a higher interval tone, while the distance to an obstruction in the rear is indicated by a deeper tone. As the distance between vehicle and object decreases, the intervals between the tones become shorter. A continuous tone indicates the presence of an object less than 1 ft. (30 cm) away.

The warning signal is canceled after approx. three seconds if the distance to the obstruction remains constant during this time (if you are moving parallel to a wall, for instance).

System malfunctions are indicated by a short, continuous tone and a flashing indicator lamp (indicator lamp only when the system is activated by shifting the transmission into "R").

Switch the system off and consult an authorized BMW center to have the problem corrected.

Park Distance Control (PDC)*



The PDC does not remove the driver's personal responsibility for evaluating the distance between the vehicle and any obstacles. Even when sensors are involved, there is a blind spot in which objects cannot be detected. This applies especially in those cases where the system approaches the physical limits of ultrasonic measurement, as occurs with tow bars and trailer couplings, and in the vicinity of thin and painted objects. Certain sources of sound, such as a loud radio, could drown the PDC signal tone. ◀



Keep the sensors clean and free of ice or snow in order to ensure that they continue to operate effectively. Do not apply high-pressure spray to the sensors for a prolonged period of time. Maintain an adequate distance of more than approx. 4 inches (10 cm). ◀

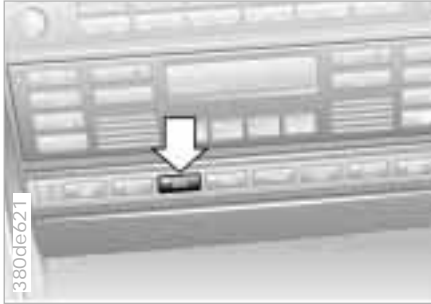

Automatic Stability Control plus Traction (ASC+T)/Dynamic Stability Control (DSC)*

These systems help provide additional dynamic stability, particularly when accelerating and cornering.

The DSC system enhances the benefits of the ASC+T. In addition to optimizing vehicle stability and traction when accelerating or starting from a standstill, another benefit is realized in cornering stability. Of course, this is subject to the limits imposed by the laws of physics.

The system activates automatically each time you start the engine.

Indicator lamp



The indicator light in the instrument cluster goes out shortly after you switch on the ignition.

Refer to page [21](#).

Indicator lamp flashes:

The system is actively regulating drive torque in response to monitored vehicle operating conditions.

If the indicator lamp fails to go out after the engine is started, or if it comes on during normal driving:

If the system has not been deactivated, there is a system malfunction. The vehicle remains operational, but without ASC+T/DSC. Consult your authorized BMW center for repair.

To deactivate the system

Press the button. The indicator lamp will come on.

Depending on equipment options, the button is marked with ASC or DSC.

With deactivated ASC+T/DSC you are driving with conventional, unregulated torque transfer.

We recommend that you deactivate the system for increased traction:

- ▷ When rocking the vehicle or starting off in deep snow or on loose surfaces
- ▷ or when driving with snow chains.
Refer also to page [129](#).

To reactivate the system

Press the button again; the indicator lamp goes out.



The laws of physics cannot be repealed, even with ASC+T/DSC.

Any consequences arising from traction loss due to excessive vehicle speed remain the responsibility of the driver. For this reason, do not take risks, using the additional safety margin provided by the system as an excuse. ◀

For additional details concerning ASC+T/DSC, please refer to the chapter describing "Advanced technology" on page [185](#).

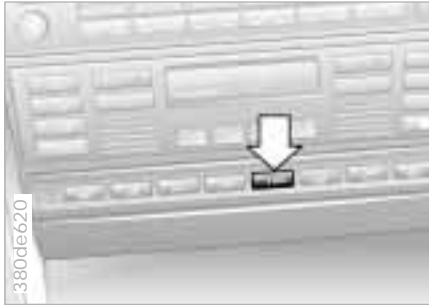

The system automatically ensures damping of the running gear on demand and thus increases comfort and driving safety.

Automatic adaptation

Automatic adaptation is activated after every engine start. It can be maintained throughout the entire vehicle speed range and for all load conditions. If operating parameters (road-surface quality, driving conditions such as steering, braking, others) change, the damping system adapts automatically to the new factors in fractions of a second.

Sport program

With the ignition key in position 2, press the EDC button (arrow). The indicator lamp next to the S comes on.

The Sport program should be invoked when you wish to have strictly performance-oriented tuning of the running gear under all operating conditions.

To switch to automatic adaptation: Press the button again; the indicator lamp goes out.

The concept

RDC monitors the tire pressures at all four wheels, even when the vehicle is moving. The system provides an alert whenever the inflation pressure drops significantly below the specified pressure in one or more tires.

In order for the RDC to "learn" the correct tire inflation pressure, check the inflation pressure in all tires. Refer to the table of "Tire inflation pressures" on page 26 and make corrections if necessary. Then activate the system.

The Check Control will inform you if the tire pressure is not correct.



Activate the system

- 1 Turn the ignition key to position 2 (do not start the engine)
- 2 Press and hold the button (arrow) until the message "SET TIRE PRES-SURE" appears in the Check Control
- 3 After you have driven for a few minutes, the RDC will import the current inflation pressure in the tires as the target values which the system will monitor.

You will only have to repeat this procedure if the tire inflation pressure must be corrected. Otherwise, the RDC functions automatically when the ignition key is in position 2, and thus operates whenever the vehicle is driven.

Loss of tire pressure

If, after a certain period of time, the air pressure has gone down significantly (which is normal for any tire), the message "CHECK TIRE PRESSURE" appears in the Check Control.

This alerts you that you should have the tires inflated to the specified pressures as soon as possible.

 If you are prompted to check the tire pressure shortly after a correction has been made, this indicates that the corrected values were not accurate. Please check the inflation pressure again and make corrections according to the inflation pressure table. ◀

Flat tire

If there is a tire failure with a loss of air pressure, the message "TIRE DEFECT" appears in the Check Control. In addition, a gong sounds.

If this occurs, reduce vehicle speed immediately and stop the vehicle. Avoid hard brake applications. Do not oversteer. Replace the wheel and flat tire.

 The spare tire which is available in your vehicle as standard equipment is equipped with the electronics required for RDC and, following activation of the system, is also monitored after it is mounted. ◀



The RDC cannot alert you to severe and sudden tire damage caused by external factors. ◀



Have the tires changed by your authorized BMW center. Your authorized BMW center has been trained to work with the RDC system and is equipped with the necessary special tools to do so. ◀

System interference

Under certain local conditions, the RDC may malfunction for brief periods because of interference from outside systems or electronic devices which have the same radio frequency.

During the period of the malfunction, the message "TIRE CONTROL INACTIVE" appears in the Check Control.

You will also see the same message

- ▷ in the event of a system fault
- ▷ if a wheel is mounted without the RDC electronics
- ▷ if, in addition to the spare tire, additional wheels with RDC electronics are on board.

Please contact your authorized BMW center for additional information.



Side lamps (side marker lamps)



With the switch in this position, vehicle lighting is illuminated on both sides. For lighting on one side while parking, refer to page 97.

Low beams/Xenon lamps*



When you switch the ignition off with the low beam headlamps on, only the side lamps (side marker lamps) will remain on.

When the low beams are switched on, the interior door handles are lighted. The brightness is controlled by the instrument panel lighting.



You can adjust the "Follow-Me-Home" function: The low beams will then remain on for a brief period after you park the vehicle if you actuate the headlamp flasher. ◀

Xenon lamps*

For additional details, refer to page 190.

"LIGHTS ON" warning

In ignition key position 0, a message appears in the Check Control after the driver's door is opened if the headlamps have not been switched off.

Daytime-driving light switch*

The headlamps are automatically switched on for daylight driving at ignition key position 2.



Turn the rotary dial to adjust the illumination intensity.



- 1 High beam
(blue indicator lamp)
- 2 Headlamp flasher
(blue indicator lamp)
- 3 Parking lamp
(not released at this time)

Parking lamp, left or right*

With the ignition key in position 0, engage the lever in the appropriate turn-signal position.



Front fog lamps



A green indicator light appears in the instrument cluster to indicate that the front fog lamps are on.

If the high beam is switched on, the fog lamps go out.

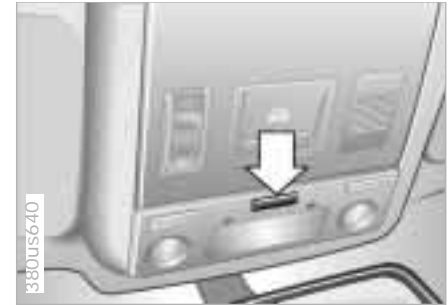

The interior lamps operate automatically.

Switching interior lamps on and off

Press the button (arrow).

If you want the interior lamps to remain off continuously, maintain pressure on the button for approximately 3 seconds. Press the button briefly to revert to normal operation.

The orientation lamps on the right and left of the button for interior lamps come on when the side lamps are switched on.

98 Interior lamps

Footwell lamps

The footwell lamps operate in the same way as the interior lamps.

Reading lamps



The reading lamps are located in the front near the interior lamp and in the rear. They can be switched on and off with the switch adjacent to each lamp.



In order to conserve the battery, all of the lamps in the vehicle are switched off automatically approx. 15 minutes after the ignition key is turned to position 0. ◀

100 Automatic climate control

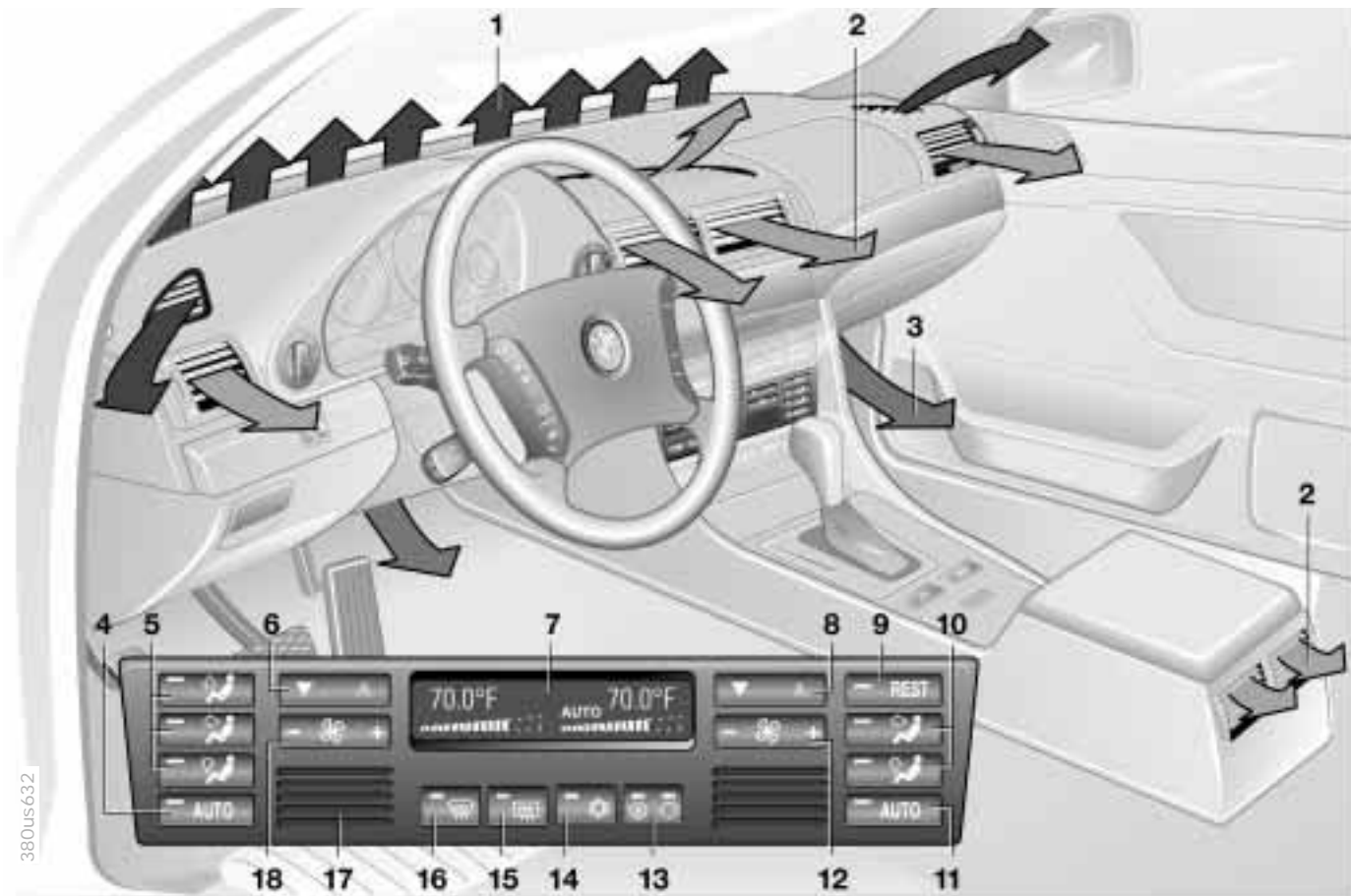

- 1 Air flow directed against windshield and door windows
- 2 Air flow toward the upper body
The rotary dials allow infinitely-variable regulation of the air supply, changes in the air-flow direction, and temperature regulation.
(Change air-flow direction in the rear passenger area with the levers in the center of the vent). In the closed position, air flows out at the upper center of the instrument panel only [104](#)
- 3 Front footwell ventilation
There are corresponding air vents in the rear footwell as well
- 4 Automatic air distribution – left-hand side [102](#)
- 5 Individual air distribution – left-hand side [102](#)
- 6 Temperature control – left-hand side [103](#)
- 7 Temperature and air flow display, left- and right-hand sides [103](#), [104](#)
- 8 Temperature control – right-hand side [103](#)
- 9 Residual heat mode [104](#)
- 10 Individual air distribution – right-hand side [102](#)
- 11 Automatic air distribution – right-hand side [102](#)
- 12 Air supply – right-hand side [104](#)
- 13 Recirculated-air mode/Automatic recirculated-air control (AUC) [103](#)
- 14 Air conditioner [103](#)
- 15 Rear window defroster [70](#), [103](#)
- 16 Defrosting the windows and remove condensation [103](#)
- 17 Air grill for interior temperature sensor - please keep clear and unobstructed
- 18 Air supply – left-hand side [104](#)

Tips for pleasant driving

Use the automatic system, i.e., press AUTO button 4. Select an interior temperature that is comfortable for you - we recommend 70°F (22°C) as a comfortable setting. When the outside temperature is above 42°F (5°C), you can also use the air conditioning system 14. This will dry the air and prevent window fogging, for example if people are wearing damp clothes in the vehicle. Set the outlets 2 so that the air flows past you and does not flow directly at you. Set the rotary dial between the air outlets 2 for the upper body to a medium position, since air that is somewhat cooler promotes driving without fatigue.

The following description will guide you through additional individual settings.





You can make the settings of your vehicle in such a manner that, when you unlock the car with your personalized remote control, your own personalized setting of the automatic climate control is initiated. ◀

Automatic air distribution

The AUTO program assumes the adjustment of the air distribution and the air supply for you and in addition adapts the temperature to external influences (summer, winter) to meet preferences you can specify. This program maintains a comfortable in-car climate regardless of the season. Select an interior temperature that is comfortable for you - we recommend 70°F (22°C) as a comfortable setting.

The temperature setting and the word "AUTO" for the air flow appear in the display 7 (refer to the overview on page 100). Open the ventilation outlet for the upper body area. Switch on the air conditioner in warm weather. The maximum cooling capacity is achieved when you set the rotary dial 3 (refer to page 104) to cold.

Individual air distribution

You can cancel the AUTO program by selecting specific distribution patterns to suit your own individual requirements. You can direct air to flow onto the windows , toward the upper body , and into the footwell .

To defrost windshield and door windows

This program quickly removes ice and condensation from the windshield and the side windows.

Air conditioner

The air is cooled and dehumidified and - depending on the temperature setting - warmed again when the air conditioner system is switched on.

Depending on the weather, the windshield may fog over briefly when the engine is started.

At outside temperatures below approx. 42°F (5°C), switch off the air conditioner. This will help to prevent the windows from fogging up.

If the windows fog over immediately after the air conditioner is switched off, switch it back on.



Condensation forms in the air conditioner system during operation, which then exits under the vehicle.

Traces of condensed water of this kind are thus normal. ◀

Automatic climate control

Automatic recirculated-air control (AUC)



You can respond to unpleasant external odors by temporarily stopping the flow of outside air. The system then recirculates the air currently within the vehicle. Press the button repeatedly to run through the following control sequence:

- ▷ Indicator lamps off: Fresh air flows into the vehicle
- ▷ Left-hand indicator lamp on – AUC mode: The system detects pollutants in the outside air and responds by deactivating the outside air flow when required. The system then recirculates the air currently within the vehicle
- ▷ Right-hand indicator lamp on: The flow of external air into the vehicle is permanently blocked. The system then recirculates the air currently within the vehicle.

If you have a multi-function steering wheel with the AUC button (refer to page 23), you can also switch between "OFF" and AUC from there.



If the windows fog over in the recirculated-air mode, switch this mode off and increase the air supply as required. ◀

Rear window defroster



When the rear window defroster is activated, the indicator lamp comes on. The rear window defroster switches off automatically.

Temperature



You can make individual temperature settings on the driver's side and the front passenger side. Your settings will be shown in the display 7. The displayed temperatures are reference values for the interior temperature. We recommend 70°F (22°C) as a comfortable setting, whether the air conditioner is operating or not. When you start the vehicle, the system ensures that the selected temperature is achieved as quickly as possible. It then maintains this temperature, regardless of the season.



You can set uncontrolled heater output at up to 90°F (32°C). Full cooling output is available from the air conditioner down to 60°F (16°C). ◀

Air supply



In the "AUTO" program, the air flow is controlled automatically. AUTO will appear in the display, refer to the overview on page 100. Use "+" and "-" to vary the air flow. When your setting is displayed by bars, the automatic air flow is switched off. Automatic air distribution maintains its setting. You can reactivate the automatic air flow by pressing the "AUTO" button.

When you press "-" during operation at minimum blower speed all displays are canceled: The fan, heating and air conditioner are switched off. The outside air supply is closed. By pressing any button of the automatic climate control (except the "REST" button 9), you can switch the system back on.

Residual heat mode

 The heat which is stored in the engine is utilized for heating of the interior when the engine has been switched off (while waiting at a railroad crossing, for instance).

In ignition key position 1, you can alter the settings of the automatic climate control. In ignition key position 0, the system automatically directs heated air to the windshield, side windows and footwells.

 This function may be activated when the outside temperature is below approx. 59°F (15°C), the engine is at operating temperature, and the battery is adequately charged. ◀

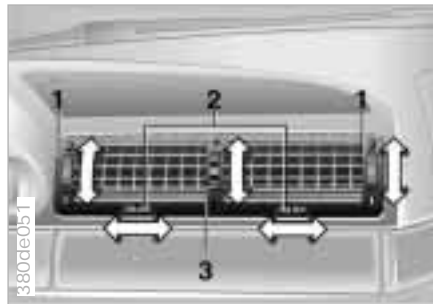
**Draft-free ventilation**

You can adjust the vent outlets for the upper body area for individual selection of air-flow rates and directions:

You can open and close the ventilation outlets with infinitely-variable adjustments and direct them up or down with the rotary dials 1. In the closed position, air exits only at the upper center of the instrument panel. You can use rotary dials 2 to adjust the flow direction from side to side.

Set the outlets so that the air flows past you and is not directed straight at you.

Rotary dial 3 allows you to temper the air flow from these outlets by adding heat or cooling as desired:

- ▷ Turn toward blue – colder
- ▷ Turn toward red – warmer

To adjust the rear compartment vents: Use the rotary dial on the left to close or open the vent for any desired air flow. You can adjust the temperature with the right rotary dial in the same manner as the adjustment for the front ventilation outlets.

Use the levers at the centers of the vent outlets to control the direction of the emerging air.

Microfilter, activated-charcoal filter

The microfilter removes dust and pollen from the incoming air. The activated-charcoal filter provides additional protection by filtering gaseous pollutants from the outside air. Your BMW center replaces the filter assemblies as a standard part of your scheduled maintenance. A substantial reduction in air flow indicates that the filter needs to be replaced early.



- 1 Display for temperature and air supply
- 2 Temperature/
Switching the system on
- 3 Air supply/
Switching the system on

2 Temperature

The rear passengers can adjust the temperature for the ventilation outlets which are positioned above this as desired. The figures in the display provide a general indication of interior temperature. We recommend 70°F (22°C) as a comfortable setting, whether the air conditioner is operating or not. When you start the vehicle, the system ensures that the selected temperature is achieved as quickly as possible. It then maintains this temperature, regardless of the season.

3 Air supply

When you press "-" in the lowest blower speed, all of the displays are canceled: This setting deactivates the blower and shuts off the air supply. You can then switch the rear air conditioner back on by pressing the button again. The air flow in the rear will vary according to the settings selected at the front.

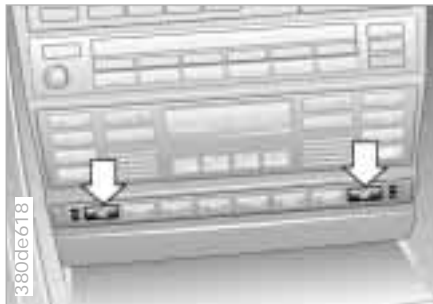

Rear seat heating*

The switches are located at the rear of the center console, beneath the air vents.

The seat cushion and backrest can be heated with ignition key in position 2.

You can call up different heating modes by repeatedly pressing the keys.

The highest heating mode is on when the three indicator lamps are lit; one lamp is lit for lowest heating. Temperature regulation in each mode is with a thermostat.

You can also switch the higher heating modes off directly:
Press the key and hold it slightly longer.



To activate and cancel the steering wheel heater, press button (arrow) with the ignition key in position 2.

The lamp within the button lights up when the steering wheel heater is in operation.

If you have a multi-function steering wheel without steering wheel heating, the button for the recirculated-air mode is in this location (refer to page [23](#)).

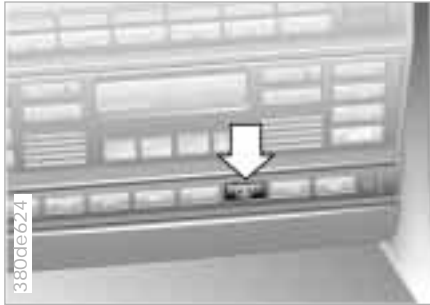

To actuate, press the button briefly after ignition key position 1.

Roller sun blinds for the rear side windows*

Use the strap to extract the blinds, then suspend them in the attachment provided.

This system uses the automatic climate control system blower to ventilate the passenger compartment and reduce interior temperatures while the vehicle is parked.

The independent ventilation system is operated via the Multi-Information Display (MID) or the onboard computer. Refer to the separate Owner's Manual.

You can preselect the activation time for a 30-minute ventilation cycle, or you can switch the system on and off manually with the ignition key at position 1. Since the system uses a substantial amount of electrical current, you should refrain from activating it twice in succession without allowing the battery to be recharged in normal operation between use.

When a preselected activation time is set, the independent ventilation system is operational at outside temperatures above 60°F (16°C), or by direct switch activation. It cannot be switched on when the vehicle is moving.

The air emerges via the vent outlets for the upper body. Therefore, the vents must be open for the system to operate.

The concept

The Integrated Universal Remote Control replaces up to three hand-held transmitters of different devices such as garage-door openers, alarm systems, or door locking systems. The Integrated Universal Remote Control recognizes and "learns" the transmitted signal of each of the original hand-held transmitters.

The signal of an original hand-held transmitter can be programmed on one of the three channel keys. Following that, each of the devices can be actuated with the appropriately-programmed channel key. Transmission of the signal is signaled by the indicator lamp. If the vehicle is sold, the memory of the channel keys should be cleared as described on page 110.

 During programming and before every remote actuation of a programmed device by the Integrated Universal Remote Control, check to be sure that there are no persons, animals or objects within the actuation range of the device in order to prevent possible injuries or damage. Also, comply with the safety precautions of the original hand-held transmitter. ◀



To Canadian residents: During programming, your hand-held transmitter may automatically stop transmitting after two seconds, which may not be long enough to program the BMW Universal Transmitter. If you are programming from one of these hand-held transmitters, the Universal Transmitter's light may begin to flash in a series of double-blinks. If this occurs, continue to hold the button on the Universal Transmitter while you reactivate your hand-held transmitter. You may have to repeat this function several times while programming. ◀



Before programming, read the "User information" section on page 110. ◀

Original hand-held transmitter

If this symbol is present on the packaging or in the instructions of the original hand-held transmitter, it may be assumed that this hand-held transmitter is compatible with the Integrated Universal Remote Control.

Checking for the conversion code

To determine whether the original hand-held transmitter is provided with a conversion-code system, you may either read the instructions for the original hand-held transmitter or program a channel key as described on page 109 (left-hand column under "Programming").

Then press and hold the programmed channel key of the Integrated Universal Remote Control. If the indicator lamp of the Integrated Universal Remote Control flashes for two seconds and then comes on steadily, the original hand-held transmitter is provided with a conversion-code system. With a conversion-code system, program the channel keys as described on page 109 (right-hand column under "Programming a hand-held transmitter with conversion code").



If you have additional questions, please consult your BMW center or call 1-800-355-3515. ◀



Programming

- 1 Channel keys
- 2 Indicator lamp
- 3 Receiver for programming

 Read and comply with the safety precautions on page 108. ◀

- 1 Ignition key position 2
- 2 For initial use: Press and hold both outside keys 1 until the indicator lamp 2 flashes, and then release them. The three channel keys are cleared



- 3 Hold the original hand-held transmitter toward the receiver 3 a maximum of 2 inches (5 cm) away
- 4 Press the transmission key of the original hand-held transmitters (arrow 2) and the desired channel key of the Integrated Universal Remote Control (arrow 1) simultaneously. Release both keys as soon as the indicator lamp flashes rapidly
- 5 To program other original hand-held transmitters, repeat steps 3 and 4.

The corresponding channel key is now programmed with the signal of the original hand-held transmitter.

Programming a hand-held transmitter with conversion code

 Read and comply with the safety precautions on page 108. ◀

When programming the Integrated Universal Remote Control, consult the instructions for the specific device. For using the Integrated Universal Remote Control with a conversion-code system, note the following supplemental programming instructions:

 A second person facilitates programming of the Integrated Universal Remote Control. ◀

- 1 Program the Integrated Universal Remote Control as described previously under "Programming"
- 2 Press and hold the programming key on the receiver of the device for approximately two seconds until the programming light on the device comes on
- 3 Press the desired channel key of the Integrated Universal Remote Control three times.

 If you have additional questions, please consult your BMW center. ◀

Clearing the channel keys

 Read and comply with the safety precautions on page 108. ◀

The memory of individual channel keys cannot be deleted. However, the three channel keys can be cleared together as follows:

- ▷ Press and hold both outside keys of the Integrated Universal Remote Control until the indicator lamp flashes, and then release them.

All of the channel keys are cleared.

User information

Do not use this BMW Universal Transmitter with any garage door opener that lacks safety "stop" and "reverse" features as required by federal safety standards (this includes any garage door opener model manufactured before April 1, 1982).

This device complies with Section 15 of the FCC Rules. Operation is subject to the following two conditions: As defined in the regulations, this device must not emit harmful interference, and must be shielded against interference from external sources to prevent unauthorized or inadvertent activation.

Glove compartment



To open

Pull the handle down. The lighting will be switched on.

It is also possible to swivel out the glove compartment after opening for improved driver access.

To close

Push the lid up after repositioning.

Glove compartment

To lock

Lock with a master key or manually press the small lever behind the glove compartment latch to the right.

 For example, if you turn over only your door and ignition keys for valet parking (refer to page 30), access to the glove compartment is not possible. ◀

 To prevent injury in the event of an accident, close the glove compartment immediately after use. ◀

Rechargeable flashlight

Located on the left-hand side of the glove compartment.

Features integral overload-protection, so it can be left in its holder continuously.

 Be sure that the flashlight is switched off when it is inserted into its holder. Failure to comply with this precaution could lead to overcharging and damage. ◀

Center armrests



Rear armrest

Pull the strap to fold down the armrest.

To open the storage compartment: Lift the button (arrow).

112 Center armrests



- 2 Actuation of the power rear window blind
- 3 Front passenger side shoulder support
- 4 Tandem telephone
- 5 Power adjustment, front passenger's seat
- 6 Seat memory for the front passenger

Multi-function armrest, rear*

In order to operate certain functions from the rear seat, corresponding controls are integrated into the center armrest.

Fold out the armrest and open the cover. Refer to "Rear armrest."

The illustration shows the maximum possible number of controls, corresponding to a full range of optional equipment. Refer to the descriptions of the individual accessories for additional details on the equipment options.

- 1 Multi-Information Display for operating the radio and onboard computer (with limited function range)



Front armrest

Press the button at the front for front/rear adjustment (arrow 1).

Press the side-mounted buttons for access to the storage compartments (arrows 2).

Additional storage areas

Front storage compartment on slanted surface of center console:

To open, press the recess at the top, press to close.

This storage area can be ordered with an optional CD or cassette holder.

Storage compartment on center console between the front seats:

To open, reach into the recess at the front and pull upward.

When a cellular phone is installed, a small storage compartment is provided on each side of the phone. Press side button to open.

A rotating coin holder is located on the right under the radio cover.

You will find additional storage compartments in all of the doors as well as on the backrests of the front seats.

Cup holder



There are holders for two beverage containers in a tray in the center console as well as in the face of the rear seat bench near the center seat position.

To open, press against the upper recess, apply pressure and slide back to close.

Cellular phones*



Handsfree system

On vehicles with a telephone hookup*, the handsfree speaker is positioned in the headliner.

For further information on the cellular phone, refer to the separate Owner's Manual.



To open

Press gently on the recess (arrow).

To extinguish a cigarette, tap off the ash and gently press the tip into the funnel.



To empty

Press button (arrow 1): You can now pull the ashtray upward for removal.



Rear

To open: Press the recess at the top.

To empty: Pull out the unit.

Cigarette lighter*



Push the lighter in (arrow 2). Remove as soon as the lighter jumps back out.

Cigarette lighter for rear passengers

At the rear of the center console.

Cigarette lighter socket

Suitable for attaching power supplies to hand-held lamps, car vacuum cleaners, etc., up to a rating of approximately 200 watts at 12 volts. Avoid damaging the socket due to inserting plugs of different shapes or sizes.



Hold or touch the hot cigarette lighter by the knob only. Holding or touching it in other areas could result in burns.

The cigarette lighter remains operational when the ignition key has been removed. For this reason, children should never be left in the car unattended. ◀

Rear foot rests*

115

You can detach the footrests to place them in any desired position within the footwell.

116 Ski bag*

Designed for safe, convenient transport of 3 to 4 pairs of skis.

The supplementary length provided by the ski sacks in combination with the space in the luggage compartment makes it possible to transport skis of up to 6.8 ft (2.10 m) in length. Because of the tapered shape of the ski bag, it can only accommodate two pairs of skis with a length of 6.8 feet (2.10 m).



Loading

Fold the center armrest completely out.

Detach the Velcro® strip holding the center cover in position and place it on the armrest.

Lower the center armrest

Gently raise the front of the armrest and press the two levers inward (arrows): The armrest drops down against the surface of the seat.



Before loading the ski bag, the center armrest must be completely lowered. ◀



Press the release button (arrow 1) to unlock the cover panel in the luggage compartment.

Press the detent levers (arrows 2) inward and fold the cover to the front.

Extend the ski bag between the front seats. The zipper provides convenient access to the inside of the bag, and can also be left open to promote drying.



From the inside of the luggage compartment, use the magnetic retainers to attach the cover panel to the underside of the rear parcel tray.

Please ensure that the skis are clean before loading them into the bag. Take care to avoid damage from sharp edges.



Secure the bag's contents by tightening down the strap at the buckle.

To store the ski bag, perform the above steps in reverse sequence. The center armrest automatically returns to its original position when you fold it back.



An unsecured ski bag could lead to loss of vehicle control and in case of an accident to personal injury. ◀



Securing the load

- ▷ Secure smaller, light pieces with the retaining straps or with a luggage compartment net or elastic straps (refer to page 39)
- ▷ For large, heavy pieces, see your BMW center for load-securing devices*. Lashing eyes are provided at the corners of the luggage compartment for attaching these load-securing devices (refer to the illustration).
- ▷ Comply with the information enclosed with the load-securing devices.



Always position and secure the load correctly, otherwise it can endanger the passengers in the event of braking, swerving or in a crash.

Do not exceed the permissible gross weight and the permissible axle loads (refer to page 196). If you do so, the operating safety of the vehicle is no longer ensured, and you are in violation of the law.

Do not stow heavy or hard objects in the passenger compartment unless they are properly secured. Improperly secured objects would be thrown around during braking and evasive maneuvers and endanger the occupants. ◀

Roof-mounted luggage rack*

A special luggage system is available as an option for your BMW. Please comply with the precautions included with the installation instructions.

Because roof racks raise the center of gravity of the car when loaded, they exercise a major effect on its handling and steering response.

You should therefore always remember not to exceed the approved roof weight, the approved gross vehicle weight or the axle weights when loading the rack. You will find the specifications under "Technical Data" on page 196.

Make sure that the load is not too heavy, and attempt to distribute it evenly. Always load the heaviest pieces first (on the bottom). Make sure there is sufficient space to raise the sliding/tilt sunroof.

Roof-mounted luggage rack*

Secure the roof luggage correctly and tightly to prevent it from shifting or being lost during driving (danger to following traffic).

Drive smoothly: Avoid sudden acceleration and braking maneuvers, corner gently.

The roof load increases aerodynamic resistance: Increased fuel consumption and additional stresses on the vehicle's body result from this.



Special operating instructions:

- Break-in procedure [122](#)
- Driving notes [123](#)
- Catalytic converter [124](#)
- Antilock Brake System (ABS) [125](#)
- Disc brakes [126](#)
- Brake system [128](#)
- Winter operation [128](#)
- Power steering [130](#)
- Level control system [130](#)
- Cellular phone [131](#)
- Radio reception [131](#)

Wheels and tires:

- Tire inflation pressure [132](#)
- Tire condition [132](#)
- Tire replacement [133](#)
- Tire rotation [133](#)
- Wheel and tire combinations [134](#)
- Winter tires [135](#)
- Snow chains [135](#)
- Approved wheel and tire specifications [136](#)

Under the hood:

- Hood [137](#)
- Engine compartment [138](#)
- Washer fluids [142](#)
- Washer nozzles [142](#)
- Engine oil [143](#)
- Coolant [146](#)
- Brake fluid [147](#)
- Oil for power steering/
Level control system [148](#)
- Vehicle Identification
Number [148](#)

Care and maintenance:

- The BMW Maintenance
System [149](#)
- Caring for your car [150](#)
- Airbags [156](#)
- Vehicle storage [156](#)

Laws and regulations:

- Technical modifications to the
vehicle [157](#)
- OBD connector [158](#)

Overview**Controls and features****Operation, care
and maintenance****Owner service procedures****Advanced technology****Technical data****Index**

To ensure that your vehicle provides maximum economy throughout a long service life, we request that you comply with the following:

Engine and differential

Up to 1,200 miles (2,000 km):

Drive at varying engine speeds and road speeds, but do not exceed 4500 rpm and/or 105 mph (170 km/h) during this initial period. Comply with the legal speed limit at all times.

Refrain from using full throttle and avoid pressing the accelerator beyond the kickdown point.

Once 1,200 miles (2,000 km) have elapsed, engine speeds and road speeds can gradually be increased.

You should also comply with these break-in procedures if the engine or differential is replaced later in the course of the vehicle service life.

Tires

Due to technical factors associated with their manufacture, tires do not achieve their full traction potential until an initial break-in period has elapsed.

Thus drive with extra care during the initial 200 miles (300 km).



When the vehicle is operated on wet or slushy roads, a wedge of water may form between the tire and the road surface. This phenomenon is referred to as aquaplaning, or hydroplaning, and can lead to partial or complete loss of traction, vehicle control and braking effectiveness. Reduce your speed on wet roads. ◀

Brake system

Approximately 300 miles (500 km) must elapse before the brake pads and rotors achieve the optimal pad-surface and wear patterns required for trouble-free operation and long service life later on.

To break-in the separate parking brake drums, apply the parking brake lightly when coasting to a standstill (at a traffic signal, for instance), provided that traffic conditions allow you to do so.

To avoid corrosion, repeat this procedure from time to time.



The brake lamps do not come on when the parking brake is applied. Vacuum for the brake system servo unit on your BMW is available only when the engine is running. When you move the car with the engine shut off – when towing, for instance – substantially higher levels of pedal force will be required to brake the vehicle. ◀

Driving notes



Brakes:

Do not drive with your foot resting on the brake pedal. Even light but consistent pedal pressure can lead to high temperatures, brake wear and possibly even brake failure.

Aquaplaning:

When driving on wet or slushy roads, reduce road speed. If you do not, a wedge of water can form between tires and road surface. This phenomenon is referred to as aquaplaning or hydroplaning. It is characterized by a partial or complete loss of contact between the tires and the road surface. The ultimate results are loss of steering and braking control.

Driving through water:

Do not drive through water more than 1 foot (30 cm) deep. In water of this depth, drive only at walking speed, otherwise damage to the engine, the electrical system and the transmission can occur.

Rear parcel tray:

Do not use the rear parcel tray to store heavy or bulky objects. They could pose a danger to the occupants during braking maneuvers.

Clothes hooks:

Hang items of clothing from the hooks so that they will not obstruct the driver's vision. In order to avoid personal injuries during braking maneuvers, do not hang heavy objects on the hooks. ◀

124 Catalytic converter

The catalytic converter reduces harmful exhaust emissions, and is designed for use with unleaded fuel only.

Even minute quantities of lead would be enough to permanently damage both the catalytic converter and the system's oxygen sensor.

To ensure efficient, trouble-free engine operation and avoid potential damage:

- ▷ Be sure to comply with the scheduled maintenance requirements
- ▷ Fill the fuel tank well before it is empty
- ▷ If you have problems starting the engine, use jumper cables (you cannot tow-start the vehicle with an automatic transmission)

- ▷ Avoid other situations in which the fuel is not burned, or burns incompletely, such as engaging the starter frequently or for extended periods, or repeated start attempts in which the engine does not start (stopping and restarting an engine which is running properly does not present a problem). Never let the engine run with any of the spark plug cables disconnected.



Be sure to comply with the instructions above to prevent unburned fuel from reaching the catalytic converter. Otherwise there is danger of overheating and damage to the catalytic converter.

Extreme temperatures occur at the catalytic converter on this and every catalyst-equipped vehicle. Heat shields are installed adjacent to some sections of the exhaust system. Never remove these shields; do not apply undercoating to their surfaces. When driving, standing at idle, and parking the vehicle, take care to avoid contact between the exhaust system and flammable materials (grass, hay, leaves, etc.). Such contact could lead to a fire, resulting in personal injury and property damage. ◀

The concept

ABS enhances active safety by helping to prevent the wheels from locking during brake applications. The reason:

Locked wheels are dangerous. When the front wheels slide, the driver loses steering control over the vehicle. Traction loss at the rear wheels can cause the rear end to break into an uncontrolled skid.

The system can achieve the shortest braking distances possible under most conditions (on straights and in curves, on asphalt, ice, wet road surfaces, etc.).

ABS is designed to meet two essential requirements during every brake application:

- ▷ To help provide vehicle stability
- ▷ To help maintain steering control and maneuverability – on all types of road surfaces (asphalt, concrete, mud, wet pavement, snow, ice).

Braking with ABS

The system becomes operative once the vehicle exceeds a speed of approx. 6 mph (10 km/h). The ABS is deactivated whenever the vehicle's speed drops back below approx. 4 mph (6 km/h). This means that the wheels can lock in the final phase of a panic stop – a factor of no significance in actual use.

If you are in a situation which requires full braking, you will exploit the full benefits of the ABS system if you apply maximum brake pressure ("panic stop").

Since the vehicle maintains steering responsiveness, you can avoid possible obstacles with a minimum of steering effort, despite the full brake application.

The ABS system closed-loop control circuit cycles in fractions of a second.

A pulsation at the brake pedal indicates to the driver that ABS is active, that is, that the vehicle is within its maximum braking range. In addition, a pulsation – a result of the control function cycles – indicates to the driver that vehicle speed should be reduced to adapt to road surface conditions when there is reduced traction and grip between tires and road surface (slippery road surface).

Always depress the brake pedal with constant pressure. Keep the brake pedal down. Do not pump the brakes.

In driving conditions where there is a loose upper surface together with a subsurface which provides better traction (on gravel or snow, for instance), or with snow chains, the braking distance may also be longer than when the wheels are locked. However, ABS continues to provide enhanced vehicle stability and steering response under these conditions.

Information for your safety

Not even ABS can suspend the laws of physics. ABS alone cannot prevent accidents when the brakes are applied without an adequate safety interval between vehicles, if the car is driven at an excessive rate of speed in curves, or if aquaplaning occurs. Responsibility for these types of situations remains in the hands (and at the feet) of the driver. You should never allow the added safety of ABS to lull you into a false sense of security, or mislead you into taking increased risks that could affect your own safety and that of others.



Do not make any modifications to the ABS system.

Service procedures on ABS are to be performed by authorized technicians only. ◀

In the event of a fault

If the ABS warning lamp in the instrument cluster comes on, refer to page 21. The brake system then reverts to conventional operation as on vehicles without ABS. However, have the brake

system checked by your BMW center as soon as possible. To prevent undetected defects and cumulative faults from adversely affecting the brake system, refer any problems to your authorized BMW center at the earliest opportunity.

**Disc brakes**

Disc brakes furnish optimum deceleration and braking control and greater fade resistance under heavy use.

When the vehicle is driven only occasionally, during extended periods when the vehicle is not used at all, and in operating conditions where brake applications are less frequent, there is an increased tendency for corrosion of the rotors and accumulation of contamination on the brake pads. This occurs because the minimal pressure which must be exerted by the pads to clean the rotors by brake applications is not reached.

If the brake rotors are corroded, they will tend to respond to braking with a pulsating effect which even extended application will fail to cure.



We recommend the use of original BMW brake pads and components, otherwise driving safety can be impaired. ◀

Disc brakes

Driving notes

While driving in wet conditions and in heavy rain, it is a good idea to apply light pressure to the brake pedal every few miles. Watch traffic conditions to ensure that this maneuver does not endanger other road users. The heat generated in this braking process helps dry the brake pads and rotors.

Maximum braking force is obtained while the wheels continue to rotate, peaking when the wheels remain on the verge of locking without actually doing so. ABS maintains this state automatically. If the ABS fails, you should revert to the staggered braking technique described below (refer to page 129).

Extended or steep mountain descents do not necessarily have to lead to reduced braking efficiency; downshift to a gear in which only minimal periodic brake applications are required - move the selector lever to the appropriate lower range.

You can continue to increase the braking effect of the engine by selecting a lower gear - you can select transmission ranges as low as position 2 for extreme conditions.

Should engine braking prove inadequate, you should still avoid extended, continuous braking. Instead of maintaining low to moderate pressure over an extended period of time, you should decelerate the vehicle by applying more substantial force on the pedal (watch for following traffic!) and then pausing before repeating the application. This staggered braking technique allows the brakes to cool in the intervals between active braking phases, preventing overheating and ensuring that full braking capacity remains available at all times.



Do not coast with the transmission selector lever in neutral. Do not drive with the engine shut off. The engine provides no braking effect when the transmission is in neutral, and there is no power-assist for braking or steering when the engine is shut off. Never allow floor mats, carpets or any other objects to protrude into the area around the accelerator and brake pedals and obstruct their movement. ◀

Dynamic Brake Control (DBC)*

If you apply the brakes rapidly, this system automatically produces the maximum braking force boost and thus helps to achieve the shortest possible braking distance during "panic stops." All of the benefits of the ABS system are exploited under these circumstances.

Do not reduce the pressure on the brake pedal for the duration of the brake application. When the brake pedal is released, the DBC is deactivated.



In the event of a malfunction, the warning lamp comes on with a yellow light. Conventional braking efficiency is available without limitations.

Have the system checked and repaired at your BMW center as soon as possible.



For "Information for your safety" covering the ABS system, refer to page 125. This information also generally applies for DBC. ◀

Brake fluid level

The warning lamp for the brake hydraulic system comes on or the message "Check Brake Fluid" appears in the Check Control:



The brake fluid level is too low in the reservoir. Refer to page [147](#).

If the brake fluid level is too low and brake pedal travel has become noticeably longer, there may be a defect in one of the brake system's hydraulic circuits.

The remaining circuit continues to provide adequate brake-system performance.



Proceed to the nearest authorized BMW center. Higher brake application pressure may be necessary under these conditions, and brake pedal travel may be significantly longer. Please remember to adapt your driving style accordingly. ◀

The warning lamp also comes on with the "Check Brake Pads" message in the Check Control.

Brake pads

The message "Check Brake Pads" appears in the Check Control:

The brake pads have reached their minimum pad thickness. Proceed to the nearest authorized BMW center as soon as possible to have the pads replaced.



We recommend the use of original BMW brake pads and components, otherwise driving safety can be impaired. ◀

Winter operation

The onset of winter is often accompanied by rapid changes in weather. Adaptations in driving style should be accompanied by preparations on the vehicle itself to ensure that your vehicle operation through the winter remains safe and trouble-free.

Coolant

Be sure that the coolant mixture is kept at the year-round ratio of 50:50 (water and antifreeze/corrosion protection). This mixture provides protection against freezing down to approx. -34°F (-37°C). Replace the coolant every four years.

Locks

BMW door lock deicer can be used to free the locks if they are frozen. This deicer also contains lubricant. After using deicer, treatment with BMW lock barrel grease is recommended.

Winter operation

Rubber seals and components

In order to prevent the weather-stripping from freezing, apply rubber treatment or a silicone spray to the seals on the doors, hood and luggage compartment lid.



A full range of car care products is available from your BMW center. ◀

Snow chains

BMW snow chains* can be fitted on both summer and winter tires in response to severe winter road conditions. Mount them in pairs on the rear wheels only, and be sure to comply with the manufacturer's safety instructions. Do not exceed a maximum speed of 30 mph (50 km/h). In this situation (snow chains mounted), deactivate the ASC+T or DSC*. Refer to page 92.

Starting off

When starting off in deep snow or when rocking the car to free it, we recommend that you switch the ASC+T or DSC* off. Refer to page 92.

Driving on low-traction road surfaces

Use smooth, gentle pressure to control the accelerator pedal. Avoid excessive engine speeds and shift to the next higher gear at an early point. Adapt your speed and driving style when approaching grades. Maintain an adequate distance between yourself and the car ahead.

Brakes

Winter road conditions substantially reduce the amount of traction available between the tires and the road surface; the resulting increases in braking distance are considerable and should be continually borne in mind.

ABS is intended to prevent the wheels from locking during brake applications, thus helping to maintain vehicle stability and steering response.

If the ABS does not respond in a critical braking situation and the wheels lock: Reduce the pressure on the brake pedal until the wheels just start to roll again while still maintaining enough force to continue braking. Following that, increase pedal pressure again. Reduce the pressure as the wheels lock, then reapply pressure, etc. This type of staggered braking will reduce the braking distance, and the vehicle still remains responsive to steering. You can then attempt to steer around hazards after you have reduced pressure on the brake pedal.



Do not shift down on slick road surfaces. Doing so could cause the rear wheels to lose traction and skid, which could result in the loss of vehicle control. ◀

Skid control

Release the accelerator pedal. Countersteer carefully and attempt to regain control of the vehicle.

Parking

Place the selector lever in position P (Park). Engage the parking brake when parking on hills and inclined surfaces. In order to prevent the parking brake linings from locking in the drum due to frost or corrosion, dry them by gently applying the parking brake as the vehicle is coming to a stop. Make sure that following traffic is not endangered.



The brake lamps do not come on when the parking brake is applied. ◀

Power steering

High steering effort:

Check the fluid level. Refer to page 148.

High steering effort during sudden transitions:

Consult your authorized BMW center immediately for an inspection.

Servotronic special*

If steering becomes lighter as speed increases:

Malfunction in the electronic control system. Have your BMW center inspect this system as soon as possible.



If the power steering fails, increased effort will be required to steer the vehicle. ◀

Level control system*

If the message "LEVEL CONTROL INACTIVE" appears in the Check Control, there is a malfunction in the level control system.

Stop and inspect the vehicle. If it is riding significantly lower in the rear than in the front, or if it is sitting at an incline (left rear compared to right rear), consult the nearest authorized BMW center. Drive with appropriate caution in the meantime. The vehicle has reduced ground clearance or driving comfort is noticeably reduced.

Even if the attitude of the vehicle is normal, you should consult the nearest authorized BMW center if the warning lamp indicates a system fault.

Cellular phone

Mobile communications systems (cellular phone, radio, etc.) are permitted with an output up to 10 watts only. Even these systems may trigger malfunctions in the operation of your vehicle if they are not specifically designed for use with the vehicle. BMW can neither test nor assume responsibility for every individual product being offered on the market. We recommend that you consult your BMW center before purchasing any device of this kind.

To ensure that your BMW continues to provide reliable and trouble-free operation, refrain from using a cellular phone or other radio device with an antenna located inside the passenger compartment. The antenna should always be mounted on the outside of the vehicle.



Before loading the vehicle on a car-carrier train or driving it through a car-wash, remove the antenna. ◀

Radio reception

The reception and sound quality obtained from mobile radios varies according to a variety of factors, including the broadcast range of the transmitter and the directional orientation of the antenna. Interference factors such as high-tension power lines, buildings and natural obstructions can all lead to unavoidable reception interference, regardless of how well the vehicle sound system is operating.

Climatic factors such as intense solar radiation, fog, rain and snow can also interfere with reception.

Cellular phones without official BMW approval can also generate interference. This phenomenon assumes the form of a low-pitched hum emanating from the speaker system.

Please refer to the supplementary operating instructions provided with your sound system for detailed information on its use.

Information for your safety

The factory-approved radial tires are matched to the car and have been selected to provide optimum safety and driving comfort on your car.

It is not merely the tire's service life, but also driving comfort and - above all else - driving safety which depend on the condition of the tires and the maintenance of the specified tire pressure.

Incorrect inflation pressure is a frequent cause of tire damage. They also influence the roadholding ability of your BMW.

 Check tire inflation pressures - including the spare tire - regularly, at least every two weeks and before beginning a longer trip. If this is not done, incorrect tire pressures can cause driving instability and tire damage, ultimately resulting in accidents. ◀

**Tire tread - tire damage**

Inspect your tires frequently for tread wear, signs of damage and for foreign objects lodged in the tread. Check the tread depth.

Tread depth should not be allowed to go below 0.12 in (3 mm), even though the legally specified minimum tread depth is only 0.063 in (1.6 mm). Wear indicators appear in the tread at 0.063 in (1.6 mm) to indicate that the legally permissible wear limit has been reached. Below 0.12 in (3 mm) tread depth, there is an increased risk of aquaplaning, even at relatively moderate speeds and with only small amounts of water on the road.

 Do not drive on a deflated (flat) tire. A flat tire greatly impairs steering and braking response, and can lead to complete loss of control over the vehicle.

Avoid overloading the vehicle so that the permitted load on the tires is not exceeded. Overloading can lead to overheating and increases the rate at which damage develops inside the tires. The ultimate result can assume the form of a sudden air loss.

Unusual vibrations encountered during normal vehicle operation can indicate tire failure or some other vehicle defect, as can variations in normal vehicle response, such as a pronounced tendency to pull to the left or right. Should this occur, respond by immediately reducing your speed and carefully proceeding to the nearest BMW center or professional tire center, or having the vehicle towed in to have it and its tires inspected.

Tire damage (up to and including blow-outs) can endanger the lives of both the vehicle occupants and other road users. ◀

Tire replacement

To maintain good handling and vehicle response, use only tires of a single tread configuration from a single manufacturer. BMW tests and approves wheel/tire combinations. Refer to page 136.



Do not use retreaded tires, since driving safety may be impaired by their use. This is due to the possible variations in casing structures and, in some cases, to their extreme age, which can lead to a decrease in their durability. ◀

Tire age

The date on which the tire was manufactured is indicated by the code on the sidewall:

DOT ... 178 means that the tires were manufactured in the 17th week of 1998.

BMW recommends the replacement of all tires when the tires are no more than 6 years old, even if a tire life of 10 years is possible.

Spare tires over 6 years old should be used only in case of emergency. Such a tire should be replaced by a new tire immediately, and should not be mounted together with new tires.

Tire rotation

Between the axles

The tread wear patterns at the front end differ from those at the rear - the actual patterns will vary according to individual driving conditions. In the interests of safety and maintaining optimal handling characteristics, tire rotation is not recommended.

If a proposed interaxle rotation of tires is based on economic considerations, one should consider whether the costs for the rotation are likely to be recaptured by any increase in the service life of the tires which might be realized. Rotation should always be carried out at short intervals, with a maximum of 3,000 miles (5,000 km). Consult your authorized BMW center for more information.

Should you decide to rotate the tires, it is essential to comply with the following:

Rotate tires on the same side only, since braking characteristics and road grip could otherwise be adversely affected.

Following rotation, correct the tire inflation pressure.



If different tire sizes are mounted on the front and rear axles (page 136), the tires may not be rotated from one axle to the other. ◀

The right choice

Use only tires approved by BMW. Refer to page 136.

Because of the high speeds this vehicle can reach, the use of specific tire brands, specifications and dimensions is mandatory. Consult any BMW center for details.

Comply with national, state, or provincial regulations.



The correct wheel-tire combination affects different systems such as ABS, ATC, ASC+T/DSC. The function of these systems is impaired if improper wheel-tire combinations are used.

For this reason, use only tires of the same brand and tread pattern. In the event of a flat tire if you have mounted winter tires, for example, remount the approved wheel-tire combination as soon as possible. ◀

Codes on tires and wheels

The tire codes will aid you in selecting the correct tire.

Codes on radial tires:

For example 235/60 R 16 100W

Nominal width in mm	_____		_____		_____		_____		_____
Aspect ratio in %	_____		_____		_____		_____		_____
Radial tire code	_____		_____		_____		_____		_____
Rim diameter in inches	_____		_____		_____		_____		_____
Load rating (not on ZR tires)	_____		_____		_____		_____		_____
Speed rating (before R on ZR tires)	_____		_____		_____		_____		_____

The speed rating indicates the approved maximum speed for the tire.

Summer tires:

S = up to 112 mph (180 km/h)
 T = up to 118 mph (190 km/h)
 H = up to 130 mph (210 km/h)
 V = up to 149 mph (240 km/h)
 W = up to 167 mph (270 km/h)
 ZR = over 149 mph (240 km/h)

Winter tires:

Q M+S = up to 100 mph (160 km/h)
 T M+S = up to 118 mph (190 km/h)
 H M+S = up to 130 mph (210 km/h)

Codes stamped on light-alloy wheels:

For example 71/2 J x 16 H 2

Rim width in inches	_____		_____		_____		_____		_____
Code letter for flange type	_____		_____		_____		_____		_____
Symbol for full-drop center rim	_____		_____		_____		_____		_____
Rim diameter in inches	_____		_____		_____		_____		_____
Hump on the 2 rim shoulders	_____		_____		_____		_____		_____

Protect valve inserts against dirt using screw-on valve stem caps. Dirt in the valves frequently leads to slow leaks.

Choosing the right tire

BMW recommends winter tires (M+S radial tires) for driving in adverse winter road conditions. While tires known as all-season tires (M+S designation) provide better winter traction than summer tires with load ratings H, V, W and ZR, they generally do not achieve the performance of winter tires.

In the interests of sure tracking and safe steering response at all four wheels, mount winter tires which are made by the same manufacturer and which have the same tread configuration.

Mount only winter tires which have been approved by BMW. Any BMW center will be glad to provide you with information on the best winter tires for your particular driving conditions.

Do not exceed specified maximum speeds



Never exceed the maximum speed for which the tires are rated.

Unprofessional attempts by laymen to service tires can lead to damage and accidents.

Have this work performed by skilled professionals only. Any BMW center has the required technical knowledge and the proper equipment and will be happy to assist you. ◀

Tire condition, tire pressure

Winter tires display a perceptible loss in their ability to cope with winter driving conditions once the tread wears to below 0.16 in (4 mm), and should thus be replaced.

Comply with the specified tire inflation pressures - and be sure to have the wheel and tire assemblies balanced every time you change the tires.

Storage

Store tires in a cool, dry place, away from light whenever possible. Protect the tires against contact with oil, grease and fuel.

Use narrow-link BMW snow chains on summer or winter tires only in pairs and only on the rear wheels. Comply with all manufacturer's safety precautions when mounting the chains.

136 Approved wheel and tire specifications

Tire specifications	Light-alloy wheel
All season tires	
235/60 R 16 100 H M+S	7.5Jx16 8Jx16
Summer tires	
235/60 R 16 100 W	7.5Jx16 8Jx16
245/55 R 16 100 W	8Jx16
235/50 ZR 18	8Jx18
Rear: 255/45 ZR 18	9Jx18 9.5Jx18
Winter tires (M+S)	
215/65 R 16 98 Q	7.5J x 16
235/60 R 16 100 Q	7.5Jx16 8Jx16
245/55 R 16 100 Q	8Jx16

Note the tire and wheel data in the official documents of the car. If sizes not approved by the manufacturer are mounted, an entry in the vehicle's documents may be necessary. Comply with local legislation.



The use of rims and wheel bolts that do not meet the specifications of the original factory-installed equipment will affect the safe operation of your vehicle and may cause an accident and personal injury. Never mix tires of different design, such as steel-belted radials with radial bias-belted or bias-ply tires, etc. Mixing tire types will adversely affect roadholding and can lead to loss of vehicle control. ◀



To unlock the hood

Pull the lever located at the lower left-hand side of the instrument panel.

 Do not work on your vehicle without appropriate skills. Switch off the engine and allow it to cool down before working in the engine compartment.

Always disconnect the battery before working on any electrical systems or equipment. Comply with all applicable instructions and warnings. Failure to work in an informed, professional manner when servicing components and materials constitutes a safety hazard for vehicle occupants and other road users. If you are not familiar with the guidelines, please have the operations performed by your authorized BMW center. ◀

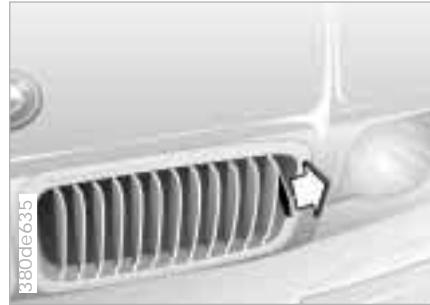

To open

Pull the release handle and open the hood.



To close

Press down lightly on the hood at the locations shown in the illustration (arrows) or drop it from approx. 4 inches (10 cm) so that it audibly engages.

 To avoid injuries, be sure that the travel path of the hood is clear when it is closed, as with all closing procedures. If it is determined that the hood is not completely closed while driving, stop immediately and close it securely. ◀

138 Engine compartment - BMW 740i/L

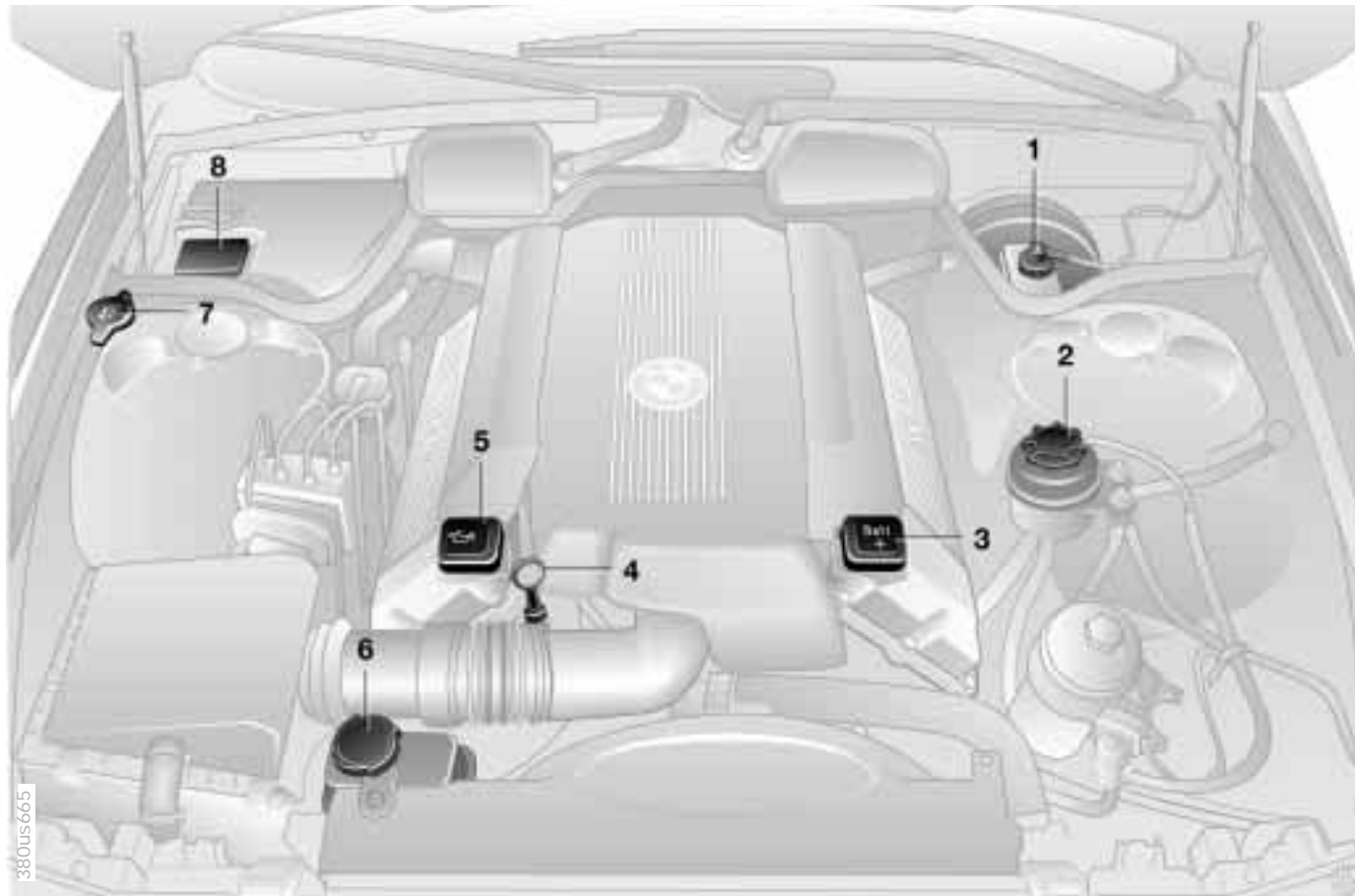

- 1 Brake fluid reservoir [147](#)
- 2 Power steering fluid reservoir/
Level control system [148](#)
- 3 Auxiliary terminal for jump
starting [179](#)
- 4 Engine oil dipstick [143](#)
- 5 Engine oil filler neck [143](#)
- 6 Coolant expansion tank [146](#)
- 7 Reservoir for headlamp
and windshield washer system [142](#)
- 8 Fuse box [176](#)

140 Engine compartment - BMW 750iL

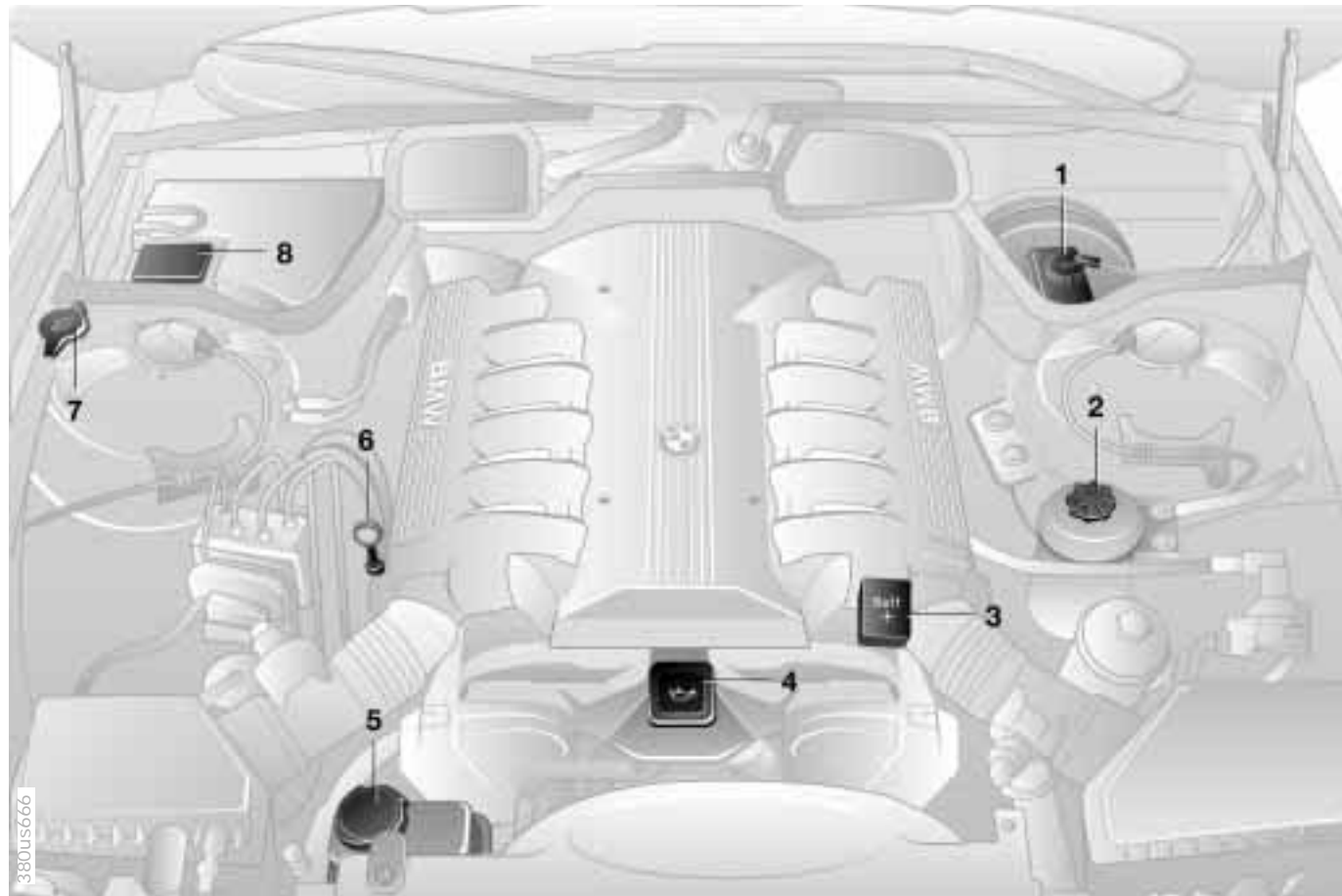

- 1 Brake fluid reservoir [147](#)
- 2 Power steering fluid reservoir/
Level control system [148](#)
- 3 Auxiliary terminal for jump
starting [179](#)
- 4 Engine oil filler neck [143](#)
- 5 Coolant expansion tank [146](#)
- 6 Engine oil dipstick [143](#)
- 7 Reservoir for headlamp
and windshield washer system [142](#)
- 8 Fuse box [176](#)



Headlamp* and windshield washer system

The filling capacity is approx. 4.7 US quarts (4.5 liters) for the windshield washer system or approx. 6.3 US quarts (6.0 liters) together with the headlamp washer system.

Fill with water and - when needed - with a washer antifreeze (according to manufacturer's recommendations).

 We recommend that you mix the washer fluid before adding it to the reservoir. ◀

 Antifreeze agents or intensive windshield cleaning agents for the washer systems are highly flammable. For this reason, keep them away from sources of flame and store them only in their original containers. Store them so that they are inaccessible to children. Comply with the instructions on the containers. ◀

Washer nozzles

Windshield washer

The spray from the nozzles should be directed so as to ensure effective cleaning, even at high speeds.

Use a needle to adjust the nozzles as required, or have them adjusted at your authorized BMW center.

Headlamp washer system

Have the nozzles adjusted by your BMW center as required.

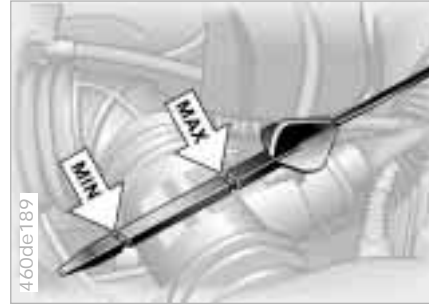

Checking the engine oil

- 1 Park the vehicle on a level surface
- 2 Shut the engine off after it has reached normal operating temperature
- 3 After approx. 5 minutes, pull the dipstick out and wipe it off with a clean lint-free cloth, paper towel, or similar material
- 4 Push the dipstick all the way into the guide tube and pull it out again
- 5 The oil level should be in between the two graduations on the dipstick.

As with fuel economy, oil consumption is directly influenced by your driving style and vehicle operating conditions.

The oil volume between the two marks on the dipstick corresponds to approx. 1.1 US quarts (1 liter). Do not fill to beyond the upper mark on the dipstick. Excess oil will damage the engine.

Adding engine oil

Wait until the level has dropped to just above the lower mark before adding oil. However, do not wait until the oil drops below the lower mark.

 BMW engines are designed to operate without oil additives. The use of additives could lead to damage in some cases. This is also true for the automatic transmission, the differential and the power steering system. ◀

Engine oil specifications

The quality of the engine oil selected has critical significance for the operation and service life of an engine. Based on extensive testing, BMW has approved only certain engine oils.

Use approved "longlife oils" only.

If it should ever occur that it is impossible to purchase an approved "longlife oil," you may use small volumes of the "special oils" approved by BMW for topping up between oil changes.

You may use oils with the specification API SH only if the special oils are also not available.



Call 1-800-831-1117, or ask your authorized BMW center for details concerning the specific "longlife oils" or "special oils" which have been approved. ◀

Viscosity ratings

Viscosity is the oil flow rating as established in SAE classes.

The selection of the correct SAE class depends on the climatic conditions in the area where you drive your BMW.

BMW recommends the use of oils in SAE classes SAE 0W-X or SAE 5W-X, where "X" stands for a specification such as 30, 40 or 50.

These oils may be used for driving in all ambient temperatures.

If you are using SAE class 10W-X, you may continue to drive for short periods at temperatures below this limit. However, the engine's cold-starting characteristics may be impaired.

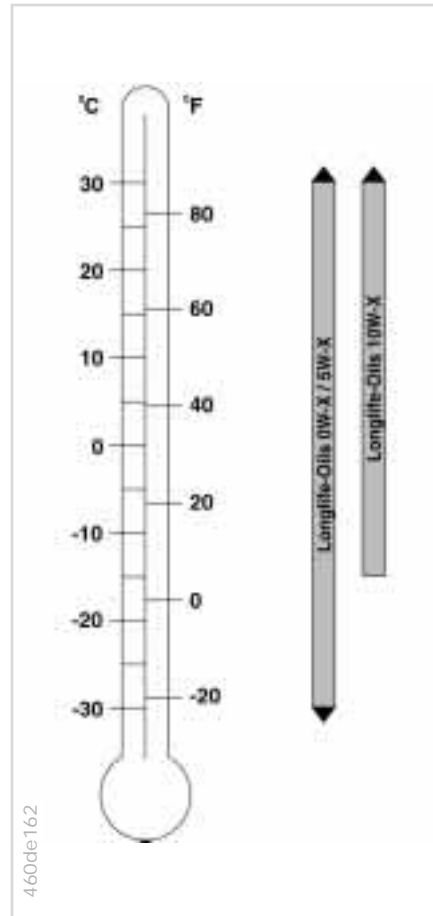

Engine oil



Comply with the applicable environmental laws regulating the disposal of used oil. ◀

Recommendation: Have the oil changed by your BMW center.



Continuous exposure to used oil has caused cancer in laboratory testing.

Any skin areas that come into contact with oil should therefore be thoroughly washed with soap and water.

Store oils, greases, and similar materials so that they are inaccessible to children. Comply with all warnings on the containers. ◀

 Do not add coolant to the cooling system when the engine is hot. Escaping coolant can cause burns. To avoid the possibility of damage later on, never use anything other than factory-approved, nitrite and amino-free extended-duty antifreeze with corrosion protectant. Your authorized BMW center is familiar with the official specifications.

Antifreeze and anti-corrosion agents are hazardous to health. Store antifreeze and anti-corrosion agents in their original containers where they are inaccessible to children.

Extended-duty antifreeze with corrosion inhibitor contains ethylene glycol - a flammable substance. For this reason, do not spill antifreeze with corrosion inhibitor on hot engine components. It could catch fire and cause serious burns. ◀

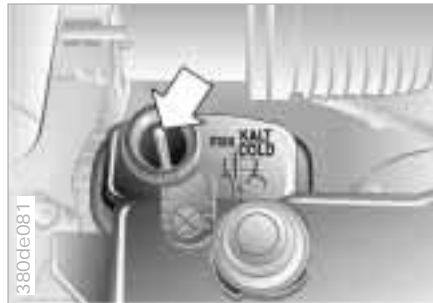

Correct coolant level when the engine is cold (approx. 68°F / 20°C):

Unscrew the cap from the expansion tank.

The coolant level is correct when the end of the red float is aligned with the upper edge of the filler opening (refer to the arrow in the illustration or the schematic diagram next to the cap).

The coolant is a mixture of water and extended-duty antifreeze with corrosion inhibitor. Always maintain the prescribed all-season 50:50 mixture ratio for year-round protection against internal corrosion. No other additives are required.

Replace the coolant every four years.

To add coolant

Wait until the engine cools before removing the cap from the expansion tank. The needle of the coolant temperature gauge in the instrument cluster must be located in the blue zone; otherwise, there is a danger of scalding.

- 1 Start by turning the cap counter-clockwise. Pause to allow any accumulated pressure to escape, then remove the cap
- 2 If the coolant is low, slowly add coolant until the correct level is reached - do not overfill.



Comply with the applicable environmental laws regulating the disposal of extended-duty antifreeze with corrosion inhibitor. ◀

Brake fluid



Brake fluid level



Brake hydraulic system warning lamp comes on, "Check brake fluid" appears in the Check Control display: The brake fluid level is too low in the reservoir.

Fill up to upper mark ("MAX" level visible through the transparent reservoir).

Any BMW center can provide you with information on factory-approved brake fluids (DOT 4).

Brake fluid loss results in extended pedal travel. Refer to the information on page [128](#).



Brake fluid is hygroscopic, that is, it absorbs moisture from the air over time.

In order to ensure the operating safety of the brake system, have the brake fluid changed every two years by your BMW center. Refer also to the Service Warranty Information Booklet (US models) or to the Warranty and Service Guide Booklet (Canadian models).

Brake fluid is toxic and damages the vehicle's paint. Always store brake fluid in the original containers. Keep the containers tightly closed and out of reach of children. Do not spill brake fluid. Do not fill beyond the "MAX" level in the reservoir. The brake fluid could ignite upon contact with hot engine parts and cause serious burns. ◀



Comply with the applicable environmental laws regulating the disposal of brake fluid. ◀



Power steering

With the engine off, unscrew the reservoir cap and remove the cap with dipstick. Then push the dipstick into the reservoir again.

The fluid level should be in between the marks on the dipstick.

Screw the reservoir cap back on.

Contact your BMW center if the fluid is low, as only ATF may be used and special knowledge is required for topping up.

Power steering/Level control system*

With the engine shut off, loosen the knurled nut and remove the reservoir cap.

With the vehicle empty, the fluid level should be barely 0.2 in (5 mm) above the screen bottom.

Correct the fluid level if required. Always use Pentosin CHF 11S.

Position the reservoir cap and tighten the knurled nut. Make sure the cover is properly seated.

In the engine compartment, stamped on the right-hand strut dome (arrow) and on the upper edge of the instrument panel on the left side.



The BMW Maintenance System has been designed as a reliable means of providing maximum driving and operating safety – and as cost-effectively as possible for you.

Please keep in mind that regular maintenance is not only necessary for the safety of your vehicle, but also plays a significant role in maintaining the resale value of the vehicle.

Service Interval Display

Advanced technology is employed to calculate the optimal maintenance intervals, which are then indicated in the Service Interval Display. While conventional systems rely on distance traveled alone to determine when service is due, the BMW Maintenance System has for years considered the actual conditions under which the vehicle operates.

From the point of view of maintenance, 62,000 miles (100,000 km) accumulated in short-distance urban driving are not the equivalent of the same distance covered at moderate speeds in long-distance highway travel. In response to this fact, the BMW Maintenance System monitors operating conditions as the basis for determining the optimum service intervals for your individual vehicle.

The BMW Maintenance System includes the Engine Oil Service and Inspections I and II.

Determining the maintenance intervals according to the actual loads on the car covers every kind of operating situation. However, even those who drive only short distances – significantly less than 6,200 miles (10,000 km) annually – should have the engine oil changed at least every 2 years since oil deteriorates over time, regardless of use.

Service and Warranty Information Booklet (US models)/Warranty and Service Guide Booklet (Canadian models)

Please refer to the Service and Warranty Information Booklet (US models) or to the Warranty and Service Guide Booklet (Canadian models) for additional information on maintenance intervals and procedures.

Depending upon operating conditions, as a precaution against rust it may be a good idea to have the body checked for stone damage and chips at the same time.

 Have your BMW center do the maintenance and repair. Your BMW center is always informed on the latest maintenance work and repair techniques and equipped with the required special tools. In addition, checking parts known from experience to be subject to wear is a permanent part of the maintenance specifications. Be sure that all maintenance work is confirmed in the Service and Warranty Information Booklet (US models) or in the Warranty and Service Guide Booklet (Canadian models). These entries will constitute your proof that the vehicle has received regular maintenance. They are also required in the event of a warranty claim. ◀

Washing your car

You can have your new BMW washed in an automatic car wash. Car wash systems that do not employ brushes are preferable.

Wipe away tough dirt and loosen and remove dead insects before washing the car.

To prevent spots, avoid washing when the hood is still warm, or immediately after and during exposure to strong sunlight.

When using an automatic car wash, be sure that:

- ▷ The car wash system is suited for the dimensions of your vehicle
- ▷ No damage will occur on vehicles with attached body accessories (such as spoilers or antennas). If you are uncertain, consult the manager of the car wash
- ▷ The wheels and tires of your vehicle cannot be damaged by the conveyance devices of the car wash system
- ▷ The vehicle is cleaned with minimum brush pressure, and that ample water is available for washing and rinsing.

Vehicles with rain sensor*:

Clean the windshield regularly. Wax from automatic car washes or insects, for example, can cause malfunctions in the function of the rain sensor.



Turn the rain sensor off in automatic car washes. If you do not, damage may occur if the wipers switch on unintentionally. ◀

Parts of the car which are inaccessible to the automatic washer - such as door sills, door and hood edges, etc. - should be cleaned by hand.

In the winter months, it is especially important to ensure that the car is washed on a regular basis. Large quantities of dirt and road salt are difficult to remove, and they also cause damage to the vehicle.



If spray wands or high-pressure washers are used, be sure to maintain an adequate distance between the spray source and the vehicle's surface.

Inadequate distance and excessive pressure can damage or weaken the finish, making it more susceptible to subsequent attack. In addition, moisture could penetrate to vehicle components, leading to long-term damage. ◀



When cleaning the headlamps, please observe the following:

- ▷ Do not clean by wiping with a dry cloth (scratches). Never use abrasives or strong solvents to clean the covers
- ▷ Remove dirt and contamination (such as insects) by soaking with BMW Car Shampoo and then rinsing with plenty of water
- ▷ Always use a deicer spray to remove accumulated ice and snow - never use a scraper. ◀



After washing the car, apply the brakes briefly to dry them. Braking efficiency might otherwise be reduced by the moisture, and the brake rotors could also be corroded. ◀

Caring for your car

Exterior finish

To provide effective corrosion protection, multilayer paintwork is applied at the factory. Cathaphoretic immersion priming techniques are supplemented using special body-cavity protectants, with the application of specially-developed and extensively tested materials. A layer of flexible PVC is first applied to the undercarriage. Following this, a comprehensive undercoating treatment with a wax-based protectant is applied. Regular maintenance makes an important contribution to maintaining the safety and value of your vehicle.

Increasing awareness of the effects of harmful environmental factors on a vehicle's exterior finish have led paint and vehicle manufacturers to initiate programs designed to further improve the durability of their finishes. Despite this, environmental factors that occur locally or regionally can have negative effects on the finish of your vehicle. These should guide you in determining the frequency and extent of your efforts to maintain the vehicle finish.

Depending upon material and type of impact (perforation of paint layer), physical stresses from sand, road salt, gravel, etc., can cause corrosion to start extending beneath the finish, starting at the point of impact.

Road dirt, tar spots, dead insects, animal droppings (strong alkali effect) and tree excretions (resins and pollen) all contain substances capable of causing damage when allowed to remain on the finish of your car for any period of time (spots, etching, flaking, separation in the top coat).

In industrial areas, deposits of flue dust, lime, oily soot, precipitation containing sulfur-dioxide (acid rain) and other environmental pollutants will damage the car's finish unless adequate care is provided – even though this is generally limited to the outside horizontal surfaces.

In coastal regions, high levels of atmospheric salt and humidity promote corrosion.

In tropical zones, temperatures of over 105°F (40°C) in the shade prevail, in addition to heavy ultraviolet radiation and high humidity. Under those circumstances, light exterior finishes reach temperatures of up to 175°F (80°C) and dark finishes up to 250°F (120°C).

Caring for the vehicle finish

Regular washing is a preventive measure against long-term effects from substances that are harmful to the vehicle's finish, especially if you drive your vehicle in areas with high levels of air pollution or aggressive natural substances (tree resins, pollen).

Nevertheless, you should immediately remove especially aggressive substances. Failure to do so can lead to changes in the paint's chemical structure or to discoloration. Gasoline spilled during refueling, oil, grease and brake fluid should always be cleaned away immediately, as should bird droppings. All of these substances cause damage to the finish.

Any contamination remaining on the surface of the vehicle will be especially conspicuous after washing. Use cleaning fluid or alcohol with a clean cloth or cotton pad to remove. Remove tar spots with tar remover. After cleaning, the affected areas should be waxed to ensure continued protection.



A full range of car-care products is available from your BMW center. ◀

Waxing your car

Protect the finish using carnauba or synthetic-based waxes only.

The best way to determine when the finish needs to be waxed is by noting when water stops beading on the surface.

You can use a glass cleaner to remove any wax or silicone that may have been left on the windows during waxing.



A full range of car-care products is available from your BMW center. ◀

Paint damage

You can touch up small areas of damage with BMW spray paint or a BMW touch-up stick.

The color code of your vehicle is located on a tag near the vehicle's data plate and on the first page of the Service and Warranty Information Booklet (US models) or of the Warranty and Service Guide Booklet (Canadian models).

Damage caused by flying stones, scratches, etc., must be touched up without delay to prevent rust from forming.

If corrosion has started to form in an area with paint damage, remove all rust and clean the area. Then prime the area with a BMW Primer Stick. Finally, apply the finish coat. Wait a few days, then polish the repaired area. Finish by applying a wax preservative.

More extensive paint damage should be repaired professionally in accordance with the manufacturer's instructions. Your BMW center uses original BMW finish materials in accordance with approved repair procedures.

Caring for your car

Window care

Water and dirt-repelling windshield (refer also to page 191).

The effectiveness of the coating is not impaired by the wax used in car washes or by windshield-washer additives.

Depending on the frequency of use of the windshield wipers as well as on environmental factors, the coating of the windshield is subject to natural wear.

As a result, the beneficial characteristics of the coating gradually diminish. After approx. 12,400 to 15,500 miles (approx. 20,000 to 25,000 km), the windshield begins to resemble more and more a standard windshield.

The coating can be renewed by your BMW center.

You can use window and glass cleaner to clean interior window surfaces and mirrors without streaking. Never use polishing pastes or abrasive (quartz) cleansers on mirror lenses.

Break-resistant security glass

The glass used for the side windows is designed to provide resistance to breakage and protection against vandalism. These break-resistant windows contain several layers of a transparent plastic film which is sandwiched between the inner and outer glass panes. There is also one additional plastic film on the inside of the glass pane (facing the passenger compartment). This film prevents shards of glass from spreading into the passenger compartment if the window is shattered.



Please observe the following precautions pertaining to this film when caring for the interior glass surfaces:

- ▷ The film is not scratch-resistant. For this reason, do not touch the glass with sharp objects which could damage the film
- ▷ Clean the glass with clean water. If necessary, you may also use regular household window cleaners. Wipe the cleaner off immediately. Do not use window cleaners containing solvents or abrasives. These cleaners can mar the film

- ▷ Do not apply any self-adhering decals, adhesive labels or other stickers with tape to the inner window surface
- ▷ Do not apply colored films to the inside surfaces of the side windows
- ▷ If the windows are fogged or iced over in cold or humid climates, do not use an ice scraper or ice-removing sprays to clean them. Start the engine and refer to the instructions for defrosting the door windows. ◀

Caring for other vehicle components and materials

Light-alloy wheels should be treated with alloy wheel cleaner, especially during the winter months. However, do not use aggressive products containing acids, strong alkalis or abrasives. Do not use steam cleaners operating at temperatures above 140°F (60 °C). Follow the manufacturer's instructions.

If your vehicle has chromed parts* such as window moldings, door handles or other parts, clean these parts especially carefully with ample clean water, especially if they have an accumulation of road salt. You may wish to add a car shampoo supplement to the water. Use a chrome polish for an additional treatment.

Plastic components, vinyl upholstery, headliners, lamp lenses, the clear cover of the instrument panel and components with a sprayed dull black surface can be cleaned with water (add plastic cleaner as required). Do not allow moisture to soak through the seats or headliner. Never use solvents such as lacquer thinner, heavy-duty grease remover, fuels, etc.

Rubber components should be cleaned with water only; a rubber treatment or silicone spray may also be applied.

Clean the wiper blades with soapy water. The wiper blades should be replaced twice a year, before and after the cold season.

 Use only wiper blades approved by BMW. ◀

The safety belts should be cleaned with a mild soap and water solution without being removed from the car. Never attempt chemical or dry cleaning, as damage to the belt fabric could result.

After cleaning, never allow the inertia reel to retract the belts until they are completely dry. Dirty safety belts prevent the inertia reel mechanism from retracting the strap properly, and thus constitute a safety hazard.

Heavily soiled floor carpets and mats* can be cleaned with an interior cleaner. The floor mats can be removed from the vehicle for cleaning.

Please use only a damp cloth to clean wooden fascia panels and components. Follow up by drying with a soft cloth.

 A full range of car-care products is available from your BMW center. ◀

Leather care

The leather upholstery used by BMW is a natural product of the highest quality, processed using state-of-the-art methods to ensure that it will maintain its high quality for years to come, provided that it is properly cared for.

Because this product is manufactured using natural materials, you must make allowance for its special characteristics as well as for the peculiarities of its use and care.

Regular periodic cleaning and care are essential, as dust and road dirt act as abrasives in the pores and creases of the material. This leads to wear spots and premature brittleness on the surface of the leather. We therefore suggest that you clean the leather with a vacuum cleaner or dust cloth at frequent intervals.

For cleaning, use BMW leather cleaning foam.

Caring for your car

Since dirt and grease gradually attack the protective layer of the leather, the cleaned surfaces should be treated with BMW leather care agent. This also acts as an antistatic agent.

For protection against dampness or moisture, treat the leather with a BMW impregnating agent.

We recommend that you perform this procedure twice a year on leather exposed to normal use.

Spills should be wiped up immediately. Remove grease and oil stains without rubbing by carefully dabbing with a cloth soaked in spot remover.

If the upholstery is to be exposed to intense sunlight or if the vehicle is to be stored for an extended period, cover all leather surfaces (or, better yet, the windows) to prevent fading.



Cleaning agents can contain substances that are dangerous or pose health risks. Therefore, always comply with the warnings and danger notices on the package.

Open the doors or windows on your vehicle when cleaning the interior. Never clean your vehicle with solvents or other materials not specifically intended for this application. ◀

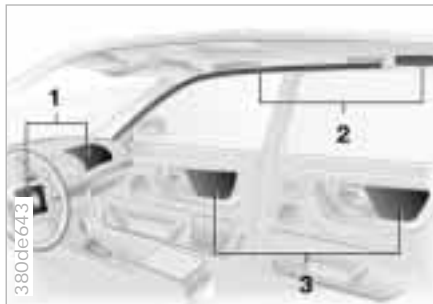

- 1 Front airbags for driver and front passenger
- 2 Side impact head protection system (front and rear*)
- 3 Side airbags (front and rear*)

Important safety notices

 Do not attempt to remove the gas generators of the airbag restraint system from the vehicle. Have testing and service procedures performed by specially-qualified technicians only. In the event of a malfunction, deactivation, or triggered actuation (as a response to an accident) of the airbag restraint system, consult your authorized BMW center for repairs or service operations.

Vehicle storage

Consult your BMW center regarding the required special procedures if you intend to store the vehicle for longer than three months.

Modifications may not be made on either the wiring or the individual components in the airbag system. These include the padded steering wheel hub, the instrument panel, the side trim panels of the front or rear doors and the roof pillars or the sides of the headliner. Never apply adhesive materials to these components or cover or modify them in any way. Do not attempt to remove or dismantle the steering wheel.

To ensure compliance with official safety regulations, entrust disposal of airbag generators to an authorized BMW center.

Unprofessional attempts to service the system could lead to failure in an emergency or undesired airbag activation, either of which could result in personal injury. ◀

Technical modifications to the vehicle

Any authorized BMW center will be glad to inform you of the advisability, legal requirements and factory recommendations with regard to technical modifications on the car. For this purpose, the BMW center requires the Vehicle Identification Number and, in some cases, also the engine number.



Do not remove the protective lens and avoid staring directly at the unfiltered beam for extended periods (several hours), as inflammation of the iris could result. ◀

Light-Emitting Diodes (LEDs)

Light-emitting diodes installed behind translucent lenses serve as the light source for many of the controls and displays in your vehicle. The concept behind their operation is related to that employed for lasers, and they are officially designated as Class 1 light-emitting diodes.

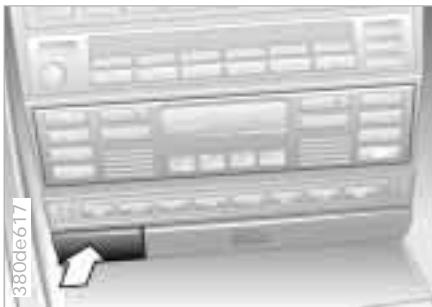

The interface socket for the onboard diagnosis system is located beneath a cover on the center console front panel (arrow).

A sticker with the text "OBD" is attached to the cover.

The purpose of the OBD (Onboard Diagnostic) system is to assure proper emission control system operation for the vehicle's lifetime by monitoring emission-related components and systems for deterioration and malfunction.



An illuminated indicator informs you of the need for service, not of the need to stop the vehicle.

However, the systems should be checked by your BMW center at the earliest possible opportunity.

Under certain conditions, the indicator will blink or flash. This indicates a rather severe level of engine misfire. When this occurs, you should reduce speed and consult the nearest BMW center as soon as possible. Severe engine misfire over only a short period of time can seriously damage emission control components, especially the catalytic converter.



When the filler cap is not properly tightened, the OBD system can detect the vapor leak and the indicator will light up. If the filler cap is subsequently tightened, the indicator should extinguish within a few days. ◀





Replacement procedures:

- Onboard tool kit [162](#)
- Windshield wiper blades [162](#)
- Lamps and bulbs [163](#)
- Remote control [168](#)
- Changing tires [170](#)
- Battery [173](#)
- Fuses [176](#)

In case of electrical malfunction:

- Fuel filler door [178](#)
- Sliding/Tilt sunroof [178](#)

Assistance, giving and receiving:

- Jump-starting [179](#)
- Towing the vehicle [180](#)

Overview

Controls and features

Operation, care and maintenance

Owner service procedures

Advanced technology

Technical data

Index



The onboard tool kit is located in the luggage compartment lid.

Loosen the wingnut to open.



- 1 To fold the wiper away from windshield:
Switch on the ignition.
Move the wiper lever to position 1 (intermittent wipe).
Switch the ignition off again when the wipers are stationary in the intermittent cycle – they will then move to a roughly vertical position
- 2 Fold the wiper arm completely out
- 3 Position the wiper blade at an angle and pull the release spring (arrow)
- 4 Fold the wiper blade down and unhook it toward the windshield
- 5 Pull the wiper blade past the wiper arm toward the top
- 6 Insert a new wiper blade and apply pressure until you hear it engage.



Use only wiper blades approved by BMW. ◀



Fold the wipers back down onto the windshield before you turn the ignition to position 1 or 2. ◀

Lamps and bulbs

The lamps and bulbs make essential contributions to the safety of your vehicle. Observe the following instructions during bulb replacement carefully. If you are not familiar with any of the procedures, consult your authorized BMW center.

 Do not touch the glass portion of a new bulb with your bare hands since even small amounts of impurities burn in to the surface, thus reducing the service life of the bulb. Use a clean cloth, paper napkin, or a similar material, or hold the bulb by its metallic base. ◀

A replacement bulb set is available from your BMW center.



Whenever working on the electrical system, switch off the electrical accessory you are working on or disconnect the cable from the negative terminal of the battery. Failure to do this could result in short circuits. To prevent injuries and damage, comply with any instructions provided by the bulb manufacturer. ◀



The illustration shows the left-hand side of the engine compartment.

Release the lamp cover.

- 1 Low beam headlamps
Press the tabs together (arrows).
- 2 Highbeams/side lamps and parking lamps
Insert the screwdriver (from the on-board tool kit) and press in the direction of the arrow.

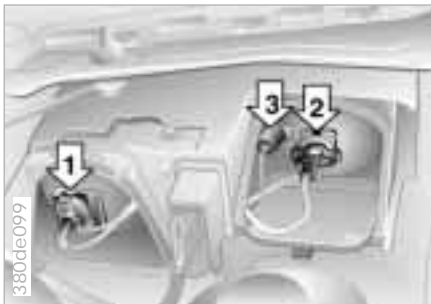

- 1 Remove the cover
- 2 Pull off the connector at the bulb
- 3 Detach the wire clamp
- 4 Replace the bulb
- 5 Install in the opposite order of work.

3 Parking lamp

5 watt bulb

- 1 Pull the bulb holder out
- 2 Remove and replace the bulb.

Xenon lamps*

The service life of these bulbs is very long and the probability of a failure is very low, provided that they are not switched on and off an unusual number of times. If one of these bulbs should nevertheless fail, it is possible to continue driving with great caution using the fog lamps, provided traffic laws in your area do not prohibit this.

 For checking and adjusting headlamp aim, please contact your BMW center. ◀

1 Low beam headlamps

H1 bulb, 55 watt

2 High beams

H7 bulb, 55 watt

 The H7 bulb is pressurized. Therefore, wear safety glasses and protective gloves. Failure to observe this precaution could lead to injury if the bulb is accidentally damaged during replacement. ◀

-  When cleaning the headlamps, please observe the following:
- ▷ Do not clean by wiping with a dry cloth (scratches). Never use abrasives or strong solvents to clean the covers
 - ▷ Remove dirt and contamination (such as insects) by soaking with BMW Car Shampoo and then rinsing with plenty of water
 - ▷ Always use a deicer spray to remove accumulated ice and snow – never use a scraper. ◀

 Because of the extremely high voltages involved, any work on the lighting system should be carried out by technically-qualified personnel only. Otherwise, there is a risk of fatal injury. ◀



Side turn signals

5 watt bulb

- 1 Use a screwdriver to pry out the lamp at the rear edge
- 2 Apply gentle pressure to the bulb while turning it to the left to remove.



Turn signals/Parking lamps (side marker lamps), front

Dual-filament bulb, 21 watt

- 1 Remove the assembly cover
- 2 Insert a Philips-head screwdriver (arrow) all the way in and loosen the screw (about four turns)
- 3 Remove the light assembly toward the front
- 4 Release and remove the bulb holder
- 5 Press gently on the bulb, turn it to the left and remove
- 6 When you have replaced the bulb, plug the light into the reliefs on the headlamp with the tabs. Push the assembly into place and tighten the screw
- 7 Secure the assembly cover.

Front fog lamps

H3 bulb, 55 watt

- 1 Use a screwdriver to release the fog lamp retainer (arrow)
- 2 Pull the fog lamp out toward the front
- 3 Release and remove the cover on the rear of the lamp assembly
- 4 Remove the plug
- 5 Detach the wire clamp
- 6 Replace the bulb
- 7 After replacing the bulb, guide the lamp assembly back into position. Continue pressing until you hear the detent snap into place.

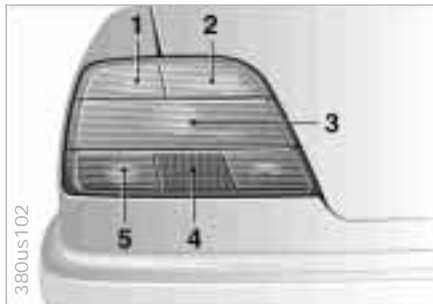

Tail lamps

Tail lamp: 5 watt bulbs

Remaining bulbs: 21 watt

- | | |
|--|--------|
| 1 Turn signal | yellow |
| 2 Backup lamp | white |
| 3 Rear lamp assembly/
Side marker lamps | red |
| 4 Reflector | red |
| 5 Brake lamp | red |

 In the event of a failure of both lamps of a rear lamp assembly, the brake lamp assumes the function of the tail lamps. ◀



- 1 Use the upper handle to fold down the side panel in the luggage compartment
- 2 Once you have found the lamp holder for the defective bulb, push it gently to the rear while turning to the left to remove
- 3 Use the same procedure to remove the bulb.

Center (high-mount) brake lamp

21 watt bulb

- 1 Open the luggage compartment lid
- 2 Remove the grommet from the lamp holder below the rear parcel tray
- 3 Press the lamp holder gently while turning to the left to remove
- 4 Use the same procedure to remove the bulb.



License plate lamps

5 watt bulb

- 1 Apply a screwdriver to the narrow side of the lamp to pry it out
- 2 Replace the bulb.

Interior lamps

Front:

Interior lamp (10 watt bulb) with reading lamps (10 watt bulbs)

- 1 Interior lamp: Use a screwdriver to press out the lamp sideways and remove the lens. Pull the bulb out of the contact studs
- 2 Reading lamp: Gently press against the lamp while turning it to the left to remove.

Rear:

Interior lamp (10 watt bulb) with reading lamp (5 watt bulb)

- 1 Use a screwdriver at the top of the recesses to press out the light
- 2 Interior lamp: Push the tab back on the reflector and change the bulb
- 3 Reading lamp: Gently press against the lamp while turning it to the left to remove.

Indirect lighting (1 watt bulb)

- 1 Unclip the lamp holder
- 2 Replace the bulb.

Footwell lamps

5 watt bulb

- 1 Use a screwdriver to remove the lens to the side
- 2 Replace the bulb.

Door warning lamps

5 watt bulb

- 1 Apply a screwdriver to the narrow side of the lamp to pry it out
- 2 Turn the bulb holder to the left to remove
- 3 Replace the bulb.

Door handle lamps

Please contact your BMW center in the case of a malfunction.

Glove compartment lamp

5 watt bulb

- 1 Apply a screwdriver to the recess to pry the lamp out
- 2 Remove the reflector
- 3 Replace the bulb.

Luggage compartment lamps

10 watt bulbs

Lamps on the underside of the package tray and in the luggage compartment lid:

- 1 Apply a screwdriver to the recess to pry the lamp out
- 2 Remove the reflector
- 3 Replace the bulb.



Changing battery

Replace the battery when the message "REMOTE KEY BATTERY" appears in the Check Control. The LED no longer lights up when a button is pressed and it is no longer possible to lock the car using the remote key.

Install only a battery of the type that is specified in the battery compartment (CR 2016). Be sure the battery is installed in the correct position.

- 1 Use a screwdriver to lift the cover at the recess (arrow)



- 2 Loosen the two screws (arrows) and remove the cover.

The battery type and its installation position are stamped into the base of the battery compartment.



Return used batteries to a recycling point or to your authorized BMW center. ◀



New transmitter

If you place a new transmitter into service (either a replacement or an additional transmitter), it must be initialized:

- 1 Enter the vehicle and close the driver's door
- 2 Briefly (max. 5 seconds) turn the ignition key to position 1 in the steering lock, then return it to position 0
- 3 Remove key; press and hold down button 1 (see illustration). Maintain pressure on button 1 while rapidly pressing button 2 three times in succession within a period of 10 seconds

Remote control

- 4 Release button 1, LED 3 will flash slowly for a maximum of 10 seconds
- 5 The central locking system activates and releases all lock mechanisms in rapid succession to indicate that the initialization procedure has been successfully completed.

If the LED does not flash or the central locking system fails to respond, you must repeat the initialization procedure.

If you possess additional transmitters for your vehicle (up to a maximum of four units), you must now initialize these as well. Be sure that no more than 30 seconds is allowed to elapse between the individual initialization procedures. Do not actuate the steering lock during this time.

In the event of a system malfunction, please contact your authorized BMW center, who can also provide you with replacement transmitters.



To prevent unauthorized use of the transmitter, surrender only the door and ignition key or the spare key (refer to page 30) for valet parking. ◀



Safety measures in the event of a flat tire or wheel change:

Stop the vehicle as far as possible from passing traffic. Park on a firm, flat, surface.

Switch on the hazard flashers.

Turn the steering wheel to the straight-ahead position, remove the key and engage the steering lock. Make sure that the selector lever is in Park, and engage the parking brake.

All passengers should be outside the car and well away from your immediate working area (for instance, behind a guardrail).

If a warning triangle or portable hazard warning lamp is available, set it up on the roadside at an appropriate distance from the rear of the vehicle.

Comply with all safety guidelines and regulations.

Change the wheel only on a level, firm surface which is not slippery. Avoid jacking the car on a soft or slippery support surface (snow, ice, loose gravel, etc.), since it could slide sideways.

Position the jack on a firm support surface.

Do not place wooden blocks or similar objects under the jack. If this is done, the jack might not be able to reach its full support capacity because of the limited height. Do not lie under the vehicle or start the engine when the vehicle is supported by the jack - risk of fatal injury. ◀

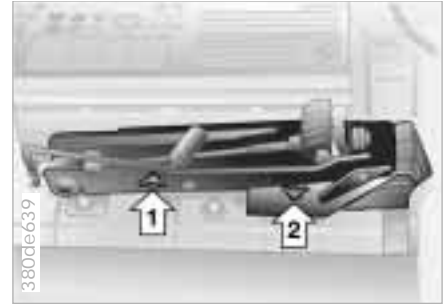

What you will need

In order to avoid rattling noises later, note the position of the tools when you remove them and return them to their original position when you are through using them.

- ▷ Car jack
 - Fold the right-hand trim panel of the luggage compartment down using the handle at the top.
 - Loosen the wing nut (arrow 1).
 - When you have completed work, screw the jack all the way back down. Fold the handle back and insert it in its holder.
- ▷ Wedge (wheel chock)
 - Next to the battery, under the jack.
 - Remove the jack and loosen the wing nut (arrow 2).



- ▷ Spare tire and adapter* for removal of the lug bolt cover*
Both are stored in the luggage compartment below the floor mat. Fold back the mat for access. Remove the adapter (arrow), unscrew the wing nut by hand and remove the wheel
- ▷ Wheel lug wrench, alignment tool and screwdriver are in the onboard tool kit on the underside of the luggage compartment lid (refer to page 162).

Procedure

- 1 Read carefully and comply with the safety precautions on the preceding page
- 2 Secure the vehicle against rolling: Place the wedge against the rear surface of the front tire on the side opposite the side being raised. If the vehicle is parked on a downward slope, place the wedge securely in front of the tire. If the wheel must be changed on a surface with a more severe slope, take additional precautions to secure the vehicle from rolling
- 3 If equipped with adapters*: Place the adapter on the lug bolt cover, position the lug wrench and press to the left (refer to the illustration)
- 4 Wheels with hub cover*: Pry the hub cover off with the screwdriver in the slot

- 5 Loosen lug bolts 1/2 turn
- 6 Position the jack at the jacking point closest to the flat tire (refer to the arrow on the sill trim) so that the jack base is vertically below the jacking point and the entire surface of the head of the jack will move into the square recess of the jacking point (refer to the illustration detail) when the jack is cranked
- 7 Jack the car up until the wheel you are changing is raised from the ground
- 8 Unscrew the lug bolts and remove the wheel
- 9 Remove accumulations of mud or dirt from the mounting surfaces of the wheel and hub; clean the lug bolts



- 10 Take the alignment tool from the onboard tool kit and insert it together with the plastic insert into one of the bolt sockets (arrow)
- 11 Position on the spare wheel. Secure it by screwing at least two lug bolts into opposite sockets. Remove the alignment tool
- 12 Screw in the remaining lug bolts. Tighten all the bolts securely
- 13 Lower the jack and remove it from beneath the car
- 14 Tighten the lug bolts, alternating between bolts positioned opposite one another
- 15 Wheels with hub covers: Position the hub cover and press on tightly

- 16 If equipped with lug bolt covers: Align the arrow on the cover with the line in the wheel and press the cover into place
- 17 Check and correct the air pressure as soon as possible.

 The vehicle jack is designed for changing tires only. Do not attempt to raise another vehicle model with it or to raise any load of any kind. To do so could cause accidents and personal injury. Have the lug bolts checked for proper tightness with a calibrated torque wrench at the earliest possibility (torque specification: 72 lb.ft./100 Nm). ◀

When storing the wheel, take care to ensure that you do not damage the retaining pin in the spare tire recess.

When light-alloy wheels other than Original BMW light-alloy wheels are fitted to the car, it may be necessary to use different lug bolts.

Replace the defective tire as soon as possible and have the new wheel/tire balanced.



Installation location, BMW 740i/L

The battery is located behind the right-side trim panel in the luggage compartment.

Grasp the handle in the upper panel and fold it down.



Installation location, BMW 750iL

Two batteries are installed in the BMW 750iL. They are located in the luggage compartment behind the right side trim panel.

 To check the charge condition or for removal or installation, please consult your BMW center. ◀

Symbols

You will find the following symbols on your car battery. To avoid injury, please observe the corresponding precautions whenever you work with or near the battery.



Please read the following information before working with the battery.



Wear eye protection. Do not allow particles containing battery acid or lead to come into contact with your eyes, your skin, or your clothing.



Battery acid is extremely corrosive. Wear eye protection and protective gloves. Do not tip the battery. Battery acid can leak from the ventilation openings.



Be sure that children keep well away from batteries and battery acid.



Never allow sparks or open flame, and do not smoke in the vicinity of the battery.

Avoid sparks from electrical cables or electrical equipment. Turn the key to position 0 in the steering lock when the battery is disconnected or connected.

Do not short circuit the battery terminals. This creates a risk of personal injury from high-voltage sparks.



A highly-explosive gas is generated when the battery is charged.



If you happen to get acid in your eyes, rinse thoroughly for 15 minutes with clear water.

Consult a physician immediately. If you get acid spray on your skin or clothing, rinse with plenty of water. If electrolyte is accidentally ingested, consult a physician immediately.



In order to protect the battery case from ultraviolet radiation, do not place it in direct sunlight.

A discharged battery can freeze. Store the battery in areas where temperature remains above freezing.

Car care

The battery is completely maintenance-free, that is, the original electrolyte will normally last for the service life of the battery.



Charge condition – BMW 740i/L

You can read the charge condition of the battery with the "Magic Eye" (a hydrometer) (not released at this time):

- ▷ Green: Adequate charge
- ▷ Black: Not charged adequately. The battery must be recharged. Please contact your BMW center
- ▷ Yellow: Replace the battery.

Charging the battery

Charge the battery in the vehicle only when the engine is off. Charge the battery using the supplementary positive terminal and ground (terminal) in the engine compartment (refer to "Jump-starting" on page 179).

On the BMW 750iL, there is an automatic switch between the two batteries during charging.



Before performing any work on the electrical system, disconnect the cable from the negative terminal. If you do not, short circuits can create the risk of fire or personal injury.

If a jump start is necessary, connect the cables only to the auxiliary terminal for jump starting and a ground in the engine compartment in order to avoid damage to the batteries (refer to "Jump-starting" on page 179). ◀

Battery

If you plan to store the vehicle for longer than 4 weeks, disconnect the battery from the vehicle electrical system by disconnecting the cable at the negative terminal.

If you intend to store your car for longer than six weeks: Remove the battery, charge it and store it in a cool (but frost-free) room. After a period not exceeding 6 months and before reinstalling the battery, have it recharged. If it is not recharged, it will not be serviceable. Every time the battery is discharged, especially over extended periods, its service life is reduced.

 Avoid environmental pollution when disposing of old batteries. ◀

 Return used batteries to a recycling point or to your authorized BMW center. Maintain the battery in an upright position for transport and storage. Secure the battery against tilting in transit. ◀

Removal and installation

 Do not disconnect the battery when the engine is running. Disconnecting the battery cable when the engine is running will cause a voltage surge that will damage the vehicle's on-board electronics.

Do not make any modifications in the wires to the positive terminal. If you do so, the protective function of the safety battery terminal is no longer ensured. Repairs and disposal may only be performed by specially-trained personnel. ◀

BMW 750iL: Please contact your authorized BMW center for additional information.



BMW 740i/L: When removing the battery, disconnect the negative terminal first, then the positive terminal.

Unscrew the battery retaining clamp (arrow).

When installing the battery, connect the positive terminal first, then connect the negative terminal.

 When installing a battery, be sure that it is mounted properly. If the battery is not mounted properly, it will not be adequately secured in case of an accident. ◀



If an electrical accessory should fail, switch it off and check the fuse.

In the engine compartment

- 1 Open the hood. Press the cover fasteners (arrows) forward and open the cover
- 2 Use the plastic tweezers (located on the inside of the cover) to remove the fuse for the accessory or equipment that has stopped working from its socket
- 3 If the fuse is burned through (the metal strip is melted and separated), replace it with a new fuse of the same ampere rating (color code).

A list of the fuses, their respective ampere ratings and the equipment in their circuits is provided next to the fuse box.

When you close the fuse box, be sure that the cover is seated securely.

Additional fuses are provided in the luggage compartment (refer to next column).

The fuse for continuous positive current is located in a separate fuse box above the battery. If this fuse is defective, refer the problem to your BMW center for repair.



Do not attempt to repair a burned fuse or replace it with a fuse having a different color or amperage rating. To do this could cause a fire in the vehicle resulting from a circuit overload. ◀

If the fuse fails repeatedly, refer the problem to your BMW center for repair.



In the luggage compartment

- 1 Fold down the right-hand trim panel with the upper handle
- 2 BMW 750iL: Unscrew the hexagon nut (arrow), lift the battery support up slightly and swing it inward together with the battery

- 3 Move the sound insulation material slightly to the side.

A list of the fuses, their respective amperage ratings and the equipment in their circuits is provided on the rear of the side trim.

**Manual release**

- 1 Use the handle to lower the trim panel on the right side of the luggage compartment
- 2 BMW 750iL: Unscrew the hexagon nut (arrow), lift the battery support up slightly and swing it inward together with the battery



- 3 Pull the knob with the fuel pump symbol.

**Manual operation**

- 1 Remove the interior lamp (refer to page 166). Reach into the opening and push out the panel
- 2 Remove the plug (arrow) and use the Allen wrench from the onboard tool kit (refer to page 162) to turn the sliding/tilt sunroof in the desired direction.

Jump-starting

Never use spray starter fluids to start the engine.

If the battery is discharged, you can use two jumper cables to start your car with power from the battery of a second vehicle. Always use jumper cables with fully insulated handles on the terminal clamps.

 Do not touch high-voltage wiring and cables on a running engine. There is a risk of fatal injury if you do this. ◀

Carefully comply with the following instructions to avoid personal injury and damage to one or both vehicles:

- 1 Ensure that the battery on the support vehicle is also rated at 12 volts, and that the capacities of the two batteries (Ah) are roughly comparable (printed on casing)
- 2 Leave your battery connected to the car electrical system
- 3 Make sure that there is no contact between the bodywork of the two vehicles – short circuit risk.



- 4 Start by connecting the jumper cable from the positive terminal of the support vehicle to the positive terminal connector located in your BMW's engine compartment. The cover of the auxiliary terminal for jump starting is marked with "Batt. +" (refer to the illustration). Remove by pulling tab. The illustration shows the auxiliary terminal for jump starting the BMW 740i/L as an example. For the BMW 750iL: Refer to "Engine compartment" on page [140](#)

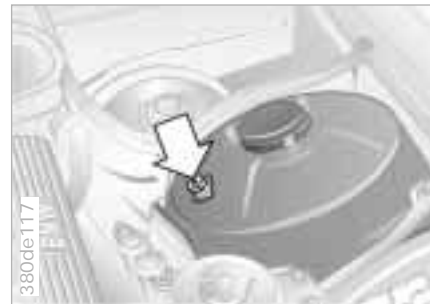

- 5 Then connect the negative terminals. Attach the cable to either the support vehicle's negative battery terminal, or to a suitable ground on its engine or bodywork. Then connect the other end of the cable to ground on the vehicle's engine or bodywork which is to be started. Then connect the other end of the cable to a ground on your vehicle's engine or bodywork (for instance, the nuts on the strut dome. Refer to the arrows in the illustration above)

 Follow the same sequence for connecting the jumper cables if you assist in jump-starting another vehicle. If you do not, there is a risk of injury caused by spark generation at the battery. ◀

- 6 If the battery of the support vehicle is weak, start its engine and let it run
- 7 Start the engine on the vehicle needing the jump-start, and allow it to run as usual. If the first start attempt is not successful, wait a few minutes before another attempt in order to allow the discharged battery to recharge
- 8 Before disconnecting the jumper cables from your BMW, turn on the rear window defroster and set the blower to the highest speed; allow the engine to run approx. 10 seconds. This will prevent a voltage surge from the voltage regulator to the electrical accessories
- 9 Then disconnect the jumper cables in reverse sequence.

Have the battery recharged if necessary.

Towing the vehicle



Tow fitting

The screw-in tow fitting is stored in the onboard tool kit; be sure that it remains in the vehicle at all times. This fitting is designed for installation in the tow sockets located at the front and rear of the vehicle, and is intended for towing on proper road surfaces only. It should not be used to pull a vehicle out of deep snow, mud, sand, etc. Always observe all applicable towing laws and regulations.

Access to tow sockets

Front:

Apply pressure to the arrow symbol on the cover panel to remove.

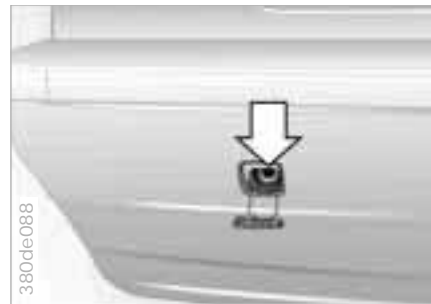

Rear:

Apply pressure to the arrow symbol on the cover panel to remove.



Screw the tow fitting in until it bottoms firmly. If this is not done, the threads could be damaged.

Do not tow the vehicle by any components of the running gear, or lash them down in any way. If you do so, the components could be damaged, leading to possible accidents. ◀

Use only a nylon towing strap to tow the vehicle, since the inherent resilience of this material helps protect both vehicles from sudden jerking movements.

Towing the vehicle

 The towed vehicle should always be the lighter of the two vehicles. If this is not the case, it is no longer possible to control vehicle response. ◀

Tow-starting

It is not possible to start the engine of vehicles equipped with automatic transmission by towing or pushing.

For instructions on jump starting, refer to page [179](#).

Never attempt to use your vehicle to push another car, as damage to the energy-absorbing bumpers could result.

Towing a vehicle with automatic transmission

- 1 Place selector lever in position N
- 2 Towing speed:
Max. 45 mph (70 km/h)
- 3 Towing distance:
Max. 95 miles (150 km)
- 4 Leave the ignition key at position 1 to ensure that the brake lamps, turn signals, horn and windshield wipers remain operative, and to prevent the steering lock detent from engaging
- 5 Switch on the hazard-warning system (observe country-specific regulations).

Find some means of identifying the vehicle in tow, for instance, place a sign or warning triangle in the rear window.

 Make sure that the ignition key remains in position 1 even when the electrical system has failed to prevent the steering lock from engaging. The steering and brakes are without power assist when the engine is off. This means that increased effort is required for steering and braking. ◀

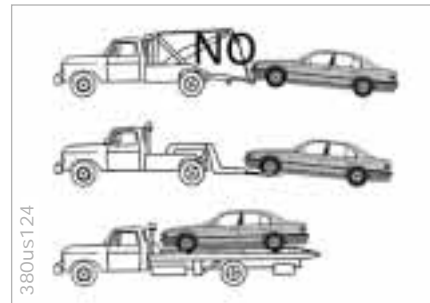

Towing with a commercial tow truck

- ▷ Do not tow with sling-type equipment
- ▷ Use a wheel lift or flat bed equipment
- ▷ Please comply with applicable towing laws.

 Never allow passengers to ride in a towed vehicle for any reason. ◀





Airbags [184](#)
Adaptive Transmission Control (ATC) [184](#)
Automatic Stability Control plus Traction (ASC+T)/Dynamic Stability Control (DSC) [185](#)
Radio reception [186](#)
BMW Active Seat [186](#)
Safety belt tensioner [187](#)
DSP sound system [187](#)
Rearview mirror with automatic dimmer [188](#)
Tire Pressure Control (RDC) [189](#)
Xenon lamps [190](#)
Water and dirt repelling windshield [191](#)

Overview

Controls and features

Operation, care and maintenance

Owner service procedures

Advanced technology

Technical data

Index



Deceleration sensors continuously monitor the physical forces acting upon the vehicle. In a severe frontal collision, the gas generators of the driver's airbag and the front passenger airbag are ignited. However, the passenger-side airbag is only triggered if an additional sensor has recognized that the passenger seat is occupied.

In the event of a severe side impact, the head protection and side airbags in the front and/or rear* are triggered.

The airbags located under the marked covers inflate and unfold in a matter of a few milliseconds. In this process they tear through the rated breaking points of the upholstered covers or press them out.

Because the inflation process must be virtually instantaneous, it is necessarily accompanied by a certain amount of ignition and inflation noise. The gas which the system employs to inflate the airbag is not dangerous, and the associated smoke is quickly dissipated.

The entire process is completed within fractions of a second.



On vehicles with automatic transmission Adaptive Transmission Control (ATC) uses a number of factors to calculate the maximally efficient gear. In this process it monitors your personal driving style, the situation in which you are driving, the condition of the road and the traffic conditions.

ATC recognizes your personal driving style from the positions and movements of the gas pedal, declaration when braking and lateral acceleration through curves. Four shift characteristics – from comfort-oriented to performance-oriented – are available for selection by ATC.

In order to take driving conditions into account, ATC registers corners and both uphill and downhill gradients. For example, if you maintain speed through a curve, the transmission does not up-shift.

On uphill gradients, it shifts only when the engine speed increases in order to make more efficient use of power reserves. On downhill gradients ATC downshifts when the speed of the vehicle increases causing the driver to step on the brakes.

With respect to road conditions, ATC monitors the friction between the tires and the road. The system responds to slippery road surfaces (snow and ice) by activating the winter program. Second gear is used when moving away from a standstill, upshifts occur sooner, and on descents downshifting does not occur in spite of the application of brakes. This enables you to "feel" the road as you drive and produces greater dynamic stability. If the friction between the tires and the road is adequate, the normal system is again activated. The system also leaves the winter program when you shift from drive position "D" to "S," "3" or "2," or if the ASC+T/DSC* is deactivated.

By recognizing traffic conditions, ATC can retain maximum driving comfort. For instance, the system recognizes stop-and-go traffic and then proceeds only in second gear until it encounters higher starting loads.

Of course the selector lever can still be used to select specific gear ratios. Performance-oriented driving is enabled by shifting from drive position "D" to "S," "3" or "2." Positions "3" and "2" each limit upshifts to the next gear. Position "2" is best for driving on steep mountain slopes with a heavy load.

Precision sensors monitor the number of revolutions of the wheels. When equipped with DSC, they also monitor steering angle, lateral acceleration, brake pressure and the movement of the vehicle around its vertical axis.

If differences in the wheel speeds occur, the system counteracts the danger of wheelspin by reducing torque. If necessary, the system also responds with additional applications of the brakes at the rear wheels.

If the system detects an instability in the vehicle's condition, the braking action can also be directed to the front wheels by the DSC in order to stabilize the vehicle.

You may need some time to become accustomed to this system intervention. However, it helps provide optimum propulsive force and driving stability.

The braking intervention may be accompanied by a certain degree of noise.

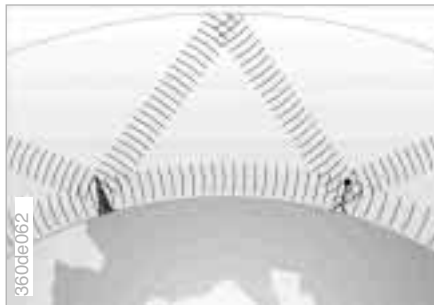

AM provides substantially longer reception ranges than FM. AM broadcast signals, propagated at ground level in the form of surface waves, are also reflected from the ionosphere as atmospheric waves.

Frequency-modulation (FM) provides substantially better sound quality than AM. However, because FM transmissions rely on line-of-sight broadcast waves, their effective reception range is limited.

Although numerous factors combine to impose inherent limitations on the reception quality available from mobile radios, specially designed systems can be employed to minimize their effects:

With radio stations which broadcast over multiple frequencies, the "Radio Data System" (RDS) ensures that the frequency with the best reception quality will automatically be selected.

The Diversity Antenna system employs several FM antennas integrated within the rear window to provide three separate sources for receiving broadcast waves. An integral processor automatically selects the antenna with the best FM reception quality at any given time. Because the ongoing antenna selection process is completed within milliseconds, it remains inaudible to the radio listener.

BMW Active Seat*



The Active Seat is an advanced development in BMW seats. These seats are engineered with orthopedic considerations so that you will be less fatigued during longer trips and sitting for long periods without moving. The seat is no longer a passive link between the road, the running gear, and the driver. Instead, by means of an active modification to the seat's surface, the seat causes weight transfers which are slight and imperceptible. The basic seating position is not changed by this. In the seat's upholstery, beneath the surface of the seat, there is a cushion of fluid on the left and right. The fluid is slowly circulated back and forth between the cushions by means of a pump.

BMW Active Seat*

This causes a movement of the spinal column which is barely detectable, together with an improvement in the flow of blood to the intervertebral disks and the muscle structure in the area of the spinal column.

The passengers do not suffer as much from muscle tension, back pain in the lumbar region or symptoms of fatigue. As a result, the Active Seat represents a significant contribution to driving comfort and driving safety.

Safety belt tensioner



The safety belt tensioner responds to collisions by tightening the belts to ensure that occupants remain firmly positioned in their seats. A gas-pressure system retracts the buckle assembly to tension the shoulder and lap belts within fractions of a second. This reduces the tendency to slide under the lap belt.

DSP sound system*

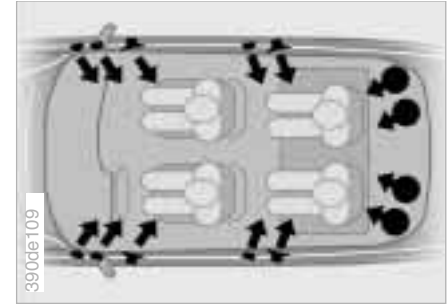

The DSP Professional premium sound system features a special amplifier combined with Digital Sound Processing (DSP) and integrated speakers to surround you with crisp, true-to-life sound reproduction.

The speaker system's subwoofers, woofers, midrange speakers and tweeters furnish you with an impressively full-bodied listening experience. The individual components are oriented so as to produce the aural sensation that you would experience facing the stage in a concert hall. The system also automatically adjusts the bass and treble settings to compensate for changes in volume and vehicle speed.

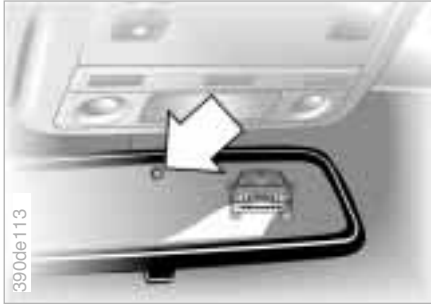

The semisolid reacts chemically to this electrical current, thus providing infinitely-variable dimming of the mirror (electrochromic technology).

As a result, it is no longer necessary to dim the mirror manually, and the driver can maintain full concentration on traffic.

The interior rearview mirror with automatic dimming feature reduces glare from following traffic by adapting the intensity of the reflected images to correspond to levels of light registered by the unit's sensors. The mirror reverts to its undimmed setting as soon as the light source disappears. One of these sensors is mounted on the front of the mirror housing and is designed to monitor light levels in the area immediately forward of the vehicle. The second sensor is integrated within the mirror's glass. The electronic control system operates by comparing the respective levels of luminous intensity in front of and behind the car. The difference provides the basic parameter used to modulate an electrical current and induce chemical changes in a semisolid layer incorporated in the lens.

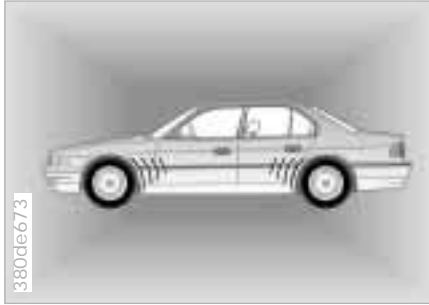

Near every wheel, there are antennas in the body which receive the signals from all four wheels. A central electronics system evaluates the quadruple signals which it receives and forwards any changes.

The RDC provides an important contribution to driving safety.

The Tire Pressure Control system assumes the task of regular tire pressure checks for you. Tire pressures are monitored at all four wheels, even when the vehicle is moving.

Behind the valve stem in every wheel, there is an electronic chip which is designed for severe-duty applications and long service life. It contains a pressure sensor, a transmitter and a battery. The pressure is measured in extremely short time intervals and then transmitted by a radio signal. If an irregularity is detected, the transmission rate is increased.

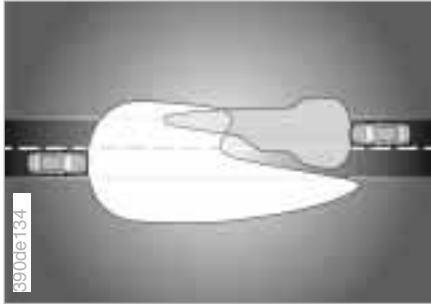

The xenon lamps light up the side and front areas of the vehicle with significantly more brightness and uniformity than the traditional halogen lamp.

In a xenon lamp, an electric arc replaces the filament in order to generate intense illumination. A gas mixture in a quartz piston with metal vapor is ignited by a high electric voltage. The arc that is generated is then sustained by a lower voltage. When the lamp is turned on there is a brief period of high intensity. Maximum brightness is attained in approx. 15 seconds.

Xenon lamps provide significantly-improved visibility, especially during adverse weather conditions and driving situations (driving at night in heavy rain or through road repair areas where there are no lanemarkers, for instance).

Vehicles with xenon lamps are equipped with automatic-dynamic headlamp range control. As a result, the highway is always optimally lighted, regardless of load conditions, and drivers in oncoming traffic are not blinded.

Xenon lamps make a significant contribution to highway safety since other highway users, bicyclists and motorcyclists in the right lane, and pedestrians are more easily detected.

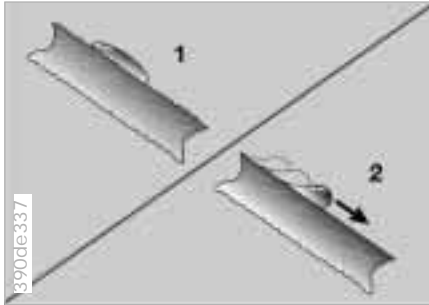

Additional benefits:

- ▷ Clear vision in adverse weather conditions, resulting in enhanced driving safety
- ▷ Less glare when driving in the rain at night.

With this windshield (not released at this time), a specially-smoothed surface causes water drops to bead up and run off, thus carrying particles of dirt with them.

Traditional windshields, even when they are in new condition, have a microscopically "rough" surface (1). The surface of the water and dirt repelling windshield is smoothed with a clear transparent fluid.

Depending on the cleanliness of the windshield, the water beads up and runs off at approx. 40 mph (60 km/h) as a result of the air flow (2). The coating has no negative effect on vision through the windshield because it is completely transparent.

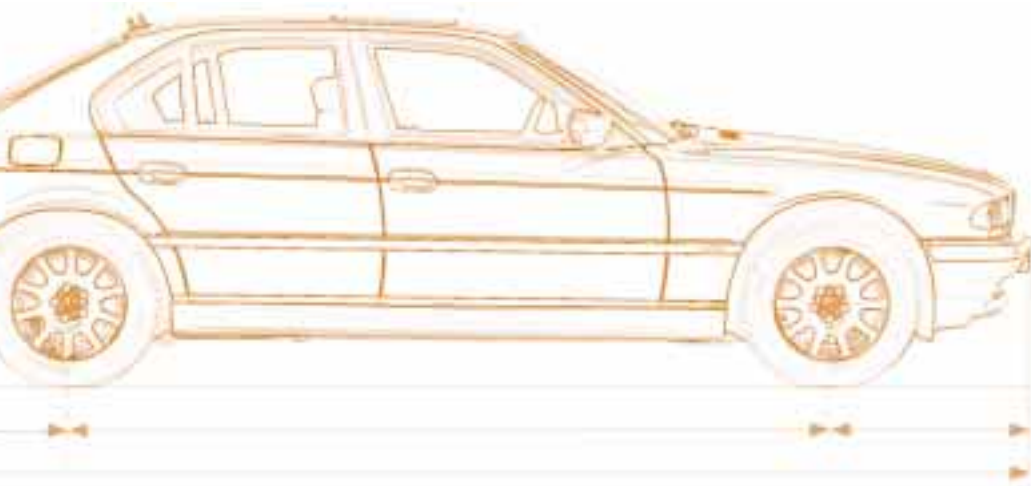

Engine specifications 194
 Dimensions 195
 Weights 196
 Capacities 197
 Electrical system 198
 Drive belts 198

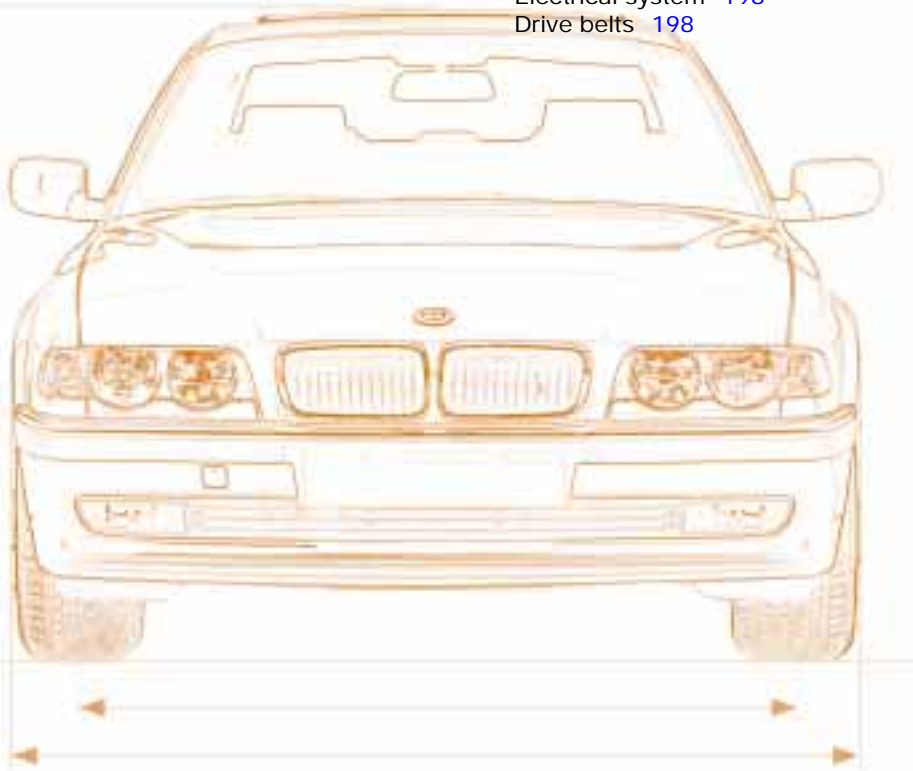

Overview

Controls and features

Operation, care
and maintenance

Owner service procedures

Advanced technology

Technical data

Index

Overview

Controls

Car care

Repairs

Technology

Data

Index

194 Engine specifications

		BMW 740i/L	BMW 750iL
Displacement	cu in (cm ³)	268.4 (4398)	328.2 (5379)
Number of cylinders		8	12
Max. output at engine speed	hp rpm	282 5700	326 5000
Maximum torque at engine speed	ft lb (Nm) rpm	310 (420) 3900	361 (490) 3900
Compression ratio	ϵ	10.0	10.0
Stroke/Bore	in (mm)	3.26/3.62 (82.7/92.0)	3.11/3.35 (79/85)
Fuel-injection system		Digital-electronic engine-management system	

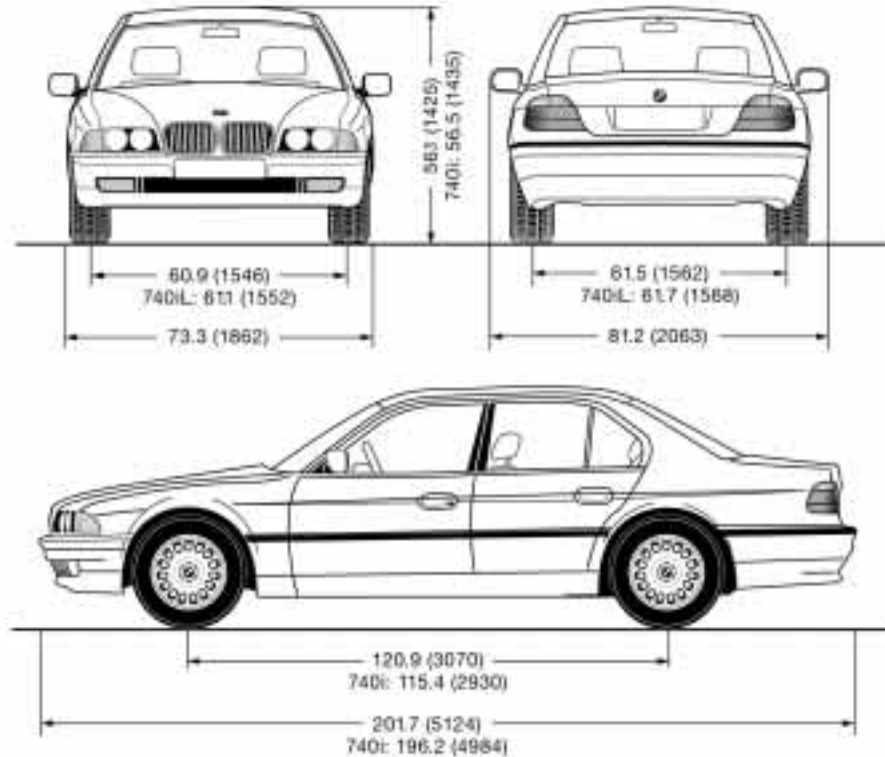

All dimensions are given in inches (mm).

Min. turning circle dia.: BMW 740iL/750iL 40.0 ft (12.2 m), BMW 740i 38.1 ft (11.6 m)

196 **Weights**

		BMW 740i	BMW 740iL	BMW 750iL
Curb weight (with driver, ready for operation, full tank of fuel, options not included)				
	lbs. (kg)	4255 (1930)	4289 (1945)	4549 (2065)
Approved gross vehicle weight	lbs. (kg)	5313 (2410)	5347 (2425)	5606 (2545)
Approved front axle weight	lbs. (kg)	2590 (1175)	2602 (1180)	2690 (1220)
Approved rear axle weight	lbs. (kg)	2910 (1320)	2933 (1330)	3040 (1380)
Maximum load capacity	lbs. (kg)	1058 (480)	1058 (480)	1058 (480)
Approved maximum roof load	lbs. (kg)	220 (100)	220 (100)	220 (100)
Permitted axle loads and permitted total vehicle weight may not be exceeded.				
Luggage compartment capacity	cu ft (liters)	17.7 (500)	17.7 (500)	17.7 (500)

				Notes
Fuel tank	gal. (liters)	approx. 22.5 (approx. 85) – BMW 740i/L approx. 25.1 (approx. 95) – BMW 750iL		Fuel specification: Refer to page 25
Reserve	gal. (liters)	approx. 2.6 (approx. 10.0) – BMW 740i/L approx. 3.2 (approx. 12.0) – BMW 750iL		
Windshield washer incl. headlamp-washing system	quarts (liters) quarts (liters)	approx. 4.7 (approx. 4.5) approx. 6.5 (approx. 6.0)		For details: Refer to page 128
Cooling system including heater circuit	quarts (liters)	13.2 (12.5) 13.7 (13.0)	– BMW 740i/L – BMW 750iL	For details: Refer to page 130
Engine oil and filter change	quarts (liters)	7.9 (7.5) 8.5 (8.0)	– BMW 740i/L – BMW 750iL	Approved HD oil for gasoline engines. Specifications: Refer to page 144
Automatic transmission	–	–		Lifetime fluid, no fluid change required
Differential	quarts (liters)	1.7 (1.6)		Approved hypoid gear oil (specifications are available from any BMW center)

Battery

BMW 740i/L: 12 V, 110 Ah

BMW 750iL: 12 V, 55 Ah
12 V, 110 Ah

Spark plugs

NGK BKR 6 EQUIP or

Bosch FGR 7 DQP

This spark ignition system meets all requirements of the Canadian Interference-Causing Equipment Regulations.

Drive belts

BMW 740i/L

Water pump – AC generator -
power steering
V-belt 7 K x 1635

A/C compressor
V-belt 5 K x 1004

BMW 750iL

AC generator – power steering
V-belt 7 K x 1045

Coolant pump – air conditioner
compressor
V-belt 6 K x 1190



You can obtain Original BMW Parts and Accessories, as well as professional advice from your authorized BMW center. ◀



Everything from A to Z [202](#)
Owner service procedures from
A to Z [207](#)

Initial overview

Controls and features

**Operation, care
and maintenance**

Owner service procedures

Advanced technology

Technical data

Index

Overview

Controls

Car care

Repairs

Technology

Data

Index

Everything from A to Z

A

ABS 125
Accessories 6
Activated-charcoal filter 105
Active seat 48
Adaptive Transmission Control (ATC) 63
Adding engine oil 143
Adding washer fluid 142
Adjust the backrest 46
Adjusting steering wheel 49
Air distribution 102
Air flow 103
Air jets 100
Air pressure 132
Airbags 55
Alarm system 40
 Deactivating in an emergency 41
Antenna diversity 186
Antifreeze 146
Antifreeze, radiator 128, 146
Antilock Brake System (ABS) 125
Anti-theft alarm system 32, 40
Approved gross vehicle weight 196
Aquaplaning 123, 132
Armrest 111
ASC+T (Automatic Stability Control plus Traction) 92

Ashtray 114
AUC (Automatic recirculated-air control) 103
Audio System 78
Automatic car washes 150
Automatic climate control 100
Automatic climate control, removing window condensation 102
Automatic recirculated-air control (AUC) 103
Automatic Soft-Close feature 38
Automatic Stability Control plus Traction (ASC+T) 92
Automatic steering wheel adjustment 49
Automatic transmission 62
Automatic transmission with Steptronic 65
Automatic windshield washer 69
Average fuel consumption 85
Average speed 86
Axle loads 196

B

Backup lamps, bulb replacement 166
Battery 173, 198
Battery capacity 198

Battery change, radio remote control 168
Battery charge current 20
Battery, discharged 179
Battery, removal and installation 175
Belts 54
Beverage holders 113
Blower 103
Body-cavity protectant 151
Brake faults 128
Brake fluid 147
Brake hydraulic system 20
Brake lamps, bulb replacement 166
Brakes 126
Break-in procedure 122
Break-resistant security glass, care 153
Bulb replacement 163

C

Car jack 170
Car Memory 53
Car radio reception 131, 186
Car telephone 113
Car wash 150
Care, exterior 152
Care, interior 154
Caring for the vehicle finish 152
Caring for your car 150

Catalytic converter 124
Cellular phone 131
Center (high-mount) brake lamp 166
Central locking system 32
Central locking system, button 36
Changing a wheel 170
Charge indicator lamp 20
Charging the battery 174
Check Control 75
CHECK key 75
Checking the engine oil 143
Checking tire pressure 26
Child restraints 57
Childproof door locks 58
Cigarette lighter 115
Clock,
 refer to Digital clock 79
Code 88
 Refer to the Radio Owner's Manual
Codes, tires 134
Coin tray 113
Cold start 60
Comfort seats 47
Connecting a car vacuum cleaner 115
Consumption display 73
Contour seat 48

Convenience operating mode for windows and sliding/tilt roof [32](#)
 Convenience operating mode for windows and sliding/tilt sunroof [33](#)
 Convenience starting [59](#)
 Coolant [146](#)
 Coolant temperature gauge [74](#)
 Coolant, antifreeze [128](#)
 Cooling system, capacity [197](#)
 Cruise control [70](#)
 Cruising range [85](#)

D

Daytime-driving light switch [96](#)
 DBC (Dynamic Brake Control) [127](#)
 Defrosting, windows [102](#)
 Digital clock [79](#)
 Digital sound processor [187](#)
 Dimensions [195](#)
 Dimming feature, interior rearview mirror [50](#)
 Dipstick, engine oil [143](#)
 Disc brakes [126](#)
 Disconnect the battery [175](#)
 Displacement [194](#)
 Displays [18](#)
 Distance [86](#)

Distance warning [90](#)
 Door key [30](#)
 Door warning lamps, bulb replacement [167](#)
 Doors, emergency release [32](#)
 Doors, radio remote control [33](#)
 Drink holders [113](#)
 Drive belts [198](#)
 Driving notes [123](#)
 DSC (Dynamic Stability Control) [92](#)
 Dynamic Brake Control (DBC) [127](#)
 Dynamic Stability Control (DSC) [92](#)

E

EDC (Electronic Damper Control) [93](#)
 Electric power windows [42](#)
 Electric rear seat adjustment [48](#)
 Electric steering wheel adjustment [49](#)
 Electrical accessories, failure [176](#)
 Electrical system [198](#)
 Electronic Damper Control (EDC) [93](#)
 Electronic immobilizer [31](#)

Emergency deactivation of the alarm system [41](#)
 Emergency release doors [32](#)
 fuel filler door [178](#)
 luggage compartment lid [37](#)
 sliding/tilt sunroof [178](#)
 Energy Control [73](#)
 Engine coolant [146](#)
 Engine data [194](#)
 Engine oil consumption [143](#)
 Engine oil pressure [20](#)
 Engine oil specifications [144](#)
 Estimated time of arrival [87](#)
 Exterior door handles, lighted [33](#)
 Exterior finish, care [151, 152](#)

F

Failure messages [75](#)
 First-aid kit [24](#)
 Fittings for tow-starting and towing [180](#)
 Flashlight [111](#)
 Flat tires [132](#)
 Fluid, power steering [148](#)
 Fog lamps [97](#)
 bulb replacement [165](#)
 switch [97](#)
 Footwell lamps [98](#)

Footwell lamps, bulb replacement [167](#)
 For wheelslip control, refer to ASC+T/DSC [92](#)
 Front armrest [112](#)
 Front seat adjustment [46](#)
 Fuel [25](#)
 Fuel consumption indicator [73](#)
 Fuel filler door [25](#)
 Fuel filler door, manual release after electrical fault [178](#)
 Fuel gauge [73](#)
 Fuel specifications [25](#)
 Fuel tank capacity [197](#)
 Fuel, average fuel consumption [85](#)
 Fuses [176](#)

G

Gasoline [25](#)
 Glove compartment [110](#)
 Glove compartment lamp, bulb replacement [167](#)
 Gross vehicle weight [196](#)

H

Hand brake, refer to Parking brake [61](#)
 Handsfree system [113](#)
 Hazard warning triangle [24](#)

Everything from A to Z

Headlamp flasher 68
Headlamp washer system 142
Headlamp washers 69
Heated seats 106
Heated steering wheel 106
Heating and ventilation 100
Heating during a stop 104
Height 195
HiFi system 187
High beam headlamps, bulb replacement 164
High beams 68
Hood release 137
Horn 23

I

Ice warning 72
Ignition key 30
Ignition switch 59
Independent ventilation system 107
Indicator lamps 20
Inflation pressures 26, 132
INSPECTION 74
Instrument cluster 18
Instrument lighting 96
Integrated Universal Remote Control 108
Interior door handles, lighted 36, 96
Interior lamps 32, 97

Interior lamps, bulb replacement 167
Interior lamps, radio remote control 34
Interior motion sensor 40
Interior rearview mirror, automatic dimming 50
Intermittent wipe switch 68

J

Jump starting 179

K

Key Memory 53
Keys 30
Kickdown 63, 66

L

Lashing eyes 39, 118
Leather care 154
Length 195
Level control system 148
License plate lamps, bulb replacement 166
Light switch 96
Lighted exterior door handles 32, 33
Lighted interior door handles 36, 96
LIGHTS ON warning 96
Limit 87
Loading 118

Load-securing devices 118
Locking and unlocking the doors 32
Locks, care 128
Low beam headlamps, bulb replacement 164
Low beams 96
Low-fuel warning lamp 73
Lug bolts 171
Luggage compartment 37, 39
Nets 39
Luggage compartment lamps, bulb replacement 167
Luggage compartment lid 37
Luggage compartment lid, Automatic Soft-Close 38
Luggage compartment lid, manual operation 37
Luggage compartment nets 39
Luggage compartment, emergency release 37
Luggage compartment, locking separately 37
Luggage compartment, radio remote control 34
Luggage rack 118
Luggage straps 39
Lumbar support 47

M

Maintenance 74, 149
Malfunction displays 75
Manually controlled recirculated-air 103
Master key 30
Memory 51, 53
MFL (Multi-function steering wheel) 23
Microfilter 105
MID (Multi-Information Display) 78
Mirror defrosting 50
Mirror memory 51
Mirrors 50
Modifications, technical 6, 157
Multi-function armrest 112
Multi-function steering wheel (MFL) 23
Multi-Information Display (MID) 78

N

New transmitter, radio remote control 168
Nozzles 100

O

OBD connector 158
Odometer 72
Oil additives 143

- Oil consumption [143](#)
 - Oil level check [143](#)
 - Oil pressure, indicator lamp [20](#)
 - Oil specifications [144](#)
 - Oil, Engine oil
 - Capacities [197](#)
 - OILSERVICE [74](#)
 - Onboard computer [84](#)
 - Onboard tool kit [162](#)
 - Opening the luggage compartment from the inside [38](#)
 - Outside mirrors [50](#)
 - Outside temperature display [72](#)
- P**
- Paint blemishes, exterior dirt [152](#)
 - Park Distance Control (PDC) [90](#)
 - Parking aid [90](#)
 - Parking brake [61](#)
 - Parking in winter [130](#)
 - PDC (Park Distance Control) [90](#)
 - Playing cassettes
 - Refer to the Radio Owner's Manual
 - Playing CDs
 - Refer to the Radio Owner's Manual
 - Pocket light [111](#)
 - Power seat adjustment [46](#)
 - Power steering [130](#)
 - Power steering fluid [148](#)
 - Power windows [42](#)
 - Pressure, tires [26](#), [132](#)
 - Pushbutton for central locking system [36](#)
- R**
- Radio
 - Car radio
 - Refer to the separate Owner's Manual
 - Radio reception [131](#), [186](#)
 - Radio remote control [33](#)
 - Radio remote control, battery change [168](#)
 - Radio remote control, new transmitter [168](#)
 - Rain sensor [68](#), [150](#)
 - RDC (Tire Pressure Control) [94](#)
 - Reading lamps [98](#)
 - Rear passenger-area air conditioning [105](#)
 - Rear seat adjustment, electric [48](#)
 - Rear seat heating [106](#)
 - Rear window blind [107](#)
 - Rear window defroster [70](#)
 - Rear-seat control
 - Front passenger's seat [112](#)
 - Onboard computer [112](#)
 - Radio [112](#)
 - Rear window blind [112](#)
 - Telephone [112](#)
 - Rearview mirrors [50](#)
 - Refueling [25](#)
 - Remote control for onboard computer [89](#)
 - Removing condensation, windows [102](#)
 - Replacement keys [30](#)
 - Replacing tires [133](#)
 - Residual heat [104](#)
 - Roof luggage rack [118](#)
 - Roof weight rating [196](#)
 - Rubber seals and components [154](#)
- S**
- Safety belt tensioner [187](#)
 - Safety belts [54](#)
 - Safety lock buttons [36](#)
 - Screw-on valve stem caps [134](#)
 - Seat adjustment [46](#)
 - Seat heating [106](#)
 - Seat memory [51](#)
 - Seat, power [46](#)
 - Securing cargo [118](#)
 - Selector lever, automatic transmission [62](#), [65](#)
 - Service and Warranty Information Booklet [149](#)
 - Service Interval Display [74](#), [149](#)
 - Servotronic [130](#)
 - Shoulder support [47](#)
 - Shutting off the engine [60](#)
 - Ski bag [116](#)
 - Skid control [130](#)
 - Sliding/Tilt sunroof [44](#)
 - Sliding/Tilt sunroof with glass moonroof [45](#)
 - Sliding/Tilt sunroof, closing after electrical fault [178](#)
 - Sliding/Tilt sunroof, convenience operating mode [32](#)
 - Sliding/Tilt sunroof, radio remote control [33](#)
 - Slippery roads [129](#)
 - Snow chains [129](#), [135](#)
 - Socket [115](#)
 - Spare key [30](#)
 - Spare tire [171](#)
 - Spark plugs [198](#)
 - Speaker [113](#)
 - Special oils [144](#)
 - Speed limit warning [87](#)
 - Speedometer [19](#)

Everything from A to Z

Starting assistance 179
Starting the engine 59
Steering 130
Steering lock 59
Steering wheel adjustment,
automatic 49
Steering wheel lock 59
Steering wheel memory 51
Steering wheel, heated 106
Steptronic 65
Stopping the vehicle 60
Storage facilities 113
Sun visors 51
Symbols 4, 173

T

Tachometer 72
Tail lamps 166
Tail lamps,
bulb replacement 166
Tank capacity 197
Technical modifications
6, 157
Telephone
Refer to Car telephone 131
Telephone hookup 113
Temperature adjustment 103
Temperature display, engine
coolant 74
Temperature display,
outside temperature 72
Third brake lamp 166

Tilt alarm 41
Tire code 134
Tire damage 132
Tire failure 170
Tire inflation pressure 26, 132
Tire Pressure Control
(RDC) 94
Tire replacement 133
Tire tread 132
Tires, specifications 136
Tools 162
Topping up the windshield/
washer fluid reservoir 142
Torque 194
Towing eyes 180
Towing the vehicle 180
Tow-starting 180
Track circle 195
Transmission 62, 65
Tread depth, tires 132
Trip odometer 72
Trunk lid, refer to luggage
compartment lid 37
Turn signal 22, 68
Turn signals, bulb
replacement 165, 166
Turning circle 195

U

Universal Remote
Control 108
Used batteries 175

V

Vanity mirrors 51
Vehicle battery 173
Vehicle identification 148
Vehicle Identification
Number 148
Vehicle storage 156
Ventilation outlet,
ventilation 100
Ventilation, draft-free 104
Voice input 23

W

Warning lamp "Please fasten
safety belts" 21
Warning lamps 20
Warnings 75
Washer system 68
Washing your car 150
Water on the roads
Flooding 123
Waxing, finish 152
Weights 196
Wheel lug wrench 171
Wheel rims 134
Wheelbase 195
Wheels and tires 134, 136
Width 195
Windows, convenience
operating mode 32
Windows, radio remote
control 33
Windows, demisting 102

Windshield washer
Reservoir capacity 197
Windshield washer nozzle
adjustment 142
Windshield wiper blades,
replacing 162
Windshield wipers 68
Windshield, defrosting 69
Winter operation 128
Winter tires 135
Wiper blades, replacing 162
Wipers 68
Work in the engine
compartment 137

X

Xenon lamps 96, 164, 190

- A**
 Adding brake fluid [147](#)
 Adding engine coolant [146](#)
 Adding engine oil [143](#)
 Adding fluid,
 power steering [148](#)
 Air pressure [26](#)
- B**
 Backup lamps, bulb
 replacement [166](#)
 Battery change, radio remote
 control [168](#)
 Battery, checking charge
 condition [174](#)
 Battery, discharged [179](#)
 Brake lamps, bulb
 replacement [166](#)
 Brakes, brake faults [128](#)
 Bulb replacement [163](#)
- C**
 Changing a wheel [170](#)
 Charging the battery [174](#)
 Check Control [75](#)
 Checking the engine oil [143](#)
 Checking tire pressure [26](#)
- D**
 Defrosting, windows [102](#)
 Difficult steering [130](#)
 Doors, manual operation [32](#)
- E**
 Electrical accessories,
 failure [176](#)
 Electrical fault
 fuel filler door [178](#)
 Sliding/Tilt sunroof [178](#)
 Emergency release
 Doors [32](#)
 Fuel filler door [178](#)
 Luggage compartment
 lid [37](#)
 Sliding/Tilt sunroof [178](#)
 Engine oil specifications [144](#)
- F**
 Failure messages [75](#)
 Filling the windshield washer
 fluid reservoir [142](#)
 First-aid kit [24](#)
 Fittings, tow-starting and
 towing [180](#)
 Fog lamp,
 replace the bulb [165](#)
 Footwell lamps, bulb
 replacement [167](#)
- G**
 Fuel filler door,
 manual release after
 electrical fault [178](#)
 Fuses, replacing [176](#)
- H**
 Hazard warning flashers [24](#)
 Hazard warning triangle [24](#)
 High beam headlamps, bulb
 replacement [164](#), [165](#)
 Hood release [137](#)
- I**
 Indicator lamps [20](#)
 Interior lamps, bulb
 replacement [167](#)
 Interior motion sensor,
 deactivation [41](#)
- J**
 Jump starting [179](#)
- L**
 License plate lamps, bulb
 replacement [166](#)
 Low beam headlamps, bulb
 replacement [164](#)
- M**
 Luggage compartment
 lamps, bulb
 replacement [167](#)
 Luggage compartment lid,
 emergency release [37](#)
- M**
 Maintenance [74](#), [149](#)
 Malfunction displays [75](#)
- N**
 New transmitter, radio re-
 mote control [168](#)
- O**
 Oil level check [143](#)
 Oil specifications [144](#)
 Onboard tool kit [162](#)
- P**
 Power steering,
 adding fluid [148](#)
 Pressure, tires [26](#)
- R**
 Radio remote control,
 battery change [168](#)
 Radio remote control,
 new transmitter [168](#)
 Rear lamp assembly [166](#)
 Removing condensation,
 windows [102](#)

Owner service procedures from A to Z

S

- Security glass, care [153](#)
- Sliding/tilt sunroof, closing
after electrical fault [178](#)
- Sliding/tilt sunroof, power
supply interruption [45](#)
- Snow chains [135](#)
- Spare tire [171](#)
- Starting assistance [179](#)
- Starting problems
[59](#), [124](#), [179](#), [180](#)

T

- Tail lamps, bulb
replacement [166](#)
- Tilt sensor alarm system,
deactivation [41](#)
- Tire damage [132](#)
- Tire failure [170](#)
- Tire inflation pressure [26](#)
- Tools [162](#)
- Towing [180](#)
- Towing eyes [180](#)
- Tow-starting [180](#)
- Turn signal,
replace the bulb [165](#)

U

- Use of antifreeze,
radiator [146](#)

W

- Warning lamps [20](#)
- Warnings [75](#)
- Washer fluid reservoir,
filling [142](#)
- Wheel change [170](#)
- Windows, demisting [102](#)
- Windshield washer nozzle
adjustment [142](#)
- Wiper blades, replacing [162](#)
- Work in the engine
compartment [137](#)

Refueling

So that you will have important specifications available when you stop to refuel, we recommend that you supplement this table with data which apply to your vehicle.

Fuel

For a description, refer to page [25](#)

Designation	
AKI: Minimum	
AKI: For rated performance	
AKI: For enhanced performance	

Engine oil

For a description, refer to page [144](#)

Quality	
---------	--

The space between the two marks on the dipstick corresponds to approx. 1.1 US quarts (1 liter).

Tire inflation pressures

For a description, refer to page [26](#)

	Summer		Winter	
	Front	Rear	Front	Rear
4 persons				
5 persons or 4 plus luggage				

**We wish you an enjoyable
driving experience.**



The Ultimate Driving Machine