



**Owner's manual**  
**ID.4**  
Edition 10.2020



Owner's manual  
ID.4  
V1, R1, en\_GB  
Print status: 12.06.2020  
English: 2020.10  
Teile-Nr.: 11A012720AB



11A012720AB

ID.4 Owner's manual

The image shows a template for a vehicle data sticker, divided into four numbered sections:

- Section 1:** Vehicle identification number (VIN). It consists of a long horizontal row of 17 boxes, with a small gap between the 10th and 11th boxes.
- Section 2:** Vehicle type, engine power, gearbox type. It consists of two rows of 17 boxes each.
- Section 3:** Engine code, gearbox code, paint number, interior equipment. It consists of two rows of boxes, with varying lengths for each field.
- Section 4:** Optional extras, PR numbers. It consists of seven rows of 17 boxes each.

At the bottom right of the sticker template, there is a small reference code: **81T-0607**.

**Fig. 1** Vehicle data sticker. 1: Vehicle identification number; 2: Vehicle type, engine power, gearbox type; 3: Engine code, gearbox code, paint number, interior equipment; 4: Optional extras, PR numbers

<p><b>Pre-delivery inspection carried out on:</b></p>	<p><b>Date of delivery / first registration (whichever comes first):</b></p>
<p>Volkswagen dealership stamp</p>	<p>Volkswagen dealership stamp</p>

Volkswagen AG works continuously to develop and further improve all vehicle types and models. Please understand that we must therefore reserve the right to alter any part of the vehicle and its equipment or technical specifications at any time. The data provided concerning scope of delivery, appearance, performance, dimensions, weights, standards and vehicle functions are all correct at the time of going to print. Some of the equipment and functions described might not yet be available or may be available only in certain countries. Information about this is available from your local Volkswagen dealership.

The vehicle illustrated on the cover may have certain items of optional equipment which

are only available at extra cost, or which are only available in certain markets. Your Volkswagen dealership will be able to inform you about variations in different countries. Subject to alteration and amendment. No legal commitment may be inferred from the information, illustrations or descriptions in this manual.

No part of this manual may be reprinted, reproduced or translated without the written permission of Volkswagen AG.

All rights under the laws of copyright are expressly reserved by Volkswagen AG. Subject to alteration and amendment.

© 2020 Volkswagen AG

## Thank you for choosing Volkswagen

By purchasing this Volkswagen, you have become the owner of a vehicle fitted with the most up-to-date technology and a multitude of convenience functions for your use and enjoyment.

**Before using your vehicle for the first time, please read and observe the information in this owner's manual. It will quickly help you to become familiar with your vehicle and all of its functions as well as making you aware of dangers to yourself and others and of how these dangers can be avoided.**

If you have any further questions about your vehicle, or if you think that the vehicle wallet has not covered everything, please get in touch with your Volkswagen dealership. They will always be happy to deal with your questions, suggestions or problems.

We hope you enjoy driving your new vehicle. Happy motoring.



### WARNING

Please observe the important safety instructions for use of child restraint systems on the front passenger seat → page 57



11A012720AB



11A012720AB

# Table of Contents

## Vehicle overviews

– Front view	7
– Rear view	8
– Driver door	9
– Driver side	10
– Centre console	13
– Front passenger side	14
– Controls and displays in the roof	14

## Driver information

– Symbols in the instrument cluster	15
– Instrument cluster	18
– Infotainment system controls and displays	30
– ID. Light	31

## Safety

– General notes	32
– Sitting position	34
– Seat belts	36
– Proactive occupant protection system	45
– Airbag system	47
– Safe transport of children	57
– In an emergency	66

## Opening and closing

– Vehicle key	73
– Keyless locking and starting system “Keyless Access”	75
– Doors and central locking button	77
– Anti-theft alarm	83
– Interior monitoring system and anti-tow alarm	83
– Boot lid	84
– Windows	89

## Steering wheel

– Adjusting the steering wheel position	92
---	----

## Seats and head restraints

– Front seats	93
– Rear seats	96
– Head restraints	98
– Seat functions	100

## Lights

– Turn signals	102
– Vehicle lighting	103
– Interior lighting	111

## Vision

– Wipers	112
– Mirrors	115
– Protection from the sun	118

## Heating and air conditioning system

– Heating, ventilation, cooling	120
– Stationary air conditioning	127

## Driving

– Notes on driving	129
– Activating and deactivating the vehicle’s drive system	137
– Selecting a position	140
– Steering	142
– Driving profile selection	143

## Driver assist systems

– Cruise control system	145
– Speed limiter	147
– Speed limiter with predictive control	149
– Adaptive Cruise Control (ACC)	151
– Predictive cruise control	156
– Area monitoring system (Front Assist)	159
– Lane keeping system (Lane Assist)	165
– Travel Assist	168
– Semi-automatic vehicle control in a medical emergency (Emergency Assist)	171
– Lane change system (Side Assist)	172

## Parking and manoeuvring

– Parking	176
– Electronic parking brake	177
– General information about the parking systems	179
– Park Distance Control	184
– Rear view camera system	185
– Area View	187
– Rear Traffic Alert	188

– Brake support systems	189	– Changing fuses	296
<b>Practical equipment</b>		– Jump starting	301
– Stowage areas	193	– Towing	304
– Sockets	193	<b>Checking and refilling</b>	
<b>Data transfer</b>		– In the front compartment	309
– Cybersecurity	195	– Service fluids and consumables	313
– System update	196	– Washer fluid	314
– Car2X communication	198	– Coolant	315
– Volkswagen We Connect Start	200	– Brake fluid	318
– Privacy settings	204	– 12-volt vehicle battery	320
– User administration	205	<b>Wheels and tyres</b>	
– Activating functions (We Upgrade)	206	– Tyre monitoring system	325
– Wi-Fi hotspot	207	– Useful information about wheels and tyres	328
– App-Connect	210	– Hubcaps	341
– Cable and wireless connections	215	– Changing a wheel	343
<b>Infotainment system</b>		– Breakdown set	348
– Getting started	217	<b>Maintenance</b>	
– Voice control	228	– Service	353
– Radio mode	231	– Vehicle care	355
– Media mode	234	– Accessories, modifications, repairs and renewal of parts	362
– Navigation	238	<b>Customer information</b>	
– Mobile phone interface	246	– Warranty	366
<b>Transporting items</b>		– Guarantee for high-voltage batteries in electric and hybrid vehicles	366
– Stowing luggage and loads	254	– Data storage and services	366
– Luggage compartment cover	255	– Event data recorder	369
– Luggage compartment floor	255	– Information stickers and plates	370
– Partition	257	– Fluids in the air conditioning system	371
– Luggage compartment equipment	259	– Infotainment system and antennas	371
– Roof carrier	262	– Component protection	372
– Towing a trailer	264	– Information in accordance with the EU Chemicals Regulation REACH	372
<b>High-voltage battery</b>		– Disposal of used batteries and electronic devices	372
– Safety notes	273	– Declaration of conformity	372
– Care instructions for the high-voltage battery	275	– Third party copyright law information	373
– Charging settings in the Infotainment system	276	– Returning and scrapping end-of-life vehicles	373
– Charging the high-voltage battery	279	– Information about vehicles with N1 approval (light commercial vehicle)	373
– Charging cable	287	– Declaration of conformity for radio systems in Europe	374
<b>If and when</b>			
– Vehicle toolkit	292		
– Wiper blades	293		
– Exterior lighting	295		

– Declaration of conformity for radio systems in countries outside of Europe 380

---

**Technical data**

– Notes on technical data 387  
– Vehicle identification number 387  
– Type plate 389  
– Safety certificate 389  
– Vehicle data sticker 389  
– Dimensions 390  
– Electric drive 391

---

**Abbreviations used** 393

**Index** 395

## About this owner's manual

This owner's manual is valid for all model types and versions of your Volkswagen. The owner's manual describes all equipment and models without indicating whether the equipment is optional or specific to the model type. This means that your vehicle may not have some of the equipment described, or it may only be available in certain markets. The scope of equipment fitted in your vehicle can be found in the sales documentation and you can contact your Volkswagen dealership for further information.

A passenger car is described in this owner's manual.

Depending on the market-specific vehicle approval, the model version may also be a light commercial vehicle.

All data in this owner's manual correspond to the information available at the time of going to print. Because the vehicle is constantly being developed and further improved, there may be differences between your vehicle and the data in this owner's manual. No discrepancy in data, illustrations or descriptions shall form the basis for any legal claim.

Please ensure that the complete vehicle wallet is always in the vehicle if you lend or sell the vehicle to someone else. Volkswagen also recommends restoring the Infotainment system to factory settings in order to delete all personal data.

- An **alphabetical index** is included at the end of this manual.
- A **list of abbreviations** at the end of the manual explains the abbreviations used.
- **Directions and positions** such as left, right, front and rear are normally relative to the

vehicle's direction of travel, unless otherwise indicated.

- **Illustrations** help with orientation and should be regarded as a general guide.
- This owner's manual was written for left-hand drive vehicles. In **right-hand drive vehicles** the controls may sometimes differ from those displayed in illustrations or described in the text.
- **Values given in miles** instead of kilometres or mph instead km/h refer to the country-specific instrument clusters or Infotainment systems.
- **Short definitions** appear in a different colour before some sections of this manual. They provide a summary of the function and use of a system or feature. More detailed information about the features, conditions and limitations of systems and equipment can be found in the relevant sections.
- Critical safety issues or any technical changes that may be made to the vehicle after publication of this booklet are contained in a **supplement** that is included with the vehicle wallet.
- For better legibility, the male form of **address** is used. However, this refers to all sexes equally. The shortened linguistic form is used for editorial reasons and does not represent a value judgement.

### Booklets in the vehicle wallet:

- Owner's manual
- Supplement (optional)
- *Other supplements*



## Description of symbols



Refers to a section within a chapter that contains important information and safety notes ⚠ that should always be observed.



Indicates the end of a section.



Indicates situations in which the vehicle must be stopped as quickly as possible.

TM

The symbol means “Trademark” and identifies an recognised but not (yet) officially registered mark. However, the absence of this symbol does not constitute a waiver of the rights concerning any term.



The symbol indicates a registered mark. However, the absence of this symbol does not constitute a waiver of the rights concerning any term.



Symbols like these refer you to warnings within the same section or on a given page. They draw your attention to possible risks of accident or injury and explain how they can be avoided.



Cross reference to potential risks of damage to property in the same section or on the page specified.

### DANGER

Texts with this symbol indicate dangerous situations which will lead to fatal or severe injuries if you do not observe the warning.

### WARNING

Texts with this symbol indicate dangerous situations which could lead to fatal or severe injuries if you do not observe the warning.

### CAUTION

Texts with this symbol indicate dangerous situations which could lead to slight or me-

dium injuries if you do not observe the warning.

### NOTICE

Texts with this symbol indicate situations which could cause vehicle damage if you do not observe the warning.



Texts with this symbol contain additional information on the protection of the environment.



Texts with this symbol contain additional information.



# Vehicle overviews

## Front view

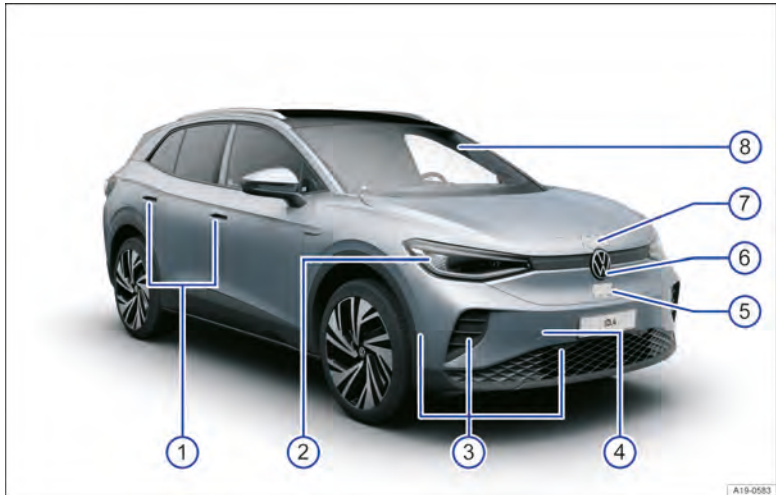


Fig. 2 Overview of vehicle from front.

①	Door handles .....	77
②	Headlights .....	295
③	Sensors for assist systems .....	358
④	Behind a cover: mounting for towing eye .....	304
⑤	Behind a cover: radar sensor for assist systems .....	358
⑥	In the Volkswagen badge: camera for assist systems .....	358
⑦	Bonnet release lever with bonnet space underneath .....	312
⑧	Windscreen:	
	– with vehicle identification number .....	387
	– with windscreen wiper .....	112
	– with camera window for assist systems .....	358
	– with rain/light sensor positioned near the interior mirror .....	114, 358 ◀

11A012720AB

## Rear view

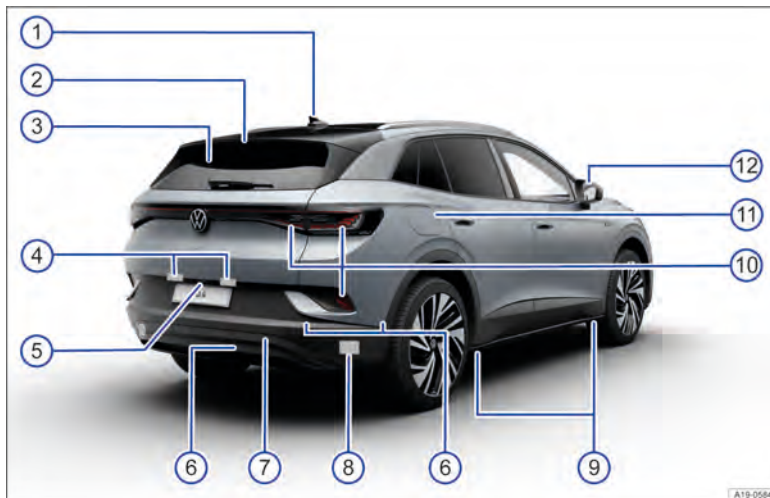



Fig. 3 Overview of vehicle from rear.

①	Roof aerial .....	371
②	High-level brake light .....	
③	Rear window:	
	– with rear window heating .....	120
	– with rear window wiper .....	112
	– with window aerial .....	371
④	Number plate light .....	295
⑤	Area:	
	– of the button for opening the boot lid .....	84
	– of the camera for parking systems .....	185, 358
⑥	Sensors for assist systems .....	358
⑦	Behind a cover: mounting for towing eye .....	304
⑧	Behind the bumper: radar sensor for assist systems .....	358
⑨	Jacking points .....	343
⑩	Tail light clusters and reflectors .....	295
⑪	Charging socket flap .....	279
⑫	Exterior mirrors .....	117
	– with “lane change system” display .....	172

## Driver door



Fig. 4 Driver door (left-hand drive vehicles): controls (mirrored for right-hand drive vehicles).

①	Door release lever	
②	Central locking system indicator lamp .....	78
③	Touch control for deactivating the rear electric window buttons and activating the electric childproof lock .....	89, 81
④	Touch control for locking and unlocking the vehicle .....	79
⑤	Rotary knob for exterior mirror adjustment and functions .....	117
⑥	Buttons for operating the electric windows .....	89
⑦	Release lever for bonnet  .....	312
⑧	Button for opening the boot lid .....	84
⑨	Stowage compartment:	
	– with bottle holder	
	– with stowage facility for high-visibility waistcoat .....	68 <

# Driver side

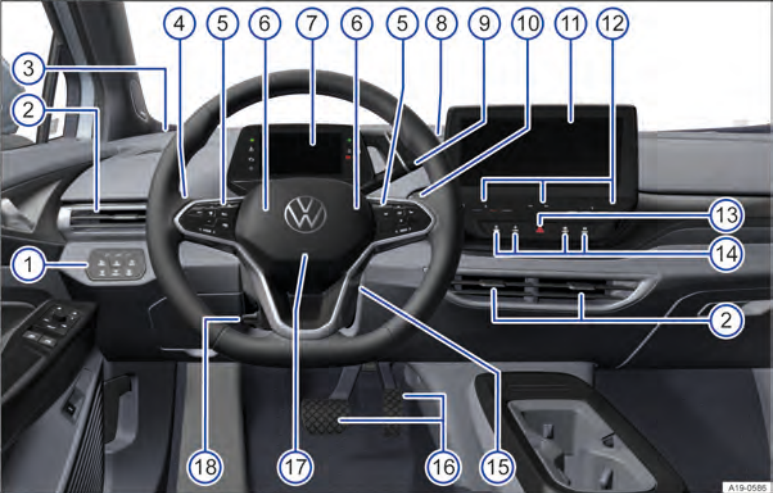


Fig. 5 Overview of the driver side (left-hand drive vehicles).

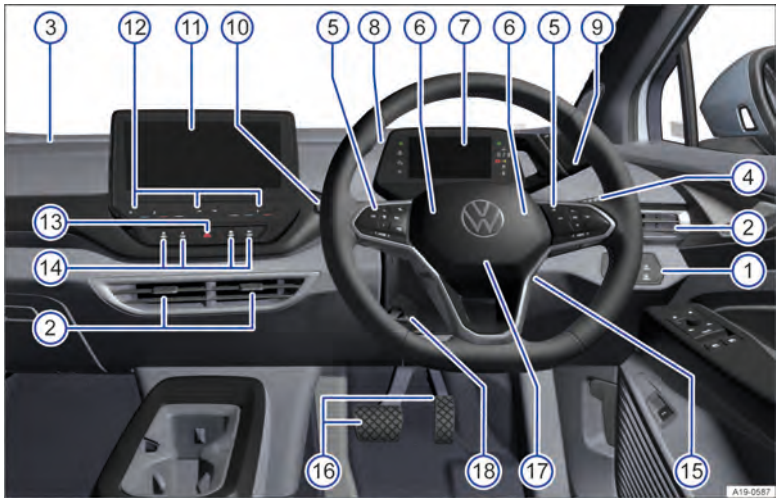






Fig. 6 Overview of the driver side (right-hand drive vehicles).

①	Touch panel:	
	– for light functions .....	103
	– for window heating and window ventilation .....	120
②	Vent .....	120
③	ID. Light (light strip between windscreen and dash panel) .....	31
④	Turn signal and main beam lever .....	102, 105
⑤	Touch controls of the multifunction steering wheel:	
	– for driver assist systems .....	145
	– for audio, navigation .....	217
	– for volume adjustment  .....	
	– for activating voice control  (function may not be available depending on vehicle equipment) .....	228
	– for switching between the views of the ID. Cockpit <b>VIEW</b> .....	18
⑥	Horn .....	
⑦	ID. Cockpit .....	18
	– with warning and indicator lamps and gear indicator .....	15
⑧	Head-up display .....	21
⑨	Position switch .....	140
	– with button for electronic parking brake .....	177
⑩	Lever for wipers and washers .....	112

11	Infotainment system .....	217
12	Touch panel:	
	– for switching the Infotainment system on and off .....	222
	– for setting temperature of air conditioning system or heating and fresh air system .....	120
	– for volume adjustment .....	
13	Touch control for switching the hazard warning lights on and off  .....	66
14	Touch panel:	
	– for the air conditioning system, heating and fresh air system .....	120
	– for driving profile selection .....	143
	– for driver assist systems .....	145
	– for assist systems for parking and manoeuvring  .....	176
15	Starter button .....	137
16	Pedals .....	129
17	Location of the driver front airbag .....	47
18	Lever for adjusting the steering column position .....	92 <

## Centre console



**Fig. 7** Overview of the lower section of the centre console.

①	Card holder	
②	Stowage compartment	
	– with removable drink holder	
	– with contact area for the vehicle key for emergency start .....	139
③	Under a cover: stowage compartment	
	– with USB ports .....	215
	– with phone interface .....	246 ◀

## Front passenger side







**Fig. 8** Front passenger side (left-hand drive vehicles): overview of dash panel (mirrored for right-hand drive vehicles).



**Fig. 9** With open front passenger door (left-hand drive vehicles): key-operated switch in the dash panel (mirrored for right-hand drive vehicles).

①	Vent .....	120
②	Glove box with button for opening	
③	Location of front passenger front airbag in the dash panel .....	47
④	Key switch for switching off the front passenger front airbag .....	53 <

## Controls and displays in the roof

Symbol	Meaning
 OFF	Touch panels for interior and reading lights → page 111.
	Touch panel for sun blind in the glass roof → page 119.
 SOS	Button for emergency call service → page 69.
 ON OFF	Indicator lamp for the front passenger front airbag switch-off function → page 47. <



# Driver information

## Symbols in the instrument cluster






The warning and indicator lamps can light up individually or in combination and indicate warnings, faults or certain functions. Some warning and indicator lamps light up when the ignition is switched on and should go out after a while.










For details on indicator lamps that light up in the light switch, see Chapter "Lights" → page 103.

### WARNING

Failure to observe illuminated warning lamps and text messages can lead to your vehicle breaking down in traffic, and can cause accidents and serious injury.

- Never ignore any illuminated warning lamps or text messages.
- Stop the vehicle as soon as possible and when safe to do so.

Symbol	Meaning
	Do not drive on!
	Central warning lamp → page 24
	Fasten seat belt → page 37
	Electronic parking brake → page 177
	Exhaustive discharge of the high-voltage battery → page 285

Symbol	Meaning
	Do not drive on! Brake system fault → page 134, → page 178
	Do not drive on! Electromechanical brake servo failure → page 191
	Do not drive on! Low brake fluid level → page 319
	Take over control of the vehicle and be prepared to brake. → page 151
	Do not drive on! Fault in engine coolant system → page 318
	Do not drive on! Steering fault → page 143
	Do not drive on! Fault in high-voltage system → page 285
	Do not tow vehicle! High voltage system overheated → page 305
	Do not drive on! Electric drive overheated → page 142



















11A012720AB

Symbol	Meaning
	Do not drive on! 12-volt vehicle battery → page 323
	High-voltage battery empty – vehicle operation not possible → page 136, → page 136
	Health risk! Open windows! CO <sup>2</sup> concentration too high → page 126
	Collision warning → page 161
	Take over steering immediately → page 170
	Intervention by proactive occupant protection system → page 46
	Central warning lamp → page 24
	Fault in airbag or belt tensioner system → page 50
	Airbag or belt tensioner system switched off with diagnostic tool → page 50
	Range calculation fault → page 285
<b>OFF</b>	Front passenger front airbag switched off → page 50
<b>ON</b>	Front passenger front airbag switched on → page 50
<b>sos</b>	Emergency call system fault → page 71  Emergency call system operation restricted → page 71
	Electronic parking brake fault → page 178
	Check the brake pads → page 134

Symbol	Meaning
	Flashes: Electronic Stability Control (ESC) or traction control system (TCS) regulating → page 192
	Lit: Electronic Stability Control (ESC) faulty → page 192
	Traction control system (TCS) switched off → page 192
	ESC Sport switched on → page 192
	Anti-lock brake system (ABS) fault → page 191
	Travel Assist fault → page 170
	Vehicle lighting failure → page 111
	Rear fog light switched on → page 104
	Health risk! Open windows! CO <sup>2</sup> concentration too high → page 126
	Air conditioning system not working properly or CO <sup>2</sup> con- centration cannot be measured → page 126
	Rain/light sensor fault → page 111, → page 115
	Fault in wipers → page 114
	Washer fluid level too low → page 114
	Fault in steering → page 143

Symbol	Meaning
	Do not drive on!
	Low tyre pressure → page 327
	Do not drive on!
	Fault in the Tyre Pressure Monitoring System → page 327
	Fault in electric drive system → page 139, → page 142
	Reduced power → page 137
	Electronic engine sound fault → page 140
	Front Assist not available → page 165
	Front Assist switched off → page 164
	Speed limiter not available → page 148
	Fault in the Cruise Control System → page 147
	Adaptive Cruise Control (ACC) is not available → page 156
	Emergency Assist not available → page 172
	Lane keeping system (Lane Assist) not available → page 167
	Lane keeping system (Lane Assist) is regulating → page 167
	Emergency Assist intervention → page 171
	Fault in the lane change system (Side Assist) → page 174
	Rear Traffic Alert braking intervention → page 189
	Rear Traffic Alert fault → page 189

Symbol	Meaning
	12-volt vehicle battery → page 323
	Low charge level of the high-voltage battery → page 285
	High-voltage battery empty → page 285
	Adaptive chassis control fault → page 144
	Ball head of the towing bracket is not locked → page 273
<b>AUTO HOLD</b>	The vehicle is held stationary → page 179
	Turn signals → page 110
	Trailer turn signal → page 111
	Cruise control system switched on, control active. → page 145
	Speed limiter active → page 147
	Lane Assist active → page 167
	Travel Assist active → page 169
	The ACC is regulating, no vehicle detected in front → page 154
	The ACC is regulating, vehicle in front detected → page 154
	Speed regulation due to the road layout → page 158
	Speed regulation due to a roundabout → page 158
	Speed regulation due to a junction → page 158
	Speed regulation due to cancellation of the speed limit → page 158
	Speed regulation due to the end of a traffic jam → page 158

Symbol	Meaning
	Speed regulation due to speed limit → page 150, → page 158
	Main beam or headlight flasher → page 105
<b>AUTO HOLD</b>	Auto Hold function switched on → page 179
	Cruise control switched on, system control not active. → page 145
	The speed limiter is not active → page 147
	Charge level of high-voltage battery → page 19
	Outside temperature colder than +4°C (+39°F) → page 23
	Service due → page 30
	Main-beam control active → page 106, → page 107
	Take over steering → page 170
	Front Assist is starting up → page 165
	Distance warning → page 161
	Eco driving profile → page 144
	Comfort mode → page 144
	Individual mode → page 144
	Sport mode → page 144
	Traction driving profile → page 144
	Reference to information in the vehicle wallet → page 24
	Take your foot off the accelerator → page 28

## Instrument cluster

### Introduction to the topic

When you activate the vehicle's drive system after the 12-volt vehicle battery has been totally discharged, replaced or after a jump start, you may find that system settings, such as personal convenience settings and programming, have been changed or deleted. Check and correct the settings as necessary once the 12-volt vehicle battery has been sufficiently charged.

### WARNING

Accidents and injuries can occur if the driver is distracted.

- Never operate the instrument cluster while the vehicle is in motion.
- Any settings for the instrument cluster display and displays in the Infotainment system should be made only when the vehicle is stationary in order to reduce the risk of accidents and serious injuries. <

### ID. Cockpit

📖 Please refer to ⚠ at the start of the chapter on page 18.



Fig. 10 ID. Cockpit in the dash panel.

The ID. Cockpit is a digital instrument cluster with a high-resolution LC colour display. By selecting different information profiles, displays from the driver assist systems and other displays can be shown in addition to the digital speedometer. The term “digital instrument cluster” is used below for the ID. Cockpit.

### Views in the display area

The digital instrument cluster can display the following views → Fig. 10:

**Summary** Before activation of the vehicle’s drive system: display with information on mileage, charge level and range.

**Basic** Driving displays with information on driver assist systems, speed and navigation.

**Driver assist systems** Display of active driver assist systems and speed. The navigation context is hidden.

**Navigation** Display with route guidance and speed information. The graphic view of the driver assist systems is hidden.

The upper display area shows situation-dependent pop-ups, for example.

The amount and scope of the displayed information may differ depending on the vehicle equipment.

### Setting views

The different views provide a better overview of the driving data, navigation or information on the driver assist systems.

The “driver assist systems” view and “navigation” view can be selected with the **(VIEW)** button on the multifunction steering wheel.

- To change to the “Navigation” view, press the right area of the **(VIEW)** button or swipe from right to left.
- To change to the “Driver assist systems” view, press the left area of the **(VIEW)** button or swipe from left to right.

### Event in the digital instrument cluster

Information and warnings are shown as an event in the digital instrument cluster. The event display appears in the digital instrument cluster from above and is hidden again after some time.

#### **⚠ WARNING**

Accidents and injuries can occur if the driver is distracted.


### Charge level and range in the digital instrument cluster

📖 Please refer to ⚠ at the start of the chapter on page 18.

#### Charge level display



**Fig. 11** In the digital instrument cluster: charge level of the high-voltage battery ① and vehicle range ②.

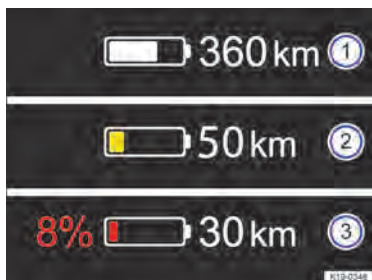
The current charge level of the high-voltage battery is displayed in the digital instrument cluster by the symbol  → Fig. 12 ①. The fill level of the battery symbol changes with the charge level.

#### Range display

The vehicle range is specified in kilometres (km) or miles (mi), depending on the setting → Fig. 12 ②.

The displayed value is calculated and updated depending on the driving style and ambient conditions. The range can therefore also vary even for a fully charged high-voltage battery.

### Reserve range



**Fig. 12** In the digital instrument cluster: range and reserve capacity display.

- ① Charge level and range.
- ② Reserve capacity warning level 1 and range.
- ③ Reserve capacity warning level 2 and range.

When the red reserve range of the high-voltage battery is reached, the symbol is displayed together with a colour percentage value → Fig. 12 ③ → .

Warning levels for the reserve range:

**Yellow** The charge level is less than 20 %.

**Red** The charge level is less than 10 %. The charge level of the high-voltage battery is additionally displayed in %.

Charge the high-voltage battery as soon as possible to prevent the vehicle from breaking down → .

### WARNING

Driving when the charge level of the high-voltage battery is too low can lead to the vehicle breaking down when in traffic, and can lead to accidents and serious injuries.

- Always make sure the high-voltage battery has sufficient charge!

### WARNING

When the charge level of the high-voltage battery reaches the reserve range, this may result in changed vehicle handling, e.g. different acceleration response of the vehicle.

- Always adapt your speed and driving style to suit visibility, weather, road and traffic conditions as well as the charge level of the high-voltage battery.

### NOTICE

Self-discharge of the high-voltage battery, e.g. due to the vehicle standing for periods of several months, can lead to the high-voltage battery being damaged if ambient temperatures are high and the high-voltage battery has a low charge level.

- Always make sure the high-voltage battery has sufficient charge!

The range for electric driving may be reduced at very low outside temperatures when the high-voltage battery is consequently very cold.

### Power display

Please refer to at the start of the chapter on page 18.



**Fig. 13** In the digital instrument cluster: power display (illustration).


The power display shows the current performance capability of the electric drive and the current drive power.

### Display concept

Using the bar divided in the middle, the power display continuously shows the availability of brake energy recuperation → Fig. 13 ① (green) to the left and traction → Fig. 13 ② (blue) to the right. The availability is unrestricted when the respective bar reaches the end marking. The bar is shown shortened in each case if availability is restricted.

The current drive power is displayed dynamically by a lighter bar, either as brake energy recuperation power (light green) to the left or traction power (light blue) to the right.

The power limit of the electric drive is reached when the current drive power and currently available performance capability are the same (bars are same length)

 The power limit cannot be achieved at all vehicle speeds.

### Influencing factors

The following influencing factors apply in addition to the vehicle speed:

- The availability of traction and brake energy recuperation depends on the charge level of the high-voltage battery. Brake energy recuperation may be restricted by a high charge level and traction by a low charge level.
- Very low or very high temperatures of the high-voltage battery can lead to an overall reduction in the available drive power. This applies to traction and brake energy recuperation

### WARNING

If the performance capability of the electric drive is reduced or the charge level of the high-voltage battery has reached the reserve range, the driving characteristics can

change, e.g. the acceleration performance of the vehicle.

- Always adapt your speed and driving style to suit visibility, weather, road and traffic conditions as well as the charge level of the high-voltage battery.

## Head-up display (HUD)

 Please refer to  at the start of the chapter on page 18.



**Fig. 14** In the driver's field of vision: head-up display close range ① and AR head-up display ②.

The head-up display (HUD) projects selected information or warning messages from the assist systems or the Infotainment system into the driver's field of vision.

### Display areas

Explanations of the areas shown in the head-up display → Fig. 14:

#### — Head-up display close range

Information on speed, navigation and driver assist systems is displayed in the HUD close range ①.

#### — Augmented reality head-up display (AR HUD)

In augmented reality HUD ②, information can be projected directly into the driver's field of vision depending on the situation. The information may be for navigation purposes, for example.

The amount and scope of the displayed information may differ depending on the vehicle equipment.

### Switching the head-up display on and off

The head-up display can be switched on and off in the vehicle settings in the Infotainment system.

1. Touch the **Vehicle** function button.
2. In the Vehicle selection, choose the view **Interior** and touch the **Head-up display** function button.
3. Switch the head-up display on or off as desired. The activated functions are highlighted in colour.

### Adjusting the height

In order to adjust the vertical position of the image to your individual seating position, the head-up display can be adjusted in the corresponding menu in the vehicle settings of the Infotainment system.

1. Assume the correct sitting position.
2. Adjust the desired position and angle of the head-up display using the function buttons.

The rotation of the close range can also be adjusted in the vehicle settings in the Infotainment system.

### Settings in the Infotainment system

You can configure additional settings for the head-up display in the vehicle settings in the Infotainment system.


The following settings are available:


In the submenu **Head-up display settings**:


- Adjust the Head-up Display brightness. If the surroundings become darker, the display brightness is automatically dimmed. The basic brightness level is adjusted to-


gether with the instrument lighting  
→ page 111.


- Select the content of the head-up display, e.g. to display the driver assist systems.
- Alternative colour scheme of the head-up display for poor weather conditions, e.g. snowfall.

 Some content cannot be hidden, e.g. warning messages.

 The ideal position to read the head-up display depends on the seat position and the height setting of the head-up display.

 Reflections can occur if the incident sunlight strikes the display at an unfavourable angle.

 Sunglasses with polarising filters can negatively affect the readability of the display.

 Clean the head-up display with a soft cloth and mild detergent only. Microfibre cloths can scratch the head-up display. <

## Displays

 Please refer to  at the start of the chapter on page 18.

### Possible notifications in the digital instrument cluster

Depending on the vehicle equipment, various kinds of information can be shown as overlays in the digital instrument cluster:

- Open doors, bonnet and boot lid.
- Warning and information messages  
→ page 23.
- Navigation information.
- Outside temperature display.
- Service interval display.
- Range display.
- Speed warning function.



- Speed warning for winter tyres.
- Road signs detected by the Dynamic Road Sign Display system → page 25.
- Remaining charging time during charging of the high-voltage battery.

### Open doors, bonnet and boot lid

The digital instrument cluster indicates if any doors, the bonnet or boot lid are open once the vehicle has been unlocked and while the vehicle is in motion. In some cases, an acoustic warning is also given.

### Outside temperature display

If the outside temperature falls below approximately +4°C (+39°F), a snowflake symbol appears in the upper area of the digital instrument cluster as an overlay ❄️. This symbol remains lit until the outside temperature rises above +6°C (+43°F).

In the following situation, the temperature displayed may be higher than the actual outside temperature as a result of the heat radiated from the engine.

- When the vehicle is stationary.
- When travelling at very low speeds.

### WARNING

Streets and bridges can be iced over at outside temperatures above freezing point.

- The snowflake symbol indicates that there is a risk of black ice.
- There may also be black ice on the road at outside temperatures above +4 °C (+39 °F) when the snowflake symbol is not displayed.
- You should never rely solely on the outside temperature display!

### Mileage displays

The *odometer* registers the total distance travelled by the car.

### Speed warning for winter tyres

A display in the digital instrument cluster indicates when you have exceeded the set maximum speed.

Speed warning settings can be made in the vehicle settings in the Infotainment system → page 31.

### Range display

Approximate calculation of the distance in km that can still be travelled with the current battery charge level under the current driving conditions and with the same consumption. This distance is calculated using factors that include the current energy consumption.



Some notifications in the digital instrument cluster may be overridden by sudden events, e.g. speed warning.



Depending on the vehicle equipment level, some settings and displays may also appear in the Infotainment system.



If several warnings are present, the symbols will appear at the bottom in the middle of the display for several seconds, one after another. The symbols will continue to appear until the faults are rectified.



If warnings about malfunctions are displayed when the ignition is switched on, it may not be possible to adjust some settings as described, or the information display may appear differently. If this is the case, take the vehicle to a qualified workshop to have the malfunctions rectified. <


## Warning and information messages

 Please refer to  at the start of the chapter on page 18.

The system runs a check on certain components and functions in the vehicle when the ignition is switched on or while the vehicle is in motion. Malfunctions are indicated by red and yellow warning symbols with information messages on the instrument cluster display. An acoustic warning is also given in certain cases. The appearance of the text messages

and symbols can vary depending on the version of the instrument cluster.

### Priority 1 warning

The red central warning lamp flashes or lights up, in some cases together with acoustic warnings or additional symbols.  **Do not drive on!** Danger. Check the fault. Seek expert assistance if necessary.

### Priority 2 warning


The yellow central warning lamp flashes or lights up, in some cases together with acoustic warnings or additional symbols. Malfunctions and insufficient service fluids can damage the vehicle and cause it to break down. Check the fault as soon as possible. Seek expert assistance if necessary.



### Reference to information in the owner's manual

You will find further information on the warning in the owner's manual.

### Information message

Information about various procedures within the vehicle.

 If several warnings are present, the symbols will appear for several seconds, one after another. The symbols will continue to appear until the faults are rectified.

 If warnings about malfunctions are displayed when the ignition is switched on, it may not be possible to adjust some settings as described, or the information display may appear differently. If this is the case, take the vehicle to a qualified workshop to have the malfunctions rectified. 

## Driver Alert System (break recommendation)


 Please refer to  at the start of the chapter on page 18.




Fig. 15 On the instrument cluster display: Driver Alert System symbol.

The Driver Alert System informs the driver if their driving shows signs of tiredness.

### Function and operation

The Driver Alert System determines the driving behaviour at the beginning of a journey and uses it to evaluate the tiredness of the driver. This is compared to the behaviour of the driver while actually driving. If the system detects driver fatigue, an acoustic warning signal will sound and a symbol will be displayed on the instrument cluster display together with a supplementary text message → Fig. 15. The message in the instrument cluster display is displayed for about five seconds and may be repeated once. The last displayed message is saved by the system.

The message on instrument cluster display can be deactivated as follows:

- Press the  button on the multifunction steering wheel.

### Function conditions

The driving behaviour can be evaluated only when the speed is above 60 km/h (37 mph) up to approximately 200 km/h (125 mph).

### Switching on and off

You can switch the Driver Alert System on and off in the **Assist systems** menu in the Infotainment system. When the vehicle's drive system is activated, the Driver Alert System is always activated too → page 31.

### Function limitations

The Driver Alert System has system-related limitations. The following conditions can limit the function of the Driver Alert System, or prevent it from working altogether:

- Speeds less than 60 km/h (37 mph).
- Speeds of more than 200 km/h (125 mph).
- Twisting roads.
- Road works.
- Poor roads.
- Adverse weather conditions.
- Sporty driving style.
- Driving with a trailer.
- The driver is distracted.

The Driver Alert System is reset in the following situations:

- The ignition is switched off.
- The driver seat belt is unfastened and the driver door is open.
- The vehicle has been stationary for longer than 15 minutes.

The Driver Alert System is automatically reset in the event of an extended period of slow driving (speed less than 60 km/h (37 mph)). If the speed is increased again, the system evaluates the driving behaviour once more.

### WARNING

The intelligent technology used in the Driver Alert System cannot overcome the laws of physics, and functions only within the limits of the system. Do not let the extra convenience afforded by the Driver Alert System tempt you into taking any risks when driving. During a long trip, plan regular and sufficient breaks.

- The driver is responsible at all times for their fitness to drive.
- Never drive a vehicle when you are tired.
- The system cannot always detect the driver's level of alertness. Observe the information in the section "Function limitations".
- In certain situations, the system may wrongly interpret intentional driving manoeuvres as a lack of alertness from the driver.
- No urgent warning will be given in the event of the phenomenon known as "microsleep".
- Observe the information in the instrument cluster display and respond according to the commands.



The Driver Alert System has been developed for use only while driving on motorways and good roads.



If there is a system fault, proceed to a qualified workshop immediately to have the system checked.

## Dynamic Road Sign Display

 Please refer to  at the start of the chapter on page 18.

Dynamic Road Sign Display uses a camera in the base of the interior mirror to monitor standard road signs and informs the driver of any detected speed limits, overtaking restrictions and danger signs. Within the system limits, the system also displays an additional sign to indicate, for example, temporary restrictions. In some cases, the system can also display the current speed limits on non-signposted routes.

The Dynamic Road Sign Display is always active when the ignition is switched on. Additional signs are displayed as a generic addi-

tional sign in the head-up display and in the instrument cluster.

### Displays

In addition to speed limits and overtaking restrictions, Dynamic Road Sign Display also detects the road sign which indicates that all restrictions have been lifted on motorways and main roads in Germany. In all other countries in which the system is operated, the current speed limit is displayed instead.

The road signs detected by the Dynamic Road Sign Display system are displayed on the instrument cluster. Road signs may also be displayed in the Infotainment system, depending on the system installed in the vehicle.

With some equipment levels, a display is also shown on the Head-up Display.

**No road signs available.** The system is in the initialisation phase. **OR:** the camera has not detected any regulatory or warning signs.

**Error: Dynamic Road Sign Display** System fault. Go to a qualified workshop.

**Speed warning currently not available.** Fault in the Dynamic Road Sign Display system speed warning. Go to a qualified workshop.

**Dynamic Road Sign Display: Clean the windscreen!** The windscreen is dirty in the area of the camera or the camera view is impaired due to the weather conditions. Clean the windscreen.

**Dynamic Road Sign Display is currently restricted.** No data transmission from the Infotainment system. Check whether valid map data is loaded in the Infotainment system. **OR:** the vehicle is located in an area that is not covered by the map stored in the Infotainment system.

**No data available.** Dynamic Road Sign Display is not supported in the country in which you are currently travelling.

### Display of road signs



**Fig. 16** In the instrument cluster display: example of recognised speed limits with generic additional sign.

After validation and evaluation of the information from the camera, the Infotainment system and the current vehicle data, the Dynamic Road Sign Display shows up to two valid road signs and one generic additional sign → Fig. 16:

**1st position:** The road sign that currently applies to the driver is shown on the left-hand side of the display, e.g. a speed limit of 130 km/h (80 mph).

**2nd position:** A further road sign can be displayed in the second position, for example a danger sign.

**Additional sign:** A detected additional sign, e.g. with time restrictions, is displayed under the valid road sign. Due to system limitations, a generic additional sign is displayed instead of the additional sign actually detected. The valid road sign is supplemented with the generic additional sign in the head-up display.

The display of danger signs is not available in all countries and the system may not be able to recognise all danger signs.

### Speed warning

If the Dynamic Road Sign Display detects that an applicable speed limit has been exceeded, it issues a visual warning signal or warns visually and acoustically with a message on the instrument cluster display.

The speed warning can be set or completely deactivated in the **Assist systems** menu in the Infotainment system → page 31. The speed warning can be set to a value of 0 km/h

(0 mph), 5 km/h (3 mph) or 10 km/h (5 mph) above the permitted speed.

### Trailer mode

In vehicles with a factory-fitted towing bracket and a trailer with an electrical connection to the vehicle, the display of road signs that may apply to the vehicle when towing a trailer, e.g. applicable speed limits and no-overtaking signs, can be activated or deactivated in the vehicle settings in the Infotainment system → page 31.

In trailer mode, the speed warning function display can be adjusted to the type of trailer or to legal requirements. The settings can be adjusted in increments of 10 km/h (5 mph) within a range between 60 km/h (35 mph) and 130 km/h (80 mph). If a higher speed is set than is permitted for driving with a trailer in the country in which you are currently travelling, Dynamic Road Sign Display automatically issues a warning at the usual speed limit, e.g. at 80 km/h (50 mph) in Germany.

### No-entry warning

If the Dynamic Road Sign Display detects a no-entry sign on a one-way road or motorway slip road, it will issue an acoustic warning signal and display a message on the instrument cluster display.

### Function limitations

Dynamic Road Sign Display is subject to system-related limitations. The following conditions can restrict the function of Dynamic Road Sign Display, or prevent it from working altogether:

- Poor visibility, for example when it snows.
- Dazzling, for example by sunlight.
- High speeds.
- A covered or dirty camera.
- Road signs located outside of the camera's field of view.
- Partially or fully hidden road signs, for example by other vehicles.
- Non-standard road signs.
- Damaged or bent road signs.

- Variable road signs on gantries (changeable road sign display using LEDs or other light sources).
- Out-of-date map material in the Infotainment system.
- Vehicles with road sign stickers, e.g. speed restrictions on trucks.

### WARNING

The intelligent road sign recognition system technology cannot overcome the laws of physics, and functions only within the limits of the system. Do not let the extra convenience afforded by Dynamic Road Sign Display tempt you into taking any risks when driving. The system is not a substitute for the full concentration of the driver.

- Always adapt your speed and driving style to suit visibility, weather, road and traffic conditions.
- Poor visibility, darkness, snow, rain and fog can cause traffic signs to be not displayed or be incorrectly displayed by the system.
- If the camera's field of view is dirty, covered or damaged, the function of the Dynamic Road Sign Display system may be impaired.

### WARNING

Driving recommendations and traffic symbols displayed by the Dynamic Road Sign Display system may differ from the current traffic situation.

- Not all road signs can be recognised by the system and displayed correctly.
- Road signs on the road and traffic regulations have priority over the recommendations and displays provided by the Dynamic Road Sign Display system.

## Eco assistance

📖 Please refer to ⚠️ at the start of the chapter on page 18.



Fig. 17 Eco Assistance display (illustration).

The Eco Assistance function supports you during defensive and energy-saving driving with notifications in the digital instrument cluster that appear according to the situation → page 130.

If you are approaching a junction, for example, the ⚠️ symbol is displayed together with an event ⚠️ in the digital instrument cluster → page 18.

### Overview of displayed symbols



Take your foot off the accelerator.



Junction ahead.



Motorway exit.



Roundabout ahead.



Left-hand bend.



Right-hand bend.



Speed limit with dynamic speed display.



The symbols displayed may differ slightly depending on vehicle equipment and model. Symbols may be altered or upgraded by a system update.

As soon as you follow the instruction and take your foot off the accelerator, the vehicle will adapt brake energy recuperation and the driving speed, depending on the selected driving profile and distance to the event → page 135.



When the system is active, Eco Assistance can also increase brake energy recuperation without displaying a message. This may be the case if you take your foot off the accelerator when there is a vehicle in front, for example. Here, brake energy recuperation is adapted to the vehicle in front without any message being displayed.

The Eco Assistance function uses the route data of the Infotainment system and the sensors of some assist systems. The most probable route is used if the route guidance function is not active.

You can override the intervention of the Eco Assistance function at any time by pressing the accelerator.

The Eco Assistance function can be activated and deactivated in the assist system settings in the Infotainment system → page 29.

The Eco Assistance function will be automatically deactivated temporarily in the following cases:

- Position B.
- Sport driving profile.
- Driving with Adaptive Cruise Control (ACC) (ACC) or cruise control system (CCS).

Eco Assistance will be activated again when you leave these conditions if the function is activated in the assist system settings as default.

The Eco assistance function is dependent on the equipment level and is not available in all countries.

## WARNING

The system uses brake energy recuperation to reduce the vehicle speed and does not activate the vehicle brake.

- Be ready to brake at all times if the deceleration is not sufficient.

## WARNING

The system is not a substitute for the full concentration of the driver.

- Always adapt your speed and driving style to the current visibility, weather and road or traffic conditions.
- Road signs on the road and traffic regulations always have priority over driving recommendations.

## Time and date



 Please refer to  at the start of the chapter on page 18.

**Setting the time and date on the Infotainment system**

1. To access the System settings menu, touch the **Settings** function button → page 31.
2. Selection the menu option **Time and date**.
3. Select the time source:
  - Automatic.
  - Manual.

The time and date are displayed only on the Infotainment system.




## Button for driver assist systems

 Please refer to  at the start of the chapter on page 18.

You can open the Assist systems menu in the Infotainment system using the button for driv-

er assist systems. The button for the driver assist systems is located on the control panel under the Infotainment system.

In the **assist systems** menu, you can switch individual driver assist systems on and off and also adjust individual settings → page 31.

1. Press the  button.
2. Select 3D or optional list view.
3. Open the corresponding driver assist system and make your desired setting. The activated functions are highlighted in colour.
4. To return to the previous menu, touch the  sensor field or press the  button.


## Service menu

 Please refer to  at the start of the chapter on page 18.

**Opening the Service menu**

1. Touch the **Vehicle** function button in the Infotainment system.
2. In the Vehicle menu, touch the **Status** function button.
3. Select the Status view.

Open the desired menu and make the desired setting. The activated functions are highlighted in colour.

4. Touch the HOME button  to return to the previous menu.

**Resetting the trip recorder**

1. In the Status view, select the Trip recorder menu.
2. Touch the **0.0** function button to reset the value.

**Displaying vehicle identification number (VIN)**

- In the Status view, select the Service menu. The vehicle identification number (VIN) is displayed.

## Service interval display

📖 Please refer to ⚠️ at the start of the chapter on page 18.


Service events are displayed on the instrument cluster and in the Infotainment system.

### Service notification

When an inspection is due, a service announcement will appear on the instrument cluster display when the ignition is switched on.

The number of kilometres or amount of time shown correspond to the maximum number of kilometres or maximum time that can still be driven before the next inspection.

### Service event

For a **scheduled inspection**, an acoustic signal will be given when the ignition is switched on and the spanner symbol  will be displayed for several seconds on the instrument cluster display. One of the following displays will also appear:


- Inspection now!
- Inspection in xx km!
- Inspection in xx days!

### Accessing service schedules in the Infotainment system

- Touch the **Vehicle** function button.
- Touch the **Status** function button and the Status view.
- Select the **Service** menu option to display the service information.

### Resetting the service interval display

The service interval display can only be reset as part of an inspection by a qualified workshop.

 The service message goes out after a few seconds after the vehicle's drive system has been activated or by pressing the **OK** button on the multifunction steering wheel. ◀

## Infotainment system controls and displays

### Introduction to the topic

The Infotainment system combines key vehicle systems in a central operating unit, e.g. menu settings, radio or navigation system.

### General information on operation

The following section contains relevant information on the settings that can be adjusted in the **Vehicle** menu.

### Systems settings and vehicle information display


After touching the **Vehicle** function button, information can be displayed or settings made by touching the corresponding function buttons. The current vehicle status can be displayed by touching the **Status** function button, for example:

- Vehicle settings → page 31.
- Vehicle status.
- Driving data.

### ⚠️ WARNING

Accidents and injuries can occur if the driver is distracted. Operating the Infotainment system can distract you from the road.

- Always drive carefully and responsibly.

 After activating the vehicle's drive system after the 12-volt vehicle battery has been totally discharged or replaced, system settings such as time, date, personal convenience settings and programming and also user accounts may have been changed or deleted. Check and correct the settings as necessary once the 12-volt vehicle battery has been sufficiently charged. ◀



## Vehicle settings menu

📖 Please refer to  at the start of the chapter on page 30.

You can switch individual functions and systems on and off and adjust the settings in the vehicle settings of the Infotainment system.


### Opening the Vehicle settings menu

1. Switch on the ignition.
2. Switch on Infotainment system if necessary.
3. Touch the **Vehicle** function button.
4. Touch the corresponding function buttons from **Interior** or **Exterior** to open additional submenus in the **Vehicle** menu or to adjust settings in the menu options.
5. Open the desired menu and make the desired setting.



The activated functions are highlighted in colour.

## Exit menu

📖 Please refer to  at the start of the chapter on page 30.

In the **Exit** menu, you can adjust settings for some functions before you leave the vehicle. When you switch off the ignition, the **Exit** menu will be displayed in the Infotainment system.


The displayed options depend on the vehicle equipment and may be available only under certain conditions. The adjustable functions may include the following, for example:

- Charging the high-voltage battery.

- Auxiliary heater or stationary air conditioning.
- Interior monitoring.



### Hiding

The **Exit** menu is automatically hidden when you leave the vehicle. The **Exit** menu is also hidden after a certain time depending on the vehicle equipment.

- Touch  to hide the **Exit** menu manually.

### Setting

You can change the order of the displayed options.

1. Touch .
2. Rearrange the options into your preferred order.
3. Touch  again.

## ID. Light

**ID. Light** is an intelligent light concept that displays additional information on the vehicle status. When the vehicle's drive system is activated and while driving, supporting information on the current driving situation is provided via **ID. Light**.

### Displayed information

- Locking and unlocking.
- Welcome and goodbye animation.
- Charging operations.
- Voice control.
- Phone call.
- Navigation.
- Reduced power.
- Front Assist braking request




The displayed information may be changed and extended by a system update.

## Brightness

1. Touch the **Brightness** function button in the control centre.
2. Adjust the brightness by means of the touch slider.


### OR:

1. Touch the **Vehicle** function button on the Infotainment system.
2. Select display content for the **Interior**. Then touch the **ID. Light** function button.
3. Adjust the brightness by means of the touch slider.
4. Touch the **HOME** button  to return to the previous menu.

## Settings in the Infotainment system

1. Touch the **Vehicle** function button.
2. Select display content for the **Interior**. Then touch the **ID. Light** function button.
3. Set the functions for ID. Light as desired. The activated functions are highlighted in colour.

Certain ID. Light functions can be optionally activated or deactivated in the vehicle settings in the Infotainment system.

- Touch the **HOME** button  to return to the previous menu.

# Safety

## General notes

### Preparing for a journey and driving safety

Observe the following information both before and during every journey to ensure your own safety, and the safety of all passengers and other road users → page 34, *General notes*:

- ✓ Check that all lights and turn signals are working properly.
- ✓ Check the tyre pressure and charge level → page 332, → page 284.
- ✓ Check the washer fluid level → page 314.
- ✓ Make sure that you have a good, clear view through all of the windows → page 358.
- ✓ Air intake to the electric drive must not be obstructed, and the electric drive must not be covered by blankets or insulating materials → page 309.
- ✓ Secure all objects and luggage in the stowage compartments or the luggage compartment → page 254.
- ✓ Ensure that you are able to operate the pedals freely at all times.
- ✓ Secure any children travelling in the vehicle in a restraint system suitable for their weight and size → page 57.
- ✓ Adjust the front seats, head restraints and mirrors properly in accordance with the size of the occupants → page 34, → page 115.
- ✓ Wear shoes that provide good grip for your feet when using the pedals.
- ✓ The floor mat in the footwell on the driver side must leave the pedal area free and must be securely fastened.
- ✓ Assume a correct sitting position before setting off and maintain this position while driving. This also applies to all passengers → page 34.

- ✓ Fasten your seat belt correctly before setting off and keep it properly fastened throughout the journey. This also applies to all passengers → page 36.
- ✓ Each vehicle occupant must sit in a seat of their own and must have their own seat belt.
- ✓ Never drive if your driving ability is impaired, e.g. by medication, alcohol or drugs.
- ✓ Do not allow yourself to be distracted from the traffic, e.g. by passengers, telephone calls, opening menus and making adjustments to settings.
- ✓ Always adapt your speed and driving style to suit visibility, weather, road and traffic conditions.
- ✓ Observe traffic regulations and speed limits.
- ✓ Take regular breaks when travelling long distances – at least every two hours.
- ✓ Secure animals in the vehicle using a system that is suitable for their weight and size.

---

### Driving abroad

In some countries, special safety standards and regulations apply that the vehicle may not comply with. Volkswagen recommends that you visit your Volkswagen dealership before travelling abroad to find out about any legal requirements and the following issues at your destination:

- ✓ Does the vehicle need any technical modifications for driving abroad, e.g. masking or switching the headlights over?
- ✓ Are the necessary tools, diagnostic equipment and spare parts available for service and repair work?
- ✓ Are there any Volkswagen dealerships in the destination country?
- ✓ Are the correct service fluids that comply with Volkswagen specifications available in the destination country → page 313?

- ✓ Does the navigation function in the factory-fitted Infotainment system work with the navigation data available in the destination country?
- ✓ Are special tyres necessary for travelling in the destination country?
- ✓ Is a fire extinguisher a requirement in your destination country?
- ✓ Which requirements must be observed regarding high-visibility waistcoats?
- ✓ Are special charging cables necessary for charging at mains sockets in the destination country?

---

### Checks when charging

Never carry out work on the high-voltage system yourself. Do not perform any work in the bonnet space unless you know exactly how to carry out the tasks, are aware of the general safety procedures and have the correct equipment, service fluids and suitable tools to hand → page 309. In any other case, all work must be carried out by a qualified workshop. Make sure that the following are checked regularly:

- ✓ Washer fluid level → page 314.
- ✓ Coolant level → page 315.
- ✓ Brake fluid level → page 318.
- ✓ Tyre pressure → page 332.
- ✓ Vehicle lighting → page 103 necessary for traffic safety:
  - Turn signals.
  - Side lights, dipped beam headlights and main beam headlights.
  - Tail light clusters.
  - Brake lights.
  - Rear fog light.
  - Number plate light.

---

Information on changing bulbs → page 295.

## DANGER

Please observe important safety information about the front passenger front airbag → page 59.

## DANGER

The voltage of the high-voltage system is dangerous and can cause burns or other injuries and even lead to a fatal electric shock.

- Please observe the important safety information about the high-voltage system and the high-voltage battery → page 273.

## WARNING

Driving under the influence of alcohol, drugs, medication or narcotics can cause serious accidents and fatal injuries.


- Alcohol, drugs, medication and narcotics can severely impair perception, reaction times and driving safety. This could cause you to lose control of the vehicle.


## WARNING

Always observe current traffic regulations and speed limits, and think ahead when driving. Correct interpretation of a driving situation can make the difference between reaching your destination safely and having an accident with serious injuries.

## NOTICE

Volkswagen is not responsible for any vehicle damage caused by inadequate servicing work or lack of Genuine Parts.

 Please observe the notes and information for vehicles with N1 approval → page 373.

 Servicing the vehicle regularly is not only about vehicle maintenance – it also ensures that your vehicle remains road-worthy and in perfect working order. You should therefore have your vehicle serviced according to the Volkswagen guidelines.

Some work may have to be carried out before the due date of the next service if the vehicle is subjected to heavy-duty operating conditions. Heavy-duty conditions are, for example, regular stop and go driving or driving in areas with high levels of dust. Further information can be obtained from your Volkswagen dealership or qualified workshop. ◀

## Sitting position

### Introduction to the topic

#### Number of seats

The vehicle has a total of **five** seats: two at the front and three at the rear.

Each seat is equipped with a seat belt.

## WARNING

Assuming an incorrect sitting position in the vehicle can increase the risk of severe or fatal injuries during a sudden driving or braking manoeuvre, in the event of a collision or accident, or if the airbags are triggered.

- All vehicle occupants must assume a correct sitting position before setting off and maintain this position throughout the trip. This also applies to the fastening of seat belts.
- The number of vehicle occupants must never exceed the number of seats with seat belts in the vehicle.
- Always secure children in the vehicle in an authorised child restraint system which is suitable for their height and weight → page 57 and → page 47.
- Always keep your feet in the footwell while the vehicle is in motion. Never place your feet on the seat or dash panel, for example, and never ride with your feet out of the window. If you sit like this, the airbag and seat belt cannot provide optimal protection and could ac-

tually increase the risk of injury during an accident.

## The dangers of assuming an incorrect sitting position

📖 Please refer to ⚠️ at the start of the chapter on page 34.

If the seat belts are not worn or are worn incorrectly, the risk of severe or fatal injuries increases. Seat belts can only provide optimal protection if the seat belt routing is correct. Assuming an incorrect sitting position considerably impairs the level of protection provided by a seat belt. This could lead to severe or even fatal injuries. The risk of severe or fatal injuries is especially increased when a deploying airbag strikes a vehicle occupant who has assumed an incorrect sitting position. The driver is responsible for all occupants transported in the vehicle, especially children.

The following list contains examples of sitting positions that can be dangerous for all vehicle occupants.

### Whenever the vehicle is in motion:

- Never stand in the vehicle.
- Never stand on the seats.
- Never kneel on the seats.
- Never tilt the backrest too far to the rear.
- Never lean against the dash panel.
- Never lie on the seats in the passenger compartment and on the rear bench seat.
- Never sit on the front edge of a seat.
- Never sit sideways.
- Never lean out of a window.
- Never put your feet out of a window.
- Never put your feet on the dash panel.
- Never place your feet on the seat cushion or seat backrest.
- Never travel in a footwell.
- Never sit on the armrests.

- Never travel on a seat without wearing the seat belt.
- Never travel in the luggage compartment.

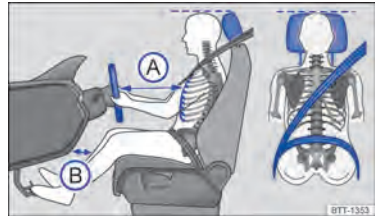
## ⚠️ WARNING

Every incorrect sitting position in the vehicle increases the risk of severe or fatal injuries in the event of an accident or sudden driving or braking manoeuvre.

- All vehicle occupants must maintain a correct sitting position and wear their seat belt properly while the vehicle is in motion.
- Sitting in an incorrect position, not fastening the seat belt, or not leaving adequate space between the occupants and the airbags could result in critical or fatal injuries, especially if the airbags deploy and strike an occupant who has assumed an incorrect sitting position.

## Correct sitting position

📖 Please refer to ⚠️ at the start of the chapter on page 34.



**Fig. 18** Illustration: correct distance between the driver and the steering wheel, correct seat belt routing and correct head restraint adjustment.

The following describes the correct sitting positions for the driver and passengers.

If any vehicle occupants cannot assume a correct sitting position due to their physical build, they should contact a qualified work-

shop to find out about possible special modifications. The seat belts and airbags can only provide a maximum level of protection if a correct sitting position is assumed. Volkswagen recommends using a Volkswagen dealership for this purpose.

Volkswagen recommends the following seating position for your own safety and to reduce the level of injury in the event of a sudden braking manoeuvre or an accident:

#### The following applies to all vehicle occupants:

- Adjust the head restraint so that its upper edge is at the same height as the top of the head, but not lower than eye level. Position the back of your head as close to the head restraint as possible at all times → Fig. 18.
- For small people, push the head restraint all the way down, even if the head is then located underneath the top edge of the head restraint.
- For tall people, push the head restraint up as far as it will go.
- Keep both feet in the footwell while the vehicle is in motion.
- Adjust and fasten seat belts properly → page 36.

#### Additional points for the driver:

- Move the backrest into an upright position so that your back rests fully against it.
- Adjust the seat so that the distance between the steering wheel and your breastbone is at least 25 cm (around 10 inches) → Fig. 18 (A) and the circumference of the steering wheel can be held at the sides with both hands and your arms slightly bent.
- The steering wheel must always point towards the breastbone and not towards the face.
- Adjust the driver seat by moving it forwards or backwards so that you are able to press the pedals to the floor with your knees still slightly bent and so that the

distance from the dash panel to your knees is at least 10 cm (around 4 inches) → Fig. 18 (B).


- Adjust the height so that you can reach the highest point of the steering wheel.
- Always leave both feet in the footwell to help ensure you maintain control of the vehicle at all times.
- Adjust and fasten seat belts properly → page 36.

#### Additional points for the front passenger:

- Move the backrest into an upright position so that your back rests fully against it.
- Push the front passenger seat as far back as possible so that the airbag can provide maximum protection if it is deployed. ◀

## Seat belts

### Introduction to the topic

Check the condition of all seat belts regularly. If the belt webbing, belt connections, belt retractor or seat belt buckle become damaged, the seat belt in question should be replaced immediately by a qualified workshop → . The qualified workshop must use correct spare parts that are compatible with the vehicle, equipment level and model year. Volkswagen recommends using a Volkswagen dealership for this purpose.

### WARNING

Incorrectly fastened or unfastened seat belts increase the risk of severe or fatal injuries. Seat belts will only offer the optimum level of protection when they are fastened and used properly.

- Seat belts are the most effective means of reducing the risk of serious and fatal injuries in the event of an accident. Seat belts must always be fastened properly when the vehicle is in motion to protect the driver and all vehicle occupants.

- Before every trip, each vehicle occupant must adopt the correct sitting position, correctly fasten the seat belt belonging to their seat and keep it fastened properly throughout the trip. This applies to all vehicle occupants and also in urban traffic.
- While the vehicle is in motion, secure all children travelling in the vehicle in a restraint system suitable for their weight and height. They must also wear correctly fastened seat belts → page 57.
- Only start driving when all passengers have correctly fastened their seat belts.
- Always insert the latch plate only into the buckle of the associated seat, and ensure that it engages properly. Using a buckle that does not belong to the seat that you are occupying reduces the level of protection and can lead to severe injuries.
- Avoid allowing foreign bodies or liquids to enter the slot for the seat belt buckle. This could prevent the belt buckle and seat belt from working properly.
- Never unfasten the seat belt while the vehicle is in motion.
- Never allow more than one person to share the same seat belt.
- Never travel when children or babies are being carried on somebody's lap and fastened with the same belt.
- Never travel wearing loose, bulky clothing (such as an overcoat over a jacket). This could prevent the seat belts from fitting and functioning properly.

### WARNING

Damaged seat belts are very dangerous and can cause severe or fatal injuries.

- Never damage the belt by trapping it in the door or in the seat mechanism.
- If the belt webbing or any other part of the seat belt becomes damaged, the seat belt may tear during an accident or sudden braking manoeuvre.

- Have damaged seat belts immediately replaced by new seat belts that have been approved by Volkswagen for the vehicle. Seat belts subjected to stress and stretched during an accident must be replaced by a qualified workshop. Renewal may be necessary even if there is no apparent damage. The belt anchorages should also be checked.
- Never try to repair, modify or remove the seat belts yourself. All repairs to the seat belts, belt retractors and buckles must be carried out by a qualified workshop.


## Warning lamp


 Please refer to  at the start of the chapter on page 36.



**Fig. 19** On the instrument cluster display: warning lamp.

### Buckle-up request for the front seats

If the driver or front passenger seat is occupied by an adult, an acoustic warning will be emitted for 126 seconds if the seat belts are not fastened at the start of a journey and the vehicle reaches a speed of more than around 25 km/h (around 15 mph) or if the seat belts are unfastened while the vehicle is in motion. The red warning lamp  → Fig. 19 also flashes on the instrument cluster display.

The red  warning lamp will not go out until all occupants have fastened their seat belts when the ignition is switched on.

### Belt status display for the rear seats (depending on country and equipment)



Fig. 20 On the instrument cluster display: seat belt status for the rear seats.

After the ignition has been switched on, the belt status display → Fig. 20 on the instrument cluster display shows the driver whether the adult rear seat passengers have fastened their seat belts.

The following symbols light up in different colours depending on whether seats are occupied and on the belt status:



The red symbol indicates that the passenger on this seat has not fastened their seat belt.



The green symbol indicates that the passenger on this seat has fastened their seat belt.



The white symbol indicates that this seat is not occupied.

### Buckle-up request for the rear seats (depending on country and equipment)

If a seat belt for one of the rear seats is unfastened while the vehicle is in motion, the symbol will light up red continuously for this seat. The red warning lamp also flashes on the instrument cluster display. If the vehicle is travelling faster than around 25 km/h (around 15 mph) an acoustic signal will also be given for 126 seconds.

### ⚠ WARNING

Incorrectly fastened or unfastened seat belts increase the risk of severe or fatal injuries. Seat belts will only offer the optimum level of protection when they are fastened and used properly.

### ⚠ WARNING

The buckle-up request is designed to detect adult persons. If a seat is occupied by lighter persons, in particular children, the detection will not be reliable. The buckle-up request also does not respond or only in a limited way if child seats and seat supports are used.

- Always ensure that all vehicle occupants, especially children, have fastened their seat belts properly.

### Frontal collisions and the laws of physics

📖 Please refer to ⚠ at the start of the chapter on page 36.



Fig. 21 Unbelted occupants in a vehicle heading for a brick wall.



Fig. 22 Unbelted occupants in a vehicle heading for a brick wall.

The physical principles involved in a frontal collision are relatively simple. As soon as the



vehicle is in motion, both the moving vehicle and its occupants gain “kinetic energy” → Fig. 21.

The higher the vehicle speed and the heavier the weight of the vehicle, the greater the amount of energy that will be released in the event of an accident.

However, the most significant factor is the speed of the vehicle. For example, if the speed doubles from around 25 km/h to around 50 km/h (around 15 mph to around 31 mph), the kinetic energy increases by a factor of four.

The amount of kinetic energy depends on the speed of the vehicle and the weight of the vehicle and passengers. The higher the speed and the heavier the weight, the greater the amount of energy that will be released in the event of an accident.

Passengers not wearing seat belts are not “connected” to the vehicle. In the event of a frontal collision, they will continue to move forwards at the same speed at which the vehicle was travelling before impact, until something stops them. Because the passengers in our example are not restrained by seat belts, the entire amount of kinetic energy will only be released at the point of impact against the wall → Fig. 22.

In the event of an accident at speeds between around 30 km/h (around 19 mph) and around 50 km/h (around 31 mph), forces act on the body which can easily exceed one tonne (1,000 kg or around 2,200 lbs). These forces are even greater at higher speeds.

This example applies not only to frontal collisions, but to all accidents and collisions.

## What happens to vehicle occupants who have not fastened their seat belts

📖 Please refer to ⚠ at the start of the chapter on page 36.



Fig. 23 An unbelted driver is thrown forwards.



Fig. 24 The unbelted rear passenger is thrown forwards, hitting the belted driver.

Many people believe that they can brace their weight with their hands in a minor collision. This is not true.

Even at low speeds, the forces acting on the body in a collision are so great that it is not possible to brace oneself with arms and hands. In a frontal collision, vehicle occupants who have not fastened their seat belts will be thrown forward and will make unchecked contact with parts of the vehicle in-

terior, e.g. the steering wheel, dash panel, or windscreen → Fig. 23.

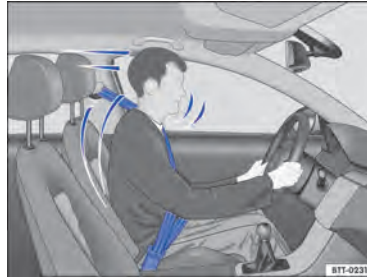
The airbag system is not a substitute for the seat belts. When triggered, the airbags only provide additional protection. Airbags are not triggered in all kinds of accidents. Even if the vehicle is equipped with an airbag system, all vehicle occupants, including the driver, must fasten their seat belt and wear it correctly while the vehicle is in motion. This reduces the risk of severe or fatal injuries in the event of an accident – regardless of whether an airbag is fitted for the seat.

Each airbag can only be triggered once. To achieve best possible protection, seat belts must always be worn properly. This also ensures that protection is provided in accidents in which the airbag is not triggered. Any vehicle occupants not wearing a seat belt can be thrown out of the vehicle and sustain more severe or even fatal injuries as a result.

It is also important for the rear seat occupants to wear seat belts properly, as they could otherwise be thrown forwards violently in an accident. Rear passengers who are not wearing seat belts endanger not only themselves and the driver, but also other people in the vehicle → Fig. 24. ◀

## Seat belt protection

📖 Please refer to ⚠ at the start of the chapter on page 36.



**Fig. 25** Driver restrained by a properly positioned seat belt during a sudden braking manoeuvre.

Correctly fastened seat belts can make a major difference. When fastened properly, seat belts hold the vehicle occupants in the correct sitting positions and considerably reduce the kinetic energy in the event of an accident. Seat belts also help to prevent uncontrolled movements that could lead to severe injuries. In addition, wearing seat belts properly reduces the risk of being thrown from the vehicle → Fig. 25.

Passengers wearing seat belts correctly benefit greatly from the ability of the belts to reduce the kinetic energy. The front crumple zones and other passive safety features (such as the airbag system) are also designed to reduce kinetic energy. The amount of energy generated will thus decrease, thereby reducing the risk of injury.

The examples describe frontal collisions. Of course, properly worn seat belts substantially reduce the risk of injury in all other types of accidents. This is why seat belts must be fastened before every trip – even if you are only planning to drive a very short distance. Ensure that all passengers also wear their seat belts properly.

Accident statistics have shown properly worn seat belts to be an effective means of substantially reducing the risk of injury and improving the chances of survival in a serious accident. Furthermore, properly worn seat belts improve the protection provided by airbags in the event of an accident. This is why wearing a seat belt is a legal requirement in most countries.

Although the vehicle is equipped with airbags, the seat belts must be fastened and worn. For example, the front airbags will be triggered only in certain types of frontal collision. The front airbags will not be triggered during minor frontal collisions, minor side collisions, rear collisions, rolls or accidents in which the airbag trigger threshold in the control unit is not exceeded. The same applies to the other airbags in the vehicle.

Therefore, always wear your seat belt and ensure that your passengers have fastened their seat belts properly before you drive off. <

## Using seat belts

📖 Please refer to ⚠ at the start of the chapter on page 36.

### Checklist

Using the seat belts → ⚠:

- ✓ Check the condition of all seat belts regularly.
- ✓ Keep the seat belts clean.
- ✓ Avoid allowing any foreign bodies or fluids to get on to the seat belt or latch plate or into the slot for the seat belt buckle.
- ✓ Do not trap or damage the seat belt and latch plate, for example when closing the door.
- ✓ Never remove, modify or repair the seat belt or any part of the belt fixture system.

- ✓ Always fasten the seat belt correctly before every journey and keep it fastened while the vehicle is in motion.

### Twisted seat belt

If it is difficult to remove the seat belt from the belt guide, the seat belt may have become twisted if it was returned too quickly into the side trim:

- Take hold of the latch plate then slowly and carefully pull out the seat belt.
- Untwist the seat belt and guide it back slowly by hand.

Fasten the seat belt even if you are unable to undo the twist. However, the twist should not be in part of the seat belt that comes into direct contact with the body. The twist should be corrected immediately by a qualified workshop.

### ⚠ WARNING

Using seat belts incorrectly increases the risk of severe or fatal injuries.

- Regularly check to see if the seat belt and its related parts are in perfect condition.
- Always keep the seat belt clean.
- Do not allow the belt webbing to become jammed, damaged or to rub on any sharp edges.
- Always keep the latch plate and slot in the buckle free from foreign bodies and liquids. <

## Fastening and unfastening seat belts

📖 Please refer to ⚠ at the start of the chapter on page 36.

If worn properly, seat belts hold the vehicle occupants in the correct sitting position during an accident or braking manoeuvre, providing maximum protection → ⚠.



In vehicles with a proactive occupant protection system, the driver and front passenger seat belts are automatically tensioned in certain situations → page 45.

### Fastening the seat belts

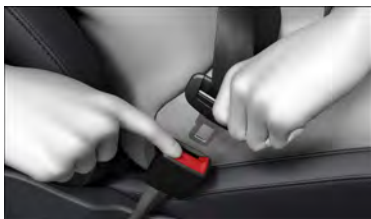


**Fig. 26** Inserting the seat belt latch plate into the buckle.


Fasten seat belts before every trip.

- Adjust the front seat and head restraint correctly → page 34.
- Engage the seat backrest in an upright position → .
- Take hold of the belt and pull it evenly across your chest and pelvis. Do **not** twist the belt in the process → .
- Insert the latch plate securely into the buckle belonging to the occupied seat → Fig. 26.
- Pull on the seat belt to ensure that the latch plate is securely locked in the buckle.

### Unfastening the seat belts



**Fig. 27** Removing the latch plate from the buckle.

Unfasten seat belts only when the vehicle is stationary → .


- Press the red button in the buckle → Fig. 27. The latch plate is released and springs out.
- Guide the belt back by hand so that it rolls up easily, without twisting the seat belt and without damaging the trim.

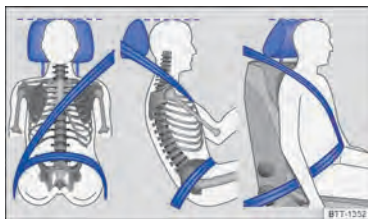
### WARNING

Incorrect seat belt routing can cause severe or fatal injuries in the event of an accident.

- The seat belts only offer best protection when the backrests are in an upright position and the seat belts have been fastened properly according to the occupant's height.
- Unfastening seat belts while the vehicle is in motion can lead to severe or fatal injuries in the event of an accident or sudden braking manoeuvre.

### Seat belt routing

 Please refer to  at the start of the chapter on page 36.



**Fig. 28** Correct seat belt routing and head restraint adjustment.



**Fig. 29** Correct seat belt routing during pregnancy.

Seat belts only provide an optimum level of protection during an accident when they are routed correctly. Correct seat belt routing reduces the risk of severe or fatal injuries. Correct seat belt routing also holds the vehicle occupants in position so that an inflating air-bag can offer the maximum level of protection. Therefore you must always fasten your seat belt and ensure that the seat belt routing is correct → [Fig. 28](#).

Assuming an incorrect sitting position can cause severe or fatal injuries → page 34.

#### Correct seat belt routing

- The shoulder belt must always lie on the centre of the shoulder, never across the neck, over or under the arm or behind the back.
- The lap belt must always lie across the pelvis, never across the stomach.
- The seat belt must always lie flat and snugly on the body. Tighten the belt if necessary.

For **pregnant women**, the seat belt must be positioned evenly over the chest and as low as possible over the pelvis. It must lie flat so that no pressure is exerted on the lower body – this applies for the entire course of the pregnancy → [Fig. 29](#).

#### Correct seat belt routing according to height

The following equipment can be used to adjust the seat belt routing:

- Seat belt height adjuster for the front seats → page 44.
- Height-adjustable front seats → page 34.

### **! WARNING**

Incorrect seat belt routing can cause severe injuries in the event of an accident or a sudden braking or driving manoeuvre.

- The seat belts only offer best protection when the backrests are in an upright position and the seat belts have been fastened properly.
- The seat belt itself or a loose seat belt can cause serious injuries if the seat belt shifts from harder body parts in the direction of softer body parts (e.g. stomach).
- The shoulder part of the seat belt must lie on the centre of the shoulder and never under the arm or across the neck.
- The seat belt must lie flat and snugly on the chest.
- The lap part of the seat belt must lie across the pelvis and never across the stomach. The seat belt must lie flat and snugly on the pelvis. Tighten the belt if necessary.
- For pregnant women, the lap part of the seat belt must be as low as possible over the pelvis and lie flat around the “bulge” of the belly.
- Do not twist the belt webbing while the seat belt is being worn.
- Never hold the seat belt away from the body by hand.
- The belt webbing should not lie over hard or fragile objects, such as glasses, pens or keys.
- Never use seat belt clips, retaining rings or similar items to alter the seat belt routing.

**i** If a person's physical build prevents them from routing the seat belt properly, contact a qualified workshop to find out about any special modifications so that the

seat belts and airbags can provide the optimum level of protection. Volkswagen recommends using a Volkswagen dealership for this purpose.

## Seat belt height adjuster

📖 Please refer to ⚠️ at the start of the chapter on page 36.



**Fig. 30** Next to the front seats: belt height adjuster.

The seat belt height adjusters for the front seats can be used to adjust the position of the seat belt on the shoulder so that it can be fastened properly:

- Push the shoulder belt guide together in the direction of the arrows and hold → Fig. 30.
- Push the shoulder belt guide up or down so that the seat belt is routed over the middle of the shoulder → page 42.
- Let go of the shoulder belt guide.
- Pull sharply on the seat belt to check whether the shoulder belt guide is engaged securely.

### ⚠️ WARNING

Never adjust the seat belt height when the vehicle is in motion.

## Belt retractor, belt tensioner, belt tension limiter

📖 Please refer to ⚠️ at the start of the chapter on page 36.

The safety belts in the vehicle are part of the vehicle safety concept → page 47. The vehicle safety concept has the following important functions:

### Belt retractor

The seat belts on the driver seat and front passenger seat, as well as those on the outer rear seats (and on the middle rear seat, depending on the level of vehicle equipment), are fitted with an automatic belt retractor at the shoulder part of the seat belt. Full freedom of movement is ensured when the shoulder belt is pulled slowly or when the vehicle is travelling at normal speeds. However, if the belt is pulled out quickly or during sudden braking, during travel in mountains or bends and during acceleration, the belt retractor blocks the seat belt.

Fastened seat belts on the front seats may be tensioned automatically by the proactive occupant protection system in critical situations, for example during an emergency stop or in the event of oversteering or understeering. Both seat belts are slackened again if the accident does not happen, or when the critical situation has passed. The proactive occupant protection system is ready to be triggered again → page 45.

### Belt tensioner

The seat belts for the front seat vehicle occupants, and, depending on the vehicle equipment, those on the outer rear seats, are equipped with belt tensioners.

The belt tensioners are activated by sensors during severe frontal, side and rear collisions and also possibly vehicle rollovers. They tighten the seat belts against the direction in which they are pulled. Any slack in the seat belt is tightened. This can reduce the forward movement of the vehicle occupants and their movement in the direction of the impact. The

belt tensioner works together with the airbag system. If the vehicle rolls over, the belt tensioner will not be activated if the curtain airbags are not triggered.

A fine dust may be produced when the airbags are triggered. This is quite normal and does not mean that there is a fire in the vehicle.

### Reversible belt tensioning (proactive occupant protection system)

Reversible belt tensioning may trigger in certain driving situations → page 45. Examples include:

- Strong braking.
- Oversteer or understeer.
- Minor collisions.



The reversible belt tensioners may remain continuously tensioned after certain driving situations. In this case, the seat belts must be manually unfastened when the vehicle is stationary and then fastened correctly again in order to release the belt tensioning.

### Belt tension limiter

The belt tension limiter reduces the pressure exerted by the seat belt on the body during an accident.



All safety requirements must be observed when the vehicle or components of the system are scrapped. Qualified workshops are familiar with these requirements → page 45.

## Service and disposal of belt tensioners

Please refer to at the start of the chapter on page 36.

Seat belts may become damaged during any work on the belt tensioners or while removing or refitting any vehicle parts in conjunction with any other repair work. This damage

will not always be noticeable. The consequence may be that the belt tensioners could function incorrectly, or not function at all, in the event of an accident.

Regulations must be observed to ensure that the effectiveness of the belt tensioner is not reduced and that removed parts do not cause any injuries or environmental pollution. Qualified workshops are familiar with these requirements.

### WARNING

The risk of severe or fatal injuries may be increased if the seat belts, automatic belt retractors and belt tensioners are not used correctly, or if they are repaired by a non-professional. As a result, the belt tensioners may not be triggered when they should, or they may be triggered unexpectedly.

- Any repairs, adjustments or removal and refitting of parts in the belt tensioners or seat belts should always be carried out by a qualified workshop and never by you yourself → page 362.
- Seat belts, belt tensioners and automatic belt retractors cannot be repaired. They must be replaced.



The airbag modules and belt tensioners may contain perchlorate. Please comply with legislation regarding disposal.

## Proactive occupant protection system

### Introduction to the topic

The proactive occupant protection system is an assistance system that initiates action to protect vehicle occupants in dangerous situations. However, the system cannot prevent a collision.

## Speed range

The basic function of the proactive occupant protection system is available when driving forwards at speeds from approx. 30 km/h (19 mph).

## Displays



In the event of intervention by the proactive occupant protection system, the red warning lamp lights up on the instrument cluster display.

## ⚠ WARNING

The intelligent proactive occupant protection system cannot overcome the laws of physics, and functions only within the limits of the system. Never let the extra convenience afforded by the proactive occupant protection system tempt you into taking any risks when driving. The system cannot prevent a collision. The system is not a substitute for the full concentration of the driver.

- Adapt your speed and distance from the vehicles ahead to suit visibility, weather, road and traffic conditions.
- The system cannot detect objects in all situations.
- The proactive occupant protection system does not react to animals or poorly visible objects.
- Reflective objects such as safety barriers, tunnel entrances, heavy rain and ice can impair the performance of the proactive occupant protection system and thus prevent it from detecting a collision risk.
- The system may be falsely triggered.

## Functions of the proactive occupant protection system

📖 Please refer to ⚠ at the start of the chapter on page 45.

### Basic functions

The following functions may be triggered individually or together in critical driving situations, e.g. in the event of emergency braking, understeer and oversteer or minor collisions:

- Reversible belt tensioning of the fastened driver and front passenger seat belts.
- Depending on the vehicle equipment, automatic closing of the side windows down to a small gap.
- Activation of the hazard warning lights.

The belts may be tensioned individually or together depending on the respective critical driving situations.

### Additional functions for vehicles with Autonomous Emergency Braking (Front Assist)

For vehicles with Autonomous Emergency Braking (Front Assist), the system limits also include calculation of the probability of a rear-end collision with the vehicle in front. If the system detects that a rear-end collision is likely, or initiates severe braking, it can trigger the proactive occupant protection system.

### Additional functions for vehicles with Emergency Assist

The proactive occupant protection system may be triggered in vehicles with Emergency Assist if no driver activity is detected.

Depending on the activation level, the following functions are triggered:

- Reversible belt tensioning of the driver's fastened seat belt for a brief or extended period of time.
- Depending on the vehicle equipment, automatic closing of the side windows down to a small gap.



### Setting in driving profile selection

In vehicles with driving profile selection, the proactive occupant protection system is adapted to the special vehicle setup of the respective driving profile.

## Limits of the proactive occupant protection system



 Please refer to  at the start of the chapter on page 45.

The availability of the proactive occupant protection system depends on country-specific legal regulations and the vehicle equipment.

The proactive occupant protection system will not be available, or will only be available to a limited extent, in the following situations:

- Malfunction in the ESC, reversible belt tensioners → page 36 or airbag control unit → page 47.
- ASR deactivated or ESC restricted → page 189.
- System fault or restriction of Autonomous Emergency Braking (Front Assist).
- System fault or restriction of Emergency Assist.
- Reverse gear engaged.

## Troubleshooting

 Please refer to  at the start of the chapter on page 45.

**A message is shown for a short time on the instrument cluster display.**

- The proactive occupant protection system functions are restricted or the system is not available. Deactivate and reactivate the vehicle's drive system.

- If the fault persists, go to a qualified workshop and have the proactive occupant protection system checked.



Depending on the malfunction, additional information may be displayed in the vehicle status → page 30.

## Airbag system

### Introduction to the topic

The vehicle is equipped with a front airbag for the driver and front passenger. The front airbags can provide front seat occupants with additional chest and head protection if the seat, seat belts, head restraints and, in the case of the driver, steering wheel are adjusted and used correctly. Airbags are meant only for additional protection. The airbags are not a substitute for seat belts. Seat belts must always be worn, even when the front seats are equipped with front airbags.

### WARNING

Never rely solely on the airbag system for your protection.

- Even if an airbag is triggered, it only offers auxiliary protection.
- The airbag system offers the best level of protection, and reduces the risk of injury, when seat belts are properly worn → page 36.
- Before every trip, each vehicle occupant must adopt the correct sitting position, correctly fasten the seat belt belonging to their seat and keep it fastened properly throughout the trip. This applies to all vehicle occupants and also in urban traffic.

### WARNING

The risk of injury increases if there are any objects between the vehicle occupants and the deployment area of the airbag when it is triggered. This will alter the deployment

zone of the airbag, or the objects will be flung against the body.

- Never hold any objects in your hand or on your lap while the vehicle is in motion.
- Never transport any objects on the front passenger seat. The objects could enter the deployment zone of the airbag during sudden braking or driving manoeuvres and then be flung dangerously through the vehicle interior if the airbag is activated.
- There must be no other persons, animals or objects between the vehicle occupants sitting on the front seats and rear outer seats and the deployment zones of the airbags. Ensure that children and adults keep to this rule.

### WARNING

The airbag system can only be triggered once. The system will have to be replaced if the airbags have been triggered.

- Airbags that have been triggered, and any affected system parts, must immediately be replaced with new parts that are approved by Volkswagen for the vehicle.
- Repairs and modifications to your vehicle should only be carried out by a qualified workshop. Qualified workshops have the necessary tools, diagnostic equipment, repair information and qualified personnel.
- Never use recycled airbag components or components that have been taken from end-of-life vehicles in your vehicle.
- Never alter any components of the airbag system.

### WARNING

Fine dust particles or steam may be released when the airbags are triggered. This is normal and does not mean that there is a fire in the vehicle.

- The fine dust can cause irritation to the skin and eye membranes and cause

breathing difficulties, particularly for people suffering from asthma or people who have (had) other respiratory problems. To help reduce breathing difficulties, get out of the vehicle or open the windows or doors for more fresh air.

- If you come into contact with the dust, you should wash your hands and face with a mild soap and water before eating.
- Do not let the dust get into your eyes or into open wounds.
- If dust has entered your eyes, rinse them with water.

### WARNING

Cleaning agents that contain solvents cause the surface of the airbag modules to become porous. In an accident that triggers the airbag, loose plastic parts can cause serious injury.

- Never clean the dash panel or the airbag covers with cleaning agents that contain solvents.

## Type of front passenger front airbag system

 Please refer to  at the start of the chapter on page 47.

Volkswagen offers two different front passenger front airbag systems.


Depending on the vehicle equipment, an **airbag system** or an **airbag system with front passenger front airbag deactivation** may be installed.

### Airbag system

The front passenger front airbag can be deactivated only by a qualified workshop.

Characteristics of the airbag system:




- Front passenger front airbag in the dash panel.

- Yellow indicator lamp  in the instrument cluster display.



### Airbag system with front passenger front airbag deactivation

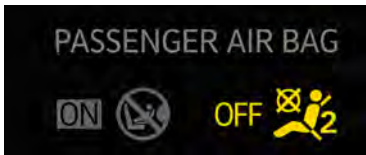
The front passenger front airbag can be deactivated manually by means of a key-operated switch → page 53.

Characteristics of the airbag system with front passenger front airbag deactivation:

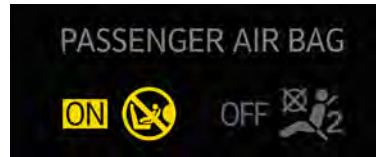
- Front passenger front airbag in the dash panel.
- Yellow indicator lamp  in the instrument cluster display.
- Yellow indicator lamp PASSENGER AIR BAG **OFF**  in the roof console.
- Yellow indicator lamp PASSENGER AIR BAG **ON**  in the roof console.
- Key-operated switch in the side of the dash panel on the passenger side (only visible when the front passenger door is open).

## Indicator lamp


 Please refer to  at the start of the chapter on page 47.





**Fig. 31** In the roof console: indicator lamp (schematic diagram) for deactivated front passenger front airbag.






**Fig. 32** In the roof console: indicator lamp (schematic diagram) for activated front passenger front airbag.

 The yellow indicator lamp in the instrument cluster display lights up briefly as a functional check when the ignition is switched on and goes out after a few seconds.

**OFF**  Front passenger front airbag switched off. The yellow indicator lamp in the roof console lights up continuously → Fig. 31.

**ON**  Front passenger front airbag switched on. The yellow indicator lamp in the roof console will go out automatically approximately 60 seconds after the ignition is switched on or after the front passenger front airbag is switched on using the key-operated switch → Fig. 32.

If the front passenger front airbag is **switched off** and the yellow PASSENGER AIR BAG indicator lamp **OFF**  in the roof console **does not light up continuously** or lights up together with the yellow  indicator lamp in the instrument cluster display, there may be a fault in the airbag system → .

## WARNING

If there is a fault in the airbag system, the airbag may not trigger correctly, may not trigger at all or may trigger unexpectedly. This can cause severe or fatal injuries.

- The airbag system should be checked by a qualified workshop as soon as possible.
- Never fit a child seat on the front passenger seat. Remove a fitted child seat!

The front passenger front airbag may trigger during an accident in spite of the fault.

## Troubleshooting

📖 Please refer to  at the start of the chapter on page 47.



### Fault in airbag or belt tensioner system

The yellow indicator lamp lights up continuously. In addition, a message may be displayed in the instrument cluster.

A malfunction has been detected in at least one airbag or belt tensioner.

- Go to a qualified workshop.
- Have the airbag system and belt tensioner system checked.



### Airbag system or belt tensioner system deactivated with diagnostic tool

The yellow indicator lamp lights up for around four seconds when the ignition is switched on and then flashes for around twelve seconds. In addition, a message may be displayed in the instrument cluster.

At least one airbag or belt tensioner was deactivated with a diagnostic tool.

- Go to a qualified workshop.
- Have a check carried out to establish whether the airbag or belt tensioner system must remain switched off.

## OFF Front passenger front airbag switched off

The yellow indicator lamp for the deactivated front passenger front airbag lights up continuously.

The front passenger front airbag has been switched off.

- Check whether the front passenger front airbag must remain switched off, e.g. when using a child seat on the front passenger seat.


## ON Front passenger front airbag switched on

The yellow indicator lamp for the activated front passenger front airbag lights up for around 60 seconds after the ignition has been switched on or after switching on the front passenger front airbag with the key-operated switch.

The front passenger front airbag has been switched on.

- Check whether the front passenger front airbag must remain switched on.

## Description and function of the airbags

📖 Please refer to  at the start of the chapter on page 47.

The airbags can protect vehicle occupants during frontal and side collisions by reducing their movement in the direction of the collision.


When an airbag is triggered, it is inflated by a gas generator. This causes the airbag covers to break, and the airbags inflate forcefully to cover their deployment zones within milliseconds. Once a vehicle occupant wearing a seat belt starts to sink into the inflated airbag, the gas inside the airbag starts to escape to cushion the occupant and slow down their movement. This can reduce the risk of severe and fatal injuries. A triggered airbag will not always prevent other injuries from occurring, such as swelling, bruising, burning and grazing. The deployment of the airbag can also produce frictional heat.

Airbags provide no protection for the arms or lower body.

The most important factors for triggering the airbag are the type of accident, the angle of impact, the vehicle speed and the type of object with which the vehicle collides. Therefore, visible damage to the vehicle does not always mean that the airbag should have been triggered.

Whether or not the airbag triggers is determined by the vehicle deceleration rate caused by the collision and registered by the electronic control unit. If this rate is below the reference value programmed into the control unit, the airbags will not be triggered, even though the vehicle may be badly damaged as a result of the collision. Vehicle damage, repair costs or even the lack of vehicle damage in an accident do not necessarily give an indication of whether an airbag should inflate or not. It is not possible to define a range of vehicle speeds and reference values, since the circumstances will vary considerably between one collision and another. It is therefore impossible to cover every possible kind and angle of impact that would trigger the airbags. Important factors in the triggering of the airbag include the nature (hard or soft) of the object that the vehicle hits, the angle of impact, and the vehicle speed.





Airbags only serve as a supplement to the three-point seat belt in some accident situations when the vehicle deceleration is sufficient to trigger the airbags. Airbags can only be triggered once and only in certain situations. The seat belts are always there to provide protection in situations where airbags are not normally triggered or where they have already been triggered, for example if the vehicle collides with another vehicle after the first collision or is hit by another vehicle.

The airbag system is part of the vehicle's overall passive safety concept. The airbag system can only work effectively when the occupants are wearing their seat belts correctly and have assumed a proper sitting position  → page 34.

#### Components of the vehicle safety concept

The following vehicle safety equipment makes up the vehicle's safety concept to reduce the risk of severe and fatal injuries. Some of this equipment may not be fitted in your particular vehicle. It may not be available at all in some countries.

- Optimised seat belts for all seats.

- Belt tensioners for the driver and front passenger and also on the rear outer seats if in conjunction with side airbags.
- Belt tension limiter for the driver, front passenger and, if applicable, for the rear outer seats.
- Red warning lamp  and, where applicable, belt status display.
- Front airbags for driver and front passenger.
- Side airbags for driver and front passenger.
- Curtain airbags on the left and right.
- Central airbag between driver and front passenger.
- Yellow airbag indicator lamp .
- Yellow indicator lamp PASSENGER AIR BAG **OFF**  in the roof console.
- Yellow indicator lamp PASSENGER AIR BAG **ON**  in the roof console.
- Control units and sensors.
- Safety-optimised and height-adjustable head restraints.
- Adjustable steering column.
- If applicable, anchor points for child seats on the rear outer seats and on the front passenger seat.
- If fitted, mounting points for the top tether for child seats.

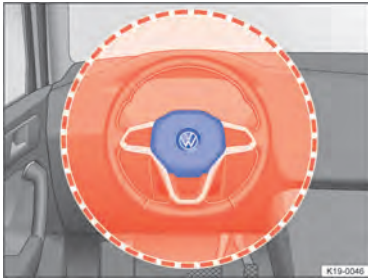
#### Situations when the front, side, curtain and central airbags will not be triggered:

- When the ignition is switched off during a collision.
- If the level of deceleration measured by the control unit is too low during a collision at the front of the vehicle.
- During a slight side collision.
- During a rear-end collision.
- If the dynamics measured by the control unit are too low in the event of a vehicle rollover.

- If the impact speed in a collision is lower than the reference value specified in the control unit.

## Front airbags

📖 Please refer to ⚠️ at the start of the chapter on page 47.



**Fig. 33** Location and deployment zone of the driver front airbag.



**Fig. 34** Location and deployment zone of the front passenger front airbag.

In conjunction with the seat belts, the front airbag system gives the front occupants additional protection for the head and chest in the event of a severe frontal collision. The curtain airbags on both sides are also triggered in the event of certain types of frontal collision.

Always keep as far away from the front airbag as possible → page 34. This allows the front airbags to inflate fully when triggered, thus providing maximum protection.

The front airbag for the driver is located in the steering wheel → Fig. 33 and the front airbag for the front passenger is located in the dash panel → Fig. 34. The airbag locations are identified by the text "AIRBAG".

The areas inside the red lines are covered by the front airbags when deployed (deployment zone). You must never leave or attach any objects in these areas → ⚠️. Any factory-fitted accessories will not be struck if the driver and front passenger front airbags are deployed.

### ⚠️ DANGER

Once triggered, the airbag inflates in fractions of a second at very high speed.

- Always leave the deployment zones of the front airbags clear.
- Never attach any objects, such as drink or telephone holders, to the covers of the airbags or anywhere in the airbag deployment zone.
- There must be no other people, animals or objects between the occupants of the front seats and the airbag deployment zones. Ensure that children and adults keep to this rule.
- Do not attach any objects, e.g. mobile navigation devices, to the windscreen above the front airbag on the front passenger side.
- Do not stick things to, cover or otherwise alter the airbag unit in the steering wheel and the surface of the dash panel in the deployment zone of the front passenger's airbag.

### ⚠️ WARNING

The front airbags are deployed in front of the steering wheel → Fig. 33 and dash panel → Fig. 34.

- When driving, always hold the steering wheel with both hands on the outside of

the ring at the 9 o'clock and 3 o'clock positions.

- Adjust the driver seat so that there is at least 25 cm (approximately 10 inches) between your rib cage and the hub of the steering wheel. Contact a qualified workshop if your physical build makes this impracticable.
- Adjust the front passenger seat so that the distance between the passenger and the dash panel is as large as possible.

## Switching the front passenger front airbag on and off

📖 Please refer to ⚠ at the start of the chapter on page 47.



**Fig. 35** In the dash panel on the front passenger side: key-operated switch for deactivating and activating the front airbag on the front passenger side

**The front passenger front airbag must be deactivated if you fit a rear-facing child seat on the front passenger seat.**

### Switching on the front passenger front airbag

- Deactivate the vehicle's drive system.
- Open the door on the front passenger side.
- Remove the spare key from the vehicle key.
- Insert the key bit of the spare key into the key-operated switch on the dash panel until you feel the second point of resistance

→ Fig. 35. Around three quarters of the key bit should be inserted in the key switch at this point → ①.

- Turn the spare key without using force to the position **ON**.
- Remove the spare key from the key-operated switch and insert it back into the vehicle key → ①.

The yellow PASSENGER AIR BAG indicator lamp **ON** in the roof console lights up and goes out after approximately 60 seconds → page 49.

- Close the door on the front passenger side.
- Check that the yellow PASSENGER AIR BAG **OFF** indicator lamp in the roof console does *not* light up when the ignition is switched on → page 49.

### Deactivating the front passenger front airbag

- Switch off the ignition.
- Open the door on the front passenger side.
- Remove the spare key from the vehicle key.
- Insert the key bit of the spare key into the key-operated switch on the dash panel until you feel the second point of resistance → Fig. 35. Around three quarters of the key bit should be inserted in the key switch at this point → ①.
- Turn the spare key without using force to the position **OFF**.
- Remove the spare key from the key-operated switch and insert it back into the vehicle key → ①.
- Close the door on the front passenger side.

The yellow PASSENGER AIR BAG **OFF** indicator lamp in the roof console lights up continuously when the ignition is switched on → page 49.

### Confirmation that the front passenger front airbag has been deactivated

A deactivated front passenger front airbag is indicated **only** by a continuously lit PASSENGER AIR BAG OFF indicator lamp (OFF indicator lights up yellow continuously) → page 49.

If the yellow PASSENGER AIR BAG OFF indicator lamp **does not light up continuously** or lights up together with the yellow indicator lamp in the instrument cluster display, no child restraint system must be fitted on the front passenger seat for safety reasons. The front passenger front airbag may trigger during an accident.

### ⚠ WARNING

The front passenger front airbag should only be switched off in exceptional circumstances.

- To prevent damage to the airbag system, only switch the front passenger front airbag on and off when the ignition is switched off.
- It is the driver's responsibility to ensure that the key-operated switch is set to the correct position.
- Only switch the front passenger front airbag off if, in exceptional circumstances, a child seat has to be attached to the front passenger seat.
- Switch the front passenger front airbag back on again as soon as the child seat on the front passenger seat is no longer being used.

### ⚠ WARNING

Do not leave the spare key inserted in the key-operated switch while the vehicle is in motion.

- Vibrations in the vehicle could cause the spare key to turn in the key-operated switch, which could then activate the front passenger front airbag.
- The front passenger front airbag could then accidentally inflate, leading to serious or fatal injuries.

### ⚠ NOTICE

If the key bit is not inserted far enough, the key switch could be damaged when the key is turned.

### ⚠ NOTICE

Do not leave the spare key in the key switch, as this could result in damage to the door trim, dash panel, key switch or vehicle key when the front passenger door is closed. ◀

## Side airbags

📖 Please refer to ⚠ at the start of the chapter on page 47.



**Fig. 36** In the interior on the left-hand side of the vehicle: side airbag deployment zone.



**Fig. 37** On the side of the front seat: location and deployment zone of the side airbag.



Side airbags are installed for the front seats → Fig. 36. The side airbags are located in the outer seat backrest cushions of the driver seat and front passenger seat → Fig. 37.

The locations of the side airbags are indicated by the "AIRBAG" label.

The areas outlined in red are inside the deployment area of the side airbags → Fig. 36 and → Fig. 37. You must never leave or attach any objects in these areas → ⚠.

In the event of a side collision, the side airbags will be deployed on the side of the vehicle which is impacted, thus reducing the risk of injury to the areas of the occupants' bodies facing the impact. The curtain airbags on both sides are also triggered.

### ⚠ WARNING

Once triggered, the airbag inflates in fractions of a second at very high speed.

- Always leave the deployment zones of the side airbags clear.
- There must be no other people, animals or objects between the occupants of the front seats and the airbag deployment zones. Ensure that children and passengers keep to this rule.
- The coat hooks in the vehicle should only be used for lightweight clothing. Do not leave any heavy or sharp objects in the pockets.
- Do not fit any accessories to the doors.
- Do not fit seat covers or protective covers over the seats unless they have been expressly approved for use in the vehicle. Otherwise the side airbag may not be able to inflate once triggered.

### ⚠ WARNING

Incorrect use of the driver and front passenger seat could hinder the proper function of the side airbag and cause serious injury.

- Never remove the front seats from the vehicle or alter any components of these seats.

- If too much pressure is applied to the backrest side bolsters, the side airbags may not be triggered correctly, may not trigger at all, or may trigger accidentally.
- Any damage to the original seat upholstery or around the seams of the side airbag units must be repaired immediately by a qualified workshop.

## Curtain airbags

📖 Please refer to ⚠ at the start of the chapter on page 47.



**Fig. 38** On the left-hand side of the vehicle: location and deployment zone of the curtain airbag.

Curtain airbags are installed in the vehicle interior above the doors on the driver and front passenger sides → Fig. 38.

The locations of the curtain airbags are indicated by the "AIRBAG" label.

The area in the red frame is covered by the curtain airbag when triggered (deployment zone) → Fig. 38. For this reason, you must never leave or attach any items in this area → ⚠.

The curtain airbags will be triggered on both sides if the vehicle rolls over or in the event of a frontal or side collision.

In rollovers, side collisions and certain types of frontal collision, the curtain airbags reduce the risk of injury for the vehicle occupants on the front seats and rear outer seats.

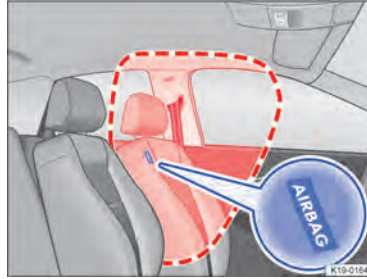
## **⚠ WARNING**

Once triggered, the airbag inflates in fractions of a second at very high speed.

- Always leave the deployment zones of the curtain airbags clear.
- Never secure any items to the cover or in the deployment zone of the curtain airbag.
- There must be no other persons, animals or objects between the vehicle occupants sitting on the front seats and rear outer seats and the deployment zones of the airbags. Ensure that children and passengers keep to this rule.
- The coat hooks in the vehicle should only be used for lightweight clothing. Do not leave any heavy or sharp objects in the pockets.
- Do not fit any accessories to the doors.
- Do not install any sun blinds onto the side windows unless they have been expressly approved for use in your vehicle.
- Only push the sun visors over to the side windows if no items are attached to the visors (e.g. pens or a garage door opener).

## **Central airbag**

📖 Please refer to ⚠ at the start of the chapter on page 47.



**Fig. 39** In the inner backrest padding of the driver seat: central airbag.

The central airbag is installed for the front seats and is located in the inner backrest padding of the driver seat.

The location of the central airbag is indicated by the "AIRBAG" label → Fig. 39.

The area in the red frame is covered by the central airbag when triggered (deployment zone) → Fig. 39. For this reason, you must never leave or attach any items in this area → ⚠.

The central airbag is triggered in the event of a side collision and vehicle rollover and thus reduces the risk of injury to the vehicle occupants.

## **⚠ WARNING**

Once triggered, the airbag inflates in fractions of a second at very high speed.

- Always leave the deployment zones of the central airbag clear.
- Never secure any items on the cover or in the deployment zone of the central airbag.
- There must be no other people, animals or objects between the occupants of the front seats and the airbag deployment

zones. Ensure that children and passengers keep to this rule.

- Do not fit seat covers or protective covers over the seats unless they have been expressly approved for use in the vehicle. Otherwise the central airbag may not be able to inflate once triggered.

### WARNING

Incorrect use of the driver and front passenger seat could hinder the proper function of the central airbag and cause serious injury.

- Never remove the front seats from the vehicle or alter any components of these seats.
- If too much pressure is applied to the backrest side bolsters, the central airbag may not be triggered correctly, may not trigger at all, or may trigger accidentally.
- Any damage to the original seat covers or around the seams of the central airbag unit must be repaired immediately by a qualified workshop.

child seats have been developed and approved for use in Volkswagen vehicles.

For further information on the child seats from the range of accessories, contact a Volkswagen dealership or visit the Volkswagen website.

### WARNING

If children are not secured or are inadequately secured, they are at greater risk of serious or even fatal injury. Please note the following:

- Children who are either under 12 years of age or less than 150 cm (approximately 59 inches) tall must not be carried in the vehicle unless they are secured in a suitable child seat while the vehicle is in motion. Regulations in some countries may differ and must be complied with.
- Always secure children in the vehicle in a suitable child seat. The seat used must be appropriate to the child's height, weight and age.
- Never fasten more than one child into one child seat.
- Under no circumstances should children or babies be held in a passenger's or drivers lap while driving.
- Never leave a child unsupervised in a child seat.
- Never allow a child to be carried in a vehicle without being properly secured, and never allow a child to stand up or to kneel on a seat, or to sit incorrectly while the car is in motion. This is particularly important for children carried on the front passenger seat. In an accident, children may sustain serious injuries to themselves and others.
- The child seat can only provide maximum protection if the seat belt is routed correctly around it. Always ensure that the seat belt is routed as specified in the instructions provided by the child seat manufacturer. If the seat belt is routed

## Safe transport of children

### Introduction to the topic

Using child seats can reduce the risk of injury to the child if there is an accident. Always use child seats when driving with children.

Note the following:

- Child seats are classified into groups depending on the size, age and weight of child for which they are designed.
- Various securing systems are used to secure child seats in the vehicle.

For safety reasons, child seats must always be fitted to the rear seats → page 59.

Volkswagen recommends child seats from the Volkswagen range of accessories. These

incorrectly it may cause injuries even in a minor accident.

- After an accident, it is vital to replace any child seats that were in use during the accident, as they could have sustained non-visible damage.

### NOTICE

Please observe the notes and information for vehicles with N1 approval → page 373, *Information about vehicles with N1 approval (light commercial vehicle)*.

## Types of child seat

📖 Please refer to ⚠️ and ⓘ at the start of the chapter on page 57.

Only use child seats that have been officially approved and are suitable for the child.

### Standards for child seats

In the user states, child seats are subject to the regulations ECE R 44 or ECE R 129 → page 58, *Standards for child seats*. Both regulations apply simultaneously. Child seats which have been tested in accordance with these standards carry an orange ECE approval label. This ECE approval label may include the following information on the child seat:

- Weight class.
- Size class.
- Approval category (universal, semi-universal, vehicle-specific or i-Size).
- Approval number.

On child seats that are approved under regulation ECE R 44, the eight-digit approval number on the ECE approval label must begin with 03 or 04. This shows that the seat is admissible for use. Older child seats with an approval number beginning with 01 or 02 are not admissible.

### Child seat weight classes



Fig. 40 Example illustrations of child seats.

Class	Child's weight
Group 0	up to 10 kg
Group 0+	up to 13 kg
Group 1	9 to 18 kg
Group 2	15 to 25 kg
Group 3	22 to 36 kg

- **Weight class 0/0+:** group 0/0+ or 0/1 rear-facing infant carriers → Fig. 40 are the best option for the period from birth to about 18 months.
- **Weight class 1:** group 1 (up to about four years old) and group 1/2 (up to about seven years old) with an integral belt system are best for children over the relevant weight limit.
- **Weight classes 2/3:** groups 2 and 3 include child seats with a backrest, and booster seats with no backrest. Child seats with a backrest have integrated seat routing and side padding, and so provide better protection than booster seats with no backrest. Volkswagen therefore recommends the use of child seats with a backrest. Group 2 child seats are for children up to the age of about seven, group 3 child seats for those older than seven.

Not every child will fit in the child seat specified for their weight group. Likewise, not every seat will fit in every vehicle. Therefore it is vital to check that the child fits properly in their child seat and that the child seat can be securely fastened in the vehicle.

## Child seat approval categories

Child seats can be classified as “universal”, “semi-universal” or vehicle-specific” (all in accordance with regulation ECE R 44) or “i-Size” (in accordance with regulation ECE R 129).

- **Universal:** child seats with “universal” approval are approved for use in all vehicles. No type list is required. ISOFIX child seats with universal approval must be additionally secured using a strap over the top of the vehicle seat (top tether).
- **Semi-universal:** “semi-universal” approval requires other safety devices for attaching the seat (that require additional testing) in addition to the standard requirements for universal approval. Child seats with “semi-universal” approval come with a type list. The seats should only be used in vehicles that are included on this list.
- **Vehicle-specific:** child seats with vehicle specific approval must have undergone dynamic testing in each model of vehicle for which it is approved. These child seats also come with a type list.
- **i-Size:** child seats classified as “i-Size” must conform to the installation and safety requirements prescribed in regulation ECE R 129. Contact the child seat manufacturer to find out whether child seats are approved for this vehicle, and if so which ones, in accordance with i-Size. <

## Installing and using child seats

📖 Please refer to  and  at the start of the chapter on page 57.


### Country-specific regulations

The standards and regulations governing the use of child seats and child seat securing mechanisms differ from country to country. Not all countries allow you to transport children on the front passenger seat. Regulations

and legal requirements take precedence over the information given in this owner's manual.

### Information on fitting a child seat

Observe the following general information when fitting a child seat. This information is relevant whatever child seat securing system is being used.

- Read and follow the instructions provided by the child seat manufacturer → .
- Whenever possible, fit the child seat on the rear bench seat behind the front passenger seat so that children can exit the vehicle on the kerb side.
- Set the seat belt height so that the seat belt routing follows a natural line and is adjusted to the child seat without turning back on itself. For rear-facing child seats, use the lowest position of the belt height adjuster.
- Deactivate the front passenger front air-bag if fitting a rear-facing child seat on the front passenger seat.
- When fitting on the front passenger seat, push the front passenger seat back fully and adjust the seat to the highest position. Adjust the backrest to an upright position → page 34.
- Always ensure that there is enough space around the child seat. If necessary, adjust the position of the seat in front. When doing so, ensure that the driver or front passenger can still maintain a correct sitting position → page 34.
- The backrest of the child seat must lay as flat as possible against the vehicle seat backrest. If required, adjust the seat backrest angle so that the child seat lies flush against the backrest. Once it has been installed, if the child seat is touching the head restraint and therefore cannot be positioned flush against the backrest, push the head restraint all the way up, or remove and stow safely in the vehicle → page 34.

## Airbag sticker



**Fig. 41** Illustration: airbag label on the sun visor.



**Fig. 42** Illustration: airbag label on the B-pillar.

The vehicle may be provided with stickers giving important information about the front passenger front airbag. The information on these stickers may vary from country to country. The stickers may be found:


- On the driver sun visor and in some cases on the front passenger sun visor → [Fig. 41](#).
- On the B-pillar on the front passenger side → [Fig. 42](#).

It is essential to observe the warning information shown on these stickers before installing a rear-facing child seat → [⚠](#).

### Risks involved in carrying children on the front passenger seat

If you are using a **rear-facing child seat**, the front passenger front airbag can cause critical or potentially fatal injuries when it inflates → [⚠](#).

Rear-facing child seats may be used on the front passenger seat only if the front passenger front airbag has been deactivated

→ page 47. A deactivated front passenger front airbag is indicated by means of the continuously lit PASSENGER AIR BAG indicator lamp **OFF**  in the driver's field of vision → page 49.

If using a **front-facing child seat**, do not deactivate the front passenger front airbag. When fitting the child seat, ensure that it is as far away as possible from the front passenger front airbag. The front passenger front airbag can cause severe injuries when it inflates → [⚠](#).

Some child seats are not suitable for use on the front passenger seat. The child seat must be specially authorised by the manufacturer for use on the front passenger seat in vehicles with front and side airbags. Volkswagen dealerships keep an up-to-date list of authorised child seats.

## DANGER

If you use a rear-facing child seat on the front passenger seat, the child in it is at increased risk of sustaining critical or fatal injuries in the event of an accident.

- Deactivate the front passenger front airbag. If the front passenger front airbag cannot be deactivated no rear-facing child seat may be used.
- Move the front passenger seat as far back and as high as it can be adjusted to create the largest possible distance between the child seat and the front passenger front airbag.
- Move the backrest to the upright position.
- Set the seat belt height so that the seat belt routing follows a natural path adapted to the child seat without excessive deviations. For rear-facing child seats, use the lowest position of the belt height adjuster.
- Only use child seats that have been approved by the child seat manufacturer for use on a front passenger seat with front and side airbag.

## WARNING

Child seats present a risk of injury if incorrectly installed.

- Always read and follow the installation instructions and warning information provided by the child seat manufacturer.

## WARNING

Using a front-facing child seat on the front passenger seat presents a risk of injury.

- Move the front passenger seat as far back and as high as it can be adjusted to create the largest possible distance between the child seat and the front passenger front airbag.
- Move the backrest to the upright position.
- Set the seat belt height so that the seat belt routing follows a natural path adapted to the child seat without excessive deviations. For rear-facing child seats, use the lowest position of the belt height adjuster.
- Only use child seats that have been approved by the child seat manufacturer for use on a front passenger seat with front and side airbag.

## WARNING

To avoid injuries caused by inflation of a head airbag or side airbag:

- Ensure that no children are seated within the airbag deployment zones → page 47.
- Do not place any objects in the side airbag deployment zones.

## Securing systems

 Please refer to  and  at the start of the chapter on page 57.

Different countries use different securing systems for safely fitting child seats in the vehicle.


### Overview of securing systems

- **ISOFIX:** ISOFIX is a standardised securing system for fitting child seats in the vehicle quickly and safely. The ISOFIX attachment system creates a rigid connection between the child seat and the car body.

The seat has two rigid attachment arms. The attachment arms engage in ISOFIX attachment points between the seat and the backrest → page 62. Atop tether or a support bracket may sometimes be used in addition to the ISOFIX anchor points described above.

- **Three-point automatic seat belt.** It is better to secure child seats using the ISOFIX system, if available, rather than with a three-point automatic seat belt → page 65.

Additional securing points:

- **Top tether:** the strap at the top of the child seat is routed over the rear seat backrest and hooked to an anchor ring on the back of the rear seats → page 64. Top tether anchor points are marked with an anchor symbol.
- **Support foot:** some child seats are supported by a support foot resting on the floor of the vehicle. This support foot helps prevent the child seat tipping forward in a crash. Child seats with a support foot can only be used on the front passenger seat and the outer rear seats → .

### Recommended child seat securing systems

Volkswagen recommends that child seats are secured as follows:

- **Infant carrier or rear-facing child seat:** ISOFIX and support foot.

- **Front-facing child seat:** ISOFIX *and* top tether and possibly also support foot.

### **WARNING**

Incorrect use of the support foot can cause severe or fatal injuries.

- Ensure that the support foot is always correctly and safely installed.

**Applies only in Australia:**

### **WARNING**

Child restraint anchorages are designed to withstand only those loads imposed by correctly fitted child restraints. Under no circumstances are they to be used for adult seatbelts, harnesses, or for attaching other items or equipment to the vehicle.

## Securing a child seat with ISOFIX/i-Size

 Please refer to  and  at the start of the chapter on page 57.

### Quick guide to ISOFIX and i-Size installation

The identification marking of the ISOFIX or i-Size anchorage points is equipment and country dependent.

The following table shows the installation options for ISOFIX or i-Size child seats at the ISOFIX or i-Size anchorage points of the individual vehicle locations.

Group	Orientation of the child seat	Size class / ISOFIX class	Front passenger seat			
			Front passenger front air-bag activated	Front passenger front air-bag deactivated	Outer seats on the rear bench seat	Centre seat on the rear bench seat
<b>Group 0:</b> up to 10 kg	Rear facing	E/R1	X	IL-SU	IL-SU	X
<b>Group 0+:</b> up to 13 kg	Rear facing	E/R1	X	IL-SU	IL-SU	X
		D/R2 C/R3				
<b>Group 1:</b> 9 to 18 kg	Rear facing	D/R2 C/R3	X	IL-SU	IL-SU	X
	Forward facing	B/F2X	IL-SU, IUF	X	IL-SU, IUF	X
		B1/F2X A/F3				
<b>Group 2:</b> 15 to 25 kg	Forward facing	–	IL-SU	X	IL-SU	X
<b>Group 3:</b> 22 to 36 kg	Forward facing	–	IL-SU	X	IL-SU	X
<b>i-Size child restraint system</b>	Rear facing	–/R2	X	i-U	i-U	X
	Forward facing	–/B2, F2X	i-U	X	i-U	X
<b>Booster seat</b>	Forward facing	–/B2, B3	i-B	X	i-B	X



- **Size class:** the size class shown corresponds to the permissible weight range of the child using the seat. The size class is indicated on the ECE approval label for child seats with “universal” or “semi-universal” approval. A size class indication is affixed to the child seat.
- **X:** seat not suitable for securing an ISOFIX or i-Size child seat in this group.
- **IL-SU:** seat suitable for installing an ISOFIX child seat with “semi-universal” approval. Refer to the vehicle list supplied by the child seat manufacturer.
- **IUF:** seat suitable for installing an ISOFIX child seat with “universal” approval.
- **i-U:** seat suitable for installing a front-facing or rear-facing i-Size child seat with “universal” approval.
- **i-UF:** seat suitable for installing a front-facing i-Size child seat with “universal” approval.
- **i-B:** seat suitable for installing a forward-facing ISOFIX booster seat of Group 2/3 as well as a forward-facing i-Size child seat for children with a height of 100 – 150 cm (approximately 39 – 59 inches).

#### Installing child seats with ISOFIX/i-Size



**Fig. 43** Markings identifying the ISOFIX anchorage points for child seats on the seats of the rear bench seat.



**Fig. 44** Markings identifying the i-Size anchorage points for child seats on the seats of the rear bench seat.



**Fig. 45** Markings identifying the i-Size anchorage points for child seats on the front passenger seat.



**Fig. 46** Illustration: fitting a child seat with the attachment arms.

The location of the ISOFIX or i-Size anchorage points is indicated by a symbol → Fig. 43, → Fig. 44 or → Fig. 45.

- Observe the instructions → page 59.

- Fold down any protective caps that may be fitted on the ISOFIX or i-Size anchor points.
- Push the attachment arms of the child seat in the direction of the arrow onto the ISOFIX or i-Size anchorages → Fig. 46. The child seat must click and audibly securely into place.

- Perform a pull test on both sides of the child seat to check that the child seat is properly engaged.

If the child seat is fitted with a support foot, the foot must stand firmly on the floor of the vehicle. ◀

## Securing child seats with the top tether

📖 Please refer to ⚠️ and ⏱️ at the start of the chapter on page 57.



**Fig. 47** In the luggage compartment: attached top tether.



**Fig. 48** On the rear of the front passenger seat: attached top tether.



**Fig. 49** In the backrest of the Top sports seat on the passenger side: opening for the top tether (schematic diagram).

① Opening for the top tether.

ISOFIX child seats with “universal” approval must be secured with an upper strap (top tether) in addition to the ISOFIX anchor points.

Only secure the strap to the top tether anchor rings provided for this purpose. Anchor rings for use with the top tether are marked by a symbol and sometimes also with “TOP TETHER”.

- Observe the instructions → page 59.
- Push the head restraint on the vehicle seat all the way up or remove it.
- Position the child seat in the centre of the seat cushion.

- Push the attachment arms on the child seat into the ISOFIX anchor points as shown by the arrows → page 62. The child seat must click and audibly securely into place.
- Remove the luggage compartment cover if necessary.
- *Only applies to the Top sports seat:* Feed the top tether through the opening in the backrest → Fig. 49 ①.
- Guide the top tether of the child seat to the rear over the seat and hook it into the corresponding anchor ring labelled “top tether”.
- Tighten the upper strap so that the top of the child seat rests against the rear seat backrest.

**⚠ WARNING**

Only secure the strap to the top tether anchor rings provided for this purpose. Failure to do this could lead to severe injuries.

- Each anchor ring can hold only *one* child seat restraining strap.
- Never fasten the strap on a child seat to any other fastening rings.

ℹ Depending on the market and model, there may be two or three anchor rings in the luggage compartment behind the rear seat backrest. ◀

## Securing a child seat using the seat belt

📖 Please refer to ⚠ and ① at the start of the chapter on page 57.

If you want to fit a child seat from the “universal” (u) approval category in your vehicle, you must first ensure that it is approved for the seat position in question. Relevant infor-

mation is given on the orange ECE approval label of the child seat. Installation options are shown in the table below.

Group	Child's weight	Front passenger seat		Seats on the rear bench seat
		Front passenger front airbag activated	Front passenger front airbag deactivated	
Group 0	up to 10 kg	x	u	u
Group 0+	up to 13 kg	x	u	u
Group 1	Rear facing	x	u	u
	Forward facing	u	x	u
Group 2	15 to 25 kg	u	x	u
Group 3	22 to 36 kg	u	x	u

u: universal; x: seat not suitable for securing a child seat of this group.

### Securing a child seat using the seat belt

- Observe the instructions → page 59.
- Set the seat belt height so that the seat belt routing follows a natural line and is adjusted to the child seat without turning back on itself. For rear-facing child seats, use the lowest position of the belt height adjuster.
- Fasten the seat belt and guide it through the child seat as described in the child seat manufacturer's instructions.
- Ensure that the seat belt is not twisted.

- Insert the latch plate into the buckle for the appropriate seat and push it down until it audibly engages.

Child seats with the approval category "semi-universal" that are secured using a seat belt and support foot must not be fitted on the middle seat of the rear bench seat.


If a child seat of Group 2/3 with backrest is used, additionally use the fourth anchorage point of the child seat for the seat belt. Observe the instructions for use of the child seat.


## In an emergency

### Making you and your vehicle safe

Observe any legislation concerning the safety of a broken-down vehicle. For example, many countries stipulate that you have to switch on the hazard warning lights and wear a high-visibility waistcoat → page 68.

#### Checklist

To ensure your own safety and that of your passengers, observe the following points in the specified order → :

1. Stop the vehicle at a safe distance away from moving traffic and on a suitable surface.
2. Depress and hold the brake pedal.
3. Switch on the hazard warning lights → page 10.
4. Switch on the electronic parking brake → page 177. The vehicle's drive system is deactivated.
5. Deactivate the vehicle's drive system → page 138. The red indicator lamp  lights up in the digital instrument cluster.
6. Take your foot off the brake pedal.
7. Ensure that all occupants exit the vehicle and go to a safe place away from moving traffic, e.g. behind the safety barrier. Take all vehicle keys with you. Observe the country-specific regulations concerning high-visibility waistcoats.
8. Set up the warning triangle to draw the attention of other road users to your vehicle.

9. Seek expert assistance if necessary.

When the hazard warning lights are switched on, for example if you are being towed, you can still indicate a change in direction or lane change by operating the turn signal. The hazard warning lights will be interrupted temporarily.

Comply with the important information on towing → page 304.

**Switch on the hazard warning lights, e.g. in the following situations:**

- When traffic ahead suddenly slows down or you reach the tail end of a traffic jam to warn vehicles behind you.
- When there is an emergency.
- If the vehicle breaks down.
- When the vehicle is being towed.

Always follow local regulations for the use of the hazard warning lights.

If the hazard warning lights are not working, you must use an alternative method of drawing attention to the broken-down vehicle. This method must comply with traffic legislation.

**⚠ WARNING**

Any broken-down vehicle poses a high accident risk for the vehicle occupants and other road users.

- Stop the vehicle as soon as possible and when safe to do so.
- Park the vehicle at a safe distance from moving traffic.
- Switch on the hazard warning lights.
- Never leave other persons alone in the vehicle, particularly children or people requiring assistance. This applies in particular when the doors are locked. People locked in the vehicle may be subjected to very high or very low temperatures.

**⚠ WARNING**

Ignoring any of the items on this important safety checklist can lead to accidents and severe injuries.

- Follow the actions in the checklist and observe the general safety procedures.

**ⓘ NOTICE**

When pushing the vehicle by hand, do not press on the rear lights, the rear spoiler or large panels. This could damage the vehicle and loosen the rear spoiler.



The 12-volt vehicle battery will discharge if the hazard warning lights are left on over a long period of time – even when the ignition is switched off.



Depending on the vehicle equipment, the brake lights flash in quick succession if you brake sharply or initiate full braking at a speed of more than 80 km/h (about 50 mph). This provides an especially conspicuous warning for the following traffic. If you then continue to brake, the hazard warning lights will be switched on automatically at speeds under approximately 10 km/h (6 mph). Once the vehicle starts to accelerate, the hazard warning lights will switch off again.

**What to do in the event of an accident or a fire**

**Checklist of what to do after an accident**

To ensure your own safety and that of your passengers in an accident, observe the following actions in the specified order → ⚠:

- ✓ Deactivate the vehicle's drive system.
- ✓ Switch on the hazard warning lights → page 13.
- ✓ Set up the warning triangle to draw the attention of other road users to your vehicle.

- ✓ If necessary, remove all persons from the hazard area and provide first aid.
- ✓ Report the accident to the fire service. Inform the fire service that the vehicle in question has an electric drive.
- ✓ Wait for the emergency services at the scene of the accident.
- ✓ Inform the emergency services and the persons involved at the scene of the accident that it is an electric vehicle.

#### Checklist of what to do in the event of a fire

To ensure your own safety and that of your passengers in the event of a vehicle fire, observe the following actions in the specified order → ⚠:

- ✓ Deactivate the vehicle's drive system.
- ✓ Switch on the hazard warning lights if possible → page 13.
- ✓ If possible, place the warning triangle in position to draw the attention of other road users to your vehicle.
- ✓ If necessary, remove all persons from the hazard area and provide first aid.
- ✓ Report the fire to the fire service. Inform the fire service that the vehicle in question has an electric drive.
- ✓ Wait for the emergency services at a safe distance.
- ✓ Inform the emergency services and the persons involved at the scene of the accident that it is an electric vehicle.
- ✓ Do not attempt to extinguish the fire yourself.
- ✓ Do not remain near the burning vehicle.

#### ⚠ WARNING

Ignoring any of the items on this important safety checklist can lead to accidents and severe injuries.

- Follow the actions in the checklist and observe the general safety procedures.

#### ⚠ WARNING

In the event of a fire, an explosion and leaking hazardous substances can cause serious injuries.

- Never remain near the burning vehicle.



If the system detects that an accident has happened, the high-voltage battery is automatically deactivated.

- When the high-voltage battery is deactivated, go to a qualified workshop to have the high-voltage battery serviced.

## Emergency equipment

### First-aid kit

Depending on the vehicle equipment, the first-aid kit may be located in a stowage compartment or a holder in the luggage compartment, under the luggage compartment floor or in the vehicle interior.

The first-aid kit must comply with legal requirements. Please observe the use-by date of the contents.

After use, renew contents if necessary and stow the first-aid kit safely again.

### Warning triangle



**Fig. 50** In the boot lid: holder for the warning triangle.

Depending on the equipment, the warning triangle may be located in the boot lid. With

the boot lid open, grasp the warning triangle at the recess and turn by 90° towards the front of the vehicle. Then remove the warning triangle through the opening.

The warning triangle must comply with legal requirements.

Return the warning triangle to its holder after use.

### High-visibility waistcoat

Depending on the vehicle equipment, the high-visibility waistcoat may be located in a stowage compartment in the front door trim or in the glove box → page 9, → page 14.

The high-visibility waistcoat must comply with legal requirements.

### Fire extinguisher

Depending on the vehicle equipment, a fire extinguisher may be located in a holder in the footwell under the front passenger seat.

The fire extinguisher must comply with legal regulations, must always be ready for use and must be checked regularly (see inspection seal on the fire extinguisher).

## ⚠ WARNING


In the event of a sudden driving or braking manoeuvre or accident, loose objects could be flung through the vehicle and cause severe injuries.

- Always secure the first-aid kit, warning triangle and fire extinguisher safely in the holders in the vehicle.
- Stow the high-visibility waistcoat in a stowage compartment so that it is easily accessible.

## Legally required eCall Emergency System



**Fig. 51** In the roof console: control for legally required eCall Emergency System (behind button cover).

 Statutory eCall emergency call system.



**Fig. 52** Control for emergency call: indicator lamp and button.

- ① Indicator lamp.
- ② Button for legally required eCall Emergency System.

Depending on the equipment and country, the vehicle may be equipped with an emergency call system. In some countries, the free legally required eCall Emergency System is activated as standard. The control unit is in the roof console.

The emergency call function enables help to be organised as quickly as possible in danger-






ous situations. A voice connection is established with a public emergency call centre. The call centre communicates in the language of the country in which the vehicle is located. In addition, legally required data relevant for the emergency call are transmitted automatically to the public emergency call centre, such as the current vehicle position.

The legal basis for data processing by the legally required eCall Emergency System corresponds to the country-specific legislation such as the EU Regulation 2015/758. Please also observe the information on data storage and services → page 366.

The required connection is established by a factory-fitted control unit. Additional components are required in order to ensure that the function is still possible even after a serious accident, e.g. emergency call microphone, emergency loudspeaker and an integrated battery that is independent of the vehicle electrical system.

### Indicator lamp for the statutory eCall Emergency System

There is an indicator lamp → Fig. 52 ① in the control. Depending on the operational status of the emergency call system in the vehicle, the indicator lamp lights up in different colours and light sequences:


-  Indicator lamp does not light up: emergency call is not available.
-  Indicator lamp flashes red for about 20 seconds after the ignition has been switched on: emergency call is deactivated.
-  Indicator lamp lights up red continuously: system error. Emergency call is restricted or not available.
-  Indicator lamp lights up green: emergency call is available, system is ready for operation in the vehicle.
-  Indicator lamp flashes green: emergency call is active.

### WARNING

The following conditions may limit or prevent the execution of a manual or automatic emergency call:

- Your current emergency call location is in an area with no or insufficient mobile communications and GPS reception.
- No 2G/3G mobile communications network of telecommunication providers is available in areas with sufficient mobile communications and GPS reception.
- The emergency call system is not available in some countries.
- The public emergency call centre is technically not able to receive emergency call data.
- The components in the vehicle required for the manual or automatic emergency call are damaged or do not have sufficient electrical power.
- The ignition of the vehicle is not switched on.

### Initiating an emergency call manually

- Briefly press on the button cover  and fold open the button cover.
- Press and hold the emergency call button → Fig. 52 ② for several seconds. The emergency call is now initiated and a voice connection is established to the public emergency call centre.

If you have accidentally pressed the emergency call button, cancel the emergency call immediately.

- Press the emergency call button again until the indicator lamp lights up green continuously.

### Automatic emergency call

An automatic emergency call is initiated only when the ignition is switched on.

A connection to the public emergency call centre is established when the airbags or belt tensioners have been triggered. The automatic emergency call **cannot** be cancelled by




pressing the emergency call button  
→ Fig. 52 ②.

Rescue measures will be initiated automatically if there is no response to questions from the public emergency call centre.

### Integrated battery

The integrated battery ensures that the legally required eCall Emergency System remains available for some time if the 12-volt vehicle battery is disconnected or faulty.

A corresponding message will be displayed in the instrument cluster display if the integrated battery is discharged or faulty. If this message is displayed, immediately go to a qualified workshop and have the integrated battery replaced.

 Have the integrated battery checked by a qualified workshop after about 3 years and replaced if necessary.

### Data transmission

In the event of an emergency call, the legally prescribed data are transmitted to the public emergency call centre in order to determine necessary rescue measures.


The data on the vehicle location are continuously overwritten so that only the last three stored locations required for correct functioning of the legally required eCall Emergency System are available. The vehicle is therefore not permanently tracked.

The data relating to the emergency call are processed exclusively in order to ensure correct functioning of the legally required eCall Emergency System. The data related to the emergency call are automatically deleted from the system 13 hours after the emergency call was triggered.

The transmitted data include the following:



- Current position of the vehicle when the emergency call was triggered.
- Two other positions shortly before the emergency call was triggered (route driven, a few 100 m or around 328 ft).
- Vehicle identification number (VIN).

- Type of vehicle drive.
- Vehicle type.
- Type of trigger (automatic or manual)
- Type of call.
- Direction in which the vehicle was moving when the emergency call was triggered.
- Time of collision.
- Reliability of positioning data.
- Data record version.
- Counter of data strings transferred per call.
- Estimated number of passengers.

 The function of the legally required eCall Emergency System may be restricted if Infotainment systems have been retrofitted.

## Troubleshooting



### Fault in legally required eCall Emergency System

The indicator lamp in the emergency call button lights up red continuously . In addition, the message  Error: Emergency call function. Please visit workshop. may be displayed in the instrument cluster display.

There is a system fault in the legally required eCall Emergency System. It is not possible to make an emergency call.

- Drive immediately to a qualified workshop.
- Have the fault rectified.

### Legally required eCall Emergency System restricted

The indicator lamp in the emergency call button lights up red continuously . In addition, the message  Emergency call function restricted. Please visit workshop. may be displayed in the instrument cluster display.

The function of the legal emergency call system eCall is only available to a limited extent. It is not possible to make an emergency call.

- Drive immediately to a qualified workshop.
- Have the fault rectified. <

# Opening and closing

## Vehicle key

### Functions of the vehicle key



Fig. 53 Vehicle key.

- 1 Unlock the vehicle. All turn signals flash *twice*.
- 2 Unlock only the boot lid. All turn signals flash *twice*. To do this, press and hold the button briefly.
- 3 Lock the vehicle. All turn signals flash *once*.
- 4 The indicator lamp flashes when the button is pressed if all doors and the boot lid are closed.

### **⚠ WARNING**

Careless or unsupervised use of the vehicle key can lead to accidents or injuries.

- Take all vehicle keys with you when you leave the vehicle. Children or unauthorised persons could otherwise lock the doors and boot lid, activate the vehicle's drive system or switch on the ignition and thus operate electrical equipment, such as the electric windows.
- Never leave children or people requiring assistance alone in the vehicle. They could become trapped in the vehicle in an emergency and may not be able to get themselves to safety. For example, locked vehicles may be subjected to very

high or very low temperatures depending on the season. This can cause serious injuries and illness or fatalities, especially among small children.

### **ⓘ NOTICE**

Protect the key from moisture and excessive vibration.

### Spare key



Fig. 54 Vehicle key: releasing the spare key.

- 1 Press the release button briefly. The key-ring folds open.
- 2 Press the release button and pull the spare key out in the direction of the arrow.
- 3 Spare key.

A spare key → Fig. 54 ③ is located in the vehicle key which can be used to lock and unlock the vehicle manually → page 73.

## Changing the button cell



**Fig. 55** Vehicle key: opening battery compartment cover.



**Fig. 56** Vehicle key: replacing the button cell.

Volkswagen recommends having the button cell changed at a Volkswagen dealership or by a qualified workshop → ①.

- Remove the spare key → Fig. 55 ① → page 73.
- Insert the spare key in the slot → Fig. 55 ②, press in the direction of the arrow and lever off the cover.
- Lever the button cell out of the battery compartment → Fig. 56.
- Press the new button cell into the battery compartment → ①.
- Press the cover onto the housing → Fig. 55.
- Put the spare key back → page 73.
- Dispose of discharged batteries in an environmentally responsible way.


## **⚠ DANGER**

If button cell batteries are swallowed or get into the wind pipe, this can lead to serious or even fatal injuries due to suffocation or internal burns within a very short space of time.

- Call for medical help immediately if you suspect that someone has swallowed a button cell battery.
- If the battery cover cannot be closed, do not use the remote control.
- Always keep the remote control and key fob with button cells out of the reach of children.

## **ⓘ NOTICE**


- The vehicle key can be damaged if the button cell is not changed properly.
- Unsuitable batteries can damage the vehicle key. Replace discharged batteries only with new batteries of the same voltage rating, size and specification.
- Pay attention to the correct polarity when inserting the battery.

 The type of batteries used in the remote control of your vehicle key may contain perchlorate. This may require special handling. Please observe all the legal requirements regarding the handling and disposal of these batteries. We recommend that you have this service carried out by a Volkswagen dealership or a qualified workshop. <


## Synchronising the vehicle key

If you cannot lock or unlock the vehicle with the vehicle key, synchronise the vehicle key or replace the button cell → page 74.

Synchronising the vehicle key:

- Stand beside the vehicle.
- Press the  button on the vehicle key twice in quick succession.

OR:

- Remove the spare key → page 73.
- If necessary, remove the cover of the driver door handle → page 80.
- Press the  button on the vehicle key.
- Unlock the vehicle using the spare key.
- Open the driver door. If the vehicle has an anti-theft alarm, this will be triggered immediately → page 83.
- Switch on the ignition. *Please note:* to switch on the ignition, place the vehicle key in the drink holder or the stowage compartment in the centre console → page 139.

The synchronisation process is complete. <

## Troubleshooting

### Vehicle cannot be locked or unlocked


The remote control is subject to interference caused by obstacles, adverse weather conditions or other transmitters operating in the same frequency range in the vicinity of the vehicle, e.g. mobile devices, or due to a weak or flat button cell.

**OR:** the central locking system has switched itself off temporarily to protect itself against overloading.

- Close the driver door.
- **OR:** synchronise the vehicle key → page 74.
- **OR:** change the button cell in the vehicle key → page 74.

### Indicator lamp does not flash

If the indicator lamp in the vehicle key does not flash when pressing the button, the button cell in the vehicle key has to be replaced → page 74.

 Additional or replacement vehicle keys can be obtained from a Volkswagen dealership.

## Keyless locking and starting system “Keyless Access”

### Introduction to the topic

The Keyless Access function allows the vehicle to be unlocked and locked without actively using the vehicle key. For this purpose, a valid vehicle key must be within close range of the vehicle. <

### Unlocking or locking the vehicle with Keyless Access

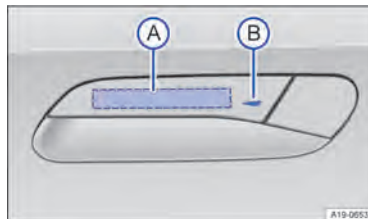


Fig. 57 In the door handle: sensors.

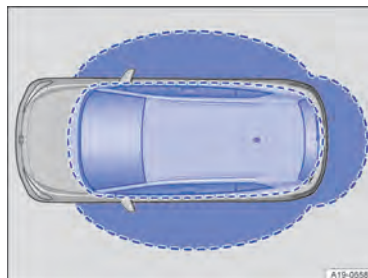


Fig. 58 Keyless Access: operating ranges.

### Configuring Keyless Access

- < The behaviour of the keyless access locking and starting system Keyless Access can be

set in the Vehicle menu in the Infotainment system.

If the Keyless Access function is deactivated, the functions of the system may be restricted.

### Unlocking the vehicle

- Touch the sensor → Fig. 57 (A) on the inside of the door handle. All turn signals flash *twice*.

The entire vehicle is unlocked if the sensor is touched twice.

### Unlocking the vehicle when approaching

The vehicle can be unlocked as you approach it. For this, the function must be activated in the Infotainment system and the vehicle key must be located in the operating range of the vehicle.

- The vehicle is unlocked if the vehicle key is detected within the operating range → Fig. 58. All turn signals flash twice.

The "Unlock vehicle when approaching" function is deactivated if the vehicle is not unlocked for a longer period of time. The function is re-activated with the next locking action.

If single door unlocking is activated in the central locking settings in the Infotainment system, there may be restrictions with the "Unlock vehicle when approaching" function.

### Locking the vehicle

- Park the vehicle.
- Touch the sensor → Fig. 57 (B) on the outside of the door handle. All turn signals flash *once*.

The unlocking function is deactivated for a few seconds so that you can check that the vehicle has been locked successfully.

### Unlocking the boot lid


When the vehicle is locked, the boot lid will be unlocked automatically if you open it when a vehicle key is located within the op-


erating range of the boot lid. The boot lid will be locked again after closing.

*Please note:* When "Central locking, all doors" and "Keyless Access unlocking when approaching" are activated in the Infotainment system, the vehicle remains unlocked after the boot lid has been opened and closed. The vehicle must be actively locked.


### Temporarily deactivating Keyless Access

The Keyless Access unlocking function can be deactivated temporarily:


- Lock the vehicle with the  button on the vehicle key.
- Touch the sensor on the outside of the door handle once within five seconds → Fig. 57 (B). Do not put your hand around the door handle when doing this. Keyless Access is now temporarily deactivated.
- You can check that it is deactivated by waiting for at least ten seconds and then pulling the door handle. It should not be possible to open the door.

When the vehicle is next unlocked, it can be unlocked electronically with the vehicle key only. Keyless Access is reactivated the next time the vehicle is unlocked → .

### Permanently deactivating Keyless Access

Keyless Access can be permanently deactivated in the Infotainment system → .

## NOTICE

When Keyless Access is deactivated, depending on equipment, the sensor-controlled opening and closing of the boot lid → page 87 is also deactivated even if the function is active in the vehicle menu. 

## Troubleshooting

### Keyless Access does not work

The function of the door handle sensors may be restricted if they become very dirty.

- Clean the sensors.

### All turn signals flash four times

The vehicle key used last is still in the vehicle.


- Remove the key and lock the vehicle.

### Automatic deactivation of the sensors

The sensors will be deactivated in the following circumstances:

- The vehicle is not unlocked or locked for an extended period.
- A sensor has been triggered an excessive number of times.

Activating sensors again:

- Unlock the vehicle with the  button in the vehicle key.

### NOTICE

Please note that the sensors in the handles could be activated by a powerful jet of water or steam if a valid remote control key is within the operating range. If at least one window is open and the sensors in a door handle are continuously activated, all windows will close. All windows could open if the jet of water or steam is moved away from the door handle sensor surfaces briefly and then moved back again → page 75.



If the message **Error: Keyless Access system** appears in the ID. Cockpit, malfunctions can occur in the Keyless Access system. Go to a qualified workshop.



If there is no vehicle key in the vehicle or if it is not detected, a corresponding message will be shown in the ID. Cockpit. This may occur if the vehicle key is disrupted by another radio signal or is covered by another item such as an aluminium suitcase. <


## Doors and central locking button

### Introduction to the topic

The doors can be locked manually and, in some cases, also unlocked manually, if the vehicle key or central locking fails, for example.

The central locking system enables you to centrally lock and unlock all the doors, the boot lid and the charging socket flap of the vehicle.

The vehicle can be locked if the ignition has been switched off or the driver has deactivated the vehicle's drive system before leaving the vehicle.

A symbol in the ID. Cockpit indicates if one or more doors are not closed properly.  **Do not drive on!** Open the door in question and then close it again.

This symbol is also visible when the ignition is switched off and will go out a few seconds after the vehicle has been locked when all doors are closed.

### WARNING

Any door that is not properly closed could open suddenly while the vehicle is in motion. This could lead to severe injuries.

- Stop as soon as possible and close the door.
- Ensure that the door is closed properly and that the lock has engaged. The closed door must be flush with the surrounding body panels.
- Doors should only be opened or closed when you are sure there is no-one in their path.

### WARNING

Any door being held open by the door arrester could close unexpectedly in strong

winds or if the vehicle is on a slope. This could lead to injuries.

- Always keep a good grip on the handle when opening and closing doors.

### WARNING

The opening and closing paths of the doors and boot lid are potential danger areas where injury can occur.

- The doors and the boot lid should therefore only be opened or closed when you are sure that nobody is in their path.

### WARNING

Careless locking of the doors can cause serious injuries.

- If the vehicle is locked from the outside, the doors and electric windows cannot be opened from the inside.
- The central locking system locks all doors. Locking the vehicle from the inside can prevent accidental opening of the doors and unauthorised persons from entering the vehicle. However, locked doors can delay assistance to passengers inside the vehicle in the event of an accident or emergency.
- Never leave children or people requiring assistance alone in the vehicle. All doors can be locked from the inside using the central locking button. This may mean that people lock themselves in the vehicle. People locked in the vehicle may be subjected to very high or very low temperatures.
- Temperatures inside a locked vehicle may be extremely hot or cold depending on the season. This can cause serious injuries and illness or fatalities, especially among small children.
- Never leave anyone inside a locked vehicle. People in the vehicle could become trapped in an emergency and may not be able to get themselves to safety.

### NOTICE

People who are locked in the vehicle can unlock the doors in an emergency by pulling the door release lever forcefully twice. The lever must be pulled beyond a noticeable resistance in this case.

### NOTICE

When carrying out manual opening or closing, remove parts carefully and install them again correctly in order to avoid damage to the vehicle.

## Opening doors

 Please refer to  and  at the start of the chapter on page 77.

### Opening doors from outside

There is a button behind the door handles.

- Unlock the vehicle using the vehicle key → page 73.
- Press the button behind the door handle.

### Opening doors from inside

Pull the door release lever only slightly. Do not pull the door release lever beyond the resistance.

## Indicator lamp in the driver door

 Please refer to  and  at the start of the chapter on page 77.

The central locking system indicator lamp is located in the driver door.


*Vehicle locked:* red LED flashes at short intervals for approximately two seconds, and then more slowly. The indicator lamp does *not* flash if the vehicle was locked with the central locking button in the driver door → page 79.



## Automatic locking and un-locking

📖 Please refer to ⚠️ and ⌚ at the start of the chapter on page 77.


### Automatic locking (Auto Lock)

The vehicle locks itself automatically at speeds above approximately 15 km/h (9 mph). The indicator lamp  in the central locking button will light up yellow when the vehicle is locked.

### Automatic unlocking (Auto Unlock)

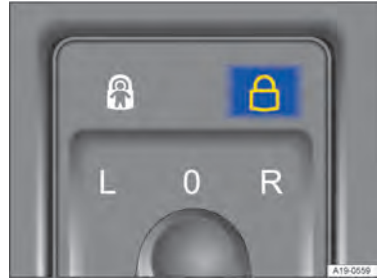
All vehicle doors and the boot lid are automatically unlocked if one of the following conditions applies:

- The electronic parking brake is engaged and the ignition is switched off.
- **OR:** the door release lever has been operated. This applies at speeds up to 15 km/h (9 mph).
- **OR:** in an accident where the airbags have been triggered → page 82.

 Automatic unlocking gives emergency responders access to the vehicle.

## Central locking touch control

📖 Please refer to ⚠️ and ⌚ at the start of the chapter on page 77.





**Fig. 59** In the driver door: central locking touch control.

Depending on the market, the touch panel for the central locking can also be found in the front passenger door.

If the vehicle has been locked from outside with the vehicle key, the central locking touch control is not activated.

⚠️ Please note the following if the vehicle was locked from inside using the central locking touch control:

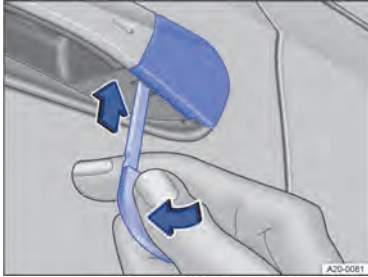
- The indicator lamp  in the touch control lights up yellow when all doors are closed and locked → Fig. 59.
- The anti-theft alarm will **not** be activated → page 83.

The doors can be opened from the inside by pulling the door release handle. The indicator lamp  in the touch control goes out. The unopened doors and boot lid remain locked and cannot be opened from the outside.

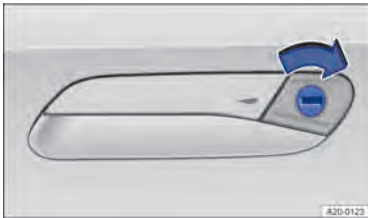
If the driver door is open, it will not be locked.

## Opening and closing the driver door manually

📖 Please refer to ⚠️ and ⌚ at the start of the chapter on page 77.



**Fig. 60** Handle on the driver door: levering off the cover.



**Fig. 61** Locking the driver door manually.

- Lever the cap off with the vehicle key in the direction of the arrow → Fig. 60.
- Insert the key bit into the lock cylinder.
- Turn the spare key clockwise to lock the vehicle → Fig. 61.
- Turn the spare key anticlockwise to unlock the vehicle.
- Pull the driver door handle forcefully to open the door.
- Fit the cap again.


### Things to note when unlocking manually

When manual locking takes place, all doors are locked. With manual unlocking, only the

driver door is unlocked. Observe the information about the anti-theft alarm → page 83.

- The alarm is triggered when the driver door is opened → page 83.
- The vehicle must be started manually once unlocked → page 139.
- Activate the vehicle's drive system to switch off the alarm.

The electronic immobiliser recognises a valid vehicle key.

 The anti-theft alarm is activated when the vehicle is locked manually using the key bit → page 83. <


## Manually closing the front passenger door and rear doors

📖 Please refer to ⚠️ and ⌚ at the start of the chapter on page 77.




**Fig. 62** In the end face of the right-hand door: locking the vehicle manually with the spare key.

The front passenger door and the rear doors can be locked manually. The anti-theft alarm is **not** activated in this case → page 83.

- Open the door.
- Remove the rubber seal  from the end face of the door.

- Insert the spare key in the vertical slot and turn → Fig. 62.
- Secure the rubber seal again.
- Ensure that the door is locked.
- The vehicle should be checked by a qualified workshop as soon as possible.

A door that has been locked manually will be unlocked again if the vehicle is unlocked or the door in question is opened from the inside.

 The doors can be unlocked and opened from the inside by pulling the door release handle.

## Electric childproof lock

 Please refer to  and  at the start of the chapter on page 77.




**Fig. 63** In the driver door: touch control for electric childproof lock.

The electric childproof lock stops the doors from being opened and the electric windows in the doors from being operated.

To switch the electric childproof lock on or off:

- *Switching on:* press the touch control.
- *Switching off:* press the touch control again.

The  indicator lamp in the touch control lights up yellow when the childproof lock is active → Fig. 63.

## WARNING


When the electric childproof lock is activated, the rear doors cannot be opened from the inside.

- Never leave children or people requiring assistance alone in the vehicle when the doors are locked. This may mean that these people lock themselves in the vehicle. They could become trapped in the vehicle in an emergency and may not be able to get themselves to safety. People locked in the vehicle may be subjected to very high or very low temperatures.
- Temperatures inside a locked vehicle may be extremely hot or cold depending on the season. This can cause serious injuries and illness or fatalities, especially among small children.

## SAFELOCK


 Please refer to  and  at the start of the chapter on page 77.

Depending on the vehicle equipment level, the vehicle may have a SAFELOCK mechanism.

The SAFELOCK deactivates the door release levers if the vehicle has been locked. This makes it more difficult to break into the vehicle. The doors can no longer be opened from the inside → .

### Deactivating SAFELOCK

The SAFELOCK can be deactivated in one of the following ways:

- Press the  button on the vehicle key again **within 2 seconds**.
- Touch the sensor on the outside of the door handle again **within 2 seconds** → page 75.

- Switch on the ignition.
- **OR:** deactivate the interior monitor and the anti-tow alarm → page 83.

Depending on the equipment level, temporarily deactivate the interior monitoring and the anti-tow alarm in the **Vehicle Settings** menu in the Infotainment system before locking the vehicle → page 83.

A message may be displayed in the ID. Cockpit indicating that SAFELock is active.



The following applies when SAFELock is deactivated:

- The vehicle can be unlocked and opened from the inside using the door release lever.
- The anti-theft alarm is active → page 83.
- The interior monitoring and anti-tow alarm are deactivated → page 83.

### **WARNING**

Always take care when using the SAFELock as you could cause serious injuries.

- Never leave anybody in the vehicle if the vehicle has been locked using the vehicle key. The doors can no longer be opened from the inside once the SAFELock is activated.

 If you unlock the driver door mechanically using the vehicle key, only the driver door is unlocked, and not the whole vehicle. The doors are released (but not unlocked) and the central locking button is activated only when you switch on the ignition. 

## Troubleshooting

 Please refer to  and  at the start of the chapter on page 77.

### Indicator lamp lights up continuously

The red LED in the vehicle door flashes at short intervals and then lights up continuously.

There is a fault in the locking system.

- Go to a qualified workshop. Volkswagen recommends using a Volkswagen dealership for this purpose.

### Turn signals do not flash

If the turn signals do *not* flash as confirmation when you lock the vehicle:


- At least one of the doors or the boot lid is not closed **or**
- The bonnet is not closed

### Vehicle locks itself automatically

The vehicle locks again automatically after approximately 45 seconds if one of the following conditions applies:

- The vehicle was unlocked but not opened.
- The ignition was not switched on.
- The boot lid was not opened.
- The vehicle was unlocked by means of the lock cylinder.
- The vehicle was locked with the control button in the vehicle interior.


### Response when locking the vehicle with a second vehicle key

The vehicle key inside the vehicle is disabled for activating the vehicle's drive system as soon as the vehicle is locked from outside with a second vehicle key. Press the  button on the inside vehicle key in order to release it for activating the vehicle's drive system → page 138.

### Locking the vehicle after airbags have been triggered

The entire vehicle is unlocked if the airbags are activated during an accident. Depending on the extent of the damage, the vehicle can be locked as follows after an accident.

- Switch off the ignition.
- Open the driver's door and close it again.
- Lock the vehicle.

 It may not be possible to lock or unlock the vehicle using the Keyless Ac-

cess if the 12-volt vehicle battery or button cell in the vehicle key is weak or discharged. The vehicle can be locked or unlocked manually → page 77.

**i** If there is no vehicle key in the vehicle or if it is not detected, a corresponding message will be shown in the ID. Cockpit. This may occur if the vehicle key is disrupted by another radio signal or is covered by another item such as an aluminium suitcase → page 137.

## Anti-theft alarm

Depending on the vehicle equipment level, the vehicle may have an anti-theft alarm.

The anti-theft alarm monitors the doors, bonnet and the boot lid.

The anti-theft alarm is automatically activated when the vehicle is locked.


If the vehicle is not opened electronically with a valid vehicle key, the anti-theft alarm is triggered and emits acoustic and visual warning signals for up to five minutes.

### When does the system trigger an alarm?

- When a door that was unlocked mechanically with the vehicle key is opened.
- When the bonnet is opened.
- When the boot lid is opened.
- When an invalid vehicle key is used.
- If there is movement inside the vehicle (in vehicles with interior monitoring) → page 83.
- If the vehicle is lifted or towed (vehicles with anti-tow alarm) → page 83.
- If the vehicle is transported on a car ferry or by rail (vehicles with anti-tow alarm or interior monitoring) → page 83.
- If a bicycle carrier that is connected to the anti-theft alarm system is removed.
- If a trailer that is connected to the anti-theft alarm system is removed.

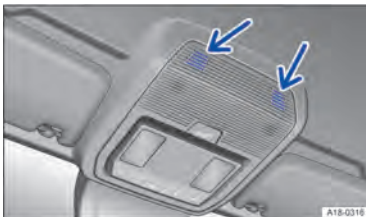
- If the 12-volt vehicle battery is disconnected.
- If the rear window is broken.

### Switching off the alarm

- Unlock the vehicle using the unlocking button  on the vehicle key.
- Grip the door handle → page 75.
- Switch on the ignition. *Please note:* To switch on the ignition, place the vehicle key in the area provided for the vehicle key when performing an emergency start → page 139.

**i** The anti-theft alarm will not function correctly if the 12-volt vehicle battery is weak or discharged.

## Interior monitoring system and anti-tow alarm



**Fig. 64** In the roof console: sensors for the interior monitoring system (arrows).

The interior monitoring triggers an alarm if movement is detected in the interior of a locked vehicle → Fig. 64.

The anti-tow alarm will be triggered if the vehicle is lifted.

### Switching on the interior monitoring system and anti-tow alarm

Lock the vehicle. When the anti-theft alarm is switched on, interior monitoring and the anti-tow alarm are also active.

Depending on the equipment, the function of interior monitoring may be impaired if a load guard is used.

### Temporarily switching off the interior monitoring system and anti-tow alarm

The interior monitoring system and anti-tow alarm can be switched off temporarily in the **Opening and closing** submenu in the Infotainment system → page 31. The interior monitoring system and anti-tow alarm remain deactivated until the next time the vehicle is locked.

The interior monitoring system and anti-tow alarm can be switched off in the exit menu. The ignition must be switched off for this purpose → page 137.


To avoid false alarms, deactivate interior monitoring and the anti-tow alarm in the following situations:


- If any people or animals are to remain in the vehicle interior for a short period.
- If the vehicle is to be loaded onto another vehicle, transported or towed away.
- If the vehicle is to be parked in a car wash or a two-storey garage.

### Risk of false alarms for the interior monitoring system


Interior monitoring can only work properly if the vehicle is completely closed. Observe the legal requirements. A false alarm can be triggered in the following situations:

- If one or more windows are fully or partially open.
- If lightweight items such as loose pieces of paper or items hung from the interior mirror are left in the vehicle.
- If the vibration alarm of a mobile telephone is switched on.

 Permanent deactivation of interior monitoring and the anti-tow alarm is not possible.

 If doors or the boot lid are still open when the anti-theft alarm is activated, only the anti-theft alarm is activated. Interior monitoring and the anti-tow alarm are not

activated until all doors and the boot lid are closed.


 SAFELock is also deactivated when the interior monitoring system and anti-tow alarm are switched off → page 81. <

## Boot lid

### Introduction to the topic

The boot lid is unlocked and locked together with the doors.

In vehicles with Keyless Access, the boot lid is automatically unlocked upon opening → page 75.

If single door or vehicle side opening is activated in the opening and closing settings in the Infotainment system, the  button on the vehicle key must be pressed **twice** to release the boot lid.

On vehicles with Keyless Access, it is necessary to operate the sensor on the inside of the driver or front passenger door handle **twice** for this.

### WARNING

Incorrect and unsupervised unlocking, opening or closing of the boot lid can cause accidents and serious injuries.

- Therefore the boot lid should only be opened or closed when you are sure that nobody is in its path.
- Always check that the boot lid is properly closed after closing it. The closed boot lid must be flush with the surrounding body panels.
- Always keep the boot lid closed while the vehicle is in motion.
- Never open the boot lid when loads, e.g. bicycles, are secured to it. The boot lid may close under its own weight due to the additional load. Support the boot lid as necessary or remove the load from the surface.

- Close and lock the boot lid and all vehicle doors when the vehicle is not in use. Ensure that no one remains in the vehicle.
- Never leave children playing unattended in or around the vehicle, especially when the boot lid is open. Children could climb into the luggage compartment and shut the boot lid, thereby trapping themselves inside. Temperatures inside a locked vehicle may be extremely hot or cold depending on the season. This can cause serious injuries and illness or fatalities, especially among small children.

### ⚠ WARNING

Serious injuries can occur if the boot lid is unlocked or opened incorrectly or without due care and attention.

- It may not always be apparent that the boot lid is unlocked, for example when a loaded luggage carrier is attached to it. If unlocked, the boot lid may open suddenly while the vehicle is in motion.

### ⚠ WARNING

If there is a large amount of snow or a heavy load on the boot lid, the boot lid may lower by itself and cause serious injuries due to the additional weight.

- Never open the boot lid if it is covered by a large amount of snow or a load is attached to it, e.g. a luggage carrier.
- Remove the snow or load before opening the boot lid.

### ⚠ WARNING

Do not close the boot lid by pushing it down with your hand on the window. The rear window may shatter and cause injuries.

### ⓘ NOTICE

Never use the opening mechanism to fix or hold a load. This could lead to damage that makes it impossible to close the boot lid.

### ⓘ NOTICE

Never use the rear window wiper or the rear spoiler to fix or hold a load. This may result in damage that causes the rear wiper or rear spoiler to be torn off.

## Opening and closing the boot lid

📖 Please refer to ⚠ and ⓘ at the start of the chapter on page 84.





Fig. 65 In the boot lid: button for opening the boot lid.



Fig. 66 In the open boot lid: handle for closing the boot lid.

### Opening the boot lid

- To unlock the boot lid, press the  or  button on the vehicle key.
- Lift the boot lid by the button → Fig. 65.

## Closing the boot lid

- Pull the boot lid down with force by the handle in the interior trim so that it engages in the lock → Fig. 66, → ⚠.

A symbol in the instrument cluster display indicates that the boot lid is opened or not properly closed.

The boot lid is locked automatically when the vehicle is moving.

### ⚠ WARNING

Serious injuries can occur if the boot lid is closed incorrectly or without due care and attention.

- When closing the boot lid, please ensure that no one has their hands in the direct path of the boot lid as it moves.



If the boot lid is not opened within a few minutes after unlocking, it automatically locks again.

## Electrically opening and closing the boot lid

📖 Please refer to ⚠ and ⌚ at the start of the chapter on page 84.



Fig. 67 In the driver door: button for opening the boot lid electrically.



Fig. 68 In the open tailgate: button for closing boot lid electrically.

### Electrically opening the boot lid

- To unlock the boot lid, briefly press the or button on the vehicle key.
  - OR: pull the button in the driver door upwards → Fig. 67.
  - OR: press the button for opening the boot lid → page 85.
- ◀ The boot lid will then open.

### Electrically closing the boot lid

- Press the button in the open boot lid → Fig. 68.
- OR: with the ignition on, pull the button in the driver door up until the boot lid is closed.
- OR: briefly press and hold the button on the vehicle key. The vehicle key must also be within the operating range.
- OR: close the tailgate by moving it manually until the tailgate closes by itself.


The boot lid is closed.

### Interrupting the opening or closing procedure

- Press the button or one of the buttons whilst opening or closing.
- OR: press the button on the boot lid during the opening or closing process → Fig. 68.

The boot lid can not be moved by hand. You will need to use more force than usual.




Pressing the  button again will move the boot lid back to its starting position.

### Signal tones

If the boot lid is opened or closed from the vehicle interior or with the vehicle key, acoustic signals will sound.

### Changing and storing the opening angle

If the area behind or above the vehicle is smaller than the path of the boot lid, the opening angle of the boot lid can be changed.

- Stop the opening procedure at the desired open position (at least half open).
- In the boot lid, press and hold the  button until the hazard warning lights flash → Fig. 68.

The changed opening angle will be stored.

The hazard warning lights flash and an acoustic signal sounds to confirm that the changed opening angle has been stored.

### NOTICE

Before opening or closing the boot lid, check whether there is enough clearance to open or close the boot lid, e.g. in garages. <

### Boot lid with Easy Open motion sensor

 Please refer to  and  at the start of the chapter on page 84.



Fig. 69 Sensor-controlled luggage compartment opener (Easy Open).

The boot lid can be unlocked and opened with a foot movement if there is a valid vehicle key within the operating range of the boot lid.

- Stand centrally behind the bumper.
- Move your foot and shin quickly towards the bumper. The shin must be located in the upper sensor area and the foot in the lower area → Fig. 69.
- Then quickly move your foot and shin away from the sensor area again. Visual feedback is provided via the turn signals. The boot lid opens.

The boot lid will lock again automatically, provided that the vehicle had been locked beforehand and as long as there is no valid vehicle key inside the vehicle.

### Activating or deactivating Easy Open

Easy Open can be activated and deactivated in the Infotainment system:

- Select the Vehicle menu.
- Swipe to the side to reach the Easy Open menu item, OR Swipe to the side to reach the Central locking menu item.
- Select menu item and scroll down to Easy Open.

If Easy Open is activated, Easy Close is also active → page 88.

### CAUTION

If a valid vehicle key is located close to the boot lid, the Easy Open function can sometimes be operated accidentally, causing the boot lid to open, e.g. when sweeping underneath the rear bumper, if a powerful jet of water or steam is directed at the bumper, or if maintenance and repair work is carried out in the area around the rear bumper. If the boot lid is opened by mistake it can cause damage to anyone in the path of the boot lid and material damage.

- Always make sure that there are no valid vehicle keys left unattended in the operating range of the boot lid.

- Always switch off the Easy Open function via the Infotainment system before carrying out any maintenance and repair work.
- Always switch off the Easy Open function via the Infotainment system before washing the vehicle.
- Always switch off the Easy Open/ Easy Close function via the Infotainment system before fitting a bicycle carrier or attaching a trailer → page 264.

## Closing the boot lid automatically Easy Close

📖 Please refer to ⚠️ and ⓘ at the start of the chapter on page 84.



**Fig. 70** Boot lid with sensor-controlled closing (Easy Close).

The Easy Close function can be activated only if there is a valid vehicle key in the operating range of the boot lid.

- Move your foot and shin quickly towards the bumper. The shin must be located in the upper sensor area and the foot in the lower area → Fig. 70.

Then quickly move your foot and shin away from the sensor area again.

Easy Close is activated **for around 20 seconds**. An acoustic signal confirms activation.

The boot lid will be closed as soon as all valid vehicle keys have been removed from the operating range of the boot lid.

Easy Close allows a maximum of one vehicle key to be locked into the boot.

The closing operation will be interrupted as soon as a vehicle key comes within the operating range again. The boot lid will then open again.

### Activating or deactivating Easy Close

The Easy Close function can be activated and deactivated together with the Easy Open function in the Vehicle menu in the Infotainment system → page 87.

## ⚠️ CAUTION

If a valid vehicle key is located close to the boot lid, the Easy Close function can sometimes be operated accidentally, causing the boot lid to close, for example when sweeping underneath the rear bumper or if maintenance and repair work is carried out in the area around the rear bumper. If the boot lid is closed by mistake, this can cause injuries to persons in the path of the boot lid and material damage.

- Always make sure that there are no valid vehicle keys left unattended in the operating range of the boot lid.
- Always switch off the Easy Close function via the Infotainment system before carrying out any maintenance and repair work.
- Always switch off the Easy Close/ Easy Open function via the Infotainment system before fitting a bicycle carrier or attaching a trailer → page 264.

ⓘ The closing operation will be automatically interrupted if another boot lid function is activated during closing or if objects are detected in the area of the boot lid.

ⓘ The boot lid locks automatically after closing if the vehicle is locked and the Easy Close function is started. If the vehicle is completely unlocked and the Easy Close function is started, the boot lid will not lock automatically after closing.

## Troubleshooting

📖 Please refer to ⚠️ and Ⓛ at the start of the chapter on page 84.

### Boot lid cannot be opened or closed

- Check whether the boot lid is blocked by an obstacle. The boot lid can be moved by hand. You will need to use more force than usual.
- The drive switches off automatically in order to prevent overheating if the boot lid is operated too frequently within a short space of time. Until the drive has cooled off, increased effort may be required to open and closed the boot lid by hand.
- When towing a trailer, the electric rear lid can **only** be opened and closed at the boot lid → page 264.
- The boot lid must be closed by hand if the 12-volt vehicle battery or fuse is disconnected or faulty.

### All turn signals flash four times

The vehicle key used last is still in the vehicle.

- Remove the key and lock the vehicle.

### Boot lid is stiff

At outside temperatures around freezing point, the opening mechanism cannot always lift the partially opened boot lid automatically.

- Guide the boot lid further upwards by hand.

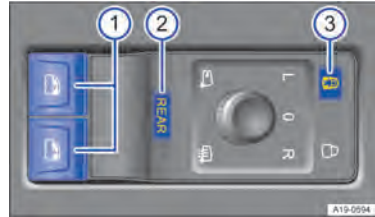
### The Easy Open sensor-controlled luggage compartment opener is not working

- Easy Open works only when the ignition is switched off.
- Clean the sensors in the rear bumper.
- The towing bracket is swivelled out → page 264.
- A towing bracket has been retrofitted to the vehicle → page 264.

- During heavy rain, Easy Open may be deactivated in order to prevent accidental activation.

## Windows

### Opening and closing windows



**Fig. 71** In the driver door: buttons for the front and rear electric windows

- ① Buttons for electric windows.
- ② Touch control **REAR** for activating operation of the rear electric windows and convenience opening and closing.
- ③ Touch control for deactivating the electric window buttons in the rear doors and switching on the electric childproof lock.

As the default setting, electric windows in the front doors can be operated with the buttons → Fig. 71 ①.

🗑️ Open windows: press the button.  
Close windows: pull the button.

**REAR** Press the touch control → Fig. 71 ② briefly to activate operation of the electric windows in the **rear** doors. The touch control function light lights up when operation of the electric windows in the rear doors is activated.  
Press the **REAR** touch control briefly again to activate operation of the electric windows in the **front** doors.

If the electric windows in the rear windows are not operated after operation has been activated, operation of the electric windows in the front doors will be activated again after around ten seconds.



Press the → Fig. 71 ③ touch control to deactivate the electric window buttons in the rear doors. The electric childproof lock is switched on at the same time. The indicator lamp in the touch control lights up yellow when the electric window buttons in the rear doors are deactivated and the childproof lock is switched on.

The windows can still be operated using the buttons several minutes after the ignition has been switched off, provided that the driver door and front passenger door are not opened.

### One-touch opening and closing


One-touch opening and closing makes it possible to fully open and close the windows. The individual buttons do not have to be held down to do this.

*One-touch closing:* pull the button for the appropriate window up briefly into the second position.

*One-touch opening:* press the button for the appropriate window down briefly into the second position.

*Stopping the one-touch function:* press or pull the button for the appropriate window again.

### Convenience opening and closing

Press and hold the **REAR** touch control to activate convenience opening and closing of the electric windows in all doors. The touch control function light flashes when the function is activated. All four windows can now be simultaneously opened or closed with each of the two buttons .

If the electric windows are not operated after convenience opening and closing has been activated, operation of the electric windows

in the front doors will be activated again after around ten seconds.

Press and hold the **REAR** touch control briefly again to deactivate the function.

The windows can be opened and closed from outside the vehicle using the vehicle key when the ignition is switched off:

- Press and hold the locking or unlocking button on the vehicle key.
- Hold your finger on the locking sensor in the door handle for several seconds until the windows are closed → page 75. The vehicle key must also be within the operating range.
- To interrupt this function, release the locking or unlocking button **OR** remove your finger from the sensor.

A valid vehicle key must be located within close range. All turn signals will flash *once* as confirmation that all the windows have been closed.

Settings for convenience opening can be adjusted in the **Vehicle** menu in the Infotainment system.

### WARNING


Careless or unsupervised use of the electric windows can cause serious injuries.


- The electric windows should only be opened or closed when you are sure that nobody is in their operating area.
- Never leave children or people requiring assistance alone in the vehicle when the vehicle is locked. The windows can no longer be opened in an emergency.
- Always take all vehicle keys with you every time you leave the vehicle. The windows can still be operated using the buttons several minutes after the ignition has been switched off, provided that the driver door and front passenger door are not opened.
- When transporting children on the rear bench seat, the rear electric windows should always be deactivated using the

safety button so that they cannot be opened or closed.

### NOTICE


During sudden rain showers, water can enter the vehicle interior via open windows and cause damage to the vehicle. Correct operation of the controls also cannot be guaranteed.


 One-touch opening and closing and the roll-back function will not work if there is a fault in the electric windows. Go to a qualified workshop.

 Convenience opening and closing works only when one-touch opening and closing is activated for all electric windows.

## Electric window roll-back function

The roll-back function for the electric windows can reduce the risk of injuries when the windows are closing.

If the window is not able to close because it is stiff or because of an obstruction, the window will immediately open again → .

- Check to see why the window has not closed.
- Try to close the window again.
- If the window closing process is interrupted again, the roll-back function will be disabled for a few seconds.
- If the window still cannot be closed, the window stops where it is. To close the window **without the roll-back function**, press the button again within a few seconds → .

### Closing windows without roll-back function


- Attempt to close the window again within a few seconds by holding the button. **The roll-back function is deactivated in the process.**

- If the closing procedure takes longer than several seconds, the roll-back function will be reactivated. If it is still stiff or obstructed, the window will stop and open again automatically.
- Please go to a qualified workshop if the window still cannot be closed.

### WARNING

Closing the electric windows without the roll-back function can lead to severe injuries.

- Always close the window carefully.
- Ensure that nobody obstructs the path of the window, especially if a window is being closed when the roll-back function is not active.
- The roll-back function does not prevent fingers or other body parts from being pressed against the window frame and sustaining injury.

 The roll-back function is also activated if the convenience closing function on the vehicle key is used to close the windows. <

## Troubleshooting

### One-touch opening and closing does not work

One-touch opening and closing is deactivated if the 12-volt vehicle battery has been disconnected or discharged while the windows were not fully closed. The function will have to be reset.

- Switch on the ignition.
- Close all windows and doors.
- Pull up the button for the window and hold it in this position for a few seconds.
- Let go of the button, then pull it up again and hold it in this position. One-touch opening and closing is now ready for operation.

The one-touch function can be restored for individual windows or for several windows at the same time.

**Touch panels do not react as expected**

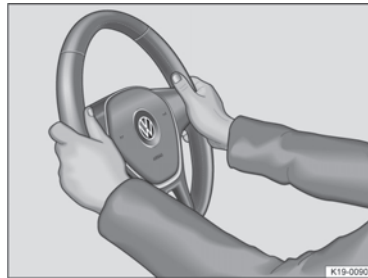
Moisture, dirt, grease etc. can restrict functioning of the touch panel. Make sure that the touch panels are always clean and dry. ◀

## Steering wheel

### Adjusting the steering wheel position




**Fig. 72** Below the steering wheel in the steering column trim: lever for mechanical adjustment of the steering wheel position.



**Fig. 73** On the steering wheel: 9 o'clock and 3 o'clock position.


Adjust the steering wheel position **before** setting off and only when the vehicle is stationary → ⚠.

- Push down the lever → Fig. 72 ①.
- Adjust the steering wheel so that you can hold it with both hands at its outer edge at the 9 o'clock and 3 o'clock positions with your arms slightly bent → Fig. 73.

- Push the lever up firmly until it is flush with the steering column trim → .

### WARNING

Incorrect use of the steering wheel position adjustment and incorrect adjustment of the steering wheel can cause serious or fatal injuries.

- After adjusting the steering wheel, always move the lever → Fig. 72  up firmly. This prevents the steering wheel from moving accidentally while the vehicle is in motion.
- Never adjust the steering wheel when the vehicle is in motion. If you determine that adjustment is necessary when driving, stop the vehicle safely and adjust the steering wheel to the correct position.
- The steering wheel must always point towards the chest and not towards the face. This ensures that the driver front airbag provides maximum protection in the event of an accident.
- While driving, always keep both hands on the outside of the steering wheel at the *9 o'clock and 3 o'clock positions*. → Fig. 73 This reduces the risk of injury if the driver front airbag is triggered.
- Never hold the steering wheel at the 12 o'clock position, or in any other manner, e.g. at the hub of the steering wheel. If the driver front airbag is triggered, you could receive severe injuries to the arms, hands and head. <

## Seats and head restraints

### Front seats

#### Introduction to the topic

The following section describes the options for adjusting the front seats. Always ensure that your sitting position is correct → page 34.

### WARNING

Always adjust the front seats to their correct position before any journey and ensure that all passengers have fastened their seat belts.

- Push the front passenger seat as far back as possible.
- Adjust the driver seat so that there is at least 25 cm between your breastbone and the hub of the steering wheel. Adjust the driver seat by moving it forwards or backwards so that you are able to press the pedals to the floor with your knees still slightly angled and the distance to the dash panel in the knee area is at least 10 cm. If your build makes it impossible to fulfil this requirement then you must contact a qualified workshop so they can make any necessary modifications.
- Never travel with the backrest tilted far back. The further back the backrest is tilted, the greater the risk of injury caused by incorrect seat belt routing or an incorrect sitting position.
- Never travel with the backrest tilted far forwards. When a front airbag is triggered it could force the seat backrest backwards and injure vehicle occupants on the back seats.
- You should always sit upright with your back against the seat backrest with the front seats properly adjusted. Do not po-

sition any body part directly against or too close to where the airbags are fitted.

### WARNING

Incorrect adjustment of the seats can cause accidents and serious injuries.

- Only adjust the seats when the vehicle is stationary. The seats could change position unexpectedly if you attempt to reposition them while the vehicle is in motion, leading to a loss of control of the vehicle. Furthermore, an incorrect sitting position is adopted while adjusting the seat.
- Only adjust the height and tilt of the seat or move it forwards and backwards when the area around the seat is clear.
- The adjustment range of the seats must not be restricted by any items.
- Only adjust the angle of the rear seats or move the seats forwards and backwards when there is no-one in the adjustment range of the seats.
- The areas for adjusting and locking the seats must not be soiled.

### WARNING

Improper use of seat covers or protective covers may lead to the electrical seat controls being operated accidentally and the front seats moving unexpectedly while the vehicle is moving. You could lose control over the vehicle. This could result in serious injury and accidents. Furthermore, this may result in damage to the electrical components in the front seats.

- Never attach or secure seat covers or protective covers to the electrical controls.
- Do not fit seat covers or protective covers over the seats unless they have been expressly approved for use in the vehicle.

### WARNING

Any lighters in the vehicle could be damaged or accidentally lit. This could lead to serious burns and other injuries.




- Before adjusting the seats, always ensure that there is no lighter on or near the movable parts of the seat.

### NOTICE

Sharp edges can damage the seats.

- Do not touch the seats with sharp-edged objects. Sharp objects, such as zips, rivets on clothing or belts, may damage surfaces. Open Velcro fasteners may also cause damage. ◀

## Mechanically adjusting the front seat

 Please refer to  and  at the start of the chapter on page 93.

The following section contains a description of all possible controls. The number of controls may vary depending on the version of the seat.

The controls are mirrored for the right-hand front seat.





**Fig. 74** On the left front seat: controls.

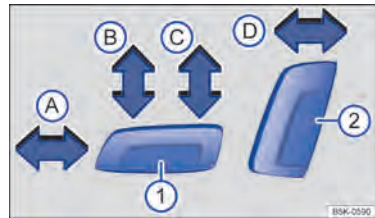
- ① Take your weight off the backrest and turn the handwheel to adjust it.
- ② Move the lever up or down, several times if necessary, to adjust the seat height.
- ③ Pull the lever to push the front seat forwards or backwards. The front seat must engage after you release the lever!

- ④ Press the button to adjust the armrest up or down.

If the armrest is not in use, it can be folded up without pressing the button.

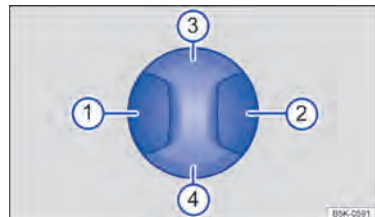
- ⑤ **Only for electric seats:**

Raise the handle to slide the seat cushion forwards or backwards.



**Fig. 75** Switches on the front left seat, adjusting the front seat forwards or backwards, adjusting the backrest and the seat cushion height and tilt.

- ① A Slides the seat forwards or backwards.
- B Adjusts the angle of the seat cushion.
- C Raises or lowers the seat.
- ② D Adjusts the angle of the backrest.



**Fig. 76** Switch on the front left seat: adjusting the lumbar support.

- ① Adjust the curve of the lumbar support forwards.
- ② Adjust the curve of the lumbar support backwards.
- ③ Adjust the curve of the lumbar support upwards.
- ④ Moves the curve of the lumbar support down.

## Electrically adjusting the front seat

📖 Please refer to ⚠️ and ① at the start of the chapter on page 93.

The controls are mirrored for the right-hand front seat.

The seat may have a combination of mechanical and electrical controls.

### **WARNING**

Careless or unsupervised use of the electric front seats can result in severe injuries.

- The electrical front seat adjustment also works when the ignition is switched off. Never leave children or people requiring assistance alone in the vehicle.
- In the event of an emergency, stop electrical adjustment by pressing another switch.

### **NOTICE**

To avoid damaging the electrical components in the front seats, do not kneel on the seats or apply sharp pressure at a single point on the seat cushion and backrest.



It may not be possible to adjust the seat electrically if the charge level of the 12-volt vehicle battery is too low.



Activating the electric drive will interrupt the seat adjustment procedure. ◀

## Rear seats

### **Introduction to the topic**

The following section describes the options for adjusting the rear seats. Always ensure that your sitting position is correct → page 35.

### **WARNING**

Always adjust the rear seats to their correct position or fold to upright position before starting any journey and make sure that all passengers have fastened their seat belts.

- The rear seat should be adjusted or folded down only when the vehicle is stationary as the rear seat could otherwise move unexpectedly while the vehicle is in motion. Furthermore, an incorrect sitting position is adopted while adjusting or folding down the seat.

- The risk of serious injury is increased for passengers on the rear seats if they are not sitting upright because the seat belts are incorrectly positioned.
- The rear seat should be adjusted or folded down only when there is no one in the adjustment area or folding path.

### **WARNING**

Any lighters in the vehicle could be damaged or accidentally lit. This could lead to serious burns and other injuries.

- Before adjusting or folding down the seats, always ensure that there is no lighter on or near the movable parts of the seat.

### **WARNING**

The centre armrest must always be folded up while the vehicle is in motion in order to reduce the risk of injury.

- The centre seat on the rear bench seat must never be used when the centre armrest is folded down – neither by adults nor children. An incorrect sitting position can cause severe injuries.
- Never transport an adult or child on the centre armrest.

### **NOTICE**

- Items in the luggage compartment could cause damage when folding down the rear seat or moving it forwards or backwards.
- When the rear seat is in forward position or folded down, objects could move into the space between the seat and luggage compartment floor. Remove any items or objects from this space before pushing the rear seat back.

### **NOTICE**

Sharp edges can damage the seats.

- Do not touch the seats with sharp-edged objects. Sharp objects, such as zips, rivets on clothing or belts, may damage surfaces.

Open Velcro fasteners may also cause damage.

## Folding the backrest of the rear bench seat forwards and backwards

📖 Please refer to ⚠️ and ❶ at the start of the chapter on page 96.

The rear seat backrest is split. Each part of the rear seat backrest can be folded down to increase the size of the luggage compartment.



**Fig. 77** In the rear seat backrest: release button.

### Folding the rear seat backrest forwards

- Push the head restraint all the way down.
- Pull the release button → Fig. 77 ❶ forwards and fold the rear seat backrest forwards at the same time.

The respective section of the rear seat backrest is unlocked when you can see the red marking → Fig. 77 ❷.

### Folding back the rear seat backrest

- Fold back the rear seat backrest and push it firmly into the catch until it engages securely into place → ⚠️.

The red marking → Fig. 77 ❷ should no longer be visible.

## ⚠️ WARNING

Injuries can be caused if the rear seat backrest is folded forwards and backwards without due care and attention.

- While folding the rear seat backrest forward, always make sure that no people or animals are in its path.
- Never fold the rear seat backrest forwards or backwards while the vehicle is in motion.
- Ensure that the seat belt is not trapped or damaged when folding back the rear seat backrest.
- Always keep hands, fingers, feet or other body parts away from the swivel area when folding the rear seat backrest forwards and backwards.
- Ensure that each rear seat backrest engages securely, otherwise the seat belts for the rear seats will not offer maximum protection. This applies to the centre seat of the rear bench seat in particular. If a seat is occupied and the corresponding rear seat backrest has not clicked securely into place, the seat occupant and rear seat backrest may move forwards in the event of a sudden braking or driving manoeuvre or during accidents.
- The rear seat backrest has not engaged properly if you can see a red marking → Fig. 77 ❷. Always ensure that the red marking is never visible when the rear seat backrest is in the upright position.
- Passengers (adults and children) must not use seats if the rear seat backrest is folded forwards or is not engaged securely into place.

## ❗ NOTICE

Damage to the vehicle or to other objects could be caused if the rear seat backrest is folded forwards and backwards in an uncontrolled way or without due care.

- Before folding the rear seat backrest forwards, always adjust the front seats so that the rear head restraints or rear seat cushions do not impact the front seats.
- Before folding down the rear seat backrest, always make sure that there are no objects located in its path.

## Head restraints

### Introduction to the topic

The following section describes the options for adjusting and removing the head restraints. Always ensure that your sitting position is correct → page 35.

Every seat is fitted with a head restraint. The rear centre head restraint (depending on vehicle equipment) is designed solely for use with the centre seat on the rear bench seat. Therefore you should not install this head restraint in any of the other positions.

There are notches in the rods of the head restraints which enable them to engage in different positions. Only correctly mounted head restraints can engage in the notches in the adjustment area. To prevent accidental removal of the head restraints after installation, stops are fitted at the top and bottom of the adjustment area.

### Correct head restraint adjustment

Adjust the head restraint so that its upper edge is at the same height as the top of the head, but not lower than eye level. Position the back of your head as close to the head restraint as possible.

### Head restraint adjustment for shorter people

Push the head restraint all the way down, even if the head is then underneath the top edge of the head restraint. There may be a small gap between the head restraint and backrest in the lowest position.

### Head restraint adjustment for taller people

Push the head restraint up as far as it will go.

### WARNING

Driving without head restraints or with incorrectly adjusted head restraints increases the risk of severe or fatal injuries in the event of an accident or sudden driving or braking manoeuvre.

- If a seat is occupied, the head restraint for that seat must be fitted and adjusted correctly.
- Each vehicle occupant must adjust the head restraint to suit their body size in order to help reduce the risk of neck injuries in an accident. As far as possible, the upper edge of the head restraint must be level with the top of the head, but not lower than eye level. Position the back of your head in the middle and as close to the head restraint as possible.
- Never adjust the head restraint when the vehicle is in motion.

### NOTICE

When removing or fitting head restraints, make sure that they do not hit the roof, the front seat backrest or other parts of the vehicle. This will prevent damage from occurring. <

## Adjusting head restraints

☞ Please refer to ⚠ and ⓘ at the start of the chapter on page 98.

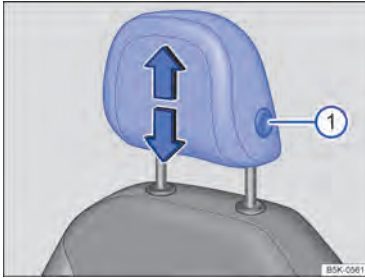


Fig. 78 Front head restraint: adjusting.

### Adjusting the height of the front head restraint

- While pressing the → Fig. 78 ⓘ button, push the head restraint up or down in the direction of the arrows.

The head restraint must securely engage in the top position or other intermediate position. In the lowest position, where the guide pin is completely pushed into the guide rail, the head restraint does not engage properly.

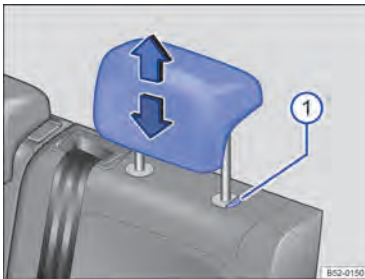


Fig. 79 Rear head restraint: adjusting.

### Adjusting the height of the rear head restraint

- While pressing the button → Fig. 79 ⓘ if necessary, push the head restraint up or down in the direction of the arrows.

The head restraint must engage securely into position. <

## Removing and installing the head restraints

☞ Please refer to ⚠ and ⓘ at the start of the chapter on page 98.

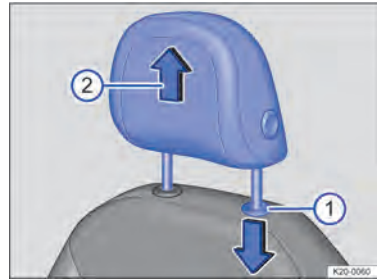


Fig. 80 Front head restraint: removing.

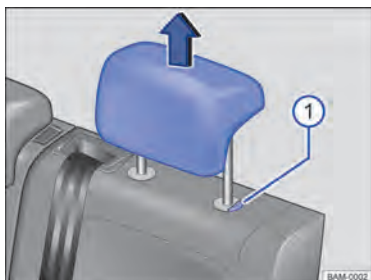
### Removing the front head restraints

- If necessary, lower the head restraint.
- To release, press the ring around the head restraint rod downwards → Fig. 80 ⓘ.
- Pull the head restraint out in the direction of the arrow → Fig. 80 ②.

### Fitting the front head restraints

- Position the head restraint correctly over the head restraint guides and then insert into the guides of the corresponding seat backrest.
- Push the head restraint down until the guide pins click into place.

- Adjust the head restraint so a correct sitting position can be assumed.



**Fig. 81** Rear head restraint: removing.

### Removing the rear head restraints

- If necessary, adjust the backrest so that the head restraint can be removed.
- Push the head restraint all the way up.
- Pull the head restraint out fully while pressing the button → Fig. 81 ①.

### Fitting the rear head restraints

- Release the rear seat backrest and fold the backrest forwards slightly.
- Position the head restraint correctly over the head restraint guides and then insert into the guides of the corresponding seat backrest.
- Press and hold the button → Fig. 81 ① and push down the head restraint.
- Fold back the rear seat backrest and allow it to engage securely.
- Adjust the head restraint so a correct sitting position can be assumed.

## Seat functions

### Centre armrest



**Fig. 82** Rear fold-out centre armrest (illustration).

### Rear centre armrest

There may be a fold-out centre armrest in the backrest of the middle seat of the rear bench seat.

- To *fold it down*: pull the loop in the direction of the arrow → Fig. 82.
- To *fold it back*: fold the centre armrest upwards in the opposite direction of the arrow → Fig. 82 and push it into the backrest as far as it will go.

Do not use the middle seat on the rear bench seat to transport passengers when the centre armrest is folded down.

### **! WARNING**

The rear centre armrest must always be folded up while the vehicle is in motion in order to reduce the risk of injury.

- The centre seat on the rear bench seat must never be used when the centre armrest is folded down – neither by adults nor children. An incorrect sitting position can cause severe injuries.

## Memory function



**Fig. 83** On the outside of the driver seat: memory buttons.

### Memory buttons

The memory buttons can be used to store and recall settings for the driver seat and the exterior mirrors.

### Storing driver seat and exterior mirror settings for driving forwards

- Switch on the electronic parking brake.
- Put the gearbox into neutral.
- Switch on the ignition.
- Adjust the driver seat and exterior mirrors.
- Press the **SET** button for longer than one second → Fig. 83.
- Press the desired memory button within approximately 10 seconds. An acoustic signal confirms that the settings have been stored.

### Storing front passenger exterior mirror settings for reversing

- Switch on the electronic parking brake.
- Put the gearbox into neutral.
- Switch on the ignition.
- Press the desired memory button → Fig. 83.
- Select reverse gear.
- Adjust the exterior mirror on the front passenger side so that you have a good view of the kerb area, for example.


The settings for the mirror position will be saved automatically and assigned to the vehicle key that was used to unlock the vehicle.

### Accessing driver seat and exterior mirror settings

- When the vehicle is stationary, the ignition is switched off and one vehicle door is open, briefly press the corresponding memory button. After around 10 minutes, the stored positions can *no longer* be adjusted automatically. The adjustment process is cancelled if one of the memory buttons is pressed again.

**OR:** with the driver door closed or ignition switched on, press and hold the corresponding memory button until the stored position has been attained.

The front passenger exterior mirror will leave the reversing position automatically if the vehicle drives forwards at a speed of at least around 15 km/h (10 mph) or if you turn the rotary knob for the exterior mirror out of the **R** position and into another position.

 If the driver door is opened later than approximately 10 minutes after unlocking the vehicle, the driver seat and exterior mirrors are not automatically adjusted.

### Convenient entry function

When the driver door is opened, the driver seat automatically moves to a position which makes it easy to enter and exit the vehicle.

The driver seat moves back to its original position automatically as soon as the driver door is closed and the ignition is switched on.

You can switch the convenient entry function on and off in the Infotainment system. 

## Massage function





**Fig. 84** In the lower area of the driver seat: button for massage function.

When the massage function is switched on, the lumbar support moves and massages the lumbar region.

The curvature of the lumbar support (massage intensity) can be individually adjusted in three levels during operation by repeatedly pressing the corresponding switch → page 95.

### Switching the massage function on or off

To switch on, press the  button in the seat touch panel. To switch off, press the  button again.

The massage function is switched off automatically after approximately ten minutes.

### WARNING

Incorrect use of the seat functions can cause serious injuries.

- Always assume a correct sitting position before you start driving and maintain this position throughout the trip. This also applies to all passengers.
- Switch the massage function on and off only when the vehicle is stationary.
- Keep hands, fingers, feet and other body parts away from the seat's moving parts and adjustment range.

## Lights

### Turn signals

#### Switching turn signals on and off



**Fig. 85** On the left-hand side of the steering column: turn signal and main beam lever.

- Switch on the ignition.
- Move the turn signal and main beam lever from the centre position to the following position → Fig. 85:
  - **A** Right turn signal →.
  - **B** Left turn signal ←.
- Return the turn signal and main beam lever to the basic position in order to switch off the turn signal.

Go to a qualified workshop if the acoustic signal does not sound when a turn signal is switched on and have the vehicle checked.

#### Convenience turn signal

To operate the convenience turn signal, push the turn signal and main beam lever up or down to the point where you meet resistance and then release the lever. The turn signal flashes three times.

To cancel the convenience turn signal, immediately move the lever in the opposite direction up to the pressure point and then release it.



The convenience turn signal can be activated and deactivated in the vehicle settings in the Infotainment system → page 31.

### ⚠ WARNING

Incorrect use of turn signals, a failure to use turn signals, or forgetting to switch off a turn signal can confuse other road users. This can lead to accidents and serious injuries.

- Always activate the turn signal in good time when changing lanes and performing overtaking or turning manoeuvres.
- Always switch off the turn signal once the lane change or overtaking or turning manoeuvre has been completed.



The hazard warning lights also work when the ignition is switched off → page 66.

## Vehicle lighting

### Switching lights on and off



**Fig. 86** Next to the steering wheel: touch panel for switching on the exterior lighting.

#### Switching lights on

- Switch on the ignition.
- Touch the button as often as required until the corresponding indicator lamps light up.



The dipped beam headlights are switched on. The indicator lamp lights up green.

#### AUTO

Automatic headlights: dipped beam is switched on or off depending on the brightness level → → page 104.



Side lights switched on, the indicator lamp lights up green. The automatic headlights function **AUTO** is activated as from a speed of around 10 km/h (6 mph).

- Light switched off. The automatic headlights function **AUTO** is activated from a speed of around 10 km/h (6 mph) or when a distance of about 100 m (0.062 miles) has been driven.

#### Switching off the lights

- Switch off the ignition.

#### AUTO

The orientation lighting can be switched on → page 109.



Side lights or continuous parking light on both sides of the vehicle switched on. The indicator lamp lights up green.

- Light switched off.

#### Daytime running lights

The daytime running lights can increase the visibility of the vehicle in traffic during the daytime and are switched on each time the ignition is switched on (if brightness is detected).

### ⚠ WARNING

Accidents and serious injuries can occur if roads are not sufficiently illuminated and other road users have difficulty seeing the vehicle, or cannot see it at all.

- The light assistance systems only provide support; the driver is responsible for making sure the vehicle lights are switched on correctly.
- Always switch the dipped beam headlights on if it is dark, raining or visibility is poor.

## WARNING



The side lights or daytime running lights are not bright enough to illuminate the road ahead and to ensure that other road users are able to see you.

- Always switch the dipped beam headlights on if it is dark, raining or visibility is poor.
- The tail lights will not be switched on with the daytime running lights. If the tail lights are not switched on, the vehicle may not be visible to other road users if it is dark, raining, or if visibility is poor.

## WARNING



The automatic headlights function **AUTO** switches the dipped beam headlights on and off only when there is a change in the level of brightness.



- Switch the dipped beam on manually if required by the weather conditions, e.g. in the event of fog.

 When reverse gear is engaged, the cornering light on both sides of the vehicle switches on to provide better illumination of the surrounding area when manoeuvring. 



## Switching the rear fog light on and off

The rear fog light can only be switched on when the ignition is switched on → page 103:

- **Switching on the rear fog light:** press button . The indicator lamp in the button lights up. The indicator lamp  also lights up yellow in the instrument cluster.
- Press the button again to switch off the rear fog light.

 If the rear fog light is switched on with switched-off lights **OFF**, switched-off side lights  or switched-on automatic




headlights **AUTO**, the dipped beam headlights will be switched on independently of the ambient brightness level.




 In vehicles with a factory-fitted **towing bracket:** the vehicle's rear fog light is not switched on if a trailer with rear fog light is electrically connected to the vehicle. 

## Switching poor weather light on and off

The poor weather light allows the driver to improve illumination of the road in poor visibility conditions.


The poor weather light can only be switched on when the ignition is switched on:

- **Switching on the  poor weather light:** Press the  button → page 103. The indicator lamp in the button lights up green. In addition, the  indicator lamp lights up for a few seconds in the instrument cluster.
- Press the button again to switch off the poor weather light.

 If the poor weather light is switched on with switched-off lights **OFF**, switched-on side lights  or switched-on automatic headlights **AUTO**, the dipped beam headlights will also be switched on regardless of the ambient brightness level. 

## Light functions

### Side lights

When the side lights  are switched on, both headlights light up with side lights together with parts of the tail light clusters, the number plate light and the buttons in the dash panel. The automatic headlights are activated as from a speed of around 10 km/h (6 mph).

### Automatic headlights **AUTO**

When the automatic headlights function is switched on, the vehicle lighting and the instrument and switch lighting will switch on under the following conditions.

- The light sensor has detected darkness.
- The windscreen wipers have been switched on for an extended period.

When the lights are switched on, the indicator lamp lights up yellow.

The automatic headlights function is merely an aid and will not always be able to detect all driving situations.

In vehicles with a corresponding equipment level, the switch-on time of the automatic headlights can be set in the Infotainment system → page 31.

### Cornering light

When dipped beam is switched on, a cornering light is switched on when turning slowly or driving around very tight bends.

### Dynamic cornering light

The dynamic cornering light permits optimum illumination of the road. The dynamic cornering light only works when the automatic headlights function **AUTO** is switched on and at speeds above approximately 10 km/h (6 mph).

### Acoustic warnings if lights are not switched off

When the ignition has been switched off and the driver door is opened, acoustic warnings will sound under the following conditions:

- If the parking light is switched on.
- If the side lights  $\Rightarrow$  are switched on.

When the exit lighting (“Coming home” function) is switched on, no acoustic signal will be given as a reminder that a light is still switched on when leaving the vehicle.  $\triangleleft$

## Switching main beam on and off



**Fig. 87** On the left-hand side of the steering column: turn signal and main beam lever.

- Switch on the ignition and dipped beam.
- Move the turn signal and main beam lever from the centre position to the following position → Fig. 87:
  - **A**  $\Rightarrow$  Main beam switched on.
  - **B** Operate the headlight flasher or switch off the main beam. The *headlight flasher* comes on for as long as the lever is pulled.

When the main beam or headlight flasher is switched on, the blue indicator lamp  $\Rightarrow$  lights up in the instrument cluster.

### Main-beam control

Depending on the vehicle equipment level, advanced main-beam control may also be available → page 105 , → page 107.


### **!** WARNING

Incorrect use of the main beam headlights can lead to accidents and serious injuries as the main beam headlights can distract and dazzle other road users.  $\triangleleft$

## Main-beam control



Main-beam control automatically dips the headlights when oncoming vehicles and vehi-

cles driving in front are detected. Main-beam control normally also recognises illuminated areas such as towns and deactivates main beam while driving through them.

Within the limits of the system, main-beam control automatically switches the main beam on or off depending on the environmental and traffic conditions and on the driving speed → .

### Switching on main-beam control

- Switch on the ignition and the automatic headlights **AUTO**.
- Briefly press the turn signal and main beam lever forwards out of the basic position.

When main-beam control is switched on, the  indicator lamp lights up in the instrument cluster display. When main-beam control is active, the blue indicator lamp  lights up in the instrument cluster.

### Switching off main-beam control

- Switch off the automatic headlights **AUTO**.
- **OR:** main-beam control switched on and active: pull back the turn signal and main beam lever.
- **OR:** main-beam control switched on and **not** active: touch the turn signal and main beam lever forwards to switch on manual main beam. Pull back the turn signal and main beam lever to switch off the manual main beam if necessary.
- **OR:** switch off the ignition.

### System limits

The main beam must be manually switched off under the following conditions, as it is not switched off by the main beam control in time or at all:

- In badly lit towns that the system cannot recognise as towns.
- In poorly lit streets where there are highly reflective signs.
- Other road users with insufficient lighting facilities, such as pedestrians, cyclists.

- In tight bends, on steep hill crests or in dips in the road or when oncoming traffic is half-hidden.
- With oncoming traffic on streets with a central barrier where the driver can see clearly over the central barrier e.g. truck drivers.
- In fog, snow or heavy rain.
- In conditions where dust or sand has been blown up.
- Damage to the windscreen in the camera's field of vision.
- If the field of view of the camera is covered by condensation, dirt, a sticker, snow or ice.
- If the camera is faulty or the power supply is interrupted.

### WARNING

Do not let the extra convenience afforded by main-beam control tempt you into taking any risks when driving. The system is not a substitute for the full concentration of the driver.

- Always check the lights yourself and adjust them to the prevailing conditions for lights, visibility and road traffic.
- The main-beam control may not be able to recognise all driving situations correctly and may not work properly in certain situations.
- If the camera's field of view is dirty, covered or damaged, the function of the main-beam control may be impaired. This also applies if changes are made to the vehicle's lighting system, for example if additional headlights are fitted.

### NOTICE


Please observe the following points in order to avoid impairing the proper function of the system:

- Regularly clean the camera's field of view, and keep it free from snow and ice.
- Do not cover the camera's field of view.

- Regularly check the area of the windscreen that is in the camera's field of view for damage.

## Advanced main-beam control



Advanced main-beam control provides maximum illumination for the road and the edges of the road. At the same time, it prevents vehicles in front or oncoming vehicles from being dazzled. The system uses a camera to detect other self-illuminated road users and their distance from your vehicle and deactivates areas within the light distribution in a targeted manner. If the system can no longer prevent other road users from being dazzled, main beam is switched off completely. Advanced main-beam control normally also recognises illuminated areas such as towns and deactivates main beam while driving through them.

Within the limits of the system, main-beam control automatically switches the main beam on or off depending on the environmental and traffic conditions and on the driving speed → .

Advanced main-beam control can be activated and deactivated in the vehicle settings in the Infotainment system → page 31.

### Switching on advanced main-beam control

- Switch on the ignition and the automatic headlights **AUTO**.
- Briefly press the turn signal and main beam lever forwards out of the basic position.

When main-beam control is switched on, the  indicator lamp lights up in the instrument cluster display. When main-beam control is active, the blue indicator lamp  lights up in the instrument cluster.

### Switching off advanced main-beam control

- Switch off the automatic headlights **AUTO**.

- **OR:** main-beam control switched on and active: pull back the turn signal and main beam lever.
- **OR:** main-beam control switched on and **not** active: touch the turn signal and main beam lever forwards to switch on manual main beam. Pull back the turn signal and main beam lever to switch off the manual main beam if necessary.
- **OR:** switch off the ignition.

### System limits

The main beam must be manually switched off under the following conditions, as it is not switched off by the main beam control in time or at all:

- In poorly lit towns that cannot be recognised as towns by the system.
- In poorly lit streets where there are highly reflective signs.
- Other road users with insufficient lighting facilities, such as pedestrians, cyclists.
- In tight bends, on steep hill crests or in dips in the road or when oncoming traffic is half-hidden.
- With oncoming traffic on streets with a central barrier where the driver can see clearly over the central barrier e.g. truck drivers.
- In fog, snow or heavy rain.
- In conditions where dust or sand has been blown up.
- Damage to the windscreen in the camera's field of vision.
- If the field of view of the camera is covered by condensation, dirt, a sticker, snow or ice.
- If the camera is faulty or the power supply is interrupted.

### WARNING

Do not let the extra convenience afforded by main-beam control tempt you into taking any risks when driving. The system is not a substitute for the full concentration of the driver.

- Always check the lights yourself and adjust them to the prevailing conditions for lights, visibility and road traffic.
- The main-beam control may not be able to recognise all driving situations correctly and may not work properly in certain situations.
- If the camera's field of view is dirty, covered or damaged, the function of the main-beam control may be impaired. This also applies if changes are made to the vehicle's lighting system, for example if additional headlights are fitted.

### ! NOTICE

Please observe the following points in order to avoid impairing the proper function of the system:

- Regularly clean the camera's field of view, and keep it free from snow and ice.
- Do not cover the camera's field of view.
- Regularly check the area of the windscreen that is in the camera's field of view for damage.

## Switching parking lights on and off



**Fig. 88** On the left-hand side of the steering column: turn signal and main beam lever.

### Switching on parking light on one side of the vehicle

When the parking lights are switched on, the headlight with side light and parts of the tail

light cluster on the corresponding side of the vehicle light up.

- Switch off the ignition.
- Move the turn signal and main beam lever from the centre position to the following position → **Fig. 88**:
  - **A** Right-hand parking light is switched on.
  - **B** Left-hand parking light is switched on.

### Continuous parking light on both sides of the vehicle

Both headlights light up with side lights as well as parts of the tail light clusters if continuous parking light on both sides of the vehicle is switched on:

- Switch on the parking lights »«.
- Switch off the ignition.
- Lock the vehicle from outside.

### Automatic switch-off of side lights and parking lights

The vehicle will detect a weak 12-volt vehicle battery and switch off the side lights or parking lights in good time so that the vehicle's drive system can still be activated – however, this will occur after two hours at the earliest.

If the battery capacity is not sufficient for the side lights or parking light to remain switched on for two hours, the 12-volt vehicle battery may discharge so far that the vehicle's drive system can no longer be activated.

### ! WARNING

Accidents and serious injuries can occur if the vehicle is parked without sufficient illumination, as other road users might have difficulty seeing the vehicle, or may not see it at all.

- Always park the vehicle safely and with sufficient lighting. Observe any applicable local legislation.
- If the vehicle lighting is required for several hours, switch on the right or left parking light if possible. The activation

duration of the one-sided parking light is generally double that of the continuous parking light on both sides.

## Entry and exit lighting (orientation lighting)

The entry and exit lighting lights up the area immediately surrounding the vehicle when you get in or out of the vehicle in darkness.

The entry and exit lighting is controlled automatically by a light sensor.

### Switching on entry lighting

- Unlock the vehicle when the automatic headlight control function **AUTO** is switched on and the light sensor detects *darkness*.

### Switching off entry lighting

- Automatically after the switch-off delay.
- **OR:** lock the vehicle.
- **OR:** press the light switch as often as necessary until the setting **OFF** is displayed in the instrument cluster.
- **OR:** switch on the ignition.

### Switching on exit lighting

- Switch off the ignition.

The exit lighting is switched on when the automatic headlight control **AUTO** is switched on and the light sensor detects *darkness*.

The *switch-off delay* starts when the last vehicle door or the boot lid is closed.

### Switching off exit lighting

- Automatically after the set switch-off delay has elapsed.
- **OR:** automatically if a vehicle door or the boot lid is opened approximately 30 seconds after switch-on.
- **OR:** press the light switch as often as necessary until the setting **OFF** is displayed in the instrument cluster.

- **OR:** switch on the ignition.

### Adjusting entry and exit lighting

The switch-off delay can be set and the function activated or deactivated in the vehicle settings in the Infotainment system → page 31.

Depending on the equipment, the behaviour of the exterior lighting can be set in the vehicle settings in the Infotainment system.

It is possible to choose between two display strategies in the **Convenience light settings** menu:

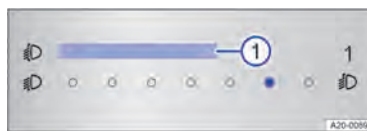
- Classic entry and exit lighting.

The surround lighting, headlights and tail light clusters are switched on and off simultaneously.

- Dynamic entry and exit lighting.

The surround lighting, headlights and tail light clusters are switched on and off dynamically and in some cases with animation.

## Headlight range control



**Fig. 89** In the Infotainment system: touch slider for headlight range control.

Headlight range control can be used to adjust the light cone of the dipped beam headlights to the vehicle load level. This gives the driver the best visibility possible and means that oncoming traffic will not be dazzled → ⚠.

Depending on the vehicle equipment, the headlight range can be adjusted in the Infotainment system → Fig. 89.

## Manual headlight range control

Adjustment using the touch slider in the Infotainment system:

- Touch the **(Vehicle)** function button.
- Touch the **(Headlights)** function button to open the menu option **Headlight range control** → Fig. 89 ①.
- Touch the required position (example vehicle load level).

Settings in the Infotainment system

0	Front seats occupied and luggage compartment empty.
2	All seats occupied and luggage compartment empty.
4	All seats occupied and luggage compartment fully loaded. Towing a trailer with a low drawbar load.
6	Only the driver seat occupied and luggage compartment fully loaded. Towing a trailer with maximum drawbar load.

## Dynamic headlight range control

The headlight range cannot be adjusted manually if the vehicle has dynamic headlight range control. The headlight range is automatically adapted to suit the vehicle load level as soon as the headlights are switched on → ⚠.

### ⚠ WARNING

Heavy objects in the vehicle can cause the headlights to dazzle and distract other road users. This can lead to accidents and serious injuries.

- The light cone should always be adjusted to the load level of the vehicle to ensure that other road users are not dazzled.


### ⚠ WARNING

Failure or malfunction in the dynamic headlight range control can cause the headlights to dazzle or distract other road users. This can lead to accidents and serious injuries.

- The headlight range control should be checked by a qualified workshop as soon as possible.

## Switching over headlights for driving abroad (travel mode)

If you have to drive a right-hand drive vehicle in a left-hand drive country, or vice versa, the dipped beam of vehicles with advanced main-beam control or dynamic cornering light may dazzle oncoming traffic → page 107, → page 104. For this reason, the headlight alignment of vehicles with this equipment can be adjusted in the Infotainment system in the **(Vehicle settings)** menu (travel mode) → page 31. Adjustment of the headlights is not necessary on vehicles without advanced main-beam control and without dynamic cornering light.

 Travel mode may only be used for a short period. Please contact a qualified workshop for permanent conversion. Volkswagen recommends using a Volkswagen dealership for this purpose.

## Troubleshooting

### ↔ Turn signal indicator lamp

The indicator lamp flashes green.

If a turn signal on the vehicle has failed, the indicator lamp will start flashing twice as fast.

- Check the lighting and change the appropriate bulb as required → page 295.



- If the fault persists, go to a qualified workshop.

#### Trailer turn signal indicator lamp

The indicator lamp flashes green.

The indicator lamp goes out if a trailer turn signal or all trailer lights stop working.

- Check the lighting and change the appropriate bulb as required → page 295.
- If the fault persists, go to a qualified workshop.

#### Exterior drive lighting not working

The indicator lamp lights up yellow.

Vehicle lighting not working partially or completely.

- Check the lighting and change the appropriate bulb as required → page 295.
- If the fault persists, go to a qualified workshop.

#### Fault in rain and light sensor

The indicator lamp lights up yellow.

In the light switch position **AUTO**, the vehicle lighting is not switched on or off automatically.

- Switch the ignition off and on.
- If the fault persists, go to a qualified workshop.

#### Dynamic cornering light

In vehicles with driving profile selection, the selected driving profile can affect the swiveling motion of the lights.

A corresponding display appears in the instrument cluster if there is a dynamic cornering light fault. Go to a qualified workshop.

#### Touch panels do not react as expected

Moisture, dirt, grease etc. can restrict functioning of the touch panel. Make sure that the touch panels are always clean and dry.

## Interior lighting

### Instrument and switch lighting

The brightness of the instrument and switch lighting and the basic brightness level of the Head-up Display can be adjusted in the vehicle settings in the Infotainment system → page 31.

The brightness setting is automatically adjusted to the changing ambient light conditions in the vehicle.



When the automatic headlights function **AUTO** is switched on, a sensor will switch the dipped beam and the lighting in the instruments and switches on and off automatically depending on the ambient brightness level.

### Interior and reading lights, background lighting



**Fig. 90** In the roof console: touch-sensitive reading lights.

Touch the corresponding symbol:

	Switch interior lights on or off or dim lights.
	Function switched off: the interior lights are switched on automatically when the vehicle is unlocked, a door is opened or the ignition is switched off.

### Touch-sensitive reading lights with manual dimming function

There are touch-sensitive reading lights in the roof console and above the rear seat row → Fig. 90. The individual reading lights can be switched on or off by touching the light surface.

In order to activate the manual dimming function, keep touching the light surface until the desired brightness level is reached.


### Luggage compartment lighting

The luggage compartment lighting is switched on or off when the boot lid is opened or closed.

### Background lighting

The background lighting provides indirect light in the various areas of the vehicle interior.

The brightness and, depending on equipment level, colour of the background lighting can be adjusted in the **Background lighting** menu in the Infotainment system. If the setting **Auto** is selected, the colour of the background lighting changes depending on the driving profile setting.

 The lights switch off when the vehicle is locked or after a few minutes once the ignition has been switched off. This prevents the 12-volt battery from discharging. <

## Vision

### Wipers


#### Operating the wiper lever












**Fig. 91** On the right-hand side of the steering column: operating the windscreen wipers.



**Fig. 92** On the right-hand side of the steering column: operating the rear window wiper.

The wipers function only when the ignition is switched on, the driver and front passenger doors are closed and the bonnet or boot lid are closed. Move the wiper lever to the desired position → :

- A**  Wipers switched off.
- B**  Interval wipe for the windscreen or rain sensor mode. The interval wipe for the windscreen depends on the speed of the vehicle. The wipers will wipe more frequently as the vehicle moves faster.
- C**  **LOW** Slow wiping.

- D  Fast wiping.
- E  Flick wipe – short wiping. Press and hold the lever for longer to wipe more quickly.
- F  Automatic wipe/wash for cleaning the windscreen with the lever pulled. The Climatronic will switch to air recirculation mode for approximately 30 seconds to prevent the smell of the windscreen washer fluid from entering the vehicle interior.
- I  Switch for interval stages (vehicles without rain and light sensor) or adjusting the sensitivity of the rain and light sensor.
- G  Intermittent wiping for the rear window. The wiper will wipe the window approximately every six seconds.
- H  Automatic wipe/wash for cleaning the rear window with the lever pushed.

### WARNING

Without adequate anti-freeze, the washer fluid may freeze onto the windscreen and obscure your view.

- In winter temperatures, the window washer system should only be used when adequate anti-freeze has been added.
- Never use the windscreen washer system at winter temperatures before the windscreen has been heated by the ventilation system. This could lead to the anti-freeze mixture freezing on the windscreen and restrict the driver's vision.

### WARNING

Worn or dirty windscreen wiper blades reduce visibility and increase the risk of accidents and severe injuries.

- Always change wiper blades if they are damaged or worn out and when they no longer clean the window sufficiently → page 293.


### NOTICE


Before setting off and **before switching on the ignition**, always check the following to avoid damage to the windows, wiper blades and wiper motor:


- The wiper lever is located in the basic position.
- Snow and ice have been removed from the wiper blades and windows.
- Wiper blades that have become frozen on to the glass have been carefully loosened. Volkswagen recommends using a de-icer spray for this.

### NOTICE

Do not switch on the wipers when the window is dry. Using the wipers when the window is dry can damage the glass.

 When switched on, the wipers will temporarily be switched to the next setting down when the vehicle is stationary.

 If the driver or front passenger door is opened when the vehicle is stationary, the windscreen wipers will move to their initial position and will be switched off. If the door is closed within a few seconds or the wiper lever is moved, the wipers will be switched back on again.

 If the vehicle is parked during cold weather, the service position of the windscreen wiper may be helpful in order to be able to release the wiper blades better from the windscreen → page 293. ◀

## Wiper function

### Automatic activation of the rear window wiper

The rear window wiper is switched on automatically if the front windscreen wipers are switched on and reverse gear is engaged. Automatic activation when reverse gear is engaged can be activated and deactivated in

the vehicle settings in the Infotainment system → page 31.

### Heated washer jets

The heating defrosts frozen washer jets. The heating output is automatically regulated when the ignition is switched on, depending on the ambient temperature. Only the washer jets are heated and not the hoses carrying washer fluid.

### Rear view camera cleaning system

The rear view camera cleaning system cleans the rear view camera and works in conjunction with the wash and wipe system to clean the rear window.

If the view from the camera remains obscured after it has been cleaned several times, the camera lens must be cleaned manually → page 8, → page 358. <

## Rain and light sensor



**Fig. 93** On the right of the steering column: wiper lever.

When the rain and light sensor is activated, it automatically controls the frequency of the wiper intervals, depending on the intensity of the rain.

### Activating and deactivating the rain and light sensor

Push the lever to the desired position → Fig. 93:

- Position **(A)** - the rain and light sensor is deactivated.

- Position **(B)** - the rain and light sensor is activated, automatic wipe when necessary.

The automatic wipe function can be activated and deactivated in the vehicle settings in the Infotainment system → page 31.

If the automatic wipe function is deactivated in the Infotainment system, the intervals are set at fixed levels.

### Adjusting the sensitivity of the rain and light sensor

The sensitivity of the rain and light sensor can be adjusted manually using the switch in the wiper lever → Fig. 93 **(1)** → **(A)**.

- Switch to the right - high sensitivity.
- Switch to the left - low sensitivity.

## **!** WARNING

The rain and light sensor cannot always detect all precipitation sufficiently and activate the wipers.

- If necessary, switch on the windscreen wipers manually if the water on the windscreen restricts the field of vision. <

## Troubleshooting

### Washer fluid level too low

The indicator lamp lights up yellow.

Fill up the washer fluid reservoir as soon as possible → page 314.

### Fault in wipers

The indicator lamp lights up yellow.

The wipers do not wipe.

- Switch the ignition off and on.
- If the fault persists, go to a qualified workshop.

### **Fault in rain and light sensor**

The indicator lamp lights up yellow.

The wipers are not switched on automatically if it rains during rain and light sensor operation.

- Switch the ignition off and on.
- If the fault persists, go to a qualified workshop.


### **Changes in the response of the rain and light sensor**

Possible causes for faults and misinterpretations relating to the sensitive surface of the rain and light sensor → page 7 include:

- **Damaged wiper blades:** a film of water or smears caused by damaged wiper blades can increase the time the wipers are switched on, can shorten the length of the intervals between wipes or cause the wipers to run quickly and continuously.
- **Insects:** insects hitting the windscreen surface can cause the wipers to be activated.
- **Salt deposits:** in winter, salt deposits can cause the wipers to continue to wipe the windscreen when it is almost dry.
- **Soiling:** dry dust, wax, windscreen coatings (lotus effect), or detergent deposits (from an automatic car wash) can cause the rain and light sensor to become less sensitive and react too slowly, or prevent it from reacting at all. Clean the sensitive surface of the rain and light sensor at regular intervals and inspect the wiper blades for damage → page 358.
- **Crack in the windscreen:** a wipe cycle will be triggered if the rain and light sensor is switched on when the windscreen is impacted by a stone. The rain and light sensor will then register the reduction in sensitivity of the surfaces and adjust accordingly. The size of the crack can affect the way in which the rain and light sensor activates the wipers.



The wipers will try to wipe away any obstacles that are on the window. The

wipers will stop moving if the obstacle blocks their path. Remove the obstacle and switch the wipers back on again. 

## Mirrors

### General safety notes

The driver can use the exterior mirrors and interior mirror to observe the traffic behind and adjust the driving style accordingly.

For safety reasons, it is important that the driver positions the exterior and interior mirrors correctly before starting a journey.

Looking in the exterior mirrors and the interior mirror does not allow the driver to see the entire area around the side and rear of the vehicle. The area that cannot be seen is known as the blind spot. There may be objects and other road users in the blind spot.

### **WARNING**

Adjusting the exterior and interior mirrors while driving may cause the driver to become distracted. This can lead to accidents and serious injuries.

- Exterior and interior mirrors should only be adjusted when the vehicle is stationary.
- When parking, changing lane, or performing an overtaking or turning manoeuvre, always pay careful attention to the area around the vehicle as objects and other road users may be located in the blind spot.
- Always ensure that the mirrors are positioned correctly and that the rear view is not restricted by ice, snow, condensation or any other objects.

### **WARNING**

If you estimate the distance from traffic behind you incorrectly, you can cause accidents and serious injuries.

- Curved mirrors (convex or aspheric) enlarge the field of vision and can make objects in the mirror seem smaller and further away than they actually are.
- Using curved mirrors to estimate the distance from other vehicles behind you when changing lanes can provide inaccurate results and can lead to accidents and severe injuries.
- Whenever possible, use the interior mirror to check the exact distance between your vehicle and following traffic or other objects.
- Ensure that you have a good view to the rear of the vehicle.

### ⚠ WARNING

Automatic anti-dazzle mirrors contain an electrolyte fluid which could leak if the mirror is broken.

- The leaking electrolyte fluid can cause irritation to the skin, eyes and respiratory organs, especially in people who suffer from asthma or similar illnesses. Immediately ensure that there is a sufficient supply of fresh air and get out of the vehicle. If this is not possible, open all of the windows and doors.
- If the electrolyte fluid gets into the eyes or onto the skin, immediately wash the area with plenty of water for at least 15 minutes and consult a doctor.
- If the electrolyte fluid gets onto shoes or clothing, wash immediately with plenty of water for at least 15 minutes. Clean shoes and clothes thoroughly before wearing them again.
- If the electrolyte fluid is swallowed, immediately rinse the mouth with plenty of water for at least 15 minutes. Do not induce vomiting unless instructed to do so by a doctor. Seek medical assistance immediately.

### 📢 NOTICE

If the glass of an automatic anti-dazzle mirror is broken, electrolyte fluid can leak from the

mirror. This fluid attacks plastic surfaces. Remove the fluid as soon as possible, e.g. using a wet sponge. ◀

## Interior mirror



**Fig. 94** On the windscreen: automatic anti-dazzle interior mirror.

### Automatic anti-dazzle interior mirror

When the ignition is switched on, the sensors measure the incident light from the rear → Fig. 94 ① and from the front ②.

The interior mirror dims *automatically* depending on the values measured.

If the incident light on the sensors is hindered or interrupted, e.g. by a sun blind or other hanging objects, the automatic anti-dazzle interior mirror will not function correctly. Mobile navigation devices attached to the windscreen or near the interior automatic anti-dazzle interior mirror can also influence the sensors → ⚠.

The automatic anti-dazzle function will be deactivated in some situations, e.g. when reverse gear is engaged.

### **WARNING**

The illuminated display from a portable navigation device can lead to functional impairment of the interior automatic anti-dazzle mirror and cause accidents or serious injuries.

- You may not be able to precisely determine the distance from vehicles travelling behind you or from other objects if the automatic anti-dazzle function is impaired.

## Exterior mirrors



**Fig. 95** In the driver door: rotary knob for the exterior mirrors.

The exterior mirror functions for left-hand drive vehicles are described below. Position **L** corresponds to the exterior mirror on the driver side and position **R** to the exterior mirror on the front passenger side. These instructions are mirrored for right-hand drive vehicles.

- Switch on the ignition.
- Turn the rotary knob in the driver door until the desired symbol lights up → Fig. 95.

- Press the rotary knob in the direction of the arrows to the front, rear, right or left in order to adjust the exterior mirror.



Fold exterior mirrors into the body electrically → .



Switch on the exterior mirror heating. The exterior mirror heating heats only at ambient temperatures below +20°C (+68°F) and initially with the highest setting. Heating takes place dependent on the ambient temperature after around two minutes.

**L**

Adjust the left-hand exterior mirror.

**O**

Neutral position. The exterior mirror cannot be adjusted and all functions are switched off.

**R**

Adjust the right-hand exterior mirror.

The selected function is active as long as the corresponding symbol lights up.

### Activating the exterior mirror functions


The following exterior mirror functions must be activated once in the vehicle settings in the Infotainment system → page 31.


### Synchronous mirror adjustment

The synchronous mirror adjustment function simultaneously adjusts the right exterior mirror when the left exterior mirror is adjusted.

- Turn the rotary knob to position **L**.
- Adjust the left-hand exterior mirror. The right-hand exterior mirror will be adjusted at the same time (synchronous adjustment).
- Correct the adjustment of the right-hand exterior mirror if necessary: turn the rotary knob to position **R** and adjust the right-hand exterior mirror.

### Folding in the exterior mirrors while parking

The exterior mirrors fold in or out automatically when the vehicle is locked or unlocked from the outside. In order for this to happen, the rotary knob must be in position , **L**, **R** or **O**.

If the rotary knob for the electrically adjustable exterior mirrors is in the position , the exterior mirrors remain folded in.

### Storing and activating front passenger exterior mirror settings for reversing

- Unlock the vehicle with the vehicle key to which the settings should be assigned.
- Select reverse gear.
- Adjust the front passenger exterior mirror so that you can see the kerb area, for example.
- Put the gearbox in neutral position.
- Switch off the ignition.
- The settings for the mirror position will be saved and assigned to the vehicle key.

### Activating the front passenger exterior mirror setting for reversing:

- Turn the rotary knob for the exterior mirrors to position **R**.
- Select reverse gear while the ignition is switched on. The right exterior mirror will now adjust itself to the stored position.

The front passenger exterior mirror will move out of the position saved for reversing when the vehicle is driven forwards faster than approximately 15 km/h (9 mph) or when the rotary knob is moved out of position **R** to another position.

### WARNING


Injuries can be sustained if you do not take care when folding the exterior mirrors in and out.



- Only fold the exterior mirrors in or out when there is no obstruction in the path of the mirror.
- Always ensure that no fingers are caught between the exterior mirror and the mirror base when the exterior mirror is moved.

### NOTICE

- Always fold in exterior mirrors before using an automatic car wash.

- Do not fold electrically folding exterior mirrors in or out manually as this can damage the electric motor.

 The exterior mirror heating should be switched off when it is no longer needed. Energy is otherwise wasted.

 In the event of a fault, the electric exterior mirrors can be adjusted by hand by pressing on the outer edge of the mirror. 

## Protection from the sun

### Sun visors

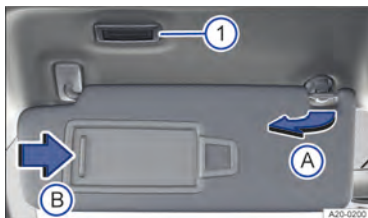


Fig. 96 In the front headliner: sun visor.

### Adjustment options for the driver and front passenger sun visors:

- Folded down over the windscreen.
- Pulled out of the bracket and swung over towards the door → Fig. 96 **A**.

### Illuminated vanity mirror

There is a vanity mirror behind a cover on the inside of the sun visor. When you open the cover → Fig. 96 **B**, the lamp → Fig. 96 **1** lights up.

### WARNING

Driving with the sun visors folded down and the sun blinds pulled out can reduce your view of the road.



- Sun visors should always be folded away and sun blinds should always be retracted if they are not being used.

**i** In certain circumstances, the lamp above the sun visor will go out automatically after a few minutes. This prevents the 12-volt battery from discharging.

## Sun blind in the glass roof



**Fig. 97** In the roof: function button for controlling the sun blind.

The electric sun blind functions when the ignition is switched on and can be opened and closed via the function button in the headliner or the vehicle settings in the Infotainment system.

### Opening and closing the sun blind

*Opening the sun blind:*

- One-touch function: swipe backwards over the function button → Fig. 97. The one-touch function is interrupted by touching the function button.

Manual operation: swipe backwards over the function button and hold until the desired position is reached.

*Closing the sun blind:*

- One-touch function: swipe forwards over the function button → Fig. 97. The one-touch function is interrupted by touching the function button.

Manual operation: swipe forwards over the function button and hold until the desired position is reached.

With some equipment levels, the sun blind can be opened and closed in the vehicle settings in the Infotainment system or using the voice control system → page 31.

### Roll-back function for the sun blind

The roll-back function can reduce the risk of injuries when closing the sun blind → ⚠. The sun blind will open again automatically if it is unable to close because it is stiff or obstructed.

- Check to see why the sun blind has not closed.
- Try to close the sun blind again.
- The sun blind will open again immediately if it is still unable to close because it is stiff or obstructed. After opening, the sun blind can be closed again within a short period of time without the roll-back function.
- If the sun blind still cannot be closed, close it without the roll-back function.

### Closing the sun blind without the roll-back function

- Try to close the sun blind again.
- If the sun blind still cannot be closed, swipe forward over the function button within 5 seconds and hold → Fig. 97 until the sun blind is fully closed.

#### The sun blind will now close without the roll-back function.

- Please go to a qualified workshop if the sun blind still cannot be closed.

If you let go of the function button during the closing procedure, the sun blind will open automatically.

### Touch panel reacts differently than expected

Moisture, dirt, grease etc. can impede the functioning of the touch panel. Make sure that the touch panels are always dry and clean.

## WARNING

Closing the sun blind without the roll-back function can cause serious injuries.

- Always close the sun blind carefully.
- Ensure that nobody obstructs the path of the sun blind, especially if the roll-back function is not active when it is closed.
- The roll-back function does not prevent fingers or other body parts from being pressed against the roof frame and sustaining injury.

# Heating and air conditioning system

## Heating, ventilation, cooling

### Introduction to the topic

The **Climatronic** is an automatic air conditioning system that heats, cools and dehumidifies the air. Automatic mode enables the Climatronic to control the air temperature, air distribution and air volume automatically.

The air conditioning system will work most effectively if the vehicle interior is kept closed. Opening the windows and glass roof to provide fresh air may accelerate cooling down the vehicle if high temperatures have built up in the vehicle interior.

#### Display of active functions

Illuminated symbols on the sensor buttons indicate that the function is switched on.

Colour-coded function buttons display an activated function in the climate settings on the Infotainment system.

#### Operating the air conditioning system with voice commands

Depending on the vehicle equipment, some functions of the air conditioning system can be operated with the voice control function → page 228.

#### Seat-related air conditioning

The air conditioning is controlled in relation to the occupied seats in order to keep the energy consumption of the air conditioning system as efficient as possible. If a seat is not occupied, **Eco** can be displayed instead of the temperature in the air conditioning block in the Infotainment system.

If a person is seated while wearing a seatbelt and the vehicle's drive system is active, the vehicle detects the occupied seat.

## WARNING

Poor visibility through the door windows, windscreen and rear window increases the risk of collisions and accidents which can cause serious injuries.

- Keep all door windows, the windscreen and the rear window free from ice, snow and condensation to maintain perfect visibility.
- Adjust the heating, air conditioning and rear window heating to prevent condensation from forming on the windows.
- Only set off once all windows are clear.
- Use air recirculation mode for a short period only. Condensation could otherwise form very quickly on the windows, greatly reducing visibility.
- Switch off the air recirculation mode when it is no longer required.

## NOTICE

Food, medicine and other items that are sensitive to heat or cold could be either damaged or rendered useless by the air flowing out of the vents.

- Never leave food, medicines or other temperature-sensitive objects in front of the vents.

## NOTICE

If the air conditioning system is not working, switch the air conditioning system off immediately and have it checked by a qualified workshop. This can help to prevent secondary damage.


## Overview of functions

 Please refer to  and  at the start of the chapter on page 120.

Some functions of the air conditioning system and menus in the Infotainment system

as well as an air conditioning block for the rear seats depend on the equipment level.

### In the Infotainment system

-  CLIMA Open the air conditioning settings in the Infotainment system.

### In the Infotainment system: upper screen edge



Switch the air conditioning system on and off.

### In the Infotainment system: lower screen edge



Select temperature. Depending on the equipment level, you can set the temperature directly in the Infotainment system or use the touch sliders beneath the Infotainment system. The selected temperatures are displayed at the bottom of the screen in the Infotainment system.

The temperatures set for the rear row of seats are shown on the displays for the air conditioning block for the rear seats.

**SYNC** Adopt temperature settings of driver side for all seats.



Switch the seat heating on and off → page 124.

**REAR** Opens the settings for the rear seats.

**In the Infotainment system: menu tab Classic Climate**

**AUTO** The set air temperature is kept constant. The volume of air and air distribution are controlled automatically. The blower speed in automatic mode can be controlled via the climate profiles. Automatic mode switches off when the blower speed is adjusted manually.



Adjust the blower speed.



Switch air recirculation mode on and off → page 123.

**A/C**

The air is cooled and dehumidified in cooling mode.

**maxA/C**

Switch maximum cooling output on and off.  
Air recirculation mode is automatically switched on and the Climatronic automatically directs air to the upper body.



Switching the steering wheel heating on and off → page 125



Direct air towards upper body.



Direct air into the footwell.



Direct air onto the windscreen.

**In the Infotainment system: Smart Climate menu tab**

Automatic mode is also switched on if a Smart Climate is activated. The Smart Climate functions remain switched on for a short time. Automatic mode remains switched on after this time elapses.



Clear the windscreen of ice and misting.



Direct warm air into the footwell.



Direct warm air onto the steering wheel.



Direct cold air into the footwell.



Direct fresh air from the outside into the vehicle interior.



Briefly increase the heating output.



Briefly increase the cooling system output.

**In the Infotainment system: Air Care menu tab**

**Air Care** The allergen filter in the Air Care Climatronic can reduce the amount of pollutants and also allergens that enter the vehicle interior → page 123.

**In the Infotainment system: settings**

- Switches automatic air recirculation mode on → page 123.
- Switch on automatic windscreen heating → page 125.

**Settings on vehicle start**

- To automatically switch on the seat heating or steering wheel heating after activation of the vehicle's drive system depending on the outside temperature, touch the respective function button.

**In the Infotainment system: Stationary air conditioning menu**



Open the Stationary air conditioning menu in the Infotainment system → page 127.

**Touch panel next to the multifunction steering wheel**



Switch rear window heating on and off with the vehicle's drive system activated.

The rear window heating switches off automatically after 10 minutes at the latest.




The defrost function of Climatronic clears the windscreen of ice and condensation.

The air is dehumidified and the blower is set to a high speed.



Switch windscreen heating on and off with the vehicle's drive system activated → page 125.

 If REAR LOCK is active in the Infotainment system, the rear air conditioning block cannot be operated.

### NOTICE



Do not apply stickers over the heating elements from the inside to prevent damage to the rear window heating.

## Air recirculation mode

 Please refer to  and  at the start of the chapter on page 120.



When air recirculation mode is switched on, no fresh air enters the vehicle interior.

### Switching manual air recirculation mode on and off

1. Touch  on the Infotainment system.
2. Touch  in the Infotainment system.

### Automatic air recirculation mode of Climatronic

Automatic air recirculation mode supports you within the system limits by temporarily switching the fresh air supply on or off if the fresh air entering the vehicle is of poor quality. The system cannot detect unpleasant odours.


1. Touch  on the Infotainment system.
2. Switch automatic air recirculation mode on or off with  ► Automatic air recirculation.

### Air Care – Climatronic with allergen filter


The allergen filter in the Air Care Climatronic can reduce the amount of pollutants and also allergens that enter the vehicle interior.

When Air Care is switched on, the air conditioning system's air recirculation mode is maximised as far as is permitted by the risk of window fogging depending on the interior humidity and outside temperature. The air recirculation mode is automatically regulated and features continuous adjustment in order

to prevent the vehicle occupants becoming tired.

1. Touch  on the Infotainment system.
2. Switch the Air Care function on or off via **Air Care** ► Active.

### When does air recirculation mode switch off?

Air recirculation mode switches off in the following situations → :

- When the defrost function is switched on.
- If a sensor detects that condensation might form on the vehicle's windows.



### WARNING

Stale air can quickly make the driver tired and negatively affect their concentration which may cause collisions, accidents and serious injuries.

- Never use air recirculation mode for an extended period as no fresh air will enter the vehicle interior.
- Use air recirculation mode for a short period only. Condensation could otherwise form very quickly on the windows, greatly reducing visibility.
- Switch off the air recirculation mode when it is no longer required.

### NOTICE

In vehicles with an air conditioning system, do not smoke when the air recirculation mode is switched on. Smoke can leave residue on the evaporator of the cooling system as well as the dust and pollen filter with pollution filter insert, producing a lasting, unpleasant odour.

 If the outside temperature is very high, brief activation of air recirculation mode helps to cool the vehicle interior more quickly. 



## Seat heating

📖 Please refer to  and  at the start of the chapter on page 120.








When the vehicle's drive system is activated, the front seats can be electrically heated in three settings.

### Heating levels of the seat heating

The seat heating operating conditions are shown in colour in the Infotainment system:

- At the highest temperature setting, all three displays under  or  on the Infotainment system are coloured red.

### Operating the seat heating

1. Touch  on the Infotainment system.
2. Touch  or  at the bottom of the screen to switch on the seat heating with the highest temperature setting.
3. Touch  or  repeatedly to adjust the temperature setting.
4. To switch off the seat heating, touch  or  repeatedly until the symbol is coloured grey.

**OR:** to switch the seat heating on or off, touch the touch sliders under the Infotainment system on the driver or front passenger side with two fingers.

### Seat heating switches on and off automatically.

The most recent temperature setting for the driver seat is activated automatically if you activate the vehicle's drive system again within approximately 10 minutes. If the front passenger seat is occupied, the most recent temperature setting for the front passenger seat is also switched on automatically.


If the front passenger leaves the seat when the seat heating is switched on and the vehicle's drive system is activated, the seat heating of the front passenger seat will be switched off automatically. The display in the Infotainment system turns grey after around 2 seconds. If the front passenger returns to

the seat when the vehicle's drive system is still activated, the seat heating of the front passenger seat will be switched on again automatically.

If the seat heating switches off automatically, you can switch on the seat heating again manually if required even if the front passenger seat is not occupied.

### When should the seat heating not be switched on?

Do not switch on the seat heating if one of the following conditions applies:

- A person with reduced sensitivity to pain or temperature is sitting on the seat → .
- The seat is not occupied.
- The seat is fitted with a protective cover.
- A child seat is installed on the seat.
- The seat cushion is damp or wet.
- The temperature in the vehicle interior or the outside temperature is above +25°C (77°F).

### WARNING

Anyone with reduced sensitivity to pain or temperature due to medication, paralysis or chronic illness (e.g. diabetes) could sustain burns on the back, buttocks and legs when using the seat heating. These burns may take a long time to heal or may never heal fully. Please consult a doctor if you have questions about your own state of health.

- Anyone with reduced sensitivity to pain or temperature should never use the seat heating.

### WARNING


Wet seat covers can cause a malfunctions in the seat heating and increase the risk of burns.

- Ensure that the seat cushion is dry before using the seat heating.
- Do not sit on the seat in damp or wet clothing.

- Do not place any damp or wet objects or items of clothing on the seat.
- Do not spill any liquids on the seat.

### ! NOTICE

- To avoid damaging the heating elements, do not kneel on the seats and do not apply sharp pressure at a single point to the seat cushion and backrest.
- Liquids, sharp objects and insulating materials, such as a protective cover or child seat, may damage the seat heating.
- If an odour develops, immediately switch off the seat heating and have it checked by a qualified workshop.
- If the original seat covers are replaced with another material, the seat heating can overheat or the seat heating function may be restricted.


 To save energy, switch off the seat heating as soon as possible.

## Steering wheel heating



 Please refer to  and  at the start of the chapter on page 120.



The steering wheel heating can function only when the vehicle's drive system is activated.

### Temperature settings of the steering wheel heating

The steering wheel heating operating conditions are shown in colour in the Infotainment system. At the highest temperature setting, all three displays under  on the Infotainment system are coloured red.

### Operating the heated steering wheel

1. Touch  on the Infotainment system.
2. Open the **Classic Climate** menu tab.
3. Touch  to switch on the steering wheel heating at the highest temperature setting.

4. To adjust the temperature setting, touch  repeatedly.
5. To switch off the steering wheel heating, touch  repeatedly until the symbol is coloured grey.

### When does the steering wheel heating switch on automatically?

The most recent temperature setting is switched on automatically if you activate the vehicle's drive system again within approximately 10 minutes.

### When does the steering wheel heating switch off automatically?

The steering wheel heating will be switched off automatically if one of the following conditions is met:


- The power consumption is too high.
- There is a fault in the steering wheel heating system.

## Windscreen heating

 Please refer to  and  at the start of the chapter on page 120.

The windscreen heating can only work when the vehicle's drive system is activated.



### Switching the windscreen heating on and off

- Touch  on the touch panel next to the multifunction steering wheel.

The windscreen heating switches itself off depending on the outside temperature or after around 8 minutes at the latest.

### Automatic windscreen heating

The windscreen heating is switched on automatically if there is a risk of condensation forming on a window.

1. Touch  on the Infotainment system.
2. Switch the automatic windscreen heating on or off with  ► **Automatic windscreen heating**.

Automatic windscreen heating is also active when the air conditioning system is switched off.

### Windscreen heating using the defrost function

The windscreen heating will be switched on when the defrost function is switched on and a sensor detects that condensation may form on the windscreen.

### When does the windscreen heating switch off?

The windscreen heating switches itself off if one of the following conditions is met:

- The power consumption is too high.
- There is a fault in the air conditioning system.
- The specified time has elapsed.

## Troubleshooting

 Please refer to  and  at the start of the chapter on page 120.



### or CO<sub>2</sub> concentration in the air of the vehicle interior too high

The indicator lamp lights up red or yellow.

The message **Health risk! High CO<sub>2</sub> concentration. Open windows!** or **Health risk! CO<sub>2</sub> too high. Open all windows immediately!** may be displayed on the instrument cluster display.

- Open all windows immediately.
- Go to a qualified workshop and have the system checked.



### Air conditioning system not working correctly or CO<sub>2</sub> concentration cannot be measured

The indicator lamp lights up yellow.

The message **Air conditioning system not working correctly. Visit workshop.** may be displayed in the instrument cluster display.

- Go to a qualified workshop and have the system checked.

### Cooling mode **A/C** cannot be switched on or its function is restricted

Cooling mode **A/C** begins to function as soon as the driver seat is occupied.

- Switch on the blower.
- Check the fuse of the air conditioning system → page 296.
- Change the dust and pollen filter → page 353.
- If the fault persists, go to a qualified workshop.

### The heating and fresh air system cannot be switched on or its function is restricted

- If the fault persists, go to a qualified workshop.

### Condensation on the windows

Condensation may form on the windows if they are colder than the ambient temperature and the air is very humid. Cold air can absorb less moisture than warm air, which is why condensation frequently forms on windows in cold weather.

- Keep the air intake in front of the windscreen free of ice, snow and leaves in order to improve heating and cooling performance → page 355.
- Do not cover the air vents in the rear of the luggage compartment. Ensuring they are not covered will allow air to flow through the vehicle from the front to the rear.
- Switch on the defrost function → page 121.

### The wrong unit of temperature has been set

- Change the unit of temperature for all temperature displays in the vehicle using the Infotainment system → page 30.



### Water or water vapour under the vehicle

If the humidity and temperature outside the vehicle are high, condensation can drip off the evaporator in the cooling system and form a pool underneath the vehicle. This is normal and does not indicate a leak.

If the outside humidity is high and the outside temperature low, condensation may evaporate through the stationary air conditioning when it is running. If this is the case, steam may appear underneath the vehicle. This is not a sign that the vehicle is damaged.

### Touch panels react differently than expected

Moisture, dirt and grease can impede the functioning of the touch panels.

- Make sure the touch panels are always clean and dry.

## Stationary air conditioning

### Introduction to the topic

With the stationary air-conditioning, the vehicle interior can be cooled, ventilated or heated when stationary. In winter, operation of the system allows ice, condensation and a thin covering of snow to be cleared from the windscreen. The stationary air conditioning is supplied with power via the main socket or via the vehicle's high-voltage battery.

The stationary air conditioning system can be programmed and managed in the Infotainment system or via an app on your mobile device.

Information about the app, the requirements for use and availability, and about compatible end devices is available on the internet → page 200.


### NOTICE

Food, medicine and other items that are sensitive to heat or cold could be either damaged or rendered useless by the air flowing out of the vents.

- Never leave food, medicines or other temperature-sensitive objects in front of the vents.

The range of the vehicle will be reduced if you operate the stationary air conditioning without a connected charging cable. At extreme outside temperatures, the heating or cooling output of the stationary air conditioning may not be sufficient to achieve the set desired temperature.



### Operating the stationary air conditioning system

Please refer to  at the start of the chapter on page 127.


The stationary air conditioning functions only if the high-voltage battery is sufficiently charged.

Depending on the vehicle equipment, the stationary air conditioning can be operated without plugged-in charging connector. When the charging connector is not inserted, the stationary air conditioning will be supplied with energy from the high-voltage battery.

#### Opening the Stationary air conditioning menu in the Infotainment system

1. Switch on the ignition.
2. Touch the HOME button  in the Infotainment system.
3. Touch .

#### Setting desired temperature

1. Open the Stationary air conditioning menu in the Infotainment system
2. Touch .

3. Set the desired temperature using  $\ominus$  and  $\oplus$ .

### Immediate air conditioning of stationary vehicle

1. Switch off the ignition.
2. Touch  $\text{⏸}$  in the exit menu in the Infotainment system → page 31.

The vehicle is air conditioned for around 30 minutes. The function switches itself off automatically. It is not necessary to activate the vehicle's drive system for the function.



Alternatively, the vehicle can be air conditioned before a desired departure time → page 128.

### Switching off the stationary air conditioning



- Activate the vehicle's drive system.

### The stationary air conditioning switches off automatically

- After around 30 minutes if the vehicle is air conditioned with the ignition switched off.
- After around 15 minutes if the vehicle's drive system was not activated after a programmed departure time.
- If the charge level of the high-voltage battery is too low → page 279.

 Operating noises can be heard if the stationary air conditioning is switched on. 

## Programming the stationary air conditioning system

 Please refer to  at the start of the chapter on page 127.

The stationary air conditioning can be programmed for your planned departure time in the Infotainment system. You can program the desired temperature of the vehicle interior at the planned departure time of the vehicle.

On the basis of the desired temperature, the vehicle calculates the time at which the stationary air conditioning must be switched on in order to achieve the desired temperature at the departure time. The maximum running time of the stationary air conditioning before the departure time is around 60 minutes.

### Air conditioning the vehicle before departure

1. Open the **Stationary air conditioning** menu.
2. To open the timer menu, touch  $\text{⌚}$ .
3. Set the planned departure time.
4. Switch on the timer by means of the checkbox.

The earliest programmed departure time is shown in the exit menu in the Infotainment system and can be switched on or off there → page 31.

### Stationary air conditioning with convenience consumers

If the vehicle is air conditioned before departure, convenience consumers such as seat heating and heated rear window can also be switched on automatically before the departure time. The convenience consumers depend on the vehicle equipment.

1. Open the **Stationary air conditioning** menu.
2. Touch  $\text{⏸}$ .
3. Select the seats whose convenience consumers should be switched on additionally to the stationary air conditioning.

Only the selected seats will be climatized before departure.

4. To switch on the windscreen heating before the departure time, activate the function **Automatic window heating**.


The maximum operating time of the convenience consumers before the departure time is around 10 minutes.

### Air conditioning the vehicle after charging the high-voltage battery

The vehicle can be air conditioned before a planned departure time if the vehicle's high-voltage battery is charged with alter-

nating current (AC) or direct current (DC). You can adjust this setting in the charging settings in the Infotainment system → page 279.

#### Air conditioning of vehicle after unlocking

1. Open the **Stationary air conditioning** menu in the Infotainment system
2. Touch .
3. Touch the checkbox **Air condition vehicle after unlocking**.

As soon as you open the door, the vehicle is air conditioned for 5 minutes.

#### Checking programming

The next activated timer and the set functions are shown in the Infotainment system when the ignition is switched off.

## Driving

### Notes on driving

#### Pedals



Fig. 98 In the footwell: pedals.

- ① Accelerator
- ② Brake pedal

The operation and freedom of movement of all pedals must never be impaired by objects or floor mats.

Use only floor mats that leave the pedal area free and can be securely fastened in the footwell.

#### **WARNING**

Objects in the driver footwell can hinder pedal operation. This can lead to loss of control of the vehicle and increase the risk of serious injury.

- Please ensure that all pedals can always be operated without any hindrance.
- The floor mats must always be properly secured in the footwell.
- No additional floor mats or other floor coverings should be placed over the fitted floor mat.
- Ensure that no objects can enter the driver footwell while the vehicle is in motion.

- If there are any objects in the footwell, remove them when the vehicle is parked.

### ! NOTICE

The pedals must be freely operable at all times. For example, a larger brake pedal travel will be necessary in order to stop the vehicle if a brake circuit fails. The brake pedal will have to be depressed further and harder than normal.

## Driving economically

Adopting the right driving style can reduce consumption, damage to the environment, and wear and tear to the electric drive, brakes and tyres. The following section lists a few tips for easing the strain on the environment and your bank account.

### Think ahead when driving

The range will decrease if you do not adopt a steady driving style. Keeping a close eye on the traffic can help to avoid frequent acceleration and braking. Keeping your vehicle at a sufficient distance from the vehicle in front can help you to think ahead when driving.

### Use energy recovery (recuperation)

The vehicle will "coast" if the Eco assistance function is deactivated and position **D** is selected and the accelerator is not pressed.

The vehicle will perform brake energy recuperation automatically if the Eco assistance function is activated and position **D** is selected and the accelerator is not pressed. It will adapt itself to the driving situation and external conditions such as vehicles in front and speed limits. The energy of the rolling vehicle is used to charge the high-voltage battery → page 135. The vehicle is braked as a result.

A high level of recuperation will take place if the accelerator is not pressed in position **B** → page 140.

Recuperation is also increased if the brake pedal is pressed.

### Avoid full throttle

The rolling and air resistance increase at excessively high speeds. This in turn increases the force needed to move the vehicle. This will reduce the range of the vehicle. Never drive the vehicle at top speed.

### Have your vehicle serviced on a regular basis

Regular maintenance is an essential prerequisite for economical driving and increases the service life of the vehicle.

### Observe the correct tyre pressures

Low tyre pressures does not just mean greater wear, but also increases the rolling resistance of the tyres and thus reduces the range of the vehicle. Use tyres with optimised rolling resistance.

Adjust the tyre pressure according to the vehicle load:

- Observe the information on the tyre pressure sticker → page 332.
- Tyre Pressure Loss Indicator → page 325

### Do not drive with unnecessary loads in the vehicle

You can reduce energy consumption by clearing out the luggage compartment before setting off, for example by removing empty drink crates or unused child seats.

In order to keep the drag coefficient of the vehicle as low as possible, remove attachments and add-on parts such as ski, bicycle or roof carriers after use.

### Save electrical energy

Convenience consumers such as the air conditioning system or window heating require energy from the high-voltage battery.

If you want to increase the range of the vehicle:

- Set a warmer interior temperature in summer and a lower temperature in winter. Air the vehicle before starting your journey at high outside temperatures.
- Use the stationary air conditioning when an external power supply is available → page 127.
- Switch off the convenience consumers when they have fulfilled their purpose.

### WARNING

Adapt your speed and distance from the vehicles ahead to suit visibility, weather, road and traffic conditions.




Inform yourself about other ways of protecting the environment. Think Blue. is the global Volkswagen brand for sustainability and environmental friendliness.



Your Volkswagen dealership will gladly provide you with further information on correct maintenance and replacement parts that are particularly energy-efficient, e.g. new tyres.


## Information on the brakes


**New brake pads** cannot generate the full braking effect during the first 200 to 300 km and must first be run in → . However, you can compensate for the slightly reduced braking force by applying more pressure to the brake pedal. **During the run-in period, the braking distance is longer when the brakes are depressed fully or during emergency braking** than with brake pads that have been fully run in. In the run-in period, the brakes should not be depressed fully and situations should be avoided that create a heavy load on the brakes, e.g. when driving up close to the vehicle ahead.

The **wear of the brake pads** depends to a great extent on the conditions under which the vehicle is operated and the way in which

the vehicle is driven. If the vehicle is used for regular urban trips or short journeys and is driven with a sporty driving style, the brake pads must be regularly checked by a qualified workshop.

When driving with **wet brakes**, for example after driving through water, after heavy rainfall or after washing the vehicle, the braking effect may be delayed as the brake discs will be wet, or possibly iced up (in winter). The driver should be prepared for more forceful brake operation.

Any **salt layer accumulating on the discs and pads** will delay the braking effect and increase the braking distance. If the brakes on the vehicle have not been applied for a long time on roads that have been gritted with salt, the layer of salt must be reduced through careful braking → .

**Corrosion** on the brake discs and **dirt** in the brake pads are facilitated through long periods of inactivity, low mileage and low load levels. If the brake pads have been hardly used or if they are corroded, Volkswagen recommends that the brake discs and brake pads be cleaned by braking strongly several times from high speed. Please ensure that no other vehicles and no road users are put at risk as a result of this action → .

### WARNING

Driving with worn brake pads or with a faulty brake system can cause accidents and serious injuries.

- If you have reason to believe that the brakes are worn down or the brake system is faulty, go to a qualified workshop immediately and have the brake system checked and have any worn brake pads replaced.

### WARNING

New brake pads will not have the optimal braking effect when first fitted.

- New brake pads cannot generate the full braking effect during the first 300 km and must first be run in. A reduced brak-

ing effect can be increased by applying more pressure to the brake pedal.

- You must drive particularly carefully when driving with new brake pads in order to reduce the risk of accidents, serious injuries and loss of control of the vehicle.
- Never drive too close to other vehicles when running in new brake pads, and never create a driving situation that will place a heavy load on the brakes.

### WARNING

Overheated brakes reduce the braking effect and considerably increase the braking distance.

- When driving downhill, the brakes are placed under particular strain and become hot very quickly.
- Before driving down a long, steep gradient, reduce your speed and select a higher recuperation level. This will make use of the electric drive braking effect and relieve the load on the brakes.
- Non-standard or damaged front spoilers could restrict the airflow to the brakes and cause them to overheat.

### WARNING

Wet brakes or brakes coated with ice or road salt react more slowly and require longer braking distances.

- Carefully apply the brakes to test them.
- Always dry brakes and clean off any coating of ice and salt with a few cautious applications of the brakes when visibility, weather, road and traffic conditions permit.



Regularly perform a visual check of the thickness of the front brake pads through the openings in the rims or from the underside of the vehicle. If necessary, remove the wheels to carry out a comprehensive check. Volkswagen recommends using a Volkswagen dealership for this purpose.



When the front brake pads are checked, the brake pads in the drum brakes on the rear axle should also be checked at the same time. This check is performed through an inspection hole on the rear of the drum. A sealing plug must be removed for this purpose. Volkswagen recommends using a Volkswagen dealership for this purpose. <

## Driving a loaded vehicle

For good vehicle handling when driving a loaded vehicle, please observe the following:

- Stow all items of luggage securely → page 254.
- Accelerate particularly cautiously and carefully.
- Avoid sudden braking and driving manoeuvres.
- Brake earlier than in normal driving.
- If applicable, observe the information concerning the roof carrier → page 262, → page 264.
- If applicable, observe the information about driving with a trailer → page 264.

### WARNING

Shifting loads can severely impair the vehicle's stability and driving safety, lengthen the braking distance in the event of braking hard, and cause accidents and serious injuries.

- Secure objects properly to prevent them from sliding.
- Use suitable lashing or securing straps when securing heavy objects.
- Securely engage the rear seat backrests.

### NOTICE

Do not carry large quantities of liquid in the vehicle interior. Leaking liquids can get into the plug connections of the orange high-voltage cables. This can cause damage to the

electrical system and to the high-voltage battery.

## Driving with an open boot lid

Driving with an open boot lid is particularly dangerous. All objects and the open boot lid must be secured properly and suitable measures taken.

**Driving with an open boot lid increases the air resistance of the vehicle and thus also the energy consumption of the electric drive. This considerably reduces the possible range of the vehicle. Volkswagen does not recommend driving with the boot lid open due to the resulting reduction in range.**

### ⚠ WARNING

Driving with an unlocked or open boot lid can cause serious injuries.

- Always drive with the boot lid closed.
- Always stow all items in the luggage compartment securely. Loose objects can fall out of the luggage compartment and injure other road users.
- Always drive carefully and ensure that you think ahead.
- Avoid any abrupt or sudden driving and braking manoeuvres as this can cause the open boot lid to move unpredictably.
- Any objects protruding from the luggage compartment must be marked to ensure that they are visible to other road users. Observe the legal requirements.
- Any objects protruding from the luggage compartment must never be held in position by the boot lid.
- If it is necessary to drive with the boot lid open, all luggage racks and cargo stowed on the rack must be removed from the boot lid.

### ⓘ NOTICE

The vehicle height, and possibly the length, are different when the boot lid is open.

## Driving through water on roads

Please follow these rules to help prevent damage to your vehicle when driving through water, for example if the road is flooded:

- The water level must be **no higher** than the lower edge of the vehicle body  
→ page 133.
- Do not drive faster than walking speed.
- Never stop the vehicle, reverse or deactivate the vehicle's drive system while in water.
- Oncoming vehicles will create waves that could increase the water level for your vehicle to such an extent that it is not safe to drive through the water.

### ⚠ WARNING

After driving through water, mud, slush etc., the brakes may react slowly and the braking distance will be increased as the brake discs and pads will be wet, or possibly iced up in winter.

- You can dry and de-ice the brakes by performing careful braking manoeuvres. Ensure that you do not endanger any other road users or violate any legal requirements when doing so.
- Avoid abrupt and sudden braking manoeuvres directly after driving through water.

### ⓘ NOTICE

- If you drive through water, parts of the vehicle, such as the electric drive, running gear and vehicle electrics, could sustain severe damage.

- Never drive through salt water as salt can cause corrosion. Rinse all components that have been exposed to salt water immediately with fresh water. <

## Using the vehicle in other countries and continents

The vehicle has been manufactured specifically for a particular country and complies with the registration regulations that applied in that country at the time of vehicle production.

If you want to use the vehicle abroad for a short period, all relevant information and instructions should be followed → page 32.

If the vehicle is going to be sold in another country or used in another country for an extended period, the legal requirements applicable in that country must be observed.

In some cases, certain equipment will have to be fitted or removed and functions deactivated. The scope of servicing and the type of servicing could also be affected. This is particularly important if the vehicle is driven in another climatic region for a long period of time.

Because different frequency bands are used in different countries, the factory-fitted Infotainment system may not work in other countries.

Due to different legal regulations, it is possible that charging at mains sockets will be permitted only with reduced charging current in other countries. The charging cable limits the charging current corresponding to the infrastructure used. The lower value is used for charging if the settings differ → page 287.

Due to different technical standards, charging at charging stations in another country may not be possible or may be possible only using a suitable charging cable. Consult a Volkswagen dealership for further information.

## NOTICE

- Volkswagen is not responsible for any vehicle damage caused by inadequate servicing work or lack of Genuine Parts.
- Volkswagen cannot be held responsible if the vehicle does not comply with or only partly complies with the relevant legal requirements in other countries and continents. <

## Troubleshooting

### Brake system fault

The warning lamp lights up red.

A text message may also be displayed.

### Do not drive on!

- Inform a qualified workshop and have the brake system checked.

### Brake pad wear indicator

The indicator lamp lights up yellow.

Front brake pads are worn.

- Go to a qualified workshop immediately.
- **All** brake pads should be checked and renewed as necessary. <

## Functions of the electric drive

### Power output of the electric drive


The maximum torque of the electric drive is available immediately when you depress the accelerator pedal.

### Brake energy recuperation

When the vehicle brakes, electrical energy is generated by the electric drive and then stored in the high-voltage battery → page 135.



This will also occur to a certain extent when the vehicle is rolling to stop when in overrun mode or travelling downhill.

The higher the charge level of the high-voltage battery, the lower the recuperation and thus also the engine braking effect. No brake energy recuperation occurs and therefore no engine braking effect is available once the high-voltage battery is fully charged → .

Brake energy recuperation can be displayed in the ID. Cockpit or on the Infotainment system screen.

### Crawling function

The crawling function allows you to drive forwards or backwards slowly at a speed of around 5 km/h (3 mph) without pressing the accelerator.

The crawling function is automatically activated when:

- The vehicle's drive system is activated and the **D/B** position or reverse gear **R** is selected.

The crawling function is deactivated:

- The position switch is in **N** position and the electronic parking brake is switched on.

### WARNING

An electric vehicle generates only very low levels of noise when stationary, driving or during operation. Other road users, such as pedestrians and children, may therefore have difficulty hearing or detecting the vehicle while it is driving. This can result in accidents and injuries, for example when driving in traffic-calmed areas, when manoeuvring the vehicle or when reversing.

### WARNING

Unintentional vehicle movements can cause serious injury.

- If the vehicle's drive system is activated and the **D/B** position or reverse gear is selected, the vehicle must be held with the foot brake.

### WARNING

The higher the charge level of the high-voltage battery, the lower the engine braking effect from recuperation, to the point where no engine braking effect may be generated at all.

- Reduce your speed before driving down a long, steep gradient.
- When driving down a long, steep gradient, slow the vehicle using the vehicle brake.

### Brake energy recuperation

When the vehicle is braked, and when the vehicle is in overrun mode or driving downhill, electrical energy is generated via the electric drive and stored in the high-voltage battery. The electric drive then acts as a generator and creates an engine braking effect. This procedure is known as brake energy recuperation.

The extent of the engine braking effect varies depending on the position → page 140. If there is a high level of brake energy recuperation, the brake lights on the vehicle can also light up. The higher the charge level of the high-voltage battery, the lower the recuperation and thus the engine braking effect effected. No brake energy recuperation occurs and therefore no engine braking effect occurs when the high-voltage battery is completely charged. If the vehicle detects that the road conditions do not allow the wheels to reliably contact the road surface, recuperation and thus the engine braking effect will be reduced automatically. The power meter provides information about the availability of brake energy recuperation and the engine braking effect → page 20.

The vehicle performs brake energy recuperation in different ways depending on the selected position and on the settings in the Infotainment system:

Position **D** engaged and ECO assistance deactivated: no brake energy recuperation.

Position **D** engaged and ECO assistance activated: automatic brake energy recuperation. The energy recovery level is selected automatically depending on the navigation data and traffic situation.

Position **B** engaged: high brake energy recuperation

The vehicle also performs recuperation when the brake pedal is pressed.

### Eco assistance

The ECO assistance function helps the driver to use the engine braking effect of the vehicle efficiently. It selects the energy recovery level depending on the navigation data and traffic situation.

The ECO assistance function can be switched on and off in the vehicle settings in the Infotainment system.

### Driving down hills

When driving down hills, you should drive in position **B** if possible.

Never allow the vehicle to roll down mountains or hills in the neutral position **N**.

## WARNING

The higher the charge level of the high-voltage battery, the lower the engine braking effect, to the point where no engine braking effect may be generated at all. This puts more strain on the vehicle brake.

- Never fully charge the high-voltage battery at high elevations, e.g. at the top of a pass, in order to facilitate a braking effect by means of recuperation when descending.
- Reduce your speed before driving down a long, steep gradient.
- When driving down a long, steep gradient, slow the vehicle using the vehicle brake.

## Troubleshooting



### Deactivation of the drive is imminent

**The charge level of the high-voltage battery is too low.**

The indicator lamp lights up during vehicle operation.

The indicator lamp lights up red.

A text message is shown on the ID. Cockpit → page 18. An acoustic warning is given.

**The vehicle is about to break down in traffic**

The vehicle can still be emergency-started **twice** → page 139 and moved a short distance of up to 7 km/h (4 mph).

Convenience functions of the air conditioning are restricted.

- If traffic conditions permit, drive to the side of the road and park the vehicle safely or drive to the charging station if possible.

The indicator lamp will go out when the power is increased again.



### Vehicle operation not possible

**The temperature of the high-voltage battery is too low.**

The indicator lamp lights up before the vehicle is started.

The indicator lamp lights up red.

A text message is shown on the ID. Cockpit → page 18. An acoustic warning is given.

**Low power can lead to the vehicle breaking down in traffic.**

Only manoeuvring operation (up to 7 km/h (4 mph)) possible.

Convenience functions of the air conditioning are restricted.

- Charge the high-voltage battery when the charge level is low → page 279.
- If a departure is planned in cold weather, Volkswagen recommends performing stationary air conditioning of the vehicle be-

forehand → page 127. The high-voltage battery is also heated when this takes place. This increases the vehicle power available immediately after the vehicle's drive system is activated.

Observe the behaviour of the power display in the ID. Cockpit → page 18.

The indicator lamp will go out when the power is increased again.



### Power restricted

The indicator lamp lights up yellow.

A text message is shown on the ID. Cockpit → page 18. An acoustic warning is given.

The power is significantly reduced and may decrease further.

Convenience functions of the air conditioning are restricted → page 120.

- Charge the high-voltage battery when the charge level is low.
- At very cold or hot outside temperatures, the high-voltage battery is heated or cooled respectively during driving. The vehicle power will increase again after some time.

Observe the behaviour of the power display in the ID. Cockpit → page 18.

The indicator lamp will go out when the power is increased again. <

## Activating and deactivating the vehicle's drive system

### Switching the ignition on and off

Some vehicle functions are already activated when the driver approaches the vehicle with the vehicle key.

### Switching on the ignition

Depress the brake pedal.

**OR:** press the starter button once. The starter button is located on the left of the steering column.

### Switching off the ignition

Press the starter button once when the ignition is active and the vehicle is stationary.

**OR:** leave the vehicle when the vehicle is stationary and the electronic parking brake is switched on.

The ignition will also be switched off if the brake is not pressed when the vehicle is stopped and the driver opens the belt buckle of the driver seat when the electronic brake is switched on.

### Automatic ignition switch-off

If the ignition is switched on and the driver moves away from the vehicle carrying the vehicle key, the ignition switches off automatically after a short time. The electronic parking brake already switches itself on automatically when the driver leaves the vehicle.

If no valid vehicle key is detected in the vehicle interior after the ignition is switched off, it is no longer possible to activate the vehicle's drive system without a valid vehicle key. A corresponding text message is shown in the ID. Cockpit.

### WARNING

Unintentional vehicle movements can cause serious injury.

- If the position switch is operated when the ignition is switched on, the vehicle's drive system will be activated immediately under certain conditions → page 138.

### WARNING

Careless or unsupervised use of the vehicle key can lead to accidents or injuries.

- Always take all vehicle keys with you every time you leave the vehicle. Children

or third parties could lock the vehicle, activate the vehicle's drive system, switch on the ignition or operate electrical equipment such as the electric windows.

### NOTICE

The ignition can be switched on and the vehicle's drive system activated only if there is a valid vehicle key in the vehicle.

## Activating the vehicle's drive system

### Requirements for activating the vehicle's drive system

The vehicle's drive system can be activated when the following conditions are fulfilled:

- The high-voltage battery is sufficiently charged.
- There is no charging cable connected.
- The temperature of the high-voltage battery is within the operating range.
- There is a valid vehicle key in the vehicle.
- Seat belt is fastened.

### Activating the vehicle's drive system

- Select the driving mode position with the brake pedal depressed → page 140. Activation of the vehicle's drive system is indicated by visual and acoustic signals.
- Repeat the procedure if the vehicle's drive system cannot be activated. If necessary, perform an emergency start → page 139.

### WARNING

An electric vehicle generates only very low levels of noise when stationary, driving or during operation. Other road users, such as pedestrians and children, may therefore have difficulty hearing or detecting the vehicle while it is driving. This can result in accidents and injuries, for example when

driving in traffic-calmed areas, when manoeuvring the vehicle or when reversing.

## Deactivating the vehicle's drive system

### The actions should only be carried out in the specified order:

- Bring the vehicle to a stop.
- Park the vehicle → page 176.
- Switch on the electronic parking brake → page 140.
- Observe information in the ID. Cockpit → page 18.

### WARNING

When leaving the vehicle, always ensure that the electronic parking brake is switched on and that all doors, windows, the boot lid and bonnet are completely closed and locked.

## Leaving the vehicle when the vehicle's drive system is active

If the vehicle is left after stopping with the vehicle's drive system activated and a position selected, the ignition and drive will switch off automatically under certain conditions.

This protects the vehicle from unauthorised use.

The electronic parking brake → page 177 is switched on automatically.

If you subsequently want to continue driving, the ignition must be switched back on again → page 137, e.g. by pressing the brake pedal, and the vehicle's drive system must be activated again → page 138. Observe any instructions shown in the ID. Cockpit.

### Automatically switching on the side lights

If the headlights are switched on at the time the ignition is automatically deactivated, the side lights are switched on either until the vehicle is locked or for no more than about 15 minutes.

#### **WARNING**

When leaving the vehicle, always ensure that the electronic parking brake is switched on and that all doors, windows, the boot lid and bonnet are completely closed and locked.

### Electronic immobiliser

The immobiliser helps to prevent the vehicle's drive system from being activated and driven with an unauthorised vehicle key.

There is a chip in the vehicle key. This deactivates the immobiliser automatically when a valid vehicle key is located inside the vehicle.

The electronic immobiliser is activated automatically when there is no longer a valid vehicle key located inside the vehicle.

Thus the vehicle's drive system can be activated only when a Volkswagen Genuine Vehicle Key with the correct code is used. Coded vehicle keys are available from a Volkswagen dealership.



The vehicle cannot be operated properly if you do not have a genuine Volkswagen key.

### Electronic engine sound

The electronic engine sound is a sound that warns other road users about approaching electric vehicles.

The electronic engine sound is switched on when the vehicle's drive system is activated.

When driving quickly, the electronic engine sound is gradually faded out.

#### **WARNING**

The volume and audibility of the electronic engine sound may be restricted by snow or heavy soiling in the area of the front grille. This could result in accidents.

- Before each journey, always check the area of the front grille for heavy soiling and clean if necessary.
- The driver should always expect that the vehicle will not be heard by other road users in spite of activated electronic engine sound.

### Troubleshooting



**Fig. 99** In the centre console: emergency start function.



**There is a fault in the electric drive or high-voltage vehicle electrical system**

The indicator lamp lights up yellow.

A corresponding text message is displayed in the ID. Cockpit.

There is a fault in the electric drive or high-voltage vehicle electrical system.

- The electric drive should be checked by a qualified workshop as soon as possible.

You can continue to drive.

### No valid vehicle key recognised

A corresponding display is shown in the ID. Cockpit.

If the button cell in the vehicle key is weak or discharged, it is possible that the vehicle key will not be recognised.

In this case it is necessary to perform an emergency start:

- Place the vehicle key in the drink holder or stowage compartment in the centre console → Fig. 99.
- Depress the brake pedal or press the starter button.
- The ignition is switched on.

### The vehicle's drive system cannot be deactivated

The vehicle's drive system cannot be deactivated.

In this case it is necessary to perform an emergency switch-off procedure:

- Bring the vehicle to a stop.
- Press the starter button twice within a few seconds or press and hold once.
- The vehicle's drive system is deactivated and the ignition is switched off.



### Electronic engine sound is not working

The indicator lamp lights up and an acoustic signal sounds.

A corresponding text message is displayed in the ID. Cockpit.

- Go to a qualified workshop.

You can continue to drive.

### The vehicle's drive system cannot be activated

A corresponding message will be displayed in the ID. Cockpit if an unauthorised vehicle key is used or there is a system fault.

- Use an authorised vehicle key.

- If the fault persists, seek expert assistance. <


## Selecting a position

### Position switch



Fig. 100 Position switch with button for the electronic parking brake (arrow).

The vehicle has one forwards D/B and one reverse gear R.

The position switch has a button  for the electronic parking brake. To change from neutral position N to a driving position, switch on the ignition, press the brake pedal and turn the position switch in the desired direction → Fig. 100:

### **D** – Standard forward driving position

The electric drive is in the Normal program (automatic brake energy recuperation when Eco Assistance is activated → page 135).

### **B** – High brake energy recuperation

High brake energy recuperation in overrun → page 135.

### **△** – Changing position

It is possible to change between the positions D and B by turning the position switch forward *once* from the position D/B → Fig. 100. The position switch always re-

turns to its initial position. Turning the switch *forward* once more switches back to **D** position.

### **(P)** – Electronic parking brake

The drive wheels are locked mechanically. Switch on only when the vehicle is *stationary* → page 177.

### **N** – Neutral

The electric drive is in the neutral position. No force is transmitted to the wheels and the braking effect of the electric drive is not available.

### **R** – Reverse gear

Reverse gear is selected. May only be selected when the vehicle is *stationary*.

#### Driving down hills

Brake energy recuperation should be used if possible when driving down hills → page 135.

#### Stopping and pulling away on uphill gradients

If you wish to stop the vehicle or pull away when driving uphill you should use the Auto Hold function → page 178.

When you stop the vehicle on an uphill gradient with a selected position, the vehicle must always be prevented from rolling by depressing the brake pedal or by applying the electronic parking brake. Release the brake pedal only when you pull away.

#### **WARNING**

Selecting the wrong position can cause you to lose control of the vehicle, which can lead to accidents and serious injuries.

- Never depress the accelerator when selecting a position.

#### **WARNING**

Rapid acceleration can cause loss of traction and skidding, particularly on slippery roads. This can cause you to lose control of

the vehicle, which can lead to accidents and serious injuries.

- Use fast acceleration only if visibility, weather, road and traffic conditions permit, and other road users are not put at risk due to the deceleration behaviour of the vehicle and driving style.
- Always adjust your driving style in accordance with the flow of traffic.
- When the TCS is switched off, the drive wheels may spin, especially if the road surface is wet, slippery or dirty. This may result in you no longer being able to steer or control the vehicle.

#### **WARNING**

If the vehicle is left unattended with the vehicle's drive system is active, it may lead to accidents and serious injuries.

- Never leave the vehicle unattended when the vehicle's drive system is active.
- Always switch off the ignition. The electronic parking brake is switched on automatically.
- When you park or leave the vehicle, always ensure that the electronic parking brake is switched on.
- When leaving the vehicle always ensure that all doors, windows, the boot lid and bonnet are completely closed and locked.
- If the vehicle's drive system is activated and the **D/B** or **R** position is selected, the vehicle must be held with the foot brake.
- Never select reverse gear when the vehicle is in motion.

#### **NOTICE**

- If you stop the vehicle on a gradient, do not attempt to stop it from rolling back by depressing the accelerator when a gear has been selected. Depress the brake pedal to avoid putting an unnecessary load on the electric drive.

- Never allow the vehicle to roll in neutral N, particularly if the vehicle's drive system is not activated.

## Troubleshooting




### Electric drive overheated

The warning lamp lights up red.

The electric drive is overheated.

A corresponding text message is shown on the ID. Cockpit.

-  **Stop the vehicle immediately!**
- Stop the vehicle as soon as it is safe and possible to do so and park in the open air.
- Deactivate the vehicle's drive system.
- **Do not add coolant.**
- Seek expert assistance.



### and **No recuperation possible**

The indicator lamps light up yellow.

Fault in brake energy recuperation.

The range can be limited.

- Go to a qualified workshop.

## NOTICE

The electric drive will be damaged if the vehicle rolls for an extended period or at high speed with the ignition switched off, the electric drive switched off or discharged 12-volt vehicle battery. The vehicle can be towed only subject to certain conditions → page 306.

## Steering

### Information on steering

The steering should be locked every time you leave the vehicle to make it more difficult for the vehicle to be stolen.

#### The steering

The power steering provided by the electro-mechanical steering system automatically adjusts to the vehicle speed, steering torque and steering angle of the wheels. The electro-mechanical steering functions only when the vehicle's drive system is activated.


You will need considerably more strength than normal to steer the vehicle if the power steering is reduced or has failed completely.

#### Electronic steering column lock

The steering column is locked electronically:

- Stop the vehicle, switch on the electronic parking brake → page 177.
- If the ignition is active, press the starter button once **or**
- open the driver door. The ignition is switched off when the door is opened. The steering column is locked.

#### Counter steering assistance

Counter steering assistance provides the driver with steering assistance in some critical driving situations. Additional steering power helps the driver when counter steering → .

### WARNING

If the power steering is not working, the steering wheel is difficult to turn, which makes it difficult to steer the vehicle.

- The power steering only functions when the vehicle's drive system is activated.

### WARNING

In conjunction with the ESC, counter steering assistance provides the driver with as-




sistance when steering in some critical driving situations. The driver must steer the vehicle at all times. Counter steering assistance does not steer the vehicle.

## Troubleshooting

### **Steering fault**

The warning lamp lights up or flashes red.

There is a fault in the electromechanical steering or electronic steering column lock.

-  **Do not drive on!** Seek expert assistance.
- If the warning lamp **lights up** red, the steering may be stiff because the electromechanical steering has failed.
- If the warning lamp **flashes** red, it is not possible to unlock the steering column.
- The vehicle should not be towed away on its own four wheels.

### **Steering fault**

The indicator lamp lights up or flashes yellow.

The steering is harder or more sensitive than usual.

The indicator lamp **lights up continuously**:

- Activate the vehicle's drive system once again and drive a short distance slowly.
- If the indicator lamp continues to light up, seek expert assistance.

The indicator lamp **flashes**:

- Turn the steering wheel to and fro.
- Switch the ignition off and then on again.
- Observe any messages in the ID. Cockpit.
- Do not continue your journey if the indicator lamp still flashes after the ignition is switched on. Seek expert assistance.

## Driving profile selection

### **Introduction to the topic**


By selecting different driving profiles, the driver can adapt the characteristics of the vehicle systems to the current driving situation, the desired ride comfort and an economical driving style. The adaptable vehicle systems include the chassis, steering, drive and the air conditioning system.

Different driving profiles are available, depending on the vehicle equipment level. The effect on the vehicle systems in the individual driving profiles depends on the vehicle equipment level.

#### **Vehicles with adaptive chassis control (DCC)**

The adaptive chassis control (DCC) continuously adjusts the chassis damping to the current road surface and driving situation while the vehicle is in motion. The DCC takes the chassis tuning of the selected driving profile into consideration

### **Selecting a driving profile**


You can select the driving profile when the ignition is switched on and the vehicle is stationary or when driving → .

If you have selected a driving profile while driving, the vehicle systems will be switched immediately to the new driving profile except for Drive.


- To activate the newly selected driving profile for the Drive system also, take your foot off the accelerator as soon as permitted by the traffic situation.

#### **Selecting the driving profile on the touch panel of the Infotainment system**



1. Touch .

2. To select driving profiles, touch  again or touch the desired driving profile in the Infotainment system.

### Displaying information on the driving profile

- To display further information on the selected driving profile, touch  in the Infotainment system.

### Selecting the Individual driving profile

1. Touch  repeatedly until the Individual driving profile is selected.
2. To open the Individual menu, touch .

### WARNING

Selecting a driving mode while the vehicle is in motion can distract you from the road and cause accidents.

- Drive with your full attention and with responsibility.

## Characteristics of the driving profiles



**Eco:** switches the vehicle into economical mode and helps you to drive the vehicle in an energy-saving manner.



**Comfort:** this driving profile corresponds to the basic setting of the vehicle systems and leads to a convenience-oriented vehicle setup. It is suitable for everyday use, for example.



**Sport:** this setting gives you a sporty driving feeling.



**Traction:** distributes the drive power equally between the front and rear axles and adjusts the running gear to a softer setting. The Traction driving profile is available only in vehicles with all-wheel drive.



**Individual:** you can adapt individual vehicle systems according to your personal wishes.

## Standard behaviour of the driving profiles and vehicle systems

The **Comfort** driving profile corresponds to the basic settings of the vehicle systems when the ignition is switched on.

### Behaviour of the driving profiles when the ignition is switched off and on

If you switch the ignition off and then back on again, the previously selected driving profile remains active.

### Behaviour of the Drive vehicle system when the ignition is switched off and on

The settings of the Drive vehicle system are reset to the settings of the **Comfort** driving profile as soon as you switch the ignition off and on again.

You can switch the Drive vehicle system to the desired driving profile again:

- Select the desired driving profile again.

The other vehicle systems retain their settings when you switch the ignition off and then back on again.

## Troubleshooting



### Fault in the adaptive chassis control (DCC)

The indicator lamp lights up yellow.

The message **Fault: damper** may be displayed on the instrument cluster display.

- Go to a qualified workshop and have the system checked.

The driving profiles or vehicle systems do not behave as expected.

- Note the standard behaviour of the driving profiles and vehicle systems → page 144 ◀

## Driver assist systems

### Cruise control system

#### Introduction to the topic

The cruise control system helps to maintain a speed set by the driver.

#### Speed range

The CCS is available when driving forwards at speeds from around 20 km/h (15 mph).

#### Driving with the cruise control system

You can exceed the stored speed at any time, e.g. to overtake. Control is interrupted for the duration of the acceleration manoeuvre and is then resumed with the stored speed.

#### Displays

When the CCS is switched on, the instrument cluster display shows the stored speed and the status of the CCS:



CCS switched on, system control active.



CCS switched on, system control not active.

If no speed is stored, the instrument cluster display shows --- instead of the speed.

#### WARNING

The use of the CCS can lead to accidents and serious injuries if traffic does not allow you to drive at a safe distance from the vehicle in front at a constant speed.

- Never use the CCS in heavy traffic, if the distance to the vehicles in front is insufficient, on steep or winding roads, on slippery road surfaces, e.g. due to snow, ice, wet roads, loose chippings, or on flooded roads.
- Never use the CCS when driving offroad or on unpaved road surfaces.

- Adapt your speed and distance from the vehicles ahead to suit visibility, weather, road and traffic conditions.
- Always switch CCS off after use to avoid unintentional speed control.
- It is dangerous to use a set speed that is too high for the prevailing road, traffic or weather conditions.

## Operating the Cruise Control System (CCS)

📖 Please refer to ⚠ at the start of the chapter on page 145.




**Fig. 101** Lefthand side of the multifunction steering wheel.

### Switching on

- Press the  button.

No speed has been stored and the system is not yet active.





### Starting control

- While driving, press the  button.

The CCS stores and regulates the current speed.

### Setting the speed

You can adjust the stored speed during speed control by the CCS:

- + 1 km/h (1 mph): Gently press the  button.
- 1 km/h (1 mph): Gently press the  button.
- + 10 km/h (5 mph): Strongly press the  button or swipe over the button from bottom to top. The first time it is actuated, it jumps to the next higher ten (km/h) or five (mph) increment.
- 10 km/h (5 mph): Strongly press the  button or swipe over the button from top to bottom. The first time it is actuated, it jumps to the next lower ten (km/h) or five (mph) increment.

Press and hold the corresponding button to continuously change the stored speed.

The vehicle adapts the current speed by accelerating or braking.

### Cancelling control

- Briefly press the  button. Alternatively, depress the brake pedal.

The speed remains stored in the memory.

### Resuming control

- Press the  button.

The CCS resumes operation with the stored speed and regulates the speed again.


### Switching off

- Press and hold the  button.

The CCS is switched off and the stored speed is deleted.

### Switch to other driver assist systems

Depending on the equipment, you can switch to the following driver assist systems:

- Adaptive Cruise Control (ACC).
  - Speed limiter
1. Press the  button or swipe over the button.

2. Swipe to the left or right to select the desired system.
3. Press the **MODE** button.

## Troubleshooting

📖 Please refer to  at the start of the chapter on page 145.

### Fault in the cruise control system.

The indicator lamp lights up yellow.

- Malfunction. Switch off CCS and go to a qualified workshop.

### System control is interrupted automatically.

- The vehicle has exceeded the stored speed for an extended period.
- No gear is engaged for forward travel.
- Brake support systems, e.g. TCS or ESC, have performed an intervention.
- The vehicle was braked by Front Assist.
- If the problem persists, switch off the CCS and go to a qualified workshop.

## Speed limiter

### Introduction to the topic

The speed limiter helps to prevent the vehicle from exceeding a speed that you have stored.

### Speed range

The speed limiter is available when driving forwards at speeds from around 30 km/h (around 20 mph).

### Driving with the speed limiter


You can interrupt the speed limiter function at any time by fully depressing the accelera-


tor beyond the point of resistance. As soon as the stored speed is exceeded, the green indicator lamp will flash and an acoustic warning may sound. The speed remains stored in the memory.

The speed limiter function is activated again automatically as soon as the speed drops below the stored speed.

### Displays

When the speed limiter is switched on, the instrument cluster display shows the stored speed and the status of the speed limiter:

 Speed limiter switched on, system control active.

 Speed limiter switched on, system control not active.

### WARNING

Always switch off the speed limiter after use to avoid unintentional speed regulation.

- The speed limiter does not relieve the driver of his responsibility for the speed of the vehicle. Do not drive at full throttle if it is not required.
- Use of the speed limiter in adverse weather conditions is dangerous and can cause serious injury, e.g. through aquaplaning, snow, ice, or leaves. Use the speed limiter only when the road and weather conditions allow it to be used safely.


## Operating the speed limiter

📖 Please refer to ⚠️ at the start of the chapter on page 147.




Fig. 102 Lefthand side of the multifunction steering wheel.

### Switching on

– Press the  button.

The system is not yet active.


### Starting control


– While driving, press the  button.


The current speed is stored as the maximum speed.


### Setting the speed

You can adjust the stored speed:

+ 1 km/h (1 mph): Gently press the  button.


- 1 km/h (1 mph): Gently press the  button.

+ 10 km/h (5 mph): Strongly press the  button or swipe over the button from bottom to top. The first time it is actuated, it jumps to the next higher ten (km/h) or five (mph) increment.

- 10 km/h (5 mph): Strongly press the  button or swipe over the button from top to bottom. The first time it is actuated, it jumps to the next lower ten (km/h) or five (mph) increment.

Press and hold the corresponding button to continuously change the stored speed.

### Cancelling control

– Press the  button.


The speed remains stored in the memory.

### Resuming control

– Press the  button.

The speed limiter is activated again as soon as the current speed is lower than the stored speed.

### Switching off



– Press and hold the  button.

The speed limiter is switched off and the speed is deleted.

### Switch to other driver assist systems

Depending on the equipment, you can switch to the following driver assist systems:

- Adaptive Cruise Control (ACC).
- Cruise control system

1. Press the  button or swipe over the button.
2. Swipe to the left or right to select the desired system.
3. Press the  button. <

## Troubleshooting

📖 Please refer to ⚠️ at the start of the chapter on page 147.

### ! LIM Speed limiter not available.

The indicator lamp lights up yellow.

- Malfunction. Switch off the speed limiter and go to a qualified workshop.

### System control is interrupted automatically.

- You have switched off Electronic Stability Control (ESC).
- The brakes have overheated. Allow the brakes to cool down and check their functionality again.

- If the problem persists, go to a qualified workshop.

For safety reasons, the speed limiter switches itself off completely only when you release the accelerator once or switch off the system manually.

## Speed limiter with predictive control

### Introduction to the topic

The speed limiter with predictive control automatically adapts a maximum speed that you have stored to detected speed limits.

The speed limiter with predictive control is an extension of the speed limiter and makes use of Dynamic Road Sign Display → page 25 and the navigation data provided in the Infotainment system.

The speed limiter with predictive control is dependent on the vehicle equipment and is not available in all countries.

### WARNING

The intelligent technology used in the speed limiter with predictive control cannot overcome the given physical limits, and functions only within the limits of the system. Never let the extra convenience tempt you into taking safety risks when driving. Careless or unintentional use of the speed limiter with predictive control can cause accidents and serious injuries. The system is not a substitute for the full concentration of the driver.

- Ensure that your speed is always appropriate for the current visibility, weather and road/traffic conditions.
- Always pay attention to the traffic situation and the area around the vehicle.

- Be prepared to control the speed yourself at all times. Malfunctions in the Dynamic Road Sign Display function and out-of-date navigation data can lead to the speed being changed unexpectedly and suddenly or not being adapted to the current traffic situation. Speeds regulated by the system may also not match your individual driving style.
- Be prepared to control the speed yourself at all times. If you are driving without route guidance or leave the route calculated by the navigation system or if the vehicle position cannot be correctly determined due to inexact GPS data, the speed may be changed unexpectedly and suddenly or not adapted to the current traffic situation.
- Keep the navigation data up-to-date.
- Always observe the maximum speed limit. The maximum speed limit may be exceeded in the case of speed limits that are not contained in the navigation data.



Please also observe the safety-relevant information on the speed limiter → page 147.

### Limits of predictive control

 Please refer to  at the start of the chapter on page 149.

In addition to the system limits of the Dynamic Road Sign Display → page 25, the speed limiter with predictive control has the following additional, system-related limits:

- The speed limiter with predictive control detects only road signs that show a speed limit.
- Road signs that indicate a speed limit indirectly, e.g. place-name signs, will be detected only on the basis of the navigation data.
- If a speed limit is announced on the basis of the navigation data but is not detected by the Dynamic Road Sign Display func-

tion, the announced speed will be reset to the last-stored speed.

- The speed limiter with predictive control is not available for detected speed limits below around 30 km/h (around 20 mph). A corresponding text message is shown on the instrument cluster display in this case. <

## Activating predictive control

📖 Please refer to ⚠ at the start of the chapter on page 149.

You can activate the speed limiter with predictive control in the Assist systems menu of the Infotainment system. <

## Driving with predictive control

📖 Please refer to ⚠ at the start of the chapter on page 149.

1. Switch on the speed limiter and start control → page 148.
2. Activate predictive control.



A message will be displayed on the instrument cluster display as soon as the system detects a speed limit on the route. The detected speed is stored as the new desired speed.


### Canceling speed adaptation


- Press the **RES** button or release the accelerator pedal twice and then press it again. The last-stored speed is resumed again.
- Press the **SET** button. The current speed is adopted.
- Press the **SM** button. The system is switched to passive mode.


### Adjusting the announced speed

- + 1 km/h (1 mph): Gently press the **+** button.
- 1 km/h (1 mph): Gently press the **-** button.
- + 10 km/h (5 mph): Strongly press the **+** button or swipe over the button from bottom to top. The first time it is actuated, it jumps to the next higher ten (km/h) or five (mph) increment.
- 10 km/h (5 mph): Strongly press the **-** button or swipe over the button from top to bottom. The first time it is actuated, it jumps to the next lower ten (km/h) or five (mph) increment.

If you adjust the announced speed excessively, predictive control will be terminated.

 If a speed limit is detected, the predictive control function will adjust the stored speed even if the speed limiter is not regulating.

 If the current speed significantly exceeds a speed limit detected by the Dynamic Road Sign Display function, a warning will appear on the instrument cluster display.


 When you join a motorway, the recommended speed will automatically be stored as the desired speed. <

## Troubleshooting

📖 Please refer to ⚠ at the start of the chapter on page 149.

**A message is displayed that the speed limiter with predictive control is currently not available or is not available in your country.**

- If this message is displayed for an extended period and the speed limiter with predictive control is available in your country, go to a qualified workshop.

 Depending on the malfunction, additional information may be displayed in the vehicle status → page 30. <



# Adaptive Cruise Control (ACC)

## Introduction to the topic

The Adaptive Cruise Control (ACC) maintains a constant speed that you have set. If the vehicle approaches a vehicle in front, the ACC automatically adapts the speed so that a distance you have selected is maintained.

### Does the vehicle have ACC?

The vehicle is equipped with ACC if you can adjust settings for ACC in the Assist systems menu in the Infotainment system.

### Speed range

You can set the speed between 20 km/h (15 mph) and the maximum speed.

### Driving with ACC

You can override the active ACC system at any time. Cruise control will be stopped if you brake. If you accelerate, cruise control will be interrupted while you are accelerating and then resumed.

The intervention by the ACC system is less dynamic when towing a trailer.

### Driver intervention prompt



If automatic deceleration by the ACC system is not sufficient or the system limits have been reached, the ACC system will request you to also brake by a corresponding message on the instrument cluster. In addition, the red warning lamp lights up and an acoustic warning is given. Take over control of the vehicle and be prepared to brake.

### Radar sensor

ACC detects driving situations using a radar sensor at the front of the vehicle. The range

of the radar sensor is up to approximately 160 m (around 520 ft).

## WARNING

The intelligent ACC technology cannot overcome the laws of physics, and functions only within the limits of the system. Never let the extra convenience tempt you into taking safety risks when driving. Careless or unintentional use of ACC can cause accidents or injuries. The system is not a substitute for the full concentration of the driver.

- Adapt your speed and the distance from the vehicles ahead to suit visibility, weather, road and traffic conditions.
- Never use the ACC in poor visibility, on steep or winding roads, or on slippery road surfaces, e.g. due to snow, ice, moisture or loose chippings, or when roads are flooded.
- Never use the ACC offroad or on unsurfaced roads. The ACC is designed for use on surfaced roads only.
- Take control of the vehicle immediately if requested to do so by a prompt on the instrument cluster display or if the speed reduction by ACC is not sufficient.
- Brake if the vehicle starts moving unintentionally, e.g. after a driver intervention prompt.
- Be prepared to control the speed yourself at all times.

## Special driving situations

Please refer to  at the start of the chapter on page 151.

### Predictive cruise control system

If the vehicle is equipped with the Dynamic Road Sign Display function and an Infotainment system with navigation, ACC can predictively adapt the vehicle speed to detected speed limits and the course of the road ahead

(depending on equipment and not available in all countries).

### Overtaking

If you indicate left (left-hand traffic: indicate right) to overtake, ACC will accelerate the vehicle and reduce the distance from the vehicle in front. Your set speed will not be exceeded.

If ACC does not detect any vehicle in front after you have changed lane, ACC will accelerate the vehicle up to the set speed.

Overtaking assistance is not available in all countries.

### Stop-and-go traffic

ACC can brake the vehicle to a standstill and keep it stationary. ACC remains active and the instrument cluster display shows ACC ready to start for a few seconds.

On vehicles with Travel Assist, you can extend this time by continuing to hold the steering wheel.

As long as ACC remains active, the vehicle will move off again automatically as soon as the vehicle in front moves off (depending on the vehicle equipment level and not available in all countries).

Extending or reactivating readiness to drive:

- Press the **RES** button.

*Vehicles with Travel Assist:* alternatively grasp the steering wheel again.

Moving off when readiness to drive has ended and the vehicle in front has already moved away:

- Press the **RES** button or briefly depress the accelerator.

ACC remains inactive in the following cases:

- The vehicle is stationary for several minutes.
- A vehicle door is opened.
- The ignition is switched off.

## ⚠ WARNING

If the message ACC ready to start is shown on the instrument cluster display and the vehicle in front moves off, your vehicle will move off automatically. In some cases, obstacles in the vehicle's path may not be detected. This can result in serious injury and accidents.

- Always check the road ahead before moving off and brake the vehicle if necessary.

### Inside Overtaking Prevention System



**Fig. 103** On the instrument cluster display: slower vehicle detected in the left-hand lane (illustration).

If ACC detects a slower vehicle in the left-hand lane (left-hand traffic: in the right-hand lane), ACC will brake the vehicle gently within the system limits and can therefore prevent a prohibited overtaking manoeuvre. The function is active from speeds of around 80 km/h (around 50 mph), but is not available in all countries. ◀

## Limits of the ACC

📖 Please refer to ⚠ at the start of the chapter on page 151.

### When not to use the ACC

ACC is not suitable for use in the following driving situations due to the system limitations. Cancel control → page 151:

- Driving in heavy rain, snow or heavy spray.

- Driving through road works, tunnels or toll stations.
- Driving on winding roads, e.g. mountain roads.
- Driving offroad.
- Driving in multi-storey car parks.
- Driving on roads with embedded metal objects, e.g. railway tracks.
- Driving on roads with loose chippings.
- *Vehicles without Inside Overtaking Prevention System*: On roads with more than one lane, if other vehicles are driving more slowly in the overtaking lane.

### WARNING

If you use ACC in the above situations, this could result in accidents and serious injuries as well as violations of legal regulations.

#### Delayed response

If the radar sensor is exposed to environmental conditions that impair sensor functioning, the system may detect this only after a certain delay. For this reason, any restrictions to functions may be displayed only after a delay at the start of the journey and when driving → page 151.

#### Objects that cannot be detected

The radar sensor detects only vehicles that are moving in the same direction or stationary. It does not detect:

- Persons.
- Animals.
- Crossing or oncoming vehicles.
- Other stationary obstacles.

#### Stationary vehicles

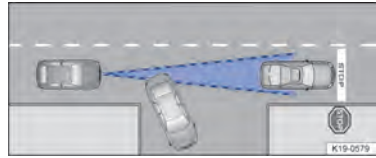


Fig. 104 Turning and stationary vehicle.

ACC reacts to stationary vehicles to a limited extent up to a speed of 60 km/h (37 mph), provided a stationary vehicle is detected and your own vehicle can be comfortably braked behind the stationary vehicle, subject to the system limits of the ACC. ACC does not perform emergency braking.

If a stationary vehicle is hidden behind a vehicle that has been detected by ACC and this vehicle turns off the road or changes lane, ACC will react to the stationary vehicle → Fig. 104.

#### Bends

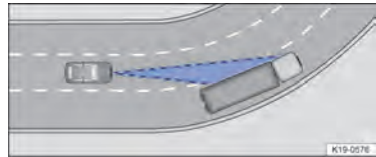


Fig. 105 Driving through bends.

The radar sensor always measures straight ahead. For this reason, vehicles may be incorrectly detected or vehicles driving ahead not detected in tight bends → Fig. 105.

#### Vehicles outside the sensor range



Fig. 106 Narrow vehicle.



**Fig. 107** Vehicle changes lane.

ACC may not react or may react with a delay or with an unwanted response in the following driving situations:

- Vehicles that are driving outside the sensor range in close proximity to your vehicle, e.g. motorbikes → Fig. 106.
- Vehicles that change into your lane directly in front of your vehicle → Fig. 107.
- Vehicles with bodies or attachments that project beyond the vehicle.

## Switching the ACC on and off

📖 Please refer to ⚠️ at the start of the chapter on page 151.



**Fig. 108** Lefthand side of the multifunction steering wheel.

### Switching on

- Press the **(SET)** button.

ACC is not yet performing a control intervention.

### Starting control

- While driving forwards, press the **(SET)** button.

ACC stores the current speed and maintains the set distance. If the current speed is outside the defined speed range, ACC will set the minimum speed (when driving more slowly than the limit) or maximum speed (when driving faster than the limit).

In addition, the traction control system (TCS) is activated and ESC Sport is deactivated.

One of the following indicator lamps will light up depending on the driving situation:



ACC has taken control; no vehicle detected ahead.



ACC has taken control; vehicle detected ahead.

When ACC is not active, the indicator lamps light up grey.

### Cancelling control

- Briefly press the **(ON)** button or press the brake pedal.

The indicator lamp corresponding to the driving situation lights up grey, the speed and distance remain stored.

Control is automatically cancelled if the traction control system (TCS) is deactivated.

### Resuming control

- Press the **(RES)** button.

ACC adopts the last set speed and last set distance. The instrument cluster display shows the set speed and the indicator lamp corresponding to the driving situation lights up.

### Switching off

- Press and hold the **(ON)** button.

The set speed is deleted.

## Switch to other driver assist systems

Depending on the equipment, you can switch to the following driver assist systems:

- Cruise control system
  - Speed limiter
1. Press the **MODE** button or swipe over the button.
  2. Swipe to the left or right to select the desired system.
  3. Press the **MODE** button.

## Setting the ACC

📖 Please refer to ⚠️ at the start of the chapter on page 151.

### Setting the distance



**Fig. 109** On the instrument cluster display: set distance ①, ACC regulating (illustration).

You can set the distance in five steps from very small to very large:

1. Press the **SET** button.
2. Press the **+** or **-** button or swipe vertically over the button area from **SET** to **+** or **-**.
3. Alternatively, press the button **SET** repeatedly until the required distance is selected.

The instrument cluster display shows the chosen setting → Fig. 109 ①. Please observe any country-specific requirements for the minimum distance.

In the Assist systems menu of the Infotainment system, you can choose whether you want to start control with the distance set at the end of the journey or a preselected distance.

### Setting the speed

You can adjust the stored speed within the defined speed range by means of the buttons on the multifunction steering wheel:

- + 1 km/h (1 mph): Gently press the **+** button.
- 1 km/h (1 mph): Gently press the **-** button.
- + 10 km/h (5 mph): Strongly press the **+** button or swipe over the button from bottom to top. The first time it is actuated, it jumps to the next higher ten (km/h) or five (mph) increment.
- 10 km/h (5 mph): Strongly press the **-** button or swipe over the button from top to bottom. The first time it is actuated, it jumps to the next lower ten (km/h) or five (mph) increment.

Press and hold the corresponding button to continuously change the stored speed.

## ⚠️ WARNING

If you do not maintain the minimum distance to the vehicle in front or if the difference in speed between the vehicle in front and your own vehicle is so great that the braking action of ACC is insufficient, you are in danger of colliding with the vehicle in front. The braking distance is also longer in rain and winter road conditions.

- The Adaptive Cruise Control may not be able to detect all driving situations correctly.
- Always be prepared to brake the vehicle yourself.
- Speed and distance control are overridden when you press the accelerator. The ACC does not brake automatically in this case.
- Observe any country-specific regulations relating to the minimum distance.

- Always set a larger distance in wet or snowy conditions or when visibility is poor.

### Setting the system behaviour

You can influence how sportily ACC reacts:

- *Vehicles with driving profile selection:* Set preferred driving profile → page 143.
- *Vehicles without driving profile selection:* Select the desired gearbox program in the Assist systems menu of the Infotainment system.

## Troubleshooting

📖 Please refer to ⚠ at the start of the chapter on page 151.



### ACC not available.

The indicator lamp lights up yellow.

- The radar sensor is dirty. Clean the radar sensor → page 355.
- The view of the radar sensor is impaired due to the weather conditions, e.g. snow, or due to detergent deposits or coatings. Clean the radar sensor → page 355.
- The view of the radar sensor is impaired by add-on parts, the trim frames of number plate holders or stickers. Keep the area around the radar sensor free.
- The radar sensor has been displaced or damaged, e.g. due to damage to the front of the vehicle. Check whether damage is visible → page 362.
- Fault or malfunction. Deactivate and reactivate the vehicle's drive system.
- Paint work or structural modifications were carried out on the front of the vehicle.
- If the problem persists, go to a qualified workshop.

### The ACC does not function as expected.

- The radar sensor is dirty. Clean the radar sensor → page 355.
- The system limits have been exceeded → page 152.
- The brakes have overheated, control was interrupted automatically. Allow the brakes to cool down and check their functionality again.
- If the problem persists, go to a qualified workshop.

### System control cannot be started.

Make sure that the following conditions are met:

- The brake lights on the vehicle are working.
- The brake lights on the electrically connected trailer are in working order.
- ESC is not active.
- The brake pedal is not depressed.

### Unusual noises during automatic braking.

- This is normal and is not a fault.

### Touch panels react differently than expected.

Moisture, dirt and grease can impede the functioning of the touch panels.

- Make sure the touch panels are always clean and dry.

## Predictive cruise control

### Introduction to the topic

The predictive cruise control adapts the vehicle speed to detected speed limits and the course of the road ahead, e.g. bends, junctions, roundabouts.

The predictive cruise control is an extension of ACC and makes use of Dynamic Road Sign

Display → page 25 and the navigation data provided in the Infotainment system.

The predictive cruise control function is dependent on the equipment level and is not available in all countries.

#### Reaction to the end of a traffic jam

Vehicles with V2X technology (depending on vehicle equipment and not available in all countries) interact with other vehicles in their vicinity. As a result, your vehicle can be informed about a traffic jam ahead and can reduce speed early on.

Prerequisites:

- V2X is activated in the Infotainment system.
- The reaction to a road characteristic ahead is activated in the Infotainment system → page 158.

### WARNING

The intelligent technology of predictive cruise control cannot overcome the physical limits specified, and functions only within the limits of the system. Never let the extra convenience afforded by predictive cruise control tempt you into taking any safety risks. Careless or unintentional use of predictive cruise control can cause accidents and lead to serious injury. The system is not a substitute for the full concentration of the driver.

- Ensure that your speed is always appropriate for the current visibility, weather and road/traffic conditions.
- Always pay attention to the traffic situation and the area around the vehicle.
- Be prepared to control the speed yourself at all times. Malfunctions in the Dynamic Road Sign Display function and out-of-date navigation data can lead to the speed being changed unexpectedly and suddenly or not being adapted to the current traffic situation. Speeds regulated by the system may also not match your individual driving style.

- Be prepared to control the speed yourself at all times. If you are driving without route guidance or leave the route calculated by the navigation system or if the vehicle position cannot be correctly determined due to inexact GPS data, the speed may be changed unexpectedly and suddenly or not adapted to the current traffic situation.
- Keep the navigation data up-to-date.
- Always observe the maximum speed limit. The maximum speed limit may be exceeded in the case of speed limits that are not contained in the navigation data.



Please also observe the safety-relevant information on ACC. <

## Limits of predictive cruise control

 Please refer to  at the start of the chapter on page 156.

In addition to the system limitations of the Dynamic Road Sign Display function → page 25 and ACC, the predictive cruise control function has the following additional, system-related limitations:

- The predictive cruise control function detects only road signs that show a speed limit. In particular, predictive cruise control does not take into account any rights of way or traffic lights.
- Road signs that indicate a speed limit indirectly, e.g. place-name signs, will be detected only on the basis of the navigation data.
- Predictive cruise control is not available on roads which are not recorded in the navigation data or not recorded with sufficient accuracy.
- If a speed limit is announced on the basis of the navigation data but is not detected by the Dynamic Road Sign Display func-

tion, the announced speed will be reset to the last-stored speed.

- Predictive cruise control is not available for detected speed limits below around 20 km/h (around 15 mph). A corresponding text message is shown on the instrument cluster display in this case.

## Activating predictive cruise control

📖 Please refer to  at the start of the chapter on page 156.

You can separately set the events to which the vehicle should react in the Assist systems menu of the Infotainment system → page 31:

- Reaction to the road layout.
- Reaction to permitted speeds.
- Reaction to the end of traffic jams.

## Driving with predictive cruise control

📖 Please refer to  at the start of the chapter on page 156.

1. Switch on ACC → page 154.
2. Set the distance and speed.
3. Activate predictive cruise control.

### Displays

A message will be displayed on the instrument cluster display as soon as the system detects a speed limit or a road characteristic ahead that has to be taken into account. This message indicates the reason and the speed to which your vehicle will be regulated due to the restriction.



Speed regulation due to speed limit.



Speed regulation due to cancellation of the speed limit.



Speed regulation due to a roundabout.



Speed regulation due to a junction.



Speed regulation due to the road layout.



Speed regulation due to the end of a traffic jam.

When automatic speed control is assumed due to a speed limit, the detected speed is stored as the new desired speed. In the case of control due to the road layout, the vehicle will accelerate back up to the previously stored speed after the restriction.

Announced speeds for driving through bends depend on the driving profile → page 143.

### Cancelling speed adaptation

- During the announcement: press the **RES** button.
- During control: press the **SET** button.

### Adjusting the announced speed

The announced speed can be adjusted only in the case of speed regulation due to a speed limit.

**+ 1 km/h (1 mph):** Gently press the **+** button.


**- 1 km/h (1 mph):** Gently press the **-** button.


**+ 10 km/h (5 mph):** Strongly press the **+** button or swipe over the button from bottom to top. The first time it is actuated, it jumps to the next higher ten (km/h) or five (mph) increment.


**- 10 km/h (5 mph):** Strongly press the **-** button or swipe over the button from top to bottom. The first time it is actuated, it jumps to the next lower ten (km/h) or five (mph) increment.




If you adjust the announced speed excessively, predictive cruise control will be terminated.

 If a speed limit is detected, the predictive cruise control function will adjust the stored speed even if ACC is deactivated. However, speed regulation will not take place.

 If the current speed significantly exceeds a speed limit detected by the Dynamic Road Sign Display function, a warning will appear on the instrument cluster display.


 When you join a motorway without a speed limit, the recommended speed will automatically be stored as the desired speed. If a higher speed has previously been stored on a motorway without a speed limit, this will be adopted instead of the recommended speed.

## Troubleshooting

 Please refer to  at the start of the chapter on page 156.

**A message is displayed that predictive cruise control is currently not available or is not available in your country.**

— If this message is displayed for an extended period and predictive cruise control is available in your country, go to a qualified workshop.

 Depending on the malfunction, additional information may be displayed in the vehicle status → page 30.

## Area monitoring system (Front Assist)

### Introduction to the topic

The Autonomous Emergency Braking (Front Assist) can detect imminent frontal collisions and issue corresponding warnings. The system can also provide assistance for braking and taking avoiding action and can also automatically brake the vehicle.

Front Assist can help to avoid accidents, but is not a substitute for the full concentration of the driver. Front Assist functions only within the system limits. The warning times vary depending on the traffic situation and driver behaviour.

### Driving with Front Assist

You can cancel the automatic braking and steering interventions of Front Assist pressing the accelerator or steering.

### Automatic braking

Front Assist can decelerate the vehicle to a standstill. The vehicle will then not be held permanently. Depress the brake pedal!

The brake pedal will feel harder during an automatic braking operation.

### Detection of the traffic situation

Front Assist detects driving situations by means of a camera located in the upper area of the windscreen and a radar sensor in the front of the vehicle.

### Functions included in the system

Front Assist includes the following functions depending on vehicle equipment and country:

- Pedestrian Monitoring.
- Cyclist Monitoring.
- Swerve support.

— Oncoming vehicle braking when turning.

The listed functions are automatically active when Front Assist is switched on.

### WARNING

The intelligent technology used in Front Assist cannot overcome the physical limits specified, and functions only within the limits of the system. Never let the extra convenience afforded by Front Assist tempt you into taking risks when driving. The driver is always responsible for braking and steering in time.

- If Front Assist issues a warning, brake your vehicle immediately depending on the traffic situation or avoid the obstacle.
- Adapt your speed and distance from the vehicles ahead to suit visibility, weather, road and traffic conditions.
- Be prepared to take over control of the vehicle yourself at all times and to override automatic braking and steering interventions. Front Assist cannot prevent accidents and serious injuries on its own.

- Front Assist can issue unnecessary warnings and carry out unwanted braking or steering interventions in certain complex driving situations, e.g. at traffic islands.
- Front Assist can issue unnecessary warnings and carry out unwanted braking or steering interventions when its function is impaired, e.g. if the radar sensor is dirty or its position has been changed.
- Front Assist does not react to pedestrians without Pedestrian Monitoring or cyclists without Cyclist Monitoring. In addition, the system does not react to animals or to vehicles that are crossing or approaching in the same lane.
- If you are unsure about what systems your vehicle has, please enquire at a qualified workshop before starting your journey.
- Be prepared to take over control of the vehicle yourself at all times.

## Warning levels and braking intervention

 Please refer to  at the start of the chapter on page 159.

Front Assist can detect the following objects within the system limits and depending on the vehicle equipment:

- Pedestrians, cyclists and vehicles also moving relative to your vehicle.
- Crossing pedestrians and cyclists.
- Stationary vehicles.

Front Assist can provide assistance and intervene if the vehicle is approaching a detected

object in such a way that a collision with the object will occur if the vehicle speed is maintained and there is no driver intervention. The assistance may include an advance warning, an urgent warning and automatic braking.

Under ideal conditions, this can prevent a collision or help to reduce the consequences of the collision.

Front Assist operates in the following speed ranges:

	Advance warning	Urgent warning	Automatic braking	Braking intervention
Vehicle stationary	30 to 85 km/h (20 to 53 mph)	30 to 85 km/h (20 to 53 mph)	5 to 85 km/h (3 to 53 mph)	5 to 85 km/h (3 to 53 mph)

	Advance warning	Urgent warning	Automatic braking	Braking intervention
Vehicle also moving	30 to 250 km/h (20 to 155 mph)	30 to 250 km/h (20 to 155 mph)	5 to 250 km/h (3 to 155 mph)	5 to 250 km/h (3 to 155 mph)
Pedestrian also moving	30 to 85 km/h (20 to 53 mph)	30 to 85 km/h (20 to 53 mph)	5 to 85 km/h (3 to 53 mph)	5 to 85 km/h (3 to 53 mph)
Crossing pedestrian	30 to 85 km/h (20 to 53 mph)	-	5 to 65 km/h (3 to 40 mph)	5 to 65 km/h (3 to 40 mph)
Cyclist also moving	30 to 250 km/h (20 to 155 mph)	30 to 250 km/h (20 to 155 mph)	5 to 250 km/h (3 to 155 mph)	5 to 250 km/h (3 to 155 mph)
Crossing cyclist	30 to 85 km/h (20 to 53 mph)	-	5 to 65 km/h (3 to 40 mph)	5 to 65 km/h (3 to 40 mph)

The values apply only under ideal conditions and are approximate values which depend on the market and vehicle equipment. Please contact a qualified workshop if you have any queries about the equipment installed in your vehicle.

#### Advance warning



The system detects a possible collision and prepares the vehicle for possible emergency braking.

An acoustic warning sounds and the red warning lamp lights up. Brake or take avoid-ing action.

#### Urgent warning

If the driver does not react to the advance warning, the system may initiate a short braking jolt in order to draw attention to the increasing collision risk. Brake or take avoid-ing action.

#### Automatic braking

If the driver also does not react to the urgent warning, the vehicle can be braked automati-

cally with braking force that increases in several stages. The reduced speed means that it is possible to minimise the consequences of an accident.

#### Braking intervention

If the system detects that the driver is braking insufficiently when there is a risk of collision, the system can increase the braking force and help prevent a collision. The braking intervention takes place only for as long as the brake pedal is pressed hard.

#### Distance warning



The system detects when safety is endangered by driving too close to the vehicle in front. The indicator lamp lights up. Increase the distance.

Speed range: around 65 km/h (around 40 mph) to around 250 km/h (around 155 mph).

## Limits of Front Assist

📖 Please refer to ⚠️ at the start of the chapter on page 159.



Front Assist is not available or its functions are restricted immediately after the vehicle is started. The indicator lamp lights up in the instrument cluster display during this time.

Front Assist has physical and system-related limitations. You should therefore always be prepared to take full control of the vehicle if necessary.

### Delayed response

If the camera or radar sensor is exposed to environmental conditions that impair functioning, the system may detect this only after a certain delay. For this reason, any restrictions to functions may be displayed only after a delay at the start of the journey and when driving → page 159.

### Objects that cannot be detected

Front Assist may not react or may react with a delay or provide with an unwanted response in the following situations:

- Vehicles that are driving outside the sensor range in close proximity to your vehicle, e.g. vehicles that are driving offset to your vehicle or motorbikes.
- Vehicles that change into your lane directly in front of your vehicle.
- Vehicles with bodies or attachments that project beyond the vehicle.
- Oncoming vehicles or vehicles crossing your path.
- Oncoming pedestrians.
- Oncoming cyclists.
- When pedestrians and cyclists are not detected, for example because they are partially or fully hidden.
- Objects or narrow objects such as walls, rails, fences, posts, trees or garage doors.

### Function limitations

Front Assist may not react or may react with a delay or provide with an unwanted response in the following situations:

- In tight bends.
- Driving in heavy rain, snow, fog or heavy spray.
- Driving in multi-storey car parks and tunnels.
- Driving on roads with embedded metal objects, e.g. railway tracks.
- Reversing.
- If ESC is regulating or faulty.
- If the radar sensor or camera window is dirty, covered or damaged.
- If several brake lights on the vehicle are faulty.
- If there is a fault in several brake lights on a trailer or bicycle carrier with an electrical connection to the vehicle.
- If the vehicle accelerates hard or the accelerator is fully depressed.
- In complex driving situations, e.g. at traffic islands.
- In unclear traffic situations, e.g. vehicles ahead are braking heavily or turning off.
- When the sun is low in the sky, in darkness or with glare from oncoming vehicles.
- When driving into and out of tunnels.
- If there is a fault in Front Assist.

### Switching off Front Assist

Front Assist is not suitable for use in the following situations due to the limitations of the system and must be switched off → ⚠️:

- If the vehicle is utilised in a capacity beyond usage on public roads, e.g. off-road or on a race track.
- If the vehicle is being towed or is loaded onto another vehicle.
- If add-on parts cover the radar sensor or camera.
- If the camera or the radar sensor is faulty.

- After external force on the radar sensor, e.g. after a rear-end collision.
- If the windscreen is damaged in the area of the camera window.
- In the event of multiple unwanted interventions.


### WARNING

Failure to switch off Front Assist in the situations mentioned can result in accidents and serious injuries.

## Pedestrian Monitoring

 Please refer to  at the start of the chapter on page 159.

Pedestrian Monitoring and Cyclist Monitoring can help to avoid accidents with pedestrians and cyclists or to mitigate the consequences of an accident.

The system may give a warning when there is a risk of collision, prepare the vehicle for emergency braking, help to brake the vehicle or perform an automatic brake intervention. In the event of an advance warning, the red warning lamp  lights up in the instrument cluster display.

When Front Assist is switched on and active, Pedestrian Monitoring is also active as an element of Front Assist.

### WARNING

The intelligent technology of Pedestrian Monitoring cannot overcome the laws of physics, and functions only within the limits of the system. Never let the extra convenience afforded by Pedestrian Monitoring tempt you into taking any risks when driving. The driver is always responsible for braking in time.

- If Pedestrian Monitoring issues a warning, brake your vehicle immediately de-

pending on the traffic situation or avoid the object.

- Pedestrian Monitoring cannot prevent accidents and serious injuries by itself.
- Pedestrian Monitoring can issue unnecessary warnings and carry out unwanted braking interventions in complex driving situations, e.g. in a sharply turning main road with an intersection.
- Pedestrian Monitoring can issue unnecessary warnings and carry out unwanted braking interventions when its function is impaired, e.g. if the radar sensor is covered or if the camera window is dirty.
- Be prepared to take over control of the vehicle yourself at all times.

## Swerve support

 Please refer to  at the start of the chapter on page 159.

The swerve support function can help to steer the vehicle around an obstacle in critical driving situations.

If you steer to avoid an obstacle after an urgent warning, swerve support can help you. Swerve support brakes individual wheels and supports you with a corrective steering intervention as long as you steer.

### Speed range

Swerve support is available in a speed range from around 30 km/h (20 mph) up to around 150 km/h (90 mph).

### Limits

Swerve support does not react to crossing objects and animals. Always also observe the fundamental limits of Front Assist → page 162.

## Oncoming vehicle braking when turning

📖 Please refer to  at the start of the chapter on page 159.

The oncoming vehicle braking when turning function can prevent the vehicle from colliding with an oncoming vehicle during a turn.


If there is a risk of the vehicle colliding with an oncoming vehicle in the adjacent lane when turning, the oncoming vehicle braking when turning function can brake your vehicle. The vehicle can then remain in its own lane as a result.

### Speed range

The oncoming vehicle braking when turning function is available up to around 15 km/h (around 9 mph).

### Limits

The oncoming vehicle braking when turning function is available only if you indicate, have turned the steering wheel and have therefore started the turning manoeuvre. After changing from right-hand traffic to left-hand traffic or vice versa, the oncoming vehicle braking when turning function is available only after a certain time (30 minutes or more).

The oncoming vehicle braking when turning function does not react to persons, animals, crossing vehicles or objects that are not detected as a vehicle. Always also observe the fundamental limits of Front Assist → page 162. 

## Operating Front Assist

📖 Please refer to  at the start of the chapter on page 159.

Front Assist and all the included functions (country-dependent) are automatically switched on when you switch on the ignition.



However, Front Assist is not available or only partially available as long as the indicator lamp is on.

Volkswagen recommends that Front Assist and all the included functions (country-dependent) are switched on at all times. Exceptions → page 162.

### Switching on and off

– Switch Front Assist on and off in the Assist systems menu of the Infotainment system → page 31.




If you switch off Front Assist, all the included functions (country-dependent) are also switched off. The yellow indicator lamp lights up in the instrument cluster display.

### Making settings for the included functions (country-dependent)

You can make further settings when Front Assist is switched on:

– Switch the desired function on and off in the Assist systems menu of the Infotainment system → page 31.

You can also set the warning time for the advance warning. 

## Troubleshooting

📖 Please refer to ⚠️ at the start of the chapter on page 159.

### 🔧 Front Assist is starting up.

The indicator lamp lights up.

- Front Assist is temporarily unavailable or limited. Front Assist is available after driving straight ahead for a short time, and the indicator light goes out. When the vehicle is not in motion, the indicator lamp lights up continuously.

### 🚫 Front Assist not available or functions restricted.

The indicator lamp lights up yellow and a text message is also displayed.

- The radar sensor or camera window is dirty. Clean the radar sensor and windscreen → page 355.
- The view of the radar sensor or camera is impaired due to the weather conditions, e.g. snow, or due to detergent deposits or coatings. Clean the radar sensor and windscreen → page 355.
- The view of the radar sensor is impaired by add-on parts, the trim frames of number plate holders or stickers. Keep the area around the radar sensor free.
- The view of the camera is impaired by add-on parts or stickers. Keep the area around the camera window free.
- The radar sensor or camera has been displaced or damaged, e.g. due to damage to the front of the vehicle or the windscreen. Check whether damage is visible → page 362.
- Paint work or structural modifications were carried out on the front of the vehicle.
- If the problem persists, switch off Front Assist and go to a qualified workshop.

**Front Assist does not function as expected or is triggered unnecessarily several times.**

- The radar sensor or camera window is dirty. Clean the radar sensor and windscreen → page 355.
- The system limits have been exceeded → page 162.
- Low sun or darkness.
- If the problem persists, switch off Front Assist and go to a qualified workshop.

**Touch panels react differently than expected.**

Moisture, dirt and grease can impede the functioning of the touch panels.

- Make sure the touch panels are always clean and dry.

## Lane keeping system (Lane Assist)

### 📖 Introduction to the topic

Within the system limits, the lane keeping system (Lane Assist) helps the driver to stay in lane. The function is not designed to keep the vehicle in lane automatically, nor is it suited to this purpose.

Using a camera in the windscreen, the lane keeping system detects road lane markings on the road. If your vehicle moves too close to a recognised road lane marking, the system will warn the driver with a corrective steering intervention. The corrective steering intervention can be overridden by the driver at any time.

### System limits

Use the lane keeping system only on motorways and well-developed country roads.

The system is not ready to intervene on both sides under the following conditions (passive system status):

- The vehicle speed is under 55 km/h (approximately 30 mph).
- The lane keeping system has not detected a road lane marking on either side.
- In tight bends.
- Temporarily if the driving style is very dynamic.
- When the turn signal is switched on before changing lane manually.
- If the driver vigorously oversteers a system intervention.
- A road lane marking is crossed despite a system intervention.
- The driver does not react to a driver intervention prompt.

### **WARNING**

The intelligent technology used in the lane keeping system cannot overcome physical limitations, and functions only within the limits of the system. Always take care when using the lane keeping system otherwise you could cause accidents or injuries. The system is not a substitute for the full concentration of the driver and their steering.

- Adapt your speed and distance from the vehicles ahead to suit visibility, weather, road and traffic conditions.
- Your hands should always be on the steering wheel so that you can steer at any time. The driver is always responsible for staying in the lane.
- The lane keeping system cannot recognise all road lane markings. In certain circumstances, the lane keeping system may detect poor road surfaces, road structures or objects incorrectly as road lane markings. Immediately override any undesired intervention by the system.
- Observe the information on the instrument cluster display and respond according to the prompts, if permitted by the traffic situation.

- In the following situations undesired intervention by the lane keeping system can occur or no control assistance is provided by the lane keeping system. This means that it is crucial that the driver is attentive in these situations. It may be necessary to switch off the lane keeping system temporarily:

- Very sporty driving.
- In poor weather conditions and when driving on poor roads.
- Driving through road works.
- Over hill tops or through dips.

- Always observe the area around the vehicle with care and watch the road ahead while driving.
- If the camera's field of view is dirty, covered or damaged, the function of the lane keeping system may be impaired.


## **Driving with the lane keeping system**

 Please refer to  at the start of the chapter on page 165.

### **Switching on and off**

Depending on country, the lane keeping system is always switched on when the ignition is switched on. You can also switch the lane keeping system on and off in the Assist systems menu of the Infotainment system and view the current system status there.

The lane keeping system (Lane Assist) is also switched on when the comfort drive function (Travel Assist) is switched on.

 If there is a system fault, the lane keeping system can deactivate itself automatically.

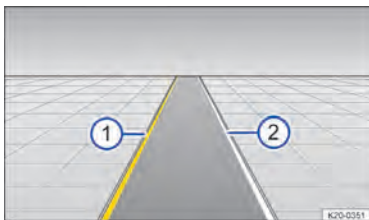
### **Speed range**

When road lane markings can be detected, the lane keeping system is ready to intervene at speeds above around 60 km/h (35 mph)



within the system limits (system status active).

### Displays



**Fig. 110** On the instrument cluster display: lane keeping system displays.

- ① Yellow line: road lane marking detected. System is actively intervening on the indicated side.
- ② White line: road lane marking detected. The system is ready to intervene on the side shown.

With some equipment levels, additional details about the road lane marking may also be shown on the instrument cluster display, e.g. dashed lane markings.

With some equipment levels, a display is also shown on the Head-up Display → page 21.

The following indicator lamps light up, depending on the driving situation:



System is active and ready to perform control intervention.



System intervention (corrective steering intervention).

If no warning lamp lights up, the system is not ready to intervene on either side (passive system status) or is switched off.



If the comfort drive function (Travel Assist) is actively performing a control operation, there is no steering intervention and the lane keeping system is not displayed.

### Driver intervention prompt

If there is no steering activity, the system prompts you to drive in the middle of the lane by means of acoustic warnings and a display on the instrument cluster.

If you do not react, the system will switch to passive state.

Depending on the vehicle equipment, Emergency Assist will be activated if Emergency Assist is switched on in the Infotainment system.

Independently of steering activity, you will be additionally requested to drive in the middle of the lane again with a display on the instrument cluster display and with acoustic warnings if the corrective steering intervention takes place for an extended time.

### Steering wheel vibration

The following situations can lead to vibration of the steering wheel:

- The system can no longer detect a lane during a major steering intervention.

You can also select the option **Vibration** or **Steering wheel vibration** in the Assist systems menu of the Infotainment system. In this case, the steering wheel will vibrate if the vehicle drives over a detected road lane marking when the lane keeping system is active. <

## Troubleshooting

📖 Please refer to ⚠ at the start of the chapter on page 165.


### 🚗 Lane keeping system not available.


The indicator lamp lights up yellow. A message will also appear on the instrument cluster display.


- The camera window is dirty. Clean the windscreen → page 355.
- The view of the camera is impaired due to the weather conditions, e.g. snow, or due

to detergent deposits or coatings. Clean the windscreen → page 355.

- The view of the camera is impaired by add-on parts or stickers. Keep the area around the camera window free.
- The camera has been displaced or damaged, e.g. due to damage to the windscreen. Check whether damage is visible → page 362.
- Fault or malfunction. Deactivate and reactivate the vehicle's drive system.
- If the problem persists, go to a qualified workshop.

 It can take a few seconds before a system fault is detected after the ignition is switched on.

 If the lane keeping system is not available, Emergency Assist is also not available.

 If the lane keeping system is not available, Travel Assist is also not available.

#### **The system is not responding as expected.**

- Do not attach any objects to the steering wheel.

#### **Touch panels react differently than expected.**

Moisture, dirt and grease can impede the functioning of the touch panels.

- Make sure the touch panels are always clean and dry.

## **Travel Assist**

### **Introduction to the topic**

Travel Assist combines Adaptive Cruise Control (ACC) with adaptive lane guidance. Within the system limits, this enables the driver to keep the vehicle at a preselected distance from the vehicle in front and stay in a predefined position within the lane.

Travel Assist uses the same sensors as the Adaptive Cruise Control (ACC) and the lane keeping system (Lane Assist). You should therefore read the information on ACC and Lane Assist carefully and observe the listed system limits and instructions.

#### **Speed range**


Travel Assist performs control as from around 20 km/h (around 15 mph), with extended operation for adaptive lane guidance from 0 km/h (0 mph). This speed range may differ in certain markets.

#### **Driving with Travel Assist**

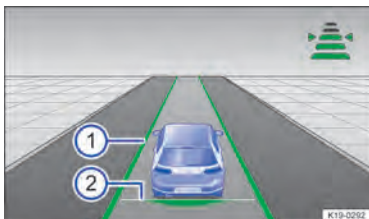
Travel Assist automatically regulates the speed and steers the vehicle. Within the system limits, Travel Assist can decelerate the vehicle to a standstill behind a vehicle that is stopping. It can also start driving again by itself.

You can override Travel Assist regulation at any time.

#### **Does the vehicle have Travel Assist?**

The vehicle is equipped with Travel Assist if the  button is available on the multifunction steering wheel.

## Displays



**Fig. 111** On the instrument cluster display: active regulation displayed (illustration).

- ① Adaptive lane guidance active.
- ② Set distance.

With some equipment levels, a display is also shown on the Head-up Display → page 21.

With some equipment levels, additional details may also be shown on the instrument cluster display, e.g. dashed lane markings and vehicles driving in front.

Depending on the vehicle equipment, indicator lamps on the instrument cluster display show the status of Travel Assist:



Travel Assist active, Adaptive Cruise Control and adaptive lane guidance active.



Travel Assist active, Adaptive Cruise Control active, adaptive lane guidance passive.

### Driver intervention prompt

If you take your hands off the steering wheel, the system prompts you within a few seconds to take over active steering by way of acoustic warnings and a display on the instrument cluster.

Travel Assist will be deactivated if you do not respond to the prompt.

Alternatively, depending on vehicle equipment, Emergency Assist will be activated if Emergency Assist is switched on in the Infotainment system.

## ⚠ WARNING

The intelligent technology used in Travel Assist cannot overcome the physical limits specified, and functions only within the limits of the system. Careless or unintentional use of Travel Assist can cause accidents and serious injuries. The system is not a substitute for the full concentration of the driver.

- Observe the system limits and information on Adaptive Cruise Control (ACC) and the lane keeping system (Lane Assist).
- Adapt your speed and the distance from the vehicles ahead to suit visibility, weather, road and traffic conditions.
- Never use Travel Assist in poor visibility, on steep or winding roads, or on slippery road surfaces, e.g. due to snow, ice, wet roads, loose chippings, or on flooded roads.
- Never use Travel Assist offroad or on unsurfaced roads. Travel Assist is designed for use on surfaced roads only.
- Travel Assist does not react to persons, animals or vehicles crossing or approaching in the same lane.
- Brake immediately if a brake request is displayed on the instrument cluster display or if the speed reduction by Travel Assist is not sufficient.
- Brake if the vehicle starts rolling unintentionally, e.g. after a brake request.
- Your hands should always be on the steering wheel so that you are ready to steer at any time. The driver is always responsible for staying in the lane.
- Take control of the vehicle immediately if a driver intervention prompt appears on the instrument cluster display.
- Be prepared to control the speed yourself at all times.


## Operating Travel Assist


📖 Please refer to ⚠️ at the start of the chapter on page 168.



**Fig. 112** Lefthand side of the multifunction steering wheel.

### Switching on and starting control

- Press the  button on the multifunction steering wheel.

The green indicator lamp  lights up in the instrument cluster display. A message is also displayed. Travel Assist maintains the current speed and the preset distance from the vehicle in front. At the same time, the vehicle is also kept in lane by steering movements if road lane markings are detected.

### Cancelling control

- Briefly press the  button or press the brake pedal.


The set distance remains stored.

### Making other settings

The other operating functions of Travel Assist correspond to operation of ACC → page 155. <


## Troubleshooting

📖 Please refer to ⚠️ at the start of the chapter on page 168.

 **Travel Assist is not available or does not function as expected.**


The indicator lamp lights up yellow. A message will also appear on the instrument cluster display.

- There is a fault in the sensor system. Check the causes and remedies described in the information on ACC → page 156 or Lane Assist → page 167.
- Fault or malfunction. Deactivate and reactivate the vehicle's drive system.
- The system limits have been exceeded.
- If the problem persists, go to a qualified workshop.

 **Take over steering.**

The warning lamp lights up white and a message is displayed in the instrument cluster display.

- You have released the steering wheel for a few seconds. Take hold of the steering wheel and take over vehicle control.

 **Take over steering.**

The warning lamp lights up red and a message is displayed in the instrument cluster display. An acoustic warning is issued or the steering wheel vibrates, depending on the driving situation.

- You have let go of the steering wheel for an extended time or the system limits have been reached. Take hold of the steering wheel immediately and take over vehicle control.

### Travel Assist switches off automatically.

- *Vehicles without Emergency Assist:* You have released the steering wheel for an extended period of time.

- Fault or malfunction. Deactivate and reactivate the vehicle's drive system.
- If the problem persists, go to a qualified workshop.

**The control system is interrupted unexpectedly.**

- You have activated the turn signal.

## Semi-automatic vehicle control in a medical emergency (Emergency Assist)

Emergency Assist can detect a lack of activity on the part of the driver and keep the vehicle in the lane automatically, or brake the vehicle to a standstill if required. The system can therefore actively contribute to preventing or reducing the consequences of an accident.

Emergency Assist uses the same sensors as the Adaptive Cruise Control (ACC) and the lane keeping system (Lane Assist). Please read the information on ACC → page 151 and Lane Assist → page 165 carefully and observe the listed system limits and instructions.

### Driver intervention prompt

If there is no driver activity, Emergency Assist prompts the driver to take control of the vehicle by acoustic warnings and by a braking jolt. A message is also displayed on the instrument cluster display and the volume of the Infotainment system is reduced.

Depending on equipment, the driver's belt is also tensioned simultaneously.

### System intervention

If the driver does not respond, the system can brake the vehicle and keep it in lane. The following indicator lamp lights up in the instrument cluster display:



System intervenes.

You can override intervention at any time by steering, accelerating strongly or braking.

Other road users will be warned as follows when Emergency Assist is actively performing control interventions:

- The hazard warning lights will be switched on after a short time.
- The vehicle horn will sound (depending on speed).

The following will happen as soon as the vehicle is stationary:

- The electronic parking brake is switched on.
- The doors will be unlocked.
- The interior lighting will be switched on.
- An emergency call (eCall) will be made, depending on the vehicle equipment.

### Switching on and off

You can switch Emergency Assist on and off in the assist systems menu of the Infotainment system.

When switched on, Emergency Assist is active only if the following prerequisites are met:

- Travel Assist or Lane Assist is switched on.
- The system has detected a road lane marking on both the right and left sides of the vehicle.



If there is a system fault, Emergency Assist can deactivate itself automatically.



If the lane keeping system (Lane Assist) is not available, Emergency Assist is also not available.



### Emergency Assist not available

The indicator lamp lights up yellow. A message will also appear on the instrument cluster display.

- Fault or malfunction. Deactivate and reactivate the vehicle's drive system.
- If the problem persists, switch off Emergency Assist and go to a qualified workshop.

### Touch panels react differently than expected.

Moisture, dirt and grease can impede the functioning of the touch panels.

- Make sure the touch panels are always clean and dry.

### WARNING

The intelligent technology used in Emergency Assist cannot overcome the physical limits specified, and functions only within the limits of the system. The driver is always responsible for controlling the vehicle.

- Adapt your speed and distance from the vehicles ahead to suit visibility, weather, road and traffic conditions.
- Emergency Assist cannot always prevent accidents and serious injuries on its own.
- If the radar sensor or the front camera are covered or have been displaced, Emergency Assist may carry out unwanted braking or steering interventions.
- Emergency Assist does not react to persons, animals or vehicles crossing or approaching in the same lane.

### WARNING

If Emergency Assist is triggered unexpectedly, it can result in accidents and serious injuries.

- If the vehicle behaves differently to expected, cancel the intervention of Emergency Assist by accelerating strongly, braking or steering.

- Do not use Travel Assist and Lane Assist. Go to a qualified workshop and have the system checked.

## Lane change system (Side Assist)

### Introduction to the topic

The lane change assist system (Side Assist) provides assistance when checking for traffic behind the vehicle.

Radar sensors monitor the area behind the vehicle. The system measures the distance and speed difference in relation to other vehicles and informs the driver by means of visual signals in the wing mirrors.

### System limits

Use the lane change system only on surfaced roads.

The lane change system may interpret the traffic situation incorrectly in the following driving situations, for example:

- In tight bends.
- When driving in the middle of two lanes.
- When road lanes are of varying width.
- At crests in the road.
- In poor weather conditions.
- Where there are special roadside structures, e.g. high or offset crash barriers.

### WARNING

The intelligent technology used in the lane change system cannot overcome the physical limits specified, and functions only within the limits of the system. Do not let the increased convenience of the lane change system tempt you into taking any safety risks. Always take care when using the lane change system as you could other-

wise cause accidents or injuries. The system is not a substitute for the full concentration of the driver.

- Adapt your speed and distance from the vehicles ahead to suit visibility, weather, road and traffic conditions.
- Your hands should always be on the steering wheel so that you can steer at any time.
- Observe the displays in the exterior mirror housings and on the instrument cluster display and act in accordance with the requests.
- Always pay attention to what is happening around the vehicle.
- Never use the lane change system if the radar sensors are dirty, covered or damaged. These circumstances can impair the proper functioning of the system.
- It may be hard to see the display in the wing mirror in direct sunlight.

**i** The radar sensors calibrate themselves once in the first few kilometres after vehicle delivery and if the sensors are repaired. The sensor range may be limited during the calibration phase.

## Driving with the lane change system

**📖** Please refer to **⚠** at the start of the chapter on page 172.



**Fig. 113** In the exterior mirror housing: visual displays of the lane change system.

### Switching on and off

You can switch the lane change system on and off in the Assist systems menu of the Infotainment system. When the lane change system is switched on, the yellow indicator lamp **■** in the exterior mirror housing lights up once briefly.


This most recent system setting is retained even after the ignition has been switched off and on.

### Function

When switched on, the lane change system is active from a speed of around 15 km/h (9 mph). The lane change system is deactivated at a vehicle speed below 10 km/h (6 mph).

In the following driving situations, the yellow indicator lamp **■** lights up in the housing of the respective exterior mirror:

- If your vehicle is being overtaken.
- When overtaking another vehicle with a speed difference of up to approximately 15 km/h (9 mph). No display will be shown if the overtaking manoeuvre is much faster.

The yellow indicator lamp  flashes if a possible critical situation is detected when you indicate in the direction of the detected vehicle.

The faster another vehicle approaches, the earlier there is a corresponding display in the exterior mirror.

### Lane change system "Side Assist Plus"

If the vehicle is equipped with a lane keeping system (Lane Assist) and the system is switched on, the driver is warned by a corrective steering intervention when changing lanes during a possible critical situation (information level, warning level). The steering intervention also occurs when the turn signal is activated for the corresponding direction. If the steering intervention is overridden by the driver, the steering wheel vibrates to give an additional warning. For this, steering wheel vibration must be activated in the Assist systems menu in the Infotainment system.

### Automatic deactivation

The lane change system will switch off automatically if the radar sensors are permanently covered. This can be caused by a layer of ice or snow in front of the radar sensor, for example.


A text message will be shown on the instrument cluster display.

If you use the factory-fitted trailer towing coupling and have set up the necessary electrical connection, the lane change system switches off automatically. After you have disconnected the electrical connection, the lane change system is switched back on automatically.

If the trailer towing coupling is not factory-fitted, you must manually switch off the lane change system and then switch it back on again.

### Brightness


The brightness of the visual display will change automatically depending on the ambient light levels.

You can adjust the basic brightness of the display in the Assist systems menu in the Infotainment system. The lane change system is not active during the setting procedure. 

## Troubleshooting

 Please refer to  at the start of the chapter on page 172.

### Lane change system fault.

The indicator lamp lights up yellow. The yellow central warning lamp  also lights up.

— Go to a qualified workshop.

### No sensor visibility, fault message, system switches itself off.

- Clean radar sensors or remove stickers or accessories from radar sensors  
→ page 358.
- Check for any visible damage.

### The system is not responding as expected.

- The radar sensors are dirty → page 358. The sensor visibility may be impaired by dirt and snow or also residue from cleaning agents or coatings.
- The general conditions for system operation have not been met → page 172.
- The radar sensors are covered by water.
- The vehicle is damaged in the area of the radar sensors, e.g. caused by parking collisions.
- The detection ranges of the radar sensors are blocked by add-on parts, e.g. bicycle carriers.
- Changes have been made to the paintwork in the area of the radar sensors or structural modifications have been made, e.g. on the vehicle front end or the running gear.
- The side windows have been retrofitted with tinted window films.



**Touch panels react differently than expected.**

Moisture, dirt and grease can impede the functioning of the touch panels.

- Make sure the touch panels are always clean and dry. <


# Parking and manoeuvring



## Parking

### Parking the vehicle

#### WARNING

If the vehicle is not parked properly it can roll away even on a slight gradient. This can cause accidents and serious injuries.

- When parking, observe the specified order.
- Before leaving the vehicle, make sure that the electronic parking brake is switched on and that the indicator lamp  next to the driving mode selector lights up red.

1. Depress and hold the brake pedal.
2. Switch on the electronic parking brake → page 177. The vehicle's drive system is deactivated. The indicator lamp  next to the driving mode selector lights up red.
3. On uphill and downhill slopes, turn the steering wheel so that the vehicle will roll against the kerb if it starts to move.
4. Take your foot off the brake pedal.
5. Get out of the vehicle → . Watch out for other road users.
6. Take all vehicle keys with you and lock the vehicle.


#### WARNING

If children, people requiring assistance or animals are left unattended in the vehicle, there is the danger of accidents and serious injuries.

- Never leave children, people requiring assistance or animals in the vehicle unattended. They could operate the position switch and switch off the electronic

parking brake as a result. The vehicle could start to move.

- Never leave children, people requiring assistance or animals in the vehicle. Depending on the time of year, very high or very low temperatures can occur inside a closed vehicle.
- Always take all vehicle keys with you every time you leave the vehicle.

To avoid damage and dangerous situations, always park the vehicle in a suitable parking space → .


#### NOTICE

The vehicle cannot be parked safely and can be damaged if the ground is uneven, sandy or muddy.

- Always park the vehicle on a firm, level surface.

#### NOTICE

Low-lying vehicle components such as the bumpers, spoiler and parts of the running gear can be damaged if the vehicle drives over objects protruding from the ground.

- Drive carefully over drives, ramps, kerbs, borders and dips. 

## Electronic parking brake

### Operating the electronic parking brake



**Fig. 114** On the driving mode selector: **P** button for the electronic parking brake.

#### Switching on

- When the vehicle is stationary, press the → **Fig. 114** **P** button.
- **OR:** the electronic parking brake is switched on automatically when the ignition is switched off.

**(P)** The indicator lamp next to the driving mode selector in the instrument cluster lights up red when the electronic parking brake is switched on.

#### Switching off

- Press the brake pedal and select a driving position **D, B, R** or neutral position **N**.
- The indicator lamp **(P)** in the instrument cluster goes out.

#### Automatic switch-on if the driver does not leave the vehicle correctly

The electronic parking brake may switch on automatically if the system detects that you have not left the vehicle correctly → **!**. The vehicle is also secured by the electronic parking brake in neutral position **N**.

### **!** WARNING

If not parked properly, the vehicle may roll away. This can cause accidents, serious injuries and damage to property.

- Always park the vehicle in the specified order → page 176, *Parking*.
- Before leaving the vehicle, make sure that the electronic parking brake is switched on and that the indicator lamp **(P)** next to the driving mode selector in the instrument cluster lights up red.

#### Enabling rolling capability of the vehicle

If you do **not** want the electronic parking brake to be switched on automatically, e.g. in a car wash → **(i)**, the rolling capability of the vehicle can be maintained.

#### Prerequisites:

- ✓ Vehicle is stationary.
- ✓ Brake is pressed.
- ✓ Neutral position **N** was engaged.

#### Establishing rolling capability:

- Confirm the “Establish rolling capacity” message in the Infotainment system.
- **OR:** Open the vehicle settings in the Infotainment system → page 31.
- Open the **Brakes** submenu.
- Switch on function.

If rolling capacity is active, a corresponding text message is shown continually on the instrument cluster display. An acoustic warning may be given.

#### Ending rolling capability:


- Press the → **Fig. 114** **(P)** button. The electronic parking brake is switched on.
- **OR:** the ignition is switched off by pressing the starter button.


### **(i)** NOTICE

The electronic parking brake must not switch on automatically in a car wash. This could lead to the vehicle being damaged.

- Enable rolling capability of the vehicle.


### Emergency braking function

The emergency braking function should be used only in those situations where the vehicle cannot be stopped using the foot brake → .

- Press and hold the → Fig. 114  button. The vehicle brakes strongly. An acoustic warning sounds at the same time.


### WARNING

Incorrect use of the electronic parking brake can cause accidents and serious injuries.

- Never use the electronic parking brake to brake the vehicle, except in emergencies. The braking distance is considerably longer. Always use the foot brake. 

## Troubleshooting



### Holding force is insufficient in the current situation

The indicator lamp  next to the driving mode selector flashes red. The vehicle is stationary. A text message is additionally shown on the instrument cluster display.

It is not possible to park the vehicle safely on the gradient.

- Park the vehicle in a different place or on a level surface.


### Electronic parking brake does not switch itself off completely

The indicator lamp  next to the driving mode selector flashes red. The vehicle is moving. The indicator lamp  is also shown on the instrument cluster display.

There is a system fault.

- Go to a Volkswagen dealership or qualified workshop.

### / Fault in electronic parking brake

The central warning lamp lights up yellow. The  symbol with a text message is additionally shown on the instrument cluster display.

Go to a Volkswagen dealership or qualified workshop.


### Electronic parking brake does not switch itself off

The charging connector is plugged in.

**OR:** the 12-volt vehicle battery is discharged.

- Jump-start the vehicle → page 302.

### Electronic parking brake makes noises


- Noises may be heard when the electronic parking brake is switched on and off.
- If the electronic parking brake has not been used for a long period, the system will carry out occasional automatic and audible checks when the vehicle is parked. 

## Auto Hold function

The Auto Hold function secures the vehicle against rolling away when stationary, without the vehicle having to be held by the foot brake.

### Prerequisites

- ✓ The driver door is closed.
- ✓ The vehicle's drive system has been activated.

If position **N** is selected, the Auto Hold function will **not** switch on or will switch itself off. As a result, the vehicle will not be held securely in a stationary position → .

### Switching on

- Open the vehicle settings in the Infotainment system → page 31.

- Open the **Vehicle** menu.
- Open the **Exterior** menu.
- Open the **Brakes** menu.
- Switch on the Auto Hold function.

**AUTO HOLD** When the Auto Hold function is switched on, the indicator lamp in instrument cluster lights up grey.

Auto Hold is ready for use, but the car is not necessarily stopped → .

The Auto Hold function remains active when the vehicle's drive system is activated again.

#### Keeping the vehicle stationary with the Auto Hold function

- Make sure that the Auto Hold function is switched on.
- Bring the vehicle to a standstill using the brake → page 176.


**AUTO HOLD** The indicator lamp in the instrument cluster lights up green when the Auto Hold function is active.

The vehicle will be kept stationary. You can release the brake → .

The hold function stops if the vehicle is driven off or if the prerequisites for the Auto Hold function are not met.


#### Switching off

- Switch off the Auto Hold function in the vehicle settings in the Infotainment system → page 31.


The Auto Hold function can only be switched off if the brake pedal is depressed → .

#### WARNING

The intelligent Auto Hold function cannot overcome the laws of physics, and operates only within the limits of the system. Do not let the extra convenience afforded by the Auto Hold function tempt you into taking any safety risks when driving.

- Make sure that the indicator lamp **AUTO HOLD** lights up green or  red on the instrument cluster display if the vehicle is to be held securely. The vehicle is being held by the Auto Hold function if the green indicator lamp is lit and by the electronic parking brake if the red warning lamp is lit.
- Never leave the vehicle if the vehicle's drive system is activated and Auto Hold is switched on.
- The Auto Hold function cannot hold the vehicle in all hill start situations or brake it sufficiently on all slopes going downhill, e.g. if the ground is slippery or icy.


#### NOTICE


Always switch off the Auto Hold function before driving into a car wash. Damage may otherwise be caused by automatic activation of the electronic parking brake. 

## General information about the parking systems

### Safety notes on the parking systems

#### Limits of sensors and cameras

There are various sensors and cameras on the vehicle which detect and monitor the area around the vehicle by means of ultrasound, radar waves and optical systems. The various parking systems use different combinations of the sensors. Common to all sensors is the fact that they are subject to technical and physical limits → .

- Some objects may not be detected under certain circumstances, such as trailer drawbars, thin bars, fences, posts, trees, very low or high obstacles, as well as open or opening boot lids → .

- The detection ranges of the parking systems have blind spots in which obstacles and people are not registered.
- In some cases, dirt or ice and water on the sensors and cameras could be registered as an obstacle or impair detection of objects. The sensor visibility may be impaired by dirt and snow, as well as residue from cleaning agents or coatings → page 183.
- External sources of sound and certain surfaces on objects and clothing may influence the sensors' signals. In certain circumstances, the systems will be unable to detect or properly detect people and objects.
- Certain objects, for example narrow posts or railings, may be difficult or impossible to see on the screen because of its low resolution or poor light conditions.
- The cameras show only two-dimensional images on the screen. The lack of depth of field means that potholes and protruding objects on the ground may only be detected with difficulty, or may not be detected at all.

### WARNING

The intelligent technology used in the parking systems cannot overcome the laws of physics, and functions only within the system limits. Never let the extra convenience afforded by the parking systems tempt you into taking any risks when driving. The parking systems cannot replace the full concentration of the driver.

- Ensure that your speed and driving style are always appropriate for the current visibility, weather and road/traffic conditions.
- Keep looking in the direction in which you are parking and at the relevant area surrounding the vehicle. Pay special attention to small children, animals and objects.
- Please note that the parking system may not be able to react if the obstacle is approached too fast and will then not issue a warning.

- Do not allow the parking system displays to distract you from the traffic around you.

### WARNING

Camera lenses enlarge and distort the field of view. The image can be inaccurate for estimating the distance from persons or obstacles and could cause accidents and serious injuries.

- Do not rely on the camera image.

### NOTICE

Observe a distance of 50 cm from walls and buildings in parking spaces without kerbs in order to avoid damage to the vehicle. <

## Prerequisites for functioning of the parking systems

### Basic information

The following prerequisites must be met so that the sensors and cameras are best able to detect the surroundings of the vehicle and display this information on the Infotainment system:

- The doors and the boot lid are closed.
- Exterior mirrors are not folded in.
- The sensors or cameras are not covered by add-on parts or trim frames for number plates.
- The surrounding area has a flat surface.
- The vehicle does not have a heavy load at the rear or on one side.
- The vehicle is ready to drive.
- TCS and where applicable ESC are switched on → page 189.



The parking function and the acoustic warnings will be deactivated if other functions are operated on the Infotainment system during a parking operation.

### Finding a suitable parking space

To ensure that a suitable parking space can be displayed and detected correctly, the following prerequisites must be met:

- The length and width of the parking space must be larger than the vehicle dimensions and offer sufficient space for manoeuvring.
- The distance when driving past the parking space should be around 1 m (3 feet).

### Parking system displays in the Infotainment system


The range of possible settings varies according to the country, the device and the vehicle's equipment specification.

The vehicle approaching an obstacle is displayed in several segments on the Infotainment system and this is backed up by acoustic signals. The display may vary depending on the situation.

The collision area has been reached when the penultimate segment is displayed, if not before. **Do not drive on!**

All equipment and displays are described without indicating whether the equipment is optional or specific to the model type. The systems available depend on the equipment in the vehicle.

#### Menu for parking systems

Touch the  touch panel in dash panel to open the menu with the parking systems in the Infotainment system.



Open the setup for the parking systems.

#### General displays



Mute audio signals.



Adjust brightness, contrast and colour.



Close current display and end function.

#### The following also applies to vehicles with Park Distance Control



Switching Park Distance Control on and off → page 185.



Switch to rear view camera system → page 186.



Manoeuvre braking deactivated or faulty → page 182.



Red-coloured image segment: close obstacle. **Vehicle is at risk. Brake.**



Yellow-coloured image segment: obstacle in the vehicle path. **Vehicle is at risk. Adjust the steering wheel angle.**



Grey-coloured image segment: obstacle outside the path of the vehicle.



System fault in the monitored area (depending on equipment level). The colour may vary.

#### The following also applies to vehicles with rear view camera system



Switch to perpendicular parking mode → page 186.



Switch to crossing traffic parking mode → page 186.



Switch to "Trailer support" or "Off-road support" parking mode (country-dependent) → page 186.



Red line: boundary or safety clearance to vehicle.



Yellow lines: vehicle path depending on the steering angle.



Green horizontal lines: boundaries.

### The following also applies to vehicles with Area View



Front perpendicular parking.



Rear perpendicular parking.



Front crossing traffic.



Rear crossing traffic.



Switch to trailer or offroad support (country-dependent) → page 186.

### NOTICE

Visual and acoustic warnings are given only for obstacles in the vehicle path.



The system displays the orientation lines irrespective of the area surrounding the vehicle. There is no automatic obstacle detection. Drivers must judge for themselves whether the vehicle will fit into the parking space.



All of the reversing camera's guiding lines are hidden when the factory-fitted towing bracket is connected electrically to a trailer.



All of the reversing camera's guiding lines are hidden when the boot lid in which the camera is installed is opened.

## Automatic braking intervention

The automatic braking intervention of a parking system is designed to reduce the possible damage due to a collision if an obstacle is detected during the parking manoeuvre.

### Braking functions

The following systems may be available depending on the vehicle equipment:

- Manoeuvre braking function of Park Distance Control → page 184.
- Emergency braking function of Rear Traffic Alert → page 188.

### WARNING

Do not let the parking systems' automatic braking intervention tempt you to take any risks while driving. In some situations, the automatic braking intervention can only work in a limited way or not at all. Collisions with obstacles can cause injuries to persons and vehicle damage. The system is not a substitute for the full concentration of the driver.

- Always pay due attention and do not rely exclusively on the parking systems.
- Always be prepared to brake and steer the vehicle yourself.
- Do not take any safety risks.
- React appropriately to the warnings and driving recommendations of the parking systems.

### Prerequisites

- ✓ The vehicle speed does not exceed a maximum of around 10 km/h (6 mph) when manoeuvring.
- ✓ A parking system was switched on.

The automatic braking intervention does not take place if Park Distance Control has been activated automatically when driving forwards → page 185.

### What happens when an automatic braking intervention takes place?


- The vehicle is braked to a standstill if an obstacle is detected and then held for around two seconds. **Step on the brake!**



## Switching on


- The automatic braking intervention function is active as soon as a parking system has been activated by the driver.

## Switching off

- The automatic braking intervention function is deactivated as soon as a parking system is deactivated.
- **OR:** in order to temporarily deactivate manoeuvre braking, touch the  function button on the Park Distance Control screen and make the setting.

## Manoeuvre braking function of Park Distance Control

The manoeuvre braking function is automatically activated every time the ignition is switched on.


The automatic braking intervention can be cancelled by pressing the accelerator → .


## Things to note for trailer towing



If an electrically connected trailer is hitched to the factory-fitted towing bracket, the following restrictions apply → page 264:

- The manoeuvre braking function for the rear area is deactivated automatically.

The parking system must be switched off manually for trailer towing if a non-factory-fitted towing bracket is used.

 Switch off the parking system if automatic braking intervention occurs too frequently, e.g. when driving off-road.

 If the vehicle has been braked by the manoeuvre braking function of Park Distance Control, the function is inactive for 5 metres in the same direction of travel or will be ready for use again after the gear or drive position has been changed.

 After an emergency braking by the Rear Traffic Alert, 10 seconds must elapse before automatic braking intervention can take place again. 

## Troubleshooting


### The parking system is not responding as expected

This could have various causes:

- The prerequisites for system operation are not met → page 180.
- The sensors or the camera are dirty or iced-up → page 358.
- The camera lens is not clean and the camera image is unclear → page 358.
- The ultrasound signal is subject to interference from external noise sources, e.g. pneumatic drill or cobblestones.
- The vehicle is damaged in the area around the sensors or the camera, e.g. caused by parking collisions.
- The detection range of the sensors or camera is blocked by add-on parts, e.g. bicycle carriers.
- Changes have been made to the paintwork or structural modifications have been made in the area of the sensors or the camera, e.g. on the vehicle front end or the running gear.

Please also observe text messages that appear in the display of the instrument cluster and the Infotainment system.

### No sensor or camera view, or the parking system has been switched off

The sensor area is switched off permanently if a sensor fails. The affected sensor area can be displayed by the  symbol in the Infotainment system. The parking system is switched off completely if necessary.

If there is a fault in the Park Distance Control, a signal tone will sound for several seconds when it is switched on. A text notification may also be shown on the instrument cluster display.

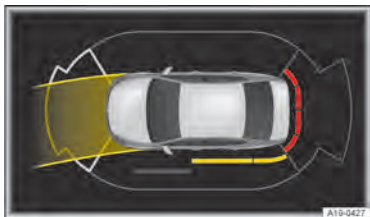
- Check whether any of the causes described apply.

- You can switch the system back on again once you have rectified the cause of the problem.
- If the problem persists, go to a qualified workshop.

## Park Distance Control

### Introduction to the topic

The Park Distance Control system assists the driver when manoeuvring and parking.



**Fig. 115** On the Infotainment system: obstacle detection and steering wheel angle for Park Distance Control (illustration).

### Function

Park Distance Control detects the distance from an obstacle by means of sensors in the front and rear areas of the vehicle → page 7, → page 8.

### WARNING

The intelligent technology used in the parking systems cannot overcome the laws of physics, and functions only within the system limits. If this is not observed, this can result in accidents, serious injuries and also damage to the vehicle.

- The parking system is not a substitute for the full concentration of the driver.

Park Distance Control warns about an obstacle by means of colour segments on the Infotainment system screen and acoustic signals → Fig. 115, → ⓘ.

### NOTICE

Do not drive on! The collision area has been reached when the penultimate segment is displayed, if not before.

An automatic braking intervention can take place if the driver does not react when an obstacle is approaching → page 182.

Also observe the information on the screen displays of the parking systems → page 181.

### Things to note for trailer towing

The rear and side sensors of Park Distance Control are not switched on if a trailer is electrically connected:

- No warnings are given for obstacles.
- The manoeuvre braking function is also automatically deactivated.

### Park Distance Control settings

When Park Distance Control is switched on, touch the ⓘ function button on the screen to make further settings, e.g. automatic activation when driving forwards or manoeuvre braking.



### NOTICE

The vehicle must be moved a few metres forwards or backwards in order to scan and display the side areas in full. An obstacle entering these areas from the outside will not be displayed.



## Switching Park Distance Control on and off

📖 Please refer to ⚠️ and ⓘ on page 179 and ⚠️ and ⓘ at the start of the chapter on page 184.

### Switching on

- Select reverse gear.
- **OR:** press the touch control for parking functions  → page 10. Then touch the  function button in the Infotainment system if necessary.
- **OR:** the vehicle rolls backwards.

### Switching off



- The vehicle drives forwards at a speed of more than 10-15 km/h (6-9 mph).
- **OR:** touch the  function button.
- **OR:** press the touch control for parking functions .

Park Distance Control is switched off when the electronic parking brake is switched on.

### Automatic activation when driving forwards (with some equipment levels)

Park Distance Control switches itself on automatically if the vehicle approaches an obstacle in front of the vehicle when driving forwards at a speed of less than 15 km/h (9 mph).

### Switching on function

- Press the touch control for parking functions .
- Touch the  function button in the Infotainment system.
- Activate function.

Automatic activation takes place only once. Renewed automatic activation is possible under the following conditions:

- Switch on Park Distance Control again.
- Switch the ignition off and then back on again. <

## Rear view camera system

### 📖 Introduction to the topic

The rear view camera system in the rear of the vehicle makes it easier for the driver to see behind the vehicle and provides support for parking manoeuvres.

### Function

The rear view camera system shows the area behind the vehicle on the Infotainment system screen. Depending on the operating mode and equipment specification, orientation lines aid the view to the rear.

### ⚠️ WARNING

The intelligent technology used in the parking systems cannot overcome the laws of physics, and functions only within the system limits. This may result in accidents, serious injuries and also damage to the vehicle.

- The parking system is not a substitute for the full concentration of the driver.

### Parking modes

Depending on the vehicle equipment, the following rear view camera system views may be available:



#### Perpendicular parking:

Orientation lines provide support when reversing into a parking space at right angles to the road.



#### Crossing traffic:

Shows a wide-angle view of the area behind the vehicle and the side areas.

Also observe the information on the screen displays of the parking systems → page 181. <

## Switching the rear view camera system on and off

📖 Please refer to ⚠️ and ⌚ on page 179 and ⚠️ at the start of the chapter on page 185.

### Switching on

- Select reverse gear.
- **OR:** press the touch control for parking functions . Touch the function button in the Infotainment system if present.

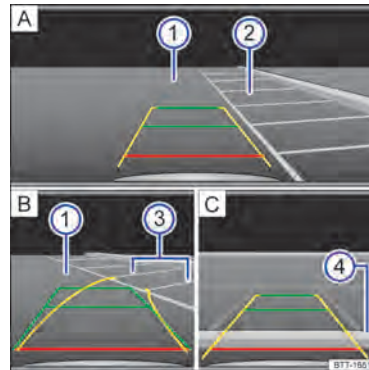
### Switching off

- The vehicle drives forwards at a speed of more than 15 km/h (9 mph).
- **OR:** touch the function button or on the Infotainment system screen. <

## Rear view camera system with parking modes: driving into a parking space

📖 Please refer to ⚠️ and ⌚ on page 179 and ⚠️ at the start of the chapter on page 185.

### Parking mode: parking perpendicular to the road



**Fig. 116** Infotainment system: parking perpendicular to the road.

- A** Choose parking space.
  - B** Drive towards the selected parking space.
  - C** Align the vehicle in the parking space.
  - 1** Road.
  - 2** Parking space.
  - 3** Side limit of the parking space.
  - 4** Rear limit of the parking space.
- 
- Before driving past the selected parking space, press the touch control for parking functions . If necessary, then touch the function button in the Infotainment system.
  - Touch the function button in the Infotainment system to select the parking mode.

- Position the vehicle in front of the parking space → Fig. 116 **A** ②.
- Steer so that the yellow lines lead into the parking space. The green and yellow lines must be aligned with the side limit lines → Fig. 116 **B** ③.
- Stop when the red line reaches the rear limit → Fig. 116 **C** ④.

#### Parking mode: trailer support



Fig. 117 Infotainment system: trailer support.

In vehicles with a factory-fitted towing bracket, the trailer support function can be used when approaching a trailer drawbar.

- Touch the **TRP** function button to select the parking mode.

The rear view camera system shows the vehicle's towing bracket in the lower part of the image. Coloured guiding lines help with the manoeuvring process → Fig. 117:


- Green lines: distance to towing bracket.
- Orange line: predicted path of the towing bracket, depending on the steering angle.

## Area View

### Introduction to the topic

Area View shows the entire vehicle surroundings in real time. This function can help you to detect obstacles at an early stage in confusing situations.

#### Function

The system uses several cameras to take images of the area around the vehicle which are then displayed on the Infotainment system screen → .

The Area View functions and displays may differ depending on the vehicle equipment, for example, if Park Distance Control is available and is also displayed.

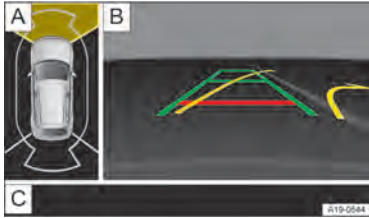
### WARNING

The intelligent technology used in the parking systems cannot overcome the laws of physics, and functions only within the system limits. If this is not observed, this can result in accidents, serious injuries and also damage to the vehicle.

- The parking system is not a substitute for the full concentration of the driver.

## Switching on and off

📖 Please refer to ⚠️ and ⌚ on page 179 and ⚠️ at the start of the chapter on page 187.



**Fig. 118** Infotainment system screen: Area View in "front perpendicular parking mode" (illustration).

- A** Bird's eye view with selectable screen areas.
- B** Camera image.
- C** Area for the Area View function buttons.

### Switching on

- Select reverse gear.
- **OR:** press the touch control for parking functions . Touch the function button on the Infotainment system screen.

### Switching off

- Drive forwards faster than approximately 15 km/h (9 mph).
- **OR:** touch the function button or on the Infotainment system screen.
- **OR:** press the touch control for parking functions .

### Screen areas

Two screen areas are displayed on the Infotainment system:

- *Left screen* → Fig. 118 **A**: the vehicle is shown in the bird's eye view. The view in the right area of the screen changes when you touch an individual area.

- *Right screen* → Fig. 118 **B**: the individual camera images are displayed corresponding to the area selected in the left screen.

### Switching between the camera images

- Touch the function buttons at the edge of the display → Fig. 118 **C** to select a corresponding view.

Observe the information on the screen displays of the parking systems → page 181. ◀

## Rear Traffic Alert

Rear Traffic Alert monitors crossing traffic when reversing out of a parking space or manoeuvring.

### ⚠️ WARNING

The intelligent technology used in the parking systems cannot overcome the laws of physics, and functions only within the system limits. If this is not observed, this can result in accidents, serious injuries and also damage to the vehicle.

- Pay attention to the traffic situation and the area around the vehicle.
- Rear Traffic Alert may not be able to detect all approaching objects, e.g. pedestrians or rapidly approaching objects.

Also observe the information and warnings that apply to all Park Assist functions → page 179.

### Switching on and off

- Press the touch control for parking functions .
- Touch the function button in the Infotainment system.
- Switch Rear Traffic Alert on or off.

## Function



**Fig. 119** Illustration of Rear Traffic Alert: monitored area around the vehicle leaving the parking space.

Rear Traffic Alert functions using radar sensors in the rear bumper.

The system detects approaching and moving objects in the rear and side areas around the vehicle → Fig. 119 and warns the driver about an obstacle → ⚠.



**Fig. 120** On the Infotainment system: Rear Traffic Alert display.

If an obstacle is detected, a warning signal is issued and the obstacle area is shown in colour in the Infotainment system → Fig. 120.

An automatic braking intervention can take place if the driver does not react → page 182. The following indicator lamp is shown on the instrument cluster:



Automatic braking intervention of Rear Traffic Alert.

**Press the brake to hold the vehicle at a standstill.**

## Fault

If the Rear Traffic Alert system has a fault, the following indicator lamp will light up in the digital instrument cluster:



The Rear Traffic Alert system has a fault, e.g. sensors are dirty or there is a system error.

## Things to note for trailer towing

Rear Traffic Alert is deactivated when the factory-fitted towing bracket is electrically connected to a trailer. <

## Brake support systems

### Information on brake support systems

These braking support systems can help the driver in critical driving or braking situations. The driver is responsible for driving safety → ⚠.

The brake pedal may move or noises may occur while the brake support systems are performing a control intervention. Continue to brake with the necessary force, and if necessary steer the vehicle.


Depending on the equipment level, settings for ESC and TCS can be made in the vehicle.

### ⚠ WARNING

The intelligent technology used in brake support systems cannot overcome the laws of physics, and functions only within the limits of the system. Driving fast on icy, slippery or wet roads can lead to a loss of control of the vehicle and could cause serious injury to the driver and passengers.

- Always adapt your speed and driving style to suit visibility, weather, road and traffic conditions. Do not take risks where safety is concerned.

- If you drive too close to the vehicle in front, brake support systems cannot prevent an accident.
- Always use suitable tyres. Driving stability depends on the tyre grip.
- Always keep the footwell under the pedals clear so that the brake pedal can move freely.


- The ESC, ABS and TCS can only function properly if all four wheels are fitted with the correct tyres → .
- If the ABS fails, ESC, TCS and EDL will also cease to function.

### WARNING


The effectiveness of ESC can be reduced considerably if other components and systems which affect driving dynamics are not serviced properly or are not functioning properly. This applies in particular to changes to the suspension and wheel and tyre combinations that have not been approved.

- Repairs and modifications to your vehicle should only be carried out by a qualified workshop.
- Always use suitable tyres. Driving stability depends on the tyre grip.


### Electronic Stability Control (ESC)

ESC helps to reduce the risk of skidding and to improve driving stability in certain driving situations → .

### Traction control system (TCS)

TCS reduces the drive output if wheelspin occurs and adapts the output to suit the road surface conditions. The TCS makes it easier to pull away, accelerate and drive up hills → .

### Anti-lock brake system (ABS)

ABS can prevent the wheels from locking when the brakes are applied up until the point where the vehicle is nearly stationary and can help the driver to steer the vehicle and keep it under control → .

### Brake Assist system

BAS can help to reduce the stopping distance. If the driver depresses the brake pedal quickly in an emergency braking situation, the BAS will increase the braking force.

### Electronic differential lock (EDL and XDS)

EDL brakes a spinning wheel automatically and distributes the drive force to the other drive wheels.

XDS uses braking interventions to improve traction and keep the vehicle in lane.

### Automatic Post-Collision Braking System

The multicollision brake automatically triggers braking if the airbag control unit detects a collision in an accident situation.


Requirements for automatic braking:

- The driver does not depress the accelerator pedal.

### Electronic brake pressure distribution system (EBD)

The electronic brake pressure distribution system controls the brake pressure for the rear wheels and thereby ensures the optimum distribution of brake pressure between the front and rear axles. EBD can prevent the rear of the vehicle breaking away due to excess braking of the rear wheels.

### Electromechanical brake servo

The electromechanical brake servo (EBS) supports the driver's foot movement when the ignition is switched on, and boosts the pressure applied to the brake pedal by the driver → . In the event of a braking intervention by a driver assist system, e.g. when ACC is regulating or during emergency braking, the brake pedal can move automatically.

The brake pressure boost will reduce gradually after you switch off the ignition. Messages are displayed on the instrument cluster display if the vehicle is still held by means of the brake pedal. The brake servo function is restricted in this case.

Secure the stationary vehicle against rolling away → page 176.



## WARNING

Driving without the brake servo or with restricted brake servo function can considerably increase the braking distance and cause accidents and serious injuries.

- Never deactivate the electric drive or switch off the ignition as long as the vehicle is still moving.
- If the brake servo does not function or the vehicle is being towed, the brake pedal will have to be depressed more forcefully as the braking distance will be increased due to the lack of assistance for the brake system.

### Brake blending

The brake blending function regulates between the braking action of the electric drive motor during energy recovery (brake energy recuperation) and mechanical braking by the driver.


## Switching ESC Sport on and off

### Switching ESC Sport on and off

The ESC Sport function intervenes later than the normal ESC to stabilise the vehicle.

With some equipment levels, ESC Sport can be switched on and off.

- Open the vehicle settings in the Infotainment system → page 31.
- Open the Vehicle menu.
- Open the Exterior menu.
- Open the Brakes menu.

The  indicator lamp lights up yellow when ESC Sport is switched on.

## WARNING

With the ESC switched off, there is a much greater chance of the vehicle breaking away than with the ESC switched on. It can be difficult for untrained drivers to retain

control of the vehicle, especially at high speeds. This can result in accidents and severe injuries.

- Volkswagen therefore recommends switching off the ESC **only in the following situations:**

- When driving the vehicle on a closed track or racetrack.

If you as a driver have experience of a sporty driving style in racing mode.

- Never take a safety risk and observe the laws of physics.

## Troubleshooting

### Electromechanical brake servo failure

#### Do not drive on!

Warning lamp lights up red.

A text message may also be displayed. Press the brake pedal firmly as the braking distance will increase due to the lack of brake servo.

- Seek expert assistance immediately.

### Electromechanical brake servo fault

Indicator lamp lights up yellow.

A text message is displayed for a few seconds.

The brake pedal may pulsate when pressed. The brake pedal must be pressed more firmly as the braking distance will increase due to the reduced brake servo.

- Go to a qualified workshop.

### Anti-lock brake system failure or fault

Indicator lamp lights up yellow.

- Go to a qualified workshop. The vehicle can be braked without ABS.



### ESC or TCS is performing control intervention

Indicator lamp flashes yellow.



### TCS switched off manually

Indicator lamp lights up yellow.



### ESP Sport switched on


Indicator lamp lights up yellow.



### ESC fault

Indicator lamp lights up yellow. ESC has been switched off.




There is a fault or a malfunction.

- Switch the ignition off and on.
- Drive a short distance at a speed of 15 – 20 km/h (9 – 12 mph) if necessary.
- If the indicator lamp  continues to light up, seek expert assistance.

### The brake support systems make noises

Noises may be heard when the brake support systems are performing control interventions.

## WARNING

- If the brake warning lamp  lights up together with the ABS indicator lamp  the control function of the ABS may have failed. This can cause the rear wheels to lock relatively quickly when you brake. Locked rear wheels can lead to a loss of control of the vehicle. If possible, reduce your speed and drive carefully at low speed to the nearest qualified workshop in order to have the brake system tested. Avoid sudden braking and driving manoeuvres on the way.
- If the ABS indicator lamp  does not go out or comes on while the vehicle is in motion, the ABS is not working properly. The vehicle can be stopped using the normal brakes only (without the anti-lock brake system). The protection provided by the anti-lock brake system is no

longer available. Go to a qualified workshop as soon as possible.



# Practical equipment

## Stowage areas

### Introduction to the topic

#### WARNING

Loose objects may be flung through the vehicle interior in the event of a sudden driving or braking manoeuvre. This can cause serious injury and can also lead to loss of control of the vehicle.

- Stow objects only in closed stowage compartments.
- Always keep stowage compartments closed while the vehicle is in motion.
- The coat hooks in the vehicle should only be used for lightweight clothing weighing max. 2.5 kg (approx. 5.5 lbs). Never leave any heavy, hard or sharp objects in the pockets.

#### WARNING

If the glove box is left open, this can increase the risk of serious injury in the event of an accident or during sudden braking or driving manoeuvres.

- Always keep the glove box closed while the vehicle is in motion.

#### WARNING

Any lighters in the vehicle could be damaged or accidentally lit. This could lead to serious burns and other injuries.

- Before closing stowage areas or compartments always make sure that there is no lighter in the way.
- Never stow lighters in stowage areas or compartments or on other surfaces in the vehicle. High surface temperatures, especially in summer, may cause lighters to self-ignite.

#### WARNING

Incorrect use of the drink holders can cause injury.

- Never place hot drinks in a drink holder. Hot drinks in a drink holder could be spilled and cause scalding in any sudden braking manoeuvre or accident.
- Make sure that only drinks of the appropriate size are placed in the drink holder. Drinks must always be stored securely in the drink holder.

#### WARNING

Closed drink bottles can explode in the vehicle in extreme heat or burst in extremely cold temperatures.

- Never leave closed drink bottles in an extremely hot or extremely cold vehicle for extended periods.

#### NOTICE

- Do not stow any temperature-sensitive objects, food or medicines inside the vehicle. Hot and cold temperatures could damage them or render them unusable.
- Objects stored in the vehicle that are made from transparent materials, such as transparent suction cups on the windows, can concentrate the sun's rays and thus cause damage to the vehicle.

## Sockets

### Introduction to the topic

Electrical equipment can be connected to the sockets in the vehicle.

The electrical devices must be in good condition. Do not use faulty devices.

The 12-volt socket will work only when the ignition is switched on.


## ⚠ WARNING


Improper use of the sockets and electrical accessories can cause fires and severe injuries.

- Never leave children unsupervised in the vehicle. Sockets and the devices connected to them can be used when the ignition is switched on.
- If the electrical device gets too hot, switch off the device immediately and disconnect it from the socket.

## 📌 NOTICE

- In order to prevent damage to the electrical system, never connect equipment that supplies electric power, such as solar panels or battery chargers for charging the 12-volt battery, to the 12-volt socket.
- Use only electrical devices that have been approved in accordance with current guidelines concerning electromagnetic compatibility.
- In order to avoid damage due to voltage fluctuations, always switch off any electrical devices before switching the ignition on or off and before activating the vehicle's drive system.
- Never connect electrical devices requiring more than the rated power to a 12-volt socket. The vehicle's electrical system can be damaged if the maximum power output is exceeded.
- Observe the operating instructions of the electrical devices.

 Using electrical consumers with the electric drive activated and the ignition switched on will drain the 12-volt vehicle battery.

 With some equipment levels, unshielded devices can cause interference with the Infotainment system and vehicle electronics. <

## Sockets in the vehicle

📖 Please refer to ⚠ and 📌 at the start of the chapter on page 193.

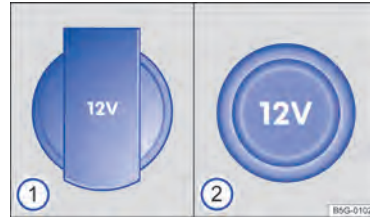


Fig. 121 In the luggage compartment on the left side: fold-open 12-volt socket ① or 12-volt socket with removable cover ②.

The maximum power of the sockets must not be exceeded. The power rating of each device is stated on its type plate.

The continuous power of all 12-volt sockets in the vehicle is 120 watts in total  
→ page 193.

The maximum power of a 12-volt socket in the vehicle is a total of 180 watts **when the vehicle's drive system is activated.**

## 📌 NOTICE

The fuse can blow as a result of extended operation of the 12-volt sockets at maximum power.

- **Never** use the 12-volt sockets at maximum power for longer than 10 minutes.
- Always use **only one** 12-volt socket with maximum power. <

# Data transfer

## Cybersecurity

### What is cybersecurity?

Cybersecurity comprises measures to reduce the risk of unauthorised access by malware or an Internet attack on vehicle functions, data and control units.

### What are connectivity components?

Control units for data transmission, interfaces, and media and diagnostic connections are connectivity components, via which information and data can be exchanged between the vehicle and external devices or the Internet. The connectivity components that are not included in all vehicles are, in particular:

- Diagnostic port.
- Control unit with built-in eSIM card (OCU).
- Mobile phone interface.
- App-Connect.
- NFC radio technology.
- Bluetooth® interface.
- USB port.

Connectivity components are the key elements for cyber security. Connectivity components are also equipped with security mechanisms that minimise the risk of unauthorised access to vehicle systems.

### Security mechanisms

The software and security mechanisms in the vehicle are subject to ongoing development. Like with computers or the operating systems of mobile devices, the software and security mechanisms in the vehicle may also be updated at irregular intervals.

Software updates improve the security, stability and running speeds of the vehicle systems in vehicles that have already been produced.

### WARNING

In spite of the security mechanisms installed in the vehicle, it is not possible to fully exclude the risk of unauthorised access by malware or an internet attack on vehicle functions and control units. Malware that has infected the vehicle can influence or deactivate control units and vehicle functions, or can take over control and lead to serious accidents and fatal injuries.

- If the vehicle functions or reacts differently than normal or behaves in an unusual way, reduce your speed (if possible) immediately and in a controlled manner and go immediately to the nearest qualified workshop or seek expert assistance, e.g. tow recovery.
- Malware can also access data and information that are stored in control units, in the Infotainment system and on connected data media and paired mobile devices.

### Minimising risks

You too can reduce the risk of unauthorised access to vehicle systems and functions:

- Use only data media, Bluetooth devices and mobile devices in the vehicle than do not contain manipulated data or malware.
- Install system updates provided by Volkswagen immediately → page 196.
- Have the vehicle serviced, repaired and maintained only by a qualified workshop. Volkswagen recommends using a Volkswagen dealership for this purpose.

### WARNING

Computers, data media and mobile devices that are connected to the internet or that are used in public and private networks may be infected by manipulated data or have malware installed on them.

- Protect computers, data media and mobile devices by means of a suitable anti-virus program and by generally known precautionary measures.

- Regularly update the appropriate anti-virus program with the updates or upgrades provided by the provider.

## System update

### Introduction to the topic

The factory-fitted central control unit supports the system update function. This allows the software of almost all control units to be updated by Volkswagen AG without the need to visit a qualified workshop:

If a system update is available for your vehicle, a corresponding message will be displayed on the Infotainment system.

System updates are downloaded via the factory-fitted control unit with eSIM card (OCU) and are free of charge. Volkswagen pays the connection costs.

The system update function is only available in some countries.

### WARNING

Control units will be deactivated and will not function while software installation is taking place. Driving with deactivated or malfunctioning control units can cause accidents and fatal injuries.

- Carry out software installation in a suitable place where other road users are not impeded.
- Never use the vehicle while software installation is taking place.

### WARNING

If the digital instrument cluster does not function after software installation, no instruments, warning lamps, symbols or text messages can be displayed. Driving with a digital instrument cluster that is not working can cause accidents and fatal injuries.

- Do not use the vehicle and contact Volkswagen Customer Care.

### WARNING

It is possible in very rare cases that a control unit will not function properly after a software installation process.

- Do not use the vehicle and contact Volkswagen Customer Care.



A measure such as engine tuning to increase performance or efficiency that has not been performed by Volkswagen may be deleted by a system update.

## Overview

 Please refer to  at the start of the chapter on page 196.

### Availability of a system update

The switched-on Infotainment system indicates that a system update is available. A system update takes place in two phases:

- Down load phase: the download of a system update takes place in the background without any previous notification and is possible during a car journey.
- Installation phase: software installation is possible only when the prerequisites for this are met → page 197, *Prerequisites*.

Before the installation phase begins, the driver is asked to grant approval.

If several system updates are available for the vehicle at the same time, one system update must first be installed successfully before the next system update can be executed.



In some vehicles, release notes may be displayed once before or after a system update which describe the changes to the vehicle status. The release notes cannot be viewed again after this.

## Prerequisites

📖 Please refer to ⚠️ at the start of the chapter on page 196.

### Prerequisites for downloading a system update

For download, the vehicle must be in areas with sufficient mobile reception.

The download process can be interrupted at any time by the system and will be resumed again as required when the vehicle's drive system is activated.

### Prerequisites for installing a system update

- A sufficient online connection to the Internet is possible at the current vehicle location via the OCU → page 204, *Status display*.
- Your current privacy settings allow data and information to be transmitted and received → page 204, *Privacy settings*.
- The following conditions must be met on the vehicle:
  - The vehicle's drive system has been deactivated.
  - Vehicle is stationary, parking brake is switched on.
  - Position switch is in "P" position.
  - Hazard warning lights and parking light are switched off.
  - All windows, doors, bonnet and boot lid are closed.
  - The electrical system in the vehicle is ready for use.
  - The 12-volt vehicle battery is appropriately charged.
  - There is no vehicle key in the vehicle.
  - All vehicle occupants have left the vehicle.
  - There are no animals in the vehicle.
  - Vehicle is locked.

## Actions

📖 Please refer to ⚠️ at the start of the chapter on page 196.

### Software installation

Choose a time for software installation when the vehicle does not have to be driven by yourself or other users.

Do not use the Infotainment system during a software installation.

After the software installation and **before** activating the vehicle's drive system, read the message in the Infotainment system and instrument cluster about completed installation. The vehicle requires up to a minute to display the status of the system update.

### Functional restrictions during software installation

- Activation of the vehicle's drive system is prevented by the system.
- The high-voltage battery is not charged.
- The diagnosis AUX-IN socket is deactivated.
- The anti-theft alarm and the SAFELOCK are deactivated.
- Control units, the central computer, functions and displays are not available. Do not use the vehicle during this time.

### If software installation is unsuccessful

If software installation is unsuccessful, a corresponding error message will be displayed on the Infotainment system and/or instrument cluster. Observe the corresponding messages and warnings.

Control units will no longer function or will not function correctly in the event of a critical installation error. Functions and displays are not available until the error is corrected. **Do not use the vehicle.** In this case, contact Volkswagen Customer Care → page 203.

### After successful software installation

Successful software installation is displayed on the Infotainment system.

## Questions and answers about system updates

📖 Please refer to ⚠️ at the start of the chapter on page 196.

### What is the purpose of a system update?

A system update is a preventive measure to stop undesirable events and states from occurring. For example protection against malware or to optimise the running of the software.

### Should I perform the system update?

It is in your own interests to carry out system updates. If the driver repeatedly rejects the system update, it is then necessary to visit a qualified workshop.

### Can I manually interrupt the download of the system update?

No, this is not possible.

### Can I interrupt software installation?

No, this is not possible.

### What will happen if software installation is interrupted?

If software installation is interrupted, for example due to damage to the electrical system in the vehicle, it is possible that control units will be not be updated and may be damaged due to incomplete software installation → page 196, *System update*.

### Can system updates with malware that are not initiated by Volkswagen be installed in the vehicle?

Further information → page 195, *Cybersecurity*.

### How long can I wait before carrying out a system update?

The available system update should be installed as soon as possible in your own interests. ◀

## Car2X communication

### 📖 Introduction to the topic

#### Function of Car2X


Car2X permits close-range communication between several vehicles and between vehicles and the traffic infrastructure (referred to below as “participants”). Communication between participants takes place based on manufacturer-independent Car2X and Wi-Fi standards. Car2X functions only in some countries.

When Car2X is switched on, data is transmitted continuously between the participants – irrespectively of whether your vehicle is in online or offline mode.


In order to prevent misuse and to sign Car2X data with changing IDs, a Car2X data sender must have valid certificates. Every receiver can thus check whether Car2X data is authentic and from an authorised participant.

Certificates in your own vehicle can be automatically renewed only in online mode.

The use of continuously changing, temporary IDs for the Car2X data minimises the possibility of the transmitted data being traced back to you.

 Further information on data processing can be found in the Infotainment system in the *Legal info* menu and on the Volkswagen AG website.

#### Meaning of the symbol

 Indication that activated Car2X also transmits and receives data in offline mode.

#### Data transmission

When Car2X is switched on, the following data is transmitted and received via the Car2X aerials on the vehicle roof and in some cases in the mirror triangle of the windscreen:

- Vehicle data, e.g. speed.
- Position data.



- Event data, e.g. for accidents.

### Recognising whether Car2X is installed

If you can switch on Car2X communication under **Settings** in the Infotainment system, this means that the vehicle is equipped with Car2X technology.

## Limits of Car2X

### Data exchange

Car2X in your vehicle communicates only with participants that are equipped with functional and compatible Car2X technology.

Participants with deactivated, faulty or incompatible Car2X are not detected.

### Range

Depending on the surroundings, Car2X participants can communicate in a near range of between around 200 m (urban) and around 800 m (extra-urban).

## ! WARNING

Car2X cannot replace your attention. If you rely exclusively on Car2X, there is a risk of accidents and serious injuries.

- Always drive with due care and attention and be ready to intervene at all times.
- Always adapt your driving style to the current visibility, weather and road/traffic conditions.

### Function limitations

Functioning of Car2X may be restricted in the following cases:

- The environmental conditions may prevent data reaching the participant.
- Vehicle add-on parts prevent data reaching the participant.
- The event is not detected as such by participants.

## Switching Car2X on and off

### Switching on

- Press the **(Home)** button on the Infotainment system.
- Open the **Settings** menu
- Switch on **Car2X communication** in the menu with the same name.

## ! WARNING

When Car2X is switched on, a distance of 20 cm must be maintained between the Car2X aerials and persons outside the vehicle.

- Car2X aerials are located on the vehicle roof and in some cases in the mirror triangle of the windscreen.

### Switching off manually

- Press the **(Home)** button on the Infotainment system.
- Open the **Settings** menu
- Switch off **Car2X communication** in the menu with the same name.

### Automatic switch-off

Car2X can switch itself off automatically in some cases → page 200, *Troubleshooting*. Car2X must be switched back on again when the reason for automatic switch-off has been remedied.

## Traffic hazard alert



**Fig. 122** Illustration: traffic hazard alert by day or mobile road works.

The traffic hazard alert function uses the switched-on V2X system and warns about nearby traffic hazards based on the current situation. This can prevent accidents and improve traffic flow.

#### Traffic hazards transmit data

When V2X data is received by other participants, warnings can be provided about the following traffic hazards:

- Emergency vehicle on active call.
- Day and mobile road works.
- Breakdown, accident or end of traffic jam.
- Intervention of an assist system in a vehicle ahead.

#### Traffic hazard alert is displayed

Depending on the type of traffic hazard, the driving speed and the degree of vehicle deceleration, a warning about a relevant traffic hazard is provided as follows:

- Acoustic warning.
- Information or warning message.

#### WARNING

Failure to observe traffic hazard alerts can lead to accidents and serious injuries.

- Never ignore traffic hazard alerts.

#### Hiding a displayed traffic hazard alert

Press the “OK” button on the multifunction steering wheel. <

### Troubleshooting

#### Car2X switches itself off independently

- Car2X is not permitted in the country in which the vehicle is currently being driven.
- The vehicle was offline too long so that certificates were not updated. Adapt the privacy settings so that an online connec-

tion is established in order to allow the certificates to be updated.

- System fault. Go to a qualified workshop.

#### No Car2X data is displayed

- Functioning of Car2X is restricted.
- There are no participants transmitting data in the vicinity.
- There are transmitting participants in the vicinity, but they are not relevant for your vehicle.
- Car2X aeriels are blocked by add-on parts or covers. Keep the areas around Car2X aeriels clear.
- Data exchange between participants is impaired or not possible due to the weather conditions.
- There is already a driver reaction to the hazard ahead. <

## Volkswagen We Connect Start

### Introduction to the topic

To use Volkswagen We Connect Start, it must first be activated online by concluding a We Connect Start contract with Volkswagen AG and is subject to a restricted, country-specific period of validity.

- < Both the We Connect Start portfolios offered by Volkswagen and individual services may be changed, discontinued, deactivated, reactivated, renamed and expanded without further notice.

For the service description and further information, see [www.connect.volkswagen-we.com](http://www.connect.volkswagen-we.com).

It is possible to set up a user account via the [www.connect.volkswagen-we.com](http://www.connect.volkswagen-we.com) and the We Connect ID. app

The provision and availability of all We Connect Start services and service portfolios can

vary from country to country and depend on the vehicle and vehicle equipment.

### Service description

Read and observe the service description before using Volkswagen We Connect Start services. Service descriptions are updated from time to time and made available online at [www.connect.volkswagen-we.com](http://www.connect.volkswagen-we.com).

- Always use the latest edition of the relevant service description.

### WARNING

In areas with insufficient mobile phone and GPS reception, no emergency calls and phone calls can be made and no data can be transmitted.

- If possible, go to another location.

### NOTICE

Vehicle damage may be caused by factors beyond the control of Volkswagen AG. Such factors include in particular:

- Misuse of mobile devices.
- Data loss during transmission.
- Unsuitable and damaging third-party applications.
- Malicious software on data media, computers, tablets and mobile devices.

### Services portfolio

The initial assignment of services listed here represents the maximum possible scope. The maximum possible scope is available only for a few vehicle models. There may be changes in the assignment shown here during the service life of the vehicle.

After activating the "Manage services" function, you can see whether and which services are available in the vehicle in the Infotainment system → page 203.

The portfolio of offered services may be different than that specified here in some countries and in the event of contract renewal.

The voice or search recognition technology for Volkswagen We Connect Start does not recognise and return search results for all words. For example, Google Speech Recognition includes a "Safe Search" feature that prevents the display of search results if (even accidentally) vulgar terms are detected.



You can find out which services are actually included when you conclude or renew your contract at [www.connect.volkswagen-we.com](http://www.connect.volkswagen-we.com). This also applies to possible We Connect Start individual options.

### We Connect Start services

*Maximum possible scope. Not available in all vehicles and countries.*

- Programming departure times.
- Charging.
- Air Conditioning.
- Apple Music®.
- TIDAL.
- Charging Stations.
- Online Map Update.
- Online Route Calculation.
- Online Voice Control.
- Online Traffic Information.
- Parking Spaces.
- Internet Radio.
- Destination import.

### We Connect Start individual options

*Maximum possible scope. Not available in all vehicles and countries.*

- In-Car Apps. These apps may be pre-installed directly in the Infotainment system or installed by the user.

## Activating We Connect Start

You can perform activation at [www.connect.volkswagen-we.com](http://www.connect.volkswagen-we.com) or in the We Connect ID. app.

The following steps are required for We Connect Start activation (including registration):

1. Register with We Connect using your existing or a newly created Volkswagen ID.
2. Order and activate Volkswagen We Connect Start.
3. Add a vehicle to your user account.
4. Provide proof of ownership.

Follow the other information and instructions.

## Proof of ownership

### Becoming the primary user (proof of ownership)

In order to become a primary user and thus provide proof of ownership of the vehicle, it is necessary to enter the 17-character vehicle identification number (VIN) of the vehicle in the We Connect ID. app. Proof of ownership is provided in the vehicle by scanning the QR code in the Infotainment system with the We Connect ID. app.

- Switch on the ignition and the Infotainment system.
- In the Infotainment system: [System settings](#) ► [Connect to We Connect](#).
- Scan the QR code with the We Connect ID. app.

Proof of ownership is established after successful scanning of the QR code and data transfer.

## Legal requirements

When using Volkswagen We Connect Start services, information about the vehicle is transmitted and processed online. This data can also indirectly provide information about the respective driver, e.g. driving behaviour, location. As the contracting party of the We Connect Start contract with Volkswagen AG, you must ensure that data protection and privacy rights are guaranteed when your vehicle is used by family members, friends and other drivers. You must inform the respective driver in advance that the vehicle is transmitting and receiving data online and that you can view this data.

- ◀ Failure to observe this obligation to inform can infringe certain rights of vehicle occupants.

### Personal data

Volkswagen protects your personal data and uses it only to the extent permitted by law, or if you have consented to its use. Further information on data processing in relation to the Volkswagen We Connect Start services can be found in the Privacy Policy. The current version of this policy can be accessed on the Volkswagen website.

### Permanent transfer of the vehicle

If the vehicle has been purchased as a used vehicle or handed over to you by another person for permanent use, We Connect Start may already be activated and the previous primary user may still have the possibility to view collected data and control certain vehicle functions via We Connect Start.

In the Infotainment system you can see whether a person is assigned to your vehicle as the primary user. In this case, you can register yourself as the primary user of the vehicle and automatically remove the previous primary user. Alternatively, you can restore the factory settings of the Infotainment system or set the vehicle to offline mode (→ page 204) and thus restrict communication of your vehicle with the data server of


Volkswagen AG and processing of vehicle-related and personal data.

## Deactivating We Connect Start services

The following functions are available for deactivating and activating the We Connect Start services:

- Preventing or permitting data transmission via the Infotainment system  
→ page 204, *Privacy settings*.
- If possible: individual deactivation and activation via your user account in the We Connect portal or in the We Connect ID app.

The respective services can then only be run again after the deactivation is cancelled.

 Legally required services and their data transmissions cannot be switched off and cannot be deactivated, e.g. "eCall Emergency System".

## Interference

Even when the above-mentioned requirements for using the services are met, the functionality of the Volkswagen We Connect Start services can be impaired or interrupted due to factors that lie outside the control of Volkswagen AG. Such factors include in particular:

- Maintenance, repairs, deactivations, software updates and technical changes to your service provider's telecommunication systems, satellites, servers and databases.
- Changing the mobile communication standard for the transmission of mobile data by the telecommunications provider, e.g. from LTE or UMTS to EDGE or GPRS.
- An existing mobile telecommunications standard has been shut down by the telecommunications provider.


- Disturbance, interference or interruption of mobile and GPS reception, e.g. due to high speeds, weather, landscape, interfering devices or intensive use of the mobile network in the relevant cells.
- If your current location is in an area with no or insufficient mobile communications and GPS reception. This can also include tunnels, streets with tall buildings, garages, multi-storey car parks, underpasses, mountains and valleys.
- Restricted availability, completeness or correctness of information provided by third parties, e.g. maps.
- Countries and regions where Volkswagen We Connect Start services are not available.

## Manage services

Depending on the technical implementation, there may be a service management function in the Infotainment system. The following would be possible if the service management function is available:

- Checking which We Connect Start services are currently available in the vehicle.
- Number of activated and deactivated We Connect Start services.
- Activating or deactivating individual We Connect Start services.

Further information: [www.connect.volkswagen-we.com](http://www.connect.volkswagen-we.com).

 If you deactivate all We Connect Start services individually, the OCU can still transmit data.

## Volkswagen Customer Support

**Free hotline:**  
**00800-43347328 / 00800-IDDIRECT**

*E-mail: [IDDIRECT@volkswagen.de](mailto:IDDIRECT@volkswagen.de)*

We will gladly answer your questions about digital services.

Europe-wide. 24 hours a day. 7 days a week.

*If your telephone provider does not support the number 00800-43347328, please call +49 5361 3790510. The costs depend on the applicable tariff of your provider. Roaming charges may apply for calls made from outside Germany.*

## Privacy settings


### Introduction to the topic

The "Privacy settings" function enables you to permit or prevent data transmission between the vehicle and the Internet.

The required mode can be set in the vehicle settings in the Infotainment system.

The "Privacy settings" function **cannot** prevent data transmission from external devices and their communication with the vehicle.

Legally required services and their data transmissions cannot be switched off and cannot be deactivated, e.g. "eCall Emergency System".

 Please note that every vehicle user can adjust individual privacy function settings. These settings may be different from those preferred by the vehicle owner.

### Privacy settings

In order to permit or prevent data transmission, activate or deactivate offline mode in the Infotainment system.



#### Offline mode activated

The following happens in this mode:

- All We Connect Start services are deactivated and do not transmit any data.
- The eSIM card is deactivated.
  - All vehicle functions that require an online connection are deactivated → page 205.
- It is not possible to update any information and data stored in the control units, e.g. emergency call numbers, certificates. This can restrict functions and services or mean that they are not available.
- Legally required services cannot be deactivated and still transmit data.
- No signal strength display of the eSIM.



#### Offline mode deactivated (online mode)

The following happens in this mode:

- All We Connect Start services can transmit and receive data depending on their settings in the user account.
  - Users can access the positioning data of the vehicle via the We Connect portal or We Connect ID app.
- The eSIM card is activated.
  - Data transmission is possible for all vehicle functions that require an online connection.
  - Signal strength display of the eSIM is available.

### Status display

The following symbols show the respective data transmission status on the Infotainment system.



No connection to the Internet (offline mode active).



A connection to the Internet has been established (online mode active).



Grey globe: it is not currently possible to establish a connection to the Internet or a connection is currently being set up.



Signal strength display of the eSIM with available mobile communication standard.

Legally required services can influence the status display for data transmission independently of activated offline mode.



Even if offline mode is activated, online mode can be activated briefly by safety-relevant and legally required services. No We Connect Start services are activated and no data of these services is transmitted during this time. Offline mode will be reactivated and the eSIM deactivated again after successful transfer of the safety-relevant or legally required data.



Signal strength display of the eSIM

The signal strength display shows in online mode whether the eSIM of the factory-installed OCU can transmit and receive data at the current vehicle location and how good the signal strength is.

The more bars that are highlighted in colour, the stronger the signal and the larger the amount of data that can be transferred. Example: one or two highlighted bars indicate a low signal strength. There may be restrictions in this case for the high data transfer rates for streaming services.

The signal strength display functions independently of the mobile communication standard display.

There is no signal strength display in offline mode and in the event of faults in the eSIM.



The signal strength display of the eSIM does not show the signal strength of a mobile device paired with the Infotainment system.

The signal strength display of the eSIM does not show whether a Wi-Fi device connected to the Infotainment system is connected to the Internet.

## Effects on online vehicle functions

If data transfer is restricted, the following online function cannot be executed, for example.

### Online vehicle functions

- Online Voice Control.
- Online Map Update.
- Online Traffic Information.
- System update.
- We Connect Start registration and activation.



The restrictions also apply to new online vehicle functions that are provided for the vehicle in future.

## User administration

### Description of the user role

The We Connect Start services can be ordered and activated for a specific vehicle by the owner or a user who is not just temporarily authorised to use the vehicle such as a lessee or company car driver (primary user).

There is only one primary user per vehicle. If a new primary user legitimises themselves for the vehicle, the previous primary user will automatically lose their primary user role. The previous primary user will be informed about this.

### Creating and deleting a user role

#### Creating a user

Register with We Connect. You can then conclude a We Connect Start contract, add the

vehicle to your user account and authenticate yourself as the user.

### Deleting a user

Step 1: set privacy settings to "Offline mode deactivated (online mode)".

Step 2: either restore the factory settings of the Infotainment system or a new user must authenticate themselves in the vehicle.



The user cannot be deleted on the server if the Infotainment system is reset to the factory settings in offline mode.

## Activating functions (We Upgrade)

### Introduction to the topic

After delivery, the vehicle can be permanently or temporarily<sup>1)</sup> extended by certain functions.

Depending on the vehicle model, you can generally activate (unlock) comfort and Infotainment system functions and also driver assistance systems.

The ability to activate functions depends on the build status of the vehicle. Function activation is possible only for some vehicle models and is not possible in all markets.

**Before using** an activated function, read and observe the relevant information and warnings in the owner's manual or in the online instructions that may be available.

Inform the user or buyer about permanently activated and time-limited functions when renting or selling the vehicle.



If the required hardware for the respective activatable function is not available in the vehicle, it can be retrofitted in some cases. Volkswagen recommends con-

tacting your Volkswagen dealership to have the hardware retrofitted.



If the required software for the respective activatable function is not available in the vehicle, the software can be retrofitted via page 196, *System update*. This may be subject to charge, depending on the type of software.

### Description

When the function has been correctly activated, it can be used up to the end of the agreed term.



Indicates that a function is activated.



Function faulty or temporarily not available.

A mobile connection is required for:

- purchase of the function,
- activation of the function and
- execution of functions that require continuous connectivity.

Activatable functions for the vehicle are described in this owner's manual and in the Infotainment system, on the Volkswagen website or in your Volkswagen We Connect user account. Some functions do not require a description, such as functions for changing the appearance or colour of the Infotainment system.

Activated functions are not linked to the duration of the Volkswagen We Connect contract.

<sup>1)</sup> Only possible for some functions and vehicle models.



## Requirements for activating a function


- A suitable Infotainment system is installed in the vehicle.
- Compatibility and performance of the hardware available in the vehicle.
- There is a valid We Connect contract between you and Volkswagen.
- The vehicle is assigned to your We Connect user account.
- Sufficient mobile reception at the current location of the vehicle.
- The electrical system in the vehicle is ready for use.
- The vehicle battery has a sufficient charge level.
- Factory-installed OCU or in some countries the Volkswagen We Connect control unit. <

## Steps for activation

Do not drive the vehicle during an activation process.

1. Switch on the ignition.
2. Confirm activation in the Infotainment system.
3. Observe the information on the Infotainment system during activation.

After activation, it is necessary to switch the ignition off and then back on again for some functions. The function can then be used properly.

 Before starting the engine again, read the message in the Infotainment system about completed activation. Observe the instructions if activation was not successful. <

## Troubleshooting

### Where can I obtain activatable functions?

From an online shop accessible via your Volkswagen We Connect user account.

Depending on equipment, functions can also be purchased and activated directly via the Infotainment system in the "In-Car Shop".

### Function restrictions during activation

The function is not available during activation.

### After successful activation

Successful activation is displayed on the Infotainment system.

### When will the activated function be available?

Depending on the function activated, it will be available either immediately or only after the next driving cycle (deactivation and renewed activation of the vehicle's drive system). <

## Wi-Fi hotspot


### Introduction to the topic

The WLAN hotspot function is not available in all markets and vehicles.


Some Infotainment systems can be used as a WLAN hotspot to provide Internet access for up to eight WLAN devices.


Some Infotainment systems can use the WLAN hotspot of an external WLAN device (WLAN client) → page 210.

A data connection is required to set up a connection to the internet and to use services such as We Connect.

 As default, the WLAN connection is encrypted using WPA2 encryption for security reasons. Volkswagen recommends

always using WPA2 encryption. Observe country-specific requirements.

 The necessary data transfer may be subject to charges. Due to the potentially high volume of data in use, Volkswagen recommends using a mobile phone tariff which includes a data flat rate. For more information contact your mobile telephone provider.

 Depending on your mobile telephone tariff, additional costs (such as roaming charges) may be charged for loading and using online data packages, especially if you use these services abroad.

## Setting up a data connection

### Wi-Fi

- WLAN in accordance with IEEE 802.11 a/b/g/n/ac.
- Transfer in 2.4 GHz and 5 GHz.
- Three Wi-Fi modes simultaneously:
  - Tethering (2.4 GHz or 5 GHz).
  - 2.4 GHz access point.
  - 5 GHz access point.
- Wi-Fi aerial.
  - One multiband aerial each for 2.4 GHz and 5 GHz.
- Up to eight Wi-Fi devices can be connected simultaneously.
- Internet connection via Wi-Fi:
  - Tethering via customer telephone or eSIM via OCU.
  - Hotspot for clients in the vehicle.
- Apple CarPlay™ via Wi-Fi.
- Android Auto™ via Wi-Fi.
- Simplified pairing process via WPS or QR Code.

### eSIM (embedded SIM) → page 208

The vehicle has an OCU with embedded SIM card (eSIM). In order to use this eSIM you must purchase data plans for use via the In-Car-Shop.

The following must be activated in the Settings menu:

- **Network settings** ► *Allow internet connection.*
- **OR: Data connection** ► *Integrated data connection.*

### External Wi-Fi device<sup>1)</sup>


Use the WLAN hotspot of an external mobile device → page 210.

## Configuring a Wi-Fi hotspot

The Infotainment system can be used as a WLAN hotspot to provide Internet access for up to 8 Wi-Fi devices.

In order to establish a connection to the Internet and be able to use services such as Volkswagen WeConnect, a data connection is additionally required, for example by using an internal eSIM or an external Wi-Fi network. The possible data connection types vary according to country and depend on the Infotainment system used.


### Setting up the Wi-Fi connection

- Touch **(HOME)** ►  ► **(Wi-Fi)** ► **(Infotainment system as Hotspot)**.
- Activate the  **Use as mobile hotspot** checkbox.
- Search for the name of the Wi-Fi hotspot on the Wi-Fi device.
- Enter the displayed network key on the Wi-Fi device and confirm.

The Wi-Fi connection is set up. Further inputs may be required on the Wi-Fi device to complete the connection.

<sup>1)</sup> These data connections depend on the vehicle's country and equipment and are not available in every vehicle.

- Repeat the procedure to connect further Wi-Fi devices.


 The name of the hotspot and the network key are automatically generated. You can then define a name for the hotspot and the network key yourself.

## Quick connection

The quick connection function makes it possible to easily and quickly establish a wireless local network with encryption. Alternatively, in some countries the function can be performed using a scanning a code.

### WPS with Infotainment system as Wi-Fi hotspot

- ✓ The WLAN hotspot of the Infotainment system must be activated.
- ✓ The Wi-Fi device must support WPS.

1. Touch **HOME** ►  ► **Wi-Fi**.
2. Touch **Quick connection with Infotainment system**.
3. Activate WPS on the WLAN device that is to be connected.
4. The Wi-Fi connection is set up. Further inputs may be required on the Wi-Fi device to complete the connection.
5. Repeat the procedure to connect further Wi-Fi devices.


It is possible to establish only one WPS connection at a time. If several connection attempts are started simultaneously, all connection attempts will fail.

### Carrying out Wi-Fi pairing via NFC


Wi-Fi pairing can be carried out via NFC using the stowage area of the wireless charging station → page 250.


Prerequisites for the NFC connection:

- ✓ The NFC technology and stowage area of the wireless charging station are installed in the vehicle.
- ✓ NFC in the Wi-Fi device is activated.
- ✓ The Wi-Fi hotspot in the Infotainment system is activated.

1. Touch **HOME** ►  ► **Wi-Fi**.
2. Touch **Quick connection with Infotainment system**.
3. Unlock the Wi-Fi device and place it on the stowage area of the wireless charging station → page 250.

The Wi-Fi device is connected as a client to the Wi-Fi hotspot in the Infotainment system.


 While the Infotainment system is in the Wi-Fi settings menu, the wireless charging function is deactivated. Wireless charging is reactivated when you exit the set-up menu.

 Older Wi-Fi devices may have limited functionality or may not work. Make sure you are using the latest software version for your Wi-Fi device.

### Wi-Fi pairing via QR code

The Wi-Fi connection can also be established by scanning a QR code.

- ✓ The Wi-Fi hotspot of the Infotainment system must be activated.
- ✓ A suitable application for scanning QR codes must be installed on the Wi-Fi device.


1. Touch **HOME** ►  ► **Wi-Fi**.
2. Touch **Quick connection with Infotainment system**.
3. Scan the QR code on the Infotainment system screen with the Wi-Fi device.

The Wi-Fi device is connected as a client to the Wi-Fi hotspot in the Infotainment system.

## Configuring a Wi-Fi client

The Infotainment system can use the WLAN hotspot of an external Wi-Fi device, such as a mobile telephone, to establish an Internet connection to use online services.


### Setting up the Wi-Fi connection


1. Activate the Wi-Fi hotspot on the Wi-Fi device; refer to the manufacturer's operating instructions.
2. Touch **HOME** ►  ► **Wi-Fi** ► **Wi-Fi**.
3. Touch **Wi-Fi search**.

The Infotainment system searches for Wi-Fi hotspots nearby. The search process may take a few seconds.

4. Select the Wi-Fi network in the desired Wi-Fi device.
5. Enter the network key for the Wi-Fi hotspot in the Infotainment system and confirm by pressing **OK**.


The Wi-Fi connection is set up. Further inputs may be required on the Wi-Fi device to complete the connection.

 Due to the large number of possible Wi-Fi devices, it is not possible to guarantee fault-free operation of all functions.

 The availability of the Wi-Fi function is country-specific and may vary.

### WPS with Infotainment system as client

- ✓ The WLAN device must support WPS.

1. Touch **HOME** ►  ► **Wi-Fi** ► **Wi-Fi**.
2. Touch **WPS quick connection (WPS button)**.
3. Activate WPS on the external Wi-Fi device.
4. The Wi-Fi connection is set up. Further inputs may be required on the Wi-Fi device to complete the connection.



WPS is not supported by all Wi-Fi devices. Establish the connection manually in this case:

- Set up the Infotainment system as a Wi-Fi hotspot → page 207, → page 208.
- Connect the Infotainment system as a client to an external Wi-Fi device → page 210.

## Adjusting the settings

### Accessing Wi-Fi settings

Touch **HOME** ► **SETTINGS** ► **Wi-Fi**.

The following settings are possible:

- Setting up the Infotainment system as a hotspot.
- Connecting to the Infotainment system via a fast connection.
- Connecting to Wi-Fi.

Make corresponding entries or touch function buttons. Changes are automatically stored when a menu is closed.

## App-Connect

### Introduction to the topic

App-Connect enables the user to display and operate content and functions from the mobile device on the Infotainment system screen.

The mobile device must be connected to the Infotainment system using a USB interface with a data transfer function.

Some technologies can also be accessed using Wireless App-Connect via the Bluetooth interface.


### The following technologies may be available:

- Apple CarPlay™.
- Apple CarPlay™ Wireless.

- Android Auto™.
- Android Auto™ Wireless.
- Mirror Link®

The availability of the App-Connect technology is country-specific and may vary according to the mobile device.

For more information please visit the Volkswagen website.

 When you cross the border into countries that have different permitted radio frequencies than in your own country, operation of the wireless function of App-Connect may be restricted or may not be possible at all due to legal requirements. This may be indicated by a message displayed on the Infotainment system. App-Connect operation is not affected by this restriction when connected by cable and App-Connect can still be used in this case.

#### Opening the App-Connect main menu

Navigation to the App-Connect main menu depends on the Infotainment system used.

- **HOME** ► .

#### Setting up Wireless App-Connect

You must first pair the mobile device with the Infotainment system to use Wireless App-Connect. Proceed as follows:

#### Connecting the mobile device for the first time

- Unlock the mobile device.
- Switch on Wi-Fi and Bluetooth® on the mobile device.
- Connect the mobile device to the Infotainment system using a USB cable or Bluetooth®.
- Open the App-Connect main menu if it does not load automatically.
- Select the mobile device and the required technology.
- Confirm authorisation prompts on the mobile device to give the Infotainment system the required permissions.

- Disconnect the USB and connect to the Infotainment system again using Wi-Fi or Bluetooth®. Wireless App-Connect is set up.

Pairing is complete. In future, the connected mobile device will also be able to use Wireless App-Connect without a USB connection.

Wireless App-Connect will not be available if you do not confirm the pop-up menus during the connection process. In this case, Volkswagen recommends deleting the devices in both the iOS and Android settings and on the Infotainment system and restarting the connection process.

 Wireless App-Connect may not be supported by all technologies. 

## Applications (apps)

Volkswagen App-Connect allows content from Volkswagen apps and third party apps on mobile devices to be shown on the Infotainment system screen.


There may be problems with compatibility with third-party apps.

Apps, their use, and the necessary mobile network connection may be subject to charges.

A wide range of apps may be available and they may depend on the vehicle and country. The content, scope and providers of apps can vary. Some apps also depend on availability of services offered by third parties.

We are unable to guarantee that the available apps can be run on all mobile devices and all operating systems.






The apps offered by Volkswagen can be changed, discontinued, deactivated, reactivated and upgraded without prior notice.

In order to avoid distracting the driver, only certified apps can be used when driving. 

## Icons and settings for App-Connect

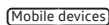
### Symbols in the menu App-Connect

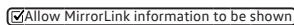
The actual symbols present depend on the installed Infotainment system and the vehicle model.

-  Show further information.
-  Open the App-Connect settings menu.
-  Select Apple CarPlay technology.
-  Select Android Auto™ technology.
-  Select MirrorLink® technology.

### Possible settings in the App-Connect settings menu

The setting options depend on the Infotainment system installed.

 Open Device Manager.

 information is displayed in MirrorLink® mode.

## Apple CarPlay™

### Requirements for Apple CarPlay

#### Checklist


The following conditions must be fulfilled in order to use Apple CarPlay:


- ✓ The iPhone **must** support Apple CarPlay.
- ✓ Voice control (Siri) **must** be activated on the iPhone.
- ✓ Apple CarPlay **must** be activated in the iPhone settings without any restrictions.
- ✓ If Apple CarPlay™ Wireless is not possible, the iPhone **must** be connected to the Infotainment system via a USB port. Only USB ports with data transfer capa-

bility are suitable for using Apple CarPlay.

- ✓ The USB cable used **must** be an original cable from Apple.

*Apple CarPlay Wireless:* in addition, iPhone Bluetooth® and WLAN **must** be activated on the iPhone.

 The availability of the technologies depends on the country and may vary.

 Information on technical requirements, compatible iPhones, certified apps and availability is available on the homepage of Volkswagen and Apple CarPlay or from your Volkswagen dealership.

### Connecting



Follow the instructions on the Infotainment system screen and the display on the iPhone when establishing a connection for the first time.

The prerequisites for using Apple CarPlay must be fulfilled.

Start Apple CarPlay:

- Touch  .
- Touch .

### Disconnecting

- In Apple CarPlay mode, touch  to go to the App-Connect main menu.
- Touch  to terminate the active connection.

How the function buttons are displayed on the screen may vary.



### Points to note

Please note the following points during an active Apple CarPlay connection:

- Bluetooth® connections between the iPhone and the Infotainment system are **not** possible.
- An active Bluetooth® connection between the iPhone and the Infotainment system will be ended automatically.

- Telephone functions are possible via Apple CarPlay only for the iPhone connected to Apple CarPlay. The functions described for the Infotainment system are **not** available.
- The connected iPhone **cannot** be used as a media device in the **Media** main menu.
- It is **not** possible to use the Apple CarPlay navigation at the same time as the internal navigation. The last route guidance to be started terminates the previous active route guidance.

#### Voice control

- Touch  briefly to start the voice control function of the Infotainment system.
- **Press and hold**  to start the voice control (Siri) function of the connected iPhone.

## Android Auto™

#### Requirements for Android Auto™

##### Checklist

The following conditions must be fulfilled in order to use Android Auto™:

- ✓ The mobile device – hereinafter referred to as a smartphone – **must** support Android Auto™.
- ✓ An Android Auto™ app **must** be installed on the smartphone.
- ✓ If Android Auto™ Wireless is not possible, the smartphone **must** be connected to the Infotainment system by means of a USB port with data transmission function.
- ✓ The USB cable used **must** be an original cable from the smartphone manufacturer.

*Android Auto™ Wireless:* in addition, Bluetooth® and Wi-Fi **must** be activated on the smartphone.



The availability of the technologies depends on the country and may vary.



Information on technical requirements, compatible mobile devices, certified apps and availability is available on the homepage of Volkswagen and Android Auto™ or from your Volkswagen dealership.

#### Connecting


Follow the instructions on the Infotainment system screen and the display on the smartphone when establishing a connection for the first time.

The requirements for using Android Auto™ must be met.

Start Android Auto™:

- Touch **HOME button** ► **App-Connect** .
- Touch **Android Auto**  to set up a connection with the smartphone.

#### Disconnecting

- In Android Auto™ mode, select the corresponding option to return to the **App-Connect** main menu.
- Touch  to terminate the active connection.



#### Points to note

The following points apply when an Android Auto™ connection is active:

- An active Android Auto™ device can also be connected simultaneously to the Infotainment system via Bluetooth® (HFP profile).
- It is possible to use telephone functions via Android Auto™. If the Android Auto™ device is connected to the Infotainment system via Bluetooth® at the same time, the telephone function of the Infotainment system can also be used.
- An active Android Auto™ device **cannot** be used as a media device in the **Media** main menu.
- It is **not** possible to use the Android Auto™ navigation at the same time as the internal navigation. The last route guidance to be started terminates the previous active route guidance.

- There is no media mode display on the instrument cluster display.

### Voice control

- Touch  briefly to start voice control of the Infotainment system.
- **Touch and hold**  to start the voice control function of the connected smartphone.

## MirrorLink®

### Prerequisites for MirrorLink

#### Checklist

The following conditions need to be fulfilled in order to use MirrorLink:

- ✓ The mobile device **must** support MirrorLink.
- ✓ The mobile device **must** be connected to the Infotainment system via a USB port with data transfer.
- ✓ The USB cable used **must** be an original cable of the mobile device manufacturer.
- ✓ Depending on the mobile device used, a suitable Car Mode app for using MirrorLink **must** be installed on the device.

### Connecting


Follow the instructions on the Infotainment system screen and the display on the mobile device when establishing a connection for the first time.


The requirements for using MirrorLink need to be met.

Start MirrorLink:

- Touch  ► .
- Touch  to set up a connection with the mobile device.

### Disconnecting

- Touch  to go to the MirrorLink main menu.

- Touch  to terminate the active connection.

### Points to note

The following points need to be noted during an active MirrorLink connection:

- An active MirrorLink device can also be connected simultaneously to the Infotainment system via Bluetooth.
- If the MirrorLink device is connected to the Infotainment system via Bluetooth at the same time, the telephone function on the Infotainment system can also be used.
- An active MirrorLink device **cannot** be used as a media device in the **Media** main menu.
- The instrument cluster display shows information about the telephone mode.
- No information about turning off at junctions or media mode displays are shown on the instrument cluster display.
- You can accept or reject incoming calls or end a telephone call via the multifunction steering wheel.



Information on technical requirements, compatible mobile devices, certified apps and availability is available on the homepage of Volkswagen and MirrorLink or from your Volkswagen dealership.

### Function buttons

Function buttons for MirrorLink:



Goes back to the **App-Connect** main menu. Here you can end the MirrorLink® connection, connect another mobile device or select another technology.




Touch to display the screen of the mobile device on the Infotainment system screen.



Touch to open the list of apps supported by MirrorLink.



Touch to close any open apps. Then touch apps to be closed or touch the function button  to close all open apps.



## Cable and wireless connections

### Introduction to the topic

Some external devices can be connected to the Infotainment system by cable and wireless connections present in the vehicle (if installed).

The type and number of cable and wireless connections differ according to country and vehicle. The connections may also be different within a model series or in special-edition models.


In the case of cable connections, use only the original device connecting cables or, if available, the factory-supplied connecting cables for your vehicle.



If the plug on the connecting cable cannot be inserted, check the angle of insertion and the connections.

### NOTICE



Use only suitable and undamaged connecting cables for cable connections.

- When inserting the plugs of the connecting cables into the appropriate connection, ensure that they are correctly positioned and apply only light pressure. Applying too much pressure may damage both the unit connection and the plug of the connecting cable.
- Make sure that the connecting cable is not pinched or sharply bent.
- Using unsuitable or damaged connecting cables may damage devices and cause malfunctions.

 If a connected device is not recognised, disconnect all devices and connect the device again. If necessary, check that the connecting cable you are using is working properly.



 If a connected device malfunctions, restart the device. In some cases this will remedy the fault. 

### USB port


 Please refer to  at the start of the chapter on page 215.

#### USB port types

The following USB ports may be available in the vehicle:

- Type C : suitable for data transfer and the charging function.
- Type C : suitable only for the charging function (for charging batteries of external devices).


Each USB port is a cable connection which can be operated only using a suitable connecting cable.


The USB port  supplies the customary USB voltage of 5 volts.

The USB types and also the number and installation locations of the USB ports depend on the vehicle and market.

Only supported audio files are displayed. Other files will be ignored.

The Infotainment system only supports mass storage and audio sources in "mass storage mode". Please refer to the description of your audio source on how to activate this mode.

Audio files on an external data medium connected to the USB port  can be played and controlled via the Infotainment system.




 Before connecting an audio source, check which USB port is installed in your vehicle. Only use suitable USB connecting cables which are appropriate for the installed USB type.

- USB ports "Type A" and "Type C" have different connector shapes.

### Possible fitting locations of USB ports


- on the front of the Infotainment system.
- In the centre console.

### Connecting external data media to the USB port

- Reduce the volume on the Infotainment system.
- Connect external data medium to the USB port .
- Start playback on the external audio source.
- Touch   to access the Media menu.
- Touch **Source** and select **My media** as the media source.

iPod-specific list views (Playlists, Artists, Albums etc.) can be displayed.

### Notes and restrictions

The number of USB ports  and compatibility with Apple devices as well as other media players depend on the equipment level.



Due to the large variety of data storage devices and the various iPod, iPad and iPhone generations available, it is not possible to guarantee fault-free operation of all functions described here.

Depending on the Infotainment system used, external hard disks with a capacity greater than 32 GB sometimes need to be reformatted for the FAT32 file system. You can find the necessary software and information online, for example.



Do not connect or use USB extension cables or USB hubs.

## Bluetooth® interface

 Please refer to  at the start of the chapter on page 215.

The Bluetooth interface is a wireless connection.

In Bluetooth audio mode, audio files from a Bluetooth audio source (e.g. mobile device) that is connected via Bluetooth can be played over the vehicle loudspeakers (Bluetooth audio playback).

Bluetooth audio mode is available if the vehicle is equipped with a factory-fitted mobile phone interface that supports this function.

### Bluetooth profiles

The Infotainment system is delivered from the factory with a Bluetooth interface.

A maximum of three Bluetooth devices can be connected at the same time.

The following Bluetooth profiles may be available in the specified or different version:

- HFP 1.7.
  - Telephony and handsfree mode.
- A2DP 1.3.
  - Music playback.
- AVRCP 1.6.
  - Display and operation of music playback.
  - Transmission of Cover Arts.
- PBAP 1.2.
  - Access to phone book and call lists.
- MAP 1.4.
  - Access to SMS and email.
- SPP 1.2.
  - Serial data transmission via Bluetooth.

### Starting Bluetooth audio transmission

#### Prerequisites

- ✓ The Bluetooth audio source is paired with and connected to the Infotainment system → page 248.
- ✓ The Bluetooth audio source must support the A2DP Bluetooth profile.

1. Reduce the volume on the Infotainment system.


2. Switch on Bluetooth visibility on the external Bluetooth audio source (e.g. mobile device).
3. Open the Media menu.
4. Touch **Source** and select **BT Audio**.
5. If necessary, start playback on the Bluetooth audio source manually.


When playback on the Bluetooth audio source is stopped, the Infotainment system remains in Bluetooth audio mode.


### Controlling playback

The extent to which the Bluetooth audio source can be controlled via the Infotainment system depends on the connected Bluetooth audio source.

With media players that support the AVRCP Bluetooth profile, playback on the Bluetooth audio source can be automatically started or stopped when the unit is switched to Bluetooth audio mode or to a different audio source. In addition, depending on the Bluetooth audio source, tracks can be displayed and changed via the Infotainment system.

 Due to the large number of possible Bluetooth audio sources, it is not possible to guarantee fault-free operation of all described functions. The Volkswagen website contains a list of compatible mobile devices.

 Always switch off the warning and service tones on a connected Bluetooth audio source, e.g. key tones on a mobile device, to prevent interference noise and malfunctions.

 With some units, the Bluetooth audio connection will be disconnected automatically if an external media player is connected to the Infotainment system with Bluetooth and the USB port **simultaneously**.

## Infotainment system


### Getting started

#### Introduction to the topic

The function and settings of the Infotainment system depend on the country and vehicle equipment.

#### Before using for the first time

Before using the device for the first time, please observe the following points so you can make full use of the available functions and settings:

- Observe the basic safety instructions  → page 218.
- Reset the Infotainment system to factory settings.
- Find your favourite radio stations and store them to station buttons for quick access → page 231.
- Use only suitable audio sources and data media → page 234.
- Use current map data for the navigation system.
- Pair a mobile device to make calls using the telephone interface → page 246.
- Register with Volkswagen We Connect to use the corresponding services.

#### Other applicable documents

In addition to this manual, please observe the following documents when using this Infotainment system and its components:

- Supplements to the vehicle wallet of your vehicle.
- The operating instructions for the mobile device or audio sources.
- The operating instructions for external data media and playback devices.
- Instructions for any Infotainment accessories subsequently installed or additionally used.

- Service description when using Volkswagen We Connect services.
- Digital operating instructions in the Infotainment system (where available) <

## Safety notes

📖 Please refer to ⚠️ and ⌚ on page 218.

- Some functions may contain links to websites that are operated by third parties. Volkswagen AG does not assume ownership of the third-party websites that are reached via links and is not responsible for their content.
- Some functions may contain external information supplied by third parties. Volkswagen AG is not responsible for external information being correct, up-to-date and complete, or for any infringement of third-party rights.
- The radio stations or owners of the data storage media and audio sources are responsible for the content provided.
- Multi-storey car parks, garages, underpasses, tunnels, high buildings, mountains and valleys, and other electrical devices, e.g. battery chargers, can also impair reception of mobile communication, GPS and radio signals.
- Films or metal-coated stickers on the aerial and on the windows can interfere with radio reception.
- Read and follow the appropriate operating manuals of the respective manufacturer when using mobile devices, data media, external devices, external audio and media sources.

### ⚠️ WARNING

The central computer of the Infotainment system is networked with the control units in the vehicle. For this reason, improper repairs or incorrect removal and installation of the central computer could constitute an increased risk of accident and injury.

- Never replace the central computer with a used central computer taken from an older vehicle or a recycling facility.
- Have the central computer removed, installed or repaired only by a qualified workshop. Volkswagen recommends using a Volkswagen dealership for this purpose.

### ⚠️ WARNING

Accidents and injuries can occur if the driver is distracted. Reading information from the screen, operating the Infotainment system and connecting, inserting or removing a data medium or audio source while driving can distract you from the traffic situation and cause accidents.

- Always drive carefully and responsibly.

### ⚠️ WARNING

Unfavourable light conditions and a damaged or dirty screen may result in displays and information not being read or not being read correctly from the screen.

- Displays and information on the screen must never cause you to take safety risks. Always drive carefully and responsibly.

### ⚠️ WARNING

If you set the volume at too high a level, this will mean that you will not hear acoustic signals from outside, and it can also damage your hearing. This is the case even if you are only exposed to high volumes for short periods.

- Set the volume so that noises outside the vehicle (e.g. emergency service sirens) can be easily heard at all times.

### ⚠️ WARNING

The volume level may suddenly change when you switch the audio or media source or connect a new source.

- Reduce the volume before switching the audio or media source or connecting a new source.

### WARNING

The following conditions can lead to situations where emergency calls, telephone calls and data transmission are not possible or are interrupted:

- If your current location is in an area with no or insufficient mobile communications and GPS reception.
- If you are in an area with sufficient mobile communications and GPS reception but the telecommunications provider's mobile network is out of order or is not available.
- If the components in the vehicle required for emergency calls, telephone calls and data transmission are damaged, not working or do not have sufficient electrical power.
- If the rechargeable battery in the mobile device is flat or has insufficient charge level.

### WARNING

Radio stations can transmit catastrophe and danger warnings. The following conditions can prevent these warnings from being received or issued:

- If your current location is in an area with no or insufficient radio signal reception.
- If the frequency bands of the radio stations are subject to interference or are not available in areas with adequate radio signal reception.
- If the loudspeakers and the components required for radio reception in the vehicle are damaged, not working or do not have a sufficient power supply.

### WARNING

In some countries and mobile networks, a call for assistance or an emergency call

can be made only subject to the following prerequisites:

- A mobile device with "unlocked" SIM card and sufficient call credit is connected to the mobile phone interface of the vehicle.
- Sufficient network coverage is available.

### WARNING

The limit values for electromagnetic radiation in the vehicle may be exceeded, and thus the health of the driver and vehicle occupants may be endangered when operating a mobile or wireless device without a connection to an external aerial. This also applies to external aerials which have not been correctly installed.

- Maintain a minimum distance of 20 centimetres between the aerials of the mobile device and an active medical implant, since the mobile devices may impair the function of active medical implants.
- Do not carry an operational mobile device close to or directly above an active medical implant, e.g. in a breast pocket.
- Switch off mobile devices immediately if you suspect they may be interfering with an active medical implant or any other medical device.

### WARNING

Mobile devices, external devices and accessories in the vehicle that are not properly secured can be flung through the vehicle interior and cause injuries in the event of a sudden driving or braking manoeuvre or in the event of an accident.

- Secure any mobile devices and accessories outside the deployment zone of the airbags or stow them safely.
- Arrange the wires for external devices and audio sources so that they do not obstruct the driver.

## WARNING

Driving recommendations and traffic symbols displayed by the navigation system may differ from the current traffic situation.

- Road signs, traffic signals, traffic regulations and local conditions have priority over the recommendations and displays provided by the navigation system.
- Adapt your speed and driving style to suit visibility, weather, road and traffic conditions.
- Certain events can make the originally planned driving time and route to the destination considerably longer or make navigation there temporarily impossible, e.g. due to a road being closed.

## NOTICE

The radiation produced by the mobile device when switched on may interfere with sensitive technical and medical equipment, possibly resulting in malfunction or damage to the equipment.

- Always switch off your mobile device in areas where special regulations apply and when the use of mobile devices is forbidden.

## NOTICE

The loudspeakers can be damaged if the volume is set at too high a level and by playback which is too loud or distorted.

- Choose the volume setting so that the loudspeakers are not damaged.

## Notes on use

 Please refer to  and  on page 218.

- The Infotainment system needs a few seconds for a complete system start and does not respond to inputs during this time.

During system startup, only the rear view camera image can be displayed.

- The Infotainment system needs to start up completely before all displays are available and before it is possible to run functions. The duration of a system start depends on the functional scope of the Infotainment system and can also take longer than usual particularly at low and high temperatures.
- When using the Infotainment system and the corresponding accessories, such as a headset or headphones, please observe the country-specific regulations and legal requirements.
- It is important to make sure the Infotainment system is switched on and, where applicable, that the correct date and time are set in the vehicle to ensure that the system works properly.
- A missing function button on the screen does not constitute a fault in the unit; it corresponds to the country-specific equipment.
- Some functions of the Infotainment system are available only when the vehicle is stationary. In some countries, the position switch must additionally be in parking position **P** or neutral position **N**. This is not a malfunction, but simply a legal requirement.
- There may be restrictions on the use of Bluetooth devices in some countries. Information is available from the local authorities.
- Switch the ignition on before switching the Infotainment system back on if the 12-volt vehicle battery has been disconnected.
- Changes to settings may cause the display content to vary and some aspects of the Infotainment system operation to differ from the descriptions given in this manual.
- The Infotainment system is automatically switched off when the vehicle's drive system is deactivated and when the charge level of the 12 V vehicle battery is low.

- In certain vehicles with Park Distance Control, the volume of the current audio source is lowered automatically when reverse gear is engaged. It is possible to lower the volume.
- Information on the included software and the licence conditions is stored under **Settings ▶ Copyright**.
- If you sell your vehicle or loan it to somebody else, make sure that all the stored data, files and settings are deleted and that the external audio sources and data media are removed where applicable.
- Some Infotainment functions require an active We Connect or We Connect Start user account for the vehicle and an Internet connection. The data transfer must not be restricted for the execution of the functions.

## Technical equipment

📖 Please refer to ⚠️ and ⓘ on page 218.

### Central computer with display and operating unit

The central computer installed in the vehicle at the factory contains country-specific components and software for connectivity and for execution of Infotainment, convenience and vehicle functions.

The corresponding displays are shown on the screen of the display and operating unit and in some cases in the instrument cluster and head-up display.

- Capacitive colour screen:

- TFT display, HD: 1,280 x 720 pixels.
- Device operation by touch controls, touching the screen, buttons in the multifunction steering wheel and proximity sensors (driver/front passenger recognition, gesture control).

### Basic equipment of the sound system

The Infotainment system available from the factory is equipped as follows:

- Seven loudspeakers, at different locations.
- Amplifier output power, max. 5 x 20 watts.
- Setting options:
  - Treble, Mid, Bass.
  - Volume distribution front, rear and left, right (balance, fader).

### Optional sound system

The Infotainment system can be extended as follows by an optional sound system:



- Up to nine loudspeakers, in different installation locations and with different power ratings (watts).
- External amplifier (DSP-Ethernet).
- Separate subwoofer.
- Setting options:
  - Sound character, Equaliser, Treble, Mid, Bass.
  - Volume distribution front, rear and left, right (balance, fader).
  - Seat-dependent sound optimisation (sound focus).
  - Subwoofer volume.
  - Surround settings.

## Overview and control elements


Please refer to  and  on page 218.



Fig. 123 Overview: display and operating unit of the 10-inch (10") and 12-inch (12") versions.

- ① Time.
- ② Privacy status display, signal strength display of the eSIM and number of notifications.
- ③ Home button: .
- ④ Status display for seat heating and seat ventilation.
- ⑤ Sensor field (Infotainment system on or off).
- ⑥ Touch slider for temperature.
- ⑦ Touch slider for volume.
- ⑧ Views (current view is highlighted).
- ⑨ Temperature display (adjustment via .
- ⑩ Scroll bar and marking for additional window.
- ⑪ Control centre.
- ⑫ Function buttons for main menus.

- ⑬ Screen (touchscreen).

 Further information and tips for operating the Infotainment system are provided on → page 224, *Operating the Infotainment system*.

- ③ Home button:

– Touch **HOME** to open the start screen.

- ⑤ Sensor field (Infotainment system on or off)

– Touch the sensor field to switch the Infotainment system on or off manually.



#### ⑥ Touch slider for temperature

---

Touch slider for the driver position and touch slider for the front passenger position.

- Swipe to the left to lower the temperature.
- Swipe to the right to increase the temperature.

#### ⑦ Touch slider for volume

---

- Swipe to the left to lower the volume.
- Swipe to the right to increase the volume.

#### ⑧ Views

---

There are other views available in addition to the view with the HOME start page. Different content can be displayed by some menus and functions in these views. The current view is highlighted.

- Touch the marking to change to a view.
- Swipe your finger to the left or to the right across the screen to switch between the views.

#### ⑩ Scroll bar and marking for additional window

---

Some menus and functions have additional content above or below the current screen display and an additional window that can be opened and closed. In radio mode, for example, the current playback content is shown in an additional window.

- Touch the scroll bar, keep your finger on the screen and swipe it up or down to display the additional content.

- To open the additional window, touch the marking for the additional window, keep your finger on the screen and swipe to the left.
- To close the additional window, touch the marking for the additional window, keep your finger on the screen and swipe to the right.

#### ⑪ Control centre

---


There are additional function buttons for functions and notifications in the control centre. You can configure the displayed functions → page 225.

- Touch the marking and slide it down to open the control centre.

#### ⑫ Function buttons for main menus

---

The position of the function buttons can be configured → page 225.

- Press the corresponding function button to open a main menu, e.g.  for the navigation.

#### ⑬ Screen

---

You can operate the functions of the Infotainment system using the screen. A detailed explanation of the different finger gestures is provided in the digital instructions.

- Touch        Operation. 

## Operating the Infotainment system

📖 Please refer to ⚠️ and ⓘ on page 218.

### Opening the instructions (if available)

You can find further information and tips for operation in the instructions for the Infotainment system.

— Touch **HOME** ▶️ ? ▶️ 🖱️.

### Switching the Infotainment system on and off

If it was not manually switched off before, the Infotainment system will start up when the ignition is switched on.

If the volume last set does not exceed the preset maximum switch-on volume, the Infotainment system will start up with this volume.



The Infotainment system switches off automatically when you open the driver door with inactive ignition.



If you switch on the Infotainment system manually when the ignition is inactive, it will switch off automatically after around 30 minutes without a user input.

### Start screen HOME

You can adapt and configure the layout of the function buttons and also the views and displays on the start screen of the display and operating unit or have them positioned on the basis of factory layout templates.

### Configuring the HOME start screen

1. Touch a function button and keep your finger on the screen until the function button is visibly highlighted.
2. Move the function button to the desired position and then take your finger off the screen.

The following main menus may be included as a function button on the start screen:



Background lighting → page 111.



App-Connect → page 210.



Apps.



Assist systems → page 145.



Vehicle → page 30.



Help: here you can find further information on the functions and operation of the Infotainment system, e.g. the quick guide → page 224.



Sound → page 226.



Navigation → page 238.



Users, User management → page 205.



Radio/Media → page 231, → page 234.



Legal.



Settings → page 226.



Auxiliary heater: auxiliary heater → page 120.



Telephone → page 246.

### Scrolling through lists, switching tracks

Use the touchscreen or menu control to select the desired function, setting or track.

### Moving objects, adjusting volume

Move objects on the screen to adjust settings, e.g. of sliders, or to move areas of a menu.

Personalise function buttons and views (this depends on the vehicle equipment level) → page 225.

### Enlarging or reducing image and map display on the screen

*Recommendation: use thumb and index finger.*

1. Touch the screen simultaneously with two fingers and hold your fingers on the screen.

- To enlarge the display of images and maps, slowly move your fingers apart.

**OR:** to reduce the display of images and maps, slowly move your fingers together.

## Personalising the Infotainment system






📖 Please refer to ⚠️ and ⏰ on page 218.


Depending on equipment, you can personalise the Infotainment system to permit faster access to favourite or frequently used functions.

### Configuring tiles

You can find tiles for accessing further menus and functions on the Infotainment system displays. Configure the tiles by removing or adding views.



Tiles with additional functions can be found in the Infotainment system as from the second view. You can configure these tiles.


- Touch the tile and keep your finger on the screen until an additional window opens.
- Touch  to open the configuration function.
  - To add a new view with tiles, touch  and the desired template. New tiles are created without functions.
  - To remove a view with tiles, touch .
- Touch  to close the configuration function.
- To return to the view, touch  or a free area on the screen.

 At least two tiles are always available. These cannot be removed. With some equipment levels, you can add two more tiles. In total, a maximum of four tiles can be displayed.

### Adapting tiles

Configure tiles and the displayed functions of the tiles in the Infotainment system views to adapt the Infotainment system to your needs.


- Touch the tile and keep your finger on the screen until an additional window opens.
- To add functions to a tile, touch the desired tile.
- Touch the desired function in the additional window → page 224. Various functions are available depending on the size of the tile.
- To remove a function from a tile, touch the desired tile and then touch .
- To return to the view, touch  or a free area on the screen.

 More functions are available for some tiles than are visible at first glance in the additional window. Swipe to the left or right in the additional window to see all functions.

### Adapting the control centre

Personalise the control centre of the Infotainment system to permit faster access to favourite or frequently used functions.

- Touch the function and keep your finger on the screen until an additional window opens.
- Touch the desired function in the additional window and keep your finger on the screen until the function is visibly highlighted.
- Move the function to the desired position and then take your finger off the screen. The active function is automatically removed from the control centre and added to the additional window.

 More functions are available for the control centre than are visible at first glance in the additional window. Swipe to the left or right in the additional window to see all functions.

### Opening the instructions (if available)

You can find further information and tips for customisation in the instructions for the Infotainment system.

- Touch    Custom.



## Settings (system, sound)



 Please refer to  and  on page 218.



### Changing settings


The meanings of the following symbols apply to all system and sound settings.


Changes are automatically stored when a menu is closed.


 or  The setting is selected and activated or switched on.


 or  The setting is not selected and is deactivated or switched off.


 or  Open the drop-down list.

 Increase the setting values.

 Decrease the setting values.

 Gradually back.




 Gradually forwards.

 Change setting values with the slider control (infinitely variable).

### Sound settings

The sound settings may contain information and setting options for equaliser, position, volume and settings.

### Opening the sound settings

- Touch    Sound to open the sound settings.

### System settings

The following functions, information and setting options may be available in the system settings:

- Offline mode.
- V2X communication.
- Screen.
- Time and date.
- Language.
- Additional keyboard languages.
- Units.
- Voice control.
- WLAN.
- Data connection.
- Mobile devices.
- Connect We Connect.
- Reset to default settings.
- System information.
- Copyright.
- Configuration assistant.

### Opening the system settings

- Touch  Settings to open the system settings.

### Adjusting the volume of external audio sources

If you need to increase the output volume of an external audio source, first lower the volume on the Infotainment system.

If the sound from the external audio source is too quiet, increase the output volume of the external audio source. If this is not sufficient, set the input volume to **Medium** or **Loud**.

If the sound from the connected external audio source is too loud or distorted, lower the output volume on the external audio source. If this is not sufficient, set the input volume to **Medium** or **Quiet**.

## Cleaning the screen

📖 Please refer to ⚠️ and ⓘ on page 218.

Observe this checklist when cleaning the screen:

- ✓ The Infotainment system is switched off.
- ✓ Use a clean, soft cloth that is moistened with water.

**OR:** use a cleaning cloth available from Volkswagen dealerships.

- ✓ *In the case of stubborn dirt:*
  - Moisten dirt with only a little water and allow to soak in.
  - Carefully remove dirt with a clean, soft cloth.

## ! NOTICE

You can damage the screen if you clean the screen with the wrong cleaning agents or when the screen is dry.

- Use only gentle pressure.
- Do not use aggressive or solvent-based cleaning products. These cleaners may damage the device and dull the screen. <

## Marks, licences, copyright

📖 Please refer to ⚠️ and ⓘ on page 218.

### Marks and licences

Certain terms in this manual are accompanied by the symbol ® or ™. They indicate trademarks or registered marks. However, the absence of these symbols does not constitute a waiver of the rights concerning any term.

Other product names are registered marks of the respective legal owners.

- Manufactured under license from Dolby Laboratories. Dolby and the double-D

symbol are trademarks of Dolby Laboratories.

- Manufactured under license from Dolby Laboratories. Dolby, Pro Logic and the double-D symbol are trademarks of Dolby Laboratories.
- All SiriusXM services require a subscription. See the SiriusXM Customer Agreement for complete terms at [www.siriusxm.com](http://www.siriusxm.com) (US) or [www.siriusxm.ca](http://www.siriusxm.ca) (Canada). All fees, content and features are subject to change. Satellite and steaming line-ups may vary. SiriusXM, Pandora and all related logos are trademarks of Sirius XM Radio Inc. and its respective subsidiaries. All rights reserved.
- HD Radio Technology manufactured under license from iBiquity Digital Corporation. U.S. and Foreign Patents. For patents see <http://dts.com/patents>. HD Radio, Artist Experience, and the HD, HD Radio, and "ARC" logos are registered trademarks or trademarks of iBiquity Digital Corporation in the United States and/or other countries.
- Android Auto™ is a certified trademark of Google Inc.
- Apple CarPlay™ is a certified trademark of Apple Inc.
- Bluetooth® is a registered trademark of Bluetooth® SIG, Inc.
- iPod®, iPad® and iPhone® are trademarks of Apple Inc.
- MirrorLink® and the MirrorLink® logo are certified trademarks of Car Connectivity Consortium LLC.
- MPEG-4 HE-AAC audio coding technology and patents are licensed by Fraunhofer IIS.
- SD® and SDHC® are brands or registered trademarks of SD-3C LLC in the USA and other countries.
- Windows® is a registered trademark of Microsoft Corporation, Redmond, USA.
- This product is subject to certain intellectual property rights and copyrights owned by the Microsoft Corporation. The use or

distribution of this type of technology outside this product requires a licence from Microsoft or an authorised Microsoft company.

### Copyright law

Audio and video files saved on data media and audio sources are normally subject to national and international copyright laws. Observe the legal requirements.

## Voice control

### Introduction to voice control

Voice control allows you to perform certain functions by spoken commands.

### Types of voice control


Depending on the language set in the Infotainment system, one of the following voice control types is available in the vehicle:


- Command-based voice control (standard).
- Advanced voice control (offline or online).

### Seat-based voice control

Voice control uses additional microphones to detect whether the driver or passenger is speaking. This enables you to access seat-related functions, e.g. switching on the seat heating.

### Does my vehicle have voice control?

Voice control is installed in the vehicle if the  button is present on the multifunction steering wheel or if your vehicle understands the activation word. Observe the relevant national languages of the activation words.

 Test voice control before starting a journey in order to familiarise yourself with the function.

## Differences in voice control systems

### Command-based voice control (standard)

Here, voice commands must follow a defined syntax in order to be recognised correctly, e.g.: "Navigate to [Town, Street name, House number]". You will find further examples in the Infotainment system. Command-based voice control can be performed in every available standard language.

### Advanced voice control (offline or online)

Advanced voice control permits natural language interaction with the system. For example, the statement "I'm cold" will lead to the set temperature in the vehicle being increased. Voice commands can be freely formulated and colloquial. You can find suggested voice commands in the Infotainment system.

Advanced voice control works online and offline. In online mode, more functions and data are available to permit improved recognition of voice commands. For online mode, you need a valid We Connect Plus or We Connect Start contract for the vehicle.

If advanced voice control is also available in a language in addition to command-based control, the advanced voice control function will always be used when voice control is activated.

### Supported languages

The number of languages available in your country depends on the vehicle equipment and model.

Language	Standard	Offline	Online
German	x	x	x
English (GB)	x	x	x
English (US)	x	x	x
Italian	x	x	x
French	x	x	x
Spanish	x	x	x
Czech	x	x	x

x = Type of voice control possible in this language.

Language	Stand-ard	Offline	Online
Dutch	x	x	x
Polish	x	x	x
Portuguese	x	x	x
Swedish	x	x	x
Danish	x	x	—
Finnish	x	x	—
Norwegian	x	x	—
Bulgarian	x	—	—
Greek	x	—	—
Russian	x	—	—
Turkish	x	—	—
Portuguese (Brazil) <sup>a)</sup>	x	—	—
Spanish (Mexico) <sup>a)</sup>	x	—	—
French (Canada) <sup>a)</sup>	x	—	—

<sup>a)</sup> Is not supported in European countries.

x = Type of voice control possible in this language.

## Starting and stopping voice control

### Voice commands

Voice control recognises only voice commands in the language set in the Infotainment system.

Observe the tips for successful voice commands:

- ✓ Speak clearly at normal volume. Speak slightly louder at higher speeds.
- ✓ Avoid excessive emphasis or strong dialect.
- ✓ Do not leave long pauses when speaking.
- ✓ Avoid exterior and background noise.
- ✓ Do not point the airflow from the vents towards the microphones or vehicle roof.

### Opening suggested voice commands

- Touch **HOME** ► ► .

Depending on the content of the telephone book, it may be advisable to swap the order of the contact's forename and surname to ensure it is reliably recognised from the telephone book.

### Starting the voice control function

Depending on the vehicle equipment, you can start voice control using different methods:

- *Starting with voice:* speak the activation word → page 229.
- *Starting via multifunction steering wheel:* Press the voice control button .

In some cases, the voice control function of the connected mobile device can be started by pressing and holding the voice control button → page 210.

In black with blue background: voice control is active and will recognise spoken words.

### Ending the voice control function

- *Ending with voice:* to open suggestions for a voice command for ending voice control, touch **HOME** ► ► ► **General**.
- *Ending via multifunction steering wheel:* press the voice control button twice in quick succession.
- *Ending automatically:* voice control is ended automatically if you use functions in the Infotainment system, activate the parking system, telephone calls are received or if there are voice outputs and warnings from the navigation system.

## Activation word

The words spoken in the vehicle are checked for the activation word in the ring memory of the Infotainment system. Voice control starts if the Infotainment system recognises the activation word. The ring memory overwrites it-

self around every 15 seconds. The ring memory is not active if the activation word is switched off. There is no transmission of data or words spoken in the vehicle.

### Switching activation word on and off

If the activation word is switched off, the voice control cannot be activated via the activation word.

— Touch **HOME** ►  ► Voice control ► Activation word.

### Speaking activation word and activation word recognition

Prerequisite:

- ✓ The Activation word is switched on in the settings.

**BG** Здравей ID.

**BR** Olá ID.

**CDN** Bonjour ID.

**CZ** Ahoj ID.

**D** Hallo ID.

**DK** Hej ID.

**E** Hola ID.

**F** Bonjour ID.

**FIN** Hei ID.

**GB** Hello ID.

**GR** Γεια σου ID.

**I** Ciao ID.

**J** ハロー ID

**MEX** Hola ID.

**N** Hallo ID.

**NL** Hallo ID.

**P** Olá ID.

**PL** Cześć ID.

**ROK** 안녕하세요 ID.

**RUS** Привет ID.

**S** Hej ID.

**TR** Merhaba ID.

**USA** Hello ID.



## Troubleshooting

### Voice control does not react

- Voice control is not available in your language.
- Set the correct language in the Infotainment system.
- Start the voice control function.
- System fault. Go to a qualified workshop.

### Voice control provides inappropriate answers

- The voice control system has interpreted the question incorrectly.
- Speak the voice command again clearly.

### Voice control does not perform function

- The function cannot be performed by voice control.
- Settings in the function prevent it from being switched on or performed.
- The voice control system has not understood the voice command.
- Insufficient data is available.





## Radio mode

### Introduction to the topic

In radio mode, you can receive available radio stations on different frequency bands and store your favourites to station buttons for quick access.


The available reception types and frequency bands depend on the equipment and country. Frequency bands may be discontinued, deactivated or no longer offered in individual countries.


#### Opening the Radio menu



- Touch **HOME** ▶  .

#### Opening settings

- Touch **HOME** ▶    ▶ **Radio**.

 The radio stations are responsible for the content of the information sent.

 Additional electrical devices connected in the vehicle can interfere with reception of the radio signal and cause noises in the loudspeakers.

 Foil or metal-coated stickers attached to the windows may affect reception on vehicles with a window aerial. 

### Equipment scope and radio symbols

 Please refer to  and  on page 218.

#### Radio

The available functions and the possible reception modes and frequency band depend on the vehicle equipment and country.


- FM dual tuner (antenna diversity).
- Combined station list (FM/DAB).
  - Combination of FM- and DAB stations in one list.


- Combined preset list.
  - Combination of all stations stored to station buttons in one list.
  - 36 station buttons as storage locations for favourites.
- Station logos.
- Aerial amplifier.
- DAB/DAB+.
- DAB slide show.
  - Stationary images are transmitted parallel to the current broadcast.
- Hybrid Radio.
- Internet Radio.


#### General symbols in radio mode


 **FM** Select FM frequency band.


 **FM/DAB** Select FM/DAB frequency band.


 **Internet radio** Select Internet Radio reception mode.


 Top right: select frequency band or reception mode.


 Show favourites that are saved to station buttons.  
Small in a station list: station already saved as a favourite to a station button.


 Open the settings.

 Select previous station from the station list or station on previous station button.


 Select next station from the station list or station on next station button.

 Mute radio.




 Display frequency band for manual selection of FM frequency.  
Possible only if the combined station list is switched off in the settings in Radio mode.

 Swap between radio and media mode.

 My playlist.

-  Add station as favourite.
- TP** Traffic news monitoring (TP) is activated.
- No TP** The selected traffic news station is not available.
- AF off** Automatic station tracking (AF) is switched off.
- RDS off** Radio Data System (RDS) is switched off.

#### Symbols in the FM and FM/DAB frequency band

-  No DAB reception possible.
-  DAB station supports slide show.
-  Slide show is not available for the DAB station.

#### Symbols in Internet Radio mode

-  Open full-text search.
-  No Internet Radio reception possible.
-  Display recently listened to internet radio stations.
- TOP 100** Display 100 most frequently listened to internet radio stations.
-  Display available internet radio podcasts.
-  Display internet radio stations from the desired country.
-  Display internet radio stations that broadcast in the desired language.
-  Display internet radio stations who broadcast programmes from the desired genre.
-  Display podcast episodes.
-  Display associated stations and podcasts.
-  Skip forward 15 seconds in podcast episode.
-  Skip back 15 seconds in podcast episode.


## Tuning, selecting and storing stations

 Please refer to  and  on page 218.

### Selecting a frequency band or reception mode

Before selecting a station, you must first select a frequency band or reception mode. Different stations are available depending on the selected frequency band or reception mode.

The available frequency bands and reception modes depend on the vehicle equipment and country.



1. Touch  to open the list of frequency bands and reception modes.
2. Select frequency band or reception mode:
  - FM (for devices without DAB support).
  - FM/DAB.
  - Internet Radio.
  - SiriusXM.

### Searching for and selecting stations

You can search for and select stations in different ways. The possibilities vary depending on frequency band and reception mode.

### Selecting via multifunction steering wheel


You can select stations from the station list or from the favourites via the multifunction steering wheel.

- To select the previous station, press  on the multifunction steering wheel.
- To select the next station, press  on the multifunction steering wheel.

### Selecting via frequency band (FM)

You can select frequencies and save them as favourites.

Prerequisite:

-  The combined station list is switched off in the settings.

1. Touch to show the frequency band.
2. Touch the marking, move on the frequency band and release at the desired frequency.

**OR:** touch a point on the frequency band. The marking automatically jumps to the corresponding frequency.

The station at the set frequency is set.

### Selecting from station list (FM/DAB)

The station list shows the stations that can currently be received. The station list is updated automatically.

1. Open the station list.
2. Touch the desired station.

The selected station is set. The best reception mode is selected automatically according to availability of the station.

### Searching for and filtering stations (Internet Radio)

In Internet Radio mode, you can search for stations by means of a full text search or filter stations according to categories.

1. To start the full text search, touch and enter the name of the desired station. The list of found stations is automatically updated during input.

**OR:** select the desired category to filter stations according to a category.

2. Touch the desired station.

### SCAN Searching in SCAN mode (FM/DAB)

In SCAN mode, the stations of the frequency band are automatically set successively and played for around 5 seconds in each case. SCAN mode is possible only in the additional window in which the current playback content is displayed.

1. Touch the SCAN function button to start the SCAN function.

The SCAN function starts and the currently set station is shown on the display. The SCAN function button is highlighted.

2. To select a station, touch SCAN. The SCAN function button is no longer highlighted.

The SCAN function stops and the station is set.

### Saving stations as favourites to station buttons

You can save up to 36 stations from different frequency bands and reception modes as favourites on station buttons.

1. Set the desired station.
2. Touch .

**OR:** touch and hold a station in the station list.

3. Touch .

**OR:** touch an already assigned station button and hold for around 3 seconds.

The station is stored to the selected station button.

If a station was already stored on the station button, this station will be removed from the station button and replaced by the new station.

## Online functions in radio mode

Please refer to and on page 218.

With some equipment levels, the Infotainment system has online functions in radio mode.

Internet Radio is an example of an online function in radio mode.

Requirements for using online functions in radio mode:

- ✓ The vehicle is equipped with We Connect Start.
- ✓ We Connect Start is activated and the vehicle is assigned to your user account.
- ✓ You have a data plan on the SIM-card of your mobile device and have connected

it to your vehicle using a WLAN hotspot  
→ page 210.

- ✓ *Optional:* you have purchased data packages from the In-Car Shop for use with the vehicle's eSIM → page 207,  
→ page 208.

## Special functions in radio mode

📖 Please refer to ⚠ and ⓘ on page 218.

The special radio mode functions listed below may not be available in all Infotainment systems depending on the equipment and country.

### TP (Traffic Programme)

The TP function monitors the traffic announcements from a set traffic news station and automatically outputs them during radio or media mode. Reception of a traffic news station must be possible for this. Traffic news stations are not available in all countries.

In media mode, the system will always automatically tune to a traffic news station in the background if one is available.

Some stations that do not broadcast their own traffic news support the TP function through a corresponding traffic news station (EON).

If no traffic news station can be received, **No TP** will be shown on the display. The unit automatically searches for a receivable traffic news station. TP will be shown on the display as soon as a new traffic news station can be received.

The TP function must be activated in the settings in order to receive traffic announcements.

### Activating the TP function

- In radio mode, touch ⚙ ▶ **Radio** and activate  **Traffic Programme (TP)**.

**OR:** in media mode, touch ⚙ ▶ **Media** and activate  **Traffic Programme (TP)**.

### Internet Radio

Internet Radio is a reception mode for internet radio stations and podcasts which is independent of FM and DAB. Due to transmission via the internet, reception is not regionally restricted.

Internet Radio is available only when the Infotainment system has an active internet connection. Costs may be incurred for data transmission from the internet when using Internet Radio mode.

### Station logos

Station logos may be pre-installed for some frequency bands in the Infotainment system.

The station logos will be assigned automatically to the stations if the **Autoselect station logos** function is activated in the settings.

In Internet Radio mode, the Infotainment system accesses station logos from an online database and automatically assigns them to the stations.

### Manually assigning station logos

1. In radio mode, touch ⚙ ▶ **Radio** ▶ **Station logos**.
2. Select the station to which you wish to assign a station logo.
3. Select station logo.
4. Repeat the process for further stations if desired.
5. Touch ⏪ to finish assigning station logos.

## Media mode

### 📖 Introduction to the topic

In media mode, you can play media files from data media and streaming services on the Infotainment system.

With some equipment levels, the following data media can be used:

- USB data medium, e.g. USB stick.
- Bluetooth device, e.g. mobile device.


With some equipment levels, the following types of media files can be played back:

- Audio files, e.g. music.
- Video files.

You can also use streaming services, depending on the equipment and country.

Conditions for using streaming services:

- ✓ We Connect or We Connect Plus is available in the vehicle.
- ✓ You have an active We Connect user account.
- ✓ The vehicle is assigned to your user account.
- ✓ You have purchased a corresponding data plan from the In-Car Shop or you have available data volume on the SIM card of your mobile device and are connected to your vehicle via WLAN Hotspot of your mobile device → page 210.
- ✓ You have a user account for the respective streaming service:

 Streaming services, such as Apple Music and TIDAL, can only be activated or deactivated as a group, even if they are listed separately in the menu → page 203.

#### Opening the Media menu

- Touch **HOME** ▶  ▶ .

#### Opening settings

- Touch **HOME** ▶  ▶  ▶ **Media**.

#### Restrictions and notes on data media



Dirty, overheated or damaged data media may be unusable. Observe the manufacturer's instructions.

Differences in the quality of data media from different manufacturers can interfere with media playback.

Incorrect configuration of a data medium can render it unreadable.

The read time of data media can be increased by the storage capacity, usage state (copying and deletion processes), file system, folder structure, and the amount of stored data.

Playlists simply specify a playback sequence. They link to the location of the media files within the folder structure. There are no media files stored in a playlist. To play a playlist, the media files must exist in the locations on the data medium referenced by the playlist.

 No liability can be accepted for damaged, modified or lost files on data media. 

## Equipment features and media symbols














 Please refer to  and  on page 218.

### Audio, media, connectivity




- Media playback and media control via Bluetooth.
- Audio playback in the following formats:
  - AAC.
  - ALAC.
  - AVI.
  - FLAC.
  - MP3.
  - MP4.
  - WMA.
- Video playback in the following formats:
  - MPEG-1 and MPEG-2 (.mpg, .mpeg).
  - ISO MPEG4; DivX 3, 4 and 5 Xvid (.avi).
  - ISO MPEG4 H.264 (.mp4, .m4v, .mov).
  - Windows Media Video 10 (.wmv, .asf).
- Cross-device playlists.
- Cross-source media database:

- The data of all media sources connected to the Infotainment system is stored in a media database.
- Media streaming (online).
- Media search.









### General symbols in media operation

-  Start playback.
-  Pause playback.
-  Go to previous track.
-  Go to next track.
-  Repeat current track.
-  Repeat all tracks.
-  Activate shuffle mode.
-  Show favourites list.
-  Add media file as favourite.
-  Top right: select media source.
-  Open the settings.
-  Open search.
-  Go back to higher-level folder of the media source.



### Symbols for media sources

-  Select **My media** as the media source. Connected USB devices can be selected under **My media**.
-  Select a device connected via Bluetooth as media source.
-  Set up available streaming services. Already set up streaming services will be displayed in the list of media sources with their own logo.

### Symbols for categories and groups of media files

-  Music tracks.
-  Videos.
-  Playlists.
-  Albums.
-  Artists.
-  Genre.
-  Podcasts.
-  Audio books.

### Symbols for video playback

-  Play video in full-screen mode.
-  Minimise playback.

## Selecting and playing a media source

 Please refer to  and  on page 218.

### Selecting a media source

1. Connect an external media source if you require playback from an external media source.
2. Select the connected media source that is to be used for playback.

### ▶ Playing audio and video files

You must connect and select a media source before playing media files.

You can search for and play media files from an available media source in various ways.


## ≡ Searching in the folder structure

All media files of USB devices are filtered according to categories, e.g. albums. This category view is always displayed in **My media**. The classic folder structure of the individual USB data media is additionally located in the **My media** folder.

1. Touch the desired folder.

The folder structure of the selected media source is displayed. If **My media** is selected, categories (music, videos, playlists) and connected media sources are displayed first.

2. Search through the folder structure for the desired track.

**OR:** touch  to start the full-text search. The input field is displayed.

3. Enter the name of the desired track. The list of found tracks is automatically updated during input.
4. Touch the desired track.


If the selection is located in a folder on a media source at the start of playback, the media files located in this folder will be added for playback.

If a playlist is played, all available tracks in the playlist will be added for playback.

5. Touch **X** to close the selection.

## ♥ Selecting favourites

You can save individual tracks, albums, artists and genres as favourites for playback.

1. Touch  to access the favourites.
2. Touch the desired favourite.

Depending on the selected favourite, all tracks that belong to the favourite are added to the current playback content.

## 📶 Streaming services

Depending on your equipment level and country, you can select and use streaming services as a media source directly via the In-fotainment system → page 234. The corresponding streaming service must be set up

and an Internet connection established before streaming services can be used.

## 📶 Setting up a streaming service

1. Touch **∨** and touch **Media streaming**.

A list of available streaming services is displayed.

2. Select the desired streaming service.

An input field for input of the login data is displayed.

3. Enter the login data of the desired user account and confirm.

The streaming service is added to the list of media sources as a new function button.

## 📶 Using a streaming service



1. Touch **∨**.

A list of available streaming services is displayed.

2. Select the desired streaming service.

## ♥ Saving favourites

Only media files that are displayed under **My Media** in the "Music" and "Video" folders can be saved as favourites. You can save individual tracks, albums, artists and genres.

1. Start playback of the desired track.
2. Touch .
3. Touch .

**OR:** touch an already assigned favourite location and hold for around 3 seconds.

4. Choose from the selection list:

- Track.
- Albums.
- Artists.
- Genres.
- Playlist.

The selection is saved as a favourite at the selected favourite location. If the favourite location was already assigned, the previously stored favourite is overwritten.

The selection options in the selection list depend on the data attached to the media file. If no genre is specified for music files, for example, the genre cannot be saved as a favourite.

If a video file is currently being played, only this video can be saved as a favourite. <

## Entertainment playback via the Infotainment system

📖 Please refer to ⚠️ and ⏸️ on page 218.

You can play music and videos on the Infotainment system.

### Video mode

In video mode, the Infotainment system display can play a video from a data medium or from a streaming service → page 236. The video soundtrack is played on the vehicle loudspeakers.

A stable Internet connection is required for playback via a streaming service. Costs may be charged by the mobile operator.

The video image is displayed only when the vehicle is stationary. When the vehicle is in motion, the Infotainment system display is switched off. The video audio can continue to be heard. <

## Navigation

### 📖 Introduction to the topic

The current vehicle position is determined by means of a global satellite system. All measurements and potential traffic reports are compared with the available map material to ensure optimum navigation to the destination.

The navigation is operated on the screen.

Acoustic navigation announcements and visual guidance direct the driver to the destination.

Depending on the country, some Infotainment functions can no longer be selected when the vehicle is travelling above a certain speed. This is not a malfunction, but simply a legal requirement.

### ⚠️ WARNING

Configure the settings and enter destinations and changes for the navigation only when the vehicle is stationary.



The navigation may recalculate the route if the driver misses a turning.



The quality of the navigation recommendations depends on the navigation data available and any reported traffic jams.



Traffic announcements will be output in the navigation system only if the available We Connect service has been activated.

### Navigation announcements

Navigation announcements are acoustic driving instructions for the current route.

The type and frequency of navigation announcements depends on the driving situation, e.g. start of route guidance, driving on a motorway or in a roundabout.

A navigation announcement informing you that you have reached the destination area is given if the exact destination cannot be reached, e.g. because it is located in a non-digitised area. In addition, information on the direction and distance to the destination are displayed on the screen.

During dynamic route guidance, you receive information about reported traffic jams on the route. An additional navigation announcement is given if the route is recalculated due to a traffic disruption or changed driving style → page 245.

The volume of a navigation announcement can be adjusted or muted during output of



the announcement. All other navigation announcements are given with this volume setting or are muted.



Navigation announcements are not given if the Infotainment system has been muted.

### Restrictions during navigation

When the Infotainment system cannot receive any data from GPS satellites, e.g. in a tunnel or underground car park, navigation can still continue using the vehicle sensors.

In areas that are not or are not completely included in the Infotainment memory, the Infotainment system will also try to enable route guidance.

If navigation data is unavailable or incomplete, the navigation system may be unable to determine the exact vehicle position. As a result, the navigation may not be as exact as usual.

Road navigation is subject to continuous changes, e.g. new roads, road works, road closures, changes in the road names and house numbers. In the case of obsolete navigation data, there may be errors or inaccuracies during navigation.

### Controlling the navigation map

For optimal viewing, you can also operate the navigation map with advanced finger movements.

### Moving the navigation map

*Recommendation: use your index finger.*

- Use your finger to move the navigation map.

### Enlarging the map view

*Recommendation: use your index finger.*

- Touch the map twice to zoom in on a particular position.

### Reducing the map view

*Recommendation: use your index and middle finger.*

- Touch the map twice with two fingers to zoom out at a particular position.

### Enlarging and reducing the map view

*Recommendation: use your index finger.*

- Touch the map twice and hold your finger on the screen.
- Move your finger upwards to zoom out from the map view. Move your finger downwards to zoom in on the map view.

### Enlarging and reducing the map view

*Recommendation: use thumb and index finger.*

- Touch the map simultaneously with two fingers and hold your fingers on the screen.
- Move your fingers together to zoom out from the map view. Move your fingers apart to zoom in on the map view.

### Tilting the map view

*Recommendation: use your index and middle finger.*

- Touch the map simultaneously with two fingers positioned horizontally to each other and hold your fingers on the screen.
- Move your fingers upwards to tilt the map view forwards. Move your fingers downwards to tilt the map view backwards.

### Rotating the map view

*Recommendation: use thumb and index finger.*


- Touch the map simultaneously with two fingers and hold your fingers on the screen.
- Turn your fingers clockwise or anticlockwise to rotate the map view.

### Stored data





The Infotainment system stores certain data, e.g. frequently driven routes and position in-

formation, to enable you to enter destinations quickly and to optimise route guidance.

### Deleting stored data

1. Touch  ► **Basic functions** ► **Delete usage pattern**.
2. Touch confirmation to delete. <

## Navigation equipment and symbols

 Please refer to  and  on page 218 and  at the start of the chapter on page 238.

### Navigation





The navigation functions depend on the equipment level and country.

The function buttons and displays depend on the settings and the current driving situation.

### Equipment








- Destination input and route calculation.
- Personal POIs.
- 3D City Maps.
- Online map update.
- Online Traffic Information.
- 360° range display.

### General navigation symbols






-  Search for and select destinations.
-  Display the navigation map.
-  Open the contact list of the connected mobile device to retrieve address data.
-  Open the settings.

### Map symbols

The map displays symbols for traffic announcements and POIs, e.g. filling stations, when navigation data is available → page 244.








-  Display current position.
-  Align the map to north.
-  Display additional window with route options.
-  Align the map to the direction of travel (position, zoom and angle).
-  Display additional window with further options.
-  Map scale.
-  Display information on the route.

### Symbols in the additional window





- To open the additional window, touch .
-  Repeat the previous navigation announcement.
-  Mute navigation announcements and adjust volume for navigation announcements.
-  Display route overview and information about the current route, e.g. alternative routes.
-  360° range display.

### Route plan symbols

Touch the route plan to open the route plan.

-  Current position.
-  Destination of the current route guidance.
-  End the current route guidance.
-  Forecast distance to the destination.
-  Forecast time of arrival at the destination.
-  Forecast time needed to reach the destination.
-  Close the route plan.








### Other symbols

-  Step-by-step destination input for an address.
-  Save as favourite.
-  Work (company).
-  Home (private).


### POI symbols

POIs are displayed on the map when navigation data is available.

Touch the desired POI to start route guidance → page 242.

-  E-charging station.
-  Filling station.
-  Car park.
-  Tourist information.
-  Train station.
-  Bank.
-  Restaurant.


### Setting preferred POI categories









The system offers various POIs, e.g. filling stations, as quick selection symbols in destination input, in the route plan and on the map. You can prioritise display of these symbols under  **Basic functions** ► **Define preferred POI categories**.

### Traffic reports





Traffic reports displayed on the map when navigation data is available → page 244, *Traffic information*.

Touch a traffic report to open an additional window with further details → page 245, *Function descriptions*.

-  Slow-moving traffic.

-  Traffic jam.
-  Accident.
-  Ice.
-  Road closed.
-  Risk of skidding.
-  Danger.
-  Road works.
-  Strong winds.

## Navigation data

 Please refer to  and  on page 218 and  at the start of the chapter on page 238.

The Infotainment system has an internal navigation data memory. Depending on the country, the required navigation data is already pre-installed.

In order to carry out route guidance correctly and make full use of the functions offered, the Infotainment system always requires up-to-date navigation data.

### ! NOTICE


If you use obsolete data, navigation may be impaired. Current routes cannot be determined or route guidance leads to the wrong destination.

- Always keep navigation data up-to-date.

### Updating navigation data online

Navigation data for frequently travelled regions is automatically updated in the background with an existing Internet connection and valid privacy settings → page 204, *Privacy settings*.


- Navigation data is automatically updated while the ignition is switched on.



 Automatic update of navigation data depends on the privacy settings set. No update is carried out in offline mode → page 204.

### Updating navigation data manually

Current navigation data for larger regions, e.g. Western Europe, can be downloaded from the Internet at "www.volkswagen.com" and stored on a suitable USB data medium available commercially. If you switch off the Infotainment system, installation will be interrupted and will automatically continue once the unit is switched on again.

1. Download the navigation data and save on a USB data medium.
2. Switch on the vehicle ignition.
3. Connect the USB data medium to the Infotainment system. The navigation data for regions that are currently frequently travelled is automatically updated in the background.

 When you update navigation data manually, the USB data medium must remain continuously connected. No message is output to indicate that the update has been completed.





— To display the map data version, touch   ▶ System information.

### WARNING

Updating navigation data manually while driving may result in accidents and serious injuries.

- Only update navigation data when the vehicle is stationary.

## Starting route guidance

 Please refer to  and  on page 218 and  at the start of the chapter on page 238.

Depending on country and vehicle equipment, different functions are available for destination input.

Further information about the symbols on the Infotainment system display is available on → page 240.

You can more precisely limit the search by indicating preferences in the results list, such as 'nearby'.

Destination inputs are located in the main menu of the navigation system.

### Opening the Navigation menu

— Touch  ▶ .




### Opening settings

— Touch  ▶  ▶ .


### Entering an address


Enter an address for route guidance. The navigation system will suggest known destinations during input. You can also enter a new, as yet unknown address for route guidance.

### Selecting a destination and starting navigation

1. Touch .  
**OR:** touch .
2. Enter the address of the destination and select the desired destination.
3. Touch Start.  
**OR:** touch .

### Quick start

1. Touch .
2. Enter the address of the destination and press and hold the desired destination for a few seconds.

 Enter the destination as accurately as possible. If you make a mistake when entering the destination, route guidance will not be possible or you may be navigated to the wrong destination.


### Recommended destinations

The navigation system uses stored data such as the last and learned destinations, favour-

ites, and home and work addresses so it can use this data for route guidance.

### Selecting a destination and starting navigation

---



1. Touch  **Suggested**.
2. Touch the desired destination.  
Route guidance starts automatically.

### Last destinations

The navigation system stores up to 25 destinations that you have driven to last in order to make them available for route guidance. A new destination automatically overwrites the oldest destination.


### Selecting a destination and starting navigation

---

1. Touch  **Last destinations**.
2. Touch the desired destination.
3. Touch **Start**.  
**OR:** touch .

### Quick start

---


1. Touch  **Last destinations**.
2. Touch the desired destination and hold for a few seconds.

### Favourite destinations

Save up to 50 destinations as favourites.



### Saving a destination as a favourite

---

- When inputting a destination, touch  in the additional window.


### Selecting a destination and starting navigation

---

1. Touch  **Favourites**.
2. Touch the desired destination.
3. Touch **Start**.  
**OR:** touch .

### Quick start

---

1. Touch  **Favourites**.

2. Touch the desired destination and hold for a few seconds.

### Selecting on the map

The navigation map contains active areas at many locations which are suitable for destination input. To enter a destination, touch the desired position or location on the map. You can start route guidance if map data is available at this location.

Destination input via the navigation map depends on the data status and is not possible for all positions.

Use the “offroad navigation” function to enter a destination point with unknown data.



### Offroad navigation

The “offroad navigation” function calculates routes to selected destination points with unknown data. If a destination point is not on known roads or there is no positioning data available for this point, the navigation system will calculate the route up to the nearest point on the known roads and then complete the route up to the destination point by a direct connection.

To start “offroad navigation”, touch a free area without positioning data.

### Starting navigation


---

1. Touch .
2. Move the map view until the desired position can be selected. The navigation map can be operated by extended touch gestures → page 238.
3. Touch the desired destination or any destination point on the map without positioning data.
4. Touch **Start**.  
**OR:** touch .

### Using the address data of a contact

Start navigation using the stored address data of a contact. Stored contacts without address data cannot be used for route guidance.

## Starting navigation


1. Touch .
2. Touch the desired contact and address data.
3. Touch Start.

OR: touch .


### NOTICE

If the address data of a contact is out-of-date, navigation will still be performed to the stored address. Make sure that the address of the contact is up-to-date.

## Adding charging stops automatically

To automatically add charging stops, activate the automatic planning of necessary charging stations along the route in the route options .

In the settings you can enter the desired method of payment at the charging stations. Depending on the selection and the available data, suitable charging stations will be planned along the route in the map view.

The charging limit for the vehicle can be adjusted in the main menu Vehicle .

## Selecting alternative charging stations

Instead of the automatically planned charging stations, you can also select alternative charging stations for the planned routes.

1. Enter or select the desired destination.
2. Touch Start.
3. Open the route plan.
4. Touch a planned charging station in the route plan.

Details of the planned charging station are displayed.

5. Touch Show more charging stations.

The location of additional nearby charging stations will be shown on the map.

6. Touch an alternative charging station nearby on the map or in the list.

Details of the alternative charging station are displayed.

7. Touch Charge here.





OR touch: Add as stopover.

The previously planned charging station will be replaced by the newly selected charging station and the route adjusted accordingly.



If you select Add as stopover, the selected charging station will be kept if the route is changed. <

## Traffic information

 Please refer to  and  on page 218 and  at the start of the chapter on page 238.

The Infotainment system automatically receives detailed traffic information when connected to the Internet. This information is indicated by symbols and colouring of the road network on the map.



Receipt of traffic information depends on the privacy settings set. No traffic information is received in offline mode → page 204.

## Traffic reports

Traffic reports, e.g. traffic jams or slow-moving traffic are shown as symbols on the navigation map → page 240, *Navigation equipment and symbols*.

When route guidance is active, traffic reports that are on the current route are displayed in the route plan. You can bypass these traffic reports → page 245, *Function descriptions*.





## Traffic flow display

The traffic flow is shown on the navigation map for all traffic reports by colouring of the road network.

**Orange** Slow-moving traffic.

**Red** Traffic jam. <

## Function descriptions


 Please refer to  and  on page 218 and  at the start of the chapter on page 238.

### Route plan

The route plan contains information on relevant events, such as stopovers and suggested destinations, if navigation data is available.

When you touch an event, an additional window opens with further options. The options available depend on the event and the current settings → page 238.

### Opening and closing the route plan

- Touch the route plan to open the route plan.
- To close the route plan, touch >.
- To stop route guidance to the destination or stopover, touch  next to the destination in the route plan.

### Editing route guidance

To edit route guidance, open the route plan and move the stopovers or destination in the route plan.

1. Hold the desired destination until it is visibly highlighted.
2. Move the destination to the desired position.
3. Take your finger off the screen. The route will be recalculated.

### Avoiding traffic incidents

The route plan displays current reports of traffic incidents when navigation data is available. To bypass traffic reports, open and edit the route plan → page 244, *Traffic information*.

1. Touch the traffic announcement.
2. Touch **Bypass**. The route will be recalculated.

### Additional window

If you touch the entries of the route plan, an extra window with additional options for

these entries can appear. The possible options depend on the entry touched.

### Closing the additional window

- Touch a free area outside the additional window.

Functions in the additional window:

**Show on map** Display the selection on the map.

**Add stopover** Add a stopover to the route guidance.

**Directly to dest.** Start direct route guidance.

**Delete** Delete stopover from route guidance.

**Bypass** Bypass traffic congestion. The route will be recalculated.

**Stop** End the current route guidance.




Save destination as a favourite.



Add a destination as a stopover or start direct route guidance to the destination.

### “Learning usage patterns”

While travelling, the navigation saves the routes travelled and destinations arrived at in order to create suggested destinations automatically. Destinations are learned depending on the time of day and the day of the week.

The navigation system can suggest learned routes. Touch  **Suggested** to display the suggested routes.

Route guidance begins when one of the suggested routes is selected.

The route guidance follows the selected route until the vehicle deviates from it. The route is recalculated and will guide you back to the selected route via a direct alternative.


Relevant traffic disruptions are taken into account in the route guidance. Relevant traffic disruptions will be avoided if an alternative route and the navigation data is available.

If you drive an already learned route when route guidance is inactive, the destination will be transferred to the route plan. It is not necessary to actively start route guidance to the learned destination. Warnings may be given about traffic disruptions.


A forecast arrival time will be displayed.

You can activate or deactivate the function at any time and also delete the stored data for the function.

### Activating and deactivating "Learn usage pattern"

1. Touch  ▶ **Basic functions** to open the settings for this function.
2. To activate the function, activate **Learn usage pattern**.
3. To deactivate the function, deactivate **Learn usage pattern**.



### Deleting stored data


1. Touch  ▶ **Basic functions** ▶ **Delete usage pattern** to delete the stored data for the function.
2. Touch confirmation to delete.


### 360° range display.

The 360° range display shows the possible range with the current charge level of the high-voltage battery.

### Activating the 360° range display

– Touch  ▶ .

 If the charge level is too low, the operating range display is automatically hidden. When the battery has recharged, the range display will reappear.

 To show the complete range display on the map, you may need to adjust the map view → page 238.

## Mobile phone interface

### Introduction to the topic


You can connect your mobile phone to the Infotainment system via the telephone interface and then use the Infotainment system to control the telephone functions. Sound is

played back using the via the vehicle loudspeakers.

You can connect up to two mobile devices to the Infotainment system simultaneously. Only one device is active and can be used to make calls. You can use the second connected device to receive calls via the Infotainment system and for media playback.

High speeds, poor weather and poor road conditions, loud noise levels (also outside the vehicle) and also network quality may impair telephone calls in the vehicle.

The mobile phone interface may contain an aerial amplifier which improves the reception quality of the mobile device.


 As a general rule, a device, e.g. mobile device, must only be paired once. The Bluetooth or Wi-Fi connection of the device with the Infotainment system can be re-stored at any time without having to pair the device again.

### Opening the menu for the mobile phone interface

– Touch  ▶  ◀

## Equipment and symbols of the mobile phone interface

 Please refer to  and  on page 218.

 The specified equipment features and symbols are not available in all markets and for all Infotainment systems.

### Equipment features







- Hands-free function.
- Use up to two mobile devices simultaneously.
- Phone book with a maximum of 5,000 contact entries.
- Text message functions via Bluetooth:
  - Read text messages.



- Write text messages (including templates).
- Have text messages read out loud.
- Message history.
- Email functions via Bluetooth:
  - Read emails.
  - Write emails.
- Convenience telephony → page 250.
- Connection to wireless charging facility (wireless charging function) → page 250.
- Connection to microphone installed in the vehicle.







### General symbols in the menu for the mobile phone interface






*The appearance of the symbols may differ depending on Infotainment system.*

-  Contacts.
-  Call lists for incoming and outgoing calls.
-  Dial phone number.
-  Text messages (texts and email).
-  Open the settings.
-  Select the active device from two or more connected mobile phones.







### Symbols for phone calls

*The appearance of the symbols may differ depending on Infotainment system.*

-  Start call, accept call or bring to foreground.
-  End or reject call.
-  Opens the contact list.
-  Dial phone number.
-  Mute hands-free system.
-  Hold call.

-  Start conference.
-  Make emergency call.
-  Obtain help in the event of breakdown.
-  Obtain information about the Volkswagen brand and selected value-added services relating to traffic and travel.
-  Voicemail.

### Symbols in the contact window


- Touch  to open the contact window.
-  Input to search for contacts.
-  Address.
-  Edit favourites.
-  Add contact as favourite.
-  Remove favourites.

### Symbols for call lists


- Touch  to open the call lists.
-  Incoming call.
-  Outgoing call.
-  Missed call.
-  Phone number (work).
-  Phone number (private).
-  Mobile number.
-  Fax (business).
-  Fax (private).


### Symbols for text messages and emails

*The appearance of the symbols may differ depending on Infotainment system.*


- To open text messages and emails, touch 

✓ Top left: select active input.

-  Activate voice recording (voice input) to answer and create messages  
→ page 228.

 Templates for text messages.

 Received text message.

 Sent text message.

## Areas where special regulations apply

 Please refer to  and  on page 218.

Switch off the mobile device and mobile phone interface in areas where there is an explosion hazard. These areas are not always clearly signposted. They include, for example:


- Areas immediately around chemical pipelines and tanks.
- Lower decks of ships and ferries.
- The area around vehicles which run on liquid gas, such as propane or butane.
- Places where there are chemicals or particles such as flour, dust and metal powder in the air.
- All other locations where the mobile device must be switched off.

### WARNING

Switch off the mobile device and mobile phone interface in areas where there is an explosion hazard.


### NOTICE

Your mobile device must always be switched off in areas where special regulations apply and when the use of mobile devices is forbidden. The radiation produced by the mobile

device when switched on may interfere with sensitive technical and medical equipment, possibly resulting in malfunction or damage to the equipment. 

## Pairing, connecting and managing

 Please refer to  and  on page 218.

 Pair a telephony-capable mobile device with the Infotainment system to use the functions of the mobile phone interface. The mobile device must be paired with the Infotainment system before the first connection is established. A user profile is then automatically stored in the Infotainment system.

The pairing process can take a few minutes. The available functions depend on the mobile device used and its operating system.

### Pairing the mobile device

Prerequisites for pairing:

- ✓ Bluetooth is activated on the mobile device.
- ✓ Bluetooth is activated in the Infotainment system.

1. Open the list of available Bluetooth devices on the mobile device and select the device name of the Infotainment system.
2. Observe the messages on the mobile device and Infotainment system and confirm as necessary.


If pairing was successful, the data of the mobile device will be stored in the user profile.

3. *Optional:* confirm message for data transfer on the mobile device.

### WARNING

If you carry out pairing when driving, this can cause accidents or injuries.

- Carry out pairing only when the vehicle is stationary.




 When some mobile devices are paired, a PIN is shown on the display of the mobile device. To finish the pairing procedure, enter this PIN on the Infotainment system.

### Bluetooth pairing via NFC


NFC is not available in all countries and vehicle models. Depending on the vehicle equipment, NFC is not available in every vehicle with a wireless charging function.

Prerequisites for one-off pairing:

- ✓ NFC technology and a stowage compartment with wireless charging function are installed in the vehicle.
- ✓ NFC is activated on the mobile device.

1. Touch    Select mobile telephone.
2. Unlock the mobile device.
3. Place the mobile device correctly on the stowage area for the wireless charging function.
4. Continue and confirm Bluetooth pairing in accordance with the displays on the mobile device and Infotainment system.

The mobile device is paired with the Infotainment system.

 The wireless charging function is deactivated while the Infotainment system is in the **Known mobile phones** menu. The wireless charging function will be reactivated when you leave the menu.

### Managing connections

Prerequisites:

- ✓ The mobile device is paired and connected.

1. Touch    Mobile devices.
2. Touch the technology desired for the connection.

### Active and passive connection

At least one mobile device must be connected to the Infotainment system in order to use the functions of the mobile phone interface. If several mobile devices are connected to the Infotainment system, you can switch between active and passive connections. Establish an active connection to the Infotainment system in order to operate the mobile phone interface with the desired mobile device.

### Difference between the connection types


**Active** Mobile device is paired and connected. The functions of the mobile phone interface are performed with the data of this mobile device.

**Passive** Mobile device is paired and connected. Only incoming calls can be accepted via the mobile phone interface. No other functions are available.

Paired mobile devices are stored in the Infotainment system even if they are not currently connected.

### Changing the connection type (passive to active)

The connection type can be changed only if several mobile devices are connected to the Infotainment system at the same time.

1. Touch . The mobile device with active connection is marked.
2. Touch the name of the desired mobile device. Other mobile devices then automatically have a passive connection.


### User profiles

An individual user profile is automatically created for every paired mobile device. Data from the mobile device are stored in the user profile, e.g. contact details. A maximum of ten user profiles can be stored in the Infotainment system simultaneously.

### Deleting a user profile

1. Touch  .

The user profiles are located in the area **Select mobile telephone** or **Mobile devices**.

2. Touch the desired user profile and touch  to delete.

## Types of mobile phone interface

 Please refer to  and  on page 218.

Depending on country and vehicle equipment, the following mobile phone interface types may be present in your vehicle:

- Basic mobile phone interface.
- Comfort mobile phone interface.

### Basic mobile phone interface

The Basic mobile phone interface uses the HFP Bluetooth profile for transmission. This allows use of telephone functions via the Infotainment system and output via the vehicle speakers.

### Comfort mobile phone interface

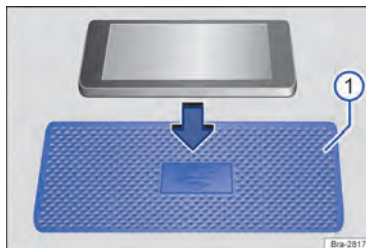
The Comfort mobile phone interface uses the HFP Bluetooth profile like the Basic mobile phone interface.

The Comfort mobile phone interface may be equipped with a wireless charging function → page 250.

In order to use the wireless charging function, you must place a suitable mobile device correctly in the stowage compartment. Depending on equipment, the mobile device is paired with the vehicle aerial. This improves the reception and call quality.

## Wireless charging function


 Please refer to  and  on page 218.



**Fig. 124** Illustration: stowage area with mat for wireless charging function.

The wireless charging function is dependent on the equipment level and is not available in all countries.

The stowage area with lining mat for the wireless charging function is located either in the centre console or in the area between the front seats, depending on the vehicle.

In some vehicles, the lining mat has a telephone symbol that marks the centre position of the wireless charging function → Fig. 124 .

The wireless charging function enables wireless energy transmission by electromagnetic induction over a short distance.

The maximum charging power is 5 watts.

The Qi standard enables wireless charging of suitable Qi-enabled mobile devices.

Consult the operating manual for the mobile device to find out if it is compatible with the Qi standard. The manufacturer of the mobile device can provide more information on compatibility.

Always place only one Qi-enabled mobile device without a protective case and with maximum dimensions (width x length) of 80 mm x 140 mm (3.15 in x 5.512 in) flat on the stowage area of the wireless charging function.

Qi-capable mobile devices with larger dimensions cannot be charged wirelessly.

Before charging, remove any foreign objects with metallic components such as coins from the stowage compartment and observe the operating instructions for the mobile device.

To charge a Qi-enabled mobile device, remove the protective cover and place the entire surface of the device flat in the centre of the stowage area with the display facing upwards. The charging process starts automatically.

The factory-fitted Infotainment system will provide information about the start of the charging operation and, where applicable, about any foreign objects with metallic components that are detected in the stowage compartment. **Remove foreign objects immediately.**

If the mobile device has not been positioned correctly in the stowage area or is too large, it cannot be detected or cannot be detected correctly. In certain circumstances, the Infotainment system will report that there is a foreign object in the stowage compartment. The fault can be rectified if a suitable mobile device is used and its position is corrected.

#### Stowage compartment cover

The storage compartment for the wireless charging function has a cover for the mobile device's display.

Always place only one mobile device with maximum dimensions (width x length) of 80 mm x 140 mm (3.15 in x 5.512 in) in the stowage compartment with cover in accordance with the specifications.

The cover can prevent distractions caused by the mobile device, e.g. incoming messages.

The cover must always remain closed when driving and the mobile device display must be fully covered.

#### WARNING

Notifications on the mobile device display can distract the driver and increase the risk of a serious accident.

- Always place only one suitable mobile device, where applicable Qi-capable, without protective case and with maximum dimensions (width x length) of 80 mm x 140 mm (3.15 in x 5.512 in) in accordance with the specifications on the stowage area in the stowage compartment.
- Remove any objects that impede the cover closing function.
- Always keep the cover closed when driving.

#### WARNING

Do not place any objects made of metal or with metallic components on the stowage area of the wireless charging function. Metallic objects may become very hot. This may cause burn injuries to the skin and cause a fire.


#### NOTICE

Do not place any ID cards, credit cards etc. with magnetic strips or with a chip on the stowage area with the wireless charger feature. The data saved on the magnetic strip or on the chip may become unusable. <

## Making phone calls and sending messages

 Please refer to  and  on page 218.

#### Opening the mobile phone interface



— Touch **HOME**  .


#### Using the telephone


Select a telephone number to start the call. Different functions are available for selection of phone numbers.

## Using contact data

*If there are several phone numbers for each contact, you must select the desired phone number.*


— Touch  ►  and enter the contact data you are looking for. Touch the contact in the list to start the call.


**OR:** touch  ► **Favourites**. Touch a contact in the list to start the call.


**OR:** touch  ► **All**. Touch a contact in the list to start the call.

## Using the call list



The mobile phone interface stores incoming and outgoing calls in the call list. Frequently used phone numbers are stored as favourites. Start calls via the call list.


— Touch  ► **All**. Touch a number in the list to start the call.

**OR:** touch  ► **Missed**. Touch a number in the list to start the call.

**OR:** touch  ► **Mobile**. To start the call, touch a contact or number.

## Entering a phone number manually

1. Touch  and enter a phone number.
2. Touch  to start the call.


 While you are entering a phone number, contacts that match the number will be shown on the Infotainment system display.

## Sending text messages


Depending on the mobile device and the Infotainment system used, you can send and receive text messages and emails via the mobile phone interface.

## Switching between text messages and email



To send text messages or emails, select the corresponding inbox at the top left of the screen. The active inbox is displayed on the screen, e.g. **Text message**.

1. Touch .
2. Touch the desired inbox.

## Sending text messages

1. Touch  and the **Text message** inbox.
2. Touch **Enter new message** at the bottom of the screen and enter a new message.
3. Touch **OK**.
4. Touch one or more contacts or the desired number in the list. If necessary, you can search for a contact by means of **Search for contact**.
5. Touch **Send**.

## Sending emails

1. Touch  and the **EMAIL** inbox.
2. Enter a subject and the message on the screen.
3. Touch **OK** and select one or more contacts in the list. If necessary, you can search for a contact by means of **Search for contact**. 

## Telephone book, favourites and speed dial buttons

 Please refer to  and  on page 218.

### Telephone book

The telephone book is stored in the Infotainment system when a telephone is paired with the Infotainment system for the first time. It may be necessary to confirm transfer on the mobile device.

The telephone book is updated each time a new connection is established. The still existing telephone book can be used during the update.

If conference calls are supported, the telephone book can be opened during a call and a further participant added to the call.

If an image is stored for a contact, this can also be displayed in the list next to the entry.


### Favourites and speed dial buttons

A favourite from the telephone book can be assigned to a speed dial button. If an image is stored in the entry, this will be displayed on the speed dial button.

Speed dial buttons must be assigned manually and are assigned to a user profile  
→ page 248.

#### Assigning a speed dial button

---

1. Touch .
2. Touch a contact from the telephone book. If several phone numbers are stored for a contact, touch a number from the list.

#### Editing a speed dial button

---

1. Press and hold the speed dial button until the telephone book is opened.
2. Touch a new contact from the telephone book. If several phone numbers are stored for a contact, touch a number from the list.

#### Calling a favourite

---





— Touch the assigned speed dial button.



Favourites are not automatically updated. If the phone number of a contact changes, the speed dial button must be assigned again.

#### Deleting favourites from the speed dial button


---

1. Touch Favourites  .
2. Touch  on the desired speed dial button to delete a favourite. 

# Transporting items

## Stowing luggage and loads

### Stowing luggage safely in the vehicle

- Always distribute any loads in the vehicle as evenly as possible. Do not cover any ventilation openings.
- Always stow luggage and heavy objects in the luggage compartment →  and place them as far forwards as possible.
- Observe gross axle weight ratings and the gross vehicle weight rating → page 387.
- Secure luggage to the fastening rings in the luggage compartment using suitable lashing, fixing and securing straps → page 259.
- Also stow small objects safely.
- If necessary, fold back the rear seat backrest and engage it securely.
- If necessary, adjust the headlight range → page 109. Vehicles with dynamic headlight range control adapt automatically to the load.
- Adjust the tyre pressure according to the vehicle load. Observe the tyre pressure sticker → page 332.

### WARNING

Objects that are not secured, or are secured incorrectly, can cause serious injuries in the event of a sudden driving or braking manoeuvre or accident. This applies particularly if objects are struck when the airbag is triggered and then flung through the vehicle interior. To reduce the risk of accidents, please observe the following guidelines:

- Always stow all objects in the vehicle securely. Always observe the legal regulations.
- Objects should be stowed in the vehicle interior in such a way that they can nev-

er enter the airbag deployment zones while the vehicle is in motion.

- Always keep stowage compartments closed while the vehicle is in motion.
- Stowed objects must never cause passengers to assume an incorrect sitting position.
- If an item is being stowed on a seat, this seat must not be used by any passengers.
- Do not stow any hard, heavy or sharp objects loose in any of the vehicle's open stowage areas, on the surface behind the rear seat backrest or on the dash panel.
- Remove any hard, heavy or sharp objects from items of clothing and bags in the vehicle interior and stow them securely.

### WARNING

Transporting heavy objects changes the vehicle's handling due to the change in the centre of gravity and increases the braking distance. Heavy loads that are not properly stowed or secured in the vehicle can lead to a loss of vehicle control and can cause serious injury.

- Never exceed the vehicle's maximum load. Both the load and the distribution of the load in the vehicle will have an effect on the driving response and braking distance of the vehicle.
- Transporting heavy objects changes the vehicle's handling and the centre of gravity.
- The load should be distributed as evenly as possible in the vehicle.
- Always secure heavy objects in the luggage compartment as far in front of the rear axle as possible.
- Loose objects in the luggage compartment can suddenly slide and change the way the vehicle handles.
- Always adapt your speed and driving style to suit visibility, weather, road and traffic conditions.



- Accelerate carefully and gently.
- Avoid sudden braking and driving manoeuvres.
- Brake earlier than in normal driving.

### NOTICE


Rubbing objects on the rear windows can cause damage, e.g. to the heating wires of the rear window heating.

## Luggage compartment cover



**Fig. 125** In the luggage compartment: removing and installing the luggage compartment cover.

When the boot lid is opened and closed, the luggage compartment cover is also raised and lowered if the retaining straps are attached.

The luggage compartment cover is not suitable as a shelf for objects, not even for light pieces of clothing → .

### Removing the luggage compartment cover

- Unhook the retaining straps from the boot lid → Fig. 125 (upper arrows).
- Push the luggage compartment cover out of the side holders (lower arrows) from below.

### Fitting the luggage compartment cover

- Push the luggage compartment cover into the side retainers from above → Fig. 125 (lower arrows).
- Hook the retaining straps onto the boot lid (upper arrows).

### WARNING

Objects or animals on the luggage compartment cover can damage the luggage compartment cover and cause serious injuries in the event of sudden driving or braking manoeuvres or accidents.

- Never transport objects or animals on the luggage compartment cover.

### NOTICE

To prevent damage to the luggage compartment cover, do not load it to such a height that the load will press against the luggage compartment cover when the tailgate is closed.

## Luggage compartment floor

### Luggage compartment floor – Functions



**Fig. 126** In the luggage compartment: luggage compartment floor

The rear part of the luggage compartment floor can be folded forward → Fig. 126. There is a stowage compartment, e.g. for the vehicle toolkit, under this → page 292.

### NOTICE

Incorrect use can damage the luggage compartment floor or the trim of the luggage compartment.

- Always guide the luggage compartment floor down carefully when closing and do not allow to drop.
- Always distribute loads over as wide an area as possible on the luggage compartment floor in order to avoid point loads.

## Second luggage compartment floor – Functions

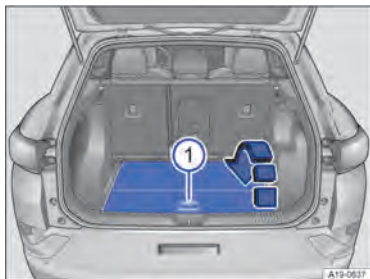


Fig. 127 In the luggage compartment: opening the second luggage compartment floor.

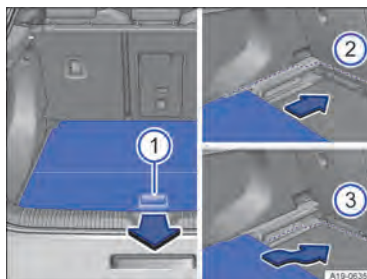


Fig. 128 In the luggage compartment: adjusting the height of the second luggage compartment floor.

Depending on the vehicle equipment, the vehicle may have a height-adjustable second luggage compartment floor.

### Opening and closing the second luggage compartment floor

- To *open*, grasp the handle → Fig. 127 ① and fold the rear part of the luggage compartment floor forward in the direction of the arrow.
- To *close*, fold back the luggage compartment floor and carefully lower into position → ①.

When the luggage compartment floor is in the lower position, the rear part touches the sides of the luggage compartment when opened and must be pressed over a slight resistance.

### Adjusting the height of the second luggage compartment floor

The second luggage compartment floor can be fitted in upper and lower positions:

- Lift the luggage compartment floor by the handle → Fig. 128 ① and pull it rearwards out of the guides on the sides of the luggage compartment.
- Insert the luggage compartment floor into the guides at the required height → Fig. 128 ② or ③ and push it forwards as far as it will go.

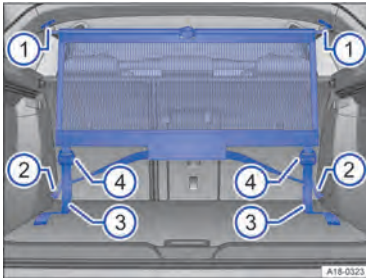
## NOTICE

Incorrect use can damage the second luggage compartment floor or the trim of the luggage compartment.

- Always guide the second luggage compartment floor down carefully when closing and do not allow to drop.
- Always distribute loads (maximum 50 kg) over as wide an area as possible on the luggage compartment floor in order to avoid point loads.

## Partition

### Fitting and removing the partition behind the rear bench seat



**Fig. 129** Partition installed behind the rear bench seat

The fitted partition can help to prevent objects from being flung from the luggage compartment into the passenger compartment, e.g. when braking.

The partition can be optionally installed behind the rear bench seat → Fig. 129 or behind the front seats → page 258.

### Fitting the partition

- Take the partition out of the bag, unroll and fold open. The partition hinge must audibly engage.
- Hook one of the retaining hooks of the upper transverse rods into one of the mounts in the roof → Fig. 129 ① → ①.
- Press both ends of the upper transverse rod together slightly and hook the second retaining hook into the opposite mount in the roof.
- Let go of the transverse rod and check that both retaining hooks of the partition are correctly engaged → ⚠.
- Hook the bottom retaining hooks into the fastening rings at the front of the luggage compartment → Fig. 129 ②.
- Pull the ends of the securing straps → Fig. 129 ③ towards the rear until the partition is securely tensioned.

### Removing the partition

- Undo the securing straps of the partition wall → Fig. 129 ③ by lifting the belt buckles → Fig. 129 ④.
- Unhook the bottom retaining hooks from the fastening rings at the front of the luggage compartment → Fig. 129 ②.
- Press both ends of the top transverse rod together and hold until the partition has been removed.
- Pull the partition to the rear slightly and then carefully remove from the mounts in the roof by pulling downwards → Fig. 129 ①.
- Press the release button on the transverse rod joint and fold up the partition.
- Roll up the partition and stow in the bag.

## WARNING

In the event of a sudden braking manoeuvre or accident, objects could be flung through the interior and lead to severe or fatal injuries.

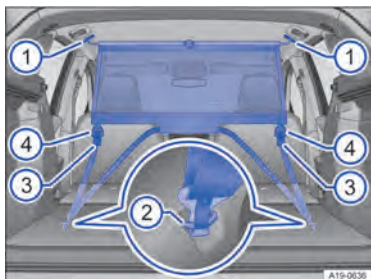
- Always check after installation to make sure that the retaining hooks of the partition are correctly engaged.
- Additionally secure all objects in the luggage compartment even when the partition is installed.
- While the vehicle is moving, no passengers may travel behind the fitted partition.

### NOTICE

If the partition is not secured at the mounting points provided for this purpose, this may result in damage.

- Always secure the partition only to the designated mounting points.

## Fitting and removing the partition behind the front seats



**Fig. 130** Partition installed behind the front seats.

The fitted partition can help to prevent objects from being flung from the luggage compartment into the passenger compartment, e.g. when braking.

The partition can be optionally installed behind the rear bench seat → page 257 or behind the front seats → Fig. 130.

### Fitting the partition

- Take the partition out of the bag, unroll and fold open. The partition hinge must audibly engage.
- Fold the seat backrests in the second row forward → page 93.
- Hook one of the retaining hooks of the upper transverse rods into one of the mounts in the roof → Fig. 130 ① → ①.
- Press both ends of the upper transverse rod together slightly and hook the second retaining hook into the opposite mount in the roof.
- Let go of the transverse rod and check that both retaining hooks of the partition are correctly engaged → ⚠.
- Hook the bottom retaining hooks into the anchor points in the B-pillar next to the front seats → Fig. 130 ②.
- Pull the ends of the securing straps → Fig. 130 ③ towards the rear until the partition is securely tensioned.

### WARNING

The anchor points on the B-pillar next to the front seats are *not fastening rings* and must be used only for securing the partition. Fatal or serious injuries may result if the anchor points are used to secure loads.

- Use the anchor points on the B-pillar next to the front seats only to secure the partition.

### Removing the partition

- Undo the securing straps of the partition wall → Fig. 130 ③ by lifting the belt buckles → Fig. 130 ④.
- Unhook the bottom retaining hooks from the anchor points on the B-pillar next to the front seats → Fig. 130 ②.
- Press both ends of the top transverse rod together and hold until the partition has been removed.

- Pull the partition to the rear slightly and then carefully remove from the mounts in the roof by pulling downwards → Fig. 130 ①.
- Press the release button on the transverse rod joint and fold up the partition.
- Roll up the partition and stow in the bag.
- If necessary, fold back the backrests of the second seat row and engage in position → page 93.

### **⚠ WARNING**

In the event of a sudden braking manoeuvre or accident, objects could be flung through the interior and lead to severe or fatal injuries.

- Always check after installation to make sure that the retaining hooks of the partition are correctly engaged.
- Additionally secure all objects in the luggage compartment even when the partition is installed.
- While the vehicle is moving, no passengers may travel behind the fitted partition.

### **ⓘ NOTICE**

If the partition is not secured at the mounting points provided for this purpose, this may result in damage.

- Always secure the partition only to the designated mounting points. ◀

## Luggage compartment equipment

### Fastening rings



**Fig. 131** In the luggage compartment: fastening ring.

There are fastening rings in the luggage compartment which can be used to secure loose items and luggage with the help of lashing, retaining or securing straps → Fig. 131.

### **⚠ WARNING**

Unsuitable or damaged lashing, retaining or securing straps could tear in the event of a braking manoeuvre or accident. This could cause objects to be flung through the vehicle interior and lead to severe or fatal injuries.

- Always use suitable and undamaged lashing, retaining or securing straps.
- Pull lashing, retaining and securing straps taut crosswise over the cargo on the luggage compartment floor and attach securely to the fastening rings.
- Make sure that the upper edge of the load is higher than the fastening rings, particularly when stowing flat objects.
- Depending on the vehicle equipment, observe the signs about stowing loads that are attached in the luggage compartment.
- Never secure a child seat to the fastening rings.

## **⚠ WARNING**

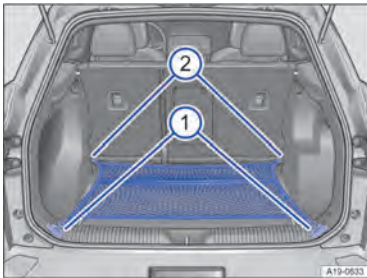
Elastic tensioning straps must be stretched to attach to the fastening rings. The hooks attached to them can cause serious injuries.

- Always protect eyes and face from injury when attaching elastic tensioning straps.
- Always hold elastic tensioning straps securely when fastening so that they cannot slip off and rebound.
- Always fasten the elastic tensioning straps first to the fastening rings in the front area of the luggage compartment, then pull them towards the loading sill and fasten them to the fastening rings there. If the tension straps slip off, they will snap away from the body.



Suitable lashing, retaining or securing straps and luggage securing systems are available from qualified workshops. Volkswagen recommends using a Volkswagen dealership for this purpose.

## **Luggage net**



**Fig. 132** In the luggage compartment: luggage net fitted flat.

The luggage net can help to prevent light items of cargo from sliding around in the luggage compartment. The luggage net also has a built-in pocket with a zip that can hold smaller items.

## **Hooking the luggage net flat on the luggage compartment floor**

- Hook the hooks of the luggage net into the fastening rings → Fig. 132 ② → ⚠. The luggage net zip must face upwards.
- Attach the hooks on the other end of the luggage net to the fastening rings under the load sill → Fig. 132 ①.

It may be necessary to fold out fastening rings in order to use them → page 259.

## **Removing the luggage net**

When fitted, the luggage net is held taut → ⚠.

- Unhook the hooks of the luggage net.
- Stow the luggage net in the luggage compartment.

## **⚠ WARNING**

The elastic luggage net must be stretched when it is secured to the fastening rings in the luggage compartment. When fitted, the luggage net is held taut. The luggage net hooks can cause injuries if the luggage net is installed or removed incorrectly.

- Always hold the luggage net hooks tightly to prevent them from jumping out of the fastening ring during installation or removal.
- Protect your eyes and face to avoid injuries from any hooks that may jump out during installation or removal.
- Always attach the luggage net hooks in the order described. There is a risk of injury if one of the hooks on the luggage net snaps back.

## Bag hook



**Fig. 133** On the left and right in the luggage compartment: bag hooks.

In the luggage compartment, there may be bag hooks for hanging light shopping bags.

### **⚠ WARNING**

Never use the bag hooks for lashing down items of luggage or other objects. The bag hooks could break off during a sudden braking manoeuvre or in the event of an accident.

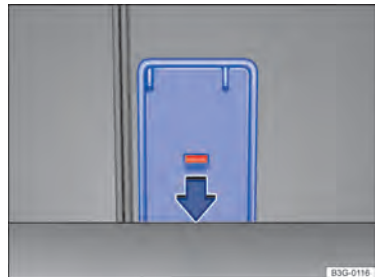
### **📌 NOTICE**

Do not load each bag hook with more than 2.5 kg (5 lb).

## Load-through hatch



**Fig. 134** In the rear seat backrest: opening the load-through hatch.



**Fig. 135** In the luggage compartment: opening the load-through hatch.

Depending on the vehicle equipment, a load-through hatch may be located behind the centre armrest on the rear seat backrest. This can be used to transport long objects in the vehicle interior, such as skis.

### **Opening the load-through hatch**

- Fold the centre armrest forwards  
→ page 100.
- Opening the load-through hatch from the vehicle interior: pull the release lever in the direction of the arrow → Fig. 134 and fold the cover of the load-through hatch fully forward → page 262, *Load-through hatch*.

- Open the boot lid.
- **OR:** opening the load-through hatch from the luggage compartment: push the release lever down in the direction of the arrow → Fig. 135 and push the cover of the load-through hatch forward.
- Push long objects through the load-through hatch from the luggage compartment.
- Secure the objects with the seat belt as required.
- Close the boot lid.

### Closing the load-through hatch

- Fold back the cover of the load-through hatch until it engages in position. The red marking on the luggage compartment side must no longer be visible → page 262, *Load-through hatch*.
- Close the boot lid.
- If necessary, fold back the centre armrest.

#### **WARNING**

Objects in the deployment zone of the centre airbag can prevent it from functioning properly and cause serious injuries.

- Never push objects forward into the deployment zones of the centre airbag → page 56.

#### **WARNING**

Injuries could be caused if the load-through hatch is folded forwards or backwards carelessly or in an uncontrolled way.

- Never fold the load-through hatch forwards or backwards while the vehicle is in motion.
- Ensure that the seat belt is not trapped or damaged when folding back the load-through hatch.
- Always keep hands, fingers, feet and other body parts away from the seat area when folding the load-through hatch forwards and backwards.

- The load-through hatch has not been secured properly if the red marking can still be seen on the locking indicator. Always ensure that the red marking is never visible when the load-through hatch is in the upright position.
- Passengers, particularly children, must not use this seat if the load-through hatch is folded forward or is not engaged securely into place.

## Roof carrier

### Introduction to the topic

Some vehicle models are designed for fitting a roof carrier.

Roof carriers can be used to transport bulky items on the roof of the vehicle.

If you are unsure whether a roof carrier can be fitted on your vehicle, please contact a qualified workshop. Volkswagen recommends using a Volkswagen dealership for this purpose.

Only roof carriers that have been approved by Volkswagen for the vehicle must be used.

If the vehicle is *not* approved for use with a roof carrier, do *not* use or retrofit a roof carrier.

#### **WARNING**

When transporting heavy or bulky objects on the roof carrier, the vehicle's handling will change due to a shift in the centre of gravity and an increased susceptibility to crosswinds.

- Always secure loads properly using suitable and undamaged lashing, retaining or securing straps.
- Cargo that is large, heavy, bulky, long or flat will have a negative effect on the vehicle aerodynamics, centre of gravity and overall handling.



- Avoid abrupt and sudden driving and braking manoeuvres.
- Always adapt your speed and driving style to suit visibility, weather, road and traffic conditions.


### WARNING

A roof carrier that has *not* been approved for the vehicle or a roof carrier that is fitted to a vehicle that is *not* approved for use with a roof carrier may cause accidents or injuries.

- Use only roof carriers that have been approved by Volkswagen for your vehicle.
- Never use a roof carrier on a vehicle that has not been approved for use with a roof carrier.
- A roof carrier that is fitted nevertheless may become loose whilst the vehicle is in motion and fall from the vehicle roof.


### NOTICE

Securing a roof carrier of any kind to a vehicle that is *not* approved for use with a roof carrier may lead to severe damage to the vehicle.

 Driving with a fitted roof carrier increases the air resistance of the vehicle and thus also the energy consumption of the electric drive. This reduces the possible range of the vehicle considerably. This applies to all roof carriers and the objects transported on them, e.g. bicycles and skis.

## Securing roof carriers

 Please refer to  and  at the start of the chapter on page 262.

Special roof carriers must be used to transport luggage, bicycles, skis, surfboards or boats safely → . Suitable accessories are available from your Volkswagen dealership.

## Securing the roof bars and load carrier

Mount roof bars on the roof railings according to the installation instructions provided.

Once you have fitted the roof bars, you can then secure the respective carrier system on them.

### WARNING

Incorrectly securing and using the roof bars and load carrier could cause the whole roof carrier system to fall off the roof. This could cause accidents and injuries.


- Only use roof bars and load carrier systems when they are undamaged and fitted correctly.
- Always fit roof bars and load carriers correctly. Always observe the installation instructions provided by the manufacturer.
- Attach the roof bars only at the specified mounting points.
- Special roof carriers for items such as bicycles, skis, surfboards, etc. should always be properly installed. Always observe the installation instructions provided by the manufacturer.
- Check that the roof carrier is secured before starting your journey and tighten as necessary after driving a short distance. During a long trip, check all bolts and fasteners at each stop.
- Do not carry out any changes or repairs to the roof bars or the load carrier system.

## Loading roof carriers

 Please refer to  and  at the start of the chapter on page 262.

### Maximum permissible roof load


The maximum permitted roof load is **75 kg (165 lbs)**

The roof load limit refers to the combined weight of the roof carrier and the load carried on the roof → .

Make sure you are aware of the weight of the roof carrier and the load to be transported. Weigh the load if necessary.

However, you will not be able to carry the maximum permitted roof load if you are using a roof carrier with a lower load rating. In this case, do not exceed the maximum weight limit for the roof carrier which is specified in the manufacturer's installation instructions.

### Distributing the load

Distribute the load evenly and secure it correctly → .

### WARNING

Accidents and vehicle damage can occur if the maximum permitted roof load is exceeded.


- Never exceed the specified roof load, the maximum permissible axle loads, and the permissible gross vehicle weight for the vehicle.
- Do not exceed the load rating of the roof carrier, even if the maximum roof load has not been reached.

### WARNING

Loose and incorrectly secured loads can fall off the roof carrier and cause accidents and injuries.

- Always use suitable and undamaged lashing, retaining or securing straps.

### NOTICE

When opening the boot lid, take care not to let it hit the roof load. 

## Notes on use



 Please refer to  and  at the start of the chapter on page 262.

### Remove the roof carrier in the following situations

- The roof carrier is no longer needed.
- Before entering a car wash.
- When the vehicle height exceeds the required clearance height, e.g. in a garage.

### NOTICE

- The height of the vehicle is changed by the installation of a roof carrier and the load secured to it. Check and compare the height of the vehicle with clearance heights, e.g. for underpasses and garage doors.
- The roof carrier and its load must not interfere with the roof aerial, the glass roof and the boot lid.

 Fitting a roof carrier increases air resistance and therefore reduces the vehicle's range. 

## Towing a trailer

### Introduction to the topic

The vehicle can be used to tow a trailer if it has the required technical equipment for this. The additional trailer load will affect the amount of wear, fuel consumption and performance of the vehicle and, in certain circumstances, could shorten the service intervals.

Driving with a trailer not only places an extra load on the vehicle, but also requires increased concentration on the part of the driver.

## DANGER

It is dangerous to transport people in a trailer and it may also be illegal.

## WARNING

Improper use of the towing bracket can lead to a loss of vehicle control, accidents and serious injuries.

- Only use the towing bracket if it is fitted properly and is not damaged.
- Do not carry out any alterations or repairs to the towing bracket.
- Wherever possible, swivel in or remove the ball coupling when a trailer is not being used in order to reduce the risk of injury in rear-end collisions, and the risk of injury to pedestrians and cyclists when the vehicle is parked.
- Never install a “weight-distributing” or “load-balancing” towing bracket to the vehicle. The vehicle was not constructed for these kinds of towing brackets. The towing bracket can fail, causing the trailer to tear loose from the vehicle.

## WARNING

Towing a trailer and transporting heavy or bulky items can change the vehicle handling, increase the braking distance and lead to accidents.

- Always secure loads properly using suitable and undamaged lashing, retaining or securing straps.
- Always adapt your speed and driving style to suit visibility, weather, road and traffic conditions. Reduce your speed, particularly when going downhill.
- Trailers with a high centre of gravity are more likely to tip over than trailers with a low centre of gravity.
- Always drive carefully and think ahead. Accelerate carefully and gently. Avoid abrupt and sudden driving and braking manoeuvres.

- Take special care when overtaking. Reduce your speed immediately if the trailer shows even the slightest sign of snaking.
- Never drive faster than 80 km/h (50 mph) when towing a trailer; also 100 km/h (60 mph) in exceptional cases. This also applies to countries where higher speeds are permitted. Keep to country-specific speed limits which may be lower for vehicles with trailers than for vehicles without trailers.
- Never try to stop a trailer from snaking by increasing your speed.
- Never install a “weight-distributing” or “load-balancing” towing bracket on the vehicle.

## NOTICE

Please observe the notes and information for vehicles with N1 approval → page 373, *Information about vehicles with N1 approval (light commercial vehicle)*.



The anti-theft alarm system can be triggered if the connection to a trailer that is integrated into the anti-theft alarm system is interrupted. → page 83



Some retrofitted towing brackets may cover the opening for fitting the towing eye. If so, the towing eye cannot be used for towing or tow-starting other vehicles. For this reason, the removed ball coupling of a retrofitted towing bracket should be stored in the vehicle at all times. ◀

## Technical prerequisites

 Please refer to ,  and  at the start of the chapter on page 264.

### Cooling system

There is an increased load on the engine and the cooling system when towing a trailer. The cooling system must contain sufficient cool-

ant and be designed to cope with the extra load added by the trailer.

### Trailer brake

If the trailer is equipped with its own brake system, comply with the legal regulations.

### Exterior mirrors

If you are unable to see the traffic behind the trailer in the vehicle's standard exterior mirrors, additional exterior mirrors should be fitted in accordance with any country-specific regulations. Before setting off, adjust the exterior mirrors so that you have a sufficient view of the rear.

### Retrofitting a towing bracket

Only use a towing bracket which has been approved by Volkswagen for your vehicle type. Always check and follow the data provided by the towing bracket manufacturer.

### Trailer tail light clusters

The trailer tail light clusters must work correctly and meet legal requirements. Do not exceed the maximum power consumption for the trailer tail light clusters.

### Using a trailer in hot or cold countries

Due to the climatic conditions in some countries, trailers may not be permitted for all engine/gearbox combinations. If you want to retrofit a towing bracket, contact a qualified workshop in advance to find out whether the vehicle is suitable for this purpose.

### **WARNING**

If the towing bracket is unsuitable or incorrectly fitted, the trailer could become detached from the towing vehicle. This can cause serious accidents and fatal injuries.

- Never fit a towing bracket to the bumper or to its mountings. The towing bracket must not prevent the bumpers from functioning correctly.
- Do not carry out any alterations to the exhaust or brake systems.

### **NOTICE**

- The vehicle electronics may be damaged if the trailer's power consumption is too high.
- Never connect the trailer's electrical system directly to the electrical connections of the tail light clusters or to other sources of electricity. Only use suitable connectors to provide power to the trailer.

**i** Towing a trailer places additional demands on the vehicle. Volkswagen recommends additional services between the normal inspection intervals if the vehicle is used frequently for towing a trailer. ◀

### Swivelling out the ball coupling on the towing bracket

**ⓘ** Please refer to **▲**, **▲** and **ⓘ** at the start of the chapter on page 264.


The towing bracket ball coupling is located in the bumper. The electrically released ball coupling is swivelled out mechanically for use and cannot be removed.




**Fig. 136** On the right of the luggage compartment: button for releasing the ball coupling.

### Releasing and swivelling out the ball coupling


— Park the vehicle → page 177.

- Open the boot lid.
- Briefly press the button  → Fig. 136 in the luggage compartment. The ball coupling is released electrically and folds out automatically. The indicator lamp in the button flashes.
- Continue rotating the ball coupling until you hear and feel it click into place and the indicator lamp in the button lights up continuously.
- Close the boot lid.

#### Swivelling in the ball coupling

- Park the vehicle → page 177.
- Unhitch the trailer and disconnect the electrical connection between the vehicle and the trailer. If fitted, remove the adapters from the trailer socket.
- Open the boot lid.
- Briefly press the button  → Fig. 136 in the luggage compartment. The ball coupling is electrically released.
- Swivel the ball coupling under the bumper until you hear and feel it click into place and the indicator lamp in the button lights up continuously.
- Close the boot lid.


#### Meaning of indicator lamp in the button

- If the indicator lamp in the button → Fig. 136 *lights up continuously* when the boot lid is open, the ball coupling is correctly engaged in the extended or retracted position.
- If the indicator lamp in the button *flashes*, the ball coupling has either not engaged properly or it is damaged → .
- The indicator lamp in the button goes out approximately one minute after the tail-gate is closed.

#### WARNING



Improper use of the towing bracket can cause injury and accidents.

- Only use the ball coupling if it has clicked into place properly.

- Ensure that no people, animals or items are in the way of the ball coupling when it is swivelled in or out.
- Never interrupt the swivel movement of the ball coupling with items or tools.
- Never press the button  if a trailer is attached or if a luggage carrier or other accessories are fitted to the ball coupling.
- If the ball coupling does not engage properly or there are faults in the electrical system or the towing bracket itself, do not use the towing bracket and have it checked by a qualified workshop.
- Never use the towing bracket if the diameter of the ball is less than 49 mm at the smallest point.

#### NOTICE

Do not aim a high-pressure cleaner or steam cleaner directly at the swivelling ball coupling or the fitted trailer socket. Seals could be damaged or the grease required for lubrication could be washed off.


 At extremely low outside temperatures, it may not be possible to swivel the ball coupling in or out. If this happens, it is sufficient to place the vehicle in a warmer room, e.g. a garage. 

#### Fitting a bicycle carrier on the ball coupling on the towing bracket

 Please refer to ,  and  at the start of the chapter on page 264.

Only bicycle carriers that have been approved by Volkswagen for the vehicle must be used.

Mount the bicycle carrier in accordance with the manufacturer's assembly instructions.

A maximum of three bicycles may be mounted on the bicycle carrier → . Position

heavy bicycles as close to the vehicle (ball coupling) as possible.

### Maximum load

The maximum load (carrier system including load) of the bicycle carrier fitted on the ball coupling is **75 kg**. However, the model-specific maximum drawbar load of the towing bracket → page 269 must not be exceeded.

### WARNING

Incorrect use of a bicycle carrier mounted on the ball coupling of the towing bracket can cause accidents and injuries.

- Read and always observe the assembly instructions provided by the bicycle carrier manufacturer.
- Never exceed the specified load and overhang.
- Never secure a bicycle carrier on the ball neck below the ball head. The bicycle carrier could slip due to the shape of the ball neck.

### NOTICE

Considerable vehicle damage could occur if the maximum permitted load specified in the manufacturer's assembly instructions or the overhang is exceeded.

- Never exceed the values specified in the assembly instructions.



Volkswagen recommends that you remove all add-on parts from the bicycles before setting off. This includes bicycle bags and baskets, child seats or batteries. This helps improve the carrier system's wind load and centre of gravity.

## Notes on towing a trailer

 Please refer to ,  and  at the start of the chapter on page 264.

### Trailer socket

The electrical connection between the towing vehicle and the trailer requires a 13-pin trailer socket. The pin assignment corresponds to DIN ISO 11446.

If the trailer has a **7-pin plug** you will need to use a suitable adapter.

If you are uncertain whether the electrical connection of the trailer with the vehicle is correct, please contact a qualified workshop. Volkswagen recommends using a Volkswagen dealership for this purpose.

### Connection to the anti-theft alarm

The trailer is integrated in the anti-theft system if the following conditions are fulfilled:

- When the vehicle has a factory-fitted anti-theft alarm and a factory-fitted towing bracket.
- When the trailer is electrically connected to the towing vehicle via the trailer socket.
- When the vehicle and trailer electric systems are functional, fault-free and undamaged.
- When the vehicle is locked with the vehicle key and the anti-theft alarm is active.

When the vehicle is locked, the alarm will be triggered as soon as the electrical connection to the trailer is interrupted.

### Connection to the anti-theft alarm (trailer with LED tail light clusters)

For technical reasons, trailers with LED tail light clusters cannot be integrated into the anti-theft alarm system.

When the vehicle is locked, the alarm is not triggered as soon as the electrical connection to the trailer with LED tail light clusters is interrupted.

## WARNING

Any electrical cables which are not connected properly or are connected incorrectly could cause a power surge to the trailer. This could lead to faults in the entire vehicle electronics system and could also cause accidents and serious injuries.

- All work on the electrical system should only be carried out by a qualified workshop.
- Never connect the trailer's electrical system directly to the electrical connections of the towing vehicle's tail light clusters or to other power sources.


## WARNING


Contact between the pins in the trailer socket can lead to short circuits, overloading of the electrical system and failure of the lighting system, thereby causing accidents and serious injuries.


- Never connect the pins in the trailer socket to one another.
- Have bent pins repaired by a qualified workshop.

## NOTICE

If you park the trailer using the support wheel or other trailer supports, disconnect the trailer from the vehicle. The vehicle could move up and down if the load changes or if there is damage to the tyres, for example. If this happens, a great deal of force will be exerted on the towing bracket and trailer, which could lead to damage to the vehicle and trailer.

 If there is a fault in the vehicle or trailer electrical systems or if there is a fault in the anti-theft alarm, have the vehicle checked by a qualified workshop.

 If the engine is not running and electrical equipment is switched on in the trailer via the trailer socket, the 12-volt vehicle battery will discharge.

 If the 12-volt vehicle battery charge level is low, the electrical connection to the trailer will be interrupted automatically. <

## Loading a trailer

 Please refer to ,  and  at the start of the chapter on page 264.

### Maximum trailer weight and drawbar load

The maximum trailer weight is the weight that the vehicle can pull.


The drawbar load is the weight that is exerted vertically from above on the towing bracket's ball coupling.

The figures for maximum trailer weight and drawbar load that are given on the type plate of the towing bracket are for certification purposes only. The correct values for your specific model, which are often *lower* than these figures, are given in the vehicle registration documents. All data in the official vehicle documents always take precedence.

In the interest of driving safety, Volkswagen recommends that you always use the maximum drawbar load. The handling of the vehicle and trailer will be impaired if the drawbar load is too small.

The drawbar load increases the weight on the rear axle and reduces the maximum load of the vehicle as a result.

### Maximum permitted drawbar load

The *maximum permitted drawbar load* exerted by the trailer drawbar on the ball coupling of the towing bracket must not exceed **75 kg** → .

### Gross combination weight

The gross combination weight is made up of the actual weight of the loaded vehicle and loaded trailer.

In some countries, trailers are divided into different classes. Volkswagen recommends

that you contact a qualified workshop to find out about suitable trailers.

### Loading a trailer

The vehicle and trailer should be balanced. For this purpose, the maximum permitted drawbar load should be utilised. Do not place the load only at the front or the rear of the trailer:

- Distribute the load in the trailer so that heavy objects are either over or as near to the axle as possible.
- Secure all loads on the trailer properly.

### Tyre pressure

Follow the trailer manufacturer's recommendations concerning the tyre pressure for the trailer tyres.

When towing a trailer, inflate the tyres on the towing vehicle with the maximum permitted tyre pressure → page 332.

### WARNING

Accidents and serious injuries can occur if you exceed the vehicle's maximum permitted gross axle weight rating, drawbar load, gross vehicle weight rating or gross combination weight rating.

- Never exceed the specified values.
- Never let the actual weights at the front and rear axles exceed the gross axle weight ratings. Never exceed the permissible gross vehicle weight for the vehicle with weight at the front and rear of the vehicle.

### WARNING

Loads that may slide can severely impair stability and driving safety, which can cause accidents and severe injuries.

- Always load trailers correctly.
- Always secure loads properly using suitable and undamaged lashing, retaining or securing straps.

## Driving with a trailer

 Please refer to ,  and  at the start of the chapter on page 264.

### Headlight adjustment

Towing a trailer can raise the front end of the vehicle so that the dipped beam dazzles other road users. Use the headlight range control to lower the light cone as required. Vehicles with dynamic headlight range control are adjusted automatically.

### Things to note when driving with a trailer

- If the trailer has an **overrun brake**, apply the brakes *gently at first* and then firmly. This will prevent the jerking that can be caused by the trailer wheels locking.
- The combination weight causes the braking distance to increase.
- Select a higher brake energy recuperation level on downhill gradients. This will make use of the electric drive braking effect and relieve the load on the brakes. The brake system could otherwise overheat and fail.
- The vehicle's centre of gravity and in turn the vehicle handling will change because of the trailer load and the increased gross weight of the vehicle and trailer.
- The weight distribution of a loaded trailer with an unladen towing vehicle is very unfavourable. When driving in this situation, drive particularly carefully and slowly.



### Pulling off on uphill gradients when towing a trailer

A vehicle towing a trailer is liable to roll back a short distance when moving off on an uphill slope depending on the gradient and the gross weight of the trailer and vehicle.

When towing a trailer, pull off on uphill gradient as follows:

- Depress and hold the brake pedal.
- Switch the electronic parking brake off → page 177.
- Select position **D/B**.



- Press and hold the  button to hold the vehicle and trailer with the electronic parking brake.
- Release the brake pedal.
- Pull away slowly.
- Release the  button only when the engine has sufficient power to move off.

### WARNING

Incorrect trailer towing can cause loss of vehicle control and serious injuries.

- Towing a trailer and transporting heavy or bulky items can change the way the vehicle handles and increase the braking distance.
- Always drive carefully and think ahead. Brake earlier than in normal driving.
- Always adapt your speed and driving style to suit visibility, weather, road and traffic conditions. Reduce your speed, particularly when going downhill.
- Accelerate carefully and gently. Avoid abrupt and sudden driving and braking manoeuvres.
- Take special care when overtaking. Reduce your speed immediately if the trailer shows even the slightest sign of snaking.
- Never try to stop a trailer from snaking by increasing your speed.
- Keep to speed limits, which may be lower for vehicles with trailers than for vehicles without trailers.

### Trailer stabilisation



 Please refer to ,  and  at the start of the chapter on page 264.

The trailer stabilisation function can detect if an attached trailer is starting to snake from side to side and can provide countersteer.

Trailer stabilisation is an extension of the Electronic Stability Control (ESC).

If trailer snaking is detected, the trailer stabilisation function automatically helps to reduce the trailer's motion using counter steering assistance.

### Prerequisites for trailer stabilisation

- The vehicle has a factory-fitted towing bracket or a compatible towing bracket has been retrofitted.
- Electronic Stability Control and traction control system (TCS) are active. The indicator lamp  or  in the instrument cluster is not lit up.
- The trailer is electrically connected to the towing vehicle via the trailer socket.
- The vehicle speed is higher than approximately 60 km/h (37 mph).
- The maximum drawbar load is being used.
- The trailer must have a rigid drawbar.
- Trailers with brakes must have a mechanical overrun system.

### WARNING

Do not let the extra safety afforded by the trailer stabilisation function tempt you into taking any risks when driving.

- Always adapt your speed and driving style to suit visibility, weather, road and traffic conditions.
- Accelerate carefully on slippery surfaces.
- Take your foot off the accelerator if one of the systems is active.

### WARNING

The trailer stabilisation function may not be able to detect all driving situations correctly.

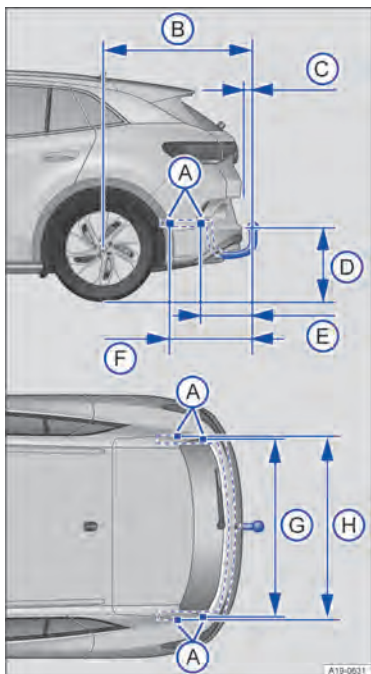
- Trailer stabilisation is switched off when ESC is deactivated.
- Light trailers that are snaking will not be recognised by the trailer stabilisation function and stabilised accordingly in all cases.
- A trailer can still *jack-knife* on slippery roads with little grip, even if the towing

vehicle is equipped with the trailer stabilisation system.

- Trailers with a high centre of gravity might tip over before snaking starts.
- Sudden braking procedures could occur automatically in extreme driving situations if the trailer socket is being used without a trailer (e.g. for a bicycle carrier with lighting).

## Retrofitting a towing bracket

📖 Please refer to ⚠️, ⚠️ and Ⓛ at the start of the chapter on page 264.



**Fig. 137** Dimensions and mounting points for retrofitting a towing bracket.

The dimensions → Fig. 137 must be adhered to when retrofitting a towing bracket. Always observe the minimum distance given from the middle of the ball coupling to the surface of the road Ⓛ. This also applies when the vehicle is fully laden, including maximum drawbar load.

- Ⓛ Mounting points
- Ⓛ 1045 mm (41.14 inch)
- Ⓛ 65 mm (2.55 inch)
- Ⓛ 350 – 420 mm (13.77 - 16.5 inch)
- Ⓛ 357 mm (14.05 inch)
- Ⓛ 577 mm (22.71 inch)
- Ⓛ 994 mm (39.13 inch)
- Ⓛ 998 mm (39.29 inch)

Volkswagen recommends having the towing bracket retrofitted by a qualified workshop. The cooling system may need to be modified or heat shields may need to be fitted, for example. Volkswagen recommends using a Volkswagen dealership for this purpose.


### ⚠️ WARNING

Electrical cables that are not connected properly or are connected incorrectly can cause faults in the entire vehicle electronics system and also cause accidents and serious injuries.

- Never connect the trailer's electrical system directly to the electrical connections of the tail light clusters or to other unsuitable power sources. Only suitable connectors may be used to connect the trailer.
- A towing bracket should be retrofitted to the vehicle by a qualified workshop.

### ⚠️ WARNING

The trailer can become detached from the towing vehicle if the towing bracket is unsuitable or incorrectly fitted. This can cause serious accidents and fatal injuries.

 Only use towing brackets which have been approved by Volkswagen for your vehicle type.

## Troubleshooting

 Please refer to ,  and  at the start of the chapter on page 264.

### Ball head of the towing bracket is not locked

The indicator lamp lights up yellow.

- Do not use towing bracket. Check the towing bracket locking mechanism  
→ page 266.
- If the problem persists, go to a qualified workshop.

# High-voltage battery

## Safety notes

### Introduction to the topic

#### DANGER

The voltage of the high-voltage system is dangerous and will cause burns or other injuries and even lead to a fatal electric shock.

- You should always assume that the high-voltage battery is charged and that all high-voltage components are live. This can also be the case when the ignition is switched off.
- Damage to high-voltage components is not visible in all cases. Never touch damaged components or allow jewellery or other metal objects to come into contact with these components.
- Never carry out work on the orange-coloured high-voltage cables or the other high-voltage components. Any work on the high-voltage system must be carried out only by authorised qualified workshops with corresponding approval for this work.
- Never damage, change or remove the orange-coloured high-voltage cables or disconnect them from the high-voltage network.
- Never open, modify or remove the cover of the high-voltage battery.
- Never carry out work with cutting, forming and sharp-edged tools or heat sources in the vicinity of high-voltage components and high-voltage cables. Work on and in the vicinity of the high-voltage system must be performed only by authorised qualified workshops.
- Any gases emitted by or escaping from the high-voltage battery may be toxic or flammable.

- Damage to the vehicle or to the high-voltage battery could lead to a leak of toxic gases or fluids, either immediately or at a later time. These emitted gases could also potentially cause a fire. Do not inhale these gases.
- Never touch the fluids that leak from the high-voltage battery.
- In the event of a fire, move away from the hazard area and call the fire service.
- Always inform any attending fire and emergency services that the vehicle is fitted with a high-voltage battery.

### WARNING

Unqualified work on the high-voltage system and on high-voltage components can lead to malfunctions, accidents and injuries.

- Any work on the high-voltage system must be carried out only by authorised qualified workshops with corresponding approval for this work.

### NOTICE

After an accident, or after the underside of the vehicle has struck an obstacle, the high-voltage battery must be checked by appropriately qualified and trained experts. <

## Warning signs for the high-voltage system

 Please refer to ,  and  at the start of the chapter on page 273.

### Where can warning signs be located?

The following components may be marked with the illustrated warning signs → Fig. 138, → Fig. 139, → Fig. 140 and → Fig. 141:

- Covers and caps over high-voltage components.
- All high-voltage components including the high-voltage battery.

- Under the bonnet.

### Warning signs



Fig. 138 Warning sign.



Fig. 139 Warning sign.

The warning signs → Fig. 138 and → Fig. 139 indicate the presence of high voltage.



Fig. 140 Warning sign.

Parts of the high-voltage system can become very hot and must not be touched → Fig. 140.



Fig. 141 Warning sign on high-voltage battery.

- ① High voltages can cause serious injuries or death. Never touch the battery terminals with your fingers, tools, jewellery or any metal objects.
- ② The high-voltage battery contains dangerous liquid and solid substances. Serious chemical burns and blindness can be caused if it outgasses. Suitable eye protection and protective clothing should always be worn when performing work on the high-voltage battery to prevent the battery fluid coming in contact with skin and eyes. If skin or eyes come into contact with battery fluid, rinse the affected areas with clean flowing water for at least 15 minutes and seek a doctor immediately.
- ③ The high-voltage battery can burn. The high-voltage battery must never be exposed to fire, sparks or naked flames. Always handle the high-voltage battery with care to avoid damage and fluid leaks.
- ④ Always keep children away from the high-voltage battery.
- ⑤ You will find further information and warnings in the owner's manual and in the workshop literature.
- ⑥ Incorrect handling of the high-voltage battery can cause serious injuries or

death. Under no circumstances remove the lid from the high-voltage battery nor disassemble the high-voltage battery.

- ⑦ Incorrect handling of the high-voltage battery can cause serious injuries or death. Have maintenance work on the high-voltage battery performed **exclusively** by properly qualified and trained specialist staff. Never make modifications to the high-voltage battery. The opened high-voltage battery must not come into contact with water or other liquids. Liquids can cause short-circuits, electric shocks and burns.

## Care instructions for the high-voltage battery

### Introduction to the topic

#### Reliability and capacity of the high-voltage battery

Lithium-ion batteries are subject to a physical and chemical ageing and wear process during their useful life. Correct handling of the high-voltage battery makes a significant contribution to maintaining its reliable condition and a high useful capacity and range in the long term. It is therefore all the more important to observe the following care instructions for the high-voltage battery. These care instructions form the basis for long value retention of the vehicle.

Please also observe the valid Volkswagen warranty and guarantee terms for the high-voltage battery.

## Handling the high-voltage battery

### Care instructions

Volkswagen recommends observing the following care instructions:

- Do not fully charge the high-voltage battery in everyday operation. Set an upper battery charge limit of 80% in the charging settings.
- Avoid complete discharge of the high-voltage battery if possible, e.g. in the case of long standing times with a low charge level. The charge level should not fall below 20% for extended periods → ⓘ.
- If the high-voltage battery has been fully charged, drive off immediately if possible.
- Avoid regular fast charging with direct current (DC) due to the high charging currents.

### ⓘ NOTICE

The high-voltage battery must not be used as a stationary power source. Otherwise irreversible damage can be caused to the high-voltage battery.

### Vehicle standing times

- In frost conditions, do not park the vehicle for several hours with a charge level below 40% → ⓘ.
- In the case of standing times of longer than 12 hours, park the vehicle with a charge level of at least 30% and no more than 80% → ⓘ, e.g. at the airport before a journey.
- Do not expose the vehicle to outside temperatures below -30°C or above 60°C for longer than 24 hours.
- Use the stationary air conditioning in good time to improve comfort and performance (depending on vehicle equipment), particularly at temperatures below -15°C → page 127.

### ⓘ NOTICE

If the vehicle is parked for an extended period with discharged high-voltage battery, it is possible that the high-voltage battery will no longer be charged or the vehicle will no longer start. In the long term, irreversible damage can be caused to the high-voltage battery.

- Charge the high-voltage battery at regular intervals.

ⓘ The high-voltage battery provides less power at very low outside temperatures. If the charge level is also low, power may be significantly restricted for a short time after driving off → page 136. <



## Charging settings in the Infotainment system

### 📖 Introduction to the topic


#### Charging modes

- AC charging (alternating current) → page 281.
- DC charging (direct current) → page 283.


#### Opening charging settings

- Switch on the Infotainment system.
- Touch the  Charging or  Locations function button in the vehicle settings in the Infotainment system → page 31.
- **OR:** if the vehicle is unlocked and the charging connector is plugged in, a screen with charging information is automatically opened on the Infotainment system.

#### Immediate charging


 Charging menu for the next charging operation → page 277.

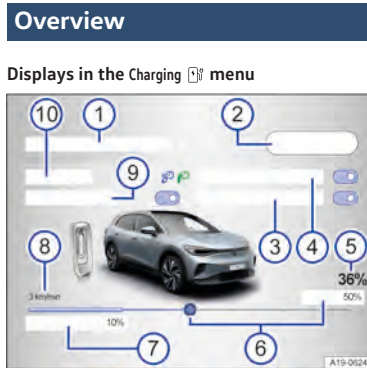
#### Charging locations


 Charging locations menu → page 279.  
Available only if the geographical co-

ordinates of the vehicle have been recognised.

### Timer-controlled charging

- 1 Menu for a departure time. First open the  Charging locations menu. A stored charging location must be available → page 279.



**Fig. 142** In the Infotainment system: Charge menu  in the vehicle settings.

Some of the following displays are available only if a charging location is used or a departure time is active → page 279.

- 1 Current settings or detected charging location → page 278.
- 2 End or restart charging.
- 3 Release charging connector: the charging connector is automatically released and can be removed after the end of AC charging.
- 4 Reduce charging current, e.g. if several large electrical consumers are operated simultaneously via the same circuit (AC charging). Charging current is 8 A.
- 5 Current charge level of the high-voltage battery.


- 6 Upper battery charge limit (maximum desired charge level of the high-voltage battery) → page 277.
- 7 Lower battery charge limit (minimum desired charge level of the high-voltage battery) → page 277.
- 8 Charging power as range increase: The amount of range added during charging is displayed (in km/h or km/min or mi/h or mi/min). The charging power depends on the charging infrastructure and the temperature of the high-voltage battery. The charging power can vary during the charging process.
- 9 Current charging duration.
- 10 End of charging or planned departure time (only for timer-controlled charging) → page 279.

**OR:** stationary air conditioning for departure time (depending on equipment and only if power supply is available) → page 127.

### Displays when charging connector is connected

Charging information for the current charging operation is displayed on the Infotainment system.

Close screen:

- Touch the  function button.
- **OR:** display of the screen is automatically ended after approx. 2 minutes.
- **OR:** vehicle is locked.

### Setting battery charge limits

The charge level and thus the vehicle range can be adapted to everyday needs by means of the battery charge limits in the Infotainment system.

### Upper battery charge limit

Full charging of the high-voltage battery is not normally necessary in daily vehicle use.


The upper battery charge limit limits the maximum charge level.

- Move the touch slider to the desired value in the charging settings of the Infotainment system → page 277.

The upper battery charge limit can also be adapted during charging.

### Lower batter charge limit

The lower battery charge limit defines the minimum charge level for a stored charging location. A minimum range can be ensured with this function.

- Touch the  function button in the vehicle settings in the Infotainment system → page 31.
- Set the lower battery charge limit in the profile of the charging location.

Following connection to a power supply, the vehicle first charges up to the lower battery charge limit. Only then are preferred charging times, off-peak times or a departure time for timer-controlled charging taken into consideration.

### Examples for AC charging

Volkswagen recommends the following charging settings for AC charging:

#### Everyday driving - a long range is not required

- ✓ Upper battery charge limit: maximum 80%.
- ✓ Lower battery charge limit: a least 20% at mild to warm outside temperatures and 40% at cool to cold outside temperatures.

#### Driving long distances - a long range is required

- ✓ Upper battery charge limit: 100 %.
- ✓ Lower battery charge limit: a least 20% at mild to warm outside temperatures

and 40% at cool to cold outside temperatures.

- ✓ Avoid standing times and drive off immediately after charging.


## Setting charging locations

Charging locations can be stored in the Infotainment system. The vehicle automatically recognises a stored charging location and adopts the settings when charging.




### Location data

The Infotainment system uses the current location data (geographical coordinates) of the vehicle when a charging location is created or used.


### Creating a charging location

- Touch the  function button in the vehicle settings in the Infotainment system → page 31.
- Add and assign a name to a charging location (maximum of five).

### Removing a charging location

- Touch the  function button in the vehicle settings in the Infotainment system → page 31.
- Touch the  function button.
- Touch the  function button to remove the stored charging location.

### Settings

 All charging settings that were stored in the charging profile are always valid for the currently recognised charging location. An active departure time is automatically taken into account.

- To charge immediately at the current charging location, switch on the function in the exit menu → page 31.




- Departure time (maximum of three) → page 279.
- Reduce charging current: Charging current is 8 A. Load on the power grid while charging at the electrical socket can be decreased with this setting.
- Lower battery charge limit (minimum desired charge level of the high-voltage battery of 0-50%) → page 277.
- Upper battery charge limit (maximum desired charge level of the high-voltage battery of 50-100%) → page 277.
- Control by an external energy management system (depending on vehicle equipment). The vehicle communicates with the charging station and takes into account external domestic settings, e.g. if a photovoltaic system is available.
- Off-peak tariff online (depending on vehicle equipment). It is checked whether off-peak tariffs are available from the energy provider. The high-voltage battery is preferably charged at certain times of day.
- Preferred charging times. Individually set charging times may be helpful if there are other domestic consumers or when using off-peak electricity.
- Release charging connector (AC charging): the charging connector is unlocked after the end of charging.
- Display address or geographical coordinates.

## Setting departure times (timer-controlled charging)

If a stored charging location is available, the high-voltage battery can be charged for a desired time.

### Setting departure time

- Touch the  function button in the vehicle settings in the Infotainment system → page 31.
- Open the profile of a charging location.
- Set departure time (maximum of three).
  - Day of the week.
  - Time at which the high-voltage battery is to be charged.
  - Use once or weekly.
  - Air conditioning (depending on equipment): the vehicle interior is cooled or heated for the departure time by means of the stationary air conditioning. Set the desired temperature in the stationary air conditioning menu → page 127.

### Activating departure time

- Open the profile of a charging location.
- Activate the departure time by placing a "tick"  in the checkbox.



An active departure time at the current charging location can be skipped in the exit menu → page 31.

### Information



Charging for a departure time activated.



Air conditioning for a departure time activated.




Departure time is used regularly.

## Charging the high-voltage battery

### Introduction to the topic

#### Checklist

- ✓ The vehicle's drive system has been deactivated → page 138.

- ✓ The charging cable and charging infrastructure are in fault-free and tested condition → .


### Charging modes

The following charging modes are possible for your vehicle:


- AC (alternating current) charging at a charging station or wall box → page 281:

Charging is performed with a high charging power. The maximum achievable charging power depends on the type of charging station and charging cable used and the charging unit equipment.

- AC (alternating current) charging at a mains socket → page 281:

The domestic electrical installation must have been tested and must be fault-free → . A longer charging time should be planned, e.g. over night.


- DC (direct current) charging at a charging station → page 283:


Charging is performed with a very high charging power. This significantly shortens the duration of charging. Observe the information on frequent charging with direct current (DC) → .

### NOTICE

Fast charging with direct current (DC) uses a very high charging power. Frequent fast charging can permanently reduce the battery capacity of the high-voltage battery.

- You should primarily charge the high-voltage battery at a charging station or wall box using alternating current (AC).

 For AC charging, Volkswagen recommends charging the high-voltage battery at a charging station or wall box with maximum charging power. This results in higher efficiency compared with charging using a mains socket.

 Please observe the technical information on charging power for your vehi-

cle. Consult a Volkswagen dealership for further information.

### Residual current protection

The vehicle is protected against DC residual currents (DC residual current). This prevents DC residual currents that may be produced when charging from flowing via the charging cable into the domestic electrical installation.


### WARNING

Incorrect battery charging, failure to observe the safety instructions or incorrect handling of the high-voltage battery can cause short circuits, electric shocks, explosions, fire, serious burns and injuries and death.


- Always observe the stipulated sequence of steps in order to avoid the risk of an electric shock and serious injuries caused by residual energy in the electrical storage system.
- Observe the safety and operating instructions for the supplied charging cable → page 287.
- Charge the high-voltage battery only at properly installed, tested and undamaged mains sockets as well as at a fault-free electrical installation. Have the mains sockets and electrical installation checked by a qualified professional on a regular basis.
- Never charge the vehicle in areas at risk of explosion. Components of the charging cable can cause sparks and thus ignite flammable or explosive vapours.
- Always protect electrical connectors against direct ingress of water, moisture and other liquids.
- For safety reasons, no other work should be carried out in or on the vehicle during the charging process.
- Always end the charging process before disconnecting the mains plug. Otherwise, the charging cable and the electrical installation could be damaged.

## ⚠ WARNING

Driving when the charge level of the high-voltage battery is too low can lead to the vehicle breaking down when in traffic, and can lead to accidents and serious injuries.

 The high-voltage battery can only be charged at charging stations that meet the requirements of the corresponding country and at least the following standards:


- IEC 61851 and IEC 62196 (Europe).
- GB/T 18487 and GB/T 20234 (China) in the 2015 version.
- SAE J1772 (Japan).
- SAE J1772 (USA and Canada).

 Charging of the high-voltage battery can be subject to limitations in very low and very high temperature conditions.

## Identification of compatible charging connections

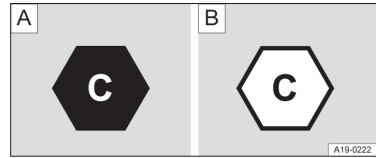
 Please refer to  and  at the start of the chapter on page 279.



### Compatibility of vehicle and charging infrastructure

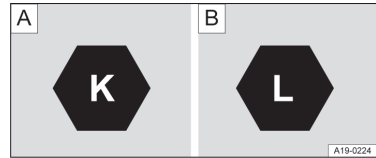
The following signs in accordance with DIN EN 17186 provide information on whether the local power supply is suitable for the vehicle → .



The signs are located on the vehicle's charging socket, components of the local charging infrastructure (charging station, socket) and on the charging cable. The signs refer to standardised charging systems in accordance with DIN EN 62196.

### Signs



**Fig. 143** Identification for alternating current (AC) and Type 2 connector  on the vehicle and  on the charging station.



**Fig. 144** Identification for direct current (DC) and CCS connector on the vehicle  with a voltage up to 500 volts and  up to 1,000 volts.

## ⚠ WARNING

Charging at untested electrical installations can cause damage and serious injuries.

- If no sign is present or if the charging infrastructure is unknown, you should first contact a specialist electrical installation company.

## AC charging (charging station, mains socket)

 Please refer to  and  at the start of the chapter on page 279.

The charger installed in the vehicle converts the power from the public AC grid into direct current.



**Fig. 145** Behind the charging socket flap at the rear right: charging socket.

- ① Charging process display → page 284.
- ② Charging socket.

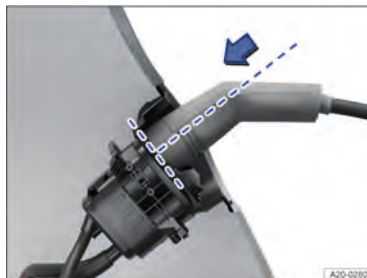
*Charging station, wall box, mains socket:* The vehicle's high-voltage battery can be charged with **alternating current (AC)** via the top connection in the charging socket → Fig. 145 ②.

#### Connecting the charge cable

- First connect the charging cable to the power supply or take it out of the charging station or wall box. Unwind charging cable completely.

*Charging cable for mains sockets:* The protective device will carry out a self-test → page 290.

- Unlock the vehicle → page 73.
- Press on the charging socket flap to open it.
- Insert the charging connector into the charging socket ensuring that it is inserted straight → Fig. 146 ②. Check whether the charging connector is inserted all the way → Fig. 146.



**Fig. 146** At the charging socket: fully plugged charging connector (schematic diagram).

The charging connector is locked automatically. The LED light unit (charging process display) on the charging socket blinks or flashes white → Fig. 145 ① → page 284.

Desired charging settings can be input in the Infotainment system → page 279.

#### Starting the charging process automatically

Charging starts immediately until the upper battery charge limit is reached, or according to the charging settings.

The charging station may need to be activated.

#### During charging

The charging process display on the charging socket pulses green → Fig. 145 ①. The charging connector is locked.

If the charging process display lights red, there is a fault → page 285.

#### Interrupting the charging process

To interrupt the charging process, unlock the vehicle or use the charging settings in the Infotainment system.

- Touch the **(STOPP)** function button in the Infotainment system. The charging process display on the charging socket lights up white → Fig. 145 ①. To automatically unlock the charging connector, the setting **Automatically release connector** must be selected in the charging settings → page 31.

- Touch the **(START)** function button to restart the charging process. The charging connector is locked. It may be necessary to authenticate again at the charging station.

#### After charging

The charging process display on the charging socket lights up green when the desired charge level has been reached.

Removing the charging connector:

- Unlock the vehicle.
- Disconnect the charging connector from the socket within 30 seconds.
- **OR:** if **Automatically release connector** is activated in the charging settings → page 31, the charging connector will be unlocked automatically after the end of charging.
- Disconnect the charging cable from the power supply and fit protective cap.
- Close the charging socket flap so that it engages audibly.

## DC charging

📖 Please refer to ⚠️ and ⌚ at the start of the chapter on page 279.

The alternating current is converted into direct current outside the vehicle. A significantly higher charging power is achieved compared with AC charging.



**Fig. 147** Behind the charging socket flap at the rear right: charging socket.

- ① Charging process display → page 279.
- ② Charging socket.
- ③ Protective cap.

*Public fast charging station:* the high-voltage battery can be charged with **direct current (DC)** at a corresponding charging station. This significantly shortens the charging time.

Use a charging cable that is less than 30 metres long at the charging station.

#### Connecting the charge cable

- Unlock the vehicle → page 73.
- Press on the charging socket flap to open it.
- Remove the protective cap and hang it on the hanger → Fig. 147 ③.
- Plug the charging connector of the charging station into the charging socket → Fig. 147 ②.

The charging connector is locked automatically.

The LED light unit (charging process display) on the charging socket blinks or flashes white → Fig. 147 ① → page 284.

#### Starting charging automatically

Enable the charging station → ⌚.

The charging process starts immediately.

## NOTICE

Follow the manufacturer's information and instructions on using the charging station.

### During charging

The charging process display on the charging socket pulses green → Fig. 147 ①.

If the charging process display lights red, there is a fault → page 285.

### Interrupting the charging process

Charging can be ended before the desired charge level is reached:

- Touch the **STOPP** function button on the In-fotainment system screen.

The charging process display on the charging socket lights up white → Fig. 147 ①. The charging connector is released.

### After charging

The charging process display on the charging socket lights up green when the desired charge level has been reached.

The charging connector is released automatically from the charging station when charging has ended.

- Remove the charging connector from the charging socket.
- Fit the protective cap on the bottom connection of the charging socket → Fig. 147 ③.
- Close the charging socket flap so that it engages audibly.

## Charging process display

☞ Please refer to ⚠ and ① at the start of the chapter on page 279.



Fig. 148 Behind the charging socket flap: charging process indicator.

An LED light unit on the charging socket → Fig. 148 (arrow) shows the charging process status.

A sticker on the charging socket flap provides information about the displays of the LED light unit.

### Displays for charging process

LED light unit flashes:

- The charging connector was recognised by the vehicle.

☐ White LED light unit:

- Blinks: vehicle communication setup with the charging infrastructure. Charging process is being prepared.
- Lights up continuously: no charging function is active.

■ Green LED light unit:

- Pulsates: the high-voltage battery is being charged.
- Lights up continuously: charging has been completed successfully.
- Flashes: timer-controlled charging is activated. Charging has not yet started.

- Lights up alternately with the red display: charging is taking place with a reduced charging current to prevent the vehicle from breaking down. A fault is present, e.g. charging connector not fully locked.

**■ Red LED light unit:**

- Lights up continuously: fault in the charging system. The charging process cannot be started or has been cancelled.

If the charging process display is continuously indicating a problem, seek expert assistance.

### ■ Illumination of the charging socket

The charging socket lights up when it gets dark in order to find it easier.

### ■ Switching on

- ✓ The vehicle has been unlocked.
- ✓ **OR:** the charging connector has been unplugged from the charging socket.


### ■ Switching off

- ✓ The illumination goes out automatically after some time when the vehicle is unlocked or locked.


## Troubleshooting

📖 Please refer to  and  at the start of the chapter on page 279.

### Fault in high-voltage system

The warning lamp lights up red.  **Stop the vehicle immediately!**

A corresponding text message is displayed.

There is a fault in the high-voltage system. High-voltage components may be damaged → .

It is not possible to charge the high-voltage battery.

## DANGER

High-voltage components, including the high-voltage battery and the high-voltage cables, may be live and damaged. The voltage of the high-voltage system is dangerous and will cause burns or other injuries and even lead to a fatal electric shock.

● **Do not touch high-voltage components!**

- Stop the vehicle as soon as it is safe and possible to do so and park in the open air.
- Deactivate the vehicle's drive system.
- Seek expert assistance.



### **Exhaustive discharge of high-voltage battery due to long standing time**

The indicator lamp lights up red. A text message is displayed.

The high-voltage battery may be damaged, e.g. due to a long standing time.

- Charge the high-voltage battery immediately.



### **High-voltage battery is empty**

◀ The indicator lamp lights up yellow. A text message is displayed.

- Charge the high-voltage battery immediately.



### **Charge level of the high-voltage battery low**

The indicator lamp lights up yellow. A text message is displayed with the remaining range.

The charge level of the high-voltage battery has reached the reserve range.

- Charge the high-voltage battery.



### **Fault in range calculation**

The indicator lamp lights up yellow. A text message is displayed.

There is a fault in range calculation. Go to a qualified workshop.

### Charging not possible or aborted

The charging process display on the charging socket lights up red.

Before you visit a qualified workshop, you can perform the following troubleshooting measures:

- Reconnect the charging cable.
- **OR:** check whether the charging connector is inserted correctly.
- **OR:** check whether a fault is indicated on the charging station or, depending on equipment, on the charging cable protection unit.

If the fault cannot be remedied, go to a qualified workshop immediately.

### Protective device of charging cable switches off

If external devices with a separate power connection are used on the vehicle simultaneously, e.g. refrigerator box, a fault may be detected during the self-test of the protection unit.

- Observe the correct order. Always connect the charging cable with the external power supply first and then with the charging socket.

### Charging time changes

During DC charging, the charging current is automatically reduced to protect the high voltage battery from overheating.

In the case of several successive rapid charging procedures, this leads to a temporary extension of the charging time. <

## Manually releasing the charging connector

📖 Please refer to ⚠️ and ⚠️ at the start of the chapter on page 279.

### Requirements for release

- ✓ The charging connector has been plugged in correctly → page 281 and not at an angle.
- ✓ The vehicle is unlocked → page 73.
- ✓ The charging process has been completed or interrupted → page 279.
- ✓ When charging with alternating current (AC), the setting *Automatically release connector* is activated in the charging settings → page 31.

Manually release the charging connector if the prerequisites are met and the charging connector still cannot be removed → ⚠️.

### ⚠️ DANGER

If the charging connector remains locked unexpectedly, the cause may be a fault in the vehicle or the charging station. Live contacts may become accessible as a result of the manual unlocking procedure. In this case, touching the contacts in the charging socket will lead to burns, other injuries or a fatal electric shock.

- Never touch the contacts in the charging socket or charging connector.

🔧 Only release the charging connector manually in the event of a malfunction on the vehicle.

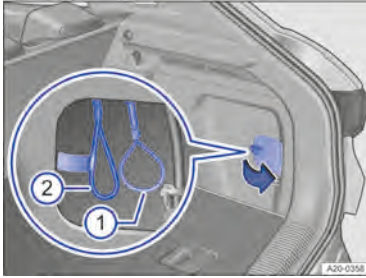
### Electrically releasing the charging connector

To avoid manually releasing the charging connector in the luggage compartment, try to release it electrically via the vehicle's central locking system → page 73.

- Unlock the vehicle three times in quick succession.
- Remove the charging connector.

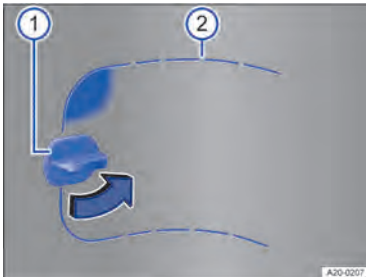


### Manually releasing the charging connector



**Fig. 149** Behind a flap in the right-hand luggage compartment trim: Manual release mechanism for the charging connector ① and emergency cut-out connection ②.

- Open the luggage compartment. On the bottom right there is a flap with a catch → Fig. 149.



**Fig. 150** Luggage compartment trim, bottom right: flap with coupling point.

- Turn the catch of the flap by 90° → Fig. 150 ① (blue directional arrow).
- Press in the area above the catch → Fig. 150 (area marked blue).
- Reach into the opening and release the flap by pulling. If necessary, use a suitable tool at the coupling point → Fig. 150 ②.
- Open the flap.

- Pull the loop for the manual release mechanism → Fig. 149 ①. The loop **does not** have a tag → ①! The charging connector can now be removed → ⚠.

- Close the flap with the catch in the luggage compartment trim.

Have the charging socket checked by a qualified workshop as soon as possible.

### High-voltage system fuse (emergency cut-out connection)

There is a fuse loop for the high-voltage system for use by emergency services directly next to the loop for manual release → Fig. 149 ②. The fuse is marked with a yellow tag → ①.

#### ⚠ NOTICE

The fuse loop for the high-voltage system (emergency cut-out connection) is designed to be used exclusively by fully qualified emergency services personnel. Damage will lead to the deactivation of the high-voltage system.

- When manually releasing the charging connector, always make sure that the fuse loop with the tag is not damaged. ◀

## Charging cable

### 📖 Introduction to the topic

#### Instructions for charging cable

The charging cable supplied with the vehicle depends on the scope of delivery and the country-specific technical requirements, e.g. charging connector connections for mains sockets.

Volkswagen recommends using **only** the supplied charging cable.

#### ⚠ DANGER

Use of a damaged charging cable or a charging cable that has been tampered

with will lead to serious injuries and a fatal electric shock.

- Always check the charging connectors and charging cable for damage, e.g. cracks, before use.
- Never use a damaged charging cable or a charging cable that has been tampered with.
- Have the charging cable checked by a Volkswagen dealership if there is a malfunction.

### ⚠ NOTICE

Before driving abroad, find out about the correct charging cable and the maximum permissible charging current. If possible, use the charging cable supplied in the country concerned.

- Handle with care → ⚠.
- Unwind or wind up completely.
- Do not fold or bend over sharp edges.
- Do not trap or drive over cable.
- Pull only at the charging connectors.
- Children must not use the charging cable.
- Keep animals away from cable.
- Stow safely without kinks after use.



**Fig. 151** Under the luggage compartment floor: stowage compartment for the charging cable (schematic diagram).

### ⚠ WARNING

Objects that are not secured or are secured incorrectly can cause serious injuries in the

event of a sudden driving or braking manoeuvre or accident.

- Stow the charging cable safely in the storage compartment under the luggage compartment floor → Fig. 151.
- **OR:** Please use the charging cable bag provided to stow the charging cable safely. Hook the charging cable bag into one of the front fastening rings in the luggage compartment.

### Instructions for charging connectors and charging cable protection unit

- Do not reach into the contacts of the charging connector.
- Protect against intense sunlight (ambient temperature not higher than 50°C or 122°F).
- Do not drop.
- Protect against submerging in liquids, such as rainwater.
- Fit the protective caps after use.

### ⚠ WARNING

Always connect the charging cable for mains sockets directly to a mains socket. Injuries due to fire could be incurred or the charging cable or the house's electrical system could become damaged.


- Never connect the charging cable to an extension cable, a cable reel, a multiple socket outlet or an adapter such as a regional adapter or timer.

### ⚠ NOTICE



The charging cable may be subject to a regular testing requirements as mobile electrical equipment. A test adapter is required.



Comply with the maximum load for the safety circuit used. If the charging cable is connected to a mains socket with other electrical consumers in the same electrical circuit, the fuse in the electrical circuit can be tripped.

 Charging cables must be disposed of in an environmentally friendly way and must not be disposed of as household waste.

#### Cleaning the charging cable

- Wipe the surface of the charging cable with a dry or only slightly moistened cloth → , → .

#### DANGER

The voltage of the high-voltage system is dangerous and will cause burns or other injuries and even lead to a fatal electric shock.

- Clean the charging cable only when it is disconnected.

#### NOTICE

The charging cable can be damaged by incorrect cleaning.



- Use only water and no additional cleaning agents.
- Make sure that no water gets into the contacts.


### Charging cable for charging stations with alternating current (AC)

 Please refer to ,  and  at the start of the chapter on page 287.



**Fig. 152** Charging cable for charging stations with alternating current (AC).

The maximum charging current is 16 A or 32 A and depends on the infrastructure used, the charging cable and the equipment on the charging unit. → , → .

The electrical installation abroad may be designed according to different technical rules than in your own country. This means that a charging cable with a cross-section of 5 x 6 mm<sup>2</sup> may be required locally to achieve the maximum charging power available → .

#### WARNING

Charging the high-voltage battery with an unsuitable charging cable may lead to short circuits, severe injury and fatal electric shocks.

- Make sure to find out the type of electrical installation available locally before travelling abroad.
- Please always observe the specifications given on the charging cable.

## CAUTION


The charging cable must not be used as an extension cable.


### Charging in Norway

In Norway, only use a charging cable with a cross-section of  $5 \times 6 \text{ mm}^2 \rightarrow \triangle$ . Before travelling to Norway, check whether your charging cable for charging stations meets the requirements given above. Please note the information on the charging cable.

## NOTICE

Follow the manufacturer's information and instructions on using the charging station.

 Charging with a charging cable with a rating of 16 A is not possible at some charging stations that support 32 A. This depends on the equipment of the charging station.

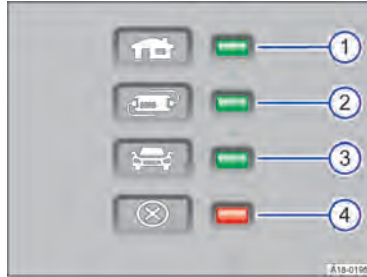
— Inform yourself about the available charging technology before charging. 

## Charging cable for mains sockets

 Please refer to ,  and  at the start of the chapter on page 287.



**Fig. 153** Charging cable for mains sockets (illustration)



**Fig. 154** Warning lamp on the charging cable protection unit.

- ① Indicator lamp for plug and power supply.
- ② Indicator lamp for protection unit
- ③ Indicator lamp for vehicle
- ④ Fault warning lamp.

### Information on the charging cable

Before using the charging cable, also pay attention to the information on the charging cable and on the rear of the protection unit.

### Protection unit

The charging connector is de-energised by the electronic protection unit  $\rightarrow$  Fig. 154 until it is inserted in the vehicle's charging socket.

### Self-test


When the charging cable is connected to a mains socket, the protection unit will automatically perform a self-test. All warning and indicator lamps will briefly light up and go out one after another. The current operating status is then displayed.

### Status indicators

One or more indicator lamps  $\rightarrow$  Fig. 154 ①, ②, ③ light up green.

Display $\rightarrow$ Fig. 154	Meaning
① Lit up	Charging cable is connected to the mains network.

Display → Fig. 154	Meaning
①, ② lit up, ③ flashing	High-voltage battery is being charged.
①, ② and ③ lit up	Charging process ended. High-voltage battery has been charged.

 It is possible that charging cable supplied outside Norway cannot be used for recharging from mains sockets in Norway.

### Setting charging current

The charging cable limits the charging current corresponding to the available power supply.

Depending on the equipment, the charging current can be reduced in the charging settings of the Infotainment system if charging is not to take place with the maximum charging current at the local power supply → page 279.

### Temperature monitoring

If the protection unit or mains plug overheats, the charging cable reduces the charging current or interrupts the charging process. The cause may be damage to the charging cable or the electrical installation. If the charging cable has been stored at high temperatures, this can also lead to the charging process being switched off.

Display → Fig. 154	Meaning
①, ④ flashing	Domestic plug overheated.
②, ④ flashing	Protection unit overheated.

If charging is continued with a lower charging current, the warning lamp → Fig. 154 ④ flashes red in addition to the current status indicator.

- Disconnect the charging cable from the mains and allow it to cool down.

- If the charging current is switched off or reduced again without any discernible external heat influence, check which green indicator lamp is flashing → Fig. 154. Have the charging cable checked by a Volkswagen dealership. Contact a qualified workshop for electrical installations to have the infrastructure connection checked.


### Fault displays

If the warning lamp → Fig. 154 ④ flashes or lights up red without an indicator lamp → Fig. 154 ①, ② or ③ of the status indicator being lit continuously, there is a fault present.

Display → Fig. 154	Meaning
① flashing, ④ lit or flashing	Fault in the power supply.
② flashing, ④ lit or flashing	Fault in the safety device.
③ flashing, ④ lit or flashing	Vehicle malfunction.

The charging process will be interrupted or aborted.

- Observe the information on the rear of the protection units.
- If the fault persists, go to a qualified workshop.

 If the vehicle is connected to the power grid via an additional connection or is located in direct proximity to high-voltage lines during the charging process, charging at a mains socket may not be possible. Additional connections to the power grid:

- Connection of a charger for 12-volt vehicle battery.
- Contact with working equipment connected to the power grid, e.g. lifting platform. <

# If and when

## Vehicle toolkit

### Introduction to the topic

Observe any country-specific legislation when securing your vehicle in the event of a breakdown.

#### ⚠ WARNING

In the event of a sudden driving or braking manoeuvre or accident, a loose vehicle toolkit, breakdown set and spare wheel or temporary spare wheel could be flung through the vehicle and cause severe injuries.

- Ensure that the vehicle toolkit, breakdown set and spare wheel or temporary spare wheel are always properly secured in the luggage compartment.

#### ⚠ WARNING

Unsuitable or damaged tools in the vehicle toolkit can lead to accidents and injuries.

- Never work with unsuitable or damaged tools from the vehicle toolkit.

### Stowage

📖 Please refer to ⚠ at the start of the chapter on page 292.

The vehicle toolkit may be located in various positions in the luggage compartment:

- In a bag on the left or right in the stowage compartments of the luggage compartment.
- In a foam rubber holder under the luggage compartment floor → page 255.

In some models, the luggage compartment may contain a loose box with the vehicle toolkit. This enclosed vehicle toolkit is inten-

ded for a possible winter tyre change and does not need to be carried in the vehicle at all times.

📖 After using the jack, crank it back to its original position so that it can be stowed safely.

#### ⚠ NOTICE

Never drop the luggage compartment floor; guide it slowly back down. The trims or the luggage compartment floor could otherwise be damaged.

### Contents of the vehicle toolkit

📖 Please refer to ⚠ at the start of the chapter on page 292.



Fig. 155 Contents of the vehicle toolkit. (illustration)

The content of the vehicle toolkit depends on the country and equipment:

- ① Adapter for the anti-theft wheel bolt. Volkswagen recommends that you carry the wheel bolt adapter in the vehicle toolkit at all times. The **code number** of the anti-theft wheel bolt is stamped on the front of the adapter. You will need this number to replace the adapter if it is lost. Make a note of the code number for

the anti-theft wheel bolt and keep it in a safe place – but not inside the vehicle.

- ② Screw-in towing eye.
- ③ Hook for pulling off the centre covers, wheel covers and the wheel bolt caps.
- ④ Extraction bracket.
- ⑤ Jack. Before you repack the jack, you must fully wind in the claw.
- ⑥ Box spanner for wheel bolts.
- ⑦ Crank.

#### Jack: maintenance

There are no maintenance cycles for the jack. Grease the jack with universal lubricant when necessary.

## Wiper blades

### Service position

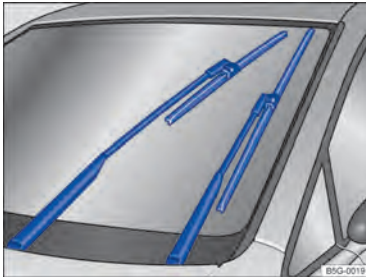


Fig. 156 Wipers in service position.

The wiper arms can be lifted off the windshield when in the service position. Carry out the following steps to move the windshield wipers to the service position:

#### Activating the service position via the wiper lever

- The bonnet and driver and front passenger doors must be closed → page 312.
- Switch the ignition on and then off again.

- Push the wiper lever up briefly.

#### Activating the service position via the exit menu

The service position of the wiper blades can be activated for a limited period in the exit menu → page 31. The ignition must be switched off when doing this → page 137.

#### Lifting the windscreen wiper arms

- Move the wiper arms to the service position before lifting → ①.
- When lifting a wiper arm, hold it **only** in the area of the wiper blade mounting.

Place the wiper arms back onto the windshield before driving away. With the ignition switched on, briefly press the wiper lever up to bring the wiper arms back to the original position.

### ⚠ NOTICE

- In order to prevent damage to the bonnet and the wiper arms, the windshield wiper arms should only be lifted when in the service position.
- Always return the wiper arms to the windshield before starting your journey.

### Cleaning and changing wiper blades

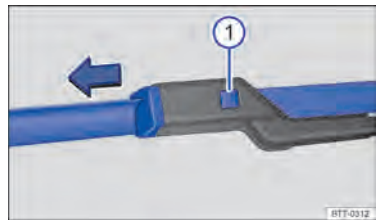
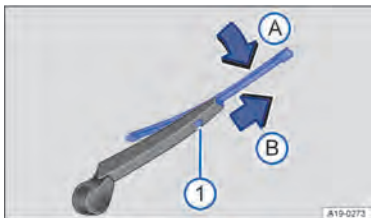


Fig. 157 Changing the windscreen wiper blades.



**Fig. 158** Changing the wiper blade for the rear window.

The factory-fitted windscreen wiper blades are coated with graphite. The graphite coating ensures that the wiper blade moves quietly over the window. If the graphite coating is damaged, the wiper will become louder.

Check the condition of the wiper blades on a regular basis. **Rubbing wiper blades** should be changed if damaged or cleaned if dirty → page 294.

Damaged wiper blades should be replaced immediately. Wiper blades can be obtained from a qualified workshop.

### Cleaning wiper blades

**Note for the windscreen wipers:** move the wiper arms to the service position before lifting them → page 293.

- When lifting a wiper arm, hold it **only** in the area of the wiper blade mounting.
- Clean the wiper blades carefully using a damp sponge → page 294.
- Place the wiper arms carefully back onto the windscreen.

### Changing the windscreen wiper blades

- Move the wiper arms to the service position before lifting → page 293.
- When lifting a wiper arm, hold it **only** in the area of the wiper blade mounting.
- Press and hold the release button and simultaneously pull off the wiper blade in the direction of the arrow → Fig. 157 ①.

- Insert a new wiper blade with the **same length and design** onto the wiper arm. Push it on until it engages.
- Place the wiper arms carefully back onto the windscreen.

### Changing the wiper blade for the rear window

- When lifting a wiper arm, hold it **only** in the area of the wiper blade mounting.
- Lift and fold back the wiper arm.
- Press and hold the release button → Fig. 158 ①.
- Tilt the wiper blade in the direction of the wiper arm → Fig. 158 (arrow A) and pull it off in the direction of the arrow B at the same time. You may need to use some force to do this.
- Insert a new wiper blade with the **same length and design** onto the wiper arm against the direction of the arrow. Push it on until it engages → Fig. 158 (arrow B). The wiper blade must be in the folded back position → Fig. 158 (arrow A).
- Carefully place the wiper arm back onto the rear window.

### ⚠ WARNING

Worn or dirty windscreen wiper blades reduce visibility and increase the risk of accidents and severe injuries.

- Always change wiper blades if they are damaged or worn and no longer clean the window properly.


### ⓘ NOTICE

Damaged or dirty wipers can scratch the windows.

- Do not use any detergents containing solvents, hard sponges and other sharp objects, as they can damage the graphite coating of the wiper blades during cleaning.



- Do not use fuel, nail varnish remover, paint thinner or similar products to clean the windows.

 Wax deposits on the windscreen and rear window could cause the wiper blades to rub. Remove wax residue using a special cleaning product or cleaning cloths. <

## Exterior lighting

### Introduction to the topic

Before changing a bulb, check whether a bulb or LED light unit has failed. You can normally change bulbs yourself. If the exterior lighting is realised using LED technology, depending on model and vehicle equipment, it is not possible for you to change the LED light units or individual LEDs yourself. If individual LEDs fail, this may be an indication that more LEDs are on the point of failure. In this case, have the LED light units checked and renewed if necessary at a qualified workshop.

It may be illegal to drive with faulty exterior lights.

#### Additional bulb specifications

Some bulbs might have factory specifications that differ from standard bulbs. The designation is inscribed on the bulb, either on the glass part or on the base.

### WARNING

Changing bulbs incorrectly can cause accidents and serious injuries.

- When working in the bonnet space, always read and observe the safety warnings → page 309. The bonnet space of any vehicle is a dangerous area. Serious injuries can be sustained here.
- Halogen bulbs are pressurised and could explode when they are being changed.
- Change the defective bulb only once it has cooled down completely.

- Never change a bulb unless you are familiar with the procedure. If you are uncertain of what to do, the work should be carried out by a qualified workshop.
- Do not touch the glass part of the bulb with unprotected fingers. When the light is switched on, heat will cause fingerprints to evaporate on the bulb, which in turn will cause the reflector to “go blind”
- There are sharp-edged parts on the headlight housing and on the tail light cluster housing. Protect your hands when changing bulbs.

### NOTICE

Damage to the electrical system can be caused by water entering the system if the rubber cover or plastic covers on the headlight housing are not properly mounted after a bulb has been changed. <

### Checklist “Information on changing bulbs”

 Please refer to  and  at the start of the chapter on page 295.

#### Checklist

Always carry out the following actions for changing a bulb in the given order → page 296:

1. Park the vehicle on a firm and level surface at a safe distance from the flow of traffic.
2. Switch on the electronic parking brake → page 177.
3. Switch off the lights → page 103.
4. Move the turn signal and main beam lever to neutral position → page 102.
5. Switch off the ignition.
6. Allow the orientation lighting to go out → page 109.
7. Leave the defective bulbs to cool down.

8. Check to see if a fuse has visibly blown → page 296.
9. Follow the instructions to change the affected bulb → ①. Always replace bulbs with identical bulbs of the same type. The designation is inscribed on the bulb, either on the glass part or on the base.
10. Do not touch the glass part of the bulb with unprotected fingers. When switched on, the heat of the bulb would cause the remaining fingerprint to evaporate and be deposited on the reflector. This will impair the light output of the headlight.
11. After changing a bulb, check to ensure that the bulb is working properly. If the bulb is not working properly, the bulb may not have been inserted properly, may have failed again, or the connector may have been fitted incorrectly.
12. Each time you change a bulb at the front of the vehicle, the headlight settings should be checked by a qualified workshop.

### **⚠ WARNING**

Ignoring any of the items on this important safety checklist can lead to accidents and severe injuries.

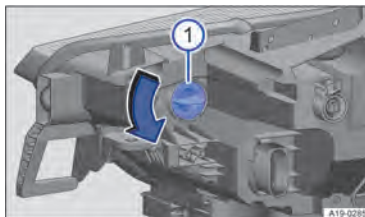
- Always follow the instructions in the checklist and observe the general safety procedures.

### **📌 NOTICE**

Always take care when removing or fitting lights to prevent damage to the paintwork or to other vehicle parts. <

## Changing the turn signal bulb

📖 Please refer to ⚠ and ① at the start of the chapter on page 295.



**Fig. 159** Rear of the right headlight: changing the turn signal bulb.

The actions should only be carried out in the specified order:

1. Observe and follow the instructions in the checklist → page 295.
2. Open the bonnet ⚠ → page 309.
3. Turn the bulb holder → Fig. 159 ① in the direction of the arrow and pull it out.
4. Replace the defective bulb with a new bulb of the same type.
5. Carefully insert the bulb holder into the headlight and turn it as far as it will go in the opposite direction to the arrow.
6. Close the bonnet ⚠ → page 309.



The illustration shows the right-hand headlight from the rear. The left-hand headlight is a mirror image of the one shown. <

## Changing fuses

### **📖 Introduction to the topic**

At the time of publication we are unable to provide an complete overview of the locations of the fuses for the electrical consumers. This is because the vehicle is under constant development, because fuses are as-

signed differently depending on the vehicle equipment level and because several electrical consumers may use a single fuse. You can obtain further information about the fuse assignment from a Volkswagen dealership.

Several electrical consumers can share a single fuse. Conversely, a single consumer could have more than one fuse.

Therefore fuses should only be replaced when the cause of the fault has been rectified. If a new fuse blows again shortly after fitting, have the electrical system checked by a qualified workshop as soon as possible.

#### Fuses for emergency services (high-voltage system)

High-voltage system fuses in the fuse box under the steering wheel, behind the stowage compartment (left-hand drive) or behind a cover in the glove box (right-hand drive) and behind a cover on the right side of the luggage compartment are identified with a tag to enable emergency services to de-energise the vehicle as quickly as possible. Never attempt to replace these fuses or swap them with other fuses in other slots → page 297. If this fuse is faulty, always have it replaced by a qualified workshop.

#### WARNING

The voltage in the high-voltage system can cause electric shocks, serious burns and death!

- Never touch the electrical cables in the bonnet space.
- Avoid causing short circuits in the electrical system.
- Never attempt to replace or repair fuses for the high-voltage system. Always have work performed by a qualified workshop.

#### WARNING

Using unsuitable or repaired fuses and bridging an electrical circuit without fuses can cause a fire and serious injuries.



- Never fit fuses that have a higher fuse rating. Fuses must always be replaced by a new fuse with the same amp rating (same colour and markings) and size.
- Never repair a fuse.
- Never use a metal strip, paper clip or similar objects to replace a fuse.

#### NOTICE

- To avoid damage to the electrical system in the vehicle, switch off the ignition, the lights and all electrical consumers before changing a fuse.
- Make sure that it is not possible to activate the vehicle's drive system when changing a fuse.
- You can damage another location in the electrical system by using a fuse with a higher amp rating.
- Fuse boxes must be protected from dirt and moisture when opened. Dirt and moisture in the fuse boxes can damage the electrical system.
- Remove the covers for the fuse boxes carefully and install them again properly so as to avoid damage to the vehicle.

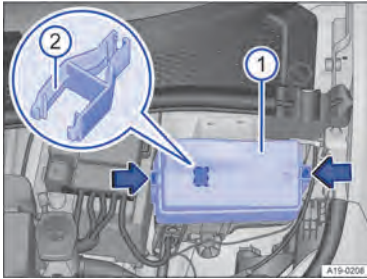
#### NOTICE

Never remove the specially tagged high-voltage fuses from the fuse box in the dash panel or luggage compartment. These are for the exclusive use of the emergency services so that the vehicle can be de-energised as quickly as possible.

 There are other fuses in the vehicle in addition to those described in this chapter. These should be changed only by a qualified workshop. 

## Fuses in the bonnet space

📖 Please refer to ⚠️ and ① at the start of the chapter on page 296.



**Fig. 160** In the bonnet space: fuse box with plastic grippers.

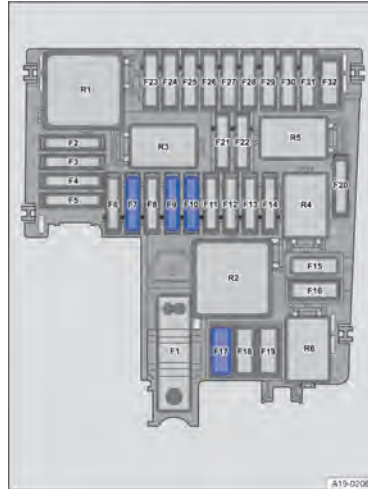
### Opening the fuse box in the bonnet space

- Open the bonnet ⚠️ → page 309.
- Press the locking button in the direction of the arrow → Fig. 160 (arrows) in order to unlock the cover of the fuse box → Fig. 160 ①.
- Lift off the cover.
- To *install*, position the cover on the fuse box and press it downwards until the cover audibly clicks into place on both sides.

There may be a pair of plastic grippers for removing fuses in the fuse box → Fig. 160 ②. <

## Fuse table for fuses in the bonnet space

📖 Please refer to ⚠️ and ① at the start of the chapter on page 296.



**Fig. 161** In the bonnet space: fuse locations.

The table shows the fuse locations of the electrical consumers relevant for the driver. The first column in the table contains the location. The other columns contain the fuse types, the amp rating and the consumer protected by the fuse.

Depending on the market and specification of your vehicle, the fuse numbers and locations may differ to those given in the table. If necessary, ask your Volkswagen dealership for the exact fuse assignment.

Fuse location → Fig. 161:

- F7** 30 amps, ATO®, front wipers, right
- F9** 15 amps, ATO®, horn.
- F10** 30 amps, ATO®, front wipers, left
- F11** 7.5 amps, ATO®, air conditioning system.

F17 40 amps, MAXI+®, windscreen heating.

## Fuses in the dash panel

Please refer to ⚠ and ⓘ at the start of the chapter on page 296.



Fig. 162 Left-hand drive vehicle: fuse box cover in the dash panel on the driver side

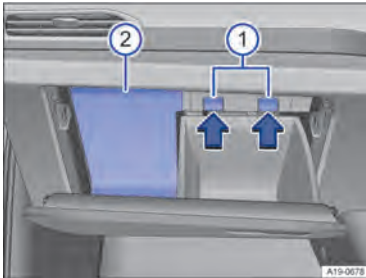


Fig. 163 Right-hand drive vehicle: fuse box cover in the dash panel on the front passenger side.

### Left-hand drive vehicle: opening the fuse box in the dash panel

- Reach behind the cover and pull off in the direction of the arrow → Fig. 162.
- To *install*: align the cover on the opposite side and fold it closed in the opposite direction to the arrow until you hear it engage.

### Right-hand drive vehicle: opening the fuse box in the dash panel

- Open the glove box and empty if necessary.
- Reach behind the cover from the side and pull it backwards. → Fig. 163 ⓘ.
- To *install*: insert the cover again and push it forwards until it clicks into place again.
- Close the glove box.

## Fuse table for fuses in the dash panel

Please refer to ⚠ and ⓘ at the start of the chapter on page 296.

Fig. 164 In the dash panel: fuse assignment.

The table shows the fuse locations of the electrical consumers relevant for the driver. The first column in the table contains the location. The other columns contain the fuse types, the amp rating and the consumer protected by the fuse.


Depending on the market and specification of your vehicle, the fuse numbers and locations may differ to those given in the table. If necessary, ask your Volkswagen dealership for the exact fuse assignment.

Fuse location → Fig. 164:

- F5** 25 amps, ATO<sup>®</sup>, left exterior lighting.
- F6** 30 amps, ATO<sup>®</sup>, interior lighting.
- F7** 30 amps, ATO<sup>®</sup>, seat heating.
- F8** 15 amps, ATO<sup>®</sup>, sun blind in glass roof.
- F13** 40 amps, MAXI+<sup>®</sup>, central locking.
- F20** 10 amps, MINI<sup>®</sup>, telephone.
- F30** 20 amps, ATO<sup>®</sup>, parts for the Infotainment system.
- F32** 25 amps, ATO<sup>®</sup>, right exterior lighting.
- F36** 40 amps, MAXI+<sup>®</sup>, blower regulator.
- F40** 10 amps, MINI<sup>®</sup>, anti-theft alarm.
- F43** 7.5 amps, MINI<sup>®</sup>, air conditioning system control panel or heating and fresh air system, rear window heating relay.
- F44** 7.5 amps, MINI<sup>®</sup>, light switch (dipped beam), rain and light sensor, background lighting, ID. Light.
- F46** 10 amps, MINI<sup>®</sup>, display, Infotainment system control panel.
- F52** 20 amps, ATO<sup>®</sup>, cigarette lighter, sockets.
- F66** 15 amps, ATO<sup>®</sup>, rear window wiper.
- F67** 30 amps, MAXI+<sup>®</sup>, rear window heating.

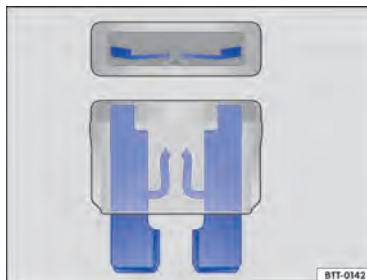
Fuse locations for vehicles with factory-fitted towing bracket:

- F3** 25 amps, ATO<sup>®</sup>, control unit for trailer detection, left
- F11** 15 amps, ATO<sup>®</sup>, control unit for trailer detection
- F29** 15 amps, ATO<sup>®</sup>, control unit for trailer detection
- F31** 25 amps, ATO<sup>®</sup>, control unit for trailer detection, right

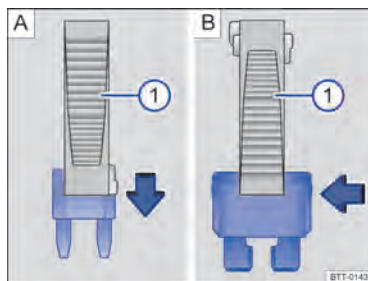
 Electric windows and electrically adjustable seats may be protected by **circuit breakers** or **control units** which switch on again automatically a few seconds after the overload, e.g. frozen windows, has been rectified. ◀

## Changing blown fuses

 Please refer to  and  at the start of the chapter on page 296.



**Fig. 165** Blown fuse.



**Fig. 166** Removing or inserting fuse with plastic grippers: **A** flat blade fuse, **B** cartridge fuse.

### Fuse types

- Standard flat blade fuse (ATO<sup>®</sup>).
- Small flat blade fuse (MINI<sup>®</sup>).
- Large flat blade fuse (MAXI<sup>®</sup> or MAXI+<sup>®</sup>).

### Colour coding of fuses

#### Fuses (ATO® - MINI® - MAXI® and MAXI+®)

Colour Amp rating

**Black** 1 amps

**Purple** 3 amps

**Orange** 5 amps

**Brown** 7.5 amps

**Red** 10 amps

**Blue** 15 amps

**Yellow** 20 amps

**White or clear** 25 amps

**Green** 30 amps

**Light green** 40 amps

### Preparations

- Switch off the ignition, the lights and all electrical consumers.
- Open the appropriate fuse box → page 299.

### Detecting a blown fuse

- Shine a torch onto the fuse. This will help you to spot the blown fuse more easily.
- You can see if a *flat blade fuse* is blown from the top and side through the transparent housing due to the melted metal strip → Fig. 165.

### Changing fuses

- If applicable, take the plastic grippers out of the fuse box or the cover of the respective fuse box → Fig. 166 ①.
- Push the plastic grippers clip suitable for the fuse design onto the fuse from the top or the side → Fig. 166.
- Remove the fuse.
- If the fuse has blown, replace it with a new fuse of the *same* amp rating (same colour and same markings) and *same* size → page 301.
- Once the new fuse has been inserted, put the plastic grippers back in the cover.
- Insert the cover again or close the fuse box cover.

### ! NOTICE

You can damage another location in the electrical system by using a fuse with a higher amp rating. <

## Jump starting

### 📖 Introduction to the topic

For technical reasons, your vehicle may not be push-started → page 301.

If the vehicle's drive system cannot be activated because the 12-volt vehicle battery is discharged, you can use the 12-volt vehicle battery in another vehicle to activate the vehicle's drive system.

Suitable jump leads are needed for jump starting.

Cable cross-section for the jump leads:

- For vehicles with an electric drive at least 25 mm<sup>2</sup>.

### ! WARNING

Using the jump leads incorrectly or completing the jump start procedure incorrectly can cause the 12-volt vehicle battery to explode, which can lead to severe injuries. Please note the following in order to reduce the risk of the 12-volt vehicle battery exploding:

- All work on the 12-volt vehicle battery and the electrical system can cause serious chemical burns, fire or electric shocks. Always read the warnings and safety information before carrying out any kind of work on the 12-volt vehicle battery → page 320.
- The vehicle battery providing assistance must have the same voltage (12 volts) and approximately the same capacity as the flat 12-volt vehicle battery (see label on battery).

- Never charge a 12-volt vehicle battery which is frozen or has been frozen. Discharged 12-volt vehicle batteries can already freeze at temperatures of around 0°C (+32°F).
- The 12-volt vehicle battery must be replaced if it is frozen or has ever been frozen.
- A highly explosive mixture of gases is given off when the 12-volt vehicle battery is jump started. Always keep fire, sparks, naked flames and lit cigarettes away from the 12-volt vehicle battery. Never use a mobile telephone when the jump leads are being connected or disconnected.
- Position the jump leads so that they never come into contact with any moving parts in the bonnet space.
- Never confuse the negative and positive terminals or connect the jump leads incorrectly.
- Observe the operating manuals of the jump lead manufacturer and the manufacturer of the other vehicle.

### NOTICE

Please note the following in order to avoid considerable damage to the vehicle electrical system:

- A short circuit can be caused if the jump leads are wrongly connected.
- Use only jump leads with fully insulated terminal clamps.
- The vehicles must not touch each other, as any contact could mean that electricity could flow as soon as the positive terminals are connected.

### NOTICE

Tow-starting the vehicle can cause damage. <

## Jump-start connection point (earth connection)

☞ Please refer to ⚠ and Ⓛ at the start of the chapter on page 301.

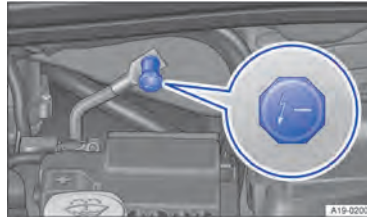


Fig. 167 In the vehicle front end: jump-start connection point (earth connection).

- Ⓛ The jump-start connection point (earth connection) is used for connecting the black jump lead → Fig. 167.

The vehicle can only be jump started via this jump-start connection point (earth connection). <

## Jump starting the vehicle

☞ Please refer to ⚠ and Ⓛ at the start of the chapter on page 301.

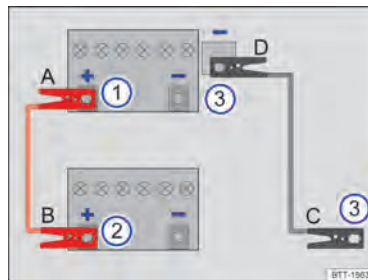


Fig. 168 How to connect the jump leads.



- ① Vehicle with discharged 12-volt vehicle battery that is being jump-started.
- ② Vehicle with 12-volt vehicle battery that is supplying power and jump-starting the other vehicle.
- ③ Suitable earth connection: jump-start connection point.

### NOTICE

Observe the instructions for jump starting in the owner's manual of the other vehicle.

The discharged 12-volt vehicle battery must be properly connected to the vehicle electrical system.

The vehicles must not be touching each other. Otherwise electricity could flow as soon as the positive terminals are connected.

Ensure that the battery clamps have good metal-to-metal contact with the battery terminals.


If the vehicle's drive system cannot be activated, stop the procedure and repeat it after approximately one minute.


Please contact an expert if the vehicle's drive system still cannot be activated.

#### Attaching the jump leads

The jump leads should be connected only in the order **A - B - C - D** → Fig. 168.

The *black* jump lead should never be connected to the negative terminal - on the 12-volt vehicle battery. Connecting the lead to the negative terminal can cause incorrect condition evaluation of the 12-volt vehicle battery in the vehicle electronics.

- Switch off the ignition in both vehicles → page 138.
- Connect one end of the *red* jump lead **A** to the positive terminal + of the battery on the vehicle with the discharged 12-volt vehicle battery → Fig. 168 ① → .
- Connect the other end of the *red* jump lead **B** to the positive terminal + of the vehicle battery providing assistance → Fig. 168 ②.

- Connect one end of the *black* jump lead **C** to the jump-start connection (earth connection) of the vehicle providing assistance → Fig. 168 ③.
- Connect the other end of the *black* jump lead **D** to the jump-start connection point (earth connection) on the vehicle with the discharged 12-volt vehicle battery → Fig. 168 ③ → .
- Position the leads in such a way that they cannot come into contact with any moving parts in the bonnet space.

#### Activating the vehicle's drive system

- Start the engine of the vehicle that is supplying power and let it run at idle, and start the ignition in the electric vehicle.
- Activate the electric drive on the vehicle with the discharged 12-volt vehicle battery.

Please seek expert assistance if the vehicle's drive system cannot be activated.

#### Removing the jump leads


- Before disconnecting the jump leads, switch off the dipped beam headlights if they are switched on.
- After activation of the vehicle's drive system and with running engine of the vehicle providing assistance or switched-on ignition of the electric vehicle, disconnect the jump leads only in the order **D - C - B - A** → Fig. 168.
- Close the battery cover as required.
- Go to a qualified workshop without delay and have the 12-volt vehicle battery checked.

### WARNING

Jump starting the vehicle incorrectly can cause the 12-volt vehicle battery to explode, which can lead to serious injuries. Please note the following in order to reduce the risk of the 12-volt vehicle battery exploding:

- All work on the 12-volt vehicle battery and the electrical system can cause serious chemical burns, fire or electric shocks. Always read the warnings and safety information before carrying out any kind of work on the 12-volt vehicle battery → page 320.
- Always wear suitable eye protection and gloves and never lean over the 12-volt vehicle battery.
- Attach the connecting cables in the correct order – the positive cable first, followed by the negative cable.
- Never connect the negative cable to parts of the high-voltage system or to the brake lines.
- The non-insulated parts of the battery clamps must not be allowed to touch each other. The jump lead attached to the positive terminal on the 12-volt vehicle battery must not touch electrically conductive parts of the vehicle.
- Avoid electrostatic discharge in the vicinity of the 12-volt vehicle battery. The explosive gas emitted from the 12-volt vehicle battery could be ignited by sparks.
- Do not use jump leads if the 12-volt vehicle battery is damaged or if it is frozen or has been frozen.

### NOTICE

Once the vehicle has been successfully jump-started, go to a qualified workshop and have the 12-volt vehicle battery checked. 

## Towing

### Introduction to the topic

Towing requires experience, especially when using a tow-rope. Both drivers should be familiar with the technique required for towing. Inexperienced drivers should not attempt to tow.

Make sure that no excessive pulling forces occur and take care to avoid jerking movements. When towing offroad, there is always a risk of overloading the anchorage points.

Observe any legal requirements when towing.

### Towing

Towing is where a vehicle that cannot be driven is pulled with the aid of another vehicle.

The vehicle can be towed with a tow-bar or a tow-rope:

- The maximum permitted towing speed is 50 km/h (30 mph).
- The maximum permitted towing distance is 50 km (30 miles).

### Tow-rope, tow-bar

It is easier and safer to tow a vehicle with a tow-bar. Use a tow-rope only if you do not have a tow-bar.

The tow-rope should be slightly elastic to reduce the strain on both vehicles. It is advisable to use a tow-rope made of synthetic fibre or similarly elastic material.

### Towing with a breakdown truck

The vehicle may only be transported on a recovery vehicle when standing on four wheels.

### WARNING

If a vehicle is being towed, the vehicle handling and braking efficiency will change significantly.

### WARNING

Never tow a vehicle that has no power supply.

- Never switch off the ignition using the starter button when the vehicle is being towed. Otherwise the electronic steering column lock could engage suddenly. You will no longer be able to steer the vehicle. This can lead to a loss of control of the vehicle, accidents and serious injuries.

- If the power supply of the towed vehicle fails, stop towing immediately and seek expert assistance.

### ! NOTICE

Towing with a tow-rope or tow-bar can damage the vehicle.

- Tow the vehicle carefully with a tow-rope or tow-bar.
- If possible, have the broken-down vehicle transported by a breakdown truck.

### ! NOTICE

When pushing the vehicle by hand, the tail light clusters, side spoilers on the rear window and large panels can be damaged and the rear spoiler may become detached.

- When pushing the vehicle by hand, do not press on the tail light clusters, side spoilers on the rear window, large panels and the rear spoiler.

### ! NOTICE

The vehicle can be damaged, e.g. the vehicle paintwork, when removing and fitting the cover and towing eye.

- Remove and install the cover and the towing eye carefully so as to avoid damage to the vehicle.

### ! NOTICE

Use of a towing eye that is not suitable for the vehicle can damage the vehicle.

- Always use the towing eye supplied in the vehicle toolkit of your vehicle or a towing eye that is suitable for the vehicle for towing.

## Notes on towing

📖 Please refer to  and  at the start of the chapter on page 304.

It is still possible to activate the turn signals in a vehicle that is being towed, even if the hazard warning lights are switched on. To do this, operate the turn signal and main beam lever in the required direction while the ignition is switched on. The hazard warning lights will not flash while the turn signal is being used. The hazard warning lights will start flashing again automatically as soon as the turn signal and main beam lever is moved back to the neutral position.

### In which situations may the vehicle not be towed?

In the following situations, the vehicle may not be towed for a long distance on its own tyres:

- A red warning lamp and text message are shown on the instrument cluster display.



Towing damages electric drive. Owner's manual!

- The power supply for the 12-volt vehicle electrical system cannot be guaranteed.
- The 12-volt vehicle battery is discharged. The steering remains locked and the parking brake and steering column lock cannot be released if they have been applied previously.
- The instrument cluster display does not work properly.
- The gearbox cannot be shifted to neutral (N).
- If the steering function or the operating clearance of the wheels cannot be ensured after an accident.

If the vehicle cannot be towed on its own wheels due to one of the above conditions, seek expert assistance and have the vehicle transported standing on a recovery vehicle if necessary. Inform the people involved, in particular the organisation office and the trans-

port company, that your vehicle is electrically driven.

## Towing

📖 Please refer to ⚠️ and ⓘ at the start of the chapter on page 304.

### Preparations

- Attach the tow-rope or the tow-bar only to the mounting points provided → page 304.  
Depending on equipment, this can be a tow-bar or a towing eye
- Ensure that the tow-rope is not twisted. Otherwise a towing eye can become unscrewed during towing.
- Switch on the ignition and hazard warning lights on both vehicles. However, observe any regulations to the contrary.
- Comply with the information on towing contained in the owner's manual for the other vehicle.

### Pulling vehicle (front)

- The tow-rope must be taut before you drive off properly.
- Press the accelerator carefully.
- Avoid sudden braking and driving manoeuvres.
- Do not exceed the maximum permitted trailer weight.

### Pulled vehicle (rear)

- Make sure that the ignition is switched on so that the steering wheel is not locked and you can indicate and operate the wipers if necessary.
- The brake servo and power steering function only when the vehicle's drive system is activated. Otherwise you must press the brake pedal with significantly more force and also use more effort for steering.
- Ensure that the tow-rope is always taut.

- Select the **N** position.

If the conditions for towing are not met, the vehicle may be towed or pushed on its own four wheels in emergency situations. The towing operation to the recovery vehicle must take place only at **walking pace** and for a **maximum distance of 100 m** → ⚠️.

### ⚠️ WARNING

If the vehicle is towed even though the text message **Towing damages electrical system. Owner's manual!** is displayed in the instrument cluster, vibrations can occur in the drive system and the rear wheels can lock, particularly on icy or wet roads. Locking wheels can cause you to lose control of the vehicle, which can lead to accidents and serious injuries.

- If the message **Towing damages electrical system. Owner's manual!** appears in the instrument cluster, tow the vehicle only in emergency situations.
- If the message **Towing damages electrical system. Owner's manual!** appears in the instrument cluster, tow the vehicle only at walking speed for a maximum of 100 m.

### ⚠️ WARNING

Never attach the tow-rope or tow-bar to axle or running gear components. These can be damaged as a result and this can cause accidents and serious injuries.

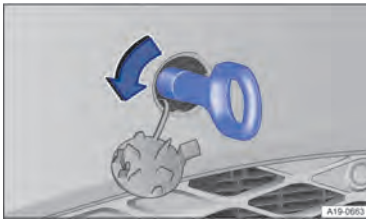
- Seek expert assistance and have the vehicle transported on a recovery vehicle if necessary.

## Fitting the towing eye at front

📖 Please refer to ⚠️ and ⚠️ at the start of the chapter on page 304.



**Fig. 169** In the front bumper on the right: removing the cover.



**Fig. 170** In the front bumper on the right: screwing in the towing eye.

The towing eye must always be kept in the vehicle.

Comply with the notes on towing  
→ page 305.

### Fitting the towing eye at front

- Remove the towing eye from the vehicle toolkit in the luggage compartment  
→ page 292.
- Push the side area of the cover in the direction of the arrow to release the cover  
→ Fig. 169.
- Pull the cover forwards to remove it and leave it to hang from the vehicle.

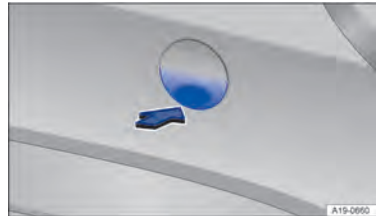
- Turn the towing eye **anti-clockwise** into the threaded hole and tighten as far as possible → Fig. 170 , → ⚠️. Use a suitable object to screw the towing eye fully and securely into the mounting.
- After you have finished towing, remove the towing eye by unscrewing it **clockwise**.
- Insert the cap in the respective recess and press in until it engages.
- Clean the towing eye if necessary and place it back in the vehicle toolkit in the luggage compartment.

### ⚠️ NOTICE

The towing eye must always be screwed fully and securely into the mounting. Otherwise, the towing eye can be wrenched out of the mounting when the vehicle is being tow-started or towed. ◀

## Fitting the rear towing eye

📖 Please refer to ⚠️ and ⚠️ at the start of the chapter on page 304.



**Fig. 171** In the rear bumper on the right: cover for the towing eye mounting.



**Fig. 172** In the rear bumper on the right: screwing in the towing eye: screwing in the towing eye.

The towing eye must always be kept in the vehicle.

In *vehicles with a factory-fitted towing bracket* there is **no** mounting for the screw-in towing eye behind the cover. In order to tow the vehicle, use the ball coupling. You will first have to swivel it out or fit it → page 264.

Comply with the notes on towing → page 305.

#### Fitting the rear towing eye

- Remove the towing eye from the vehicle toolkit in the luggage compartment → page 292.
- Press on the lower area of the cover in the direction of the arrow to release the cover → Fig. 171.
- Remove the cover and place in the vehicle if necessary.
- Screw the towing eye **anticlockwise** into the threaded hole and tighten as far as possible → Fig. 172, → ⚠. Use a suitable object to screw the towing eye fully and securely into the mounting.
- After you have finished towing, remove the towing eye by unscrewing it with a suitable object **clockwise**.
- Insert the cap in the respective recess and press in until it engages.
- Clean the towing eye if necessary and place it back in the vehicle toolkit in the luggage compartment.

#### ⚠ NOTICE

- The towing eye must always be screwed fully and securely into the mounting. Otherwise, the towing eye can be wrenched out of the mounting when the vehicle is being tow-started or towed.
- Vehicles with a factory-fitted towing bracket can be used to tow other vehicles **only** with a tow-bar that is specially designed to be fitted to a ball coupling. If you use an unsuitable tow-bar, the ball coupling and the vehicle could be damaged. You should use a tow-rope instead. ◀

# Checking and refilling

## In the front compartment

### Safety notes for working in the bonnet space

The bonnet space of a vehicle is a hazardous area. You should only carry out work in the bonnet space if you know exactly how to perform the required tasks, are aware of the general safety procedures and have access to the correct equipment, service fluids and suitable tools. Failing to carry out work correctly can cause serious injuries → ⚠. The work should be carried out by a qualified workshop if you are uncertain. Volkswagen recommends using a Volkswagen dealership for this purpose.

Always park the vehicle on a level and stable surface before carrying out any work in the bonnet space.

#### DANGER

The voltage of the high-voltage system is dangerous and can cause burns or other injuries and even lead to a fatal electric shock.

- You should always assume that the high-voltage battery is charged and that all high-voltage components are live. This can also be the case when the ignition is switched off.
- Never touch damaged components of the high-voltage system or allow jewellery or other metal objects to come into contact with these components. Damage is not visible in all cases.
- Never carry out work on the orange-coloured high-voltage cables or the other high-voltage components. Any work on the high-voltage system must be carried out only by authorised qualified workshops with corresponding approval for this work.

- Never damage, change or remove the orange-coloured high-voltage cables or disconnect them from the high-voltage network.
- Never carry out work with cutting, forming and sharp-edged tools or heat sources in the vicinity of high-voltage components and high-voltage cables. Work on and in the vicinity of the high-voltage system must be performed only by authorised qualified workshops.
- Any gases emitted by or escaping from the high-voltage battery may be toxic or flammable.
- Damage to the vehicle or to the high-voltage battery could lead to a leak of toxic gases or fluids, either immediately or at a later time. These emitted gases could also potentially cause a fire. Do not inhale these gases.
- Never touch the fluids that leak from the high-voltage battery.
- In the event of a fire, move away from the hazard area and call the fire service.
- Always inform any attending fire and emergency services that the vehicle is fitted with a high-voltage battery.

#### WARNING

Unqualified work on the high-voltage system and on high-voltage components can lead to malfunctions, accidents and injuries.

- Any work on the high-voltage system must be carried out only by authorised qualified workshops with corresponding approval for this work.

#### WARNING

Unintentional vehicle movements during service work can cause serious injury.

- Never work underneath a vehicle if it is not secured against rolling away. If you are working underneath the vehicle while the wheels are on the ground, the vehicle must be on a level surface and the wheels must be blocked.

- If you have to work underneath the vehicle, use suitable stands to provide extra support for the vehicle. The jack is not sufficient for this task and can fail, which can lead to serious injuries.

### WARNING

The bonnet space of any vehicle is a dangerous area. Serious injuries can be sustained here.

- The utmost care and attention must be paid when carrying out any work and you must follow the general safety rules. Never take any risks.
- Never perform any work in the bonnet space unless you know exactly how to carry it out. If you are uncertain of what to do, the work should be carried out by a qualified workshop. Serious injuries can result from work that has not been carried out properly.
- Never open or close the bonnet if you see steam or coolant escaping from the bonnet space. Hot steam or hot coolant can cause serious burns. Always wait until you can no longer see or hear steam or coolant coming from the bonnet space.
- Hot electric drive components can burn the skin.
- The following must be observed before opening the bonnet:
  - Electronic parking brake must be active.
  - Keep the vehicle key safe and far enough away from the vehicle to prevent any risk of the vehicle's drive system being accidentally activated and the electrical system thus energised.
  - Always keep children away from the bonnet space and never leave them unsupervised.
- The cooling system is under pressure when the electric drive is hot. Never open the cap of the coolant expansion tank when the electric drive is hot. Cool-

ant may spray out and cause serious burns and other injuries.

- Slowly and carefully turn the cap on the coolant expansion tank anticlockwise while exerting gentle downward pressure on the cap.
- Always protect the face, hands and arms from hot coolant or steam with a large, thick cloth.

### WARNING

High voltages in the electrical system can cause electric shocks, burns, serious injuries and death!

- Never short circuit the electric system. The 12-volt vehicle battery could explode.
- In order to reduce the risk of a potentially fatal electric shock and serious injuries while the vehicle's drive system is active or being activated, never touch high-voltage components, the high-voltage battery or the high-voltage system, in particular orange high-voltage cables.

### WARNING

There are rotating components in the bonnet space that can cause serious injury.

- Never reach into the radiator fan or into the area of the radiator fan. Touching the rotor blades can result in serious injuries. The fan is temperature-controlled and can start automatically, even when the ignition has been switched off or the vehicle key has been removed from the ignition lock.
- If any work has to be performed during the start procedure or when the vehicle's drive system is activated, the rotating parts (such as the radiator fan etc.) pose an additional safety risk, and can potentially cause fatal injuries. Always be particularly careful.
  - Always ensure that no body parts, jewellery, ties, loose items of clothing or long hair can be caught up in rotating engine components. Before start-



ing work, remove any jewellery and ties, tie up long hair and pull clothes in tightly to avoid them getting caught in engine parts.

- Always take due care and attention when depressing the accelerator.
- Always ensure you have not left any objects, such as cleaning cloths and tools, in the bonnet space. Any forgotten items can cause malfunctions, damage to the electric drive and fires.

### WARNING

Additional insulating materials, such as example blankets in the bonnet space, can interfere with the operation of the electric drive, and can cause fires and lead to severe injuries.

- Never cover the electric drive with blankets or other insulating materials.

### WARNING

Service fluids and some materials in the bonnet space are highly flammable and can cause fires and serious injuries!

- Never smoke in the vicinity of the bonnet space.
- Never work near naked flames or sparks.
- Observe the following if work on the 12-voltage vehicle electrical system is necessary:
  - Always disconnect the 12-volt vehicle battery. Ensure that the vehicle is unlocked when the 12-volt vehicle battery is disconnected as otherwise the anti-theft alarm will be activated.
  - Never work in the direct proximity of heating systems, water heaters or any other naked flames.
- Always have a fully functional and tested fire extinguisher to hand.

### NOTICE

When refilling or replacing service fluids, ensure that you pour the correct service fluids

into the correct openings. The use of incorrect service fluids could result in serious malfunctions and engine damage.

### NOTICE


After an accident, or after the underside of the vehicle has struck an obstacle, the high-voltage battery must be checked by appropriately qualified and trained experts.



Any service fluids leaks from the vehicle are harmful to the environment. You should therefore regularly check the ground underneath your vehicle. If there are spots of oil or other fluids on the ground, the vehicle should be inspected by a qualified workshop. Any spilt service fluids must be disposed of properly. <

## Preparing the vehicle for working in the bonnet space

### Checklist

The following steps should always be carried out in the specified order before working in the bonnet space → :

1. Park the vehicle on a level and stable surface.
2. Depress and hold the brake pedal until the vehicle's drive system has been deactivated.
3. Switch on the electronic parking brake at the position switch.
4. Deactivate the vehicle's drive system → page 138.
5. Remove the vehicle key from the vehicle and keep in a location outside the vehicle so that the vehicle is not put into operation accidentally → page 138.
6. Always keep other persons away from the bonnet space.
7. Secure the vehicle against rolling away.

## **⚠ WARNING**

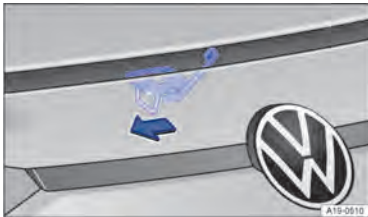
Ignoring any of the items on this important safety checklist can lead to severe injuries.

- Always follow the instructions in the checklist and observe the general safety procedures.

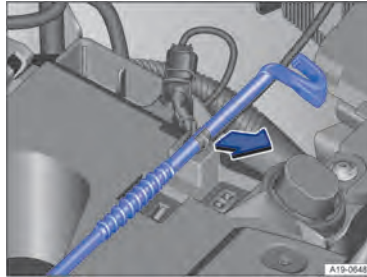
## Opening and closing the bonnet



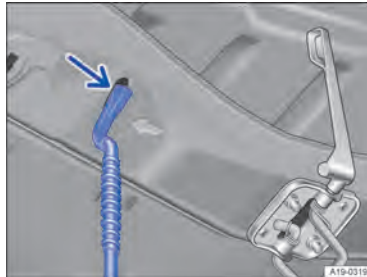
**Fig. 173** In the footwell on the driver side: bonnet release lever (schematic diagram).



**Fig. 174** On the bonnet: control lever.



**Fig. 175** In the bonnet space: bonnet stay in holder.



**Fig. 176** On the bonnet: holder for bonnet stay.

### Opening the bonnet

- Open the driver door and pull the release lever in the direction of arrow → Fig. 173. The bonnet is released from the lock carrier catch by spring force → page 313.
- Raise the bonnet slightly and at the same time press the control lever in the direction of arrow → Fig. 174 to fully open the bonnet.
- Take the bonnet stay in the direction of arrow → Fig. 175 and push it into the opening → Fig. 176.

### Closing the bonnet

- Lift the bonnet slightly and hold.
- Unhook the bonnet stay from the opening → Fig. 175 and push it into its holder → Fig. 174.

- Let the bonnet drop into the catch from a height of about 20 cm (8 in) – *do not* press it down!

If the bonnet has not closed properly, open it once more and then close it again.

The bonnet is flush with the body parts around it when it is closed properly → ⚠.

### ⚠ WARNING

If the bonnet is not closed properly, it can open suddenly while you are driving and completely obscure your view of the road. This can lead to accidents and serious injuries.

- After closing bonnet, always check that the catch is properly engaged in the lock carrier.
- If you notice that the bonnet is not closed properly while the vehicle is in motion, switch on the hazard warning lights, brake carefully, stop the vehicle as soon as possible and close the bonnet.
- Open or close the bonnet only when no one is in its movement path.

### ⓘ NOTICE

- The bonnet should only be opened when the wiper arms are flush to the windscreen and when they are switched off in order to avoid damage to the bonnet and the wiper arms. <

## Display



**Fig. 177** On the instrument cluster display: the bonnet is open or not closed properly (illustration).

A symbol on the instrument cluster display indicates if the bonnet is open or is not closed properly → Fig. 177.

**STOP** Do not drive on! If necessary, lift the bonnet and then close it again.

This symbol is also visible when the ignition is switched off and will go out a few seconds after the vehicle has been locked when all doors are closed.

### ⚠ WARNING

Failure to observe warnings can cause your vehicle to break down in traffic, which can lead to accidents and serious injuries.

- Never ignore any warnings.
- Stop the vehicle as soon as possible and when safe to do so.



The symbol can differ depending on the version of the instrument cluster. <

## Service fluids and consumables

All service fluids and consumables, e.g. coolant and batteries, are being constantly devel-

oped. This also applies to engine oils in the case of combustion engines. For this reason, service fluids and consumables should be replaced at a qualified workshop. Volkswagen dealerships are kept up to date on all changes.


### **⚠ WARNING**

Unsuitable service fluids and consumables, and the incorrect use of these fluids and consumables, can cause accidents, serious injuries, burns or poisoning.

- Service fluids must be kept in their original sealed container.
- Never store service fluids in empty food containers, bottles or any other non-original containers as people finding these containers could drink them.
- Keep children away from all service fluids and consumables.
- Always read and follow the information and warnings on the service fluid packaging.
- When using products that give off harmful fumes, always work outdoors or in a well-ventilated area.

### **📢 NOTICE**

- Only use suitable service fluids for refilling. Never use the wrong service fluid. Failure to observe this warning can result in serious malfunctions and engine damage.

 Leaking service fluids can pollute the environment. Spilt service fluids must be collected in suitable containers and disposed of properly and in an environmentally responsible way.





## Washer fluid



**Fig. 178** In the bonnet space: cap of washer fluid reservoir.

The washer fluid level should be checked regularly and refilled as necessary.

There is a strainer in the filler throat of the washer fluid reservoir. The strainer keeps large dirt particles away from the washer jets when refilling. The strainer should only be removed for cleaning. If the strainer is damaged or is not present when refilling, dirt particles can enter the system and block the washer jets.

- Open the bonnet  → page 312.
- The washer fluid reservoir is identified by the  symbol on the cap → Fig. 178.
- Check whether there is enough washer fluid in the reservoir.
- To top up, mix clean water (not distilled water) with a commercially available washer fluid → . Observe the mixture instructions on the packaging.
- At low outside temperatures, add a special anti-freeze agent so that the fluid cannot freeze → .

The filling quantity of the washer fluid reservoir is approx. 3.0–7.5 litres (3.1–7.9 quarts) depending on the vehicle and equipment.

### **⚠ WARNING**

Never mix coolant additive or other unsuitable additives into the windscreen washer

fluid. These may leave an oily film on the window, considerably restricting the field of vision.

### ! NOTICE

- Never mix suitable cleaning agents with other cleaning agents. This can cause the ingredients to separate and block the washer jets.

- Coolant can freeze at extremely cold outside temperatures, causing the vehicle to break down. Vehicle occupants with inadequate winter clothing could then freeze to death as the heating will also no longer function.



Coolant and coolant additives can pollute the environment. Spilt service fluids must be collected and disposed of properly and in an environmentally responsible way.

## Coolant

### 📖 Introduction to the topic

Do not work on the cooling system unless you are familiar with the task, aware of the general safety procedures and have the correct equipment, service fluids and suitable tools. Failing to carry out work correctly can cause serious injuries → page 315. The work should be carried out by a qualified workshop if you are uncertain. Volkswagen recommends using a Volkswagen dealership for this purpose.

Information on warning and indicator lamps that light up can be found in the troubleshooting sections at the end of the chapter → page 318.

### ⚠ WARNING

Coolant is toxic.

- Coolant should only be kept in sealed original containers in a safe place.
- Never store coolant in empty food containers, bottles or any other non-original containers as people finding these containers may then drink the coolant.
- Coolant must be stored out of the reach of children.
- The amount of correct coolant additive used must be sufficient for the lowest ambient temperature that you expect the vehicle to be exposed to.

### Coolant specification

📖 Please refer to ⚠, ⚠ and ⚠ on page 309 and ⚠ at the start of the chapter on page 315.

The cooling system is filled at the factory with a mixture of specially prepared water and at least 40% coolant additive.

Inform yourself at a qualified workshop about which coolant is suitable for your vehicle. Volkswagen recommends using a Volkswagen dealership for this purpose.

The proportion of coolant additive must always be at least 40% to protect the cooling system. If greater frost protection is required in very cold climates, the proportion of anti-freeze additive can be increased. However, the percentage of coolant additive should not exceed 55 %, as this would reduce the frost protection and the cooling effect.

The coolant additive is dyed purple. The mixture of water and a coolant additive offers anti-freeze protection down to  $-25^{\circ}\text{C}$  ( $-13^{\circ}\text{F}$ ), protects the alloy parts in the cooling system against corrosion, prevents limescale deposits and significantly increases the boiling point of the coolant.

When refilling the coolant, a mixture of **distilled water** and at least 40% of the suitable coolant additive must be used in order to obtain the optimum corrosion protection → page 316.

## ⚠ WARNING


Insufficient anti-freeze in the cooling system of the vehicle can cause the electric drive to break down and thereby cause serious injuries.

- The amount of correct coolant additive used must be sufficient for the lowest ambient temperature that you expect the vehicle to be exposed to.
- Coolant can freeze at extremely cold outside temperatures, causing the vehicle to break down. Vehicle occupants with inadequate winter clothing could then freeze to death as the heating will also no longer function.

## ⓘ NOTICE

Never mix genuine coolant additives with other coolants that have not been approved by Volkswagen.

- If the liquid in the coolant expansion tank is not pink (colouring results from mixing the purple coolant additive with distilled water) but for example brown instead of purple, the suitable coolant has been mixed with an unsuitable coolant additive. The coolant must be changed as soon as possible if this is the case. Failure to observe this warning can result in serious malfunctions or damage to the electric drive and cooling system.

 Coolant and coolant additives can pollute the environment. Spilt service fluids must be collected and disposed of properly and with respect for the environment.

## Checking the coolant level and refilling coolant

📖 Please refer to ⚠, ⚠ and ⓘ on page 309 and ⚠ at the start of the chapter on page 315.




**Fig. 179** Under the bonnet: markings on the coolant expansion tank.



**Fig. 180** Under the bonnet: coolant expansion tank cap (illustration).

### ◀ Preparations

1. Park the vehicle on a firm and level surface.
2. Allow the electric drive to cool down → ⚠.
3. Open the bonnet ⚠ → page 312.
4. The coolant expansion tank is identified by the  symbol on the cap → Fig. 180.

### Checking the coolant level

The engine coolant may be above the marked area upon delivery (**new vehicles**). This is nor-

mal. The coolant does not have to be sucked off.

- Check the coolant level at the side markings of the coolant expansion tank when the electric drive is cold → Fig. 179. The coolant level must be between the marks.
- Refill coolant if the liquid level in the coolant expansion tank is below the minimum marking ("min"). When the engine is warm, the engine coolant level may be slightly above the upper mark.

### Adding coolant

The warning lamp for the coolant will light up if the coolant level is too low. In this case, seek specialist assistance immediately.

Observe the following if the coolant level is too low and there is no qualified workshop in the near vicinity:

- Always protect your face, hands and arms from hot coolant or steam by placing a suitable cloth on the cap of the coolant expansion tank.
- Unscrew the cap carefully → ⚠.
- Refill only **new** coolant according to the Volkswagen specification → page 315.
- Only refill coolant if there is still a remaining quantity of coolant in the expansion tank. If this is not observed, the engine could be damaged. If you cannot see any coolant in the expansion tank **do not drive on**. Seek expert assistance.
- If there is still a residual quantity of coolant in the coolant expansion tank, add coolant up to the upper level marking and check after one day. If the level drops **again**, please visit a qualified workshop and have the cooling system checked.
- The coolant level must be between the marks on the coolant expansion tank → Fig. 179. **Do not fill above the top edge of the marked area** → ⚠.
- Screw the cap closed tightly.
- If in an emergency you do not have access to coolant with the required specification, do not use any other coolant additive

→ page 315! Instead, initially refill with **distilled water** → ⓘ only. Then add the correct proportion of the specified coolant additive as soon as possible → page 315.

### ⚠ WARNING

Hot steam and hot coolant can cause serious burns.

- Never open the bonnet if you can see or hear steam or coolant coming out of the front compartment. Always wait until you can no longer see or hear escaping steam or coolant. Hot components can burn the skin.
- The following must be observed before opening the bonnet:
  - Switch on the electronic parking brake.
  - Always keep children away from the front compartment and never leave them unsupervised.
- The cooling system is under pressure when the engine is hot. Never open the cap of the coolant expansion tank when the engine is hot. Coolant may spray out and cause serious burns and other injuries.
  - Turn the cap slowly and very carefully anticlockwise while exerting gentle downward pressure on the cap.
  - Always protect the face, hands and arms from hot coolant or steam with a large, thick cloth.

### ⓘ NOTICE

- Refill only with distilled water. All other types of water can cause corrosion in the engine due to the chemical components contained in the water. This can also lead to engine failure. If any other type of water is refilled, the fluid in the cooling system should be completely replaced immediately by a qualified workshop.
- Do not fill coolant above the top of the marked area → Fig. 179. Otherwise the excess coolant will be pressed out of the

cooling system when the engine is hot and could cause damage.

- If a large amount of coolant has been lost, do not refill the coolant until the engine has *cooled completely*. Heavy coolant loss is an indication of leaks in the cooling system. The cooling system should be checked by a qualified workshop as soon as possible. Failure to do so can result in engine damage.
- Do not refill coolant if there is no more coolant in the coolant expansion tank. Air could have entered the cooling system. Do not drive on! Seek expert assistance. Failure to do so can result in engine damage.
- When refilling service fluids, please ensure that you pour the correct service fluids into the correct openings. The use of incorrect service fluids can result in serious malfunctions and damage to the electric drive.

## Troubleshooting

📖 Please refer to ⚠️, ⚠️ and ⌚ on page 309 and ⚠️ at the start of the chapter on page 315.

### Coolant

The indicator lamp flashes red.

Engine coolant temperature too high or engine coolant level too low.

#### Do not drive on!

Stop the vehicle as soon as possible and when safe to do so.

- Deactivate the vehicle's drive system.
- Allow the electric drive to cool down until the warning lamp goes out.
- Check the engine coolant level at the **coolant expansion tank** → page 316.

If the engine coolant level is too low:

- Refill coolant → page 316.

If the warning lamp does not go out, seek expert assistance.

### together with

The indicator lamps flash red.

#### Stop the vehicle immediately

Fault in the high-voltage coolant circuit.

- Deactivate the vehicle's drive system.
- Seek expert assistance.

## Brake fluid



**Fig. 181** In the bonnet space: cap of the brake fluid reservoir.

Brake fluid will gradually absorb water from the surrounding air over the course of time. The brake system will be damaged if there is too much water in the brake fluid. The boiling point of the brake fluid is also considerably reduced by the water content. Heavy use of the brakes may cause a vapour lock in the brake system if the water content is too high. Vapour locks reduce the braking efficiency, considerably increase braking distance and can even cause the brake system to fail completely. Your own safety and that of other road users depends on having a brake system that functions properly at all times → page 319.



### Brake fluid specification

Volkswagen has developed a brake fluid that has been optimised for the brake system in the vehicle. To ensure the best possible operation of the brake system, Volkswagen expressly recommends the use of brake fluid compliant with **VW standard 501 14**.

Before using a particular brake fluid, check that the specifications printed on the container correspond to the vehicle requirements.

Brake fluid that is compliant with VW standard 501 14 is available from Volkswagen dealerships.

If this brake fluid is not available and it is necessary to use another high-quality brake fluid instead, brake fluid that is compliant with DIN ISO 4925 or US standard FMVSS 116 DOT 4 CLASS 6 can be used.

Not all brake fluids that are compliant with DIN ISO 4925 or US standard FMVSS 116 DOT 4 CLASS 6 have the same chemical composition. Some of these brake fluids may contain chemicals that can damage or destroy brake system components over time.

Volkswagen therefore recommends the use of brake fluid that is compliant with **VW standard 501 14** to ensure sustained optimal operation of the brake system.

Brake fluid that is compliant with VW standard 501 14 fulfils the requirements of DIN ISO 4925 or US standard FMVSS 116 DOT 4 CLASS 6.

### Brake fluid level

The brake fluid level must always be between the MIN and MAX markings on the brake fluid reservoir → page 319.

The brake fluid level cannot be checked accurately in all models as a flap or engine components may partially conceal the brake fluid container. If the brake fluid level cannot be read exactly, please go to a qualified workshop.

The brake fluid level drops slightly during vehicle operation as the brake pads wear and the brakes are automatically adjusted.

### Brake fluid level

The indicator lamp lights up red.

Brake fluid level is too low.

—  **Do not drive on!**

— Check the brake fluid level.

If the brake fluid level is too low:

— Inform a qualified workshop.

— Have the brake system checked.

### Changing the brake fluid

The brake fluid should be changed by a qualified workshop. Volkswagen recommends using a Volkswagen dealership for this purpose. Only brake fluid that conforms with the required specification should be used.

### WARNING

Brake failure or reduced braking efficiency can be caused by the brake fluid level being too low or by brake fluid that is too old or unsuitable.

- The brake system and brake fluid level must be checked regularly.
- The brake fluid should be changed regularly.
- Heavy use of the brakes with old brake fluid can cause a vapour lock. Vapour locks reduce braking efficiency, considerably increase braking distance and can cause the brake system to fail completely.
- Please ensure that the correct brake fluid is used. Only use brake fluid that is explicitly compliant with VW standard 501 14.
- Any other brake fluid or a low-quality fluid can affect the functioning of the brakes and reduce braking efficiency.
- If a brake fluid compliant with VW standard 501 14 is not available, use a high-quality brake fluid compliant with DIN ISO 4925 CLASS 6 or the US standard FMVSS 116 DOT 4, but only in exceptional circumstances.

- The refilled brake fluid must be new.

### WARNING

Brake fluid is toxic.

- In order to reduce the risk of poisoning, never use bottles or other containers to store brake fluid. There is always a risk of someone drinking from such containers, even if they are labelled appropriately.
- Brake fluid must always be stored in its original sealed container and kept out of the reach of children.

### NOTICE

Brake fluid that has leaked or been spilt can damage the vehicle paintwork, plastic parts and tyres. Wipe off brake fluid that has leaked or been spilled immediately from all parts of the vehicle.




Brake fluid can pollute the environment. Any spilt service fluids must be cleaned up and disposed of properly.

## 12-volt vehicle battery

### Introduction to the topic

The 12-volt vehicle battery is a component of the electrical system and in event of the high-voltage system failing, supplies the safety-relevant systems of the vehicle with energy. In the scope of maintenance work, the 12-volt vehicle battery is checked and where required, replaced.

You should only carry out work on the electrical system if you know exactly how to perform the required tasks, are aware of the general safety procedures and have access to the correct equipment, service fluids and suitable tools. Failing to carry out work correctly can cause serious injuries → . All work should be carried out by a qualified

workshop. Volkswagen recommends using a Volkswagen dealership for this purpose.

Information on warning and indicator lamps that light up can be found in the trouble-shooting sections at the end of the chapter → page 323.

### Location of 12-volt vehicle battery

The 12-volt vehicle battery is located in the bonnet space.

### Explanation of the warnings on the 12-volt vehicle battery



Always wear eye protection!



Electrolyte is very corrosive and caustic. Always wear protective gloves and eye protection!



No fire, sparks, naked lights or smoking!



A highly explosive mixture of gases is given off when the 12-volt vehicle battery is charging!



Always keep children away from electrolyte and the 12-volt vehicle battery!



Always observe the owner's manual!

### WARNING

Any work on the 12-volt vehicle battery and the electrical system can cause serious chemical burns, fire or electric shocks. Always read the following warnings and safety information before carrying out any kind of work:

- Switch off the ignition and all electrical consumers before carrying out any work on the 12-volt vehicle battery and also disconnect the negative cable from the 12-volt vehicle battery.

- Children should always be kept away from electrolyte and the 12-volt vehicle battery.
- Always wear eye protection and protective gloves.
- Electrolyte is very aggressive. It can burn the skin and can cause blindness. When working with the 12-volt vehicle battery, ensure that your hands, arms and face in particular are protected from acid spillage.
- Do not smoke during the work, and never work near naked flames or sparks.
- When handling cables and electrical equipment, avoid generating sparks and electrostatic charge.
- Never short circuit the battery terminals.
- Never use a damaged 12-volt vehicle battery. It can explode. Damaged 12-volt vehicle batteries must be replaced as soon as possible.
- Never use a frozen 12-volt vehicle battery. Discharged 12-volt vehicle batteries can already freeze at temperatures of around 0°C (+32°F). Frozen 12-volt vehicle batteries must be replaced immediately.

### NOTICE


Do not expose the 12-volt vehicle battery to direct daylight for an extended time.


- The ultraviolet radiation can damage the battery housing.

### NOTICE

Protect the 12-volt vehicle battery against frost if the vehicle is left standing for extended periods.

- The 12-volt battery can freeze and be destroyed as a result.

 When you activate the vehicle's drive system after the 12-volt battery has been totally discharged, replaced or after a successful jump start, you may find that system settings (time, date, personal conven-


ience settings and programming) have been changed or deleted. Check and correct the settings as necessary once the 12-volt vehicle battery has been sufficiently charged. 

## Checking the electrolyte level of the 12-volt vehicle battery

 Please refer to ,  and  on page 309 and  and  at the start of the chapter on page 320.

The 12-volt vehicle battery is located under the bonnet.

The electrolyte level of the 12-volt vehicle battery cannot be checked because the battery window is hidden by the main fuse box of the vehicle.


Always have the electrolyte level of the 12-volt vehicle battery checked by a qualified workshop. 

## Charging, replacing, disconnecting and connecting the 12-volt vehicle battery

 Please refer to ,  and  on page 309 and  and  at the start of the chapter on page 320.

If you suspect that the 12-volt vehicle battery is damaged or faulty, go to a qualified workshop and have the 12-volt vehicle battery checked.

### Charging the 12-volt vehicle battery

The 12-volt vehicle battery should be charged by a qualified workshop, as the technology used in factory-fitted 12-volt vehicle batteries requires voltage-limited charging → . Volkswagen recommends using a Volkswagen dealership for this purpose.

## Replacing the 12-volt vehicle battery


The 12-volt vehicle battery has been developed to suit the conditions of its installation location and has special safety features. If a 12-volt vehicle battery has to be replaced, discuss the electromagnetic compatibility, size and necessary servicing, output and safety requirements for the new 12-volt vehicle battery with a Volkswagen dealership before purchase. The ventilation opening of the 12-volt vehicle battery must always be on the negative terminal side: the ventilation opening on the positive terminal side must always be sealed.

Only maintenance-free 12-volt vehicle batteries compliant with the standards TL 825 06 and VW 7 50 73 should be used. These standards must be dated October 2014 or later.


Always have the 12-volt vehicle battery replaced by a qualified workshop, as the vehicle electronics must be adapted as part of the replacement process. Only qualified workshops have the technology required to carry out this adjustment correctly. Volkswagen recommends that the 12-volt vehicle battery is replaced by a Volkswagen dealership.

## Disconnecting the 12-volt vehicle battery

Please observe the following if the 12-volt vehicle battery has to be disconnected from the electrical system in the vehicle:

- Switch all electrical consumers off.
- Unlock the vehicle before disconnecting the battery in order to avoid triggering the anti-theft alarm.
- First disconnect the negative cable and then the positive cable → .

## Connecting the 12-volt vehicle battery

- Switch off all electrical consumers before reconnecting the 12-volt vehicle battery.
- First reconnect the positive cable and then the negative cable → .

Various indicator lamps may light up after the 12-volt vehicle battery has been connected and the ignition is switched on. They will go

out if you drive a short distance at a speed of approximately 15 – 20 km/h (10 – 12 mph). If the indicator lamps remain lit up, the vehicle should be checked by a qualified workshop.

If the 12-volt vehicle battery was disconnected for an extended period, the system may not be able to calculate or correctly display the time when the next service is due → page 18. Observe the maximum permissible service intervals → page 353.

*Vehicles with Keyless Access:* → page 75: if the ignition cannot be switched on after connecting the 12-volt vehicle battery, lock and unlock the vehicle from the outside. Then try to switch on the ignition again. Please seek expert assistance if the ignition cannot be switched on.

## Automatic switch-off for electrical consumers

The intelligent vehicle electrical system automatically implements a range of measures to prevent the 12-volt vehicle battery from discharging under high loads:

- The performance of large electrical consumers may be reduced or they may be switched off completely.

The vehicle electrical system cannot always prevent the 12-volt vehicle battery from discharging. For example, if ignition or the side or parking lights are left switched on while the vehicle is parked for a long period.

## 12-volt vehicle battery is discharged

- Through use of electrical consumers when the vehicle's drive system has been deactivated.

### WARNING

Incorrectly securing the battery and using incorrect 12-volt vehicle batteries can cause short circuits, fire and serious injuries.

- Always use maintenance-free and leak-proof 12-volt vehicle batteries that have the same properties, specifications and

dimensions as the factory-fitted 12-volt vehicle battery.


## WARNING


A highly explosive mixture of gases is given off when the 12-volt vehicle battery is being charged.

- 12-volt vehicle batteries should only be charged in well-ventilated spaces.
- Never charge a 12-volt vehicle battery which is frozen or has been frozen. Discharged 12-volt vehicle batteries can already freeze at temperatures of around 0°C (+32°F).
- Always have the 12-volt vehicle battery replaced if it has ever frozen.
- Incorrectly connected cables can cause a short circuit. First connect the positive cable and then the negative cable.





## NOTICE

- Never connect or disconnect 12-volt vehicle batteries when the electric drive is activated. Never use a 12-volt vehicle battery that does not correspond with the vehicle's specifications. This can damage the electrical system or electronic components, which can cause electrical faults.
- Never connect equipment that supplies electric power, such as solar panels or a battery charger, to the 12-volt socket or to the cigarette lighter to charge the 12-volt vehicle battery. This can damage the vehicle electrical system.

 12-volt vehicle batteries may contain toxic substances such as sulphuric acid and lead. Dispose of the 12-volt vehicle battery in accordance with the relevant regulations.

 Electrolyte can pollute the environment. Clean up any service fluid leaks and dispose of them properly.

## Troubleshooting

 Please refer to ,  and  on page 309 and  and  at the start of the chapter on page 320.



### 12-volt vehicle battery

The indicator lamp lights up red. The following messages can be displayed:

- Error: 12 V battery not charging. Stop vehicle safely!
- Error: 12 V onboard supply. Stop vehicle safely! Consult vehicle wallet.



**Do not drive on!** Stop the vehicle as soon as possible and when safe to do so.

The 12-volt vehicle battery will not be charged while the vehicle is in motion.

- Switch off any electrical consumers that are not required.
- Inform a qualified workshop.
- Have the electrical system checked.

There is a fault in the 12-volt vehicle electrical system.

- Inform a qualified workshop.
- Have the electrical system checked.



### 12-volt vehicle battery

The indicator lamp lights up yellow. The following text message will be displayed:

- Error: 12 V battery. Unable to restart. Please visit workshop.

Fault in the connection between the vehicle electrical system and the 12-volt vehicle battery.

If the vehicle's drive system is deactivated in this situation it cannot be switched back on again. Start the vehicle using jump leads if necessary → page 301 or seek expert assistance.

- Go to a qualified workshop.
- Have the electrical system checked.

### 12-volt vehicle battery

The indicator lamp lights up yellow. The following messages can be displayed:

- Error: 12V battery diagnostics. Please visit workshop.

Fault in the system for monitoring the 12-volt vehicle battery.

- Go to a qualified workshop.
- Have the electrical system checked.

**OR:** .

- Error: 12 V onboard supply. Please visit workshop.

Fault in the 12-volt vehicle electrical system.

- Go to a qualified workshop.
- Have the electrical system checked.

### 12-volt vehicle battery

The indicator lamp lights up yellow. The following text message will be displayed:

- Error: Replace 12V battery. Please visit workshop.

The 12-volt vehicle battery has almost reached the end of its service life.

- Go to a qualified workshop.
- Have the 12-volt vehicle battery checked and replaced if necessary → page 321.

### 12-volt vehicle battery

The indicator lamp lights up yellow. The following text message will be displayed:

- Please have 12V battery checked. Please visit workshop.

Fault in the connection between the vehicle electrical system and the 12-volt vehicle battery.

- Go to a qualified workshop.
- Have the electrical system checked.

### 12-volt vehicle battery

The indicator lamp lights up yellow. The following text message will be displayed:

- 12-V battery low. Charge by driving.

12-volt vehicle battery has poor charging capacity, caused for example by low temperatures.

- Drive a short distance to recharge the 12-volt vehicle battery.

**OR:** .

The indicator lamp lights up yellow.

Diagnosis of 12-volt vehicle battery stopped due to the vehicle being restarted, for example.

- If the warning lamp continues to steadily shine after the vehicle has been parked for a longer period of time, for example, overnight, visit a qualified workshop and have the electrical system checked. <

# Wheels and tyres

## Tyre monitoring system

### Introduction to the topic

The tyre monitoring system warns the driver when the tyre pressures are too low.

The following tyre monitoring systems are available for this vehicle:

#### Tyre Pressure Loss Indicator

- Monitors various parameters (including rolling circumference) of all four tyres while driving using ABS sensors (indirect measurement).

The reference pressure for the tyre monitoring system is the recommended tyre pressure for cold factory-fitted tyres at maximum load. The reference pressure corresponds to the information on the tyre pressure sticker → page 332.

If the tyre pressure of all four tyres has been adjusted correctly, the Tyre Pressure Loss Indicator must be re-synchronised → page 325. This adjusts the reference pressure to the current tyre pressure.

### WARNING

The intelligent tyre monitoring system technology cannot overcome the laws of physics, and functions only within the limits of the system. Incorrect handling of the wheels and tyres can lead to a sudden loss of pressure in the tyres, tread separation and even tyre blow-out.

- Check tyre pressures regularly and always maintain the specified tyre pressure value → page 332. If the tyre pressure is too low, it is possible that the tyre temperature will increase to such an extent that the tread peels off and the tyre bursts.

- Always maintain the correct cold tyre pressure as specified on the tyre pressure sticker → page 332.
- Check the tyre pressure regularly when the tyres are cold. If necessary, adjust the tyre pressure in the cold tyre to the recommended tyre pressure for the tyres installed on your vehicle → page 332.
- Check your tyres regularly for signs of wear or damage.
- Never exceed the top speed and load permitted for the fitted tyres.



Under-inflated tyres will increase energy consumption and tyre wear.



When new tyres are driven at high speeds for the first time, they can expand slightly and trigger a one-off pressure warning.



Old tyres should only be replaced by tyres that have been approved by Volkswagen for the vehicle type.



Do not rely solely on the tyre monitoring system. Check your tyres regularly to ensure that they are properly inflated and have no signs of damage, such as punctures, cuts, cracks, and blisters. Remove any objects that become embedded in the tyre tread but have not penetrated into the body of the tyre itself.

### Tyre Pressure Loss Indicator

 Please refer to  at the start of the chapter on page 325.

#### Functional description

The Tyre Pressure Loss Indicator uses data from the ABS sensors and other functions to check the speed of rotation and the rolling circumference of the individual wheels.



The Tyre Pressure Loss Indicator does not work if there is a fault in the ESC or ABS → page 191.

### The rolling circumference can change:

- If the tyre pressure has been changed.
- If the tyre pressure is too low.
- If the tyre has structural damage.
- If the vehicle is loaded more heavily on one side.
- If snow chains have been fitted.
- If a temporary spare wheel has been fitted.
- If one wheel per axle has been changed.

The Tyre Pressure Loss Indicator (Ⓛ) may react with a delay or not display anything at all in the event of a sporty driving style, when driving on snow-covered or icy roads or unpaved roads or when driving with snow chains.

The tyre monitoring system indicates a change in rolling circumference of the tyres with the (Ⓛ) warning lamp in the instrument cluster.

The recommended tyre pressure for the factory-fitted tyres is indicated on the tyre pressure sticker on the driver's door pillar → page 332.

The tyre pressure of all tyres including the spare wheel or temporary spare wheel must be checked monthly on a cold tyre and correspond to the vehicle manufacturer's specifications on the tyre pressure sticker. If the tyre size of the mounted tyres differs from the specifications on the type plate or tyre pressure sticker, the correct tyre pressure must be determined.

The Tyre Pressure Loss Indicator does not remove the need for regular maintenance and inspection of tyres. The driver is responsible for ensuring the correct tyre pressure is maintained at all times, even if the Tyre Pressure Loss Indicator does not give any warning that the tyre pressure is too low.

The Tyre Pressure Loss Indicator also can display a malfunction in conjunction with the (Ⓛ) warning lamp. If the Tyre Pressure Loss Indicator is malfunctioning, the (Ⓛ) warning lamp flashes for about a minute after the vehicle's

drive system has been activated and then stays continuously lit.


If the Tyre Pressure Loss Indicator shows a malfunction, tyre pressure cannot be monitored correctly. The malfunctioning of the Tyre Pressure Loss Indicator can have various causes, e.g. due to replacing a wheel or tyre. When a wheel or tyre has been replaced, a check needs to be made whether the (Ⓛ) warning lamp is indicating a system malfunction → page 327 to ensure that the Tyre Pressure Loss Indicator is functioning properly.

### Synchronising the Tyre Pressure Loss Indicator

The Tyre Pressure Loss Indicator must be re-synchronised under the following conditions:

- If the tyre pressures have been changed.
- If one or more wheels have been changed.
- If the wheels are swapped over, e.g. from front to rear.

The Tyre Pressure Loss Indicator may only be re-synchronised if all the tyres have been filled at the correct tyre pressure when measured on a cold tyre. To measure the cold tyre pressure, the vehicle must have been stationary for 3 hours or driven only a few kilometres at a slow speed during this time.

 After a warning about the tyre pressure being too low, switch the ignition off and then back on again. The Tyre Pressure Loss Indicator can only then be re-synchronised.

1. Switch on the ignition.
2. Switch on Infotainment system if necessary.
3. Touch **Vehicle** in the Infotainment system.
4. Touch **Vehicle** (left).
5. Touch **Tyres**.
6. Touch **(Ⓛ) SET**.
7. When all four tyre pressures correspond to the required values, touch **OK**.



**OR:** to cancel the operation, touch **Cancel**. The current tyre pressure is not saved and the system will not be re-synchronised.

After an extended driving time (at least 20 minutes) with driving at different speeds, the system will automatically learn the new values and monitor them. <

## Troubleshooting for Tyre Pressure Loss Indicator

📖 Please refer to ⚠ at the start of the chapter on page 325.

### ⚠ Low tyre pressure

The indicator lamp lights up yellow.

There is a loss of pressure in one or more tyres or the tyre is structurally damaged.

- 🚫 **Do not drive on!**
- Check and adjust all tyre pressures → page 332.
- Damaged tyres should be replaced.
- Re-synchronise the Tyre Pressure Loss Indicator → page 325.
- If the fault persists, go to a qualified workshop.

### ⚠ Fault in the Tyre Pressure Loss Indicator

The indicator lamp flashes for about a minute and then remains lit up in yellow.

There is a system fault.

- 🚫 **Do not drive on!**
- Switch the ignition off and then back on again.
- Re-synchronise the Tyre Pressure Loss Indicator → page 325.
- If the fault persists, go to a qualified workshop.

## ⚠ WARNING

Differing tyre pressures or tyre pressures that are too low can cause tyre damage, tyre failure, loss of vehicle control, accidents, serious injury and death.

- If the indicator lamp (⚠) lights up, stop the vehicle as soon as possible and check all the tyres → page 332.
- Different tyre pressures or tyre pressures that are too low can increase wear on the tyres, reduce vehicle stability and increase the braking distance.
- Differing tyre pressures or tyre pressures that are too low can cause sudden tyre failure and lead to a tyre bursting and the loss of control over the vehicle.
- The driver is responsible for the correct tyre pressure of all tyres on the vehicle. The recommended tyre pressure can be found on a sticker → page 332.
- The tyre monitoring system cannot function correctly unless all cold tyres have the correct tyre pressure.
- The pressure in all tyres must always be appropriate to the vehicle load → page 332.
- Always inflate all tyres to the correct tyre pressure before every journey → page 332.
- If the vehicle is driven with insufficient tyre pressure, this results in greater tyre flexing. This could warm up the tyre to such an extent that the tread may separate and the tyre could burst. This could cause the driver to lose control of the vehicle.
- High speeds and overloading of the vehicle may cause the tyres to heat up to such an extent that the tyre bursts, leading you to lose control of the vehicle.
- If the tyre pressure is too low or too high, the tyres will wear prematurely and the vehicle will not handle well.
- If the tyre is not flat and it is not necessary to change the wheel immediately, drive at low speed to the nearest quali-

fied workshop and check and correct the tyre pressure → page 332.

- The Tyre Pressure Loss Indicator must always be correctly calibrated.



Driving on unpaved roads for long periods or a sporty driving style can temporarily deactivate the Tyre Pressure Loss Indicator. In the event of a malfunction, the indicator lamp will flash for about a minute and then light up continuously. However, the indicator lamp will go out when the road conditions or driving style change. ◀

## Useful information about wheels and tyres

### Introduction to the topic

The tyres are the most heavily loaded and most underestimated parts of a vehicle. Tyres are very important as the narrow tyre surfaces are the only contact between the vehicle and the road.

The service life of tyres is dependent on tyre pressure, driving style, handling and correct fitting.

### WARNING

New tyres or tyres which are old, worn down or damaged cannot provide full levels of vehicle control and braking efficiency.

- Incorrect handling of wheels and tyres can reduce vehicle safety and cause accidents and serious injuries.
- All wheels must be fitted with radial tyres of the same type, size (rolling circumference) and the same tread. Exception → page 329.
- New tyres will have to be run in as they will initially have reduced grip and braking effect. Drive particularly carefully for the first 600 km (370 miles) in order to prevent accidents and serious injury.

- Check tyre pressures regularly when the tyres are cold, and always keep to the specified value. If the tyre pressure is too low, it is possible that the tyre temperature will increase to such an extent when driving that the tread peels off and the tyre bursts.

- Check the tyres for damage and wear at regular intervals.

- Never drive with worn tyres or tyres that are damaged (i.e. they have holes, cuts, cracks or blisters). Driving with tyres in this condition can result in burst tyres, accidents and serious injuries. Worn or damaged tyres must be replaced as soon as possible.

- Never exceed the top speed and load permitted for the fitted tyres.

- The effectiveness of the driver assist systems and brake support systems depends on the tyre grip.

- If you notice unusual vibrations or if the vehicle pulls to one side when driving, stop the car immediately and check the wheels and tyres for damage.

- In order to reduce the risk of losing control of the vehicle, and the risk of accident and serious injury, never loosen the bolts on rims with bolted-on rim rings.

- Do not use wheels or tyres if you do not know their history. Used wheels and tyres may be damaged, even if the damage is not visible. This can cause tyre damage, tyre failure and loss of control of the vehicle.

- Even if they have not been used, old tyres can suddenly lose pressure or burst, especially at high speeds, and thus cause accidents and serious injuries. Avoid using tyres that are more than six years old. If you have no alternative, drive slowly and with extra care at all times.

### WARNING

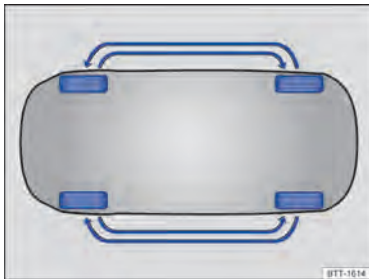
If the wheels are incorrectly fastened or if wheel bolts are missing, the wheels could

come loose, leading to a loss of control of the vehicle, causing accidents and serious injuries.

- Never drive if wheel bolts are missing or loose.
- Always use wheel bolts that match the wheel rims and the vehicle type.
- Always tighten the wheel bolts with the correct tightening torque. If you do not have a torque wrench, tighten the wheel bolts with the wheel bolt wrench and have the torque checked without delay by the nearest qualified workshop.

## Handling wheels and tyres

📖 Please refer to ⚠ at the start of the chapter on page 328.



**Fig. 182** Illustration: diagram for rotating wheels when all wheels have the same tyre and rim sizes.

The wheels and tyres approved by Volkswagen have been carefully selected.

### Rotating wheels when all wheels have the same tyre and rim sizes

If all wheels have the same tyre and rim sizes, it is recommended to regularly rotate the wheels in accordance with the diagram → Fig. 182 to ensure even wear of all tyres. All the tyres will then last for about the same time.

Volkswagen recommends having the wheels changed by a qualified workshop.

### Different tyre and rim sizes on front and rear axles

Your vehicle may be equipped with wheels which have different tyre and rim sizes depending on the axle on which they are fitted. The different wheels must not be swapped between the front and rear axles because this may also lead to the type approval for the vehicle becoming invalid.


◀ The size (rolling circumference) and tread design of the tyres on the front and rear axles may differ.

### Avoiding damage to the wheel rims and tyres

- Drive over kerbs and other low obstacles slowly and at right angles so that the two front wheels come into contact with the obstacle at the same time.
- Check the tyre pressure regularly.
- Regularly check tyres for damage, e.g. holes, slits, punctures or blisters.
- Never exceed the maximum speed and load permitted for the tyres that are fitted → page 336.
- Damaged or worn tyres must be replaced immediately → page 334.
- Protect the tyres from contact with aggressive substances, including grease, oil, petrol and brake fluid.
- Replace missing dust caps on the valves immediately.
- Remove foreign bodies that have not yet penetrated to the inside of the tyre → page 334.
- Observe all warnings of the tyre monitoring system → page 327.

### Tyres that are more than six years old

Tyres age through physical and chemical processes that can impair their function. Tyres that have been stored unused for an extended period of time age more quickly than tyres that are used all the time.

Volkswagen recommends replacing tyres that are more than six years old with new tyres. This also applies to tyres which appear to still be in good condition and whose tread depth has not yet reached the minimum value stipulated by legislation → .



Winter and all-year tyres also largely lose their effectiveness through **ageing** – regardless of the remaining tread depth.

The age of each tyre can be determined on the basis of the manufacturing date → page 332.


### Storing tyres


- Always store tyres in a cool, dry and preferably dark place. **Do not** store tyres mounted on the rim vertically.
- Any tyres not fitted on rims should be kept in suitable sleeves to protect against dirt and should be stored vertically (standing on the tread).

### New tyres

- Drive particularly carefully for the first 600 km (370 miles) with new tyres as the tyres have to be *run in*. Tyres that have not been run in have reduced grip →  and braking efficiency → .
- All wheels must be fitted with radial tyres of the same type, size (rolling circumference) and the same tread. Exceptions for wheel rotation apply if wheel and tyre sizes on the front and rear axles differ.

### Replacing tyres

- The vehicle is fitted at the factory with Volkswagen Genuine reduced rolling resistance tyres. Volkswagen Genuine tyres are marked with the symbol . The specified energy consumption and the specified range can be achieved only with these tyres. Make sure that any new tyres purchased have optimised rolling resistance → page 130.
- Seek advice at a qualified workshop before purchasing new low rolling resistance tyres. Volkswagen recommends using a Volkswagen dealership for this purpose.

- Always replace tyres at least on an axle-by-axle basis → .
- Old tyres should only be replaced by tyres that have been approved by Volkswagen for the vehicle type.
- Never use tyres with an effective size that is larger than Volkswagen-approved tyres.

### Re-synchronising the Tyre Pressure Loss Indicator

The Tyre Pressure Loss Indicator must be re-synchronised each time one or more wheels is changed → page 325.

This also applies when wheels are swapped, e.g. from the front to the rear. Exceptions for wheel rotation apply if wheel and tyre sizes on the front and rear axles differ.

### WARNING

Corrosive liquids and other substances can cause visible and invisible damage to the tyres, which can cause the tyre to burst.

- Always keep chemicals, oils, lubricants, fuel, brake fluid and other corrosive substances away from the tyres.

### WARNING

Even if they have not been used, old tyres can suddenly lose pressure or burst, especially at high speeds, and thus cause accidents and serious injuries.

- Avoid using tyres that are more than six years old. If you have no alternative, drive slowly and with extra care at all times.

### WARNING

New tyres will have to be run in as they will initially have reduced grip and braking effect.

- Drive particularly carefully for the first 600 km (370 miles) in order to prevent accidents and serious injury.

## WARNING

Wheels must have the necessary clearance. If the wheels do not have the necessary clearance, the tyre could rub on parts of the running gear, the vehicle body and the brake lines. This can lead to a fault in the brake system and to tread separation and thus to a tyre bursting.

- The actual tyre size must not exceed the tyre dimensions of manufacturers approved by Volkswagen and must not rub on any vehicle body parts.

## NOTICE

Avoid heavy impacts and drive round obstacles whenever possible. Tyres can be deformed in particular by potholes and kerb edges. This can cause damage to the tyres and wheel rims.

## NOTICE

Do not damage the valves when fitting different tyres. Never drive without valve caps. This could cause damage to the valves.



Old tyres should be disposed of properly and as required by legislation.





If the spare tyre is not the same as the tyres that are mounted on the car - for example in the case of winter tyres or a temporary spare wheel - only use the spare tyre in the event of a breakdown for a short period of time and drive with extra care. Refit the normal road wheel as soon as possible.



Volkswagen-approved tyres are guaranteed to have the dimensions that are suitable for the vehicle. In the case of other tyres, the tyre seller must provide a certificate from the tyre manufacturer stating that the tyre is also suitable for the vehicle. This certificate must be stored in a safe place in the vehicle.

## Wheel rims and wheel bolts

 Please refer to  at the start of the chapter on page 328.

Wheel rims, tyres and wheel bolts are matched to the vehicle type. If different wheel rims are fitted, the correct wheel bolts with the correct length and correctly shaped bolt heads must be used. This ensures that the brakes work properly and that the vehicle drives quietly and safely.

For technical reasons, it is not generally possible to use the wheel rims from other vehicles. This can also apply to wheel rims of the same vehicle type.

The tightening torque of the wheel bolts must be checked regularly with a properly functioning torque wrench. → page 344.


### Wheel bolts

The correct wheel bolts must be used for all vehicle types; these bolts must always be tightened with the correct tightening torque → page 344.


### Two-piece wheel bolts

Two-piece wheel bolts must be used for the vehicle. With two-piece wheel bolts, the ball seat is loosely connected to the head.

### Wheel rims with bolted rim rings or trim elements

Rims with bolted-on rings or trim elements consist of several components. These components are joined together using special bolts. Damaged wheel rims must be replaced and must always be repaired only by a qualified workshop. Volkswagen recommends using a Volkswagen dealership for this purpose → .

### Wheel rim identification

 In some countries, new wheel rims must contain information on certain properties. The following information may be provided on the wheel rim:

- Seal of conformity.

- Rim size.
- Name of manufacturer or brand name.
- Date manufactured (month/year).
- Country of origin.
- Production number.
- Raw materials batch number.
- Product code.

### **⚠ WARNING**

The use of unsuitable or damaged wheel rims can impair vehicle safety and cause accidents and serious injury.

- Only use wheel rims that have been approved for the vehicle.
- Check the rims regularly for damage and replace as necessary.

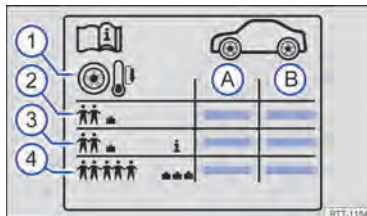
### **⚠ WARNING**

Incorrect loosening and tightening of the bolts on wheel rims with bolted-on rings can cause accidents and serious injury.

- Never loosen the bolts on wheel rims with bolted-on rings.
- All work on wheel rims with bolted-on rings must be carried out by a qualified workshop. Volkswagen recommends using a Volkswagen dealership for this purpose.

## Tyre pressure

📖 Please refer to **⚠** at the start of the chapter on page 328.



**Fig. 183** Symbols on the tyre pressure sticker.

- (A) Tyre pressure for the tyres on the front axle.
- (B) Tyre pressure for the tyres on the rear axle.
- (1) Note: check the tyre pressure when the tyres are cold.
- (2) Tyre pressure for partial load.
- (3) *Vehicle-dependent*: comfort tyre pressure for partial load.
- (4) Tyre pressure for full load.



**Fig. 184** On the driver door pillar: tyre pressure sticker (alternatively on the inside of the charging socket flap).

The sticker provides the correct tyre pressure for approved tyres and is located either on the driver door pillar → Fig. 184 or inside the charging socket flap.

The appearance of the sticker may differ between vehicles. It may include additional tyre sizes.

The wrong tyre pressure will have a negative effect on the vehicle's response and lead to high levels of wear or even a burst tyre → ⚠️. The correct tyre pressure is particularly important at **high speeds**.

### Comfort tyre pressure

Depending on the vehicle, the tyre pressure sticker may show details of a comfort tyre pressure → Fig. 183. The comfort tyre pressure allows increased driving comfort. Energy consumption may increase when driving with comfort tyre pressure.

### Checking the tyre pressure

- Check the tyre pressure at least once a month.
- Always check the tyre pressure when the tyres are cold. The specified tyre pressure applies to **cold tyres**. Tyre pressure is always higher in warm tyres than it is in cold tyres. For this reason, never reduce the pressure in warm tyres to adjust the tyre pressure.
- Always adjust the tyre pressure to the load level → Fig. 183.
- After adjusting the tyre pressures, always screw the caps onto the valves and observe the information on the tyre monitoring system.
- Always use the tyre pressure specified on the sticker. Never exceed the maximum tyre pressure which is given on the sidewall of the tyre

### ⚠️ WARNING

Incorrect tyre pressure may cause the tyre to suddenly lose pressure or burst while the vehicle is in motion. This can cause serious accidents and fatal injuries.

- If the tyre pressure is too low, it is possible that the tyre temperature will increase to such an extent when driving that the tread detaches and the tyre bursts.

- Excessive speeds and overloading of the vehicle can cause overheating, sudden tyre damage including tyre bursts and detachment of the tread surface, and thus to a loss of control of the vehicle.
- If the tyre pressure is too low, the tyres will wear prematurely and the car will not handle well.
- Check tyre pressures regularly, at least once a month, and before every long journey.
- All tyres must have the correct tyre pressure to suit the vehicle load.
- Never reduce excess pressure when the tyres are warm.

### ⓘ NOTICE

- When attaching the tyre pressure gauge, ensure that you do not position it at an angle to the valve stem. This can damage the tyre valve.
- Always make sure the valve caps are completely screwed on while driving.

🌿 Underinflated tyres can contribute to an increase in energy consumption. <

### Tread depth and tread wear indicators


📖 Please refer to ⚠️ at the start of the chapter on page 328.



Fig. 185 Tyre tread: tread wear indicators.

## Tread depth

Most driving situations require the highest possible tread depth. All tyres should have an even tread depth on at least one axle. This is especially true in wet or wintry road conditions.

In most countries, the legally permissible minimum tread depth is reached at 1.6 mm (1/16 in) residual tread - measured in the tread grooves next to the wear indicators (observe deviating country-specific legal regulations). The tyres should have the same tread depth, at the minimum on each axle → .

Observe any country-specific legal requirements relating to the permissible minimum tread depths for winter and all-year tyres.


## Tread wear indicators in tyres

The tread wear indicators show if a tyre is worn down. The tyre must be replaced at the latest when the tread depth is just down to the tread wear indicator.

There are 1.6 mm (1/16 in) high wear indicators → Fig. 185 in the tread base of the tyres. Markings on the tyre sidewall indicate the position of the tread wear indicators → Fig. 185.


## WARNING

Worn tyres are a safety risk and can lead to a loss of control of the vehicle and cause serious injury.

- Tyres must be replaced at the latest when the tread is worn down to the tread wear indicators.
- Worn tyres have considerably less grip, particularly on wet roads, which can cause the vehicle to "float" along the road surface (aquaplaning).
- Worn tyres reduce the possibility of controlling the vehicle well in normal and difficult driving situations and increase braking distance and the risk of skidding. 

## Tyre damage

 Please refer to  at the start of the chapter on page 328.

Damage to tyres and wheel rims is often hidden → .

- If you suspect that a wheel is damaged, slow down immediately and stop the vehicle as soon as it is safe to do so.
- Check the tyres and wheel rims for damage.
- Do not drive on if a tyre is damaged.
- Changing a damaged wheel → page 343. Seek expert assistance for this if necessary.  
**Or:** seal damaged wheel with the breakdown set and inflate → page 348.
- If there is no visible damage, drive slowly and cautiously to the next qualified workshop in order to have the vehicle checked.

## Embedded foreign bodies in the tyres

- Leave the foreign body in the tyre if it has entered the inner tyre. Foreign bodies that are stuck between the tyre tread blocks can be removed.
- Changing a damaged wheel → page 343. Seek expert assistance for this if necessary.  
**Or:** seal damaged wheel with the breakdown set and inflate → page 348.
- Check and adjust the tyre pressure.
- Go to a qualified workshop. Volkswagen recommends using a Volkswagen dealership for this purpose.
- *On vehicles with mobility tyres:* leave the foreign body in the tyre and go to a qualified workshop. A sealant applied to the inside of the tyre tread encloses the foreign body and seals the tyre temporarily.

## Tyre wear

The tyre wear is affected by several factors:

- Style of driving.



- How well the tyres are balanced.
- Adjustments made to the running gear.

Fast cornering, heavy acceleration and hard braking all increase tyre wear.

Wheel imbalance may develop when the vehicle is driven; you will notice this by the nervous steering response. Unbalanced wheels will affect the level of tyre wear. In this case the wheels should be balanced again.

Incorrect wheel alignment causes excessive tyre wear, impairing the safety of the vehicle. The wheel alignment should be checked by a qualified workshop if tyres show excessive wear.

### **WARNING**

If you notice unusual vibration or the car pulling to one side while the vehicle is in

motion, this may indicate that one of the tyres is damaged.

- Reduce speed immediately and park the vehicle without obstructing traffic.
- Check the tyres and wheel rims for damage.
- Never drive on if tyres or wheel rims are damaged. Seek expert assistance instead.
- If there is no visible damage, drive slowly and cautiously to the next qualified workshop in order to have the vehicle checked.

## Tyre lettering and tyre type

📖 Please refer to  at the start of the chapter on page 328.

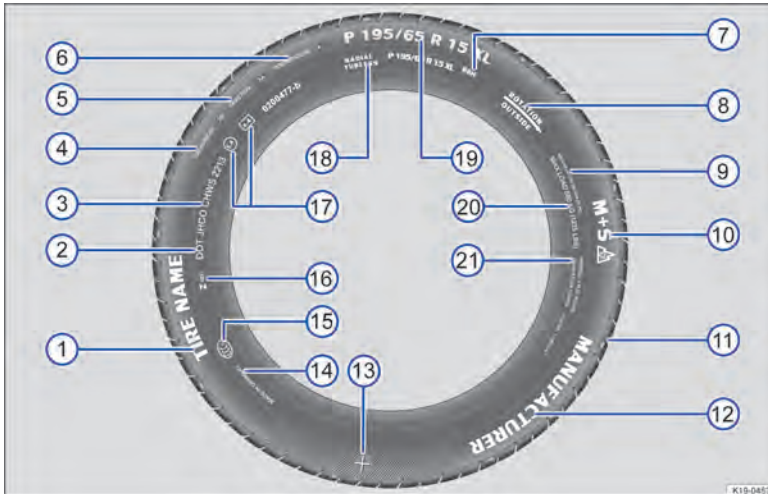






Fig. 186 International tyre lettering.

### → Fig. 186 Tyre lettering (example), meaning

①	Product name	Individual tyre designation of the manufacturer.
②	DOT	The tyre complies with the legal requirements of the USA Department of Transportation, responsible for tyre safety standards.
③	JHCO CHWS 2213	Tyre identification number (TIN <sup>a</sup> ) – may be only on the inner side of the wheel) and date of manufacture:
		JHCO CHWS Identifier of producing plant and specifications of the tyre manufacturer on size and characteristics.
		2213 Date of manufacture: 22nd week in 2013.
Information for the end user concerning comparative values for specified basic tyres (standardised test procedure) → page 366:		
④	TREADWEAR 280	Relative life expectancy for the tyre, with reference to a US-specific standard test. Tyres with the specification 280 wear at a rate of 2.8 times more slowly than standard tyres that have a treadwear value of 100. The performance of tyres is determined by how they are used and can significantly deviate from standard values due to driving style, maintenance, road surface and climatic conditions.

→ Fig. 186 Tyre lettering (example), meaning

⑤	TRACTION AA	Wet braking performance of the tyre (AA, A, B or C). The wet braking performance is tested under controlled conditions on certified test tracks. Tyres marked C have a low traction performance. The traction value assigned to the tyres is based on linear traction tests and does not include acceleration and lateral stability or aquaplaning and traction under maximum load.
⑥	TEMPERATURE A	Temperature stability of the tyre at high speeds on a test bed (A, B or C). A and B tyres exceed legal requirements. The temperature evaluation is based on tyres with correct pressure and does not allow for excess pressure. Excessive speed, incorrect pressure or excess pressure can cause heat build-up or tyre damage. This applies to one or a combination of these factors.
⑦	88 H	Load index → page 338 and speed index → page 338.
⑧	Rotation and arrow	Denotes direction of rotation → page 338.
	OR: Outside	Denotes outside of tyres → page 338.
⑨	MAX INFLATION 350 KPA (51 psi/ 3.51 bar)	US limitation for the maximum air pressure.
⑩	M+S or M/S or 	Denotes winter tyres (mud and snow tyres) → page 339. Stud-ded snow tyres are labelled with an E after the S.
⑪	TWI	Indicates the position of the tread wear indicator → page 333.
⑫	Brand name, logo	Manufacturer.
⑬		Marking for Volkswagen Genuine tyres → page 329.
⑭	Made in Germany	Country of manufacture.
⑮		Country-specific identification for China (China Compulsory Certification).
⑯	 023	Country-specific identification for Brazil.
⑰	E4 e4 0200477-b	Indicates conformity with international regulations with the number of the country that granted approval. Approved tyres which comply with ECE regulations are identified with E, tyres which comply with EC regulations are identified with e. This is followed by the multiple-digit approval number.
⑱	RADIAL TUBELESS	Tubeless radial tyre.
		Size designation:
		P Identification for passenger vehicle.
		195 Tyre width from wall to wall in mm.
		65 Aspect ratio in %.
		R Tyre construction: radial.
		15 Rim diameter in inches.
		XL Heavy-duty tyres (extra load tyres).
⑳	MAX LOAD 615 KG (1235 LBS)	US load data for the maximum load per wheel.

→ Fig. 186 Tyre lettering (example), meaning

21	SIDEWALL 1 PLY	Details of the tyre carcass components:
	RAYON	1 ply of rayon (artificial silk).
21	TREAD 4 PLYS	Details of the tread components:
	1 RAYON + 2 STEEL	In the example there are 4 plies under the tread surface: 1 ply of rayon (artificial silk), 2 steel belt plies and 1 nylon ply.
	+ 1 NYLON	

a) The TIN is the tyre serial number.

The tyre lettering is located on both sides. Certain labels may only be found on one side of the tyre, e.g. tyre identification number and manufacturing date.

**Any further numbers and letters are internal codes used by the tyre manufacturer or country-specific codes.**

#### Low-profile tyres

Low-profile tyres have a wider tread surface, larger rim diameter and lower sidewalls than conventional wheel/tyre combinations → page 329. Low-profile tyres can improve the vehicle's handling and precision. They may however result in a less comfortable ride on uneven road surfaces and tracks.

#### Tyres with directional tread pattern

An arrow on the tyre sidewall indicates the direction of rotation on tyres with directional tread. The direction of rotation must be observed in all cases. This guarantees the best possible running characteristics.

If, however, the tyre is fitted in the opposite direction to the tread pattern, you must take more care when driving as the tyre is now no longer being used according to its designation. The tyres must be replaced as quickly as possible or be fitted with the tread in the correct direction.

#### Asymmetrical tyres

Asymmetrical tyres take into account the differing behaviour of the inner and outer areas of the tread pattern. The sidewalls of asymmetrical tyres are marked to indicate "inside" or "outside". Always observe the correct tyre position on the wheel rim.

#### Tyre load

The load index indicates the maximum load capacity of an individual tyre in kilograms (tyre load).

Examples:

<b>78</b>	425 kg
<b>81</b>	462 kg
<b>83</b>	487 kg
<b>85</b>	515 kg
<b>87</b>	545 kg
<b>88</b>	560 kg
<b>91</b>	615 kg
<b>92</b>	630 kg
<b>93</b>	650 kg
<b>95</b>	690 kg
<b>97</b>	730 kg
<b>99</b>	775 kg
<b>100</b>	800 kg
<b>101</b>	825 kg
<b>102</b>	850 kg
<b>103</b>	875 kg
<b>104</b>	900 kg

#### Speed index

The speed index indicates the maximum permitted speed that may be driven with the tyre.

<b>P</b>	max. 150 km/h (93 mph)
<b>Q</b>	max. 160 km/h (99 mph)
<b>R</b>	max. 170 km/h (106 mph)
<b>S</b>	max. 180 km/h (112 mph)
<b>T</b>	max. 190 km/h (118 mph)
<b>U</b>	max. 200 km/h (125 mph)
<b>H</b>	max. 210 km/h (130 mph)
<b>V</b>	max. 240 km/h (149 mph)

- W max. 270 km/h (168 mph)
- Y max. 300 km/h (186 mph)
- Z above 240 km/h (149 mph)

Some tyre manufacturers use the code "ZR" for tyres with a maximum permitted speed of over 240 km/h (149 mph). ◀

## Maximum load and speed range for tyres

📖 Please refer to ▲ at the start of the chapter on page 328.

Vehicles in the EU and the so-called EU user states are issued an EC Certificate of Conformity. This details the size, diameter and speed range of all tyres approved by Volkswagen for the relevant vehicle type.

The type plate shows whether there is an EC Certificate of Conformity for this particular vehicle → page 387.

- If the type plate has a row marked "Permit" then the vehicle has an EC Certificate of Conformity.
- If there is no type plate, or no row marked "Permit" the vehicle does not have an EC Certificate of Conformity. ◀

The following applies when using winter tyres:

- Observe any country-specific legal requirements.
- Use winter tyres on all four wheels at the same time.
- Only use in winter road conditions.
- Only use the sizes of tyre that have been approved for the vehicle.
- Winter tyres must have the same belt type, size and the same tread pattern. Exception → page 329.
- Observe the maximum speed permitted by the speed index → ▲.

### Speed limitation

Winter tyres have a speed limit depending on the speed index → page 336.

You can set a speed warning using the Vehicle settings and the Tyres menus in the Infotainment system.

If you use **V-rated winter tyres**, the speed limits and required tyre pressure will be determined by the engine size. You must ask a Volkswagen dealership about the maximum permitted speed and required tyre pressure.

## Winter tyres

📖 Please refer to ▲ at the start of the chapter on page 328.

Summer tyres have less grip on icy or snow-covered roads. Winter or all-season tyres improve the handling and braking characteristics in winter road conditions. Volkswagen recommends that winter tyres be fitted to the vehicle at temperatures below +7°C (+45°F) or in winter road conditions.

Winter and all-season tyres lose their effectiveness when the **tread** is worn down to a depth of 4 mm (3/16 inch).

### All-wheel drive (4MOTION)

Thanks to its all-wheel drive, the vehicle will have plenty of traction in winter conditions, even with the standard tyres. Nevertheless, Volkswagen still recommends that winter tyres or all-year tyres should be fitted *on all four wheels* in winter, above all because this will give improved *braking efficiency*.


Observe information on **snow chains** → page 340.


## ⚠ WARNING


The improved winter driving characteristics afforded by the winter tyres should not encourage you to take any risks.

Exceeding the speed limitation of winter tyres can cause the tyres to fail suddenly and the vehicle to lose control.

- Never disregard the speed limitation of the winter tyres fitted, even if the permissible top speed of the vehicle is higher.
- Never exceed the maximum payload of the winter tyres that are fitted.
- Adapt your speed and driving style to suit visibility, weather, road and traffic conditions.

 The vehicle handling is better if summer tyres are fitted at temperatures above +7°C (+45°F). The rolling noise is quieter, the tyre wear lower and the energy efficiency higher in this case.

 In vehicles with Tyre Pressure Loss Indicator, the system must be re-synchronised after changing from summer tyres to winter tyres or vice versa → page 325.

 Volkswagen dealerships can provide details on permissible winter tyre sizes.

## Snow chains

📖 Please refer to ⚠ at the start of the chapter on page 328.

Please observe legislation and also the maximum permitted speed when driving your vehicle with snow chains.

On icy or snow-covered roads, snow chains will improve traction and braking response.

Snow chains may be fitted **only to the rear wheels**. They may be fitted **only to the following tyre and wheel combinations**:

Capacity of high-voltage battery	Tyre size	Wheel rim
55 kWh, 62 kWh	235/60 R 18	8 J x 18 ET45
55 kWh, 62 kWh	235/55 R 19	8 J x 19 ET45
82 kWh	255/50 R 19	8 J x 19 ET45

Volkswagen recommends that you ask your Volkswagen dealership for information about appropriate wheel, tyre and snow chain size.

If possible, use snow chains with fine-pitch links which do not protrude more than 12 mm, including the tensioner.

Remove hubcaps and trim rings before fitting snow chains. For safety reasons, cover caps must then be fitted over the wheel bolts. Caps are available from Volkswagen dealerships.


## ⚠ WARNING

The use of snow chains that are unsuitable for your vehicle or the incorrect installation of snow chains can cause accidents and serious injuries.

- Always use the correct snow chains.
- Follow the assembly instructions provided by the snow chain manufacturer.
- Never exceed the maximum speed permitted for the snow chains that are fitted.

## ! NOTICE

- Remove the snow chains when driving on roads that are free of snow. The snow chains will otherwise impair handling, damage the tyres and wear out very quickly.
- Snow chains that are in direct contact with the wheel rim can scratch or damage it. Volkswagen recommends using snow chains with built-in rim protection.

 In vehicles with a Tyre Pressure Loss Indicator, the system must be re-synchronised when snow chains are fitted → page 325.

## Hubcaps

### Centre wheel trim



**Fig. 187** Removing the centre wheel trim by pulling off.

The centre wheel trim protects the wheel bolts and must be fitted again after changing the wheel.

- *To remove:* take the wire hook from the vehicle toolkit → page 292 and insert it into a hole (alloy wheel) or fit it on the edge (steel wheel) of the trim → Fig. 187.
- Pull off the cover in the direction of the arrow.
- *To fit:* press the centre wheel trim against the rim until you feel it engage.



**Fig. 188** Removing the centre wheel trim by turning.

- *To remove:* turn the centre wheel trim clockwise or anticlockwise until it is released from the rim.
- Reach behind one of the ribs and pull off the centre wheel trim.
- *To fit:* place the centre wheel trim centrally on the rim.
- Press the centre wheel trim against the rim until you feel it engage.

### WARNING

Using unsuitable hubcaps, or fitting them incorrectly, can cause accidents and serious injuries.

Incorrectly fitted hubcaps can become loose while the vehicle is in motion and endanger other road users.

- Do not use damaged hubcaps.
- Always ensure that the airflow to cool the brakes is not restricted or reduced. This also applies if hubcaps are retrofitted. If the airflow is not sufficient, the braking distance could increase significantly.

## Wheel cover



Fig. 189 Removing the wheel cover.

The wheel cover protects the wheel bolts and must be fitted again after changing the wheel.

### Removing wheel covers

- Take the wire hook from the vehicle toolkit → page 292.
- Insert the wire hook into one of the holes in the wheel cover.
- Use the wire hook to pull off the wheel cover in the direction of the arrow. If necessary, use a box spanner to do this → Fig. 189.

### Fitting wheel covers

- Check the correct position of the anti-theft wheel bolt → page 344.
- Press the wheel cover onto the wheel rim so that the valve hole is located over the tyre valve. Please ensure the cover engages securely all the way round.

## ⚠ WARNING

Using unsuitable hubcaps, or fitting them incorrectly, can cause accidents and serious injuries.

Incorrectly fitted hubcaps can become loose while the vehicle is in motion and endanger other road users.

- Do not use damaged hubcaps.

- Always ensure that the airflow to cool the brakes is not restricted or reduced. This also applies if hubcaps are retrofitted. If the airflow is not sufficient, the braking distance could increase significantly.

## ⚠ NOTICE

The wheel cover can be firmly fixed and should not be removed using force. <

## Wheel bolt caps



Fig. 190 Removing the wheel bolt caps.

The caps protect the wheel bolts and should be fitted fully back in position after changing the wheel.

### Removing and fitting the caps

- *Removing:* take the wire hook from the vehicle toolkit → page 292.
- Insert the wire hook through the opening in the cap → Fig. 190 and pull off in the direction of the arrow.
- *Fitting:* press the caps onto the bolts as far as they will go.

The **anti-theft wheel bolt** has a separate cap. It only fits onto the anti-theft wheel bolt and not onto the conventional wheel bolts. <



## Changing a wheel

### Introduction to the topic

You should carry out a wheel change yourself only when the vehicle is parked safely, you are familiar with the safety procedures and have access to the correct equipment. Some models are delivered from the factory without a jack or box spanner. If this is the case, wheels should be changed by a qualified workshop.

The jack supplied with the vehicle is only designed for changing a wheel when one vehicle tyre is damaged and has to be replaced. If both tyres on one side of the vehicle, both tyres on one axle, or all tyres are damaged, seek expert assistance.

### WARNING

Changing a wheel can be dangerous, especially when carried out at the side of a road. Please note the following steps in order to reduce the risk of serious injuries:

- Stop the vehicle as soon as possible and when safe to do so. Park the vehicle at a safe distance from moving traffic in order to carry out the wheel change.
- All passengers and children in particular must be at a safe distance and away from the area of work during the wheel change.
- Switch on the hazard warning lights to warn other road users.
- Check that the surface the vehicle is parked on is level and firm. If necessary, use a large, strong board or similar support for the jack.
- Only change the wheel yourself when you feel confident with carrying out the procedure. If not, seek expert assistance.
- Always use suitable and undamaged tools to change the wheel.
- Always switch off the electric drive via the ignition and move the selector lever


to the **P** position to reduce the risk of unintended vehicle movement.

- Switch on the electronic parking brake.
- The wheel bolt tightening torque should be checked with a correctly functioning torque wrench immediately after changing a wheel.
- In the case of vehicles with a Tyre Pressure Loss Indicator, the system must be re-synchronised immediately after a wheel change → page 325.

### Preparations for changing a wheel

 Please refer to  at the start of the chapter on page 343.

#### Checklist

The following actions must always be carried out in the given order in preparation for changing the wheel → :

1. If your vehicle has a flat tyre, park the vehicle on a firm and level surface at a safe distance from moving traffic.
2. Deactivate the vehicle's drive system and switch off the ignition → page 176.
3. Ask all vehicle occupants to leave the vehicle and stand at a safe distance away from moving traffic.
4. Switch on the hazard warning lights and set up the warning triangle → page 66. Observe any legal requirements.
5. Check the wheel diagonally opposite the wheel being worked on with a stone, collapsible chocks or another suitable object.
6. When towing a trailer: unhitch the trailer from the vehicle and park it properly → page 264.
7. Remove any items of luggage from the luggage compartment.

8. Remove the spare wheel or temporary spare wheel and the vehicle toolkit from the luggage compartment.
9. Remove the hubcaps → page 341.

### **⚠ WARNING**

Ignoring any of the items on this important safety checklist can lead to accidents and severe injuries.

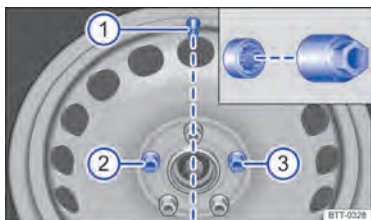
- Follow the actions in the checklist and observe the general safety procedures.

## Wheel bolts

📖 Please refer to **⚠** at the start of the chapter on page 343.



**Fig. 191** Changing a wheel: loosening the wheel bolts.



**Fig. 192** Changing a wheel: tyre valve ① and locations of the anti-theft wheel bolt ② or ③.

Use a suitable box spanner to loosen the wheel bolts.

Only loosen the wheel bolts by approximately one turn before raising the vehicle with the jack.

If one of the wheel bolts is very tight, you may be able to loosen it by pushing down the end of the box spanner carefully with your foot. Hold on to the vehicle for support and ensure that you have a secure footing.

### **Two-piece wheel bolts**

Two-piece wheel bolts must be used for the vehicle. With two-piece wheel bolts, the ball seat is loosely connected to the head.

Single-piece wheel bolts may not be used. If you are not sure which wheel bolts can be used for your vehicle, consult a qualified workshop. Volkswagen recommends using a Volkswagen dealership for this purpose.

### **Loosening wheel bolts**

- Fit the box spanner over the wheel bolt as far as it will go → Fig. 191.
- Hold the end of the box spanner and turn the wheel bolt *one* turn anticlockwise → **⚠**.

### **Loosening the anti-theft wheel bolt**

- Take the adapter for the anti-theft wheel bolt out of the vehicle toolkit.
- Insert the adapter into the anti-theft wheel bolt as far as it will go.
- Push the box spanner onto the adapter as far as it will go.
- Hold the end of the box spanner and turn the wheel bolt *one* turn anticlockwise → **⚠**.

### **Screwing in the anti-theft wheel bolt (wheel cover)**

On wheels with a wheel cover, the anti-theft wheel bolt must be screwed in at position → Fig. 192 ② or ③ according to the position of the tyre valve ①. The wheel cover can otherwise not be fitted.

### Tightening torque for wheel bolts

Specified tightening torque for wheel bolts for steel or alloy wheel rims:

— 120 Nm.

If the wheel bolts are corroded and stiff, they must be renewed and the wheel hub threads cleaned **before the tightening torque is checked**.

Never grease or oil the wheel bolts or the threads of the wheel hubs.

The tightening torque should be checked with a properly functioning torque wrench immediately after changing a wheel.

### WARNING

Incorrectly tightened wheel bolts can loosen while the vehicle is in motion and cause accidents, serious injury, and loss of control of the vehicle.

- The wheel bolts and threads of the wheel hubs must be clean, free from oil and grease, and turn easily.
- Always use the box spanner placed in the vehicle at the factory to loosen and tighten the wheel bolts.
- Only loosen the wheel bolts by approximately one turn before raising the vehicle with the jack.
- Never grease or oil the wheel bolts or the threads of the wheel hubs. This could cause them to loosen while the vehicle is in motion, even if the required torque setting is used.
- Never loosen the bolts on wheel rims with bolted-on rings.
- If the tightening torque of the wheel bolts is too low, the wheel bolts and rims can loosen while the vehicle is in motion. The wheel bolts and the threads could be damaged if the tightening torque is too high. Check the tightening torque regularly using a torque wrench.

### WARNING

The wrong wheel bolts can loosen while the vehicle is in motion and cause accidents, serious injury, and loss of control of the vehicle.

- Only use wheel bolts that belong to the respective wheel rim.
- Never use different wheel bolts.
- On vehicles with two-piece wheel bolts: use only two-piece wheel bolts.

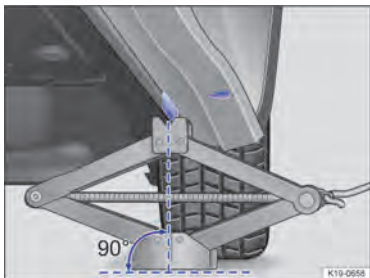
### Lifting the vehicle with the jack

 Please refer to  at the start of the chapter on page 343.

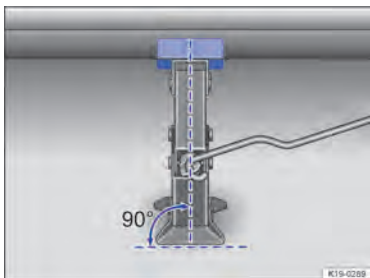


Fig. 193 Jacking points.

The jack may be positioned only at the reinforcements on the underbody, which are located behind the markings on the body. Always use the jacking point closest to the wheel you are working on → Fig. 193.




**Fig. 194** Jack applied at the rear left-hand side of the vehicle.



**Fig. 195** Correct alignment of the jack.

### Checklist

For your own safety, carry out the following points in the specified order → :

1. Choose a firm and level surface suitable for lifting the vehicle.
2. Deactivate the vehicle's drive system and switch off the ignition → page 176.
3. Chock the wheel diagonally opposite using collapsible chocks or other suitable objects.
4. When towing a trailer → page 264: unhitch the trailer from the vehicle and park it properly.
5. Loosen the wheel bolts → page 344.
6. Find the jacking point under the vehicle → Fig. 193 which is closest to the wheel that is being changed.

7. Insert the hand crank into the opening on the jack (depending on equipment).
8. Crank up the jack until it just fits under the jacking point of the vehicle.
9. Make sure that the entire surface of the foot of the jack is resting securely on the ground and that the foot of the jack is positioned vertically directly beneath the point of application → Fig. 194 and → Fig. 195.
10. Position the jack and simultaneously continue to crank the claw up until it is in position around the vertical rib underneath the vehicle → Fig. 194.
11. Crank the jack further until the wheel is just clear of the ground.

### WARNING

Incorrect use of the vehicle jack can cause the vehicle to slip off the jack, which can lead to severe injuries. Please note the following to help reduce the risk of injuries:

- Only use vehicle jacks that have been approved by Volkswagen for your vehicle type. Other vehicle jacks could slip out of position – this includes vehicle jacks supplied with other Volkswagen models.
- The ground must be firm and level. Soft ground or surfaces at an incline under the vehicle jack may cause the vehicle to slip off the jack. If necessary, use a large, strong board or similar support for the jack.
- On a hard, slippery surface (such as tiles), use a rubber mat or similar to prevent the jack from slipping.
- Apply the jack only at the points described. The jack claw must grip the jacking point under the side member securely → Fig. 194.
- Never place any part of your body (e.g. an arm or leg) underneath a vehicle which is only supported by the jack.
- If you have to work underneath the vehicle, use suitable stands to provide extra support for the vehicle.

- Never lift the vehicle when the electric drive is switched on or if the vehicle is tilted to the side or on a gradient.

### **⚠ WARNING**

Ignoring any of the items on this important safety checklist can lead to accidents and severe injuries.

- Follow the actions in the checklist and observe the general safety procedures.

## Changing a wheel

📖 Please refer to **⚠** at the start of the chapter on page 343.



**Fig. 196** Wheel change: Unscrew the wheel bolts with the wheel wrench.

### Removing the wheel

- Observe the checklist → page 343.
- Loosen the wheel bolts → page 344.
- Jack up the vehicle → page 345.
- Using the wheel wrench → **Fig. 196**, completely unscrew loosened wheel bolts and place them on a clean surface.
- Remove the wheel.

### Fitting the spare wheel or temporary spare wheel

- Note the tyre direction of rotation → page 336.

- Put the wheel in place.
- Screw the anti-theft wheel bolt with the adapter clockwise to the correct position → page 344 and tighten *slightly*.
- Screw in all the other wheel bolts in clockwise direction and tighten them *slightly*.
- Lower the vehicle with the jack.
- Use the box spanner to tighten all the wheel bolts securely in a clockwise direction → **⚠**. Do not tighten the bolts in clockwise or anticlockwise sequence. Tighten them in diagonal sequence.
- Fit the caps, wheel centre trim or wheel cover → page 341.

### After changing a wheel

- Clean the tools and place them back in the foam rubber holder in the luggage compartment.
- Stow the changed wheel securely in the luggage compartment.
- Have the tightening torque of the wheel bolts checked immediately → page 344.
- The damaged wheel should be replaced as soon as possible.

### **⚠ WARNING**

Incorrect torque or incorrect use of wheel bolts can lead to a loss of control of the vehicle, cause accidents and serious injuries.

- Always keep all wheel bolts and threads in the wheel hubs clean and free from oil and grease. The wheel bolts must be easy to turn and be tightened to the specified torque.

**i** After changing a wheel, the indicator lamp for the tyre monitoring system may indicate a fault in the system → page 327.

## Breakdown set

### Introduction to the topic

The breakdown set can be used to temporarily and reliably seal any tyre damage caused by foreign bodies or punctures (up to approx. **4 mm** in diameter). **Do not remove foreign objects (e.g. screws or nails) from the tyre!**

Once the sealant has been added to the tyre, the tyre pressure must be checked and adjusted again after approximately 10 minutes of driving.

Seek expert assistance if more than one of the vehicle's tyres is damaged. The breakdown set is designed to fill only one tyre.

Use the breakdown set only when the vehicle has been safely parked and you are familiar with the work and safety precautions needed. Seek expert assistance if this is not the case.

#### The tyre sealant must not be used:

- If the wheel rim is damaged.
- If the outside temperature is below  $-20^{\circ}\text{C}$  ( $-4^{\circ}\text{F}$ ).
- If there are cuts or punctures in the tyre that are larger than 4mm.
- If the vehicle was driven with very low tyre pressure or a flat tyre.
- If the use-by date on the tyre filler bottle has expired.
- If a foreign object has been removed from the tyre.
- In connection with mobility tyres. The word "Seal" is visible on the outer wall of the tyre if your vehicle is fitted with mobility tyres.

### WARNING

Using the breakdown set can be dangerous, especially if the tyre is inflated at the roadside. Please note the following steps in order to reduce the risk of serious injuries:

- Stop the vehicle as soon as possible and when safe to do so. Park the vehicle at


a safe distance from moving traffic in order to fill the tyre.


- Check that the surface the vehicle is parked on is level and firm.
- All passengers, and children in particular, must be at a safe distance and away from your area of work.
- Switch on the hazard warning lights to warn other road users.
- The breakdown set should be used only if you feel confident with carrying out the procedure. If not, seek expert assistance.
- Tyres repaired with the breakdown set are intended for temporary, emergency use only. They should be used only until you can reach the nearest qualified workshop.
- Tyres that have been repaired using the breakdown set should be replaced as soon as possible.
- Sealant is hazardous to health and must be washed off immediately if it gets onto the skin.
- The breakdown set must be stored out of the reach of children.
- Never use a jack, even if it is approved for the vehicle.
- Always deactivate the vehicle's drive system and switch off the ignition → page 176.


### WARNING

Tyres that have been filled with sealant will not handle in the same way as a standard tyre.

- Never drive faster than 80 km/h (50 mph).
- Avoid full acceleration, sudden braking and fast driving through bends in the road.
- Drive for just 10 minutes at no more than 80 km/h (50 mph) and then check the tyre.

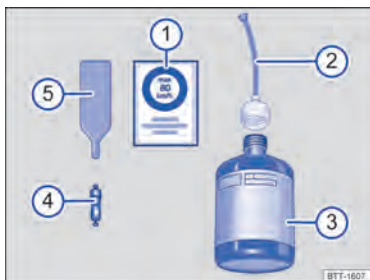
 Dispose of used or out-of-date sealant in accordance with legal requirements.

 You can get a new tyre filler bottle from a Volkswagen dealership.

 Observe the separate instructions from the manufacturer of the breakdown set.

## Contents of the breakdown set

 Please refer to  at the start of the chapter on page 348.



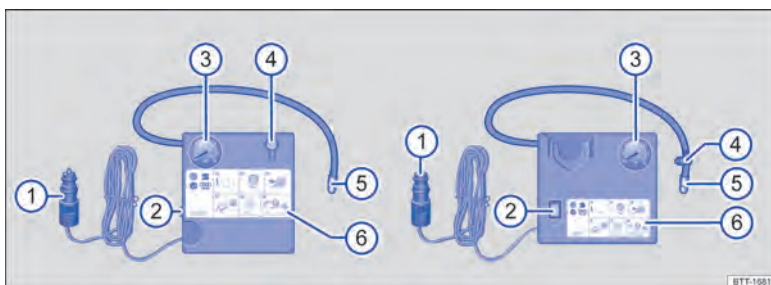
**Fig. 197** Illustration: components of the breakdown set.

- ② Tyre sealant tube with plug.
- ③ Tyre filler bottle.
- ④ Spare valve core.
- ⑤ Valve core extractor.

There is a slot on the lower end of the **valve core extractor** → Fig. 197 ⑤ for the valve core. This is required for extracting the valve core from the tyre valve and then screwing it back into the valve again. This also applies to the spare valve core ④.

The breakdown set consists of the following items → Fig. 197:

- ① Sticker with the maximum permitted speed "max. 80 km/h" or "max. 50 mph".



**Fig. 198** Illustration: compressor from the breakdown set.

The compressor in the breakdown set consists of the following components

→ Fig. 198:

- ① 12-volt plug.
- ② ON/OFF switch.
- ③ Tyre pressure display.
- ④ Air bleed screw <sup>1)</sup>.
- ⑤ Tyre filler hose.

## Preparations

📖 Please refer to ⚠ at the start of the chapter on page 348.


### Checklist

The following actions must always be carried out in the given order in preparation for filling a tyre → ⚠:

1. If your vehicle has a flat tyre, park the vehicle on a firm and level surface at a safe distance from moving traffic.
2. Deactivate the vehicle's drive system and switch off the ignition → page 176.
3. Ask all vehicle occupants to leave the vehicle and stand at a safe distance away from moving traffic.
4. Switch on the hazard warning lights and set up the warning triangle → page 66. Observe any legal requirements.
5. Check whether the puncture can be repaired with the breakdown set → page 348.
6. Remove any items of luggage from the luggage compartment.
7. Take the breakdown set out of the luggage compartment.

### ⑥ Air compressor.

The breakdown set is located underneath the floor covering in the luggage compartment.

 The air compressor from the breakdown set may be operated from the 12-volt socket, even if the power stated on the type plate of the air compressor exceeds the maximum power of the socket. <

8. Take the sticker from the breakdown set → page 349 and stick it on the dash panel within the driver's field of vision.
9. Do **not** remove foreign objects (e.g. screws or nails) from the tyre.

### ⚠ WARNING

Ignoring any of the items on this important safety checklist can lead to accidents and severe injuries.

- Follow the actions in the checklist and observe the general safety procedures. <

## Sealing and inflating tyres

📖 Please refer to ⚠ at the start of the chapter on page 348.

### Sealing a tyre

- Unscrew the cap from the tyre valve.
- Use the valve core extractor → Fig. 197 ⑤ to screw the valve core out of the tyre valve. Place the core on a clean surface.
- Shake the tyre filler bottle → Fig. 197 ③ vigorously several times.
- Screw the tyre filler hose → Fig. 197 ② tightly onto the tyre filler bottle in a clock-

<sup>1)</sup> There may also be a button in the compressor instead of the air bleed screw.



wise direction. The seal on the top of the bottle is pierced when doing so.

- Remove the plug from the tyre filler hose → Fig. 197 ② and place the open end fully on the tyre valve.
- Hold the bottle upside down and fill the **entire** contents of the tyre filler bottle into the tyre.
- Remove the empty tyre filler bottle from the valve.
- Use the valve core extractor → Fig. 197 ⑤ to screw the valve core back into the tyre valve.

### Inflating the tyre

- Screw the tyre filler hose → Fig. 198 ⑤ of the air compressor tightly onto the tyre valve.
- Check that the bleed screw → Fig. 198 ④ is closed.
- Activate the vehicle's drive system.
- Insert the 12-volt plug → Fig. 198 ① into one of the vehicle's 12-volt sockets.
- Use the ON/OFF switch → Fig. 198 ② to switch on the air compressor.
- Run the air compressor until the tyre pressure has reached 2.0 – 2.5 bar (29 – 36 psi / 200 – 250 kPa). **Maximum running time: 8 minutes** → ⚠, → ⚠.
- Switch off the air compressor.
- If a pressure level of 2.0 – 2.5 bar (29 – 36 psi/200 – 250 kPa) **cannot be achieved**, unscrew the tyre filler hose from the tyre valve.
- Drive (or reverse) the vehicle approximately 10 metres so that the sealing compound is evenly distributed in the tyre.
- Screw the compressor's tyre filler hose firmly back onto the tyre valve and inflate the tyre again.
- If the required pressure still cannot be reached, the tyre is too badly damaged. The tyre cannot be sealed with the break-

down set. Do not drive on. Seek expert assistance → ⚠.

- Disconnect the air compressor and unscrew the tyre filler hose from the tyre valve.
- Drive the vehicle no faster than 80 km/h (50 mph) if a tyre pressure of 2.0 – 2.5 bar (29 – 36 psi / 200 – 250 kPa) has been reached.

### Check after driving for 10 minutes

- Park the vehicle on a firm and level surface at the next safe opportunity, e.g. a car park.
- Reconnect the tyre filler hose → Fig. 198 ⑤ and read the tyre pressure on the tyre pressure display → Fig. 198 ③
- **1.3 bar (19 psi/130 kPa) and lower:**
  - **Do not drive on!** The tyre cannot be sealed adequately with the breakdown set.
  - Seek expert assistance → ⚠.
- **1.4 bar (20 psi/140 kPa) and higher:**
  - Adjust the tyre pressure back to the correct value.
  - Resume your journey to the nearest qualified workshop. Do not exceed a maximum speed of 80 km/h (50 mph).
  - The damaged tyre should be replaced at the qualified workshop.

### ⚠ WARNING

The tyre filler hose and the air compressor can become hot during inflation.

- Protect your hands and skin from the hot components.
- Do not place the hot tyre filler hose or the hot air compressor on any inflammable materials.
- Allow the device to cool down fully before stowing.
- If the tyre will not inflate to at least 2.0 bar (29 psi/200 kPa), the tyre is too damaged. The sealant is unable to seal

the tyre. Do not drive on. Seek expert assistance.

### **WARNING**

If the defective tyre cannot be sealed adequately with the breakdown set, the tyre will lose air when driving. This can lead to tyre failure, loss of control of the vehicle, accidents, serious injuries and death.

- Do not carry on driving if the tyre pressure is 1.3 bar (19 psi/130 kPa) or lower after driving for 10 minutes.
- Seek expert assistance.

### **NOTICE**

Switch the air compressor off after a maximum of 8 minutes to avoid overheating. Let the air compressor cool down for a few minutes before switching it back on. <

# Maintenance

## Service

### Service work and digital service schedule

The **vehicle data stickers** attached to the inside cover of this owner's manual help ensure that you can have the correct Volkswagen Genuine Parts® installed in your vehicle whenever required. It also determines which type of servicing applies to your vehicle.

The vehicle data sticker confirms **when the vehicle was first registered or delivered, when the delivery inspection was carried out,** and thus the date from which your vehicle is covered by our warranty.

#### Recording the service work performed ("digital service schedule")

The service records are stored by your Volkswagen dealership or qualified workshop in a central system. This transparent documentation of the service history allows the service operations performed to be reproduced at any time. Each time you have your vehicle serviced, Volkswagen recommends asking for a printed service record, which contains all service work stored in the system.

With every service, the printout of the previous service record is replaced by a current printout.

**The digital service schedule is not available in some markets. In this case, your Volkswagen dealership will inform you about the documentation process for service work.**

#### Service work

The following information is documented in the digital service schedule by your Volkswagen dealership or qualified workshop:

- When which service was carried out.
- Whether any repairs are recommended, such as replacement of the brake pads in the near future.
- Whether you had any special requests before or during the maintenance work. Your service advisor will note these on the order.
- Which components and service fluids were changed.
- When your next service is scheduled for.

The type and scope of service work may differ from vehicle to vehicle. Information on specific work for your vehicle can be requested from a qualified workshop.



#### WARNING

Inadequate servicing, no servicing at all, or failure to adhere to service intervals can result in breakdowns, accidents and serious injury.

- Have service work carried out by an authorised Volkswagen dealership or workshop.

#### NOTICE

Volkswagen is not responsible for any vehicle damage caused by inadequate service work or the lack of availability of parts.

 Regular servicing of your vehicle not only maintains its value, it also ensures that your vehicle remains roadworthy and in working order. You should therefore have your vehicle serviced according to the Volkswagen guidelines. 

## Inspection

Service event	PR No.	Service interval
Inspection	V16	According to the service interval display <sup>a)</sup> or after 2 years at the latest.

<sup>a)</sup> In some markets, scheduled services are carried out at intervals that differ from the specified service intervals. More detailed information is available from a qualified dealership.

### Service interval display

The service interval display in the digital instrument cluster shows information about

a due inspection → page 30. If necessary, additional work that is due can then also be carried out, e.g. changing brake fluid. <

## Information on operating conditions

The service intervals and scope of service always apply to vehicles used under **normal operating conditions**.

If the vehicle is operated under **heavy-duty conditions**, some work will have to be performed before the next service is due or at shorter intervals than those specified.

**Heavy-duty conditions are, for example:**

- Use in areas with high levels of dust.
- Driving mainly in wintry conditions.

**This applies particularly to the following components (depending on the vehicle equipment):**

- Active combi-filter.
- Air Care active combi-filter.

**The service advisor at your qualified workshop will be pleased to advise you** on whether your vehicle requires more frequent work due to the conditions under which it is used.

### WARNING

Inadequate servicing, no servicing at all, or failure to adhere to service intervals can result in breakdowns, accidents or serious injury.

- Have your service work carried out by an authorised Volkswagen dealership or workshop.

### NOTICE

Volkswagen is not responsible for any vehicle damage caused by inadequate service work or the lack of availability of parts. <

## Scope of service

The scope of service includes all **maintenance work** that is necessary in order to keep your vehicle roadworthy (**depending on the operating conditions and vehicle equipment**). The maintenance work is divided into *inspection work* and *servicing work*. You can find out what work is required in detail for your vehicle:

- From your Volkswagen dealership.
- From your qualified workshop.
- In the electronic repair and workshop information system **erWin** → page 362.

### Inspection work

#### *Electrics*

- 12-volt vehicle battery: check and replace if necessary.
- Lighting: check.

- High-voltage components: check.
- Horn: check.
- Headlight setting: check.
- Service interval display: reset.

#### Engine and gearbox

- Gearbox and final drive: check.
- Cooling system: check.
- Engine: check.
- Components in the front compartment: check.

#### Running gear

- Swivel joints and track rods: check.
- Tyres: check.
- Brake system: check.
- Brake pads and brake discs: check.
- Brake fluid level: check.
- Boots: check.
- Coupling rod and stabiliser bearings: check.
- Breakdown set: check.
- Tyre pressure on all wheels: check.
- Power steering: check.
- Shock absorbers and coil springs: check.

#### Body

- Windscreen: check.
- Body: check for corrosion.
- Wiper blades: check.
- Window washer system: check.
- Underbody: check.
- Road test: perform.

#### Servicing work

In addition to the inspection work, additional servicing work will need to be carried out, **depending on the conditions and environment in which your vehicle is used and the vehicle**

**equipment.** This work is dependent on *time* and *mileage* or only *time* or *mileage*.

- Brake fluid: change.
- Active combi-filter: replace.
- Air Care active combi-filter: replace.

It is also possible to have servicing work carried out in between the displayed scheduled service events.

The scope of service is subject to change for technical reasons, e.g. continuous further development of components. Your Volkswagen dealership or qualified workshop always has the latest information about any changes. ◀

## Vehicle care

### Notes on vehicle care

Regular and expert care helps to maintain your vehicle's condition.

The longer contamination or dirt is left on the surface of vehicle components, the more difficult it can become to clean and treat them. Extended exposure may mean that it is no longer possible to remove contamination or dirt.

Volkswagen recommends using genuine care products designed especially for your vehicle.

<sup>1)</sup> Consult a qualified workshop if you have any specific questions or if vehicle parts are not listed.

### WARNING

Incorrect care and cleaning of vehicle parts can impair the safety features of the vehicle and cause serious injury.

- Vehicle parts must be cleaned according to the manufacturer's instructions.
- Always use approved or recommended cleaning products.

<sup>1)</sup> Suitable accessories are available from your Volkswagen dealership. Follow the application instructions on the packaging.

- Do not use cleaning agents that contain solvents. Solvents can cause irreparable damage to the airbag modules.
- Protect your hands and arms against parts with sharp edges, e.g. when cleaning the insides of the wheel housings.

### WARNING

If the windscreen, door windows or rear window are dirty, iced up or affected by condensation, visibility will be reduced and the risk of accidents and severe injuries will increase. This could impair the safety equipment of the vehicle.

- Drive only when you have a clear view through all windows.
- Do not treat the windscreen with water-repellent window coating agents. In unfavourable conditions, they can cause increased dazzle.

### WARNING

Care products may be toxic and hazardous. Unsuitable care products and incorrect application of care products can cause accidents, severe injuries, burns or poisoning.



- Store care products only in the closed original container.
- Observe the manufacturer's instructions.
- Keep children away from all care products.
- Use care products only outside or in well-ventilated rooms so that you do not breathe in any toxic vapours.
- Never use turpentine, nail varnish remover or other volatile fluids for vehicle care. These substances are toxic and highly flammable.

### NOTICE

Soiling with aggressive and solvent-based ingredients can cause irreparable damage to the vehicle equipment, even if left for only a short time, e.g. on seat padding or trim parts.

- Do not let contamination or dirt dry.
- Have stubborn stains removed by a qualified workshop.


## Washing the vehicle

To wash your vehicle correctly and properly, please observe the following information → , → .

### Automatic car washes

- ✓ The windows must be closed and the exterior mirrors must be folded away.
- ✓ *Vehicles with steering column lock*: If the vehicle is mechanically pulled through the car wash (wash tunnel), the steering column must not unlock → page 142.
- ✓ The windscreen wipers → page 112 and the rain and light sensor → page 114 are switched off.
- ✓ The Auto Hold function → page 178 is switched off.


Further information:

- Please observe information of the car wash operator, especially where add-on parts such as spoilers are concerned → .
- Preferably use textile car washes without brushes.
- Do not select cleaning programmes with hot wax for vehicles with decorative and protective films.
- Regularly have the bottom of the vehicle thoroughly cleaned to remove residue.

### NOTICE

Car washes that scan the contours mechanically may damage the vehicle, e.g. spoiler.

### High-pressure cleaner

- Observe information issued by the manufacturer and do not use rotating nozzles under any circumstances → .

- Use water up to a maximum temperature of +60°C (+140°F) only.
- Do not clean windows that are iced up or covered in snow with a high-pressure cleaner.
- Move the jet of water uniformly so that the nozzle is at least 50 cm (20 inches) away from the vehicle components.
- Do not apply the water jet to the same area for too long.
- Do not direct the jet of water at rubber seals or other sensitive vehicle components such as side windows, glossy strips, tyres, sensors, camera lenses, decorative and protective film.

#### Hand wash

- Clean the vehicle with a soft sponge, a cleaning glove or a cleaning brush using only light pressure. Start with the roof and work from the top to the bottom → ⓘ.

Use a shampoo for very stubborn dirt only.

#### Notes on the high-voltage system

End the charging process and completely close the charging socket before washing the vehicle.

Also observe the safety information for the high-pressure cleaner → ⚠.

#### ⚠ WARNING

The incorrect use of a high-pressure cleaner can result in damage. This can cause accidents and serious injuries.

- Never point the jet from the high-pressure cleaner straight at the orange high-voltage cables or at components belonging to the high-voltage system or the 12-volt vehicle electrical system.

#### Waxing

Waxing protects the paintwork. At the latest when water no longer clearly forms small drops and runs off the paintwork when the vehicle is *clean*, the vehicle should be protected again using a good preservative wax.

Even if a preservative wax is applied regularly in the automatic car wash, Volkswagen recommends protecting the vehicle paintwork at least twice a year using Volkswagen Genuine Hard Wax (000 096 317).

#### Polishing

Only if the paint has lost its shine and the gloss cannot be brought back by applying preservative agents is polishing necessary.

Matt-painted vehicle parts must not be polished! The surface will be irreparably damaged by polishing the paint.

#### Washing matt-painted vehicles

Clean vehicles with matt-painted surfaces by hand or in a textile car wash **without** wax preservation → ⓘ. When washing the vehicle by hand, first remove the coarse dirt with sufficient water and then wash the surface with a mild soap solution consisting of a maximum of two tablespoons of neutral soap diluted in one litre of water.

Slight soiling such as grease stains or insect residue can be removed with a special cleaner for matt paint.

#### ⓘ NOTICE

Painted parts and surfaces with a matt finish, unpainted plastic parts, headlight lenses and tail light clusters can be damaged if the vehicle is not washed correctly.

- Do not use hard or abrasive brushes.

#### ⚠ WARNING


After a car wash, the braking action may be delayed and this may extend the braking distance as the brake discs and brake pads will be wet or iced up in winter.

- Dry and de-ice the brakes by performing careful braking manoeuvres. Do not endanger any other road users when doing this.


#### ⓘ NOTICE

Improper vehicle cleaning can cause severe damage to the vehicle.

- Always follow the manufacturer's instructions.
- Do not wash the vehicle in direct sunlight.
- Never aim a water jet directly at doors or the boot lid in cold weather. The components could freeze up.

 Wash the vehicle in dedicated cleaning areas only. This prevents any waste water contaminated by oil from entering the sewage system.

## Caring for and cleaning the vehicle exterior

The following overview contains recommendations for cleaning and care of individual vehicle components → .

### Windows, glass surfaces:

Remove wax residue, e.g. from care products, using the Volkswagen Genuine Cleaning Cloth (000 096 166 A) or a suitable glass cleaner.

Use a hand brush to remove snow and ice. If you use a plastic scraper, move it in one direction only. Use the Volkswagen Genuine De-icing Agent (000 096 322) to remove ice.

**Wiper blades:** → page 293.

### Paint:

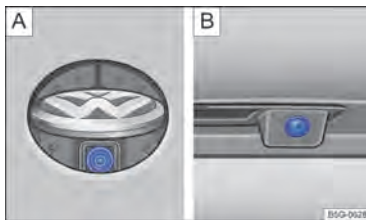
Always treat surfaces carefully in order to prevent damage to the paint coat. Use a clean, soft cloth and a mild soap solution consisting of a maximum of two tablespoons of neutral soap diluted in one litre of water or cleaning clay to remove any light dirt immediately, e.g. deposits, insect residue, or cosmetics.

Repair minor paint damage with a touch-up pen. Refer to the vehicle data sticker for the paint code → page 387. Consult a qualified workshop in the event of damage to surfaces with matt paint.

Further information:

- Flash rust deposits: moisten deposits with a soap solution. Then remove any deposits with cleaning clay.
- Corrosion: have removed by a qualified workshop.

### Sensors, camera lenses:



**Fig. 199** At the rear of the vehicle: rear view camera system in the Volkswagen badge **A** or on the handle button **B** (schematic diagram).

Clean the area in front of the sensors or camera with a soft cloth and solvent-free cleaning agent. Check where they are installed → page 7.

*On vehicles with a rear view camera in the rear Volkswagen badge → Fig. 199 **A**:*

- Depress the brake.
- Select reverse gear.
- Switch on the electronic parking brake.
- Clean the camera lens.

Clean sensitive surfaces on the rain and light sensor and the camera window on the windscreen in the same way as **windows and glass surfaces** (depending on vehicle equipment).

Remove snow with a hand brush. Do not use warm or hot water. Use the Volkswagen Genuine De-icing Agent (000 096 322) to remove ice.

### Decorative films, protective films:

Remove soiling the same way as for **paint**. Always use Volkswagen Genuine Plastic Cleaner (000 096 314) for matt decorative films.



Treat the vehicle with liquid hard wax every three months after washing and removing dust. Only use clean, soft microfibre cloths to apply the wax. **Do not use hot wax**, even in car washes.

Further information:

- Stubborn dirt: remove carefully using white spirits, and then rinse with warm water.

**Trim parts made of chrome-plated plastic, aluminium or stainless steel and tailpipes:**

Clean the surface with Volkswagen Genuine Chrome and Aluminium Care Product (000 096 319 D).

Chrome-plated trim parts can be protected using Volkswagen Genuine Hard Wax (000 096 317).

**Headlights, tail light clusters:**

Use a soft sponge soaked with a mild soap solution consisting of a maximum of two tablespoons of neutral soap diluted in one litre of water. Do not use any cleaning agents that contain alcohol or solvents.

Further information:

- Stubborn dirt: remove with Volkswagen Genuine Chrome and Aluminium Care Product (000 096 319 D).

**Wheels:**

Remove dirt and gritting salt deposits with plenty of water.

Alloy wheels: treat dirty aluminium wheels with Volkswagen Genuine Wheel Cleaner (000 096 304). Volkswagen recommends treating the wheel rims with Volkswagen Genuine Hard Wax (000 096 317) every three months.

Further information:

- Damaged protective paint coating: repair immediately with a touch-up pen. If necessary go to a qualified workshop.
- Brake dust: use Volkswagen Genuine Wheel Rim Cleaner (000 096 304).

**⚠ WARNING**

The area under the bonnet of the vehicle is a hazardous area. All work carries the risk of injury, scalding, accidents and fire.

- Before carrying out any work in the area of the bonnet, always observe the required procedures and safety precautions → page 309.
- Volkswagen recommends having the work carried out by a qualified workshop.

**ⓘ NOTICE**

Incorrect cleaning and care may cause vehicle damage.

- Always follow the manufacturer's instructions.
- Do not use excessively hard, abrasive cleaning tools.



The durability and colour of decorative and protective films may be affected by environmental influences, such as sunlight, moisture, polluted air, stone impacts, etc. Decorative films may show signs of wear and ageing after around one to three years, and protective films after two to three years. In very hot climates, decorative films may become faded within one year and protective films within two years.

**Vehicle interior cleaning and care**

The following overview contains recommendations for cleaning and care of individual vehicle components → ⓘ.

**Windows**

Clean with a glass cleaning agent and then wipe dry using a clean chamois cloth or a lint-free cloth.

### **Textiles, microfibre cloth and leatherette**

Remove any dirt with Volkswagen Genuine Interior Cleaning Agent (000 096 301). Never treat materials with leather care agents, solvents, wax polish, shoe cream, stain removers or similar substances.

Further information:

- Never use high-pressure cleaners, steam cleaners and coolant spray.
- Dirt particles adhering to surfaces: remove with a vacuum cleaner on a regular basis so that the material is not permanently damaged by abrasion.
- For greased-based soiling, use Volkswagen Genuine Interior Cleaning Agent (000 096 301), e.g. for oil. Dab off dissolved grease and colour particles with an absorbent cloth and then treat with water if necessary.
- For special soiling, use Volkswagen Genuine Interior Cleaning Agent (000 096 301), e.g. for ballpoint pen ink, nail varnish. If necessary, treat subsequently with a mild soap solution consisting of a maximum of two tablespoons of neutral soap diluted in one litre of water.

### **Natural leather**

Remove fresh contamination using a cotton cloth with a mild soap solution consisting of a maximum of two tablespoons of neutral soap diluted in one litre of water. Do not allow fluids to seep into the seams.

Treat any dried spots with Volkswagen Genuine Leather Cleaner (000 096 323).

Apply leather care agent for seating furniture regularly and each time after the leather is cleaned. If the vehicle is parked outdoors for long periods, you should cover the leather to protect it from direct sunlight.

Never treat leather with solvents, wax polish, shoe cream, stain removers or similar.

Further information:

- For grease-based soiling, e.g. oil, remove fresh stains with an absorbent cloth.

- Treat special soiling with Volkswagen Genuine Leather Cleaner (000 096 323), e.g. ballpoint pen ink, nail varnish and dried spots.

### **Plastic parts**

Use a soft, moist cloth.

If stubborn soiling cannot be removed with mild soap solution consisting of a maximum of two tablespoons of neutral soap diluted in one litre of water, use a solvent-free plastic cleaning agent if necessary, e.g. Volkswagen Genuine Plastic Cleaner (000 096 314).

### **Trim parts, trim strips made of chrome, aluminium or stainless steel**

Clean with a clean, soft cloth and mild soap solution consisting of a maximum of two tablespoons of neutral soap diluted in one litre of water in a dust-free environment.

Treat anodised surfaces with Volkswagen Genuine Chrome and Aluminium Care Product (000 096 319 D).

### **Control elements**

Remove coarse dirt and other dirt that is difficult to reach using a soft brush. Then use a clean, soft cloth with some mild soap solution consisting of a maximum of two tablespoons of neutral soap diluted in one litre of water. Do not allow liquids to enter the controls.


### **Displays and screens**

Use a Volkswagen Genuine Cleaning Cloth (000 096 166 A) with a little water, a suitable glass cleaner or LCD cleaner. Do not clean the instrument cluster display and Infotainment system screen with a dry cloth. Switch off the Infotainment system temporarily before cleaning.

### **Rubber seals**

Clean with a soft and lint-free cloth as well as plenty of water. Treat with Volkswagen Genuine Rubber Care Agent (000 096 310) on a regular basis.


### Seat belts

Carefully pull the seat belt right out and leave it out →  Remove coarse dirt with a soft brush. If necessary, clean the seat belt with a mild soap solution consisting of a maximum of two tablespoons of neutral soap diluted in one litre of water. Leave the belt fabric to dry completely and then allow it to roll up.

### Wooden trims

Clean with a soft cloth and some mild soap solution consisting of a maximum of two tablespoons of neutral soap diluted in one litre of water.

### Cleaning seat covers

If clothing that is not sufficiently colour-fast, e.g. denim which leaves stains on the seat cushion, then this is not due to the cover fabric. The seat padding may contain components for the airbag system and electrical connections. Seat padding that is damaged, incorrectly cleaned or treated, or that becomes wet, may cause damage to the vehicle electrical system or trigger a fault in the airbag system → .

Depending on the vehicle equipment, seat cushions with seat heating have electrical components and connectors that may be damaged in the event of incorrect cleaning or treatment. This can also result in damage to other parts of the vehicle electrics.

- Never use high-pressure cleaners, steam cleaners and coolant spray.
- Do not switch on the seat heating to dry the seats.
- Do not use washing paste or fine detergent solutions.
- Avoid getting the seat wet.
- In the event of uncertainty, contact a Volkswagen dealership.

### WARNING

Failure to clean the parts properly can cause damage to the seat belts, the fastenings and the belt retractor.

- Never try to modify or remove the seat belts for cleaning.
- Never clean the seat belts and their components with chemical agents.
- Do not use any caustic liquids, solvents or sharp objects.
- Protect the belt buckles against the ingress of liquids and foreign bodies.
- Let the cleaned seat belt to dry completely before allowing it to retract.

### WARNING



Incorrect care and cleaning of vehicle parts can impair the safety features of the vehicle and cause serious injury.

- Vehicle parts must be cleaned according to the manufacturer's instructions.

### NOTICE

Incorrect cleaning and care may cause vehicle damage.

- Do not use a steam cleaner, brushes or hard sponges etc. under any circumstances.
- Have stubborn stains removed by a qualified workshop.

 The signs of wear and soiling visible due to normal use are naturally more easily visible in the case of light-coloured materials in the vehicle interior. These signs of use cannot be prevented and also represent unavoidable ageing due to normal use. Please observe the corresponding care instructions. 

## Accessories, modifications, repairs and renewal of parts

### Accessories and parts

Volkswagen recommends that you seek advice from a Volkswagen dealership before purchasing accessories, replacement parts or service fluids, for example if the vehicle is to be retrofitted with accessories or if parts have to be renewed. Volkswagen dealerships can recommend accessories, parts and service fluids suitable for your requirements. They can also answer any questions you might have regarding official regulations.

Volkswagen recommends that you use only approved **Volkswagen accessories** and **Volkswagen Genuine Parts**®. These parts and accessories have been specially tested by Volkswagen for suitability, reliability and safety. And Volkswagen dealerships are qualified to install them correctly.

Although the market is constantly scrutinised, Volkswagen cannot assume responsibility for the reliability, safety and suitability of products **Volkswagen has not approved**. Volkswagen can therefore assume no responsibility for these parts, even if they have been approved by an official testing agency or are covered by an official approval certificate.

Any **retrofitted equipment** which has a direct effect on the control of the vehicle must be approved by Volkswagen for use in your vehicle and bear the **e** mark (approval symbol of the European Union). These devices include cruise control systems or electronically controlled damping systems, for example.


Any **additional electrical components** fitted that do not serve to control the vehicle itself must bear the **CE** mark (manufacturer declaration of conformity in the European Union). Such devices include refrigerator boxes, computers and ventilator fans.

### WARNING

Incorrectly performed repairs or modifications to your vehicle can impair the effectiveness of the airbags, cause faults, accidents and fatal injury.

- Never secure or position objects, e.g. telephone holders, in the deployment zone of the airbags since these objects can cause serious or fatal injuries if the airbags are triggered.

### Repairs and technical modifications

**Repairs and technical modifications must always be carried out according to Volkswagen specifications** → .

Unauthorised modifications to the electronic components or software in the vehicle may cause faults. As the electronic components are linked together in networks, these faults may indirectly affect the working of other systems. This can seriously impair vehicle safety, lead to excessive wear of components and also invalidate the type approval for the vehicle.

The Volkswagen dealership cannot be held liable for any damage caused by technical modifications and/or work performed incorrectly.

The Volkswagen dealership is not responsible for damage caused by technical modifications and/or work performed incorrectly. Such damage is not covered by the Volkswagen guarantee.

Volkswagen recommends that all repairs and technical modifications be performed by an authorised Volkswagen workshop using **Volkswagen Genuine Parts**®.

#### Volkswagen repair information

Volkswagen Service information and official Volkswagen repair information can be obtained for a fee.

### Customers in Europe, Asia, Australia, Africa, Central and South America:

Please contact a Volkswagen dealership or qualified workshop or register on the **erWin** online portal (electronic repair and workshop information):

<https://erwin.volkswagen.de>

### Customers in North America and Canada:

To order printed service information please contact:

Volkswagen Technical Literature Ordering Center

[literature.vw.com](http://literature.vw.com)

You can also register online in the **erWin** internet portal:

<https://erwin.vw.com>

### Vehicles with special auxiliary equipment or body parts

Auxiliary equipment and second stage manufacturers must ensure that the equipment and bodies (conversions) adhere to the stipulated environmental laws and regulations, particularly the EU directive 2000/53/EC concerning end-of-life vehicles and EU directive 2003/11/EC concerning the restriction on the marketing and use of certain dangerous substances and preparations.

The vehicle owner must keep all assembly documentation for these conversions and pass it on to the scrapping company upon vehicle handover if the vehicle is scrapped. This is intended to facilitate environmentally responsible disposal for all vehicles, including refitted vehicles.

### Windscreen repairs

To function properly, some items of equipment require an electrical or electronic module, which is located on the inside of the windscreen near the interior mirror. If the windscreen has been damaged in the viewing field of the electrical or electronic module, e.g. by stone impact, the windscreen must be replaced. Repairing the crack can lead to malfunction or functional faults in the equipment.

After changing the windscreen, the camera and sensors must be adjusted and calibrated by a qualified workshop.

### Impairment or damage to sensors and cameras

Incorrectly performed repairs, structural changes to the vehicle, e.g. lowering the suspension, retrofitted add-on parts or changes to the trim can lead to sensors and cameras being displaced or damaged. This can also be caused by collisions when parking, or also even by minor damage such as stone impacts on the windscreen.

The area in front of and around the sensors and cameras must not be covered by stickers, additional headlights, trim frames for number plates or similar. Observe the position of sensors and cameras on the vehicle → page 7.

Failure to observe this may impair important functions of driver assist systems and damage the vehicle.

Repairs and structural modifications should be carried out by a qualified workshop.

Further information:

- Repainting and paint touch-ups in the area around the sensors may impair the function of the system in question.
- On some vehicle models, the Volkswagen badge can impair the view of the radar sensor in the front area. You should therefore operate the vehicle only with the original Volkswagen badge or a badge approved by Volkswagen.

### WARNING

Incorrect repairs and modifications can cause functional problems and damage to the vehicle and impair the effectiveness of the driver assist systems. This can result in accidents and severe injuries.

- Have repairs and modifications to your vehicle carried out only by a qualified workshop.

## WARNING

Unsuitable spare parts and accessories, incorrectly carried out work, modifications and repairs can lead to damage to the vehicle and cause accidents and serious injuries.


- Volkswagen strongly recommends that you use only approved Volkswagen accessories and Volkswagen Genuine Parts®. These parts and accessories have been specially tested by Volkswagen for suitability, reliability and safety.
- Have repairs and modifications to your vehicle carried out only by a qualified workshop. Qualified workshops have the necessary tools, diagnostic equipment, repair information and qualified personnel.
- Never fit parts to your vehicle that differ in their design or characteristics from the factory-fitted parts.
- Never secure or position objects, e.g. telephone holders, in the deployment zone of the airbags since these objects can cause serious or fatal injuries if the airbags are triggered.
- Use only wheel rim/tyre combinations that have been approved by Volkswagen for your vehicle type.

system may be damaged. The consequence may be that, in the event of an accident, the airbag inflates incorrectly or does not inflate at all.

Regulations must be observed to ensure that the effectiveness of the airbags is not reduced and that removed parts do not cause any injuries or environmental pollution. Qualified workshops are familiar with these requirements.

Any modifications to the vehicle's suspension could prevent the airbag system from working properly during a collision. For example, using wheel rim/tyre combinations that have not been approved by Volkswagen, lowering the vehicle or making modifications to the suspension rate including work on the springs, struts and shock absorbers etc., could change the forces that are measured by the airbag sensors and sent to the electronic control unit. Some changes to the suspension could cause the forces measured by the sensors to increase, for example. This can lead to the airbag system being triggered in collision scenarios where it normally would not be triggered if modifications to the suspension had not been made. Other modifications can cause the forces measured by the sensors to decrease, therefore preventing the airbag system from being triggered when it should have been.

## Repairs and faults in the airbag system

**Repairs and technical modifications must always be carried out according to Volkswagen specifications → **

Modifications and repairs to the front bumper, the doors, the front seats, the headliner, or the bodywork should be carried out by a qualified workshop. System components and airbag system sensors might be fitted on these vehicle components.

If you work on the airbag system or remove and install parts of the system when performing other repair work, parts of the airbag

## WARNING

Incorrect repairs and modifications can cause function problems and damage to the vehicle and impair the effectiveness of the airbag system. This can result in accidents and serious or even fatal injuries.

- Have repairs and modifications to your vehicle carried out only by a qualified workshop.
- Airbag modules cannot be repaired. They must be replaced.
- Never install recycled airbag components or components that have been taken from end-of-life vehicles in your vehicle.


## WARNING

Modifications to the vehicle's suspension, including the use of unsuitable tyre/rim combinations, can cause the airbag system to work differently and increase the risk of serious or fatal injuries in the event of an accident.

- Never install components in the suspension system which do not have the same characteristics as the original factory-fitted components.
- Never use wheel rim/tyre combinations that have not been approved by Volkswagen.


## Mobile communication in the vehicle

### Electromagnetic radiation

If a mobile telephone or radio device is used without being connected to the external aerial, the electromagnetic radiation will not be optimally directed to the outside of the vehicle. Increased levels of radiation in the vehicle interior may occur in areas with poor signal in particular, for instance in rural areas. This could constitute a health hazard → .

Depending on the vehicle's equipment level, a suitable mobile phone interface can be used to connect the mobile telephone to the external aerial. The connection quality is improved and the range is increased.

### Using the telephone

Many countries require a hands-free system to be used when using a telephone inside the vehicle, e.g. via a Bluetooth<sup>®</sup> connection. Before use, secure the mobile telephone to a suitable bracket →  or stow it in a storage compartment so that it cannot slip around, e.g. in the centre console.

### Two-way radios

Observe legal requirements and the manufacturer's operating instructions for operat-

ing two-way radios. The retrofitting of two-way radios requires authorisation.

Contact your Volkswagen dealership for further information on installing a two-way radio.

## WARNING

Mobile telephones which are loosely placed in the vehicle or not properly secured could be flung through the interior and cause injuries during a sudden driving or braking manoeuvre, or in the event of an accident.

- Secure a mobile telephone and accessories outside the deployment zone of the airbags, or stow them safely.

## WARNING

If mobile telephones or two-way radios that are not connected to an external aerial are used, electromagnetic radiation in the vehicle could exceed limit values and thus be a health hazard for drivers and other vehicle occupants. This also applies to external aerials which have not been correctly installed.

- Keep a distance of at least 20 cm (8 in) between a device's aerial and an active medical implant, such as a pacemaker.
- Do not carry device which is operationally ready close to or directly above an active medical implant, e.g. in a breast pocket.
- Switch off the device immediately if you suspect it may be interfering with an active medical implant or any other medical device.

## Customer information

### Warranty

#### Volkswagen dealership warranty

Volkswagen dealerships guarantee that the vehicles they sell are free from defects. The dealerships are also responsible for handling warranty claims.

Please refer to your sales contract or contact your Volkswagen dealership for details of the warranty and guarantee conditions.

#### Warranty for the paintwork and body

Volkswagen dealerships provide a warranty on the paintwork and body of all vehicles purchased from them.

In addition to the warranty conditions for factory-new Volkswagen vehicles (as detailed in the purchase contract), the Volkswagen dealer guarantees that the body of any vehicles it sells will not be affected by paint imperfections or corrosion perforation for a specified period:

- a three-year warranty on paint imperfections and
- a twelve-year corrosion perforation warranty. Here, corrosion perforation refers to rust forming on the inside (cavity) of the body and causing holes in the sheet metal.
- *Applies only to the USA:* a seven-year corrosion perforation warranty. Here, corrosion perforation refers to rust forming on the inside (cavity) of the body and causing holes in the sheet metal.

If such damage occurs nevertheless, it will be repaired free of charge for parts and labour by any Volkswagen dealership.

*The warranty does not cover the following:*

- Damage caused by external influence or insufficient care.
- Imperfections on the body or paintwork which are not repaired promptly according to manufacturer specifications.
- Corrosion perforation that is directly related to body repairs not being carried out according to manufacturer specifications.

If the body is repaired or painted, your Volkswagen dealership will confirm your warranty against corrosion perforation for the repaired area.

### Guarantee for high-voltage batteries in electric and hybrid vehicles

In addition to the above warranties and guarantees, Volkswagen dealerships also fulfil the warranty for high-voltage batteries that exists in many countries.

Please refer to your sales contract or contact your Volkswagen dealership for details of the warranty conditions.

### Data storage and services

Valid in EU countries where the General Data Protection Regulation of the European Union is effective:

#### Data processing in the vehicle

Your vehicle is fitted with electronic control units. Control units process data that they receive from vehicle sensors, generate themselves or exchange with each other, for example. Some control units are required for the safe functioning of your vehicle, others support you when driving (driver assist systems), others enable convenience or Infotainment functions.



### Personal reference

Each vehicle is given a unique vehicle identification number. In Germany, for example, this vehicle identification number can be traced back to the current and former owners of the vehicle using information provided by the Federal Motor Transport Authority (Kraftfahrtbundesamt ). There are also other ways of tracing the vehicle to the owner or driver, via data collected for the vehicle e.g. the registration number.

The data generated or processed by control units may therefore be personal data or under certain conditions is personal data. Depending on the vehicle data available, it may be possible to draw conclusions, e.g. about your driving behaviour, your location or your route or your usage behaviour.

### Your rights regarding data protection

In accordance with applicable data protection law, you have certain rights vis-à-vis Volkswagen when your personal data is processed.

Accordingly, you are entitled to receive comprehensive information free of charge from Volkswagen and third parties, e.g. breakdown services or workshops used and providers of online services in the vehicle if they have stored your personal data. You are entitled to request information concerning what personal data and for what purpose it is stored as well as where the data originates from. Your right to information also includes the transfer of data to other bodies.

Further information on your legal rights, e.g. your right to have your data deleted or corrected, can be found in the applicable data protection information on the Volkswagen website including the contact details and a reference to the data protection officer.

Data that is only stored locally in the vehicle can be read out for a fee with expert assistance, e.g. in a workshop.

### Legal requirements for the disclosure of data

If legal requirements exist, Volkswagen is obliged to disclose data stored at Volkswagen to the extent required to government agen-

cies in individual cases, e.g. as part of a police investigation of a criminal offence.

Within the framework of applicable law, government agencies are also authorised to read data from vehicles themselves in individual cases. In the event of an accident, information can be read from the airbag control unit to help clarify the situation.

### Operating data in the vehicle

Control units process data to operate the vehicle.

These include, for example:

- Vehicle status information, e.g. speed, deceleration, lateral acceleration, number of wheel revolutions and display of closed seat belts.
- Ambient conditions, e.g. temperature, rain and light sensor, adaptive cruise control.

As a rule, this data is volatile and is not stored beyond the operating time and is only processed in the vehicle itself. Control units often contain data storage devices. These are used to document information regarding the vehicle status, component load levels, maintenance requirements, technical events and faults on a temporary or permanent basis.


Depending on the technical equipment, the following data is stored:

- Operating states of system components, e.g. filling levels, tyre pressure, status of the vehicle battery.
- Faults or malfunctions in important system components, e.g. lights, brakes.
- System reactions to specific driving situations, e.g. triggering of an airbag, intervention of the stability control systems.
- Information on events which damaged the vehicle.

In special cases, e.g. when the vehicle has detected a malfunction, it may be necessary to store data that would normally only be volatile.

If you make use of services, e.g. repairs or maintenance work, the stored operating data can, if necessary, be read and used together

with the vehicle identification number. The data can be read from the vehicle by employees of the service network, e.g. workshops, or third parties, e.g. breakdown services. The same applies to warranty cases and quality assurance measures.

The data is read using the legally required OBD interface ("On Board Diagnosis") in the vehicle → . The operating data that is read documents the technical status of the vehicle or individual components thereof and provides support with fault diagnosis, compliance with warranty obligations and quality improvement. This data, in particular information on component load-levels, technical events, operating errors and other faults, is transmitted to Volkswagen together with the vehicle identification number if necessary. Furthermore, the manufacturer is liable for the product. Here too, Volkswagen uses operating data from vehicles for product recalls, for example. This data can also be used to check the customer's warranty and guarantee claims.

Fault memories in the vehicle can be reset by an authorised workshop or at your request as part of repair or service work.

The event memory should only be read and reset by a qualified workshop. Additional information on the stored data is available from qualified workshops.

After a fault has been rectified, the information in the memory relating to the fault is deleted. Other memory content is overwritten on an ongoing basis.

### Reprogramming control units

All data for the control of components is stored in the control units. Some convenience functions, such as convenience turn signal, single door unlocking and displays, can be reprogrammed using special workshop equipment. If the convenience functions are reprogrammed, the specifications and descriptions in this owner's manual will no longer match the original functions. Volkswagen recommends having any reprogramming entered into the digital service schedule by

a Volkswagen dealership or qualified workshop.

Information about possible reprogramming can be obtained from the Volkswagen dealership.

### Infotainment functions

Depending on the equipment installed, you may be able to store your own data in the vehicle's Infotainment functions.

Depending on the equipment in the vehicle, this includes, for example:

- Media files for playback of music, films or photos in an Infotainment system.
- Address book data for use with a hands-free system or navigation system.
- Navigation destinations entered.
- Data on the use of online services.

This data can be stored locally in the vehicle or located on a device that you have connected to the vehicle, e.g. mobile device, USB stick or MP3 player. If this data is stored in the vehicle, you can delete it at any time.

This data is transmitted to third parties only at your request, in particular in relation to the use of online services and in accordance with your personal settings.

### Integration of mobile devices

If your vehicle contains the necessary equipment, you can connect your mobile device or any other mobile end device to your vehicle so that you can control this device via the controls integrated in the vehicle when the corresponding functions are available. For example, images and sound from the mobile device can be outputted via the Infotainment system. At the same time, certain information is sent to your mobile device. This includes location data and further general vehicle information, depending on the type of integration. For more details, refer to the information about display of apps in the Infotainment system.

This enables selected apps on the mobile device to be used in the vehicle, e.g. navigation or music player. The mobile device and vehi-

cle do not interact in any other ways than those described here, in particular the device does not actively access vehicle data. The type of further data processing depends on the app provider. The settings that you can adjust here depend on the app in question and the operating system on your mobile device.

### Online services

If your vehicle is equipped with a connection to a mobile network, your vehicle will be able to exchange data with other systems. The vehicle can be connected to a mobile network using a transmitter and receiver unit in the vehicle or using your own mobile device. This mobile network connection enables you to use online functions. This includes online services and apps provided by Volkswagen or other third-party providers.

### Manufacturer services

In the case of Volkswagen online services, Volkswagen describes the respective functions in a suitable place, e.g. in a separate service description or on an Internet page, and the associated privacy information is provided. Personal data may be required in order to provide online services. For this, data is exchanged over a secure connection, e.g. using the designated IT systems of the manufacturer. Any collection, processing and use of personal data that goes beyond the provision of the service takes place exclusively according to legal regulations, contractual agreements or the necessary permission.

You can activate and deactivate the services and functions, some of which are subject to a fee and in some cases also disable the vehicle's entire data connection. This does not apply to any functions and services required by law, e.g. emergency call systems.

### Third-party services

If you are able to use online services provided by a party other than the manufacturer, these services are the sole responsibility of the provider in question and are subject to this provider's data protection policy and terms and conditions of use. Volkswagen has no influ-

ence over the content exchanged as part of these services.

Please refer to the provider in question for information about the type, scope and purpose of the collection and use of personal data related to third-party services.

### WARNING

Incorrect use of the diagnostic interface can cause malfunctions, which can result in accidents and serious injuries.

- Never read the event memory yourself using the diagnostic interface.
- The event memory should be read only by a qualified workshop using the diagnostic interface. Volkswagen recommends using a Volkswagen dealership for this purpose.

## Event data recorder

This vehicle is equipped with an event data recorder. The main task of an event data recorder is to record data in particular accident scenarios or situations which are similar to an accident, e.g. when the airbags are triggered or when there is a collision with an obstacle on the road. These data help in analysis of how a vehicle system behaved in these situations. The event data recorder records data relating to driving dynamics and the restraint system for a short period of ten seconds or less. This information includes, for example:

- how various systems in your vehicle have functioned.
- whether the seat belts of the driver and front passenger were fastened.
- the extent to which the driver pressed the brake or accelerator pedal.
- how fast the vehicle was travelling.

These data help to obtain a better understanding of the circumstances in the situations where accidents and injuries have occurred.

Data from driver assist systems are also recorded. In addition to information about whether the systems were switched on or off, available only to a restricted extent or inactive, it is also possible to determine whether these functions steered, accelerated or braked the vehicle in the above-described situations. Depending on the vehicle equipment, these systems include the following:

- adaptive cruise control.
- lane keeping system.
- Park Assist.
- emergency braking function.

The data of the event data recorder are recorded only if a particular situation occurs which is similar to an accident. No recordings occur under normal driving conditions. Audio or video data from the vehicle interior or vehicle surroundings are not stored. Personal data such as name, gender, age or accident location are also not recorded at any time. However, third parties such as law enforcement agencies can use appropriate means to link the content of the event data recorder with other sources of data and thus establish a reference to persons as part of an accident investigation.

In order to read the data in the event data recorder you need the necessary special equipment, a connection to the legally required diagnostic interface (on-board diagnosis) and the ignition must be switched on.

Volkswagen will not access, read or process data from the event data recorder unless the vehicle owner (or lessee in the case of leasing) grants their permission. Exceptions to this are contractual or legal provisions.

Due to its legal product monitoring obligations, Volkswagen is entitled to use the data for field monitoring and also for research purposes and quality improvements. For research purposes, Volkswagen makes the data available to third parties in anonymous form, in other words without any reference to the individual vehicle, vehicle owner or lessee. <

## Information stickers and plates

Stickers and plates showing important information for vehicle operation are factory-fitted in the bonnet space and on certain vehicle parts.

- Never remove stickers and plates or render them illegible.
- If vehicle parts bearing stickers or plates are removed from the vehicle, replacement stickers or plates with the same information must be applied properly to the new parts by the qualified workshop.

### Safety certificate

There is a safety certificate on the door pillar of the driver door which states that all necessary safety standards and specifications from the transport safety authorities of the particular country were met at the time of production. The month and year of production and the vehicle identification number may also be listed. Observe notes in the owner's manual.

### High-voltage warning sticker

Stickers with warnings about the high voltage in the vehicle electrical system are affixed in the vehicle front end and on high-voltage components, including the high-voltage battery → page 274.

#### WARNING

Handling the vehicle incorrectly will increase the risk of accident and injuries.

- Observe legal requirements.
- Observe the owner's manual.

#### NOTICE

Handling the vehicle incorrectly could lead to the vehicle becoming damaged.

- Observe legal requirements.
- Carry out servicing work in accordance with the specifications. <

## Fluids in the air conditioning system

### Refrigerant in the air conditioning system

The sticker in the bonnet space contains information regarding the type and quantity of refrigerant used in the vehicle's air conditioning system. The sticker is located at the front of the bonnet space, close to the refrigerant filler neck.



Warning: the air conditioning system must always be serviced by trained specialists.



Type of refrigerant.



Type of refrigerant oil.



See workshop information (available only for Volkswagen dealerships).



The air conditioning system must always be serviced by trained specialists.



Flammable refrigerant.



Make sure you dispose of all components correctly and never install components taken from older vehicles or recycling facilities into the vehicle.

### Refrigerant oil in the air conditioning system

The air conditioning system is filled with a refrigerant oil. The label on the air conditioning compressor states the type and amount of refrigerant oil used → page 362.

#### **WARNING**


In order to ensure safe and risk-free operation, always have the air conditioning system serviced by trained specialists.

#### **NOTICE**

- Never repair the air conditioning system's evaporator using spare parts taken from older vehicles or recycling facilities, or other such spare parts.
- *USA and Canada:* Spare parts for the evaporator of the air-conditioning system must be certified and marked in accordance with SAE standards J2842 HFO-1234y and R744.
- *USA and Canada:* The air conditioning system must only be serviced by qualified specialist staff instructed according to SAE standard J2845 and certified according to SAE standard J2911. <

## Infotainment system and antennas

The aerials for the Infotainment system are installed at different points in the vehicle:

- On the windscreen between the glass layers.
- On the rear window and side windows with a printed aerial structure → .

#### **NOTICE**

The printed aerial structure on the rear window and side windows can be damaged by corrosive or acidic substances or if hard objects rub against the windows.

- Do not affix any stickers in the area of the rear window and side windows.
- Never clean the area of the aerial structure with corrosive or acidic agents. <

## Component protection

Some electronic components and control units are fitted with component protection as standard, e.g. the Infotainment system.

The component protection permits a qualified workshop to legitimately install or replace components and control units.

The component protection prevents the full operation of factory-supplied components outside the vehicle in the following situations:

- Installation in other vehicles, e.g. after theft.
- Operation of components outside the vehicle.

If a text message about component protection appears in the display of the instrument cluster or the screen of the Infotainment system, go to a qualified workshop. <


## Information in accordance with the EU Chemicals Regulation REACH

In accordance with the European regulations on chemicals, known as REACH, Volkswagen would like to inform you about the substances that may be found in your vehicle.

You can access this information online using your vehicle identification number → page 387:

<https://reachinfo.volkswagen.com>

## Disposal of used batteries and electronic devices

Vehicle keys, radio remote controls and used batteries contained in them must not be disposed of with household waste. This is indicated by the symbol .

- Dispose of electronic devices and batteries at a collection point in accordance with local regulations.
- Consult a Volkswagen dealership for further information.



*USA and Canada:* Batteries for vehicle keys and remote controls can contain perchlorate. For correct handling of this substance, observe the information on the website <http://www.dtsc.ca.gov/hazardouswaste/perchlorate>. Observe all legal requirements for handling and disposal of batteries. Volkswagen recommends having replacement and disposal of these batteries performed by a Volkswagen dealership or a qualified workshop. <

## Declaration of conformity

The respective manufacturers declare herewith that the following products conform, at the time of vehicle production, with the basic requirements and other relevant laws and regulations, including FCC Part 15.19, FCC Part 15.21 and RSS-Gen Issue 1:

### Radio-based equipment

- Electronic immobiliser.
- Vehicle key.
- Keyless locking and starting system Keyless Access. <
- Adaptive Cruise Control (ACC).
- Autonomous Emergency Braking (Front Assist) incl. City Emergency Braking System.
- Lane change system (Side Assist).

- Pedestrian Monitoring.
- Emergency Assist.
- Driving assistant (Travel Assist).

#### Electrical equipment

- 12-volt socket.
- Depending on the vehicle equipment and country, additional sockets with a voltage of 100 to 230 volts → page 193.

## Third party copyright law information

<http://www.volkswagen.com/softwareinfo>

Some of the products installed in the vehicle contain software components for which Open Source licences are required.

A list of the Open Source software components used including information on copyright laws as well as the respective Open Source licence conditions and the corresponding licence text is available via the aforementioned website. The source code of certain Open Source software components can be requested from the manufacturer of the vehicle. The manufacturer will provide you with the source code according to the respective licence conditions, whereby you will only be charged with the cost of making it available (for example, costs for the data storage device and postage and packing). You can find the required information at the aforementioned website.

## Returning and scrapping end-of-life vehicles

### Returning end-of-life vehicles

Volkswagen has already made provision for your vehicle to be recycled in an environmentally responsible way. Once the vehicle has been returned, a certificate of destruction will be issued to show that the vehicle has

been disposed of correctly and in an environmentally responsible way.

End-of-life vehicles can be returned free of charge, provided that national legislation is complied with.

Further information on return and recycling of end-of-life vehicles can be obtained from a Volkswagen dealership.

### ◀ Scrapping

The relevant safety requirements must be observed when scrapping the vehicle or its individual components, e.g. the airbag system and belt tensioners. Qualified workshops are familiar with these requirements. ▶

## Information about vehicles with N1 approval (light commercial vehicle)

Please observe the following for vehicles used to transport goods with a maximum permitted weight of up to 3.5 t (N1 approval in Europe):

### Variants and number of seats

There are a number of designs for N1 vehicles based on a Volkswagen passenger car. The number of seats may be restricted to two or four.

*Vehicles with two seats:* there is no floor covering in the rear of the vehicle interior because there is no rear bench seat → ▲. ▶

*Vehicles with four seats:* the centre seat on the rear bench seat **cannot be used** → ▲.

### Transporting children safely

As in vehicles with passenger car approval (M1), approved child restraint systems can be used on the seats → page 57.

### Trailer towing

If the vehicle is approved for towing a trailer, observe any local regulations for driving with a trailer and using a towing bracket.

If the vehicle exceeds the gross vehicle weight rating or the rear axle load, the vehicle speed must not exceed 80 km/h when towing a trailer. This also applies to countries where higher speeds are permitted. Observe local speed limits. These may be lower for vehicles with trailers than for vehicles without trailers.

Any permitted excess loads for the vehicle are entered in the vehicle documents. If no excess load has been entered, it is possible to drive up to 100 km/h, although local regulations must be observed.

#### Technical data

Technical data can be found in the vehicle documents.

#### WARNING

Risk of injury and electric shock from exposed wires.

- Ensure the luggage compartment trim is installed upon or before delivery, so that the cables in the rear of the vehicle are covered up when using the vehicle.

#### WARNING

Risk of severe injuries due to persons being transported incorrectly.

- Never transport adults or children in the middle of the rear bench seat.
- The lack of restraint systems such as seat belt and head restraint can result in serious or fatal injury in the event of an accident.

#### WARNING

Risk of severe and fatal injuries.

- Do not travel with people in the luggage compartment.
- Observe the safety notes and information regarding the luggage compartment and transporting items → page 254.

## Declaration of conformity for radio systems in Europe

### Simplified declaration of conformity

Your vehicle is equipped with various radio systems. The manufacturers of these radio systems declare that this equipment complies with Directive 2014/53/EU where required by law.

The complete text of the EU declaration of conformity is available at the following internet address:

[www.volkswagen.com/generalinfo](http://www.volkswagen.com/generalinfo)



#### Ukraine

Your vehicle is equipped with various radio systems. The manufacturers of these radio systems declare that this equipment complies with Directive TR-355 where required by law.

The complete text of the declaration of conformity is available at the following internet address:

[www.volkswagen.com/generalinfo](http://www.volkswagen.com/generalinfo)



### Manufacturers' addresses

For components that, due to their size or nature, cannot be provided with a sticker, the respective manufacturers' addresses as required by law are listed here:

#### Door opening lever with NFC wireless technology

HELLA GmbH & Co. KGaA

Rixbecker Straße 75

59552 Lippstadt



GERMANY

**Radio remote control (auxiliary heater), auxiliary heating (transmitter/receiver unit)**

Digades GmbH

Äußere Weberstr. 20

02763 Zittau

GERMANY

Webasto Thermo & Comfort SE

Friedrichshafener Str. 9

82205 Gilching

GERMANY

**Tyre pressure sensors**

HUF Baolong Electronics Bretten GmbH

Gewerbestraße 40

75015 Bretten

GERMANY

**ID. Cockpit**

LG Electronics European Shared Service Center

B.V. Krijgsman 1

1186 DM Amstelveen

The Netherlands

## Mapping tables

The mapping tables are designed to help you link the device name used in a declaration of conformity with the vehicle equipment and terms used in the manuals contained the vehicle wallet.

**Safety**

This section contains the certificate numbers of the following components:

- *Garage door opener, Keyless Access, remote control key (vehicle), instrument cluster, ID. Cockpit, electronic immobiliser.*

ADHL5D, BNF\_HL, BNF\_LL, DTCO 13B1, DoC 0001 mobile key\_DFR, EFAS-4.10, EHL2, eNSF, EZS-VW-Touareg, FS09,

FS12A, FS12P, FS12PM, FS14, FS19, FS125C, FS1744, FS1744M, FS94, G09CO4 Key, Kessy MQB-A, Kessy MQB-B B, Kessy MQB-B H, Kessy PQ35, Kessy PQ35GP, Kessy MQB37W, Kombiinstrument 1, Kombiinstrument 2, Kombiinstrument 3, LCW05-VWE1, LCW05-VWE5, LCW05-SEE6, NSF\_HL, NSF\_LL1, NSF\_LL3, RSB19, VWTOUA PKETOUA, VWTOUA RKETOUA, 2017-02-EU-LF\_IC\_IM, Immobilizer integrated in dashboard module instrument cluster, 17101001, 17101002, 17101010, 17101021, 17101022, 17101023, 17101031, 17101032, 17101033, 17101034, 17101041, 17101042, 17101043, 17101051, 17101052, 17101053, 17101054, 17101055, 17101056, 17101057, 17101071, 17101072, 18020501, 18020531, 18020532, 18020533, 18020534, 2017-02-EULF\_IC\_IM, 3G0.837.205, 5ZA 010 176.

**Air conditioning**

This section contains the certificate numbers of the following components:

- *Radio remote control (auxiliary heater), auxiliary heater (transmitter/receiver unit).*

EasyStart R, EasyStart R (22 1000 32 95 00, 22 1000 34 72 00), STH VW - 50000884, Sender STH VW - 50000886, Telestart, 50000864 D208L VW, 9019510C / Receiver of aux heater 869 MHz, 9019747B / Remote control of aux heater 868 MHz,

**Tyres**

This section contains the certificate numbers of the following components:

- *Tyre inflation pressure sensors.*

AG2FW4, TSSRE4Dg, TSSRE4Uf, TSSSG4G5, TSSSG4G5b.

**Control unit**

This section contains the certificate numbers of the following components:

- *Central control unit, door control unit, door opening lever with NFC radio technology, mobile key service card, wireless charging function.*

BC-Module, BCM PQ26 ROW (502N1xF0x), BCMevo, BCMevoC, BCM2, BCM2R, BR11, HUF71110, KGF-Max, Mobile Key 4K0.959.754.xx, NFCTGS, RXI-35-433-DC, WCH-185, WCH-186, 3G0.837.205, 3G0.837.206, 5WK50248, 5WK50254, 5WK50474.

**Driver assist systems**

This section contains the certificate numbers of the following components:

11A012720AB

- Radar sensors for assistance systems, Car2X communication.

ARS4-B, ARS5-B, BSD 3.0, FR5CEPC, LCA 2.0A, LRR3, LRR3 Master & Slave, LRR4, LRR4R, MRRe14FCR, MRRe-vo14F, MRR1Plus, MRR1Rear, RSB19, RS4, R3TR.

### Infotainment and online communication

This section contains the certificate numbers of the following components:

- Infotainment system, Bluetooth, Wi-Fi hotspot, mobile phone interface, OCU, Car-Net "Security & Service", Car-Net "e-Remote".

ALPS UGZZF-102B, ALPS UGZZF-202B, A109, A473/A476/A750, A475/A754, A486/A449/A493/183, A580/A270, Data-Plug, HT-5, HT-6, HT-6d, HT-6e, L40VW2, L53VW2, L56VW2, L62VW2, L69VW2, L73VW2, L77VW2, MEB ICAS3, MIB Global Entry/Standard, MIB 2 Standard ZR, MIB Standard 2 – PQ +/-NAV with BT, MIB Standard 2 – PQ +/-NAV with BT and WLAN, MIB Standard 2 – ZR with BT, MIB Standard 2 – ZR +/-Nav with BT, MIB Standard 2 – ZR +/-Nav mit BT and WLAN, MIB2 Entry, MIB2 Main-Unit, MIB2STD, MIB2STD Nav, MIB 2 Standard PQ, MIB 2 Standard ZR, MIB3 0l, MMI3G, MMI3G RU, New Radio Ultra Low SBT, New Radio Ultra Low SBB, RRVW401\*, RRVW402\*, RRVW402B, TLAHW3IU-E, TLAHW3IU-W, TLVHM3IU-E, TLVHM3IU-W, TLVHW3IU-E, TLVHW3IU-W, TLVLM3IU-E, TLVLM3IU-R, TLVLW3IU-R, TUVMO2IU-C, TUVMO2IU-E, TUVMO3IU-C, TUVMO3IU-E, TLVHE4IU-E, TLVHE4IU-R, 7C0.035.153, 7C0.035.153.A, 7LA.035.153.A.

### Aerials

This section contains the certificate numbers of the following components:

- Aerials, aerial amplifier, connection to the external aerial.

DSRC CAN Module / EFAS-4 DU(200046-8)

CSA-1, LTE-MBC-EU, LTE-MBC-EU2, MIB IW G2 AM/FM/TV, MIB IW G2 FM/DAB, UMTS/GSM-MMC, UMTS/GSM-MMC-AG2, UMTS/GSM-MMC-AG3, 3789.01, 920 301 A, 920 611 A

1K8.035.552, 1K8.035.552.C, 1K8.035.552.F, 1S0.035.577.A, 10A.035.577.A, 10A.035.577.B, 10A.035.577.C, 10A.035.577.D, 11A.035.577.A, 11A.035.577.B, 11A.035.577.C, 11A.035.577.D, 11A.035.577.F, 11A.035.577.M, 11E.035.577.A, 11E.035.577.B, 11E.035.577.C, 11E.035.577.D, 2GA.035.577, 2GA.035.577.A, 2GA.035.577.B, 2GC.035.577, 2GC.035.577.A,

2GC.035.577.S, 2GM.035.577.A, 2GO.035.577.A, 2K5.035.525.AB, 2K5.035.525.AC, 2K5.035.525.AD, 2K5.035.525.AE, 2K5.035.525.L, 2K5.035.525.M, 2K5.035.525.Q, 2K5.035.525.T, 2K5.035.526.AA, 2K5.035.526.AB, 2K5.035.526.AC, 2K5.035.526.AD, 2K5.035.526.AE, 2K5.035.526.AF, 2K5.035.526.L, 2K5.035.526.M, 2K5.035.526.Q, 2K5.035.526.T, 2K5.035.532.Q, 2K5.035.532.R, 2K5.035.532.S, 2K5.035.540.A, 3C0.035.507.AA, 3C0.035.507.N, 3C0.035.507.P, 3G0.980.611, 3G5.035.577, 3G5.035.577.A, 3G5.035.577.B, 3G5.035.577.G, 3G5.035.577.H, 3G5.035.577.J, 3G5.035.577.K, 3G7.035.577.A, 3G7.035.577.D, 3G8.035.577, 3G8.035.577.A, 3G8.035.577.B, 3G8.035.577.E, 3G8.035.577.F, 3G8.035.577.G, 3G8.035.577.H, 3G8.035.577.J, 3G8.035.577.K, 3G9.035.577, 3G9.035.577.A, 3G9.035.577.B, 3G9.035.577.C, 3G9.035.577.H, 3G9.035.577.J, 3G9.035.577.K, 3V5.035.577, 3V5.035.577.A, 3V5.035.577.B, 3V5.035.577.F, 3789.01, 4G5.035.225.B, 4G8.035.225.B, 4G9.035.225.B, 4N0.035.503.AB, 4N0.035.503.AC, 4N0.035.503.AG, 4N0.035.503.AF, 4N0.035.503.E, 4N0.035.503.F, 4N0.035.503.J, 4N0.035.503.L, 4N0.035.503.M, 4N0.035.503.Q, 450.035.225.A, 450.035.225.D.

5C3.035.552, 5C3.035.552.A, 5C3.035.552.B, 5C5.035.552, 5C5.035.552.A, 5C5.035.552.B, 5E5.035.577.A, 5E5.035.577.B, 5E6.035.577, 5E6.035.577.A, 5E6.035.577.B, 5E7.035.577, 5E7.035.577.A, 5E7.035.577.B, 5F4.035.225, 5F4.035.225.A, 5F4.035.225.B, 5G6.035.577, 5G6.035.577.A, 5G6.035.577.B, 5G6.035.577.E, 5G6.035.577.F, 5G9.035.577, 5G9.035.577.A, 5G9.035.577.B, 5G9.035.577.G, 5G9.035.577.H, 5G9.035.577.J, 5G9.035.577.K, 5H0.035.510, 5H6.035.577, 5H6.035.577.A, 5H6.035.577.B, 5H6.035.577.T, 5L0.035.501.A, 5LE.035.577.A, 5LG.035.577.A, 5NA.035.577, 5NA.035.577.A, 5NA.035.577.B, 5NA.035.577.E, 5NA.035.577.F, 5QD.035.507.AG, 5QD.035.507.AH, 5QG.035.507.AG, 5QG.035.507.AH, 5QO.035.507.A, 5QO.035.507.AG, 5QO.035.507.AH, 5QO.035.507.B, 5QO.035.507.C, 5QO.035.507.P, 5QO.035.507.Q, 5QO.035.507.S, 5TA.035.577, 5TA.035.577.A, 5TA.035.577.B, 5WA.035.507.A, 5WA.035.507.B, 5WA.035.507.E, 5WA.035.507.F, 5WA.035.507.T, 5WD.035.507.A, 5WD.035.507.B, 5WG.035.507.A, 5WG.035.507.B, 510.035.577, 510.035.577.A, 510.035.577.B, 565.035.577, 565.035.577.A, 565.035.577.C, 575.035.225, 575.035.225.A, 575.035.225.B.

6C0.035.501, 6C0.035.501.5FQ, 6C0.035.501.A, 6C0.035.501.C, 6C0.035.501.D, 6C0.035.501.G, 6C0.035.501.J, 6C0.035.501.N, 6C0.035.501.P,

6C0.035.501.Q, 6C0.035.577, 6R0.035.501, 6R0.035.501.A,  
 6R0.035.501.C, 6R0.035.501.D, 6R0.035.501.F,  
 6R0.035.501.L, 6V6.035.577.A, 6V6.035.577.B,  
 6V9.035.577.A, 6V9.035.577.B, 7C0.035.501, 7C0.035.501.C,  
 7C0.035.501.D, 7C0.035.501.F, 7C0.035.501.G, 7E0.035.503,  
 7E0.035.503.A, 7E0.035.503.B, 7E0.035.503.C,  
 7E0.035.503.D, 7E0.035.503.E, 7E0.035.510, 7E0.035.510.A,  
 7H0.035.507.E, 7N0.035.507.A, 7N0.035.507.B,  
 7N0.035.552.K, 7N0.035.552.J, 7N0.035.552.Q, 7P6.035.552,  
 7P6.035.552.A, 7P6.035.552.M, 760.035.577.T,  
 857.035.503.B, 8W9.035.225.H.

920 105 105, 920 105 110, 920 211 072, 920 211 172, 920  
 211 201, 920 211 202, 920 213 172, 920 286 002, 920 286  
 005, 920 286 009, 920 286 010, 920 286 011, 920 286 012,  
 920 286 013, 920 286 015, 920 286 313, 920 286 323, 920  
 286 343, 920 286 351, 920 286 352, 920 286 353, 920 286  
 354, 920 286 362, 920 286 382, 920 286 383, 920 286 385,  
 920 286 386, 920 301 022, 920 301 030, 920 301 031, 920  
 301 041, 920 301 042, 920 304 022, 920 336 003, 920 336  
 005, 920 336 006, 920 336 007, 920 336 008, 920 336 010,  
 920 336 011, 920 336 012, 920 336 013, 920 336 014, 920  
 355 001, 920 417 007, 920 417 010, 920 437 003, 920 437  
 023, 920 437 035, 920 437 303, 920 437 323, 920 437 335,  
 920 460 003, 920 460 009, 920 460 018, 920 460 025, 920  
 460 028, 920 460 042, 920 460 047, 920 460 069, 920 460  
 303, 920 460 318, 920 460 325, 920 460 328, 920 460 342,  
 920 460 347, 920 460 369, 920 461 001, 920 461 002, 920  
 461 003, 920 461 004, 920 461 005, 920 481 002, 920 481  
 003, 920 481 004, 920 481 012, 920 481 013, 920 481 014,  
 920 554 001, 920 554 002, 920 554 003, 920 554 004, 920  
 611 001, 920 611 002, 920 611 011, 920 611 012, 920 615  
 001, 920 615 002, 920 627 003, 920 627 007, 920 627 023,  
 920 627 024, 920 627 048, 920 627 049, 920 639 001, 920  
 639 002, 920 639 003, 920 639 011.

## Radio equipment, frequency band, maximum transmit power

If not otherwise stated, the specifications apply to all Volkswagen models or to vehicles that are equipped with the respective radio system<sup>1)</sup>. Deviations are marked by footnotes.

<sup>1)</sup> In certain European countries, the activation of or permission to use radio technology may be restricted, not possible, or possible only when additional requirements have been fulfilled.

$\mu$ W = Microwatt, mW = Milliwatt, W = Watt.

### Radar sensors for assist systems

#### Frequency band, maximum transmit power

	6.0 – 8.5 GHz (6.52 GHz, 7.04 GHz, EIRP 7.56 GHz)	-6,2 dBm
Front:	24.05 – 24.25 GHz	0.1 W
	76 – 77 GHz	0.66 W
	76 – 77 GHz	3.16 W
	76 – 77 GHz	2 W EIRP
	76 – 77 GHz	33 dBm
		EIRP
side:	76 – 77 GHz	0.59 W
	77 – 81 GHz	0.22 W
rear:	76 – 77 GHz	1 W
	24.05 – 24.25 GHz	0.1 W EIRP

### Keyless Access

125 kHz	22.7 dB $\mu$ A/m
434.42 MHz	32 $\mu$ W
868.000 – 868.600 MHz	25 mW

### Tyre pressure sensors

433.92 MHz	10 mW
------------	-------

### Central control unit

21.13 – 22.75 kHz	34.2 dBuA/m @ 10 m
-------------------	-----------------------

### Instrument cluster

125 kHz	40 dB $\mu$ A/m
125 kHz	0.000147 mW

### ID. Cockpit

125 kHz	5.4 dBuA/m
---------	------------

### Electronic immobiliser

125 kHz +/- 10 kHz	5.4 dB $\mu$ A/m
--------------------	------------------

### Remote control (auxiliary heater)

868.7 – 869.2 MHz	25 mW
869.0 MHz	
868.0 – 868.6 MHz	3.1 mW
868.3 MHz	

#### Auxiliary heater (Transmitter / Receiver unit)

868.0 – 868.6 MHz	23.5 mW
868.3 MHz	
868.7 – 869.2 MHz	23.5 mW
869.0 MHz	
868.0 – 868.6 MHz	10 mW
868.525 MHz	

#### Remote control key (vehicle)

433.05 – 434.78 MHz,	10 mW
433.05 – 434.79 MHz	
868.0 – 868.6 MHz	25 mW
434.42 MHz	32 µW

#### Bluetooth

2,402 – 2,480 MHz	6.1 mW
2,402 – 2,480 MHz	0.05 W
2,400 – 2,483.5 MHz	10 mW
2,408 – 2,480 MHz	

#### Outside door handle with NFC radio technology

13.56 MHz	0.67 mW
-----------	---------

#### Valet keycard

13.56 MHz	0.0004 mW
-----------	-----------

#### Wireless charging function

105 – 115 kHz	6 W
111 kHz	42dBµA/m

#### Car2X auxiliary antenna

5855 – 5925 MHz	2 W EIRP
-----------------	----------

#### Wi-Fi hotspot

2400 – 2484 MHz	100 mW
5150 – 5250 MHz	25 mW
5725 – 5845 MHz	25 mW

#### Garage door opener

868.00 – 868.60 MHz	25 mW
868.70 – 869.20 MHz	
433.05 – 434.79 MHz	10 mW
40.660 – 40.700 MHz	
26.957 – 27.293 MHz	

#### Compensator

GSM 900 (uplink: 880 – 915 MHz / downlink: 925 – 960 MHz)	2 W
GSM 1800 (uplink: 1,710 – 1,785 MHz / downlink: 1,805 – 1,880 MHz)	1 W
WCDMA FDDI (uplink: 1,920 – 1,980 MHz / downlink: 2,110 – 2,170 MHz)	0.125 W
WCDMA FDDIII (uplink: 1,710 – 1,785 MHz / downlink: 1,805 – 1880 MHz)	0.125 W
WCDMA FDDV (uplink: 880 – 915 MHz / downlink: 925 – 960 MHz)	0.125 W
LTE FDD1 (uplink: 1,920 – 1,980 MHz / downlink: 2,110 – 2,170 MHz)	0.2 W
LTE FDD3 (uplink: 1,710 – 1,785 MHz / downlink: 1,805 – 1,880 MHz)	0.2 W
LTE FDD7 (uplink: 2,500 – 2,570 MHz / downlink: 2,620 – 2,690 MHz)	0.2 W
LTE FDD8 (uplink: 880 – 915 MHz / downlink: 925 – 960 MHz)	0.2 W
LTE FDD20 (uplink: 832 – 862MHz / downlink: 791 – 821 MHz)	0.2 W

#### Mobile phone interface

GSM 850: 824–849 MHz	2 W
GSM 900: 880–915 MHz	
GSM 1800: 1,710–1,785 MHz	1 W
GSM 1900: 1,850 – 1,910 MHz	
WCDMA FDDI: 1,920 – 1,980 MHz	0.25 W
WCDMA FDDV: 824 – 849 MHz	

#### We Connect

GSM 900: 880 – 915 MHz	2 W
GSM 1800: 1,710 – 1,785 MHz	1 W
WCDMA band 1: 1,920 – 1,980 MHz	0.25 W
WCDMA band 3: 1,710 – 1,785 MHz	
WCDMA band 8: 880 – 915 MHz	

FDD LTE band 1: 1,920 – 1,980 MHz	0.2 W
FDD LTE band 3: 1,710 – 1,785 MHz	
FDD LTE band 7: 2,500 – 2,570 MHz	
FDD LTE band 8: 880 – 915 MHz	
FDD LTE band 20: 832 – 862 MHz	
FDD LTE band 28A: 703 – 733 MHz	

#### Car-Net Security & Service

GSM 900 (880.2 – 959.8 MHz)	2 W
GSM 1800 (1,710.2 – 1,879.8 MHz)	1 W
UMTS B1 (1,920 – 2,170 MHz)	0.25 W
UMTS B8 (880–960 MHz)	
GPS (1,575.42 MHz)	

#### Car-Net e-Remote

GSM 850 (824 – 849 MHz)	2 W
GSM 900 (880 – 915 MHz)	

GSM 1800 (1,710 – 1,785 MHz)	1 W
GSM 1900 (1,850 – 1,910 MHz)	
EGPRS 850 (824 – 849 MHz)	0.5 W
EGPRS 900 (880 – 915 MHz)	
EGPRS 1800 (1,710 – 1,785 MHz)	0.4 W
EGPRS 1900 (1,850 – 1,910 MHz)	
UMTS I (1,920 – 1,980 MHz)	0.25 W
UMTS II (1,850 – 1,910 MHz)	
UMTS III (IX) (1,710 – 1,785 MHz)	
UMTS IV (1,710 – 1,755 MHz)	
UMTS V (VI) (824 – 849 MHz)	
UMTS VIII (880 – 915 MHz)	

#### Car-Net e-Remote

GSM 900: 880 – 915 MHz	2 W
GSM 1800: 1,710 – 1,785 MHz	1 W
WCDMA FDDI: 1,920 – 1,980 MHz / GPS (1.57542 GHz)	0.25 W



## Declaration of conformity for radio systems in countries outside of Europe



Fig. 200 Overview of some type approval numbers

- ① Argentina.
- ② Brazil.
- ③ Malaysia.
- ④ Moldavia.
- ⑤ Australia, New Zealand.
- ⑥ Russia and countries where radio systems are approved and permitted according to EAC Directives.
- ⑦ Serbia.
- ⑧ Taiwan.
- ⑨ South Africa.
- ⑩ South Korea.
- ⑪ Europe and countries where radio systems are approved and permitted according to European Directives.
- ⑫ Vietnam.
- ⑬ Ukraine.
- ⑭ Paraguay.
- ⑮ Zambia.

- ⑯ Brunei.
- ⑰ Belarus.

The manufacturer hereby declares that the following radio systems are in compliance with the basic requirements and other relevant regulations and laws at the time of production of the vehicle:

*The following radio systems are not available in every market and not in every vehicle.*

- Connection to the external aerial.
- Aerial.
- Aerial amplifier.
- Bluetooth.
- Remote control (auxiliary heater).
- Vehicle key.
- Garage door opener.
- ID. Cockpit.
- Infotainment.

- Keyless Access.
- Instrument cluster, electronic immobiliser.
- Radar sensors for assist systems.
- Tyre pressure sensors.
- Auxiliary heater (transmitter/receiver unit).
- Control units with embedded eSIM card.
- Mobile phone interface.
- Volkswagen Car-Net control unit.
- WLAN hotspot.
- Central control unit.

2019/5046, 2020/3991, 2020/3992, 2020/5158,  
2020/5159, 2020/5191, 3372

## Brazil

05674-15-06830, 05674-16-06830, 07084-18-03745  
Este equipamento opera em caráter secundário, isto é, não tem direito à proteção contra interferência prejudicial, mesmo de estações do mesmo tipo, e não pode causar interferência a sistemas operando em caráter primário.

00939-19-06673, 01812-19-05364, 01814-19-05364,  
02450-17-02010, 02452-17-02010, 02992-14-06673,  
03563-17-05364, 03764-17-05386, 03833-18-06353,  
03834-18-06353, 04282-19-01925, 04383-18-06673,  
04998-19-02405, 04999-19-02405, 05273-18-02496,  
05292-18-06353, 05293-18-06353, 05296-18-06353,  
05297-18-06353, 05505-18-06353, 05506-18-06353,  
05507-18-06353, 05508-18-06353, 05509-18-06353,  
05511-18-06353, 05512-18-06353, 06215-16-03430,  
06763-18-06353, 06962-18-06353, 07183-18-06353,  
07184-18-06353, 07185-18-06353, 07186-18-06353,  
07189-18-06353, 07188-18-06353, 07189-18-06353,  
07191-18-06353, 09275-19-06353.

Este equipamento não tem direito à proteção contra interferência prejudicial e não pode causar interferência em sistemas devidamente autorizados.

Este produto está homologado pela ANATEL, de acordo com os procedimentos regulamentados pela resolução nº. 242/2000 e atende aos requisitos técnicos e aplicados. Para maiores informações, consulte o site da ANATEL - [www.anatel.gov.br](http://www.anatel.gov.br).

## Brunei

DTA-001794, DTA-001977, DTA-001978, DTA-001983,  
DTA-001985, DTA-001986, DTA-002302, DTA-002306,  
DTA-002307, DTA-004928, DTA-004929, DTA-005532  
DRQ-D-MAJU-02-2011-111083:  
DTA-001793, DTA-001981, DTA-001982, DTA-002433,  
DTA-003220

## Chile

3458/DO N°45141/f26, 12190/DO N° 48994/F26  
58798, 58799

## Dominican Republic

DE-0000320-Cc-17445, DE-0001203-19, DE-0001204-19,  
183507

## Approval numbers

### Egypt

TAC.07021815923.WIR, TAC.24061918671.WIR,  
TAC.24061918672.WIR

### Algeria

31.AF/528/DT/DG/ARPT/18

### Argentina

C-17908, C-18053, C-21797, C-22394, H-20369, H-20370,  
H-20731, H-20732, H-20733, H-21901, H-21902,  
H-21961, H-21962, H-22190, H-22191, H-22192,  
H-22240, H-22362, H-22363, H-22364, H-22377,  
H-22378, H-22379, H-22380, H-22381, H-22382,  
H-22383, H-22524, H-22793, H-22794, H-22855, H-  
22856, H-22961, H-23480, H-23481, H-24442, H-24559,  
H-24598

### Australia

ACN/ARBN 004 528 778 / 58004528778, ABN 81 145 810  
206, N11042, 2150-01, 2152-01

### Bahrain

3002, 3003, DLM / 1405

### Botswana

BOCRA/TA/REGISTERED No:  
2018/2026, 2018/3012, 2018/3991, 2018/3992,  
2018/4129, 2018/4130, 2018/4131, 2018/4132,  
2018/4133, 2018/4134, 2018/4135, 2018/4136,  
2018/4193, 2018/4194, 2018/4195, 2018/4196,  
2019/4311, 2019/4997, 2019/4998, 2019/5045,

## Europe and countries that approve radio equipment according to European Directives:

See EU Declarations of Conformities at [www.volkswagen.com/generalinfo](http://www.volkswagen.com/generalinfo).

### Ghana

1R3-1M-7E1-160, 1R3-1M-7E1-087, 6X6-4H-7E0-0F3  
BR3-1M-GE2-087, BR3-1M-GE2-088, BR3-1M-GE2-089,  
BR3-1M-GE2-0AF, BR3-1M-GE2-0BA, BR3-1M-GE2-0BB,  
BR3-1M-GE2-0BC, BR3-1M-GE2-0B0, BR3-1M-GE2-0B3,  
BR3-1M-GE2-0B4, BR3-1M-GE2-0B7, BR3-1M-GE2-0D2,  
BR3-1M-GE2-0BA, BR3-1M-GE2-0BC, BR3-1M-GE2-0EC,  
BR3-1M-GE2-0ED, BR3-1M-GE2-0EE, BR3-1M-GE2-10A,  
BR3-1M-GE2-10B, BR3-1M-GE2-130, EX6-6M-GE2-17B,  
ZRO-MB-7E3-X90, ZRO-MB-7E3-X92, ZRO-1H-7E3-14E,  
ZRO-MB-7E3-20B, ZRO-MB-7E3-27B.

### Hong Kong

US0031800001, HK0011902060, HK0011902061

### India

ETA-1609/17-RLO(NE), ETA-SD-20190500531, ETA-  
SD-20190500547, ETA-SD-20190702496, ETA-  
SD-20190702597, ETA-SD-20190702602, NR-ETA/7218-  
RLO(NR), NR-ETA/7219-RLO(NR), NR-ETA/7220-RLO(NR).

### Indonesia

Certificates are available at the following Internet address [www.volkswagen.com/generalinfo](http://www.volkswagen.com/generalinfo).

34539//SDPPI/2017, PLG ID: 4211, 38132//SDPPI/2017,  
PLG ID: 2130, 47817//SDPPI/2016, PLG ID: 6094, 50459/  
SDPPI/2017, PLG ID: 6051, 53856//SDPPI/2017, PLG ID:  
4211, 55438//SDPPI/2018, PLG ID: 6051, 55776//SDPPI/  
2018, PLG ID: 7205, 56625//SDPPI/2018, PLG ID: 7708,  
57406//SDPPI/2018, PLG ID: 7708, 57647//SDPPI/2018, PLG  
ID: 7708, 57687//SDPPI/2018, PLG ID: 7708, 58206//SDPPI/  
2018, PLG ID: 5834, 62361//SDPPI/2019, PLG ID: 8837

PLG ID: 4334:

58849//SDPPI/2018, 60924//SDPPI/2019, 61642//SDPPI/  
2019, 62637//SDPPI/2019, 62638//SDPPI/2019, 62825/  
SDPPI/2019, 62826//SDPPI/2019, 62827//SDPPI/2019,  
62828//SDPPI/2019, 63076//SDPPI/2019, 63077//SDPPI/  
2019, 63078//SDPPI/2019, 63079//SDPPI/2019, 63080/  
SDPPI/2019, 63081//SDPPI/2019, 63082//SDPPI/2019,  
63128//SDPPI/2019, 63129//SDPPI/2019, 63130//SDPPI/  
2019, 63131//SDPPI/2019, 63132//SDPPI/2019, 63133/  
SDPPI/2019, 63134//SDPPI/2019, 63135//SDPPI/2019,  
63136//SDPPI/2019, 63137//SDPPI/2019, 63138//SDPPI/  
2019, 63139//SDPPI/2019, 63140//SDPPI/2019, 63147/

SDPPI/2019, 63160//SDPPI/2019, 63161//SDPPI/2019,  
63162//SDPPI/2019, 63577//SDPPI/2019, 63578//SDPPI/  
2019, 63579//SDPPI/2019, 63580//SDPPI/2019, 63581/  
SDPPI/2019, 63582//SDPPI/2019, 63583//SDPPI/2019,  
64639//SDPPI/2019, 64640//SDPPI/2019, 66074//SDPPI/  
2020, 67149//SDPPI/2020, 67154//SDPPI/2020, 67359/  
SDPPI/2020, 67495//SDPPI/2020, 67512//SDPPI/2020.

### Iran

Iran\_Kombiinstrument\_MDE\_VIS\_1710

### Israel

51-63653, 51-69416, 51-69417, 63-63304.

### Jamaica

FCC ID: 2AA98A, Kombiinstrument-1, -2, -3

### Jordan

TRC/LPD/:

2014/248, 2016/584, 2017/254, 2018/1, 2018/381,  
2019/153, 2019/233, 2019/234.

TRC No.:

T/4/11/11/3680, T/4/11/11/3681, T/4/11/11/9851

### Columbia

2018300044, 2019802791, 2019802792

### Kuwait

Ref 2410, 3399, 3421.

### Lebanon

2665/E&M/2018, 11372

### Malaysia

CIDF15000490, CIDF15000578, CIDF17000143,  
HIDF1500019, MRR14F, ARS4-B



RAAY/84A/0618/S(18-2241), RAAY/85A/0618/S(18-2242), RAAY/86A/0618/S(18-2378), RAAY/87A/0718/S(18-2596), RAAY/89A/0718/S(18-3107), RAAY/92A/1218/S(18-4731), RALM/69A/1018/S(18-3829), RCFL/22A/0818/S(18-3109), RCFL/24A/0818/S(18-3152), RFC/21A/0718/S(18-2717), RFC/23A/0818/S(18-3153), RFCL/09A/0218/S(18-0609), RFCL/13A/0618/S(18-2379), RFCL/14A/0618/S(18-2543), RFCL/15A/0718/S(18-2544), RAAY/92A/1218/S(18-4731), RFCL/19A/0718/S(18-2545), RFCL/20A/0718/S(18-2718), RFCL/26A/0918/S(18-3810), RFCL/27A/0918/S(18-3812), RFCL/28A/1018/S(18-3977), RFCL/29A/1018/S(18-4127), RFCL/30A/1018/S(18-4129), RFCL/31A/1018/S(18-3976), RFCL/35A/0719/S(19-2874), RFCL/36A/0719/S(19-2875), RFCL/41A/0220/S(20-0390), RFCL/42A/0220/S(20-0391), RFCL/44A/0320/S(20-1385)

## Morocco

AGREE PAR L'ANRT MAROC : Numéro d'agrément, Date d'agrément  
MR 9778 ANRT 2014, 11/11/2014, MR 12623 ANRT 2016, 11/10/2016, MR 13255 ANRT 2017, 09/02/2017, MR 13900 ANRT 2017, 04/05/2017, MR 15669 ANRT 2018, 31/01/2018, MR 15674 ANRT 2018, 31/01/2018, MR 15675 ANRT 2018, 31/01/2018, MR 16606 ANRT 2018, 17.05.2018, MR 16657 ANRT 2018, 23.05.2018, MR 16860 ANRT 2018, 18.06.2018, MR 16861 ANRT 2018, 18.06.2018, MR 16905 ANRT 2018, 21.06.2018, MR 16906 ANRT 2018, 21.06.2018, MR 16907 ANRT 2018, 21.06.2018, MR 16908 ANRT 2018, 21.06.2018, MR 17015 ANRT 2018, 03.07.2018, MR 17016 ANRT 2018, 03.07.2018, MR 17079 ANRT 2018, 11.07.2018, MR 17080 ANRT 2018, 11.07.2018, MR 17201 ANRT 2018, 06.08.2018, MR 17202 ANRT 2018, 06.08.2018, MR 17203 ANRT 2018, 06.08.2018, MR 17204 ANRT 2018, 06.08.2018, MR 17505 ANRT 2018, 2018/09/14, MR 17528 ANRT 2018, 19/09/2018, MR 17576 ANRT 2018, 26/09/2018, MR 17678 ANRT 2018, 11.10.2018, MR 17679 ANRT 2018, 11.10.2018, MR 18103 ANRT 2018, 30.11.2018

MR 19106 ANRT 2019, 2019/03/04, MR 19108 ANRT 2019, 2019\_03\_14, MR 19338 ANRT 2019, 09.04.2019, MR 19339 ANRT 2019, 09.04.2019, MR 19768 ANRT 2019, 2019\_05\_15, MR 19769 ANRT 2019, 2019\_05\_15, MR 20859 ANRT 2019, 11.09.2019, MR 21807 ANRT 2019, 23.12.2019

## Mauritius

TA/2018/0084, TA/2019/0509, TA/2019/0510

## Mexico

IFT/223/UCS/DG-AUSE/0311/2018  
RCPAPR318-2005, RCPBOFR18-1885, RCPCOAR18-1800, RTIWWCO19-1185, RLVCO1820-0821, RLVCOAR15-0008,

RLVHE0119-0720, RLVDER316-1666, RLVDER316-2005, RLVHEFS19-1298, RLVHERS17-0286, RLVMABN18-1512, RLVMABN18-1512-A1, RLVVICO18-0155, RLVVIME19-1022, RLVVIME19-1023, RLVVW1718-1092, RLVVW1718-1169, RLVVW1718-1170, RLVVW1718-1314, RLVVW1718-1315, RLVVW1718-1316, RLVVW1718-1317, RLVVW1718-1507, RLVVW1718-1508, RLVVW1718-1509, RLVVW1718-1517, RLVVW1718-1519, RLVVW1718-1567, RLVVW1718-1568, RLVVW1718-1790, RLVVW1718-1928, RLVVW1718-1929, RLVVW1719-1795, RLVVW1818-1249, RLVVW1818-1258, RLVVW1819-0009, RLVVW1819-0023. La operación de este equipo está sujeta a las siguientes dos condiciones:

- (1) es posible que este equipo o dispositivo no cause interferencia perjudicial y
- (2) este equipo o dispositivo debe aceptar cualquier interferencia, incluyendo la que pueda causar su operación no deseada.

## Moldavia

024, 1014, 8526, MD OC TIP 024 A674-19, MD OC TIP 024 A675-19

## New Zealand

ABN 81 145 810 206, 2151-01, 2153-01

## Nigeria

Connection and use of this communications equipment is permitted by the Nigerian Communications Commission.  
NCC/TSNi/WW/TA/CERT/:  
3137/2019, 3138/2019

## Oman

R/3370/16, R/5130/18, 23/01/2018, R/6132/18, D172249, R/6696/18, R/7704/19, R/7752/19, R/8052/19, D090024, R/8056/19, D090024, R/8749/19.

## D080134:

R/1733/14, R/2210/14, R/3621/16, R/3848/17, R/3957/17.

## D100428:

R/5725/18, R/5772/18, R/5774/18, R/5819/18, R/5820/18, R/5884/18, R/5885/18, R/5886/18, R/5887/18, R/6021/18, R/6022/18, R/6023/18, R/6024/18, R/6166/18, R/6366/18, R/6372/18, R/6535/18, R/6616/18, R/6695/18, R/7383/19, R/7384/19, R/8171/19.

## Pakistan

Approved by PTA.

## Paraguay

2018-10-I-000480, 2018-10-I-000481, 2018-11-I-000612, 2019-05-I-000243  
1297/2019, 1298/2019.

Este vehículo posee el siguiente componente de radiofrecuencias, homologado por la CONATEL – Paraguay.

## Philippines

ESD-1816419C, ESD-1818098C, ESD-1919803C, ESD-1919804C

## Qatar

CRA/SA/2016/R-5808, CRA/SA/2018/R-6820, CRA/SM/2018/R-7447, CRA/SM/2019/R-8053, CRA/SM/2019/R-8054

## Zambia

ZMB/ZICTA/TA/:

2018/8/38, 2018/8/39, 2018/8/40, 2018/8/41, 2018/10/10, 2018/10/15, 2018/10/17, 2018/10/18, 2018/10/19, 2018/10/20, 2018/10/21, 2018/10/24, 2018/10/25, 2018/10/26, 2018/10/27, 2018/12/16, 2019/7/7, 2020/2/35

## Saudi Arabia

29563, 2019-1205, 2019-1221

## Serbia

P1617197200, P1619073700, P1619073800, P1619095800, M005 17, M005 18, M005 19, M011 14, M011 17, M011 19, 34540-768/18-5, 34540-1313/16-3.

## Singapore

Complies with IMDA Standards:

103238, DA103787, DA104682, DA104682 (N0688-15), DA105282, DB106879, DB106879 (N3083-18)  
G1594-19, N2404-19, N2405-19, N3688-18, N4975-17.

## South Africa

TA-2013/2465, TA-2014/1783, TA-2016/501, TA-2016/820, TA-2016/2759, TA-2016-3407, TA-2016/3539, TA-2017/2824, TA-2018/2868TA-2018/5159, TA-2019/115, TA-2019/582, TA-2019/583, TA-2019/5101, TA-2019/5116, TA-2019/5167.

## Thailand

Class A NBTC ID: 5700619-XXXXMRRe14FCR, NBTC ID: A57004-17-xxxx, NBTC ID: A57019-16-xxxx, RT 1751, RT 1752, 255.A.2560

1) เครื่องวิทยุคมนาคมและอุปกรณ์นี้มีความสอดคล้องตามมาตรฐานหรือข้อกำหนดของ กสทช.

2) เครื่องวิทยุคมนาคมนี้ มีระดับการแผ่คลื่นแม่เหล็กไฟฟ้าสอดคล้องตามมาตรฐานความปลอดภัยต่อสุขภาพของมนุษย์จากการใช้เครื่องวิทยุคมนาคมที่คณะกรรมการกิจการโทรคมนาคมแห่งชาติประกาศกำหนด

เครื่องโทรคมนาคมและอุปกรณ์นี้ มีความสอดคล้องตามมาตรฐานหรือข้อกำหนดทางเทคนิคของ กสทช. เครื่องวิทยุคมนาคมนี้ มีระดับการแผ่คลื่นแม่เหล็กไฟฟ้าสอดคล้องตามมาตรฐานความปลอดภัยต่อสุขภาพของมนุษย์จากการใช้เครื่องวิทยุคมนาคมที่คณะกรรมการกิจการโทรคมนาคมแห่งชาติประกาศกำหนด

เครื่องโทรคมนาคมและอุปกรณ์นี้ มีความสอดคล้องตามข้อกำหนดของ กทช.

## Tunisia

AHO-0177-18, AHO-0991-19

## Turkey

MDE\_VIS\_1710, 32423510-254.01-E.39919

## Countries outside the US, which approve and permit radio systems in accordance with FCC guidelines:

FCC ID:

2AOUZ17101001, 2AOUZ17101002, 2AOUZ17101010, 2AOUZ17101022, 2AOUZ17101023, 2AOUZ17101031, 2AOUZ17101032, 2AOUZ17101033, 2AOUZ17101034, 2AOUZ17101041, 2AOUZ17101042, 2AOUZ17101043, 2AOUZ17101051, 2AOUZ17101052, 2AOUZ17101053, 2AOUZ17101054, 2AOUZ17101055, 2AOUZ17101056, 2AOUZ17101057, 2AOUZ17101071, 2AOUZ17101072, 2AOUZ18020531, 2AOUZ18020532, 2AOUZ18020533, 2AOUZ18020534, 2AOUZ18100931  
2AA98, 2AA98A, 2AA98-COLOURSC, 2AA98-MEDIUMSC, BEJLCW05-VWE5, LTQR3TR, NBGF319, NBGF3191, NBGR319, NBGO13854, NF3-FR5PEC, OAYAR35B, RX2BNFHL, RX2BNFLL, RK7MBC-NAR.

This device complies with part 15 of the FCC Rules. Operation is subject to the following two conditions:

- (1) This device may not cause harmful interference, and
- (2) This device must accept any interference received, including interference that may cause undesired operation.

Any changes or modifications to this device not explicitly approved by manufacturer could void your authority to operate this equipment.

This equipment complies with FCC RF Radiation exposure limits set forth for an uncontrolled environment. This device and its antenna must not be co-located or operating in conjunction with any other antenna or transmitter. This equipment should be installed and operated with a minimum distance of 20 cm between the radiator and your body.

This equipment (FCC ID: BEJLCW05-VWE5) has been tested and found to comply with the limits for a Class B digital device, pursuant to part 15 of the FCC Rules. These limits are designed to provide reasonable protection against harmful interference when the equipment is operated in a commercial environment. This equipment generates, uses, and can radiate radio frequency energy and, if not installed and used in accordance with the instruction manual, may cause harmful interference to radio communications. Operation of this equipment in a residential area is likely to cause harmful interference in which case the user will be required to correct the interference at his own expense.

**WARNING:** Changes or modifications not expressly approved by the manufacturer (or party responsible) for compliance could void the user's authority to operate the equipment.

FCC ID:

RK7185-00, QZ9-KA3

**CAUTION TO USERS:** Changes or modifications not expressly approved by the party responsible for compliance may void the FCC authorization to operate the equipment.

This device complies with Part 15 and Part 18 of the FCC Rules. Operation is subject to the following two conditions:

- (1) This device may not cause harmful interference, and
- (2) This device must accept any interference received, including interference that may cause undesired operation.

This equipment has been tested and found to comply with the limits for a Class B digital device, pursuant to Part 15 and to Part 18 of the FCC Rules. These limits are designed to provide reasonable protection against harmful interference in a residential installation. This equipment generates, uses and can radiate radio frequency energy and, if not installed and used in accordance with the instructions, may cause harmful interference to radio communications. However, there is no guarantee that interference will not occur in a particular installation.

If this equipment does cause harmful interference to radio or television reception, which can be determined by turning the equipment off and on, the user is encouraged to try to correct the interference by one or more of the following measures:

- Reorient or relocate the receiving antenna.
- Increase the separation between the equipment and receiver.
- Connect the equipment into an outlet on a circuit different from that to which the receiver is connected.
- Consult the dealer or an experienced radio/TV technician for help.

**Radiation Exposure:** This device has been tested for human exposure limits and found compliant at a minimum distance of 5 cm during operation. Thus during the operation of device a distance of 5 cm must be respected in every direction.

## Ukraine

Imported by:

Чистий і шлях©

Імпорт та експорт ТОВ компанії

Десь Ave. 14

01004 Київ

## Україна

BSD 3.0	24,05 - 24,25 GHz	20 dBm
LCA 2.0	24,05 - 24,25 GHz	20 dBm
RS4	24,05 - 24,25 GHz	20 dBm

1APTV R3TR, 1BOSCO001, 10094.007280-19, 0848,  
UA.R.TR.052.081-20

повний текст декларації про відповідність  
доступний на веб-сайті за такою адресою:  
[www.volkswagen.com/generalinfo](http://www.volkswagen.com/generalinfo).

ЛГ Електроникс Вьетнам Хай Фонг Ко.,  
Лтд., Лот СН2, Транг Дью Индастриал  
Парк, Ле Лой Комуна, Ан, Дуонг Дистрикт,  
Хай Фонг Сити, Вьетнам;

Koppelantenne Gen.3, UA.TR.109.0009-18,  
UA.TR.109.R.0336-19, UA.TR.109.R.0337-19,  
UA.TR.109.R.0425-18, UA.TR.028, 10094.007280-19  
0754, 0781, 0816, 0826, 0848, 0849, 0869, 0870, 0871,  
0872, 0874, 0880, 0911, 0912, 0942, 0978, 0992, 0993,  
1004, 1033

справжнім (найменування виробника  
MANUFACTURER) заявляє, що тип  
радіообладнання (позначення типу  
радіообладнання DESIGNATION) відповідає  
Технічному регламенту радіообладнання.  
повний текст декларації про відповідність  
доступний на веб-сайті за такою адресою:  
[www.volkswagen.com/generalinfo](http://www.volkswagen.com/generalinfo)  
ЛГ Електроникс Вьетнам Хай Фонг Ко.,  
Лтд., Лот СН2, Транг Дью Индастриал  
Парк, Ле Лой Комуна, Ан, Дуонг Дистрикт,  
Хай Фонг Сити, Вьетнам;

## United Arab Emirates

TRA, REGISTERED No, DEALER No  
ER49719/16, DA0062437/11, ER50430/16, ER53878/17,  
DA44932/15, ER54754/17, DA0043253/10, ER55421/17,  
DA36758/14, ER61136/18, DA40068, ER61137/18,  
DA0089862/12, ER66978/18, DA36758/14, ER68006/18,  
DA40068/15ER70009/19, DA44932, ER70046/19, DA44932,  
ER70554/19, DA0043253/10, ER71148/19, DA0043253/10,  
ER71413/19, DA0089862/12, ER71414/19.

## Vietnam

C00082015, C0118220519AF04A2, C0119220519AF04A2

## Belarus

BY/112 11.01.TP024 020 00007  
BY/112 11.01.TP024 020 00008  
BY/112 11.01.TP024 020 00047

BY/112 11.01.TP024 020 00059  
BY/112 11.01.TP024 030 00140  
Ra.RU.21ИР01



# Technical data

## Notes on technical data

### General information on the data

Except where indicated or specifically stated, the technical data applies to the basic model. The values may differ if additional equipment is fitted, for different model versions and for special vehicles and in the case of country-specific vehicle specifications. All data in the official vehicle documents always take precedence.

The vehicle data sticker and the official vehicle documents show which drive and which power output are installed in your vehicle.

Please observe the notes and information for vehicles with N1 approval → page 373, *Information about vehicles with N1 approval (light commercial vehicle)*.

#### Weight

The values for the kerb weight in the following tables apply to the road-ready vehicle with driver (75 kg), service fluids and, if applicable, tools and spare tyre. Additional equipment and retrofitted accessories increase the stated kerb weight and reduce the maximum permitted load accordingly.

The load comprises the weights of the following:

- Passengers
- All luggage

- Add-on parts
- Roof load

The permitted gross vehicle weight rating and gross axle weight rating must never be exceeded. The permitted values are provided on the safety certificate ("safety compliance label") on the B-pillar on the driver side → page 389.

#### Performance figures

The values apply only for optimum road and weather conditions.

The performance figures were measured without equipment which may detrimentally affect performance, such as add-on parts.

#### Gross combination weight

The gross combination weight ratings listed apply only to altitudes up to 1,000 m (3000 ft) above sea level. The maximum gross combination weight rating must be reduced by approximately 10% for every further started 1,000 m (3000 ft) in altitude.

#### Gradient angle

The gradient angle is an indication of the vehicle's gradeability and corresponds to the gradient that the vehicle can drive up under its own power. This depends on aspects such as the road surface, weather conditions and engine power. The values apply to a moving vehicle and not to driving off from standstill.

The number of metres in height gained over a distance of 100 m (300 ft) (gradient) will be given as a percentage or degree value (100% = 45 degrees).

## Vehicle identification number

### Structure of the vehicle identification number

The vehicle identification number VIN comprises 17 characters. These characters are categorised into seven groups.

The basic structure is explained below using the example of the vehicle identification number WVVZZZCZBZLE400953. This is an example.

Group	①			②			③		④	⑤	⑥	⑦					
Position:	1	2	3	4	5	6	7	8	9	10	11	12	13	14	15	16	17
Example	W	V	W	Z	Z	Z	C	B	Z	L	E	4	0	0	9	5	3

① Vehicle manufacturer identifier:

**WVW** Volkswagen Passenger Cars

**WVG** VW Touareg/Auto 5000 AMPV

**1VW** Volkswagen Group of America Inc.,  
Volkswagen de México, S.A. de C.V

**3VW** Volkswagen de México, S.A. de C.V

**XWB** LLC Volkswagen Group Rus (Volkswagen/Skoda Kaluga)

**MFB** Garuda Matraman Motor (Indonesia)

**D** Volkswagen Bratislava Plant

**E** Volkswagen Emden Plant

**G, K** Volkswagen Kaluga Plant

**M** Volkswagen Puebla Plant

**P** Volkswagen Zwickau Plant

**T** Volkswagen Pune Plant

**V, U** Volkswagen Palmela Plant

**W** Volkswagen Wolfsburg Plant

**Y** Volkswagen Pamplona Plant

② Filler characters: the filler characters may differ depending on manufacturer or contain information about the body or gearbox type.

③ Vehicle class per model:

**3H** Arteon

**5T** Touran

**6R** Polo

**AC** T-Roc Cabriolet

**BV** Golf

**CB** Passat

**CA** Atlas

Depending on manufacturer, the places 7 to 9 can also contain information on the fuel type (7) and vehicle class (8 and 9).

④ Filler or check character: the filler characters may differ depending on manufacturer.

⑤ VIN index per model year:

**K** 2019

**L** 2020

**M** 2021

**N** 2022

⑥ Production location, manufacturing plant:

**C** Volkswagen Chattanooga Plant

⑦ Sequential production number in a model year.

#### Position of the vehicle identification number



**Fig. 201** In the windshield: vehicle identification number.

The vehicle identification number can be read from outside the vehicle through a viewer in the windshield. The viewer is located in the lower corner of the windshield.

For some models, depending on the Infotainment system version, the vehicle identification number can be displayed in the **Service** menu or in the vehicle settings. The vehicle identification number can also be found on the type plate. <

## Type plate



Fig. 202 Type plate (illustration).

Depending on country, the number of the type approval, e.g. EC type approval number, may be specified.

- ① Gross vehicle weight rating.
- ② Gross combination weight rating (vehicle plus trailer).
- ③ Gross front axle weight rating.
- ④ Gross rear axle weight rating.

Depending on country and model, the type plate is visible in the lower area of the door pillar after opening the driver or front passenger door. Vehicles for certain export countries do not have a type plate.

## Safety certificate



Fig. 203 Safety certificate (illustration).

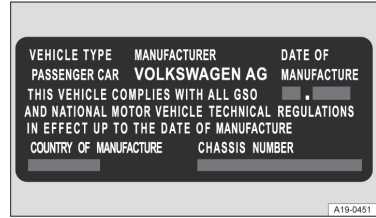


Fig. 204 Safety certificate (illustration).

A safety certificate on the door pillar in the driver door shows the following information:

- Vehicle type
- Manufacturer
- Date of manufacture
- Country of manufacture
- Vehicle identification number

## Vehicle data sticker

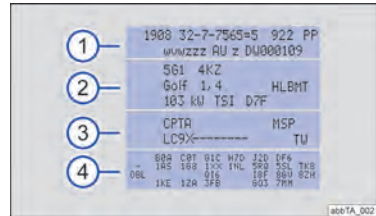



Fig. 205 Illustration: vehicle data sticker

- ① Vehicle identification number (chassis number).
- ② Vehicle type, engine power, gearbox type.
- ③ Engine and gearbox codes, paint number, interior equipment. In the example, the engine code is **CPTA**.
- ④ Optional extras, PR numbers.

The vehicle data sticker is located inside the front cover of the owner's manual and in the

area of the luggage compartment. Depending on the vehicle equipment, the vehicle data sticker is affixed under the luggage compartment trim on the luggage compartment wall or luggage compartment floor, in the spare wheel well or on the cross panel.

 Depending on the vehicle equipment, the engine code may be displayed on the instrument cluster → page 22.

## Dimensions

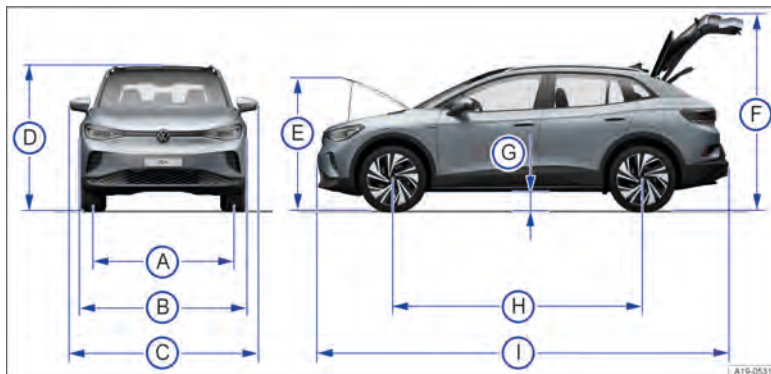


Fig. 206 Dimensions.

The data in the table apply to the basic model with basic equipment.

different model versions, retrofitted accessories and for special vehicles.

The specified values can vary due to different tyre and wheel sizes, additional equipment,

Key to Fig. 206:		
Ⓐ	Front track	1,587 mm – 1,597 mm
	Rear track	1,567 mm – 1,577 mm
Ⓑ	Width (excluding exterior mirrors)	1,852 mm
Ⓒ	Width (from exterior mirror to exterior mirror)	2,108 mm
Ⓓ	Height to the upper edge of the roof at kerb weight <sup>a)</sup>	1,612 mm
	Height at kerb weight <sup>a)</sup> with navigation aerial	1,631 mm – 1,632 mm
Ⓔ	Height with open bonnet at kerb weight <sup>a)</sup>	1,730 mm
Ⓕ	Height with open boot lid at kerb weight <sup>a)</sup>	2,169 mm – 2,170 mm
Ⓖ	Ground clearance in road-ready state <sup>b)</sup> between the axles	116 mm
Ⓗ	Wheelbase	2,771 mm



Key to Fig. 206:		
①	Length (from bumper to bumper)	4,584 mm
	Length with a factory-fitted towing bracket	4,692 mm
-	Turning circle diameter	10.2 m

- a) Kerb weight without driver, without payload.  
b) Maximum permitted gross vehicle weight rating.

## Electric drive

### Electric motor 109 kW, 55 kWh

Power, maximum	kW	109
Engine code	EBJA	
Engine	Permanent magnet synchronous motor	
Maximum torque	Nm	220
Maximum speed	km/h	160
Kerb weight	kg	1,891 – 2,056
Gross vehicle weight rating	kg	2,480 – 2,490
Gross front axle weight rating	kg	1,110 – 1,120
Gross rear axle weight rating	kg	1,420
Maximum trailer weight braked, gradients up to 12 %	kg	1,000
Maximum trailer weight braked, gradients up to 8 %	kg	1,200
Maximum trailer weight unbraked	kg	750
Maximum permitted gross combination weight	kg	3,480 – 3,490

### High-voltage system

Battery capacity	kWh	55
Charging power AC charging, maximum	kW	7.2
Charging power DC charging, maximum	kW	100

### Electric motor 125 kW, 55 kWh

Power, maximum	kW	125
Engine code	EBJA	
Engine	Permanent magnet synchronous motor	
Maximum torque	Nm	310
Maximum speed	km/h	160
Kerb weight	kg	1,891 – 2,056
Gross vehicle weight rating	kg	2,660
Gross front axle weight rating	kg	1,110

11A012720AB

Gross rear axle weight rating	kg	1,120
Maximum trailer weight braked, gradients up to 12 %	kg	1,000
Maximum trailer weight braked, gradients up to 8 %	kg	1,200
Maximum trailer weight unbraked	kg	750
Maximum permitted gross combination weight	kg	3,480 – 3,490

#### High-voltage system

Battery capacity	kWh	55
Charging power AC charging, maximum	kW	7.2
Charging power DC charging, maximum	kW	100

### Electric motor 150 kW, 82 kWh

Power, maximum	kW	150
Engine code	EBJA	
Engine	Permanent magnet synchronous motor	
Maximum torque	Nm	310
Maximum speed	km/h	160
Kerb weight	kg	2,049 – 2,209
Gross vehicle weight rating	kg	2,660
Gross front axle weight rating	kg	1,170
Gross rear axle weight rating	kg	1,540
Maximum trailer weight braked, gradients up to 12 %	kg	1,000
Maximum trailer weight braked, gradients up to 8 %	kg	1,200
Maximum trailer weight unbraked	kg	750
Maximum permitted gross combination weight	kg	3,660

#### High-voltage system

Battery capacity	kWh	82
Charging power AC charging, maximum	kW	11
Charging power DC charging, maximum	kW	125

## Abbreviations used

Abbreviation	Definition
A2DP	Advanced Audio Distribution Profile: manufacturer-independent technology for audio signal transmission via Bluetooth®.
AAC	Advanced Audio Coding: format for compressing audio files.
ABS	anti-lock brake system
AC	Alternating Current: alternating current.
ACC	Adaptive Cruise Control: adaptive cruise control.
AF	Automatic station tracking
ALAC	Apple Lossless Audio Codec: format for compressing audio files.
AVI	Audio Video Interleave: format for playback of video and audio files.
AVRCP	Audio Video Remote Control Profile: manufacturer-independent technology for remote control of audio sources via Bluetooth®.
BAS	Brake assist system.
CCS	Cruise control system.
DAB	Digital Audio Broadcasting.
DC	Direct Current: direct current.
DCC	adaptive chassis control.
DSP	Digital Signal Processor: processes digital audio and video signals.
EBD	Electronic brake pressure distribution.
EBS	Electromechanical brake servo.
ECE	Economic Commission for Europe: Europäische Wirtschaftskommission.
EDGE	Enhanced Data Rates for GSM Evolution: technology for enhancing conventional GSM and GPRS mobile networks.
EDL	electronic differential lock
EON	Enhanced Other Network: Enhanced Other Network.
ESC	Electronic Stability Control
eSIM	embedded Subscriber Identity Module: embedded, non-exchangeable SIM card.
FLAC	Free Lossless Audio Codec: format for compressing audio files.
FM	(frequency modulation): very high frequency, VHF.
GPRS	General Packet Radio Service: packet-oriented service for transmitting data in GSM networks.
GPS	Global Positioning System: global navigation satellite system for position determination.
HFP	Hands-free Profile: wireless telephony.
HUD	Head-up display.
LED	Light Emitting Diode: light-emitting diode.
LTE	Long Term Evolution.
MAP	Message Access Profile: protocol for transmission of text messages and e-mails.
MP3	Format for compressing audio files.

<b>Abbreviation</b>	<b>Definition</b>
MP4	Format for compressing audio files.
MPEG	Moving Picture Experts Group.
NFC	Near Field Communication: standard for data transmission in the near range using radio technology.
OBD	On-Board Diagnostic System.
OCU	On-Board Connectivity Unit: control unit with emergency call module, communication unit and embedded eSIM.
PBAP	Phone Book Access Profile: manufacturer-independent technology for transmission of mobile telephone phone book data.
PIN	Personal Identification Number.
POI	Point of Interest.
QR Code	Quick Response Code: binary representation of coded data.
RDS	Radio Data System: Radio data system for additional services.
SIM	Subscriber Identity Module
SPP	Serial Port Profile: serial data transmission via Bluetooth®.
TCS	Traction control system
TIN	Tire Identification Number: tyre identification number.
TP	Traffic Programme in radio mode.
TWI	Tread Wear Indicator: tread wear indicator.
UMTS	Universal Mobile Telecommunications System: mobile communications standard that enables Internet access and other multimedia functions.
USB	Universal Serial Bus. Serial bus system for connecting external devices.
VIN	Vehicle identification number.
WLAN	Wireless Local Area Network: Wireless Local Area Network.
WMA	Format for compressing audio files.
WPA2	Wi-Fi Protected Access 2: Verschlüsselungsmethode für ein drahtloses Netzwerk.
WPS	Wi-Fi Protected Setup: Standard for simple setup of a wireless local area network with encryption.
XDS	Extension of the electronic differential lock. <span style="float: right;">◀</span>

# Index

## A

### Abroad

- Extended trips with your vehicle 134
- Selling the vehicle 134

### ABS

- see Brake support systems 190

### AC charging

- Charging power 391, 392

### ACC

- see Adaptive Cruise Control (ACC) 151

### Accessing service schedules

- 30

### Accessories

- 362

### Accident

- What to do 67

### Acoustic warnings

- Seat belt not fastened 37
- Warning and indicator lamps 15

### Activating functions

- Troubleshooting 206

### Activating the vehicle's drive system

- 137, 138

### Activating We Connect Start

- 202

### Adaptive chassis control (DCC)

- see Driving profile selection 143
- Troubleshooting 144

### Adaptive Cruise Control

- see Adaptive Cruise Control (ACC) 151

### Adaptive Cruise Control (ACC)

- 151
- Driving situations 151
- Overtaking assistance 152
- Overtaking prevention 152
- Predictive cruise control 156
- Radar sensor 151, 152
- Setting 155
- Switching on and off 154
- System limits 152
- Troubleshooting 156

### Adjusting

- Correct sitting position 35
- Electrically adjustable front seat 95
- Head restraints 99
- Headlight range 109
- Massage function 102
- Mechanically adjustable front seat 94

- Memory function 101
- Steering wheel 92

### Adjusting playback volume 226

### Advanced main-beam control (Dynamic Light Assist)

- 107
- Switching on and off 107

### Aerials 371

### Air Care

- see Air conditioning system 121, 123

### Air conditioning system

- 120
- Adjusting the temperature 121
- Air Care 121, 123
- Air distribution 121
- Air recirculation mode 123
- Automatic mode (AUTO) 121
- Blower 121
- Cooling mode 121
- Defrosting windows 121
- Eco 120
- Maximum cooling output 121
- Overview 121
- Rear window heating 121
- Seat heating 124
- Seat-occupied recognition system 120
- Steering wheel heating 121, 125
- Switching off 121
- Troubleshooting 126
- Windscreen heating 121, 125

### Air pressure

- see Tyre pressure 332

### Air recirculation mode

- Air Care 123
- see Air conditioning system 123

### Airbag system

- 47
- Central airbag 56
- Curtain airbags 55
- Description 50
- Faults 364
- Front airbags 52
- Function 50
- Indicator lamp 49
- Repairs 364
- Side airbags 54
- Switching off the front passenger front airbag 53
- Using child seats 53

<b>Alarm system</b>	83	Electronic brake pressure distribution (EBD)	190
<b>All-wheel drive</b>		Electronic differential lock (EDL)	190
Winter tyres	339	Electronic Stability Control (ESC)	190, 191
<b>All-year tyres</b>	339	Emergency Assist	171
<b>Android Auto™</b>		Lane change system (Side Assist)	172
Connecting	213	Lane keeping system (Lane Assist)	165
Disconnecting	213	Park Distance Control	184
Menu	213	Proactive occupant protection system	45
Requirements	213	Rear Traffic Alert	188
Things to note	213	Rear view camera system	185
<b>Anti-freeze</b>	315	Recommendation for rest breaks	24
<b>Anti-lock brake system (ABS)</b>	190	Speed limiter	147
<b>Anti-theft alarm</b>	83	Speed limiter with predictive control	149
Anti-tow alarm	83	Swerve support	163
Description	83	Switching off	29
Interior monitoring system	83	Switching on	29
Trailer	268	Traction control system (TCS)	190
<b>Anti-theft wheel bolts</b>	343, 344	Travel Assist	168
<b>Anti-tow alarm</b>	83	Tyre monitoring system	325
<b>App-Connect</b>	210	Tyre Pressure Loss Indicator	325
Apps	211	<b>Assistance systems</b>	
Settings	212	Oncoming vehicle braking when turning	164
<b>Apple CarPlay</b>	212	<b>Asymmetrical tyres</b>	338
<b>Applications (apps)</b>	211	<b>Auto Hold function</b>	178
<b>Area monitoring system (Front Assist)</b>		<b>Automatic braking intervention</b>	182
see Front Assist	159	<b>Automatic gearbox</b>	
<b>Area View</b>	187	see Selecting a position	140
Areas of the screen	188	<b>Automatic headlights</b>	105
Operating Area View	188	<b>Automatic Post-Collision Braking System</b>	190
Screen	182	<b>Automatic switch-off for electrical consumers</b>	322
Screen areas	188	<b>Auxiliary equipment or body parts</b>	362
see Area View	187	<b>Axle weight</b>	391, 392
Switching on and off	188		
<b>Areas where special regulations apply</b>	248	<b>B</b>	
<b>Armrest</b>	100	<b>Background lighting</b>	112
<b>Assist systems</b>		<b>Bag hook</b>	261
Adaptive Cruise Control (ACC)	151	<b>Ball coupling</b>	
Anti-lock brake system (ABS)	190	Fitting a bicycle carrier	267
Area monitoring system (Front Assist)	159	Indicator lamp	267
Area View	187	Swivelling out	266
Auto Hold function	178	<b>BAS</b>	
Automatic Post-Collision Braking System	190	see Brake support systems	190
Brake Assist system	190	<b>Battery capacity</b>	391, 392
Brake blending	191		
Car2X communication	198		
Cruise control system	145		
Driver Alert System	24		
Driving profile selection	143		
Dynamic Road Sign Display	25		

<b>Battery charge limits</b>	277	Brake fluid level	319
<b>Belt retractor</b>	44	Brake pads	131, 134
<b>Belt status display</b>		Brake support systems	189
see Seat belts	37	Changing the brake fluid	319
<b>Belt tension limiter</b>	44	Electromechanical brake servo	190
<b>Belt tensioner</b>	44	Electronic parking brake	177
Disposal	45	Emergency braking function	178
Service and disposal	45	Parking brake	177
<b>Bench seat</b>	97	Running in brake pads	131
<b>Bicycle carrier</b>		<b>Braking intervention</b>	
Fitting on the ball coupling	267	Automatic	182
<b>Black ice warning</b>	23	Damage minimisation	182
<b>Bluetooth</b>	216	<b>Break recommendation</b>	
Profile	216	Switching on and off	25
<b>Bonnet</b>		<b>Breakdown</b>	
Closing	312	Making your vehicle safe	66
Display	313	<b>Breakdown set</b>	348
Opening	312	Check after driving for 10 minutes	351
Warning lamp	313	Contents	349
<b>Bonnet space</b>		Inflating the tyre	350
Preparations	311	Preparations	350
Safety notes	309	Sealing the tyre	350
<b>Boot</b>		When not to use	348
see Luggage compartment	254	<b>Buckle-up request</b>	
<b>Boot lid</b>	84	see Seat belts	37
Closing	88	<b>Bulb failure</b>	
Closing automatically	88	see Changing bulbs	295
Driving with an open boot lid	133	<b>Button cell</b>	
Electrically closing	86	Replacing in the vehicle key	74
Electrically opening	86		
Opening	87	<b>C</b>	
Opening automatically	87	<b>Camera</b>	159
<b>Brake Assist system</b>	190	<b>Cameras</b>	
<b>Brake blending</b>	191	Add-on parts	363
<b>Brake energy recuperation (energy recovery)</b>	134	Damage	363
ECO assistance	136	Repairs	363
<b>Brake fluid</b>	318	<b>Car wash</b>	
Specification	319	Parking brake	177
<b>Brake servo</b>	189, 190	Vehicle care	355
<b>Brake support systems</b>	189	<b>Car2X communication</b>	198
ABS	189	Switching on and off	199
BAS	189	System limits	199
EDL	189	Troubleshooting	200
ESC	189	<b>Care</b>	
TCS	189	see Vehicle care	355
XDS	189	<b>CCS</b>	
<b>Brake system</b>		see Cruise control system	145
Malfunction	134	<b>Central airbag</b>	
<b>Brakes</b>	189	see Airbag system	56
Brake fluid	318	<b>Central locking</b>	

Anti-theft alarm	83	<b>Charging connector</b>	
Central locking button	77, 79	Current identification	281
Central locking touch control	79	Lever for manual release	286
Description	79	Manual releasing	286
Locking and unlocking from the inside	79	Unlocking	281
Single door unlocking	79	<b>Charging infrastructure</b>	
<b>Central locking system</b>		Current identification	281
SAFELOCK	81	<b>Charging power</b>	391, 392
<b>Centre armrest</b>	100	<b>Charging process display</b>	284
<b>Changing a wheel</b>	343	<b>Charging settings</b>	
Lifting the vehicle	345	Overview	277
Preparations	343	<b>Charging socket</b>	
Wheel bolts	344	Illumination	285
<b>Changing bulbs</b>	295	<b>Charging stations</b>	
Checklist	295	Navigation	244
Preparations	295	<b>Chassis</b>	
<b>Changing gear</b>		see Driving profile selection	143
see Selecting a position	140	<b>Checklist</b>	
<b>Changing lights</b>		Before working in the bonnet	
see Changing bulbs	295	space	311
<b>Charge level</b>		Breakdown	66
Display	19	Breakdown set	350
<b>Charging</b>		Changing bulbs	295
Charging process display	284	Charging the high-voltage battery	279
Charging station (AC)	281	Checks when charging	33
Connecting the charging cable	281, 283	Driving abroad	33
Fast charging station	283	Driving safety	32
High-voltage battery	279	Emergency	66, 67
LED light unit on the charging socket	284	Lifting the vehicle with the jack	346
Mains socket	281	Park Distance Control	180
Manually releasing the charging connector	286	Preparation for changing a wheel	343
Setting a departure time	279	Preparing for a journey	32
Wall box	281	Rear view camera system	180
With alternating current (AC)	281	Releasing the charging connector	286
With direct current (DC)	283	Requirements for Android Auto™	213
<b>Charging cable</b>		Seat belts	41
Charging station with alternating current (AC)	289	Using seat belts	41
Cleaning	287	What to do after an accident	67
General information	287	What to do in the event of a fire	68
Mains socket	290	<b>Checks when charging</b>	
<b>Charging cable for mains sockets</b>		Checklist	33
Fault displays	291	<b>Cheque cards, data loss</b>	250
Operation	290	<b>Child seat</b>	57
Overheating	291	Airbag sticker	60
Setting the charging current	291	Approval categories	59
Status indicators	290	Securing systems	61
		Securing with a lockable seat belt	65



Securing with a seat belt	65	<b>Conversions</b>	362, 370
Securing with i-Size	62	<b>Coolant</b>	315
Securing with ISOFIX	62	Checking the coolant level	316
Securing with the top tether	64	Filler opening	316
Standards	58	Refilling	316
Switching off the front passenger front airbag	53	Specification	315
Weight classes	58	<b>Copyright law</b>	227
<b>Childproof lock</b>		<b>Cornering light</b>	105
Electrical	81	Dynamic	105
<b>Cleaning</b>		Things to note	111
see Vehicle care	355	<b>Counter steering assistance</b>	142
<b>Climatronic</b>		<b>Cruise control system</b>	145
see Air conditioning system	120	Displays	145
<b>Clock</b>	29	Operating	146
<b>Closing</b>		<b>Cruise control system (CCS)</b>	
Doors	77	Troubleshooting	147
Sun blind in the glass roof	119	<b>Curtain airbags</b>	
Windows	89	see Airbag system	55
<b>Cockpit</b>	10	<b>Customer Care - Call Centre</b>	203
<b>Comfort drive (Travel Assist)</b>		<b>Customer information</b>	366
see Travel Assist	168	<b>Customer Interaction Centre</b>	203
<b>Comfort tyre pressure</b>	333	<b>Customer Support</b>	203
<b>Coming home and Leaving home function</b>		<b>Cybersecurity</b>	195
see entry and exit lighting	109	<b>Cyclist Monitoring</b>	163
<b>Commercial vehicle registration</b>	373		
<b>Component protection</b>	372	<b>D</b>	
<b>Connection</b>		<b>Dash panel</b>	10
Bluetooth	216	Airbag system	47
Cable	215	<b>Data connection</b>	
USB	215	see Internet	208
Wireless	215, 216	<b>Data Link Connector (DLC)</b>	367
<b>Connectivity components</b>	195	<b>Data memory</b>	
<b>Consumables</b>	313	Data services	366
<b>Continuous parking light</b>	108	Infotainment functions	368
<b>Control elements</b>	222	<b>Data storage</b>	
<b>Control units</b>		Control units	366
Reprogramming	368	Disclosure of data	367
System update	196	Event data recorder	369
<b>Controls</b>		Event memory	367
Cleaning and care	359	Integration of mobile devices	368
Electrically adjustable front seat	95	On-board diagnostic system (OBD)	367
Mechanically adjustable front seat	94	Online services	369
<b>Convenience closing</b>		Operating data in the vehicle	367
Windows	90	Personal reference	367
<b>Convenience functions</b>		Rights	367
Reprogramming	368	<b>Data transfer</b>	195
<b>Convenience opening</b>		Blocking	204
Windows	90	Unblocking	204
<b>Convenience turn signal</b>	102	<b>Daytime running lights</b>	103
		<b>DC charging</b>	

Charging power	391, 392	Travel Assist	169
<b>DCC</b>		Warning and information messages	23
see Driving profile selection	143		
<b>De-icing</b>		<b>Displays, screens</b>	
see Air conditioning system	125	Cleaning and care	359
<b>Deactivating</b>		<b>Disposal</b>	
We Connect Start services	203	Airbag system	373
<b>Deactivating the vehicle's drive system</b>	138	Belt tensioner	45
<b>Deactivating We Connect Start services</b>	203	End-of-life vehicle	373
<b>Declaration of conformity</b>	372, 374	Used batteries and electronic devices	372
Radio systems	380	<b>Doors</b>	77
<b>Defrost function</b>	121	Childproof lock	81
<b>Defrosting</b>		Manual opening and closing	80
see Air conditioning system	125	<b>Drawbar load</b>	
see Defrost function	121	Loading a trailer	269
<b>Diagnostic connection</b>	367	<b>Driver Alert System</b>	24
<b>Differential lock</b>		Function	24
see Electronic differential lock (EDL)	190	Operation	24
<b>Digital clock</b>	29	Switching on and off	25
<b>Digital instrument cluster</b>		<b>Driving</b>	
Display	18	Economically	130
<b>Dimensions</b>	390	Parking on a downhill gradient	176
<b>Directive</b>		Parking on an uphill gradient	176
2014/53/EU	374	Preparing for a journey	32
TR-355	374	Pulling away on uphill gradients	141
<b>Directive 2014/53/EU</b>	374	Stopping on uphill gradients	141
<b>Directive TR-355</b>	374	Water on the roads	133
<b>Display and operating unit</b>		With a trailer	270
10"	222	With respect for the environment	130
<b>Displays</b>	22	<b>Driving abroad</b>	
Area View	182	Checklist	33
Black ice warning	23	Headlights	110
Bonnet	313	<b>Driving economically</b>	130
Cruise control system	145	<b>Driving profile</b>	
Dynamic Road Sign Display	26	see Driving profile selection	143
Eco assistance	28	<b>Driving profile selection</b>	143
Emergency Assist	171	Adaptive chassis control (DCC)	143
ID. Cockpit	22	Characteristics of the driving profiles	144
Lane keeping system (Lane Assist)	167	Proactive occupant protection system	47
Mileage displays	23	Setting a driving profile	143
Open doors, bonnet and boot lid	23	Troubleshooting	144
Parking systems	181	Warning lamp	144
Proactive occupant protection system	47	<b>Driving safety</b>	32
Range	23	<b>Driving through water</b>	133
Rear view camera system	181	<b>Driving with respect for the environment</b>	130
Service interval display	30	<b>Dynamic cornering light</b>	
Speed limiter	147	Malfunction	105
Speed warning	23		

<b>Dynamic Road Sign Display</b>	25, 26	Checklist	66
Display	26	Fire extinguisher	68
Function	25	First-aid box	68
Function limitations	27	First-aid pack	68
Speed warning	26	Hazard warning lights	66
Trailers	27	Making you and your vehicle safe	66
		Warning triangle	68
<b>E</b>		<b>Emergency Assist</b>	171
<b>Earth connection</b>	302	Displays	171
<b>EBD</b>		Switching on and off	171
see Brake support systems	190	Troubleshooting	172
<b>eCall</b>	69	<b>Emergency braking</b>	182
<b>eCall Emergency System</b>	69	<b>Emergency braking function</b>	178
<b>Eco</b>		<b>Emergency switch-off</b>	140
Air conditioning system	120	<b>Energy recovery</b>	134
<b>Eco Assistance</b>		<b>Engine and ignition</b>	
Displayed symbols	28	Immobiliser	139
Efficient driving	28	Unauthorised vehicle key	139
<b>EDL</b>		<b>Engine code</b>	389, 391, 392
see Brake support systems	190	<b>Engine compartment</b>	
<b>Electric drive</b>		see Bonnet space	309
Activating and deactivating the vehicle's drive system	137	see Front compartment	309
Activating the vehicle's drive system	138	<b>Engine sound</b>	
Brake energy recuperation (energy recovery)	134	Electronic engine sound	139
Crawling function	135	<b>Entry lighting</b>	109
Deactivating	138	<b>Equipment scope</b>	
Power output of the electric drive	134	Mobile phone interface	246
Switching off crawling function	135	<b>ESC</b>	
Technical data	391	see Brake support systems	191
What to do after an accident or in case of fire	67	<b>ESC Sport</b>	
<b>Electric windows</b>		Switching on and off	191
see Windows	89	<b>Event data recorder</b>	369
<b>Electrical devices</b>	194	<b>Event memory</b>	
<b>Electromechanical brake servo</b>	190	Connector	367
see Brake support systems	190	<b>Exit lighting</b>	109
<b>Electromechanical steering</b>	142	<b>Exit menu</b>	31
<b>Electronic brake pressure distribution system (EBD)</b>	190	<b>Explosion hazard areas</b>	248
<b>Electronic differential lock (EDL)</b>	190	<b>Exterior mirrors</b>	117
<b>Electronic engine sound</b>	139	Driving with a trailer	266
<b>Electronic immobiliser</b>	139	Folding in	117
<b>Electronic parking brake</b>	177	Saving settings for reversing	117
<b>Electronic Stability Control (ESC)</b>	190, 191	Synchronous mirror adjustment	117
<b>Email</b>	251	<b>External audio sources</b>	
<b>Emergency</b>	66	Adjusting volume	226
Breakdown	66	Bluetooth audio	216
		<b>F</b>	
		<b>Fabrics</b>	
		Cleaning and care	359
		<b>Fast charging</b>	283

<b>Fastening rings</b>	259	Rear view camera system	181
<b>Fault memory</b>		<b>Fuses</b>	296
see Event memory	367	Changing	300
<b>Filling</b>		Colour coding of fuses	301
Safety notes	309	Detecting a blown fuse	301
<b>Fire</b>		In the bonnet space	298
What to do	67	In the dash panel	299
<b>Fire extinguisher</b>	69	Preparation for changing	301
<b>First-aid box</b>		Types	300
see First-aid kit	68	<b>G</b>	
<b>First-aid kit</b>	68	<b>General notes</b>	32
Storage location	68	<b>Glass roof</b>	
<b>First-aid pack</b>		Sun blind in the glass roof	119
see First-aid kit	68	<b>Gradient angle</b>	387
<b>Floor mats</b>	129	<b>Gross combination weight</b>	
<b>Frequency bands</b>	232	Information	387
<b>Front airbags</b>		<b>H</b>	
see Airbag system	52	<b>Handbrake</b>	
<b>Front Assist</b>	159	see Parking brake	177
Advance warning	161	<b>Hazard warning lights</b>	66
Camera	159	<b>Head restraint</b>	99
Cyclist monitoring	163	<b>Head restraints</b>	98
Distance warning	161	Removing and installing	99
Oncoming vehicle braking when turn-		<b>Head-up display</b>	21
ing	164	Adjusting	22
Operating	164	Adjusting the height	22
Pedestrian Monitoring	163	Display areas	21
Problem solving	165	Switching off	22
Radar sensor	159	Switching on	22
Swerve support	163	<b>Headlight range control</b>	109
Switching off	164	<b>Headlights</b>	
System boundaries	162	Driving abroad	110
Urgent warning	161	<b>Heated seats</b>	
<b>Front compartment</b>	309	see Air conditioning system	124
Vehicle battery (12-volt)	320	<b>Help apps</b>	203
<b>Front passenger exterior mirror lowering</b>	117	<b>Help for mobile online services</b>	203
<b>Front passenger front airbag</b>		<b>High-visibility waistcoat</b>	68, 69
see Airbag system	47	<b>High-voltage battery</b>	273
Switching off with key-operated		AC charging	281
switch	53	Battery capacity	275, 391, 392
<b>Front seats</b>	93	Battery care	276
Electrical controls	95	Battery charge limits	277
Electrically adjusting	95	Care instructions	275, 276
Mechanical controls	94	Charge level	19
Mechanically adjusting	94	Charging	279
<b>Function buttons</b>		Charging power	391, 392
Area View	182	Charging process display	284
Manoeuvre braking	181	Charging settings	276
Park Distance Control	181		
Parking systems	181		

Current identification	281	Active charging process	284
DC charging	283	Charging active	282
External energy management	278	Charging connector plugged in	283
Frost	276	Electromechanical brake servo	191
Immediate charging	276	<b>Indicator lamps</b>	
Off-peak tariff online	278	ABS	191
Outside temperatures	276	Airbag system	49
Preferred charging times	278	Ball coupling	267
Range	19	Brake pad wear indicator	131
Reducing the charging current	278	Brake support systems	191
Releasing the charging connector	278	Central locking	78
Reserve range	19	ESC	191
Safety instructions	273	In the driver door	78
Setting charging locations	278	Overview	15
Start screen	276	Position selection	142
Timer-controlled charging	276	Seat belts	37
Vehicle standing times	276	Steering column lock	143
<b>High-voltage system</b>		Tyre monitoring system	327
Safety instructions	273	<b>Infotainment</b>	
Warning signs	274	Function buttons	225
<b>Hill Start Assist</b>		Getting started	217
See Auto Hold function	178	Media mode	234
<b>Hood</b>		Mobile phone interface	246
see Bonnet	312	Navigation	238
<b>How do I activate We Connect?</b>	203	Radio	231
<b>How do I connect my vehicle?</b>	203	Radio mode	231
<b>How do I use the We Connect service?</b>	203	Sound settings	226
<b>Hubcaps</b>	341	System settings	226
Centre wheel trim	341	<b>Infotainment system</b>	217
Wheel bolt caps	342	Adapting menus	225
Wheel cover	342	aerials	371
		Before using for the first time	217
		Charging settings (high-voltage battery)	276
		Cleaning	227
		Control centre	225
		Controls and display	30
		Drop-down menu	225
		Notes on use	220
		Operating	224
		Overview	222
		Personalising	225
		Safety notes	218
		Setting battery charge limits	277
		Setting charging locations	278
		Start screen	222, 224
		Switching on and off	224
		Tiles	225
		Time and date	29
		Vehicle settings menu	31
		<b>Infotainment systems</b>	
<b>Ice removal</b>			
see Defrost function	121		
<b>ID. Cockpit</b>			
Digital instrument cluster	18		
Displays	22		
Event in the ID. Cockpit	18		
Views	19		
<b>ID. Light</b>	31		
Displayed information	31		
Settings	31		
<b>Identification number</b>	387		
Position	388		
<b>Ignition</b>			
Switching off the ignition	137		
Switching on the ignition	137		
<b>Immobiliser</b>	139		
<b>Indicator lamp</b>			

Carrying out functions	224	Troubleshooting	174
<b>Inspection</b>	30, 354	<b>Lane keeping system (Lane Assist)</b>	165
<b>Inspection now!</b>	30	Displays	167
<b>Instrument cluster</b>	18	Switching on and off	166
Service interval display	30	System limits	165
Symbols	15	Troubleshooting	167
Warning and indicator lamps	15	<b>Leatherette</b>	
<b>Interior mirror</b>	116	Cleaning and care	359
<b>Interior monitoring system</b>	83	<b>Leaving the vehicle</b>	138
Risk of false alarm	84	<b>LED lights</b>	295
<b>Internet</b>		<b>Legal requirements</b>	202
Quick connection	209	<b>Licences</b>	227
Setting up a data connection	208	<b>Lifting the vehicle</b>	
Wi-Fi Client	210	Checklist	346
Wi-Fi hotspot	208	Jack	345
<b>Internet Radio</b>	234	With the jack	345
<b>ISOFIX</b>	62	<b>Light</b>	
see Child seat	57	Entry and exit lighting	109
<b>J</b>		<b>Light Assist</b>	
<b>Jack</b>	343	see Main-beam control	105
<b>Jump starting</b>		<b>Lights</b>	102
Earth connection	302	Advanced main-beam control (Dynamic Light Assist)	107
Jump leads	302	AUTO	105
Jump-start connection point (earth connection)	302	Automatic switch-off of side lights and parking lights	108
Procedure	302	Background lighting	112
<b>K</b>		Continuous parking light on both sides of the vehicle	108
<b>Kerb weight</b>	391, 392	Cornering light	105
<b>Key</b>		Daytime running lights	103
Vehicle key	73	Dynamic headlight range control	110
<b>Key-operated switch</b>		Functions	104
Switching off front passenger front air-bag	53	Headlight range control	109
<b>Keyless Access</b>	75	Instrument and switch lighting	111
Emergency switch-off	140	Interior and reading lights	111
Steering column lock	142	Main-beam control	105
<b>Keyless locking and starting system Keyless Access</b>		Poor weather light	104
see Keyless Access	75	Rear fog light	104
<b>L</b>		Side lights	104
<b>Lane Assist</b>		Switching on and off	103
see Lane keeping system (Lane Assist)	165	Turn signals	102
<b>Lane change system (Side Assist)</b>	172	Vehicle lighting	103
Side Assist Plus	174	<b>Limiters</b>	
Switching on and off	173	see Speed limiter	147
System limits	172	<b>Load carrier</b>	262
		<b>Load compartment net</b>	260
		<b>Load-through hatch</b>	261
		<b>Loading</b>	
		Driving with an open boot lid	133

Fastening rings	259	Streaming services	237
General information	254	Using streaming services	237
Load-through hatch	261	Video mode	238
Luggage compartment	254	<b>MEDIA</b>	
Trailer	269	Bluetooth audio	216
<b>Locking</b>		<b>Media connections</b>	215
From the inside	79	<b>Media mode</b>	234
<b>Luggage compartment</b>	254	Equipment	235
Luggage compartment cover	255	Symbols	235
Luggage compartment floor	255	<b>Memory function</b>	101
Luggage compartment floor (second)	256	<b>Menu</b>	
Luggage net	260	Android Auto™	213
Partition	257, 258	Apple CarPlay	212
<b>Luggage compartment cover</b>	255	Radio	231
<b>Luggage compartment equipment</b>	259	<b>Microfibre fabrics</b>	
<b>Luggage compartment floor</b>	255	Cleaning and care	359
<b>Luggage compartment floor (second)</b>	256	<b>Mileage</b>	29
<b>Luggage net</b>	260	<b>Mileage recorder</b>	
		see Infotainment system	18
		<b>MirrorLink</b>	214
		Connecting	214
		<b>Mirrors</b>	115
		Convenience functions	117
		Exterior mirrors	117
		Front passenger exterior mirror lowering function	117
		Interior mirror	116
		Synchronous mirror adjustment	117
		<b>Mobile device</b>	
		Switching off	248
		<b>Mobile phone interface</b>	246
		Basic	250
		Comfort	250
		Equipment	246
		Explosion hazard areas	248
		Pairing	248
		Switching off	248
		Symbols	246
		User profiles	249
		<b>Mobile telephone</b>	
		Use without external aerial	365
		<b>Modifications to the vehicle</b>	362
		Plates	370
		Stickers	370
		<b>Multicollision brake</b>	
		see Automatic Post-Collision Braking System	190
		<b>N</b>	
		<b>Natural leather</b>	
		Cleaning and care	359

<b>Navigation</b>	238, 240, 242	<b>Old tyres</b>	329
Additional window	245	<b>On-board diagnostic system (OBD)</b>	367
Controlling the map	239	<b>Oncoming vehicle braking when turning</b>	164
Controlling the navigation map	239	<b>Online functions</b>	
Detailed view	245	Radio	233
Edit route	245	<b>Online services</b>	200
Entering an address for route guidance	242	<b>Online system update</b>	196
Equipment level	240	<b>Online vehicle functions</b>	205
Favourite destinations	243	<b>Opening</b>	
Function: destination input	242	Doors	77
Further options	245	Sun blind in the glass roof	119
Last destinations	242, 243	Windows	89
Learn usage patterns	245	<b>Operation</b>	
Map	239, 243	Park Distance Control	185
Navigation announcements	238	<b>Orientation lighting</b>	109
Navigation map	239	<b>Other applicable documents</b>	217
Offroad mode	243	<b>Overview</b>	
Operating the map	243	Centre console	13
Personal POIs	242	Driver door	9
Predictive navigation	242	Driver side	10
Restrictions	239	Front passenger side	14
Route plan	245	Front view	7
Saved data	239, 245	Rear view	8
Saving destinations	243	Roof	14
Selecting alternative charging stations	244	Vehicle	7
Selecting charging stations	244	Warning and indicator lamps	15
Stored destinations	243	<b>Overview of indicator lamps</b>	15
Suggestions	242	<b>Overview of warning lamps</b>	15
Symbols	240		
Traffic reports	244	<b>P</b>	
Updating navigation data	241	<b>Park Distance Control</b>	
Using contact data	243	Checklist	180
Using the map for destination input	243	Malfunction	184
Zooming into the map	239	Operating	185
Zooming into the navigation map	239	Prerequisites	180
Zooming out of the map	239	<b>Parking</b>	176
Zooming out of the navigation map	239	<b>Parking brake</b>	177
<b>New tyres</b>	329	Automatic switch-on	177
<b>Noises</b>		Car wash	177
Brake support systems	192	Emergency braking function	178
<b>Notes on driving</b>	129	Rolling capability	177
<b>Number of seats</b>	34	Switching off	177
		Switching on	177
		Troubleshooting	178
		<b>Parking light</b>	108
		Switching on and off	108
		<b>Parking systems</b>	
		Displays	181
		Function buttons	181
		General information	179
<b>O</b>			
<b>Odometer</b>			
see View summary	18		



Settings	181	Front Assist	165
Troubleshooting	183	<b>Proof of ownership</b>	202
<b>ParkPilot</b>		<b>Protection from the sun</b>	118
see Park Distance Control	184		
<b>Partition</b>	257, 258	<b>Q</b>	
<b>Parts</b>	362	<b>Qi charging function</b>	250
<b>PDC</b>			
see Park Distance Control	184	<b>R</b>	
<b>Pedals</b>	36, 129	<b>Radar sensor</b>	151, 152, 159
<b>Pedestrian Monitoring</b>	163	Impairment by stickers or add-on parts	363
<b>Performance figures</b>	387	<b>Radio</b>	
<b>Plastic parts</b>		Equipment scope	231
Cleaning and care	359	Frequency bands	232
<b>Plates</b>	370	Internet Radio	234
<b>Position selection</b>		Online functions	233
Pulling away on uphill gradients	141	Reception mode	232
Stopping on uphill gradients	141	Station buttons	232
Warning and indicator lamps	142	Symbols	231
<b>Power display</b>	20	TP (Traffic Programme)	234
<b>Power output of the electric drive</b>	134	Tuning to stations	232
<b>Predictive cruise control</b>	156	<b>Radio device</b>	365
Activating	158	<b>Radio mode</b>	231
System limits	157	<b>Rain and light sensor</b>	114
Troubleshooting	159	Malfunction	115
<b>Predictive Cruise Control</b>		<b>Range</b>	
see Predictive cruise control	156	Display	19
<b>Preparations</b>		<b>Rear bench seat</b>	97
Before every journey	32	<b>Rear seat backrest</b>	
Breakdown set	350	Folding backwards	97
Changing a wheel	343	Folding forwards	97
Changing bulbs	295	<b>Rear seats</b>	96
Checking the coolant level	316	<b>Rear Traffic Alert</b>	188
Refilling coolant	316	Operating	188
Vehicle battery (12-volt)	321	Switching on and off	188
Working in the bonnet space	311	<b>Rear View</b>	
<b>Preparing for a journey</b>	32	see Rear view camera system	185
<b>Prerequisites for activating the vehicle's drive system</b>	138	<b>Rear view camera cleaning system</b>	114
<b>Privacy</b>		<b>Rear view camera system</b>	185
Settings	204	Checklist	180
<b>Privacy settings</b>	204	Operating	186
<b>Proactive occupant protection system</b>	45	Parking	186
Autonomous Emergency Braking (Front Assist)	46	Prerequisites	180
Displays	47	Switching off	186
Driving profile selection	47	Switching on	186
Emergency Assist	46	Trailer support	187
Malfunction	47	<b>Rear view mirror</b>	116
<b>Problem solving</b>		<b>Rear window heating</b>	
Charging time changes (fast charging)	286	see Air conditioning system	121
		<b>Recommendation for rest breaks</b>	24

Function	24	Manoeuvre braking	181
Operation	24	Park Distance Control	181
<b>Recuperation (energy recovery)</b>		<b>Seat belt height adjuster</b>	44
Activating	135	<b>Seat belt routing</b>	42
Display	135	<b>Seat belts</b>	36
Selecting level	135	Belt retractor	44
<b>Repairing stone chips (note)</b>	363	Belt status display	37
<b>Repairs</b>	362	Belt tension limiter	44
Airbag system	364	Belt tensioner	44
Plates	370	Buckle-up request	37
Stickers	370	Checklist	41
Windscreen	363	Cleaning and care	359
<b>Retrofitting a towing bracket</b>	266	Fastening	41
<b>Returning end-of-life vehicles</b>	373	Not fastened	39
<b>Returning end-of-life vehicles</b>	373	Seat belt height adjuster	44
<b>Reverse assistant</b>		Seat belt routing	42
see Rear view camera system	185	Twisted seat belt	41
<b>Reversible belt tensioning</b>	45	Unfastening	41
<b>Roll-back function</b>		Use	41
Sun blind in the glass roof	119	Warning lamp	37
Windows	91	<b>Seat covers</b>	
<b>Rolling capability</b>		Cleaning and care	359
Parking brake	177	<b>Seat cushions with seat heating</b>	
<b>Roof carrier</b>	262	Cleaning and care	359
Loading	263	<b>Seat functions</b>	100
Notes on use	264	<b>Seat heating</b>	
Securing	263	see Air conditioning system	124
<b>Roof load</b>	263	<b>Seat-occupied recognition system</b>	
Technical data	263	see Air conditioning system	120
<b>Roof rack</b>	262	<b>Seats</b>	34, 93
<b>Rubber seals</b>		Adjusting the head restraints	99
Cleaning and care	359	Adjusting the steering wheel position	92
<b>Running in</b>		Correct sitting position	35
Brake pads	131	Electrically adjustable front seat	95
Tyres	330	Incorrect sitting position	35
<b>Running in brake pads</b>		Massage function	102
see Brakes	131	Mechanically adjustable front seat	94
		Memory function	101
		Number of seats	34
		Rear seat backrest	97
		Removing and installing the head restraints	99
		Seat heating	124
		Sitting position	34
		<b>Seats with airbag components</b>	
		Cleaning and care	359
		<b>Selecting a position</b>	140
		<b>Selling the vehicle</b>	202
		In other countries/continents	134

## S

### SAFELOCK

Safelock	81
SAFELOCK	81

<b>Safety certificate</b>	389
---------------------------	-----

<b>Safety equipment</b>	50
-------------------------	----

<b>Safety notes</b>	218
---------------------	-----

<b>Scanning QR code</b>	202
-------------------------	-----

<b>Scrapping</b>	373
------------------	-----

<b>Screen</b>	222
---------------	-----

Cleaning	227
----------	-----

<b>Screen displays</b>	
------------------------	--

<b>Sensor fields</b>	222	<b>Special features</b>	371
<b>Sensors</b>		Infotainment system	371
Add-on parts	363	<b>Speed index</b>	338
Damage	363	<b>Speed limiter</b>	147
Repairs	363	Displays	147
<b>Service</b>		Operating	148
Digital service schedule	353	Troubleshooting	148
Inspection	354	<b>Speed limiter with predictive control</b>	149
Operating conditions	354	Activating	150
Scope of service	354	Operation	150
Service record	353	System limits	149
Service repairs	353	Troubleshooting	150
Vehicle data sticker	353	<b>Static cornering light</b>	
<b>Service fluids</b>	313	see Cornering light	105
<b>Service interval display</b>	29, 30	<b>Stationary air conditioning</b>	
<b>Service menu</b>	29	Programming	128
Resetting trip	29	Switching on	127, 128
Service interval display	29	<b>Steering</b>	
<b>Service position</b>		Counter steering assistance	142
Windscreen wipers	293	Electromechanical	142
<b>Setting</b>		Electronic steering column lock	142
Time and date	29	Indicator lamp	143
<b>Setting the time and date</b>	29	Power steering	142
<b>Setting views</b>		Warning lamp	143
Multifunction steering wheel	19	<b>Steering wheel</b>	92
<b>Settings</b>		Adjusting	92
App-Connect	212	Heating	125
Area View	182	<b>Steering wheel heating</b>	
Parking systems	181	see Air conditioning system	125
Rear view camera system	181	<b>Stickers</b>	370
Wi-Fi	210	<b>Stowage areas</b>	193
<b>Setup</b>		<b>Stowing loads</b>	254
Head-up display	22	<b>Stowing luggage</b>	254
Park Distance Control	181	<b>Sun blind in the glass roof</b>	
<b>Side airbags</b>		Opening and closing	119
see Airbag system	54	Roll-back function	119
<b>Side Assist</b>		<b>Sun visors</b>	118
see Lane change system (Side Assist)	172	<b>Support</b>	203
<b>Side lights</b>	104	<b>Swerve support</b>	163
<b>Signal strength display</b>	205	<b>Switch-off for electrical consumers</b>	322
<b>Single door unlocking</b>	79	<b>Switching main beam on and off</b>	105
<b>Snow chains</b>	340	<b>Switching off</b>	
<b>Sockets</b>	193	Mobile device	248
12-volt	194	Mobile phone interface	248
Trailer	268	Telephone	248
<b>Sound settings</b>	226	<b>Switching turn signals on and off</b>	102
<b>Sound system</b>	221	<b>Symbols</b>	
<b>Spanner symbol</b>	30	Mobile phone interface	246
<b>Spare key</b>	73	see Warning and indicator lamps	15
<b>Spares</b>	362	<b>System</b>	
		Traffic hazard alert	199

<b>System limits</b>			
Car2X communication	199	Android Auto™	213
<b>System settings</b>	226	Car wash	356
<b>System update</b>	196	Component protection	372
<b>Systems</b>		Hand wash	356
ABS	190	High-pressure cleaner	356
Anti-lock brake system (ABS)	190	Towing	304, 305
BAS	190	Travel mode	105
Brake Assist system (BAS)	190	<b>Tightening torque</b>	
EDL	190	Wheel bolts	345
Electronic differential lock (EDL)	190	<b>Tools</b>	
Proactive occupant protection system	45	see Vehicle toolkit	292
TCS	190	<b>Top tether</b>	
Traction control system (TCS)	190	see Child seat	57
XDS	190	<b>Torque</b>	391, 392
<b>T</b>		<b>Touchscreen</b>	222
<b>Tailgate</b>		<b>Tow-starting</b>	301
see Boot lid	84	<b>Towing</b>	304
<b>TCS</b>		Front towing eye	307
see Brake support systems	190	Preparations	306
<b>Technical data</b>	387	Rear towing eye	307
Dimensions	390	Things to note	304, 305
Engine code	389	Tow-bar	305
Factory plate	389	Tow-rope	305
General information	387	When not to tow	305
Gross combination weight	387	<b>Towing a trailer</b>	264
Information on the gradient angle	387	<b>Towing bracket</b>	
Information on weights	387	Fitting a bicycle carrier	267
Notes	387	Malfunction	268
Performance figures	387	Retrofitting	272
Roof load	263	see Trailer towing	264
Safety certificate	389	Swivelling out	266
Type plate	389	<b>TP (Traffic Programme)</b>	
Tyre pressure	332	EON	234
Vehicle data sticker	389	Function	234
Vehicle identification number	389	<b>Traction control system (TCS)</b>	190
<b>Technical modifications</b>	362	<b>Traction hazard alert</b>	199
Plates	370	<b>Traffic information</b>	244
Stickers	370	<b>Traffic Programme</b>	
<b>Telephone</b>		see TP (Traffic Programme)	234
Connecting	248	<b>Trailer</b>	
Function: favourites	253	Anti-theft alarm	268
Function: speed dial buttons	253	Coupling	268
Know-how: contacts	252	Drawbar load	269
Know-how: telephone book	252	Driving	270
Switching off	248	Exterior mirrors	266
<b>Text message</b>	251	Headlight adjustment	270
<b>Things to note</b>		Hitching	268
		LED tail light clusters	266
		Loading	269
		Malfunction	268
		Maximum trailer weight	269

Retrofitting a towing bracket	272	Boot lid	89
see Trailer towing	264	Brake energy recuperation fault	142
Socket	268	Brake fluid level too low	319
Swivelling out the ball coupling	266	Brake servo	191
Tail light clusters	266	Brake support systems	191
Things to note	270	Brake system	134
Towing	270	Car2X communication	200
Trailer stabilisation	271	Central locking	75
<b>Trailer coupling</b>		Coolant indicator lamp	318
see Towing bracket	266	Coolant temperature display	318
<b>Trailer stabilisation</b>	271	Coolant warning lamp	318
<b>Trailer towing</b>		Cooling system: engine coolant level too low	318
Technical prerequisites	265	Cooling system: engine coolant temperature too high	318
<b>Transporting items</b>	254	Cooling system: fault in the coolant circuit	318
Bag hook	261	Cruise control system (CCS)	147
Driving tips	132	Deactivation of the drive is imminent	136
Driving with a trailer	270	Driving instructions	134
Driving with an open boot lid	133	Driving profile selection	144
Fastening rings	259	Easy Open	89
Load-through hatch	261	eCall emergency call system fault	71
Loading a trailer	269	eCall Emergency System restricted	71
Loading roof carriers	263	Electric drive	139
Luggage net	260	Electrical system overheated	142
Roof carrier	262	Electronic engine sound	140
Securing roof carriers	263	Electronic parking brake	178
Stowing loads	254	Electronic parking brake does not switch itself off	178
Stowing luggage	254	Electronic parking brake does not switch itself off completely	178
Trailer towing	264	Electronic parking brake fault	178
<b>Travel Assist</b>	168	Emergency Assist	172
Displays	169	Emergency start function	140
Switching on and off	170	Emergency switch-off	140
Troubleshooting	170	ESC fault	192
<b>Travel mode</b>	110	Exhaustive discharge (high-voltage battery)	285
Things to note	105	Fault in the high-voltage system	285
<b>Tread depth</b>	334	Front passenger front airbag deactivated	50
<b>Tread wear indicators</b>	334	Front passenger front airbag switched on	50
<b>Trim parts</b>		Heating and fresh air system	126
Cleaning and care	359	High-voltage battery is empty	285
<b>Trim strips</b>		Holding force of the electronic parking brake is insufficient	178
Cleaning and care	359	Ignition lock	139
<b>Trip recorder</b>	29	Immobiliser	139, 140
<b>Troubleshooting</b>			
Activating functions	207		
Adaptive chassis control (DCC)	144		
Adaptive Cruise Control (ACC)	156		
Air conditioning system	126		
Airbag system	50		
Airbag system deactivated	50		
Airbag triggering	82		
Alternator warning lamp	323		
Automatic locking	82		

Indicator lamp	82	Vehicle operation not possible	136
Indicator lamp in the vehicle key	75	Vision	114
Keyless Access	76, 82, 140	Voice control	230
Lane change system	174	Washer fluid level	114
Lane keeping system (Lane Assist)	167	Water under the vehicle	127
Lights	110	Window condensation	126
Low charge level	285	Wipers	114
Noises of the electronic parking brake	178	<b>Type plate</b>	389
One-touch opening and closing	91	<b>Tyre damage</b>	334
Parking system cameras	183	<b>Tyre load</b>	338
Parking system sensors	183	<b>Tyre Mobility System</b>	
Parking systems	183	see Breakdown set	348
Predictive cruise control	159	<b>Tyre monitoring system</b>	325
Proactive occupant protection system	47	Indicator lamp	327
Rain and light sensor	111, 115	Malfunction	327
Reduced power	137	Tyre Pressure Loss Indicator	325
Roll-back function	91	<b>Tyre pressure</b>	332
Sensors	77	Checking	333
Speed limiter	148	Comfort tyre pressure	333
Speed limiter with predictive control	150	<b>Tyre Pressure Loss Indicator</b>	325
Starter button	139, 140	Replacing tyres	330
Steering	143	<b>Tyre repair set</b>	
Steering column	143	see Breakdown set	348
Towing bracket	273	<b>Tyre wear</b>	334
Trailer turn signals	111	<b>Tyres</b>	
Travel Assist	170	see Wheels and tyres	328
Turn signals	77, 82, 89, 110	<b>Tyres with directional tread pattern</b>	338
Tyre monitoring system	327	<b>U</b>	
Tyre Pressure Loss Indicator	327	<b>Unlocking</b>	
Unit of temperature	126	From the inside	79
Vehicle battery (12-volt) is not charged	323	<b>Updating the software</b>	196
Vehicle battery (12-volt) warning lamp	323	<b>USB port</b>	215
Vehicle battery (12-Volt): 12-volt battery diagnosis	324	<b>User administration</b>	205
Vehicle battery (12-Volt): battery diagnosis	324	<b>Using the telephone</b>	251
Vehicle battery (12-Volt): checking the 12-volt battery	324	<b>V</b>	
Vehicle battery (12-volt): low charge level	324	<b>V2X communication</b>	
Vehicle battery (12-Volt): replacing the 12-volt battery	324	Traffic hazard alert	199
Vehicle battery (12-volt): vehicle will not restart	323	<b>Vanity mirrors</b>	118
Vehicle key not recognised	140	<b>Vehicle</b>	
Vehicle lighting	111	Lending or selling	202
		Locking and unlocking from the inside	79
		Making safe in the event of breakdown	66
		Parking on a downhill gradient	176
		Parking on an uphill gradient	176
		Recycling	373
		Returning	373

Unlocking or locking with Keyless Access	75	<b>Vehicle identification number</b>	387, 389
<b>Vehicle battery (12-volt)</b>	320	Displaying	29
Automatic switch-off for electrical consumers	322	Position	388
Charging	321	<b>Vehicle key</b>	73
Checking the electrolyte level	321	Replacing the button cell	74
Connecting	321	Spare key	73
Discharge	322	<b>Vehicle overview</b>	
Disconnecting	321	Driver side	10
Earth connection for jump starting	302	<b>Vehicle overviews</b>	
Explanation of symbols	320	Centre console	13
Jump starting	302	Driver door	9
Location	320	Front passenger side	14
Preparations	321	Front view	7
Replacing	321	Rear view	8
<b>Vehicle care</b>	355	Roof	14
Aerials	371	<b>Vehicle settings menu</b>	
Automatic car washes	356	Opening	31
Car wash	355	Setting	31
Controls	359	<b>Vehicle toolkit</b>	292
Displays, screens	359	Contents	292
Electrically adjustable seats	359	Stowage	292
Exterior	355, 358	<b>Vehicle's drive system</b>	
Fabrics	359	Automatic reactivation	138
Hand wash	356	Leaving warning	138
High-pressure cleaners	356	<b>Vehicle's drive system</b>	
Interior	355, 359	Emergency switch-off	140
Leatherette	359	<b>Vision</b>	112
Microfibre fabrics	359	<b>Voice control</b>	228
Natural leather	359	Activation word	229, 230
Plastic parts	359	Android Auto™	214
Polishing (paintwork)	356	Ending	229
Rubber seals	359	Starting	229
Seat belts	359	Troubleshooting	230
Seat covers	359	Voice commands	229
Seat cushions with seat heating	359	<b>Voice control (Siri)</b>	
Seats with airbag components	359	Apple CarPlay	213
Service position for windscreen wipers	293	<b>Volkswagen Customer Support</b>	203
Trim parts	359	<b>Volkswagen We Connect Start</b>	200
Trim strips	359	Deactivating	203
Waxing (paintwork)	356	Interference	203
Windows	359	Legal requirements	202
Winter conditions	356	<b>Volume</b>	
Wiper blades	293	Defining external audio sources	226
Wooden trims	359	<b>W</b>	
<b>Vehicle data sticker</b>	389	<b>Warning and indicator lamps</b>	
<b>Vehicle functions</b>		Brakes	134
Online	205	<b>Warning lamp</b>	
		Adaptive chassis control (DCC)	144
		Brake support systems	191

Brake system	191	Old tyres	329
Electronic parking brake	178	Replacing tyres	330
Overview	15	Rotating wheels	329
<b>Warning lamps</b>		Running in	330
Position selection	142	Snow chains	340
Seat belts	37	Speed index	338
Steering column lock	143	Storing tyres	330
<b>Warning messages when leaving the vehicle</b>	138	Technical data	336
<b>Warning signs</b>		Tread depth	334
High-voltage battery	274	Tread wear indicators	334
<b>Warning triangle</b>	68	Tyre damage	334
<b>Warranty</b>		Tyre lettering	336
General	366	Tyre load	338
High-voltage battery	366	Tyre pressure	332
Paint and body	366	Tyre type	336
<b>Washer fluid</b>		Tyre wear	334
Checking	314	Tyres with directional tread pattern	338
Refilling	314	Wheel rims	331
<b>Washing the vehicle</b>		Winter tyres	339
Sensors	184	<b>Wi-Fi</b>	208
<b>We Connect Start</b>	200	Client	210
Interference	203	Hotspot	208
Legal requirements	202	NFC	209
<b>We Upgrade</b>	206	QR-Code	209
<b>Weight</b>	387, 391, 392	Quick connection	209
<b>What to do after an accident</b>		Settings	210
Checklist	67	<b>Wi-Fi hotspot</b>	207
<b>What to do in the event of a fire</b>		<b>Windows</b>	89
Checklist	68	Buttons	89
<b>Wheel bolts</b>	343, 344	Childproof lock	81
Caps	342	Cleaning and care	359
Tightening torque	345	Closing	89
<b>Wheel change</b>		Convenience closing	90
Changing a wheel	347	Convenience opening	90
<b>Wheel lock</b>		Defrosting (air conditioning system)	121
see Anti-theft wheel bolts	344	Malfunction	89
<b>Wheel rims</b>	331	Opening	89
Bolted rim rings	331	Roll-back function	91
Bolted trim elements	331	<b>Windscreen</b>	
Identification	331	Repairing (note)	363
<b>Wheels and tyres</b>	328	Repairing stone chips (note)	363
All-year tyres	339	Replacing (note)	363
Asymmetrical tyres	338	Windscreen heating	125
Avoiding damage	329	<b>Windscreen heating</b>	
Changing a wheel	343	see Air conditioning system	121
Embedded foreign bodies	334	<b>Windshield</b>	
Handling wheels and tyres	329	see Windscreen	125, 363
Identification	336	<b>Winter conditions</b>	
Low-profile tyres	338	Snow chains	340
New tyres	330		



Vehicle care	356
Winter tyres	339
<b>Winter tyres</b>	339
All-wheel drive	339
Speed limitation	339
<b>Wiper blades</b>	
Changing	293
Cleaning and care	293
<b>Wipers</b>	112
Folding back wiper arm	293
Function	113
Heated washer jets	113
Lifting wiper arm	293
Rain and light sensor	114
Service position	293
Wiper lever	112
<b>Wireless charging function</b>	250
<b>X</b>	
<b>XDS</b>	
see Brake support systems	190