



QUICK
REFERENCE
GUIDE



Land Cruiser

2021

2021

LAND CRUISER

This Quick Reference Guide is a summary of basic vehicle operations. It contains brief descriptions of fundamental operations so you can locate and use the vehicle's main equipment quickly and easily.

The Quick Reference Guide is not intended as a substitute for the Owner's Manual located in your vehicle's glove box. We strongly encourage you to review the Owner's Manual and supplementary manuals so you will have a better understanding of your vehicle's capabilities and limitations.

Your dealership and the entire staff of Toyota Motor North America, Inc. wish you many years of satisfied driving in your new Land Cruiser.

A word about safe vehicle operations

This Quick Reference Guide is not a full description of Land Cruiser operations. Every Land Cruiser owner should review the Owner's Manual that accompanies this vehicle.

Pay special attention to the boxed information highlighted in color throughout the Owner's Manual. Each box contains safe operating instructions to help you avoid injury or equipment malfunction.

All information in this Quick Reference Guide is current at the time of printing. Toyota reserves the right to make changes at any time without notice.

OVERVIEW

Engine maintenance	9
Fuel tank door release & cap	8
Hood release	8
Indicator symbols	4-5
Instrument cluster	4
Instrument panel	2-3
Instrument panel light control	9
Keyless entry ¹	6-7
Smart Key system ^{1,2}	7

FEATURES & OPERATIONS

Air conditioning/heating	22-23
Audio	20
Auto lock/unlock ¹	10
Automatic transmission	10-11
Back door	16
Blind Spot Monitor with Rear	
Cross Traffic Alert (BSM w/RCTA)	29
Clock	21
Cool box	33
Crawl Control	
(w/Turn Assist Function)	26
Cup holders	33
Door locks	15
Four-wheel drive	11
Garage door opener (HomeLink [®]) ³	30
Headlight cleaner switch	16
Heated/ventilated seats	23
Heated steering wheel	24
Intuitive parking assist	28
Lights ¹ & turn signals	17
Moonroof	19
Multi-Information Display (MID) ²	24
Multi-terrain Monitor	27
Multi-terrain Select	27
Parking brake	32
Power back door	16
Power outlets-12V DC	31
Power outlet-120V AC	31
Power tilt & telescopic steering wheel	15

FEATURES & OPERATIONS (continued)

Power windows	18
Qi Wireless charger	32
Rear seat entertainment system	31
Rear view mirror-Outside	19
Seat adjustments-Front	12
Seat adjustments-Rear	12
Seats-Head restraints	12
Seats-Tumbling 2nd row seats	13
Seats-Tumbling 3rd row seats	14
Steering lock release	15
Steering wheel switches & telephone controls (Bluetooth [®])	25
USB media/AUX port	21
Vehicle Stability Control (VSC)/ TRAC OFF Switch	30
Windshield wipers & washers	18

TOYOTA SAFETY SENSE™ P (TSS-P)

Automatic High Beams (AHB)	44
Dynamic Radar	
Cruise Control (DRCC)	41-43
Lane Departure Alert (LDA)	37-40
Pre-Collision System with Pedestrian Detection (PCS w/PD)	35-37
Quick overview-	
Toyota Safety Sense™ P (TSS-P)	34
Sensors	34

SAFETY & EMERGENCY FEATURES

Floor mat installation	49
Rear door child safety locks	45
Safety Connect [®]	47
Seat belts	45
Seat belts-Shoulder belt anchor	45
Spare tire & tools	46
Star Safety System™	48-49
Tire Pressure Monitoring (warning) System (TPMS)	47

¹ Visit your Toyota dealer for information on customizing this feature.

² Programmable by customer. Refer to the Owner's Manual for instructions and more information.

³ HomeLink[®] is a registered trademark of Gentex Corporation.

Instrument panel

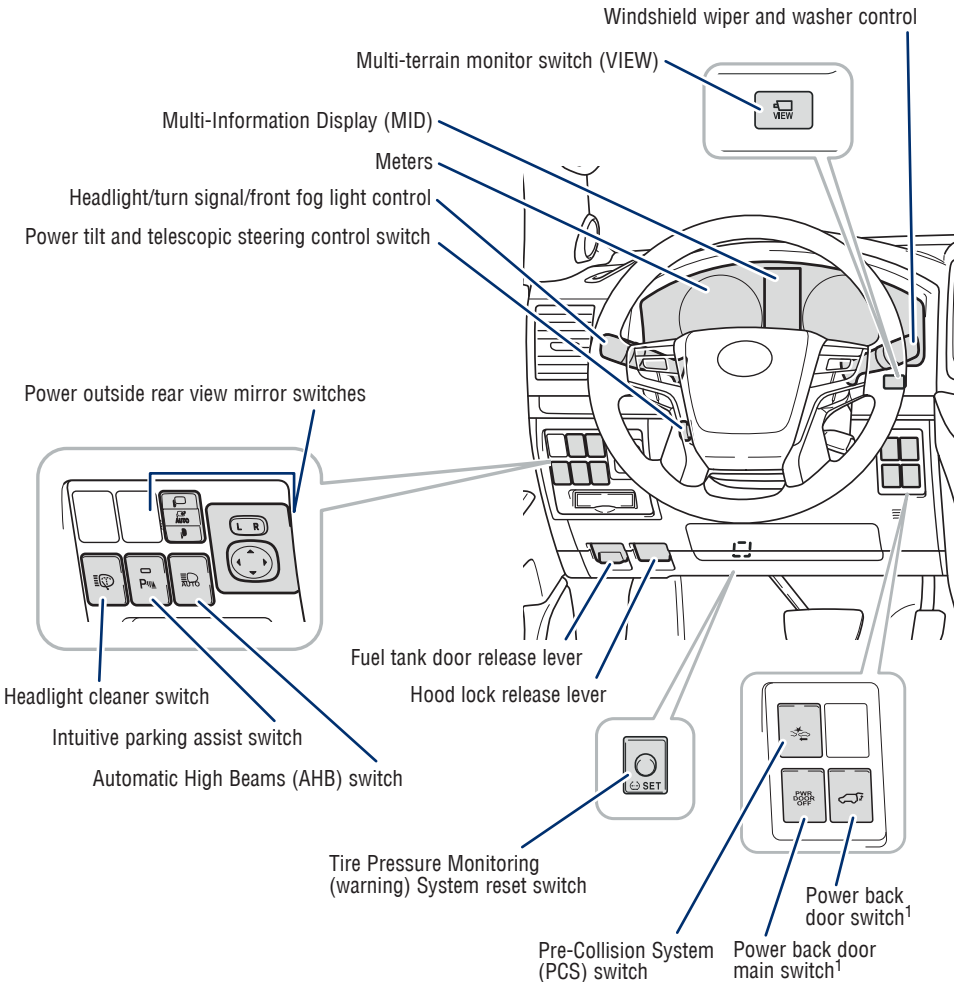
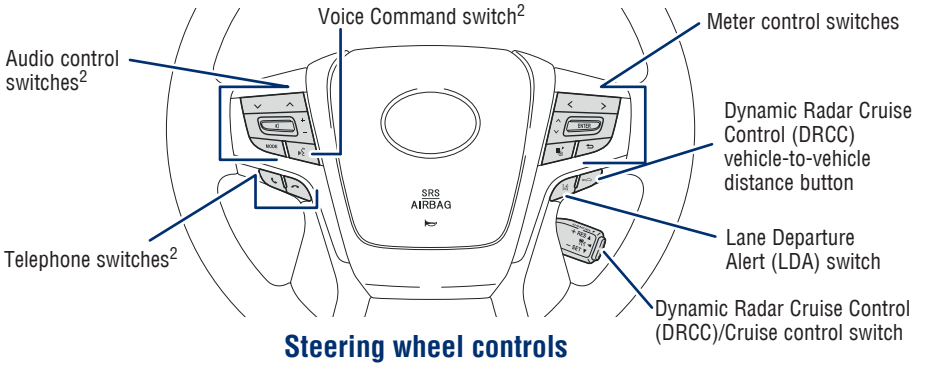

¹ If equipped

² For details, refer to the “Navigation System Owner’s Manual” or visit www.toyota.com/audio-multimedia for additional resources.

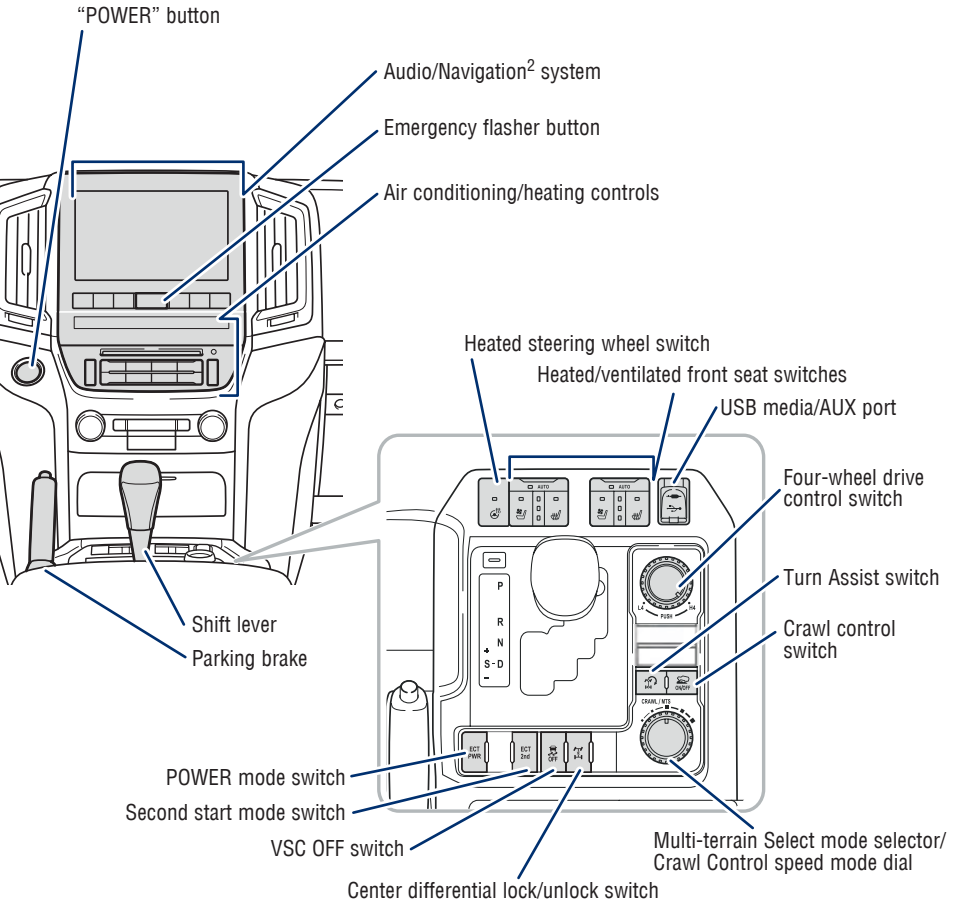





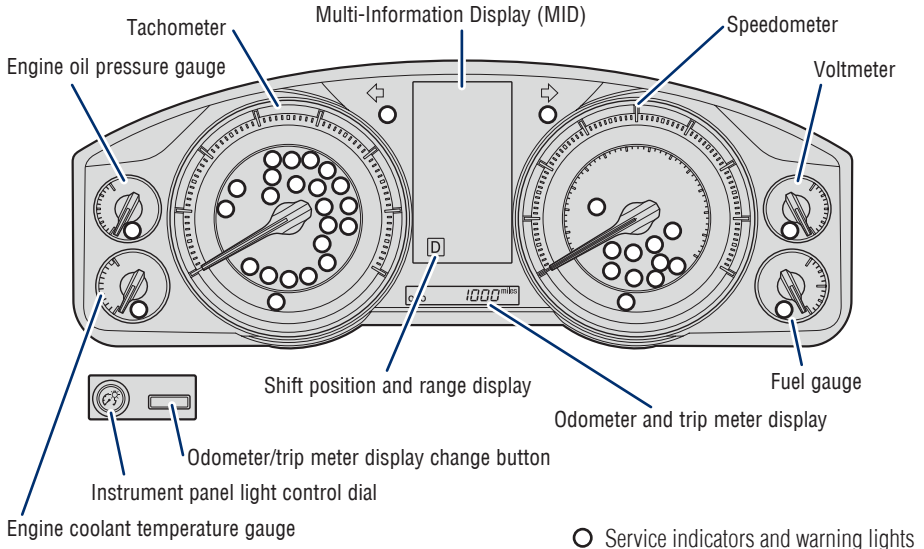









Instrument cluster

Vehicles with a monochrome display



Indicator symbols

For details, refer to “Warning lights and indicators,” Section 2, 2021 Owner’s Manual.

- | | | | |
|--|--|---|---|
|  | AIR BAG ON-OFF indicator ¹ |  | Blind Spot Monitor (BSM) indicator ¹ |
|  | Airbag SRS warning ¹ |  | Brake system warning ¹ |
|  | Anti-lock Brake System (ABS) warning ¹ |  | BSM outside rear view mirror indicators |
|  | Arrow direction indicates fuel tank door position |  | BSM w/Rear Cross Traffic Alert (RCTA) Indicator |
|  | Auto High Beams (AHB) indicator |  | Center differential lock indicator |
|  | Automatic headlight leveling system warning ^{1,2} |  | Charging system warning ¹ |
| | |  | Crawl Control indicator ¹ |
| | |  | Constant speed cruise control indicator/Constant speed cruise control SET indicator |



Driver seat belt reminder
(alarm will sound when the vehicle
is on)



SET Dynamic Radar Cruise Control
(DRCC) indicator/DRCC SET
indicator



ECO driving indicator¹



Fog light indicator



Front passenger seat belt reminder
(alarm will sound if the seat belt is not
fastened)



Headlight low/high beam
indicator



Lane Departure Alert (LDA) indicator



Low fuel level warning



4LO Low speed four-wheel drive indicator



Low tire pressure warning¹



Malfunction/Check Engine indicator¹



Master warning^{1,2}



Multi-terrain select indicator



Open door warning



Parking brake indicator



Power mode indicator



Pre-Collision System (PCS)
warning^{1,2}



Second start indicator



Shift position and range indicators



Slip indicator^{1,3}



TRAC OFF indicator¹



Turn assist function indicator



Turn signal indicator



Vehicle Stability Control (VSC) OFF
indicator¹

¹ If the indicator does not turn off within a few seconds of starting the engine, there may be a malfunction. Have the vehicle inspected by your Toyota dealer.

² If the indicator flashes, there may be a malfunction. Refer to the Owner's Manual.

³ If the indicator flashes, it indicates that the system is operating.

⁴ If equipped.

OVERVIEW

Keyless entry

UNLOCKING OPERATION



Push
ONCE: Driver door
TWICE: All doors

Carry Smart
Key remote

Driver door unlock*

Grasp



NOTE: If a door is not opened within 60 seconds of unlocking, all doors will relock for safety.

LOCKING OPERATION



Push

Carry Smart
Key remote

All-door lock

Touch



BACK DOOR LOCK/UNLOCK

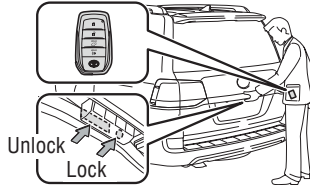

Carry Smart
Key remote

POWER BACK DOOR (IF EQUIPPED)



HOLD



Push and hold

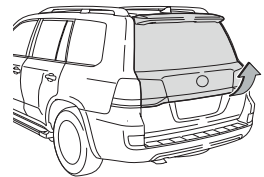

* Driver door unlocking function can be programmed to unlock driver door only, or all doors.

Please refer to the Owner's Manual for more details on how to program the doors.

NOTE: Doors may also be locked/unlocked using remote.

PANIC BUTTON



Push and hold



Smart Key system

START FUNCTION

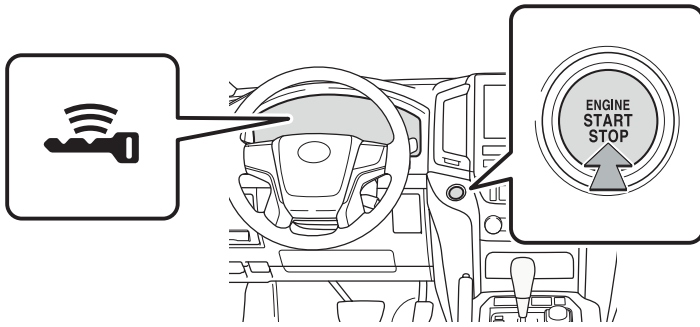

NOTE: The Smart Key must be carried to enable the start function. With the gear shift lever in Park and the brake pedal depressed, push the power button.

POWER (WITHOUT STARTING ENGINE)

Without depressing the brake pedal, pressing the power button will change the operation mode in succession from:

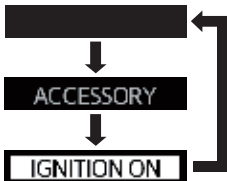

Off - All systems OFF. Emergency flashers can be used.

Accessory – Some electrical components can be used.

On - All electrical components can be used.

Fuel tank door release & cap

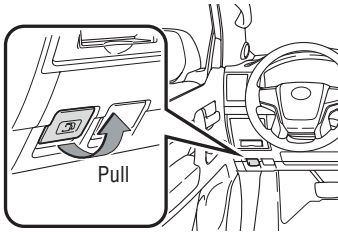

Turn to open

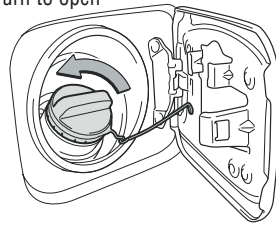

Store

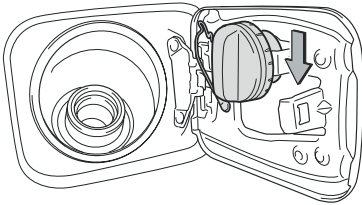

NOTE: Tighten until one click is heard. If the cap is not tightened enough, check Engine "CHECK" indicator may illuminate.

Hood release

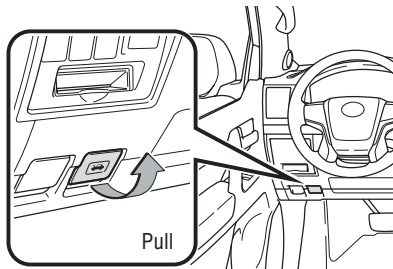

Pull up latch and raise hood

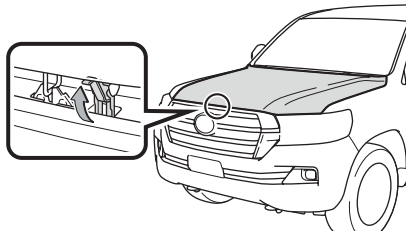

Instrument panel light control

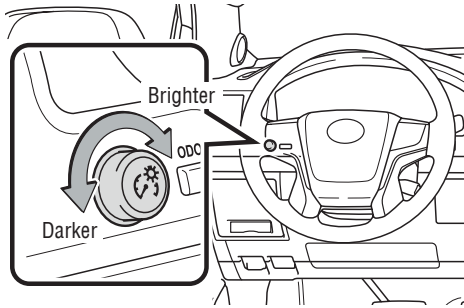

Engine maintenance

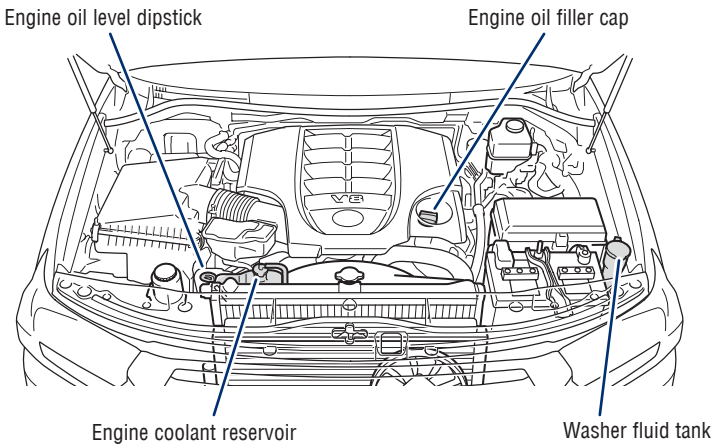

NOTE: Regularly scheduled maintenance, including oil changes, will help extend the life of your vehicle and maintain performance. Please refer to the "Warranty & Maintenance Guide."

FEATURES & OPERATIONS

Auto lock/unlock

Automatic door locks can be programmed to operate in different modes, or turned OFF.

DEFAULT SETTING

Shift position linked door locking/unlocking function

- Doors lock when shifting from Park.
- Doors unlock when shifting into Park.

CUSTOMIZED SETTING

Speed linked door locking function

- Doors lock when the vehicle speed is approximately 12 mph (20 km/h) or higher.

Driver's door linked door unlocking function

- Doors unlock when the driver's door is opened approximately 45 seconds after turning the vehicle OFF.

Refer to the Owner's Manual for more details.

Automatic transmission

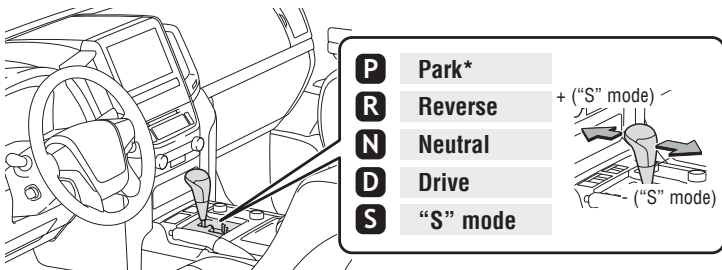

* The vehicle must be on and the brake pedal depressed to shift from Park.

"S" (SEQUENTIAL) MODE

Shift the shift lever to "S" position from "D" position.

- + : Upshift (push and release)
- : Downshift (pull and release)

Downshifting increases power going uphill, or provides engine braking downhill. For best fuel economy during normal driving conditions, always drive with the shift lever in the "D" position.

Refer to the Owner's Manual for more details.

POWER MODE

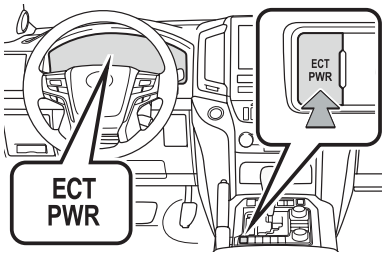

For powerful acceleration and driving in mountainous regions. Press button again to return to normal mode.

SECOND GEAR START MODE

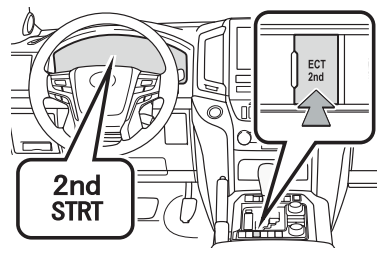

For starting on slippery surfaces, such as snowy roads. Press button again to return to normal mode.

Four-wheel drive

FOUR-WHEEL DRIVE CONTROL SWITCH

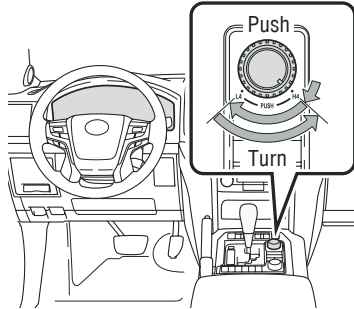

4LO

H4 High speed

L4 Low speed
Shift to "N" position when stopped, then push and turn to "L4."

CENTER DIFFERENTIAL LOCK/UNLOCK SWITCH

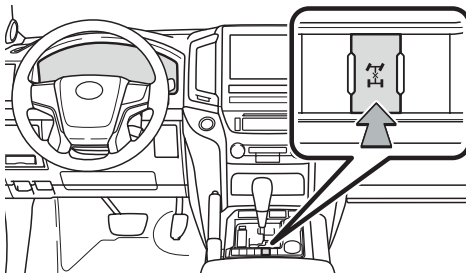

Lock the center differential when your vehicle's wheels get stuck in a ditch or when driving on a slippery or bumpy surface.

Refer to the Owner's Manual for limitations and more details on this system.

Seat adjustments-Front

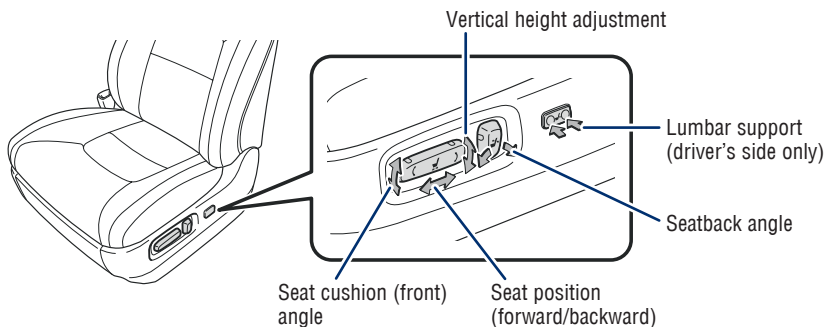

Seat adjustments-Rear

Second row

Seatback angle

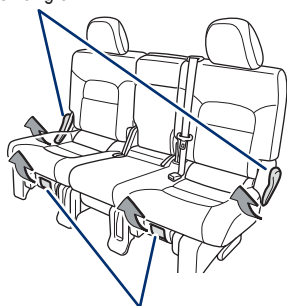

Seat position

Third row - fold down (if equipped)

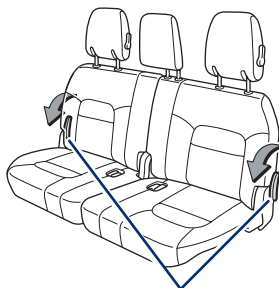

Seatback angle

Refer to the Owner's Manual for more details.

Seats-Head restraints

Front

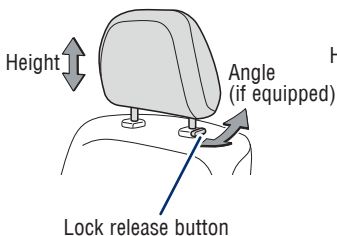

Lock release button

Second row

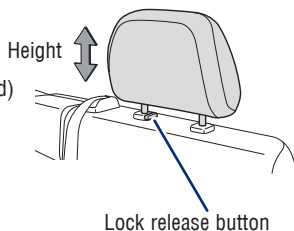

Lock release button

Third row-outboard seats*

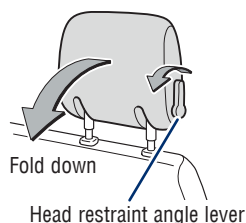

Head restraint angle lever

* If equipped

Seats-Tumbling 2nd row seats

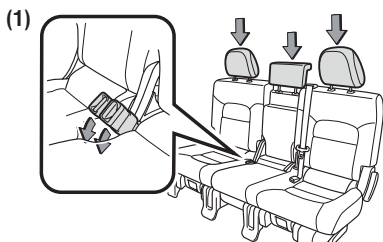

Stow the seat belt buckles and lower the head restraints.

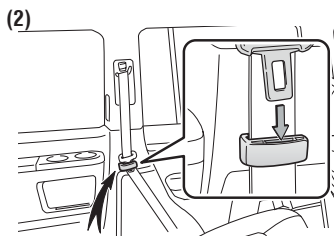

Hook the seat belt to the seat belt hangers.

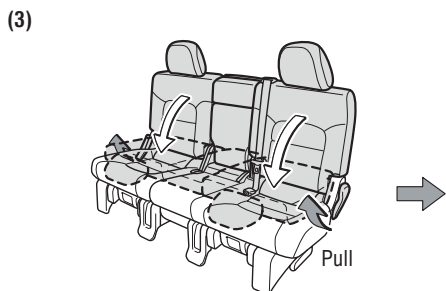

Fold down the seatback and swing the whole seat up and forward.

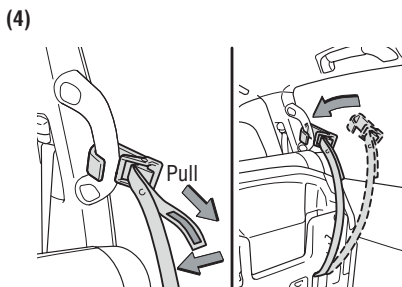

Hook the holding strap to the assist grip and secure the seat.

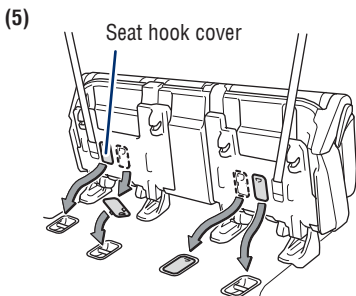

Install the seat hook covers on the seat hooks.

FEATURES & OPERATIONS

Seats-Tumbling 3rd row seats (if equipped)

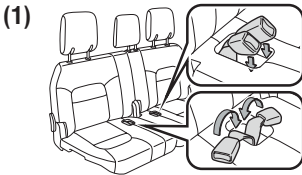

Stow the seat belt buckles.

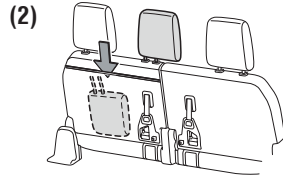

Stow the center head restraint.

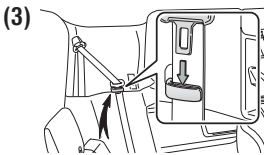

Hook the seat belt to the seat belt hangers.

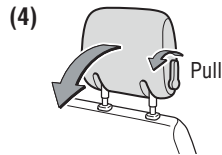

Fold down the outer head restraints.

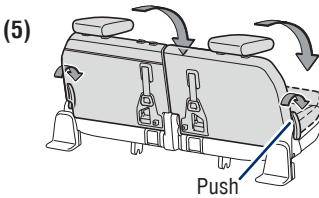

Fold the seats.

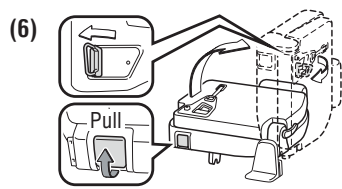

Lift the seats sideward.

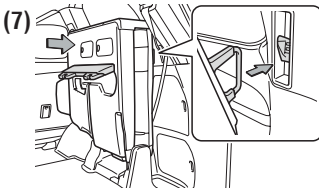

Lock the seats.

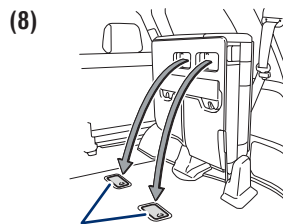

Seat hook cover

Install the seat hook covers on the seat hooks.

Returning seats

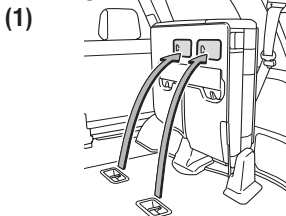

Install the seat hook covers into the back of the seat cushions.

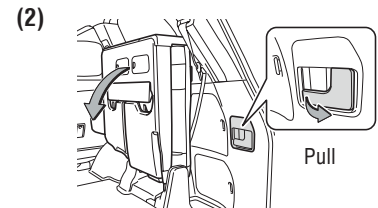

Lower the seats to their original position.

Steering lock release

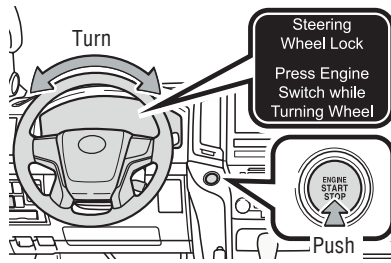

A message will be displayed on the Multi-Information Display. Check that the shift lever is set in P. Press the power button while turning the steering wheel left and right.

Power tilt and telescopic steering wheel

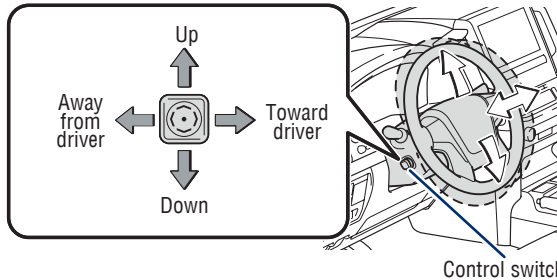

NOTE: Do not attempt to adjust while the vehicle is in motion.

Door locks

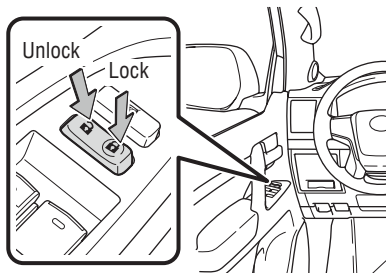

FEATURES & OPERATIONS

Back door

Upper back door

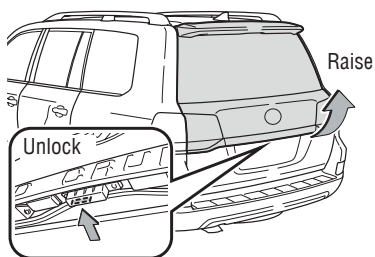

Lower back door

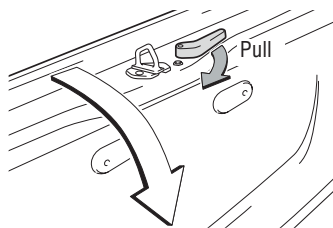

The back door can be locked and unlocked using the entry function, wireless remote control or door lock switch.

Power back door (if equipped)

Instrument panel

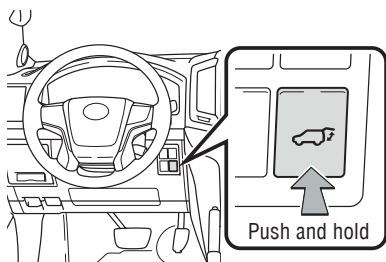

Open: Push and hold
Close: Push and hold again

Upper back door

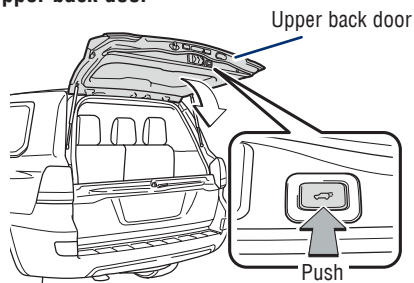

NOTE: Door will stop closing if obstructed, or to manually stop door closing, push button again.

NOTE: If battery is disconnected, the power back door needs to be reinitialized. Refer to the Owner's Manual for more details.

Headlight cleaner switch

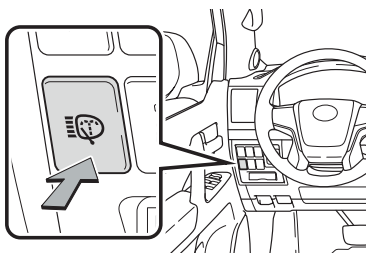

Lights & turn signals

HEADLIGHTS

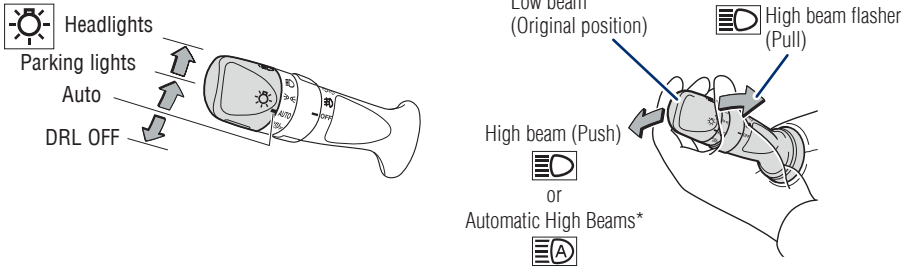

Daytime Running Light system (DRL) Automatically turns on under certain conditions to make vehicle more visible to other drivers. Not for use at night.

Automatic light cut off system Automatically turns lights off after 30 second delay.

Automatic High Beams (AHB) system Automatically switches between high and low beams as appropriate to enhance vision at night.

Refer to Toyota Safety Sense™ P (TSS-P) in this guide or the Owner's Manual for more details on the Automatic High Beams feature.

* Operating conditions must be met. Refer to the Owner's Manual for details.

FRONT FOG LIGHTS

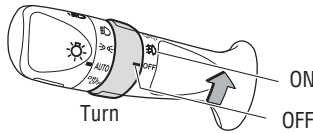

Front fog lights come on only when the headlights are on low beam.

TURN SIGNALS

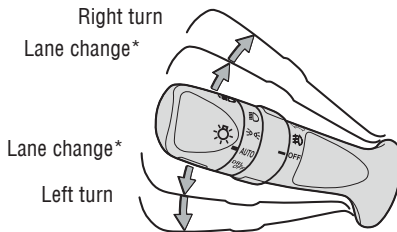

* Move lever partway and hold. The signals will flash until you release the lever.

FEATURES & OPERATIONS

Windshield wipers & washers

FRONT

With intermittent wiper

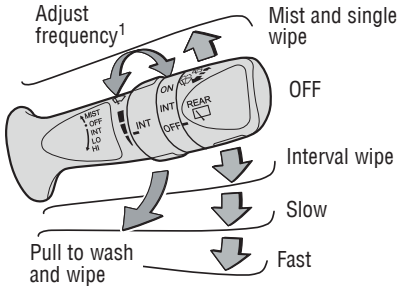

With AUTO rain-sensing wiper

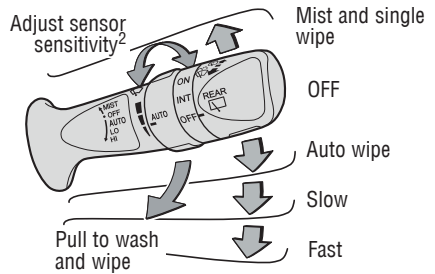

¹ **Intermittent windshield wiper frequency adjustment** Rotate to increase/decrease wiper frequency.

² **Rain-sensing windshield wiper** Rotate to increase/decrease sensor sensitivity.

REAR

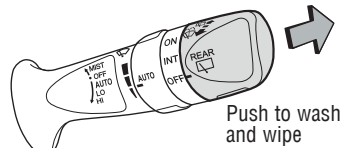
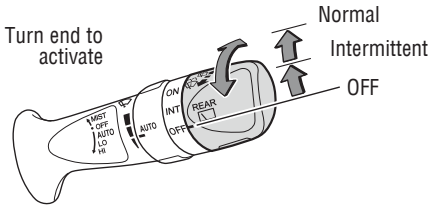

Power windows

Driver side

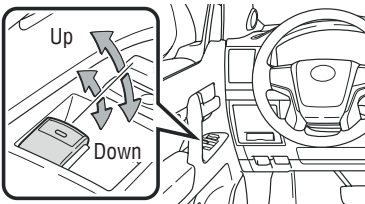

Window lock switch

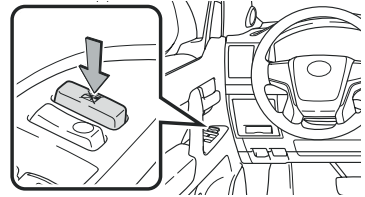

All window auto up/down Push the switch completely down or pull it completely up and release to fully open or close. To stop window midway, lightly push the switch in the opposite direction.

Window lock switch Deactivates all passenger windows. Driver's window remains operable.

Rear view mirror-Outside

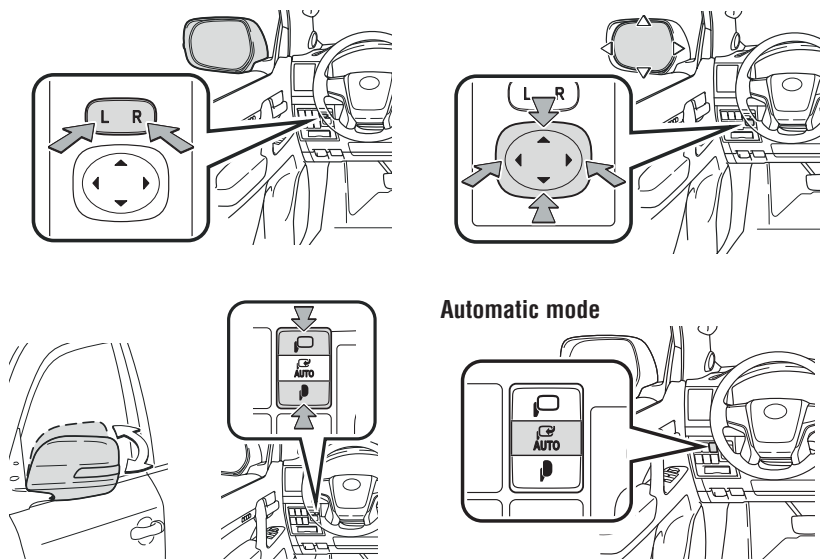

The vehicle must be in the “ACCESSORY” or “IGNITION ON” mode for use.

Linked mirror function when reversing The outside rear view mirrors automatically angle downwards when vehicle is in reverse. Will only operate when switch is in “L” or “R” position.

Moonroof

SLIDING OPERATION

Push once to open partway.
Push again to open completely.

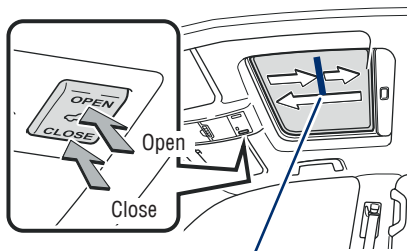

Recommended open position to minimize wind noise.

TILTING OPERATION

Push once to open completely.

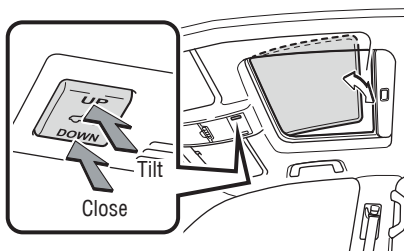

Lightly press either side of the moonroof switch while opening/tilting is in progress, the moonroof stops partway.

Audio

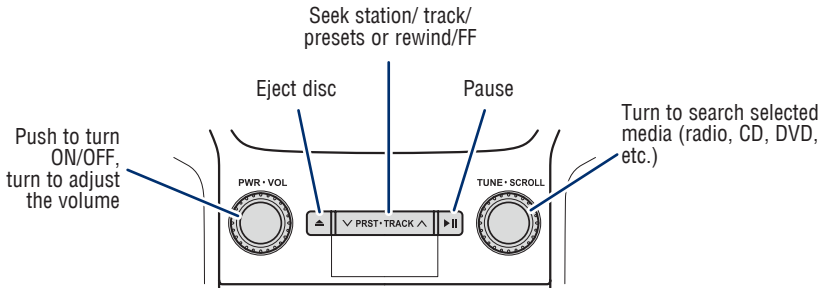
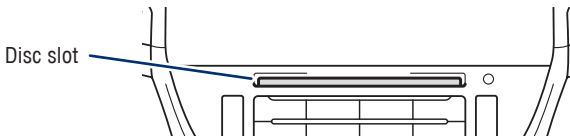
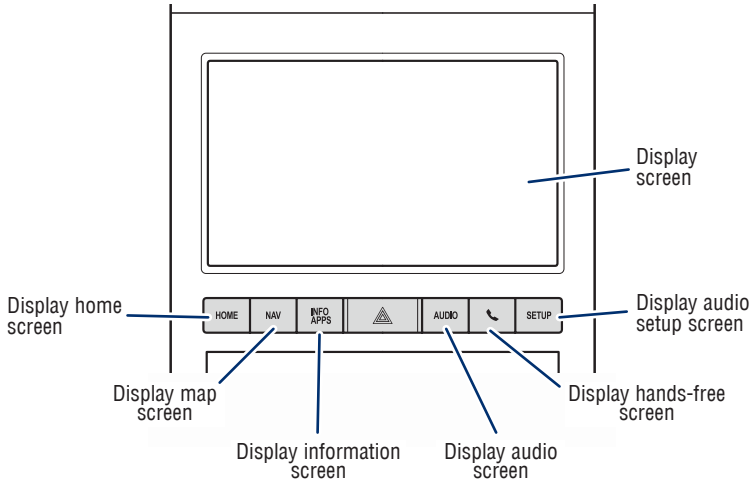

Refer to the Navigation System Owner's Manual for more details.

NOTE: Always use safe driving practices and follow all traffic rules.

USB media/AUX port

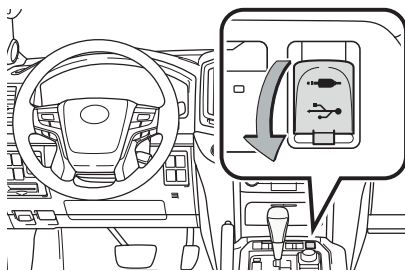

USB media port

Connecting a compatible device and cable into the USB media port will support charging and music playback through the audio multimedia system.

AUX port

By inserting an AUX cable into the AUX port, you can listen to music from a portable audio device through the vehicle's speaker system while in AUX mode.

Clock

Select to change the time zone.

Select to set daylight saving time ON/OFF/AUTO.

Select to set to automatic GPS adjustment of clock.

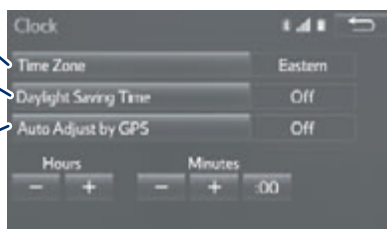

- 1) Push "**SETUP**" button next to the screen.
- 2) Select "**General**" in the touch screen to access the general settings screen.
- 3) Select "**Clock**."
- 4) Then select desired items to be reset.

Refer to the "Navigation System Owner's Manual" for more details.

Air conditioning/heating

FRONT AIR CONDITIONING

Control screen

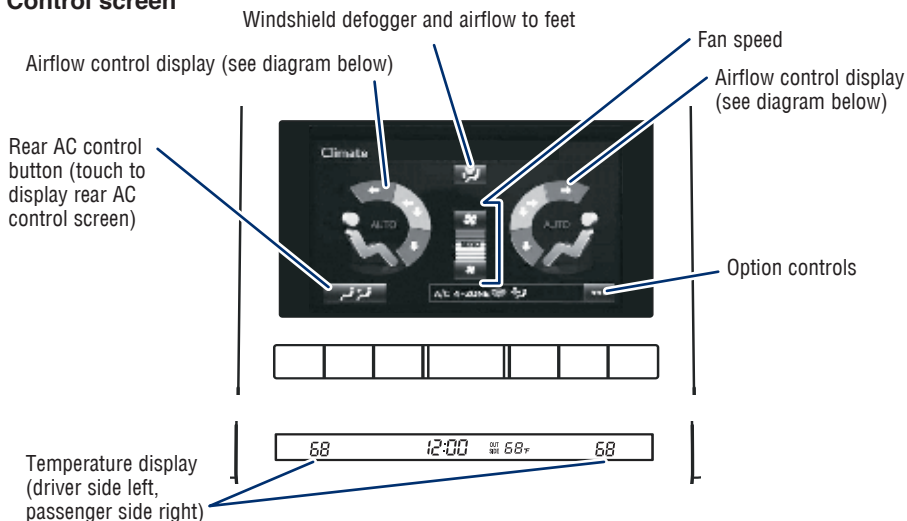

Control panel

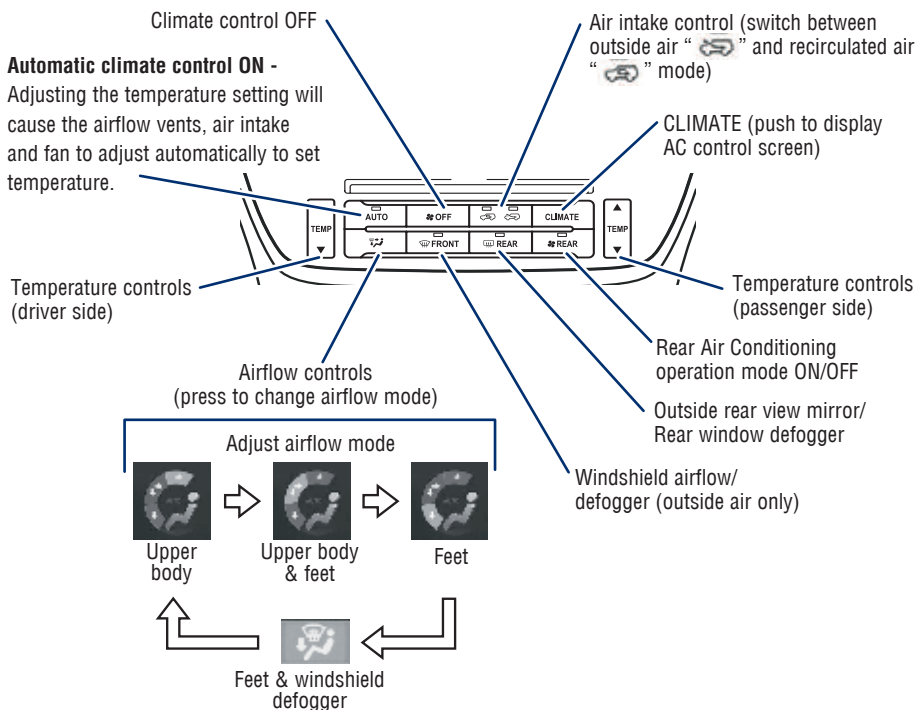

Refer to the Owner's Manual for more details.

REAR AIR CONDITIONING

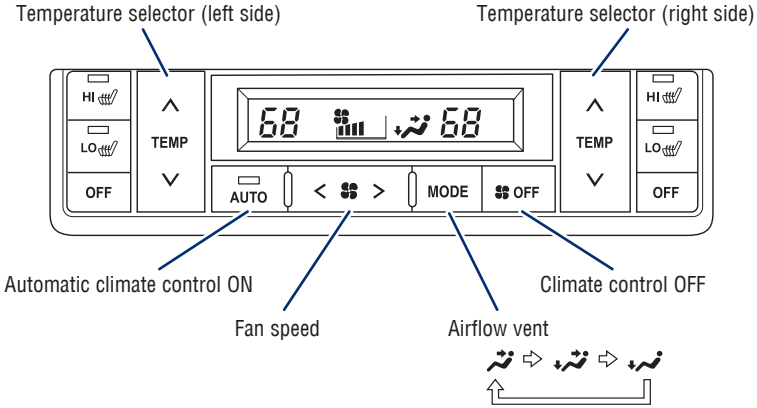

Heated/ventilated seats

FRONT SEATS

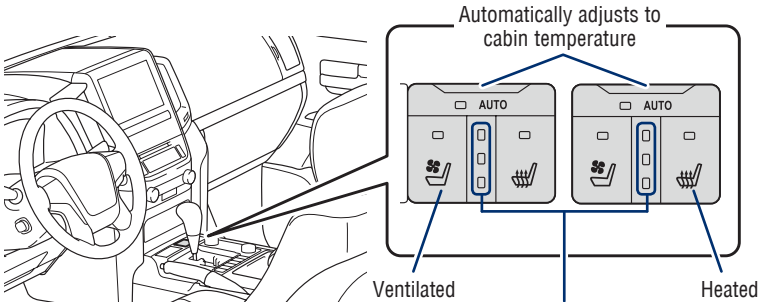

Press or to cycle through.

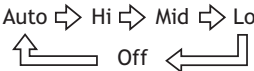

Level indicators:
 Yellow - heated seat on
 Green - ventilated seat on

Note: Auto setting changes according to climate control temperature.

SECOND SEATS

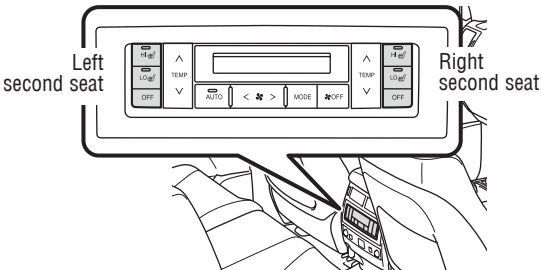

The vehicle must be on for use.

Multi-Information Display (MID)

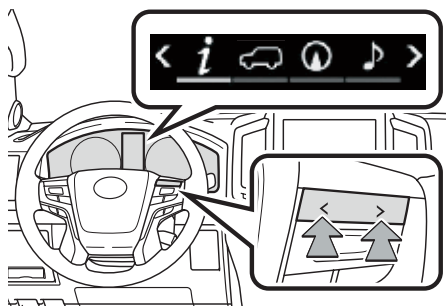

Select: To select an item/change pages

Press: Enter, moves to next screen and functions on/off
Up and down: Switches screens and moves the cursor

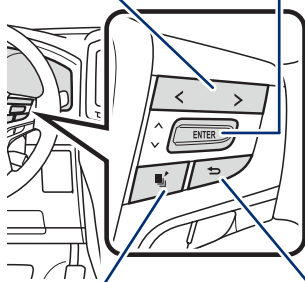

Menu/Display: Switch the top screen

Return: To previous screen

Press meter control switches to change and select information in the following:



Drive information



Vehicle information display (if equipped)



Navigation system-linked display



Audio system-linked display



Driving assist system information (if equipped)



Warning message display



Settings display

Heated steering wheel

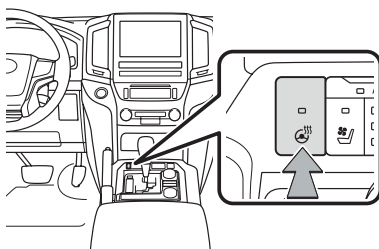

The vehicle must be on for use.

Steering wheel switches & telephone controls (Bluetooth®)

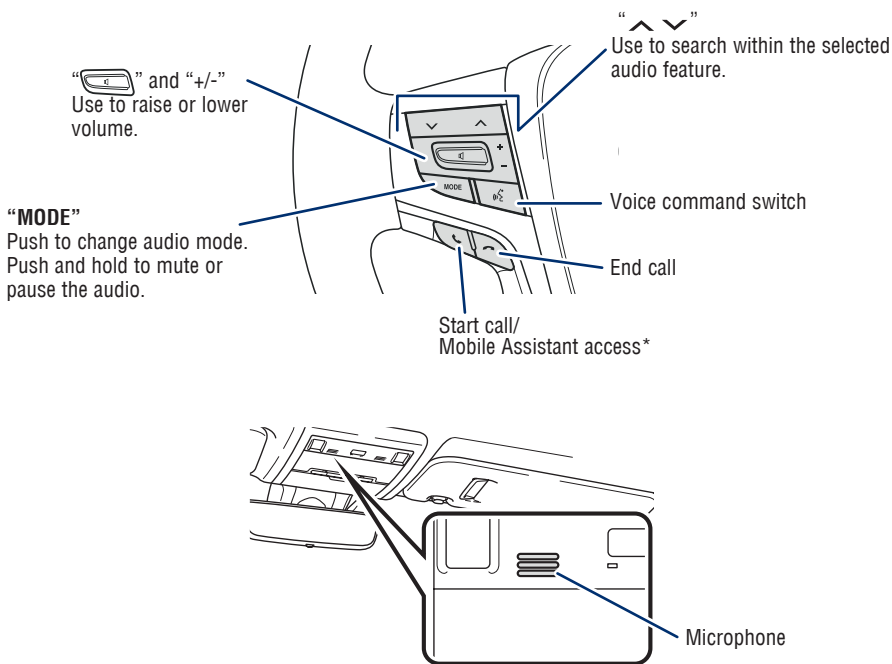

Bluetooth® technology allows dialing or receipt of calls without removing your hands from the steering wheel.

* Push and hold to access Mobile Assistant. When a compatible smartphone is Bluetooth® connected push and hold the off hook switch 2-3 seconds to access Siri® Eyes Free.

Refer to the Navigation System Owner's Manual for Mobile Assistant operation and Bluetooth® device pairing information.

NOTE: Always use safe driving practices and follow all traffic rules.

Crawl Control (with Turn Assist function)

CRAWL CONTROL SWITCH

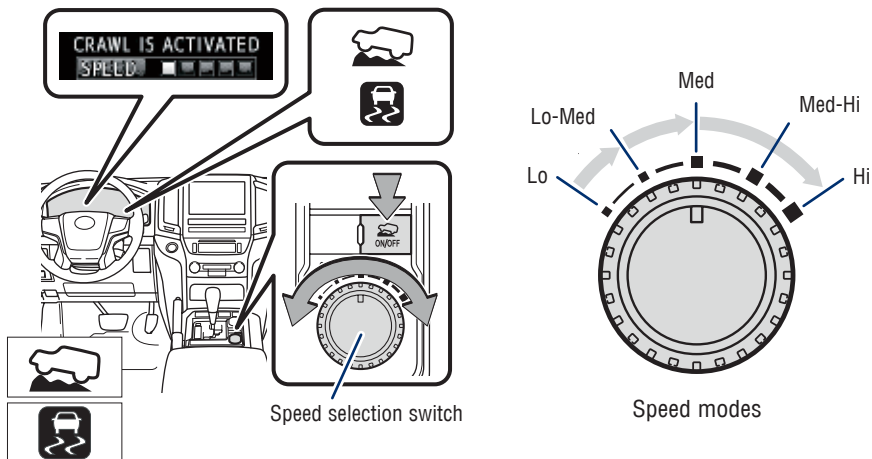

Crawl Control allows travel on extremely rough off-road surfaces at a fixed low speed without pressing the accelerator or brake pedal. Operating status displays on the MID.

Lo to Lo-Med - Rock, mogul (downhill) and gravel (downhill)

Lo-Med to Med - Mogul (uphill)

Med to Hi - Snow, mud, gravel (uphill), sand, dirt, mogul (uphill) and grass

TURN ASSIST FUNCTION

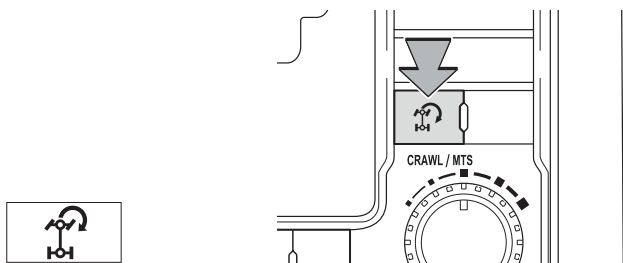

This function assists cornering performance in accordance with steering operation when driving through a tight corner. It maintains vehicle speed while driving and reduces the number of turns needed to navigate a corner that requires turning the wheel in the opposite direction.

Refer to the Owner's Manual for limitations and more details on this system.

Multi-terrain Select

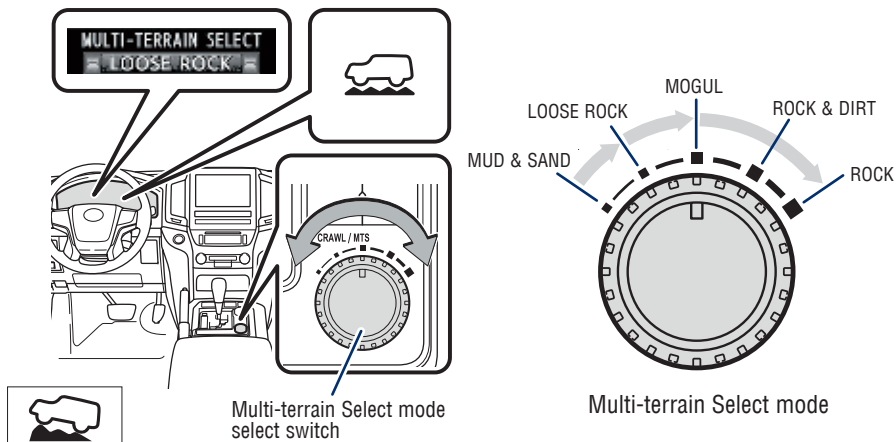

Multi-terrain Select is a system that helps drivability in off-road situations. When the Crawl Control is turned off, a mode which matches the road conditions can be selected from among the following 5 modes.

MUD & SAND - Muddy roads, sandy roads, snow-covered roads, dirt trails and other slippery or dirty conditions

LOOSE ROCK - Slippery conditions consisting of mixtures of earth and loose rock

MOGUL - Wide range of off-road conditions, particularly very bumpy conditions

ROCK & DIRT - Very bumpy road conditions, such as mogul or rocky roads.

ROCK - Rocky terrain

Refer to the Owner's Manual for limitations and more details on this system before attempting to use it.

Multi-terrain Monitor

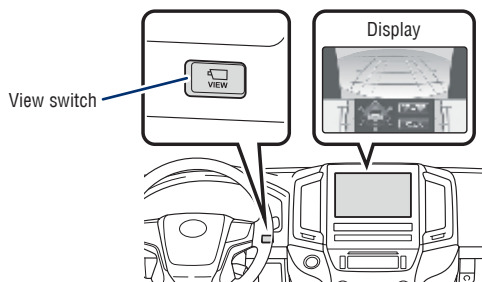

Press “**VIEW**” switch while the vehicle is on to check vehicle surroundings.

Note: The amount of time that the screen is displayed changes according to the vehicle speed at the time the **VIEW** switch was pressed. Speeds exceeding approximately 7 mph (12 km/h) will cancel monitor viewing.

Refer to the Owner's Manual for limitations and more details on this system before attempting to use it.

Intuitive parking assist

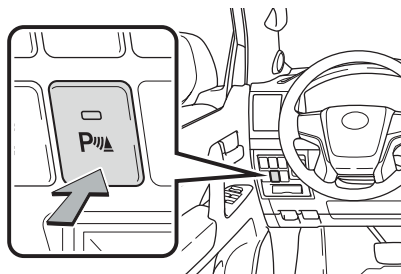

Multi-Information Display (MID)

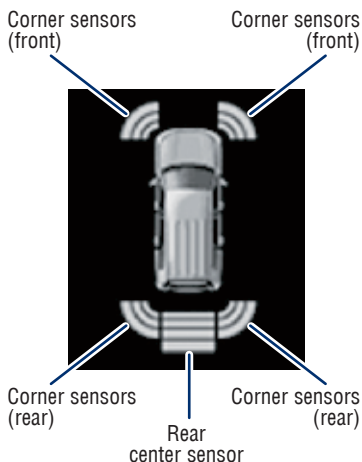

Navigation system screen

Intuitive parking assist display



Intuitive parking assist

Rear Cross Traffic Alert (if equipped)

The parking assist sonar system operates when the vehicle approaches an obstacle. The distance from your vehicle to nearby obstacles when parallel parking or maneuvering into a garage is measured by sensors and communicated via the Multi-Information Display (MID), the navigation system screen and audible beeps.

When the sensor detects an obstacle, the direction and the approximate distance to the obstacle are displayed on the MID display or the navigation system screen by illuminating continuously (far) or blinking (near), and beeping sounds will switch from intermittent to continuous as you approach and get closer to a detected obstacle. When the sensors detect two or more obstacles, the audible alerts will respond to the nearest zone.

Always check the surrounding area when using this system.

Refer to the Owner's Manual for limitations and more details.

Blind Spot Monitor with Rear Cross Traffic Alert (BSM w/RCTA) (if equipped)

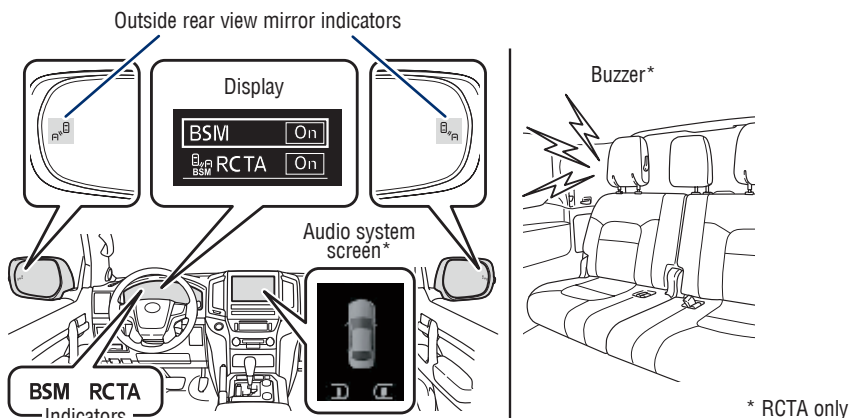

The Blind Spot Monitor is a system that has two functions:









- The Blind Spot Monitor function (assists the driver in making the decision when changing lanes)
- The Rear Cross Traffic Alert function (assists the driver when backing up)

The system is designed to use radar sensors to detect vehicles traveling in the Land Cruiser's blind spot. If a vehicle is detected, the driver will be alerted via the outside rear view side mirror indicators.

Rear Cross Traffic Alert function:

While in reverse, when a vehicle approaching from the right or left rear of the Land Cruiser is detected, the outside rear view mirror indicators will flash. Also, the RCTA icon for the detected side will be displayed on the audio system display, and the RCTA buzzer will sound.

SYSTEM ON/OFF

- (1) Press “<>” switches and select “” from the Multi-Information Display (MID).
- (2) Use “” switches and select “” and then press “.
 The setting screen is displayed.- (3) Use “” switches and select “BSM” or “RCTA” and press “.
 select the “On/Off” setting function and then press “.- (4) Press “” to go back to the menu.

Refer to the Owner's Manual for limitations and more details on this system before attempting to use it.

Garage door opener (HomeLink®)*

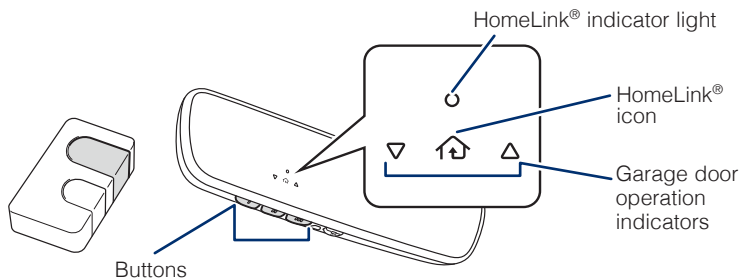

Garage door openers manufactured under license from HomeLink®* can be programmed to operate garage doors, estate gates, security lighting, etc.

Refer to the Owner's Manual for more details.

For programming assistance, contact HomeLink® at 1-800-355-3515, or visit <http://www.homelink.com/toyota>.

* HomeLink® is a registered trademark of Gentex Corporation.

Vehicle Stability Control (VSC)/ TRAC OFF switch

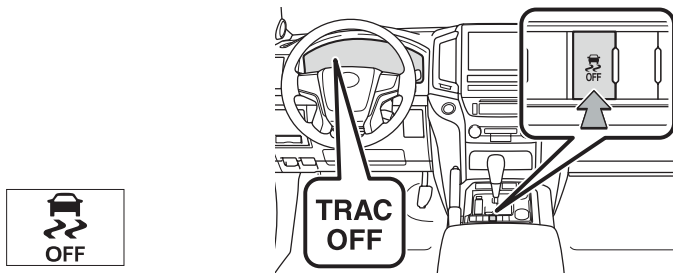

The VSC OFF switch can be used to help free a stuck vehicle in surroundings like mud, dirt or snow. While the vehicle is stopped, press switch to disable the TRAC system.

To disable VSC/TRAC/Trailer Sway Control systems, press and hold the switch for at least 3 seconds.

Refer to the Owner's Manual for limitations and more details.

Power outlets-12V DC

Front

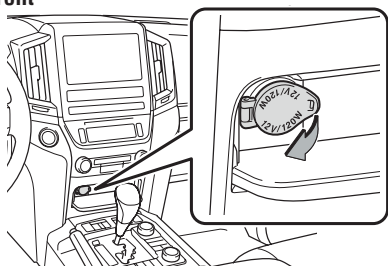

Rear

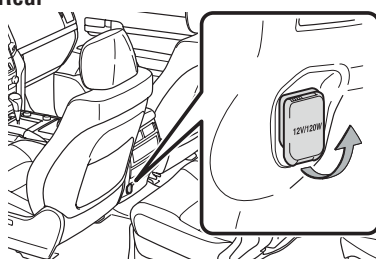

The vehicle must be in "ACCESSORY" or "IGNITION ON" mode for use.

Power outlet-120V AC

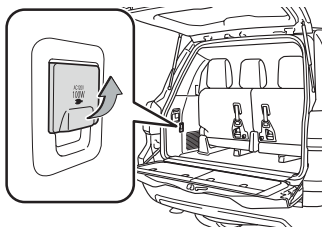

The vehicle must be on for use.

Rear seat entertainment system (if equipped)

Front audio system (DVD player)

Displays

Remote control

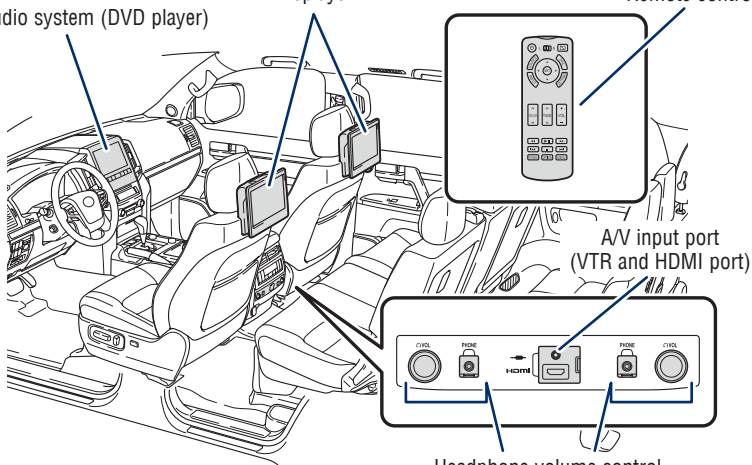

A/V input port
(VTR and HDMI port)

Headphone volume control
and headphone jacks

For details, refer to the "Navigation System Owner's Manual."

Qi Wireless charger

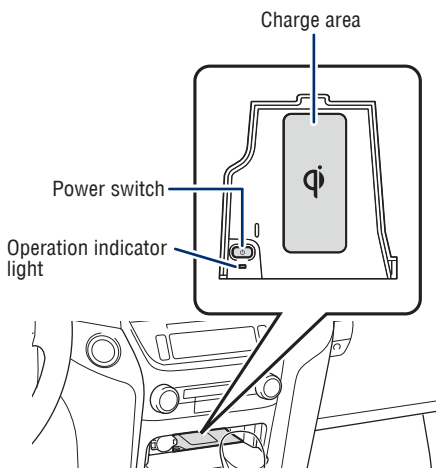

When the engine is turned off, the last state (ON/OFF) of the charger is memorized.

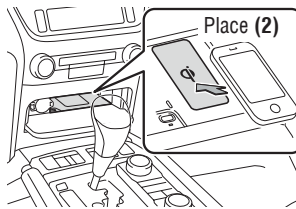

Place device nearest the center of charging area for best results. Moving device may result in stopping or restarting the charging process.

A mobile device can be charged wirelessly on the tray. After press the lid to open, **(1)** Press the wireless charger power switch and the green operation indicator light turns on. **(2)** Place a compatible mobile device on the tray as shown in the illustration. An amber indicator illuminates while charging is in progress. When charging is complete, the indicator illuminates green. Some phones, cases or cover type wireless chargers may not cause the green indicator to illuminate even though it is fully charged.

The vehicle must be in "ACCESSORY" or "IGNITION ON" mode for use.

Refer to the Owner's Manual for limitations and more details on this system before attempting to use it.

Parking brake

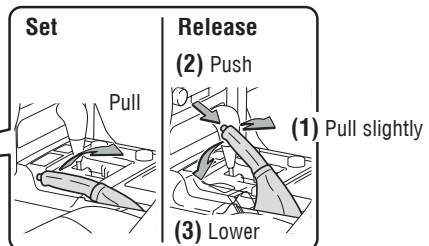
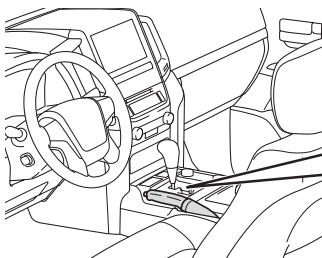

Cup holders

Front seats

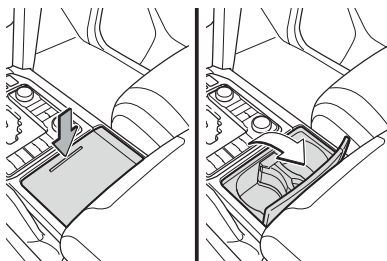

Removing the cup holder insert (front cup holders)

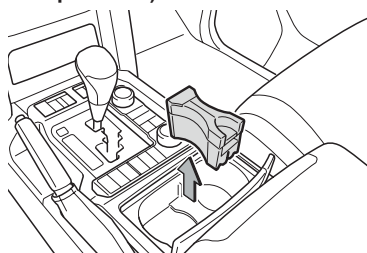

Second seats

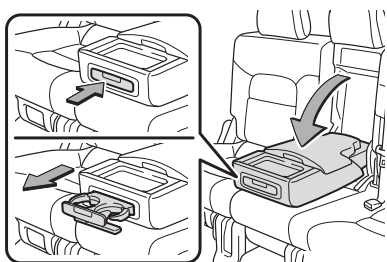

Third seats (if equipped)

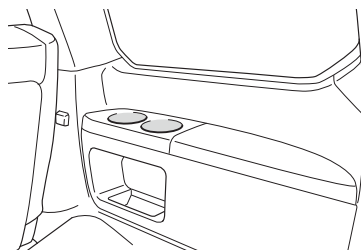

Luggage compartment (if equipped)

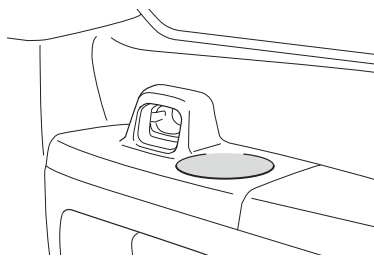

Cool box (if equipped)

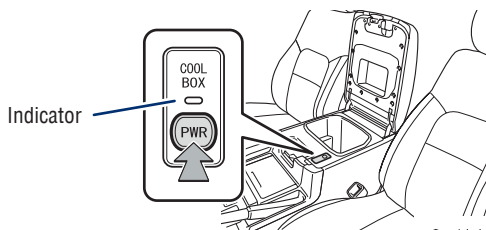

Push "PWR" button to turn cool box ON; indicator will illuminate.
The front air conditioning system cannot be turned off while the cool box is on.

Quick overview-Toyota Safety Sense™ P (TSS-P)

Toyota Safety Sense™ P (TSS-P) is a set of active safety technologies designed to help prevent or mitigate collisions across a wide range of traffic situations. TSS-P is designed to help support the driver's awareness, decision making and vehicle operation contributing to a safe and comfortable driving experience.

Refer to the Owner's Manual for operation, setting adjustments, limitations and more details to understand these functions and complete safety precautions. For more information, please go to <http://www.toyota.com/safety-sense>.



Pre-Collision System with Pedestrian Detection (PCS w/PD)

PCS w/PD is designed to provide alert, mitigation, and/or avoidance support in certain conditions, when the system detects a potential collision with a preceding vehicle is likely to occur.

The advanced grille-mounted radar system is designed to work with the forward-facing camera to help recognize a preceding pedestrian, and provide an alert, mitigation and/or avoidance support in certain conditions.



Lane Departure Alert (LDA)

LDA is designed to provide notification when the system detects an unintended lane departure.



Dynamic Radar Cruise Control (DRCC)

DRCC is designed to help maintain a pre-set distance to a preceding vehicle when the preceding vehicle is traveling at a lower speed.



Automatic High Beams (AHB)

AHB is designed to detect the headlights of oncoming vehicles and the tail lights of preceding vehicles and switch between high beams and low beams as appropriate.

Sensors

TSS-P Combines a forward-facing camera mounted in front of the inside rear view mirror and a grille-mounted radar mounted in the front grille. These sensors support the driver assist systems.

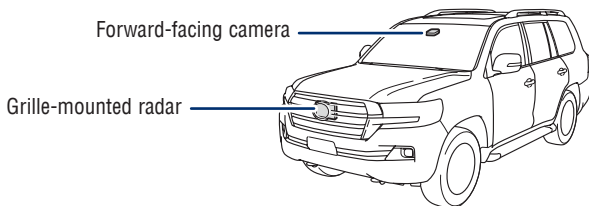

Pre-Collision System with Pedestrian Detection (PCS w/PD)

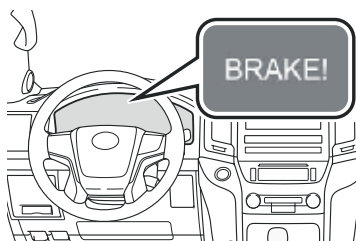

The Pre-Collision System with Pedestrian Detection (PCS w/PD) is designed to help detect a vehicle or a pedestrian in certain situations. Using a combination of a camera and radar, PCS w/ PD can provide an audio/visual alert to warn you of a possible collision under certain circumstances. If you don't react, the system is designed to automatically brake.

As there is a limit to the degree of recognition accuracy and control performance that this system can provide, do not overly rely on this system. This system will not prevent collisions or lessen collision damage or injury in every situation. Do not use PCS instead of normal braking operations under any circumstances. Do not attempt to test the operation of the pre-collision system yourself, as the system may not operate or engage, possibly leading to an accident. In some situations, such as when driving in inclement weather such as heavy rain, fog, snow or a sandstorm or while driving on a curve and for a few seconds after driving on a curve, a vehicle or pedestrian may not be detected by the grille-mounted radar and forward-facing camera, preventing the system from operating or engaging properly.

See Toyota.com/safety-sense for more information.

Refer to the *Toyota Owner's Manual* for a list of additional situations in which the system operation may be limited.

Pre-Collision Warning

When the system determines that the possibility of a frontal collision is high, a buzzer will sound and a warning message will be displayed on the Multi-Information Display (MID) to urge the driver to take evasive action.

Pre-Collision Brake Assist

If the driver notices the hazard and brakes, the system may provide additional braking force using Brake Assist. This system may prime the brakes and may apply greater braking force in relation to how strongly the brake pedal is depressed.

Pre-Collision Braking

If the driver does not brake in a set time and the system determines that the possibility of a frontal collision with a preceding vehicle is extremely high, the system may automatically apply the brakes, reducing speed in order to help the driver reduce the impact and in certain cases avoid the collision.

Refer to the *Toyota Owner's Manual* for additional information on PCS w/PD operation, settings adjustments, limitations, and precautions before attempting to use it.

TOYOTA SAFETY SENSE™

PCS PEDESTRIAN DETECTION

Under certain conditions, the PCS system included with the TSS-P package may also help to detect a pedestrian in front of your vehicle using the forward-facing camera and front grille-mounted radar. The forward-facing camera of PCS detects a potential pedestrian based on size, profile, and motion of the detected pedestrian. However, a pedestrian may not be detected depending on the conditions, including the surrounding brightness and the motion, posture, size, and angle of the potential detected pedestrian, preventing the system from operating or engaging.

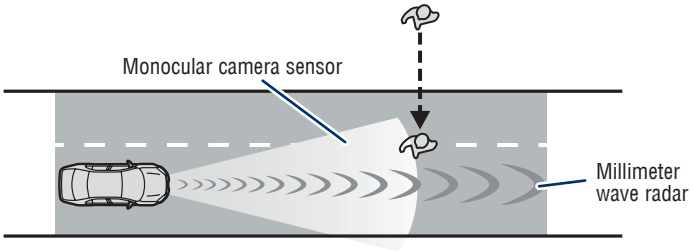

As part of the Pre-Collision System, this function is also designed to first provide an alert and then automatic braking if needed.

Refer to the Toyota Owner's Manual for additional limitations and information.

CHANGING PCS ALERT TIMING

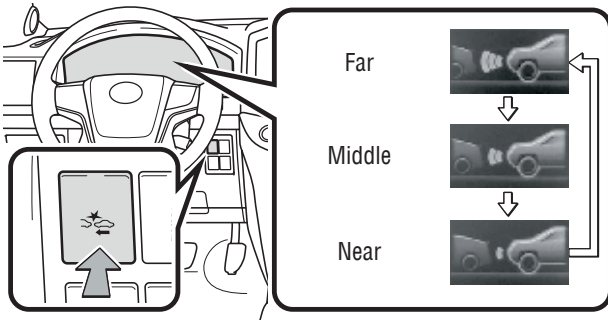

Each time the Pre-Collision System switch is pressed, the response to the warning distance changes.

DISABLING PRE-COLLISION SYSTEM (PCS)

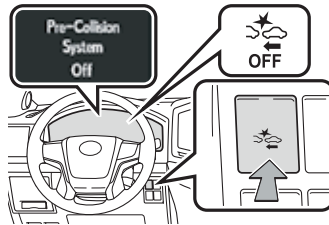

To disable the system

Press the PCS switch for 3 seconds or more.

The PCS warning light will turn on and a message will be displayed on the Multi-Information Display (MID).

To enable the system

Press the PCS switch again.

The system is enabled each time the vehicle is turned on.

Lane Departure Alert (LDA)



By detecting visible white/yellow lane markings at speeds above 32 mph, Lane Departure Alert (LDA) is designed to issue an audio/visual alert if an inadvertent lane departure is detected.

* See Toyota.com/safety-sense for model applicability.

Refer to the *Toyota Owner's Manual* for a list of additional situations in which the system operation may be limited.

TURNING THE LDA SYSTEM ON/OFF

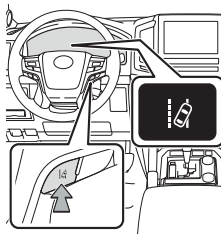

Press the LDA switch to turn the LDA system on. Depress again to turn it off.

Note: The system will continue in the last state it was in (ON or OFF) when the engine is started again.

Refer to the *Owner's Manual* for limitations and more details on this system before attempting to use it.

LANE DEPARTURE ALERT

LDA function display



Lane Departure Alert (LDA) indicator flashes orange when operating.



(1)



(2)

The LDA function displays when the Multi-Information Display (MID) is switched to the driving assist system information screen.

- (1) The system displays solid white lines on the LDA indicator when visible lane markers on the road are detected. A side flashes orange to alert the driver when the vehicle deviates from its lane.
- (2) The system displays outlines on the LDA indicator when lane markers on the road are not detected or the function is temporarily canceled.







Note: When operation conditions are no longer met, a function may be temporarily canceled. However, when the operation conditions are met again, operation of the function is automatically restored. For example, LDA may not function on the side(s) where white/yellow lines are not detectable.

ADJUSTING LDA ALERT SENSITIVITY

The driver can adjust the sensitivity of the LDA (warning) function from the Multi-Information Display (MID) customization screen.

High - Is designed to warn approximately before the front tire crosses the lane marker.

Normal - Is designed to warn approximately when the front tire crosses the lane marker.

- (1) Press “<>” switches and select “” from the Multi-Information Display (MID).
- (2) Use “” switch and select “” and then press “.
 The setting screen is displayed.- (3) Use “” switch and select “Alert sensitivity” and then press “” to select the desired setting.
- (4) Press “” to go back to the menu.

Note: Operation of the LDA system and setting adjustments continues in the same condition regardless of ignition cycle until changed by the driver or the system is reset.

SWAY WARNING SYSTEM



Continuous lane deviations from swaying.









Gentle swaying from driver's inattentiveness.



Acute steering wheel operation after the number of operations decrease due to driver's inattentiveness.







The sway warning function can detect swaying based on the vehicle location in the lane and the driver's steering wheel operation. To help prevent swaying, the system alerts the driver using a buzzer sound and a warning display in the MID.

DISABLING LDA SWAY WARNING SYSTEM

- (1) Press “<>” switches and select “” from the Multi-Information Display (MID).
- (2) Use “” switch and select “” and then press “.
 The setting screen is displayed.- (3) Use “” switch and select “Sway warning” and then press “” to select the desired setting.
- (4) Press “” to go back to the menu.

Note: Operation of the LDA system and setting adjustments continues in the same condition regardless of ignition cycle until changed by the driver or the system is reset.

ADJUSTING SWAY ALERT SENSITIVITY

- (1) Press “<>” switches and select “” from the Multi-Information Display (MID).
- (2) Use “” switch and select “” and then press “.
 The setting screen is displayed.- (3) Use “” switch and select “Sway sensitivity” and then press “” to select the desired setting.
- (4) Press “” to go back to the menu.

Note: Operation of the LDA system and setting adjustments continues in the same condition regardless of ignition cycle until changed by the driver or the system is reset.

Refer to the Toyota Owner's Manual for additional information on LDA operation, settings adjustments, limitations, and precautions before attempting to use it.

Dynamic Radar Cruise Control (DRCC)

Intended for highway use, Dynamic Radar Cruise Control (DRCC) lets you drive at a preset speed. DRCC is designed to function at speeds of 25-110 mph and uses vehicle-to-vehicle distance control, helping maintain a preset distance from the vehicle ahead of you.*

* Not available on all models. See Toyota.com/safety-sense for model applicability.

Refer to the Toyota Owner's Manual for a list of additional situations in which the system operation may be limited.

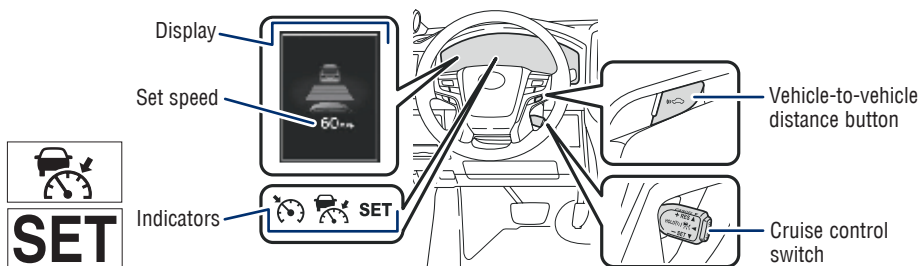

TURNING SYSTEM ON/OFF

(1)

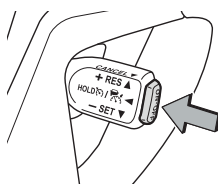

Push once: On
Push twice: Off

Refer to page 43 for switching to Constant Speed (Cruise) Control Mode.

ADJUSTING SET SPEED

(2)

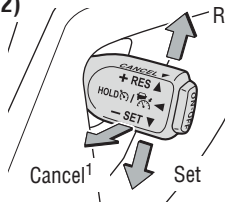

(3)

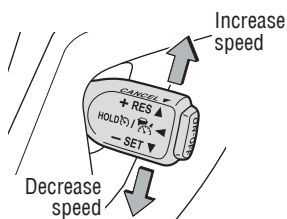

Vehicle will cruise at a set speed, decelerate to maintain selected distance from a slower vehicle traveling in front and accelerate back up to the selected speed if the vehicle in front changes lanes or speeds up.

- (1) Push the ON-OFF button. The "RADAR READY" and "  " indicator will come on.
- (2) Push the lever down to SET speed, push it up to Resume and pull it or depress brake to Cancel the speed control.
- (3) Push up to increase the set speed, push down to decrease (1 mph [1.6 km/h] or 1 km/h [0.6 mph] increments).

¹ The speed control may also be canceled by depressing the brake pedal.

² The speed control may be resumed once vehicle speed exceeds 25 mph (40 km/h).

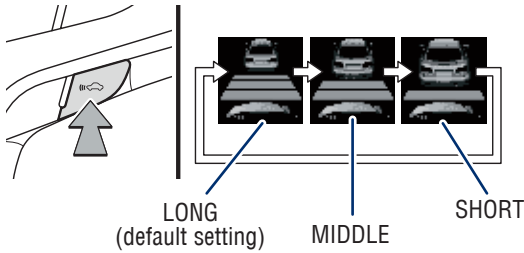

To change the vehicle-to-vehicle distance

Push the “” button to cycle through the settings, which will change progressively.

This mode employs a radar sensor to detect the presence of vehicles up to approximately 328 ft (100 m) ahead, determines the current vehicle-to-vehicle following distance and operates to maintain a preset following distance from the vehicle ahead. These distances vary based on vehicle speed.

Note: Vehicle-to-vehicle distance will close in when traveling on long downhill slopes.

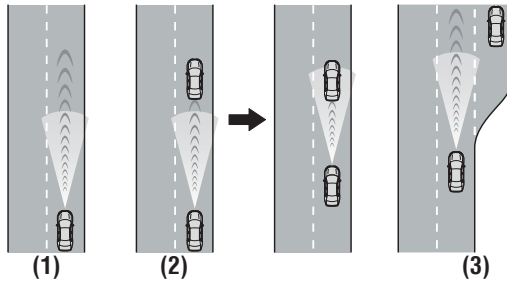

(1) Constant speed cruising when there are no vehicles ahead

The vehicle travels at the speed set by the driver. The desired vehicle-to-vehicle distance can also be set by operating the vehicle-to-vehicle distance control.

(2) Deceleration cruising and follow-up cruising when a preceding vehicle driving slower than the set speed appears

When a vehicle is detected running ahead of you, the system automatically decelerates your vehicle. When a greater reduction in vehicle speed is necessary, the system applies the brakes (the brake lights will come on at this time). The system will respond to changes in the speed of the vehicle ahead in order to maintain the vehicle-to-vehicle distance set by the driver. A warning tone warns you when the system cannot decelerate sufficiently to prevent your vehicle from closing in on the vehicle ahead.

ADJUSTING DISTANCE (CONTINUED)

(3) Acceleration when there are no longer any preceding vehicles driving slower than the set speed

The system accelerates until the set speed is reached. The system then returns to constant speed cruising.

Note: When your vehicle is too close to a vehicle ahead, and sufficient automatic deceleration via the cruise control is not possible, the display will flash and the buzzer will sound to alert the driver. An example of this would be if another driver cuts in front of you while you are following a vehicle. Depress the brake pedal to ensure an appropriate vehicle-to-vehicle distance.

SWITCHING TO CONSTANT SPEED (CRUISE) CONTROL MODE

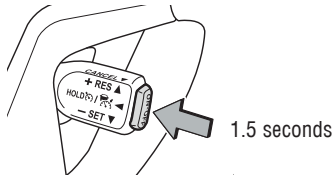

If you are already using DRCC “,” push ON-OFF button to turn the system off first, then push and hold ON-OFF button for at least 1.5 seconds to switch.

Note: When the engine is turned off, it will automatically default to DRCC.

SETTING CONSTANT SPEED (CRUISE) CONTROL

SET

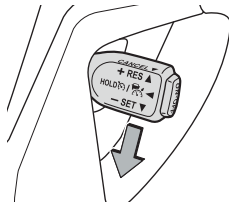

To adjust speed or cancel, see steps (2) and (3) of ADJUSTING SET SPEED on page 41.

Refer to the Toyota Owner’s Manual for preadditional information on DRCC operation, settings adjustments, limitations, and precautions before attempting to use it.

Automatic High Beams (AHB)

(1)

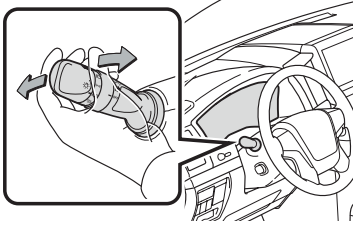

(2)

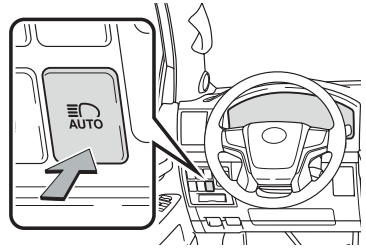

The Automatic High Beams (AHB) safety system is designed to help you see more clearly at night. At speeds above 25 mph, AHB can detect the headlights of oncoming vehicles and taillights of preceding vehicles, then automatically toggles between high and low beams accordingly.

See Toyota.com/safety-sense for more information.

Refer to the Toyota Owner's Manual for a list of additional situations in which the system operation may be limited.

ACTIVATING THE AHB SYSTEM

- (1) Push the lever away from you with the headlight switch is in the "AUTO" or "☰☒" position.
- (2) Press the "☰☒ AUTO" switch.

The AHB indicator will come on when the headlights are turned on automatically to indicate that the system is active.

Note: Pull the lever back toward you or press the AHB switch to turn the AHB system off.

The AHB indicator will turn off and "☰☒" or "☰☒" will turn on. To activate the system again, push the lever its original position or press the "☰☒ AUTO" switch.

CONDITIONS WHERE AHB WILL TURN ON/OFF AUTOMATICALLY

When all of the following conditions are met, the high beams will be automatically turned on (after approximately 1 second):

- Vehicle speed is above approximately 21 mph (34 km/h).
- The area ahead of the vehicle is dark.
- There are no oncoming or preceding vehicles with headlights or tail lights turned on.
- There are few streetlights on the road ahead.

If any of the following conditions occur, the high beams will be automatically turned off:

- Vehicle speed drops below approximately 17 mph (27 km/h).
- The area ahead of the vehicle is not dark.
- Oncoming or preceding vehicles have headlights or tail lights turned on.
- There are many streetlights on the road ahead.

Rear door child safety locks

Rear door

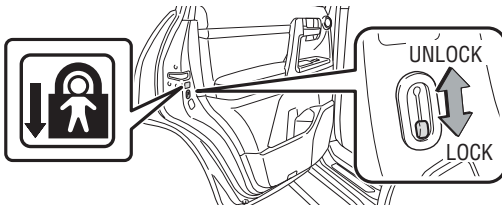

Moving the lever downward will allow the door to be opened only from the outside.

Seat belts

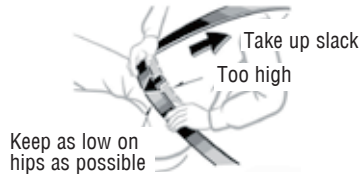

NOTE: If a passenger's seat belt is fully extended, then retracted even slightly, the Automatic locking retractor (ALR) will prevent it from being re-extended beyond that point, unless fully retracted again. This feature is used to help hold child restraint systems securely.

To find more information about seat belts, and how to install a child restraint system, refer to the Owner's Manual.

Seat belts-Shoulder belt anchor

Push up, or squeeze lock release to lower

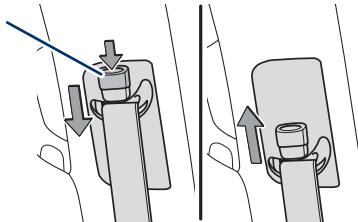

SAFETY AND EMERGENCY FEATURES

Spare tire & tools

TOOL LOCATION

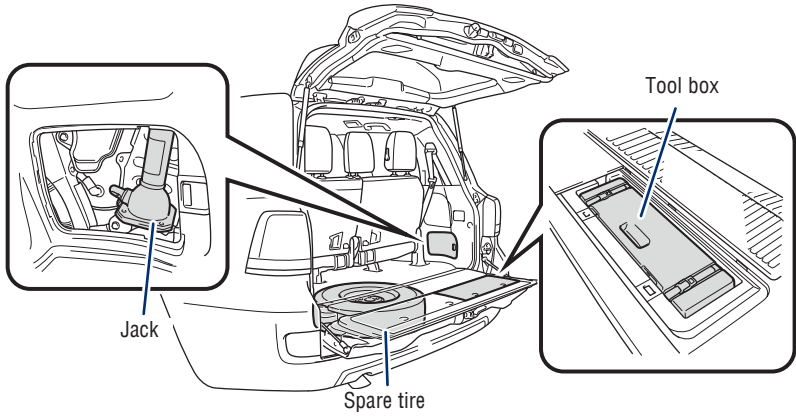

REMOVING THE SPARE TIRE

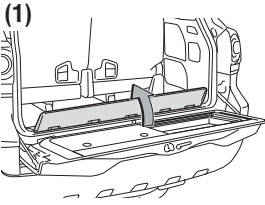

(1) Open the cover.

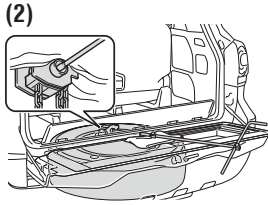

(2) Insert the jack handle extension into the lowering screw.

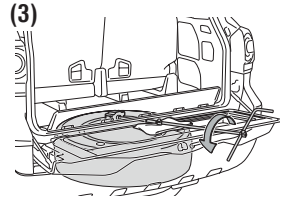

(3) Lower the spare tire completely to the ground.

Refer to the Owner's Manual for tire changing and jack positioning procedures.

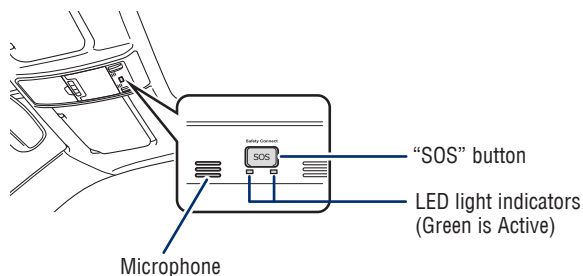

Safety Connect is a subscription-based telematics service that uses Global Positioning System (GPS) data and embedded cellular technology to provide safety and security features to subscribers. Safety Connect is staffed with live agents at the Toyota response center, which operates 24 hours per day, 7 days per week.

Services for subscribers include:

- Automatic collision notification
- Stolen vehicle locator
- Emergency assistance ("SOS" button)
- Enhanced roadside assistance

For additional information, refer to the "Owner's Manual" or visit www.Toyota.com/connected-services.

Tire Pressure Monitoring (warning) System (TPMS)

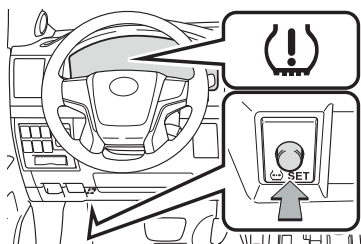
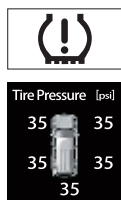

System reset initialization

1. Push and hold "SET" button until the indicator blinks three times.
2. Wait several minutes to allow initialization to complete.

After adjusting tire pressures, or after tires have been rotated or replaced, turn the ignition switch to "ON" and press and hold the "SET" button until indicator blinks three times. Let the vehicle sit for a few minutes to allow initialization to complete.

Refer to the load label on the door jamb or the Owner's Manual for tire inflation specifications.

If the tire pressure indicator flashes for 1 minute and then remains on, take the vehicle to your local Toyota dealer.

NOTE: The warning light may come on due to temperature changes or changes in tire pressure from natural air leakage. If the system has not been initialized recently, setting the tire pressures to factory specifications should turn off the light.

SAFETY AND EMERGENCY FEATURES

Star Safety System™

Your vehicle comes standard with the Star Safety System™, which combines Anti-lock Brake System (ABS), Brake Assist (BA), Electronic Brake-force Distribution (EBD), Smart Stop Technology (SST), Traction Control (TRAC) and Vehicle Stability Control (VSC).

Refer to the Owner's Manual for more details and important information on limitations to these systems.

ACTIVE TRACTION CONTROL (A-TRAC)

Helps to maintain drive power and prevent the 4 wheels from spinning when starting the vehicle or accelerating on slippery roads.

BRAKE ASSIST (BA)

Brake Assist is designed to detect sudden or “panic” braking, and then add braking pressure to decrease the vehicle’s stopping distance. When there’s only a split second to react, Brake Assist can add additional brake pressure more quickly than just the driver alone can.

ELECTRONIC BRAKE FORCE DISTRIBUTION (EBD)

Toyota’s ABS technology has Electronic Brake-force Distribution (EBD) to help maintain control and balance when braking. EBD responds to sudden stops by redistributing brake force to enhance the braking effectiveness of all four wheels.

MULTI-TERRAIN ANTI-LOCK BRAKE SYSTEM (ABS)

Toyota’s ABS sensors detect which wheels are locking up and limits wheel lockup by “pulsing” each wheel’s brakes independently. Pulsing releases brake pressure repeatedly for fractions of a second. This helps the tires attain the traction that current road conditions will allow, helping you to stay in directional control.

SMART STOP TECHNOLOGY (SST)

Smart Stop Technology automatically reduces engine power when the accelerator and brake pedals are pressed simultaneously under certain conditions.

SST engages when the accelerator is depressed first and the brakes are applied firmly for longer than one-half second at speeds greater than five miles per hour.

SST doesn’t engage if the brake pedal is depressed before the accelerator pedal, allowing vehicles to start on a steep hill and safely accelerate without rolling backward.

VEHICLE STABILITY CONTROL (VSC)

VSC helps prevent loss of traction during cornering by reducing engine power and applying brake force to selected wheels.

Toyota’s VSC monitors steering angle and the direction your vehicle is traveling. When it senses that the front or rear wheels begin to lose traction, VSC reduces engine power and applies braking to selected wheels. This helps restore traction and vehicle control.

VSC helps prevent loss of traction during cornering by reducing engine power, and Traction Control helps maintain traction on loose gravel and wet, icy, or uneven surfaces by applying brake force to the spinning wheel(s).

Toyota's TRAC sensors are activated when one of the drive wheels starts to slip. TRAC limits engine output and applies the brakes to the spinning wheel. This transfers power to the wheels that still have traction to help keep you on track.

Floor mat installation

There are two types of Toyota floor mats: carpeted and all-weather. Each vehicle has model-specific floor mats. Installation is easy.

To keep your floor mat properly positioned, follow these steps:

- Only use Toyota floor mats designed for your specific model.
- Use only one floor mat at a time, using the retaining hooks to keep the mat in place.
- Install floor mats right side up.

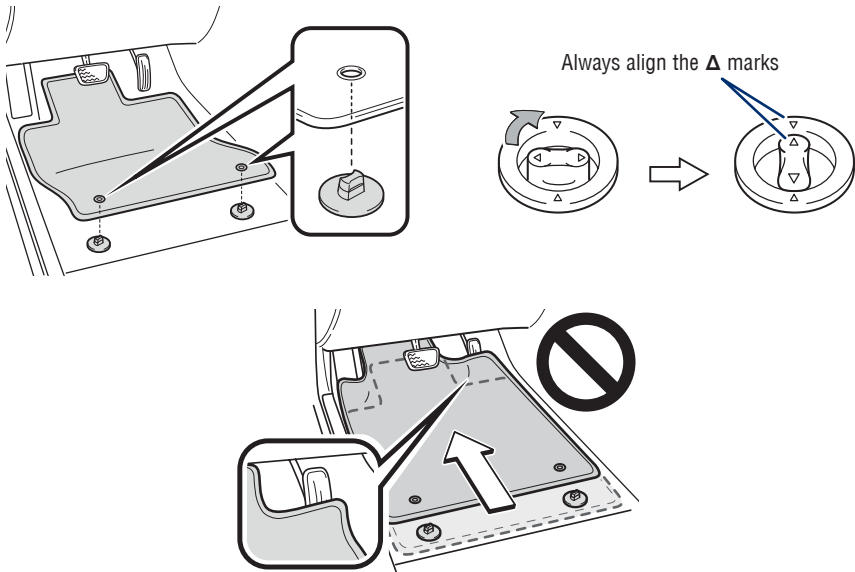

NOTES

NOTES

NOTES



Land Cruiser

Quick Reference Guide 2021



00505QRG21LC

toyota.com



Printed in U.S.A. 7/20
20-MKG-14818