

<b>Pictorial index</b>	Search by illustration	
<b>For safety and security</b>	Make sure to read through them (Main topics: Child seat, theft deterrent system)	1
<b>Vehicle status information and indicators</b>	Reading driving-related information (Main topics: Meters, multi-information display)	2
<b>Before driving</b>	Opening and closing the doors and windows, adjustment before driving (Main topics: Keys, doors, seats)	3
<b>Driving</b>	Operations and advice which are necessary for driving (Main topics: Starting engine, refueling)	4
<b>Audio</b>	Operating the Audio (Main topics: Audio/visual, phone)	5
<b>Interior features</b>	Usage of the interior features (Main topics: Air conditioner, storage features)	6
<b>Maintenance and care</b>	Caring for your vehicle and maintenance procedures (Main topics: Interior and exterior, light bulbs)	7
<b>When trouble arises</b>	What to do in case of malfunction and emergency (Main topics: Battery discharge, flat tire)	8
<b>Vehicle specifications</b>	Vehicle specifications, customizable features (Main topics: Fuel, oil, tire inflation pressure)	9
<b>For owners</b>	Reporting safety defects for U.S. owners, and seat belt and SRS airbag instructions for Canadian owners	10
<b>Index</b>	Search by symptom	
	Search alphabetically	

For your information .....	7
Reading this manual.....	11
How to search.....	12
Pictorial index .....	13

## 1 For safety and security

<b>1-1. For safe use</b>	
Before driving.....	24
For safe driving .....	25
Seat belts .....	27
SRS airbags .....	31
Front passenger occupant classification system.....	41
Exhaust gas precautions.....	46
<b>1-2. Child safety</b>	
Riding with children .....	47
Child restraint systems.....	48
<b>1-3. Emergency assistance</b>	
Safety Connect .....	73
<b>1-4. Theft deterrent system</b>	
Engine immobilizer system ...	80
Alarm.....	82

## 2 Vehicle status information and indicators

<b>2-1. Instrument cluster</b>	
Warning lights and indicators .....	86
Gauges and meters (4.2-inch display).....	91
Gauges and meters (7-inch display) .....	95
Multi-information display ....	100
Fuel consumption information .....	106

## 3 Before driving

<b>3-1. Key information</b>	
Keys .....	110
<b>3-2. Opening, closing and locking the doors</b>	
Doors .....	117
Trunk .....	122
Smart key system .....	125
<b>3-3. Adjusting the seats</b>	
Front seats .....	133
Rear seats.....	134
Head restraints.....	136
<b>3-4. Adjusting the steering wheel and mirrors</b>	
Steering wheel .....	138
Inside rear view mirror .....	139
Outside rear view mirrors...	140
<b>3-5. Opening and closing the windows</b>	
Power windows .....	142
Moon roof.....	145

## 4 Driving

<b>4-1. Before driving</b>	
Driving the vehicle.....	150
Cargo and luggage .....	158
Vehicle load limits .....	161
Trailer towing.....	161
Dinghy towing .....	162
<b>4-2. Driving procedures</b>	
Engine (ignition) switch (vehicles without a smart key system) .....	163
Engine (ignition) switch (vehicles with a smart key system) .	164
Continuously variable transmission (vehicles without paddle shift switches) .....	169

<p>Continuously variable transmission (vehicles with paddle shift switches)..... 172</p> <p>Manual transmission ..... 176</p> <p>Turn signal lever..... 179</p> <p>Parking brake..... 180</p> <p>Electric parking brake..... 181</p> <p>Brake Hold ..... 184</p> <p><b>4-3. Operating the lights and wipers</b></p> <p>Headlight switch..... 186</p> <p>Automatic High Beam ..... 189</p> <p>Windshield wipers and washer ..... 192</p> <p><b>4-4. Refueling</b></p> <p>Opening the fuel tank cap .. 194</p> <p><b>4-5. Using the driving support systems</b></p> <p>Toyota Safety Sense 2.0 .... 196</p> <p>PCS (Pre-Collision System) ..... 203</p> <p>LTA (Lane Tracing Assist)... 211</p> <p>LDA (Lane Departure Alert with steering control) ..... 221</p> <p>Dynamic radar cruise control with full-speed range..... 229</p> <p>Dynamic radar cruise control ..... 240</p> <p>RSA (Road Sign Assist) .... 250</p> <p>BSM (Blind Spot Monitor)... 253</p> <p>RCTA (Rear Cross Traffic Alert) function ..... 258</p> <p>Rear view monitor system.. 263</p> <p>Driving mode select switch ..... 271</p> <p>Driving assist systems..... 272</p> <p><b>4-6. Driving tips</b></p> <p>Winter driving tips..... 277</p>	<p><b>5 Audio</b></p> <p><b>5-1. Basic function</b></p> <p>Buttons overview..... 283</p> <p>Menu screen ..... 285</p> <p>Status icon ..... 286</p> <p>“Setup” screen ..... 288</p> <p><b>5-2. Basic information before operation</b></p> <p>Initial screen..... 289</p> <p>Touch screen..... 290</p> <p>Home screen..... 292</p> <p>Entering letters and numbers/list screen operation ..... 293</p> <p>Screen adjustment ..... 296</p> <p>Linking multi-information display and the system ..... 297</p> <p><b>5-3. Connectivity settings</b></p> <p>Registering/Connecting a Bluetooth® device ..... 298</p> <p>Setting Bluetooth® details .. 302</p> <p>Wi-Fi® Hotspot ..... 310</p> <p>Apple CarPlay/Android Auto ..... 314</p> <p><b>5-4. Other settings</b></p> <p>General settings..... 321</p> <p>Voice settings..... 325</p> <p>Vehicle settings ..... 326</p> <p><b>5-5. Using the audio/visual system</b></p> <p>Quick reference..... 328</p> <p>Some basics ..... 329</p> <p><b>5-6. Radio operation</b></p> <p>AM radio/FM radio/SiriusXM® Satellite Radio(SXM) ..... 333</p> <p>Internet radio..... 338</p> <p><b>5-7. Media operation</b></p> <p>USB memory..... 339</p>	<p>1</p> <p>2</p> <p>3</p> <p>4</p> <p>5</p> <p>6</p> <p>7</p> <p>8</p> <p>9</p> <p>10</p>
---	---	--





**7-2. Maintenance**  
 Maintenance requirements ..... 457  
 General maintenance..... 458  
 Emission inspection and maintenance (I/M) programs..... 461

**7-3. Do-it-yourself maintenance**  
 Do-it-yourself service precautions ..... 462  
 Hood ..... 464  
 Positioning a floor jack ..... 465  
 Engine compartment..... 466  
 Tires ..... 475  
 Tire inflation pressure..... 484  
 Wheels ..... 486  
 Air conditioning filter..... 487  
 Wireless remote control/electronic key battery..... 489  
 Checking and replacing fuses ..... 492  
 Light bulbs..... 495

**8 When trouble arises**

**8-1. Essential information**  
 Emergency flashers ..... 502  
 If your vehicle has to be stopped in an emergency ..... 502  
 If the vehicle is trapped in rising water ..... 504

**8-2. Steps to take in an emergency**  
 If your vehicle needs to be towed ..... 505  
 If you think something is wrong ..... 509  
 Fuel pump shut off system ..... 510  
 If a warning light turns on or a warning buzzer sounds .... 511  
 If a warning message is displayed ..... 521

If you have a flat tire (vehicles without spare tire) ..... 523  
 If you have a flat tire (vehicles with a spare tire) ..... 534  
 If the engine will not start ... 542  
 If you lose your keys ..... 544  
 If the electronic key does not operate properly..... 544  
 If the vehicle battery is discharged ..... 546  
 If your vehicle overheats .... 550  
 If the vehicle becomes stuck ..... 553

**9 Vehicle specifications**

**9-1. Specifications**  
 Maintenance data (fuel, oil level, etc.)..... 556  
 Fuel information ..... 568  
 Tire information ..... 570

**9-2. Customization**  
 Customizable features ..... 581

**9-3. Initialization**  
 Items to initialize ..... 589

**10 For owners**

**10-1. For owners**  
 Reporting safety defects for U.S. owners ..... 592  
 Seat belt instructions for Canadian owners (in French)... 592  
 SRS airbag instructions for Canadian owners (in French) ..... 594



**Index**

What to do if... (Troubleshooting) .....	604
Alphabetical Index.....	607

## For your information

### Main Owner's Manual

Please note that this manual applies to all models and explains all equipment, including options. Therefore, you may find some explanations for equipment not installed on your vehicle.

All specifications provided in this manual are current at the time of printing. However, because of the Toyota policy of continual product improvement, we reserve the right to make changes at any time without notice.

Depending on specifications, the vehicle shown in the illustrations may differ from your vehicle in terms of equipment.

### Noise from under vehicle after turning off the engine

Approximately five hours after the engine is turned off, you may hear sound coming from under the vehicle for several minutes. This is the sound of a fuel evaporation leakage check and, it does not indicate a malfunction.

### Accessories, spare parts and modification of your Toyota

A wide variety of non-genuine spare parts and accessories for Toyota vehicles are currently available in the market. You should know that Toyota does not warrant these products and is not responsible for their performance, repair, or replacement, or for any damage they may cause to, or adverse effect they may have on, your Toyota vehicle.

This vehicle should not be modified with non-genuine Toyota products. Modification with non-genuine Toyota products could affect its performance, safety or durability, and may even violate governmental regulations. In addition, damage or performance problems resulting from the modification may not be covered under warranty.

### Installation of a mobile two-way radio system

The installation of a mobile two-way radio system in your vehicle could affect electronic systems such as:

- Multiport fuel injection system/sequential multiport fuel injection system
- Toyota Safety Sense 2.0

- Anti-lock brake system
- SRS airbag system
- Seat belt pretensioner system

Be sure to check with your Toyota dealer for precautionary measures or special instructions regarding installation of a mobile two-way radio system.

### Vehicle data recording

The vehicle is equipped with sophisticated computers that will record certain data, such as:

- Engine speed/Electric motor speed (traction motor speed)
- Accelerator status
- Brake status
- Vehicle speed
- Operation status of the driving assist systems
- Images from the cameras  
Your vehicle is equipped with cameras. Contact your Toyota dealer for the location of recording cameras.

The recorded data varies according to the vehicle grade level and options with which it is equipped.

These computers do not record conversations or sounds, and only record images outside of the vehicle in certain situations.

- Data Transmission

Your vehicle may transmit the data recorded in these computers to Toyota without notification to you.

- Data usage

Toyota may use the data recorded in this computer to diagnose malfunctions, conduct research and development, and improve quality.

Toyota will not disclose the recorded data to a third party except:

- With the consent of the vehicle owner or with the consent of the lessee if the vehicle is leased
- In response to an official request by the police, a court of law or a government agency
- For use by Toyota in a lawsuit
- For research purposes where the data is not tied to a specific vehicle or vehicle owner
- Recorded image information can be erased by your Toyota dealer.

The image recording function can be disabled. However, if the function is disabled, data from when the system operates will not be available.

- To learn more about the vehicle data collected, used and shared by Toyota, please visit [www.toyota.com/privacyvts/](http://www.toyota.com/privacyvts/).

### Usage of data collected through Safety Connect (U.S. mainland only)

If your Toyota has Safety Connect and if you have subscribed to those services, please refer to the Safety Connect Telematics Subscription Service Agreement

for information on data collected and its usage.

To learn more about the vehicle data collected, used and shared by Toyota, please visit [www.toyota.com/privacyvts/](http://www.toyota.com/privacyvts/).

### Event data recorder

This vehicle is equipped with an event data recorder (EDR). The main purpose of an EDR is to record, in certain crash or near crash-like situations, such as an air bag deployment or hitting a road obstacle, data that will assist in understanding how a vehicle's systems performed. The EDR is designed to record data related to vehicle dynamics and safety systems for a short period of time, typically 30 seconds or less.

The EDR in this vehicle is designed to record such data as:

- How various systems in your vehicle were operating;
- Whether or not the driver and passenger safety belts were buckled/fastened;
- How far (if at all) the driver was depressing the accelerator and/or brake pedal; and,
- How fast the vehicle was traveling.

These data can help provide a better understanding of the circumstances in which crashes

and injuries occur.

NOTE: EDR data are recorded by your vehicle only if a non-trivial crash situation occurs; no data are recorded by the EDR under normal driving conditions and no personal data (e.g., name, gender, age, and crash location) are recorded. However, other parties, such as law enforcement, could combine the EDR data with the type of personally identifying data routinely acquired during a crash investigation.

To read data recorded by an EDR, special equipment is required, and access to the vehicle or the EDR is needed. In addition to the vehicle manufacturer, other parties, such as law enforcement, that have the special equipment, can read the information if they have access to the vehicle or the EDR.

#### ● Disclosure of the EDR data

Toyota will not disclose the data recorded in an EDR to a third party except when:

- An agreement from the vehicle's owner (or the lessee for a leased vehicle) is obtained
- In response to an official request by the police, a court of law or a government agency
- For use by Toyota in a lawsuit

However, if necessary, Toyota may:

- Use the data for research on vehicle safety performance

- Disclose the data to a third party for research purposes without disclosing information about the specific vehicle or vehicle owner

### Scrapping of your Toyota

The SRS airbag and seat belt pretensioner devices in your Toyota contain explosive chemicals. If the vehicle is scrapped with the airbags and seat belt pretensioners left as they are, this may cause an accident such as fire. Be sure to have the systems of the SRS airbag and seat belt pretensioner removed and disposed of by a qualified service shop or by your Toyota dealer before you scrap your vehicle.

### Perchlorate Material

Special handling may apply, See [www.dtsc.ca.gov/hazardouswaste/perchlorate](http://www.dtsc.ca.gov/hazardouswaste/perchlorate).

Your vehicle has components that may contain perchlorate. These components may include the airbags, seat belt pretensioners, wireless remote control batteries, and the batteries in the tire pressure warning valve and transmitters.

### WARNING

#### ■ General precautions while driving

**Driving under the influence:** Never drive your vehicle when under the influence of alcohol or drugs that have impaired your ability to operate your vehicle. Alcohol and certain drugs delay reaction time, impair judgment and reduce coordination, which could lead to an accident that could result in death or serious injury.

**Defensive driving:** Always drive defensively. Anticipate mistakes that other drivers or pedestrians might make and be ready to avoid accidents.

**Driver distraction:** Always give your full attention to driving. Anything that distracts the driver, such as adjusting controls, talking on a cellular phone or reading can result in a collision with resulting death or serious injury to you, your occupants or others.

#### ■ General precaution regarding children's safety



Never leave children unattended in the vehicle, and never allow children to have or use the key.



Children may be able to start the vehicle or shift the vehicle into neutral. There is also a danger that children may injure themselves by playing with the windows, the moon roof, or other features of the vehicle. In addition, heat build-up or extremely cold temperatures inside the vehicle can be fatal to children.

**Reading this manual**



**Explains symbols used in this manual.**

**Symbols in this manual**

Symbols	Meanings
	<b>WARNING:</b> Explains something that, if not obeyed, could cause death or serious injury to people.
	<b>NOTICE:</b> Explains something that, if not obeyed, could cause damage to or a malfunction in the vehicle or its equipment.
1 2 3...	Indicates operating or working procedures. Follow the steps in numerical order.

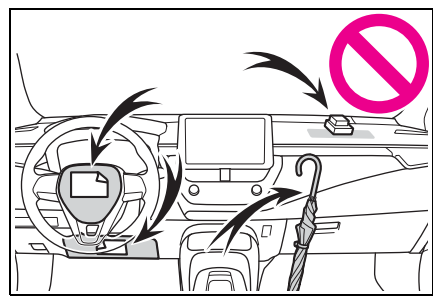
Symbols	Meanings
	Indicates the action (pushing, turning, etc.) used to operate switches and other devices.
	Indicates the outcome of an operation (e.g. a lid opens).



Symbols	Meanings
	Indicates the component or position being explained.
	Means <b>Do not</b> , <b>Do not do this</b> , or <b>Do not let this happen</b> .

**Symbols in illustrations**

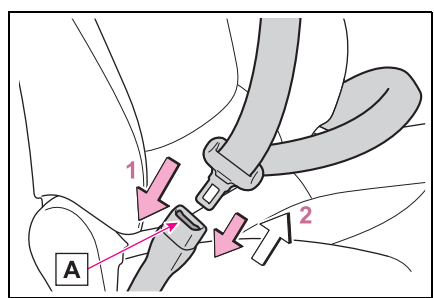

## How to search

### ■ Searching by name

- Alphabetical index: →P.607

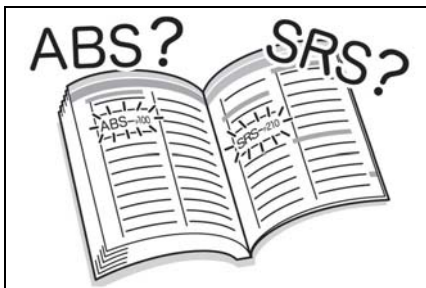

### ■ Searching by installation position

- Pictorial index: →P.13

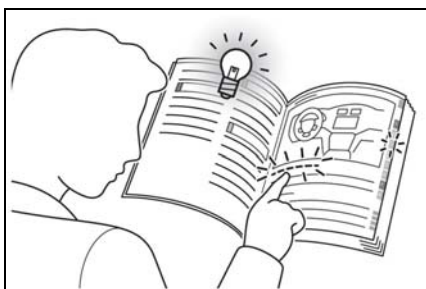

### ■ Searching by symptom or sound

- What to do if... (Troubleshooting): →P.604



### ■ Searching by title

- Table of contents: →P.2

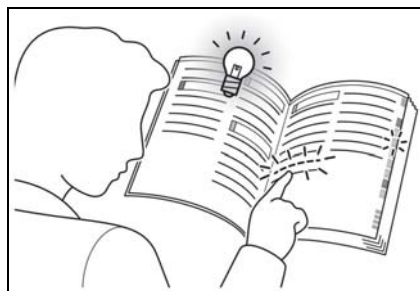



# Pictorial index

## ■ Exterior

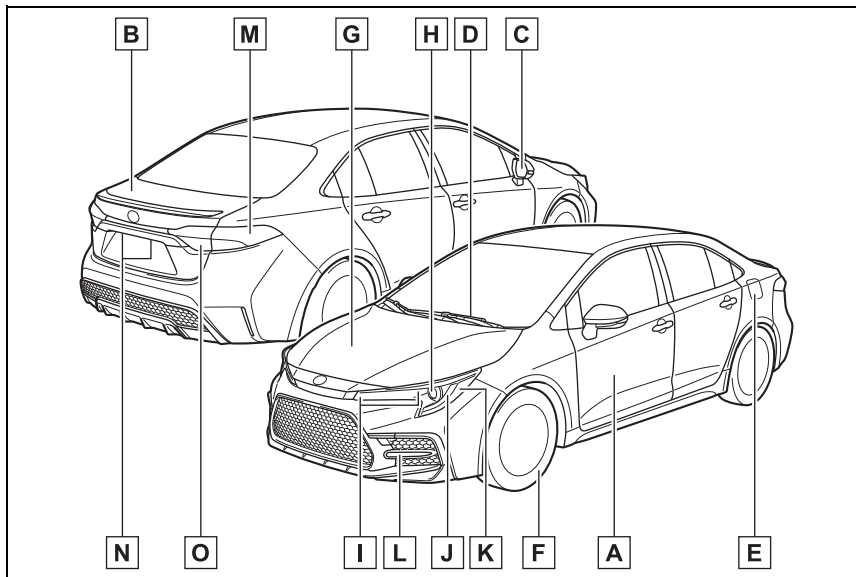

<b>A</b>	<b>Doors</b> .....	<b>P.117</b>
	Locking/unlocking .....	P.117
	Opening/closing the side windows .....	P.142
	Locking/unlocking by using the mechanical key <sup>*1</sup> .....	P.544
	Warning messages .....	P.121
<b>B</b>	<b>Trunk</b> .....	<b>P.122</b>
	Opening from inside .....	P.123
	Opening from outside.....	P.123
	Warning messages .....	P.125
<b>C</b>	<b>Outside rear view mirrors</b> .....	<b>P.140</b>
	Adjusting the mirror angle .....	P.140
	Folding the mirrors .....	P.141
	Defogging the mirrors <sup>*2</sup> .....	P.418, 422
<b>D</b>	<b>Windshield wipers</b> .....	<b>P.192</b>
	Precautions for winter season.....	P.277
	To prevent freezing (windshield wiper de-icer) <sup>*2</sup> .....	P.425

<b>E</b>	<b>Fuel filler door</b> .....	<b>P.194</b>
	Refueling method .....	P.195
	Fuel type/fuel tank capacity .....	P.558
<b>F</b>	<b>Tires</b> .....	<b>P.475</b>
	Tire size/inflation pressure .....	P.564
	Winter tires/tire chains .....	P.277
	Checking/rotation/tire pressure warning system <sup>*2</sup> .....	P.475
	Coping with flat tires.....	P.523, 534
<b>G</b>	<b>Hood</b> .....	<b>P.464</b>
	Opening .....	P.464
	Engine oil .....	P.558
	Coping with overheating .....	P.550

**Light bulbs of the exterior lights for driving**

(Replacing method: P.495, Watts: P.566)

<b>H</b>	<b>Headlights/daytime running lights</b> .....	<b>P.186</b>
<b>I</b>	<b>Turn signal lights/parking lights</b> .....	<b>P.186</b>
<b>J</b>	<b>Parking lights</b> <sup>*2</sup> .....	<b>P.186</b>
<b>K</b>	<b>Front side marker lights</b> .....	<b>P.186</b>
<b>L</b>	<b>LED accent lights</b> <sup>*2</sup> .....	<b>P.186</b>
<b>M</b>	<b>Stop lights/tail lights/rear side marker lights/turn signal lights</b> <b>P.186</b>	
<b>N</b>	<b>License plate lights</b> .....	<b>P.186</b>
<b>O</b>	<b>Tail lights</b> <sup>*2</sup> .....	<b>P.186</b>
	<b>Back-up lights</b>	
	Shifting the shift position to R .....	P.169, 172, 176

<sup>\*1</sup>: Vehicles with a smart key system

<sup>\*2</sup>: If equipped

## ■ Instrument panel

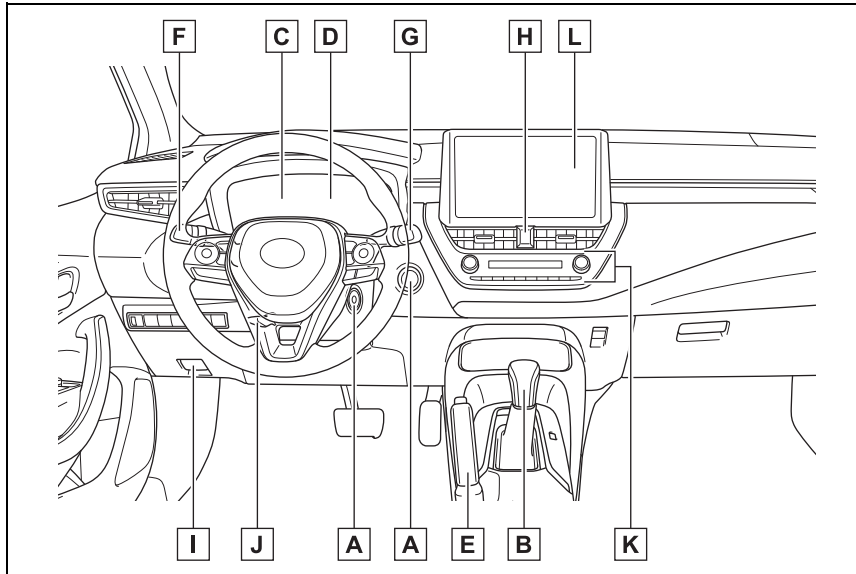

- A Engine switch** ..... **P.163, 164**  
 Starting the engine/changing the positions <sup>\*1</sup> ..... P.163  
 Starting the engine/changing the modes <sup>\*2</sup> ..... P.164  
 Emergency stop of the engine ..... P.502  
 When the engine will not start ..... P.542  
 Warning messages ..... P.521
- B Shift lever** ..... **P.169, 172, 176**  
 Changing the shift position ..... P.169, 172, 176  
 Precautions for towing ..... P.505  
 When the shift lever does not move <sup>\*3</sup> ..... P.171
- C Meters** ..... **P.91, 95**  
 Reading the meters/adjusting the instrument panel light . P.91, 95  
 Warning lights/indicator lights ..... P.86  
 When a warning light turns on ..... P.511
- D Multi-information display** ..... **P.100**  
 Display ..... P.100

When a warning message is displayed..... P.521

**E Parking brake** <sup>\*4</sup>..... **P.180**

Applying/releasing..... P.180

Precautions for winter season..... P.278

Warning light/message..... P.180, 511

**F Turn signal lever**..... **P.179**

**Headlight switch** ..... **P.186**

Headlights/parking lights/tail lights/side marker lights/daytime running lights/LED accent lights <sup>\*4</sup> ..... P.186

**G Windshield wiper and washer switch**..... **P.192**

Usage..... P.192

Adding washer fluid..... P.474

**H Emergency flasher switch**..... **P.502**

**I Hood lock release lever**..... **P.464**

**J Tilt and telescopic steering lock release lever**..... **P.138**

**K Air conditioning system** ..... **P.416, 421**

Usage..... P.416, 421

Rear window defogger ..... P.418, 422

**L Audio** <sup>\*4</sup> ..... **P.283**

**Audio Plus** <sup>\*4, 5</sup>

**Premium Audio** <sup>\*4, 5</sup>

\*1: Vehicles without a smart key system

\*2: Vehicles with a smart key system

\*3: Vehicles with a continuously variable transmission

\*4: If equipped

\*5: Refer to “NAVIGATION AND MULTIMEDIA SYSTEM OWNER’S MANUAL”.

■ Switches

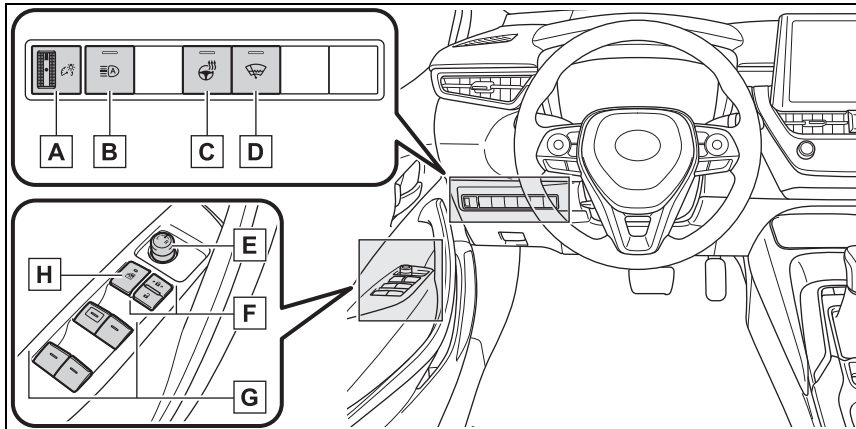

- A** Instrument panel light control dial ..... P.93, 98
- B** Automatic High Beam switch ..... P.189
- C** Heated steering wheel switch\* ..... P.427
- D** Windshield wiper de-icer switch\* ..... P.425
- E** Outside rear view mirror switch ..... P.140
- F** Door lock switches ..... P.120
- G** Power window switches ..... P.142
- H** Window lock switch ..... P.144

\*: If equipped

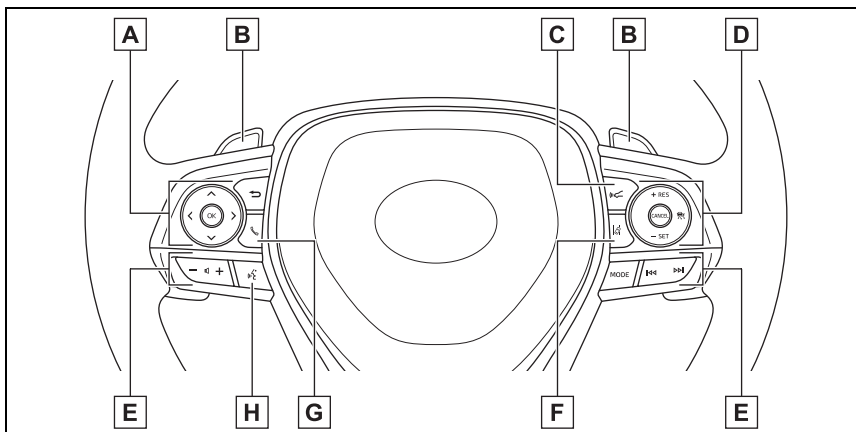

- A Meter control switches** ..... P.101
- B Paddle shift switches** <sup>\*1</sup> ..... P.174
- C Vehicle-to-vehicle distance switch** ..... P.235, 245
- D Cruise control switches**
  - Dynamic radar cruise control with full-speed range <sup>\*1</sup> ..... P.229
  - Dynamic radar cruise control <sup>\*1</sup> ..... P.240
- E Audio remote control switches** <sup>\*2</sup> ..... P.349
- F LTA (Lane Tracing Assist) switch** <sup>\*1</sup> ..... P.211
- LDA (Lane Departure Alert with steering control) switch** <sup>\*1</sup> P.221
- G Phone switch** <sup>\*2</sup> ..... P.376
- H Talk switch** <sup>\*2</sup> ..... P.364

<sup>\*1</sup>: If equipped

<sup>\*2</sup>: Vehicles with Audio Plus or Premium Audio, refer to “NAVIGATION AND MULTIMEDIA SYSTEM OWNER’S MANUAL”.

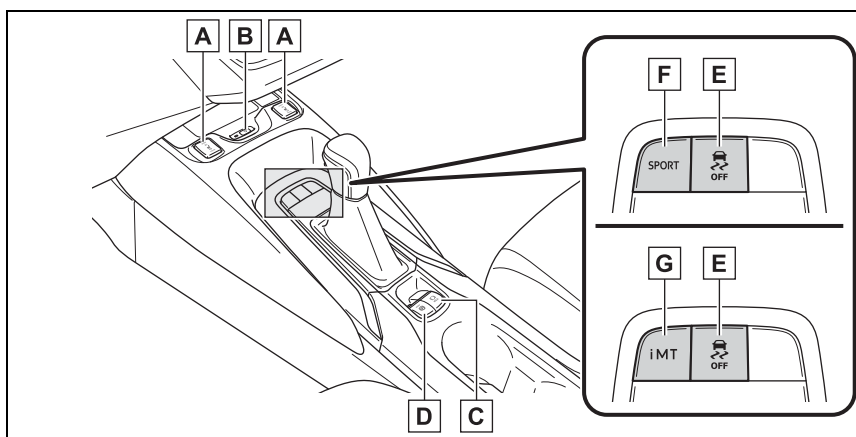

- A Seat heater switches** <sup>\*</sup> ..... P.427
- B Wireless charger switch** <sup>\*</sup> ..... P.435
- C Brake hold switch** <sup>\*</sup> ..... P.184
- D Parking brake switch** <sup>\*</sup> ..... P.181
  - Precautions for winter season ..... P.278
- E VSC OFF switch** ..... P.273

**F** Sport mode switch\* ..... P.271

**G** "iMT" (Intelligent Manual Transmission) switch\* ..... P.178

\*: If equipped

■ Interior

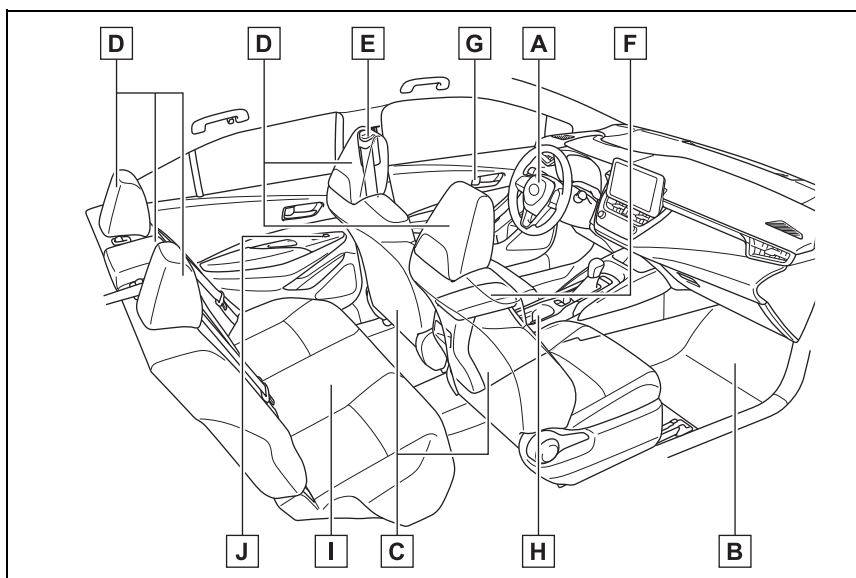

<b>A</b>	<b>SRS airbags</b> .....	<b>P.31</b>
<b>B</b>	<b>Floor mats</b> .....	<b>P.24</b>
<b>C</b>	<b>Front seats</b> .....	<b>P.133</b>
<b>D</b>	<b>Head restraints</b> .....	<b>P.136</b>
<b>E</b>	<b>Seat belts</b> .....	<b>P.27</b>
<b>F</b>	<b>Console box</b> .....	<b>P.432</b>
<b>G</b>	<b>Inside lock buttons</b> .....	<b>P.121</b>
<b>H</b>	<b>Cup holders</b> .....	<b>P.431</b>
<b>I</b>	<b>Rear seats</b> .....	<b>P.134</b>
<b>J</b>	<b>Rear seat heater switches</b> *	<b>P.427</b>

\*: If equipped



■ Ceiling

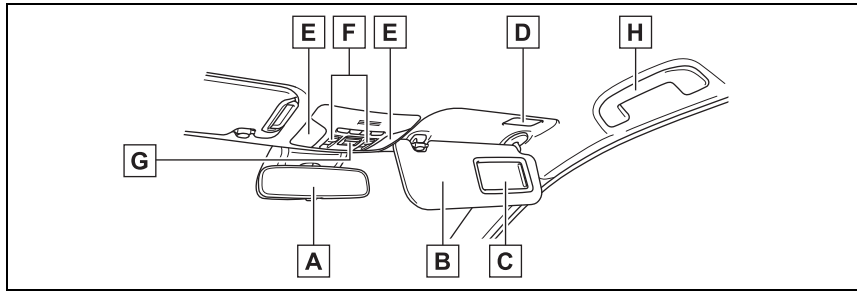

<b>A</b>	<b>Inside rear view mirror</b> .....	<b>P.139</b>
<b>B</b>	<b>Sun visors</b> .....	<b>P.442</b>
<b>C</b>	<b>Vanity mirrors</b> .....	<b>P.442</b>
<b>D</b>	<b>Vanity lights*</b> .....	<b>P.442</b>
<b>E</b>	<b>Interior lights/personal lights</b> .....	<b>P.428</b>
<b>F</b>	<b>Moon roof switches*</b> .....	<b>P.145</b>
<b>G</b>	<b>“SOS” button*</b> .....	<b>P.73</b>
<b>H</b>	<b>Assist grips</b> .....	<b>P.443</b>

\*: If equipped



## For safety and security

1

23

### 1-1. For safe use

- Before driving ..... 24
- For safe driving ..... 25
- Seat belts ..... 27
- SRS airbags ..... 31
- Front passenger occupant  
classification system .... 41
- Exhaust gas precautions  
..... 46

### 1-2. Child safety

- Riding with children ..... 47
- Child restraint systems... 48

### 1-3. Emergency assistance

- Safety Connect ..... 73

### 1-4. Theft deterrent system

- Engine immobilizer system  
..... 80
- Alarm..... 82

1

For safety and security

## Before driving

**Observe the following before starting off in the vehicle to ensure safety of driving.**

### Floor mat

Use only floor mats designed specifically for vehicles of the same model and model year as your vehicle. Fix them securely in place onto the carpet.

- 1 Insert the retaining hooks (clips) into the floor mat eyelets.

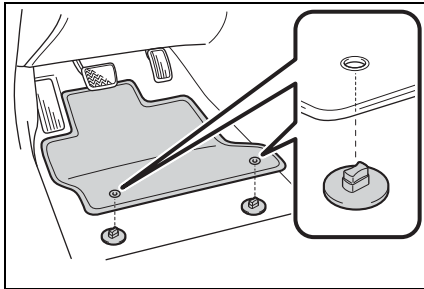

- 2 Turn the upper knob of each retaining hook (clip) to secure the floor mats in place.

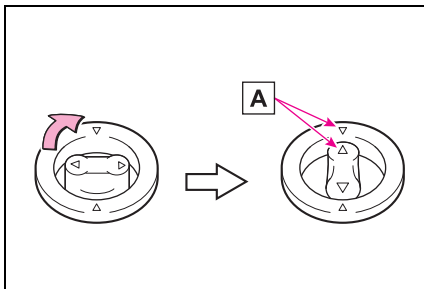

Always align the  $\triangle$  marks **A**.

The shape of the retaining hooks (clips) may differ from that shown in the illustration.

### **⚠ WARNING**

Observe the following precautions. Failure to do so may cause the driver's floor mat to slip, possibly interfering with the pedals while driving. An unexpectedly high speed may result or it may become difficult to stop the vehicle. This could lead to an accident, resulting in death or serious injury.

#### ■ When installing the driver's floor mat

- Do not use floor mats designed for other models or different model year vehicles, even if they are Toyota Genuine floor mats.
- Only use floor mats designed for the driver's seat.
- Always install the floor mat securely using the retaining hooks (clips) provided.
- Do not use two or more floor mats on top of each other.
- Do not place the floor mat bottom-side up or upside-down.

**⚠ WARNING****■ Before driving**

- Check that the floor mat is securely fixed in the correct place with all the provided retaining hooks (clips). Be especially careful to perform this check after cleaning the floor.

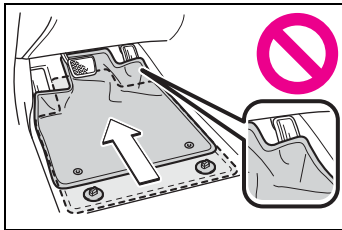

- With the engine stopped and the shift lever in P (continuously variable transmission) or N (manual transmission), fully depress each pedal to the floor to make sure it does not interfere with the floor mat.

**For safe driving**

**For safe driving, adjust the seat and mirror to an appropriate position before driving.**

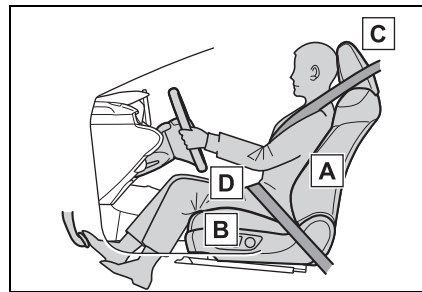
**Correct driving posture**

- A** Adjust the angle of the seat-back so that you are sitting straight up and so that you do not have to lean forward to steer. (→P.133)
- B** Adjust the seat so that you can depress the pedals fully and so that your arms bend slightly at the elbow when gripping the steering wheel. (→P.133)
- C** Lock the head restraint in place with the center of the head restraint closest to the top of your ears. (→P.136)
- D** Wear the seat belt correctly. (→P.27)

1

For safety and security

**WARNING****■ For safe driving**

Observe the following precautions.

Failure to do so may result in death or serious injury.

- Do not adjust the position of the driver's seat while driving. Doing so could cause the driver to lose control of the vehicle.
- Do not place a cushion between the driver or passenger and the seatback. A cushion may prevent correct posture from being achieved, and reduce the effectiveness of the seat belt and head restraint.
- Do not place anything under the front seats. Objects placed under the front seats may become jammed in the seat tracks and stop the seat from locking in place. This may lead to an accident and the adjustment mechanism may also be damaged.
- Always observe the legal speed limit when driving on public roads.
- When driving over long distances, take regular breaks before you start to feel tired. Also, if you feel tired or sleepy while driving, do not force yourself to continue driving and take a break immediately.
- Take care when adjusting the seat position to ensure that other passengers are not injured by the moving seat.
- When adjusting the seat position, do not put your hands under the seat or near the moving parts to avoid injury. Fingers or hands may become jammed in the seat mechanism.

**Correct use of the seat belts**

Make sure that all occupants are wearing their seat belts before driving the vehicle. (→P.27)

Use a child restraint system appropriate for the child until the child becomes large enough to properly wear the vehicle's seat belt. (→P.48)

**Adjusting the mirrors**

Make sure that you can see backward clearly by adjusting the inside and outside rear view mirrors properly. (→P.139, 140)

## Seat belts

**Make sure that all occupants are wearing their seat belts before driving the vehicle.**

### WARNING

Observe the following precautions to reduce the risk of injury in the event of sudden braking, sudden swerving or an accident. Failure to do so may cause death or serious injury.

#### ■ Wearing a seat belt

- Ensure that all passengers wear a seat belt.
- Always wear a seat belt properly.
- Each seat belt should be used by one person only. Do not use a seat belt for more than one person at once, including children.
- Toyota recommends that children be seated in the rear seat and always use a seat belt and/or an appropriate child restraint system.
- To achieve a proper seating position, do not recline the seat more than necessary. The seat belt is most effective when the occupants are sitting up straight and well back in the seats.
- Do not wear the shoulder belt under your arm.
- Always wear your seat belt low and snug across your hips.

#### ■ Pregnant women

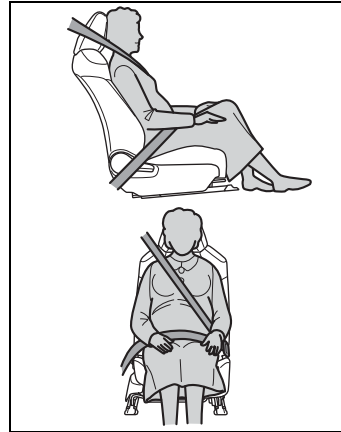

Obtain medical advice and wear the seat belt in the proper way. (→P.28)

Women who are pregnant should position the lap belt as low as possible over the hips in the same manner as other occupants, extending the shoulder belt completely over the shoulder and avoiding belt contact with the rounding of the abdominal area.

If the seat belt is not worn properly, not only the pregnant woman, but also the fetus could suffer death or serious injury as a result of sudden braking or a collision.

#### ■ People suffering illness

Obtain medical advice and wear the seat belt in the proper way. (→P.28)

#### ■ When children are in the vehicle

→P.63

#### ■ Seat belt damage and wear

- Do not damage the seat belts by allowing the belt, plate, or buckle to be jammed in the door.

**⚠ WARNING**

- Inspect the seat belt system periodically. Check for cuts, fraying, and loose parts. Do not use a damaged seat belt until it is replaced. Damaged seat belts cannot protect an occupant from death or serious injury.
- Ensure that the belt and plate are locked and the belt is not twisted.  
If the seat belt does not function correctly, immediately contact your Toyota dealer.
- Replace the seat assembly, including the belts, if your vehicle has been involved in a serious accident, even if there is no obvious damage.
- Do not attempt to install, remove, modify, disassemble or dispose of the seat belts. Have any necessary repairs carried out by your Toyota dealer. Inappropriate handling may lead to incorrect operation.

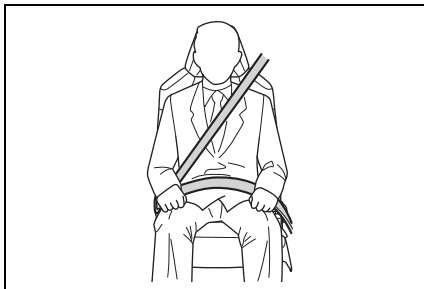
**Correct use of the seat belts**

- Extend the shoulder belt so that it comes fully over the shoulder, but does not come into contact with the neck or slide off the shoulder.

- Position the lap belt as low as possible over the hips.
- Adjust the position of the seatback. Sit up straight and well back in the seat.
- Do not twist the seat belt.

**■ Child seat belt usage**

The seat belts of your vehicle were principally designed for persons of adult size.

- Use a child restraint system appropriate for the child, until the child becomes large enough to properly wear the vehicle's seat belt. (→P.48)
- When the child becomes large enough to properly wear the vehicle's seat belt, follow the instructions regarding seat belt usage. (→P.27)

**■ Seat belt extender**

If your seat belts cannot be fastened securely because they are not long enough, a personalized seat belt extender is available from your Toyota dealer free of charge.

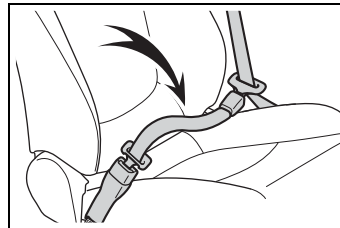
**⚠ WARNING**

- **Using a seat belt extender**
- Do not wear the seat belt extender if you can fasten the seat belt without the extender.



**⚠ WARNING**

- Do not use the seat belt extender when installing a child restraint system because the belt will not securely hold the child restraint system, increasing the risk of death or serious injury in the event of an accident.
- The personalized extender may not be safe on another vehicle, when used by another person, or at a different seating position other than the one originally intended.

**⚠ NOTICE****■ When using a seat belt extender**

When releasing the seat belt, press on the buckle release button on the extender, not on the seat belt.

This helps prevent damage to the vehicle interior and the extender itself.

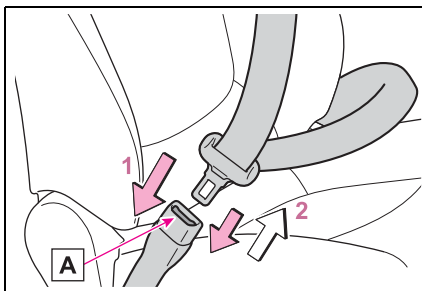
**Fastening and releasing the seat belt**

- 1 To fasten the seat belt, push the plate into the buckle until a click sound is heard.
- 2 To release the seat belt, press the release button **A**.

**■ Emergency locking retractor (ELR)**

The retractor will lock the belt during a sudden stop or on impact. It may also lock if you lean forward too quickly. A slow, easy motion will allow the belt to extend so that you can move around fully.

**■ Automatic locking retractor (ALR)**

When a passenger's shoulder belt is completely extended and then retracted even slightly, the belt is locked in that position and cannot be extended. This feature is used to hold the child restraint system (CRS) firmly. To free the belt again, fully retract the belt and then pull the belt out once more. (→P.48)

**■ Rear seat belt**

Use the seat belt after passing it through the guide if the seat belt comes free from the guide.

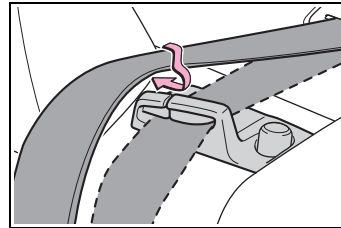
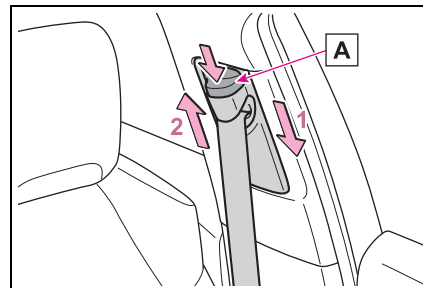
**Adjusting the seat belt shoulder anchor height (front seats)**

- 1 Push the seat belt shoulder

anchor down while pressing the release button **A**.

- 2 Push the seat belt shoulder anchor up while pressing the release button **A**.

Move the height adjuster up and down as needed until you hear a click.

### **! WARNING**

#### ■ **Adjustable shoulder anchor**

Always make sure the shoulder belt is positioned across the center of your shoulder. The belt should be kept away from your neck, but not falling off your shoulder. Failure to do so could reduce the amount of protection in an accident and cause death or serious injuries in the event of a sudden stop, sudden swerve or accident.

### **Seat belt pretensioners (front seats)**

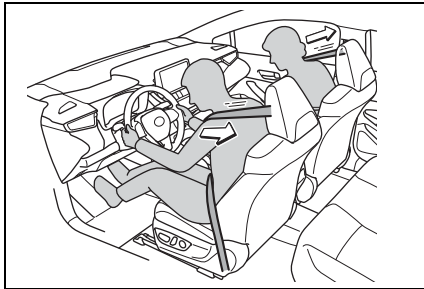

The pretensioners help the seat belts to quickly restrain the occupants by retracting the seat belts when the vehicle is subjected to certain types of severe frontal or side collision or a vehicle rollover.

The pretensioners do not activate

in the event of a minor frontal impact, a minor side impact or a rear impact.

### ■ **Replacing the belt after the pretensioner has been activated**

If the vehicle is involved in multiple collisions, the pretensioner will activate for the first collision, but will not activate for the second or subsequent collisions.

### **! WARNING**

#### ■ **Seat belt pretensioners**

- Do not place anything, such as a cushion, on the front passenger's seat. Doing so will disperse the passenger's weight, which prevents the sensor from detecting the passenger's weight properly. As a result, the seat belt pretensioner for the front passenger's seat may not activate in the event of a collision.
- If the pretensioner has activated, the SRS warning light will come on. In that case, the seat belt cannot be used again and must be replaced at your Toyota dealer.

## SRS airbags

The SRS airbags inflate when the vehicle is subjected to certain types of severe impacts that may cause significant injury to the occupants. They work together with the seat belts to help reduce the risk of death or serious injury.

### SRS airbag system

#### ■ Location of the SRS airbags

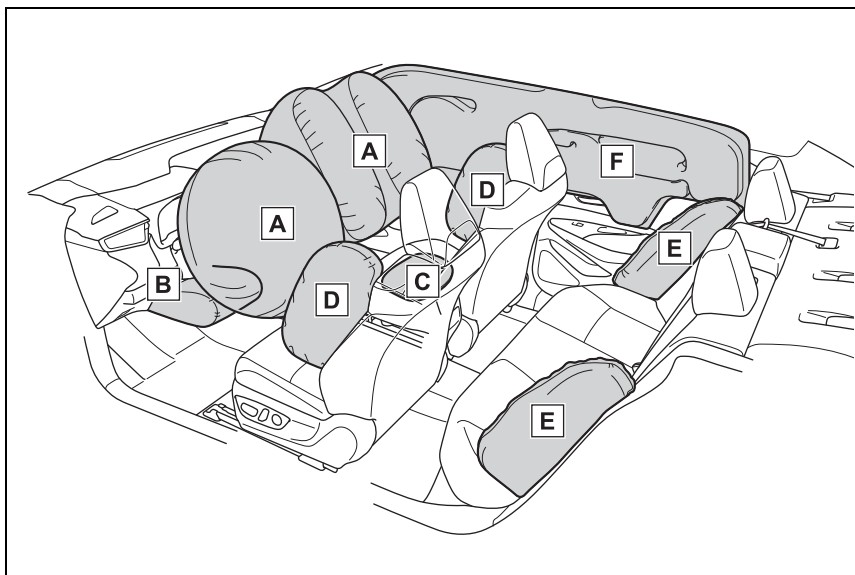

#### ► SRS front airbags

##### **A** SRS driver airbag/front passenger airbag

Can help protect the head and chest of the driver and front passenger from impact with interior components

##### **B** SRS knee airbag

Can help provide driver protection

##### **C** SRS seat cushion airbag

Can help restrain the front passenger

#### ► SRS side and curtain shield airbags

##### **D** SRS front side airbags

Can help protect the torso of the front seat occupants

**E** SRS rear side airbags

Can help protect the torso of occupants in the rear outer seats

**F** SRS curtain shield airbags

- Can help protect primarily the head of occupants in the outer seats
- Can help prevent the occupants from being thrown from the vehicle in the event of vehicle rollover

■ **SRS airbag system components**

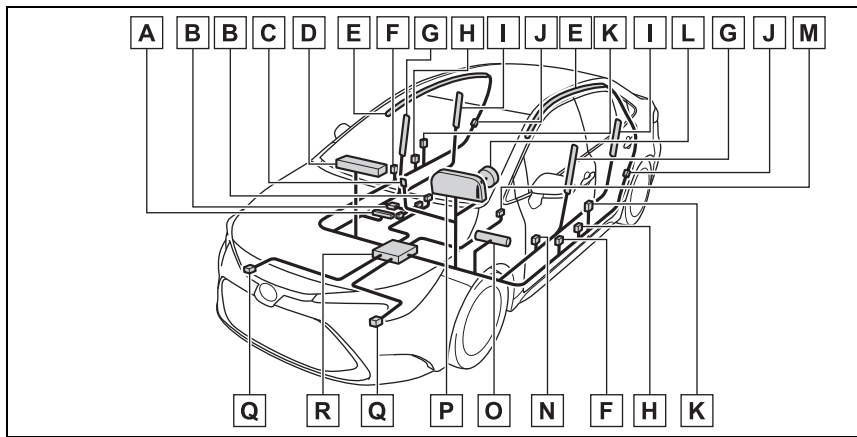

**A** Seat cushion airbag

**B** Front passenger occupant classification system (ECU and sensors)

**C** “AIR BAG ON” and “AIR BAG OFF” indicator lights

**D** Front passenger airbag

**E** Curtain shield airbags

**F** Side impact sensors (front doors)

**G** Front side airbags

**H** Seat belt pretensioners and force limiters

**I** Rear side airbags

**J** Side impact sensors (rear)

**K** Side impact sensors (front)

**L** Driver airbag

**M** Driver’s seat belt buckle switch

**N** Driver’s seat position sensor

**O** Driver’s knee airbag

- P** SRS warning light
- Q** Front impact sensors
- R** Airbag sensor assembly

Your vehicle is equipped with ADVANCED AIRBAGS designed based on the US motor vehicle safety standards (FMVSS208). The airbag sensor assembly (ECU) controls airbag deployment based on information obtained from the sensors etc. shown in the system components diagram above. This information includes crash severity and occupant information. As the airbags deploy, a chemical reaction in the inflators quickly fills the airbags with non-toxic gas to help restrain the motion of the occupants.

#### ■ If the SRS airbags deploy (inflate)

- Slight abrasions, burns, bruising etc., may be sustained from SRS airbags, due to the extremely high speed deployment (inflation) by hot gases.
- A loud noise and white powder will be emitted.
- Parts of the airbag module (steering wheel hub, airbag cover and inflator) as well as the front seats, parts of the front and rear pillars, and roof side rails, may be hot for several minutes. The airbag itself may also be hot.
- The windshield may crack.
- The brakes and stop lights will be controlled automatically. (→P.272)
- The interior lights will turn on automatically. (→P.429)
- The emergency flashers will turn on automatically. (→P.502)
- Fuel supply to the engine will be stopped. (→P.510)
- For Safety Connect subscribers, if any of the following situations occur, the system is designed to send an emergency call to the response center, notifying them of the vehicle's location (without needing to push the "SOS" button) and an agent will attempt to speak

with the occupants to ascertain the level of emergency and assistance required. If the occupants are unable to communicate, the agent automatically treats the call as an emergency and helps to dispatch the necessary emergency services. (→P.73)

- An SRS airbag is deployed.
- A seat belt pretensioner is activated.
- The vehicle is involved in a severe rear-end collision.

#### ■ SRS airbag deployment conditions (SRS front airbags)

- The SRS front airbags will deploy in the event of an impact that exceeds the set threshold level (the level of force corresponding to an approximately 12 - 18 mph [20 - 30 km/h] frontal collision with a fixed wall that does not move or deform).

However, this threshold velocity will be considerably higher in the following situations:

- If the vehicle strikes an object, such as a parked vehicle or sign pole, which can move or deform on impact
- If the vehicle is involved in an underride collision, such as a collision in which the front of the vehicle "underrides", or goes under, the bed of a truck

- Depending on the type of collision, it is possible that only the seat belt pretensioners will activate.
- The SRS front airbags for the front passenger will not activate if there is no passenger sitting in the front passenger seat. However, the SRS front airbags for the front passenger may deploy if luggage is put in the seat, even if the seat is unoccupied.
- The SRS seat cushion airbag on the front passenger seat will not operate if the occupant is not wearing a seat belt.

■ **SRS airbag deployment conditions (SRS side and curtain shield airbags)**

- The SRS side and curtain shield airbags will deploy in the event of an impact that exceeds the set threshold level (the level of force corresponding to the impact force produced by an approximately 3300 lb. [1500 kg] vehicle colliding with the vehicle cabin from a direction perpendicular to the vehicle orientation at an approximate speed of 12 - 18 mph [20 - 30 km/h]).
- Both SRS curtain shield airbags may deploy in the event of a severe side collision.
- Both SRS curtain shield airbags will deploy in the event of vehicle rollover.
- Both SRS curtain shield airbags may also deploy in the event of a severe frontal collision.

■ **Conditions under which the SRS airbags may deploy (inflate), other than a collision**

The SRS front airbags and SRS side and curtain shield airbags may also deploy if a serious impact occurs to the underside of your vehicle. Some examples are shown in the illustration.

- Hitting a curb, edge of pavement or hard surface

- Falling into or jumping over a deep hole
- Landing hard or falling

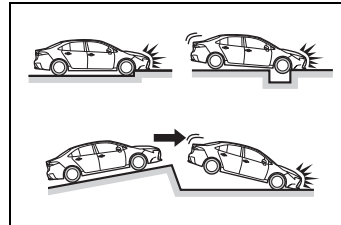

The SRS curtain shield airbags may also deploy under the situations shown in the illustration.

- The angle of vehicle tip-up is marginal.
- The vehicle skids and hits a curb stone.

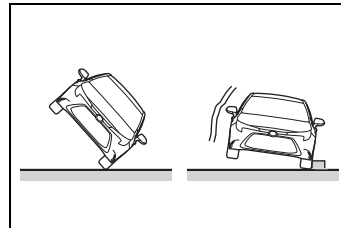

■ **Types of collisions that may not deploy the SRS airbags (SRS front airbags)**

The SRS front airbags do not generally inflate if the vehicle is involved in a side or rear collision, if it rolls over, or if it is involved in a low-speed frontal collision. But, whenever a collision of any type causes sufficient forward deceleration of the vehicle, deployment of the SRS front airbags may occur.

- Collision from the side
- Collision from the rear
- Vehicle rollover

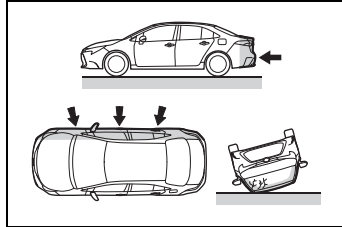

**Types of collisions that may not deploy the SRS airbags (SRS side and curtain shield airbags)**

The SRS side and curtain shield airbags may not activate if the vehicle is subjected to a collision from the side at certain angles, or a collision to the side of the vehicle body other than the passenger compartment.

- Collision from the side to the vehicle body other than the passenger compartment
- Collision from the side at an angle

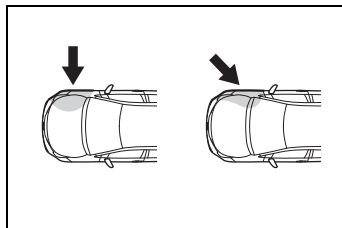

The SRS side airbags do not generally inflate if the vehicle is involved in a frontal or rear collision, if it rolls over, or if it is involved in a low-speed side collision.

- Collision from the front
- Collision from the rear
- Vehicle rollover

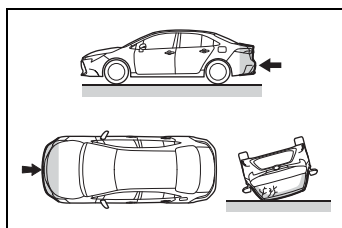

The SRS curtain shield airbags do not generally inflate if the vehicle is

involved in a rear collision, if it pitches end over end, or if it is involved in a low-speed side or low-speed frontal collision.

- Collision from the rear
- Pitching end over end

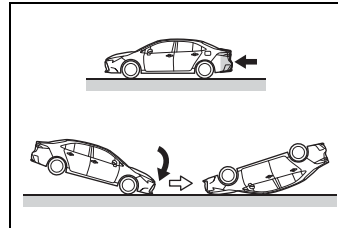

**When to contact your Toyota dealer**

In the following cases, the vehicle will require inspection and/or repair. Contact your Toyota dealer as soon as possible.

- Any of the SRS airbags have been inflated.
- The front of the vehicle is damaged or deformed, or was involved in an accident that was not severe enough to cause the SRS front airbags to inflate.

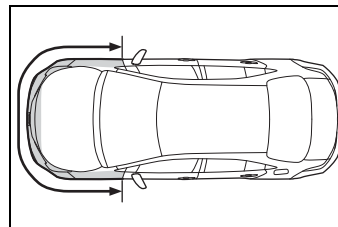

- A portion of a door or its surrounding area is damaged, deformed or has had a hole made in it, or the vehicle was involved in an accident that was not severe enough to cause the SRS side and curtain shield airbags to inflate.

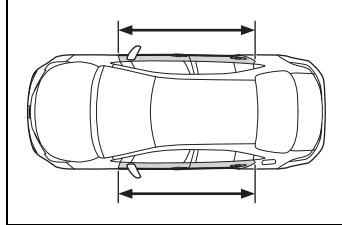

- The pad section of the steering wheel, dashboard near the front passenger airbag or lower portion of the instrument panel is scratched, cracked, or otherwise damaged.

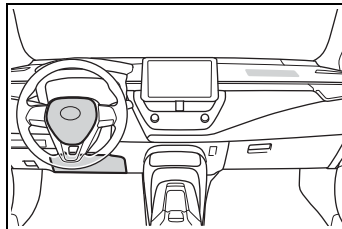

- The seat cushion surface is scratched, cracked, or otherwise damaged.

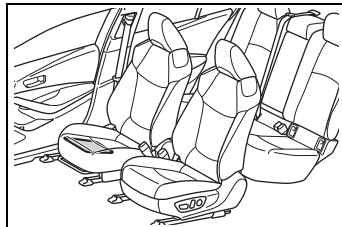

- The surface of the seats with the SRS side airbag is scratched, cracked, or otherwise damaged.

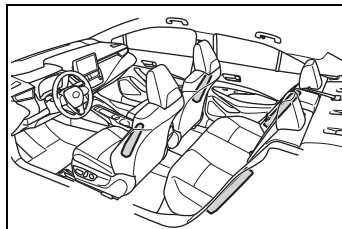

- The portion of the front pillars, rear pillars or roof side rail garnishes (padding) containing the SRS curtain shield airbags inside is

scratched, cracked, or otherwise damaged.

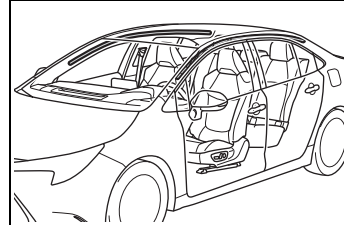

### ⚠ WARNING

#### ■ SRS airbag precautions

Observe the following precautions regarding the SRS airbags. Failure to do so may cause death or serious injury.

- The driver and all passengers in the vehicle must wear their seat belts properly. The SRS airbags are supplemental devices to be used with the seat belts.
- The SRS driver airbag deploys with considerable force, and can cause death or serious injury especially if the driver is very close to the airbag. The National Highway Traffic Safety Administration (NHTSA) advises:

Since the risk zone for the driver's airbag is the first 2 - 3 in. (50 - 75 mm) of inflation, placing yourself 10 in. (250 mm) from your driver airbag provides you with a margin of safety. This distance is measured from the center of the steering wheel to your breastbone. If you sit less than 10 in. (250 mm) away now, you can change your driving position in several ways:

- Move your seat to the rear as far as you can while still reaching the pedals comfortably.



**⚠ WARNING**

- Slightly recline the back of the seat. Although vehicle designs vary, many drivers can achieve the 10 in. (250 mm) distance, even with the driver seat all the way forward, simply by reclining the back of the seat somewhat. If reclining the back of your seat makes it hard to see the road, raise yourself by using a firm, non-slippery cushion, or raise the seat if your vehicle has that feature.
- If your steering wheel is adjustable, tilt it downward. This points the airbag toward your chest instead of your head and neck.

The seat should be adjusted as recommended by NHTSA above, while still maintaining control of the foot pedals, steering wheel, and your view of the instrument panel controls.

- If the seat belt extender has been connected to the front seat belt buckles but the seat belt extender has not also been fastened to the latch plate of the seat belt, the SRS front airbags will judge that the driver and front passenger are wearing the seat belt even though the seat belt has not been connected. In this case, the SRS front airbags may not activate correctly in a collision, resulting in death or serious injury in the event of a collision. Be sure to wear the seat belt with the seat belt extender.

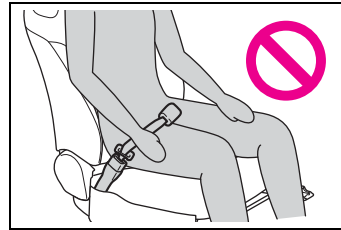

- The SRS front passenger airbag also deploys with considerable force, and can cause death or serious injury especially if the front passenger is very close to the airbag. The front passenger seat should be as far from the airbag as possible with the seat-back adjusted, so the front passenger sits upright.

**⚠ WARNING**

- Improperly seated and/or restrained infants and children can be killed or seriously injured by a deploying airbag. An infant or child who is too small to use a seat belt should be properly secured using a child restraint system. Toyota strongly recommends that all infants and children be placed in the rear seats of the vehicle and properly restrained. The rear seats are safer for infants and children than the front passenger seat. (→P.48)

- Do not sit on the edge of the seat or lean against the dashboard.

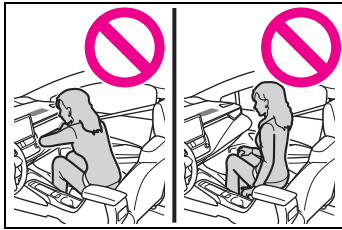

- Do not allow a child to stand in front of the SRS front passenger airbag unit or sit on the knees of a front passenger.

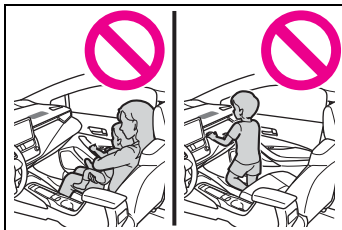

- Do not allow the front seat occupants to hold items on their knees.

- Do not lean against the door, the roof side rail or the front, side and rear pillars.



- Do not allow anyone to kneel on the passenger seats or put their head or hands outside the vehicle.

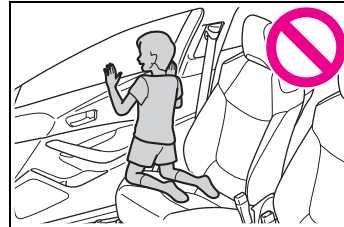

- Do not attach anything to or lean anything against areas such as the dashboard, steering wheel pad and lower portion of the instrument panel. These items can become projectiles when the SRS driver, front passenger and knee airbags deploy.

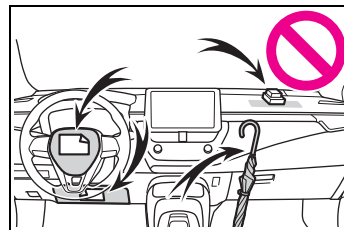

**⚠ WARNING**

- Do not attach anything to areas such as a door, windshield, side windows, front or rear pillar, roof side rail and assist grip. (Except for the speed limit label →P.525)

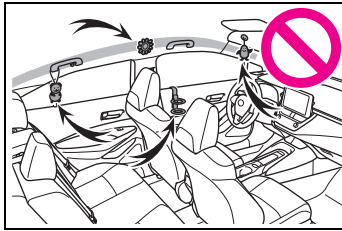

- Vehicles without a smart key system: Do not attach any heavy, sharp or hard objects such as keys and accessories to the key. The objects may restrict the SRS knee airbag inflation or be thrust into the driver's seat area by the force of the deploying airbag, thus causing a danger.

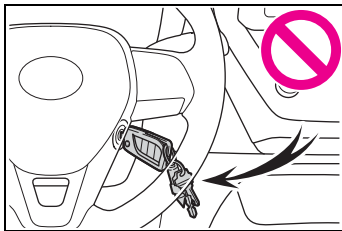

- Do not hang hangers or other hard objects on the coat hooks. All of these items could become projectiles and may cause death or serious injury, should the SRS curtain shield airbags deploy.
- If a vinyl cover is put on the area where the SRS driver's knee airbag will deploy, be sure to remove it.

- Do not use seat accessories which cover the parts where the SRS side airbags and SRS seat cushion airbag inflate as they may interfere with inflation of the SRS airbags. Such accessories may prevent the side airbags and seat cushion airbag from activating correctly, disable the system or cause the side airbags and seat cushion airbag to inflate accidentally, resulting in death or serious injury.

- Do not strike or apply significant levels of force to the area of the SRS airbag components or the front doors. Doing so can cause the SRS airbags to malfunction.

- Do not touch any of the component parts immediately after the SRS airbags have deployed (inflated) as they may be hot.

- If breathing becomes difficult after the SRS airbags have deployed, open a door or window to allow fresh air in, or leave the vehicle if it is safe to do so. Wash off any residue as soon as possible to prevent skin irritation.

- If the areas where the SRS airbags are stored, such as the steering wheel pad and front and rear pillar garnishes, are damaged or cracked, have them replaced by your Toyota dealer.

- Do not place anything, such as a cushion, on the front passenger's seat. Doing so will disperse the passenger's weight, which prevents the sensor from detecting the passenger's weight properly. As a result, the SRS front airbags for the front passenger may not deploy in the event of a collision.

**WARNING****■ Modification and disposal of SRS airbag system components**

Do not dispose of your vehicle or perform any of the following modifications without consulting your Toyota dealer. The SRS airbags may malfunction or deploy (inflate) accidentally, causing death or serious injury.

- Installation, removal, disassembly and repair of the SRS airbags
- Repairs, modifications, removal or replacement of the steering wheel, instrument panel, dashboard, seats or seat upholstery, front, side and rear pillars, roof side rails, front door panels, front door trims or front door speakers
- Modifications to the front door panel (such as making a hole in it)
- Repairs or modifications of the front fender, front bumper, or side of the occupant compartment
- Installation of a grille guard (bull bars, kangaroo bar, etc.), snow plows, winches or roof luggage carrier
- Modifications to the vehicle's suspension system
- Installation of electronic devices such as mobile two-way radios and CD players
- Modifications to your vehicle for a person with a physical disability

## Front passenger occupant classification system

Your vehicle is equipped with a front passenger occupant classification system. This system detects the conditions of the front passenger seat and activates or deactivates the front passenger airbag and seat cushion airbag in the front passenger side.

### System components

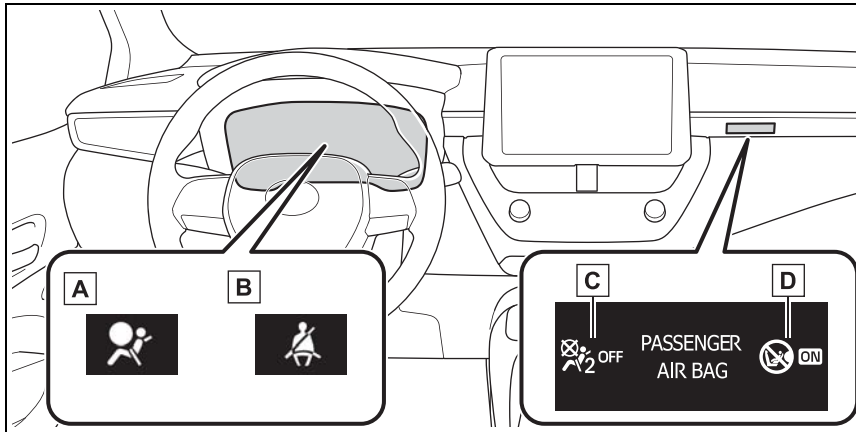

- A** SRS warning light
- B** Front passenger seat belt reminder light
- C** "AIR BAG OFF" indicator light
- D** "AIR BAG ON" indicator light

#### **⚠ WARNING**

#### **■ Front passenger occupant classification system precautions**

Observe the following precautions regarding the front passenger occupant classification system. Failure to do so may cause death or serious injury.

- Wear the seat belt properly.

- Make sure the front passenger's seat belt latch plate has not been left inserted into the buckle before someone sits in the front passenger seat.

**WARNING**

- Make sure the “AIR BAG OFF” indicator light is not illuminated when using the seat belt extender for the front passenger seat. If the “AIR BAG OFF” indicator light is illuminated, disconnect the extender tongue from the seat belt buckle, and reconnect the seat belt. Reconnect the seat belt extender after making sure the “AIR BAG ON” indicator light is illuminated. If you use the seat belt extender while the “AIR BAG OFF” indicator light is illuminated, the SRS airbags for the front passenger may not activate, which could cause death or serious injury in the event of a collision.
- Do not apply a heavy load to the front passenger seat or equipment (e.g. seatback pocket).
- Do not put weight on the front passenger seat by putting your hands or feet on the front passenger seat seatback from the rear passenger seat.
- Do not let a rear passenger lift the front passenger seat with their feet or press on the seatback with their legs.
- Do not put objects under the front passenger seat.
- Do not recline the front passenger seatback so far that it touches the rear seat. This may cause the “AIR BAG OFF” indicator light to be illuminated, which indicates that the SRS airbags for the front passenger will not activate in the event of a severe accident. If the seatback touches the rear seat, return the seatback to a position where it does not touch the rear seat. Keep the front passenger seatback as upright as possible when the vehicle is moving. Reclining the seatback excessively may lessen the effectiveness of the seat belt system.
- If an adult sits in the front passenger seat, the “AIR BAG ON” indicator light is illuminated. If the “AIR BAG OFF” indicator is illuminated, ask the passenger to sit up straight, well back in the seat, feet on the floor, and with the seat belt worn correctly. If the “AIR BAG OFF” indicator still remains illuminated, either ask the passenger to move to the rear seat, or if that is not possible, move the front passenger seat fully rearward.
- When it is unavoidable to install a forward-facing child restraint system on the front passenger seat, install the child restraint system on the front passenger seat in the proper order. (→P.50)
- Do not modify or remove the front seats.
- Do not kick the front passenger seat or subject it to severe impact. Otherwise, the SRS warning light may come on to indicate a malfunction of the front passenger occupant classification system. In this case, contact your Toyota dealer immediately.

**⚠ WARNING**

- Child restraint systems installed on the rear seat should not contact the front seatbacks.
- Do not use a seat accessory, such as a cushion and seat cover, that covers the seat cushion surface.
- Do not modify or replace the upholstery of the front seat.

**Condition and operation in the front passenger occupant classification system**

■ **Adult\*1**

Indicator/warning light	“AIR BAG ON” and “AIR BAG OFF” indicator lights	“AIR BAG ON”
	SRS warning light	Off
	Front passenger’s seat belt reminder light	Off*2 or flashing*3
Devices	Front passenger airbag	Activated
	Seat cushion airbag in the front passenger side	Activated*2 or deactivated*3

■ **Child\*4**

Indicator/warning light	“AIR BAG ON” and “AIR BAG OFF” indicator lights	“AIR BAG OFF” or “AIR BAG ON”*4
	SRS warning light	Off
	Front passenger’s seat belt reminder light	Off*2 or flashing*3
Devices	Front passenger airbag	Deactivated or activated*4
	Seat cushion airbag in the front passenger side	Deactivated or activated*4, 2

■ Child restraint system with infant\*5

Indicator/warning light	“AIR BAG ON” and “AIR BAG OFF” indicator lights	“AIR BAG OFF” <sup>*6</sup>
	SRS warning light	Off
	Front passenger’s seat belt reminder light	Off <sup>*2</sup> or flashing <sup>*3</sup>
Devices	Front passenger airbag	Deactivated
	Seat cushion airbag in the front passenger side	

■ Unoccupied

Indicator/warning light	“AIR BAG ON” and “AIR BAG OFF” indicator lights	“AIR BAG OFF”
	SRS warning light	Off
	Front passenger’s seat belt reminder light	
Devices	Front passenger airbag	Deactivated
	Seat cushion airbag in the front passenger side	

■ There is a malfunction in the system

Indicator/warning light	“AIR BAG ON” and “AIR BAG OFF” indicator lights	“AIR BAG OFF”
	SRS warning light	On
	Front passenger’s seat belt reminder light	
Devices	Front passenger airbag	Deactivated
	Seat cushion airbag in the front passenger side	

\*1: The system judges a person of adult size as an adult. When a smaller adult sits in the front passenger seat, the system may not recognize him/her as an adult depending on his/her physique and posture.

\*2: In the event the front passenger is wearing a seat belt.

\*3: In the event the front passenger does not wear a seat belt.

\*4: For some children, child in seat, child in booster seat or child in convert-



ible seat, the system may not recognize him/her as a child. Factors which may affect this can be the physique or posture.

\*5: Never install a rear-facing child restraint system on the front passenger seat. A forward-facing child restraint system should only be installed on the front passenger seat when it is unavoidable. (→P.48)

\*6: In case the indicator light is not illuminated, consult this manual on how to install the child restraint system properly. (→P.48)

## Exhaust gas precautions

**Harmful substance to the human body is included in exhaust gases if inhaled.**

### **WARNING**

Exhaust gases include harmful carbon monoxide (CO), which is colorless and odorless. Observe the following precautions. Failure to do so may cause exhaust gases enter the vehicle and may lead to an accident caused by light-headedness, or may lead to death or a serious health hazard.

#### ■ Important points while driving

- Keep the trunk lid closed.
- If you smell exhaust gases in the vehicle even when the trunk lid is closed, open the windows and have the vehicle inspected at your Toyota dealer as soon as possible.

#### ■ When parking

- If the vehicle is in a poorly ventilated area or a closed area, such as a garage, stop the engine.
- Do not leave the vehicle with the engine on for a long time. If such a situation cannot be avoided, park the vehicle in an open space and ensure that exhaust fumes do not enter the vehicle interior.
- Do not leave the engine running in an area with snow build-up, or where it is snowing. If snowbanks build up around the vehicle while the engine is running, exhaust gases may collect and enter the vehicle.

#### ■ Exhaust pipe

The exhaust system needs to be checked periodically. If there is a hole or crack caused by corrosion, damage to a joint or abnormal exhaust noise, be sure to have the vehicle inspected and repaired by your Toyota dealer.

## Riding with children

**Observe the following precautions when children are in the vehicle.**

**Use a child restraint system appropriate for the child, until the child becomes large enough to properly wear the vehicle's seat belt.**

- It is recommended that children sit in the rear seats to avoid accidental contact with the shift lever, wiper switch, etc.
- Use the rear door child-protector lock or the window lock switch to avoid children opening the door while driving or operating the power window accidentally.  
(→P.121, 144)
- Do not let small children operate equipment which may catch or pinch body parts, such as the power window, hood, trunk, seats, etc.

### **WARNING**

#### ■ **When children are in the vehicle**

Never leave children unattended in the vehicle, and never allow children to have or use the key.

Children may be able to start the vehicle or shift the vehicle into neutral. There is also a danger that children may injure themselves by playing with the windows, the moon roof (if equipped) or other features of the vehicle. In addition, heat build-up or extremely cold temperatures inside the vehicle can be fatal to children.

1

For safety and security

## Child restraint systems

**Before installing a child restraint system in the vehicle, there are precautions that need to be observed, different types of child restraint systems, as well as installation methods, etc., written in this manual.**

Use a child restraint system when riding with a small child that cannot properly use a seat belt. For the child's safety, install the child restraint system to a rear seat. Be sure to follow the installation method that is in the operation manual enclosed with the restraint system.

### Table of contents

Points to remember: P.48

Child restraint system: P.50

When using a child restraint system: P.52

Child restraint system compatibility for each seating position (for Puerto Rico): P.54

Child restraint system installation method

- Fixed with a seat belt: P.59
- Fixed with a child restraint LATCH anchor (except for Puerto Rico): P.64
- Fixed with an ISOFIX lower

anchorage (for Puerto Rico): P.66

- Using an anchor bracket (for top tether strap) (except for Puerto Rico): P.68
- Using a top tether anchorage (for Puerto Rico): P.70

### Points to remember

The laws of all 50 states of the U.S.A. as well as Canada now require the use of child restraint systems.

- Prioritize and observe the warnings, as well as the laws and regulations for child restraint systems.
- Use a child restraint system until the child becomes large enough to properly wear the vehicle's seat belt.
- Choose a child restraint system that suits your vehicle and is appropriate to the age and size of the child.

### WARNING

#### ■ When a child is riding

Observe the following precautions.

Failure to do so may result in death or serious injury.

**WARNING**

- For effective protection in automobile accidents and sudden stops, a child must be properly restrained, using a seat belt or child restraint system which is correctly installed. For installation details, refer to the operation manual enclosed with the child restraint system. General installation instruction is provided in this manual.
- Toyota strongly urges the use of a proper child restraint system that conforms to the weight and size of the child, installed on the rear seat. According to accident statistics, the child is safer when properly restrained in the rear seat than in the front seat.
- Holding a child in your or someone else's arms is not a substitute for a child restraint system. In an accident, the child can be crushed against the windshield or between the holder and the interior of the vehicle.

**■ Handling the child restraint system**

If the child restraint system is not properly fixed in place, the child or other passengers may be seriously injured or even killed in the event of sudden braking, sudden swerving, or an accident.

- If the vehicle were to receive a strong impact from an accident, etc., it is possible that the child restraint system has damage that is not readily visible. In such cases, do not reuse the restraint system.

- For Puerto Rico: Depending on the child restraint system, installation may be difficult or impossible. In those cases, check whether the child restraint system is suitable for installment in the vehicle. (→P.54) Be sure to install and observe the usage rules after carefully reading the child restraint system fixing method in this manual, as well as the operation manual enclosed with the child restraint system.
- Except for Puerto Rico: Make sure you have complied with all installation instructions provided with the child restraint system manufacturer and that the system is properly secured.
- Keep the child restraint system properly secured on the seat even if it is not in use. Do not store the child restraint system unsecured in the passenger compartment.
- If it is necessary to detach the child restraint system, remove it from the vehicle or store it securely in the trunk.

### Child restraint system

#### ■ Types of child restraint system installation methods

Confirm with the operation manual enclosed with the child restraint system about the installation of the child restraint system.

	Installation method	Page
Seat belt attachment		P.59

Installation method	Page
<p>Except for Puerto Rico: Child restraint LATCH anchors attachment</p> <p>For Puerto Rico: ISOFIX lower anchor- age attachment</p>	 <p><b>A</b> Except for Puerto Rico <b>B</b> For Puerto Rico</p> <p>P.64, 66</p>

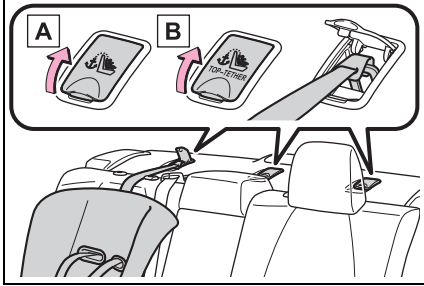
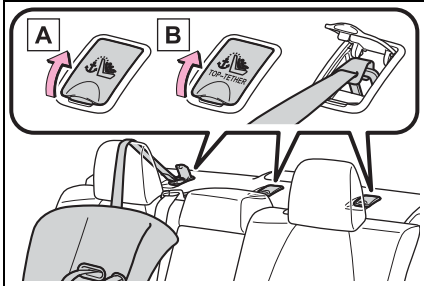
	Installation method	Page
<p>Except for Puerto Rico: Anchor brackets (for top tether strap) attachment</p> <p>For Puerto Rico: Top tether anchorage attachment</p>	<p>Seats with an adjustable type head restraint:</p>  <p><b>A</b> Except for Puerto Rico <b>B</b> For Puerto Rico</p> <p>Seats with an integrated type head restraint:</p>  <p><b>A</b> Except for Puerto Rico <b>B</b> For Puerto Rico</p>	<p>P.68, 70</p>

### When using a child restraint system

#### ■ When installing a child restraint system to a front passenger seat

For the safety of a child, install a child restraint system to a rear seat. When installing a child restraint system to a front passenger seat is unavoidable, adjust the seat as follows and

install the child restraint system:

- Move the front seat fully rearward.
- If the passenger seat height can be adjusted, Adjust the seat height to the upper most position.
- Adjust the seatback angle to the most upright position.

If there is a gap between the child seat and the seatback, adjust the



seatback angle until good contact is achieved.

- If the head restraint interferes with the child restraint system installation and the head restraint can be removed, remove the head restraint.

Otherwise, put the head restraint in the upper most position.

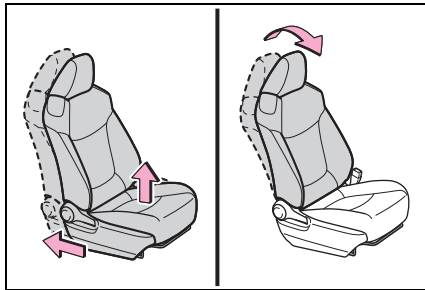

### **WARNING**

#### ■ **When using a child restraint system**

Observe the following precautions.

Failure to do so may result in death or serious injury.

- Never install a rear-facing child restraint system on the front passenger seat even if the "AIR BAG OFF" indicator light is illuminated. In the event of an accident, the force of the rapid inflation of the front passenger airbag can cause death or serious injury to the child if the rear-facing child restraint system is installed on the front passenger seat.

- A forward-facing child restraint system may be installed on the front passenger seat only when it is unavoidable. A child restraint system that requires a top tether strap should not be used in the front passenger seat since there is no top tether strap anchor for the front passenger seat.

- A forward-facing child restraint system may be installed on the front passenger seat only when it is unavoidable. When installing a forward-facing child restraint system on the front passenger seat, adjust the seatback angle to the most upright position, move the seat to the rearmost position, and raise the seat to the upper most position, even if the "AIR BAG OFF" indicator light is illuminated. If the head restraint interferes with the child restraint system installation and the head restraint can be removed, remove the head restraint.

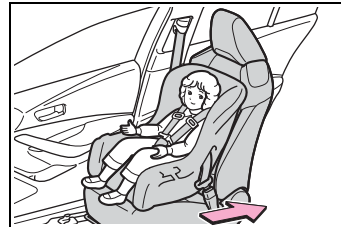

**⚠ WARNING**

- Do not allow the child to lean his/her head or any part of his/her body against the door or the area of the seat, front or rear pillars, or roof side rails from which the SRS side airbags or SRS curtain shield airbags deploy even if the child is seated in the child restraint system. It is dangerous if the SRS side and curtain shield airbags inflate, and the impact could cause death or serious injury to the child.



- When a booster seat is installed, always ensure that the shoulder belt is positioned across the center of the child's shoulder. The belt should be kept away from the child's neck, but not so that it could fall off the child's shoulder.
- Use child restraint system suitable to the age and size of the child and install it to the rear seat.

- If the driver's seat interferes with the child restraint system and prevents it from being attached correctly, attach the child restraint system to the right-hand rear seat.

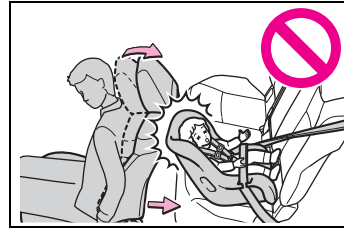

- Adjust the front passenger seat so that it does not interfere with the child restraint system.

### Child restraint system compatibility for each seating position (for Puerto Rico)

#### ■ Child restraint system compatibility for each seating position

Compatibility of each seating position with child restraint systems (→P.56) displays the type of child restraint systems that can be used and possible seating positions for installation using symbols.

Also, the recommended child restraint system that is suitable for your child can be selected. Otherwise, check [Recommended child restraint systems and Compatibility table] for recommended child restraint systems. (→P.58)

Check the selected child

restraint system together with the following [Before confirming the compatibility of each seating position with child restraint systems].

■ **Before confirming the compatibility of each seating position with child restraint systems**

- 1 Checking the child restraint system standards.  
Use a child restraint system that conforms to UN(ECE) R44\*<sup>1</sup> or UN(ECE) R129\*<sup>1, 2</sup>. The following approval mark is displayed on child restraint systems which are conformed.  
Check for an approval mark attached to the child restraint system.

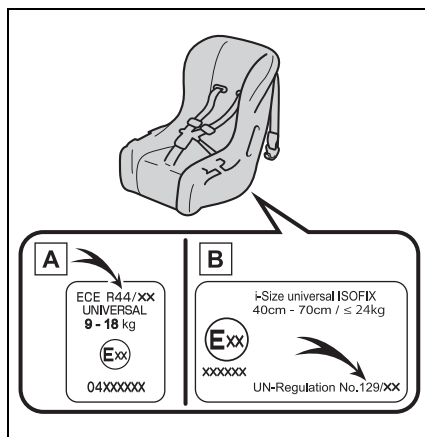

Example of the displayed regulation number

- A UN(ECE) R44 approval mark\*<sup>3</sup>  
The weight range of the child

who is applicable for an UN(ECE) R44 approval mark is indicated.

- B UN(ECE) R129 approval mark\*<sup>3</sup>  
The height range of the child who is applicable as well as available weights for an UN(ECE) R129 approval mark is indicated.
- 2 Checking the category of the child restraint system.  
Check the approval mark of the child restraint system for which of the following categories the child restraint system is suitable.  
Also, if there are any uncertainties, check the user's guide included with the child restraint system or contact the retailer of the child restraint system.

- "universal"
- "semi-universal"
- "restricted"
- "vehicle specific"

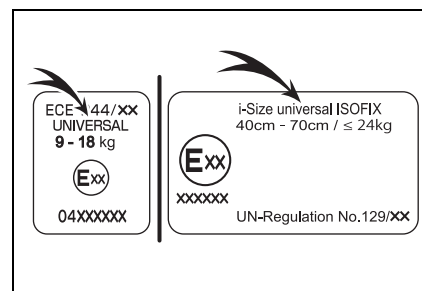

\*<sup>1</sup>: UN(ECE) R44 and UN(ECE) R129 are U.N. regulations for child restraint systems.

\*<sup>2</sup>: The child restraint systems men-

tioned in the table may not be available outside of the EU area.

\*3: The displayed mark may differ depending on the product.

■ **Compatibility of each seating position with child restraint systems**

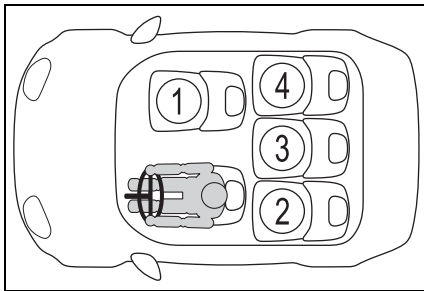

① *1, 2, 3	U	
② *3	U	L
③	U	Anchor icon
④ *3	U	L

**U** Suitable for “universal” category child restraint system fixed with the seat belt.

**L** Suitable for child restraint systems given on recommended child restraint systems and compatibility table (→P.58).

**i** Suitable for i-Size and ISO-FIX child restraint system.

**Anchor icon** Includes a top tether anchorage point.

\*1: Move the front seat fully rearward. If the passenger seat height can be adjusted, move it to the upper most position.

\*2: Adjust the seatback angle to the most upright position. When installing a forward-facing child seat, if there is a gap between the child seat and the seatback, adjust the seatback angle until good contact is achieved.

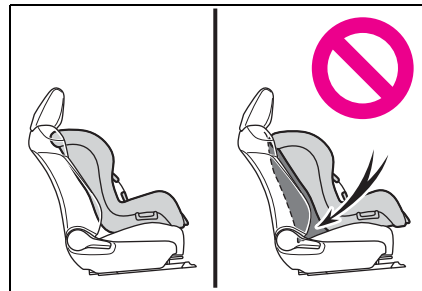

\*3: If the head restraint interferes with your child restraint system, and the head restraint can be removed, remove the head restraint. Otherwise, put the head restraint in the upper most position.

### ■ Detail information for child restraint systems installation

Seating position					
Seat position number	①		②	③	④
	Vehicle with front passenger occupant detection system				
	Passenger airbag indicator light				
	ON	OFF*			
Seating position suitable for universal belted (Yes/No)	Yes Forward facing only	Yes	Yes	Yes	Yes
i-Size seating position (Yes/No)	No	No	Yes	No	Yes
Seating position suitable for lateral fixture (L1/L2/No)	No	No	No	No	No
Suitable rearward facing fixture (R1/R2X/R2/R3/No)	No	No	R1, R2X, R2	No	R1, R2X, R2
Suitable forward facing fixture (F2X/F2/F3/No)	No	No	F2X, F2, F3	No	F2X, F2, F3
Suitable junior seat fixture (B2/B3/No)	No	No	B2, B3	No	B2, B3

\*: When it is unavoidable to install a rear-facing child restraint system on the front passenger seat, a child restraint system can be installed if the PASSENGER AIR BAG OFF indicator lamp is lit.

ISOFIX child restraint systems are divided into different “fixture”. The child restraint system can be used in the seating positions for “fixture” mentioned in the table above. For kind of “fixture” relation, confirm the following table.

If your child restraint system has no kind of “fixture” (or if you cannot find information in the table below), please refer to the child restraint system “vehicle list” for compatibility information or ask the retailer of your child seat.

Fixture	Description
F3	Full-height, forward-facing child restraint systems
F2	Reduced-height forward-facing child restraint systems
F2X	Reduced-height forward-facing child restraint systems
R3	Full-size, rearward-facing child restraint systems
R2	Reduced-size, rearward-facing child restraint systems
R2X	Reduced-size, rearward-facing child restraint systems
R1	Rearward-facing infant seat
L1	Left lateral-facing (carrycot) infant seat
L2	Right lateral-facing (carrycot) infant seat
B2	Junior seat
B3	Junior seat

■ Recommended child restraint systems and Compatibility table

Mass groups	Recommended Child Restraint System	Seating position				
		①		②	③	④
		Vehicle with front passenger occupant detection system				
		Passenger airbag indicator light				
ON	OFF*					
0, 0+ Up to 28 lb. (13 kg)	MIDI 2 (Yes/No)	No	No	Yes	No	Yes
I 20 to 39 lb. (9 to 18 kg)	MIDI 2 (Yes/No)	No	No	Yes	No	Yes

\*: When it is unavoidable to install a rear-facing child restraint system on the front passenger seat, a child restraint system can be installed if the PASSENGER AIR BAG OFF indicator lamp is lit.

The child restraint systems mentioned in the table may not be avail-

able outside the LATIN area.

When securing some types of child restraint systems in rear seat, it may not be possible to properly use the seat belts in positions next to the child restraint without interfering with it or affecting seat belt effectiveness. Be sure your seat belt fits snugly across your shoulder and low on your hips. If it does not, or if it interferes with the child restraint, move to a different position. Failure to do so may result in death or serious injury.

- When installing a child restraint in the rear seats, adjust the front seat so that it does not interfere with the child or child restraint system.
- When installing a child seat with support base, if the child seat interferes with the seatback when latching it into the support base, adjust the seatback rearward until there is no interference.
- If the seat belt shoulder anchor is ahead of the child seat belt guide, move the seat cushion forward.

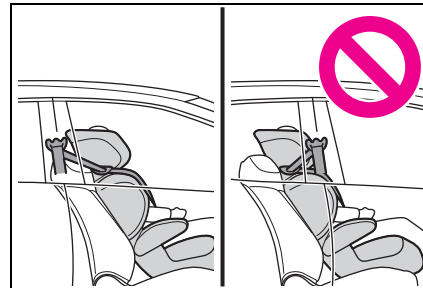

- When installing a junior seat, if the child in your child restraint system is in a very upright position, adjust the seatback angle to the most comfortable position. And if the seat belt shoulder anchor is ahead of the child seat belt guide, move the seat cushion forward.

#### **Child restraint system fixed with a seat belt**

A child restraint system for a small child or baby must itself be properly restrained on the seat with the lap portion of the lap/shoulder belt.

#### **■ Installing child restraint system using a seat belt (child restraint lock function belt)**

Install the child restraint system in accordance to the operation manual enclosed with the child restraint system.

For Puerto Rico: If the child restraint system on hand is not within the “universal” category

(or the necessary information is not in the table), refer to the “Vehicle List” provided by the child restraint system maker for various possible installation positions, or check the compatibility after asking the retailer of the child seat. (→P.55, 56)

■ **Rear-facing — Infant seat/convertible seat**

- 1 Place the child restraint system on the rear seat facing the rear of the vehicle.

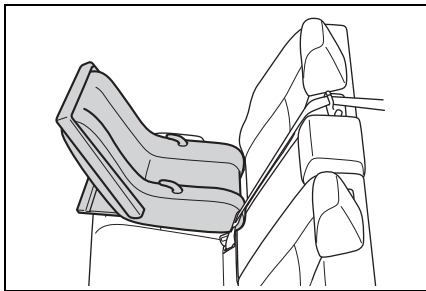

- 2 Run the seat belt through the child restraint system and insert the plate into the buckle. Make sure that the belt is not twisted.

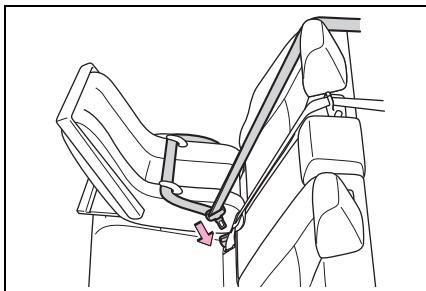

- 3 Fully extend the shoulder belt and allow it to retract to put it

in lock mode. In lock mode, the belt cannot be extended.

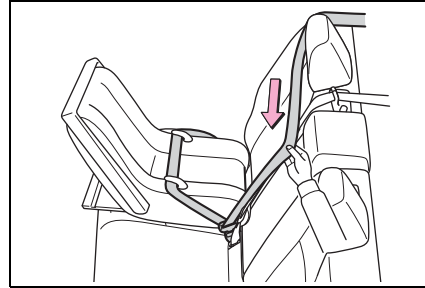

- 4 While pushing the child restraint system down into the rear seat, allow the shoulder belt to retract until the child restraint system is securely in place.

After the shoulder belt has retracted to a point where there is no slack in the belt, pull the belt to check that it cannot be extended.

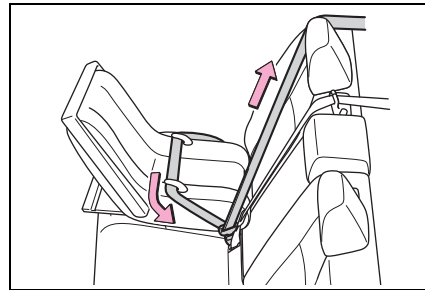

- 5 After installing the child restraint system, rock it back and forth to ensure that it is installed securely. (→P.63)

■ **Forward-facing — Convertible seat**

- 1 If installing the child restraint system to the front passenger seat is unavoidable, refer to P.52 for the front passenger seat adjustment.



- 2 If the head restraint interferes with your child restraint system, and the head restraint can be removed, remove the head restraint. Otherwise, put the head restraint in the upper most position. (→P.136)

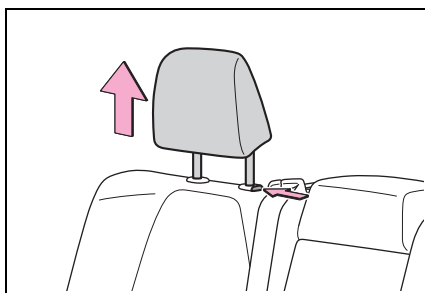

- 3 Place the child restraint system on the seat facing the front of the vehicle.

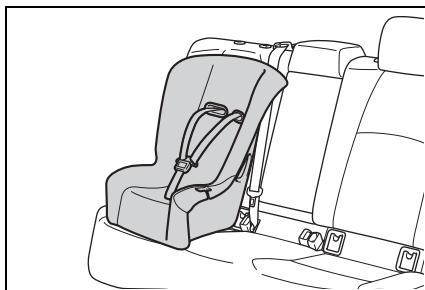

- 4 Run the seat belt through the child restraint system and insert the plate into the

buckle. Make sure that the belt is not twisted.

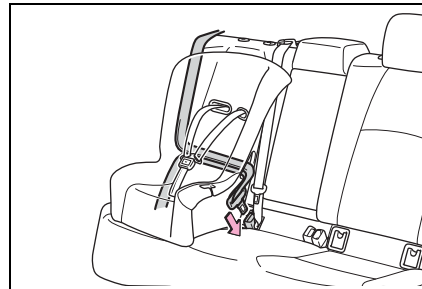

- 5 Fully extend the shoulder belt and allow it to retract to put it in lock mode. In lock mode, the belt cannot be extended.

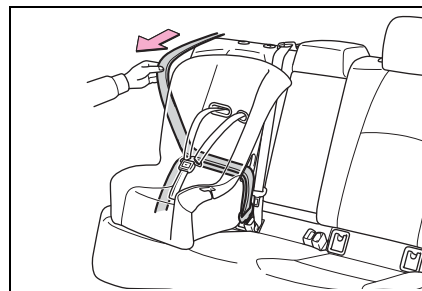

- 6 While pushing the child restraint system into the rear seat, allow the shoulder belt to retract until the child restraint system is securely in place.

After the shoulder belt has retracted to a point where there is no slack in the belt, pull the belt to

check that it cannot be extended.

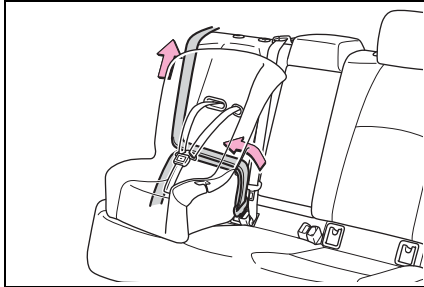

7 If the child restraint has a top tether strap, follow the child restraint manufacturer's operation manual regarding the installation, using the top tether strap to latch onto the top tether strap anchor. (→P.68)

8 After installing the child restraint system, rock it back and forth to ensure that it is installed securely. (→P.63)

■ **Booster seat**

1 If installing the child restraint system to the front passenger seat is unavoidable, refer to P.52 for the front passenger seat adjustment.

2 High back type: If the head restraint interferes with your child restraint system, and the head restraint can be removed, remove the head restraint.

Otherwise, put the head restraint in the upper most position. (→P.136)

3 Place the child restraint system on the seat facing the front of the vehicle.

▶ **Booster type**

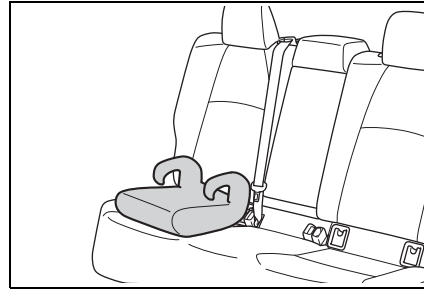

▶ **High back type**

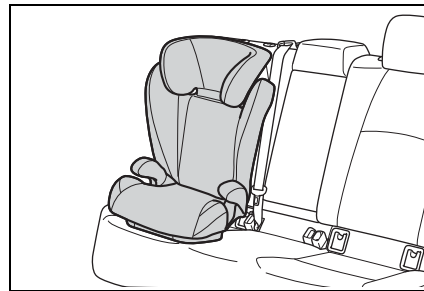

4 Sit the child in the child restraint system. Fit the seat belt to the child restraint system according to the manufacturer's instructions and insert the plate into the buckle. Make sure that the belt is not twisted.

Check that the shoulder belt is correctly positioned over the child's shoulder and that the lap belt is as

low as possible. (→P.27)



### ■ Removing a child restraint system installed with a seat belt

Press the buckle release button and fully retract the seat belt.

When releasing the buckle, the child restraint system may spring up due to the rebound of the seat cushion. Release the buckle while holding down the child restraint system.

Since the seat belt automatically reels itself, slowly return it to the stowing position.

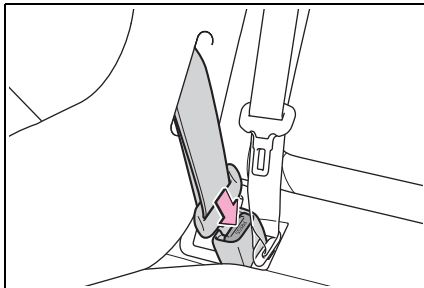

### ⚠ WARNING

#### ■ When installing a child restraint system

Observe the following precautions.

Failure to do so may result in death or serious injury.

- Do not allow children to play with the seat belt. If the seat belt becomes twisted around a child's neck, it may lead to choking or other serious injuries that could result in death. If this occurs and the buckle cannot be unfastened, scissors should be used to cut the belt.
- Ensure that the belt and plate are securely locked and the seat belt is not twisted.
- Shake the child restraint system left and right, and forward and backward to ensure that it has been securely installed.
- After securing a child restraint system, never adjust the seat.
- When a booster seat is installed, always ensure that the shoulder belt is positioned across the center of the child's shoulder. The belt should be kept away from the child's neck, but not so that it could fall off the child's shoulder.
- Follow all installation instructions provided by the child restraint system manufacturer.
- When securing some types of child restraint systems in rear seats, it may not be possible to properly use the seat belts in positions next to the child restraint without interfering with it or affecting seat belt effectiveness. Be sure your seat belt fits snugly across your shoulder and low on your hips. If it does not, or if it interferes with the child restraint, move to a different position. Failure to do so may result in death or serious injury.

**⚠ WARNING**

■ **When installing a booster seat**

To prevent the belt from going into ALR lock mode, do not fully extend the shoulder belt. ALR mode causes the belt to tighten only. This could cause injury or discomfort to the child. (→P.29)

■ **Do not use a seat belt extender**

If a seat belt extender is used when installing a child restraint system, the seat belt will not securely hold the child restraint system, which could cause death or serious injury to the child or other passengers in the event of sudden braking, sudden swerving or an accident.

**Child restraint system fixed with a child restraint LATCH anchor (except for Puerto Rico)**

■ **Child restraint LATCH anchors**

LATCH anchors are provided for the outboard rear seat. (Marks displaying the location of the anchors are attached to the seats.)

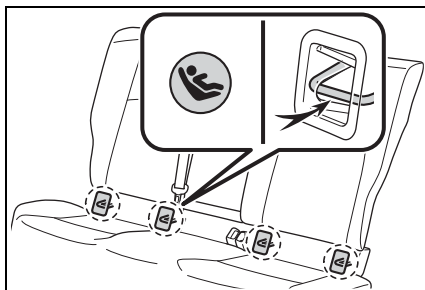

■ **When installing in the rear outboard seats**

Install the child restraint system in accordance to the operation manual enclosed with the child restraint system.

- 1 If the head restraint interferes with your child restraint system, and the head restraint can be removed, remove the head restraint. Otherwise, put the head restraint in the upper most position. (→P.136)
- ▶ With flexible lower attachments
- 2 Remove the anchor covers, and install the child restraint system to the seat.

The bars are installed behind the anchor covers.

For owners in Canada:  
The symbol on a child restraint system indicates **A** the presence of a lower connector system.

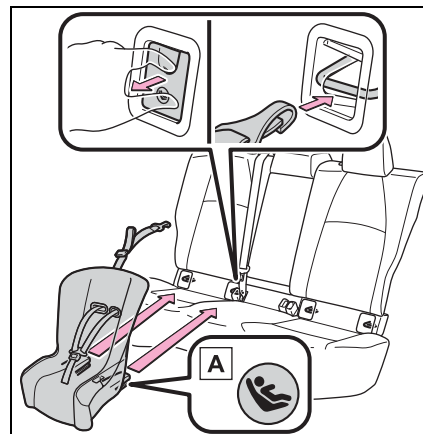

**A** Canada only

- ▶ With rigid lower attachments
- 2 Remove the anchor covers, and install the child restraint system to the seat.

The bars are installed behind the anchor covers.

For owners in Canada:  
The symbol on a child restraint system indicates **A** the presence of a lower connector system.

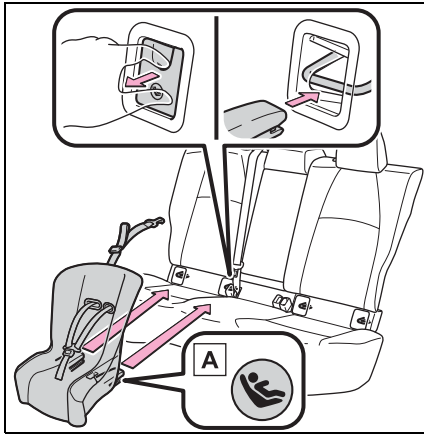

**A** Canada only

- 3 If the child restraint has a top tether strap, follow the child restraint manufacturer's operation manual regarding the installation, using the top tether strap to latch onto the top tether strap anchor. (→P.68)
- 4 After installing the child restraint system, rock it back and forth to ensure that it is installed securely. (→P.63)

#### ■ When installing in the rear center seat

There are no LATCH anchors behind the rear center seat.

However, the inboard LATCH anchors of the outboard seats, which are 15.6 in. (396 mm) apart, can be used if the child restraint system manufacturer's instructions permit use of those anchors with the anchor spacing stated.

Child restraint systems with rigid lower attachments cannot be installed in the center seat. This type of child restraint system can only be installed in the outboard seat.

#### ■ Laws and regulations pertaining to anchors

The LATCH system conforms to FMVSS225 or CMVSS210.2. Child restraint systems conforming to FMVSS213 or CMVSS213 specifications can be used. This vehicle is designed to conform to SAE J1819.

#### **▲ WARNING**

##### ■ When installing a child restraint system

Observe the following precautions. Failure to do so may result in death or serious injury.

- When using the LATCH anchors, be sure that there are no foreign objects around the anchors and that the seat belt is not caught behind the child restraint system.
- Follow all installation instructions provided by the child restraint system manufacturer.

**⚠ WARNING**

- Never attach two child restraint system attachments to the same anchor. In a collision, one anchor may not be strong enough to hold two child restraint system attachments and may break. If the LATCH anchors are already in use, use the seat belt to install a child restraint system in the center seat.
- When securing some types of child restraint systems in rear seats, it may not be possible to properly use the seat belts in positions next to the child restraint without interfering with it or affecting seat belt effectiveness. Be sure your seat belt fits snugly across your shoulder and low on your hips. If it does not, or if it interferes with the child restraint, move to a different position. Failure to do so may result in death or serious injury.
- If the seat is adjusted, reconfirm the security of the child restraint system.

### Child restraint system fixed with an ISOFIX lower anchorage (for Puerto Rico)

#### ■ ISOFIX lower anchorages (ISOFIX child restraint system)

Lower anchorages are provided for the outboard rear seats. (Marks displaying the location of the anchorages are attached to the seats.)

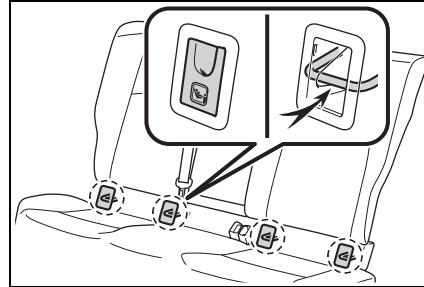

#### ■ When installing in the rear outboard seats

Install the child restraint system in accordance to the operation manual enclosed with the child restraint system.

If the child restraint system on hand is not within the “universal” category (or the necessary information is not in the table), refer to the “Vehicle List” provided by the child restraint system maker for various possible installation positions, or check the compatibility after asking the retailer of the child seat. (→P.55, 56)

- 1 If the head restraint interferes with your child restraint system, and the head restraint can be removed, remove the head restraint. Otherwise, put the head restraint in the upper most position. (→P.136)
- ▶ With flexible lower attachments
- 2 Remove the anchorage covers, and install the child restraint system to the seat.

The bars are installed behind the

anchorage covers.

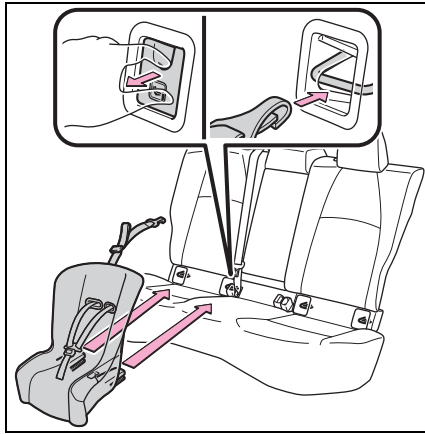

- ▶ With rigid lower attachments
- 2 Remove the anchorage covers, and install the child restraint system to the seat.

The bars are installed behind the anchorage covers.

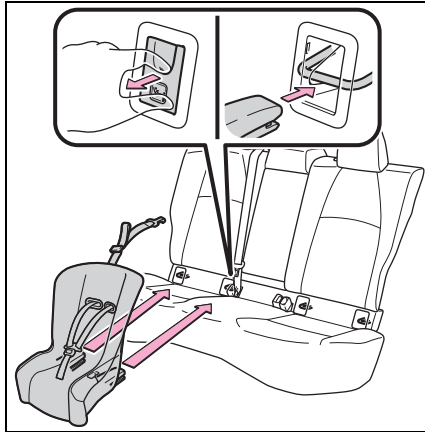

- 3 If the child restraint has a top strap, follow the child restraint manufacturer's operation manual regarding the installation, using the top strap to latch onto the top strap anchorage. (→P.68)

- 4 After installing the child restraint system, rock it back and forth to ensure that it is installed securely. (→P.63)

■ **When installing in the rear center seat**

There are no lower anchorages behind the rear center seat. However, the inboard lower anchorages of the outboard seats, which are 15.6 in. (396 mm) apart, can be used if the child restraint system manufacturer's instructions permit use of those anchorages with the anchorage spacing stated.

Child restraint systems with rigid lower attachments cannot be installed in the center seat. This type of child restraint system can only be installed in the outboard seat.

■ **When using a "MIDI 2"**

Adjust the support leg and ISOFIX connectors as follows:

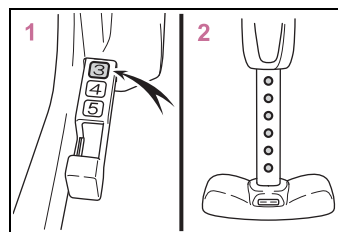

- 1 Lock the ISOFIX connectors where number 3 can be seen.
- 2 Lock the support leg where 6 holes can be seen.

### WARNING

#### ■ When installing a child restraint system

Observe the following precautions.

Failure to do so may result in death or serious injury.

- When using the lower anchorages, be sure that there are no foreign objects around the anchorages and that the seat belt is not caught behind the child restraint system.
- Follow all installation instructions provided by the child restraint system manufacturer.
- Never attach two child restraint system attachments to the same anchorage. In a collision, one anchorage may not be strong enough to hold two child restraint system attachments and may break. If the lower anchorages are already in use, use the seat belt to install a child restraint system in the center seat.
- When securing some types of child restraint systems in rear seats, it may not be possible to properly use the seat belts in positions next to the child restraint without interfering with it or affecting seat belt effectiveness. Be sure your seat belt fits snugly across your shoulder and low on your hips. If it does not, or if it interferes with the child restraint, move to a different position. Failure to do so may result in death or serious injury.
- If the seat is adjusted, reconfirm the security of the child restraint system.

### Using an anchor bracket (for top tether strap) (except for Puerto Rico)

#### ■ Anchor brackets (for top tether strap)

Anchor brackets are provided for each rear seat.

Use anchor brackets when fixing the top tether strap.

- ▶ Seats with an adjustable type head restraint

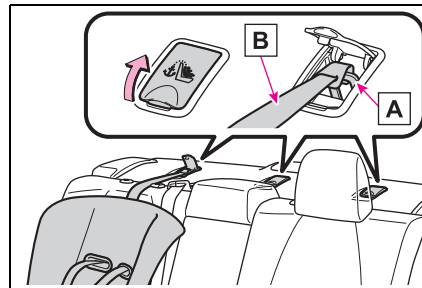

**A** Anchor brackets

**B** Top tether strap

- ▶ Seats with an integrated type head restraint

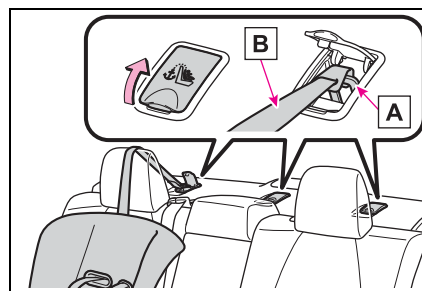

**A** Anchor brackets

**B** Top tether strap



■ **Fixing the top tether strap to the anchor bracket**

Install the child restraint system in accordance to the operation manual enclosed with the child restraint system.

▶ **Rear outboard seats**

- 1 Adjust the head restraint to the upmost position.

If the head restraint interferes with your child restraint system, and the head restraint can be removed, remove the head restraint. Otherwise, put the head restraint in the upper most position. (→P.136)

- 2 Open the anchor bracket cover, latch the hook onto the anchor bracket and tighten the top tether strap.

Make sure the top tether strap is securely latched. (→P.63)  
When installing the child restraint system with the head restraint being raised, be sure to have the top tether strap pass underneath the head restraint.

▶ **Seats with an adjustable type head restraint**

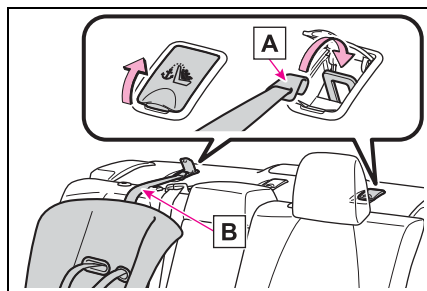

A Hook  
B Top tether strap

▶ **Seats with an integrated type head restraint**

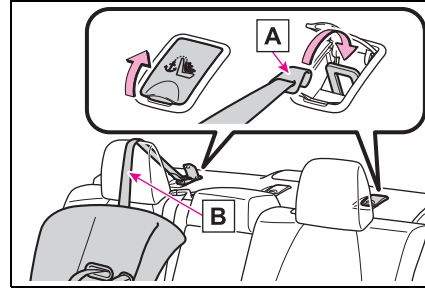

A Hook  
B Top tether strap

▶ **Rear center seat**

Latch the hook onto the anchor bracket and tighten the top tether strap.

Make sure the top tether strap is securely latched. (→P.63)

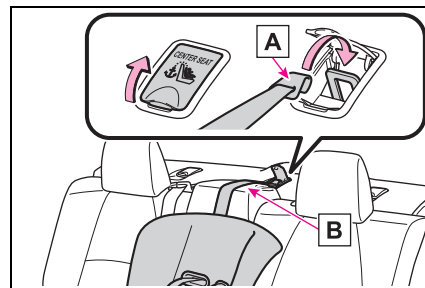

A Hook  
B Top tether strap

■ **Laws and regulations pertaining to anchors**

The LATCH system conforms to FMVSS225 or CMVSS210.2.  
Child restraint systems conforming to FMVSS213 or CMVSS213 specifications can be used.  
This vehicle is designed to conform to SAE J1819.

**⚠ WARNING****■ When installing a child restraint system**

Observe the following precautions. Failure to do so may result in death or serious injury.

- Firmly attach the top tether strap and make sure that the belt is not twisted.
- Do not attach the top tether strap to anything other than the anchor bracket.
- After securing a child restraint system, never adjust the seat.
- Follow all installation instructions provided by the child restraint system manufacturer.
- Outboard rear seats: When installing the child restraint system with the head restraint being raised, after the head restraint has been raised and then the anchor bracket has been fixed, do not lower the head restraint.

**⚠ NOTICE****■ Anchor brackets (for top tether strap)**

When not in use, make certain to close the lid. If it remains open, the lid may be damaged.

**Using a top tether anchorage (for Puerto Rico)****■ Top tether anchorages**

Top tether anchorages are provided for each rear seat.

Use top tether anchorages when fixing the top strap.

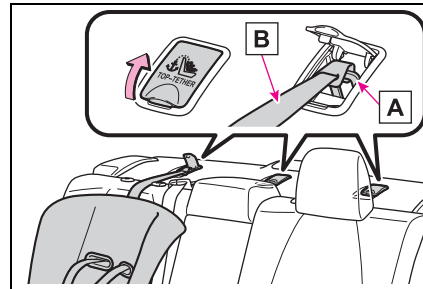
**▶ Seats with an adjustable type head restraint**

**A** Top tether anchorages

**B** Top strap

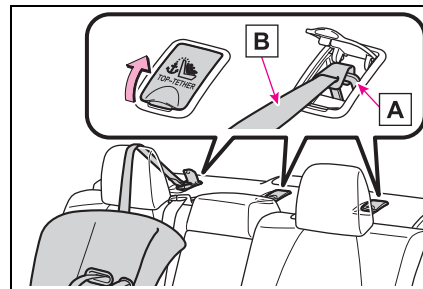
**▶ Seats with an integrated type head restraint**

**A** Top tether anchorages

**B** Top strap

**■ Fixing the top strap to the top tether anchorages**

Install the child restraint system in accordance to the operation manual enclosed with the child restraint system.

**▶ Rear outboard seats**

- 1 Adjust the head restraint to the upmost position.

If the head restraint interferes with your child restraint system, and the head restraint can be removed, remove the head restraint.

Otherwise, put the head restraint in the upper most position. (→P.136)

- 2 Open the top tether anchorage cover, latch the hook onto the top tether anchorage and tighten the top strap.

Make sure the top strap is securely latched. (→P.63)

When installing the child restraint system with the head restraint being raised, be sure to have the top strap pass underneath the head restraint.

- ▶ Seats with an adjustable type head restraint

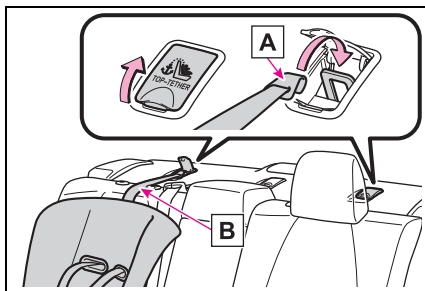

**A** Hook

**B** Top strap

- ▶ Seats with an integrated type head restraint

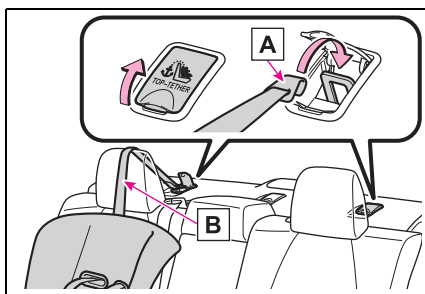

**A** Hook

**B** Top strap

- ▶ Rear center seat

Latch the hook onto the top tether anchorage and tighten the top strap.

Make sure the top strap is securely latched. (→P.63)

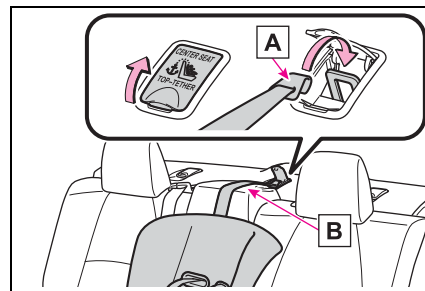

**A** Hook

**B** Top strap

### ⚠ WARNING

#### ■ When installing a child restraint system

Observe the following precautions. Failure to do so may result in death or serious injury.

- Firmly attach the top strap and make sure that the belt is not twisted.
- Do not attach the top strap to anything other than the top tether anchorages.
- After securing a child restraint system, never adjust the seat.
- Follow all installation instructions provided by the child restraint system manufacturer.

**WARNING**

- **Outboard rear seats:** When installing the child restraint system with the head restraint being raised, after the head restraint has been raised and then the top tether anchorage has been fixed, do not lower the head restraint.

**NOTICE**

- **Top tether anchorages**  
When not in use, make certain to close the lid. If it remains open, the lid may be damaged.

## Safety Connect\*

\*: If equipped

**Safety Connect is a subscription-based telematics service that uses Global Positioning System (GPS) data and embedded cellular technology to provide safety and security features to subscribers. Safety Connect is supported by Toyota's designated response center, which operates 24 hours per day, 7 days per week.**

**Safety Connect service is available by subscription on select, telematics hardware-equipped vehicles.**

**By using the Safety Connect service, you are agreeing to be bound by the Telematics Subscription Service Agreement and its Terms and Conditions, as in effect and amended from time to time, a current copy of which is available at [Toyota.com](http://Toyota.com) in the United States, [Toyota.pr.com](http://Toyota.pr.com) in Puerto Rico and [Toyota.ca](http://Toyota.ca) in Canada. All use of the Safety Connect service is subject to such then-applicable Terms and Conditions.**

## System components

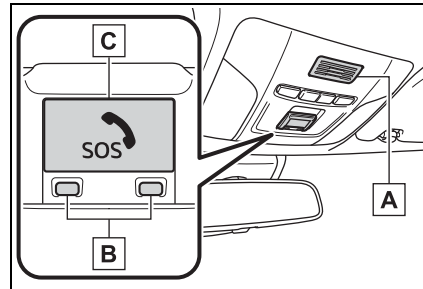

- A Microphone
- B LED light indicators
- C "SOS" button

■ **Certification**

FCC ID : BEJTL19BNN

**NOTE:**

This device complies with part 15 of the FCC Rules. Operation is subject to the following two conditions: (1) This device may not cause harmful interference, and (2) this device must accept any interference received, including interference that may cause undesired operation.

**FCC WARNING:**

Changes or modifications not expressly approved by the party responsible for compliance could void the user's authority to operate the equipment.

**CAUTION: Radio Frequency Radiation Exposure**

This equipment complies with FCC radiation exposure limits set forth for uncontrolled equipment and meets the FCC radio frequency (RF) Exposure Guidelines in Supplement C to OET65. This equipment has very low levels of RF energy that it deemed to comply without maximum permissive exposure evaluation (MPE). But it is desirable that it should be installed and operated with at least 20cm and more between the radiator and person's body (excluding extremities: hands, wrists, feet and ankles).

**FCC WARNING:**

This device complies with Part 15 of the FCC Rules. Operation is subject to the following two conditions: (1) this device may not cause harmful interference, and (2) this device must accept any interference received, including interference that may cause undesired operation.

IC ID :  
2703H-TL19BNN

**NOTE:**

This device complies with Industry Canada licence-exempt RSS standard(s). Operation is subject to the following two conditions: (1) this device may not cause interference, and (2) this device must accept any interference, including interference that may cause undesired operation of the device.

This radio transmitter (identify the device by certification number, or model number if Category II) has been approved by Industry Canada to operate with the antenna types listed below with the maximum permissible gain and required antenna impedance for each antenna type indicated. Antenna types not included in this list, having a gain greater than the maximum gain indicated for that type, are strictly prohibited for use with this device.

The antenna cannot be removed (and changed) by user.

This device complies with RSS-310 of Industry Canada. Operation is subject to the condition that this device does not cause harmful interference.

IC ID :  
2703H-TL19BNN

**NOTE:**

Le présent appareil est conforme aux CNR d'Industrie Canada applicables aux appareils radio exempts de licence. L'exploitation est autorisée aux deux conditions suivantes: (1) l'appareil ne doit pas produire de brouillage, et (2) l'utilisateur de l'appareil doit accepter tout brouillage radioélectrique subi, même si le brouillage est susceptible d'en compromettre le fonctionnement.

Le présent émetteur radio (identifier le dispositif par son numéro de certification ou son numéro de modèle s'il fait partie du matériel de catégorie I) a été approuvé par Industrie Canada pour fonctionner avec les types d'antenne énumérés ci-dessous et ayant un gain admissible maximal et l'impédance requise pour chaque type d'antenne. Les types d'antenne non inclus dans cette liste, ou dont le gain est supérieur au gain maximal indiqué, sont strictement interdits pour l'exploitation de l'émetteur.

L'antenne ne peut pas être enlevée (et a changé) par utilisateur.

Cet appareil est conforme au CNR-310 d'Industrie Canada. Son exploitation est autorisée sous réserve que l'appareil ne cause pas de brouillage préjudiciable.

### Services

Subscribers have the following Safety Connect services available:

- Automatic Collision Notification\*

Helps drivers receive necessary response from emergency service providers. (→P.78)

\*: U.S. Patent No. 7,508,298 B2

- Stolen Vehicle Location

Helps drivers in the event of vehicle theft. (→P.78)

- Emergency Assistance Button

### ("SOS")

Connects drivers to response-center support. (→P.78)

- Enhanced Roadside Assistance

Provides drivers various on-road assistance. (→P.78)

### Subscription

After you have signed the Telematics Subscription Service Agreement and are enrolled, you can begin receiving services.

A variety of subscription terms



are available for purchase. Contact your Toyota dealer, call the following appropriate Customer Experience Center or push the “SOS” button in your vehicle for further subscription details.

- The United States

1-800-331-4331

- Canada

1-888-869-6828

- Puerto Rico

1-877-855-8377

#### ■ Safety Connect Services Information

- Phone calls using the vehicle's Bluetooth® technology will not be possible when Safety Connect is active and in use.
- Safety Connect is available beginning Fall 2009 on select Toyota models (in the contiguous United States only). Contact with the Safety Connect response center is dependent upon the telematics device being in operative condition, cellular connection availability, and GPS satellite signal reception, which can limit the ability to reach the response center or receive emergency service support. Enrollment and Telematics Subscription Service Agreement are required. A variety of subscription terms are available; charges vary by subscription term selected and location.
- Automatic Collision Notification, Emergency Assistance and Stolen Vehicle Location are available in the United States, including Hawaii and Alaska, Puerto Rico and Canada, and Enhanced Roadside Assistance are available in the United States, Puerto Rico and Canada.
- Automatic Collision Notification,

Emergency Assistance, Stolen Vehicle and Enhanced Road Assistance are not available in the U.S. Virgin Islands.

For vehicles first sold in the U.S. Virgin Islands, no Safety Connect services will function in or outside the U.S. Virgin Islands.

- Safety Connect services are not subject to section 255 of the Telecommunications Act and the device is not TTY compatible.

#### ■ Languages

The Safety Connect response center will offer support in multiple languages.

The Safety Connect system will offer voice prompts in English, Spanish, and French. Please indicate your language of choice when enrolling.

#### ■ When contacting the response center

You may be unable to contact the response center if the network is busy.

### Safety Connect LED light Indicators

When the engine switch is turned to ON, the red indicator light comes on for 2 seconds then turns off. Afterward, the green indicator light comes on, indicating that the service is active.

The following indicator light patterns indicate specific system usage conditions:

- Green indicator light on = Active service
- Green indicator light flashing = Safety Connect call in process

- Red indicator light (except at vehicle start-up) = System malfunction (contact your Toyota dealer)
- No indicator light (off) = Safety Connect service not active

### Safety Connect services

#### ■ Automatic Collision Notification

In case of either airbag deployment or severe rear-end collision, the system is designed to automatically call the response center. The responding agent receives the vehicle's location and attempts to speak with the vehicle occupants to assess the level of emergency. If the occupants are unable to communicate, the agent automatically treats the call as an emergency, contacts the nearest emergency services provider to describe the situation, and requests that assistance be sent to the location.

#### ■ Stolen Vehicle Location

If your vehicle is stolen, Safety Connect can work with local authorities to assist them in locating and recovering the vehicle. After filing a police report, call the Customer Experience Center at 1-800-331-4331 in the United States, 1-877-855-8377 in Puerto Rico

or 1- 888-869-6828 in Canada, and follow the prompts for Safety Connect to initiate this service.

In addition to assisting law enforcement with recovery of a stolen vehicle, Safety-Connect-equipped vehicle location data may, under certain circumstances, be shared with third parties to locate your vehicle. Further information is available at Toyota.com in the United States, Toyotapr.com in Puerto Rico and Toyota.ca in Canada.

#### ■ Emergency Assistance Button ("SOS")

In the event of an emergency on the road, push the "SOS" button to reach the Safety Connect response center. The answering agent will determine your vehicle's location, assess the emergency, and dispatch the necessary assistance required.

If you accidentally press the "SOS" button, tell the response-center agent that you are not experiencing an emergency.

#### ■ Enhanced Roadside Assistance

Enhanced Roadside Assistance adds GPS data to the already included warranty-based Toyota roadside service.

Subscribers can press the "SOS" button to reach a Safety Connect response-center agent, who can help with a wide range

of needs, such as: towing, flat tire, fuel delivery, etc. For a description of the Enhanced Roadside Assistance services and their limitations, please see the Safety Connect Terms and Conditions, which are available at Toyota.com in the United States, Toyotapr.com in Puerto Rico and Toyota.ca in Canada.

### Safety information for Safety Connect

Important! Read this information before using Safety Connect.

#### ■ Exposure to radio frequency signals

The Safety Connect system installed in your vehicle is a low-power radio transmitter and receiver. It receives and also sends out radio frequency (RF) signals.

In August 1996, the Federal Communications Commission (FCC) adopted RF exposure guidelines with safety levels for mobile wireless phones. Those guidelines are consistent with the safety standards previously set by the following U.S. and international standards bodies.

- ANSI (American National Standards Institute) C95.1 [1992]
- NCRP (National Council on Radiation Protection and

Measurement) Report 86 [1986]

- ICNIRP (International Commission on Non-Ionizing Radiation Protection) [1996]

Those standards were based on comprehensive and periodic evaluations of the relevant scientific literature. Over 120 scientists, engineers, and physicians from universities, and government health agencies and industries reviewed the available body of research to develop the ANSI Standard (C95.1).

The design of Safety Connect complies with the FCC guidelines in addition to those standards.

### Engine immobilizer system

**The vehicle's keys have built-in transponder chips that prevent the engine from starting if a key has not been previously registered in the vehicle's on-board computer.**

**Never leave the keys inside the vehicle when you leave the vehicle.**

**This system is designed to help prevent vehicle theft but does not guarantee absolute security against all vehicle thefts.**

### Operating the system

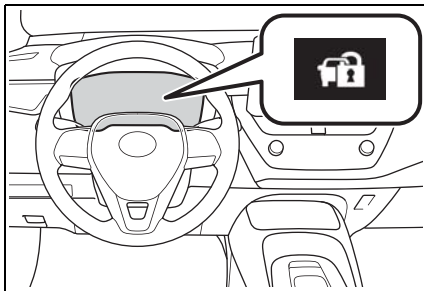

- ▶ Vehicles without a smart key system

The indicator light flashes after the key has been removed from the engine switch to indicate that the system is operating.

The indicator light stops flashing after the registered key has

been inserted into the engine switch to indicate that the system has been canceled.

- ▶ Vehicles with a smart key system

The indicator light flashes after the engine switch has been turned off to indicate that the system is operating.

The indicator light stops flashing after the engine switch has been turned to ACC or ON to indicate that the system has been canceled.

### ■ System maintenance

The vehicle has a maintenance-free type engine immobilizer system.

### ■ Conditions that may cause the system to malfunction

- If the grip portion of the key is in contact with a metallic object
- If the key is in close proximity to or touching a key to the security system (key with a built-in transponder chip) of another vehicle

**■ Certifications for the engine immobilizer system****► Except for vehicles sold in Canada**

FCC ID: MOZRI-57BTY

This device complies with part 15 of the FCC Rules. Operation is subject to the following two conditions: (1) This device may not cause harmful interference, and (2) this device must accept any interference received, including interference that may cause undesired operation.

Changes or modifications not expressly approved by the party responsible for compliance could void the user's authority to operate the equipment.

FCC ID: NI4TMLF18D-1

**NOTE**

This device complies with part 15 of the FCC Rules. Operation is subject to the following two conditions: (1) This device may not cause harmful interference, and (2) this device must accept any interference received, including interference that may cause undesired operation.

**FCC WARNING**

Changes or modifications not expressly approved by the party responsible for compliance could void the user's authority to operate the equipment.

**► For vehicles sold in Canada****NOTE**

This device complies with Industry Canada's licence-exempt RSSs.

Operation is subject to the following two conditions:

- (1) This device may not cause interference; and
- (2) This device must accept any interference, including interference that may cause undesired operation of the device.

**NOTE**

Le présent appareil est conforme aux CNR d'Industrie Canada applicables aux appareils radio exempts de licence. L'exploitation est autorisée aux deux conditions suivantes :

- (1) l'appareil ne doit pas produire de brouillage;
- (2) l'utilisateur de l'appareil doit accepter tout brouillage radioélectrique subi, même si le brouillage est susceptible d'en compromettre le fonctionnement.

**NOTICE****■ To ensure the system operates correctly**

Do not modify or remove the system. If modified or removed, the proper operation of the system cannot be guaranteed.

**Alarm\***

\*: If equipped

**The alarm uses light and sound to give an alert when an intrusion is detected. The alarm is triggered in the following situations when the alarm is set:**

- A locked door or trunk is unlocked or opened in any way other than using the entry function (if equipped), wireless remote control, mechanical key (if equipped) or key (if equipped). (The doors will lock again automatically.)
- The hood is opened.

**Setting/deactivating/stopping the alarm system****■ Items to check before locking the vehicle**

To prevent unexpected triggering of the alarm and vehicle theft, make sure of the following:

- Nobody is in the vehicle.
- The windows and moon roof (if equipped) are closed before the alarm is set.
- No valuables or other personal items are left in the vehicle.

**■ Setting**

Close the doors, trunk and

hood, and lock all the doors. The system will set automatically after 30 seconds.

The indicator light changes from being on to flashing when the system is set.

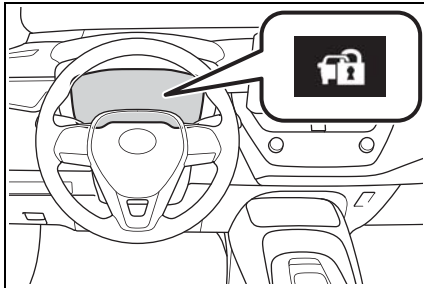

#### ■ Deactivating or stopping

Do one of the following to deactivate or stop the alarms:

- Unlock the doors.
- Turn the engine switch to ACC or ON, or start the engine. (The alarm will be deactivated or stopped after a few seconds.)

#### ■ System maintenance

The vehicle has a maintenance-free type alarm system.

#### ■ Triggering of the alarm

The alarm may be triggered in the following situations: (Stopping the alarm deactivates the alarm system.)

- A person inside the vehicle opens a door, the trunk or hood, or unlocks the vehicle using a door lock switch or inside lock button.



- The battery is recharged or replaced when the vehicle is locked. (→P.549)

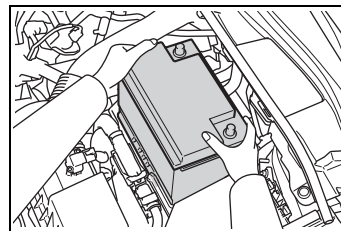

#### ■ Alarm-operated door lock

In the following cases, depending on the situation, the door may automatically lock to prevent improper entry into the vehicle:

- When a person remaining in the vehicle unlocks the door and the alarm is activated.
- While the alarm is activated, a person remaining in the vehicle unlocks the door.
- When recharging or replacing the battery

#### ⚠ NOTICE

##### ■ To ensure the system operates correctly

Do not modify or remove the system. If modified or removed, the proper operation of the system cannot be guaranteed.





## Vehicle status information and indicators

2

85

### 2-1. Instrument cluster

- Warning lights and indicators ..... 86
- Gauges and meters (4.2-inch display)..... 91
- Gauges and meters (7-inch display)..... 95
- Multi-information display ..... 100
- Fuel consumption information ..... 106

2

Vehicle status information and indicators

### Warning lights and indicators

The warning lights and indicators on the instrument cluster, center panel and outside rear view mirrors inform the driver of the status of the vehicle's various systems.

### Warning lights and indicators displayed on the instrument cluster

For the purpose of explanation, the following illustrations display all warning lights and indicators illuminated.

▶ 4.2-inch display

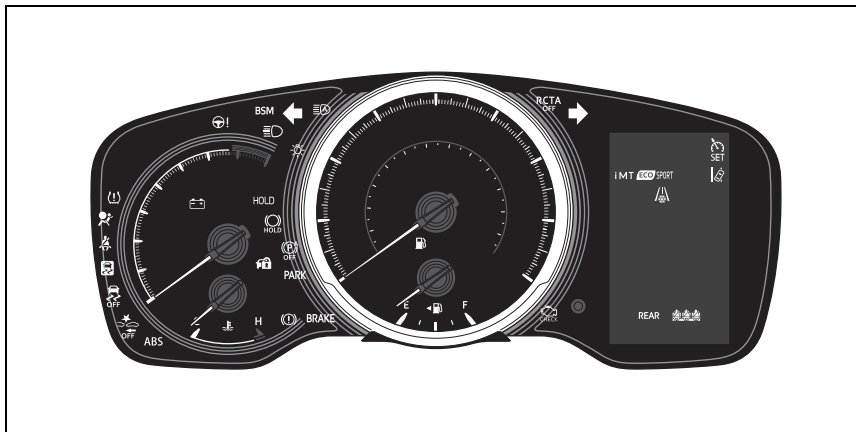

▶ 7-inch display (when analog speedometer is displayed)

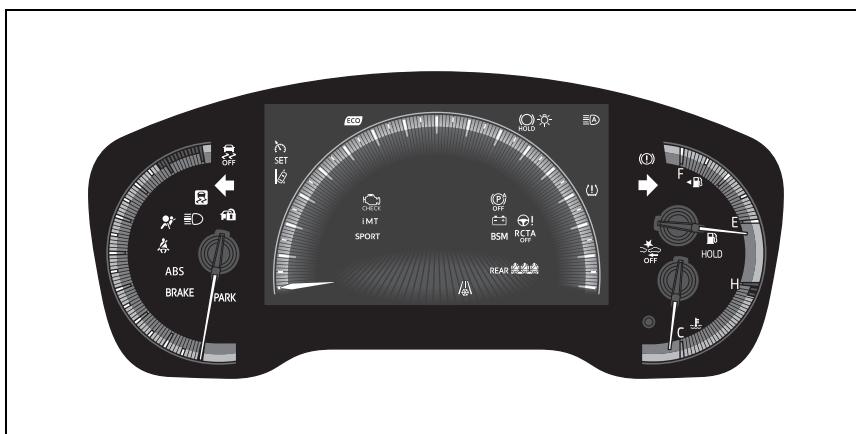

- ▶ 7-inch display (when digital speedometer is displayed)



















2











Vehicle status information and indicators

### Warning lights

Warning lights inform the driver of malfunctions in the indicated vehicle's systems.

-  Brake system warning light\*<sup>1</sup> (→P.511) (U.S.A.)
-  Brake system warning light\*<sup>1</sup> (→P.511) (Red) (Canada)
-  Brake system warning light\*<sup>1</sup> (→P.511) (Yellow)
-  High coolant temperature warning light\*<sup>2</sup> (→P.511)
-  Charging system warning light\*<sup>1</sup> (→P.512)
-  Low engine oil pressure warning light\*<sup>2</sup> (→P.512)
-  Malfunction indicator lamp\*<sup>1</sup> (→P.512) (U.S.A.)

-  Malfunction indicator lamp\*<sup>1</sup> (→P.512) (Canada)
-  SRS warning light\*<sup>1</sup> (→P.512)
-  ABS warning light\*<sup>1</sup> (→P.513) (U.S.A.)
-  ABS warning light\*<sup>1</sup> (→P.513) (Canada)
-  Brake Override System warning light/Drive-Start control warning light\*<sup>2</sup> (→P.513)
-  Electric power steering system warning light\*<sup>1</sup> (Red) (→P.514)
-  Electric power steering system warning light\*<sup>1</sup> (Yellow) (→P.514)
-  Low fuel level warning light (→P.514)
-  Driver's and front passenger's seat belt reminder light (→P.514)

	Rear passengers' seat belt reminder lights (→P.515)
	Tire pressure warning light <sup>*1</sup> (if equipped) (→P.515)
	LTA indicator (if equipped) (→P.515)
	LDA indicator (if equipped) (→P.515)
	RCTA OFF indicator <sup>*1</sup> (if equipped) (→P.516)
	PCS warning light <sup>*1</sup> (Flashes or illuminates) (→P.516)
	Slip indicator <sup>*1</sup> (→P.516)
	Parking brake indicator (Flashes) (→P.517) (U.S.A.)
	Parking brake indicator (Flashes) (→P.517) (Canada)
	Brake hold operated indicator <sup>*1</sup> (if equipped) (Flashes) (→P.517)
	iMT indicator <sup>*1</sup> (if equipped) (→P.517) (Orange)

<sup>\*1</sup>: These lights come on when the engine switch is turned to ON to indicate that a system check is being performed. They will turn off after the engine is started, or after a few seconds. There may be a malfunction in a system if the lights do not come on, or turn off. Have the vehicle inspected by your Toyota dealer.

<sup>\*2</sup>: This light illuminates on the multi-information display.









### WARNING

#### ■ If a safety system warning light does not come on

Should a safety system light such as the ABS and SRS warning light not come on when you start the engine, this could mean that these systems are not available to help protect you in an accident, which could result in death or serious injury. Have the vehicle inspected by your Toyota dealer immediately if this occurs.

### Indicators

The indicators inform the driver of the operating state of the vehicle's various systems.

	Turn signal indicator (→P.179)
	Headlight indicator (→P.186) (U.S.A.)
	Tail light indicator (→P.186) (Canada)
	Headlight high beam indicator (→P.188)
	Automatic High Beam indicator (→P.189)
	PCS warning light <sup>*1, 2</sup> (→P.205)
	Cruise control indicator (→P.229, 240)
	Dynamic radar cruise control indicator (→P.229, 240)
	Cruise control "SET" indicator (→P.229, 240)

 LTA indicator (if equipped) (→P.216)

<sup>\*3</sup> LDA indicator (if equipped) (→P.225)  
BSM outside rear view

 mirror indicators<sup>\*4, 5</sup> (if equipped) (→P.253)

**BSM** BSM indicator (if equipped) (→P.253)

**RCTA OFF** RCTA OFF indicator<sup>\*1, 2</sup> (if equipped) (→P.258)

 Slip indicator<sup>\*1</sup> (→P.273)  
(Flashes)

 VSC OFF indicator<sup>\*1, 2</sup> (→P.273)

 Smart key system indicator<sup>\*6</sup> (if equipped) (→P.164)

**PARK** Parking brake indicator (U.S.A.) (→P.180, 181)

 Parking brake indicator (Canada) (→P.180, 181)

 Brake hold standby indicator<sup>\*1</sup> (if equipped) (→P.184)

**HOLD** Brake hold operated indicator<sup>\*1</sup> (if equipped) (→P.184)

 Auto EPB OFF indicator<sup>\*1, 2</sup> (if equipped) (→P.181)

**ECO** Eco Driving Indicator Light<sup>\*1</sup> (if equipped) (→P.102)

 Low outside temperature indicator<sup>\*7</sup> (→P.91, 95)

 Security indicator (→P.80, 82)

 "AIR BAG ON/OFF" indicator<sup>\*1, 8</sup> (→P.41)

**SPORT** Sport mode indicator (if equipped) (→P.271)



**iMT** iMT indicator (if equipped) (Green) (→P.178)

<sup>\*1</sup>: These lights come on when the engine switch is turned to ON to indicate that a system check is being performed. They will turn off after the engine is started, or after a few seconds. There may be a malfunction in a system if the lights do not come on, or turn off. Have the vehicle inspected by your Toyota dealer.

<sup>\*2</sup>: This light comes on when the system is turned off.

<sup>\*3</sup>: Depending on the operating condition, the color and illuminating/flashing state of the light change.

<sup>\*4</sup>: In order to confirm operation, the BSM outside rear view mirror indicators illuminate in the following situations:

- When the engine switch is turned to ON, the BSM function is enabled on  of the multi-information display.
- When the BSM function is enabled on  of the multi-information display, the engine switch is turned to ON.

If the system is functioning correctly, the BSM outside rear view mirror indicators will turn off after a few seconds.

If the BSM outside rear view mirror indicators do not illuminate or do not turn off, there may be a malfunction in the system.

If this occurs, have the vehicle inspected by your Toyota dealer.

\*5: This light illuminates on the outside rear view mirrors.

\*6: This light illuminates on the multi-information display.

\*7: When the outside temperature is approximately 37°F (3°C) or lower, this indicator will flash for approximately 10 seconds, then stay on.

\*8: This light illuminates on the center panel.

## Gauges and meters (4.2-inch display)

## Meter display

## ■ Locations of gauges and meters

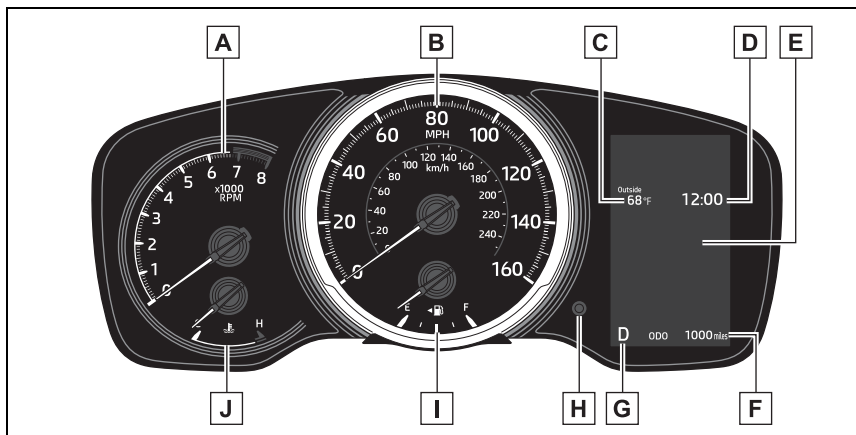

The units of measure may differ depending on the intended destination of the vehicle.

**A** Tachometer

Displays the engine speed in revolutions per minute

**B** Speedometer

**C** Outside temperature

Displays the outside temperature within the range of -40°F (-40°C) to 122°F (50°C)

**D** Clock (→P.93)

**E** Multi-information display

Presents the driver with a variety of vehicle data (→P.100)

Displays warning messages if a malfunction occurs (→P.521)

**F** Odometer and trip meter display (→P.92)

**G** Shift position indicator (→P.169)

**H** Display change button (→P.92)

**I** Fuel gauge

Displays the quantity of fuel remaining in the tank

**J** Engine coolant temperature gauge

Displays the engine coolant temperature

### ■ Outside temperature display

- In the following situations, the correct outside temperature may not be displayed, or the display may take longer than normal to change:
  - When stopped, or driving at low speeds (less than 16 mph [25 km/h])
  - When the outside temperature has changed suddenly (at the entrance/exit of a garage, tunnel, etc.)
- When "--" or "E" is displayed, the system may be malfunctioning. Take your vehicle to your Toyota dealer.

### ■ Liquid crystal display

→P.101

### ⚠ WARNING

#### ■ The information display at low temperatures

Allow the interior of the vehicle to warm up before using the liquid crystal information display. At extremely low temperatures, the information display monitor may respond slowly, and display changes may be delayed.

For example, there is a lag between the driver's shifting and the new gear number appearing on the display. This lag could cause the driver to downshift again, causing rapid and excessive engine braking and possibly an accident resulting in death or injury.

### ⚠ NOTICE

#### ■ To prevent damage to the engine and its components

- Do not let the indicator needle of the tachometer enter the red zone, which indicates the maximum engine speed.
- The engine may be overheating if the engine coolant temperature gauge is in the red zone (H). In this case, immediately stop the vehicle in a safe place, and check the engine after it has cooled completely. (→P.550)

### Odometer and trip meter display

#### ■ Changing the display

Press the display change button until the desired item is displayed.

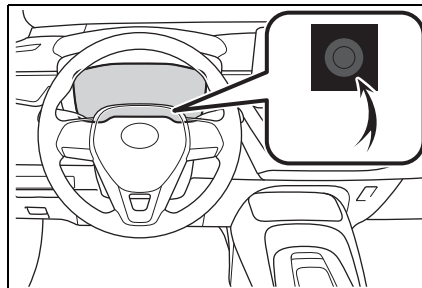

#### ■ Display items

##### ● Odometer

Displays the total distance the vehicle has been driven.

##### ● Trip meter A/Trip meter B

Displays the distance the vehicle has been driven since the meter was last reset. Trip meters A and B can be used to record and display



different distances independently.

To reset, display the desired trip meter and press and hold the display change button.

### Changing the instrument panel light brightness

The brightness of the instrument panel lights can be adjusted.

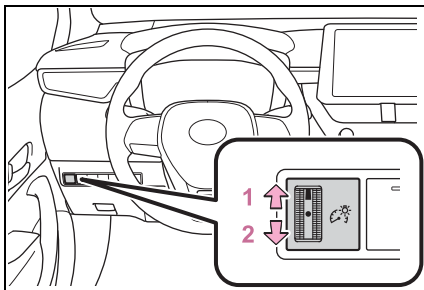

- 1 Brighter
- 2 Darker

### Instrument panel light brightness adjustment

The brightness of the instrument panel lights can be adjusted separately for when the tail lights are on and off.

### Adjusting the clock

#### Clock adjustment

The clocks on the following can be adjusted on the audio system screen.

- Multi-information display
- Audio system screen

#### Setting the clock to be adjusted automatically by GPS (Audio [for U.S.A.]/Audio Plus)

- 1 Press the "MENU" button.
- 2 Select "Setup" on the "Menu" screen.
- 3 Select "General" on the "Setup" screen.
- 4 Select "Clock".
- 5 Select "Auto Adjust by GPS" to set to on.

#### Adjusting the clock manually

- ▶ Audio (except for U.S.A.)
  - 1 Press the "MENU" button.
  - 2 Select "Setup" on the "Menu" screen.
  - 3 Select "General" on the "Setup" screen.
  - 4 Select "Clock".
  - 5 Adjust the displayed time.
    - Hour: Select "-" or "+" of "Hours" to adjust the hour.
    - Minute: Select "-" or "+" of "Minutes" to adjust the minute.
    - ":00": Select to set the clock to the beginning of the nearest hour.

e.g.

1:00 to 1:29 → 1:00

1:30 to 1:59 → 2:00

- ▶ Audio (for U.S.A.)/Audio Plus
  - 1 Press the "MENU" button.

- 2 Select "Setup" on the "Menu" screen.
- 3 Select "General" on the "Setup" screen.
- 4 Select "Clock".
- 5 Select "Auto Adjust by GPS" to set to off.
- 6 Adjust the displayed time.
  - Hour: Select "-" or "+" of "Hours" to adjust the hour.
  - Minute: Select "-" or "+" of "Minutes" to adjust the minute.
  - ":00": Select to set the clock to the beginning of the nearest hour.

e.g.

1:00 to 1:29 → 1:00

1:30 to 1:59 → 2:00

#### ■ Setting the time zone (Audio [for U.S.A.]/Audio Plus)

- 1 Press the "MENU" button.
- 2 Select "Setup" on the "Menu" screen.
- 3 Select "General" on the "Setup" screen.
- 4 Select "Clock".
- 5 Select "Time Zone".

Select the desired time zone.

#### ■ Setting daylight saving time (Audio [for U.S.A.]/Audio Plus)

- 1 Press the "MENU" button.

- 2 Select "Setup" on the "Menu" screen.
- 3 Select "General" on the "Setup" screen.
- 4 Select "Clock".
- 5 Select "Daylight Saving Time" then on/off.

#### ■ Changing the clock between 12-hour/24-hour format

- 1 Press the "MENU" button.
- 2 Select "Setup" on the "Menu" screen.
- 3 Select "General" on the "Setup" screen.
- 4 Select "Clock".
- 5 Select "24-Hour Time Format" and then on/off.

When set to off, the clock is displayed in 12 hour time format.

#### ■ Clock settings screen (Audio [for U.S.A.]/Audio Plus)

If "Clock : 00" is displayed when  is selected on the multi-information display, the system may be malfunctioning. Have the vehicle inspected by your Toyota dealer.

## Gauges and meters (7-inch display)

## Meter display

## ■ Locations of gauges and meters

## ► Analog speedometer

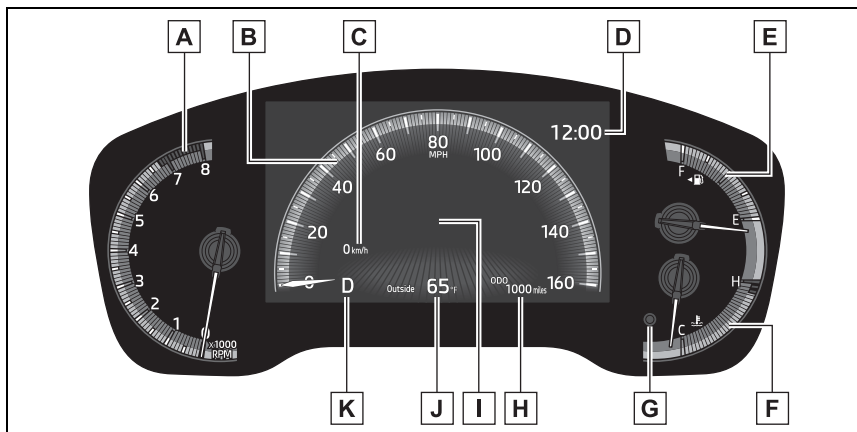

The units of measure may differ depending on the intended destination of the vehicle.

**A** Tachometer

Displays the engine speed in revolutions per minute

**B** Speedometer

**C** Sub speedometer

**D** Clock (→P.98)

**E** Fuel gauge

Displays the quantity of fuel remaining in the tank

**F** Engine coolant temperature gauge

Displays the engine coolant temperature

**G** Display change button (→P.97)

**H** Odometer and trip meter display (→P.97)

**I** Multi-information display

Presents the driver with a variety of vehicle data (→P.100)

Displays warning messages if a malfunction occurs (→P.521)

**J** Outside temperature

Displays the outside temperature within the range of -40°F (-40°C) to 122°F

(50°C)

**K** Shift position indicator (→P.169)

► Digital speedometer

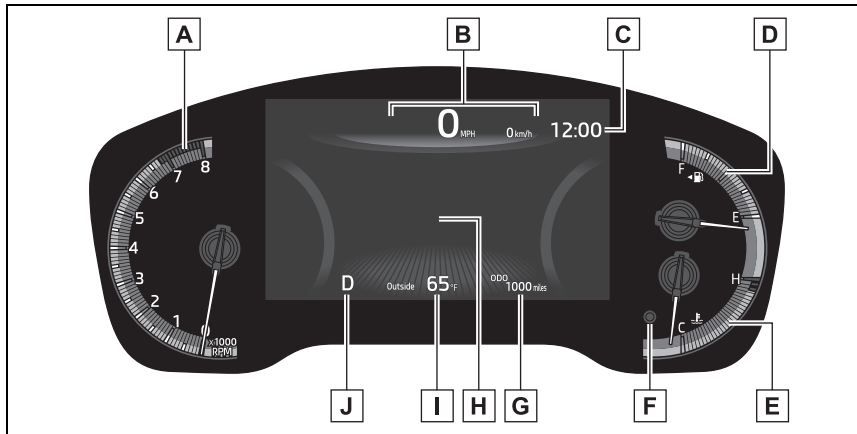

The units of measure may differ depending on the intended destination of the vehicle.

**A** Tachometer

Displays the engine speed in revolutions per minute

**B** Speedometer

**C** Clock (→P.98)

**D** Fuel gauge

Displays the quantity of fuel remaining in the tank

**E** Engine coolant temperature gauge

Displays the engine coolant temperature

**F** Display change button (→P.97)

**G** Odometer and trip meter display (→P.97)

**H** Multi-information display

Presents the driver with a variety of vehicle data (→P.100)

Displays warning messages if a malfunction occurs (→P.521)

**I** Outside temperature

Displays the outside temperature within the range of -40°F (-40°C) to 122°F (50°C)

**J** Shift position indicator (→P.169)

■ **Outside temperature display**

● In the following situations, the correct outside temperature may not

be displayed, or the display may take longer than normal to change:

- When stopped, or driving at low speeds (less than 16 mph [25 km/h])
- When the outside temperature has changed suddenly (at the entrance/exit of a garage, tunnel, etc.)
- When "--" or "E" is displayed, the system may be malfunctioning. Take your vehicle to your Toyota dealer.

#### ■ Liquid crystal display

→P.101

#### ■ Customization

The gauges and meters can be customized in  of the multi-information display. (→P.104)

#### WARNING

##### ■ The information display at low temperatures

Allow the interior of the vehicle to warm up before using the liquid crystal information display. At extremely low temperatures, the information display monitor may respond slowly, and display changes may be delayed.

For example, there is a lag between the driver's shifting and the new gear number appearing on the display. This lag could cause the driver to downshift again, causing rapid and excessive engine braking and possibly an accident resulting in death or injury.

#### NOTICE

##### ■ To prevent damage to the engine and its components

- Do not let the indicator needle of the tachometer enter the red zone, which indicates the maximum engine speed.
- The engine may be overheating if the engine coolant temperature gauge is in the red zone (H). In this case, immediately stop the vehicle in a safe place, and check the engine after it has cooled completely. (→P.550)

#### Odometer and trip meter display

##### ■ Changing the display

Press the display change button until the desired item is displayed.

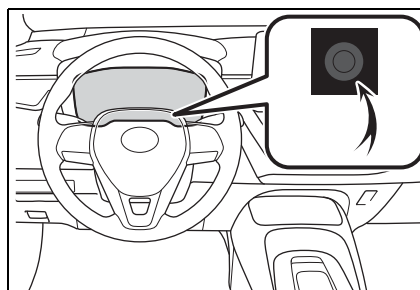

##### ■ Display items

###### ● Odometer

Displays the total distance the vehicle has been driven.

###### ● Trip meter A/Trip meter B

Displays the distance the vehicle has been driven since the meter was last reset. Trip meters A and B can be used to record and display

different distances independently.

To reset, display the desired trip meter and press and hold the display change button.

### Changing the instrument panel light brightness

The brightness of the instrument panel lights can be adjusted.

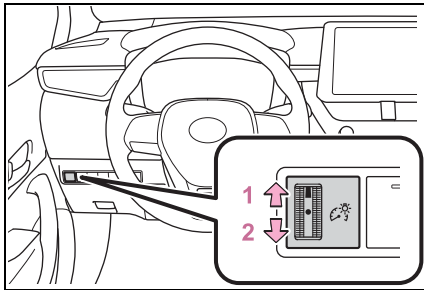

- 1 Brighter
- 2 Darker

### Instrument panel light brightness adjustment

The brightness of the instrument panel lights can be adjusted separately for when the tail lights are on and off.

### Adjusting the clock

#### ■ Clock adjustment

The clocks on the following can be adjusted on the audio system screen.

- Multi-information display
- Audio system screen

#### ■ Setting the clock to be adjusted automatically by GPS

- 1 Press the "MENU" button.
- 2 Select "Setup" on the "Menu" screen.
- 3 Select "General" on the "Setup" screen.
- 4 Select "Clock".
- 5 Select "Auto Adjust by GPS" to set to on.

#### ■ Adjusting the clock manually

- 1 Press the "MENU" button.
- 2 Select "Setup" on the "Menu" screen.
- 3 Select "General" on the "Setup" screen.
- 4 Select "Clock".
- 5 Select "Auto Adjust by GPS" to set to off.
- 6 Adjust the displayed time.
  - Hour: Select "-" or "+" of "Hours" to adjust the hour.
  - Minute: Select "-" or "+" of "Minutes" to adjust the minute.
  - ":00": Select to set the clock to the beginning of the nearest hour.

e.g.

1:00 to 1:29 → 1:00

1:30 to 1:59 → 2:00

#### ■ Setting the time zone

- 1 Press the "MENU" button.

- 2 Select "Setup" on the "Menu" screen.
- 3 Select "General" on the "Setup" screen.
- 4 Select "Clock".
- 5 Select "Time Zone".

Select the desired time zone.

Premium Audio only:

If "Auto" is selected, the time zone is selected automatically by current vehicle position.

#### ■ Setting daylight saving time

- 1 Press the "MENU" button.
- 2 Select "Setup" on the "Menu" screen.
- 3 Select "General" on the "Setup" screen.
- 4 Select "Clock".
- 5 Select "Daylight Saving Time" then on/off/auto\*.

\*: Premium Audio only

#### ■ Changing the clock between 12-hour/24-hour format

- 1 Press the "MENU" button.
- 2 Select "Setup" on the "Menu" screen.
- 3 Select "General" on the "Setup" screen.
- 4 Select "Clock".
- 5 Select "24-Hour Time Format" and then on/off.

When set to off, the clock is displayed in 12 hour time format.

#### ■ Clock settings screen

If "Clock : 00" is displayed when  is selected on the multi-information display, the system may be malfunctioning. Have the vehicle inspected by your Toyota dealer.

## Multi-information display

## Display and menu icons

## ■ Display

## ▶ 4.2-inch display

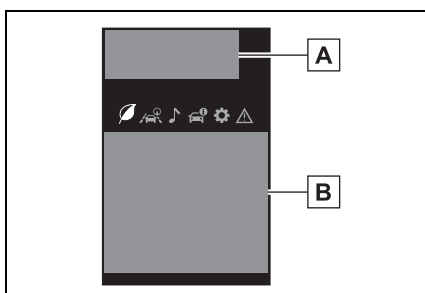
**A** Driving support system status display area

Displays an image when the following systems are operating and a menu icon other than  is selected:

- LTA (Lane Tracing Assist) (if equipped)
- LDA (Lane Departure Alert with steering control) (if equipped)
- Dynamic radar cruise control (if equipped)
- Dynamic radar cruise control with full-speed range (if equipped)
- RSA (Road Sign Assist) (if equipped) (→P.250)

**B** Content display area

By selecting menu icons on the multi-information display, a variety of driving-related information can be displayed. The multi-information display can also be used to change display settings and other vehicle settings.

Warning or advice pop-up displays

are also displayed in certain situations.

## ▶ 7-inch display

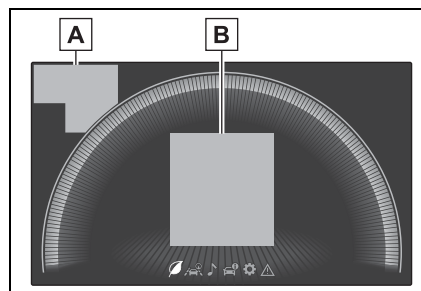
**A** Driving support system status display area

Displays an image when the following systems are operating and a menu icon other than  is selected:

- LTA (Lane Tracing Assist)
- Dynamic radar cruise control with full-speed range
- RSA (Road Sign Assist) (if equipped) (→P.250)

**B** Content display area







By selecting menu icons on the multi-information display, a variety of driving-related information can be displayed. The multi-information display can also be used to change display settings and other vehicle settings.

Warning or advice pop-up displays are also displayed in certain situations.

## ■ Menu icons

The menu icons will be displayed by pressing the < or > meter control switch.



-  Driving information display (→P.101)
-  Driving support system information display (→P.103)
-  Audio system-linked display (→P.104)
-  Vehicle information display (→P.104)
-  Settings display (→P.104)
-  Warning message display (→P.521)

**Liquid crystal display**

Small spots or light spots may appear on the display. This phenomenon is characteristic of liquid crystal displays, and there is no problem continuing to use the display.

**WARNING**

- **Caution for use while driving**
- When operating the multi-information display while driving, pay extra attention to the safety of the area around the vehicle.
- Do not look continuously at the multi-information display while driving as you may fail to see pedestrians, objects on the road, etc. ahead of the vehicle.
- **The information display at low temperatures**  
→P.92, 97

**Changing the meter display**

The multi-information display is operated using the meter control switches.

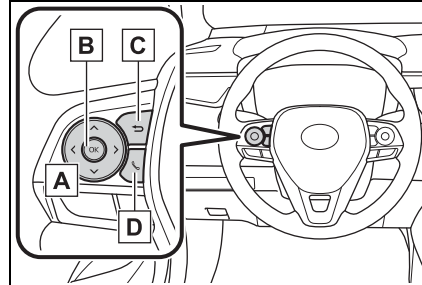

- A** < / > : Select menu icons  
^ / v : Change displayed content, scroll up/down the screen and move the cursor up/down
- B** Press: Enter/Set  
Press and hold: Reset/Display customizable items
- C** Return to the previous screen
- D** Call sending/receiving and history display

Linked with the hands-free system, sending or receiving call is displayed. For details regarding the hands-free system, refer to the "NAVIGATION AND MULTIMEDIA SYSTEM OWNER'S MANUAL".

**Content of driving information**

- **Display items**
- Speedometer display/Driving range (4.2-inch display)
- Fuel economy
- Eco Driving Indicator/Driving range (if equipped)

2  
Vehicle status information and indicators

■ **Speedometer display/Driving range (4.2-inch display)**

- Speedometer display
- Driving range

Displays driving range with remaining fuel. Use the displayed values as a reference only.

This distance is computed based on your average fuel consumption. As a result, the actual distance that can be driven may differ from that displayed.

When only a small amount of fuel is added to the tank, the display may not be updated.

When refueling, turn the engine switch off. If the vehicle is refueled without turning the engine switch off, the display may not be updated.

■ **Fuel economy**

Use the displayed values as a reference only.

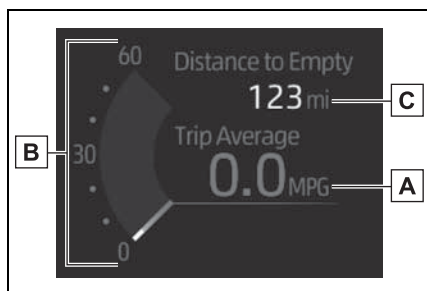

**A** Average fuel economy (after reset)

To reset the average fuel economy display, press and hold the OK meter control switch.

**B** Current fuel consumption

Displays instantaneous current fuel consumption.

**C** Driving range

Displays driving range with remaining fuel.

This distance is computed based on your average fuel consumption. As a result, the actual distance that can be driven may differ from that displayed.

When only a small amount of fuel is added to the tank, the display may not be updated.

When refueling, turn the engine switch off. If the vehicle is refueled without turning the engine switch off, the display may not be updated.

The average fuel economy display can be changed in . (→P.104)

- Average fuel economy (after start)

Displays the average fuel consumption since engine start.

- Average fuel economy (after refuel)

Displays the average fuel consumption since the vehicle was refueled.

■ **Eco Driving Indicator/Driving range (if equipped)**

- Eco Driving Indicator

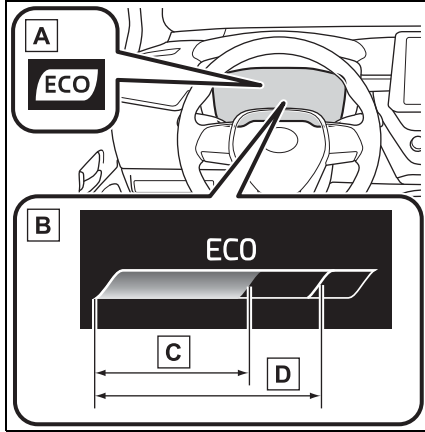

**A** Eco Driving Indicator Light  
 During Eco-friendly acceleration (Eco driving), the Eco Driving Indicator Light will turn on. When the acceleration exceeds the Zone of Eco driving, or when the vehicle is stopped, the light turns off.

**B** Eco Driving Indicator Zone Display  
 Suggests the Zone of Eco driving with current Eco driving ratio based on acceleration.

**C** Eco driving ratio based on acceleration  
 If the acceleration exceeds the Zone of Eco driving, the right side of the Eco Driving Indicator Zone Display will illuminate.

At this time, the Eco Driving Indicator Light will turn off.

**D** Zone of Eco driving

- Driving range

Displays driving range with remaining fuel. Use the displayed values as a reference only.

This distance is computed based on your average fuel consumption. As a result, the actual distance that can be driven may differ from that displayed.

When only a small amount of fuel is added to the tank, the display may not be updated.

When refueling, turn the engine switch off. If the vehicle is refueled without turning the engine switch off, the display may not be updated.

**Eco Driving Indicator**

Eco Driving Indicator will not operate under the following conditions:

- The shift lever is in any position other than D.
- A paddle shift switch is operated. (If equipped)
- The driving mode is set to sport mode. (If equipped)
- The vehicle speed is approximately 80 mph (130 km/h) or higher.

**Driving support system information display**

**Driving support system information**

Select to display the operational status of the following systems:

- LTA (Lane Tracing Assist) (if equipped) (→P.211)
- LDA (Lane Departure Alert with steering control) (if equipped) (→P.221)
- Dynamic radar cruise control (if equipped) (→P.240)
- Dynamic radar cruise control

with full-speed range (if equipped) (→P.229)

■ **Navigation system-linked display (if equipped)**

Select to display the following navigation system-linked information:

- Route guidance to destination
- Compass display (heading-up display)

**Audio system-linked display**

Select to enable selection of an audio source or track on the meter using the meter control switches.

This menu icon can be set to be displayed/not displayed in .

**Vehicle information display**

■ **Drive information**

Displays drive information such as the following:

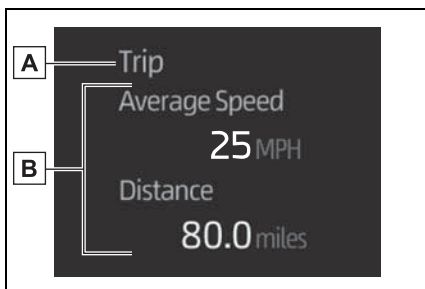

- A** Drive information type
- B** Drive information items

Displays the following depending on which drive information type and drive information items were selected in . (→P.104)

- After start
  - Distance: Displays the distance driven since engine start
  - Elapsed time: Displays the elapsed time since engine start
  - Average vehicle speed: Displays the average vehicle speed since engine start
- After reset
  - Distance: Displays the distance driven since the display was reset\*
  - Elapsed time: Displays the elapsed time since the display was reset\*
  - Average vehicle speed: Displays the average vehicle speed since the display was reset\*

\*: To reset, display the desired item and press and hold the OK meter control switch.

**Settings display**

■ **Meter display settings that can be changed**

- Language
 

Select to change the language displayed.
- Units
 

Select to change the units of measure displayed.
- Speedometer display (7-inch

display)

Select to set the display of the speedometer to analog/digital.

- Eco Driving Indicator Light (if equipped)

Select to enable/disable the Eco Driving Indicator Light.



- Fuel economy display

Select to change the average fuel consumption display between after start/after reset. (→P.102)



Select to display/not display the audio system linked display.



Select to change the displayed content of the following:

- Drive information type

Select to change the drive information type display between after start/after reset.

- Drive information items

Select to set the first and second items of the drive information display to any of the following: average vehicle speed/distance/elapsed time.

- Pop-up display

Select to enable/disable pop-up displays for each relevant system.

- Multi-information display off

Select to turn the multi-information display off.

To turn the multi-information display on again, press any of the following meter control switches

/ OK / .

- Default setting

Select to reset the meter display settings to the default setting.

■ **Vehicle functions and settings that can be changed**

→P.581

■ **Suspension of the settings display**

- Some settings cannot be changed while driving. When changing settings, park the vehicle in a safe place.
- If a warning message is displayed, operation of the settings display will be suspended.

**WARNING**

■ **Cautions during setting up the display**

If the engine is running when changing the display settings, ensure that the vehicle is parked in a place with adequate ventilation. In a closed area such as a garage, exhaust gases including harmful carbon monoxide (CO) may collect and enter the vehicle. This may lead to death or a serious health hazard.

**NOTICE**

■ **During setting up the display**

To prevent battery discharge, ensure that the engine is running while setting up the display features.

### Fuel consumption information

Fuel consumption information can be displayed on the audio system screen.

### System components

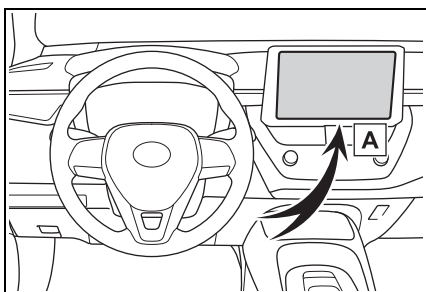

A Audio system screen

### Consumption

#### ■ Trip information

▶ Audio without DCM/Audio Plus without DCM

- 1 Press the "MENU" button.
- 2 Select "Info" on the "Menu" screen.

If a screen other than "Trip Information" is displayed, select "Trip Information".

▶ Audio with DCM/Audio Plus with DCM/Premium Audio

- 1 Press the "MENU" button.
- 2 Select "Info" on the "Menu" screen.
- 3 Select "ECO" on the "Information" screen.

If a screen other than "Trip Information" is displayed, select "Trip Information".



- A Resetting the consumption data
- B Fuel consumption in the past 15 minutes
- C Current fuel consumption
- D Average vehicle speed since the engine was started.
- E Elapsed time since the engine was started.
- F Cruising range

Average fuel consumption for the past 15 minutes is divided by color into past averages and averages attained since the engine switch was last turned to ON. Use the displayed average fuel consumption as a reference.

The image is an example only, and may vary slightly from actual conditions.

#### ■ History

▶ Audio without DCM/Audio Plus without DCM

- 1 Press the "MENU" button.

- 2 Select "Info" on the "Menu" screen.

If a screen other than "History" is displayed, select "History".

- ▶ Audio with DCM/Audio Plus with DCM/Premium Audio

- 1 Press the "MENU" button.
- 2 Select "Info" on the "Menu" screen.
- 3 Select "ECO" on the "Information" screen.

If a screen other than "History" is displayed, select "History".

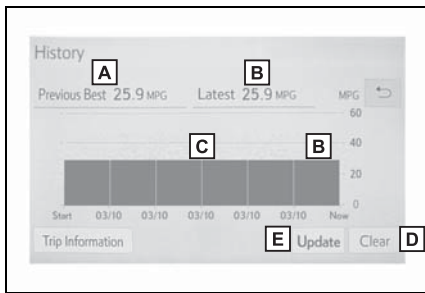

- A** Best recorded fuel consumption
- B** Latest fuel consumption
- C** Previous fuel consumption record
- D** Resetting the history data
- E** Updating the latest fuel consumption data

The average fuel consumption history is divided by color into past averages and the average fuel consumption since the last updated. Use the displayed average fuel consumption as a reference.

The image is an example only, and may vary slightly from actual conditions.

■ **Updating the history data**

Update the latest fuel consumption by selecting "Update" to measure the current fuel consumption again.

■ **Resetting the data**

The fuel consumption data can be deleted by selecting "Clear".

■ **Cruising range**

Displays the estimated maximum distance that can be driven with the quantity of fuel remaining.

This distance is computed based on your average fuel consumption. As a result, the actual distance that can be driven may differ from that displayed.





**Before driving****3**

- 3-1. Key information**
  - Keys ..... 110
- 3-2. Opening, closing and locking the doors**
  - Doors ..... 117
  - Trunk ..... 122
  - Smart key system ..... 125
- 3-3. Adjusting the seats**
  - Front seats ..... 133
  - Rear seats ..... 134
  - Head restraints ..... 136
- 3-4. Adjusting the steering wheel and mirrors**
  - Steering wheel ..... 138
  - Inside rear view mirror  
..... 139
  - Outside rear view mirrors  
..... 140
- 3-5. Opening and closing the windows**
  - Power windows ..... 142
  - Moon roof ..... 145

**3**

Before driving

Keys

The keys

The following keys are provided with the vehicle.

► Type A

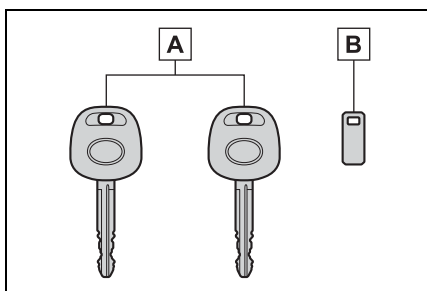

**A** Keys (without a wireless remote control function)

**B** Key number plate

► Type B

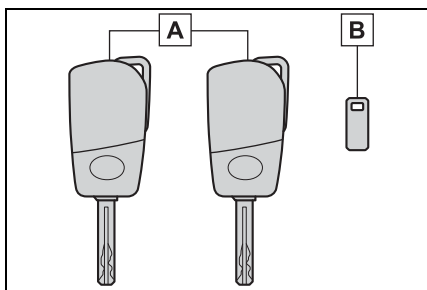

**A** Keys (with a wireless remote control function)

Operating the wireless remote control function (→P.112)

**B** Key number plate

► Type C

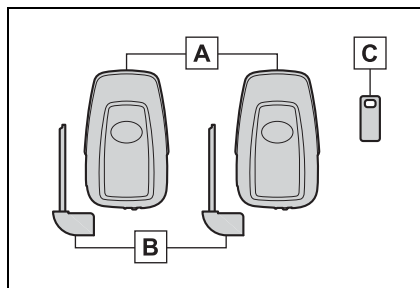

**A** Electronic keys

- Operating the smart key system (→P.125)
- Operating the wireless remote control function (→P.112)

**B** Mechanical keys

**C** Key number plate

■ When riding in an aircraft (with a wireless remote control function)

When bringing a key with wireless remote control function onto an aircraft, make sure you do not press any buttons on the key while inside the aircraft cabin. If you are carrying the key in your bag, etc., ensure that the buttons are not likely to be pressed accidentally. Pressing a button may cause the key to emit radio waves that could interfere with the operation of the aircraft.

■ Key battery depletion (with a wireless remote control function)

► Vehicles without a smart key system

- The standard battery life is 1 to 2 years.
- The battery will become depleted even if the key is not used. The following symptoms indicate that the key battery may be depleted. Replace the battery when necessary. (→P.489)

- The wireless remote control does not operate.
- The detection area becomes smaller.
- ▶ Vehicles with a smart key system
- The standard battery life is 1 to 2 years.
- If the battery becomes low, an alarm will sound in the cabin and a message will be shown on the multi-information display when the engine is stopped.
- To reduce key battery depletion when the electronic key is to not be used for long periods of time, set the electronic key to the battery-saving mode. (→P.127)
- As the electronic key always receives radio waves, the battery will become depleted even if the electronic key is not used. The following symptoms indicate that the electronic key battery may be depleted. Replace the battery when necessary. (→P.489)
- The smart key system or the wireless remote control does not operate.
- The detection area becomes smaller.
- The LED indicator on the key surface does not turn on.
- To avoid serious deterioration, do not leave the electronic key within 3 ft. (1 m) of the following electrical appliances that produce a magnetic field:
  - TVs
  - Personal computers
  - Cellular phones, cordless phones and battery chargers
  - Recharging cellular phones or cordless phones
  - Table lamps
  - Induction cookers
- If the electronic key is near the vehicle for longer than necessary, even if the smart key system is not operated, the key battery may become depleted faster than normal.

■ **Replacing the battery (with a wireless remote control function)**

→P.489

■ **If “A New Key has been Registered Contact Your Dealer for Details” is shown on the multi-information display (vehicles with a smart key system)**

This message will be displayed each time the driver’s door is opened when the doors are unlocked from the outside for approximately 10 days after a new electronic key has been registered. If this message is displayed but you have not had a new electronic key registered, ask your Toyota dealer to check if an unknown electronic key (other than those in your possession) has been registered.

■ **If a wrong key is used (with a wireless remote control function)**

The key cylinder rotates freely, isolated from the internal mechanism.

 NOTICE

■ **To prevent key damage**

- Do not drop the keys, subject them to strong shocks or bend them.
- Do not expose the keys to high temperatures for long periods of time.
- Do not get the keys wet or wash them in an ultrasonic washer etc.
- Vehicles with a smart key system: Do not attach metallic or magnetic materials to the keys or place the keys close to such materials.
- Do not disassemble the keys.

 NOTICE

- Do not attach a sticker or anything else to the surface of the key.
  - Vehicles with a smart entry & start system: Do not place the keys near objects that produce magnetic fields, such as TVs, audio systems and induction cookers.
  - Vehicles with a smart entry & start system: Do not place the keys near medical electrical equipment such as low-frequency therapy equipment or microwave therapy equipment, and do not receive medical attention with the keys on your person.
- **Carrying the electronic key on your person (vehicles with a smart key system)**
- Carry the electronic key 3.9 in. (10 cm) or more away from electric appliances that are turned on. Radio waves emitted from electric appliances within 3.9 in. (10 cm) of the electronic key may interfere with the key, causing the key to not function properly.
- **In case of a smart key system malfunction or other key-related problems (vehicles with a smart key system)**  
→P.544
- **When an electronic key is lost (vehicles with a smart key system)**  
→P.544

**Wireless remote control (if equipped)**

The keys are equipped with the following wireless remote con-

trol:

- ▶ Vehicles without a smart key system

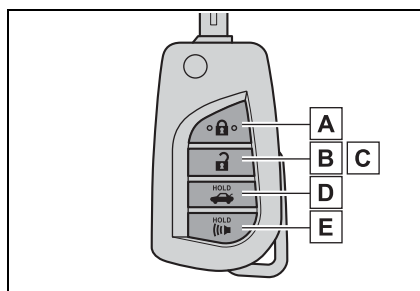

- A Locks the doors (→P.117)
- B Unlocks the doors (→P.117)
- C Opens the windows<sup>\*1</sup> and moon roof<sup>\*1, 2</sup> (→P.117)
- D Opens the trunk (→P.124)
- E Sounds the alarm (→P.113)

- ▶ Vehicles with a smart key system

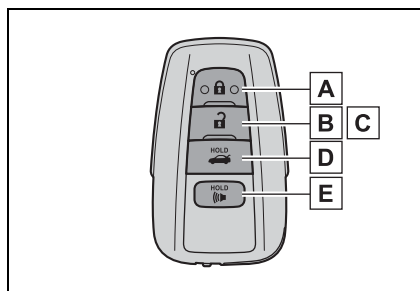

- A Locks the doors (→P.117)
- B Unlocks the doors (→P.117)
- C Opens the windows<sup>\*1</sup> and moon roof<sup>\*1, 2</sup> (→P.117)
- D Opens the trunk (→P.124)
- E Sounds the alarm (→P.113)

<sup>\*1</sup>: This setting must be customized

at your Toyota dealer.

\*2: If equipped

**■ Panic mode (with a wireless remote control function)**

- ▶ Vehicles without a smart key system

When  is pressed for longer than about one second, an alarm will sound intermittently and the vehicle lights will flash to deter any person from trying to break into or damage your vehicle.

To stop the alarm, press any button on the wireless remote control.



- ▶ Vehicles with a smart key system

When  is pressed for longer than about one second, an alarm will sound intermittently and the vehicle lights will flash to deter any person from trying to break into or damage your vehicle.

To stop the alarm, press any button on the electronic key.



**■ Conditions affecting the operation of the smart key system or wireless remote control (with a wireless remote control function)**

- ▶ Vehicles without a smart key system

The wireless remote control function may not operate normally in the following situations:

- When the wireless key battery is depleted
- Near a TV tower, electric power plant, gas station, radio station, large display, airport or other facility that generates strong radio waves or electrical noise
- When carrying a portable radio, cellular phone or other wireless communication devices
- When the wireless key is in contact with, or is covered by a metallic object
- When a wireless key (that emits radio waves) is being used nearby
- If window tint with a metallic content or metallic objects are attached to the rear window

- ▶ Vehicles with a smart key system
- P.127

**Using the key (vehicles without a smart key system and with a wireless remote control function)**

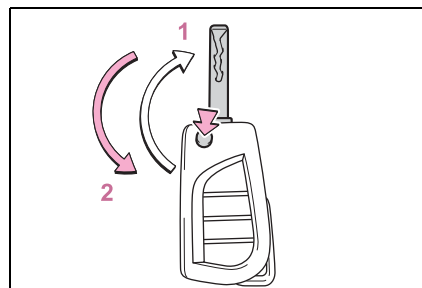

1 Releasing

To release the key, press the button

2 Folding

To stow the key, press the button then fold the key.

■ If you lose your mechanical keys

→P.544

**Using the mechanical key (vehicles with a smart key system)**

To take out the mechanical key, slide the release button and take the key out.

The mechanical key can only be inserted in one direction, as the key only has grooves on one side. If the key cannot be inserted in a lock cylinder, turn it over and re-attempt to insert it.

After using the mechanical key, store it in the electronic key.

Carry the mechanical key together with the electronic key.

If the electronic key battery is depleted or the entry function does not operate properly, you will need the mechanical key.

(→P.544)

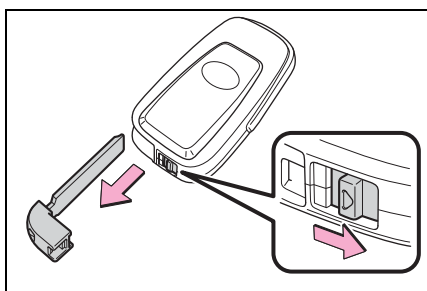

■ **Certification for the wireless remote control (vehicles without a smart key system)**

- ▶ Except for vehicles sold in Canada

FCC ID:HYQ23ABE

FCC ID:HYQ12BFB

NOTE:

This device complies with part 15 of the FCC Rules. Operation is subject to the following two conditions: (1) This device may not cause harmful interference, and (2) this device must accept any interference received, including interference that may cause undesired operation.

FCC WARNING:

Changes or modifications not expressly approved by the party responsible for compliance could void the user's authority to operate the equipment.

<For 12BFB>

The FCC ID is affixed inside the equipment. You can find the ID when replacing the battery.

- ▶ For vehicles sold in Canada

NOTE:

This device contains licence-exempt transmitter(s)/receiver(s) that comply with Innovation, Science and Economic Development Canada's licence-exempt RSS(s).

Operation is subject to the following two conditions:

- (1) This device may not cause interference.
- (2) This device must accept any interference, including interference that may cause undesired operation of the device.

<For 12BFH/12BFB>

The IC Certification number is affixed inside the equipment. You can find the number when replacing the battery.

NOTE:

L'émetteur/récepteur exempt de licence contenu dans le présent appareil est conforme aux CNR d'Innovation, Sciences et Développement économique Canada applicables aux appareils radio exempts de licence.

L'exploitation est autorisée aux deux conditions suivantes :

- (1) L'appareil ne doit pas produire de brouillage;
- (2) L'appareil doit accepter tout brouillage radioélectrique subi, même si le brouillage est susceptible d'en compromettre le fonctionnement.

<Pour 12BFH/12BFB>

Le numéro d'accréditation IC est apposé à l'intérieur de l'appareil. Ce numéro est visible au remplacement de la pile.

■ **Certification for the wireless remote control (vehicles with a smart key system)**

→P.130



Doors

Unlocking and locking the doors from the outside

■ Smart key system (if equipped)

Carry the electronic key to enable this function.

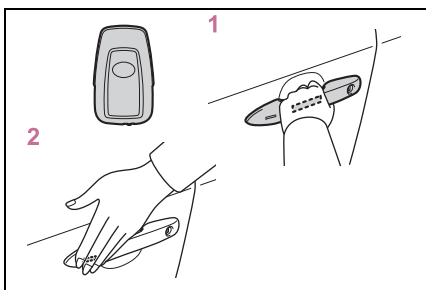

- 1 Grip the driver's door handle to unlock the door. Holding the driver's door handle for approximately 2 seconds unlocks all the doors. Grip the front passenger's door handle to unlock all the doors.\*

Make sure to touch the sensor on the back of the handle.

The doors cannot be unlocked for 3 seconds after the doors are locked.

\*: The door unlock settings can be changed. (→P.118, 581)

- 2 Touch the lock sensor (the indentation on the side of the front door handle) to lock all the doors.

Check that the door is securely locked.

■ Wireless remote control (if equipped)

- ▶ Vehicles without a smart key system

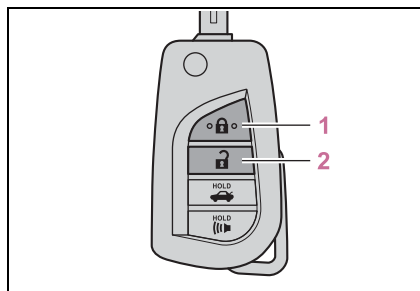

- 1 Locks all the doors

Check that the door is securely locked.

- 2 Unlocks all the doors

Pressing the button unlocks the driver's door. Pressing the button again within 3 seconds unlocks the other doors.

Press and hold to open the windows\*<sup>1,2</sup> and moon roof.\*<sup>1,2</sup>

- ▶ Vehicles with a smart key system

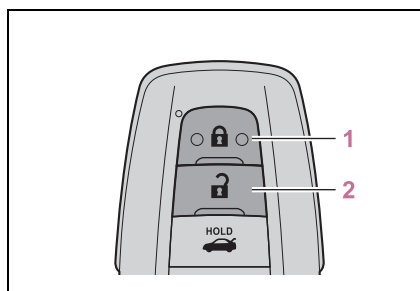

- 1 Locks all the doors

Check that the door is securely locked.

- 2 Unlocks all the doors

Pressing the button unlocks the driver's door. Pressing the button

3

Before driving

again within 3 seconds unlocks the other doors.

Press and hold to open the windows\*1 and moon roof.\*1, 2

\*1: This setting must be customized at your Toyota dealer.

\*2: If equipped

■ Key

Turning the key operates the doors as follows:

- ▶ Vehicles without a smart key system

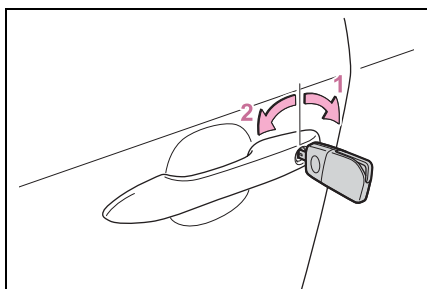

1 Unlocks all the doors

Turning the key unlocks the driver's door. Turning the key again unlocks the other doors.

Turn and hold to open the windows\*1 and moon roof.\*1, 2

2 Locks all the doors

Turn and hold to close the windows\*1 and moon roof.\*1, 2

\*1: This setting must be customized at your Toyota dealer.

\*2: If equipped

- ▶ Vehicles with a smart key system

The doors can also be locked and unlocked with the mechanical key. (→P.544)

■ Switching the door unlock function (vehicles with a smart key system)

It is possible to set which doors the entry function unlocks using the wireless remote control.

- 1 Turn the engine switch off.
- 2 When the indicator light on the key surface is not on, press and hold , or for approximately 5 seconds while pressing and holding .

The setting changes each time an operation is performed, as shown below. (When changing the setting continuously, release the buttons, wait for at least 5 seconds, and repeat step 2.)

Multi-information display/Beep	Unlocking function
<p>Exterior: Beeps 3 times Interior: Pings once</p>	<p>Holding the driver's door handle unlocks only the driver's door.</p>
<p>Exterior: Beeps twice Interior: Pings once</p>	<p>Holding the front passenger's door handle unlocks all the doors.</p>
<p>Exterior: Beeps twice Interior: Pings once</p>	<p>Holding either front door handle unlocks all the doors.</p>

For vehicles with an alarm: To prevent unintended triggering of the alarm, unlock the doors using the wireless remote control and open and close a door once after the settings have been changed. (If a door

is not opened within 60 seconds after  is pressed, the doors will be locked again and the alarm will automatically be set.)  
In case that the alarm is triggered, immediately stop the alarm. (→P.83)

■ **Operation signals (with a wireless remote control function)**

- ▶ Vehicles without a smart key system

A buzzer sounds and the emergency flashers flash to indicate that the doors have been locked/unlocked using the wireless remote control. (Locked: Once; Unlocked: Twice)

- ▶ Vehicles with a smart key system

A buzzer sounds and the emergency flashers flash to indicate that the doors have been locked/unlocked using the entry function or wireless remote control. (Locked: Once; Unlocked: Twice)

A buzzer sounds to indicate that the windows and moon roof\* are operating.

\*: If equipped

■ **Security feature (with a wireless remote control function)**

- ▶ Vehicles without a smart key system

If a door is not opened within approximately 60 seconds after the vehicle is unlocked using the wireless remote control, the security feature automatically locks the vehicle again.

- ▶ Vehicles with a smart key system

If a door is not opened within approximately 60 seconds after the vehicle is unlocked using the entry function or wireless remote control, the security feature automatically locks the vehicle again.

■ **When the door cannot be locked by the lock sensor on the surface of the front door handle (vehicles with a smart key system)**

If the doors cannot be locked by touching the lock sensor with a finger, touch the lock sensor with the palm of your hand.

If you are wearing gloves, remove them.

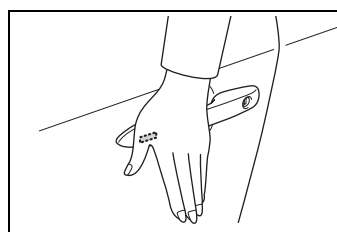

■ **Door lock buzzer (vehicles with a smart key system)**

If an attempt to lock the doors using the entry function or wireless remote control is made when a door is not fully closed, a buzzer will sound continuously for 5 seconds. Fully close the door to stop the buzzer, and lock the doors again.

■ **Alarm (if equipped)**

Locking the doors will set the alarm system. (→P.82)

■ **Conditions affecting the operation of the smart key system or wireless remote control (if equipped)**

- ▶ Vehicles without a smart key system

→P.113

- ▶ Vehicles with a smart key system

→P.127

■ **If the smart key system or the wireless remote control does not operate properly (if equipped)**

- ▶ Vehicles without a smart key system

Replace the key battery with a new one if it is depleted. (→P.489)

- ▶ Vehicles with a smart key system

Use the mechanical key to lock and unlock the doors. (→P.544)

Replace the key battery with a new one if it is depleted. (→P.489)

■ **If the battery is discharged (vehicles with a smart key system)**

The doors cannot be locked and unlocked using the smart key system or wireless remote control. Lock or unlock the doors using the mechanical key. (→P.544)

■ **Customization**

Some functions can be customized. (→P.581)

**⚠ WARNING**

■ **To prevent an accident**

Observe the following precautions while driving the vehicle.

Failure to do so may result in a door opening and an occupant being thrown out of the vehicle, resulting in death or serious injury.

- Ensure that all doors are properly closed and locked.
- Do not pull the inside door handle while driving. Be especially careful of the front doors, as the doors may be opened even if the inside lock buttons are in the locked position.
- Set the rear door child-protector locks when children are seated in the rear seats.

■ **When opening or closing a door**

Check the surroundings of the vehicle such as whether the vehicle is on an incline, whether there is enough space for a door to open and whether a strong wind is blowing. When opening or closing the door, hold the door handle tightly to prepare for any unpredictable movement.

■ **When using the wireless remote control or the key and operating the power windows or moon roof (if equipped)**

Operate the power windows or moon roof after checking to make sure that there is no possibility of any passenger having any of their body parts caught in the windows or moon roof. Also, do not allow children to operate the wireless remote control or the key. It is possible for children and other passengers to get caught in the power windows or moon roof.

**Unlocking and locking the doors from the inside**

■ **Door lock switches (to lock/unlock)**

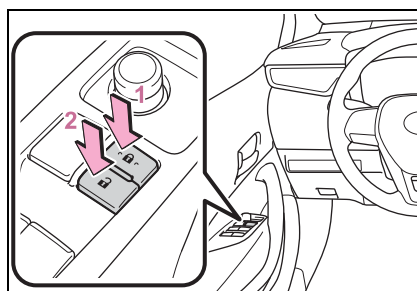

- 1 Locks all the doors
- 2 Unlocks all the doors

■ **Inside lock buttons**

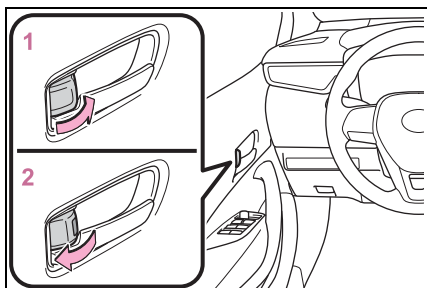

- 1 Locks the door
- 2 Unlocks the door

The front doors can be opened by pulling the inside handle even if the lock buttons are in the lock position.

■ **Locking the front doors from the outside without a key**

- 1 Move the inside lock button to the lock position.
  - 2 Close the door.
- ▶ Vehicles without a smart key system

The door cannot be locked if the key is in the engine switch.

- ▶ Vehicles with a smart key system

The door cannot be locked if the engine switch is in ACC or ON, or the electronic key is left inside the vehicle.

The key may not be detected correctly and the door may be locked.

■ **Open door warning buzzer**

If a door or the trunk is not fully closed, a buzzer will sound when the vehicle speed reaches 3 mph (5 km/h).

The open door(s) or trunk is indicated on the multi-information display.

**Rear door child-protector lock**

The door cannot be opened from inside the vehicle when lock is set.

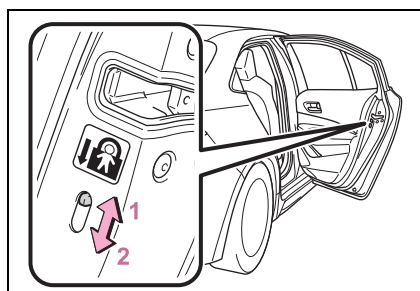

- 1 Unlock
- 2 Lock

These locks can be set to prevent children from opening the rear doors. Push down on each rear door switch to lock both rear doors.

**Automatic door locking and unlocking systems**

The following functions can be set or canceled:

For instructions on customizing, refer to P.581.

3

Before driving

Function	Operation
Speed linked door locking function	All doors are automatically locked when vehicle speed is approximately 12 mph (20 km/h) or higher.
Shift position linked door locking function*	All doors are automatically locked when shifting the shift lever out of P.
Shift position linked door unlocking function*	All doors are automatically unlocked when shifting the shift lever to P.
Driver's door linked door unlocking function	All doors are automatically unlocked when driver's door is opened.

\*: Vehicles with a continuously variable transmission

## Trunk

**The trunk can be opened using the trunk opener, entry function or wireless remote control or key.**

### WARNING

Observe the following precautions. Failure to do so may result in death or serious injury.

#### ■ Before driving

- Make sure that the trunk lid is fully closed. If the trunk lid is not fully closed, it may open unexpectedly while driving and hit near-by objects or luggage in the trunk may be thrown out, causing an accident.

- Do not allow children to play in the trunk. If a child is accidentally locked in the trunk, they could suffer from heat exhaustion, suffocation or other injuries.

- Do not allow a child to open or close the trunk lid. Doing so may cause the trunk lid to open unexpectedly, or cause the child's hands, head, or neck to be caught by the closing trunk lid.

#### ■ Important points while driving

Never let anyone sit in the trunk. In the event of sudden braking or a collision, they are susceptible to death or serious injury.

#### ■ Using the trunk

Observe the following precautions. Failure to do so may cause parts of the body to be caught, resulting in serious injury.

**⚠ WARNING**

- Remove any heavy loads, such as snow and ice, from the trunk lid before opening it. Failure to do so may cause the trunk lid to suddenly shut again after it is opened.
- When opening or closing the trunk lid, thoroughly check to make sure the surrounding area is safe.
- If anyone is in the vicinity, make sure they are safe and let them know that the trunk is about to open or close.
- Use caution when opening or closing the trunk lid in windy weather as it may move abruptly in strong wind.
- The trunk lid may suddenly shut if it is not opened fully. It is more difficult to open or close the trunk lid on an incline than on a level surface, so beware of the trunk lid unexpectedly opening or closing by itself. Make sure that the trunk lid is fully open and secure before using the trunk.

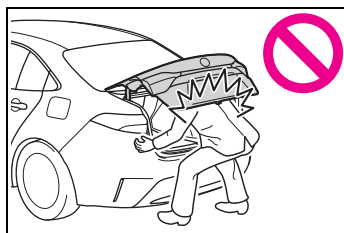

- When closing the trunk lid, take extra care to prevent your fingers etc. from being caught.

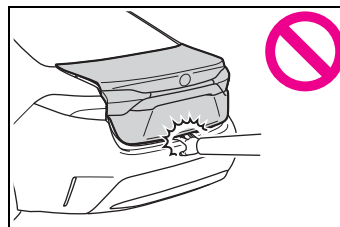

- When closing the trunk lid, make sure to press it lightly on its outer surface.
- Do not attach any accessories other than genuine Toyota parts to the trunk lid. Such additional weight on the trunk lid may cause the lid to suddenly shut again after it is opened.

**Opening the trunk**

■ **Trunk opener**

Pull the lever upward to release the trunk lid.

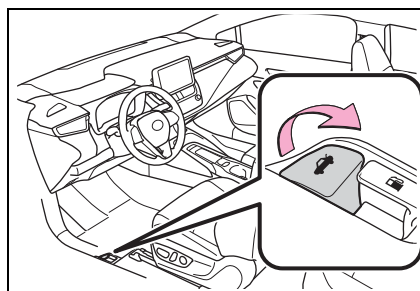

■ **Trunk release button (vehicles with a smart key system)**

While carrying the electronic key, press the button on the trunk lid.

When all the doors are unlocked

3 Before driving

using one of the following methods, the trunk can be opened without the electronic key:

- Entry function
- Wireless remote control
- Door lock switches
- Automatic door unlocking system
- Mechanical key

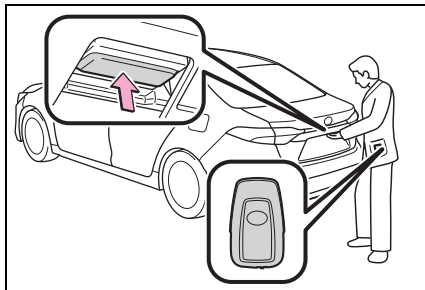

■ **Wireless remote control (if equipped)**

- ▶ Vehicles without a smart key system

Press and hold the switch.

A buzzer sounds.

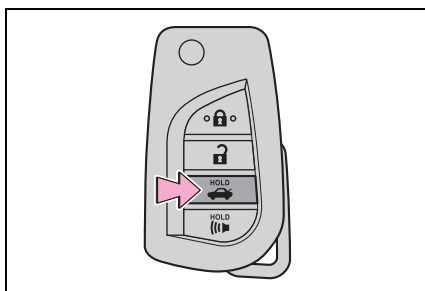

- ▶ Vehicles with a smart key system

Press and hold the switch.

A buzzer sounds.

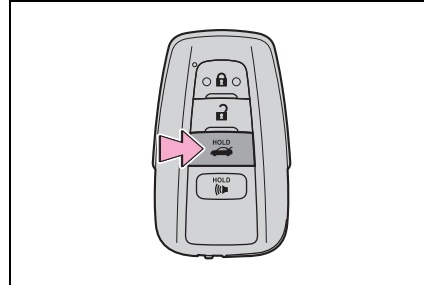

■ **Key (vehicles with a key cylinder on the trunk lid)**

Turn the key clockwise to release the trunk lid.

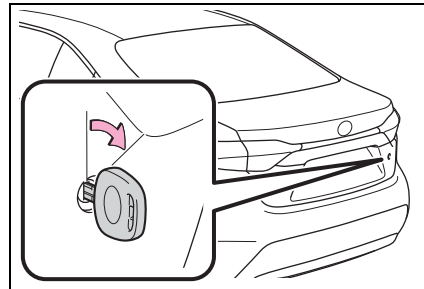

■ **Trunk light**

- The trunk light turns on when the trunk is opened.
- If the trunk light is left on when the engine switch is turned off, the light will go off automatically after 20 minutes.

■ **Function to prevent the trunk being locked with the electronic key inside (vehicles with a smart key system)**

- When all doors are locked, closing the trunk lid with the electronic key left inside the trunk will sound an alarm.

In this case, the trunk lid can be opened pressing the trunk release button on the trunk lid.

- If the spare electronic key is put in the trunk with all the doors locked, the key confinement prevention function is activated so the trunk



can be opened. In order to prevent theft, take all electronic keys with you when leaving the vehicle.

- If the electronic key is put in the trunk with all the doors locked, the key may not be detected depending on the location of the key and the surrounding radio wave conditions. In this case, the key confinement prevention function cannot be activated, causing the doors to lock when the trunk is closed. Make sure to check where the key is before closing the trunk.
- The key confinement prevention function cannot be activated if any one of the doors is unlocked. In this case, open the trunk using the trunk opener.

■ **Internal trunk release lever**

The trunk lid can be opened by pulling up the glow-in-the-dark lever located on the inside of the trunk lid.

The lever will continue to glow for some time after the trunk lid is closed.

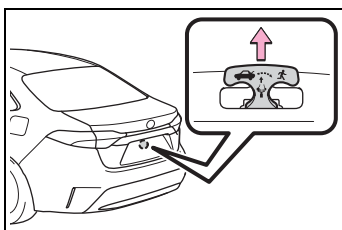

■ **If the smart key system or the wireless remote control does not operate properly (if equipped)**

Replace the key battery with a new one if it is depleted. (→P.489)

■ **Open door warning buzzer**

→P.121

■ **Customization**

Some functions can be customized. (→P.581)

**Smart key system\***

\*: If equipped

**The following operations can be performed simply by carrying the electronic key on your person, for example in your pocket. The driver should always carry the electronic key.**

- Locks and unlocks the doors (→P.117)
- Opens the trunk (→P.123)
- Starts the engine (→P.164)

■ **Antenna location**

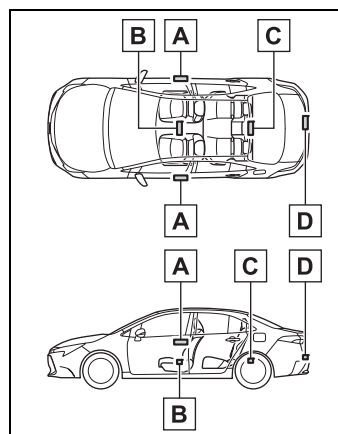

- A Antennas outside the cabin
- B Antennas inside the cabin
- C Antenna inside the trunk
- D Antenna outside the trunk

3  
Before driving

■ **Effective range (areas within which the electronic key is detected)**

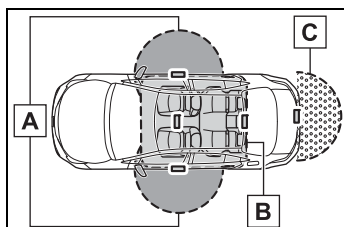

**A** When locking or unlocking the doors

The system can be operated when the electronic key is within about 2.3 ft. (0.7 m) of either of the front outside door handles. (Only the doors detecting the key can be operated.)

**B** When starting the engine or changing engine switch modes

The system can be operated when the electronic key is inside the vehicle.

**C** When opening the trunk

The system can be operated when the electronic key is within about 2.3 ft. (0.7 m) of the trunk release button.

■ **Alarms and warning messages**

A combination of exterior and interior buzzers as well as warning messages shown on the multi-information display are used to prevent theft of the vehicle and accidents resulting from erroneous operation. Take appropriate measures based on the displayed message. (→P.521)

When only an alarm sounds, circumstances and correction procedures are as follows.

- Exterior buzzer sounds once for 5 seconds

Situation	Correction procedure
An attempt was made to lock the vehicle while a door was open.	Close all of the doors and lock the doors again.
The trunk was closed while the electronic key was still inside the trunk and all the doors were locked.	Retrieve the electronic key from the trunk and close the trunk lid.

- Interior buzzer sounds continuously

Situation	Correction procedure
The engine switch was turned to ACC while the driver's door was open (or the driver's door was opened while the engine switch was in ACC).	Turn the engine switch off and close the driver's door.
The engine switch was turned to off while the driver's door was open.	Close the driver's door

■ **Battery-saving function**

The battery-saving function will be activated in order to prevent the electronic key battery and the vehicle battery from being discharged while the vehicle is not operated for a long time.



- In the following situations, the smart key system may take some time to unlock the doors.
  - The electronic key has been left within approximately 11 ft. (3.5 m) of the outside of the vehicle for 2 minutes or longer.
  - The smart key system has not

been used for 5 days or longer.

- If the smart key system has not been used for 14 days or longer, the doors cannot be unlocked from any door except the driver's door. In this case, hold the driver's door handle, or use the wireless remote control or mechanical key to unlock the doors.

■ **Electronic key battery-saving function**

When battery-saving mode is set, battery depletion is minimized by stopping the electronic key from receiving radio waves.

Press  twice while pressing and holding . Confirm that the electronic key indicator flashes 4 times.

While the battery-saving mode is set, the smart key system cannot be used. To cancel the function, press any of the electronic key buttons.

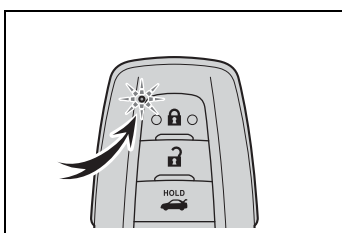

■ **Conditions affecting operation**

The smart key system uses weak radio waves. In the following situations, the communication between the electronic key and the vehicle may be affected, preventing the smart key system, wireless remote control and engine immobilizer system from operating properly.

- When the electronic key battery is depleted
- Near a TV tower, electric power plant, gas station, radio station, large display, airport or other facility that generates strong radio waves or electrical noise
- When carrying a portable radio, cellular phone, cordless phone or

other wireless communication device

- When the electronic key is in contact with, or is covered by the following metallic objects
  - Cards to which aluminum foil is attached
  - Cigarette boxes that have aluminum foil inside
  - Metallic wallets or bags
  - Coins
  - Hand warmers made of metal
  - Media such as CDs and DVDs
- When other wireless keys (that emit radio waves) are being used nearby
- When carrying the electronic key together with the following devices that emit radio waves
  - Another vehicle's electronic key or a wireless key that emits radio waves
  - Personal computers or personal digital assistants (PDAs)
  - Digital audio players
  - Portable game systems
- If window tint with a metallic content or metallic objects are attached to the rear window
- When the electronic key is placed near a battery charger or electronic devices
- When the vehicle is parked in a pay parking spot where radio waves are emitted

If the doors cannot be locked/unlocked using the smart key system, lock/unlock the doors by performing any of the following:

- Bring the electronic key close to either front door handle and operate the entry function.
- Operate the wireless remote control.

If the doors cannot be locked/unlocked using the above methods, use the mechanical key. (→P.544)

If the engine cannot be started using the smart key system, refer to

P.545.

**■ Note for the entry function**

- Even when the electronic key is within the effective range (detection areas), the system may not operate properly in the following cases:
  - The electronic key is too close to the window or outside door handle, near the ground, or in a high place when the doors are locked or unlocked.
  - The electronic key is near the ground or in a high place, or too close to the center of the rear bumper when the trunk is opened.
  - The electronic key is on the instrument panel, rear package tray or floor, or in the door pockets or glove box when the engine is started or engine switch modes are changed.
- Do not leave the electronic key on top of the instrument panel or near the door pockets when exiting the vehicle. Depending on the radio wave reception conditions, it may be detected by the antenna outside the cabin and the door will become lockable from the outside, possibly trapping the electronic key inside the vehicle.
- As long as the electronic key is within the effective range, the doors may be locked or unlocked by anyone. However, only the doors detecting the electronic key can be used to unlock the vehicle.
- Even if the electronic key is not inside the vehicle, it may be possible to start the engine if the electronic key is near the window.
- The doors may unlock or lock if a large amount of water splashes on the door handle, such as in the rain or in a car wash when the electronic key is within the effective range. (The doors will automatically be locked after approximately 60 seconds if the doors are not opened and closed.)
- If the wireless remote control is used to lock the doors when the electronic key is near the vehicle, there is a possibility that the door may not be unlocked by the entry function. (Use the wireless remote control to unlock the doors.)
- If the doors have been locked from outside of the vehicle and are then not unlocked using the wireless remote control or smart key system, the engine cannot be started using the smart key system. (However, if the doors have been locked from inside the vehicle, the engine can be started using the smart key system.) If it is necessary to start the engine, it can be started using the procedure in "If the electronic key does not operate properly" (→P.545).
- Touching the door lock or unlock sensor while wearing gloves may prevent lock or unlock operation.
- When the lock operation is performed using the lock sensor, recognition signals will be shown up to two consecutive times. After this, no recognition signals will be given.
- If the door handle becomes wet while the electronic key is within the effective range, the door may lock and unlock repeatedly. In that case, follow the following correction procedures to wash the vehicle:
  - Place the electronic key in a location 6 ft. (2 m) or more away from the vehicle. (Take care to ensure that the key is not stolen.)
  - Set the electronic key to battery-saving mode to disable the smart key system. (→P.127)
- If the electronic key is inside the vehicle and a door handle becomes wet during a car wash, a message may be shown on the multi-information display and a buzzer will sound outside the vehicle. To turn off the alarm, lock all

the doors.

- The lock sensor may not work properly if it comes into contact with ice, snow, mud, etc. Clean the lock sensor and attempt to operate it again.
- A sudden handle operation or a handle operation immediately after entering the effective range may prevent the doors from being unlocked. Touch the door unlock sensor and check that the doors are unlocked before pulling the door handle again.
- If there is another electronic key in the detection area, it may take slightly longer to unlock the doors after the door handle is gripped.

■ **When the vehicle is not driven for extended periods**

- To prevent theft of the vehicle, do not leave the electronic key within 6 ft. (2 m) of the vehicle.
- The smart key system can be deactivated in advance. (→P.581)
- Setting the electronic key to battery-saving mode helps to reduce key battery depletion. (→P.127)

■ **To operate the system properly**

- Make sure to carry the electronic key when operating the system. Do not get the electronic key too close to the vehicle when operating the system from the outside of the vehicle.

Depending on the position and holding condition of the electronic key, the key may not be detected correctly and the system may not operate properly. (The alarm may go off accidentally, or the door lock prevention function may not operate.)

- Do not leave the electronic key inside the trunk.  
The key confinement prevention function may not operate, depending on the location of the key (the inside edge of the trunk), conditions (inside a metal bag, close to

metallic objects) and the radio waves in the surrounding area. (→P.124)

■ **If the smart key system does not operate properly**

- Locking and unlocking the doors: →P.544
- Starting the engine: →P.545

■ **Customization**

Some functions can be customized. (→P.581)

■ **If the smart key system has been deactivated in a customized setting**

- Locking and unlocking the doors: Use the wireless remote control or mechanical key. (→P.117, 544)
- Starting the engine and changing engine switch modes: →P.545
- Stopping the engine: →P.166

■ **Certification for the smart key system**

► Except for vehicles sold in Canada

FCC ID: NI4TMLF18D-1

NOTE

This device complies with part 15 of the FCC Rules. Operation is subject to the following two conditions: (1) This device may not cause harmful interference, and (2) this device must accept any interference received, including interference that may cause undesired operation.

FCC WARNING

Changes or modifications not expressly approved by the party responsible for compliance could void the user's authority to operate the equipment.

FCC ID:HYQ23AAAY

FCC ID:HYQ14FBN

NOTE:

This device complies with part 15 of the FCC Rules. Operation is subject to the following two conditions: (1) This device may not cause harmful interference, and (2) this device must accept any interference received, including interference that may cause undesired operation.

FCC WARNING:

Changes or modifications not expressly approved by the party responsible for compliance could void the user's authority to operate the equipment.

<For 14FBN>

The FCC ID is affixed inside the equipment. You can find the ID when replacing the battery.

► For vehicles sold in Canada

NOTE

This device complies with Industry Canada's licence-exempt RSSs.

Operation is subject to the following two conditions:

(1) This device may not cause interference; and

(2) This device must accept any interference, including interference that may cause undesired operation of the device.

**NOTE:**

This device contains licence-exempt transmitter(s)/receiver(s) that comply with Innovation, Science and Economic Development Canada's licence-exempt RSS(s).

Operation is subject to the following two conditions:

- (1) This device may not cause interference.
- (2) This device must accept any interference, including interference that may cause undesired operation of the device.

## &lt;For 14FBN&gt;

The IC Certification number is affixed inside the equipment. You can find the number when replacing the battery.

**NOTE**

Le présent appareil est conforme aux CNR d'Industrie Canada applicables aux appareils radio exempts de licence. L'exploitation est autorisée aux deux conditions suivantes :

- (1) l'appareil ne doit pas produire de brouillage;
- (2) l'utilisateur de l'appareil doit accepter tout brouillage radioélectrique subi, même si le brouillage est susceptible d'en compromettre le fonctionnement.

**NOTE:**

L'émetteur/récepteur exempt de licence contenu dans le présent appareil est conforme aux CNR d'Innovation, Sciences et Développement économique Canada applicables aux appareils radio exempts de licence.

L'exploitation est autorisée aux deux conditions suivantes :

- (1) L'appareil ne doit pas produire de brouillage;
- (2) L'appareil doit accepter tout brouillage radioélectrique subi, même si le brouillage est susceptible d'en compromettre le fonctionnement.

## &lt;Pour 14FBN&gt;

Le numéro d'accréditation IC est apposé à l'intérieur de l'appareil. Ce numéro est visible au remplacement de la pile.

 **WARNING****■ Caution regarding interference with electronic devices**

- People with implantable cardiac pacemakers, cardiac resynchronization therapy-pacemakers or implantable cardioverter defibrillators should keep away from the smart key system antennas. (→P.125)

The radio waves may affect the operation of such devices. If necessary, the entry function can be disabled. Ask your Toyota dealer for details, such as the frequency of radio waves and timing of the emitted radio waves. Then, consult your doctor to see if you should disable the entry function.

- Users of any electrical medical device other than implantable cardiac pacemakers, cardiac resynchronization therapy-pacemakers or implantable cardioverter defibrillators should consult the manufacturer of the device for information about its operation under the influence of radio waves.

Radio waves could have unexpected effects on the operation of such medical devices.

Ask your Toyota dealer for details on disabling the entry function.



Front seats

Adjustment procedure

▶ Manual seat

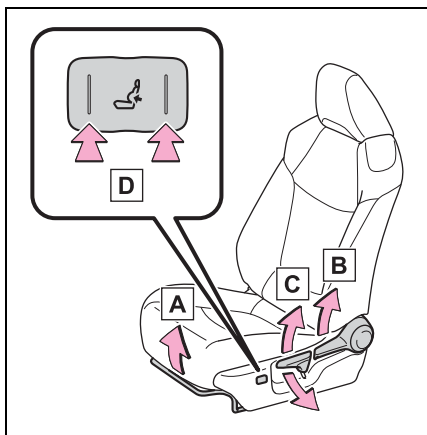

- A** Seat position adjustment lever
- B** Seatback angle adjustment lever
- C** Vertical height adjustment lever (driver's side only)
- D** Lumbar support adjustment switch\* (driver's side only)

\*: If equipped

▶ Power seat (driver's side only)

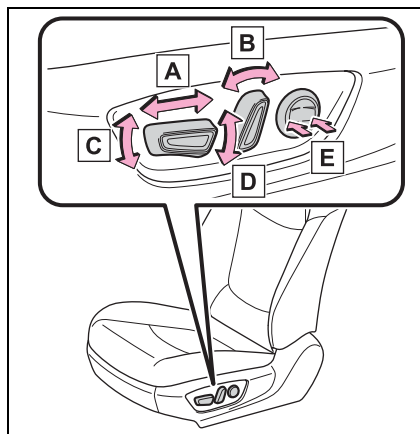

- A** Seat position adjustment switch
- B** Seatback angle adjustment switch
- C** Seat cushion (front) angle adjustment switch
- D** Vertical height adjustment switch
- E** Lumbar support adjustment switch\*

\*: If equipped

**⚠ WARNING**

**■ When adjusting the seat position**

- Take care when adjusting the seat position to ensure that other passengers are not injured by the moving seat.
- Do not put your hands under the seat or near the moving parts to avoid injury. Fingers or hands may become jammed in the seat mechanism.

**⚠ WARNING**

- Make sure to leave enough space around the feet so they do not get stuck.
- **Seat adjustment**
- Be careful that the seat does not hit passengers or luggage.
- To reduce the risk of sliding under the lap belt during a collision, do not recline the seat more than necessary.  
If the seat is too reclined, the lap belt may slide past the hips and apply restraint forces directly to the abdomen, or your neck may contact the shoulder belt, increasing the risk of death or serious injury in the event of an accident.  
Adjustments should not be made while driving as the seat may unexpectedly move and cause the driver to lose control of the vehicle.
- Manual seat only: After adjusting the seat, make sure that the seat is locked in position.

**⚠ NOTICE**

- **When adjusting a front seat**  
When adjusting a front seat, make sure that the head restraint does not contact the headliner. Otherwise, the head restraint and headliner may be damaged.

**Rear seats****The seatbacks of the rear seats can be folded down.****Folding down the rear seatbacks**

- 1 Move the front seats forward. (→P.133)
- 2 Stow the rear armrest. (if equipped) (→P.443)
- 3 Seats with an adjustable type head restraint: Lower the head restraints to the lowest position. (→P.136)
- 4 Fold the seatback down while pushing the seatback lock release button.

Each seatback may be folded separately.

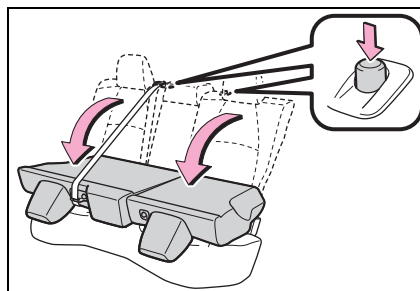
**⚠ WARNING**

Observe the following precautions. Failure to do so may result in death or serious injury.

- **When folding the rear seatbacks down**
- Do not fold the seatbacks down while driving.

**⚠ WARNING**

- Stop the vehicle on level ground, set the parking brake and shift the shift lever to P (continuously variable transmission) or N (manual transmission).
- Do not allow anyone to sit on a folded seatback or in the trunk while driving.
- Do not allow children to enter the trunk.
- Be careful not to get your hand caught when folding the rear seatbacks.
- Adjust the position of the front seats before folding down the rear seatbacks so that the front seats do not interfere with the rear seatbacks when folding down the rear seatbacks.
- **After returning the rear seatback to the upright position**
- Make sure that the seatback is securely locked in position by lightly pushing it back and forth.

If the seatback is not securely locked, the red marking will be visible on the seatback lock release button. Make sure that the red marking is not visible.

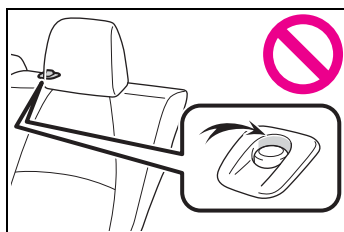

- Check that the seat belts are not twisted or caught in the seatback.

If the seat belt gets caught between the seatback's securing hook and latch, it may damage the seat belt.

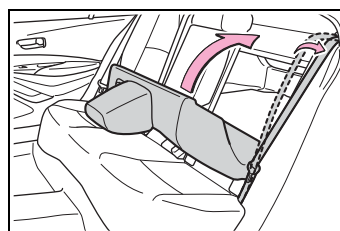

**⚠ NOTICE**

- **When the right seatback is folded down**

Make sure the luggage loaded in the enlarged trunk will not damage the webbing of the rear center seat belt.

3

Before driving

## Head restraints

Head restraints are provided for all seats.

### WARNING

#### ■ Head restraint precautions

Observe the following precautions regarding the head restraints. Failure to do so may result in death or serious injury.

- Use the head restraints designed for each respective seat.
- Adjust the head restraints to the correct position at all times.
- After adjusting the head restraints, push down on them and make sure they are locked in position.
- Do not drive with the head restraints removed.

## Adjusting a head restraint

### ■ Front seats

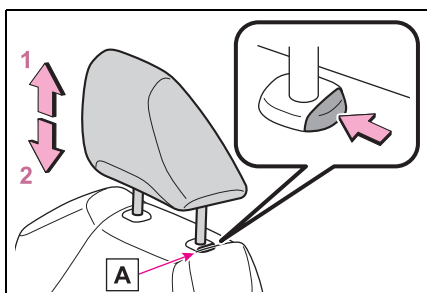

#### 1 Up

Pull the head restraints up.

#### 2 Down

Push the head restraint down while pressing the lock release button **A**.

### ■ Rear outside seats (adjustable type)

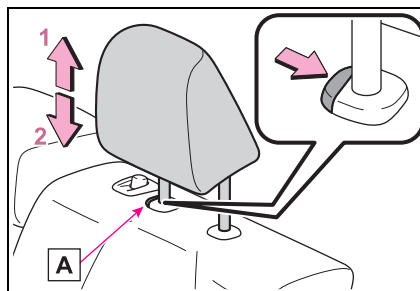

#### 1 Up

Pull the head restraints up.

#### 2 Down

Push the head restraint down while pressing the lock release button **A**.

### ■ Adjusting the height of the head restraints (front seats)

Make sure that the head restraints are adjusted so that the center of the head restraint is closest to the top of your ears.

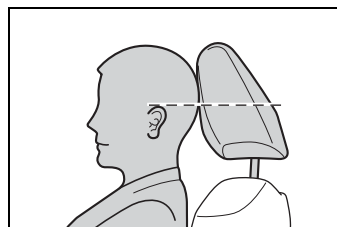

## Removing the head restraints

### ■ Front seats

Pull the head restraint up while pressing the lock release button **A**.

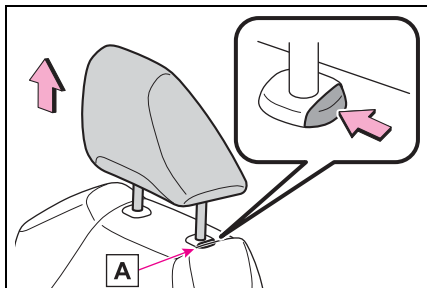

■ **Rear outside seats (adjustable type)**

Pull the head restraint up while pressing the lock release button

**A**.

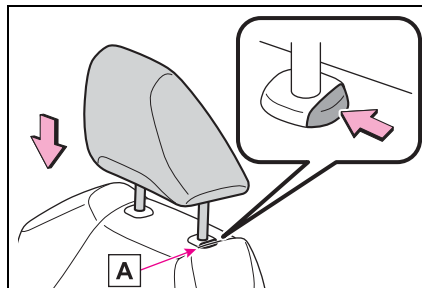

■ **Rear outside seats (adjustable type)**

Align the head restraint with the installation holes and push it down to the lock position.

Press and hold the lock release button **A** when lowering the head restraint.

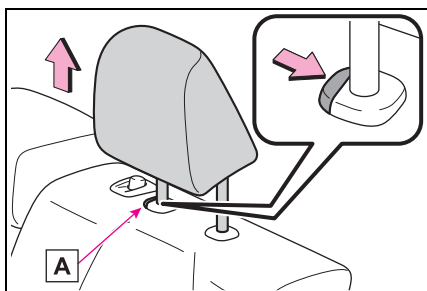

**Installing the head restraints**

■ **Front seats**

Align the head restraint with the installation holes and push it down to the lock position.

Press and hold the lock release button **A** when lowering the head restraint.

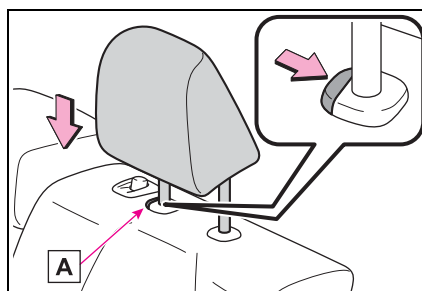

3

Before driving

### Steering wheel

#### Adjustment procedure

- 1 Hold the steering wheel and push the lever down.

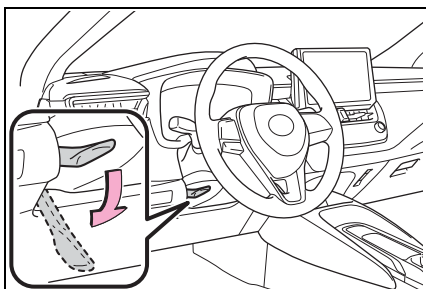

- 2 Adjust to the ideal position by moving the steering wheel horizontally and vertically.

After adjustment, pull the lever up to secure the steering wheel.

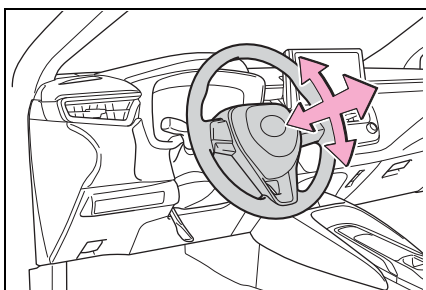

#### WARNING

##### ■ Caution while driving

Do not adjust the steering wheel while driving. Doing so may cause the driver to mishandle the vehicle and cause an accident, resulting in death or serious injury.

##### ■ After adjusting the steering wheel

Make sure that the steering wheel is securely locked. Otherwise, the steering wheel may move suddenly, possibly causing an accident, and resulting in death or serious injury. Also, the horn may not sound if the steering wheel is not securely locked.

### Horn

To sound the horn, press on or close to the  mark.

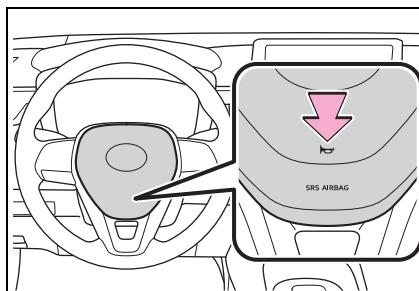

**Inside rear view mirror**

The rear view mirror's position can be adjusted to enable sufficient confirmation of the rear view.

**Adjusting the height of rear view mirror**

The height of the rear view mirror can be adjusted to suit your driving posture.

Adjust the height of the rear view mirror by moving it up and down.

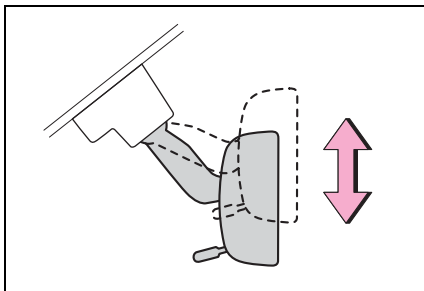

**⚠ WARNING**

**■ Caution while driving**

Do not adjust the position of the mirror while driving. Doing so may lead to mishandling of the vehicle and cause an accident, resulting in death or serious injury.

**Anti-glare function**

- ▶ Manual anti-glare inside rear view mirror

Reflected light from the headlights of vehicles behind can be

reduced by operating the lever.

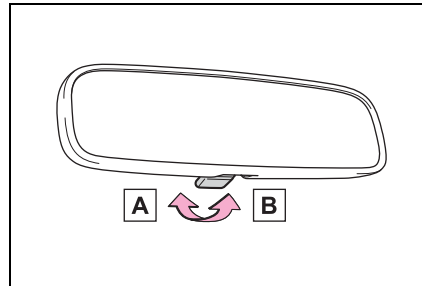

**A** Normal position

**B** Anti-glare position

- ▶ Auto anti-glare inside rear view mirror

Responding to the level of brightness of the headlights of vehicles behind, the reflected light is automatically reduced.

Changing automatic anti-glare function mode

On/off

When the automatic anti-glare function is in ON mode, the indicator **A** illuminates. The function will set to ON mode each time the engine switch is turned to ON.

Pressing the button turns the function to off mode. (The indicator **A** also turns off.)

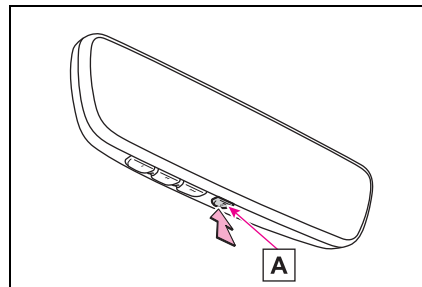

3

Before driving

■ **To prevent sensor error (vehicles with an auto anti-glare inside rear view mirror)**

To ensure that the sensors operate properly, do not touch or cover them.

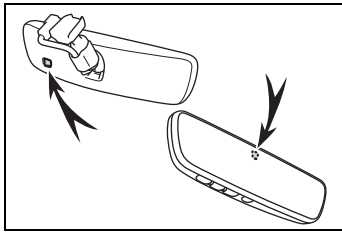

### Outside rear view mirrors

**The rear view mirror's position can be adjusted to enable sufficient confirmation of the rear view.**

#### ⚠ WARNING

#### ■ Important points while driving

Observe the following precautions while driving.

Failure to do so may result in loss of control of the vehicle and cause an accident, resulting in death or serious injury.

- Do not adjust the mirrors while driving.
- Do not drive with the mirrors folded.
- Both the driver and passenger side mirrors must be extended and properly adjusted before driving.

### Adjustment procedure

- 1 To select a mirror to adjust, turn the switch.

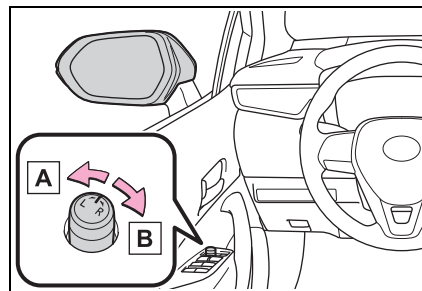

**A** Left

**B** Right



- 2 To adjust the mirror, operate the switch.

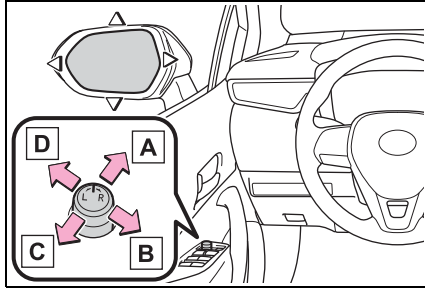

- A Up
- B Right
- C Down
- D Left

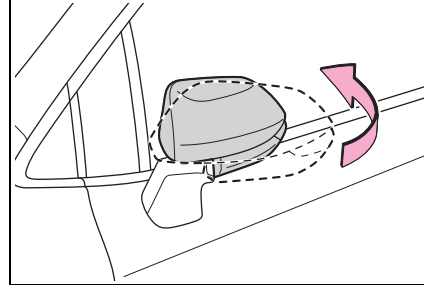

**⚠ WARNING**

**■ When a mirror is moving**

To avoid personal injury and mirror malfunction, be careful not to get your hand caught by the moving mirror.

**■ Mirror angle can be adjusted when**

The engine switch is in ACC or ON.

**■ When the mirrors are fogged up (vehicles with outside rear view mirror defoggers)**

The outside rear view mirrors can be cleared using the mirror defoggers. Turn on the rear window defogger to turn on the outside rear view mirror defoggers. (→P.418, 422)

**⚠ WARNING**

**■ When the mirror defoggers are operating (vehicles with outside rear view mirror defoggers)**

Do not touch the rear view mirror surfaces, as they can become very hot and burn you.

**Folding the mirrors**

Push the mirror back in the direction of the vehicle's rear.

3

Before driving

## Power windows

### Opening and closing the power windows

The power windows can be opened and closed using the switches.

Operating the switch moves the windows as follows:

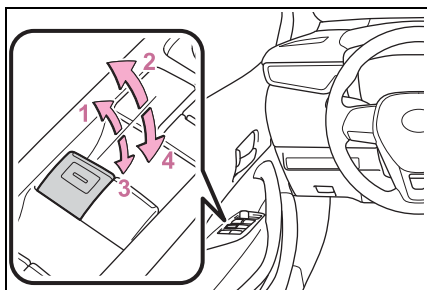

- 1 Closing
- 2 One-touch closing\*
- 3 Opening
- 4 One-touch opening\*

\*: To stop the window partway, operate the switch in the opposite direction.

#### ■ The power windows can be operated when

The engine switch is in ON.

#### ■ Operating the power windows after turning the engine off

The power windows can be operated for approximately 45 seconds after the engine switch is turned to ACC or OFF. They cannot, however, be operated once either front door is opened.

#### ■ Jam protection function

If an object becomes jammed between the window and the win-

dow frame while the window is closing, window movement is stopped and the window is opened slightly.

#### ■ Catch protection function

If an object becomes caught between the door and window while the window is opening, window movement is stopped.

#### ■ When the window cannot be opened or closed

When the jam protection function or catch protection function operates unusually and the door window cannot be opened or closed, perform the following operations with the power window switch of that door.

- Stop the vehicle. With the engine switch in ON, within 4 seconds of the jam protection function or catch protection function activating, continuously operate the power window switch in the one-touch closing direction or one-touch opening direction so that the door window can be opened and closed.
- If the door window cannot be opened and closed even when performing the above operations, perform the following procedure for function initialization.
  - 1 Turn the engine switch to ON.
  - 2 Pull and hold the power window switch in the one-touch closing direction and completely close the door window.
  - 3 Release the power window switch for a moment, resume pulling the switch in the one-touch closing direction, and hold it there for approximately 6 seconds or more.
  - 4 Press and hold the power window switch in the one-touch opening direction. After the door window is completely opened, continue holding the switch for an additional 1 second or more.
  - 5 Release the power window switch for a moment, resume

pushing the switch in the one-touch opening direction, and hold it there for approximately 4 seconds or more.

- 6 Pull and hold the power window switch in the one-touch closing direction again. After the door window is completely closed, continue holding the switch for a further 1 second or more.

If you release the switch while the window is moving, start again from the beginning.

If the window reverses and cannot be fully closed or opened, have the vehicle inspected by your Toyota dealer.

#### ■ Door lock linked window operation

- Vehicles without a smart key system: The power windows can be opened and closed using the key.\* (→P.118)

Vehicles with a smart key system: The power windows can be opened and closed using the mechanical key.\* (→P.545)

- The power windows can be opened using the wireless remote control.\* (with a wireless remote control function) (→P.117)

\*: These settings must be customized at your Toyota dealer.

#### ■ Customization

Some functions can be customized. (→P.581)

#### ⚠ WARNING

Observe the following precautions. Failure to do so may result in death or serious injury.

#### ■ Closing the windows

- The driver is responsible for all the power window operations, including the operation for the passengers. In order to prevent accidental operation, especially by a child, do not let a child operate the power windows. It is possible for children and other passengers to have body parts caught in the power window. Also, when riding with a child, it is recommended to use the window lock switch. (→P.144)
- Check to make sure that all passengers do not have any part of their body in a position where it could be caught when a window is being operated.

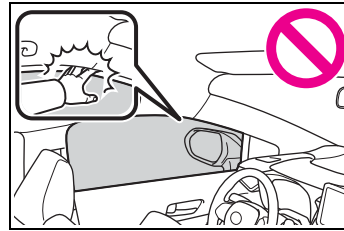

- When using the wireless remote control (if equipped), key or mechanical key and operating the power windows, operate the power window after checking to make sure that there is no possibility of any passenger having any of their body parts caught in the window. Also do not let a child operate window by the wireless remote control (if equipped), key or mechanical key. It is possible for children and other passengers to get caught in the power window.
- When exiting the vehicle, turn the engine switch off, carry the key and exit the vehicle along with the child. There may be accidental operation, due to mischief, etc., that may possibly lead to an accident.

**⚠ WARNING**

■ **Jam protection function**

- Never use any part of your body to intentionally activate the jam protection function.
- The jam protection function may not work if something gets jammed just before the window is fully closed. Be careful not to get any part of your body jammed in the window.

■ **Catch protection function**

- Never use any part of your body or clothing to intentionally activate the catch protection function.
- The catch protection function may not work if something gets caught just before the window is fully opened. Be careful not to get any part of your body or clothing caught in the window.

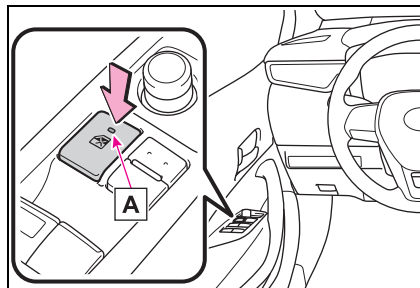

■ **The power windows can be operated when**

The engine switch is in ON.

■ **When the battery is disconnected**

The window lock switch is disabled. If necessary, press the window lock switch after reconnecting the battery.

**Preventing accidental operation (window lock switch)**

This function can be used to prevent children from accidentally opening or closing a passenger window.

Press the switch.

The indicator **A** will come on and the passenger windows will be locked.

The passenger windows can still be opened and closed using the driver's switch even if the lock switch is on.

**Moon roof\***

\*: If equipped

**Use the overhead switches to open and close the moon roof and tilt it up and down.**

**Operating the moon roof**

■ **Opening and closing**

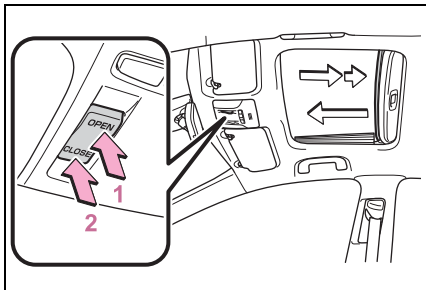

**1** Opens the moon roof\*  
The moon roof stops slightly before the fully open position to reduce wind noise. Press the switch again to fully open the moon roof.

**2** Closes the moon roof\*  
\*: Lightly press either side of the moon roof switch to stop the moon roof partway.

■ **Tilting up and down**

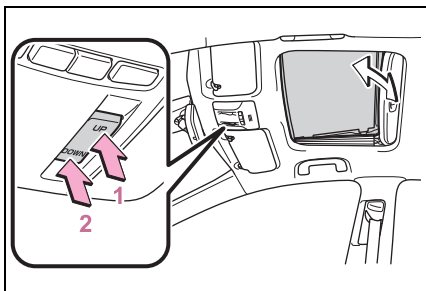

**1** Tilts the moon roof up\*

**2** Tilts the moon roof down\*

\*: Lightly press either side of the moon roof switch to stop the moon roof partway.

■ **The moon roof can be operated when**

The engine switch is in ON.

■ **Operating the moon roof after turning the engine off**

The moon roof can be operated for approximately 45 seconds after the engine switch is turned to ACC or OFF. It cannot, however, be operated once either front door is opened.

■ **Jam protection function**

If an object is detected between the moon roof and the frame while the moon roof is closing or tilting down, travel is stopped and the moon roof opens slightly.

■ **Sunshade**

The sunshade can be opened and closed manually. However, the sunshade will open automatically when the moon roof is opened.

■ **Door lock linked moon roof operation**

● Vehicles without a smart key system: The moon roof can be opened and closed using the key.\* (→P.118)

Vehicles with a smart key system: The moon roof can be opened and closed using the mechanical key.\* (→P.545)

● The moon roof can be opened using the wireless remote control.\* (→P.117)

\*: These settings must be customized at your Toyota dealer.

■ **When the moon roof does not close normally**

Perform the following procedure:

3 Before driving

- If the moon roof closes but then re-opens slightly

- 1 Stop the vehicle.
- 2 Press and hold the "CLOSE" switch.\*<sup>1</sup>

The moon roof will close, reopen and pause for approximately 10 seconds.\*<sup>2</sup> Then it will close again, tilt up and pause for approximately 1 second. Finally, it will tilt down, open and close.

- 3 Check to make sure that the moon roof is completely closed and then release the switch.

- If the moon roof tilts down but then tilts back up

- 1 Stop the vehicle.
- 2 Press and hold the "UP" switch\*<sup>1</sup> until the moon roof moves into the tilt up position and stops.
- 3 Release the "UP" switch once and then press and hold the "UP" switch again.\*<sup>1</sup>

The moon roof will pause for approximately 10 seconds in the tilt up position.\*<sup>2</sup> Then it will adjust slightly and pause for approximately 1 second. Finally, it will tilt down, open and close.

- 4 Check to make sure that the moon roof is completely closed and then release the switch.

\*<sup>1</sup>: If the switch is released at the incorrect time, the procedure will have to be performed again from the beginning.

\*<sup>2</sup>: If the switch is released after the above mentioned 10 second pause, automatic operation will be disabled. In that case, press and hold the "CLOSE" or "UP" switch, and the moon roof will tilt up and pause for approximately 1 second. Then it will tilt down, open and close. Check to make sure that the moon roof is com-

pletely closed and then release the switch.

If the moon roof does not fully close even after performing the above procedure correctly, have the vehicle inspected by your Toyota dealer.

#### ■ Customization

Some functions can be customized. (→P.581)

#### WARNING

Observe the following precautions.

Failure to do so may cause death or serious injury.

#### ■ Opening the moon roof

- Do not allow any passengers to put their hands or heads outside the vehicle while it is moving.

- Do not sit on top of the moon roof.

#### ■ Opening and closing the moon roof

- The driver is responsible for moon roof opening and closing operations. In order to prevent accidental operation, especially by a child, do not let a child operate the moon roof. It is possible for children and other passengers to have body parts caught in the moon roof.

**⚠ WARNING**

- Check to make sure that all passengers do not have any part of their body in a position where it could be caught when the moon roof is being operated.

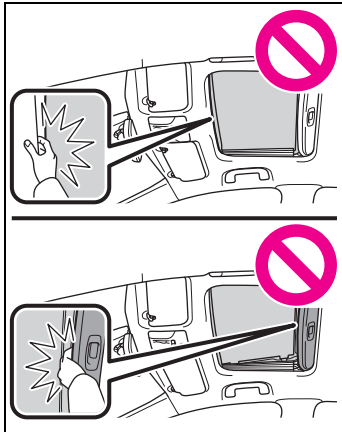

- When using the wireless remote control, key or mechanical key and operating the moon roof, operate the moon roof after checking to make sure that there is no possibility of any passenger having any of their body parts caught in the moon roof. Also, do not let a child operate moon roof by the wireless remote control, key or mechanical key. It is possible for children and other passengers to get caught in the moon roof.
- When exiting the vehicle, turn the engine switch off, carry the key and exit the vehicle along with the child. There may be accidental operation, due to mischief, etc., that may possibly lead to an accident.

**■ Jam protection function**

- Never use any part of your body to intentionally activate the jam protection function.

- The jam protection function may not work if something gets caught just before the moon roof is fully closed. Also, the jam protection function is not designed to operate while the moon roof switch is being pressed. Take care so that your fingers, etc. do not get caught.





<b>4-1. Before driving</b>	<b>4-4. Refueling</b>
Driving the vehicle..... 150	Opening the fuel tank cap ..... 194
Cargo and luggage ..... 158	<b>4-5. Using the driving support systems</b>
Vehicle load limits ..... 161	Toyota Safety Sense 2.0 ..... 196
Trailer towing..... 161	PCS (Pre-Collision System) ..... 203
Dinghy towing ..... 162	LTA (Lane Tracing Assist) ..... 211
<b>4-2. Driving procedures</b>	LDA (Lane Departure Alert with steering control) . 221
Engine (ignition) switch (vehicles without a smart key system)..... 163	Dynamic radar cruise con- trol with full-speed range ..... 229
Engine (ignition) switch (vehicles with a smart key system)..... 164	Dynamic radar cruise con- trol ..... 240
Continuously variable trans- mission (vehicles without paddle shift switches) ..... 169	RSA (Road Sign Assist) ..... 250
Continuously variable trans- mission (vehicles with pad- dle shift switches)..... 172	BSM (Blind Spot Monitor) ..... 253
Manual transmission ... 176	RCTA (Rear Cross Traffic Alert) function ..... 258
Turn signal lever..... 179	Rear view monitor system ..... 263
Parking brake..... 180	Driving mode select switch ..... 271
Electric parking brake . 181	Driving assist systems ..... 272
Brake Hold ..... 184	<b>4-6. Driving tips</b>
<b>4-3. Operating the lights and wipers</b>	Winter driving tips..... 277
Headlight switch..... 186	
Automatic High Beam . 189	
Windshield wipers and washer..... 192	

## Driving the vehicle

**The following procedures should be observed to ensure safe driving:**

### Driving procedure

#### ■ Starting the engine

→P.163, 164

#### ■ Driving

- ▶ Continuously variable transmission
  - 1 With the brake pedal depressed, shift the shift lever to D. (→P.169)
  - 2 Release the parking brake. (→P.180, 181)
  - 3 Gradually release the brake pedal and gently depress the accelerator pedal to accelerate the vehicle.
- ▶ Manual transmission
  - 1 While depressing the clutch pedal, shift the shift lever to 1. (→P.176)
  - 2 Release the parking brake. (→P.180, 181)
  - 3 Gradually release the clutch pedal. At the same time, gently depress the accelerator pedal to accelerate the vehicle.

#### ■ Stopping

- ▶ Continuously variable transmission
  - 1 With the shift lever in D, depress the brake pedal.
  - 2 If necessary, set the parking brake.

If the vehicle is to be stopped for an extended period of time, shift the shift lever to P. (→P.169)

#### ▶ Manual transmission

- 1 While depressing the clutch pedal, depress the brake pedal.
- 2 If necessary, set the parking brake.

If the vehicle is to be stopped for an extended period of time, shift the shift lever to N. (→P.176)

#### ■ Parking the vehicle

- ▶ Continuously variable transmission
  - 1 With the shift lever in D, depress the brake pedal to stop the vehicle completely.
  - 2 Set the parking brake (→P.180, 181), and shift the shift lever to P. (→P.169)

Check the parking brake indicator is illuminated.

- 3 Vehicles without a smart key system: Turn the engine switch to OFF to stop the engine.  
Vehicles with a smart key system: Press the engine switch to stop the engine.

- 4 Slowly release the brake pedal.
- 5 Lock the door, making sure that you have the key on your person.

If parking on a hill, block the wheels as needed.

▶ Manual transmission

- 1 While depressing the clutch pedal, depress the brake pedal.
- 2 Set the parking brake. (→P.180, 181)

Check that the parking brake indicator is illuminated.

- 3 Shift the shift lever to N. (→P.176)

If parking on a hill, shift the shift lever to 1 or R and block the wheels as needed.

- 4 Vehicles without a smart key system: Turn the engine switch to OFF to stop the engine.

Vehicles with a smart key system: Press the engine switch to stop the engine.

- 5 Slowly release the brake pedal.
- 6 Lock the door, making sure that you have the key on your person.

### ■ Starting off on a steep uphill

▶ Continuously variable transmission

- 1 Make sure that the parking brake is set and shift the shift lever to D.
- 2 Gently depress the accelerator pedal.
- 3 Release the parking brake.

▶ Manual transmission

- 1 Make sure that the parking brake is set and shift the shift lever to 1.
- 2 Lightly depress the accelerator pedal at the same time as gradually releasing the clutch pedal.
- 3 Release the parking brake.

### ■ Driving in the rain

- Drive carefully when it is raining, because visibility will be reduced, the windows may become fogged-up, and the road will be slippery.
- Drive carefully when it starts to rain, because the road surface will be especially slippery.
- Refrain from high speeds when driving on an expressway in the rain, because there may be a layer of water between the tires and the road surface, preventing the steering and brakes from operating properly.

### ■ Engine speed while driving (vehicles with a continuously variable transmission)

In the following conditions, the engine speed may become high while driving. This is due to auto-

matic up-shifting control or down-shifting implementation to meet driving conditions. It does not indicate sudden acceleration.

- The vehicle is judged to be driving uphill or downhill
- When the accelerator pedal is released
- When the brake pedal is depressed while sport mode is selected

#### ■ Restraining the engine output (Brake Override System)

- When the accelerator and brake pedals are depressed at the same time, the engine output may be restrained.
- A warning message is displayed on the multi-information display while the system is operating.

#### ■ Restraining sudden start (Drive-Start Control [vehicles with a continuously variable transmission])

- When the following unusual operation is performed, the engine output may be restrained.
- When the shift lever is shifted from R to D, D to R, N to R, P to D, or P to R (D includes B<sup>\*1</sup> or M<sup>\*2</sup>) with the accelerator pedal depressed, a warning message appears on the multi-information display. If a warning message is shown on the multi-information display, read the message and follow the instruction.
- When the accelerator pedal is depressed too much while the vehicle is in reverse.

\*1: Vehicles without paddle shift switches

\*2: Vehicles with paddle shift switches

- While Drive-Start Control is being activated, your vehicle may have trouble escaping from the mud or fresh snow. In such case, deacti-

vate TRAC (→P.273) to cancel Drive-Start Control so that the vehicle may become able to escape from the mud or fresh snow.

#### ■ Breaking in your new Toyota

To extend the life of the vehicle, observing the following precautions is recommended:

- For the first 186 miles (300 km):  
Avoid sudden stops.
- For the first 621 miles (1000 km):
  - Do not drive at extremely high speeds.
  - Avoid sudden acceleration.
  - Do not drive continuously in low gears.
  - Do not drive at a constant speed for extended periods.

#### ■ Operating your vehicle in a foreign country

Comply with the relevant vehicle registration laws and confirm the availability of the correct fuel. (→P.558)

#### WARNING

Observe the following precautions. Failure to do so may result in death or serious injury.

#### ■ When starting the vehicle (vehicles with a continuously variable transmission)

Always keep your foot on the brake pedal while stopped with the engine running. This prevents the vehicle from creeping.

**WARNING****■ When driving the vehicle**

- Do not drive if you are unfamiliar with the location of the brake and accelerator pedals to avoid depressing the wrong pedal.
- Accidentally depressing the accelerator pedal instead of the brake pedal will result in sudden acceleration that may lead to an accident.
- When backing up, you may twist your body around, leading to a difficulty in operating the pedals. Make sure to operate the pedals properly.
- Make sure to keep a correct driving posture even when moving the vehicle only slightly. This allows you to depress the brake and accelerator pedals properly.
- Depress the brake pedal using your right foot. Depressing the brake pedal using your left foot may delay response in an emergency, resulting in an accident.
- Do not drive the vehicle over or stop the vehicle near flammable materials. The exhaust system and exhaust gases can be extremely hot. These hot parts may cause a fire if there is any flammable material nearby.

- During normal driving, do not turn off the engine. Turning the engine off while driving will not cause loss of steering or braking control, but the power assist to these systems will be lost. This will make it more difficult to steer and brake, so you should pull over and stop the vehicle as soon as it is safe to do so. However, in the event of an emergency, such as if it becomes impossible to stop the vehicle in the normal way:  
→P.502

- Use engine braking (shift position B<sup>\*1</sup> or downshift<sup>\*2, \*3</sup>) to maintain a safe speed when driving down a steep hill. Using the brakes continuously may cause the brakes to overheat and lose effectiveness.  
(→P.169, 172, 176)

\*1: Vehicles with a continuously variable transmission (without paddle shift switches)

\*2: Vehicles with a continuously variable transmission (with paddle shift switches)

\*3: Vehicles with a manual transmission

- Do not adjust the positions of the steering wheel, the seat, or the inside or outside rear view mirrors while driving. Doing so may result in a loss of vehicle control.
- Always check that all passengers' arms, heads or other parts of their body are not outside the vehicle.

**⚠ WARNING**

- Do not drive in excess of the speed limit. Even if the legal speed limit permits it, do not drive over 85 mph (140 km/h) unless your vehicle has high-speed capability tires. Driving over 85 mph (140 km/h) may result in tire failure, loss of control and possible injury. Be sure to consult a tire dealer to determine whether the tires on your vehicle are high-speed capability tires or not before driving at such speeds.

**■ When driving on slippery road surfaces**

- Sudden braking, acceleration and steering may cause tire slippage and reduce your ability to control the vehicle.
- Sudden acceleration, engine braking due to shifting, or changes in engine speed could cause the vehicle to skid.
- After driving through a puddle, lightly depress the brake pedal to make sure that the brakes are functioning properly. Wet brake pads may prevent the brakes from functioning properly. If the brakes on only one side are wet and not functioning properly, steering control may be affected.

**■ When shifting the shift lever**

- Vehicles with a continuously variable transmission: Do not let the vehicle roll backward while a forward driving position is selected, or roll forward while the shift lever is in R. Doing so may cause the engine to stall or lead to poor brake and steering performance, resulting in an accident or damage to the vehicle.

- Vehicles with a continuously variable transmission: Do not shift the shift lever to P while the vehicle is moving. Doing so can damage the transmission and may result in a loss of vehicle control.

- Do not shift the shift lever to R while the vehicle is moving forward. Doing so can damage the transmission and may result in a loss of vehicle control.

- Do not shift the shift lever to a driving position while the vehicle is moving backward. Doing so can damage the transmission and may result in a loss of vehicle control.

- Moving the shift lever to N while the vehicle is moving will disengage the engine from the transmission. Engine braking is not available when N is selected.

- Vehicles with a continuously variable transmission: Be careful not to shift the shift lever with the accelerator pedal depressed. Shifting the shift lever to any positions other than P or N may lead to unexpected rapid acceleration of the vehicle that may cause an accident and result in death or serious injury.

**■ If you hear a squealing or scraping noise (brake pad wear indicators)**

Have the brake pads checked and replaced by your Toyota dealer as soon as possible.

Rotor damage may result if the pads are not replaced when needed.

It is dangerous to drive the vehicle when the wear limits of the brake pads and/or those of the brake discs are exceeded.

**WARNING****■ When the vehicle is stopped**

- Do not race the engine.  
If the vehicle is in any gear other than P (continuously variable transmission) or N, the vehicle may accelerate suddenly and unexpectedly, causing an accident.
- Vehicles with a continuously variable transmission: In order to prevent accidents due to the vehicle rolling away, always keep depressing the brake pedal while the engine is running, and apply the parking brake as necessary.
- If the vehicle is stopped on an incline, in order to prevent accidents caused by the vehicle rolling forward or backward, always depress the brake pedal and securely apply the parking brake as needed.
- Avoid revving or racing the engine.  
Running the engine at high speed while the vehicle is stopped may cause the exhaust system to overheat, which could result in a fire if combustible material is nearby.

**■ When the vehicle is parked**

- Do not leave glasses, cigarette lighters, spray cans, or soft drink cans in the vehicle when it is in the sun.  
Doing so may result in the following:
  - Gas may leak from a cigarette lighter or spray can, and may lead to a fire.
  - The temperature inside the vehicle may cause the plastic lenses and plastic material of glasses to deform or crack.

- Soft drink cans may fracture, causing the contents to spray over the interior of the vehicle, and may also cause a short circuit in the vehicle's electrical components.
- Do not leave cigarette lighters in the vehicle. If a cigarette lighter is in a place such as the glove box or on the floor, it may be lit accidentally when luggage is loaded or the seat is adjusted, causing a fire.
- Do not attach adhesive discs to the windshield or windows. Do not place containers such as air fresheners on the instrument panel or dashboard. Adhesive discs or containers may act as lenses, causing a fire in the vehicle.
- Do not leave a door or window open if the curved glass is coated with a metallized film such as a silver-colored one. Reflected sunlight may cause the glass to act as a lens, causing a fire.
- Vehicles with a continuously variable transmission: Always apply the parking brake, shift the shift lever to P, stop the engine and lock the vehicle. Do not leave the vehicle unattended while the engine is running.  
If the vehicle is parked with the shift lever in P but the parking brake is not set, the vehicle may start to move, possibly leading to an accident.  
Vehicles with a manual transmission: Always apply the parking brake, stop the engine and lock the vehicle.  
Do not leave the vehicle unattended while the engine is running.

**⚠ WARNING**

- Do not touch the exhaust pipes while the engine is running or immediately after turning the engine off. Doing so may cause burns.

**■ When taking a nap in the vehicle**

Always turn the engine off. Otherwise, if you accidentally move the shift lever or depress the accelerator pedal, this could cause an accident or fire due to engine overheating. Additionally, if the vehicle is parked in a poorly ventilated area, exhaust gases may collect and enter the vehicle, leading to death or a serious health hazard.

**■ When braking**

- When the brakes are wet, drive more cautiously. Braking distance increases when the brakes are wet, and this may cause one side of the vehicle to brake differently than the other side. Also, the parking brake may not securely hold the vehicle.
- If the brake booster device does not operate, do not follow other vehicles closely and avoid hills or sharp turns that require braking. In this case, braking is still possible, but the brake pedal should be depressed more firmly than usual. Also, the braking distance will increase. Have your brakes fixed immediately.
- Do not pump the brake pedal if the engine stalls. Each push on the brake pedal uses up the reserve for the power-assisted brakes.

- The brake system consists of 2 individual hydraulic systems; if one of the systems fails, the other will still operate. In this case, the brake pedal should be depressed more firmly than usual and the braking distance will increase. Have your brakes fixed immediately.

**■ If the vehicle becomes stuck**

Do not spin the wheels excessively when a driven wheel is up in the air, or the vehicle is stuck in sand, mud, etc. This may damage the driveline components or propel the vehicle forward or backward, causing an accident.

**⚠ NOTICE****■ When driving the vehicle (vehicles with a continuously variable transmission)**

- Do not depress the accelerator and brake pedals at the same time during driving, as this may restrain the engine output.
- Do not use the accelerator pedal or depress the accelerator and brake pedals at the same time to hold the vehicle on a hill.

**■ When driving the vehicle (vehicles with a manual transmission)**

- Do not depress the accelerator and brake pedals at the same time during driving, as this may restrain the engine output.
- Do not shift gears unless the clutch pedal is fully depressed. After shifting, do not release the clutch pedal abruptly. Doing so may damage the clutch, transmission and gears.



**NOTICE**

- Observe the following precautions. Failure to do so may cause excessive premature wear or damage to the clutch, eventually making it difficult to accelerate and start off from a stop. Have the vehicle inspected by your Toyota dealer.
- Do not rest your foot on the clutch pedal or depress it any time other than when shifting. Doing so may cause clutch trouble.
- Do not use any gear other than the 1st gear when starting off and moving forward. Doing so may damage the clutch.
- Do not use the clutch pedal to adjust vehicle speed. Doing so may damage the clutch.
- When stopping the vehicle with the shift lever in a position other than N, make sure to fully depress the clutch pedal and stop the vehicle using the brakes.
- Do not shift the shift lever to R without the vehicle completely stopped. Doing so may damage the clutch, transmission and gears.

■ **When parking the vehicle (vehicles with a continuously variable transmission)**

Always set the parking brake and shift the shift lever to P. Failure to do so may cause the vehicle to move or the vehicle may accelerate suddenly if the accelerator pedal is accidentally depressed.

■ **Avoiding damage to vehicle parts**

- Do not turn the steering wheel fully in either direction and hold it there for an extended period of time. Doing so may damage the power steering motor.
- When driving over bumps in the road, drive as slowly as possible to avoid damaging the wheels, underside of the vehicle, etc.
- For APEX models: APEX vehicle height is lower than other vehicle grades. Driving over rough or damaged road surfaces, as well as parking blocks, curbs, and other obstacles may cause damage to the underside of your vehicle. Drive carefully under rough conditions to avoid damage.

■ **If you get a flat tire while driving**

A flat or damaged tire may cause the following situations. Hold the steering wheel firmly and gradually depress the brake pedal to slow down the vehicle.

- It may be difficult to control your vehicle.
- The vehicle will make abnormal sounds or vibrations.
- The vehicle will lean abnormally.

Information on what to do in case of a flat tire (→P.534)

■ **When encountering flooded roads**

Do not drive on a road that has flooded after heavy rain etc. Doing so may cause the following serious damage to the vehicle:

- Engine stalling

**NOTICE**

- Short in electrical components
- Engine damage caused by water immersion

In the event that you drive on a flooded road and the vehicle becomes flooded or stuck in mud or sand, be sure to have your Toyota dealer check the following:

- Brake function
- Changes in the quantity and quality of the engine oil, transaxle fluid, clutch fluid, etc.
- Lubricant condition for the bearings and suspension joints (where possible), and the function of all joints, bearings, etc.

**Cargo and luggage**

**Take notice of the following information about storage precautions, cargo capacity and load:**

**Capacity and distribution**

Cargo capacity depends on the total weight of the occupants.

(Cargo capacity) = (Total load capacity) — (Total weight of occupants)

Steps for Determining Correct Load Limit —

(1) Locate the statement “The combined weight of occupants and cargo should never exceed XXX kg or XXX lbs.” on your vehicle’s placard.

(2) Determine the combined weight of the driver and passengers that will be riding in your vehicle.

(3) Subtract the combined weight of the driver and passengers from XXX kg or XXX lbs.

(4) The resulting figure equals the available amount of cargo and luggage load capacity.

For example, if the “XXX” amount equals 1400 lbs. and there will be five 150 lb passengers in your vehicle, the amount of available cargo and luggage load capacity is 650 lbs. (1400 –

750 (5 × 150) = 650 lbs.)

(5) Determine the combined weight of luggage and cargo being loaded on the vehicle. That weight may not safely exceed the available cargo and luggage load capacity calculated in Step 4.

(6) If your vehicle will be towing a trailer, load from your trailer will be transferred to your vehicle. Consult this manual to determine how this reduces the available cargo and luggage load capacity of your vehicle. (→P.161)

Toyota does not recommend towing a trailer with your vehicle. Your vehicle is not designed for trailer towing.

**Calculation formula for your vehicle**

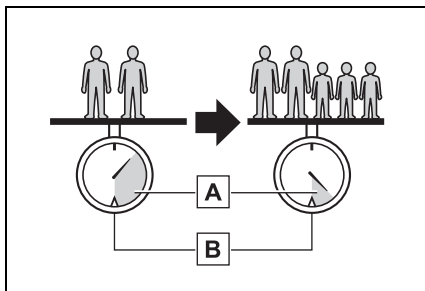

- A** Cargo capacity
- B** Total load capacity (vehicle capacity weight) (→P.556)

When 2 people with the combined weight of A lb. (kg) are riding in your vehicle, which has a

total load capacity (vehicle capacity weight) of B lb. (kg), the available amount of cargo and luggage load capacity will be C lb. (kg) as follows:

$$B^{*2} \text{ lb. (kg)} - A^{*1} \text{ lb. (kg)} = C^{*3} \text{ lb. (kg)}$$

\*1: A =Weight of people

\*2: B =Total load capacity

\*3: C =Available cargo and luggage load

In this condition, if 3 more passengers with the combined weight of D lb. (kg) get on, the available cargo and luggage load will be reduced E lb. (kg) as follows:

$$C \text{ lb. (kg)} - D^{*4} \text{ lb. (kg)} = E^{*5} \text{ lb. (kg)}$$

\*4: D =Additional weight of people

\*5: E =Available cargo and luggage load

As shown in the example above, if the number of occupants increases, the cargo and luggage load will be reduced by an amount that equals the increased weight due to the additional occupants. In other words, if an increase in the number of occupants causes an excess of the total load capacity (combined weight of occupants plus cargo and luggage load), you must reduce the cargo and luggage on your vehicle.

**WARNING****■ Things that must not be carried in the trunk**

The following things may cause a fire if loaded in the trunk:

- Receptacles containing gasoline
- Aerosol cans

**■ Storage precautions**

Observe the following precautions.

Failure to do so may prevent the pedals from being depressed properly, may block the driver's vision, or may result in items hitting the driver or passengers, possibly causing an accident.

- Stow cargo and luggage in the trunk whenever possible.
- To prevent cargo and luggage from sliding forward during braking, do not stack anything in the enlarged trunk. Keep cargo and luggage low, as close to the floor as possible.
- When you fold down the rear seats, long items should not be placed directly behind the front seats.
- Do not place cargo or luggage in or on the following locations.
  - At the feet of the driver
  - On the front passenger or rear seats (when stacking items)
  - On the package tray
  - On the instrument panel
  - On the dashboard
- Secure all items in the occupant compartment.

- Never allow anyone to ride in the enlarged trunk. It is not designed for passengers. They should ride in their seats with their seat belts properly fastened.

**■ Capacity and distribution**

- Do not exceed the maximum axle weight rating or the total vehicle weight rating.
- Even if the total load of occupant's weight and the cargo load is less than the total load capacity, do not apply the load unevenly. Improper loading may cause deterioration of steering or braking control which may cause death or serious injury.

Vehicle load limits

**Vehicle load limits include total load capacity, seating capacity, towing capacity and cargo capacity.**

- Total load capacity (vehicle capacity weight): →P.556

Total load capacity means the combined weight of occupants, cargo and luggage.

- Seating capacity: →P.556

Seating capacity means the maximum number of occupants whose estimated average weight is 150 lb. (68 kg) per person.

- Towing capacity

Toyota does not recommend towing a trailer with your vehicle.

- Cargo capacity

Cargo capacity may increase or decrease depending on the weight and the number of occupants.

■ **Total load capacity and seating capacity**

These details are also described on the tire and loading information label. (→P.484)

**⚠ WARNING**

■ **Overloading the vehicle**

Do not overload the vehicle. It may not only cause damage to the tires, but also degrade steering and braking ability, resulting in an accident.

Trailer towing

**Toyota does not recommend towing a trailer with your vehicle. Toyota also does not recommend the installation of a tow hitch or the use of a tow hitch carrier for a wheelchair, scooter, bicycle, etc. Your vehicle is not designed for trailer towing or for the use of tow hitch mounted carriers.**

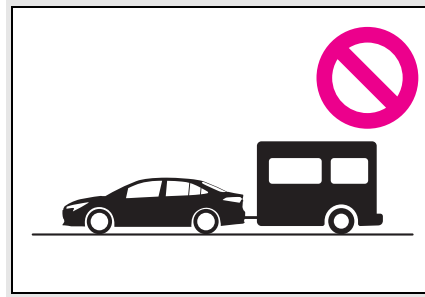

### Dinghy towing

**Your vehicle is not designed to be dinghy towed (with 4 wheels on the ground) behind a motor home.**

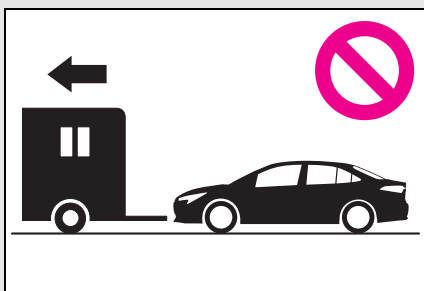

 NOTICE

**■ To avoid serious damage to your vehicle**

Do not tow your vehicle with the four wheels on the ground.

Engine (ignition) switch (vehicles without a smart key system)

**Starting the engine**

- 1 Check that the parking brake is set. (→P.180, 181)
- 2 Check that the shift lever is in P (continuously variable transmission) or N (manual transmission).
- 3 Firmly depress the brake pedal (continuously variable transmission) or clutch pedal (manual transmission).
- 4 Turn the engine switch to START to start the engine.

**■ If the engine does not start**

The engine immobilizer system may not have been deactivated. (→P.80) Contact your Toyota dealer.

**■ When the steering lock cannot be released**

When starting the engine, the engine switch may seem stuck in OFF. To free it, turn the key while turning the steering wheel slightly left and right.

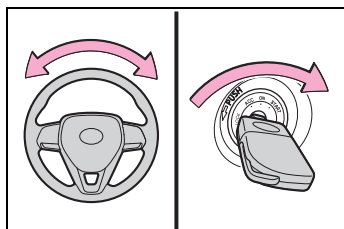

**⚠ WARNING**

**■ When starting the engine**  
Always start the engine while sitting in the driver's seat. Do not depress the accelerator pedal while starting the engine under any circumstances. Doing so may cause an accident resulting in death or serious injury.

**⚠ NOTICE**

**■ When starting the engine**

- Do not crank the engine for more than 30 seconds at a time. This may overheat the starter and wiring system.
- Do not race a cold engine.
- If the engine becomes difficult to start or stalls frequently, have your vehicle checked by your Toyota dealer immediately.

**Changing the engine switch positions**

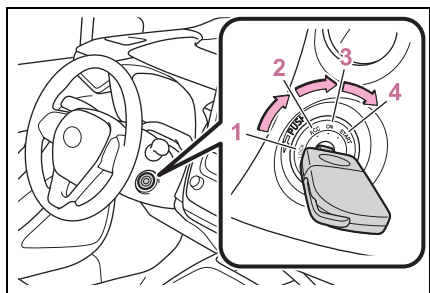

- 1 OFF ("LOCK" position)**  
The steering wheel is locked and the key can be removed. (vehicles with a continuously variable transmission: The key can be removed only when the shift lever is in P.)
- 2 ACC ("ACC" position)**  
Some electrical components such

4  
Driving

as the audio system can be used.

**3 ON ( "ON" position)**

All electrical components can be used.

**4 START ( "START" position)**

For starting the engine.

**Turning the key from ACC to OFF**

- 1 Shift the shift lever to P (continuously variable transmission) or N (manual transmission).
- 2 Push in the key and turn it to OFF.

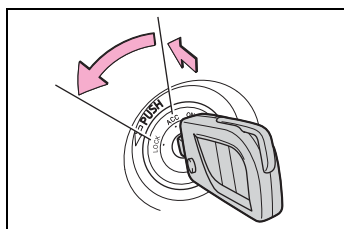

**Key reminder function**

A buzzer sounds if the driver's door is opened while the engine switch is in OFF or ACC to remind you to remove the key.

**WARNING**

**Caution when driving**

Do not turn the engine switch to OFF while driving. If, in an emergency, you must turn the engine off while the vehicle is moving, turn the engine switch only to ACC to stop the engine. An accident may result if the engine is stopped while driving. (→P.502)

**NOTICE**

**To prevent battery discharge**

Do not leave the engine switch in ACC or ON for long periods of time without the engine running.

**Engine (ignition) switch (vehicles with a smart key system)**

**Performing the following operations when carrying the electronic key on your person starts the engine or changes engine switch modes.**

**Starting the engine**

- 1 Check that the parking brake is set. (→P.180, 181)
- 2 Check that the shift lever is in P (continuously variable transmission) or N (manual transmission).
- 3 Firmly depress the brake pedal (continuously variable transmission) or clutch pedal (manual transmission).

and a message will be displayed on the multi-information display. If it is not displayed, the engine cannot be started.

- 4 Press the engine switch shortly and firmly.

When operating the engine switch, one short, firm press is enough. It is not necessary to press and hold the switch.

The engine will crank until it starts or for up to 30 seconds, whichever is less.

Continue depressing the brake pedal (continuously variable transmission) or clutch pedal (manual transmission) until the engine is completely started.



The engine can be started from any engine switch mode.

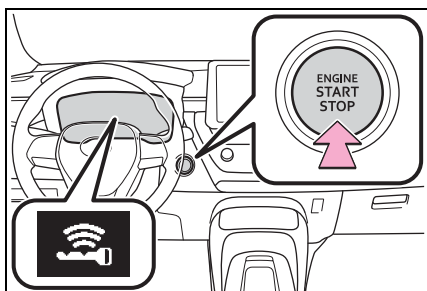

■ **If the engine does not start**

- The engine immobilizer system may not have been deactivated. (→P.80)  
Contact your Toyota dealer.
- If a message related to start-up is shown on the multi-information display, read the message and follow the instructions.

■ **If the battery is discharged**

The engine cannot be started using the smart key system. Refer to P.546 to restart the engine.

■ **Electronic key battery depletion**

→P.110

■ **Conditions affecting operation**

→P.127

■ **Notes for the entry function**

→P.128

■ **Steering lock function**

- After turning the engine switch off and opening and closing the doors, the steering wheel will be locked due to the steering lock function. Operating the engine switch again automatically cancels the steering lock.
- When the steering lock cannot be released, "Push Engine Switch while Turning Steering Wheel in Either Direction" will be displayed on the multi-information display. Press the engine switch shortly and firmly while turning the steer-

ing wheel left and right.

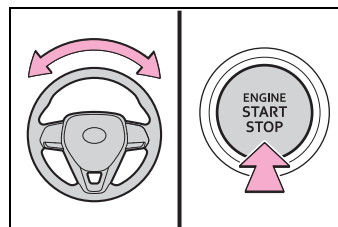

- To prevent the steering lock motor from overheating, operation of the motor may be suspended if the engine is turned on and off repeatedly in a short period of time. In this case, refrain from operating the engine switch. After about 10 seconds, the steering lock motor will resume functioning.

■ **Electronic key battery**

→P.489

■ **Operation of the engine switch**

- If the switch is not pressed shortly and firmly, the engine switch mode may not change or the engine may not start.
- If attempting to restart the engine immediately after turning the engine switch off, the engine may not start in some cases. After turning the engine switch off, please wait a few seconds before restarting the engine.

■ **Customization**

If the smart key system has been deactivated in a customized setting, refer to P.544.

**WARNING**

■ **When starting the engine**

Always start the engine while sitting in the driver's seat. Do not depress the accelerator pedal while starting the engine under any circumstances. Doing so may cause an accident resulting in death or serious injury.

**⚠ WARNING****■ Caution while driving**

If engine failure occurs while the vehicle is moving, do not lock or open the doors until the vehicle reaches a safe and complete stop. Activation of the steering lock in this circumstance may lead to an accident, resulting in death or serious injury.

**⚠ NOTICE****■ When starting the engine**

- Do not race a cold engine.
- If the engine becomes difficult to start or stalls frequently, have your vehicle checked by your Toyota dealer immediately.

**■ Symptoms indicating a malfunction with the engine switch**

If the engine switch seems to be operating somewhat differently than usual, such as the switch sticking slightly, there may be a malfunction. Contact your Toyota dealer immediately.

**Stopping the engine**

- ▶ Continuously variable transmission
  - 1 Stop the vehicle completely.
  - 2 Set the parking brake (→P.180, 181), and shift the shift lever to P.

Check the parking brake indicator is illuminated.

- 3 Press the engine switch.

The engine will stop, and the meter display will be extinguished.

- 4 Release the brake pedal and check that “ACCESSORY” or “IGNITION ON” is not shown on the multi-information display.

**▶ Manual transmission**

- 1 Stop the vehicle completely.
- 2 Set the parking brake. (→P.180, 181)

Check the parking brake indicator is illuminated.

- 3 Shift the shift lever to N. (→P.176)

- 4 Press the engine switch.

The engine will stop, and the meter display will be extinguished.

- 5 Release the brake pedal and check that “ACCESSORY” or “IGNITION ON” is not shown on the multi-information display.

**■ Automatic engine shut off feature**

- The vehicle is equipped with a feature that automatically shuts off the engine when the shift lever is in P (continuously variable transmission) or the parking brake is set (manual transmission) with the engine running for an extended period.
- The engine will automatically shut off after approximately 1 hour if it has been left running while the shift lever is in P (continuously variable transmission) or the parking brake is set (manual transmission).
- The timer for the automatic engine shut off feature will reset if the brake pedal (continuously variable transmission) or the clutch pedal

(manual transmission) is depressed, or if the shift lever is in a position other than P (continuously variable transmission) or the parking brake is released (manual transmission).

- After the vehicle is parked, if the door is locked with the door lock switch (→P.120) from the inside or the mechanical key (→P.544) from the outside, the automatic engine shut off feature will be disabled. The timer for the automatic engine shut off feature will be re-enabled if the driver's door is opened.

### WARNING

#### ■ Stopping the engine in an emergency

- If you want to stop the engine in an emergency while driving the vehicle, press and hold the engine switch for more than 2 seconds, or press it briefly 3 times or more in succession. (→P.502)  
However, do not touch the engine switch while driving except in an emergency. Turning the engine off while driving will not cause loss of steering or braking control, but the power assist to these systems will be lost. This will make it more difficult to steer and brake, so you should pull over and stop the vehicle as soon as it is safe to do so.
- If the engine switch is operated while the vehicle is running, a warning message will be shown on the multi-information display and a buzzer sounds.
- Vehicles with a continuously variable transmission: To restart the engine after performing an emergency shutdown, shift the shift lever to N and then press the engine switch.

- Vehicles with a manual transmission: To restart the engine after performing an emergency shutdown, depress the clutch pedal and then press the engine switch.

#### ■ When parking

Exhaust gases include harmful carbon monoxide (CO), which is colorless and odorless. Observe the following precautions.

Failure to do so may cause exhaust gases to enter the vehicle and may lead to an accident caused by light-headedness, or may lead to death or a serious health hazard.

- If the vehicle is in a poorly ventilated area or a closed area, such as a garage, stop the engine.
- Do not leave the vehicle with the engine running for a long time. If such a situation cannot be avoided, park the vehicle in an open space and ensure that exhaust fumes do not enter the vehicle interior.
- Do not leave the engine running in an area with snow build-up, or where it is snowing. If snowbanks build up around the vehicle while the engine is running, exhaust gases may collect and enter the vehicle.

### Changing engine switch modes

Modes can be changed by pressing the engine switch with brake pedal (continuously variable transmission) or clutch pedal (manual transmission) released. (The mode changes each time the switch is

pressed.)

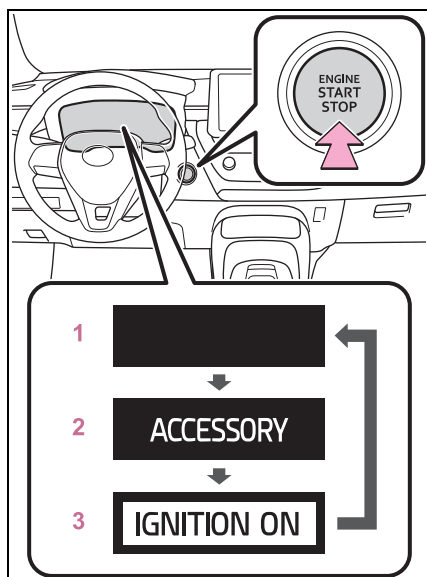

**1 OFF\***

The emergency flashers can be used.

**2 ACC**

Some electrical components such as the audio system can be used. "ACCESSORY" will be displayed on the multi-information display.

**3 ON**

All electrical components can be used.

"IGNITION ON" will be displayed on the multi-information display.

\*: Vehicles with a continuously variable transmission: If the shift lever is in a position other than P when turning off the engine, the engine switch will be turned to ACC, not to off.

**■ Auto power off function**

Continuously variable transmission: If the vehicle is left in ACC for more

than 20 minutes or ON (the engine is not running) for more than an hour with the shift lever in P, the engine switch will automatically turn off. However, this function cannot entirely prevent battery discharge. Do not leave the vehicle with the engine switch in ACC or ON for long periods of time when the engine is not running.

Manual transmission: If the vehicle is left in ACC for more than 20 minutes or ON (the engine is not running) for more than an hour, the engine switch will automatically turn off. However, this function cannot entirely prevent battery discharge. Do not leave the vehicle with the engine switch in ACC or ON for long periods of time when the engine is not running.

**⚠ NOTICE**

**■ To prevent battery discharge**

- Do not leave the engine switch in ACC or ON for long periods of time without the engine running.
- If "ACCESSORY" or "IGNITION ON" is displayed on the multi-information display, the engine switch is not off. Exit the vehicle after turning the engine switch off.

**When stopping the engine with the shift lever in a position other than P (vehicles with a continuously variable transmission)**

If the engine is stopped with the shift lever in a position other than P, the engine switch will not be turned off but instead be turned to ACC. Perform the fol-

lowing procedure to turn the switch off:

- 1 Check that the parking brake is set.
- 2 Shift the shift lever to P.
- 3 Check that “ACCESSORY” is displayed on the multi-information display and press the engine switch shortly and firmly.
- 4 Check that “ACCESSORY” or “IGNITION ON” on the multi-information display are off.

 **NOTICE**

**■ To prevent battery discharge**

Do not stop the engine when the shift lever is in a position other than P. If the engine is stopped in another shift lever position, the engine switch will not be turned off but instead be turned to ACC mode. If the vehicle is left in ACC, battery discharge may occur.

Continuously variable transmission (vehicles without paddle shift switches)\*

\*: If equipped

**Select the shift position depending on your purpose and situation.**

**Shift position purpose and functions**

Shift position	Objective or function
P	Parking the vehicle/starting the engine
R	Reversing
N	Neutral (Condition in which the power is not transmitted)
D	Normal driving*
B	Applying moderate engine braking driving down hills

\*: To improve fuel efficiency and reduce noise, shift the shift lever to D for normal driving.

**■ When driving with the dynamic radar cruise control or dynamic radar cruise control with full-speed range activated**

Even when switching the driving mode to sport mode with the intent of enabling engine braking, engine braking will not occur because dynamic radar cruise control or dynamic radar cruise control with

full-speed range will not be canceled. (→P.271)

■ **Restraining sudden start (Drive-Start Control)**

→P.152

■ **G AI-SHIFT**

G AI-SHIFT automatically selects a suitable gear for sporty driving according to driver's input and driving conditions. G AI-SHIFT operates automatically when the shift lever is in D and sport mode is selected for the driving mode. (Selecting normal mode or shifting the shift lever to the B position cancels this function.)

■ **After recharging/reconnecting the battery**

→P.549

■ **Continuously variable transmission fail-safe control**

The system detects malfunctioning parts targeted (all of the solenoids that perform the shifting function) by the On-Board Diagnostics, and performs fail-safe mechanisms, such as restricting the shifting function or transmission ratio control. In this event, the malfunction indicator lamp turns on.

**⚠ WARNING**

■ **When driving on slippery road surfaces**

Do not accelerate or shift the shift gears suddenly. Sudden changes in engine braking may cause the vehicle to spin or skid, resulting in an accident.

**Shifting the shift lever**

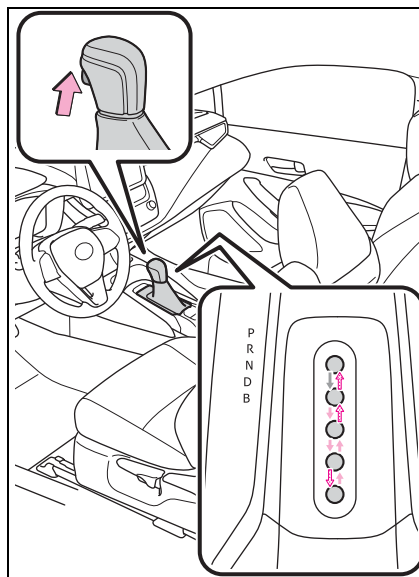

←: While the engine switch is in ON and the brake pedal depressed\*, shift the shift lever while pushing the shift release button on the shift knob.

←: Shift the shift lever while pushing the shift release button on the shift knob.

←: Shift the shift lever normally.

When shifting the shift lever between P and D, make sure that the vehicle is completely stopped and the brake pedal is depressed.

\*: For the vehicle to be able to be shifted from P, the brake pedal must be depressed before the shift release button is pushed. If the shift release button is pushed first, the shift lock will not be released.

### ■ Shift lock system

The shift lock system is a system to prevent accidental operation of the shift lever in starting.

The shift lever can be shifted from P only when the engine switch is in ON and the brake pedal is being depressed.

### ■ If the shift lever cannot be shifted from P

First, check whether the brake pedal is being depressed.

If the shift lever cannot be shifted with your foot on the brake pedal, there may be a problem with the shift lock system. Have the vehicle inspected by your Toyota dealer immediately.

The following steps may be used as an emergency measure to ensure that the shift lever can be shifted.

Releasing the shift lock:

- 1 Set the parking brake.
- 2 Turn the engine switch off.
- 3 Depress the brake pedal.
- 4 Ply the cover up with a flathead screwdriver or equivalent tool. To prevent damaging the cover, wrap the tip of the flathead screwdriver with a tape.

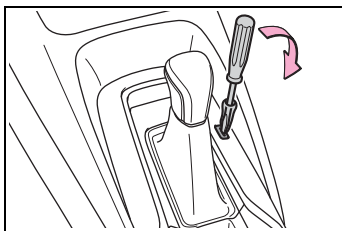

- 5 Press and hold the shift lock override button and then push the shift release button on the shift knob.

The shift lever can be shifted while

the button is pressed.

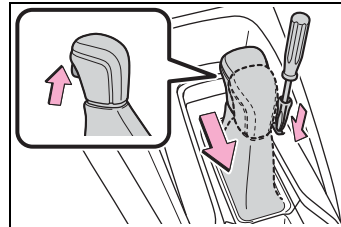

### ⚠ WARNING

#### ■ To prevent an accident when releasing the shift lock

Before pressing the shift lock override button, make sure to set the parking brake and depress the brake pedal.

If the accelerator pedal is accidentally depressed instead of the brake pedal when the shift lock override button is pressed and the shift lever is shifted out of P, the vehicle may suddenly start, possibly leading to an accident resulting in death or serious injury.

### Selecting the driving mode

→P.271

Continuously variable transmission (vehicles with paddle shift switches)\*

\*: If equipped

**Select the shift position depending on your purpose and situation.**

**Shift position purpose and functions**

Shift position	Objective or function
P	Parking the vehicle/starting the engine
R	Reversing
N	Neutral (Condition in which the power is not transmitted)
D	Normal driving*
M	10-speed sport sequential shiftmatic mode driving (→P.175)

\*: To improve fuel efficiency and reduce noise, shift the shift lever to D for normal driving.

**■ To protect the continuously variable transmission**

If the continuously variable transmission fluid temperature is high, "Transmission Oil Temp. High Stop in a Safe Place and See Owner's Manual" will be displayed on the multi-information display and the vehicle will go into transmission protection mode automatically. Have

the vehicle inspected by your Toyota dealer.

**■ When driving with dynamic radar cruise control with full-speed range activated**

Even when switching the driving mode to sport mode with the intent of enabling engine braking, engine braking will not occur because dynamic radar cruise control with full-speed range will not be canceled. (→P.271)

**■ Restraining sudden start (Drive-Start Control)**

→P.152

**■ G AI-SHIFT**

G AI-SHIFT automatically selects a suitable gear for sporty driving according to driver's input and driving conditions. G AI-SHIFT operates automatically when the shift lever is in D and sport mode is selected for the driving mode. (Selecting normal mode or shifting the shift lever to the M position cancels this function.)

**■ After recharging/reconnecting the battery**

→P.549

**⚠ WARNING**

**■ When driving on slippery road surfaces**

Do not accelerate or shift the shift gears suddenly. Sudden changes in engine braking may cause the vehicle to spin or skid, resulting in an accident.



**Shifting the shift lever**

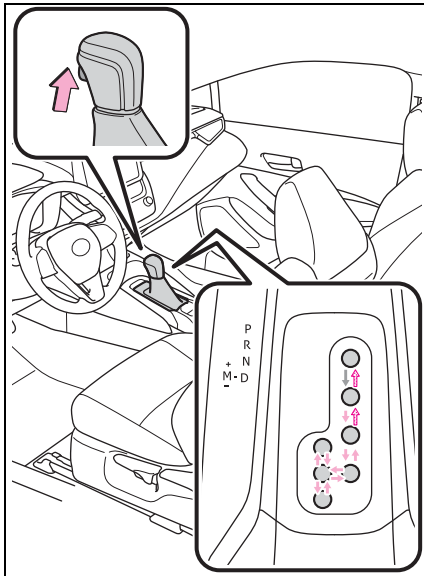

←: While the engine switch is in ON and the brake pedal depressed\*, shift the shift lever while pushing the shift release button on the shift knob.

↔: Shift the shift lever while pushing the shift release button on the shift knob.

←: Shift the shift lever normally.

When shifting the shift lever between P and D, make sure that the vehicle is completely stopped and the brake pedal is depressed.

\*: For the vehicle be able to be shifted from P, the brake pedal must be depressed before the shift release button is pushed. If the shift release button is pushed first, the shift lock will not be released.

**Shift lock system**

The shift lock system is a system to prevent accidental operation of the shift lever in starting.

The shift lever can be shifted from P only when the engine switch is in ON and the brake pedal is being depressed.

**If the shift lever cannot be shifted from P**

First, check whether the brake pedal is being depressed.

If the shift lever cannot be shifted with your foot on the brake pedal, there may be a problem with the shift lock system. Have the vehicle inspected by your Toyota dealer immediately.

The following steps may be used as an emergency measure to ensure that the shift lever can be shifted.

Releasing the shift lock:

- 1 Set the parking brake.
- 2 Turn the engine switch off.
- 3 Depress the brake pedal.
- 4 Ply the cover up with a flathead screwdriver or equivalent tool. To prevent damaging the cover, wrap the tip of the flathead screwdriver with a tape.

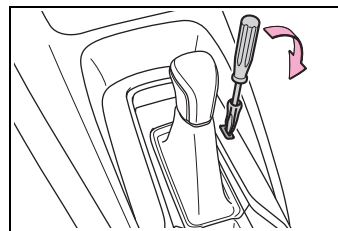

- 5 Press and hold the shift lock override button and then push the shift release button on the shift knob.

The shift lever can be shifted while

the button is pressed.

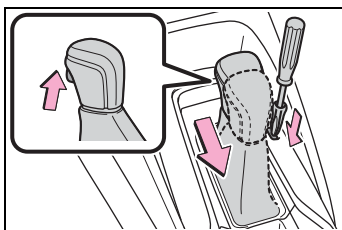

**⚠ WARNING**

**■ To prevent an accident when releasing the shift lock**

Before pressing the shift lock override button, make sure to set the parking brake and depress the brake pedal.

If the accelerator pedal is accidentally depressed instead of the brake pedal when the shift lock override button is pressed and the shift lever is shifted out of P, the vehicle may suddenly start, possibly leading to an accident resulting in death or serious injury.

**Selecting the driving mode**

→P.271

**Selecting shift ranges in the D position**

To drive using temporary shift range selection, operate the “-” or “+” paddle shift switch. When the “-” paddle shift switch is operated, the shift range switches to a range that enables engine braking force that is suitable to driving conditions. When the “+” paddle shift switch is operated, the shift range switches to a range that is one

range higher than the current range.

Changing the shift range allows restriction of the highest gear, preventing unnecessary upshifting and enabling the level of engine braking force to be selected.

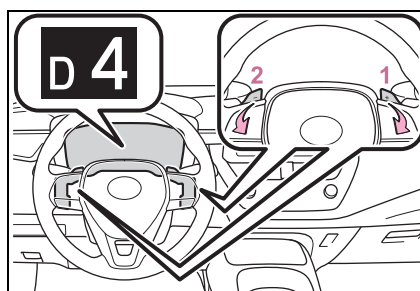

1 Upshifting

2 Downshifting

The selected shift range, from D1 to D10, will be displayed on the multi-information display.

**■ Gear step functions**

- You can choose from 10 levels of engine braking force.
- A lower gear step will provide greater engine braking force than a higher gear step, and the engine speed will also increase.

**■ Deactivation of temporary 10-speed Sport Sequential Shiftmatic mode**

In the following situations, temporary 10-speed Sport Sequential Shiftmatic mode will be deactivated:

- When the vehicle is stopped
- If the accelerator pedal is depressed continuously for more than a certain amount of time while in one gear range
- If the accelerator pedal is depressed abruptly and heavily

- When the shift lever is shifted to a position other than D
- When the “+” paddle shift switch is operated for a certain amount of time continuously

### Changing gears in the M position

To enter 10-speed sport sequential shiftmatic mode, shift the shift lever to M position. Gear steps can then be selected by operating the shift lever or paddle shift switches, allowing you to drive in the gear step of your choosing.

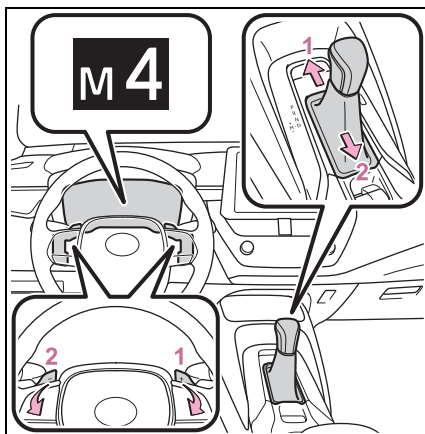

- 1 Upshifting
- 2 Downshifting

The gear changes once every time the shift lever or paddle shift switch is operated.

The selected gear step, from M1 to M10, will be displayed on the multi-information display.

However, even when in the M position, the gear steps will be automatically changed if the

engine speed is too high, or too low.

#### ■ Gear step functions

- You can choose from 10 levels of engine braking force.
- A lower gear step will provide greater engine braking force than a higher gear step, and the engine speed will also increase.

#### ■ When the vehicle comes to a stop with the shift lever in the M position

- The transmission will automatically downshift to M1 once the vehicle is stopped.
- After a stop, the vehicle will start off in M1.
- When the vehicle is stopped, the transmission is set at M1.

#### ■ Downshifting restriction warning buzzer

To help ensure safety and driving performance, downshifting operation may sometimes be restricted. In some circumstances, downshifting may not be possible even when the shift lever or paddle shift switch is operated. (A buzzer will sound twice.)

#### ■ If the 10-speed sport sequential shiftmatic mode indicator does not come on even after shifting the shift lever to M

This may indicate a malfunction in the continuously variable transmission system. Have the vehicle inspected by your Toyota dealer immediately.

(In this situation, the transmission will operate in the same manner as when the shift lever is in D.)

#### ■ Continuously variable transmission fail-safe control

The system detects malfunctioning parts targeted (all of the solenoids that perform the shifting function) by the On-Board Diagnostics, and per-

forms fail-safe mechanisms, such as restricting the shifting function or transmission ratio control. In this event, the malfunction indicator lamp turns on.

## Manual transmission\*

\*: If equipped

### Operating instructions

#### ■ Shifting the shift lever

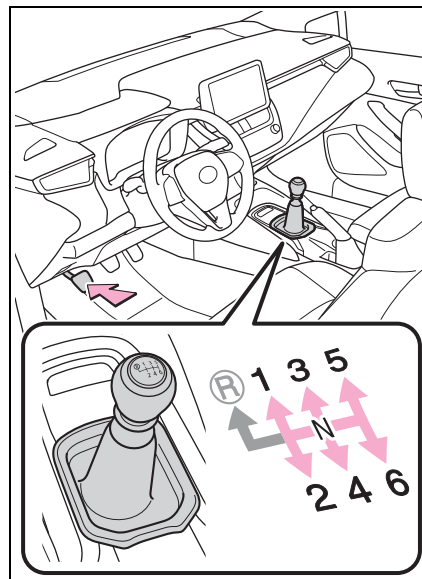

- 1 Depress the clutch pedal firmly.
- 2 Shift the shift lever to the desired gear.

Make sure to only shift gears sequentially.

- 3 Gradually release the clutch pedal.

It is difficult to shift in R, shift the lever to N, release the clutch pedal momentarily, and then try again.

#### ■ Shifting the shift lever to R

Shift the shift lever to R while lifting up the ring section.

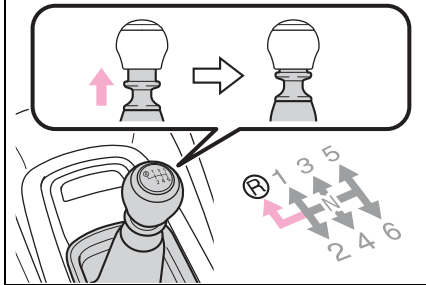

■ **Maximum allowable speeds**

Observe the following maximum allowable speeds in each gear when maximum acceleration is necessary.

▶ 1.8 L 4-cylinder (2ZR-FAE) engine

Shift position	Maximum speed mph (km/h)
1	30 (48)
2	57 (91)
3	83 (133)

▶ 2.0 L 4-cylinder (M20A-FKS) engine

Shift position	Maximum speed mph (km/h)
1	35 (56)
2	61 (98)
3	91 (146)

NOTICE

■ **To prevent damage to the vehicle**

When shifting gears, observe the following precautions. Failure to do so may cause damage to the engine, manual transmission, and/or clutch.

- Do not shift the shift lever to R without depressing the clutch pedal.

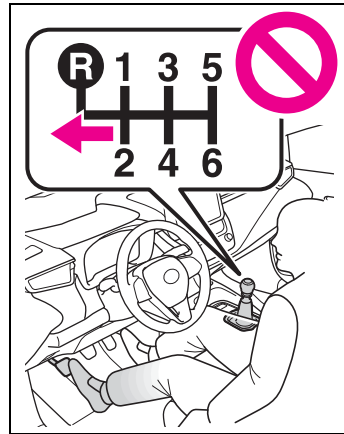

- Do not lift up the ring section except when shifting the lever to R.
- Shift the shift lever to R only when the vehicle is stationary.
- Do not rest your hand on or hold the shift lever any time other than when shifting.
- In order to not cause the engine to overrev, make sure to only shift gears sequentially.
- Do not release the clutch pedal suddenly.

### iMT (Intelligent Manual Transmission) (if equipped)

The iMT optimally controls the engine speed to suit the driver's operation of the clutch pedal and shift lever, helping the driver to shift gears more smoothly. Additionally, when the clutch pedal is operated, the iMT helps reduce shift shock, allowing for lighter shift operations when driving on a winding road or incline.

Press the "iMT" switch.

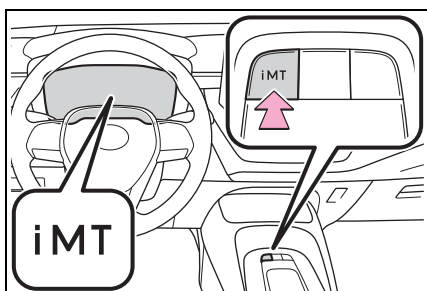

The iMT indicator will illuminate in green. Press the switch again to cancel iMT.

#### ■ The iMT may not operate when

In the following situations, iMT may not operate. However, this does not indicate a malfunction.

- The clutch pedal is not fully depressed
- The clutch pedal is not fully released, such as if a foot is resting on the clutch pedal\*
- Shift operation is performed after the vehicle has been coasting with the shift lever in N

- The shift lever is not operated for a long time after the clutch pedal is depressed

\*: After the shift lever is moved, unless your foot is completely removed from the clutch pedal, the iMT may not operate and the engine speed may not be controlled optimally for the next gear change.

To enable the iMT, release the clutch pedal completely and then depress it again before operating the shift lever.

#### ■ If the iMT indicator illuminates in amber

The iMT may be temporarily unavailable or malfunctioning. Have the vehicle inspected at your Toyota dealer.

#### ⚠ WARNING

##### ■ Limitations of the iMT

iMT is not a system that prevents shift lever operation error or engine overrevving. Depending on the situation, iMT may not operate normally and the shift position may not be changed smoothly. Overly relying on iMT may cause an unexpected accident.

Turn signal lever

burned out.

Operating instructions

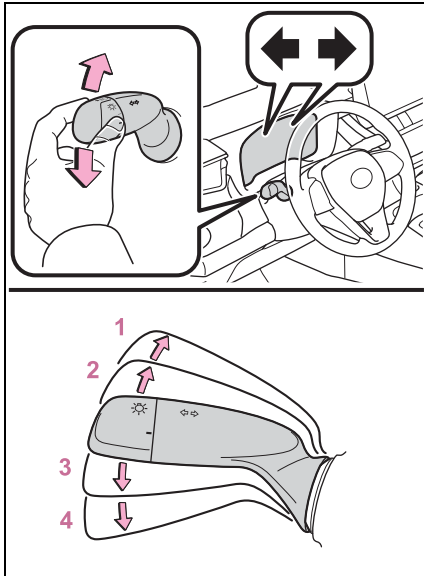

- 1 Right turn
- 2 Lane change to the right  
(move the lever partway and release it)  
The right hand signals will flash 3 times.
- 3 Lane change to the left  
(move the lever partway and release it)  
The left hand signals will flash 3 times.
- 4 Left turn

■ Turn signals can be operated when

The engine switch is in ON.

■ If the indicator flashes faster than usual

Check that a light bulb in the front or rear turn signal lights has not

**Parking brake\***

\*: If equipped

**Operating instructions**

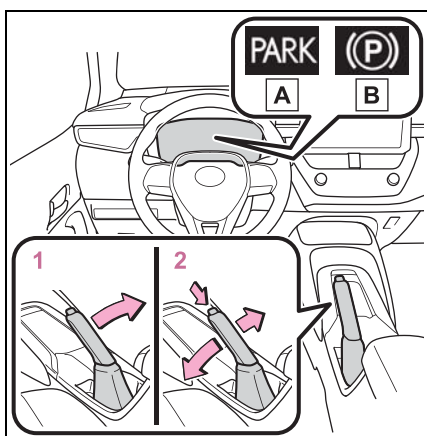

**A** U.S.A.

**B** Canada

- 1 To set the parking brake, fully pull the parking brake lever while depressing the brake pedal.
- 2 To release the parking brake, slightly raise the lever and lower it completely while pressing the button.

**■ Parking the vehicle**

→P.150

**■ Parking brake engaged warning buzzer**

If the vehicle is driven at a speed of approximately 3 mph (5 km/h) or more with the parking brake engaged, a buzzer will sound.

“Release Parking Brake” will be displayed on the multi-information display.

**■ Usage in winter time**

→P.277

**⚠ NOTICE**

**■ Before driving**

Fully release the parking brake. Driving the vehicle with the parking brake set will lead to brake components overheating, which may affect braking performance and increase brake wear.



**Electric parking brake\***

\*: If equipped

**The parking brake can be set or released automatically or manually.**

**In automatic mode, the parking brake can be set or released automatically. Also, even in automatic mode, the parking brake can be set or released manually.**

**Operating instructions**

**■ Using the manual mode**

The parking brake can be set and released manually.

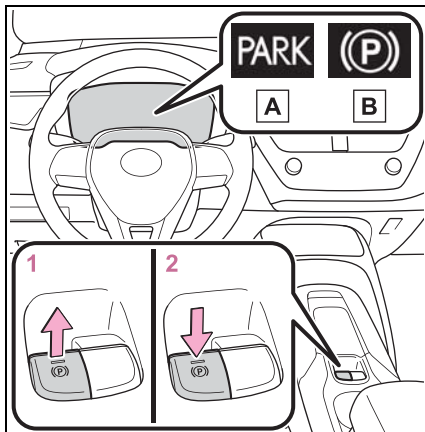

**A** U.S.A.

**B** Canada

**1** Pull the switch to set the parking brake

The parking brake indicator and parking brake light will turn on.

Pull and hold the parking brake switch if an emergency occurs and it is necessary to operate the parking brake while driving.

**2** Push the switch to release the parking brake

- Operate the parking brake switch while depressing the brake pedal.
- Using the parking brake automatic release function, the parking brake can be released by depressing the accelerator pedal. When using this function, slowly depress the accelerator pedal.

Make sure that the parking brake indicator and parking brake light turn off.

**■ Turning automatic mode on**

While the vehicle is stopped, pull and hold the parking brake switch until a message **A** is shown on the multi-information display (vehicles with a continuously variable transmission) or auto EPB OFF indicator **B** turn off (vehicles with a manual transmission)

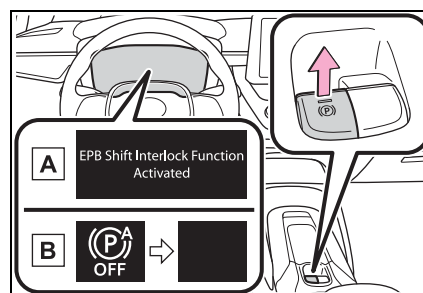

When the automatic mode is turned on, the parking brake operates as follows.

- ▶ Vehicles with a continuously variable transmission
- When the shift lever is moved out of P, the parking brake will be released, and the parking brake indicator and parking brake light will turn off.
- When the shift lever is moved into P, the parking brake will be set, and the parking brake indicator and parking brake light will turn on.

Operate the shift lever with the vehicle stopped and the brake pedal depressed.

The parking brake may not operate automatically if the shift lever is moved quickly.

In this case, it is necessary to operate the parking brake switch. (→P.181)

- ▶ Vehicles with a manual transmission

When the engine is off, the parking brake will be set, and the parking brake indicator and parking brake light turn on.

#### ■ Turning automatic mode off

While the vehicle is stopped and depressing the brake pedal, press and hold the parking brake switch until a message **A** is shown on the multi-information display (vehicles with a continuously variable transmission) or auto EPB OFF indicator **B** comes on (vehicles with a manual transmission)

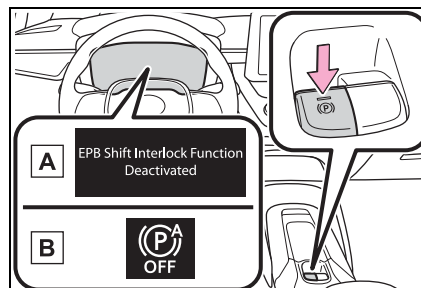

#### ■ Parking brake operation

- When the engine switch is not in ON, the parking brake cannot be released using the parking brake switch.
- When the engine switch is not in ON, automatic mode (automatic brake setting and releasing [vehicles with a continuously variable transmission]) is not available.

#### ■ Parking brake automatic release function

The parking brake is automatically released when slowly depress the accelerator pedal.

The parking brake will be released automatically under the following conditions:

- The driver's door is closed
- The driver is wearing the seat belt
- The shift lever is a forward or reverse position.
- The malfunction indicator lamp or brake system warning light is not illuminated.

If the automatic release function does not operate, manually release the parking brake.

#### ■ If "Parking Brake Temporarily Unavailable" is displayed on the multi-information display

If the parking brake is operated repeatedly over a short period of time, the system may restrict operation to prevent overheating. If this happens, refrain from operating the parking brake. Normal operation will

return after about 1 minute.

■ **If “Parking Brake Unavailable” is displayed on the multi-information display**

Operate the parking brake switch. If the message does not disappear after operating the switch several times, the system may be malfunctioning. Have the vehicle inspected by your Toyota dealer.

■ **Parking brake operation sound**

When the parking brake operates, a motor sound (whirring sound) may be heard. This does not indicate a malfunction.

■ **Parking brake operation**

- Depending on the engine switch position/mode, the parking brake indicator and parking brake light will turn on and stay on as described below:

ON: Comes on until the parking brake is released.

Not in ON: Stays on for approximately 15 seconds.

- When the engine switch is turned off with the parking brake set, the parking brake indicator and parking brake light will stay on for about 15 seconds. This does not indicate a malfunction.

■ **When the parking brake switch malfunctions**

Automatic mode (automatic brake setting and releasing) will be turned on automatically.

■ **Parking the vehicle**

→P.150

■ **Parking brake engaged warning buzzer**

A buzzer will sound if the vehicle is driven with the parking brake engaged. “Parking Brake ON” is displayed on the multi-information display.

■ **If the brake system warning light comes on**

→P.511

■ **Usage in winter time**

→P.277

 **WARNING**

■ **When parking the vehicle**

Do not leave a child in the vehicle alone. The parking brake may be released unintentionally and there is the danger of the vehicle moving that may lead to an accident resulting in death or serious injury.

■ **Parking brake switch**

Do not set any objects near the parking brake switch. Objects may interfere with the switch and may lead the parking brake to unexpectedly operate.

 **NOTICE**

■ **When parking the vehicle**

Before you leave the vehicle, set the parking brake, shift the shift lever to P (continuously variable transmission) or N (manual transmission) and make sure that the vehicle does not move.

■ **When the system malfunctions**

Stop the vehicle in a safe place and check the warning messages.

■ **When the parking brake cannot be released due to a malfunction**

Driving the vehicle with the parking brake set will lead to brake components overheating, which may affect braking performance and increase brake wear.

Have the vehicle inspected by your Toyota dealer immediately if this occurs.

## Brake Hold\*

\*: If equipped

### ● Continuously variable transmission

The brake hold system keeps the brake applied when the shift lever is in D, B (vehicles without paddle shift switches), M (vehicles with paddle shift switches) or N with the system on and the brake pedal has been depressed to stop the vehicle. The system releases the brake when the accelerator pedal is depressed with the shift lever in D, B (vehicles without paddle shift switches) or M (vehicles with paddle shift switches) to allow smooth start off.

### ● Manual transmission

The brake hold system keeps the brake applied when the shift lever is in a forward driving position or N with the system on and the brake pedal has been depressed to stop the vehicle. The system releases the brake when the accelerator pedal is depressed with the shift lever in a forward driving position to allow smooth start off.

## Enabling the system

Turn the brake hold system on

The brake hold standby indicator (green) **A** comes on. While the system is holding the brake, the brake hold operated indicator (yellow) **B** comes on.

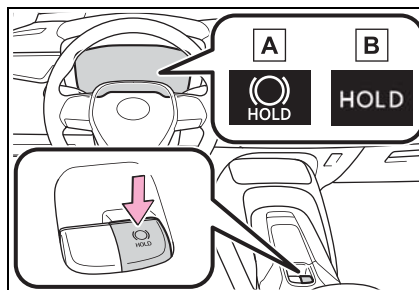

## ■ Brake hold system operating conditions

The brake hold system cannot be turned on in the following conditions:

- The driver's door is not closed.
- The driver is not wearing the seat belt.

If any of the conditions above are detected when the brake hold system is enabled, the system will turn off and the brake hold standby indicator light will go off. In addition, if any of the conditions are detected while the system is holding the brake, a warning buzzer will sound and a message will be shown on the multi-information display. The parking brake will then be set automatically.

## ■ Brake hold function

- If the brake pedal is left released for a period of about 3 minutes after the system has started holding the brake, the parking brake will be set automatically. In this case, a warning buzzer sounds and a message is shown on the multi-information display.
- To turn the system off while the system is holding the brake, firmly depress the brake pedal and press the button again.
- The brake hold function may not hold the vehicle when the vehicle is on a steep incline. In this situation, it may be necessary for the driver to apply the brakes. A warn-

ing buzzer will sound and the multi-information display will inform the driver of this situation. If a warning message is shown on the multi-information display, read the message and follow the instructions.

■ **When the parking brake is set automatically while the system is holding the brakes**

Perform any of the following operations to release the parking brake.

- Depress the accelerator pedal. (The parking brake will not be released automatically if the seat belt is not fastened.)
- Operate the parking brake switch with the brake pedal depressed.

Make sure that the parking brake indicator light goes off. (→P.181)

■ **When an inspection at your Toyota dealer is necessary**

When the brake hold standby indicator (green) does not illuminate even when the brake hold switch is pressed with the brake hold system operating conditions met, the system may be malfunctioning. Have the vehicle inspected at your Toyota dealer.

■ **If “Brake Hold Malfunction Press Brake to Deactivate Visit Your Dealer” or “Brake Hold Malfunction Visit Your Dealer” is displayed on the multi-information display**

The system may be malfunctioning. Have the vehicle inspected by your Toyota dealer.

■ **Warning messages and buzzers**

Warning messages and buzzers are used to indicate a system malfunction or to inform the driver of the need for caution. If a warning message is shown on the multi-information display, read the message and follow the instructions.

■ **If the brake hold operated indicator flashes**

→P.517

 **WARNING**

■ **When the vehicle is on a steep incline**

When using the brake hold system on a steep incline exercise caution. The brake hold function may not hold the vehicle in such a situation.

■ **When stopped on a slippery road**

The system cannot stop the vehicle when the gripping ability of the tires has been exceeded. Do not use the system when stopped on a slippery road.

 **NOTICE**

■ **When parking the vehicle**

The brake hold system is not designed for use when parking the vehicle for a long period of time. Turning the engine switch off while the system is holding the brake may release the brake, which would cause the vehicle to move. When operating the engine switch, depress the brake pedal, shift the shift lever to P (continuously variable transmission) or N (manual transmission) and set the parking brake.

### Headlight switch

The headlights can be operated manually or automatically.

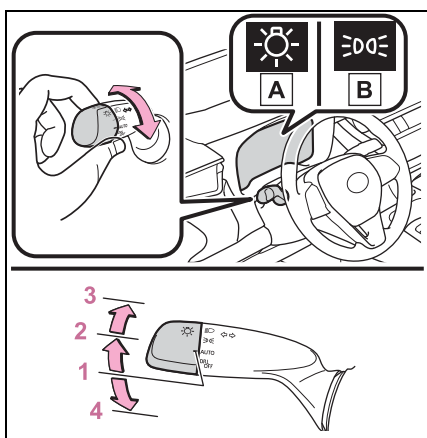

### Operating instructions

Operating the  switch turns on the lights as follows:



**A** U.S.A.

**B** Canada

- 1  The headlights, daytime running lights (→P.186) and all the lights listed below turn on and off automatically.
- 2  The side marker, parking, LED accent (if equipped), tail, license plate, instrument panel lights, and daytime running lights (→P.186) turn on.
- 3  The headlights and all lights listed above (except

daytime running lights) turn on.



4  (U.S.A.) Off

 (Canada) The daytime running lights turn on. (→P.186)

#### ■ AUTO mode can be used when

The engine switch is in ON.

#### ■ Daytime running light system

- The daytime running lights illuminate using the same lights as the headlights and illuminate darker than the headlights.
- To make your vehicle more visible to other drivers during daytime driving, the daytime running lights turn on automatically when all of the following conditions are met. (The daytime running lights are not designed for use at night.)
  - The engine is running
  - The parking brake is released
  - The headlight switch is in the  (Canada only),  or **AUTO** \* position

\*: When the surroundings are bright

The daytime running lights remain on after they illuminate, even if the parking brake is set again.

- For the U.S.A.: Daytime running lights can be turned off by operating the switch.
- Compared to turning on the headlights, the daytime running light system offers greater durability and consumes less electricity, so it can help improve fuel economy.

■ **Headlight control sensor**

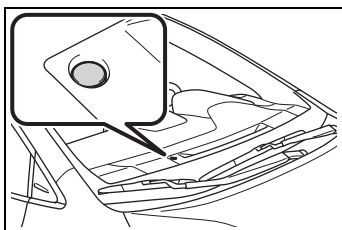

The sensor may not function properly if an object is placed on the sensor, or anything that blocks the sensor is affixed to the windshield. Doing so interferes with the sensor detecting the level of ambient light and may cause the automatic headlight system to malfunction.

■ **Automatic light off system**

- When the headlights are on: The headlights and tail lights turn off 30 seconds after the driver's door is opened and closed if the engine switch is turned to ACC or OFF. (Vehicles with a wireless remote control: The lights turn off immediately if  on the key is pressed after all the doors are closed.)
- When only the tail lights are on: The tail lights turn off automatically if the engine switch is turned to ACC or OFF and the driver's door is opened.

To turn the lights on again, turn the engine switch to ON, or turn the light switch off once and then back to

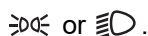

■ **Light reminder buzzer**

A buzzer sounds when the engine switch is turned to OFF or ACC and the driver's door is opened while the lights are turned on.

■ **Automatic headlight leveling system (if equipped)**

The level of the headlights is automatically adjusted according to the number of passengers and the loading condition of the vehicle to ensure that the headlights do not

interfere with other road users.

■ **Windshield wiper linked headlight illumination**

When driving during daytime with the headlight switch turned to AUTO, if the windshield wipers are used, the headlights will turn on automatically after several seconds to help enhance the visibility of your vehicle.

■ **Battery-saving function**

In order to prevent the battery of the vehicle from discharging, if the headlights and/or tail lights are on when the engine switch is turned off the battery saving function will operate and automatically turn off all the lights after approximately 20 minutes. When the engine switch is turned to ON, the battery-saving function will be disabled.

When any of the following are performed, the battery-saving function is canceled once and then reactivated. All the lights will turn off automatically 20 minutes after the Battery-saving function has been reactivated:

- When the headlight switch is operated
- When a door is opened or closed

■ **Customization**

Some functions can be customized. (→P.581)

 NOTICE

■ **To prevent battery discharge**

Do not leave the lights on longer than necessary when the engine is not running.



### Turning on the high beam headlights

(→P.581)

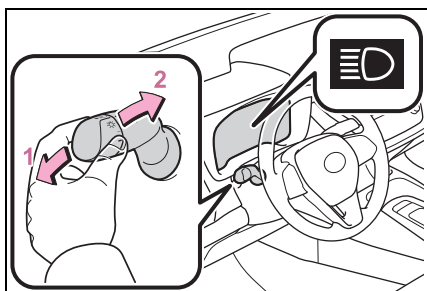

- 1 With the headlights on, push the lever away from you to turn on the high beams.

Pull the lever toward you to the center position to turn the high beams off.

- 2 Pull the lever toward you and release it to flash the high beams once.

You can flash the high beams with the headlights on or off.

### AFS (Adaptive Front-lighting System) (if equipped)

AFS (Adaptive Front-lighting System) secures excellent visibility at intersections and on curves by automatically adjusting the direction of the light axis of the headlights according to vehicle speed and the degree of the tire's angle as controlled by steering input.

AFS operates at speeds of approximately 6 mph (10 km/h) or higher.

#### ■ Customization

Some functions can be customized.



### Automatic High Beam

The Automatic High Beam uses a camera sensor located behind the upper portion of the windshield to assess the brightness of the lights of vehicles ahead, streetlights, etc., and automatically turns the high beams on or off as necessary.

#### WARNING

##### ■ Limitations of the Automatic High Beam

Do not overly rely on the Automatic High Beam. Always drive safely, taking care to observe your surroundings and turning the high beams on or off manually if necessary.

##### ■ To prevent incorrect operation of the Automatic High Beam system

Do not overload the vehicle.

### Activating the Automatic High Beam

- 1 Press the Automatic High Beam switch.

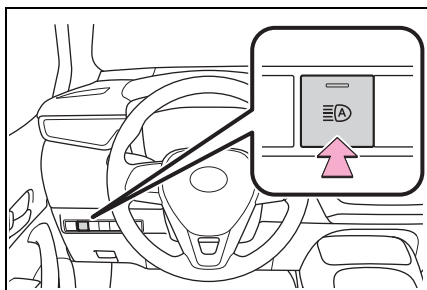

- 2 Push the lever away from you with the headlight switch in the  or AUTO position.

The Automatic High Beam indicator will come on when the system is operating.

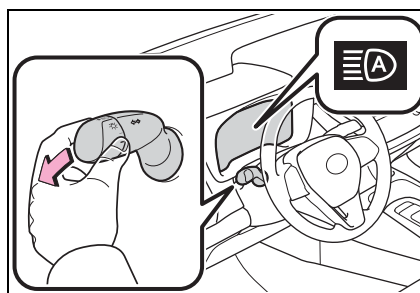

#### ■ Conditions to turn the high beams on/off automatically

- When all of the following conditions are met, the high beams will be turned on automatically (after approximately 1 second):
  - The vehicle speed is approximately 21 mph (34 km/h) or more.
  - The area ahead of the vehicle is dark.
  - There are no vehicles ahead with headlights or tail lights turned on.
  - There are few streetlights on the road ahead.
- If any of the following conditions are met, the high beams will turn off automatically:
  - The vehicle speed is below approximately 17 mph (27 km/h).
  - The area ahead of the vehicle is not dark.
  - Vehicles ahead have their headlights or tail lights turned on.
  - There are many streetlights on the road ahead.
- Camera sensor detection information
  - The high beams may not be automatically turned off in the following situations:
    - When a vehicle suddenly appears

- from around a curve
- When the vehicle is cut in front of by another vehicle
- When vehicles ahead cannot be detected due to repeated curves, road dividers or roadside trees
- When vehicles ahead appear in a faraway lane on a wide road
- When the lights of vehicles ahead are not on
- The high beams may be turned off if a vehicle ahead that is using fog lights without its headlights turned on is detected.
- House lights, streetlights, traffic signals, and illuminated billboards or signs and other reflective objects may cause the high beams to change to the low beams, or the low beams to remain on.
- The following factors may affect the amount of time taken for the high beams to turn on or off:
  - The brightness of the headlights, fog lights, and tail lights of vehicles ahead
  - The movement and direction of vehicles ahead
  - When a vehicle ahead only has operational lights on one side
  - When a vehicle ahead is a two-wheeled vehicle
  - The condition of the road (gradient, curve, condition of the road surface, etc.)
  - The number of passengers and amount of luggage in the vehicle
- The high beams may turn on or off unexpectedly.
- Bicycles or similar vehicles may not be detected.
- In the following situations the system may not be able to correctly detect the surrounding brightness level. This may cause the low beams to remain on or the high beams to flash or dazzle pedestrians or vehicles ahead. In such a case, it is necessary to manually switch between the high and low beams.
  - When driving in inclement weather (heavy rain, snow, fog, sandstorms, etc.)
  - When the windshield is obscured by fog, mist, ice, dirt, etc.
  - When the windshield is cracked or damaged
  - When the camera sensor is deformed or dirty
  - When the temperature of the camera sensor is extremely high
  - When the surrounding brightness level is equal to that of headlights, tail lights or fog lights
  - When headlights or tail lights of vehicles ahead are turned off, dirty, changing color, or not aimed properly
  - When the vehicle is hit by water, snow, dust, etc. from a preceding vehicle
  - When driving through an area of intermittently changing brightness and darkness
  - When frequently and repeatedly driving ascending/descending roads, or roads with rough, bumpy or uneven surfaces (such as stone-paved roads, gravel roads, etc.)
  - When frequently and repeatedly taking curves or driving on a winding road
  - When there is a highly reflective object ahead of the vehicle, such as a sign or mirror
  - When the back of a preceding vehicle is highly reflective, such as a container on a truck
  - When the vehicle's headlights are damaged or dirty, or are not aimed properly
  - When the vehicle is listing or titling due to a flat tire, a trailer being towed, etc.
  - When the headlights are changed between the high beams and low beams repeatedly in an abnormal manner
  - When the driver believes that the high beams may be flashing or dazzling pedestrians or other drivers

■ **Temporarily lowering sensor sensitivity**

The sensitivity of the sensor can be temporarily lowered.

1 Turn the engine switch off while the following conditions are met.

- The headlight switch is in  or AUTO .

- The headlight switch lever is in high beam position.

- Automatic High Beam switch is on.

2 Turn the engine switch to ON.

3 Within 60 seconds after step 2, repeat pulling the headlight switch lever to the original position then pushing it to the high beam position quickly 10 times, then leave the lever in high beam position.

4 If the sensitivity is changed, the Automatic High Beam indicator is turn on and off 3 times.

Automatic High Beam (headlights) may turn on even when the vehicle is stopped.

**Turning the high beams on/off manually**

■ **Switching to the low beams**

Pull the lever to its original position.

The Automatic High Beam indicator will turn off.

Push the lever away from you to activate the Automatic High Beam system again.

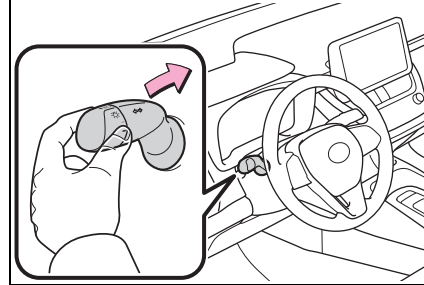

■ **Switching to the high beams**

Press the Automatic High Beam switch.

The Automatic High Beam indicator will turn off and the high beam indicator will turn on.

Press the switch to activate the Automatic High Beam system again.

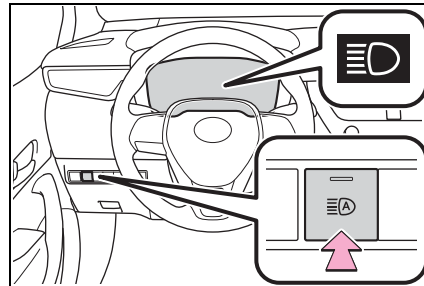

Windshield wipers and washer

Operating the lever can use the windshield wipers or the washer.



 NOTICE

■ **When the windshield is dry**  
Do not use the wipers, as they may damage the windshield.

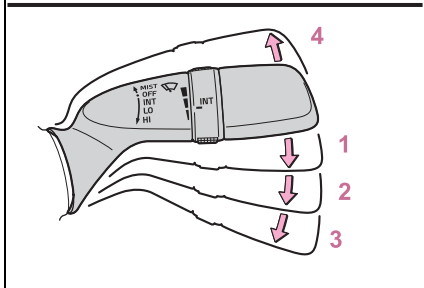
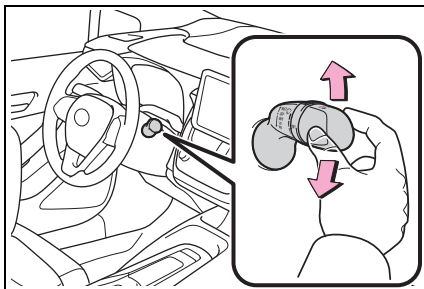

Operating the wiper lever

Operating the  lever operates the wipers or washer as follows.



- 1 INT (U.S.A.) or  (Canada)  
Intermittent windshield wiper operation
- 2 LO (U.S.A.) or  (Canada)  
Low speed windshield wiper

operation

- 3 HI (U.S.A.) or  (Canada)  
High speed windshield wiper operation
- 4 MIST (U.S.A.) or  (Canada)  
Temporary operation

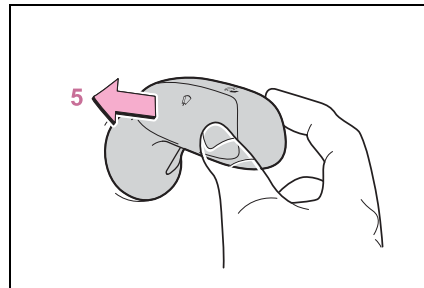

- 5  Washer/wiper dual operation

Pulling the lever operates the wipers and washer.

Wipers will automatically operate a couple of times after the washer squirts.

Interval adjustment type only:  
Wiper intervals can be adjusted when intermittent operation is selected.

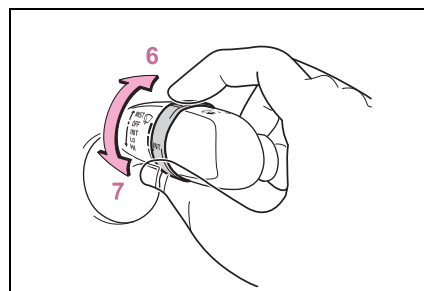

- 6 Increases the intermittent windshield wiper frequency
- 7 Decreases the intermittent windshield wiper frequency

■ **The windshield wiper and washer can be operated when**

The engine switch is in ON.

■ **If no windshield washer fluid sprays**

Check that the washer nozzles are not blocked if there is washer fluid in the windshield washer fluid reservoir.

■ **When stopping the engine in an emergency while driving**

If the windshield wipers are operating when the engine is stopped, the windshield wipers will operate in high speed operation. After the vehicle is stopped, operation will return to normal when the engine switch is turned to ON.

 **WARNING**

■ **Caution regarding the use of washer fluid**

When it is cold, do not use the washer fluid until the windshield becomes warm. The fluid may freeze on the windshield and cause low visibility. This may lead to an accident, resulting in death or serious injury.

 **NOTICE**

■ **When the washer fluid tank is empty**

Do not operate the switch continually as the washer fluid pump may overheat.

■ **When a nozzle becomes blocked**

In this case, contact your Toyota dealer. Do not try to clear it with a pin or other object. The nozzle will be damaged.

## Opening the fuel tank cap

**Perform the following steps to open the fuel tank cap:**

### Before refueling the vehicle

- Turn the engine switch off and ensure that all the doors and windows are closed.
- Confirm the type of fuel.

#### ■ Fuel types

→P.568

#### ■ Fuel tank opening for unleaded gasoline

To help prevent incorrect fueling, your vehicle has a fuel tank opening that only accommodates the special nozzle on unleaded fuel pumps.

#### ■ If the malfunction indicator lamp illuminates

The malfunction indicator lamp may illuminate erroneously if refueling is performed repeatedly when the fuel tank is nearly full.

### WARNING

#### ■ When refueling the vehicle

Observe the following precautions while refueling the vehicle. Failure to do so may result in death or serious injury.

- After exiting the vehicle and before opening the fuel door, touch an unpainted metal surface to discharge any static electricity. It is important to discharge static electricity before refueling because sparks resulting from static electricity can cause fuel vapors to ignite while refueling.

- Always hold the grips on the fuel tank cap and turn it slowly to remove it. A whooshing sound may be heard when the fuel tank cap is loosened. Wait until the sound cannot be heard before fully removing the cap. In hot weather, pressurized fuel may spray out the filler neck and cause injury.

- Do not allow anyone that has not discharged static electricity from their body to come close to an open fuel tank.

- Do not inhale vaporized fuel. Fuel contains substances that are harmful if inhaled.

- Do not smoke while refueling the vehicle. Doing so may cause the fuel to ignite and cause a fire.

- Do not return to the vehicle or touch any person or object that is statically charged. This may cause static electricity to build up, resulting in a possible ignition hazard.

#### ■ When refueling

Observe the following precautions to prevent fuel overflowing from the fuel tank:

- Securely insert the fuel nozzle into the fuel filler neck.

- Stop filling the tank after the fuel nozzle automatically clicks off.

**⚠ WARNING**  
 ● Do not top off the fuel tank.

**⚠ NOTICE**  
 ■ **Refueling**  
 Do not spill fuel during refueling. Doing so may damage the vehicle, such as causing the emission control system to operate abnormally or damaging fuel system components or the vehicle's painted surface.

**Opening the fuel tank cap**

- 1 Pull up the opener to open the fuel filler door.

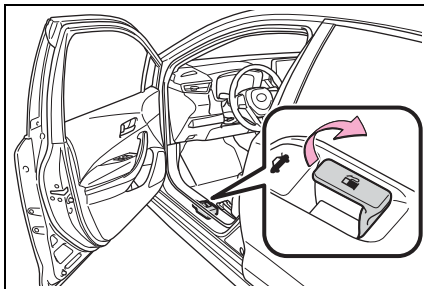

- 2 Turn the fuel tank cap slowly and remove it, then hang it on the back of the fuel filler door.

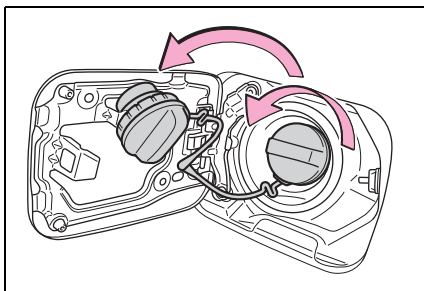

**Closing the fuel tank cap**

After refueling, turn the fuel tank cap until you hear a click. Once the cap is released, it will turn slightly in the opposite direction.

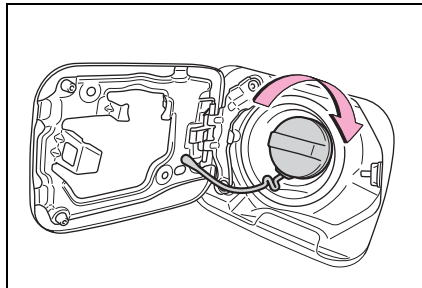

**⚠ WARNING**  
 ■ **When replacing the fuel tank cap**  
 Do not use anything but a genuine Toyota fuel tank cap designed for your vehicle. Doing so may cause a fire or other incident which may result in death or serious injury.

## Toyota Safety Sense 2.0

The Toyota Safety Sense 2.0 consists of the following drive assist systems and contributes to a safe and comfortable driving experience:

### Driving assist system

- **PCS (Pre-Collision System)**

→P.203

- **LTA (Lane Tracing Assist)\***

→P.211

\*: If equipped

- **LDA (Lane Departure Alert with steering control)\***

→P.221

\*: If equipped

- **AHB (Automatic High Beam)**

→P.189

- **RSA (Road Sign Assist)\***

→P.250

\*: If equipped

- **Dynamic radar cruise control with full-speed range\***

→P.229

\*: If equipped

- **Dynamic radar cruise control\***

→P.240

\*: If equipped

### WARNING

#### ■ Toyota Safety Sense 2.0

The Toyota Safety Sense 2.0 is designed to operate under the assumption that the driver will drive safely, and is designed to help reduce the impact to the occupants and the vehicle in the case of a collision or assist the driver in normal driving conditions.

As there is a limit to the degree of recognition accuracy and control performance that this system can provide, do not overly rely on this system. The driver is always responsible for paying attention to the vehicle's surroundings and driving safely.

### Sensors

Two types of sensors, located behind the front grille and windshield, detect information necessary to operate the drive assist systems.

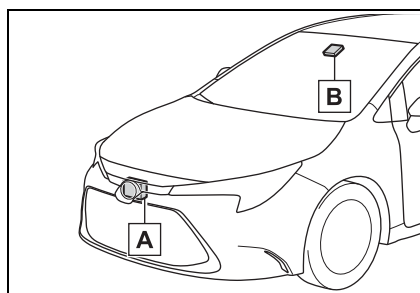

**A** Radar sensor

**B** Front camera



**⚠ WARNING**

■ **To avoid malfunction of the radar sensor**

Observe the following precautions. Otherwise, the radar sensor may not operate properly, possibly leading to an accident resulting in death or serious injury.

- Keep the radar sensor and the radar sensor cover clean at all times.

▶ 1.8 L 4-cylinder (2ZR-FAE) engine

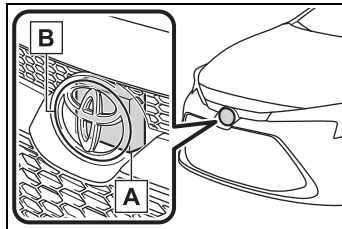

- A Radar sensor
- B Radar sensor cover

If the front of the radar sensor or the front or back of the radar sensor cover is dirty or covered with water droplets, snow, etc., clean it.

Clean the radar sensor and radar sensor cover with a soft cloth to avoid damaging them.

▶ 2.0 L 4-cylinder (M20A-FKS) engine

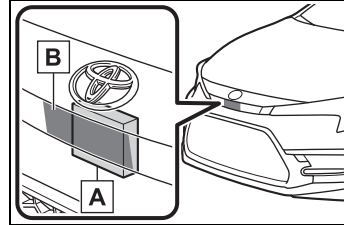

- A Radar sensor
- B Radar sensor cover

If the front of the radar sensor or the front or back of the radar sensor cover is dirty or covered with water droplets, snow, etc., clean it.

Clean the radar sensor and radar sensor cover with a soft cloth to avoid damaging them.

- Do not attach accessories, stickers (including transparent stickers) or other items to the radar sensor, radar sensor cover or surrounding area.
- Do not subject the radar sensor or its surrounding area to a strong impact. If the radar sensor, front grille, or front bumper has been subjected to a strong impact, have the vehicle inspected by your Toyota dealer.
- Do not disassemble the radar sensor.
- Do not modify or paint the radar sensor or radar sensor cover.
- In the following cases, the radar sensor must be recalibrated. Contact your Toyota dealer for details.
  - When the radar sensor or front grille are removed and installed, or replaced

**⚠ WARNING**

- When the front bumper is replaced

■ **To avoid malfunction of the front camera**

Observe the following precautions.

Otherwise, the front camera may not operate properly, possibly leading to an accident resulting in death or serious injury.

- Keep the windshield clean at all times.
- If the windshield is dirty or covered with an oily film, water droplets, snow, etc., clean the windshield.
- If a glass coating agent is applied to the windshield, it will still be necessary to use the windshield wipers to remove water droplets, etc. from the area of the windshield in front of the front camera.
- If the inner side of the windshield where the front camera is installed is dirty, contact your Toyota dealer.

- Do not attach objects, such as stickers, transparent stickers, etc., to the outer side of the windshield in front of the front camera (shaded area in the illustration).

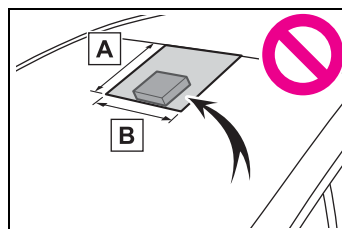

- A** From the top of the windshield to approximately 0.4 in. (1 cm) below the bottom of the front camera

- B** Approximately 7.9 in. (20 cm) (Approximately 4.0 in. [10 cm] to the right and left from the center of the front camera)

- If the part of the windshield in front of the front camera is fogged up or covered with condensation, or ice, use the windshield defogger to remove the fog, condensation, or ice. (→P.417, 422)
- If water droplets cannot be properly removed from the area of the windshield in front of the front camera by the windshield wipers, replace the wiper insert or wiper blade.
- Do not attach window tint to the windshield.
- Replace the windshield if it is damaged or cracked. After replacing the windshield, the front camera must be recalibrated. Contact your Toyota dealer for details.
- Do not allow liquids to contact the front camera.

**WARNING**

- Do not allow bright lights to shine into the front camera.
- Do not dirty or damage the front camera.  
When cleaning the inside of the windshield, do not allow glass cleaner to contact the lens of the front camera. Also, do not touch the lens.  
If the lens is dirty or damaged, contact your Toyota dealer.
- Do not subject the front camera to a strong impact.
- Do not change the installation position or direction of the front camera or remove it.
- Do not disassemble the front camera.
- Do not modify any components of the vehicle around the front camera (inside rear view mirror, etc.) or ceiling.
- Do not attach any accessories to the hood, front grille or front bumper that may obstruct the front camera. Contact your Toyota dealer for details.
- If a surfboard or other long object is to be mounted on the roof, make sure that it will not obstruct the front camera.
- Do not modify the headlights or other lights.

■ **Certification**

- ▶ Except for vehicles sold in Canada

FCC ID: HYQDNMWR009

**NOTE:**

This device complies with part 15 of the FCC Rules. Operation is subject to the following two conditions: (1) This device may not cause harmful interference, and (2) this device must accept any interference received, including interference that may cause undesired operation.

**FCC WARNING:**

Changes or modifications not expressly approved by the party responsible for compliance could void the user's authority to operate the equipment.

**Radiofrequency radiation exposure Information:**

This equipment complies with FCC radiation exposure limits set forth for an uncontrolled environment. This equipment should be installed and operated with minimum distance of 20 cm between the radiator (antenna) and your body. This transmitter must not be co-located or operating in conjunction with any other antenna or transmitter.

- ▶ For vehicles sold in Canada

**NOTE:**

This device contains licence-exempt transmitter(s)/receiver(s) that comply with Innovation, Science and Economic Development Canada's licence-exempt RSS(s). Operation is subject to the following two conditions:

- (1) This device may not cause interference.
- (2) This device must accept any interference, including interference that may cause undesired operation of the device.

This equipment complies with IC radiation exposure limits set forth for an uncontrolled environment and meets RSS-102 of the IC radio frequency (RF) Exposure rules. This equipment should be installed and operated keeping the radiator at least 20 cm or more away from person's body.

**NOTE:**

L'émetteur/récepteur exempt de licence contenu dans le présent appareil est conforme aux CNR d'Innovation, Sciences et Développement économique Canada applicables aux appareils radio exempts de licence. L'exploitation est autorisée aux deux conditions suivantes :

- 1) L'appareil ne doit pas produire de brouillage;
- 2) L'appareil doit accepter tout brouillage radioélectrique subi, même si le brouillage est susceptible d'en compromettre le fonctionnement.

Cet équipement est conforme aux limites d'exposition aux rayonnements énoncées pour un environnement non contrôlé et respecte les règles d'exposition aux fréquences radioélectriques (RF) CNR-102 de l'IC. Cet équipement doit être installé et utilisé en gardant une distance de 20 cm ou plus entre le dispositif rayonnant et le corps.

■ **If a warning message is displayed on the multi-information display**

A system may be temporarily unavailable or there may be a malfunction in the system.

- In the following situations, perform the actions specified in the table. When the normal operating conditions are detected, the message will disappear and the system will become operational.

If the message does not disappear, contact your Toyota dealer.

Situation	Actions
When the area around a sensor is covered with dirt, moisture (fogged up, covered with condensation, ice, etc.), or other foreign matter	To clean the part of the windshield in front of the front camera, use the windshield wipers or the windshield defogger of the air conditioning system (→P.417, 422).

Situation	Actions
When the temperature around the front camera is outside of the operational range, such as when the vehicle is in the sun or in an extremely cold environment	<p>If the front camera is hot, such as after the vehicle had been parked in the sun, use the air conditioning system to decrease the temperature around the front camera.</p> <p>If a sunshade was used when the vehicle was parked, depending on its type, the sunlight reflected from the surface of the sunshade may cause the temperature of the front camera to become excessively high.</p>
	<p>If the front camera is cold, such after the vehicle is parked in an extremely cold environment, use the air conditioning system to increase the temperature around the front camera.</p>
The area in front of the front camera is obstructed, such as when the hood is open or a sticker is attached to the part of the windshield in front of the front camera.	Close the hood, remove the sticker, etc. to clear the obstruction.

- In the following situations, if the situation has changed (or the vehicle has been driven for some time) and the normal operating conditions are detected, the message will disappear and the system will become operational.

If the message does not disappear, contact your Toyota dealer.

- When the temperature around the radar sensor is outside of the operational range, such as when the vehicle is in the sun or in an extremely cold environment
- When the front camera cannot detect objects in front of the vehicle, such as when driving in the dark, snow, or fog, or when bright lights are shining into the front camera

## PCS (Pre-Collision System)

The pre-collision system uses a radar sensor and front camera to detect objects (→P.206) in front of the vehicle. When the system determines that the possibility of a frontal collision with an object is high, a warning operates to urge the driver to take evasive action and the potential brake pressure is increased to help the driver avoid the collision. If the system determines that the possibility of a frontal collision with an object is extremely high, the brakes are automatically applied to help avoid the collision or help reduce the impact of the collision.

The pre-collision system can be disabled/enabled and the warning timing can be changed. (→P.205)

## Detectable objects

The system can detect the following:

- Vehicles
- Bicyclists
- Pedestrians

## System functions

### ■ Pre-collision warning

When the system determines that the possibility of a frontal collision is high, a buzzer will sound and a warning message will be displayed on the multi-information display to urge the driver to take evasive action.

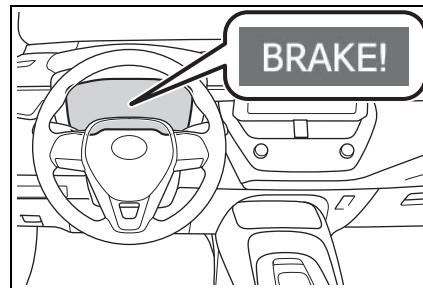

### ■ Pre-collision brake assist

When the system determines that the possibility of a frontal collision is high, the system applies greater braking force in relation to how strongly the brake pedal is depressed.

### ■ Pre-collision braking

If the system determines that the possibility of a frontal collision is extremely high, the brakes are automatically applied to help avoid the collision or reduce the impact of the collision.

**⚠ WARNING****■ Limitations of the pre-collision system**

- The driver is solely responsible for safe driving. Always drive safely, taking care to observe your surroundings. Do not use the pre-collision system instead of normal braking operations under any circumstances. This system will not prevent collisions or lessen collision damage or injury in every situation. Do not overly rely on this system. Failure to do so may lead to an accident, resulting in death or serious injury.
- Although this system is designed to help avoid a collision or help reduce the impact of the collision, its effectiveness may change according to various conditions, therefore the system may not always be able to achieve the same level of performance. Read the following conditions carefully. Do not overly rely on this system and always drive carefully.
- Conditions under which the system may operate even if there is no possibility of a collision: →P.207
- Conditions under which the system may not operate properly: →P.208
- Do not attempt to test the operation of the pre-collision system yourself. Depending on the objects used for testing (dummies, cardboard objects imitating detectable objects, etc.), the system may not operate properly, possibly leading to an accident.

**■ Pre-collision braking**

- When the pre-collision braking function is operating, a large amount of braking force will be applied.
- If the vehicle is stopped by the operation of the pre-collision braking function, the pre-collision braking function operation will be canceled after approximately 2 seconds. Depress the brake pedal as necessary.
- The pre-collision braking function may not operate if certain operations are performed by the driver. If the accelerator pedal is being depressed strongly or the steering wheel is being turned, the system may determine that the driver is taking evasive action and possibly prevent the pre-collision braking function from operating.
- In some situations, while the pre-collision braking function is operating, operation of the function may be canceled if the accelerator pedal is depressed strongly or the steering wheel is turned and the system determines that the driver is taking evasive action.
- If the brake pedal is being depressed, the system may determine that the driver is taking evasive action and possibly delay the operation timing of the pre-collision braking function.

**■ When to disable the pre-collision system**

In the following situations, disable the system, as it may not operate properly, possibly leading to an accident resulting in death or serious injury:

- When the vehicle is being towed



**⚠ WARNING**

- When your vehicle is towing another vehicle
- When transporting the vehicle via truck, boat, train or similar means of transportation
- When the vehicle is raised on a lift with the engine running and the tires are allowed to rotate freely
- When inspecting the vehicle using a drum tester such as a chassis dynamometer or speedometer tester, or when using an on vehicle wheel balancer
- When a strong impact is applied to the front bumper or front grille, due to an accident or other reasons
- If the vehicle cannot be driven in a stable manner, such as when the vehicle has been in an accident or is malfunctioning
- When the vehicle is driven in a sporty manner or off-road
- When the tires are not properly inflated
- When the tires are very worn
- When tires of a size other than specified are installed
- When tire chains are installed
- When a compact spare tire or an emergency tire puncture repair kit is used
- If equipment (snow plow, etc.) that may obstruct the radar sensor or front camera is temporarily installed to the vehicle

**Changing settings of the pre-collision system****■ Enabling/disabling the pre-collision system**

The pre-collision system can be enabled/disabled on  (→P.581) of the multi-information display.

The system is automatically enabled each time the engine switch is turned to ON.

If the system is disabled, the PCS warning light will turn on and a message will be displayed on the multi-information display.

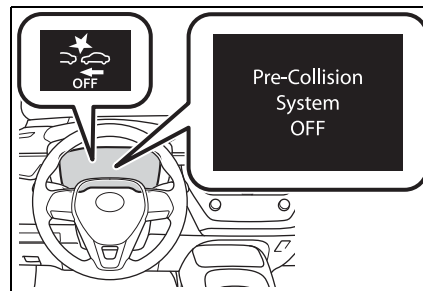
**■ Changing the pre-collision warning timing**

The pre-collision warning timing can be changed on  (→P.581) of the multi-information display.

The warning timing setting is retained when the engine switch is turned off. However, if the pre-collision system is disabled and re-enabled, the operation timing will return to the default setting (middle).

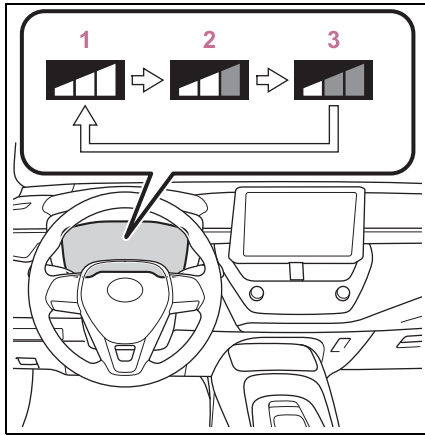

- 2 Middle  
This is the default setting.
- 3 Late

1 Early

■ **Operational conditions**

The pre-collision system is enabled and the system determines that the possibility of a frontal collision with a detected object is high. Each function is operational at the following speed

● Pre-collision warning

Detectable objects	Vehicle speed	Relative speed between your vehicle and object
Vehicles	Approx. 7 to 110 mph (10 to 180 km/h)	Approx. 7 to 110 mph (10 to 180 km/h)
Bicyclists and pedestrians	Approx. 7 to 50 mph (10 to 80 km/h)	Approx. 7 to 50 mph (10 to 80 km/h)

● Pre-collision brake assist

Detectable objects	Vehicle speed	Relative speed between your vehicle and object
Vehicles	Approx. 20 to 110 mph (30 to 180 km/h)	Approx. 20 to 110 mph (30 to 180 km/h)
Bicyclists and pedestrians	Approx. 20 to 50 mph (30 to 80 km/h)	Approx. 20 to 50 mph (30 to 80 km/h)

● Pre-collision braking

Detectable objects	Vehicle speed	Relative speed between your vehicle and object
Vehicles	Approx. 7 to 110 mph (10 to 180 km/h)	Approx. 7 to 110 mph (10 to 180 km/h)
Bicyclists and pedestrians	Approx. 7 to 50 mph (10 to 80 km/h)	Approx. 7 to 50 mph (10 to 80 km/h)

The system may not operate in the following situations:

- If a battery terminal has been disconnected and reconnected and then the vehicle has not been driven for a certain amount of time
- If the shift lever is in R
- When the VSC OFF indicator is illuminated (only the pre-collision warning function will be operational)

■ **Object detection function**

The system detects objects based on their size, profile, motion, etc. However, an object may not be detected depending on the surrounding brightness and the motion, posture, and angle of the detected object, preventing the system from operating properly. (→P.208)  
The illustration shows an image of detectable objects.

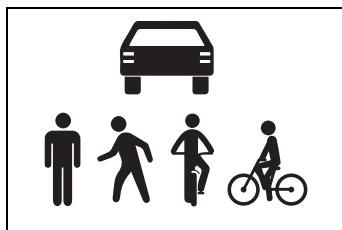

■ **Cancellation of the pre-collision braking**

If either of the following occur while the pre-collision braking function is operating, it will be canceled:

- The accelerator pedal is depressed strongly.
- The steering wheel is turned sharply or abruptly.

■ **Conditions under which the system may operate even if there is no possibility of a collision**

- In some situations such as the following, the system may determine that there is a possibility of a frontal collision and operate.
  - When passing a detectable object, etc.
  - When changing lanes while overtaking a detectable object, etc.
  - When approaching a detectable object in an adjacent lane or on the roadside, such as when changing the course of travel or driving on a winding road

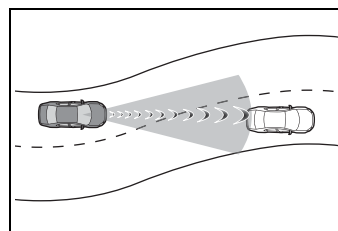

- When rapidly closing on a detectable object, etc.
- When approaching objects on the roadside, such as detectable objects, guardrails, utility poles, trees, or walls
- When there is a detectable object or other object by the roadside at the entrance of a curve

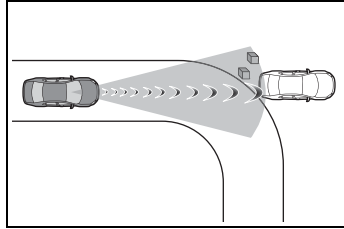

- When there are patterns or paint in front of your vehicle that may be mistaken for a detectable object
- When the front of your vehicle is hit by water, snow, dust, etc.
- When overtaking a detectable object that is changing lanes or making a right/left turn

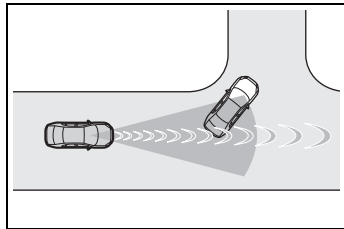

- When passing a detectable object in an oncoming lane that is stopped to make a right/left turn

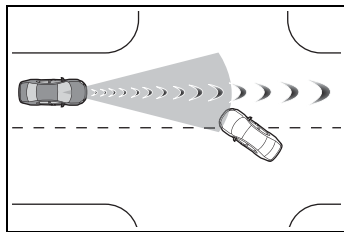

- When a detectable object approaches very close and then stops before entering the path of your vehicle
- If the front of your vehicle is raised or lowered, such as when on an uneven or undulating road surface
- When driving on a road surrounded by a structure, such as in a tunnel or on an iron bridge
- When there is a metal object (manhole cover, steel plate, etc.), steps, or a protrusion in front of your vehicle
- When passing under an object

(road sign, billboard, etc.)

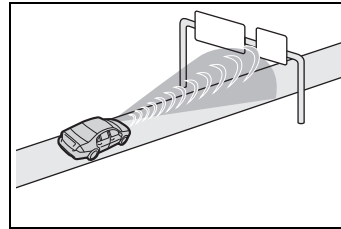

- When approaching an electric toll gate barrier, parking area barrier, or other barrier that opens and closes
- When using an automatic car wash
- When driving through or under objects that may contact your vehicle, such as thick grass, tree branches, or a banner

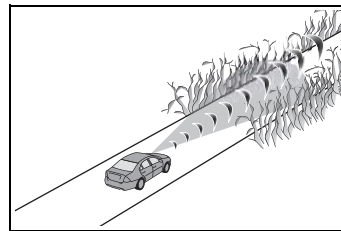

- When driving through steam or smoke
- When driving near an object that reflects radio waves, such as a large truck or guardrail
- When driving near a TV tower, broadcasting station, electric power plant, or other location where strong radio waves or electrical noise may be present

#### ■ Situations in which the system may not operate properly

- In some situations such as the following, an object may not be detected by the radar sensor and front camera, preventing the system from operating properly:
  - When a detectable object is approaching your vehicle
  - When your vehicle or a detectable object is wobbling
  - If a detectable object makes an abrupt maneuver (such as sudden

swerving, acceleration or deceleration)

- When your vehicle approaches a detectable object rapidly
- When a detectable object is not directly in front of your vehicle

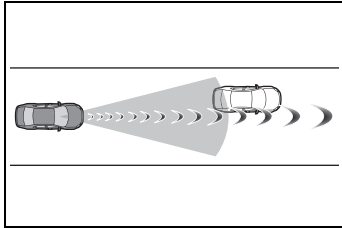

- When a detectable object is near a wall, fence, guardrail, manhole cover, vehicle, steel plate on the road, etc.
- When a detectable object is under a structure
- When part of a detectable object is hidden by an object, such as large baggage, an umbrella, or guardrail
- When multiple detectable objects are close together
- If the sun or other light is shining directly on a detectable object
- When a detectable object is a shade of white and looks extremely bright
- When a detectable object appears to be nearly the same color or brightness as its surroundings
- If a detectable object cuts or suddenly emerges in front of your vehicle
- When the front of your vehicle is hit by water, snow, dust, etc.
- When a very bright light ahead, such as the sun or the headlights of oncoming traffic, shines directly into the front camera
- When approaching the side or front of a vehicle ahead
- If a vehicle ahead is a motorcycle
- If a vehicle ahead is narrow, such as a personal mobility vehicle
- If a preceding vehicle has a small rear end, such as an unloaded truck
- If a preceding vehicle has a low

rear end, such as a low bed trailer

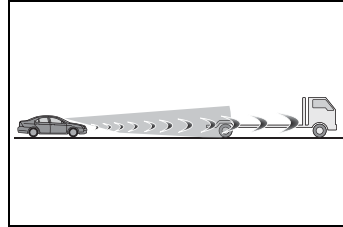

- If a vehicle ahead has extremely high ground clearance

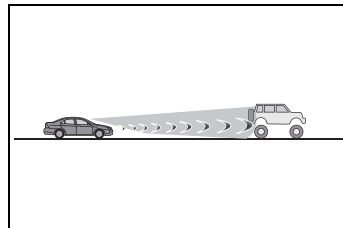

- If a vehicle ahead is carrying a load which protrudes past its rear bumper
- If a vehicle ahead is irregularly shaped, such as a tractor or side car
- If a vehicle ahead is a child sized bicycle, a bicycle that is carrying a large load, a bicycle ridden by more than one person, or a uniquely shaped bicycle (bicycle with a child seat, tandem bicycle, etc.)
- If a pedestrian/or the riding height of a bicyclist ahead is shorter than approximately 3.2 ft. (1 m) or taller than approximately 6.5 ft. (2 m)
- If a pedestrian/bicyclist is wearing oversized clothing (a rain coat, long skirt, etc.), making their silhouette obscure
- If a pedestrian is bending forward or squatting or bicyclist is bending forward
- If a pedestrian/bicyclist is moving fast
- If a pedestrian is pushing a stroller, wheelchair, bicycle or other vehicle
- When driving in inclement weather such as heavy rain, fog, snow or a sandstorm

- When driving through steam or smoke
- When the surrounding area is dim, such as at dawn or dusk, or while at night or in a tunnel, making a detectable object appear to be nearly the same color as its surroundings
- When driving in a place where the surrounding brightness changes suddenly, such as at the entrance or exit of a tunnel
- After the engine has started the vehicle has not been driven for a certain amount of time
- While making a left/right turn and for a few seconds after making a left/right turn
- While driving on a curve and for a few seconds after driving on a curve
- If your vehicle is skidding
- If the front of the vehicle is raised or lowered

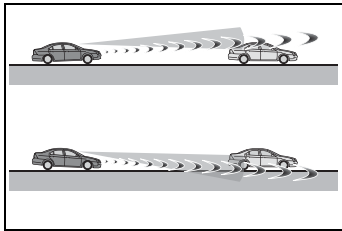

- If the wheels are misaligned
- If a wiper blade is blocking the front camera
- The vehicle is being driven at extremely high speeds
- When driving on a hill
- If the radar sensor or front camera is misaligned
- In some situations such as the following, sufficient braking force may not be obtained, preventing the system from performing properly:
  - If the braking functions cannot operate to their full extent, such as when the brake parts are extremely cold, extremely hot, or wet
  - If the vehicle is not properly maintained (brakes or tires are exces-

- sively worn, improper tire inflation pressure, etc.)
- When the vehicle is being driven on a gravel road or other slippery surface

■ **If VSC is disabled**

- If VSC is disabled (→P.273), the pre-collision brake assist and pre-collision braking functions are also disabled.
- The PCS warning light will turn on and “VSC Turned OFF Pre-Collision Brake System Unavailable” will be displayed on the multi-information display.

### LTA (Lane Tracing Assist)\*

\*: If equipped

**When driving on highways and freeways with white (yellow) lane lines, this function alerts the driver when the vehicle might depart from its lane or course\* and provides assistance by operating the steering wheel to keep the vehicle in its lane or course\*. Furthermore, the system provides steering assistance when dynamic radar cruise control with full-speed range is operating to keep the vehicle in its lane.**

**The LTA system recognizes white (yellow) lane lines or a course\* using the front camera. Additionally, it detects preceding vehicles using the front camera and radar.**

\*: Boundary between asphalt and the side of the road, such as grass, soil, or a curb

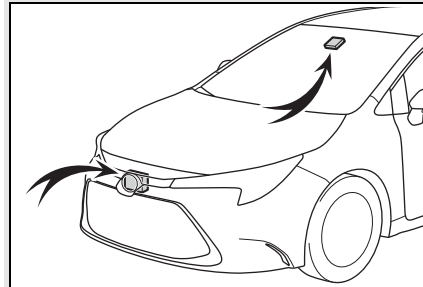

#### **! WARNING**

##### **■ Before using LTA system**

- Do not rely solely upon the LTA system. The LTA system does not automatically drive the vehicle or reduce the amount of attention that must be paid to the area in front of the vehicle. The driver must always assume full responsibility for driving safely by paying careful attention to the surrounding conditions and operating the steering wheel to correct the path of the vehicle. Also, the driver must take adequate breaks when fatigued, such as from driving for a long period of time.
- Failure to perform appropriate driving operations and pay careful attention may lead to an accident, resulting in death or serious injury.
- When not using the LTA system, use the LTA switch to turn the system off.

##### **■ Situations unsuitable for LTA system**

In the following situations, use the LTA switch to turn the system off. Failure to do so may lead to an accident, resulting in death or serious injury.

**⚠ WARNING**

- Vehicle is driven on a road surface which is slippery due to rainy weather, fallen snow, freezing, etc.
- Vehicle is driven on a snow-covered road.
- White (yellow) lines are difficult to see due to rain, snow, fog, dust, etc.
- Vehicle is driven in a temporary lane or restricted lane due to construction work.
- Vehicle is driven in a construction zone.
- A spare tire, tire chains, etc. are equipped.
- When the tires have been excessively worn, or when the tire inflation pressure is low.
- When tires of a size other than specified are installed.
- Vehicle is driven in traffic lanes other than that highways and freeways.
- During emergency towing.
- **Preventing LTA system malfunctions and operations performed by mistake**
- Do not modify the headlights or place stickers, etc. on the surface of the lights.
- Do not modify the suspension etc. If the suspension etc. needs to be replaced, contact your Toyota dealer.
- Do not install or place anything on the hood or grille. Also, do not install a grille guard (bull bars, kangaroo bar, etc.).

- If your windshield needs repairs, contact your Toyota dealer.

- **Conditions in which functions may not operate properly**

In the following situations, the functions may not operate properly and the vehicle may depart from its lane. Drive safely by always paying careful attention to your surroundings and operate the steering wheel to correct the path of the vehicle without relying solely on the functions.

- When the follow-up cruising display is displayed (→P.217) and the preceding vehicle changes lanes. (Your vehicle may follow the preceding vehicle and also change lanes.)

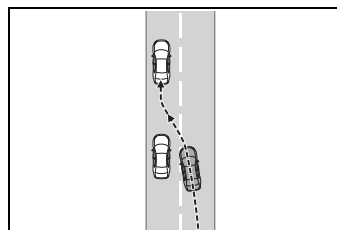

- When the follow-up cruising display is displayed (→P.217) and the preceding vehicle is swaying. (Your vehicle may sway accordingly and depart from the lane.)
- When the follow-up cruising display is displayed (→P.217) and the preceding vehicle departs from its lane. (Your vehicle may follow the preceding vehicle and depart from the lane.)
- When the follow-up cruising display is displayed (→P.217) and the preceding vehicle is being driven extremely close to the left/right lane line. (Your vehicle may follow the preceding vehicle and depart from the lane.)



**⚠ WARNING**

- Vehicle is being driven around a sharp curve.
- Objects or patterns that could be mistaken for white (yellow) lines are present on the side of the road (guardrails, reflective poles, etc.).

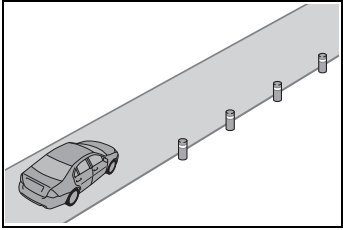

- Vehicle is driven where the road diverges, merges, etc.

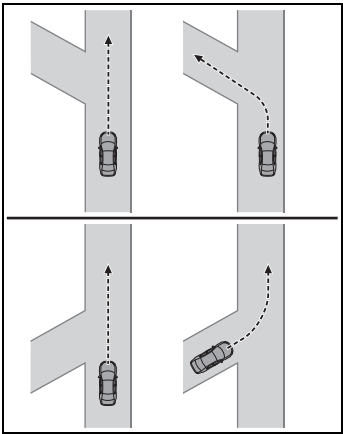

- Repair marks of asphalt, white (yellow) lines, etc. are present due to road repair.

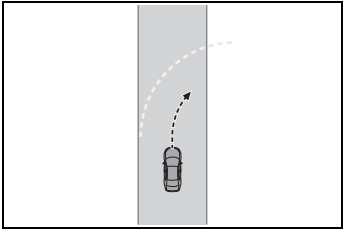

- There are shadows on the road that run parallel with, or cover, the white (yellow) lines.
- The vehicle is driven in an area without white (yellow) lines, such as in front of a tollgate or checkpoint, or at an intersection, etc.
- The white (yellow) lines are cracked, "Botts' dots", "Raised pavement marker" or stones are present.
- The white (yellow) lines cannot be seen or are difficult to see due to sand, etc.
- The vehicle is driven on a road surface that is wet due to rain, puddles, etc.
- The traffic lines are yellow (which may be more difficult to recognize than lines that are white).
- The white (yellow) lines cross over a curb, etc.
- The vehicle is driven on a bright surface, such as concrete.
- If the edge of the road is not clear or straight.
- The vehicle is driven on a surface that is bright due to reflected light, etc.
- The vehicle is driven in an area where the brightness changes suddenly, such as at the entrances and exits of tunnels, etc.
- Light from the headlights of an oncoming vehicle, the sun, etc. enters the camera.
- The vehicle is driven on a slope.
- The vehicle is driven on a road which tilts left or right, or a winding road.

**⚠ WARNING**

- The vehicle is driven on an unpaved or rough road.
- The traffic lane is excessively narrow or wide.
- The vehicle is extremely tilted due to carrying heavy luggage or having improper tire pressure.
- The distance to the preceding vehicle is extremely short.
- The vehicle is moving up and down a large amount due to road conditions during driving (poor roads or road seams).
- When driving in a tunnel or at night with the headlights off or when a headlight is dim due to its lens being dirty or it being misaligned.
- The vehicle is struck by a crosswind.
- The vehicle is affected by wind from a vehicle driven in a nearby lane.
- The vehicle has just changed lanes or crossed an intersection.
- Tires which differ by structure, manufacturer, brand or tread pattern are used.
- Snow tires, etc. are equipped.
- The vehicle is being driven at extremely high speeds.

**Functions included in LTA system**

■ **Lane departure alert function**

When the system determines

that the vehicle might depart from its lane or course\*, a warning is displayed on the multi-information display, and a warning buzzer will sound to alert the driver.

When the warning buzzer sounds, check the area around your vehicle and carefully operate the steering wheel to move the vehicle back to the center of the lane.

Vehicle with BSM: When the system determines that the vehicle might depart from its lane and that the possibility of a collision with an overtaking vehicle in the adjacent lane is high, the lane departure alert will operate even if the turn signals are operating.

\*: Boundary between asphalt and the side of the road, such as grass, soil, or a curb

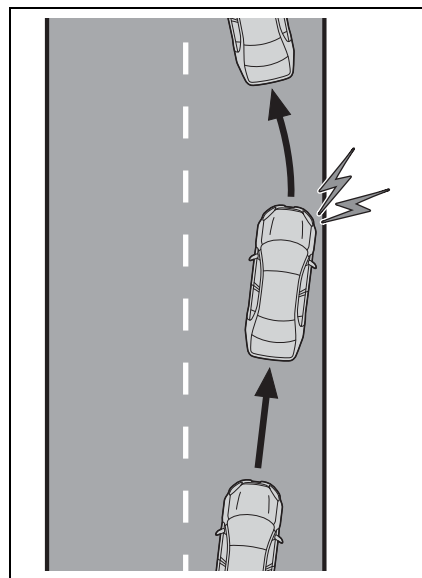

■ **Steering assist function**

When the system determines

that the vehicle might depart from its lane or course<sup>\*</sup>, the system provides assistance as necessary by operating the steering wheel in small amounts for a short period of time to keep the vehicle in its lane.

If the system detects that the steering wheel has not been operated for a fixed amount of time or the steering wheel is not being firmly gripped, a warning is displayed on the multi-information display and the function is temporarily canceled.

Vehicle with BSM: When the system determines that the vehicle might depart from its lane and that the possibility of a collision with an overtaking vehicle in the adjacent lane is high, the steering assist function will operate even if the turn signals are operating.

<sup>\*</sup>: Boundary between asphalt and the side of the road, such as grass, soil, or a curb

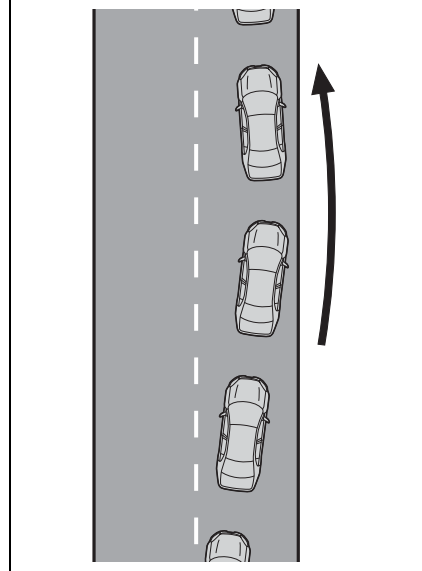

#### ■ Vehicle sway warning function

When the vehicle is swaying within a lane, the warning buzzer will sound and a message will be displayed on the multi-information display to alert the driver.

4

Driving

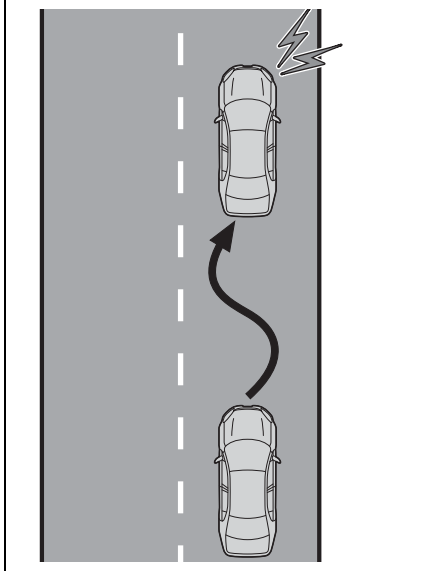

#### ■ Lane centering function

This function is linked with dynamic radar cruise control with full-speed range and provides the required assistance by operating the steering wheel to keep the vehicle in its current lane.

When dynamic radar cruise control with full-speed range is not operating, the lane centering function does not operate.

In situations where the white (yellow) lane lines are difficult to see or are not visible, such as when in a traffic jam, this function will operate to help follow a preceding vehicle by monitoring the position of the preceding vehicle.

If the system detects that the steering wheel has not been operated for a fixed amount of time or the steering wheel is not being firmly gripped, a warning is displayed on

the multi-information display and the function is temporarily canceled.

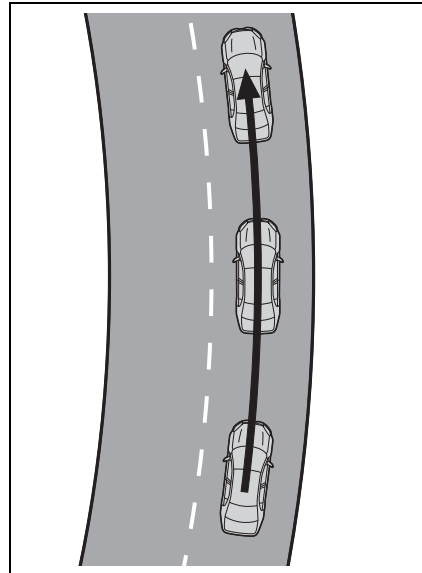

#### Turning LTA system on

Press the LTA switch to turn the LTA system on.

The LTA indicator illuminates and a message is displayed on the multi-information display.

Press the LTA switch again to turn the LTA system off.

When the LTA system is turned on or off, operation of the LTA system continues in the same condition the next time the engine is started.

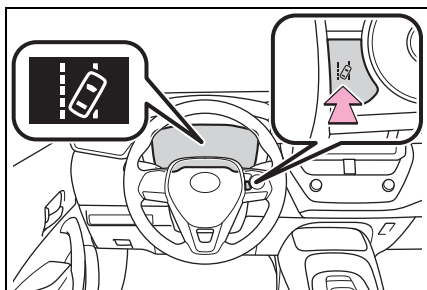

**Indications on multi-information display**

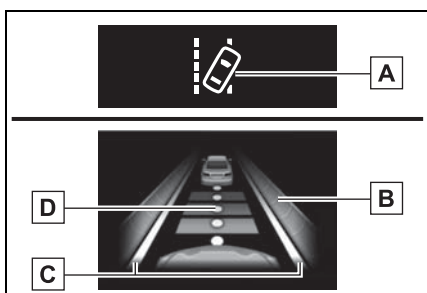

**A LTA indicator**

The illumination condition of the indicator informs the driver of the system operation status.

Illuminated in white: LTA system is operating.

Illuminated in green: Steering wheel assistance of the steering assist function or lane centering function is operating.

Flashing in orange: Lane departure alert function is operating.

**B Operation display of steering wheel operation support**

Displayed when the multi-information display is switched to the driving support system information screen.

Indicates that steering wheel assistance of the steering assist function

or lane centering function is operating.

Both outer sides of the lane are displayed: Indicates that steering wheel assist of the lane centering function is operating.

One outer side of the lane is displayed: Indicates that steering wheel assist of the steering assist function is operating.

Both outer sides of the lane are flashing: Alerts the driver that their input is necessary to stay in the center of the lane (lane centering function).

**C Lane departure alert function display**

Displayed when the multi-information display is switched to the driving support system information screen.

► Inside of displayed lines is white

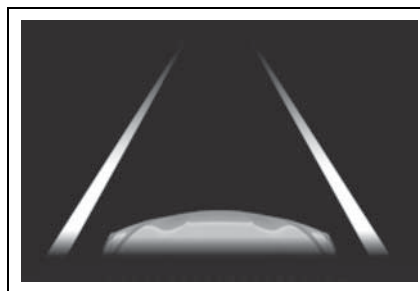

Indicates that the system is recognizing white (yellow) lines or a course\*. When the vehicle departs from its lane, the white line displayed on the side the vehicle departs from flashes orange.

- ▶ Inside of displayed lines is black

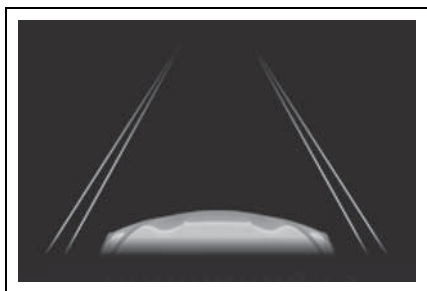

Indicates that the system is not able to recognize white (yellow) lines or a course\* or is temporarily canceled.

\*: Boundary between asphalt and the side of the road, such as grass, soil, or a curb

#### **D** Follow-up cruising display

Displayed when the multi-information display is switched to the driving support system information screen.

Indicates that steering assist of the lane centering function is operating by monitoring the position of a preceding vehicle.

When the follow-up cruising display is displayed, if the preceding vehicle moves, your vehicle may move in the same way. Always pay careful attention to your surroundings and operate the steering wheel as necessary to correct the path of the vehicle and ensure safety.

#### **■ Operation conditions of each function**

- Lane departure alert function  
This function operates when all of the following conditions are met.
  - LTA is turned on.

- Vehicle speed is approximately 32 mph (50 km/h) or more.\*<sup>1</sup>
- System recognizes white (yellow) lane lines or a course\*<sup>2</sup>. (When a white [yellow] line or course\*<sup>2</sup> is recognized on only one side, the system will operate only for the recognized side.)
- Width of traffic lane is approximately 9.8 ft. (3 m) or more.
- Turn signal lever is not operated. (Vehicle with BSM: Except when another vehicle is in the lane on the side where the turn signal was operated)
- Vehicle is not being driven around a sharp curve.
- No system malfunctions are detected. (→P.220)

\*<sup>1</sup>: The function operates even if the vehicle speed is less than approximately 32 mph (50 km/h) when the lane centering function is operating.

\*<sup>2</sup>: Boundary between asphalt and the side of the road, such as grass, soil, or a curb

#### ● Steering assist function

This function operates when all of the following conditions are met in addition to the operation conditions for the lane departure alert function.

- Setting for "Steering Assist" in  of the multi-information display is set to "ON". (→P.581)
- Vehicle is not accelerated or decelerated by a fixed amount or more.
- Steering wheel is not operated with a steering force level suitable for changing lanes.
- ABS, VSC, TRAC and PCS are not operating.
- TRAC or VSC is not turned off.
- Hands off steering wheel warning is not displayed. (→P.220)

● Vehicle sway warning function  
This function operates when all of

the following conditions are met.

- Setting for “Sway Warning” in  of the multi-information display is set to “ON”. (→P.581)
- Vehicle speed is approximately 32 mph (50 km/h) or more.
- Width of traffic lane is approximately 9.8 ft. (3 m) or more.
- No system malfunctions are detected. (→P.220)

● Lane centering function

This function operates when all of the following conditions are met.

- LTA is turned on.
- Setting for “Steering Assist” and “Lane Center” in  of the multi-information display are set to “ON”. (→P.581)
- This function recognizes white (yellow) lane lines or the position of a preceding vehicle (except when the preceding vehicle is small, such as a motorcycle).
- The dynamic radar cruise control with full-speed range is operating in vehicle-to-vehicle distance control mode.
- Width of traffic lane is approximately 10 to 13 ft. (3 to 4 m).
- Turn signal lever is not operated.
- Vehicle is not being driven around a sharp curve.
- No system malfunctions are detected. (→P.220)
- Vehicle does not accelerate or decelerate by a fixed amount or more.
- Steering wheel is not operated with a steering force level suitable for changing lanes.
- ABS, VSC, TRAC and PCS are not operating.
- TRAC or VSC is not turned off.
- Hands off steering wheel warning is not displayed. (→P.220)
- The vehicle is being driven in the center of a lane.
- Steering assist function is not operating.

■ Temporary cancelation of functions

- When operation conditions are no longer met, a function may be temporarily canceled. However, when the operation conditions are met again, operation of the function is automatically restored. (→P.218)
- If the operation conditions (→P.216) are no longer met while the lane centering function is operating, the buzzer may sound to indicate that the function has been temporarily canceled.

■ Steering assist function/lane centering function

- Depending on the vehicle speed, lane departure situation, road conditions, etc., the driver may not feel the function is operating or the function may not operate at all.
- The steering control of the function is overridden by the driver's steering wheel operation.
- Do not attempt to test the operation of the steering assist function.

■ Lane departure alert function

- The warning buzzer may be difficult to hear due to external noise, audio playback, etc.
- If the edge of the course\* is not clear or straight, the lane departure alert function may not operate.
- Vehicle with BSM: It may not be possible for the system to determine if there is a danger of a collision with a vehicle in an adjacent lane.
- Do not attempt to test the operation of the lane departure alert function.

\*: Boundary between asphalt and the side of the road, such as grass, soil, or a curb

#### ■ Hands off steering wheel warning

In the following situations, a warning message urging the driver to hold the steering wheel and the symbol shown in the illustration are displayed on the multi-information display to warn the driver. The warning stops when the system determines that the driver holds the steering wheel. Always keep your hands on the steering wheel when using this system, regardless of warnings.

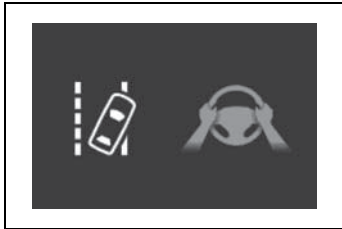

- When the system determines that the driver is driving without holding the steering wheel while the system is operating

If the driver continues to keep their hands off of the steering wheel, the buzzer sounds, the driver is warned and the function is temporarily canceled. This warning also operates in the same way when the driver continuously operates the steering wheel only a small amount.

- When the system determines that the vehicle may not turn and instead depart from its lane while driving around a curve

Depending on the vehicle condition and road conditions, the warning may not operate. Also, if the system determines that the vehicle is driving around a curve, warnings will occur earlier than during straight-lane driving.

- When the system determines that the driver is driving without holding the steering wheel while the steering wheel assist of the steering assist function is operating.

If the driver continues to keep their hands off of the steering wheel and the steering wheel assist is operating, the buzzer sounds and the driver is warned. Each time the buzzer sounds, the continuing time of the buzzer becomes longer.

#### ■ Vehicle sway warning function

When the system determines that the vehicle is swaying while the vehicle sway warning function is operating, a buzzer sounds and a warning message urging the driver to rest and the symbol shown in the illustration are simultaneously displayed on the multi-information display.



Depending on the vehicle and road conditions, the warning may not operate.

#### ■ Warning message

If the following warning message is displayed on the multi-information display and the LTA indicator illuminates in orange, follow the appropriate troubleshooting procedure. Also, if a different warning message is displayed, follow the instructions displayed on the screen.

- “LTA Malfunction Visit Your Dealer”

The system may not be operating properly. Have the vehicle inspected by your Toyota dealer.

- “LTA Unavailable”

The system is temporarily canceled due to a malfunction in a sensor other than the front camera. Turn the LTA system off, wait for a little while, and then turn the LTA system back on.



- “LTA Unavailable at Current Speed”

The function cannot be used as the vehicle speed exceeds the LTA operation range. Drive slower.

- **Customization**

Function settings can be changed. (→P.581)

### LDA (Lane Departure Alert with steering control)\*

\*: If equipped

**When driving on highways and freeways with white (yellow) lane lines, this function alerts the driver when the vehicle might depart from its lane or course\* and provides assistance by operating the steering wheel to keep the vehicle in its lane or course\*.**

**The LDA system recognizes white (yellow) lane lines or a course\* using the front camera. Additionally, it detects preceding vehicles using the front camera and radar.**

\*: Boundary between asphalt and the side of the road, such as grass, soil, or a curb

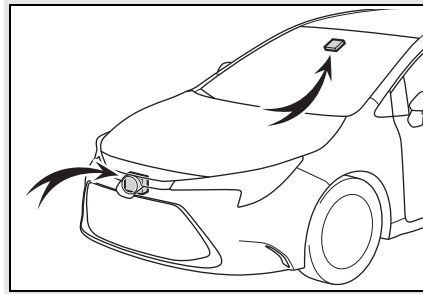

**WARNING****■ Before using LDA system**

- Do not rely solely upon the LDA system. The LDA system does not automatically drive the vehicle or reduce the amount of attention that must be paid to the area in front of the vehicle. The driver must always assume full responsibility for driving safely by paying careful attention to the surrounding conditions and operating the steering wheel to correct the path of the vehicle. Also, the driver must take adequate breaks when fatigued, such as from driving for a long period of time.
- Failure to perform appropriate driving operations and pay careful attention may lead to an accident, resulting in death or serious injury.
- When not using the LDA system, use the LDA switch to turn the system off.

**■ Situations unsuitable for LDA system**

In the following situations, use the LDA switch to turn the system off. Failure to do so may lead to an accident, resulting in death or serious injury.

- Vehicle is driven on a road surface which is slippery due to rainy weather, fallen snow, freezing, etc.
- Vehicle is driven on a snow-covered road.
- White (yellow) lines are difficult to see due to rain, snow, fog, dust, etc.
- A spare tire, tire chains, etc. are equipped.

- When the tires have been excessively worn, or when the tire inflation pressure is low.

- When tires of a size other than specified are installed.

- Vehicle is driven in traffic lanes other than that highways and freeways.

- During emergency towing.

**■ Preventing LDA system malfunctions and operations performed by mistake**

- Do not modify the headlights or place stickers, etc. on the surface of the lights.

- Do not modify the suspension etc. If the suspension etc. needs to be replaced, contact your Toyota dealer.

- Do not install or place anything on the hood or grille. Also, do not install a grille guard (bull bars, kangaroo bar, etc.).

- If your windshield needs repairs, contact your Toyota dealer.

**■ Conditions in which functions may not operate properly**

In the following situations, the functions may not operate properly and the vehicle may depart from its lane. Drive safely by always paying careful attention to your surroundings and operate the steering wheel to correct the path of the vehicle without relying solely on the functions.

- Vehicle is being driven around a sharp curve.

**⚠ WARNING**

- Objects or patterns that could be mistaken for white (yellow) lines are present on the side of the road (guardrails, reflective poles, etc.).

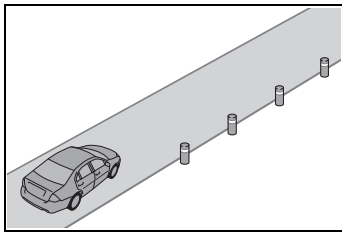

- Vehicle is driven where the road diverges, merges, etc.

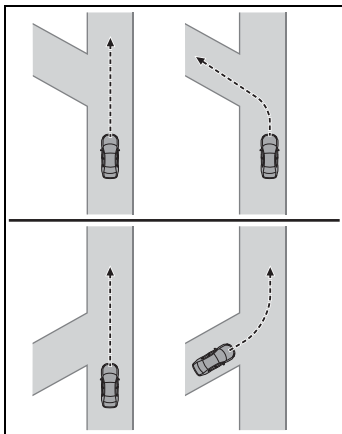

- Repair marks of asphalt, white (yellow) lines, etc. are present due to road repair.

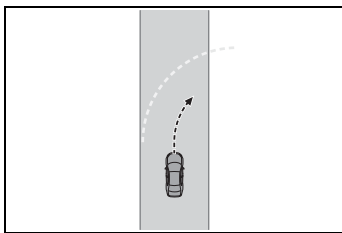

- There are shadows on the road that run parallel with, or cover, the white (yellow) lines.

- The vehicle is driven in an area without white (yellow) lines, such as in front of a tollgate or checkpoint, or at an intersection, etc.
- The white (yellow) lines are cracked, "Botts' dots", "Raised pavement marker" or stones are present.
- The white (yellow) lines cannot be seen or are difficult to see due to sand, etc.
- The vehicle is driven on a road surface that is wet due to rain, puddles, etc.
- The traffic lines are yellow (which may be more difficult to recognize than lines that are white).
- The white (yellow) lines cross over a curb, etc.
- The vehicle is driven on a bright surface, such as concrete.
- If the edge of the road is not clear or straight.
- The vehicle is driven on a surface that is bright due to reflected light, etc.
- The vehicle is driven in an area where the brightness changes suddenly, such as at the entrances and exits of tunnels, etc.
- Light from the headlights of an oncoming vehicle, the sun, etc. enters the camera.
- The vehicle is driven on a slope.
- The vehicle is driven on a road which tilts left or right, or a winding road.
- The vehicle is driven on an unpaved or rough road.

**⚠ WARNING**

- The traffic lane is excessively narrow or wide.
- The vehicle is extremely tilted due to carrying heavy luggage or having improper tire pressure.
- The distance to the preceding vehicle is extremely short.
- The vehicle is moving up and down a large amount due to road conditions during driving (poor roads or road seams).
- When driving in a tunnel or at night with the headlights off or when a headlight is dim due to its lens being dirty or it being misaligned.
- The vehicle is struck by a crosswind.
- The vehicle has just changed lanes or crossed an intersection.
- Tires which differ by structure, manufacturer, brand or tread pattern are used.
- Snow tires, etc. are equipped.

**Functions included in LDA system****■ Lane departure alert function**

When the system determines that the vehicle might depart from its lane or course<sup>\*</sup>, a warning is displayed on the multi-information display, and a warning buzzer will sound to alert the driver.

When the warning buzzer sounds, check the area around your vehicle and carefully operate the steering wheel to move the vehicle back to the center of the lane.

Vehicle with BSM: When the system determines that the vehicle might depart from its lane and that the possibility of a collision with an overtaking vehicle in the adjacent lane is high, the lane departure alert will operate even if the turn signals are operating.

\*: Boundary between asphalt and the side of the road, such as grass, soil, or a curb

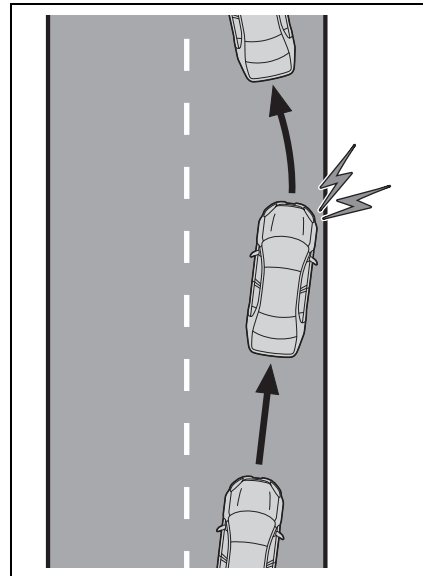
**■ Steering assist function**

When the system determines that the vehicle might depart from its lane or course<sup>\*</sup>, the system provides assistance as necessary by operating the steering wheel in small amounts for a short period of time to keep the

vehicle in its lane.

If the system detects that the steering wheel has not been operated for a fixed amount of time or the steering wheel is not being firmly gripped, a warning is displayed on the multi-information display and the function is temporarily canceled.

Vehicle with BSM: When the system determines that the vehicle might depart from its lane and that the possibility of a collision with an overtaking vehicle in the adjacent lane is high, the steering assist function will operate even if the turn signals are operating.

\*: Boundary between asphalt and the side of the road, such as grass, soil, or a curb

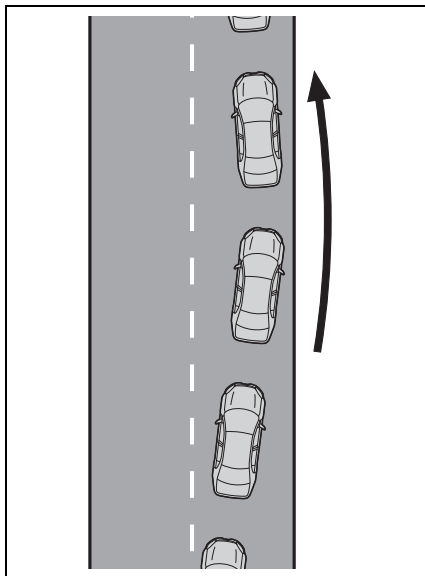

■ **Vehicle sway warning function**

When the vehicle is swaying within a lane, the warning

buzzer will sound and a message will be displayed on the multi-information display to alert the driver.

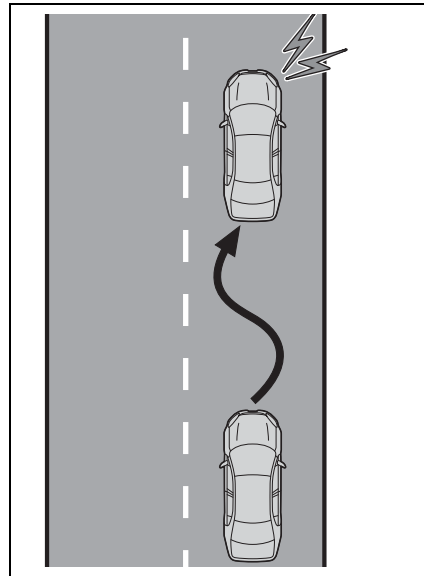

**Turning LDA system on**

Press the LDA switch to turn the LDA system on.

The LDA indicator illuminates and a message is displayed on the multi-information display.

Press the LDA switch again to turn the LDA system off.

When the LDA system is turned on or off, operation of the LDA system continues in the same condition the next time the engine is started.

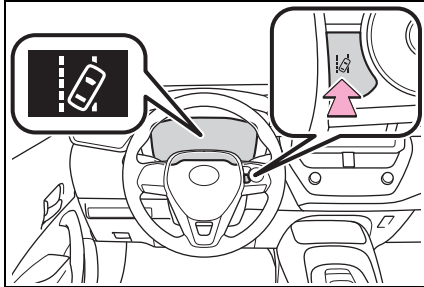

**Indications on multi-information display**

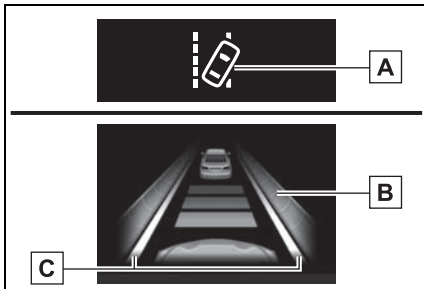

**A LDA indicator**

The illumination condition of the indicator informs the driver of the system operation status.

Illuminated in white: LDA system is operating.

Illuminated in green: Steering wheel assistance of the steering assist function is operating.

Flashing in orange: Lane departure alert function is operating.

**B Operation display of steering wheel operation support**

Displayed when the multi-information display is switched to the driving support system information screen.

Indicates that steering wheel assistance of the steering assist function is operating.

**C Lane departure alert function display**

Displayed when the multi-information display is switched to the driving support system information screen.

► Inside of displayed lines is white

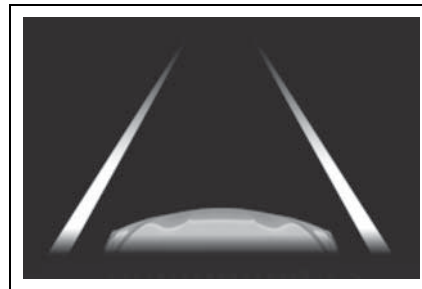

Indicates that the system is recognizing white (yellow) lines or a course\*. When the vehicle departs from its lane, the white line displayed on the side the vehicle departs from flashes orange.

► Inside of displayed lines is black

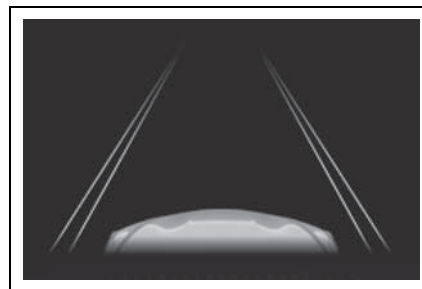

Indicates that the system is not able to recognize white (yellow) lines or a course\* or is temporarily canceled.

\*: Boundary between asphalt and the side of the road, such as grass, soil, or a curb

**■ Operation conditions of each function**

- Lane departure alert function  
This function operates when all of the following conditions are met.
  - LDA is turned on.
  - Vehicle speed is approximately 32 mph (50 km/h) or more.
  - System recognizes white (yellow) lane lines or a course\*. (When a white [yellow] line or course\* is recognized on only one side, the system will operate only for the recognized side.)
  - Width of traffic lane is approximately 9.8 ft. (3 m) or more.
  - Turn signal lever is not operated. (Vehicle with BSM: Except when another vehicle is in the lane on the side where the turn signal was operated)
  - Vehicle is not being driven around a sharp curve.
  - No system malfunctions are detected. (→P.228)

\*: Boundary between asphalt and the side of the road, such as grass, soil, or a curb

- Steering assist function  
This function operates when all of the following conditions are met in addition to the operation conditions for the lane departure alert function.
  - Setting for “Steering Assist” in  of the multi-information display is set to “ON”. (→P.581)
  - Vehicle is not accelerated or decelerated by a fixed amount or more.
  - Steering wheel is not operated with a steering force level suitable for changing lanes.
  - ABS, VSC, TRAC and PCS are not operating.

- TRAC or VSC is not turned off.
- Hands off steering wheel warning is not displayed. (→P.228)

● Vehicle sway warning function

This function operates when all of the following conditions are met.

- Setting for “Sway Warning” in  of the multi-information display is set to “ON”. (→P.581)
- Vehicle speed is approximately 32 mph (50 km/h) or more.
- Width of traffic lane is approximately 9.8 ft. (3 m) or more.
- No system malfunctions are detected. (→P.228)

**■ Temporary cancelation of functions**

When operation conditions are no longer met, a function may be temporarily canceled. However, when the operation conditions are met again, operation of the function is automatically restored. (→P.227)

**■ Steering assist function**

- Depending on the vehicle speed, lane departure situation, road conditions, etc., the driver may not feel the function is operating or the function may not operate at all.
- The steering control of the function is overridden by the driver’s steering wheel operation.
- Do not attempt to test the operation of the steering assist function.

**■ Lane departure alert function**

- The warning buzzer may be difficult to hear due to external noise, audio playback, etc.
- If the edge of the course\* is not clear or straight, the lane departure alert function may not operate.
- Vehicle with BSM: It may not be possible for the system to determine if there is a danger of a collision with a vehicle in an adjacent lane.

- Do not attempt to test the operation of the lane departure alert function.

\* : Boundary between asphalt and the side of the road, such as grass, soil, or a curb

■ **Hands off steering wheel warning**

In the following situations, a warning message urging the driver to hold the steering wheel and the symbol shown in the illustration are displayed on the multi-information display to warn the driver. The warning stops when the system determines that the driver holds the steering wheel. Always keep your hands on the steering wheel when using this system, regardless of warnings.

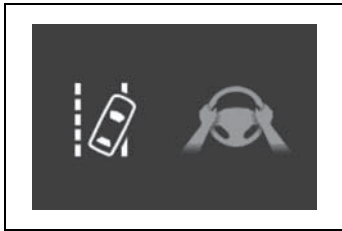

- When the system determines that the driver is driving without holding the steering wheel while the system is operating

If the driver continues to keep their hands off of the steering wheel, the buzzer sounds, the driver is warned and the function is temporarily canceled. This warning also operates in the same way when the driver continuously operates the steering wheel only a small amount.

- When the system determines that the vehicle may not turn and instead depart from its lane while driving around a curve

Depending on the vehicle condition and road conditions, the warning may not operate. Also, if the system determines that the vehicle is driv-

ing around a curve, warnings will occur earlier than during straight-lane driving.

- When the system determines that the driver is driving without holding the steering wheel while the steering wheel assist of the steering assist function is operating.

If the driver continues to keep their hands off of the steering wheel and the steering wheel assist is operating, the buzzer sounds and the driver is warned. Each time the buzzer sounds, the continuing time of the buzzer becomes longer.

■ **Vehicle sway warning function**

When the system determines that the vehicle is swaying while the vehicle sway warning function is operating, a buzzer sounds and a warning message urging the driver to rest and the symbol shown in the illustration are simultaneously displayed on the multi-information display.



Depending on the vehicle and road conditions, the warning may not operate.

■ **Warning message**

If the following warning message is displayed on the multi-information display and the LDA indicator illuminates in orange, follow the appropriate troubleshooting procedure. Also, if a different warning message is displayed, follow the instructions displayed on the screen.

- "LDA Malfunction Visit Your Dealer"



The system may not be operating properly. Have the vehicle inspected by your Toyota dealer.

● “LDA Unavailable”

The system is temporarily canceled due to a malfunction in a sensor other than the front camera. Turn the LDA system off, wait for a little while, and then turn the LDA system back on.

● “LDA Unavailable at Current Speed”

The function cannot be used as the vehicle speed exceeds the LDA operation range. Drive slower.

● “LDA Unavailable Below Approx. 32MPH”

The LDA system cannot be used as the vehicle speed is less than approximately 32 mph (50 km/h). Drive the vehicle at approximately 32 mph (50 km/h) or more.

■ Customization

Function settings can be changed. (→P.581)

Dynamic radar cruise control with full-speed range\*

\*: If equipped

**In vehicle-to-vehicle distance control mode, the vehicle automatically accelerates, decelerates and stops to match the speed changes of the preceding vehicle even if the accelerator pedal is not depressed. In constant speed control mode, the vehicle runs at a fixed speed.**

**Use the dynamic radar cruise control with full-speed range on free-ways and highways.**

- Vehicle-to-vehicle distance control mode (→P.232)
- Constant speed control mode (→P.236)

System Components

■ Meter display

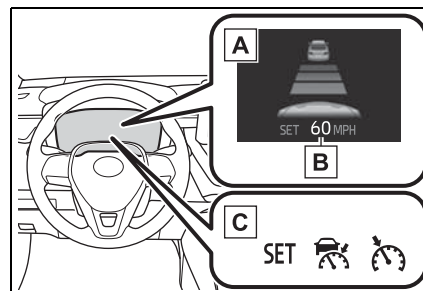

A Multi-information display

- B** Set speed
- C** Indicators
- **Operation switches**

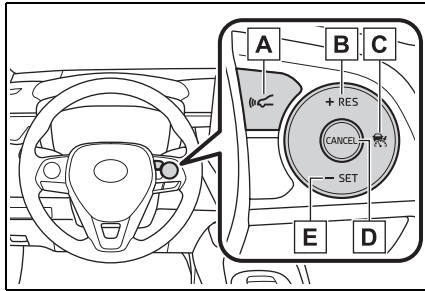

- A** Vehicle-to-vehicle distance switch
- B** "+RES" switch
- C** Cruise control main switch
- D** Cancel switch
- E** "-SET" switch

**⚠ WARNING**

■ **Before using dynamic radar cruise control with full-speed range**

- Driving safely is the sole responsibility of the driver. Do not rely solely on the system, and drive safely by always paying careful attention to your surroundings.
- The dynamic radar cruise control with full-speed range provides driving assistance to reduce the driver's burden. However, there are limitations to the assistance provided.

Read the following conditions carefully. Do not overly rely on this system and always drive carefully.

- When the sensor may not be correctly detecting the vehicle ahead: →P.238

- Conditions under which the vehicle-to-vehicle distance control mode may not function correctly: →P.239

- Set the speed appropriately depending on the speed limit, traffic flow, road conditions, weather conditions, etc. The driver is responsible for checking the set speed.

- Even when the system is functioning normally, the condition of the preceding vehicle as detected by the system may differ from the condition observed by the driver. Therefore, the driver must always remain alert, assess the danger of each situation and drive safely. Relying solely on this system or assuming the system ensures safety while driving can lead to an accident, resulting in death or serious injury.

- Switch the dynamic radar cruise control with full-speed range setting to off, using the cruise control main switch when not in use.

■ **Cautions regarding the driving assist systems**

Observe the following precautions, as there are limitations to the assistance provided by the system. Failure to do so may cause an accident resulting in death or serious injury.

**WARNING**

- Assisting the driver to measure following distance

The dynamic radar cruise control with full-speed range is only intended to help the driver in determining the following distance between the driver's own vehicle and a designated vehicle traveling ahead. It is not a mechanism that allows careless or inattentive driving, and it is not a system that can assist the driver in low-visibility conditions.

It is still necessary for driver to pay close attention to the vehicle's surroundings.

- Assisting the driver to judge proper following distance

The dynamic radar cruise control with full-speed range determines whether the following distance between the driver's own vehicle and a designated vehicle traveling ahead is within a set range. It is not capable of making any other type of judgement. Therefore, it is absolutely necessary for the driver to remain vigilant and to determine whether or not there is a possibility of danger in any given situation.

- Assisting the driver to operate the vehicle

The dynamic radar cruise control with full-speed range does not include functions which will prevent or avoid collisions with vehicles ahead of your vehicle. Therefore, if there is ever any possibility of danger, the driver must take immediate and direct control of the vehicle and act appropriately in order to ensure the safety of all involved.

- **Situations unsuitable for dynamic radar cruise control with full-speed range**

Do not use dynamic radar cruise control with full-speed range in any of the following situations. Doing so may result in inappropriate speed control and could cause an accident resulting in death or serious injury.

- Roads where there are pedestrians, cyclists, etc.
- In heavy traffic
- On roads with sharp bends
- On winding roads
- On slippery roads, such as those covered with rain, ice or snow
- On steep downhill, or where there are sudden changes between sharp up and down gradients

Vehicle speed may exceed the set speed when driving down a steep hill.

- At entrances to freeways and highways
- When weather conditions are bad enough that they may prevent the sensors from detecting correctly (fog, snow, sandstorm, heavy rain, etc.)
- When there is rain, snow, etc. on the front surface of the radar or front camera
- In traffic conditions that require frequent repeated acceleration and deceleration
- During emergency towing
- When an approach warning buzzer is heard often

### Driving in vehicle-to-vehicle distance control mode

This mode employs a radar to detect the presence of vehicles up to approximately 328 ft. (100 m) ahead, determines the current vehicle-to-vehicle following distance, and operates to maintain a suitable following distance from the vehicle ahead. The desired vehicle-to-vehicle distance can also be set by operating the vehicle-to-vehicle distance switch.

When driving on downhill slopes, the vehicle-to-vehicle distance may become shorter.

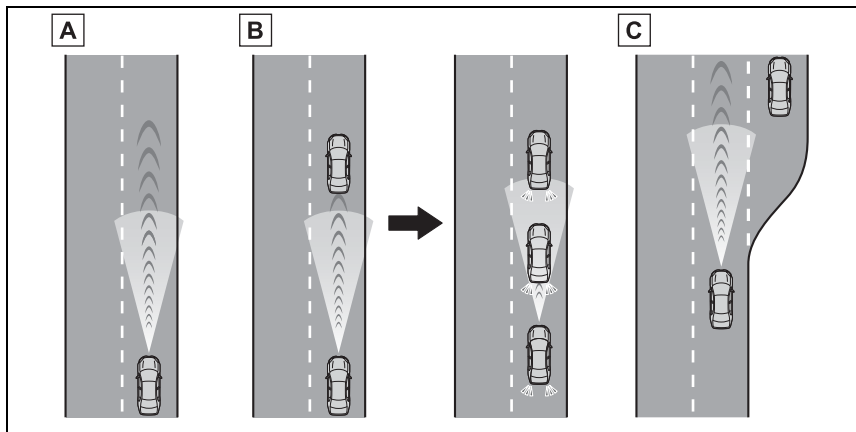

- A** Example of constant speed cruising  
When there are no vehicles ahead

The vehicle travels at the speed set by the driver.

- B** Example of deceleration cruising and follow-up cruising  
When a preceding vehicle driving slower than the set speed appears

When a vehicle is detected running ahead of you, the system automatically decelerates your vehicle. When a greater reduction in vehicle speed is necessary, the system applies the brakes (the stop lights will come on at this time). The system will respond to changes in the speed of the vehicle ahead in order to maintain the vehicle-to-vehicle distance set by the driver. Approach warning warns you when the system cannot decelerate sufficiently to prevent your vehicle from closing in on the vehicle ahead.

When the vehicle ahead of you stops, your vehicle will also stop (vehicle is stopped by system control). After the vehicle ahead starts off, pressing the "+RES" switch or depressing the accelerator pedal (start-off operation) will resume follow-up cruising. If the start-off operation is not performed, system control continues to keep your vehicle stopped.

When the turn signal lever is operated and your vehicle moves to an overtaking lane while driving at 50 mph (80 km/h) or more, the vehicle will accelerate to help to overtake a passing vehicle.

The system's identification of what is an overtaking lane may be determined solely based on the location of the steering wheel in the vehicle (left side driver position versus right side driver position.) If the vehicle is driven to a region where the overtaking lane is on a different side from where the vehicle is normally driven, the vehicle may accelerate when the turn signal lever is operated in the opposite direction to the overtaking lane (e.g., if the driver normally operates the vehicle in a region where the overtaking lane is to the right but then drives to a region where the overtaking lane is to the left, the vehicle may accelerate when the right turn signal is activated).

**C** Example of acceleration

When there are no longer any preceding vehicles driving slower than the set speed

The system accelerates until the set speed is reached. The system then returns to constant speed cruising.

**Setting the vehicle speed (vehicle-to-vehicle distance control mode)**

- 1 Press the cruise control main switch to activate the cruise control.

Dynamic radar cruise control indicator will come on and a message will be displayed on the multi-information display. Press the switch again to deactivate the cruise control.

If the cruise control main switch is pressed and held for 1.5 seconds or more, the system turns on in constant speed control mode.

(→P.236)

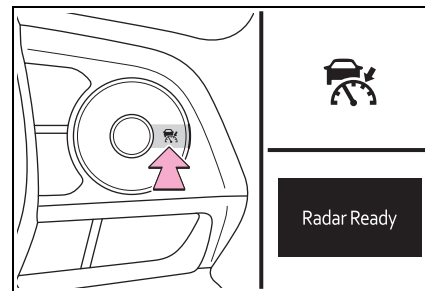

- 2 Accelerate or decelerate, with accelerator pedal operation, to the desired vehicle speed (at or above approximately 20 mph [30 km/h]) and press the “-SET” switch to set the speed.

Cruise control “SET” indicator will come on.

The vehicle speed at the moment the switch is released becomes the

set speed.

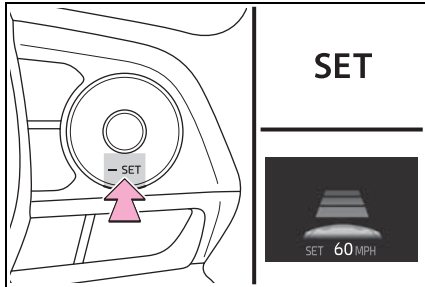

### Adjusting the set speed

To change the set speed, press the “+RES” or “-SET” switch until the desired set speed is displayed.

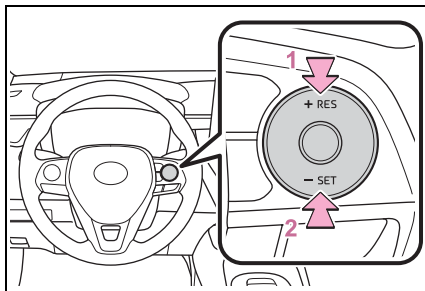

1 Increases the speed (Except when the vehicle has been stopped by system control in vehicle-to-vehicle distance control mode)

2 Decreases the speed

Fine adjustment: Press the switch.

Large adjustment: Press and hold the switch to change the speed, and release when the desired speed is reached.

In the vehicle-to-vehicle distance control mode, the set speed will be increased or decreased as follows:

► For the U.S. mainland and Hawaii

Fine adjustment: By 1 mph (1.6 km/h)<sup>\*1</sup> or 1 km/h (0.6 mph)<sup>\*2</sup> each time the switch is pressed

Large adjustment: Increases or decreases in 1 mph (1.6 km/h)<sup>\*1</sup> or 1 km/h (0.6 mph)<sup>\*2</sup> increments for as long as the switch is held

► Except for the U.S. mainland and Hawaii

Fine adjustment: By 1 mph (1.6 km/h)<sup>\*1</sup> or 1 km/h (0.6 mph)<sup>\*2</sup> each time the switch is pressed

Large adjustment: Increases or decreases in 5 mph (8 km/h)<sup>\*1</sup> or 5 km/h (3.1 mph)<sup>\*2</sup> increments for as long as the switch is held

In the constant speed control mode (→P.236), the set speed will be increased or decreased as follows:

Fine adjustment: By 1 mph (1.6 km/h)<sup>\*1</sup> or 1 km/h (0.6 mph)<sup>\*2</sup> each time the switch is pressed

Large adjustment: The speed will continue to change while the switch is held.

\*1: When the set speed is shown in “MPH”

\*2: When the set speed is shown in “km/h”

### Changing the vehicle-to-vehicle distance (vehicle-to-vehicle distance control mode)

Pressing the switch changes the

vehicle-to-vehicle distance as follows:

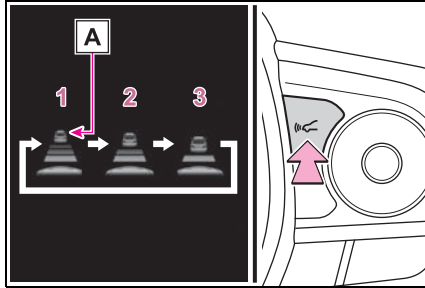

- 1 Long
- 2 Medium
- 3 Short

The vehicle-to-vehicle distance is set automatically to long mode when the engine switch is turned to ON.

If a vehicle is running ahead of you, the preceding vehicle mark **A** will also be displayed.

**Vehicle-to-vehicle distance settings (vehicle-to-vehicle distance control mode)**

Select a distance from the table below. Note that the distances shown correspond to a vehicle speed of 50 mph (80 km/h). Vehicle-to-vehicle distance increases/decreases in accordance with vehicle speed. When the vehicle is stopped by system control, the vehicle stops at a certain vehicle-to-vehicle distance depending on the situation.

Distance options	Vehicle-to-vehicle distance
Long	Approximately 160 ft. (50 m)
Medium	Approximately 130 ft. (40 m)
Short	Approximately 100 ft. (30 m)

**Resuming follow-up cruising when the vehicle has been stopped by system control (vehicle-to-vehicle distance control mode)**

After the vehicle ahead of you starts off, press the “+RES” switch.

Your vehicle will also resume follow-up cruising if the accelerator pedal is depressed after the vehicle ahead of you starts off.

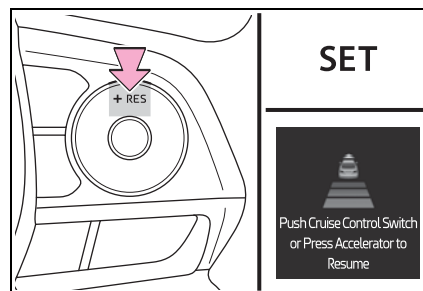

4 Driving

### Canceling and resuming the speed control

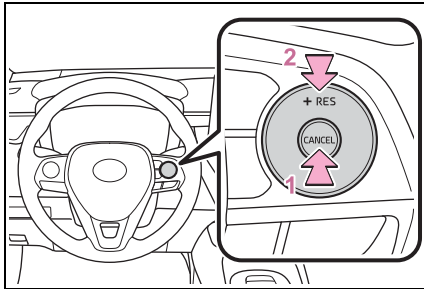

- 1 Pressing the cancel switch cancels the speed control.

The speed control is also canceled when the brake pedal is depressed. (When the vehicle has been stopped by system control, depressing the brake pedal does not cancel the setting.)

- 2 Pressing the “+RES” switch resumes the cruise control and returns vehicle speed to the set speed.

### Approach warning (vehicle-to-vehicle distance control mode)

When your vehicle is too close to a vehicle ahead, and sufficient automatic deceleration via the cruise control is not possible, the display will flash and the buzzer will sound to alert the driver. An example of this would be if another driver cuts in front of you while you are following a vehicle. Depress the brake pedal to ensure an appropriate vehicle-to-vehicle distance.

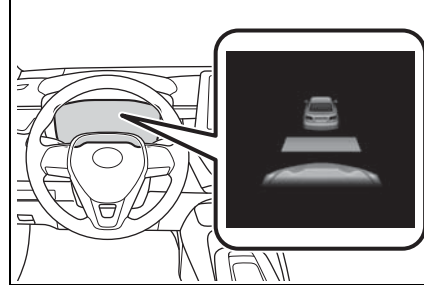

### Warnings may not occur when

In the following instances, warnings may not occur even when the vehicle-to-vehicle distance is small.

- When the speed of the preceding vehicle matches or exceeds your vehicle speed
- When the preceding vehicle is traveling at an extremely slow speed
- Immediately after the cruise control speed was set
- When depressing the accelerator pedal

### Selecting constant speed control mode

When constant speed control mode is selected, your vehicle will maintain a set speed without controlling the vehicle-to-vehicle distance. Select this mode only when vehicle-to-vehicle distance control mode does not function correctly due to a dirty radar, etc.



- 1 With the cruise control off, press and hold the cruise control main switch for 1.5 seconds or more.

Immediately after the switch is pressed, the dynamic radar cruise control indicator will come on. Afterwards, it switches to the cruise control indicator.

Switching to constant speed control mode is only possible when operating the switch with the cruise control off.

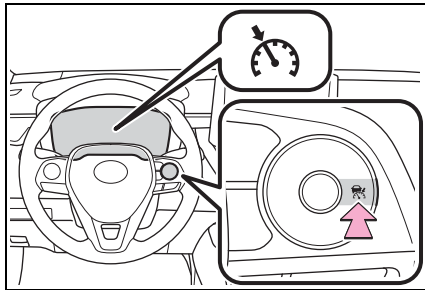

- 2 Accelerate or decelerate, with accelerator pedal operation, to the desired vehicle speed (at or above approximately 20 mph [30 km/h]) and press the “-SET” switch to set the speed.

Cruise control “SET” indicator will come on.

The vehicle speed at the moment the switch is released becomes the set speed.

Adjusting the speed setting:  
→P.234

Canceling and resuming the speed

setting: →P.236

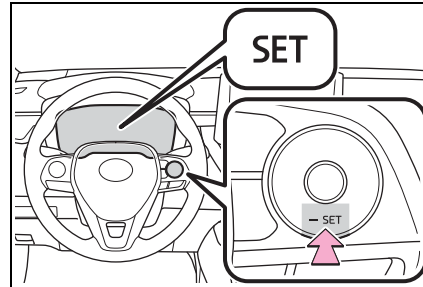

■ **Dynamic radar cruise control with full-speed range can be set when**

- The shift lever is in D.
- The desired set speed can be set when the vehicle speed is approximately 20 mph (30 km/h) or more. (However, when the vehicle speed is set while driving at below approximately 20 mph [30 km/h], the set speed will be set to approximately 20 mph [30 km/h].)

■ **Accelerating after setting the vehicle speed**

The vehicle can accelerate by operating the accelerator pedal. After accelerating, the set speed resumes. However, during vehicle-to-vehicle distance control mode, the vehicle speed may decrease below the set speed in order to maintain the distance to the preceding vehicle.

■ **When the vehicle stops while follow-up cruising**

- Pressing the “+RES” switch while the vehicle ahead stops will resume follow-up cruising if the vehicle ahead starts off within approximately 3 seconds after the switch is pressed.
- If the vehicle ahead starts off within 3 seconds after your vehicle stops, follow-up cruising will be resumed.

#### ■ Automatic cancelation of vehicle-to-vehicle distance control mode

Vehicle-to-vehicle distance control mode is automatically canceled in the following situations.

- VSC is activated.
- TRAC is activated for a period of time.
- When the VSC or TRAC system is turned off.
- The sensor cannot detect correctly because it is covered in some way.
- Pre-collision braking is activated.
- The parking brake is operated.
- The vehicle is stopped by system control on a steep incline.
- The following are detected when the vehicle has been stopped by system control:
  - The driver is not wearing a seat belt.
  - The driver's door is opened.
  - The vehicle has been stopped for about 3 minutes

If vehicle-to-vehicle distance control mode is automatically canceled for any reasons other than the above, there may be a malfunction in the system. Contact your Toyota dealer.

#### ■ Automatic cancelation of constant speed control mode

Constant speed control mode is automatically canceled in the following situations:

- Actual vehicle speed is more than approximately 10 mph (16 km/h) below the set vehicle speed.
- Actual vehicle speed falls below approximately 20 mph (30 km/h).
- VSC is activated.
- TRAC is activated for a period of time.
- When the VSC or TRAC system is turned off.
- Pre-collision braking is activated.

If constant speed control mode is automatically canceled for any reasons other than the above, there may be a malfunction in the system. Contact your Toyota dealer.

#### ■ Brake operation

A brake operation sound may be heard and the brake pedal response may change, but these are not malfunctions.

#### ■ Warning messages and buzzers for dynamic radar cruise control with full-speed range

Warning messages and buzzers are used to indicate a system malfunction or to inform the driver of the need for caution while driving. If a warning message is shown on the multi-information display, read the message and follow the instructions. (→P.201, 521)

#### ■ When the sensor may not be correctly detecting the vehicle ahead

In the case of the following and depending on the conditions, operate the brake pedal when deceleration of the system is insufficient or operate the accelerator pedal when acceleration is required.

As the sensor may not be able to correctly detect these types of vehicles, the approach warning (→P.236) may not be activated.

- Vehicles that cut in suddenly
- Vehicles traveling at low speeds
- Vehicles that are not moving in the same lane
- Vehicles with small rear ends (trailers with no load on board, etc.)

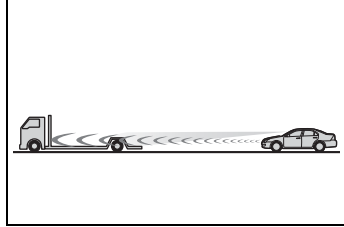

- Motorcycles traveling in the same lane
- When water or snow thrown up by the surrounding vehicles hinders the detecting of the sensor
- When your vehicle is pointing upwards (caused by a heavy load in the luggage compartment, etc.)

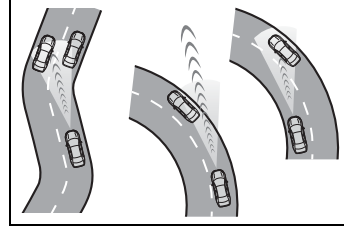

- When steering wheel operation or your position in the lane is unstable

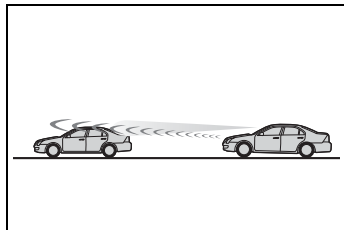

- Preceding vehicle has an extremely high ground clearance

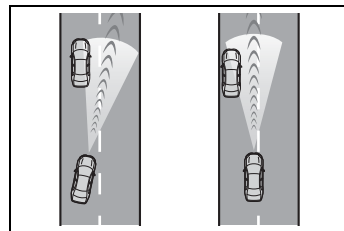

- When the vehicle ahead of you decelerates suddenly
- When driving on a road surrounded by a structure, such as in a tunnel or on a bridge
- While the vehicle speed is decreasing to the set speed after the vehicle accelerates by depressing the accelerator pedal

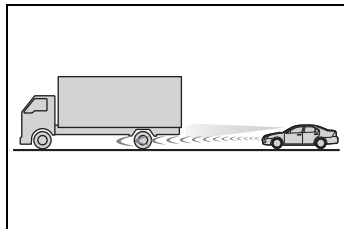

■ **Conditions under which the vehicle-to-vehicle distance control mode may not function correctly**

In the case of the following conditions, operate the brake pedal (or accelerator pedal, depending on the situation) as necessary.

As the sensor may not be able to correctly detect vehicles ahead, the system may not operate properly.

- When the road curves or when the lanes are narrow

### Dynamic radar cruise control\*

\*: If equipped

**In vehicle-to-vehicle distance control mode, the vehicle automatically accelerates and decelerates to match the speed changes of the preceding vehicle even if the accelerator pedal is not depressed. In constant speed control mode, the vehicle runs at a fixed speed.**

**Use the dynamic radar cruise control on freeways and highways.**

- Vehicle-to-vehicle distance control mode (→P.242)
- Constant speed control mode (→P.247)

### System Components

#### ■ Meter display

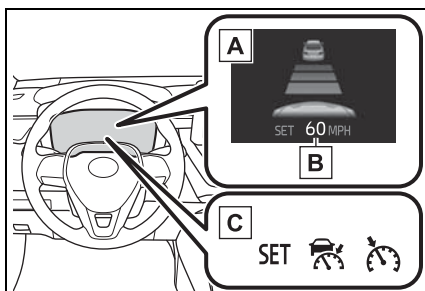

- A** Multi-information display
- B** Set speed
- C** Indicators

#### ■ Operation switches

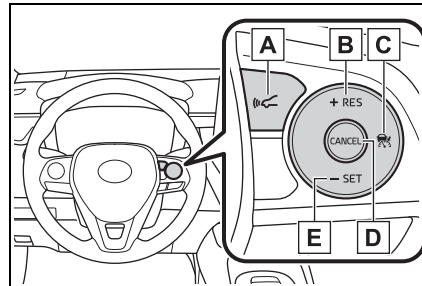

- A** Vehicle-to-vehicle distance switch
- B** "+RES" switch
- C** Cruise control main switch
- D** Cancel switch
- E** "-SET" switch

#### ⚠ WARNING

##### ■ Before using dynamic radar cruise control

● Driving safely is the sole responsibility of the driver. Do not rely solely on the system, and drive safely by always paying careful attention to your surroundings.

● The dynamic radar cruise control provides driving assistance to reduce the driver's burden. However, there are limitations to the assistance provided.

Read the following conditions carefully. Do not overly rely on this system and always drive carefully.

- When the sensor may not be correctly detecting the vehicle ahead: →P.248
- Conditions under which the vehicle-to-vehicle distance control mode may not function correctly: →P.249

**WARNING**

- Set the speed appropriately depending on the speed limit, traffic flow, road conditions, weather conditions, etc. The driver is responsible for checking the set speed.
- Even when the system is functioning normally, the condition of the preceding vehicle as detected by the system may differ from the condition observed by the driver. Therefore, the driver must always remain alert, assess the danger of each situation and drive safely. Relying solely on this system or assuming the system ensures safety while driving can lead to an accident, resulting in death or serious injury.
- Switch the dynamic radar cruise control setting to off, using the cruise control main switch when not in use.

**■ Cautions regarding the driving assist systems**

Observe the following precautions, as there are limitations to the assistance provided by the system. Failure to do so may cause an accident resulting in death or serious injury.

- Assisting the driver to measure following distance

The dynamic radar cruise control is only intended to help the driver in determining the following distance between the driver's own vehicle and a designated vehicle traveling ahead. It is not a mechanism that allows careless or inattentive driving, and it is not a system that can assist the driver in low-visibility conditions.

It is still necessary for driver to pay close attention to the vehicle's surroundings.

- Assisting the driver to judge proper following distance

The dynamic radar cruise control determines whether the following distance between the driver's own vehicle and a designated vehicle traveling ahead is within a set range. It is not capable of making any other type of judgement. Therefore, it is absolutely necessary for the driver to remain vigilant and to determine whether or not there is a possibility of danger in any given situation.

- Assisting the driver to operate the vehicle

The dynamic radar cruise control does not include functions which will prevent or avoid collisions with vehicles ahead of your vehicle. Therefore, if there is ever any possibility of danger, the driver must take immediate and direct control of the vehicle and act appropriately in order to ensure the safety of all involved.

**■ Situations unsuitable for dynamic radar cruise control**

Do not use dynamic radar cruise control in any of the following situations. Doing so may result in inappropriate speed control and could cause an accident resulting in death or serious injury.

- Roads where there are pedestrians, cyclists, etc.
- In heavy traffic
- On roads with sharp bends
- On winding roads
- On slippery roads, such as those covered with rain, ice or snow

**WARNING**

- On steep downhills, or where there are sudden changes between sharp up and down gradients

Vehicle speed may exceed the set speed when driving down a steep hill.

- At entrances to freeways and highways
- When weather conditions are bad enough that they may prevent the sensors from detecting correctly (fog, snow, sandstorm, heavy rain, etc.)
- When there is rain, snow, etc. on the front surface of the radar or front camera
- In traffic conditions that require frequent repeated acceleration and deceleration
- During emergency towing
- When an approach warning buzzer is heard often

**Driving in vehicle-to-vehicle distance control mode**

This mode employs a radar to detect the presence of vehicles up to approximately 328 ft. (100 m) ahead, determines the current vehicle-to-vehicle following distance, and operates to maintain a suitable following distance from the vehicle ahead. The desired vehicle-to-vehicle distance can also be set by operating the vehicle-to-vehicle distance switch.

When driving on downhill slopes, the vehicle-to-vehicle distance may become shorter.

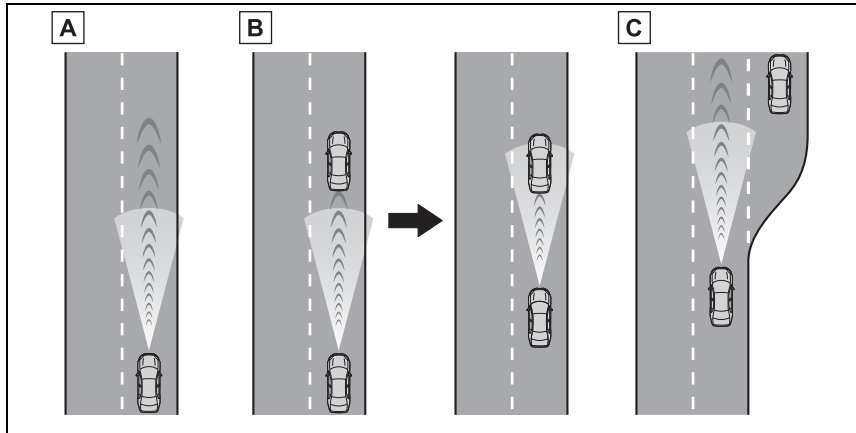
**A** Example of constant speed cruising

When there are no vehicles ahead

The vehicle travels at the speed set by the driver.

**B** Example of deceleration cruising and follow-up cruising

When a preceding vehicle driving slower than the set speed appears

When a vehicle is detected running ahead of you, the system automatically decelerates your vehicle. When a greater reduction in vehicle speed is necessary, the system applies the brakes (the stop lights will come on at this time). The system will respond to changes in the speed of the vehicle ahead in order to maintain the vehicle-to-vehicle distance set by the driver. Approach warning warns you when the system cannot decelerate sufficiently to prevent your vehicle from closing in on the vehicle ahead.

When the turn signal lever is operated and your vehicle moves to an overtaking lane while driving at 50 mph (80 km/h) or more, the vehicle will accelerate to help to overtake a passing vehicle.

The system's identification of what is an overtaking lane may be determined solely based on the location of the steering wheel in the vehicle (left side driver position versus right side driver position.) If the vehicle is driven to a region where the overtaking lane is on a different side from where the vehicle is normally driven, the vehicle may accelerate when the turn signal lever is operated in the opposite direction to the overtaking lane (e.g., if the driver normally operates the vehicle in a region where the overtaking lane is to the right but then drives to a region where the overtaking lane is to the left, the vehicle may accelerate when the right turn signal is activated).

**C** Example of acceleration

When there are no longer any preceding vehicles driving slower than the set speed

The system accelerates until the set speed is reached. The system then returns to constant speed cruising.

**Setting the vehicle speed (vehicle-to-vehicle distance control mode)**

- 1 Press the cruise control main switch to activate the cruise control.

Dynamic radar cruise control indicator will come on and a message will be displayed on the multi-information display. Press the switch again to deactivate the cruise control.

If the cruise control main switch is pressed and held for 1.5 seconds or more, the system turns on in constant speed control mode. (→P.247)

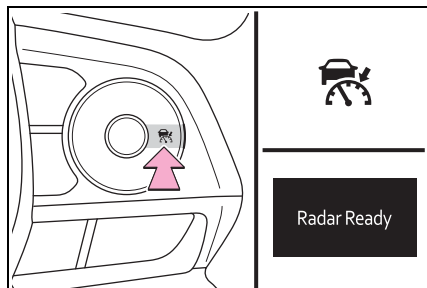

- 2 Accelerate or decelerate, with accelerator pedal operation, to the desired vehicle speed (at or above approximately 20 mph [30 km/h]) and press the “-SET” switch to set the speed.

Cruise control “SET” indicator will come on.

The vehicle speed at the moment the switch is released becomes the

set speed.

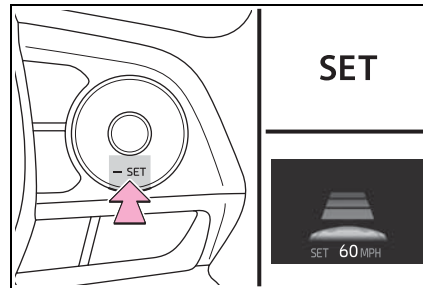

**Adjusting the set speed**

To change the set speed, press the “+RES” or “-SET” switch until the desired set speed is displayed.

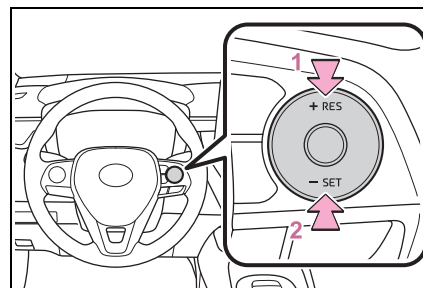

- 1 Increases the speed
- 2 Decreases the speed

Fine adjustment: Press the switch.

Large adjustment: Press and hold the switch to change the speed, and release when the desired speed is reached.

In the vehicle-to-vehicle distance control mode, the set speed will be increased or decreased as follows:



- ▶ For the U.S. mainland and Hawaii

Fine adjustment: By 1 mph (1.6 km/h)<sup>\*1</sup> or 1 km/h (0.6 mph)<sup>\*2</sup> each time the switch is pressed

Large adjustment: Increases or decreases in 1 mph (1.6 km/h)<sup>\*1</sup> or 1 km/h (0.6 mph)<sup>\*2</sup> increments for as long as the switch is held

- ▶ Except for the U.S. mainland and Hawaii

Fine adjustment: By 1 mph (1.6 km/h)<sup>\*1</sup> or 1 km/h (0.6 mph)<sup>\*2</sup> each time the switch is pressed

Large adjustment: Increases or decreases in 5 mph (8 km/h)<sup>\*1</sup> or 5 km/h (3.1 mph)<sup>\*2</sup> increments for as long as the switch is held

In the constant speed control mode (→P.247), the set speed will be increased or decreased as follows:

Fine adjustment: By 1 mph (1.6 km/h)<sup>\*1</sup> or 1 km/h (0.6 mph)<sup>\*2</sup> each time the switch is pressed

Large adjustment: The speed will continue to change while the switch is held.

<sup>\*1</sup>: When the set speed is shown in "MPH"

<sup>\*2</sup>: When the set speed is shown in "km/h"

**Changing the vehicle-to-vehicle distance (vehicle-to-vehicle distance control mode)**

Pressing the switch changes the

vehicle-to-vehicle distance as follows:

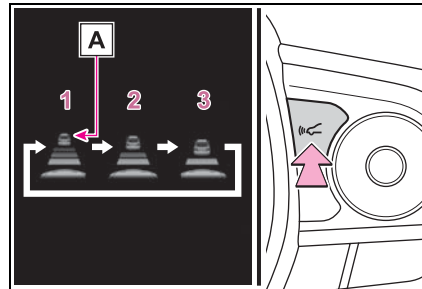

- 1 Long
- 2 Medium
- 3 Short

The vehicle-to-vehicle distance is set automatically to long mode when the engine switch is turned to ON.

If a vehicle is running ahead of you, the preceding vehicle mark **A** will also be displayed.

**Vehicle-to-vehicle distance settings (vehicle-to-vehicle distance control mode)**

Select a distance from the table below. Note that the distances shown correspond to a vehicle speed of 50 mph (80 km/h). Vehicle-to-vehicle distance increases/decreases in accordance with vehicle speed.

Distance options	Vehicle-to-vehicle distance
Long	Approximately 160 ft. (50 m)
Medium	Approximately 130 ft. (40 m)
Short	Approximately 100 ft. (30 m)

**Canceling and resuming the speed control**

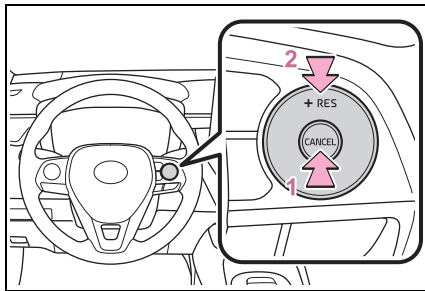

- 1 Pressing the cancel switch cancels the speed control. The speed control is also canceled when the brake pedal is depressed.
  - 2 Pressing the “+RES” switch resumes the cruise control and returns vehicle speed to the set speed.
- However, cruise control does not resume when the vehicle speed is approximately 16 mph (25 km/h) or less.

**Approach warning (vehicle-to-vehicle distance control mode)**

When your vehicle is too close to a vehicle ahead, and suffi-

cient automatic deceleration via the cruise control is not possible, the display will flash and the buzzer will sound to alert the driver. An example of this would be if another driver cuts in front of you while you are following a vehicle. Depress the brake pedal to ensure an appropriate vehicle-to-vehicle distance.

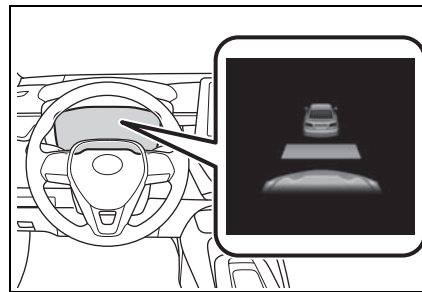

■ **Warnings may not occur when**

In the following instances, warnings may not occur even when the vehicle-to-vehicle distance is small.

- When the speed of the preceding vehicle matches or exceeds your vehicle speed
- When the preceding vehicle is traveling at an extremely slow speed
- Immediately after the cruise control speed was set
- When depressing the accelerator pedal

**Selecting constant speed control mode**

When constant speed control mode is selected, your vehicle will maintain a set speed without controlling the vehicle-to-vehicle distance. Select this mode only when vehicle-to-vehicle distance control mode does not function correctly due to a dirty radar, etc.

- 1 With the cruise control off, press and hold the cruise control main switch for 1.5 seconds or more.

Immediately after the switch is pressed, the dynamic radar cruise control indicator will come on. Afterwards, it switches to the cruise control indicator.

Switching to constant speed control mode is only possible when operating the switch with the cruise control off.

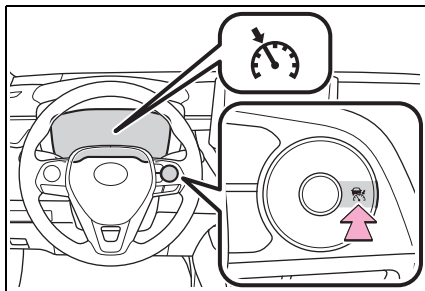

- 2 Accelerate or decelerate, with accelerator pedal operation, to the desired vehicle speed (at or above approximately 20 mph [30 km/h]) and press the “-SET” switch to set the speed.

Cruise control “SET” indicator will

come on.

The vehicle speed at the moment the switch is released becomes the set speed.

Adjusting the speed setting:  
→P.244

Canceling and resuming the speed setting: →P.246

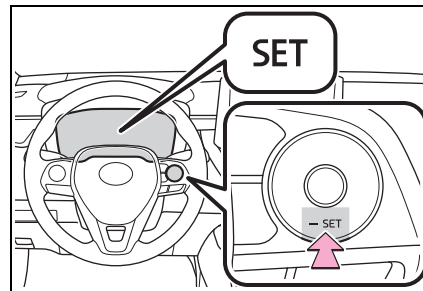

**Dynamic radar cruise control can be set when**

- Vehicles with a continuously variable transmission: The shift lever is in D.
- Vehicles with a manual transmission: The shift lever is in range 2nd or higher.
- Depending on the control mode, this item can be set at the following speeds.
  - Vehicle-to-vehicle distance control mode: Approximately 20 mph (30 km/h) or more
  - Constant speed control mode: Approximately 20 mph (30 km/h) or more

**Accelerating after setting the vehicle speed**

The vehicle can accelerate by operating the accelerator pedal. After accelerating, the set speed resumes. However, during vehicle-to-vehicle distance control mode, the vehicle speed may decrease below the set speed in order to maintain the distance to the preceding vehicle.

#### ■ Shift position selection (vehicles with a manual transmission)

Select a shift position according to the vehicle speed. If the engine speed is too high or too low, control may be automatically canceled.

#### ■ Automatic cancelation of vehicle-to-vehicle distance control mode

Vehicle-to-vehicle distance control mode is automatically canceled in the following situations.

- Actual vehicle speed falls below approximately 16 mph (25 km/h).
- VSC is activated.
- TRAC is activated for a period of time.
- When the VSC or TRAC system is turned off.
- The sensor cannot detect correctly because it is covered in some way.
- Pre-collision braking is activated.
- Vehicles with a manual transmission: When the shift lever is in N or the clutch pedal is depressed for a certain amount of time or more.

If vehicle-to-vehicle distance control mode is automatically canceled for any reasons other than the above, there may be a malfunction in the system. Contact your Toyota dealer.

#### ■ Automatic cancelation of constant speed control mode

Constant speed control mode is automatically canceled in the following situations:

- Actual vehicle speed is more than approximately 10 mph (16 km/h) below the set vehicle speed.
- Actual vehicle speed falls below approximately 20 mph (30 km/h).
- VSC is activated.
- TRAC is activated for a period of time.

- When the VSC or TRAC system is turned off.
- Pre-collision braking is activated.
- Vehicles with a manual transmission: When the shift lever is in N or the clutch pedal is depressed for a certain amount of time or more.

If constant speed control mode is automatically canceled for any reasons other than the above, there may be a malfunction in the system. Contact your Toyota dealer.

#### ■ Brake operation

A brake operation sound may be heard and the brake pedal response may change, but these are not malfunctions.

#### ■ Warning messages and buzzers for dynamic radar cruise control

Warning messages and buzzers are used to indicate a system malfunction or to inform the driver of the need for caution while driving. If a warning message is shown on the multi-information display, read the message and follow the instructions. (→P.201, 521)

#### ■ When the sensor may not be correctly detecting the vehicle ahead

In the case of the following and depending on the conditions, operate the brake pedal when deceleration of the system is insufficient or operate the accelerator pedal when acceleration is required.

As the sensor may not be able to correctly detect these types of vehicles, the approach warning (→P.246) may not be activated.

- Vehicles that cut in suddenly
- Vehicles traveling at low speeds
- Vehicles that are not moving in the same lane
- Vehicles with small rear ends (trailers with no load on board,

etc.)

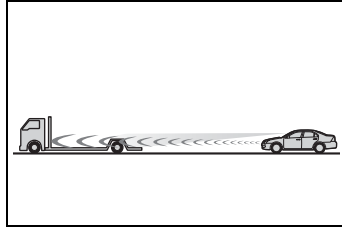

- Motorcycles traveling in the same lane
- When water or snow thrown up by the surrounding vehicles hinders the detecting of the sensor
- When your vehicle is pointing upwards (caused by a heavy load in the luggage compartment, etc.)

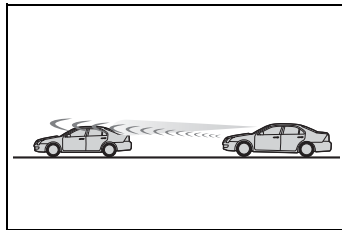

- Preceding vehicle has an extremely high ground clearance

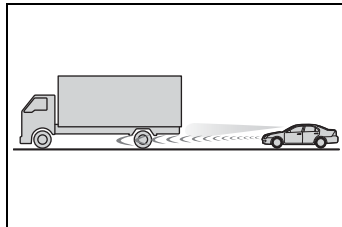

■ **Conditions under which the vehicle-to-vehicle distance control mode may not function correctly**

In the case of the following conditions, operate the brake pedal (or accelerator pedal, depending on the situation) as necessary.

As the sensor may not be able to correctly detect vehicles ahead, the system may not operate properly.

- When the road curves or when the

lanes are narrow

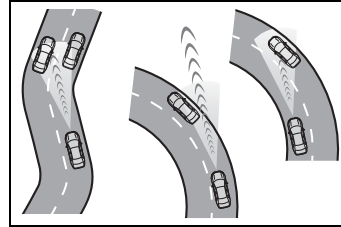

- When steering wheel operation or your position in the lane is unstable

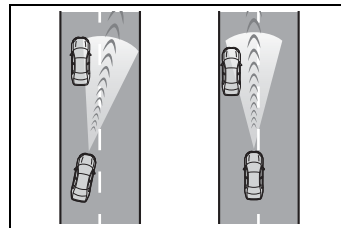

- When the vehicle ahead of you decelerates suddenly
- When driving on a road surrounded by a structure, such as in a tunnel or on a bridge
- While the vehicle speed is decreasing to the set speed after the vehicle accelerates by depressing the accelerator pedal

### RSA (Road Sign Assist)\*

\*: If equipped

**The RSA system recognizes specific road signs using the front camera to provide information to the driver via the display.**

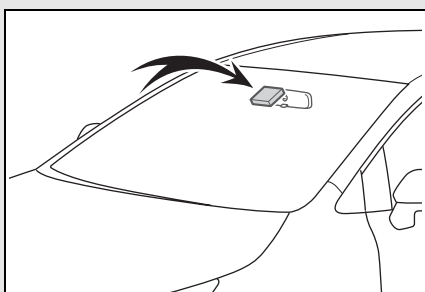

**If the system judges that the vehicle is being driven over the speed limit, performing prohibited actions, etc. according to the recognized road signs, it notifies the driver through a visual notification and notification buzzer.**

#### **WARNING**

##### **■ Before using the RSA**

Do not rely solely upon the RSA system. RSA is a system which supports the driver by providing information, but it is not a replacement for a driver's own vision and awareness. Drive safely by always paying careful attention to the traffic rules.

### Indication on the multi-information display

When the front camera recognizes a sign, the sign will be displayed on the multi-information display.

- When the driving support system information is selected, a maximum of 3 signs can be displayed. (→P.100)

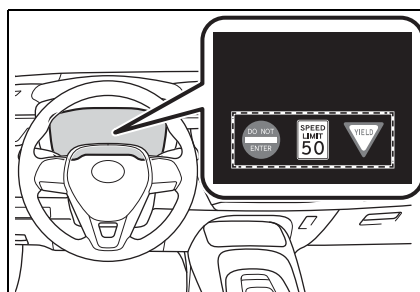

- When a tab other than the driving support system information is selected, the following types of road signs will be displayed. (→P.100)
  - Speed limit sign
  - Do Not Enter sign (when notification is necessary)

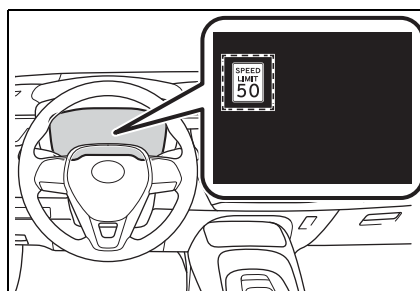

If signs other than speed limit signs are recognized, they will be displayed in an overlapping stack

under the current speed limit sign.

**Supported types of road signs**

The following types of road signs, including electronic signs and blinking signs, are recognized.

A non-official or a recently introduced traffic sign may not be recognized.



**Notification function**

In the following situations, the RSA system will notify the driver.

- When the vehicle speed exceeds the speed notification threshold of the speed limit sign displayed, the sign display will be emphasized and a buzzer will sound.
- When the RSA system recognizes a do not enter sign and

determines that your vehicle has entered a no-entry area, the displayed sign will flash and a buzzer will sound.

Depending on the situation, a notification function may not operate properly.

**Setting procedure**

- 1 Press < or > of the meter control switches and select
- 2 Press ^ or v of the meter control switches and select , then press OK

**Automatic turn-off of RSA sign display**

In the following situations, a displayed speed limit sign and/or do not enter sign will stop being displayed automatically:

- No sign has been recognized for a certain distance.
- The road changes due to a left or right turn, etc.

In the following situations, stop and yield signs will stop being displayed automatically:

- The system determines that your vehicle has passed the sign.
- The road changes due to a left or right turn, etc.

**Conditions in which the function may not operate or detect correctly**

In the following situations, RSA does not operate normally and may not recognize signs, display the incorrect sign, etc. However, this does not indicate a malfunction.

- The front camera is misaligned due to a strong impact being applied to the sensor, etc.
- Dirt, snow, stickers, etc. are on the

windshield near the front camera.

- In inclement weather such as heavy rain, fog, snow or sand storms.
- Light from an oncoming vehicle, the sun, etc. enters the front camera.
- The sign is dirty, faded, tilted or bent.
- The contrast of electronic sign is low.
- All or part of the sign is hidden by the leaves of a tree, a pole, etc.
- The sign is only visible to the front camera for a short amount of time.
- The driving scene (turning, lane change, etc.) is judged incorrectly.
- If a sign not appropriate for the currently traveled lane, but the sign exists directly after a freeway branches, or in an adjacent lane just before merging.
- Stickers are attached to the rear of the preceding vehicle.
- A sign resembling a system compatible sign is recognized.
- Side road speed signs may be detected and displayed (if positioned in sight of the front camera) while the vehicle is traveling on the main road.
- Roundabout exit road speed signs may be detected and displayed (if positioned in sight of the front camera) while traveling on a roundabout.
- The front of the vehicle is raised or lowered due to the carried load.
- The surrounding brightness is not sufficient or changes suddenly.
- When a sign intended for trucks, etc. is recognized.
- The speed information displayed on the meter and on the navigation system may be different due to the navigation system using map data.

#### ■ Speed limit sign display

If the engine switch was last turned off while a speed limit sign was displayed on the multi-information display, the same sign displays again when the engine switch is turned to ON.

#### ■ If “RSA Malfunction Visit Your Dealer” is shown

The system may be malfunctioning. Have the vehicle inspected by your Toyota dealer.

#### ■ Customization

Some functions can be customized. (→P.581)



**BSM (Blind Spot Monitor)\***

\*: If equipped

**The Blind Spot Monitor is a system that uses rear side radar sensors installed on the inner side of the rear bumper on the left and right side to assist the driver in confirming safety when changing lanes.**

**⚠ WARNING****■ Cautions regarding the use of the system**

The driver is solely responsible for safe driving. Always drive safely, taking care to observe your surroundings.

The Blind Spot Monitor is a supplementary function which alerts the driver that a vehicle is in a blind spot of the outside rear view mirrors or is approaching rapidly from behind into a blind spot. Do not overly rely on the Blind Spot Monitor. As the function cannot judge if it is safe to change lanes, over reliance could lead to an accident resulting in death or serious injury.

As the system may not function correctly under certain conditions, the driver's own visual confirmation of safety is necessary.

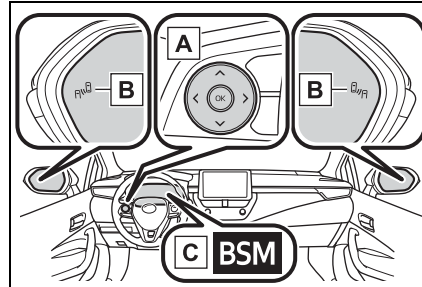
**System components****A** Meter control switches

Turning the Blind Spot Monitor on/off.

**B** Outside rear view mirror indicators

When a vehicle is detected in a blind spot of the outside rear view mirrors or approaching rapidly from behind into a blind spot, the outside rear view mirror indicator on the detected side will illuminate. If the turn signal lever is operated toward the detected side, the outside rear view mirror indicator flashes.

**C** BSM indicator

Illuminates when the Blind Spot Monitor is enabled

**■ Outside rear view mirror indicator visibility**

In strong sunlight, the outside rear view mirror indicator may be difficult to see.

**■ When “Blind Spot Monitor Unavailable” is shown on the multi-information display**

Ice, snow, mud, etc., may be attached to the rear bumper around the sensors. (→P.255) The system should return to normal operation after removing the ice, snow, mud, etc. from the rear bumper. Additionally, the sensors may not operate

normally when driving in extremely hot or cold environments.

■ **When “Blind Spot Monitor Malfunction Visit Your Dealer” is shown on the multi-information display**

There may be a sensor malfunction

■ **Certification**

► Except for vehicles sold in Canada

FCC ID : OAYSRR3A

This device complies with part 15 of the FCC Rules. Operation is subject to the following two conditions:  
(1) This device may not cause harmful interference, and  
(2) this device must accept any interference received, including interference that may cause undesired operation.

FCC Warning

Changes or modifications not expressly approved by the party responsible for compliance could void the user's authority to operate the equipment.

► For vehicles sold in Canada

Applicable law : Canada 310

This device complies with Industry Canada licence-exempt RSS standard(s). Operation is subject to the following two conditions: (1) this device may not cause interference, and (2) this device must accept any interference, including interference that may cause undesired operation of the device.

Frequency bands : 24.05 - 24.25GHz

Output power : less than 20 milliwatts

Droit applicable : Canada 310

Le présent appareil est conforme aux CNR d'Industrie Canada applicables aux appareils radio exempts de licence. L'exploitation est autorisée aux deux conditions suivantes : (1) l'appareil ne doit pas produire de brouillage, et (2) l'utilisateur de l'appareil doit accepter tout brouillage radioélectrique subi, même si le brouillage est susceptible d'en compromettre le fonctionnement.

Bandes de fréquences : 24.05 - 24.25GHz

Puissance émise : Moins de 20 milliwatts

of misaligned. Have the vehicle inspected by your Toyota dealer.

■ **Customization**

Some functions can be customized.  
(→P.581)

**⚠ WARNING****■ Handling the rear side radar sensor**

Blind Spot Monitor sensors are installed behind the left and right sides of the rear bumper respectively. Observe the following to ensure the Blind Spot Monitor can operate correctly.

- Keep the sensors and the surrounding areas on the rear bumper clean at all times.

If a sensor or its surrounding area on the rear bumper is dirty or covered with snow, the Blind Spot Monitor may not operate and a warning message (→P.253) will be displayed. In this situation, clear off the dirt or snow and drive the vehicle with the operation conditions of the BSM function (→P.257) satisfied for approximately 10 minutes. If the warning message does not disappear, have the vehicle inspected by your Toyota dealer.

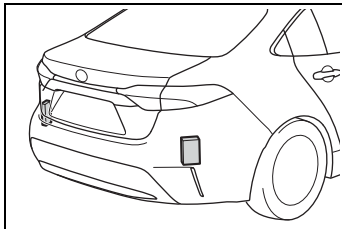

- Do not attach accessories, stickers (including transparent stickers), aluminum tape, etc. to a sensor or its surrounding area on the rear bumper.

- Do not subject a sensor or its surrounding area on the rear bumper to a strong impact. If a sensor is moved even slightly off position, the system may malfunction and vehicles may not be detected correctly. In the following situations, have your vehicle inspected by your Toyota dealer.

- A sensor or its surrounding area is subject to a strong impact.
- If the surrounding area of a sensor is scratched or dented, or part of them has become disconnected.

- Do not disassemble the sensor.



- Do not modify the sensor or surrounding area on the rear bumper.

- If a sensor or the rear bumper needs to be removed/installed or replaced, contact your Toyota dealer.

- Do not paint the rear bumper any color other than an official Toyota color.

**Turning the Blind Spot Monitor on/off**

Use the meter control switches to turn on/off the function.

- 1 Press < or > to select .
- 2 Press ^ or v to select  and then press OK .

### Blind Spot Monitor operation

#### ■ Vehicles that can be detected by the Blind Spot Monitor

The Blind Spot Monitor uses rear side radar sensors to detect the following vehicles traveling in adjacent lanes and advises the driver of the presence of such vehicles via the indicators on the outside rear view mirrors.

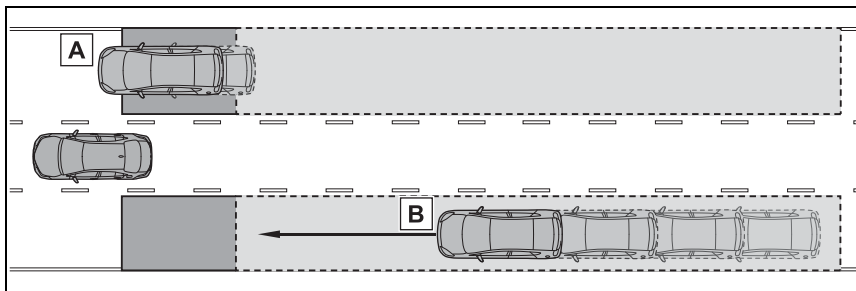

- A** Vehicles that are traveling in areas that are not visible using the outside rear view mirrors (the blind spots)
- B** Vehicles that are approaching rapidly from behind in areas that are not visible using the outside rear view mirrors (the blind spots)

#### ■ The Blind Spot Monitor detection areas

The areas that vehicles can be detected in are outlined below.

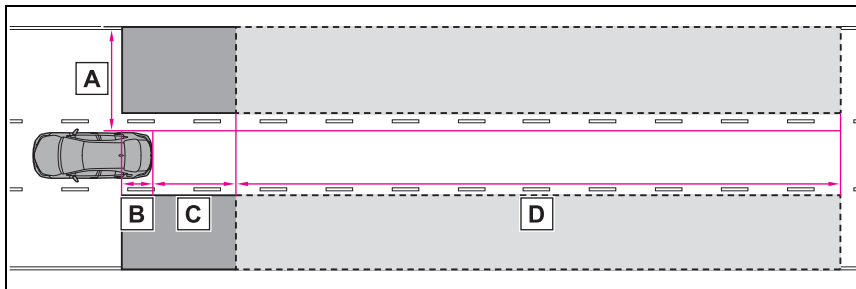

The range of each detection area is:

- A** Approximately 1.6 ft. (0.5 m) to 11.5 ft. (3.5 m) from either side of the vehicle<sup>\*1</sup>
- B** Approximately 3.3 ft. (1 m) forward of the rear bumper
- C** Approximately 9.8 ft. (3 m) from the rear bumper
- D** Approximately 9.8 ft. (3 m) to 197 ft. (60 m) from the rear bumper<sup>\*2</sup>

\*1: The area between the side of the vehicle and 1.6 ft. (0.5 m) from the side of the vehicle cannot be detected.

\*2: The greater the difference in speed between your vehicle and the detected vehicle is, the farther away the vehicle will be detected, causing the outside rear view mirror indicator to illuminate or flash.

**■ The Blind Spot Monitor is operational when**

The Blind Spot Monitor is operational when all of the following conditions are met:

- The Blind Spot Monitor is on.
- The shift lever is in a position other than R.
- The vehicle speed is greater than approximately 10 mph (16 km/h).

**■ The Blind Spot Monitor will detect a vehicle when**

The Blind Spot Monitor will detect a vehicle present in the detection area in the following situations:

- A vehicle in an adjacent lane overtakes your vehicle.
- You overtake a vehicle in adjacent lane slowly.
- Another vehicle enters the detection area when it changes lanes.

**■ Conditions under which the Blind Spot Monitor will not detect a vehicle**

The Blind Spot Monitor is not designed to detect the following types of vehicles and/or objects:

- Small motorcycles, bicycles, pedestrians, etc.\*
- Vehicles traveling in the opposite direction
- Guardrails, walls, signs, parked vehicles and similar stationary objects\*
- Following vehicles that are in the same lane\*
- Vehicles traveling 2 lanes away from your vehicle\*

- Vehicles which are being overtaken rapidly by your vehicle\*

\*: Depending on the conditions, detection of a vehicle and/or object may occur.

**■ Conditions under which the Blind Spot Monitor may not function correctly**

● The Blind Spot Monitor may not detect vehicles correctly in the following situations:

- When the sensor is misaligned due to a strong impact to the sensor or its surrounding area
- When mud, snow, ice, a sticker, etc. is covering the sensor or surrounding area on the rear bumper
- When driving on a road surface that is wet with standing water during bad weather, such as heavy rain, snow, or fog
- When multiple vehicles are approaching with only a small gap between each vehicle
- When the distance between your vehicle and a following vehicle is short
- When there is a significant difference in speed between your vehicle and the vehicle that enters the detection area
- When the difference in speed between your vehicle and another vehicle is changing
- When a vehicle enters a detection area traveling at about the same speed as your vehicle
- As your vehicle starts from a stop, a vehicle remains in the detection area
- When driving up and down consecutive steep inclines, such as hills, dips in the road, etc.
- When driving on roads with sharp bends, consecutive curves, or

- uneven surfaces
- When vehicle lanes are wide, or when driving on the edge of a lane, and the vehicle in an adjacent lane is far away from your vehicle
  - When an accessory (such as a bicycle carrier) is installed to the rear of the vehicle
  - When there is a significant difference in height between your vehicle and the vehicle that enters the detection area
  - Immediately after the Blind Spot Monitor is turned on
  - Instances of the Blind Spot Monitor unnecessarily detecting a vehicle and/or object may increase in the following situations:
    - When the sensor is misaligned due to a strong impact to the sensor or its surrounding area
    - When the distance between your vehicle and a guardrail, wall, etc. that enters the detection area is short
    - When driving up and down consecutive steep inclines, such as hills, dips in the road, etc.
    - When vehicle lanes are narrow, or when driving on the edge of a lane, and a vehicle traveling in a lane other than the adjacent lanes enters the detection area
    - When driving on roads with sharp bends, consecutive curves, or uneven surfaces
    - When the tires are slipping or spinning
    - When the distance between your vehicle and a following vehicle is short
    - When an accessory (such as a bicycle carrier) is installed to the rear of the vehicle

### RCTA (Rear Cross Traffic Alert) function\*

\*: If equipped

**The RCTA function uses the BSM rear side radar sensors installed behind the rear bumper. This function is intended to assist the driver in checking areas that are not easily visible when backing up.**

### System components

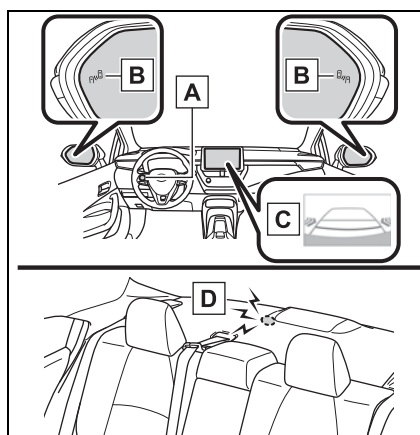

#### **A** Meter control switches

Turning the RCTA function on/off. When the RCTA function is disabled, the RCTA OFF indicator illuminates.

#### **B** Outside rear view mirror indicators

When a vehicle approaching from the right or left at the rear of the vehicle is detected, both outside rear view mirror indicators will flash.

#### **C** Audio system display

If a vehicle approaching from the right or left at the rear of the vehicle is detected, the RCTA icon (→P.260) for the detected side will be displayed on the audio system display. This illustration shows an example of a vehicle approaching from both sides of the vehicle.

#### **D** RCTA buzzer

If a vehicle approaching from the right or left at the rear of the vehicle is detected, a buzzer will sound. The buzzer also sounds for approximately 1 second immediately after the RCTA function is turned on.

### Turning the RCTA function on/off

Use the meter control switches to enable/disable the RCTA function. (→P.101)

- 1 Press **<** or **>** to select .
- 2 Press **^** or **v** to select "RCTA" and then press **OK**.

When the RCTA function is disabled, the RCTA OFF indicator (→P.88) illuminates. (Each time the engine switch is turned off then changed to ON, the RCTA function will be enabled automatically.)

### **WARNING**

#### ■ **Cautions regarding the use of the function**

The driver is solely responsible for safe driving. Always drive safely, taking care to observe your surroundings.

The RCTA function is only a supplementary function which alerts the driver that a vehicle is approaching from the right or left at the rear of the vehicle. As the RCTA function may not function correctly under certain conditions, the driver's own visual confirmation of safety is necessary. Over reliance on this function may lead to an accident resulting death or serious injury.

#### ■ **Outside rear view mirror indicator visibility**

In strong sunlight, the outside rear view mirror indicator may be difficult to see.

#### ■ **Hearing the RCTA buzzer**

The RCTA buzzer may be difficult to hear over loud noises, such as if the audio system volume is high.

#### ■ **When "Rear Cross Traffic Alert Unavailable" is shown on the multi-information display**

Water, snow, mud, etc., may be attached to the rear bumper around the sensors. (→P.255) Removing the water, snow, mud, etc., from the attached to the rear bumper around the sensors to normal.

Additionally, the function may not function normally when used in extremely hot or cold environments.

#### ■ **Rear side radar sensors**

→P.255

**RCTA function**

■ **Operation of the RCTA function**

The RCTA function uses rear side radar sensors to detect vehicles approaching from the right or left at the rear of the vehicle and alerts the driver of the presence of such vehicles by flashing the outside rear view mirror indicators and sounding a buzzer.

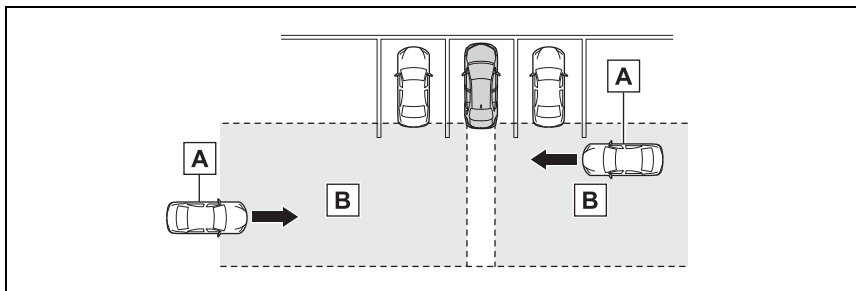

- **A** Approaching vehicles
- **B** Detection areas of approaching vehicles

■ **RCTA icon display**

When a vehicle approaching from the right or left at the rear of the vehicle is detected, the following will be displayed on the audio system display.

- Toyota parking assist monitor: Vehicles are approaching from both sides of the vehicle

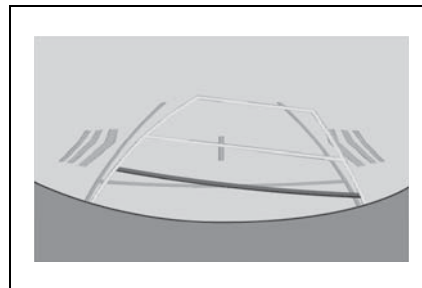

■ **RCTA function detection areas**

The areas that vehicles can be detected in are outlined below.

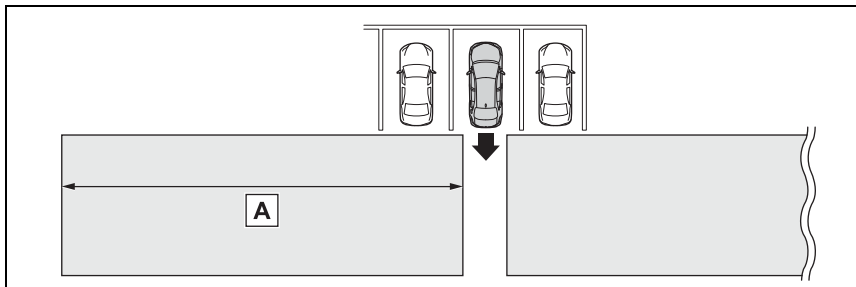



The buzzer can alert the driver of faster vehicles approaching from farther away.

Example:

Approaching vehicle speed	A Approximate alert distance
18 mph (28 km/h) (fast)	65 ft. (20 m)
5 mph (8 km/h) (slow)	18 ft. (5.5 m)

■ **The RCTA function is operational when**

The RCTA function operates when all of the following conditions are met:

- The engine switch is in ON.
- The RCTA function is on.
- The shift lever is in R.
- The vehicle speed is less than approximately 5 mph (8 km/h).
- The approaching vehicle speed is between approximately 5 mph (8 km/h) and 18 mph (28 km/h).

■ **Conditions under which the RCTA function will not detect a vehicle**

The RCTA function is not designed to detect the following types of vehicles and/or objects:

- Vehicles approaching from directly behind
- Vehicles backing up in a parking space next to your vehicle
- Vehicles that the sensors cannot detect due to obstructions

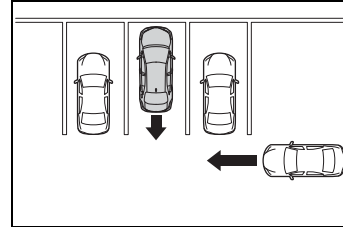

- Guardrails, walls, signs, parked vehicles and similar stationary objects\*
- Small motorcycles, bicycles, pedestrians, etc.\*
- Vehicles moving away from your vehicle
- Vehicles approaching from the parking spaces next to your vehicle\*

\*: Depending on the conditions, detection of a vehicle and/or object may occur.

■ **Conditions under which the RCTA function may not function correctly**

- The RCTA function may not detect vehicles correctly in the following situations:
  - When a sensor is misaligned due to a strong impact to the sensor or its surrounding area
  - When mud, snow, ice, a sticker, etc. is covering a sensor or its surrounding area on the rear bumper
  - When driving on a road surface that is wet with standing water during bad weather, such as heavy rain, snow, or fog
  - When multiple vehicles are approaching with only a small gap between each vehicle
  - If a vehicle is approaching the rear of your vehicle rapidly
  - When a towing eyelet is installed to the rear of the vehicle. (if equipped)
  - When backing up on a slope with a sharp change in grade

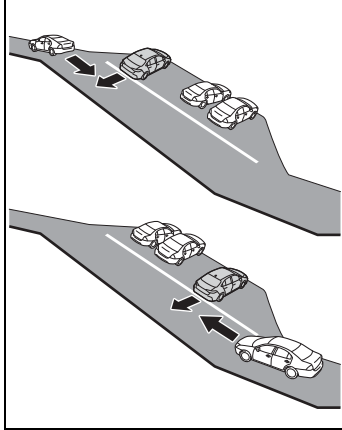

- When backing out of a shallow angle parking spot

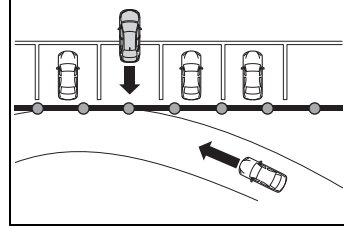

- When the distance between your vehicle and metal objects, such as a guardrail, wall, sign, or parked vehicle, which may reflect electrical waves toward the rear of the vehicle, is short
- When a towing eyelet is installed to the rear of the vehicle (if equipped)

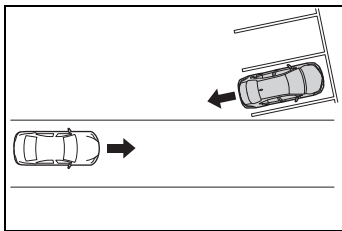

- Immediately after the RCTA function is turned on
- Immediately after the engine is started with the RCTA function on
- When the sensors cannot detect a vehicle due to obstructions

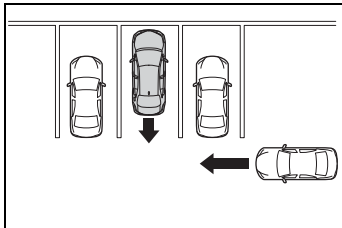

- Instances of the RCTA function unnecessarily detecting a vehicle and/or object may increase in the following situations:
  - When a vehicle passes by the side of your vehicle
  - When the parking space faces a street and vehicles are being driven on the street

**Rear view monitor system**

- Audio

**The rear view monitor system assists the driver by displaying an image of the view behind the vehicle with fixed guide lines on the screen while backing up, for example while parking.**

**The screen illustrations used in this text are intended as examples, and may differ from the image that is actually displayed on the screen.**

- Audio Plus or Premium Audio

**Owners of models equipped with a navigation/multimedia system should refer to the “NAVIGATION AND MULTIMEDIA SYSTEM OWNER’S MANUAL”.**

**System overview**

The rear view image is displayed when the shift lever is in R and the engine switch is in ON.

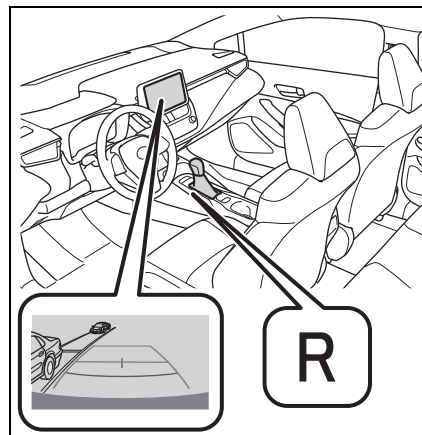

The rear view monitor system will be deactivated when the shift lever is shifted to any position other than R.

**Using the rear view monitor system**

■ **Screen description**

The rear view monitor system screen will be displayed if the shift lever is shifted to R while the engine switch is in ON.

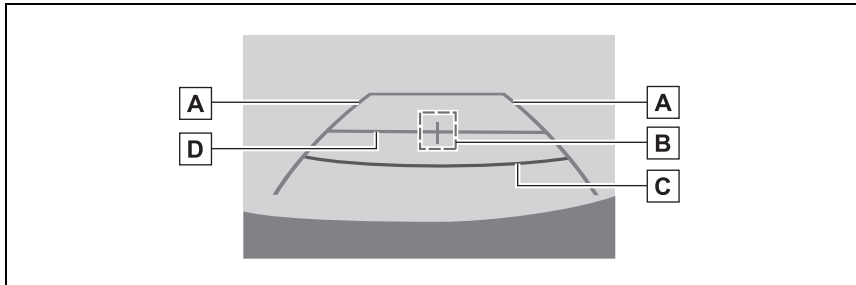

**A** Vehicle width extension guide line

Displays a guide path when the vehicle is being backed straight up. The displayed width is wider than the actual vehicle width.

**B** Vehicle center guide line

This line indicates the estimated vehicle center on the ground.

**C** Distance guide line

Displays a point approximately 1.5 ft. (0.5 m) (red) from the edge of the bumper.

**D** Distance guide line

Displays a point approximately 3 ft. (1 m) (blue) from the edge of the bumper.

**Rear view monitor system precautions**

■ Area displayed on screen

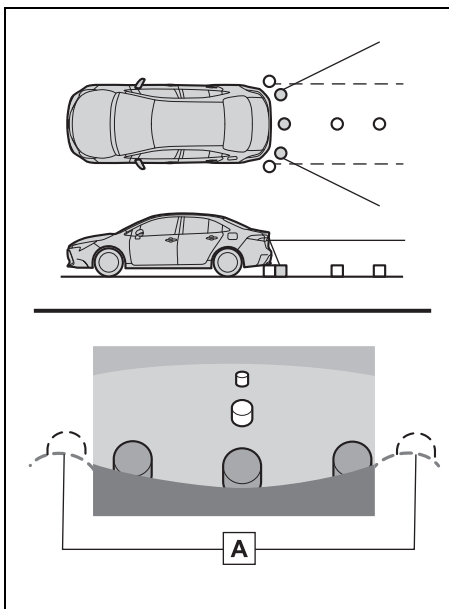

**A** Corners of bumper

The rear view monitor system displays an image of the view from the bumper of the rear area of the vehicle.

The image adjustment procedure for the rear view monitor system screen is the same as the procedure for adjusting the screen. (→P.296)

- The area displayed on the screen may vary according to vehicle orientation conditions.
- Objects which are close to either corner of the bumper or under the bumper cannot be displayed.
- The camera uses a special lens. The distance of the image that appears on the screen differs from the actual distance.
- Items which are located higher than the camera may not be displayed on the monitor.

#### ■ Rear view monitor system camera

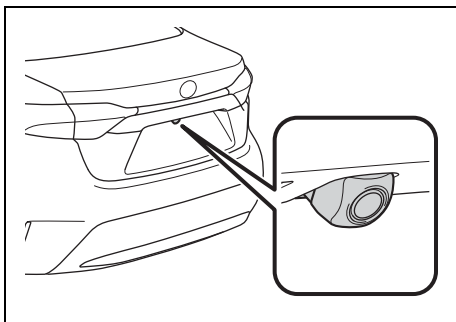

The camera for the rear view monitor system is located as

shown in the illustration.

#### ● Using the camera

If dirt or foreign matter (such as water droplets, snow, mud etc.) is adhering to the camera, it cannot transmit a clear image. In this case, flush it with a large quantity of water and wipe the camera lens clean with a soft and wet cloth.

#### ■ Differences between the screen and the actual road

The distance guide lines and the vehicle width guide lines may not actually be parallel with the dividing lines of the parking space, even when they appear to be so. Be sure to check visually.

The distances between the vehicle width guide lines and the left and right dividing lines of the parking space may not be equal, even when they appear to be so. Be sure to check visually.

The distance guide lines give a distance guide for flat road surfaces. In any of the following situations, there is a margin of error between the fixed guide lines on the screen and the actual distance/course on the road.

- When the ground behind the vehicle slopes up sharply

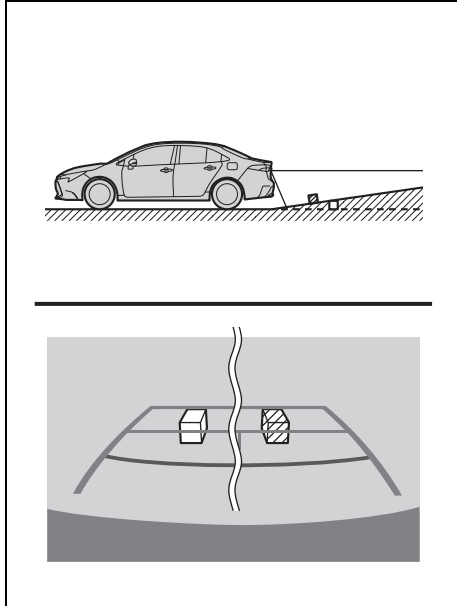

The distance guide lines will appear to be closer to the vehicle than the actual distance. Because of this, objects will appear to be farther away than they actually are. In the same way, there will be a margin of error between the guide lines and the actual distance/course on the road.

- When the ground behind the vehicle slopes down sharply

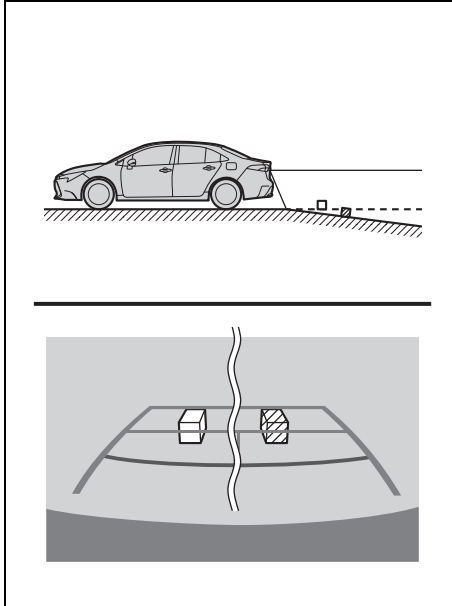

The distance guide lines will appear to be further from the vehicle than the actual distance. Because of this, objects will appear to be closer than they actually are. In the same way, there will be a margin of error between the guide lines and the actual distance/course on the road.

- When any part of the vehicle sags

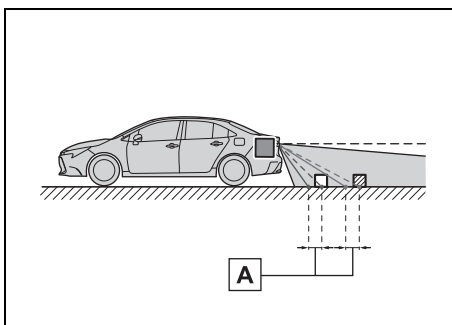

**A** A margin of error

When any part of the vehicle sags due to the number of passengers or

the distribution of the load, there is a margin of error between the fixed guide lines on the screen and the actual distance/course on the road.

■ **When approaching three-dimensional objects**

The distance guide lines are displayed according to flat surfaced objects (such as the road). It is not possible to determine the position of three-dimensional objects (such as vehicles) using the distance guide lines. When approaching a three-dimensional object that extends outward (such as the flatbed of a truck), be careful of the following.

- Vehicle width guide lines

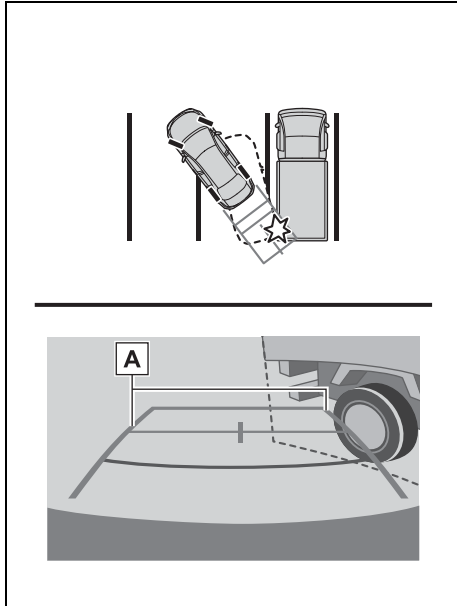

**A** Vehicle width guide lines

Visually check the surroundings and the area behind the vehicle. In

the case shown below, the truck appears to be outside of the vehicle width guide lines and the vehicle does not look as if it hits the truck. However, the rear body of the truck may actually cross over the vehicle width guide lines. In reality if you back up as guided by the vehicle width guide lines, the vehicle may hit the truck.

- Distance guide lines

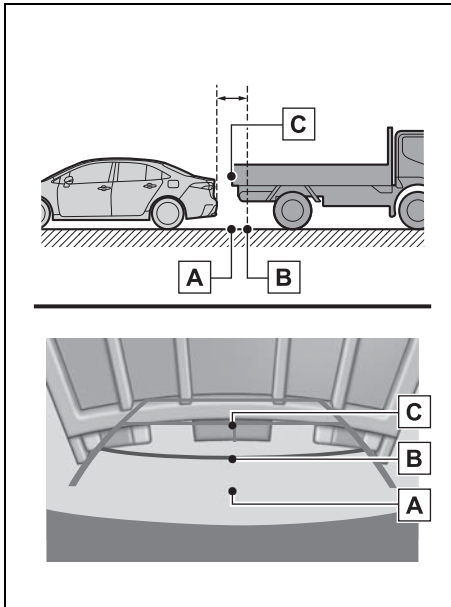

Visually check the surroundings and the area behind the vehicle. On the screen, it appears that a truck is parking at point **B**. However, in reality if you back up to point **A**, you will hit the truck. On the screen, it appears that **A** is closest and **C** is farthest away. However, in reality, the distance to **A** and **C** is the same, and **B** is farther than **A** and **C**.

### Things you should know

#### ■ If you notice any symptoms

If you notice any of the following symptoms, refer to the likely cause and the solution, and re-check.

If the symptom is not resolved by the solution, have the vehicle inspected by your Toyota dealer.

Symptom	Likely cause	Solution
The image is difficult to see	<ul style="list-style-type: none"> <li>• The vehicle is in a dark area</li> <li>• The temperature around the lens is either high or low</li> <li>• The outside temperature is low</li> <li>• There are water droplets on the camera</li> <li>• It is raining or humid</li> <li>• Foreign matter (mud etc.) is adhering to the camera</li> <li>• Sunlight or headlights are shining directly into the camera</li> <li>• The vehicle is under fluorescent lights, sodium lights, mercury lights etc.</li> </ul>	If this happens due to these causes, it does not indicate a malfunction. Back up while visually checking the vehicle's surroundings. (Use the monitor again once conditions have been improved.) The procedure for adjusting the picture quality of the rear view monitor system is the same as the procedure for adjusting the screen. (→P.296)
The image is blurry	Dirt or foreign matter (such as water droplets, snow, mud etc.) is adhering to the camera.	Flush the camera with a large quantity of water and wipe the camera lens clean with a soft and wet cloth.
The image is out of alignment	The camera or surrounding area has received a strong impact.	Have the vehicle inspected by your Toyota dealer.



Symptom	Likely cause	Solution
The fixed guide lines are very far out of alignment	The camera position is out of alignment.	Have the vehicle inspected by your Toyota dealer.
	<ul style="list-style-type: none"> <li>The vehicle is tilted (there is a heavy load on the vehicle, tire pressure is low due to a tire puncture, etc.)</li> <li>The vehicle is used on an incline.</li> </ul>	<p>If this happens due to these causes, it does not indicate a malfunction.</p> <p>Back up while visually checking the vehicle's surroundings.</p>

**⚠ WARNING**

■ **When using the rear view monitor system**

The rear view monitor system is a supplemental device intended to assist the driver when backing up. When backing up, be sure to visually check all around the vehicle both directly and using the mirrors before proceeding. Observe the following precautions to avoid an accident that could result in death or serious injuries.

- Never depend on the rear view monitor system entirely when backing up. The image and the position of the guide lines displayed on the screen may differ from the actual state. Use caution, just as you would when backing up any vehicle.
- Be sure to back up slowly, depressing the brake pedal to control vehicle speed.
- The instructions given are only guide lines. When and how much to turn the steering wheel will vary according to traffic conditions, road surface conditions, vehicle condition, etc. when parking. It is necessary to be fully aware of this before using the rear view monitor system.

- When parking, be sure to check that the parking space will accommodate your vehicle before maneuvering into it.
- Do not use the rear view monitor system in the following cases:
  - On icy or slick road surfaces, or in snow
  - When using tire chains or emergency tires
  - When the trunk is not closed completely
  - On roads that are not flat or straight, such as curves or slopes
- In low temperatures, the screen may darken or the image may become faint. The image could distort when the vehicle is moving, or you may become unable to see the image on the screen. Be sure to visually check all around the vehicle both directly and using the mirrors before proceeding.
- If the tire sizes are changed, the position of the fixed guide lines displayed on the screen may change.

**WARNING**

- The camera uses a special lens. The distances between objects and pedestrians that appear in the image displayed on the screen will differ from the actual distances. (→P.265)

- Do not expose the camera to strong impact as this could cause a malfunction. If this happens, have the vehicle inspected by your Toyota dealer as soon as possible.

**NOTICE****■ How to use the camera**

- The rear view monitor system may not operate properly in the following cases.
  - If the back of the vehicle is hit, the position and mounting angle of the camera may change.
  - As the camera has a water proof construction, do not detach, disassemble or modify it. This may cause incorrect operation.
  - When cleaning the camera lens, flush the camera with a large quantity of water and wipe it with a soft and wet cloth. Strongly rubbing the camera lens may cause the camera lens to be scratched and unable to transmit a clear image.
  - Do not allow organic solvent, car wax, window cleaner or glass coating to adhere to the camera. If this happens, wipe it off as soon as possible.
  - If the temperature changes rapidly, such as when hot water is poured on the vehicle in cold weather, the system may not operate normally.
  - When washing the vehicle, do not apply intensive bursts of water to the camera or camera area. Doing so may result in the camera malfunctioning.

**Driving mode select switch\***

mode will be changed to normal mode.

\*: If equipped

**The driving modes can be selected to suit driving condition.**

**Selecting a drive mode**

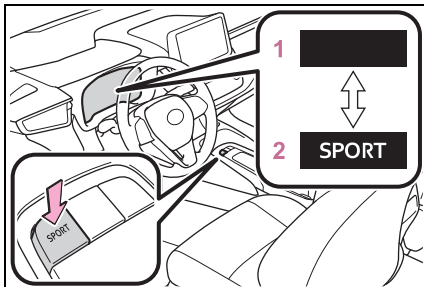

Each time the switch is pressed, the system changes between sport mode and normal mode.

**1 Normal mode**

Provides an optimal balance of fuel economy, quietness, and dynamic performance. Suitable for normal driving.

**2 Sport mode**

Controls the transmission and engine to provide quick, powerful acceleration. This mode also changes the steering feel, making it suitable for when agile driving response is desired, such as when driving on roads with many curves.

When the sport mode is selected, sport mode indicator comes on.

**■ Automatic deactivation of sport mode**

If the engine switch is turned off after driving in sport mode, the drive

### Driving assist systems

**To keep driving safety and performance, the following systems operate automatically in response to various driving situations. Be aware, however, that these systems are supplementary and should not be relied upon too heavily when operating the vehicle.**

### Summary of the driving assist systems

#### ■ ABS (Anti-lock Brake System)

Helps to prevent wheel lock when the brakes are applied suddenly, or if the brakes are applied while driving on a slippery road surface

#### ■ Brake assist

Generates an increased level of braking force after the brake pedal is depressed when the system detects a panic stop situation

#### ■ VSC (Vehicle Stability Control)

Helps the driver to control skidding when swerving suddenly or turning on slippery road surfaces.

#### ■ Enhanced VSC (Enhanced Vehicle Stability Control)

Provides cooperative control of the ABS, TRAC, VSC and EPS. Helps to maintain directional stability when swerving on slippery road surfaces by controlling steering performance.

#### ■ TRAC (Traction Control)

Helps to maintain drive power and prevent the drive wheels from spinning when starting the vehicle or accelerating on slippery roads

#### ■ Active Cornering Assist (ACA)

Helps to prevent the vehicle from drifting to the outer side by performing inner wheel brake control when attempting to accelerate while turning

#### ■ Hill-start assist control

Helps to reduce the backward movement of the vehicle when starting on an uphill

#### ■ EPS (Electric Power Steering)

Employs an electric motor to reduce the amount of effort needed to turn the steering wheel.

#### ■ The Secondary Collision Brake

When the SRS airbag sensor detects a collision and the system operates, the brakes and brake lights are automatically

controlled to reduce the vehicle speed and help reduce the possibility of further damage due to a secondary collision.

■ **When the TRAC/VSC systems are operating**

The slip indicator light will flash while the TRAC/VSC systems are operating.

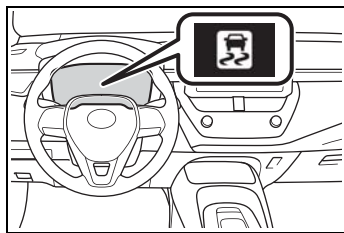

■ **Disabling the TRAC system**

If the vehicle gets stuck in mud, dirt or snow, the TRAC system may reduce power from the engine to the wheels. Pressing  to turn the system off may make it easier for you to rock the vehicle in order to free it.

To turn the TRAC system off, quickly press and release .

The “Traction Control Turned OFF” will be shown on the multi-information display.

Press  again to turn the system back on.

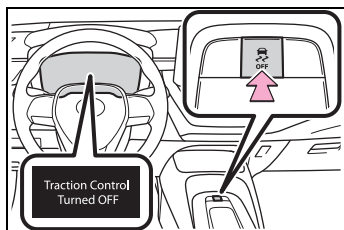

■ **Turning off both TRAC and VSC systems**

To turn the TRAC and VSC systems off, press and hold  for more than 3 seconds while the vehicle is stopped.

The VSC OFF indicator light will come on and the “Traction Control Turned OFF” will be shown on the multi-information display.\*

Press  again to turn the system back on.

\*: PCS will also be disabled (only Pre-Collision warning is available). The PCS warning light will come on and a message will be displayed on the multi-information display. (→P.210)

■ **When the message is displayed on the multi-information display showing that TRAC has been disabled even if  has not been pressed**

TRAC is temporary deactivated. If the information continues to show, contact your Toyota dealer.

■ **Operating conditions of hill-start assist control**

When the following four conditions are met, the hill-start assist control will operate:

- Vehicles with continuously variable transmission: The shift lever is in a position other than P or N (when starting off forward/backward on an upward incline)
- Vehicles with manual transmission: The shift lever is in a position other than R when starting off forward on an upward incline, or the shift lever is in R when starting off backward on an upward incline.
- The vehicle is stopped
- The accelerator pedal is not

depressed

- The parking brake is not engaged

#### ■ Automatic system cancelation of hill-start assist control

The hill-start assist control will turn off in any of the following situations:

- Vehicles with a continuously variable transmission: The shift lever is shifted to P or N.
- Vehicles with a manual transmission: The shift lever is shifted to R when starting off forward on an upward incline, or the shift lever is shifted to other than R when starting off backward on an upward incline.
- The accelerator pedal is depressed
- The parking brake is engaged
- 2 seconds at maximum elapsed after the brake pedal is released

#### ■ Sounds and vibrations caused by the ABS, brake assist, VSC, TRAC and hill-start assist control systems

- A sound may be heard from the engine compartment when the brake pedal is depressed repeatedly, when the engine is started or just after the vehicle begins to move. This sound does not indicate that a malfunction has occurred in any of these systems.
- Any of the following conditions may occur when the above systems are operating. None of these indicates that a malfunction has occurred.
  - Vibrations may be felt through the vehicle body and steering.
  - A motor sound may be heard also after the vehicle comes to a stop.
  - The brake pedal may pulsate slightly after the ABS is activated.
  - The brake pedal may move down slightly after the ABS is activated.

#### ■ Active Cornering Assist operation sounds and vibrations

When the Active Cornering Assist is operated, operation sounds and vibrations may be generated from the brake system, but this is not a malfunction.

#### ■ EPS operation sound

When the steering wheel is operated, a motor sound (whirring sound) may be heard. This does not indicate a malfunction.

#### ■ Automatic reactivation of TRAC and VSC systems

After turning the TRAC and VSC systems off, the systems will be automatically re-enabled in the following situations:

- When the engine switch is turned off
- If only the TRAC system is turned off, the TRAC will turn on when vehicle speed increases. If both the TRAC and VSC systems are turned off, automatic re-enabling will not occur when vehicle speed increases.

#### ■ Operating conditions of Active Cornering Assist

The system operates when the following occurs.

- TRAC/VSC can operate
- The driver is attempting to accelerate while turning
- The system detects that the vehicle is drifting to the outer side
- The brake pedal is released

#### ■ Reduced effectiveness of the EPS system

The effectiveness of the EPS system is reduced to prevent the system from overheating when there is frequent steering input over an extended period of time. The steering wheel may feel heavy as a result. Should this occur, refrain from excessive steering input or stop the vehicle and turn the engine

off. The EPS system should return to normal within 10 minutes.

■ **Secondary Collision Brake operating conditions**

The system operates when the SRS airbag sensor detects a collision while the vehicle is in motion. However, the system does not operate in any of the following situations.

- The vehicle speed is below 6 mph (10 km/h)
- Components are damaged

■ **Secondary Collision Brake automatic cancellation**

The system is automatically canceled in any of the following situations.

- The vehicle speed drops below approximately 6 mph (10 km/h)
- A certain amount of time elapses during operation
- The accelerator pedal is depressed a large amount

**⚠ WARNING**

■ **The ABS does not operate effectively when**

- The limits of tire gripping performance have been exceeded (such as excessively worn tires on a snow covered road).
- The vehicle hydroplanes while driving at high speed on wet or slick roads.

■ **Stopping distance when the ABS is operating may exceed that of normal conditions**

The ABS is not designed to shorten the vehicle's stopping distance. Always maintain a safe distance from the vehicle in front of you, especially in the following situations:

- When driving on dirt, gravel or snow-covered roads

- When driving with tire chains
- When driving over bumps in the road
- When driving over roads with potholes or uneven surfaces

■ **TRAC/VSC may not operate effectively when**

Directional control and power may not be achievable while driving on slippery road surfaces, even if the TRAC/VSC system is operating. Drive the vehicle carefully in conditions where stability and power may be lost.

■ **Active Cornering Assist does not operate effectively when**

- Do not overly rely on Active Cornering Assist. Active Cornering Assist may not operate effectively when accelerating down slopes or driving on slippery road surfaces.
- When Active Cornering Assist frequently operates, Active Cornering Assist may temporarily stop operating to ensure proper operation of the brakes, TRAC and VSC.

■ **Hill-start assist control does not operate effectively when**

- Do not overly rely on hill-start assist control. Hill-start assist control may not operate effectively on steep inclines and roads covered with ice.
- Unlike the parking brake, hill-start assist control is not intended to hold the vehicle stationary for an extended period of time. Do not attempt to use hill-start assist control to hold the vehicle on an incline, as doing so may lead to an accident.

**WARNING****■ When the TRAC/VSC is activated**

The slip indicator light flashes. Always drive carefully. Reckless driving may cause an accident. Exercise particular care when the indicator light flashes.

**■ When the TRAC/VSC systems are turned off**

Be especially careful and drive at a speed appropriate to the road conditions. As these are the systems to help ensure vehicle stability and driving force, do not turn the TRAC/VSC systems off unless necessary.

**■ Replacing tires**

Make sure that all tires are of the specified size, brand, tread pattern and total load capacity. In addition, make sure that the tires are inflated to the recommended tire inflation pressure level.

The ABS, TRAC and VSC systems will not function correctly if different tires are installed on the vehicle.

Contact your Toyota dealer for further information when replacing tires or wheels.

**■ Handling of tires and the suspension**

Using tires with any kind of problem or modifying the suspension will affect the driving assist systems, and may cause a system to malfunction.

**■ Secondary Collision Brake**

Do not rely solely upon the Secondary Collision Brake. This system is designed to help reduce the possibility of further damage due to a secondary collision, however, that effect changes according to various conditions. Overly relying on the system may result in death or serious injury.



Winter driving tips

**Carry out the necessary preparations and inspections before driving the vehicle in winter. Always drive the vehicle in a manner appropriate to the prevailing weather conditions.**

Pre-winter preparations

- Use fluids that are appropriate to the prevailing outside temperatures.
- Engine oil
- Engine coolant
- Washer fluid
- Have a service technician inspect the condition of the battery.
- Have the vehicle fitted with four snow tires or purchase a set of tire chains for the front tires.

Ensure that all tires are the same size and brand, and that chains match the size of the tires.

 **WARNING**

■ **Driving with snow tires**

Observe the following precautions to reduce the risk of accidents. Failure to do so may result in a loss of vehicle control and cause death or serious injury.

- Use tires of the size specified.
- Maintain the recommended level of air pressure.

● Do not drive in excess of 75 mph (120 km/h), regardless of the type of snow tires being used.

● Use snow tires on all, not just some wheels.

■ **Driving with tire chains**

Observe the following precautions to reduce the risk of accidents. Failure to do so may result in the vehicle being unable to be driven safely, and may cause death or serious injury.

● Do not drive in excess of the speed limit specified for the tire chains being used, or 30 mph (50 km/h), whichever is lower.

● Avoid driving on bumpy road surfaces or over potholes.

● Avoid sudden acceleration, abrupt steering, sudden braking and shifting operations that cause sudden engine braking.

● Slow down sufficiently before entering a curve to ensure that vehicle control is maintained.

● Do not use LTA (Lane Tracing Assist) system. (if equipped)

● Do not use LDA (Lane Departure Alert with steering control) system. (if equipped)

 **NOTICE**

■ **Repairing or replacing snow tires (vehicles with a tire pressure warning system)**

Request repairs or replacement of snow tires from Toyota dealers or legitimate tire retailers. This is because the removal and attachment of snow tires affects the operation of the tire pressure warning valves and transmitters.

**Before driving the vehicle**

Perform the following according to the driving conditions:

- Do not try to forcibly open a window or move a wiper that is frozen. Pour warm water over the frozen area to melt the ice. Wipe away the water immediately to prevent it from freezing.
- To ensure proper operation of the climate control system fan, remove any snow that has accumulated on the air inlet vents in front of the windshield.
- Check for and remove any excess ice or snow that may have accumulated on the exterior lights, vehicle's roof, chassis, around the tires or on the brakes.
- Remove any snow or mud from the bottom of your shoes before getting in the vehicle.

**When driving the vehicle**

Accelerate the vehicle slowly, keep a safe distance between you and the vehicle ahead, and drive at a reduced speed suitable to road conditions.

**When parking the vehicle**

- Park the vehicle and shift the shift lever to P (continuously

variable transmission), or 1 or R (manual transmission) without setting the parking brake. The parking brake may freeze up, preventing it from being released. If the vehicle is parked without setting the parking brake, make sure to block the wheels.

Failure to do so may be dangerous because it may cause the vehicle to move unexpectedly, possibly leading to an accident.

- Vehicles with a continuously variable transmission: If the vehicle is parked without setting the parking brake, confirm that the shift lever cannot be moved out of P\*.

\*: The shift lever will be locked if it is attempted to be shifted from P to any other position without depressing the brake pedal. If the shift lever can be shifted from P, there may be a problem with the shift lock system. Have the vehicle inspected by your Toyota dealer immediately.

**Selecting tire chains**

Use the correct tire chain size when mounting the tire chains. Chain size is regulated for each tire size.

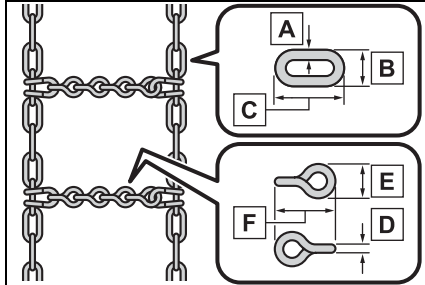

- A** Side chain (0.12 in. [3 mm] in diameter)
- B** Side chain (0.39 in. [10 mm] in width)
- C** Side chain (1.18 in. [30 mm] in length)
- D** Cross chain (0.16 in. [4 mm] in diameter)
- E** Cross chain (0.55 in. [14 mm] in width)
- F** Cross chain (0.98 in. [25 mm] in length)

### Regulations on the use of tire chains

Regulations regarding the use of tire chains vary depending on location and type of road. Always check local regulations before installing chains.

#### ■ Tire chain installation

Observe the following precautions when installing and removing chains:

- Install and remove tire chains in a safe location.
- Install tire chains on the front tires only. Do not install tire chains on the rear tires.

- Install tire chains on the front tires as tightly as possible. Retighten chains after driving 1/4—1/2 mile (0.5—1.0 km).
- Install tire chains following the instructions provided with the tire chains.

#### ⚠ NOTICE

#### ■ Fitting tire chains (vehicles with a tire pressure warning system)

The tire pressure warning valves and transmitters may not function correctly when tire chains are fitted.



- 5-1. Basic function**
  - Buttons overview..... 283
  - Menu screen ..... 285
  - Status icon ..... 286
  - “Setup” screen ..... 288
- 5-2. Basic information before operation**
  - Initial screen..... 289
  - Touch screen..... 290
  - Home screen..... 292
  - Entering letters and numbers/list screen operation ..... 293
  - Screen adjustment..... 296
  - Linking multi-information display and the system ..... 297
- 5-3. Connectivity settings**
  - Registering/Connecting a Bluetooth® device ..... 298
  - Setting Bluetooth® details ..... 302
  - Wi-Fi® Hotspot ..... 310
  - Apple CarPlay/Android Auto..... 314
- 5-4. Other settings**
  - General settings..... 321
  - Voice settings..... 325
  - Vehicle settings ..... 326
- 5-5. Using the audio/visual system**
  - Quick reference..... 328
  - Some basics..... 329
- 5-6. Radio operation**
  - AM radio/FM radio/SiriusXM® Satellite Radio(SXM)..... 333
  - Internet radio ..... 338
- 5-7. Media operation**
  - USB memory ..... 339
  - iPod/iPhone (Apple CarPlay) ..... 341
  - Android Auto..... 344
  - Bluetooth® audio ..... 345
- 5-8. Audio/visual remote controls**
  - Steering switches ..... 349
- 5-9. Audio settings**
  - Setup..... 351
- 5-10. Tips for operating the audio/visual system**
  - Operating information.. 352
- 5-11. Voice command system operation**
  - Voice command system ..... 364
  - Command list ..... 367
- 5-12. Mobile Assistant operation**
  - Mobile Assistant ..... 371

---

<b>5-13.Phone operation (Hands-free system for cellular phones)</b>	
Quick reference.....	373
Some basics .....	374
Placing a call using the Bluetooth® hands-free sys- tem .....	378
Receiving a call using the Bluetooth® hands-free sys- tem .....	381
Talking on the Bluetooth® hands-free system.....	382
Bluetooth® phone message function.....	384
<b>5-14.Phone settings</b>	
Setup.....	388
<b>5-15.What to do if... (Blue- tooth®)</b>	
Troubleshooting .....	398
<b>5-16.Connected Services Over- view</b>	
Functional overview ....	402
Type A: Function achieved by using a smart phone or DCM.....	403
Type B: Function achieved by using DCM and the sys- tem .....	406
Type C: Function achieved by using DCM.....	407
Type D: Function achieved by using DCM and a smartphone .....	407
<b>5-17.Connected Services Operation</b>	
Toyota apps.....	409
<b>5-18.Toyota apps settings</b>	
Setup.....	413

Buttons overview\*

\*: If equipped

▶ Audio Plus/Premium Audio

Owners of this system should refer to the “NAVIGATION AND MULTIMEDIA SYSTEM OWNER’S MANUAL”.

Operations of each part

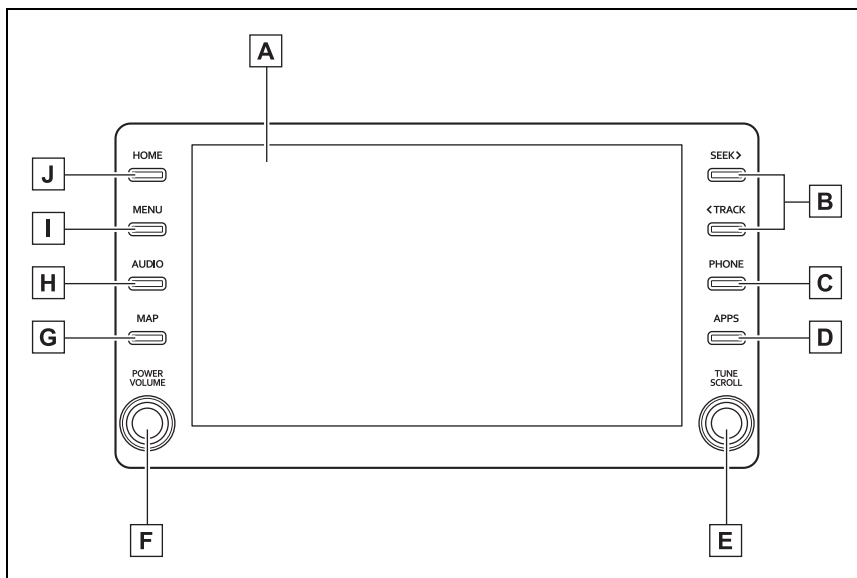

- A** By touching the screen with your finger, you can control the selected functions. (→P.290)
- B** Press to seek up or down for a radio station or to access a desired track/file. (→P.333, 339, 341, 345)
- C** Press to access the Bluetooth® hands-free system. (→P.373)  
When an Apple CarPlay connection is established, press to display the Phone app screen.\*1, 2
- D** Press to display the Toyota apps screen.\*2, 3 (→P.402)
- E** Turn to change the radio station or skip to the next or previous track/file. (→P.333, 339, 341, 345)
- F** Press to turn the audio/visual system on and off, and turn it to adjust the volume. Press and hold to restart the system. (→P.289,

5  
Audio

329)

**G** When an Apple CarPlay/Android Auto connection is established, press to display the Maps app screen.\*<sup>1, 2</sup>

**H** Press to display the audio/visual system screen. (→P.328, 329)

**I** Press to display the “Menu” screen. (→P.285)

**J** Press to display the home screen. (→P.292)

\*<sup>1</sup>: For details about Apple CarPlay/Android Auto: →P.314

\*<sup>2</sup>: This function is not made available in some countries or areas.

\*<sup>3</sup>: When an Apple CarPlay/Android Auto connection is established, this function will be unavailable.

 **WARNING**

For safety, the driver should not operate the system while he/she is driving. Insufficient attention to the road and traffic may cause an accident.

---

The screen shots in this document and the actual screens of the system differ depending on whether the functions and/or a contract existed.



## Menu screen

## Menu screen operation

Press the “MENU” button to display the “Menu” screen.

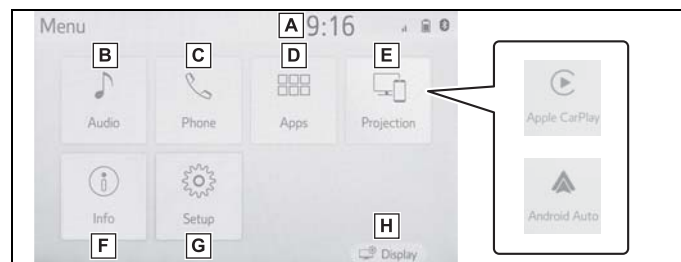

- A** Displays the clock. Select to display the clock settings screen. (→P.322)
- B** Select to display the audio control screen. (→P.328)
- C** Select to display the hands-free operation screen. (→P.373)  
When an Apple CarPlay connection is established, select to display the Phone app screen.\*1
- D** Select to display the application screen.\*1, 2 (→P.402)
- E** When an Apple CarPlay/Android Auto connection is established and this button displays “Apple CarPlay”/“Android Auto”, select to display the home screen of Apple CarPlay/Android Auto.\*1 (→P.314)
- F** Vehicles without DCM: Select to display the fuel consumption screen. (→P.106)  
Vehicles with DCM: Select to display the information screen.  
Select “ECO” to display the fuel consumption screen. (→P.106)  
The “Vehicle Alert History” shown on the information screen.\*1
- G** Select to display the “Setup” screen. (→P.288)
- H** Select to adjust the contrast, brightness, etc. of the display. (→P.296)

\*1: This function is not made available in some countries or areas.

\*2: When an Apple CarPlay/Android Auto connection is established, this function will be unavailable.

Status icon

Status icons are displayed at the top of the screen.

Status icon explanation



- A** Indicate during data communication performed via Data Communication Module (DCM)<sup>\*1</sup>
- B** The reception level of Data Communication Module (DCM) display<sup>\*1</sup> (→P.286)
- C** The reception level of the connected phone display (→P.286)
- D** Remaining battery charge display (→P.287)
- E** Bluetooth<sup>®</sup> phone connection condition display (→P.287)
- F** Wi-Fi<sup>®</sup> connection condition display<sup>\*1, 2</sup> (→P.310)

<sup>\*1</sup>: Vehicles with DCM

<sup>\*2</sup>: This function is not made available in some countries or areas.

The number of status icons that can be displayed differs depending on the displayed screen.

Reception level display

The level of reception does not always correspond with the level displayed on the cellular phone. The level of reception may not be displayed depending on the phone you have.

When the cellular phone is out of the service area or in a place inaccessible by radio waves,

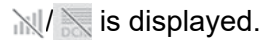



“Rm” is displayed when receiving in a roaming area. While roaming, display “Rm” top-left on the icon.

The receiving area may not be displayed depending on the type of Bluetooth<sup>®</sup> phone you have.



- ▶ While connected with cellular phone

Reception Level	Indicators
Poor	
Excellent	

- ▶ While using Data Communication Module (DCM)

Reception Level	Indicators
Poor	
Excellent	

- ▶ While using Wi-Fi® Hotspot

Reception Level	Indicators
No connection	
Connected	



When Wi-Fi® Hotspot is off, no item is displayed.

**Remaining battery charge display**

The amount displayed does not always correspond with the amount displayed on the Bluetooth® device.

The amount of battery charge left may not be displayed depending on the type of the Bluetooth® device connected.

This system does not have a charging function.

Remaining charge	Indicators
Empty	
Full	

**Bluetooth® connection condition display**



An antenna for the Bluetooth® connection is built into the instrument panel.

The condition of the Bluetooth® connection may deteriorate and the system may not function when a Bluetooth® phone is used in the following conditions and/or places:

The cellular phone is obstructed by certain objects (such as when it is behind the seat or in the glove box or console box).

The cellular phone is touching or is covered with metal materials.

Leave the Bluetooth® phone in a place where the condition of the Bluetooth® connection is good.

Indicators	Conditions
 (Blue)	Indicates that the condition of the Bluetooth® connection is good.
 (Gray)	While in this condition, sound quality during phone calls may deteriorate.
	Indicates that the cellular phone is not connected via Bluetooth®.

## “Setup” screen

### “Setup” screen

Press the “MENU” button, then select “Setup” to display the “Setup” screen. The items shown on the “Setup” screen can be set.

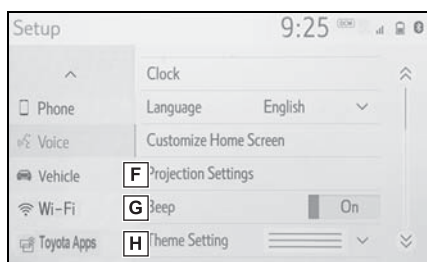
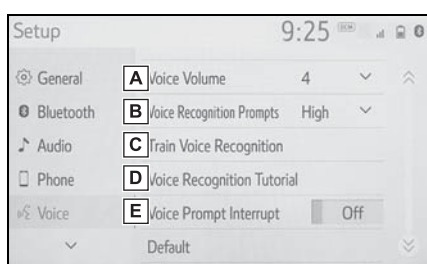

- A** Select to change the selected language, operation sound settings, etc. (→P.321)
- B** Select to set Bluetooth<sup>®</sup> device and Bluetooth<sup>®</sup> system settings. (→P.302)
- C** Select to set audio settings. (→P.351)
- D** Select to set the phone sound, contacts, message settings, etc. (→P.388)
- E** Select to set the voice settings. (→P.325)

**F** Select to set vehicle information. (→P.326)

**G** Select to set Wi-Fi<sup>®</sup> connection settings.<sup>\*1, 2</sup> (→P.311)

**H** Select to set Toyota apps settings.<sup>\*2</sup> (→P.413)

<sup>\*1</sup>: Vehicles with DCM

<sup>\*2</sup>: This function is not made available in some countries or areas.

### Initial screen

**When the engine switch is turned to ACC or ON, the initial screen will be displayed and the system will begin operating.**

### Caution screen

After a few seconds, the caution screen will be displayed.

After about 5 seconds or selecting "Continue", the caution screen automatically switches to the next screen.

### WARNING

When the vehicle is stopped with the engine running, always apply the parking brake for safety.

### Restarting the system

When system response is extremely slow, the system can be restarted.

Press and hold the "POWER VOLUME" knob for 3 seconds or more.

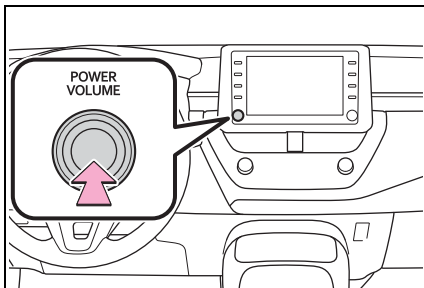

Touch screen

Touch screen gestures

Operations are performed by touching the touch screen directly with your finger.

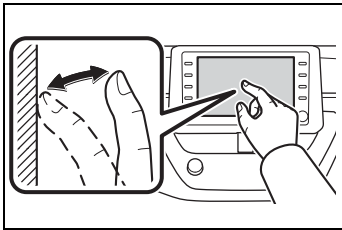
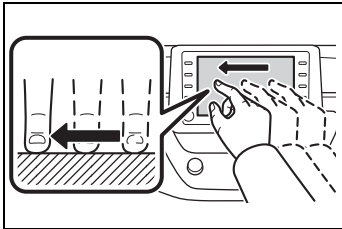
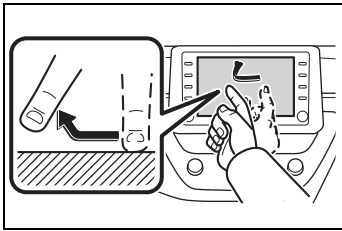
Operation method	Outline	Main use
	<ul style="list-style-type: none"> <li>• Touch</li> </ul> <p>Quickly touch and release once.</p>	<ul style="list-style-type: none"> <li>• Selecting an item on the screen</li> </ul>
	<ul style="list-style-type: none"> <li>• Drag*</li> </ul> <p>Touch the screen with your finger, and move the screen to the desired position.</p>	<ul style="list-style-type: none"> <li>• Scrolling the lists</li> </ul>
	<ul style="list-style-type: none"> <li>• Flick*</li> </ul> <p>Quickly move the screen by flicking with your finger.</p>	<ul style="list-style-type: none"> <li>• Scrolling the main screen page</li> </ul>

\*: The above operations may not be performed on all screens.

Flick operations may not be performed smoothly at high altitudes.



Touch screen operation

This system is operated mainly by the buttons on the screen. (Referred to as screen buttons in this manual.)

When a screen button is

touched, a beep sounds. (To set the beep sound: →P.321)

- If the system does not respond to touching a screen button, move your finger away from the screen and then touch it again.
- Dimmed screen buttons cannot be

- operated.
- The displayed image may become darker and moving images may be slightly distorted when the screen is cold.
- In extremely cold conditions, the screen may not be displayed and the data input by a user may be deleted. Also, the screen buttons may be harder than usual to depress.
- When you look at the screen through polarized material such as polarized sunglasses, the screen may be dark and hard to see. If so, look at the screen from different angles, adjust the screen settings on the display settings screen or take off your sunglasses.
- When  is displayed on the screen, select  to return to the previous screen.

 NOTICE
<ul style="list-style-type: none"> <li>● To prevent damaging the screen, lightly touch the screen buttons with your finger.</li> <li>● Do not use objects other than your finger to touch the screen.</li> <li>● Wipe off fingerprints using a glass cleaning cloth. Do not use chemical cleaners to clean the screen, as they may damage the touch screen.</li> </ul>

**Capacitive touch screen buttons**

The operable areas of the capacitive touch screen buttons use capacitive touch sensors and may not operate properly in the following situations:

- If the screen is dirty or wet

- If a source of strong electromagnetic waves is brought near the screen
- If a glove is worn during operation
- If the screen is touched by a fingernail
- If a stylus is used to operate the buttons
- If your palm touches the operable area of another button during operation
- If a button is touched quickly
- If the operable part of a capacitive touch screen button is touched by or covered with a metal object, such as the following, it may not operate properly:
  - Magnetic isolation cards
  - Metallic foil, such as the inner packaging of a cigarette box
  - Metallic wallets or bags
  - Coins
  - Discs, such as a CD or DVD
- If the operable part of a capacitive touch screen button is wiped, it may operate unintentionally.
- If the capacitive touch screen button is being touched when the engine switch is changed to ACC or ON, the button may not operate properly. In this case, remove anything touching the button, turn the engine switch off and then turn it to

ACC or ON, or restart the system by press and hold the "POWER VOLUME" knob for 3 seconds or more.

Capacitive touch screen button sensor sensitivity can be adjusted. (→P.321)

### Home screen

**On the home screen, multiple screens, such as the audio/visual system screen, hands-free screen and clock screen, can be displayed simultaneously.**

### Home screen operation

- 1 Press the "HOME" button.

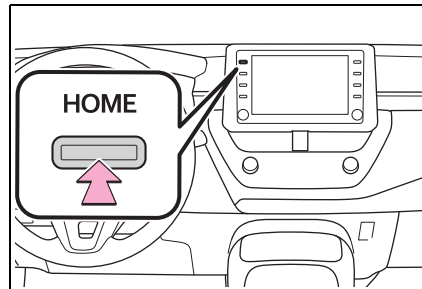

- 2 Check that the home screen is displayed.

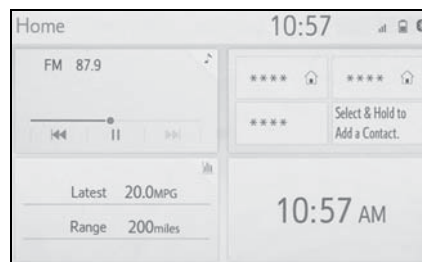

Selecting a screen will display it full screen.

- The display information and area on the home screen can be customized.
- The home screen can be set to several types of split layouts



**Customizing the home screen**

The display information/area on the home screen and the home screen layout can be changed.

- 1 Press the "MENU" button.
  - 2 Select "Setup".
- If the general settings screen is not displayed, select "General".
- 3 Select "Customize Home Screen".
  - 4 Select the items to be set.

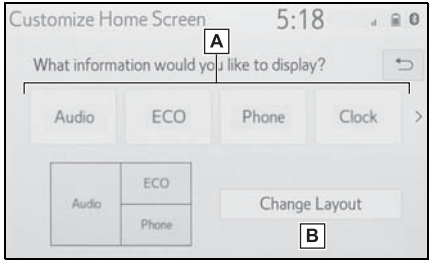

- A** Select to change the display information and area on the home screen.
- B** Select to change the home screen layout.

**Entering letters and numbers/list screen operation**

**Entering letters and numbers**

When searching by a name or entering data, letters and numbers can be entered via the screen.

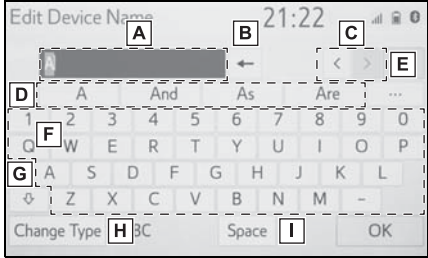

- A** Text field. Entered character(s) will be displayed.
- B** Select to erase one character. Select and hold to continue erasing characters.
- C** Select to move the cursor.
- D** Select to choose predictive text candidate for entered text. (→P.294)
- E** Select to display a list of predictive text candidates when there is more than one. (→P.294)
- F** Select to enter desired characters.
- G** Select to enter characters in lower case or in upper case.

5

Audio

- H** Select to change character types. (→P.294)
- I** Select to make a space on cursor.

Keyboard layout can be changed. (→P.321)

**Changing character type**

- 1 Select "Change Type".

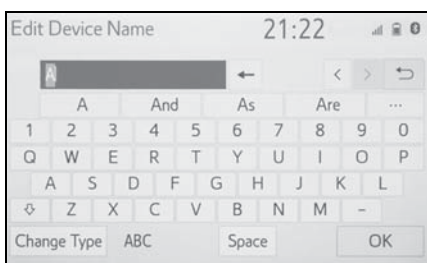

- 2 Select the desired character.

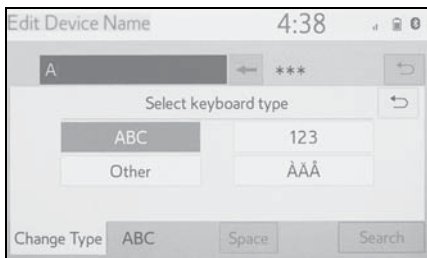

Depending on the screen being displayed, it may not be possible to change keyboard characters.

**Displaying predictive text candidates**

When text is input, the system predicts the text that may complete the currently unconfirmed text and displays predictive replacement candidates that match the beginning of the text.

- 1 Input text.
- 2 Select the desired candidate.

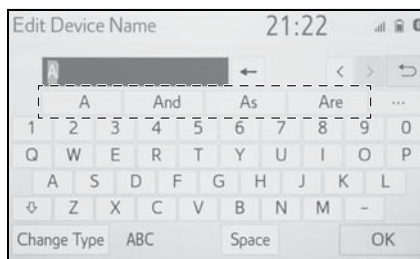

To select a candidate that is not displayed, select **...**, and then select the desired predictive replacement candidate.

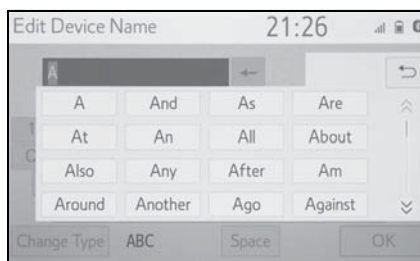



**List screen**

The list screen may be displayed after entering characters. When a list is displayed, use the appropriate screen button to scroll through the list.

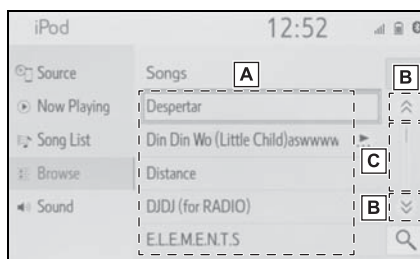
**Scrolling list screen**



- A** To scroll up/down the list, flick the list up/down.
- B** Select to skip to the next or previous page. Select and hold  or  to scroll through the displayed list.
- C** Indicates the position of the displayed entries in the entire list. To scroll up/down pages, drag the bar.



2 Input text.



3 Select "Search".

4 The list is displayed.

If  appears to the right of an item name, the complete name is too long to display.

- Select to  scroll to the end of the name.
- Select  to move to the beginning of the name.

### Searching a list

Items are displayed in the list with the most similar results of the search at the top.

1 Select .



5  
Audio

### Screen adjustment

The contrast and brightness of the screen display and the image of the camera display can be adjusted. The screen can also be turned off, and/or changed to either day or night mode.

(For information regarding audio/visual screen adjustment: →P.331)

### Displaying the screen adjustment screen

- 1 Press the "MENU" button.

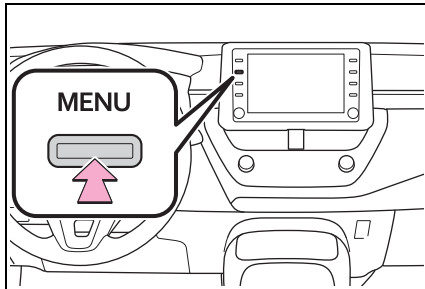

- 2 Select "Display".
- 3 Select the desired items to be set.



- 1 Select to turn the screen off. To turn it on, press any but-

ton.

- Select to turn day mode on/off. (→P.296)
- Select to adjust the screen display. (→P.296)
- Select to adjust the camera display.

When the screen is viewed through polarized sunglasses, a rainbow pattern may appear on the screen due to optical characteristics of the screen. If this is disturbing, please operate the screen without polarized sunglasses.

### Changing between day and night mode

Depending on the position of the headlight switch, the screen changes to day or night mode. This feature is available when the headlight is switched on. Select "Day Mode".

If the screen is set to day mode with the headlight switch turned on, this condition is memorized even with the engine turned off.

### Adjusting the contrast/brightness

The contrast and brightness of the screen can be adjusted according to the brightness of your surroundings.

- 1 Select "General" or "Camera".
- 2 Select the desired item. "Display (General)" screen only:

Select “<” or “>” to select the desired display.

- “Contrast”

“+”: Select to strengthen the contrast of the screen.

“-”: Select to weaken the contrast of the screen.

- “Brightness”

“+”: Select to brighten the screen.

“-”: Select to darken the screen.

### Linking multi-information display and the system

**The following functions of the system are linked with the multi-information display in the instrument cluster:**

- Audio
- Phone\*

**etc.**

**These functions can be operated using multi-information display control switches on the steering wheel. (→P.101)**

\*: When an Apple CarPlay connection is established, this function will be unavailable.

### Registering/Connecting a Bluetooth® device

**To use the hands-free system, it is necessary to register a Bluetooth® phone with the system.**

**Once the phone has been registered, it is possible to use the hands-free system.**

**This operation cannot be performed while driving.**

**When an Apple CarPlay connection is established, Bluetooth® functions of the system will become unavailable and any connected Bluetooth® devices will be disconnected.\***

**When connecting to Android Auto, a Bluetooth® connection will be made automatically.\***

**When an Android Auto connection is established, some Bluetooth® functions other than hands-free system cannot be used.\***

\*: This function is not made available in some countries or areas.

- This system is not guaranteed to operate with all Bluetooth® devices.

- If your cellular phone does not support HFP, registering the Bluetooth® phone or using OPP, PBAP, MAP or SPP profiles individually will not be possible.
- If the connected Bluetooth® device version is older than recommended or incompatible, the Bluetooth® device function may not work properly.
- Refer to <https://www.toyota.com/audio-multimedia> in the United States, <https://www.toyota.ca/connected> in Canada, and <http://www.toyotapr.com/audio-multimedia> in Puerto Rico, to find approved Bluetooth® phones for this system.
- Certification



Bluetooth is a registered trademark of Bluetooth SIG, Inc.

### Registering a Bluetooth® phone for the first time

#### ■ Registering from the system

- 1 Turn the Bluetooth® connection setting of your cellular phone on.

This function is not available when Bluetooth® connection setting of your cellular phone is set to off.

2 Press the "MENU" button.

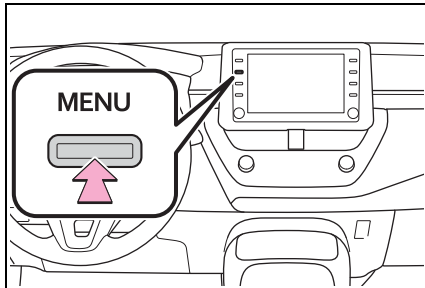

3 Select "Phone".

Operations up to this point can also be performed by pressing the "PHONE" button on the instrument panel.

4 Select "Yes" to register a phone.



5 Select the desired Bluetooth® device.

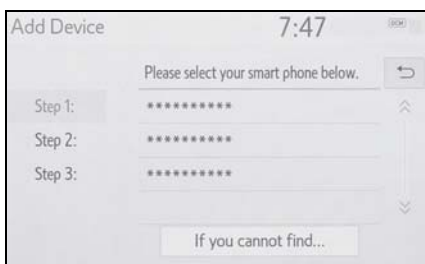

If the desired Bluetooth® phone is not on the list, select "If you cannot find..." and follow the guidance on the screen. (→P.300)

6 Register the Bluetooth® device using your Bluetooth® device.



- For details about operating the Bluetooth® device, see the manual that comes with it.
  - A PIN code is not required for SSP (Secure Simple Pairing) compatible Bluetooth® devices. Depending on the type of Bluetooth® device being connected, a message confirming registration may be displayed on the Bluetooth® device's screen. Respond and operate the Bluetooth® device according to the confirmation message.
- 7 Check that the following screen is displayed, indicating pairing was successful (a Bluetooth® link has been

5

Audio

established but registration is not yet complete).



- The system is connecting to the registered device.
  - At this stage, the Bluetooth® functions are not yet available.
- 8 Check that “Connected” is displayed and registration is complete.



If an error message is displayed, follow the guidance on the screen to try again.

If a cellular phone does not operate properly after being connected, turn the cellular phone off and on and then connect it again.

### ■ Registering from phone

- 1 Select “If you cannot find...”.

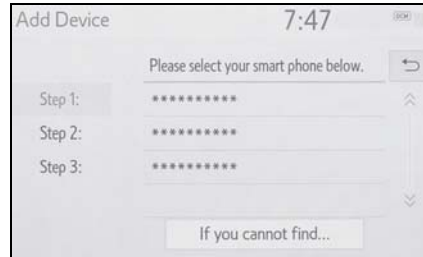

- 2 Select “Register from Phone”.

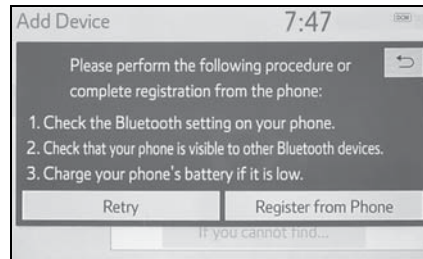

- 3 Check that the following screen is displayed, and register the Bluetooth® device using your Bluetooth® device.

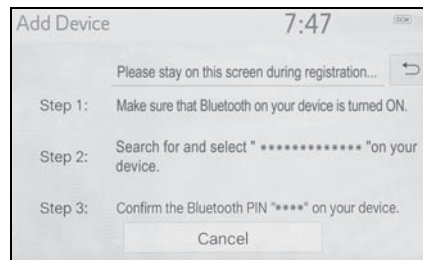

- For details about operating the Bluetooth® device, see the manual that comes with it.
- A PIN code is not required for SSP (Secure Simple Pairing) compatible Bluetooth®



devices. Depending on the type of Bluetooth® device being connected, a message confirming registration may be displayed on the Bluetooth® device's screen. Respond and operate the Bluetooth® device according to the confirmation message.

- 4 Follow the steps in "Registering a Bluetooth® phone for the first time" from step 7. (→P.298)

### Registering a Bluetooth® audio player for the first time

To use the Bluetooth® audio, it is necessary to register an audio player with the system.

Once the player has been registered, it is possible to use the Bluetooth® audio.

This operation cannot be performed while driving.

For details about registering a Bluetooth® device: →P.298

- 1 Turn the Bluetooth® connection setting of your audio player on.

This function is not available when the Bluetooth® connection setting of your audio player is set to off.

- 2 Press the "AUDIO" button.

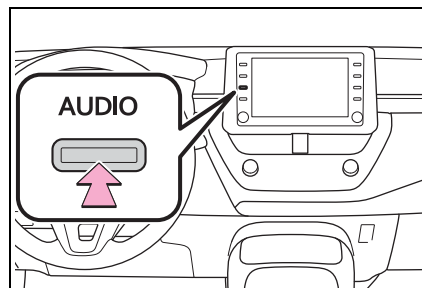

- 3 Select "Source" on the audio screen or press "AUDIO" button again.
- 4 Select "Bluetooth".
- 5 Select "Yes" to register an audio player.
- 6 Follow the steps in "Registering a Bluetooth® phone for the first time" from step 5. (→P.298)

### Profiles

This system supports the following services.

#### ■ Bluetooth® Core Specification

Ver. 2.0 (Recommended: Ver. 4.1 +EDR)

#### ■ Profiles

- HFP (Hands Free Profile) Ver. 1.0 (Recommended: Ver. 1.7)

This is a profile to allow hands-free phone calls using a cellular phone. It has outgoing and incoming call functions.

- OPP (Object Push Profile) Ver. 1.1 (Recommended: Ver. 1.1)

## 1.2)

This is a profile to transfer contacts data.

- PBAP (Phone Book Access Profile) Ver. 1.0 (Recommended: Ver. 1.2)

This is a profile to transfer phone-book data.

- MAP (Message Access Profile) Ver. 1.0 (Recommended: Ver. 1.2)

This is a profile to use phone message functions.

- SPP (Serial Port Profile) Recommended: Ver. 1.2

This is a profile to use the Toyota audio multimedia function.

- A2DP (Advanced Audio Distribution Profile) Ver. 1.0 (Recommended: Ver. 1.3)

This is a profile to transmit stereo audio or high quality sound to the audio/visual system.

- AVRCP (Audio/Video Remote Control Profile) Ver. 1.0 (Recommended: Ver. 1.6)

This is a profile to allow remote control the A/V equipment.

### Setting Bluetooth® details

**When an Apple CarPlay connection is established, this function will be unavailable.\***

**When an Android Auto connection is established, some functions will be unavailable.\***

\*: This function is not made available in some countries or areas.

### Displaying the Bluetooth® setup screen

- 1 Press the "MENU" button.

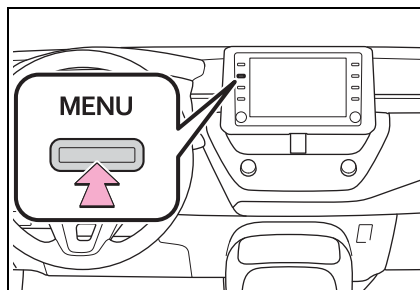

- 2 Select "Setup".
- 3 Select "Bluetooth".

- 4 Select the desired item to be set.

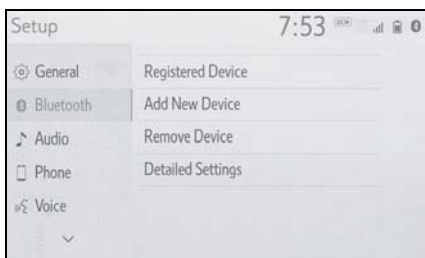

**Bluetooth® setup screen**

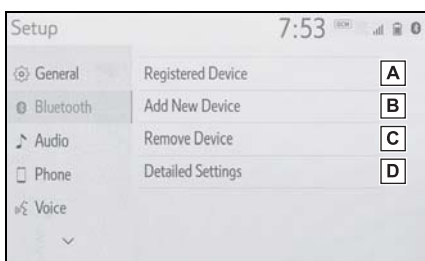

- A** Connecting a Bluetooth® device and editing the Bluetooth® device information (→P.303, 306)
- B** Registering a Bluetooth® device (→P.305)
- C** Deleting a Bluetooth® device (→P.305)
- D** Setting the Bluetooth® system (→P.307)

**Connecting a Bluetooth® device**

Up to 5 Bluetooth® devices (Phones (HFP) and audio players (AVP)) can be registered.

If more than 1 Bluetooth® device

has been registered, select which device to connect to.

- 1 Display the Bluetooth® settings screen. (→P.302)
- 2 Select “Registered Device”.
- 3 Select the device to be connected.



- : Phone
- : Audio player
- : Phone/Toyota apps services

- The profile icon for a currently connected device will be displayed in color.
- Selecting a profile icon which is not currently connected will switch the connection to the function.
- If the desired Bluetooth® device is not on the list, select “Add New Device” to register the device. (→P.305)

5

Audio

- 4 Select the desired connection.

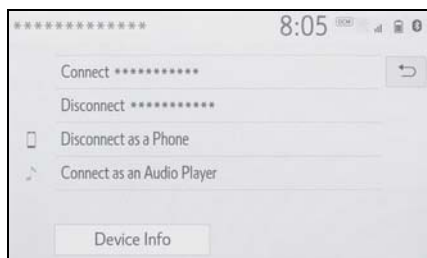

“Device Info”: Select to confirm and change the Bluetooth® device information. (→P.306)

When another Bluetooth® device is connected

To disconnect the Bluetooth® device, select “Yes”.

- 5 Check that a confirmation screen is displayed when the connection is complete.

If an error message is displayed, follow the guidance on the screen to try again.

- It may take time if the device connection is carried out during Bluetooth® audio playback.
- Depending on the type of Bluetooth® device being connected, it may be necessary to perform additional steps on the device.
- When disconnecting a Bluetooth® device, it is recommended to disconnect using the system.

■ **Connecting a Bluetooth® device in a different way (from phone top screen)**

→P.375

■ **Connecting a Bluetooth® device in a different way (from phone setup screen)**

→P.388

■ **Connecting a Bluetooth® device in a different way (from Bluetooth® audio screen)**

→P.347

■ **Auto connection mode**

To turn auto connection mode on, set “Bluetooth Power” to on. (→P.307) Leave the Bluetooth® device in a location where the connection can be established.

- When the engine switch is in ACC or ON, the system searches for a nearby registered device.
- The system will connect with the registered device that was last connected, if it is nearby. When automatic connection priority is set to on and there is more than one registered Bluetooth® phone available, the system will automatically connect to the Bluetooth® phone with the highest priority. (→P.307)

■ **Connecting manually**

When the auto connection has failed or “Bluetooth Power” is turned off, it is necessary to connect the Bluetooth® device manually.

- 1 Display the Bluetooth® settings screen. (→P.302)
- 2 Follow the steps in “Connecting a Bluetooth® device” from step 2. (→P.303)

#### ■ Reconnecting the Bluetooth® phone

If a Bluetooth® phone is disconnected due to poor reception from the Bluetooth® network when the engine switch is in ACC or ON, the system automatically reconnects the Bluetooth® phone.

#### ■ Registering a Bluetooth® device

Up to 5 Bluetooth® devices can be registered.

Bluetooth® compatible phones (HFP) and audio players (AVP) can be registered simultaneously.

This operation cannot be performed while driving.

- 1 Display the Bluetooth® settings screen. (→P.302)
- 2 Select “Add New Device”.
  - ▶ When another Bluetooth® device is connected

To disconnect the Bluetooth® device, select “Yes”.

- ▶ When 5 Bluetooth® devices have already been registered

A registered device needs to be replaced. Select “Yes”, and select the device to be replaced.

- 3 Follow the steps in “Registering a Bluetooth® phone for the first time” from step 5. (→P.298)

#### ■ Deleting a Bluetooth® device

This operation cannot be performed while driving.

- 1 Display the Bluetooth® settings screen. (→P.302)
- 2 Select “Remove Device”.
- 3 Select the desired device.

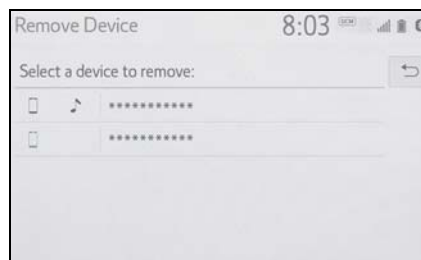

- 4 Select “Yes” when the confirmation screen appears.
- 5 Check that a confirmation screen is displayed when the operation is complete.

When deleting a Bluetooth® phone, the contact data will be deleted at the same time.

### Editing the Bluetooth® device information

The Bluetooth® device's information can be displayed on the screen. The displayed information can be edited.

This operation cannot be performed while driving.

- 1 Display the Bluetooth® settings screen. (→P.302)
- 2 Select "Registered Device".
- 3 Select the desired device to be edited.
- 4 Select "Device Info".

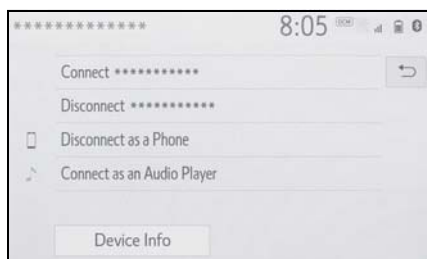

- 5 Confirm and change the Bluetooth® device information.

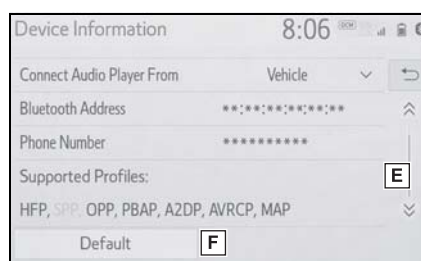
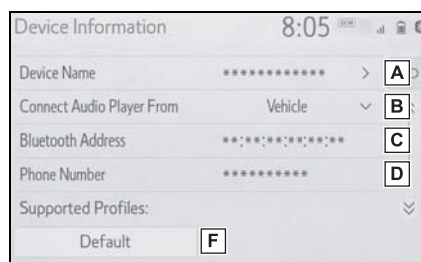

- A** The name of the Bluetooth® device is displayed. It can be changed to a desired name. (→P.307)
- B** Select to set the Bluetooth® audio player connection method. (→P.307)
- C** Device address is unique to the device and cannot be changed.
- D** Phone number is unique to the Bluetooth® phone and cannot be changed.
- E** Compatibility profile is unique to the Bluetooth® device and cannot be changed.
- F** Select to reset all setup items.

- If 2 Bluetooth® devices have been registered with the same device name, the devices can be distinguished referring to the device's address.
- Depending on the type of Bluetooth® phone, some information may not be displayed.

**Changing a device name**

- 1 Select "Device Name".
- 2 Enter the name and select "OK".

Even if the device name is changed, the name registered in your Bluetooth® device does not change.

**Setting audio player connection method**

- 1 Select "Connect Audio Player From".
- 2 Select the desired connection method.

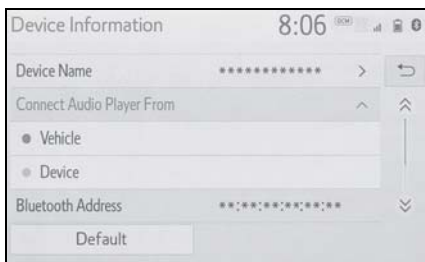

"Vehicle": Select to connect the audio player from the vehicle's audio/visual system.

"Device": Select to connect the vehicle's audio/visual system from the audio player.

Depending on the audio player, the "Vehicle" or "Device" connection method may be best. As such, refer

to the manual that comes with the audio player.

**"Detailed Settings" screen**

The Bluetooth® settings can be confirmed and changed.

- 1 Display the Bluetooth® settings screen. (→P.302)
- 2 Select "Detailed Settings".
- 3 Select the desired item to be set.



- A** Select to set Bluetooth® connection on/off. (→P.307)
- B** Select to change the automatic connection priority of the registered Bluetooth® devices. (→P.308)
- C** Select to edit the system information. (→P.308)
- D** Select to reset all setup items.

**Changing "Bluetooth Power"**

- 1 Select "Bluetooth Power".
- When "Bluetooth Power" is on:  
The Bluetooth® device is auto-

5  
Audio

atically connected when the engine switch is in ACC or ON.

When “Bluetooth Power” is off:

The Bluetooth® device is disconnected, and the system will not connect to it next time.

While driving, the auto connection state can be changed from off to on, but cannot be changed from on to off.

### Setting automatic connection priority

The automatic connection priority of the registered Bluetooth® devices can be changed.

- 1 Select “Preferred Device Settings”.
- 2 Select the desired item to be set.



- A** Select to set automatic connection priority on/off.
- B** Select to change the automatic connection priority of the registered Bluetooth® phones. (→P.308)
- C** Select to change the automatic connection priority of the registered Bluetooth®

audio players. (→P.308)

- D** Select to reset all setup items.

### Changing Bluetooth® device automatic connection priority

- 1 Select “Preferred Phones” or “Preferred Audio Players”.
- 2 Select the desired Bluetooth® device and select “Move Up” or “Move Down” to change the preferred order.

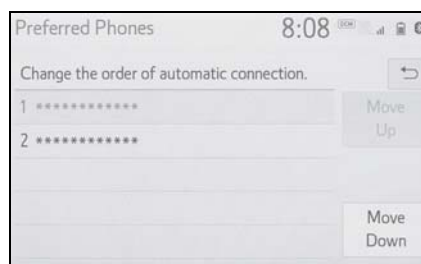

A newly registered Bluetooth® device will automatically be given the highest automatic connection priority.

### Editing the system information

- 1 Select “System Information”.



- 2 Select the desired item to be set.



- A** Displays system name. Can be changed to a desired name. (→P.309)
- B** PIN code used when the Bluetooth<sup>®</sup> device was registered. Can be changed to a desired code. (→P.309)
- C** Device address is unique to the device and cannot be changed.
- D** Select to set the connection status display of the phone on/off.
- E** Select to set the connection status display of the audio player on/off.
- F** Compatibility profile of the system
- G** Select to reset all setup items.

#### ■ Editing the system name

- 1 Select "System Name".
- 2 Enter a name and select "OK".

#### ■ Editing the PIN code

- 1 Select "System PIN Code".
- 2 Enter a PIN code and select "OK".

**Wi-Fi® Hotspot\***

\*: If equipped

**By connecting a device to the vehicle via Wi-Fi®, it can access the internet through the DCM.**

- To use this function, a Wi-Fi® Hotspot service subscription from Verizon Wireless is required. Contact your Toyota dealer for details.
- This function is not made available in some countries or areas.

**Connecting a device to the in-vehicle access point****Searching for and connecting a device to the vehicle access point**

- 1 Enable the Wi-Fi® Hotspot function. (→P.311)
- 2 Disable the “Hide Access Point” function. (→P.310)
- 3 Search for the vehicle access point using the device you wish to connect.

For details about operating the device, refer to the documentation which came with it.

- 4 Operate the device to connect it to the vehicle access point.

To check the vehicle access point password, check “Password”. (→P.311)

Hints for connecting to the vehicle via Wi-Fi® can be displayed. (→P.311)

**Connecting a device to the in-vehicle access point using the access point name (SSID)**

- 1 Enable the Wi-Fi® Hotspot function. (→P.311)
  - 2 Enable the “Hide Access Point” function. (→P.310)
  - 3 Enter the access point name (SSID) into the device you wish to connect and connect it.
- To check the vehicle access point password, check “Password”. (→P.311)
  - The security settings on the device must be the same as that displayed for “Security”. (→P.311)
  - For details about operating the device, refer to the documentation which came with it.

### Changing the Wi-Fi® settings

1 Press the “MENU” button.

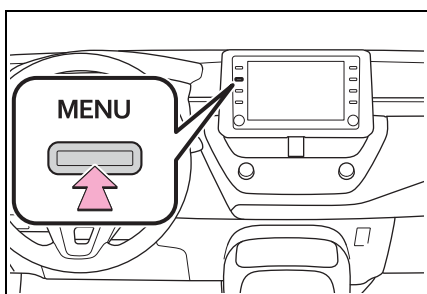

2 Select “Setup”.

3 Select “Wi-Fi”.

\*: Wi-Fi® is a registered trademark of Wi-Fi Alliance®.

4 Select the desired item to be set.

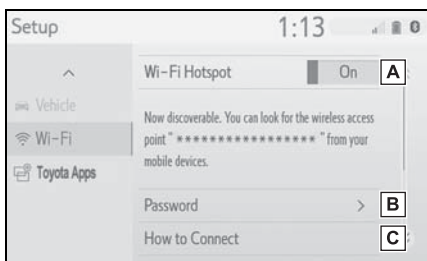

**A** Select to enable/disable the Wi-Fi® Hotspot function. (→P.311)

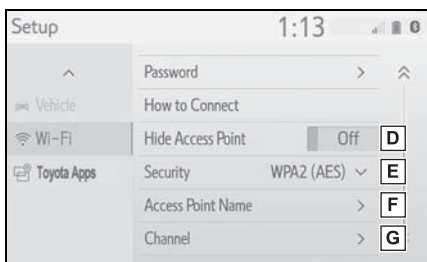

**B** Select to check/change the access point password. (→P.312)

**C** Select to display hints for connecting to the vehicle via Wi-Fi®.

**D** Select to make the access point searchable/unsearchable.

**E** Select to check/change the security protocol of the access point (for authentication and encryption). (→P.312)

**F** Select to change the access point name (SSID). (→P.312)

**G** Select to change the Wi-Fi® connection channel (within the 2.4GHz frequency band). (→P.312)

If any settings have been changed, it will be necessary to reset the Wi-Fi® system to complete the changes. To reset the Wi-Fi® system, select “Yes” on the pop-up displayed after changing the settings.

### Enabling/disabling the Wi-Fi® Hotspot function

When the Wi-Fi® Hotspot function is enabled, the system checks for a valid Hotspot service subscription.

If a hotspot service subscription has not been started, connect your device to the in-vehicle access point to start your sub-

scription. A trial subscription may be available.

### Checking/changing the password

- 1 Select "Password".
- 2 Check that the following screen is displayed.

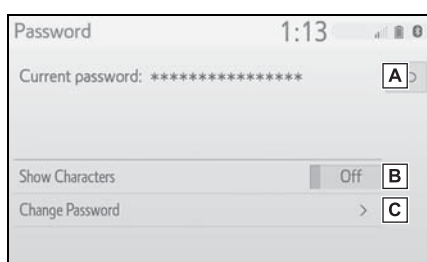

- A** Displays the password
- B** Select to display/hide the entered password.
- C** Select to change the password.

### Changing the password

- 1 Select "Change Password".
- 2 Enter the desired password and select "OK".

When setting/changing a password, observe the following guidelines to help prevent the password from being cracked by a third party:

- Use an 8-character or longer password consisting of letters and numbers. (Non-ASCII characters will not be recognized by the system.)
- Change the password regularly.

- If you write the password down, do not leave it somewhere where it would be visible.
- Do not use the same or a similar password to that for other accounts.
- Avoid using easy to identify words, such as your vehicle's model name or license plate number, simple dictionary words, or words with simple obfuscation, such as c@t (for cat), as your password.

### Changing the security protocol

- 1 Select "Security".
- 2 Select the desired security protocol.

### Changing the access point name (SSID)

- 1 Select "Access Point Name".
- 2 Enter the desired access point name (SSID) and select "OK".

### Selecting a Wi-Fi® connection channel

- 1 Select "Channel".

- 2 Check that the following screen is displayed.

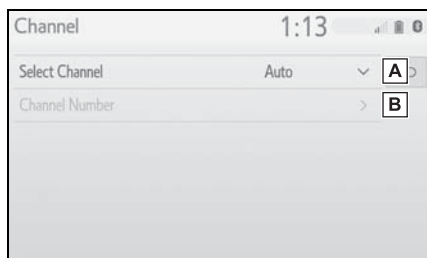

- A** Select to change the channel selection to auto/manual.
- B** When “Manual” is selected, select to change the channel.

#### Changing the channel

- 1 Set “Select Channel” to “Manual”.
- 2 Select “Channel Number”.
- 3 Enter the desired channel number and select “OK”.

Channels 1 through 11 can be selected.

#### Wi-Fi® function operating hints

##### ■ Wi-Fi® function operating hints

- If a connected device is taken out of the Wi-Fi® connection area, the connection will be severed.
- If the vehicle is driven out of the cellular communication coverage area, connecting to the internet via the Wi-Fi® Hotspot will not be possible.
- If a Bluetooth® device is used while a device is connected using

the Wi-Fi® Hotspot function, the communication speed may decrease.

- If the vehicle is near a radio antenna, radio station or other source of strong radio waves and electrical noise, communication may be slow or impossible.

#### ⚠ WARNING

- Use Wi-Fi® devices only when safe and legal to do so.
- Your audio unit is fitted with Wi-Fi® antennas. People with implantable cardiac pacemakers, cardiac resynchronization therapy-pacemakers or implantable cardioverter defibrillators should maintain a reasonable distance between themselves and the Wi-Fi® antennas. The radio waves may affect the operation of such devices.
- Before using Wi-Fi® devices, users of any electrical medical device other than implantable cardiac pacemakers, cardiac resynchronization therapy-pacemakers or implantable cardioverter defibrillators should consult the manufacturer of the device for information about its operation under the influence of radio waves. Radio waves could have unexpected effects on the operation of such medical devices.

#### Conditions displayed with Wi-Fi® icon

The condition of Wi-Fi® connection appears on the right upper side of the screen. (→P.286)

### Specifications

- Communication standards
  - IEEE 802.11b
  - IEEE 802.11g
  - IEEE 802.11n (2.4GHz)
- Security
  - WPA™
  - WPA2™
- WPA™ and WPA2™ are trademarks of Wi-Fi Alliance®.

### Apple CarPlay/ Android Auto\*

\*: This function is not made available in some countries or areas.

**Apple CarPlay allows some applications, such as Map, Phone, and Music, to be used on the system.**

**When an Apple CarPlay connection is established, Apple CarPlay compatible applications will be displayed on the system display.**

#### ● Compatible devices

Apple iPhone (iOS Ver. 9.3 or later) that supports Apple CarPlay.

For details, refer to <https://www.apple.com/ios/carplay/>.\*

Android™ devices with Android OS Ver. 5.0 or higher which support Android Auto and have the Android Auto application installed.

For details, refer to <https://www.android.com/auto/>

\*

.

\*: Some devices may not operate with this system.

### Establishing an Apple CarPlay connection

- 1 Enable Siri on the device to be connected.

- 2 Connect the device to the USB port. (→P.330)
- 3 Select “Always Enable” or “Enable Once”.

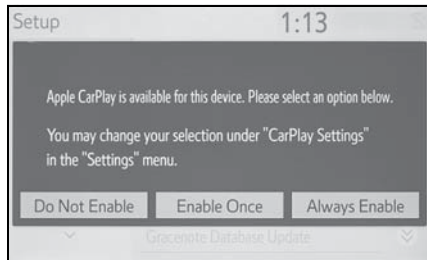

- If “Do Not Enable” is selected, an Apple CarPlay connection will not be established. In this case, the device can be operated as a normal Apple device, such as an iPod.
  - Depending on the device connected, it may take approximately 3 to 6 seconds before an Apple CarPlay connection is established.
- 4 Check that home screen of Apple CarPlay is displayed.



- A** Select to display the home screen of Apple CarPlay. Touch and hold to activate Siri.
- B** Select to start the application. User can use any iPhone

application supported by Apple CarPlay.

- C** Select to display the system screen.

### Establishing an Android Auto connection

- 1 Check that the Android Auto application is installed to the device to be connected.
- 2 Connect the device to the USB port. (→P.329)
- 3 Select “On” to enable the function.
  - “Off”: Select to not enable Android Auto. Android Auto will remain off until “Android Auto” of “Projection Settings” on the general settings screen is turned on.
  - Depending on the device connected, it may take approximately 3 to 6 seconds before the system returns to previous screen.
  - The screen may change to “step 6” depending on the system.

5  
Audio

4 Press the "MENU" button.

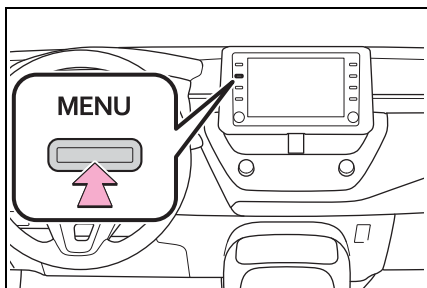

5 Select "Android Auto".

6 Check that home screen of Android Auto is displayed.

- When an Apple CarPlay/Android Auto connection is established, the function of some system buttons will change.
- When an Apple CarPlay/Android Auto connection is established, some system functions, such as the following, will be replaced by similar Apple CarPlay/Android Auto functions or will become unavailable:
  - iPod (Audio Playback)
  - Hands-free Phone
  - USB audio/USB video
  - Bluetooth® audio
  - Bluetooth® phone (Apple CarPlay only)
  - Toyota apps
- When an Apple CarPlay/Android Auto connection is established, voice command system (Siri/Google Assistant) and map application voice guidance volume can be changed by selecting "Voice Volume" on the voice settings screen. It cannot be changed by "POWER VOLUME" knob on Audio control panel. (→P.325)
- Apple CarPlay/Android Auto is an application developed by Apple Inc/Google LLC. Its functions and services may be terminated or changed without notice depending

on the connected device's operation system, hardware and software, or due to changes in Apple CarPlay/Android Auto specifications.

- For a list of the apps supported by Apple CarPlay or Android Auto, refer to their respective website.
- While using these functions, vehicle and user information, such as location and vehicle speed, will be shared with the respective application publisher and the cellular service provider.
- By downloading and using each application, you agree to their terms of use.
- Data for these functions is transmitted using the internet and may incur charges. For information about data transmission fees, contact your cellular service provider.
- Depending on the application, certain functions, such as music playback, may be restricted.
- As the applications for each function are provided by a third-party, they may be subject to change or discontinuation without notice. For details, refer to the website of the function.
- If the USB cable is disconnected, operation of Apple CarPlay/Android Auto will end. At this time, sound output will stop and change to the system screen.



- Use of the Apple CarPlay logo means that a vehicle user interface meets Apple performance standards. Apple is not responsible for the operation of this vehicle



or its compliance with safety and regulatory standards. Please note that the use of this product with iPhone or iPod may affect wireless performance.

- Apple CarPlay is a trademark of Apple Inc.
- Compatible models
  - Made for
  - iPhone X
  - iPhone 8
  - iPhone 8 Plus
  - iPhone 7
  - iPhone 7 Plus
  - iPhone SE
  - iPhone 6s
  - iPhone 6s Plus
  - iPhone 6
  - iPhone 6 Plus
  - iPhone 5s
  - iPhone 5c
  - iPhone 5

- Android and Android Auto are trademarks of Google LLC.

#### **WARNING**

Do not connect iPhone or operate the controls while driving.

#### **NOTICE**

- Do not leave your iPhone in the vehicle. In particular, high temperatures inside the vehicle may damage the iPhone.
- Do not push down on or apply unnecessary pressure to the iPhone while it is connected as this may damage the iPhone or its terminal.
- Do not insert foreign objects into the port as this may damage the iPhone or its terminal.

androidauto

5

Audio

## Troubleshooting

If you are experiencing difficulties with Apple CarPlay/Android Auto, check the following table.

Symptom	Solution
An Apple CarPlay/Android Auto connection cannot be established.	<p>Check if the device supports Apple CarPlay/Android Auto.</p> <p>Check if Apple CarPlay/Android Auto is enabled on the connected device.</p> <p>Check if that the Android Auto application is installed to the device to be connected.</p> <p>For details, refer to</p> <p>Apple CarPlay:  <a href="https://www.apple.com/ios/carplay/">https://www.apple.com/ios/carplay/</a>.</p> <p>Android Auto:  <a href="https://www.android.com/auto/">https://www.android.com/auto/</a>.</p>
	<p>Check if “Apple CarPlay”/“Android Auto” of “Projection Settings” on the general settings screen is set to on. (→P.321)</p>
	<p>Check if the USB cable being used is securely connected to the device and USB port.</p> <p>Check that the device is connected directly to the USB port of the system and not connected to a USB hub.</p> <p>For Apple CarPlay: Check if the Lightning cable being used is certified by Apple. Check if Siri is enabled.</p>
	<p>After checking all of the above, try to establish an Apple CarPlay/Android Auto connection. (→P.314, 315)</p>
When an Apple CarPlay/Android Auto connection is established and a video is being played, the video is not displayed, but audio is output through the system.	As the system is not designed to play video through Apple CarPlay/Android Auto, this is not a malfunction.
Although an Apple CarPlay/Android Auto connection is established, audio is not output through the system.	The system may muted or the volume may be low. Increase the system volume.

Symptom	Solution
The Apple CarPlay/Android Auto screen has artifacts and/or audio from Apple CarPlay/Android Auto has noise.	<p>Check if the USB cable being used to connect the device to the system is damaged. To check if the USB cable is damaged internally, connect the device to another system, such as a PC, and check if the device is recognized by the connected system. (The device should begin charging when connected.)</p> <p>After checking all of the above, try to establish an Apple CarPlay/Android Auto connection. (→P.314, 315)</p>
The map display of the Apple CarPlay Maps app cannot be enlarged or contracted with pinch multi-touch gestures.	As the Apple CarPlay Maps app is not compatible with pinch multi-touch gestures, this is not a malfunction.
During Apple CarPlay music application (Apple Music, Spotify, etc.) playback, if the iPhone is operated to start and play audio from an application that is not compatible with Apple CarPlay* and the onboard device volume is changed, the audio of the incompatible application stops and the system resumes playback of the original music application.	This operation is performed according to the specification of the onboard device, this is not a malfunction.
After interrupt audio (such as navigation route guidance) is played from an application that is not compatible with Apple CarPlay while the onboard device is playing audio, the system does not resume playback of the original audio.	<p>This operation is performed according to the specification of the onboard device, this is not a malfunction.</p> <p>Manually change the audio source by yourself. Or, do not use applications that are not compatible with Apple CarPlay.* Due to some navigation applications are compatible from iOS 12, update to the latest iOS and application versions.</p>

Symptom	Solution
<p>When using Apple CarPlay, route guidance arrows and turn by turn navigation are not displayed on the multi-information display and system display.</p> <p>When using Android Auto, turn by turn navigation is not displayed on the multi-information display and system display.</p>	<p>This is not a malfunction as display of these items is not possible with this function.</p>
<p>When using Android Auto, hands-free call audio cannot be heard from the vehicle's speakers.</p>	<p>Disconnect the phone from the USB cable and check if hands-free call audio can be heard using the hands-free system.</p> <p>Connect the phone to the system using Android Auto, turn up the volume on the system and check if hands-free call audio can be heard. Check if other sounds can be heard from the vehicle's speakers.</p>

\*: Applications not compatible with Apple CarPlay are applications installed on the iPhone that are not displayed on the Apple CarPlay screen application list. (such as visual voicemail)

General settings

Settings are available for clock, operation sounds, etc.

Displaying the general settings screen

- 1 Press the "MENU" button.

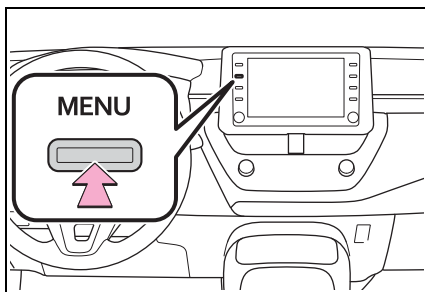

- 2 Select "Setup".

If the general settings screen is not displayed, select "General".

- 3 Select the desired items to be set.

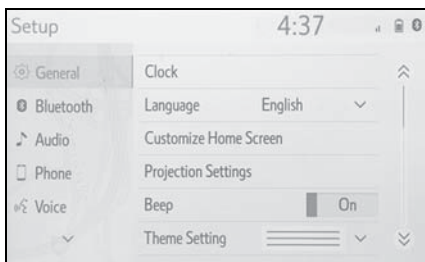

General settings screen

- "Clock"

Select to change the time zone and select "On" or "Off" for daylight saving time, automatic adjustment of the clock, etc. (→P.322)

- "Language"

Select to change the language. The language setting of Apple CarPlay/Android Auto can only be changed on the connected device.

- "Customize Home Screen"

Select to change the display information/area on the home screen and the home screen layout. (→P.292)

- "Theme Setting"

Select to change the screen theme setting.

- "Beep"

Select to turn the beep sound on/off.

- "Units of Measurement"

Select to change the unit of measure for distance/fuel consumption.

- "Keyboard Layout"

Select to change the keyboard layout.

- "Delete Keyboard History"

Select to delete the keyboard history.

- "Memorize Keyboard History"

Select to set the memorize keyboard history on/off.

- "Animation"

Select to turn the animations on/off.

- "Projection Settings"\*1

Select to set automatic Apple CarPlay/Android Auto connection establishment on/off. (→P.323)

- "Driver Setting"

Select to change the driver set-

tings. (→P.323)

- “Delete Personal Data”

Select to delete personal data. (→P.324)

- “Software Update”

Select to update software versions. For details, contact your Toyota dealer.

- “Software Update Setting”<sup>\*2</sup>

Select to set software update setting. (→P.324)

- “Gracenote Database Update”

Select to update Gracenote® database versions. For details, contact your Toyota dealer.

- “Software Information”

Select to display the software information. Notices related to third party software used in this product are enlisted. (This includes instructions for obtaining such software, where applicable.)

- “SW Sensitivity Level”

Select to change the capacitive touch screen button sensitivity to 1 (low), 2 (medium), or 3 (high).

<sup>\*1</sup>: This function is not made available in some countries or areas.

<sup>\*2</sup>: If equipped

### Clock settings

- 1 Display the general settings screen. (→P.321)
- 2 Select “Clock”.

- 3 Select the desired items to be set.

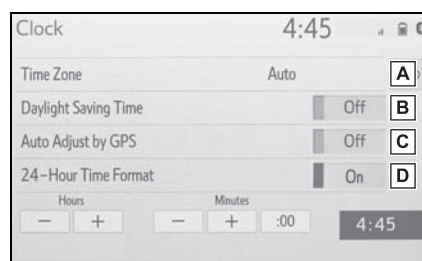

- A Select to change the time zone. (→P.322)
- B Select to set daylight saving time on/off.
- C Select to set automatic adjustment of the clock by GPS on/off. When set to off, the clock can be manually adjusted. (→P.322)
- D Select to set the 24 hour time format on/off. When set to off, the clock is displayed in 12 hour time format.

### Setting the time zone

- 1 Select “Time Zone”.
- 2 Select the desired time zone.

### Manual clock setting

When “Auto Adjust by GPS” is turned off, the clock can be manually adjusted.

- 1 Select “Auto Adjust by GPS” to set to off.

2 Adjust the clock manually.

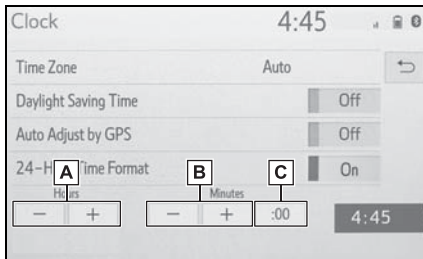

- A** Select “+” to set the time forward one hour and “-” to set the time back one hour.
- B** Select “+” to set the time forward one minute and “-” to set the time back one minute.
- C** Select to round to the nearest hour.  
e.g.  
1:00 to 1:29 → 1:00  
1:30 to 1:59 → 2:00

**Projection settings\***

\*: This function is not made available in some countries or areas.

- 1 Display the general settings screen. (→P.321)
- 2 Select “Projection Settings”.
- 3 Select the desired items to be set.

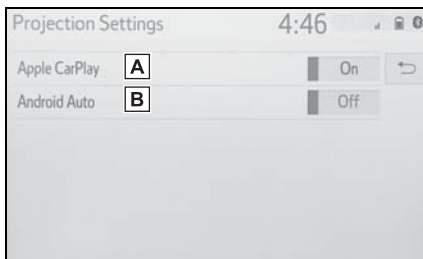

- A** Select to turn Apple CarPlay

connection establishment on/off when a compatible iPhone is connected to the system via USB. (→P.314) Depending on the system, this setting cannot be changed when a device is connected to the system via USB. Disconnect the device before attempting to change the setting.

- B** Select to turn Android Auto connection establishment on/off when a compatible device is connected to the system via USB. (→P.315) Depending on the system, this setting cannot be changed when a device is connected to the system via USB. Disconnect the device before attempting to change the setting.

**Driver settings**

The driver settings feature will allow the system to link some preferences (such as audio presets, screen theme, language, etc.) to a paired Bluetooth® phone.

- 1 Display the general settings screen. (→P.321)
- 2 Select “Driver Setting”.

5  
Audio

- 3 Select "Enable This Feature".

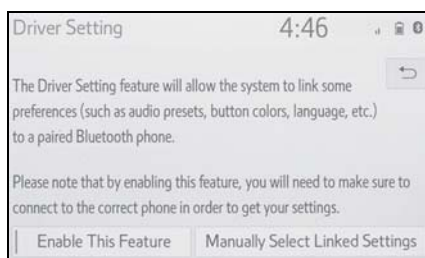

### Manually select linked settings

- 1 Select "Manually Select Linked Settings".
- 2 Select the desired phone.

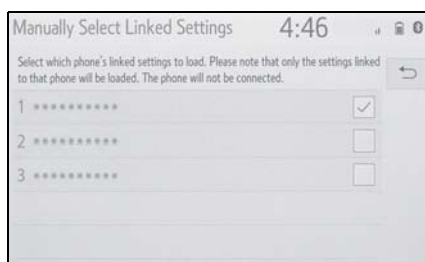

After a few seconds, loaded screen automatically switches to the home screen.

### Deleting personal data

Registered or changed personal settings will be deleted or returned to their default conditions.

- 1 Display the general settings screen. (→P.321)
- 2 Select "Delete Personal Data".
- 3 Select "Delete".

- 4 Select "Yes" when the confirmation screen appears.

Examples of settings that can be returned to their default conditions:

- Audio settings
  - Phone settings
- etc.

### Software update settings\*

\*: This function is not made available in some countries or areas.

When the automatic update check function is enabled, if a software update is available from the Toyota response center, a message will be displayed.

- 1 Display the general settings screen. (→P.321)
- 2 Select "Software Update Setting".
- 3 Select "Automatic Update Check" to enable/disable the automatic update check function.

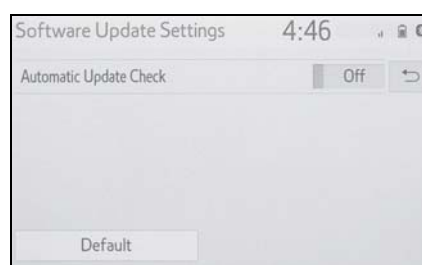

When software update information is displayed, contact your Toyota dealer.



Voice settings

Voice volume, etc. can be set.

Displaying the voice settings screen

- 1 Press the "MENU" button.

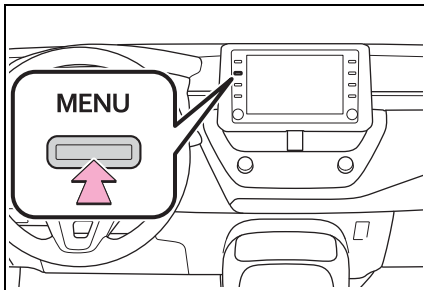

- 2 Select "Setup".
- 3 Select "Voice".
- 4 Select the desired items to be set.

Voice settings screen

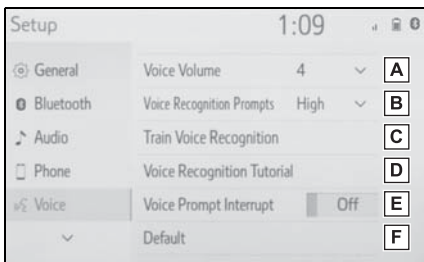

- A** Select to adjust the volume of voice guidance.
- B** Select to set the voice recognition prompts.
- C** Select to train voice recognition.

The voice command system adapts the user accent.

- D** Select to start the voice recognition tutorial.
- E** Select to set the voice prompt interrupt on/off.
- F** Select to reset all setup items.

## Vehicle settings

Settings are available for vehicle customization, etc.

### Displaying the vehicle settings screen

- 1 Press the "MENU" button.

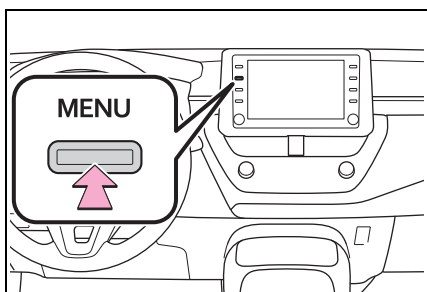

- 2 Select "Setup".
- 3 Select "Vehicle".
- 4 Select the desired items to be set.

### Vehicle settings screen

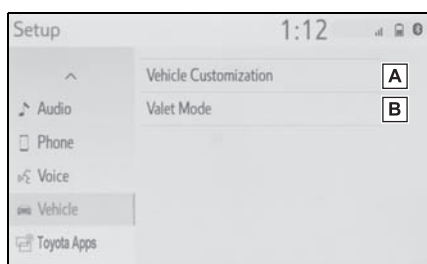

- A** Select to set vehicle customization. (→P.581)
- B** Select to set valet mode. (→P.326)

## Setting the valet mode

The security system can be set to on by entering a security code (4-digit number).

When set to on, the system will become inoperative once the electrical power source is disconnected until the security code is entered.

- 1 Display the vehicle settings screen. (→P.326)
- 2 Select "Valet Mode".
- 3 Enter the 4-digit personal code and select "OK".
- 4 Enter the same 4-digit personal code again and select "OK".

- The system will request that you input the security code again to confirm that you remember it correctly.
- When valet mode activates, the system stops and a security code (4-digit number) standby screen is displayed.

If the 4-digit personal code is forgotten, please contact your Toyota dealer.

### If the valet mode has been activated

Enter the 4-digit personal code and select "OK".

If an incorrect security code (4-digit number) is entered 6 times, the system will not accept another security

code (4-digit number) for 10 minutes.

5

Audio

## Quick reference

## Functional overview

The audio control screen can be reached by the following methods:

- ▶ From the “AUDIO” button

Press the “AUDIO” button.

- ▶ From the “MENU” button

Press the “MENU” button, then select “Audio”.

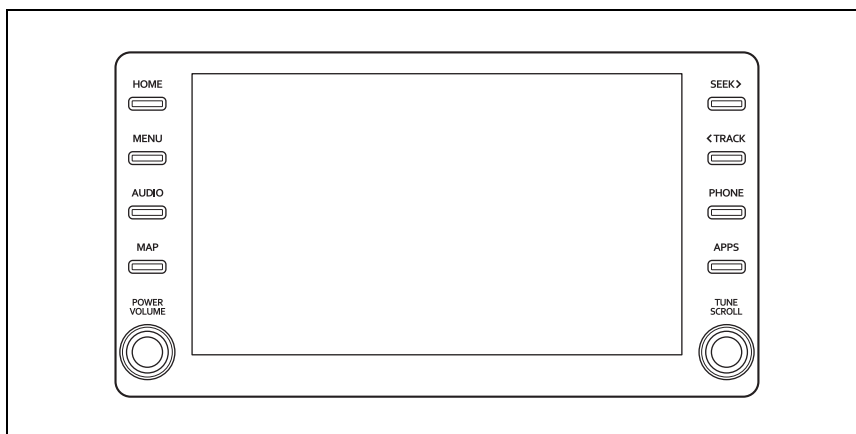

- Using the radio (→P.333)
- Playing a USB memory (→P.339)
- Playing an iPod/iPhone (Apple CarPlay<sup>\*</sup>) (→P.341)
- Using the Android Auto<sup>\*</sup> (→P.344)
- Playing a Bluetooth<sup>®</sup> device (→P.345)
- Using the steering wheel audio switches (→P.349)
- Audio system settings (→P.351)

\*: This function is not made available in some countries or areas.

**Some basics**

**This section describes some of the basic features of the audio/visual system. Some information may not pertain to your system.**

**Your audio/visual system works when the engine switch is in ACC or ON.**

 **NOTICE**

To prevent the battery from being discharged, do not leave the audio/visual system on longer than necessary when the engine is not running.

**Turning the system on and off**

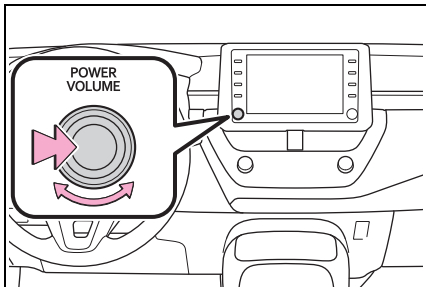



**“POWER VOLUME” knob:**  
Press to turn the audio/visual system on and off. The system turns on in the last mode used. Turn this knob to adjust the volume.

**Selecting an audio source**

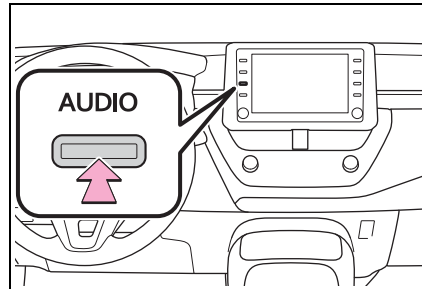
- 1 Press the “AUDIO” button.



- 2 Select “Source” or press “AUDIO” button again.
- 3 Select the desired source.

- Dimmed screen buttons cannot be operated.
  - When there are two pages, select  or  to change the page.
  - When an Apple CarPlay/Android Auto connection is established, some system functions, such as the following, will be replaced by similar Apple CarPlay/Android Auto function or will become unavailable\* :
    - iPod (Audio Playback)
    - USB audio/USB video
    - Bluetooth® audio
    - Toyota apps
- \*: This function is not made available in some countries or areas.

**Reordering the audio source**

- 1 Display the audio source selection screen. (→P.329)
- 2 Select “Reorder”.

- 3 Select the desired audio source then < or > to reorder.
- 4 Select "OK".

### USB port

Connect a device.

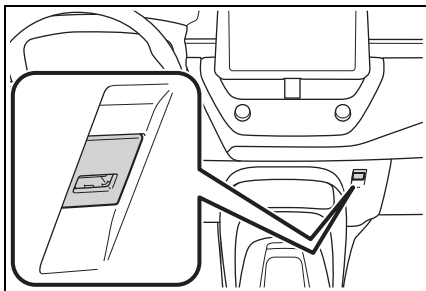

Turn on the power of the device if it is not turned on.

- If a USB hub is plugged-in, two devices can be connected at a time.
- Even if a USB hub is used to connect more than two USB devices, only the first two connected devices will be recognized.
- If a USB hub that has more than two ports is connected to the USB port, devices connected to the USB hub may not charge or be inoperable, as the supply of current may be insufficient.

### Sound settings

- 1 Display the audio control screen. (→P.329)
- 2 Select "Sound".

- 3 Select the desired item to be set.

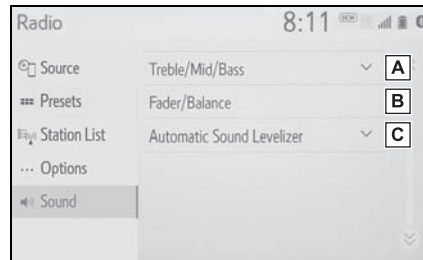

- A** Select to set the treble/mid/bass. (→P.330)
- B** Select to set the fader/balance. (→P.331)
- C** Select to set the automatic sound levelizer. (→P.331)

#### ■ Treble/Mid/Bass

How good an audio program sounds is largely determined by the mix of the treble, mid and bass levels. In fact, different kinds of music and vocal programs usually sound better with different mixes of treble, mid and bass.

- 1 Select "Treble/Mid/Bass".
- 2 Select the desired screen button.

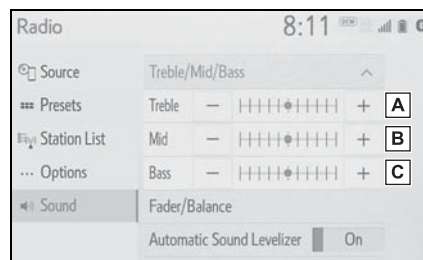

- A** Select "+" or "-" to adjust high-pitched tones.

- B** Select “+” or “-” to adjust mid-pitched tones.
- C** Select “+” or “-” to adjust low-pitched tones.

■ **Fader/Balance**

A good balance of the left and right stereo channels and of the front and rear sound levels is also important.

Keep in mind that when listening to a stereo recording or broadcast, changing the right/left balance will increase the volume of 1 group of sounds while decreasing the volume of another.

- 1 Select “Fader/Balance”.
- 2 Select the desired screen button.

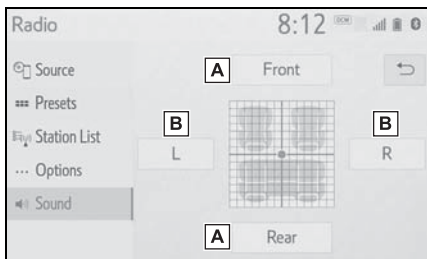

- A** Select to adjust the sound balance between the front and rear speakers.
- B** Select to adjust the sound balance between the left and right speakers.

■ **Automatic sound levelizer (ASL)**

The system adjusts to the optimum volume and tone quality

according to vehicle speed to compensate for increased road noise, wind noise, or other noises while driving.

- 1 Select “Automatic Sound Levelizer”.
- 2 Select “High”, “Mid”, “Low” or “Off”.

**Audio screen adjustment**

■ **Screen format settings**

The screen format can be selected for USB video.

- 1 Press the “MENU” button.
- 2 Select “Setup”.
- 3 Select “Audio”.
- 4 Select “Common”.
- 5 Select “Screen Format”.
- 6 Select the desired item to be adjusted.

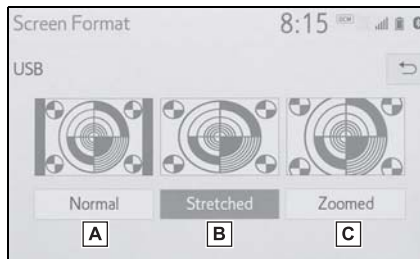

- A** Select to display a 4 : 3 screen, with either side in black.
- B** Select to enlarge the image horizontally and vertically to full screen.
- C** Select to enlarge the image by the same ratio horizontally

and vertically.

### ■ Contrast and brightness adjustment

The contrast and brightness of the screen can be adjusted.

- 1 Press the "MENU" button.
- 2 Select "Setup".
- 3 Select "Audio".
- 4 Select "Common".
- 5 Select "Display".
- 6 Select the desired item to be adjusted.

#### ● "Contrast"

"+": Select to strengthen the contrast of the screen.

"-": Select to weaken the contrast of the screen.

#### ● "Brightness"

"+": Select to brighten the screen.

"-": Select to darken the screen.

Depending on the audio source, some functions may not be available.

### Voice command system

- 1 Press this switch to operate the voice command system.

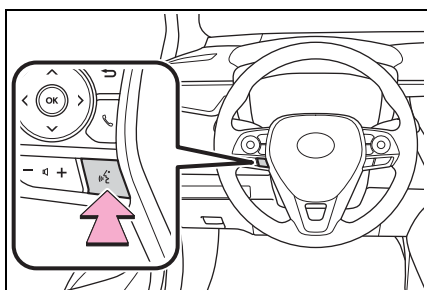

The voice command system and its list of commands can be operated. (→P.364)



AM radio/FM radio/SiriusXM® Satellite Radio(SXM)\*

\*: If equipped

Overview

The radio operation screen can be reached by the following methods:  
→P.329

Control screen

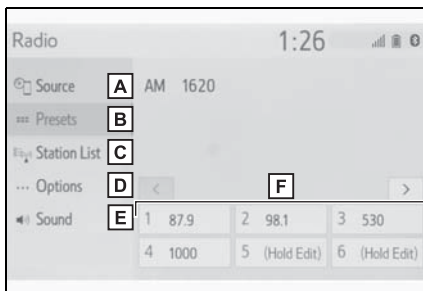

- A** Select to display the audio source selection screen.
- B** Select to display the preset stations screen. (→P.333)
- C** Select to display a list of receivable stations. (→P.334)
- D** Select to display the radio options screen. (→P.334)
- E** Select to display the sound setting screen. (→P.330)
- F** Select to tune to preset stations/channels. (→P.333)

Control panel

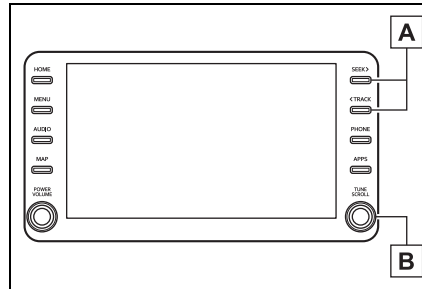

- A** Press to seek for stations in the relevant program type. Press and hold for continuous seek.
- B** Turn to step up/down frequencies. Turn to move up/down the station. Also, the knob can be used to enter selections on the list screens by pressing it.

The radio automatically changes to stereo reception when a stereo broadcast is received.

Presetting a station

Radio mode has a mix preset function, which can store up to 36 stations (6 stations per page x 6 pages) from any of the AM, FM or SXM bands.

- 1 Tune in the desired station.

- 2 Select and hold “(Hold Edit)”.

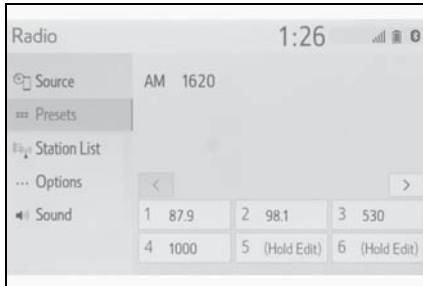

- To change the preset station to a different one, select and hold the preset station.

The number of preset radio stations displayed on the screen can be changed. (→P.351)

### Selecting a station from the list

- 1 Select “Station List”.
- 2 Select “AM”, “FM” or “SXM”.

Select the desired program genre when the genre selection screen is displayed.

- 3 Select the desired station.

### ■ Refreshing the station list

- 1 Select “Refresh”.

“Cancel Refresh”: Select to cancel the refresh.

“Source”: Select to change to another audio source while refreshing.

- The audio/visual system sound is muted during refresh operation.
- In some situations, it may take some time to update the station list.

### Radio options

- 1 Select “Options”.
- 2 Select the desired item to be set.

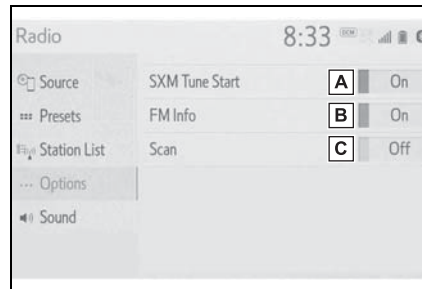

- A** When “SXM Tune Start” is turned on, the current song is played from the beginning when you select the channel.
- B** Analog FM only: Select to display RBDS text messages.
- C** Select to scan for receivable stations.

### Radio Broadcast Data System

This audio/visual system is equipped with Radio Broadcast Data Systems (RBDS). RBDS mode allows text messages to be received from radio stations that utilize RBDS transmitters.

When RBDS is on, the radio can do the following functions.

- Only selecting stations of a particular program type
- Displaying messages from radio stations

- Searching for a stronger signal station

RBDS features are available only when listening to an FM station that broadcasts RBDS information and the “FM Info” function is on. (→P.334)

### How to subscribe to SiriusXM Radio Services

All SiriusXM services, including satellite radio and data services, plus streaming services, require a subscription, sold separately or as a package by Sirius XM Radio Inc. (or in Canada, Sirius XM Canada Inc.), after any trial subscription which may be included with your vehicle purchase or lease. To subscribe after your trial subscription, call 1-877-447-0011 (U.S.A.) or 1-877-438-9677 (Canada).

#### ■ Important information about your subscription

Your SiriusXM services will automatically stop at the end of your trial unless you decide to subscribe. If you decide to continue service, the paid subscription plan you choose will automatically renew and you will be charged the rate in effect at that time and according to your chosen payment method. Fees and taxes apply. You may cancel at any time by calling 1-866-635-2349. See SiriusXM

Customer Agreement for complete terms at [www.siriusxm.com](http://www.siriusxm.com) (U.S.A.) or [www.siriusxm.ca](http://www.siriusxm.ca) (Canada). All fees and programming subject to change. Traffic information not available in all markets.

#### NOTICE

- It is prohibited to copy, decompile, disassemble, reverse engineer, hack, manipulate, or otherwise make available any technology or software incorporated in receivers compatible with the SiriusXM Satellite Radio System or that support the SiriusXM website, the streaming service or any of its content. Furthermore, the AMBE<sup>®</sup> voice compression software included in this product is protected by intellectual property rights including patent rights, copyrights, and trade secrets of Digital Voice Systems, Inc.
- Note: this applies to SiriusXM Satellite Radio receivers only and not SiriusXM Ready devices.

- About SiriusXM Services
  - Most in-car trials today include SiriusXM's best package — All Access. It includes every channel available on your radio, plus streaming.
- SiriusXM All Access Subscription
  - Listen everywhere with All Access. You get every channel available in your ride, plus you can listen on the app and online — so you can enjoy the best SiriusXM has to offer, anywhere life takes you. It's the only package that gives you all of our premium programming, including Howard

Stern, every NFL, MLB® and NBA game, every NASCAR® race, NHL® games, 24/7 talk channels dedicated to the biggest leagues, and more. You get all kinds of commercial-free music, including artist-dedicated channels and more, plus sports, news, talk and entertainment.

- Radio operation
- Look for the Sirius, XM, SiriusXM, Band, SAT, AUX, Radio or Source button and you're in. If you can't hear us, it's easy to get started: U.S.A.:  
Locate your Radio ID by turning to Channel 0. If you don't see your number there, go to [siriusxm.com/activationhelp](http://siriusxm.com/activationhelp) to find it. Visit [siriusxm.com/refresh](http://siriusxm.com/refresh) or call 1-855-MYREFRESH (697-3373) to send a refresh signal to your radio.  
Canada:  
Locate your Radio ID by turning to Channel 0.  
Visit [siriusxm.ca/refresh](http://siriusxm.ca/refresh) to send a

refresh signal to your radio or call 1-888-539-7474 for service.

### Displaying the radio ID

Each SiriusXM tuner is identified with a unique radio ID. The radio ID is required when activating an SiriusXM service or when reporting a problem.

- If "Ch 000" is selected using the "TUNE SCROLL" knob, the ID code, which is 8 alphanumeric characters, will be displayed. If another channel is selected, the ID code will no longer be displayed. The channel (000) alternates between displaying the radio ID and the specific radio code.

### Refer to the table below to identify the problem and take the suggested corrective action

When problems occur with the SiriusXM tuner, a message will appear on the screen. Referring to the table below to identify the problem, take the suggested corrective action.

Message	Explanation
"Check Antenna"	The SiriusXM antenna is not connected. Check whether the SiriusXM antenna cable is attached securely. Contact your Toyota dealer for assistance.
	A short circuit occurs in the antenna or the surrounding antenna cable. Contact your Toyota dealer for assistance.
"No Signal"	The SiriusXM signal is too weak at the current location. Wait until your vehicle reaches a location with a stronger signal.

---

Message	Explanation
“Chan Unavailable”	The channel you selected is not broadcasting any programming. Select another channel.
“Ch Unsubscribed”	The channel you selected is no longer available. Wait for about 2 seconds until the radio returns to the previous channel or “Ch 001”. If it does not change automatically, select another channel.

### Internet radio

**One of Toyota apps Connect features is the ability to listen to internet radio. In order to use this service, a compatible phone and the system needs to be set up. For details: →P.409**

already registered, it will be connected automatically.

- Other applications can be activated while listening to internet radio.
- Some parts of applications can be adjusted using the switches on the steering wheel.
- For additional information, refer to <https://www.toyota.com/audio-multimedia> or call 1-800-331-4331 in the United States, <https://www.toyota.ca/connected> or call 1-888-869-6828 in Canada, and <http://www.toyotapr.com/audio-multimedia> or call 1-877-855-8377 in Puerto Rico.

### Listening to internet radio

- 1 Display the audio source selection screen. (→P.329)
  - 2 Select the desired application screen button.
- The internet radio application screen is displayed.
  - Perform operations according to the displayed application screen.
  - For the instrument panel operation method: →P.329
  - If a compatible phone is

**USB memory**

**WARNING**

Do not operate the player's controls or connect the USB memory while driving.

**NOTICE**

- Do not leave your portable player in the car. In particular, high temperatures inside the vehicle may damage the portable player.
- Do not push down on or apply unnecessary pressure to the portable player while it is connected as this may damage the portable player or its terminal.
- Do not insert foreign objects into the port as this may damage the portable player or its terminal.

**Overview**

The USB memory operation screen can be reached by the following methods: →P.329

Connecting a USB memory (→P.330)

When an Apple CarPlay/Android Auto connection is established, this function will be unavailable\*.

\*: This function is not made available in some countries or areas.

**Control screen**

▶ USB audio

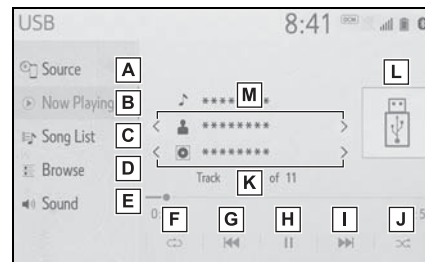

- A** Select to display the audio source selection screen.
- B** Select to return to the top screen.
- C** Select to display a song list screen.
- D** Select to display the play mode selection screen.
- E** Select to display the sound setting screen. (→P.330)
- F** Select to set repeat playback. (→P.340)
- G** Select to change the file/track. Select and hold to fast rewind.
- H** Select to play/pause.
- I** Select to change the file/track. Select and hold to fast forward.
- J** Select to set random playback. (→P.341)
- K** Select to change the folder/album.
- L** Displays cover art

5  
Audio

- M** Select to change the artist.
- ▶ USB video
  - 1 Select "Browse".
  - 2 Select "Videos".
  - 3 Select the desired folder and file.

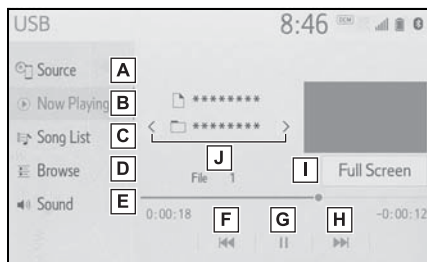

- A** Select to display the audio source selection screen.
- B** Select to return to the top screen.
- C** Select to display a song list screen.
- D** Select to display the play mode selection screen.
- E** Select to display the sound setting screen. (→P.330)
- F** Select to change the file. Select and hold to fast rewind.
- G** Select to play/pause.
- H** Select to change the file. Select and hold to fast forward.
- I** Select to display a full screen image.
- J** Select to change the folder.

### Control panel

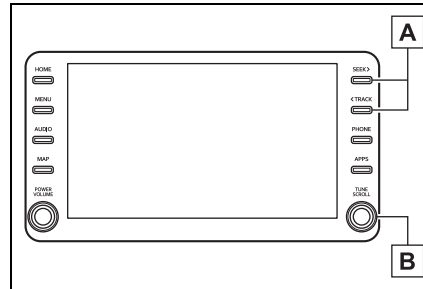

- A** Press to change the file/track. Press and hold to fast forward/rewind.
- B** Turn to change the file/track. Turn to move up/down the list. Also, the knob can be used to enter selections on the list screens by pressing it.

- While the vehicle is being driven, this function can only output sound.
- If tag information exists, the file/folder names will be changed to track/album names.

### Repeating

The file/track or folder/album currently being listened to can be repeated.

Select .

- Each time  is selected, the mode changes as follows:
  - ▶ When random playback is off  
File/track repeat → folder/album repeat → off
  - ▶ When random playback is on  
File/track repeat → off



**Random order**

Files/tracks or folders/albums can be automatically and randomly selected.

Select .

Each time  is selected, the mode changes as follows:  
 Random (1 folder/album random) → folder/album random (all folder/album random) → off

**iPod/iPhone (Apple CarPlay\*)**

\*: This function is not made available in some countries or areas.

**Overview**

The iPod/iPhone(Apple CarPlay) operation screen can be reached by the following methods: →P.329

Connecting an iPod/iPhone (→P.314, 330)

When an Android Auto connection is established, this function will be unavailable.\*

\*: This function is not made available in some countries or areas.

5

Audio

**Control screen**

▶ An Apple CarPlay connection is not established

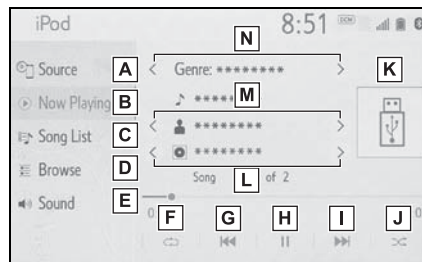

- An Apple CarPlay connection is established

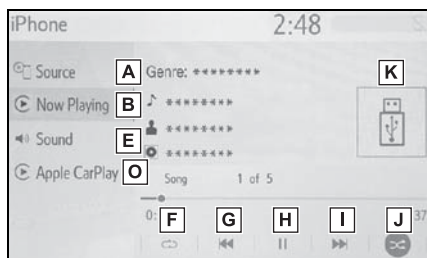

- A** Select to display the audio source selection screen.
- B** Select to return to the top screen.
- C** Select to display a song list screen.
- D** Select to display the play mode selection screen.
- E** Select to display the sound setting screen. (→P.330)
- F** Select to set repeat playback. (→P.343)
- G** Select to change the track. Select and hold to fast rewind.
- H** Select to play/pause.
- I** Select to change the track. Select and hold to fast forward.
- J** Select to set random playback. (→P.343)
- K** Displays cover art
- L** Select to change the album.
- M** Select to change the artist.
- N** Select to change the playlist.
- O** Select to display the audio

control screen of Apple CarPlay.

### Control panel

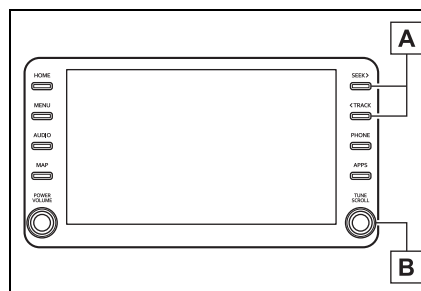

- A** Press to change the track. Press and hold to fast forward/rewind.
- B** Turn to move up/down the list. Also, the knob can be used to enter selections on the list screens by pressing it.

- Some functions may not be available depending on the type of model.
- When an iPod/iPhone is connected using a genuine iPod/iPhone cable, the iPod/iPhone starts charging its battery.
- Depending on the iPod/iPhone, the video sound may not be able to be heard.
- Depending on the iPod/iPhone and the songs in the iPod/iPhone, a cover art may be displayed. This function can be changed to "On" or "Off". (→P.351) It may take time to display the cover art, and the iPod/iPhone may not be operated while the cover art display is in process.
- When an iPod/iPhone is connected and the audio source is changed to iPod/iPhone mode,

the iPod/iPhone will resume playing from the same point it was last used.

- Tracks selected by operating a connected iPod/iPhone may not be recognized or displayed properly.
- The system may not function properly if a conversion adapter is used to connect a device.

### Repeating

The track currently being listened to can be repeated.

1 Select .

- Each time  is selected, the mode changes as follows:
  - ▶ When shuffle is off (iPhone 5 or later)
    - Track repeat → album repeat → off
  - ▶ When shuffle is off (iPhone 4s or earlier)
    - Track repeat → off
  - ▶ When shuffle is on
    - Track repeat → off

### Random order

Tracks or albums can be automatically and randomly selected.

1 Select .

- Each time  is selected, the mode changes as follows:
  - Shuffle (1 album shuffle) → album shuffle (all album shuffle) → off

### WARNING

Do not operate the player's controls or connect the iPod/iPhone while driving.

### NOTICE

- Do not leave your portable player in the vehicle. In particular, high temperatures inside the vehicle may damage the portable player.
- Do not push down on or apply unnecessary pressure to the portable player while it is connected as this may damage the portable player or its terminal.
- Do not insert foreign objects into the port as this may damage the portable player or its terminal.

### Android Auto\*

\*: This function is not made available in some countries or areas.

### Overview

The Android Auto operation screen can be reached by the following methods: →P.329

Connecting an Android device (→P.314, 330)

When an Apple CarPlay connection is established, this function will be unavailable.\*

\*: This function is not made available in some countries or areas.

### Control screen

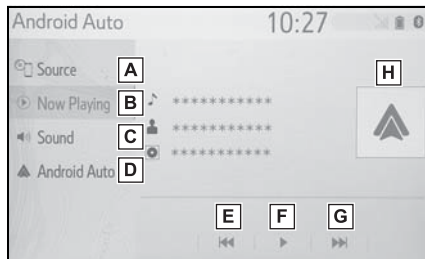

- A** Select to display the audio source selection screen.
- B** Select to return to the top screen.
- C** Select to display the sound setting screen. (→P.330)
- D** Select to display the audio control screen of Android Auto.
- E** Select to change the track.

- F** Select to play/pause.
- G** Select to change the track.
- H** Displays cover art

### Control panel

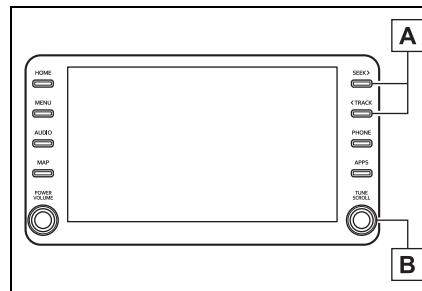

- A** Press to change the track.
- B** Turn to change the track.

### WARNING

Do not connect smartphone or operate the controls while driving.



### NOTICE

- Do not leave your smartphone in the vehicle. In particular, high temperatures inside the vehicle may damage the smartphone.
- Do not push down on or apply unnecessary pressure to the smartphone while it is connected as this may damage the smartphone or its terminal.
- Do not insert foreign objects into the port as this may damage the smartphone or its terminal.

## Bluetooth® audio

**The Bluetooth® audio system enables users to enjoy listening to music that is played on a portable player on the vehicle speakers via wireless communication.**

**This audio/visual system supports Bluetooth®, a wireless data system capable of playing portable audio music without cables. If your device does not support Bluetooth®, the Bluetooth® audio system will not function.**

- Depending on the Bluetooth® device that is connected to the system, the music may start playing when selecting  while it is paused. Conversely, the music may pause when selecting  while it is playing.
- In the following conditions, the system may not function:
  - The Bluetooth® device is turned off.
  - The Bluetooth® device is not connected.
  - The Bluetooth® device has a low battery.
- When using the Bluetooth® audio and Wi-Fi® Hotspot functions at the same time, the following problems may occur:
  - It may take longer than normal to connect to the Bluetooth® device.
  - The sound may cut out.
- It may take time to connect the phone when Bluetooth® audio is being played.
- For operating the portable player, see the instruction manual that comes with it.
- If the Bluetooth® device is disconnected due to poor reception from the Bluetooth® network when the engine switch is in ACC or ON, the system automatically reconnects the portable player.
- If the Bluetooth® device is disconnected on purpose, such as it was turned off, this does not happen. Reconnect the portable player manually.
- Bluetooth® device information is registered when the Bluetooth® device is connected to the Bluetooth® audio system. When selling or disposing of the vehicle, remove the Bluetooth® audio information from the system. (→P.324)
- In some situations, sound output via the Bluetooth® audio system may be out of sync with the connected device or output intermittently.

### WARNING

- Do not operate the player's controls or connect to the Bluetooth® audio system while driving.

**⚠ WARNING**

- Your audio unit is fitted with Bluetooth® antennas. People with implantable cardiac pacemakers, cardiac resynchronization therapy-pacemakers or implantable cardioverter defibrillators should maintain a reasonable distance between themselves and the Bluetooth® antennas. The radio waves may affect the operation of such devices.
- Before using Bluetooth® devices, users of any electrical medical device other than implantable cardiac pacemakers, cardiac resynchronization therapy-pacemakers or implantable cardioverter defibrillators should consult the manufacturer of the device for information about its operation under the influence of radio waves. Radio waves could have unexpected effects on the operation of such medical devices.

**⚠ NOTICE**

Do not leave your portable player in the vehicle. In particular, high temperatures inside the vehicle may damage the portable player.

**Overview**

The Bluetooth® audio operation screen can be reached by the following methods: →P.329

Connecting a Bluetooth® audio device (→P.347)

Depending on the type of portable player connected, some functions may not be available

and/or the screen may look differently than shown in this manual.

When an Apple CarPlay/Android Auto connection is established, Bluetooth® audio will be suspended and become unavailable\*.

\*: This function is not made available in some countries or areas.

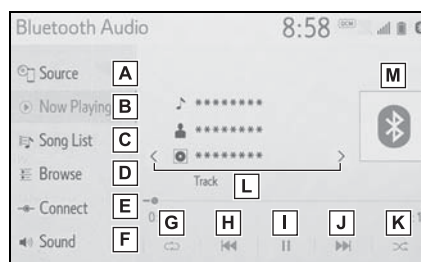
**Control screen**

- A** Select to display the audio source selection screen.
- B** Select to return to the top screen.
- C** Select to display a song list screen.
- D** Select to display the play mode selection screen.
- E** Select to display the portable device connection screen. (→P.347)
- F** Select to display the sound setting screen. (→P.330)
- G** Select to set repeat playback. (→P.347)
- H** Select to change the track. Select and hold to fast

rewind.

- I** Select to play/pause.
- J** Select to change the track. Select and hold to fast forward.
- K** Select to set random playback. (→P.347)
- L** Select to change the album.
- M** Displays cover art

**Control panel**

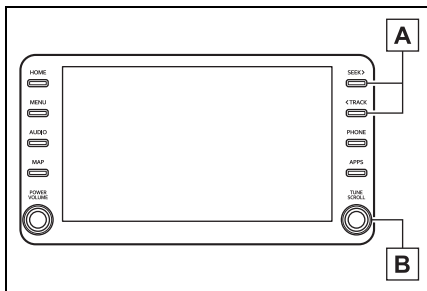

- A** Press to change the track. Press and hold to fast forward/rewind.
- B** Turn to move up/down the list. Also, the knob can be used to enter selections on the list screens by pressing it.

**Repeating**

The track or album currently being listened to can be repeated.

Select .

- Each time  is selected, the mode changes as follows:

- ▶ When random playback is off  
Track repeat → album repeat → off
- ▶ When random playback is on  
Track repeat → off

**Random order**

Tracks or albums can be automatically and randomly selected.

Select .

Each time  is selected, the mode changes as follows:

- Random (1 album random) → album random (all album random) → off

**Registering/Connecting a Bluetooth® device**

To use the Bluetooth® audio system, it is necessary to register a Bluetooth® device with the system.

- ▶ Registering an additional device

  - 1 Display the Bluetooth® audio control screen. (→P.346)
  - 2 Select “Connect”.
  - 3 Select “Add Device”.

When another Bluetooth® device is connected, a confirmation screen will be displayed. To disconnect the Bluetooth® device, select “Yes”.

- 4 Follow the steps in “Registering a Bluetooth® phone for the first time” from step 5. (→P.298)

- ▶ Selecting a registered device
- 1 Display the Bluetooth® audio control screen. (→P.346)
- 2 Select “Connect”.
- 3 Select the desired device to be connected.
- 4 Check that a confirmation screen is displayed when the connection is complete.

If an error message is displayed, follow the guidance on the screen to try again.



Steering switches

Steering switch operation

Some parts of the audio/visual system can be adjusted using the switches on the steering wheel.

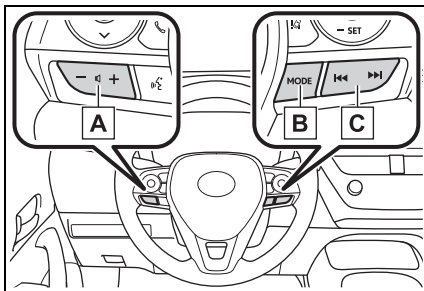

A Volume control switch

Mode	Operation/function
All	Press: Volume up/down
	Press and hold (0.8 sec. or more): Volume up/down continuously

B "MODE" switch

Mode	Operation/function
AM/FM/SXM <sup>*1</sup>	Press: Change audio modes
	Press and hold (0.8 sec. or more): Mute <sup>*2</sup> (Press and hold again to resume the sound.)

Mode	Operation/function
USB <sup>*3, 4</sup> , iPod/iPhone <sup>*4</sup> , Android Auto <sup>*3</sup> , Bluetooth <sup>®</sup> audio <sup>*3, 4</sup> , APPS <sup>*3, 4</sup>	Press: Change audio modes
	Press and hold (0.8 sec. or more): Pause (Press and hold again to resume the play mode.)

<sup>\*1</sup>: If equipped

<sup>\*2</sup>: If cached radio is enabled, pressing and holding the "MODE" switch pauses the broadcast. (Press and hold again to play back the cached radio program.)

<sup>\*3</sup>: When an Apple CarPlay is established, this function will be unavailable.

<sup>\*4</sup>: When an Android Auto is established, this function will be unavailable.

C ⏮ ⏭ switch

Mode	Operation/function
AM/FM	Press: Preset channel up/down
	Press and hold (0.8 sec. or more): Seek up/down
	Press and hold (1.5 sec. or more): Seek up/down continuously while the switch is being pressed

Mode	Operation/function
SXM <sup>*1</sup>	Press: Preset channel up/down
	Press and hold (0.8 sec. or more): Seek for stations in the relevant program type/channel category
	Press and hold (1.5 sec. or more): Fast channel up/down
USB <sup>*2, 3</sup> , iPod/iPhone <sup>*3</sup> , Bluetooth <sup>®</sup> audio <sup>*2, 3</sup>	Press: Track/file up/down
	Press and hold (0.8 sec. or more): Fast forward/rewind
Android Auto <sup>*2</sup>	Press: Track up/down

\*1: If equipped

\*2: When an Apple CarPlay is established, this function will be unavailable.

\*3: When an Android Auto is established, this function will be unavailable.

In the APPS mode, some operation may be done on the screen depend on the selected APPS.

Setup

Detailed audio settings can be programmed.

Displaying the audio settings screen

- 1 Press the "MENU" button.

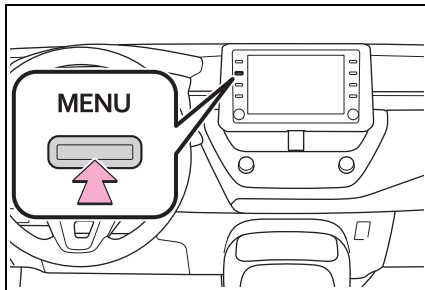

- 2 Select "Setup".
- 3 Select "Audio".
- 4 Select the desired items to be set.

Audio settings screen



- A** Select to set the common settings. (→P.351)
- B** Select to set the radio settings. (→P.351)

Common settings

- 1 Display the audio settings screen. (→P.351)
- 2 Select "Common".
- 3 Select the desired items to be set.



- A** Select to set the cover art display on/off.
- B** Select to prioritize the display of information from the Gracenote database.
- C** Select to change the screen size.\* (→P.331)
- D** Select to display the image quality adjustment screen.\* (→P.332)

\*: Only in USB video mode

Radio settings

- 1 Display the audio settings screen. (→P.351)
- 2 Select "Radio".
- 3 Select the desired number of preset radio stations displayed on the screen.

### Operating information

The use of a cellular phone inside or near the vehicle may cause a noise from the speakers of the audio/visual system which you are listening to. However, this does not indicate a malfunction.



#### NOTICE

To avoid damage to the audio/visual system:

Be careful not to spill beverages over the audio/visual system.

### Radio

Usually, a problem with radio reception does not mean there is a problem with the radio — it is just the normal result of conditions outside the vehicle.

For example, nearby buildings and terrain can interfere with FM reception. Power lines or phone wires can interfere with AM signals. And of course, radio signals have a limited range. The farther the vehicle is from a station, the weaker its signal will be. In addition, reception conditions change constantly as the vehicle moves.

Here are some common reception problems that may not indicate a problem with the radio as described.

#### ■ FM

Fading and drifting stations:  
Generally, the effective range of

FM is about 25 miles (40 km). Once outside this range, you may notice fading and drifting, which increase with the distance from the radio transmitter. They are often accompanied by distortion.

Multi-path: FM signals are reflective, making it possible for 2 signals to reach the vehicle's antenna at the same time. If this happens, the signals will cancel each other out, causing a momentary flutter or loss of reception.

Static and fluttering: These occur when signals are blocked by buildings, trees or other large objects. Increasing the bass level may reduce static and fluttering.

Station swapping: If the FM signal being listened to is interrupted or weakened, and there is another strong station nearby on the FM band, the radio may tune in the second station until the original signal can be picked up again.

#### ■ AM

Fading: AM broadcasts are reflected by the upper atmosphere — especially at night. These reflected signals can interfere with those received directly from the radio station, causing the radio station to sound alternately strong and weak.

**Station interference:** When a reflected signal and a signal received directly from a radio station are very nearly the same frequency, they can interfere with each other, making it difficult to hear the broadcast.

**Static:** AM is easily affected by external sources of electrical noise, such as high tension power lines, lightning or electrical motors. This results in static.

#### ■ SiriusXM

- Cargo loaded on the roof luggage carrier, especially metal objects, may adversely affect the reception of SiriusXM Satellite Radio.
- Alternation or modifications carried out without appropriate authorization may invalidate the user's right to operate the equipment.

### iPod

#### ■ Certification



- Use of the Made for Apple badge means that an accessory has been designed to connect specifically to the Apple product(s) identified in the badge, and has been certified by the developer to meet Apple performance standards. Apple is not responsible for the operation of this device or its compliance with safety and regulatory standards. Please note that the use of this accessory with an Apple product may affect wireless performance.
- iPhone<sup>®</sup>, iPod<sup>®</sup>, iPod classic<sup>®</sup>, iPod nano<sup>®</sup>, iPod touch<sup>®</sup>, and Lightning<sup>®</sup> are trademarks of Apple Inc., registered in the U.S. and other countries.

#### ■ Compatible models

Made for

- iPhone X
- iPhone 8
- iPhone 8 Plus
- iPhone 7
- iPhone 7 Plus
- iPhone SE
- iPhone 6s
- iPhone 6s Plus

- iPhone 6
- iPhone 6 Plus
- iPhone 5s
- iPhone 5c
- iPhone 5
- iPod touch (6th generation)
- iPod touch (5th generation)

- This system only supports audio playback.
- Depending on difference between models or software versions etc., some models might be incompatible with this system.

### High-resolution sound source

This device supports high-resolution sound sources.

The definition of high-resolution is based on the standards of groups such as the CTA (Consumer Technology Association).

Supported formats and playable media are as follows.

#### ■ Supported formats

WAV, FLAC, ALAC, OGG Vorbis

#### ■ Playable media

USB memory

### File information

#### Compatible USB devices

USB communication formats	USB 2.0 HS (480 Mbps)
---------------------------	-----------------------

File formats	FAT 16/32
Correspondence class	Mass storage class

#### Compatible audio format

#### Compatible compressed files

Item	USB
Compatible file format	MP3/WMA/AAC
	WAV(LPCM)/FLAC/ALAC/OGG Vorbis
	MP4/AVI/WMV
Compatible file format (video)*	MP4/AVI/WMV
Folders in the device	Maximum 3000
Files in the device	Maximum 9999
Files per folder	Maximum 255

\*: USB video only

#### Corresponding sampling frequency

File type	Frequency (kHz)
MP3 files: MPEG 1 LAYER 3	32/44.1/48
MP3 files: MPEG 2 LSF LAYER 3	16/22.05/24

File type	Frequency (kHz)
WMA files: Ver. 7, 8, 9* <sup>1</sup> (9.1/9.2)	32/44.1/48
AAC files: MPEG4/AAC-LC	11.025/12/16/ 22.05/24/32/ 44.1/48
WAV (LPCM) files* <sup>2</sup>	8/11.025/12/16/ 22.05/24/32/ 44.1/48/88.2/ 96/176.4/192
FLAC* <sup>2</sup>	8/11.025/12/16/ 22.05/24/32/ 44.1/48/88.2/ 96/176.4/192
ALAC* <sup>2</sup>	8/11.025/12/16/ 22.05/24/32/ 44.1/48/64/ 88.2/96
OGG Vorbis* <sup>2</sup>	8/11.025/16/ 22.05/32/44.1/ 48

\*<sup>1</sup>: Only compatible with Windows Media Audio Standard

\*<sup>2</sup>: Sound source of 48kHz or more is down-converted to 48kHz/24bit.

**Corresponding bit rates\*<sup>1</sup>**

File type	Bit rate (kbps)
MP3 files: MPEG 1 LAYER 3	32 - 320
MP3 files: MPEG 2 LSF LAYER 3	8 - 160

File type	Bit rate (kbps)
WMA files: Ver. 7, 8	CBR 48 - 192
WMA files: Ver. 9* <sup>2</sup> (9.1/9.2)	CBR 48 - 320
AAC files: MPEG4/AAC-LC	8 - 320
OGG Vorbis	32-500

\*<sup>1</sup>: Variable Bit Rate (VBR) compatible

\*<sup>2</sup>: Only compatible with Windows Media Audio Standard

File type	Quantization bit rate (bit)
WAV (LPCM) files	16/24
FLAC	
ALAC	

**Compatible channel modes**

File type	Channel mode
MP3 files	Stereo, joint stereo, dual channel and monaural
WMA files	2ch
AAC files	1ch, 2ch (Dual channel is not supported)
WAV (LPCM)/ FLAC/ALAC/ OGG Vorbis	2ch

- MP3 (MPEG Audio Layer 3), WMA (Windows Media Audio)

and AAC (Advanced Audio Coding) are audio compression standards.

- This system can play MP3/WMA/AAC files on USB memory.
- MP4, WMV and AVI files can use the following resolutions: 128x96, 160x120, 176x144 (QCIF), 320x240 (QVGA), 352x240 (SIF), 352x288 (CIF), 640x480 (VGA), 720x480 (NTSC), 720x576 (PAL)
- When naming an MP3/WMA/AAC file, add an appropriate file extension (.mp3/.wma/.m4a).
- This system plays back files with .mp3/.wma/.m4a file extensions as MP3/WMA/AAC files respectively. To prevent noise and playback errors, use the appropriate file extension.
- MP3 files are compatible with the ID3 Tag Ver. 1.0, Ver. 1.1, Ver. 2.2 and Ver. 2.3 formats. This system cannot display disc title, track title and artist name in other formats.
- WMA/AAC files can contain a WMA/AAC tag that is used in the same way as an ID3 tag. WMA/AAC tags carry information such as track title and artist name.
- The emphasis function is available only when playing MP3 files.
- This system can play back AAC files encoded by iTunes.
- The sound quality of MP3/WMA files generally improves with higher bit rates.
- m3u playlists are not compatible with the audio player.
- MP3i (MP3 interactive) and MP3PRO formats are not compatible with the audio player.
- The player is compatible with VBR (Variable Bit Rate).
- When playing back files recorded as VBR (Variable Bit Rate) files, the play time will not be correctly displayed if the fast forward or reverse operations are used.
- It is not possible to check folders that do not include MP3/WMA/AAC files.
- MP3/WMA/AAC files in folders up to 8 levels deep can be played. However, the start of playback may be delayed when using USB memory containing numerous levels of folders. For this reason, we recommend creating USB memory with no more than 2 levels of folders.



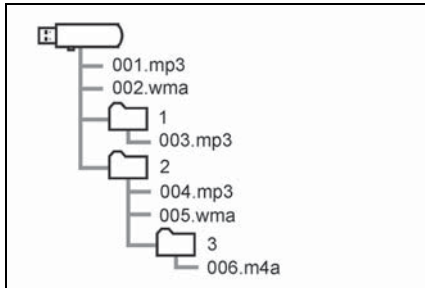

- The play order of the USB memory with the structure shown above is as follows:

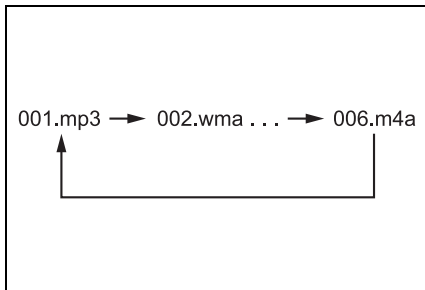

- The order changes depending on the personal computer and MP3/WMA/AAC encoding software you use.

**Compatible video format**

Format	Codec
MPEG-4	Video codec: <ul style="list-style-type: none"> <li>• H.264/MPEG-4 AVC</li> <li>• MPEG4</li> </ul> Audio codec: <ul style="list-style-type: none"> <li>• AAC</li> <li>• MP3</li> </ul> Corresponding screen size: <ul style="list-style-type: none"> <li>• MAX 1920×1080</li> </ul> Corresponding frame rate: <ul style="list-style-type: none"> <li>• MAX 60i/30p</li> </ul>

Format	Codec
AVI Container	<p>Video codec:</p> <ul style="list-style-type: none"> <li>• H.264/MPEG-4 AVC</li> <li>• MPEG4</li> <li>• WMV9</li> <li>• WMV9 Advanced profile</li> </ul> <p>Audio codec:</p> <ul style="list-style-type: none"> <li>• AAC</li> <li>• MP3</li> <li>• WMA9.2 (7,8,9.1,9.2)</li> </ul> <p>Corresponding screen size:</p> <ul style="list-style-type: none"> <li>• MAX 1920×1080</li> </ul> <p>Corresponding frame rate:</p> <ul style="list-style-type: none"> <li>• MAX 60i/30p</li> </ul>
Windows Media Video	<p>Video codec:</p> <ul style="list-style-type: none"> <li>• WMV9</li> <li>• WMV9 Advanced profile</li> </ul> <p>Audio codec:</p> <ul style="list-style-type: none"> <li>• WMA9.2 (7,8,9.1,9.2)</li> </ul> <p>Corresponding screen size:</p> <ul style="list-style-type: none"> <li>• MAX 1920×1080</li> </ul> <p>Corresponding frame rate:</p> <ul style="list-style-type: none"> <li>• MAX 60i/30p</li> </ul>

**Terms**

■ **ID3 tag**

This is a method of embedding

track-related information in an MP3 file. This embedded information can include the track number, track title, the artist's name, the album title, the music genre, the year of production, comments, cover art and other data. The contents can be freely edited using software with ID3 tag editing functions. Although the tags are restricted to a number of characters, the information can be viewed when the track is played back.

■ **WMA tag**

WMA files can contain a WMA tag that is used in the same way as an ID3 tag. WMA tags carry information such as track title and artist name.

■ **MP3**

MP3 is an audio compression standard determined by a working group (MPEG) of the ISO (International Standard Organization). MP3 compresses audio data to about 1/10 the size of that on conventional discs.

■ **WMA**

● WMA (Windows Media Audio) is an audio compression format developed by Microsoft®. It compresses files into a size smaller than that of MP3 files. The decoding formats for WMA files are Ver. 7, 8 and 9.

● This product includes technology owned by Microsoft Cor-

poration and cannot be used or distributed without a license from Microsoft Licensing, Inc.

■ **AAC**

AAC is short for Advanced Audio Coding and refers to an audio compression technology standard used with MPEG2 and MPEG4.

**Error messages**

■ **USB**

Message	Explanation
"USB Error"	This indicates a problem in the USB memory or its connection.
"No music files found."	This indicates that no MP3/WMA/AAC files are included in the USB memory.
"No video files found."	This indicates that no video files are included in the USB memory.

■ **iPod**

Message	Explanation
"iPod Error"	This indicates a problem in the iPod or its connection.
"No music files found."	This indicates that there is no music data in the iPod.
"Please check the iPod firmware version."	This indicates that the software version is not compatible. Perform the iPod firmware updates and try again.
"Unable to authorize the iPod."	This indicates that it failed to authorize the iPod. Please check your iPod.

■ **Bluetooth® audio**

Message	Explanation
"Music tracks not supported. Please check your portable player."	This indicates a problem in the Bluetooth® device.

If the malfunction is not rectified:  
Take your vehicle to your Toyota dealer.

## Certification

### ■ Except for vehicles sold in Canada

FCC ID: AJDK101, AJDK102

[For 2.4 GHz Radio Transmitters]

This equipment complies with FCC/ISED radiation exposure limits set forth for an uncontrolled environment and meets the FCC radio frequency (RF) Exposure Guidelines and RSS-102 of the ISED radio frequency (RF) Exposure rules. This equipment should be installed and operated keeping the radiator at least 20 cm or more away from person's body.

This transmitter must not be co-located or operated in conjunction with any other antenna or transmitter.

This device complies with Part 15 of FCC Rules and Innovation, Science, and Economic Development Canada licence-exempt RSS standard(s). Operation is subject to the following two conditions: (1) this device may not cause interference, and (2) this device must accept any interference, including interference that may cause undesired operation of this device.

Information to User - Alteration or modifications carried out without appropriate authorization may invalidate the user's right to operate the equipment.

#### FEDERAL COMMUNICATIONS COMMISSION SUPPLIER'S DECLARATION OF CONFORMITY

Product Name: In-vehicle equipment

Model Number: AVH-7998, AVH-8098, AVH-8198, AVH-8298  
AVH-8398, AVH-8598  
AVH-9098, AVH-9198, AVH-9298, AVH-9398  
AVH-9498, AVH-9598, AVH-9698

Responsible Party Name: PIONEER ELECTRONICS (USA), INC.  
SERVICE SUPPORT DIVISION

Address: 2050 W. 190TH STREET, SUITE 100, TORRANCE,  
CA 90504, U.S.A.

Phone: 1-800-421-1404

URL: <http://www.pioneerelectronics.com>

**■ For vehicles sold in Canada**

IC: 775E-K101, 775E-K102

[For 2.4 GHz Radio Transmitters]

This equipment complies with FCC/ISED radiation exposure limits set forth for an uncontrolled environment and meets the FCC radio frequency (RF) Exposure Guidelines and RSS-102 of the ISED radio frequency (RF) Exposure rules. This equipment should be installed and operated keeping the radiator at least 20 cm or more away from person's body.

[Pour 2,4 GHz émetteurs radio]

Cet équipement est conforme aux limites d'exposition aux rayonnements énoncées pour un environnement non contrôlé et respecte les règles les radioélectriques (RF) de la FCC lignes directrices d'exposition et d'exposition aux fréquences radioélectriques (RF) CNR-102 de l'ISDE. Cet équipement doit être installé et utilisé en gardant une distance de 20 cm ou plus entre le radiateur et le corps humain.

This device complies with Part 15 of FCC Rules and Innovation, Science, and Economic Development Canada licence-exempt RSSs. Operation is subject to the following two conditions: (1) This device may not cause interference; and (2) This device must accept any interference, including interference that may cause undesired operation of the device.

Le présent appareil est conforme aux la partie 15 des règles de la FCC et CNR d'Innovation, Sciences et Développement économique Canada applicables aux appareils radio exempts de licence. L'exploitation est autorisée aux deux conditions suivantes: (1) l'appareil ne doit pas produire de brouillage; (2) l'utilisateur de l'appareil doit accepter tout brouillage radioélectrique subi, même si le brouillage est susceptible d'en compromettre le fonctionnement.

■ **Gracenote**

Gracenote, the Gracenote logo and logotype, “Powered by Gracenote” and Gracenote MusicID are either registered trademarks or trademarks of Gracenote, Inc. in the United States and/or other countries.



■ **For U.S. owners**

Total Traffic and Weather Network, a division of TTWN Media Networks, LLC (“TTWN”), owns or holds the rights to the traffic, news, sports, weather, stocks and other data (the “TTWN Data”) and network through which it is delivered, together the “TTN Service”. Use of the TTN Service is subject to the terms of these Device End User Terms.

THE TTWN SERVICE IS INFORMATIONAL ONLY. YOUR USE OF TTWN SERVICE IS AT YOUR SOLE RISK. TTWN DATA IS PROVIDED “AS IS”, “WHERE IS”, AND “WHERE AVAILABLE”. TTWN AND ITS SUPPLIERS AND LICENSORS EXPRESSLY DISCLAIM ALL WARRANTIES WITH RESPECT TO THE TTWN SERVICE (INCLUDING, WITHOUT LIMITATION, THAT THE TTWN DATA WILL BE ERROR-FREE, THAT THE TTWN SERVICE WILL OPERATE WITHOUT INTERRUPTION OR THAT THE TTWN DATA WILL BE ACCURATE), EXPRESS, IMPLIED OR STATUTORY, INCLUDING, WITHOUT LIMITATION, THE IMPLIED WARRANTIES OF MERCHANTABILITY, NON-INFRINGEMENT, FITNESS FOR A PARTICULAR PURPOSE, OR THOSE ARISING FROM A COURSE OF DEALING OR USAGE OF TRADE.

TTWN AND ITS SUPPLIERS AND LICENSORS WILL NOT BE LIABLE TO YOU UNDER ANY LEGAL THEORY, INCLUDING CONTRACT, TORT, NEGLIGENCE OR STRICT LIABILITY, FOR ANY DIRECT, INDIRECT, INCIDENTAL, SPECIAL, PUNITIVE, CONSEQUENTIAL OR EXEMPLARY DAMAGES, INCLUDING BUT NOT LIMITED TO, DAMAGES FOR LOSS OF PROFITS, GOODWILL, USE, DATA OR OTHER INTANGIBLE LOSSES (EVEN IF TTWN, ITS SUPPLIERS OR LICENSORS HAS BEEN ADVISED OF THE POSSIBILITY OF SUCH DAMAGES), RESULTING FROM OR ARISING OUT OF YOUR USE OF, OR YOUR INABILITY TO USE, THE TTWN SERVICE, THIS AGREEMENT, OR ANY OTHER MATTER RELATING TO THE TTWN SERVICE.

SOME JURISDICTIONS DO NOT ALLOW THE EXCLUSION OF CERTAIN WARRANTIES OR THE LIMITATION OR EXCLUSION OF LIABILITY FOR INCIDENTAL OR CONSEQUENTIAL DAMAGES. ACCOORDINGLY, SOME OF THE ABOVE LIMITATIONS MAY NOT APPLY TO YOU.



Voice command system

The voice command system enables the radio, phone dialing, etc. to be operated using voice commands. Refer to the command list for samples of voice commands. (→P.367)

Using the voice command system

■ Steering switch

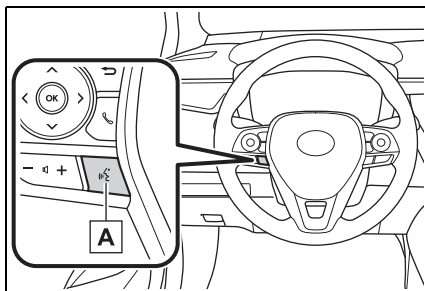

A Talk switch

▶ Voice command system

Press the talk switch to start the voice command system. To cancel voice command, press and hold the talk switch.

▶ When an Apple CarPlay/Android Auto connection is established

- Press and hold the talk switch to start Siri/Google Assistant. To cancel Siri/Google Assistant, press the talk switch.
- Press the talk switch to start

the voice command system.

■ Microphone

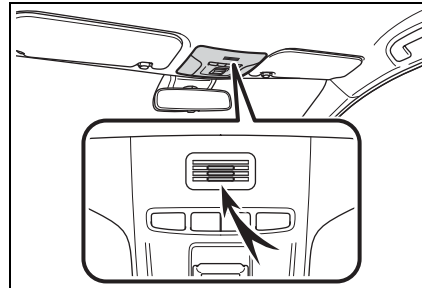

It is unnecessary to speak directly into the microphone when giving a command.

- Voice commands may not be recognized if:
  - Spoken too quickly.
  - Spoken at a low or high volume.
  - The windows are open.
  - Passengers are talking while voice commands are spoken.
  - The fan speed of the air conditioning system is set at high.
  - The air conditioning vents are turned towards the microphone.
- In the following conditions, the system may not recognize the command properly and using voice commands may not be possible:
  - The command is incorrect or unclear. Note that certain words, accents or speech patterns may be difficult for the system to recognize.
  - There is excessive background noise, such as wind noise.
- Normally, it is necessary to wait for a beep before saying a command. To enable the ability to talk over prompts and say commands before the beep, enable the voice prompt interrupt function. (→P.325)
- This system may not operate immediately after the engine



switch is in ACC or ON.

 **NOTICE**  
Do not touch and put a sharp object to the microphone. It may cause failure.

**Voice command system operation**

The voice command system is operated by saying commands which correspond to a supported function. To display examples of commands for supported functions, select a function button on the screen after starting the voice command system.

**Operation from the main menu**

1 Press the talk switch.

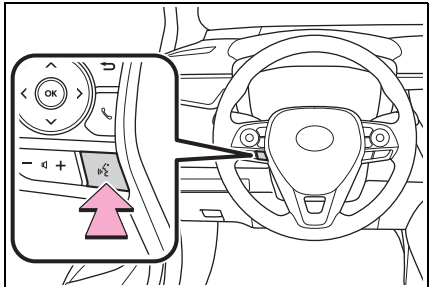



Voice guidance for the voice command system can be skipped by pressing the talk switch.

2 If "Getting Started with Voice" screen is displayed, select "OK" or press the talk switch. (→P.366)

3 After hearing a beep, say a supported command.

- To display sample commands of the desired function, say the desired function or select the desired function button. To display more commands, select "More Commands".
- Selecting "Help" or saying "Help" prompts the voice command system to offer examples of commands and operation methods.
- Registered POIs, registered names in the contacts list etc., can be said in the place of the "<>" next to the commands. (→P.367)

For example: Say "Find a restaurant", "Call John Smith" etc.

- If a desired outcome is not shown, or if no selections are available, perform one of the following to return to the previous screen:
  - Say "Go back".
  - Select .
- To cancel voice recognition, select , say "Cancel", or press and hold the talk switch.
- To perform the voice command operation again, select "Start Over" or say "Start over".
- To suspend voice command operation, select "Pause" or say "Pause". To resume the

voice command operation, select “Resume” or press the talk switch.

- If the system does not respond or the confirmation screen does not disappear, press the talk switch and try again.
- If a voice command cannot be recognized 3 consecutive times, voice recognition will be canceled.
- Voice recognition prompts can be changed on the voice settings screen. (→P.325)

This function can be used to cancel voice guidance by turning the voice prompts off. When you press the talk switch while using this setting, a beep sounds, and then you can immediately say a command.

- Some voice guidance can be canceled by setting voice prompts to off. Use this setting when it is desirable to say a command immediately after pressing the talk switch and hearing a beep.

#### Increasing the voice recognition performance

To increase voice recognition performance, use the “Tutorials” and “Voice Training” functions on the “Getting Started with Voice” screen. These functions are only available when the vehicle is not moving.

The “Tutorials” and “Voice Training” functions can also be started on the voice settings screen. (→P.325)

- 1 Press the talk switch.

- 2 Select the desired item to be set.

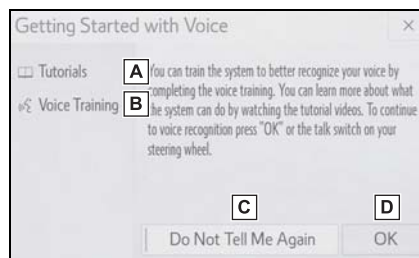

- A** Select to display the voice command tutorials.
- B** Select to train the voice command system.

The user will be asked to say 10 sample phrases. This will help the voice command system adapt to the user’s accent.

- C** Select to prevent the screen from being displayed again.
- D** Select to proceed to the voice command screen.

Command list

Command list overview

Recognizable voice commands and their actions are shown below.

- Frequently used commands are listed in the following tables.
- For devices that are not installed to the vehicle, commands relating to that device may not be displayed on the screen. Also, depending on other conditions, such as compatibility, some commands may not be displayed on the screen.
- The functions available may vary according to the system installed.
- When an Apple CarPlay/Android Auto connection is established, some commands will become unavailable.
- Voice recognition language can be changed. (→P.321)

Command list

■ Common

Command	Action
“Help”	Displays examples of some of the available commands
“Go back”	Returns to the previous screen
“Cancel”	Cancels the voice command system
“Start over”	Returns to top menu screen
“Pause”	Temporarily pauses a voice session until it is resumed by pressing the talk switch again.

■ Top menu

Command	Action
“Show command examples for <menu>”	Displays the command list of the selected menu
“More commands”	Displays more commonly used commands
“Voice settings”	Displays Voice Setting screen
“Train my voice”	Displays Train Voice Recognition screen *

\*: Vehicle must be parked

### ■ Phone <sup>\*1</sup>

Command	Action
“Call <contact>” <sup>*2</sup>	Places a call to the specified contact from the phone book
“Call <contact> <phone type>” <sup>*2</sup>	Places a call to the specified phone type of the contact from the phone book
“Dial <phone number>”	Places a call to the specified phone number
“Redial”	Places a call to the phone number of the latest outgoing call
“Call back”	Places a call to the phone number of latest incoming call
“Show recent calls”	Displays the call history screen
“Send a message to <contact>”	Sends a text message to specified contact from the phone book

<sup>\*1</sup>: When an Apple CarPlay connection is established, this voice commands will be unavailable.

<sup>\*2</sup>: If the system does not recognize the name of a contact, create a voice tag. (→P.390) The name of a contact can also be recognized by adding a voice tag.

### ■ While in a phone call <sup>\*</sup>

Command	Action
“Send <digits>”	Sends DTMF tones has specified
“Mute”	Mutes the microphone (far side cannot hear the conversation)
“Unmute”	Unmutes the microphone

<sup>\*</sup>: When an Apple CarPlay connection is established, this voice commands will be unavailable.

### ■ While incoming message notification is displayed <sup>\*1, 2</sup>

Command	Action
“Read message”	Reads the incoming message over the vehicle speakers
“Ignore”	Ignores the incoming message notification
“Reply”	Initiates sending a reply to the incoming message
“Call”	Places a call to the phone number of incoming message

<sup>\*1</sup>: Full screen message notification must be turned on within the phone settings (→P.388)

<sup>\*2</sup>: When an Apple CarPlay connection is established, this voice

commands will be unavailable.

■ Radio

Command	Action
“Tune to <frequency> AM”	Changes the radio to the specified AM frequency
“Tune to <frequency> FM”	Changes the radio to the specified FM frequency
“Play a <genre> station”	Changes the radio to an FM station of the specified genre *1
“Tune to preset <1-36>”	Changes the radio to the specified preset radio station
“Tune to a <genre> satellite radio channel”	Changes the radio to a satellite radio channel of the specified genre *2
“Tune to <satellite channel name>”	Changes the radio to the satellite radio channel with the specified name *2
“Tune to channel <number> on XM”	Changes the radio to a satellite radio channel of the specified number *2

\*1: A station list must be built first using the radio screen (→P.333)

\*2: Requires a satellite radio subscription

■ Audio \*1

Command	Action
“Play Playlist <name>” *2	Plays tracks from the selected playlist
“Play Artist <name>” *2	Plays tracks from the selected artist
“Play Song <name>” *2	Plays the selected track
“Play Album <name>” *2	Plays tracks from the selected album
“Play Genre <name>” *2	Plays tracks from the selected genre
“Play Composer <name>” *2	Plays tracks from the selected composer
“Play Podcast <name>” *2	Plays tracks from the selected podcast
“Play Audiobook <name>” *2	Plays tracks from the selected audiobook
“Audio On”	Turns the audio/visual system on
“Audio Off”	Turns the audio/visual system off
“Change the audio source to <source name>”	Sets the source to the specified audio mode

\*1: The audio device must be connected via a USB cable to use

the functionality in this section

\*2: When an Apple CarPlay connection is established, this voice commands will be unavailable.

■ **Toyota apps**

Command	Action
“Launch <application name>”*	Activates the Toyota apps

\*: When an application is opened and is in full screen mode, pressing the talk switch will start the voice command system and commands for the currently displayed application will be available

---

Commands relating to operation of the audio/visual system can only be performed when the audio/visual system is turned on.

## Mobile Assistant

**The Mobile Assistant function is a voice input assist function. Mobile Assist supports the Siri Eyes Free Mode and Google App. (Google App can be used only with the corresponding device.) Instructions can be spoken into the vehicle microphone as if speaking a command to the phone. The content of the request is then interpreted by the phone and the result is output from the vehicle speakers. To operate the Mobile Assistant, a compatible device must be registered and connected to this system via Bluetooth®. (→P.298)**

**When an Apple CarPlay connection is established, this function will be unavailable.**

- While a phone call is active, the Mobile Assistant cannot be used.
- If using the navigation feature of the cellular phone, ensure the active audio source is Bluetooth® audio or iPod in order to hear turn by turn direction prompts.
- Wait for the listening beeps before using the Mobile Assistant.
- The Mobile Assistant may not recognize commands in the following situations:
  - Spoken too quickly.
  - Spoken at a low or high volume.

- The windows are open.
- Passengers are talking while the Mobile Assistant is being used.
- The fan speed of the air conditioning system is set at high.
- The air conditioning vents are turned toward the microphone.

## Connectable devices and available functions

Mobile Assist supports the Siri Eyes Free Mode and Google App. The available features and functions may vary based on the iOS/Android version installed on the connected device.

## Mobile Assistant operation

- ▶ Type A
  - 1 Press and hold the talk switch on the steering wheel until Mobile Assistant screen is displayed.

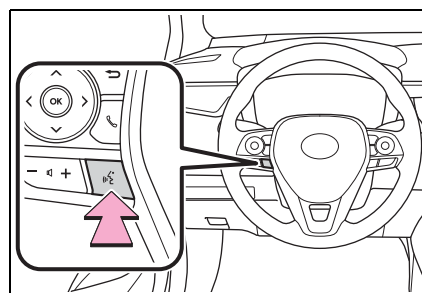

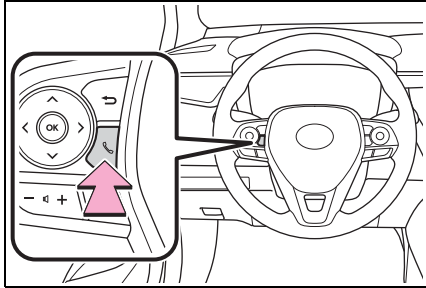

- ▶ Type B
  - 1 Press and hold the  switch on the steering wheel until

Mobile Assistant screen is displayed.

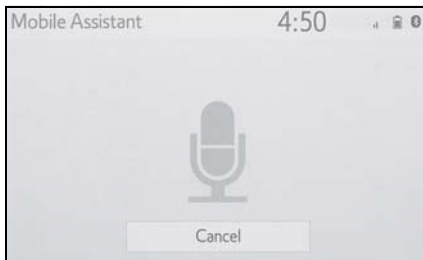

2 The Mobile Assistant can be used only when the following screen is displayed.



- Type A: To cancel the Mobile Assistant, select “Cancel” or press and hold the talk switch on the steering wheel.  
Type B: To cancel the Mobile Assistant, select “Cancel” or press and hold the  switch on the steering wheel.
- Type A: To restart the Mobile Assistant for additional commands, press the talk switch on the steering wheel.  
Type B: To restart the Mobile Assistant for additional commands, press the  switch on the steering wheel.
- Mobile Assistant can only be

restarted after the system responds to a voice command.

- After some phone and music commands, the Mobile Assistant feature will automatically end to complete the requested action.
- The volume of the Mobile Assistant can be adjusted using the “POWER VOLUME” knob or steering wheel volume control switches. The Mobile Assistant and phone call volumes are synchronized.



Quick reference

**Phone screen operation**

The phone screen can be reached by the following methods:

- ▶ From the “PHONE” button

Press the “PHONE” button.

- ▶ From the “MENU” button

Press the “MENU” button, then select “Phone”.



**Bluetooth® hands-free system operation**

The following functions can be used on phone operation:

- Registering/connecting a Bluetooth® device (→P.298)
- Placing a call using the Bluetooth® hands-free system (→P.378)
- Receiving a call using the Bluetooth® hands-free system (→P.381)
- Talking on the Bluetooth® hands-free system (→P.382)

**Message function**

The following function can be used on message function:

Using the Bluetooth® phone message function (→P.384)

**Setting up a phone**

The following functions can be made in the system:

- Phone settings (→P.388)
- Bluetooth® settings (→P.302)

### Some basics

**The hands-free system enables calls to be made and received without having to take your hands off the steering wheel.**

**This system supports Bluetooth®. Bluetooth® is a wireless data system that enables cellular phones to be used without being connected by a cable or placed in a cradle.**

**The operating procedure of the phone is explained here.**

**When an Apple CarPlay connection is established, phone functions will be performed by Apple CarPlay instead of the hands-free system.**

- This system is not guaranteed to operate with all Bluetooth® devices.
- If your cellular phone does not support Bluetooth®, this system cannot function.
- In the following conditions, the system may not function:
  - The cellular phone is turned off.
  - The current position is outside the communication area.
  - The cellular phone is not connected.
  - The cellular phone has a low battery.
- Depending on the type of Bluetooth® phone, some function is not available.

- When using the hands-free system or Bluetooth® audio and Wi-Fi® Hotspot functions at the same time, the following problems may occur:
  - The Bluetooth® connection may be cut.
  - Noise may be heard on the Bluetooth® audio playback.
  - A noise may be heard during phone calls.
- Bluetooth® uses the 2.4 GHz frequency band. If both a Wi-Fi® connection and Bluetooth® connection are being used simultaneously, each connection may be affected.
- If a Bluetooth® device is attempting to connect to the vehicle while another device is connected as a Bluetooth® audio device or connected using the hands-free system or Wi-Fi® Hotspot function, the communication speed may decrease or malfunctions may occur, such as image distortion or audio skipping. If a Bluetooth® device is connected to the system, the interference it may cause will be reduced. When carrying a device with its Bluetooth® connection enabled, make sure to register it to the system and connect it or disable its Bluetooth® function.
- When a device is connected via Bluetooth®, the Bluetooth® icon on the status bar will be displayed in blue. (→P.286)



#### WARNING

- While driving, do not operate a cellular phone.

**⚠ WARNING**

- Your audio unit is fitted with Bluetooth® antennas. People with implantable cardiac pacemakers, cardiac resynchronization therapy-pacemakers or implantable cardioverter defibrillators should maintain a reasonable distance between themselves and the Bluetooth® antennas. The radio waves may affect the operation of such devices.
- Before using Bluetooth® devices, users of any electrical medical device other than implantable cardiac pacemakers, cardiac resynchronization therapy-pacemakers or implantable cardioverter defibrillators should consult the manufacturer of the device for information about its operation under the influence of radio waves. Radio waves could have unexpected effects on the operation of such medical devices.

**⚠ NOTICE**

Do not leave your cellular phone in the vehicle. The temperature inside may rise to a level that could damage the phone.

**Registering/Connecting a Bluetooth® phone**

To use the hands-free system for cellular phones, it is necessary to register a cellular phone with the system. (→P.298)

**■ Connecting a Bluetooth® device**

▶ Registering an additional device

- 1 Display the phone top screen. (→P.373)
- 2 Select “Select Device”.
- 3 Select “Add Device”.

When another Bluetooth® device is connected, a confirmation screen will be displayed. To disconnect the Bluetooth® device, select “Yes”.

- 4 Follow the steps in “Registering a Bluetooth® phone for the first time” from step 5. (→P.298)

▶ Selecting a registered device

- 1 Display the phone top screen. (→P.373)
- 2 Select “Select Device”.
- 3 Select the desired device to be connected.
- 4 Check that a confirmation screen is displayed when the connection is complete.

If an error message is displayed, follow the guidance on the screen to try again.

**■ Bluetooth® phone condition display**

The condition of the Bluetooth® phone appears on the upper right side of the screen. (→P.287)

### Using the phone switch/microphone

#### ■ Steering switch

By pressing the phone switch, a call can be received or ended without taking your hands off the steering wheel.

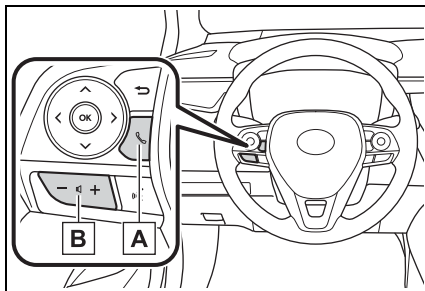

#### A Phone switch

- If the switch is pressed during a call, the call will end.
- If the switch is pressed when an incoming call is received, the call will be answered.
- If the switch is pressed during a call when a separate incoming call is waiting, the waiting call will be answered.
- If the switch is pressed when an Apple CarPlay connection is established, the Apple CarPlay phone application will be displayed on the system screen.

#### B Volume control switch

- Press the "+" side to increase the volume.
- Press the "-" side to decrease the volume.

#### ■ Microphone

The microphone is used when talking on the phone.

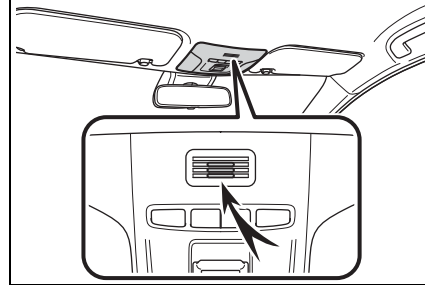

- The other party's voice will be heard from the front speakers. The audio/visual system will be muted during phone calls or when hands-free voice commands are used.
- Talk alternately with the other party on the phone. If both parties speak at the same time, the other party may not hear what has been said. (This is not a malfunction.)
- Keep call volume down. Otherwise, the other party's voice may be audible outside the vehicle and voice echo may increase. When talking on the phone, speak clearly towards the microphone.
- The other party may not hear you clearly when:
  - Driving on an unpaved road. (Making excessive traffic noise.)
  - Driving at high speeds.
  - The windows are open.
  - The air conditioning vents are pointed towards the microphone.
  - The sound of the air conditioning fan is loud.
  - There is a negative effect on sound quality due to the phone and/or network being used.

#### ⚠ NOTICE

Do not touch and put a sharp object to the microphone. It may cause failure.

**Voice command system**

Press this switch to operate the voice command system.

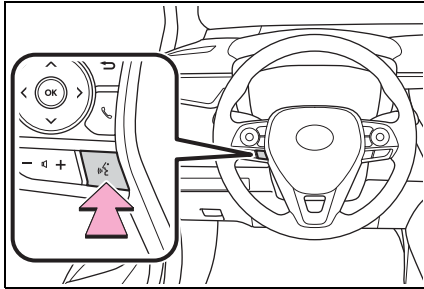

The voice command system and its list of commands can be operated. (→P.364)

**About the contacts in the contact list**

The following data is stored for every registered phone. When another phone is connected, the following registered data cannot be read:

- Contact data
- Call history data
- Favorites data
- Image data
- All phone settings
- Message settings

When a phone's registration is deleted, the above-mentioned data is also deleted.

**When selling or disposing of the vehicle**

A lot of personal data is registered when the hands-free system is used. When selling or disposing of the vehicle, initialize the data. (→P.324)

The following data in the system can be initialized:

- Contact data
- Call history data
- Favorites data
- Image data
- All phone settings
- Message settings

Once initialized, the data and settings will be erased. Pay additional attention when initializing the data.

### Placing a call using the Bluetooth® hands-free system

After a Bluetooth® phone has been registered, a call can be made using the hands-free system. There are several methods by which a call can be made, as described below.

### Calling methods on the Bluetooth® phone

- 1 Display the phone top screen. (→P.373)
- 2 Select the desired method to call from.

#### ■ Calling methods from phone screen

- By call history (→P.378)
- By favorites (→P.378)
- By contacts (→P.379)
- By keypad (→P.380)
- By message (→P.387)

#### ■ Also the following lists are available from each function's screen

- By voice command system (→P.365)
- By home screen (→P.380)

### By call history

Up to 30 of the latest call history

items (missed, incoming and outgoing) can be selected.

- 1 Display the phone top screen. (→P.373)
- 2 Select "History" and select the desired contact.

If the contact which is not registered on the contact list is selected, the name is displayed as "Unknown Contact". In this case, select the number to make a call properly.

- 3 Check that the dialing screen is displayed.

- The icons of call type are displayed.

: Missed call

: Incoming call

: Outgoing call

- When making a call to the same number continuously, only the most recent call is listed in call history.
- When a phone number registered in the contact list is received, the name is displayed.
- Number-withheld calls are also memorized in the system.
- International phone calls may not be made depending on the type of Bluetooth® phone you have.
- The list should group together consecutive entries with the same phone number and same call type. For example, two calls from John's mobile would be displayed as follows: John (2)

### By favorites list

Calls can be made using registered contacts which can be

selected from a contact list.  
(→P.379)

- 1 Display the phone top screen. (→P.373)
- 2 Select “Favorites” and select the desired contact.
- 3 Select the desired number.
- 4 Check that the dialing screen is displayed.

**By contacts list**

Calls can be made by using contact data which is transferred from a registered cellular phone. (→P.390)

Up to 5000 contacts (maximum of 4 phone numbers, e-mail addresses and addresses per contact) can be registered in the contact list.

- 1 Display the phone top screen. (→P.373)
- 2 Select “Contacts” and select the desired contact.
- 3 Select the desired number.

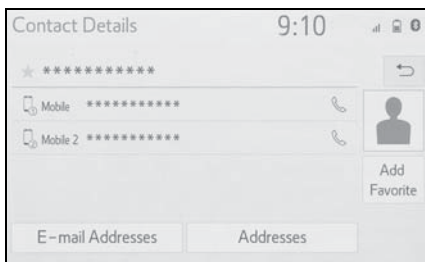

“Add Favorite”/“Remove Favorite”: Select to register/remove the contact in the favorites list. (→P.394, 395)

“E-mail Addresses”: Select to dis-

play all registered e-mail addresses for the contact.

“Addresses”: Select to display all registered addresses for the contact.

- 4 Check that the dialing screen is displayed.

**When the contact list is empty**

- For PBAP compatible Bluetooth® phones when “Automatic Transfer” is set to on (→P.390)

Contacts are transferred automatically.

- For PBAP compatible Bluetooth® phones when “Automatic Transfer” is set to off (→P.390)

- 1 Select the desired item.

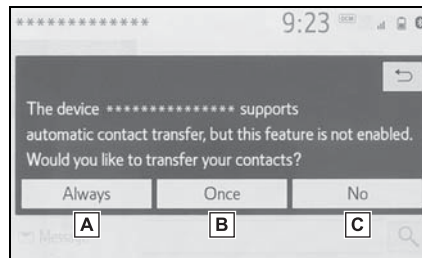

- A** Select to always transfer all the contacts from a connected cellular phone automatically.
- B** Select to transfer all the contacts from a connected cellular phone only once.
- C** Select to cancel transferring.

5  
Audio

- 2 Check that a confirmation screen is displayed when the operation is complete.

#### ■ For PBAP incompatible but OPP compatible Bluetooth® phones

- 1 Select the desired item.

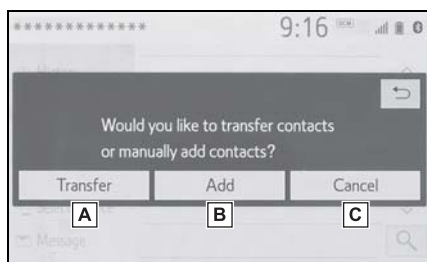

- A Select to transfer the contacts from the connected cellular phone.

Transfer the contact data to the system using a Bluetooth® phone.

- B Select to add a new contact manually.
- Follow the steps in "Registering a new contact to the contacts list" from step 2.

(→P.393)

- C Select to cancel transferring.

- If your cellular phone is neither PBAP nor OPP compatible, the contacts cannot be transferred using Bluetooth®. But the contacts can be transferred from USB device. (→P.393)
- Depending on the type of Bluetooth® phone:
  - It may be necessary to perform additional steps on the phone when transferring contact data.
  - The registered image in the con-

tact list may not transfer depending on the type of Bluetooth® phone connected.

#### By keypad

- 1 Display the phone top screen. (→P.373)
- 2 Select "Keypad" and enter the phone number.
- 3 Select or press the switch on the steering wheel.
- 4 Check that the dialing screen is displayed.

Depending on the type of Bluetooth® phone being connected, it may be necessary to perform additional steps on the phone.

#### By home screen

- 1 Display the home screen. (→P.292)
- 2 Select the desired contact.
- 3 Check that the dialing screen is displayed.

#### ■ Registering a new contact

- 1 Select and hold the screen button to add a contact.
- 2 Select the desired contact.
- 3 Select the desired number.

- If there is no contact in the contacts list, the contacts cannot be registered at the home screen.
- The contact cannot be registered at the home screen while driving.



Receiving a call using the Bluetooth® hands-free system

Bluetooth® phone, both the system and Bluetooth® phone may ring simultaneously when there is an incoming call. (→P.388)

When a call is received, the following screen is displayed with a sound.

Incoming calls

- 1 Select "Answer" or press the  switch on the steering wheel to talk on the phone.

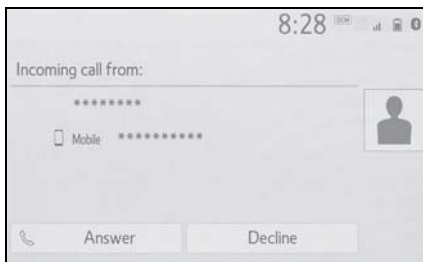

"Decline": Select to refuse to receive the call.

To adjust the volume of a received call: Turn the "POWER VOLUME" knob, or use the volume control switch on the steering wheel.

- The contact image picture can be displayed only when the vehicle is not moving.
- During international phone calls, the other party's name or number may not be displayed correctly depending on the type of Bluetooth® phone you have.
- The incoming call display mode can be set. (→P.389)
- The ringtone that has been set in the sound settings screen can be heard when there is an incoming call. Depending on the type of

## Talking on the Bluetooth® hands-free system

**While talking on the phone, the following screen is displayed. The operations outlined below can be performed on this screen.**

### Call screen operation

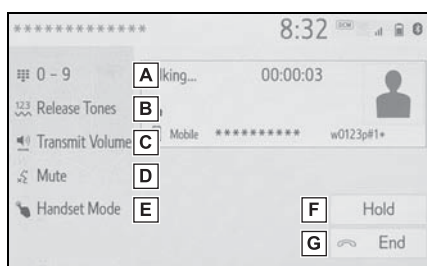

- A** Select to display the keypad to send tones. (→P.382)
- B** Select to send tones. This button only appears when a number that contains a (w) is dialed in hands-free mode. (→P.382)
- C** Select to adjust your voice volume that the other party hears from their speaker. (→P.383)
- D** Select to mute your voice to the other party.
- E** Select to change handset modes between hands-free and cellular phone.
- F** Select to put a call on hold. To cancel this function, select

“Activate”.

- G** Select to hang up the phone.

- Changing from hands-free call to cellular phone call is not possible while driving.
- Only when the vehicle is not moving, the contact image can be displayed.
- When cellular phone call is changed to hands-free call, the hands-free screen will be displayed and its functions can be operated on the screen.
- Changing between cellular phone call and hands-free call can be performed by operating the cellular phone directly.
- Transferring methods and operations will be different depending on the type of cellular phone you have.
- For the operation of the cellular phone, see the manual that comes with it.

### Sending tones

#### ■ By keypad

This operation cannot be performed while driving.

- 1 Select “0-9”.
- 2 Enter the desired number.

#### ■ By selecting “Release Tones”

“Release Tones” appear when a continuous tone signal (s) containing a (w) is registered in the contact list.

This operation can be performed while driving.

Select “Release Tones”.

- A continuous tone signal is a character string that consists of numbers and the characters “p” or “w”. (e.g. 056133w0123p#1)
- When the “p” pause tone is used, the tone data up until the next pause tone will be automatically sent after 2 seconds have elapsed. When the “w” pause tone is used, the tone data up until the next pause tone will be automatically sent after a user operation is performed.
- Release tones can be used when automated operation of a phone based service such as an answering machine or bank phone service is desired. A phone number with continuous tone signals can be registered in the contact list.
- Tone data after a “w” pause tone can be operated by voice command during a call.

### Transmit volume setting

- 1 Select “Transmit Volume”.
- 2 Select the desired level for the transmit volume.
- 3 Select  to display previous screen.

- The sound quality of the voice heard from the other party’s speaker may be negatively impacted.
- “Transmit Volume” is dimmed when mute is on.

### Switching calls while a call is in progress

- When there are no calls on hold during a call: “Hold” is displayed. When selected, the

current call is placed on hold.

- When there is no current call, but there is a call on hold: “Activate” is displayed. When selected, the system switches to the call that was on hold.
- When there is another call on hold during a call: “Swap Calls” is displayed. When selected, the current call is placed on hold, and the system switches to the call that was on hold.

This function may not be available depending on the type of cellular phone.

### Incoming call waiting

When a call is interrupted by a third party while talking, the incoming screen is displayed.

Select “Answer” or press the  switch on the steering wheel to start talking with the other party.

- To refuse to receive the call: Select “Decline”.
- Each time “Swap Calls” is selected, the party who is on hold will be switched.

This function may not be available depending on the type of Bluetooth® phone.

### Bluetooth® phone message function

**Received messages can be forwarded from the connected Bluetooth® phone, enabling checking and replying using the system.**

**Depending on the type of Bluetooth® phone connected, received messages may not be transferred to the system.**

**If the phone does not support the message function, this function cannot be used. Even when the supported phone is used, reply function may not be used.**

### Displaying the message screen

- 1 Display the phone top screen. (→P.373)
- 2 Select "Message".

A confirmation message appears when the "Automatic Message Transfer" function is set to off (→P.396), select "Yes".

- 3 Check that the message screen is displayed.

"Phone": Select to change to phone mode.

- The account name is displayed on the left side of screen.
- Account names are the

names of the accounts that exist on the currently connected phone.

- The following functions can be used on message function:
  - Receiving a message (→P.384)
  - Checking messages (→P.385)
  - Replying to a message (dictation reply) (→P.386)
  - Replying to a message (quick reply) (→P.386)
  - Calling the message sender (→P.387)
  - Message settings (→P.396)

### Receiving a message

When an e-mail/SMS/MMS is received, the incoming message screen pops up with sound and is ready to be operated on the screen.

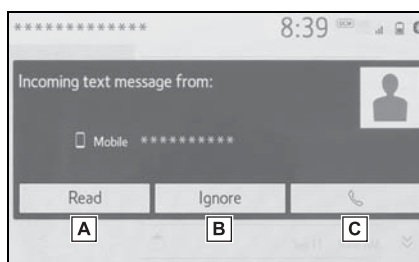

- A** Select to check the message.
- B** Select to not open the message.
- C** Select to call the message sender.

- Depending on the type of Blue-

tooth® phone used for receiving messages, or its registration status with the system, some information may not be displayed.

- The pop-up screen is separately available for incoming e-mail and SMS/MMS messages under the following conditions:

E-mail:

- “Incoming E-mail Display” is set to “Full Screen”. (→P.389)
- “E-mail Notification Pop-up” is set to on. (→P.389)

SMS/MMS:

- “Incoming SMS/MMS Display” is set to “Full Screen”. (→P.389)
- “SMS/MMS Notification Pop-up” is set to on. (→P.389)
- Depending on the type of Bluetooth® phone being connected, E-Mail function cannot be used via Bluetooth®.

### Checking received messages

- 1 Display the message screen. (→P.384)
- 2 Select a desired account name.
- 3 Select the desired message from the list.
- 4 Check that the message is displayed.

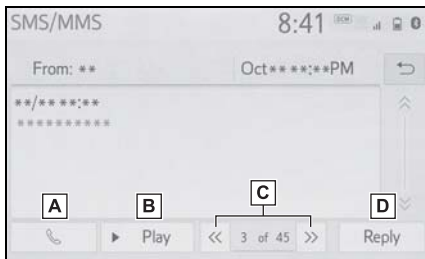

- A** Select to call the message

sender.

- B** Select to have messages read out.  
To cancel this function, select “Stop”.  
When “Automatic Message Readout” is set to on, messages will be automatically read out. (→P.396)
- C** Select to display the previous or next message.
- D** This function can be chosen the method to reply message with “Dictation” or “Quick Message”.

- Reading a text message is not available while driving.
- Depending on the type of Bluetooth® phone being connected, this function cannot be used.
- Depending on the type of Bluetooth® phone being connected, it may be necessary to perform additional steps on the phone.
- Messages are displayed in the appropriate connected Bluetooth® phone’s registered mail address folder. Select the desired folder to be displayed.
- Only received messages on the connected Bluetooth® phone can be displayed.
- The text of the message is not displayed while driving.
- Turn the “POWER VOLUME” knob, or use the volume control switch on the steering wheel to adjust the message read out volume.
- “Subject:” field is not shown on SMS case.
- E-mail only: Select “Mark Unread”

or "Mark Read" to mark mail unread or read on the message screen.  
This function is available when "Update Message Read Status on Phone" is set to on. (→P.396)

### Replying to a message (dictation reply)\*

\*: If equipped

- 1 Display the message screen. (→P.384)
- 2 Select the desired message from the list.
- 3 Select "Reply".
- 4 Select "Dictation".
- 5 When the "Say Your Message" screen is displayed, speak message that you want to send.
- 6 Select "Send" to send message.

"Cancel": Select to cancel sending the message.

"Retry": Select to retry speaking message that you want to send.

While the message is being sent, a sending message screen is displayed.

- 7 Check that a confirmation screen is displayed when the operation is complete.

If an error message is displayed, follow the guidance on the screen to try again.

### Replying to a message (quick reply)

15 messages have already

been stored.

- 1 Display the message screen. (→P.384)
- 2 Select the desired message from the list.
- 3 Select "Reply".
- 4 Select "Quick Message".
- 5 Select the desired message.

: Select to edit the message. (→P.386)

- 6 Select "Send".

"Cancel": Select to cancel sending the message.

While the message is being sent, a sending message screen is displayed.

- 7 Check that a confirmation screen is displayed when the operation is complete.

If an error message is displayed, follow the guidance on the screen to try again.

Depending on the type of Bluetooth® phone, reply function is not available.

### ■ Editing quick reply messages

This operation cannot be performed while driving.

- 1 Select  corresponding to the desired message to edit.
- 2 Select "OK" when editing is completed.



To reset the edited quick reply messages, select "Default".

**Calling the message sender**

Calls can be made to an e-mail/SMS/MMS message sender's phone number.

This operation can be performed while driving.

■ **Calling from e-mail/SMS/MMS message display**

- 1 Display the message screen. (→P.384)
- 2 Select the desired message.
- 3 Select , or press the  switch on the steering wheel.

If there are 2 or more phone numbers, select the desired number.

- 4 Check that the dialing screen is displayed.

■ **Calling from a number within a message**

Calls can be made to a number identified in a message's text area.

This operation cannot be performed while driving.

- 1 Display the message screen. (→P.384)
- 2 Select the desired message.

- 3 Select the text area.



Identified phone numbers contained in the message are displayed in blue text.

- 4 Select the desired number.
- 5 Check that the dialing screen is displayed.

A series of numbers may be recognized as a phone number. Additionally, some phone numbers may not be recognized, such as those for other countries.

■ **Calling from the incoming message screen**

For detail, refer to "Receiving a message". (→P.384)

5

Audio

Setup

Displaying the phone settings screen

- 1 Press the "MENU" button.

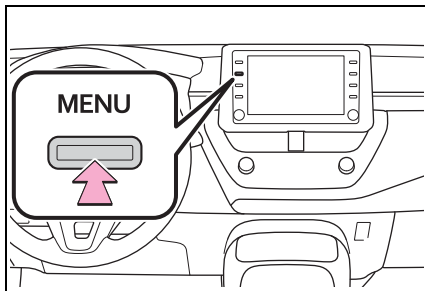

- 2 Select "Setup".
- 3 Select "Phone".
- 4 Select the desired item to be set.

Phone settings screen

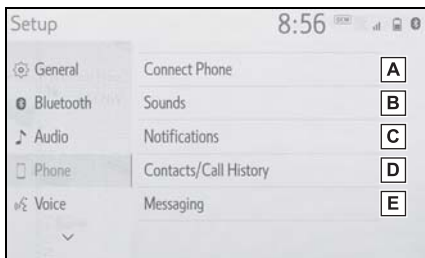

- A** Connecting a Bluetooth® device and editing the Bluetooth® device information (→P.302, 306)
- B** Sound settings\* (→P.388)
- C** Notification settings\* (→P.389)
- D** Contact/call history settings\*

(→P.390)

- E** Message settings\* (→P.396)

\*: This operation cannot be performed while driving.

Sounds settings screen

The call and ringtone volume can be adjusted. A ringtone can be selected.

- 1 Display the phone settings screen. (→P.388)
- 2 Select "Sounds".
- 3 Select the desired item to be set.



- A** Select to set the desired ringtone.
- B** Select "-" or "+" to adjust the ringtone volume.
- C** Select "-" or "+" to adjust the default volume of the other party's voice.



- D** Select to set the desired incoming e-mail tone.
- E** Select to set the desired incoming SMS/MMS tone.
- F** Select “-” or “+” to adjust the incoming SMS/MMS tone volume.
- G** Select “-” or “+” to adjust the incoming e-mail tone volume.
- H** Select “-” or “+” to adjust the message readout volume.
- I** Select to reset all setup items.

Depending on the type of Bluetooth® phone, certain functions may not be available.

### Notifications settings screen

- 1 Display the phone settings screen. (→P.388)
- 2 Select “Notifications”.

- 3 Select the desired item to be set.

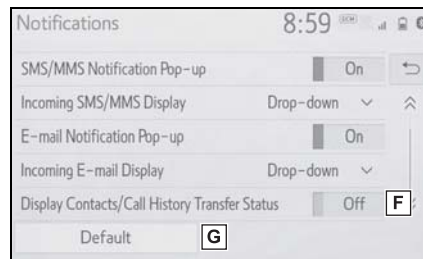

- A** Select to change the incoming call display.

“Full Screen”: When a call is received, the incoming call screen is displayed and can be operated on the screen.

“Drop-down”: A message is displayed at the top of the screen.

- B** Select to set the SMS/MMS notification pop-up on/off.

- C** Select to change the incoming SMS/MMS display.

“Full Screen”: When an SMS/MMS message is received, the incoming SMS/MMS display screen is displayed and can be operated on the screen.

“Drop-down”: When an SMS/MMS message is received, a message is displayed at the top of the

screen.

- D** Select to set the e-mail notification pop-up on/off.
- E** Select to change the incoming e-mail display.  
“Full Screen”: When an e-mail is received, the incoming e-mail display screen is displayed and can be operated on the screen.  
“Drop-down”: When an e-mail is received, a message is displayed at the top of the screen.
- F** Select to set display of the contact/history transfer completion message on/off.
- G** Select to reset all setup items.

Depending on the type of Bluetooth® phone, these functions may not be available.

### Contacts/Call history settings screen

Contacts can be transferred from a Bluetooth® phone to this system. Contacts and favorites can be added, edited and deleted. Also, the call history can be deleted.

- 1 Display the phone settings screen. (→P.388)
- 2 Select “Contacts/Call History”.

- 3 Select the desired item to be set.



- A** For PBAP compatible Bluetooth® phones: Select to change the contact/history transfer settings. (→P.391)
- B** Select to update contacts from the connected device. (→P.391)
- C** Select to sort contacts by the first name or last name field.
- D** Select to add contacts to the favorites list. (→P.394)
- E** Select to delete contacts from the favorites list. (→P.394)
- F** Select to clear the call history.\*
- G** Select to add new contacts to the contact list.\* (→P.393)
- H** Select to edit contacts in the

contact list.\* (→P.394)

**I** Select to delete contacts from the contact list.\* (→P.394)

**J** Select to set the voice tags. (→P.395)

**K** Select to reset all setup items.

\*: For PBAP compatible Bluetooth® phones, this function is available when “Automatic Transfer” is set to off. (→P.391)

- Depending on the type of Bluetooth® phone, certain functions may not be available.
- Contact data is managed independently for every registered phone. When one phone is connected, another phone’s registered data cannot be read.

**Setting automatic contact/history transfer**

The automatic contact/history function is available for PBAP compatible Bluetooth® phones only.

- 1 Select “Automatic Transfer”.
- 2 Select the desired item to be set.

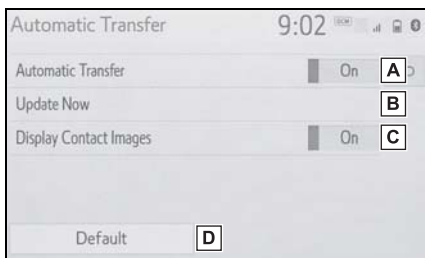

**A** Select to set automatic contact/history transfer on/off. When set to on, the phone’s contact data and history are automatically transferred.

**B** Select to update contacts from the connected phone. (→P.391)

**C** Select to set the transferred contact image display on/off. Only when the vehicle is not moving, the contact image can be displayed.

**D** Select to reset all setup items.

**Updating contacts from phone**

- 1 Select “Update Now”.

Contacts are transferred automatically.

- 2 Check that a confirmation screen is displayed when the operation is complete.

- This operation may be unnecessary depending on the type of Bluetooth® phone.
- If another Bluetooth® device is connected when transferring contact data, depending on the phone, the connected Bluetooth® device may need to be disconnected.
- Depending on the type of Bluetooth® phone being connected, it may be necessary to perform additional steps on the phone.

### ■ Updating the contacts in a different way (from the call history screen)\*

- 1 Display the phone top screen. (→P.373)
- 2 Select "History" and select a contact not yet registered in the contact list.
- 3 Select "Update Contact".
- 4 Select the desired contact.
- 5 Select a phone type for the phone number.

\*: For PBAP compatible Bluetooth® phones, this function is available when "Automatic Transfer" is set to off. (→P.390)

### Transfer contacts from device

When an Android Auto connection is established, this function will be unavailable.\*

\*: This function is not made available in some countries or areas.

### From phone (OPP compatible Bluetooth® phones only)

- ▶ When the contact is not registered
- 1 Select "Transfer Contacts from Device".
  - 2 Select "From Phone (Bluetooth)".

- 3 Transfer the contact data to the system using a Bluetooth® phone.

● This operation may be unnecessary depending on the type of Bluetooth® phone.

● To cancel this function, select "Cancel".

- 4 Check that a confirmation screen is displayed when the operation is complete.

▶ When the contact is registered

- 1 Select "Transfer Contacts from Device".
- 2 Select "From Phone (Bluetooth)".
- 3 Select "Replace Contacts" or "Add Contact".

"Replace Contacts": Select to transfer the contact from the connected cellular phone and replace the current one.

"Add Contact": Select to transfer the desired contact data from the connected cellular phone to add to the current one.

- 4 Transfer the contact data to the system using a Bluetooth® phone.

● This operation may be unnecessary depending on the type of Bluetooth® phone.

● To cancel this function, select "Cancel".

- 5 Check that a confirmation screen is displayed when the operation is complete.

**From USB device**

Backed-up contact data (vCard formatted) can be transferred from USB device or Bluetooth® phone to this system.

- 1 Connect a USB device. (→P.330)
- 2 Select “Transfer Contacts from Device”.
- 3 Select “From USB”.
- 4 Select “USB 1” or “USB 2” when the multiple USB devices are connected. If a USB device is connected, skip this procedure.
- 5 Select “Replace Contacts” or “Add Contact”. If the contact is already registered, skip this procedure.

“Replace Contacts”: Select to transfer the contact from the connected USB device or Bluetooth® phone and replace the current one.

“Add Contact”: Select to transfer the desired contact data from the connected USB device or Bluetooth® phone to add to the current one.

- 6 Select a desired file from vCard file list.
- 7 Check that a confirmation screen is displayed when the operation is complete.

- Depending on the type of Bluetooth® phone used and number of files, it may take time to display vCard file lists and download contacts.

- Downloading may not complete correctly in the following cases:
  - If the engine switch is turned off during downloading.
  - If the USB device or Bluetooth® phone is removed before downloading is complete.

**Registering a new contact to the contacts list**

New contact data can be registered.

Up to 4 numbers per person can be registered. For PBAP compatible Bluetooth® phones, this function is available when “Automatic Transfer” is set to off. (→P.390)

- 1 Select “New Contact”.
- 2 Enter the name and select “OK”.
- 3 Enter the phone number and select “OK”.
- 4 Select the phone type for the phone number.
- 5 To add another number to this contact, select “Yes”.

**Registering a new contact in a different way (from the call history screen)**

- 1 Display the phone top screen. (→P.373)
- 2 Select “History” and select a contact not yet registered in the contact list.
- 3 Select “Add to Contacts”.
- 4 Follow the steps in “Registering a new contact to the con-

tacts list" from step 2.  
(→P.393)

#### Editing the contact data

For PBAP compatible Bluetooth® phones, this function is available when "Automatic Transfer" is set to off. (→P.390)

- 1 Select "Edit Contact".
- 2 Select the desired contact.
- 3 Select  next to the name or desired number.
- 4 Enter the name or the phone number and select "OK".

#### Deleting the contact data

For PBAP compatible Bluetooth® phones, this function is available when "Automatic Transfer" is set to off. (→P.390)

- 1 Select "Delete Contacts".
- 2 Select the desired contact and select "Delete".
- 3 Select "Yes" when the confirmation screen appears.

- Multiple data can be selected and deleted at the same time.
- When a Bluetooth® phone is deleted, the contact data will be deleted at the same time.

#### Favorites list setting

Up to 15 contacts (maximum of 4 numbers per contact) can be registered in the favorites list.

#### ■ Registering the contacts in the favorites list

- 1 Select "Add Favorite".
- 2 Select the desired contact to add to the favorites list.

Dimmed contacts are already stored as a favorite.

- 3 Check that a confirmation screen is displayed when the operation is complete.

▶ When 15 contacts have already been registered to the favorites list

- 1 When 15 contacts have already been registered to the favorites list, a registered contact needs to be replaced. Select "Yes" when the confirmation screen appears to replace a contact.

- 2 Select the contact to be replaced.
- 3 Check that a confirmation screen is displayed when the operation is complete.

#### ■ Registering contacts in the favorites list in a different way (from the contact details screen)

- 1 Display the phone top screen. (→P.373)
- 2 Select "Contacts" and select the desired contact.
- 3 Select "Add Favorite".
- 4 Check that a confirmation screen is displayed when the operation is complete.

### ■ Deleting the contacts in the favorites list

- 1 Select "Remove Favorite".
- 2 Select the desired contacts and select "Remove".
- 3 Select "Yes" when the confirmation screen appears.
- 4 Check that a confirmation screen is displayed when the operation is complete.

### ■ Deleting contacts in the favorites list in a different way (from the contact details screen)

- 1 Display the phone top screen. (→P.373)
- 2 Select "Favorites" or "Contacts" and select the desired contact to delete.
- 3 Select "Remove Favorite".
- 4 Select "Yes" when the confirmation screen appears.
- 5 Check that a confirmation screen is displayed when the operation is complete.

### Setting voice tags

Calls can be made by saying the voice tag of a registered contact in the contact list. (→P.364)

- 1 Select "Manage Voice Tags".

- 2 Select the desired item to be set.

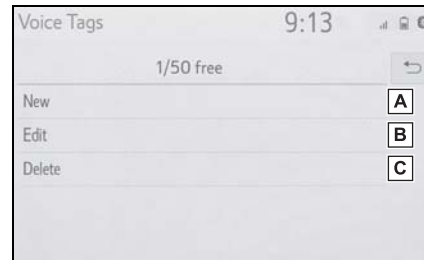

- A** Select to register a new voice tag. (→P.395)
- B** Select to edit a voice tag. (→P.395)
- C** Select to delete a voice tag. (→P.396)

### ■ Registering a voice tag

Up to 50 voice tags can be registered.

- 1 Select "New".
- 2 Select the desired contact to register a voice tag for.
- 3 Select "REC" and record a voice tag.

When recording a voice tag, do so in a quiet area.

"Play": Select to play the voice tag.

- 4 Select "OK" when voice tag registration is complete.

### ■ Editing a voice tag

- 1 Select "Edit".
- 2 Select the desired contact to edit.
- 3 Follow the steps in "Registering a voice tag" from step 3. (→P.395)

### ■ Deleting the voice tag

- 1 Select "Delete".
- 2 Select the desired contact and select "Delete".
- 3 Select "Yes" when the confirmation screen appears.

- Multiple data can be selected and deleted at the same time.
- Voice tags are deleted when the set language of the system is changed. (→P.321)

### Message settings screen

- 1 Display the phone settings screen. (→P.388)
- 2 Select "Messaging".
- 3 Select the desired item to be set.



- A** Select to set automatic message transfer on/off.
- B** Select to set automatic message readout on/off.
- C** Select to set updating message read status on phone on/off.
- D** Select to set display of messaging account names on the message screen on/off. When set to on, messaging

account names used on the cellular phone will be displayed.

- E** Select to set adding the vehicle signature to outgoing messages on/off. The vehicle signature can be edited. (→P.396)
- F** Select to reset all setup items.

Depending on the phone, these functions may not be available.

### Vehicle signature settings

- 1 Select "Vehicle Signature".
- 2 Select the desired item to be set.



- A** Select to set adding the vehicle signature to outgoing messages on/off.
- B** Select to edit the vehicle signature. (→P.396)
- C** Select to reset all setup items.

### ■ Editing vehicle signature

- 1 Select "Edit Vehicle Signature".



- 2 Enter desired signature with using keyboard.
- 3 Select "OK".
- 4 Select "OK" on the confirmation screen, or select "Edit Again" when it needs to amend.

5

Audio

**Troubleshooting**

**If there is a problem with the hands-free system or a Bluetooth® device, first check the table below.**

**Troubleshooting**

■ **When using the hands-free system with a Bluetooth® device**

The hands-free system or Bluetooth® device does not work.

Likely cause	Solution
The connected device may not be a compatible Bluetooth® cellular phone.	For a list of specific devices which operation has been confirmed on this system, check with your Toyota dealer or the following website: <a href="https://www.toyota.com/audio-multimedia">https://www.toyota.com/audio-multimedia</a> in the United States, <a href="https://www.toyota.ca/connected">https://www.toyota.ca/connected</a> in Canada, and <a href="http://www.toyotapr.com/audio-multimedia">http://www.toyotapr.com/audio-multimedia</a> in Puerto Rico
The Bluetooth® version of the connected cellular phone may be older than the specified version.	Use a cellular phone with Bluetooth® version 2.0 or higher (recommended: Ver. 4.1 +EDR or higher). (→P.301)

■ **When registering/connecting a cellular phone**

A cellular phone cannot be registered.

Likely cause	Solution
An incorrect passcode was entered on the cellular phone.	Enter the correct passcode on the cellular phone.
The registration operation has not been completed on the cellular phone side.	Complete the registration operation on the cellular phone (approve registration on the phone).
Old registration information remains on either this system or the cellular phone.	Delete the existing registration information from both this system and the cellular phone, then register the cellular phone you wish to connect to this system. (→P.305)



A Bluetooth® connection cannot be made.

Likely cause	Solution
Another Bluetooth® device is already connected.	Manually connect the cellular phone you wish to use to this system. (→P.302)
Bluetooth® function is not enabled on the cellular phone.	Enable the Bluetooth® function on the cellular phone.

Likely cause	Solution
Automatic Bluetooth® connection on this system is set to off.	Set automatic Bluetooth® connection on this system to on when the engine switch is in ACC or ON. (→P.307)
Preferred device settings function on this system is set to on.	Set preferred device settings function on this system to off. (→P.308)
	Set the desired cellular phone to the highest automatic connection priority. (→P.308)

■ **When making/receiving a call**

A call cannot be made/received.

Likely cause	Solution
Your vehicle is in a  area.	Move to where  no longer appears on the display.

■ **When using the phonebook**

Phonebook data cannot be transferred manually/automatically.

Likely cause	Solution
The profile version of the connected cellular phone may not be compatible with transferring phonebook data.	For a list of specific devices which operation has been confirmed on this system, check with your Toyota dealer or the following website: <a href="https://www.toyota.com/audio-multimedia">https://www.toyota.com/audio-multimedia</a> in the United States, <a href="https://www.toyota.ca/connected">https://www.toyota.ca/connected</a> in Canada, and <a href="http://www.toyotapr.com/audio-multimedia">http://www.toyotapr.com/audio-multimedia</a> in Puerto Rico
Automatic contact transfer function on this system is set to off.	Set automatic contact transfer function on this system to on. (→P.391)
Passcode has not been entered on the cellular phone.	Enter the passcode on the cellular phone if requested (default passcode: 1234).
Transfer operation on the cellular phone has not completed.	Complete transfer operation on the cellular phone (approve transfer operation on the phone).

Phonebook data cannot be

edited.

Likely cause	Solution
Automatic contact transfer function on this system is set to on.	Set automatic contact transfer function on this system to off. (→P.391)

■ **When using the Bluetooth® message function**

Messages cannot be viewed.

Likely cause	Solution
Message transfer is not enabled on the cellular phone.	Enable message transfer on the cellular phone (approve message transfer on the phone).
Automatic transfer function on this system is set to off.	Set automatic transfer function on this system to on. (→P.391)

New message notifications are not displayed.

Likely cause	Solution
Notification of SMS/MMS/E-mail reception on this system is set to off.	Set notification of SMS/MMS/E-mail reception on this system to on. (→P.389)
Automatic message transfer function is not enabled on the cellular phone.	Enable automatic transfer function on the cellular phone.

■ In other situations

The Bluetooth® connection status is displayed at the top of the screen each time the engine switch is in ACC or ON.

Likely cause	Solution
Connection confirmation display on this system is set to on.	To turn off the display, set connection confirmation display on this system to off. (→P.308)

Even though all conceivable measures have been taken, the symptom status does not change.

Likely cause	Solution
The cellular phone is not close enough to this system.	Bring the cellular phone closer to this system.
Radio interference has occurred.	Turn off Wi-Fi® devices or other devices that may emit radio waves.

Likely cause	Solution
The cellular phone is the most likely cause of the symptom.	Turn the cellular phone off, remove and reinstall the battery pack, and then restart the cellular phone.
	Enable the cellular phone's Bluetooth® connection.
	Stop the cellular phone's security software and close all applications.
	Before using an application installed on the cellular phone, carefully check its source and how its operation might affect this system.

For details, refer to the owner's manual that came with the cellular phone.

**Functional overview**

**Toyota Connected hotspot includes Toyota apps, Wi-Fi® Hotspot, Safety Connect and Service Connect.**

▶ Audio Plus/Premium Audio

Owners of this system should refer to the “NAVIGATION AND MULTIMEDIA SYSTEM OWNER’S MANUAL”.

- Each function is available in the following areas:
  - Toyota apps is available in the contiguous United States, Washington D.C., Alaska, Hawaii, Puerto Rico and Canada.
  - Toyota apps is not available in the United States Virgin Islands.
  - Wi-Fi® Hotspot is available in the contiguous United States, Washington D.C., Alaska and Hawaii.
  - Wi-Fi® Hotspot is not available in Puerto Rico, Canada, and in the United States Virgin Islands.
  - Safety Connect features include: Automatic Collision Notification, Emergency Assistance, S.O.S, Stolen Vehicle Location (available in the contiguous United States, Washington D.C., Hawaii, Alaska, Puerto Rico and Canada) and Enhanced Roadside Assistance (available in the contiguous United States, Washington D.C., Alaska, Puerto Rico and Canada).
  - Safety Connect is not available in the United States Virgin Islands.
  - Service Connect is available in the contiguous United States, Washington D.C., Alaska, Hawaii, the United States Virgin Islands, Puerto Rico and Canada.
- Connected services functionality is dependent upon network reception level and signal strength.

**Functional overview**

- The functions included are classified into the following four types.
  - Type A: Function achieved by using a smart phone or an embedded cellular device in the vehicle (DCM: Data Communication Module) and the system
  - Type B: Function achieved by using DCM and the system
  - Type C: Function achieved by using DCM
  - Type D: Function achieved by using DCM and a smartphone

Function	Type
Toyota apps	Type A
Wi-Fi® Hotspot	Type B
Safety Connect	Type C
Service Connect	Type D

Type A: Function achieved by using a smart phone or DCM\*

\*: If equipped

**Of the functions included with Connected Services, the Toyota apps relies on the use of a smart phone or DCM.**

- Using a smart phone
  - Toyota audio multimedia system enables applicable apps installed on a smart phone to be displayed on and operated from the screen via a Bluetooth®.
- Via DCM
  - Toyota audio multimedia system enables applicable apps installed on the system to be displayed on and operated from the screen.

**A few settings must be performed before Toyota apps can be used. (→P.409)**

5

**By using a smart phone or DCM**

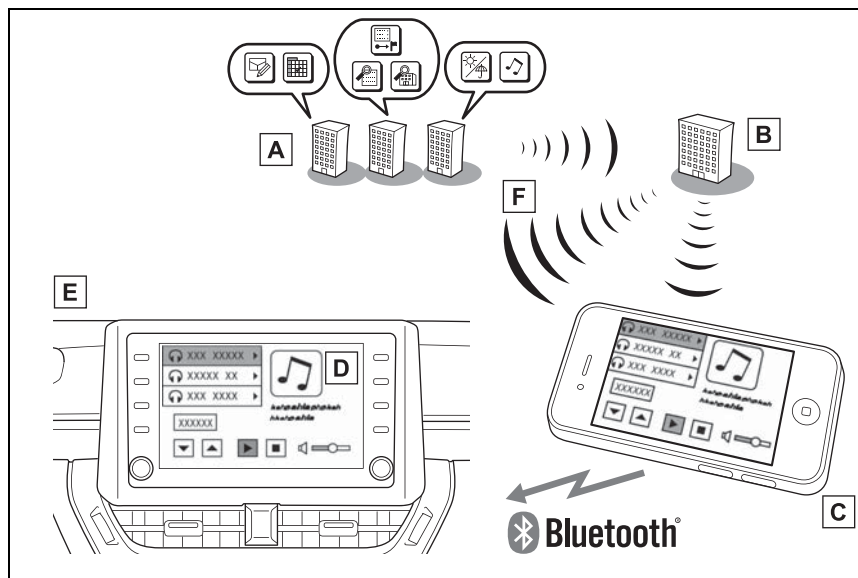

**A** Content provider

Audio

Provides contents to the application server.

**B** Application server

Provides applications to the system or a smart phone.

**C** Smart phone\*

Using the Toyota mobile application, communication is relayed between the system, application server and contents provider.

The smart phone cannot be operated while communicating.

**D** Applications

Display usable content from the content providers on the screen using the data connection of the connected smart phone or DCM.

**E** System

Content received, via a smart phone or DCM, from content provider servers is displayed on the screen. The system is equipped with an application player to run applications.

**F** Via DCM

\*: For known compatible phones, refer to

<https://www.toyota.com/connected-services> in the United States,

<https://www.toyota.ca/connected> in Canada, and

<http://www.toyotapr.com/connected-services> in Puerto Rico.

### Before using the function

The required operations to activate applications and connect a smart phone to the system, and the registration steps for the connected services are explained in this section.

#### ■ Subscription

- Toyota apps does not require an activation fee or monthly recurring fees.
- Services requiring a separate contract can also be used.\*

\*: For details, refer to

<https://www.toyota.com/connected-services>

or call 1-800-331-4331 in the

United States,

<https://www.toyota.ca/connected>

or call 1-888-869-6828 in Canada, and

<http://www.toyotapr.com/connected-services>

or call 1-877-855-8377 in Puerto Rico.

#### ■ Availability of function

- Toyota apps is available in the contiguous United States, Washington D.C., Alaska, Hawaii, Puerto Rico and Canada.
- Toyota apps is not available in the United States Virgin Islands.

- 
- Data usage fees may apply while



using Toyota apps function. Confirm data usage fees before using this function.

- For details regarding operation of the Toyota apps, refer to <https://www.toyota.com/connected-services> in the United States, <https://www.toyota.ca/connected> in Canada, and <http://www.toyotapr.com/connected-services> in Puerto Rico.
- These functions are not made available in some countries or areas. Availability of functions of the Toyota apps is dependent on network reception level.

#### ■ Initializing personal data

The personal data used in applications can be reset. (→P.324)

The following personal data can be deleted and returned to their default settings:

- Downloaded contents
- Radio stations that were listened to

Once initialized, the data and settings will be erased. Pay much attention when initializing the data.

### Preparation before using Toyota mobile application

#### ■ Settings required to use Toyota mobile application

Perform the settings in the following order.

- 1 Download the Toyota mobile application to your smart phone or the system.

- 2 Open the Toyota mobile application on your smart phone and follow instructions. Bluetooth® Pairing is required.

In order to use Toyota mobile application, the following must first be performed:

- Register a Bluetooth® phone with the hands-free system. (→P.298)

- Applications can only be used when the Toyota mobile application has been downloaded to your smart phone or the system, and the application is running.
- Toyota mobile application operational procedures can also be confirmed by visiting <https://www.toyota.com/connected-services> in the United States, <https://www.toyota.ca/connected> in Canada, and <http://www.toyotapr.com/connected-services> in Puerto Rico.
- If a Toyota mobile application is used while iPod audio/video is being played back, system operation may become unstable.

Type B: Function achieved by using DCM and the system \*

\*: If equipped

**The functionality of Wi-Fi® Hotspot is made possible through the shared work of the DCM and the system.**

**This service is available by subscription and supported by the Toyota response center, which operates 24 hours a day, 7 days a week.**

**For details about Wi-Fi® Hotspot: →P.310**

### Before using the function

#### ■ Subscription

After you have signed the Telematics Subscription Service Agreement and are enrolled, you can begin receiving services. A variety of subscription terms are available. Contact your Toyota dealer, or call 1-800-331-4331 in the United States, 1-888-869-6828 in Canada, and 1-877-855-8377 in Puerto Rico, for further subscription details. (→P.404)

#### ■ Availability of functions

- Wi-Fi® Hotspot is available in the contiguous United States, Washington D.C., Alaska and Hawaii.

- Wi-Fi® Hotspot is not available in Puerto Rico, Canada, and in the United States Virgin Islands.

Type C: Function achieved by using DCM\*

\*: If equipped

**The functionality of Safety Connect is made possible by the use of a DCM. For details, (→P.73)**

Type D: Function achieved by using DCM and a smart-phone\*

\*: If equipped

**The functionality of Service Connect is made possible by the use of a DCM and a smartphone.**

**For details about these services, refer to <https://www.toyota.com/connected-services>.**

**Service Connect**

Service Connect uses DCM to collect and transmit vehicle data that allows Toyota to provide:

- Vehicle Health Report (VHR) (Safety Recalls, Service Campaigns, Current Vehicle Alerts, Required Maintenance, and Vehicle Condition Status)
- Maintenance Notifications
- Vehicle Alert Notifications

■ **Availability of function**

- Service Connect is available in the contiguous United States, Washington D.C., Alaska, Hawaii, the United States Virgin Islands, Puerto Rico and Canada.

5

Audio

- Availability of functions of the Service Connect is dependent on network reception level.

**Toyota apps**

**Toyota apps is a function that enables certain apps installed on a smart phone or the system to be displayed on and operated from the system screen. Before the Toyota apps can be used, some setup needs to be performed. (→P.405)**

**For details about the functions and services provided by each application, refer to <https://www.toyota.com/connected-services> in the United States, <https://www.toyota.ca/connected> in Canada, and <http://www.toyotapr.com/connected-services> in Puerto Rico.**

**Using Toyota apps**

- ▶ From the “MENU” button
- 1 Press the “MENU” button.

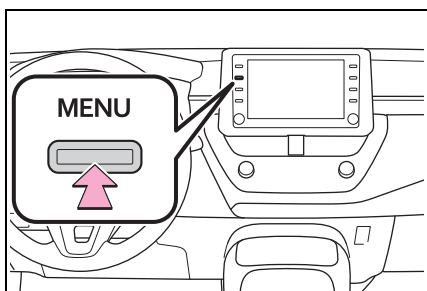

- 2 Select “Apps”.

- 3 Follow the steps in “From the “APPS” button” from step 3. (→P.409)

- ▶ From the “APPS” button
- 1 Press the “APPS” button.

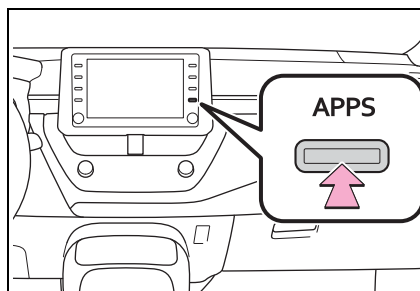

- 2 Select “Apps”.

If a specific application screen is displayed, select “Apps” again.

- 3 Select the desired application screen button.

**APPS** : Select to activate an application.

“Update”: Select to update the applications. (→P.409)

“App Catalog”: Select to change the order of the applications. (→P.410)

**2** : Displays the number of new notifications for the application

**Updating an application**

When the Toyota apps is activated, an application may need to be updated. To update an application, it is necessary to download update data and install it.

**■ Downloading update**

If an update is available, “Update” can be selected.

- 1 Select "Update" on the application screen. (→P.409)
- 2 Check that downloading starts.

"Download in Background": Select to operate other functions while downloading.

"Cancel": Select to cancel updating.

- 3 Check that downloading is complete.

"Later": Select to install later. When this screen button is selected, the screen will return to the last displayed screen. To install the update data: (→P.410)

"See Detail": Select to display detailed information on the update data.

"Install": Select to install the update data. Follow the steps "Installing the update data" from step 2. (→P.410)

#### ■ Installing the update data

After the downloading is complete, "Update" will be changed to "Install".

- 1 Select "Install" on the application screen. (→P.409)
- 2 Select "Continue".

"Later": Select to postpone the installation of the update data and go back to the previous screen.

- 3 Check that installing is started.

"Install in Background": Select to operate other functions while installing.

- 4 Select "OK" after the installing is complete.

---

The Toyota apps cannot be operated while installing.

#### Reordering the applications

Order of the applications can be changed.

- 1 Display the application screen. (→P.409)
- 2 Select "App Catalog".
- 3 Select the desired application to be moved.
- 4 Select "<<" or ">>" to move the application, and then select the done button.

#### If a message appears on the screen

When problems occur with starting the application player, a message will appear on the screen. Referring to the following items, identify the problem and take the suggested corrective action.

- "When it is safe and legal to do so, please ensure your mobile application is running and logged in on your phone."

The Toyota mobile application cannot be connected to Bluetooth® SPP.

Refer to  
<https://www.toyota.com/connected-services>  
 in the United States,  
<https://www.toyota.ca/connected>  
 in Canada, and  
<http://www.toyotapr.com/connected-services>  
 in Puerto Rico, to confirm if the

phone is Bluetooth® SPP compatible or not, and then activate the Toyota mobile application.

- “Installation failed, please try again”

Installation can be attempted again by changing to the application screen and pressing the “Install” switch.

- “Application download error. Please try again later.”

Downloading can be attempted again by checking the communication status, changing to the application screen and pressing the “Download” switch again.

- “Download error, some mobile application functions may not work as expected. Please reinitiate the download process.”

The Toyota mobile application cannot be connected to Bluetooth® SPP.

Refer to <https://www.toyota.com/connected-services> in the United States, <https://www.toyota.ca/connected> in Canada, and <http://www.toyotapr.com/connected-services>

in Puerto Rico, to confirm if the phone is Bluetooth® SPP compatible or not, and then activate the Toyota mobile application.

Please ensure your Toyota mobile application is running and logged in on your phone while vehicle is not moving.

- “To use the services, mobile application needs to be running on your phone. For more information, please visit [toyota.com](http://toyota.com) or call 1-800-331-4331 in the United States, 1-888-869-6828 in Canada, and 1-877-855-8377 in Puerto Rico.”

The Toyota mobile application cannot be connected to Bluetooth® SPP.

Refer to <https://www.toyota.com/connected-services> in the United States, <https://www.toyota.ca/connected> in Canada, and <http://www.toyotapr.com/connected-services>

in Puerto Rico, to confirm if the phone is Bluetooth® SPP compatible or not, and then activate the Toyota mobile application.

- “Communication unsuccessful. Please try again.”

Communication was disconnected.

After a few moments, retry the operation.

### Entering keyword operation

A keyword can be entered to an application by the software keyboard or voice recognition function. For details about the functions and services provided by each application, refer to <https://www.toyota.com/connected-services>

in the United States,  
<https://www.toyota.ca/connected>  
in Canada, and  
[http://www.toyotapr.com/  
connected-services](http://www.toyotapr.com/connected-services)  
in Puerto Rico.

The keyboard layout can be changed. (→P.321)

detected automatically.

- 5 Search results will be displayed on the screen.

#### **Entering a keyword using the software keyboard**

- 1 Display the application screen. (→P.409)
- 2 Select the desired application screen button.
- 3 Select the character entering space.
- 4 Enter a search term, and then select "OK".
- 5 Entering characters will be reflected on the character entering space.

For details on operating the keyboard: →P.293

#### **Entering a keyword using the voice recognition function**

- 1 Display the application screen. (→P.409)
- 2 Select the desired application screen button.
- 3 Press the talk switch. (→P.364)
- 4 Say the desired keyword.

Completion of the keyword will be



Setup

The settings of Toyota apps can be changed.

Displaying the Toyota apps settings screen

- 1 Press the "MENU" button.

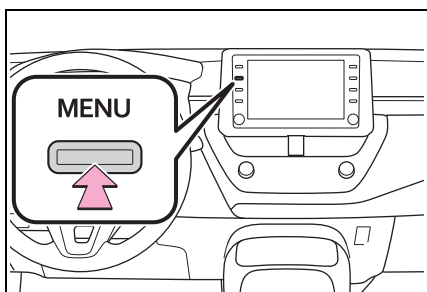

- 2 Select "Setup".
- 3 Select "Toyota apps".
- 4 Select the desired items to be set.

Toyota apps settings screen

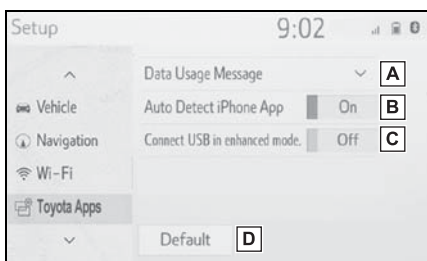

- A** Select to set the pop up reminder for smart phone data usage. (→P.411)
- B** Select to detect iPhone app automatically on/off.

- C** Select to set the enhanced mode with connecting USB device on/off.

When an iPhone is connected while this setting is set to "On", communication with devices connected to other USB ports may not be possible. Also, depending on the device, charging may not be possible.

- D** Select to reset all setup items.

Data use notification pop-up settings

The data use notification pop-up, which indicates that the system will use an internet connection, can be enabled/disabled.

- 1 Display the Toyota apps settings screen. (→P.413)
- 2 Select "Data Usage Message".
- 3 Change the setting as desired.



**Interior features****6****6-1. Using the air conditioning system and defogger**

Manual air conditioning system ..... 416

Automatic air conditioning system..... 421

Heated steering wheel/seat heaters ..... 426

**6-2. Using the interior lights**

Interior lights list ..... 428

**6-3. Using the storage features**

List of storage features ..... 430

Trunk features ..... 433

**6-4. Other interior features**

Other interior features . 434

Garage door opener.... 444

Manual air conditioning system\*

\*: If equipped

Air conditioning controls

The display and button positions will differ depending on the type of the system.

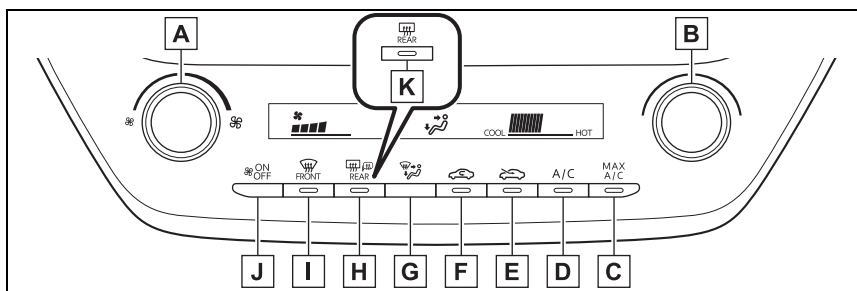

- A** Fan speed control switch
- B** Temperature control switch
- C** “MAX A/C” switch
- D** “A/C” switch
- E** Outside air mode switch
- F** Recirculated air mode switch
- G** Airflow mode control switch
- H** Rear window defogger and outside rear view mirror defoggers switch\*
- I** Windshield defogger switch
- J** On/off switch
- K** Rear window defogger switch\*



\*: If equipped

■ Adjusting the temperature setting

To adjust the temperature setting, turn the temperature control switch clockwise (warm) or counterclockwise (cool).

If “A/C” switch is not pressed, the system will blow ambient temperature air or heated air.

For quick cooling, press the “MAX A/C” switch. The air conditioning will automatically turn on and, if an

air outlet position  or  is selected, the system will be set to recirculated air mode. While "MAX A/C" is selected, it is not possible to turn off the air conditioning.

■ **Fan speed setting**

To adjust the fan speed, turn the fan speed control switch clockwise (increase) or counterclockwise (decrease).

Pressing the on/off switch to turns off the fan.

When the fan is off, pressing the on/off switch or turning the fan speed control switch clockwise will turn on the fan.

■ **Change the airflow mode**

Press the airflow mode control switch.

The airflow mode changes as follows each time the switch is pressed.

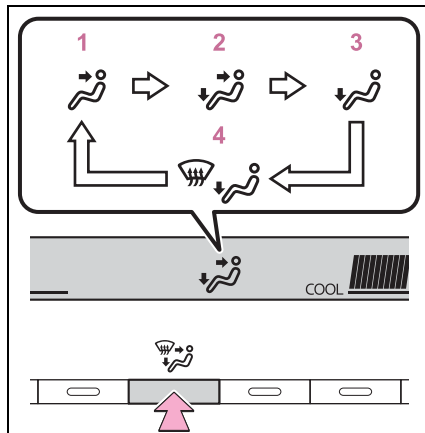

- 1 Upper body
- 2 Upper body and feet
- 3 Feet
- 4 Feet and the windshield

defogger operates

■ **Switching between outside air and recirculated air modes**

- To change to recirculated air mode, press the recirculated air mode switch.

The indicator illuminates on the recirculated air mode switch.

- To change to outside air mode, press the outside air mode switch.

The indicator illuminates on the outside air mode switch.

■ **Set cooling and dehumidification function**

Press the "A/C" switch.

When the function is on, the indicator illuminates on the "A/C" switch.

■ **Defogging the windshield**

Defoggers are used to defog the windshield and front side windows.

Press the windshield defogger switch.

Set the outside/recirculated air mode switch to outside air mode if the recirculated air mode is used.

To defog the windshield and the side windows quickly, turn the air flow and temperature up.

To return to the previous mode, press the windshield defogger switch again when the windshield is defogged.

When the windshield defogger switch is on, the indicator illuminates on the windshield defogger

switch.

■ **Defogging the rear window and outside rear view mirrors**

- ▶ Vehicles without outside rear view mirror defoggers

A defogger is used to defog the rear window.

Press the rear window defogger switch.

The defogger will automatically turn off after a while.

When the rear window defogger switch is on, the indicator illuminates on the rear window defogger switch.

- ▶ Vehicles with outside rear view mirror defoggers

Defoggers are used to defog the rear window, and to remove raindrops, dew and frost from the outside rear view mirrors.

Press the rear window and outside rear view mirror defoggers switch.

The defoggers will automatically turn off after a while.

When the rear window and outside rear view mirror defoggers switch is on, the indicator illuminates on the rear window and outside rear view mirror defoggers switch.

■ **Fogging up of the windows**

- The windows will easily fog up when the humidity in the vehicle is high. Turning “A/C” switch is on will dehumidify the air from the outlets and defog the windshield effectively.

- If you turn “A/C” switch is off, the windows may fog up more easily.

- The windows may fog up if the recirculated air mode is used.

■ **When driving on dusty roads**

Close all windows. If dust thrown up by the vehicle is still drawn into the vehicle after closing the windows, it is recommended that the air intake mode be set to outside air mode and the fan speed to any setting except off.

■ **Outside/recirculated air mode**

Setting to the recirculated air mode temporarily is recommended in preventing dirty air from entering the vehicle interior and helping to cool the vehicle when the outside air temperature is high.

■ **When the outside temperature falls to nearly 32°F (0°C)**

The dehumidification function may not operate even when “A/C” switch is pressed.

■ **Ventilation and air conditioning odors**

- To let fresh air in, set the air conditioning system to the outside air mode.

- During use, various odors from inside and outside the vehicle may enter into and accumulate in the air conditioning system. This may then cause odor to be emitted from the vents.

- It is recommended that the air conditioning system be set to outside air mode prior to turning the vehicle off.

- When parking, the system automatically switches to outside air mode to encourage better air circulation throughout the vehicle, helping to reduce odors that occur when starting the vehicle.

■ **Air conditioning filter**

→P.487

■ **Air conditioning system refrigerant**

- A label regarding the refrigerant of the air conditioning system is attached to the hood at the location shown in the following illustration.

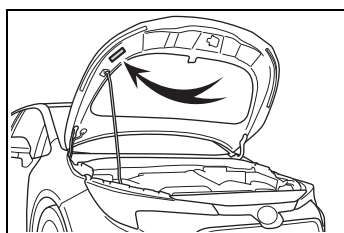

- The meaning of each symbol on the label are as follows:

	Caution
	Air conditioning system
	Air conditioning system lubricant type
	Requires registered technician to service air conditioning system
	Flammable refrigerant

**⚠ WARNING**

■ **To prevent the windshield from fogging up**

Do not use the windshield defogger switch during cool air operation in extremely humid weather. The difference between the temperature of the outside air and that of the windshield can cause the outer surface of the windshield to fog up, blocking your vision.

■ **When the outside rear view mirror defoggers are operating (vehicles with outside rear view mirror defoggers)**

Do not touch the outside rear view mirror surfaces, as they can become very hot and burn you.

**⚠ NOTICE**

■ **To prevent battery discharge**

Do not leave the air conditioning system on longer than necessary when the engine is off.

■ **When repairing/replacing parts of the air conditioning system**

Have repair/replacement performed by your Toyota dealer. When a part of the air conditioning system, such as the evaporator, is to be replaced, it must be replaced with a new one.

**Air outlet layout and operations**

■ **Location of air outlets**

The air outlets and air volume changes according to the selected air flow mode.

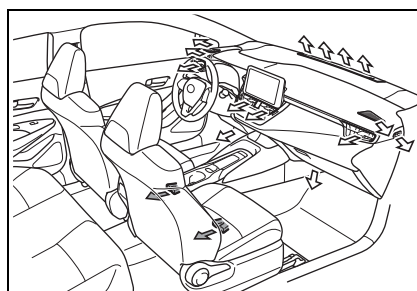

←: If equipped

■ **Adjusting the position of and opening and closing the air outlets**

► Front center

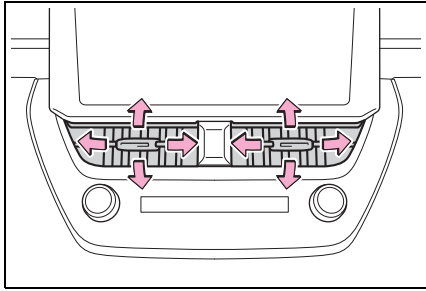

Direct air flow to the left or right, up or down

► Front right-hand side

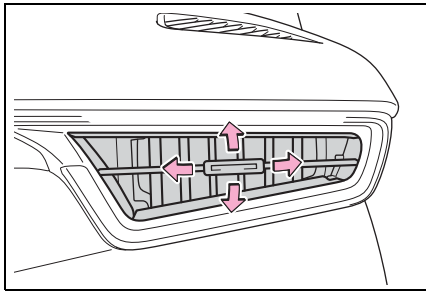

Direct air flow to the left or right, up or down

► Front left-hand side

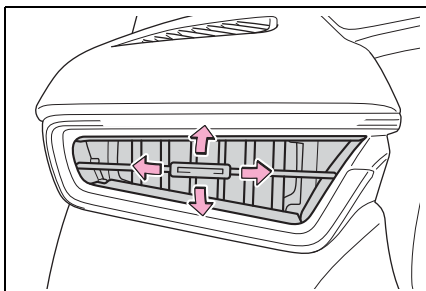

Direct air flow to the left or right, up or down

**⚠ WARNING**

■ **To prevent the windshield defogger from operating improperly**

Do not place anything on the instrument panel which may cover the air outlets. Otherwise, air flow may be obstructed, preventing the windshield defoggers from defogging.

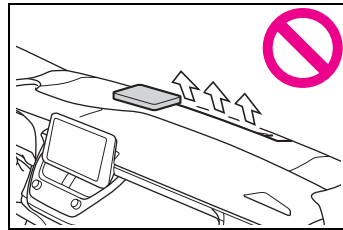



## Automatic air conditioning system\*

\*: If equipped

**Air outlets are automatically selected and fan speed is automatically adjusted according to the set temperature setting. Also, the display and button positions will differ depending on the type of the system.**

### Air conditioning controls

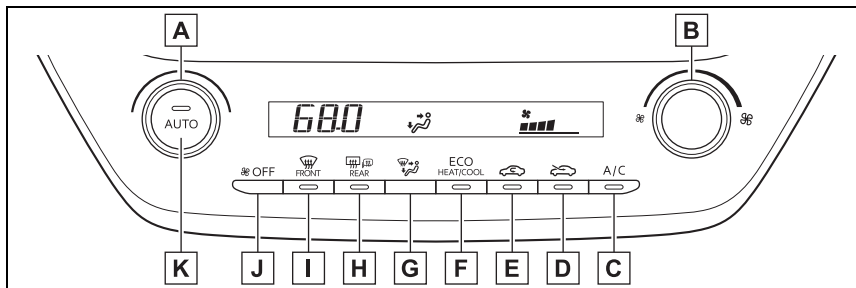

- A** Temperature control switch
- B** Fan speed control switch
- C** "A/C" switch
- D** Outside air mode switch
- E** Recirculated air mode switch
- F** Eco air conditioning mode switch
- G** Airflow mode control switch
- H** Rear window defogger and outside rear view mirror defoggers switch
- I** Windshield defogger switch
- J** Off switch
- K** Automatic mode switch

#### ■ Adjusting the temperature setting

To adjust the temperature setting, turn the temperature control switch clockwise (warm) or

counterclockwise (cool).

If "A/C" switch is not pressed, the system will blow ambient temperature air or heated air.

■ **Setting the fan speed**

To adjust the fan speed, turn the fan speed control switch clockwise (increase) or counterclockwise (decrease).

Pressing the off switch turns off the fan.

■ **Change the airflow mode**

Press the airflow mode control switch.

The airflow mode changes as follows each time the switch is pressed.

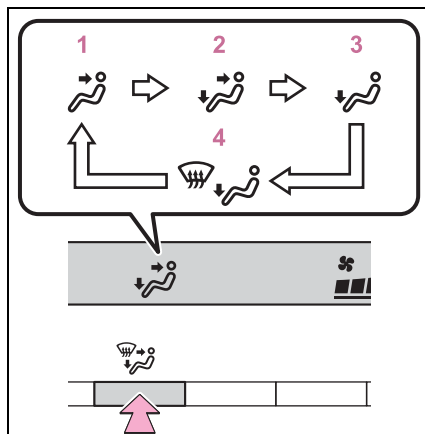

- 1 Upper body
- 2 Upper body and feet
- 3 Feet
- 4 Feet and the windshield defogger operates

■ **Switching between outside air and recirculated air modes**

- To change to recirculated air mode, press the recirculated air mode switch.

The indicator illuminates on the

recirculated air mode switch.

- To change to outside air mode, press the outside air mode switch.

The indicator illuminates on the outside air mode switch.

■ **Set cooling and dehumidification function**

Press the "A/C" switch.

When the function is on, the indicator illuminates on the "A/C" switch.

■ **Defogging the windshield**

Defoggers are used to defog the windshield and front side windows.

Press the windshield defogger switch.

Set the outside/recirculated air mode switch to outside air mode if the recirculated air mode is used. (It may switch automatically.)

To defog the windshield and the side windows quickly, turn the air flow and temperature up.

To return to the previous mode, press the windshield defogger switch again when the windshield is defogged.

When the windshield defogger switch is on, the indicator illuminates on the windshield defogger switch.

■ **Defogging the rear window and outside rear view mirrors**

Defoggers are used to defog the rear window, and to remove raindrops, dew and frost from

the outside rear view mirrors.

Press the rear window and outside rear view mirror defoggers switch.

The defoggers will automatically turn off after a while.

When the rear window and outside rear view mirror defoggers switch is on, the indicator illuminates on the rear window and outside rear view mirror defoggers switch.

#### ■ Eco air conditioning mode

The air conditioning is controlled with low fuel consumption prioritized such as reducing fan speed, etc.

Press the eco air conditioning mode switch.

When the eco air conditioning mode is on, the indicator illuminates on the eco air conditioning mode switch.

#### ■ When the outside temperature exceeds 75°F (24°C) and the air conditioning system is on

- In order to reduce the air conditioning power consumption, the air conditioning system may switch to recirculated air mode automatically. This may also reduce fuel consumption.
- Recirculated air mode is selected as a default mode when the engine switch is turned to ON.
- It is possible to switch to outside air mode at any time by pressing the outside air mode switch.

#### ■ Fogging up of the windows

- The windows will easily fog up when the humidity in the vehicle is high. Turning "A/C" on will dehumidify the air from the outlets and

defog the windshield effectively.

- If you turn "A/C" off, the windows may fog up more easily.
- The windows may fog up if the recirculated air mode is used.

#### ■ When driving on dusty roads

Close all windows. If dust thrown up by the vehicle is still drawn into the vehicle after closing the windows, it is recommended that the air intake mode be set to outside air mode and the fan speed to any setting except off.

#### ■ Outside/recirculated air mode

- Setting to the recirculated air mode temporarily is recommended in preventing dirty air from entering the vehicle interior and helping to cool the vehicle when the outside air temperature is high.
- Outside/recirculated air mode may automatically switch depending on the temperature setting or the inside temperature.

#### ■ When the outside temperature falls to nearly 32°F (0°C)

The dehumidification function may not operate even when "A/C" switch is pressed.

#### ■ Ventilation and air conditioning odors

- To let fresh air in, set the air conditioning system to the outside air mode.
- During use, various odors from inside and outside the vehicle may enter into and accumulate in the air conditioning system. This may then cause odor to be emitted from the vents.
- To reduce potential odors from occurring:
  - It is recommended that the air conditioning system be set to outside air mode prior to turning the vehicle off.
  - The start timing of the blower may

be delayed for a short period of time immediately after the air conditioning system is started in automatic mode.

- When parking, the system automatically switches to outside air mode to encourage better air circulation throughout the vehicle, helping to reduce odors that occur when starting the vehicle.

■ **Air conditioning filter**

→P.487

■ **Air conditioning system refrigerant**

- A label regarding the refrigerant of the air conditioning system is attached to the hood at the location shown in the following illustration.

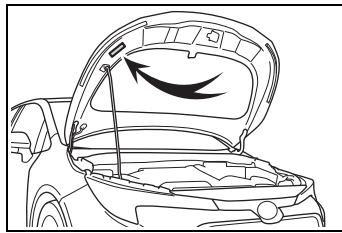

- The meaning of each symbol on the label are as follows:

	Caution
	Air conditioning system
	Air conditioning system lubricant type
	Requires registered technician to service air conditioning system
	Flammable refrigerant

■ **Customization**

Some functions can be customized. (→P.581)

**WARNING**

■ **To prevent the windshield from fogging up**

Do not use the windshield defogger switch during cool air operation in extremely humid weather. The difference between the temperature of the outside air and that of the windshield can cause the outer surface of the windshield to fog up, blocking your vision.

■ **When the outside rear view mirror defoggers are operating**

Do not touch the outside rear view mirror surfaces, as they can become very hot and burn you.

**NOTICE**

■ **To prevent battery discharge**

Do not leave the air conditioning system on longer than necessary when the engine is off.

■ **When repairing/replacing parts of the air conditioning system**

Have repair/replacement performed by your Toyota dealer. When a part of the air conditioning system, such as the evaporator, is to be replaced, it must be replaced with a new one.

**Using automatic mode**

- 1 Press the automatic mode switch.
- 2 Adjust the temperature setting.

- 3 To stop the operation, press the off switch.

If the fan speed setting or air flow modes are operated, the automatic mode indicator goes off. However, automatic mode for functions other than that operated is maintained.

**■ Using automatic mode**

Fan speed is adjusted automatically according to the temperature setting and the ambient conditions.

Therefore, the fan may stop for a while until warm or cool air is ready to flow immediately after the automatic mode switch pressed.

**Windshield wiper de-icer (if equipped)**

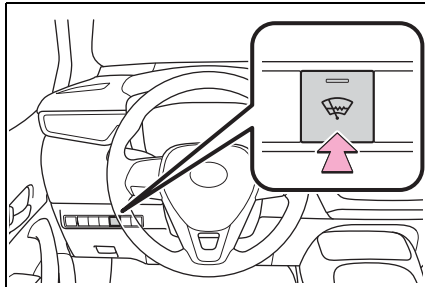

Prevent ice from building up on the windshield and wiper blades.

When the windshield wiper de-icer switch is on, the indicator illuminates on the windshield wiper de-icer switch.

The windshield wiper de-icer will automatically turn off after a period of time.

**! WARNING**

**■ To prevent burns**

Do not touch the glass at lower part of the windshield or to the side of the front pillars when the windshield wiper de-icer is on.

**Air outlet layout and operations**

**■ Location of air outlets**

The air outlets and air volume changes according to the selected air flow mode.

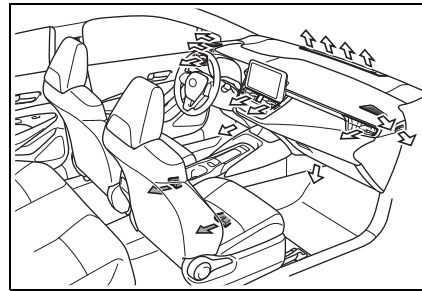

← :If equipped

**■ Adjusting the position of and opening and closing the air outlets**

- ▶ Front center

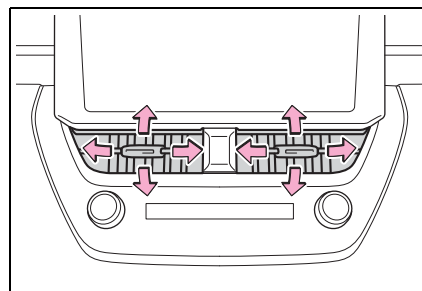

Direct air flow to the left or right, up or down

► Front right-hand side

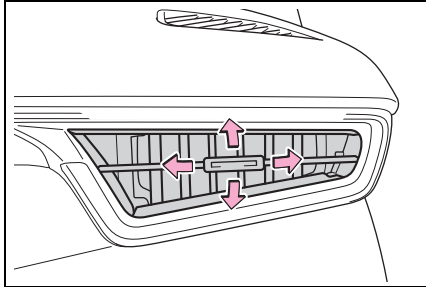

Direct air flow to the left or right, up or down

► Front left-hand side

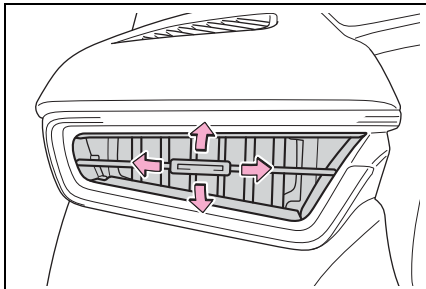

Direct air flow to the left or right, up or down

**⚠ WARNING**

■ **To prevent the windshield defogger from operating improperly**

Do not place anything on the instrument panel which may cover the air outlets. Otherwise, air flow may be obstructed, preventing the windshield defoggers from defogging.

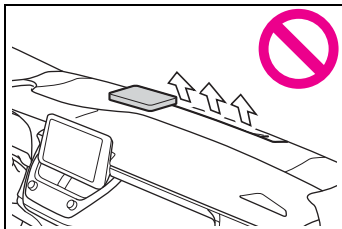

Heated steering wheel\* / seat heaters\*

\*: If equipped

● Heated steering wheel

Warms up the grip of the steering wheel

● Seat heaters

Warm up the seat upholstery

**⚠ WARNING**

■ **To prevent minor burn injuries**

Care should be taken if anyone in the following categories comes in contact with the steering wheel or seats when the heater is on:

- Babies, small children, the elderly, the sick and the physically challenged
- Persons with sensitive skin
- Persons who are fatigued
- Persons who have taken alcohol or drugs that induce sleep (sleeping drugs, cold remedies, etc.)

**⚠ NOTICE**

■ **To prevent damage to the seat heaters**

Do not put heavy objects that have an uneven surface on the seat and do not stick sharp objects (needles, nails, etc.) into the seat.

■ **To prevent battery discharge**

Do not use the functions when the engine is off.

**Operation instructions**

■ **Heated steering wheel**

Turns heated steering wheel on/off

When the heated steering wheel is on, the indicator illuminates on the heated steering wheel switch.

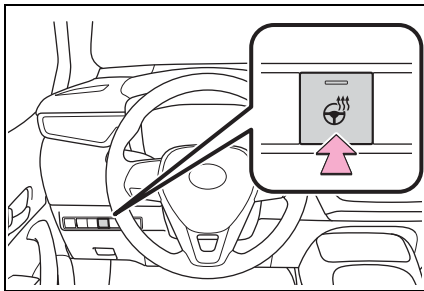

■ **Seat heaters**

► **Front**

Turns seat heaters on/off

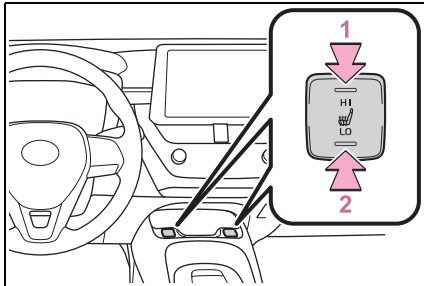

- 1 High temperature
- 2 Low temperature

When the seat heater is on, the indicator illuminates on the seat heater switch.

When not in use, put the switch in the neutral position. The indicator will turn off.

► **Rear**

Turns seat heaters on/off

When the seat heater is on, the indicator illuminates on the seat heater switch.

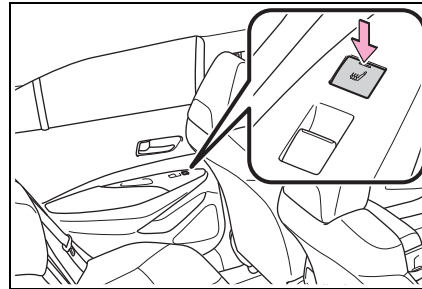

■ **The heated steering wheel and seat heaters can be used when**  
The engine switch is in ON.

**⚠ WARNING**

■ **To prevent overheating and minor burn injuries**

Observe the following precautions when using the seat heaters.

- Do not cover the seat with a blanket or cushion when using the seat heater.
- Do not use seat heater more than necessary.

## Interior lights list

### Location of the interior lights

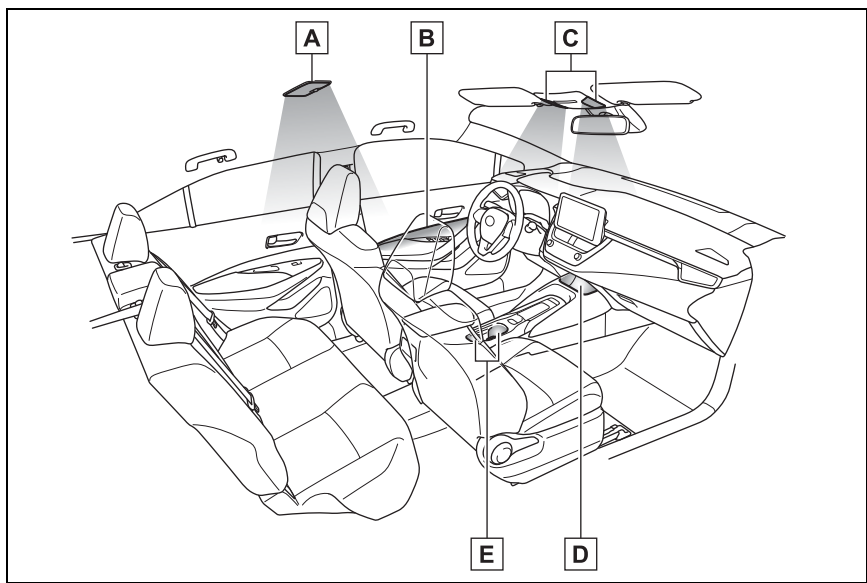

- A** Rear interior light (→P.429)
- B** Door trim lights (if equipped)
- C** Front interior/personal lights (→P.428)
- D** Center tray light (if equipped)
- E** Cup holder lights (if equipped)

### Operating the interior lights

#### ■ Front

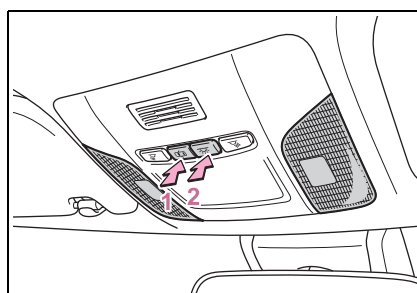

**1** Turns the door position on/off  
When a door is opened while the door position is on, the lights turn on.



2 Turns the lights on/off

■ Rear

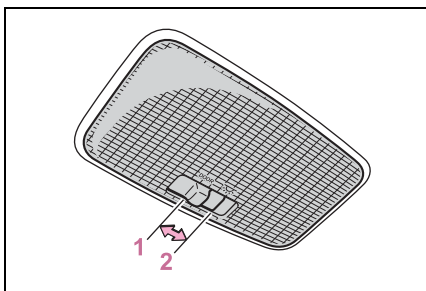

- 1 Turns the door position on  
The rear interior light turns on/off together the front interior lights. When a door is opened while the front and rear interior light door position is on, the lights turn on.
- 2 Turns the light on

**Operating the personal lights**

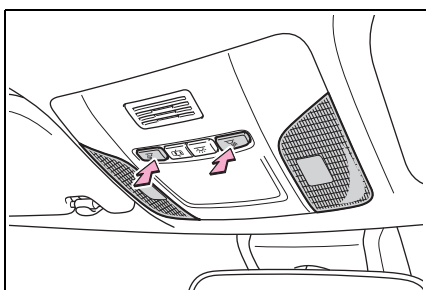

Turns the lights on/off

■ Illuminated entry system

The lights automatically turn on/off according to the engine switch mode (position), the presence of the electronic key (vehicles with a smart key system), whether the doors are locked/unlocked, and whether the doors are opened/closed.

■ To prevent the battery from being discharged

If the interior lights remain on when the engine switch is turned off, the lights will go off automatically after 20 minutes.

■ The interior lights may turn on automatically when

If any of the SRS airbags deploy (inflate) or in the event of a strong rear impact, the interior lights will turn on automatically. The interior lights will turn off automatically after approximately 20 minutes.

The interior lights can be turned off manually. However, in order to help prevent further collisions, it is recommended that they be left on until safety can be ensured. (The interior lights may not turn on automatically depending on the force of the impact and conditions of the collision.)

■ Customization

Some functions can be customized. (→P.581)

NOTICE

■ To prevent battery discharge

Do not leave the lights on longer than necessary when the engine is not running.

List of storage features

Location of the storage features

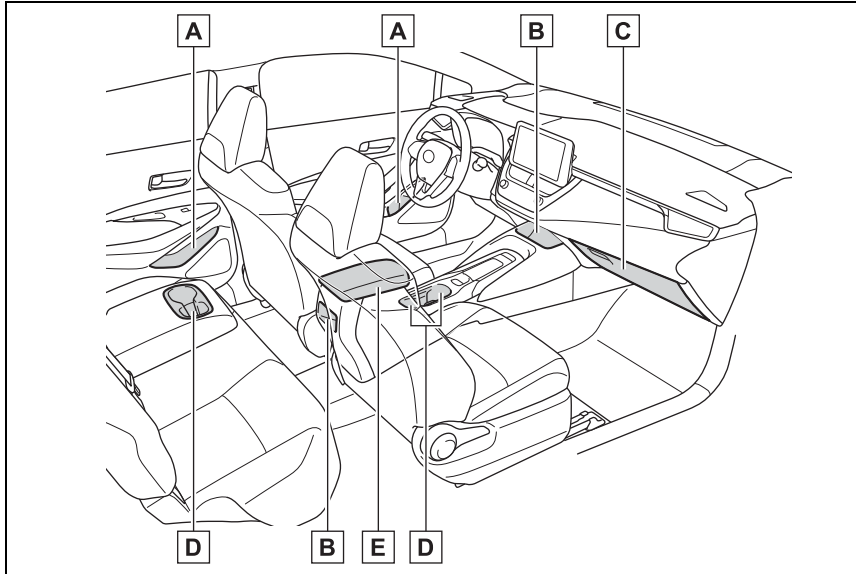

- A** Bottle holders/door pockets (→P.431)
- B** Open trays (if equipped) (→P.432)
- C** Glove box (→P.431)
- D** Cup holders (if equipped) (→P.431)
- E** Console box (→P.432)

**⚠ WARNING**

**■ Items that should not be left in the storage spaces**

Do not leave glasses, lighters or spray cans in the storage spaces, as this may cause the following when cabin temperature becomes high:

- Glasses may be deformed by heat or cracked if they come into contact with other stored items.

- Lighters or spray cans may explode. If they come into contact with other stored items, the lighter may catch fire or the spray can may release gas, causing a fire hazard.

**Glove box**

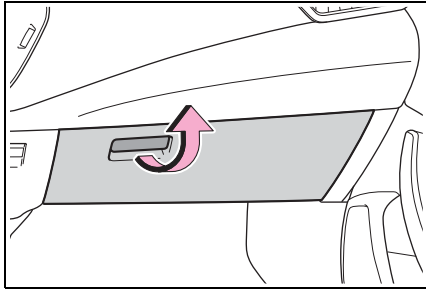

Pull up the lever to open the glove box.

**Glove box light (if equipped)**

The glove box light turns on when the tail lights are on.

**WARNING**

**Caution while driving**

Keep the glove box closed. In the event of sudden braking or sudden swerving, an accident may occur due to an occupant being struck by the open glove box or the items stored inside.

**Cup holders**

► Front

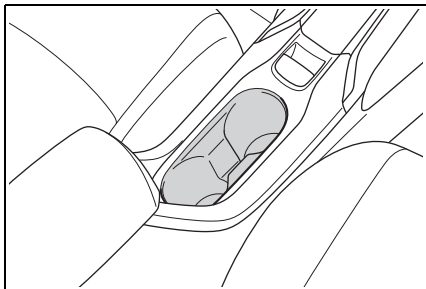

► Rear (if equipped)

Pull the armrest down.

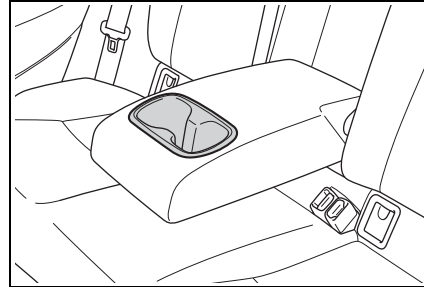

**WARNING**

**Items unsuitable for the cup holder**

Do not place anything other than cups or beverage cans in the cup holders.

Other items may be thrown out of the holders in the event of an accident or sudden braking and cause injury. If possible, cover hot drinks to prevent burns.

**Bottle holders**

► Front

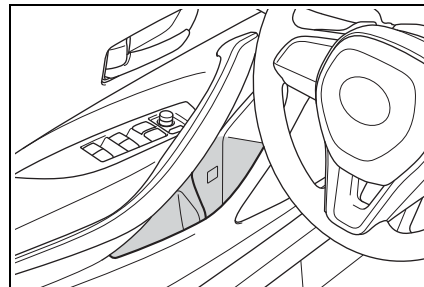

► Rear

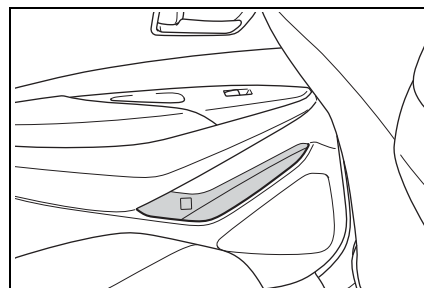

**■ Bottle holders**

- When storing a bottle, close the cap.
- The bottle may not be stored depending on its size or shape.

**⚠ WARNING**

**■ Items unsuitable for the bottle holders**

Do not place anything other than a bottle in the bottle holders. Other items may be thrown out of the holders in the event of an accident or sudden braking and cause injury.

**Console box**

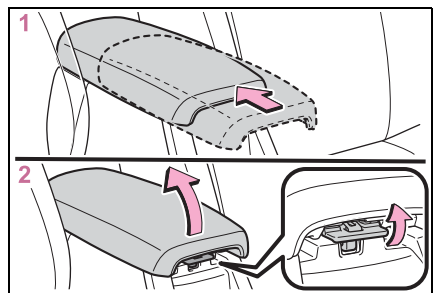

- 1 Slide the lid to the rear most position. (vehicles with a slide function)
- 2 Lift the lid while pulling up the knob.

**■ Slide function (if equipped)**

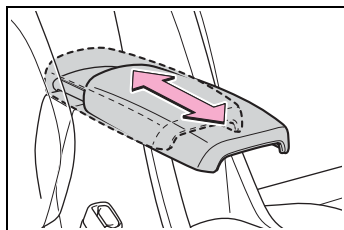

The console box lid can be slid for-

ward or backward.

**⚠ WARNING**

**■ Caution while driving**

Keep the console box closed. Injuries may result in the event of an accident or sudden braking.

**Open trays**

► Front (if equipped)

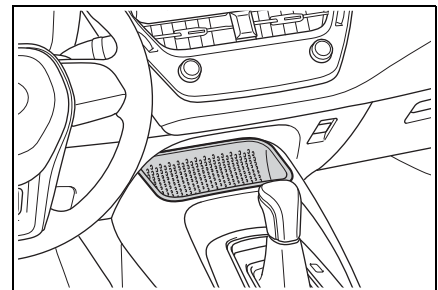

► Rear

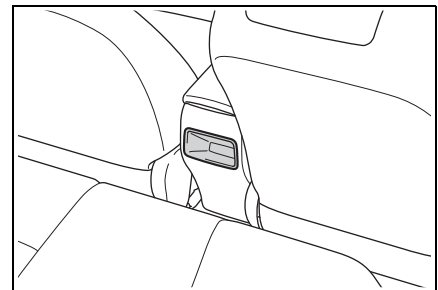

**⚠ WARNING**

**■ Caution while driving**

Observe the following precautions when putting items in the open tray. Failure to do so may cause items to be thrown out of the tray in the event of sudden braking or steering. In these cases, the items may interfere with pedal operation or cause driver distraction, resulting in an accident.

**⚠ WARNING**

- Do not store items in the tray that can easily shift or roll out.
- Do not stack items in the tray higher than the tray's edge.
- Do not put items in the tray that may protrude over the tray's edge.

**Trunk features**

**Auxiliary box**

Lift the deck mat.

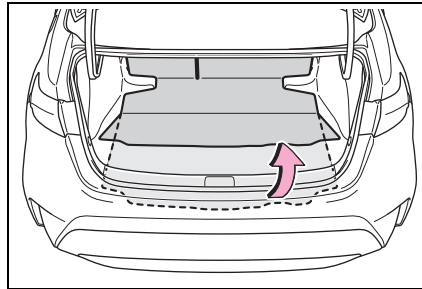

▶ Type A

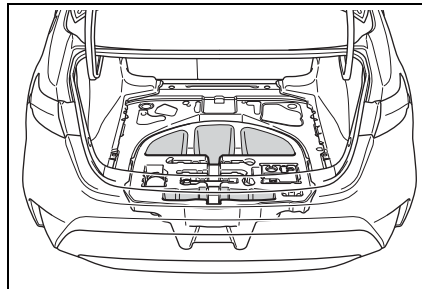

▶ Type B

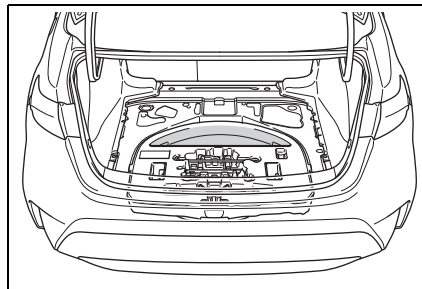

Other interior features

**USB charging port (if equipped)**

The USB charging port are used to supply 2.1 A of electricity at 5 V to external devices.

The USB charging port are for charging only. They are not designed for data transfer or other purposes.

Depending on the external device, it may not charge properly. Refer to the manual included with the device before using a USB charging port.

■ **Using the USB charging port**

Lift the lid while pulling up the knob.

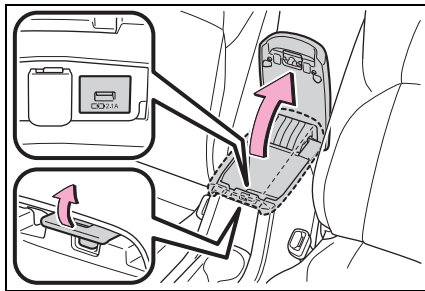

■ **The USB charging port can be used when**

The engine switch is in ACC or ON.

■ **Situations in which the USB charging port may not operate correctly**

- If a device which consumes more than 2.1 A at 5 V is connected
- If a device designed to communicate with a personal computer,

such as a USB memory device, is connected

- If the connected external device is turned off (depending on device)
- If the temperature inside the vehicle is high, such as after the vehicle has been parked in the sun

■ **About connected external device**

Depending on the connected external device, charging may occasionally be suspended and then start again. This is not a malfunction.

 NOTICE

■ **To prevent damage to the USB charging port**

- Do not insert foreign objects into the port.
- Do not spill water or other liquids into the port.
- Do not apply excessive force to or impact the USB charging port.
- Do not disassemble or modify the USB charging port.

■ **To prevent damage to external devices**

- Do not leave external devices in the vehicle. The temperature inside the vehicle may become high, resulting in damage to an external device.
- Do not push down on or apply unnecessary force to an external device or the cable of an external device while it is connected.

■ **To prevent battery discharge**

Do not use the USB charging port for a long period of time with the engine stopped.

**Power outlet**

The power outlet can be used for 12 V accessories that run on less than 10 A.

Lift the lid while pulling up the knob and open the power outlet lid.

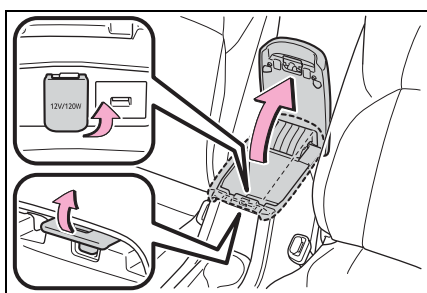

■ **The power outlet can be used when**

The engine switch is in ACC or ON.

■ **When turning the engine switch off**

Disconnect electrical devices with charging functions, such as mobile battery packs. If such devices are left connected, the engine switch may not be turned off normally.

 **NOTICE**

■ **To prevent the fuse from being blown**

Do not use an accessory that uses more than 12 V 10 A.

■ **To avoid damaging the power outlet**

Close the power outlet lid when the power outlet is not in use. Foreign objects or liquids that enter the power outlet may cause a short circuit.

■ **To prevent the battery from being discharged**

Do not use the power outlet longer than necessary when the engine is not running.

**Wireless charger (if equipped)**

A portable device, such as a smartphone or mobile battery, can be charged by just placing it on the charging area, provided the device is compatible with the Qi wireless charging standard created by the Wireless Power Consortium.

The wireless charger cannot be used with a portable device that is larger than the charging area. Additionally, depending on the portable device, the wireless charger may not operate properly. Refer to the operation manual of the portable device.

■ **The “Qi” symbol**

The “Qi” symbol is a trademark of the Wireless Power Consortium.



■ Name for all parts

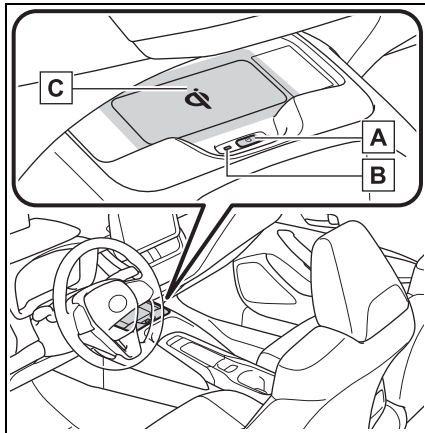

- A Power supply switch
- B Operation indicator light
- C Charge area

■ Using the wireless charger

- 1 Press the power supply switch of the wireless charger.

Pressing the switch again turns the wireless charger off. When turned on, the operation indicator light (green) comes on. When the engine switch is turned off, the on/off state of the wireless charger will be memorized.

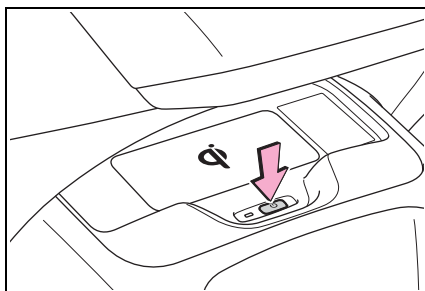

- 2 Place a portable device on the charging area with its charging surface facing down.

While charging, the operation indicator light (orange) will be illuminated.

If charging does not begin, move the portable device as close to the center of the charging area as possible.

When charging is complete, the operation indicator light (green) will illuminate.

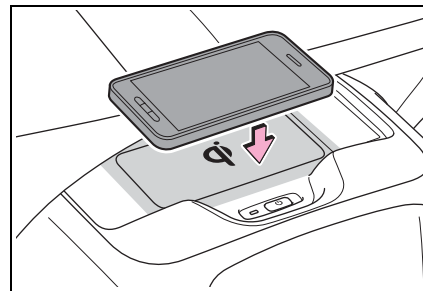

■ Recharging function

- If a certain amount of time has elapsed since charging completed and the portable device has not been moved, the wireless charger will restart charging.
- If the portable device is moved within the charging area, charging will stop temporarily then restart.



### ■ Operation indicator light status

Operation indicator light	State
Off	The Wireless charger is off
Green (illuminated)	Standby (charging is possible)
	Charging is complete*
Orange (illuminated)	A portable device has been placed on the charging area (identifying the portable device)
	Charging in progress

\*: Depending on the portable device, the operation indicator light may stay illuminated (orange) after charging has completed.

#### ● If the operation indicator light blinks

If an error is detected, the operation indicator light will blink (orange). Take the appropriate measures according to the table below.

Operation indicator light	Suspected cause	Measure
Blinks (orange) at a one second interval continuously	Vehicle to charger communication failure.	Contact your Toyota dealer.
Blinks (orange) 3 times repeatedly	A foreign object exists between the portable device and charging area.	Remove the foreign object.
	Portable device is not positioned properly on the charging area.	Move the portable device toward the center of the charging area.
Blinks (orange) 4 times repeatedly	The temperature of the wireless charger is excessively high.	Stop charging immediately and continue charging after a while.

#### ■ The wireless charger can be operated when

The engine switch is in ACC or ON.

#### ■ Portable devices that can be charged

- Portable devices compatible with the Qi wireless charging standard can be charged by the wireless

charger. However, compatibility with all devices which meet the Qi wireless charging standard is not guaranteed.

- The wireless charger is designed to supply low power electricity (5 W or less) to a cellular phone, smartphone, or other portable device.

■ **If a cover or accessory is attached to the portable device**

Do not charge a portable device if a cover or accessory which is not Qi compatible is attached. Depending on the type of cover and/or accessory attached, it may not be possible to charge the portable device. If the portable device is placed on the charging area and does not charge, remove the cover and/or accessories.

■ **If interference is heard in AM radio broadcasts while charging**

Turn off the wireless charger and check if the noise is reduced. If noise is reduced, press and hold the power supply switch of the wireless charger for 2 seconds. The frequency of the wireless charger is changed and noise may be reduced. When the frequency is changed, the operation indicator light will blink (orange) 2 times.

■ **Charging precautions**

- If the electronic key cannot be detected in the cabin, charging cannot be performed. When a door is opened and closed, charging may be temporarily suspended.
- While charging, the wireless charger and the portable device will become warm. This is not a malfunction. If a portable device becomes warm while charging and charging stops due to the protection function of the portable device, wait until the portable device cools down and charge it again.

■ **Sound generated during operation**

When the power supply switch is turned on or while a portable device is being identified, operation sounds may be heard. This is not a malfunction.

■ **Cleaning the wireless charger**

→P.455

■ **Certification for the wireless charger**

FCC Provided Information:

This equipment has been tested and found to comply with Part 18 of the FCC Rules. These limits are designed to provide reasonable protection against harmful interference in a residential installation. Any changes or modifications not expressly approved by the party responsible for compliance could void the user's authority to operate this equipment.

This device complies with Part 18 of the FCC Rules. Operation is subject to the following two conditions:

- (1) This device may not cause harmful interference, and (2) this device must accept any interference received, including interference that may cause undesired operation.

Declaration of Conformity

Trade Name: Panasonic  
 Model Numbers: AT1701 contains CA-QS03J1AJ  
 Responsible Party: Panasonic Corporation of North America  
 Two Riverfront Plaza, Newark, NJ 07102-5490  
 Support Contact: <http://www.panasonic.com/support/>



PRODUCT SAFETY AND COMPLIANCE DEPARTMENT . PANASONIC CORPORATION OF NORTH AMERICA . TWO RIVERFRONT PLAZA, 8<sup>TH</sup> FLOOR, NEWARK, NJ 07102-5480

### FCC Declaration of Conformity Summary

Product Name	In-Vehicle Wireless Charger	
Model Number	AT1701	
Brand Name	Panasonic	
Size and Mass	• 245mm (w), 136mm (l) and 48mm (h) and mass is 515grams	
Purpose Updated DoC	Added similarity variant model / AT1701 contains CA-QS03J1AJ	
Compliance Information	<ul style="list-style-type: none"> <li>• 47 CFR, FCC Part 18, Subpart C for ISM Equipment</li> <li>• FCC's KDB 680106 D01 RF Exposure Wireless Charging Apps v02</li> <li>• Industry Canada RSS-216, Issue 1, dated August 2014</li> </ul> For Wireless Power Transfer Devices (Wireless Chargers)	
Responsible Applicant	Panasonic Corporation Automotive & Industrial Systems Company Automotive Infotainment Systems Business Division 4261, Ikonobe-cho, Tsuzuki-ku, Yokohama-shi, 224-8520, Japan	
Responsible Factories	<ul style="list-style-type: none"> <li>• Panasonic Corporation, Automotive &amp; Industrial Systems Company                              Automotive Infotainment / Systems Business Division                              Global Manufacturing Innovation Center, Matsumoto Factory                              5652 Sasaga, Matsumoto city, Nagano 399-8730, Japan</li> <li>• Panasonic Automotive Systems Czech, s.r.o.                              U Panonicu 266, 530 06 Pardubice-Stare Cvice, Czech Republic</li> <li>• Panasonic Automotive Systems Asia Pacific (Thailand) Co.,Ltd.                              101 Moo 2 Teparak Road, T.Bangsaothong Ging A.Bangsaothong                              Samutprakam 10540 Thailand</li> <li>• Panasonic Automotive Systems Dalian Co., Ltd.                              No.300, HongGang Road, GanJingZi District, Dalian,                              Liaoning Province, 116033 China</li> </ul>	
Responsible Sales Company	Panasonic Consumer Electronics Company Division of Panasonic Corporation of North America Two Riverfront Plaza, Newark, NJ 07102-5490 General Contact: <a href="http://shop.panasonic.com/support">http://shop.panasonic.com/support</a>	
Special Conditions For Compliance	In-Vehicle Wireless Charger will be installed and used exclusively within transportation vehicle and as such, it is exempt from the following requirements: (1) Part 15 digital device technical rules in accordance with §15.103(a); and (2) §15.105(b) full text information to user to appear in User Manual in accordance with §18.213.	
EMI Test Report	TCB	UL Japan
	Test Report	10120384-R2
	Model Tested	AT1701 contains CA-QS03J1AJ
	Date Issued	12/14/2015
	Methodology	FCC-OET MP-4



PRODUCT SAFETY AND COMPLIANCE DEPARTMENT . PANASONIC CORPORATION OF NORTH AMERICA . TWO RIVERFRONT PLAZA, 8<sup>TH</sup> FLOOR, NEWARK, NJ 07102-5480

6

Interior features



PRODUCT SAFETY AND COMPLIANCE DEPARTMENT . PANASONIC CORPORATION OF NORTH AMERICA . TWO RIVERFRONT PLAZA, 8<sup>TH</sup> FLOOR, NEWARK, NJ 07102-6480

**FCC Declaration of Conformity**

**Summary**

RF Exposure Evaluation	TCB	UL Japan
	MPE Test Report	10197157S-E-R1
	Model Tested	AT1701 contains CA-QS03J1AJ
	Date Issued	12/14/2015
	Methodology	KDB 680106 D01 RF Exposure Wireless Charging Apps v02
Importation	The subject In-Vehicle Wireless Charger can be imported on behalf of Panasonic affiliated sales companies by PNA's Logistics Import Customs, or their authored brokers, by electrically filing FCC Form 740 while declaring Box 2 with no reference to any FCC ID.	

This DoC is granted for the subject In-Vehicle Wireless Charger on the basis of the manufacturer's attested compliance with the above described conditions and in accordance with FCC Part 18 and FCC's KDB 0680106 D01 RF Exposure Wireless Charging Apps v02.

Certificate Number: DoC 2014-008C  
 Applicant Ref No.: PAS-16-F001

*Richard Mullen*  
 Issued by: Richard Mullen  
 Issue Date: January 14, 2016

PRODUCT SAFETY AND COMPLIANCE DEPARTMENT . PANASONIC CORPORATION OF NORTH AMERICA . TWO RIVERFRONT PLAZA, 8<sup>TH</sup> FLOOR, NEWARK, NJ 07102-6480

**⚠ WARNING****■ Caution while driving**

When charging a portable device while driving, for safety reasons, the driver should not operate the portable device.

**■ Caution regarding interference with electronic devices**

People with implantable cardiac pacemakers, cardiac resynchronization therapy pacemakers or implantable cardioverter defibrillators, as well as any other electrical medical device, should consult their physician about the usage of the wireless charger.

Operations of the wireless charger may have an affect on medical devices.

**■ To prevent damage or burns**

Observe the following precautions.

Failure to do so may result in the possibility of fire, equipment failure or damage, or burns due to heat.

- Do not put any metallic objects between the charging area and the portable device while charging.
- Do not attach metallic objects, such as aluminum stickers, to the charging area.
- Do not cover the wireless charger with a cloth or other object while charging.
- Do not attempt to charge portable devices which are not compatible with the Qi wireless charging standard.
- Do not disassemble, modify or remove the wireless charger.
- Do not apply force or impact to the wireless charger.

**⚠ NOTICE****■ Conditions in which the wireless charger may not operate correctly**

In the following situations, the wireless charger may not operate correctly:

- When a portable device is fully charged
- When there is a foreign object between the charging area and portable device
- When a portable device becomes hot while charging
- When a portable device is placed on the wireless area with its charging surface facing up
- When a portable device is not centered on the charging area
- When the vehicle is near a TV tower, electric power plant, gas station, radio station, large display, airport or other facility that generates strong radio waves or electrical noise
- When the portable device is in contact with, or is covered by any of the following metallic objects:
  - Cards to which aluminum foil is attached
  - Cigarette boxes that have aluminum foil inside
  - Metallic wallets or bags
  - Coins
  - Metal hand warmers
  - Media such as CDs and DVDs

 NOTICE

- When wireless keys (that emit radio waves) other than those of your vehicle are being used nearby.

If in situations other than above the wireless charger does not operate properly or the operation indicator light is blinking, the wireless charger may be malfunctioning. Contact your Toyota dealer.

■ **To prevent failure or damage to data**

- Do not bring magnetic cards, such as a credit card, or magnetic recording media, close to the wireless charger while charging. Otherwise, data may be erased due to the influence of magnetism.

Additionally, do not bring precision instruments such as wrist watches, close to the wireless charger, as such objects may malfunction.

- Do not leave portable devices in the cabin. The temperature inside the cabin may become high when parked in the sun, and cause damage to the device.

■ **To prevent battery discharge**

Do not use the wireless charger for a long period of time with the engine stopped.

**Sun visors**

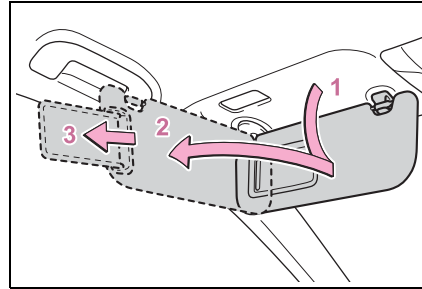

- 1 To set the visor in the forward position, flip it down.
- 2 To set the visor in the side position, flip down, unhook, and swing it to the side.
- 3 To use the side extender, place the visor in the side position, then slide it backward. (if equipped)

**Vanity mirrors**

Slide the cover to open.

The vanity light turns on. (if equipped)

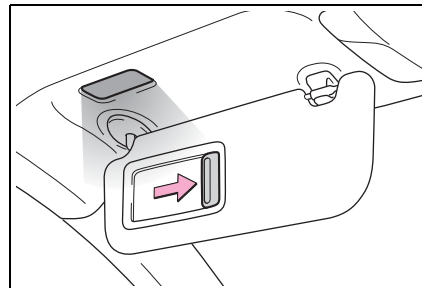

■ **To prevent battery discharge (vehicles with vanity lights)**

If the vanity lights remain on when the engine switch is OFF, the lights will go off automatically after 20 minutes.

**NOTICE**

■ **To prevent the battery from being discharged (vehicles with vanity lights)**

Do not leave the vanity lights on for extended periods while the engine is stopped.

**Armrest (if equipped)**

Fold down the armrest for use.

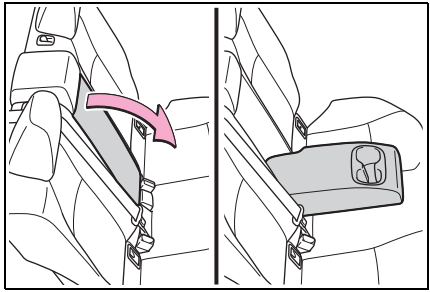

**NOTICE**

■ **To prevent damage to the armrest**

Do not apply too much load on the armrest.

**Assist grips**

An assist grip installed on the ceiling can be used to support your body while sitting on the seat.

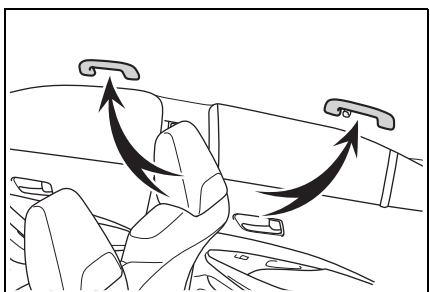

**WARNING**

■ **Assist grip**

Do not use the assist grip when getting in or out of the vehicle or rising from your seat.

**NOTICE**

■ **To prevent damage to the assist grip**

Do not hang any heavy object or put a heavy load on the assist grip.

**Coat hooks**

The coat hooks are provided with the rear assist grips.

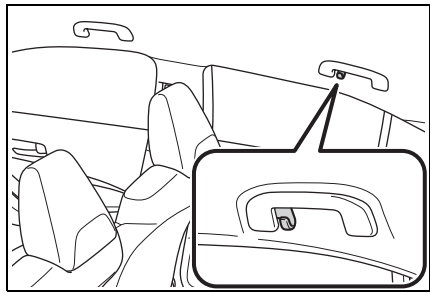

**WARNING**

■ **Items that cannot be hung on the coat hook**

Do not hang coat hangers or other hard or sharp objects on the hook. If the SRS curtain shield airbags deploy, these items may become projectiles, causing death or serious injury.



**Garage door opener\***

\*: If equipped

The garage door opener can be programmed using the HomeLink® to operate garage doors, gates, entry doors, door locks, home lighting systems, security systems, and other devices.

**System components**

The HomeLink® wireless control system in your vehicle has 3 buttons which can be programmed to operate 3 different devices. Refer to the programming methods on the following pages to determine the method which is appropriate for the device.

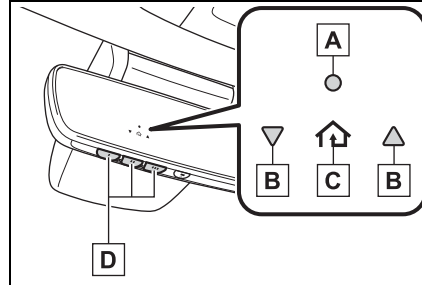

- A HomeLink® indicator light
- B Garage door operation indicators

- C HomeLink® icon

Illuminates while HomeLink® is operating.

- D Buttons

**Codes stored in the HomeLink® memory**

- The registered codes are not erased even if the battery cable is disconnected.
- If learning failed when registering a different code to a HomeLink® button that already has a code registered to it, the already registered code will not be erased.

**Certification for the garage door opener**

- ▶ Except for vehicles sold in Canada

This device complies with FCC rules part 15 and Innovation, Science, and Economic Development Canada RSS-210. Operation is subject to the following two conditions: (1) This device may not cause harmful interference, and (2) This device must accept any interference that may be received including interference that may cause undesired operation. WARNING: The transmitter has been tested and complies with FCC and ISED rules. Changes or modifications not expressly approved by the party responsible for compliance could void the user's authority to operate the device.

This equipment complies with FCC and ISED radiation exposure limits set forth for an uncontrolled environment. End Users must follow the specific operating instructions for satisfying RF exposure compliance. This transmitter must be at least 20 cm from the user and must not be co-located or operating in conjunction with any other antenna or transmitter.



► For vehicles sold in Canada

This device complies with FCC rules part 15 and Innovation, Science, and Economic Development Canada RSS-210. Operation is subject to the following two conditions: (1) This device may not cause harmful interference, and (2) This device must accept any interference that may be received including interference that may cause undesired operation. **WARNING:** The transmitter has been tested and complies with FCC and ISDE rules. Changes or modifications not expressly approved by the party responsible for compliance could void the user's authority to operate the device.

This equipment complies with FCC and ISDE radiation exposure limits set forth for an uncontrolled environment. End Users must follow the specific operating instructions for satisfying RF exposure compliance. This transmitter must be at least 20 cm from the user and must not be co-located or operating in conjunction with any other antenna or transmitter.

Cet appareil est conforme aux règlements de la FCC, section 15, et au CNR-210 d'Innovation, Sciences et Développement économique Canada. Le fonctionnement est assujéti aux deux conditions suivantes : (1) cet appareil ne doit pas causer d'interférences nuisibles et (2) cet appareil doit accepter toute interférence reçue, y compris celle qui pourrait entraîner un dysfonctionnement. **MISE EN GARDE :** L'émetteur a subi des tests et est conforme aux règlements de la FCC et d'ISDE. Les changements ou modifications non approuvés explicitement par la partie responsable de la conformité pourraient rendre caduque l'autorisation de l'utilisateur de se servir du dispositif.

Cet appareil est conforme aux limites d'exposition aux radiations de la FCC et d'ISDE établies pour un environnement non contrôlé. Les utilisateurs finaux doivent respecter les instructions d'utilisation spécifiques pour satisfaire aux exigences de conformité aux expositions de RF. L'émetteur doit se trouver à 20 cm au minimum de l'utilisateur et ne doit pas être situé au même endroit que tout autre émetteur ou antenne ni fonctionner avec un autre émetteur ou antenne.

■ **When support is necessary**

Visit on the web at [www.homelink.com/toyota](http://www.homelink.com/toyota) or call 1-800-355-3515.

■ **When operating or programming HomeLink®**

Never allow a child to operate or play with the HomeLink® buttons.

**⚠ WARNING**

■ **When programming a garage door or other remote control device**

The garage door or other device may operate, so ensure people and objects are out of danger to prevent potential harm.

■ **Conforming to federal safety standards**

Do not use the HomeLink® compatible transceiver with any garage door opener or device that lacks safety stop and reverse features as required by federal safety standards.

This includes any garage door that cannot detect an interfering object. A door or device without these features increases the risk of death or serious injury.

**Programming the Home-Link®**

■ **Before programming Home-Link®**

- During programming, it is possible that garage doors, gates, or other devices may operate. For this reason, make sure that people and objects are clear of the garage door or other devices to prevent injury or other potential harm.
- It is recommended that a new battery be placed in the remote control transmitter for more accurate programming.

- Garage door opener motors manufactured after 1995 may be equipped with rolling code protection. If this is the case, you may need a stepladder or other sturdy, safe device to reach the “Learn” or “Smart” button on the garage door opener motor.

■ **Programming HomeLink®**

Steps 1 through 3 must be performed within 60 seconds, otherwise the indicator light will stop flashing and programming will not be able to be completed.

- 1 Press and release the HomeLink® button you want to program and check that the HomeLink® indicator light flashes (orange).
- 2 Point the remote control transmitter for the device at the rear view mirror, 1 to 3 in. (25 to 75 mm) from the HomeLink® buttons.

Keep the HomeLink® indicator light in view while programming.

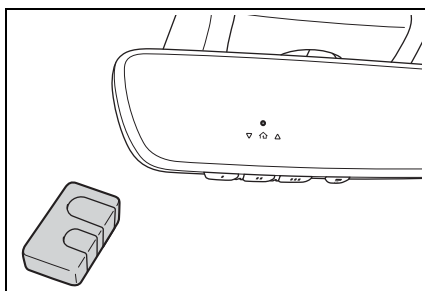

- 3 Program a device.

- ▶ Programming a device other than an entry gate (for U.S.A. owners)

Press and hold the handheld transmitter button until the HomeLink® indicator light changes from slowly flashing orange to rapidly flashing green (rolling code) or continuously lit green (fixed code), then release the button.

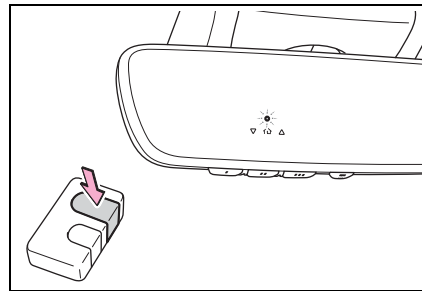

- ▶ Programming an entry gate (for U.S.A. owners)/Programming a device in the Canadian market

Press and release the remote control transmitter button at 2 second intervals, repeatedly, until the HomeLink® indicator light changes from slowly flashing (orange) to rapidly flashing (green) (rolling code) or continuously lit (green) (fixed code).

- 4 Test the HomeLink® operation by pressing the newly programmed button and observing the indicator light:

- Indicator light illuminates: Programming of a fixed code device has completed. The

garage door or other device should operate when a HomeLink<sup>®</sup> button is pressed and released.

- Indicator light flashes rapidly: The garage door opener motor or other device is equipped with a rolling code. To complete programming, firmly press and hold the HomeLink<sup>®</sup> button for 2 seconds then release it.
  - If the garage door or other device does not operate, proceed to “Programming a rolling code system”.
- 5 Repeat the steps above to program another device for any of the remaining HomeLink<sup>®</sup> buttons.

■ **Programming a rolling code system**

2 or more people may be necessary to complete rolling code programming.

- 1 Locate the “Learn” or “Smart” button on the garage door opener motor in the garage.

This button can usually be found where the hanging antenna wire is attached to the unit. The name and color of the button may vary by manufacturer. Refer to the owner’s manual supplied with the garage

door opener motor for details.

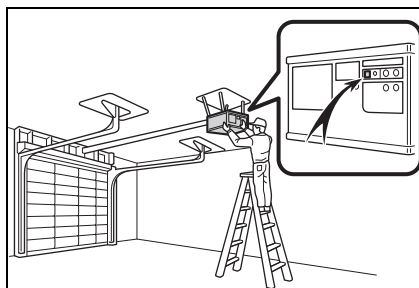

- 2 Press and release the “Learn” or “Smart” button.

Perform 3 within 30 seconds after performing 2.

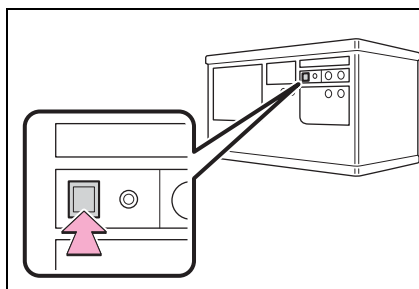

- 3 Press and hold the desired HomeLink<sup>®</sup> button (inside the vehicle) for 2 seconds and release it. Repeat this sequence (press/hold/release) up to 3 times to complete programming.

If the garage door opener motor operates when the HomeLink<sup>®</sup> button is pressed, the garage door

opener motor recognizes the HomeLink® signal.

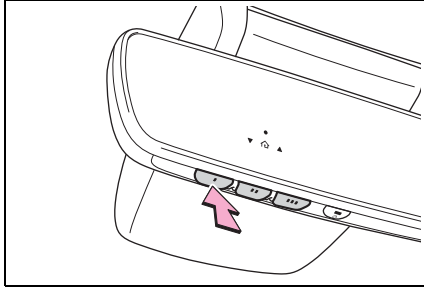

■ **Enabling 2-way communication with a garage door (only available for compatible devices)**

When enabled, 2-way communication allows you to check the status of the opening and closing of a garage door through indicators in your vehicle.

2-way communication is only available if the garage door opener motor used is a compatible device. (To check device compatibility, refer to [www.homelink.com](http://www.homelink.com).)

- 1 Within 5 seconds after programming the garage door opener has been completed, if the garage door opener motor is trained to HomeLink®, both garage door operation indicators will flash rapidly (green) and the light on the garage door opener motor will blink twice, indicating that 2-way communication is enabled.

If the indicators do not flash, per-

form 2 and 3 within the first 10 presses of the HomeLink® button after programming has been completed.

- 2 Press a programmed HomeLink® button to operate a garage door.
- 3 Within 1 minute of pressing the HomeLink® button, after the garage door operation has stopped, press the “Learn” or “Smart” button on the garage door opener motor. Within 5 seconds of the establishment of 2-way communication with the garage door opener, both garage door operation indicators in the vehicle will flash rapidly (green) and the light on the garage door opener motor will blink twice, indicating that 2-way communication is enabled.

■ **Reprogramming a single HomeLink® button**

When the following procedure is performed, buttons which already have devices registered to them can be overwritten:

- 1 With one hand, press and hold the desired HomeLink® button.
- 2 When the HomeLink® indicator starts flashing (orange), continue to hold the HomeLink® button and perform “Programming HomeLink®” 1

(it takes 20 seconds for the HomeLink<sup>®</sup> indicator to start flashing).

**■ Before programming**

- Install a new battery in the transmitter.
- The battery side of the transmitter must be pointed away from the HomeLink<sup>®</sup>.

**Operating HomeLink<sup>®</sup>**

Press the appropriate HomeLink<sup>®</sup> button. The HomeLink<sup>®</sup> indicator light should turn on.

The status of the opening and closing of a garage door is shown by the indicators.

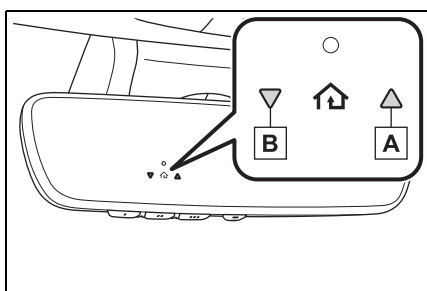





**A** Opening

**B** Closing

This function is only available if the garage door opener motor used is a compatible device. (To check device compatibility, refer to [www.homelink.com](http://www.homelink.com).)

Color	Status
Orange (flashing)	Currently opening/closing
Green	Opening/closing has completed
Red (flashing)	Feedback signals cannot be received

The indicators can operate within approximately 820 ft. (250 m) of the garage door. However, if there are obstructions between the garage door and the vehicle, such as houses and trees, feedback signals from the garage door may not be received.

To recall the previous door operation status, press and release either HomeLink<sup>®</sup> buttons  and  or  and  simultaneously. The last recorded status will be displayed for 3 seconds.

**Erasing the entire HomeLink<sup>®</sup> memory (all three codes)**

Press and hold the 2 outside buttons for 10 seconds until the HomeLink<sup>®</sup> indicator light changes from continuously lit (orange) to rapidly flashing (green).

If you sell your vehicle, be sure to erase the programs stored in the

HomeLink® memory.

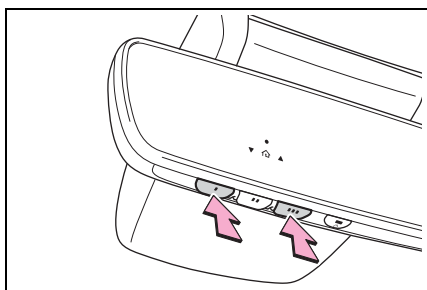

**Maintenance and care****7****7-1. Maintenance and care**

Cleaning and protecting the  
vehicle exterior ..... 452

Cleaning and protecting the  
vehicle interior ..... 454

**7-2. Maintenance**

Maintenance requirements  
..... 457

General maintenance.. 458

Emission inspection and  
maintenance (I/M) pro-  
grams ..... 461

**7-3. Do-it-yourself mainte-  
nance**

Do-it-yourself service pre-  
cautions..... 462

Hood ..... 464

Positioning a floor jack  
..... 465

Engine compartment... 466

Tires ..... 475

Tire inflation pressure.. 484

Wheels ..... 486

Air conditioning filter.... 487

Wireless remote con-  
trol/electronic key battery  
..... 489

Checking and replacing  
fuses..... 492

Light bulbs..... 495

## Cleaning and protecting the vehicle exterior

**Perform cleaning in a manner appropriate to each component and its material.**

### Cleaning instructions

- Working from top to bottom, liberally apply water to the vehicle body, wheel wells and underside of the vehicle to remove any dirt and dust.
- Wash the vehicle body using a sponge or soft cloth, such as a chamois.
- For hard-to-remove marks, use car wash soap and rinse thoroughly with water.
- Wipe away any water.
- Wax the vehicle when the waterproof coating deteriorates.

If water does not bead on a clean surface, apply wax when the vehicle body is cool.

#### ■ Automatic car washes

- Fold the mirrors before washing the vehicle. Start washing from the front of the vehicle. Make sure to extend the mirrors before driving.
- Brushes used in automatic car washes may scratch the vehicle surface, parts (wheel, etc.) and harm your vehicle's paint.
- Vehicles with a rear spoiler: In certain automatic car washes, the

rear spoiler may interfere with machine operation. This may prevent the vehicle from being cleaned properly or result in damage to the rear spoiler.

#### ■ High pressure car washes

As water may enter the cabin, do not bring the nozzle tip near the gaps around the doors or perimeter of the windows, or spray these areas continuously.

#### ■ When using a car wash (vehicles with a smart key system)

If the door handle becomes wet while the electronic key is within the effective range, the door may lock and unlock repeatedly. In that case, follow the following correction procedures to wash the vehicle:

- Place the key in a position 6 ft. (2 m) or more separate from the vehicle while the vehicle is being washed. (Take care to ensure that the key is not stolen.)
- Set the electronic key to battery-saving mode to disable the smart key system. (→P.126)

#### ■ Wheels and wheel ornaments

- Remove any dirt immediately by using a neutral detergent.
- Wash detergent off with water immediately after use.
- To protect the paint from damage, make sure to observe the following precautions.
  - Do not use acidic, alkaline or abrasive detergent
  - Do not use hard brushes
  - Do not use detergent on the wheels when they are hot, such as after driving or parking in hot weather

#### ■ Bumpers and side moldings

Do not scrub with abrasive cleaners.

#### ■ Plated portions

If dirt cannot be removed, clean the parts as follows:



- Use a soft cloth dampened with an approximately 5% solution of neutral detergent and water to clean the dirt off.
- Wipe the surface with a dry, soft cloth to remove any remaining moisture.
- To remove oily deposits, use alcohol wet wipes or a similar product.

**⚠ WARNING**

■ **When washing the vehicle**  
Do not apply water to the inside of the engine compartment. Doing so may cause the electrical components, etc. to catch fire.

■ **Precautions regarding the exhaust pipe**  
Exhaust gasses cause the exhaust pipe to become quite hot. When washing the vehicle, be careful not to touch the pipe until it has cooled sufficiently, as touching a hot exhaust pipe can cause burns.

■ **Precaution regarding the rear bumper with Blind Spot Monitor (if equipped)**  
If the paint of the rear bumper is chipped or scratched, the system may malfunction. If this occurs, consult your Toyota dealer.

**⚠ NOTICE**

■ **To prevent paint deterioration and corrosion on the body and components (aluminum wheels, etc.)**

- Wash the vehicle immediately in the following cases:
  - After driving near the sea coast
  - After driving on salted roads
  - If coal tar or tree sap is present on the paint surface

- If dead insects, insect droppings or bird droppings are present on the paint surface
- After driving in an area contaminated with soot, oily smoke, mine dust, iron powder or chemical substances
- If the vehicle becomes heavily soiled with dust or mud
- If liquids such as benzene and gasoline are spilled on the paint surface
- If the paint is chipped or scratched, have it repaired immediately.
- To prevent the wheels from corroding, remove any dirt and store in a place with low humidity when storing the wheels.
- **Cleaning the exterior lights**
- Wash carefully. Do not use organic substances or scrub with a hard brush. This may damage the surfaces of the lights.
- Do not apply wax to the surfaces of the lights. Wax may cause damage to the lenses.
- **To prevent damage to the windshield wiper arms**  
When lifting the wiper arms away from the windshield, pull the driver side wiper arm upward first, and repeat for the passenger side. When returning the wipers to their original position, do so from the passenger side first.

**NOTICE****■ When using a high pressure car wash**

- When washing the vehicle, do not spray the camera or its surrounding area directly with a high pressure washer. Shock applied from high pressure water may cause the device to not operate normally.
- Do not bring the nozzle tip close to boots (rubber or resin manufactured cover), connectors or the following parts. The parts may be damaged if they come into contact with high-pressure water.
  - Traction related parts
  - Steering parts
  - Suspension parts
  - Brake parts
- Keep the cleaning nozzle at least 11.9 in. (30 cm) away from the vehicles body. Otherwise resin section, such as moldings and bumpers, may be deformed and damaged. Also, do not continuously hold the nozzle in the same place.
- Do not spray the lower part of the windshield continuously. If water enters the air conditioning system intake located near the lower part of the windshield, the air conditioning system may not operate correctly.
- Do not wash the underside of the vehicle using a high pressure car washer.

**Cleaning and protecting the vehicle interior**

**Perform cleaning in a manner appropriate to each component and its material.**

**Protecting the vehicle interior**

- Remove dirt and dust using a vacuum cleaner. Wipe dirty surfaces with a cloth dampened with lukewarm water.
- If dirt cannot be removed, wipe it off with a soft cloth dampened with neutral detergent diluted to approximately 1%.

Wring out any excess water from the cloth and thoroughly wipe off remaining traces of detergent and water.

**■ Shampooing the carpets**

There are several commercial foaming-type cleaners available. Use a sponge or brush to apply the foam. Rub in overlapping circles. Do not use water. Wipe dirty surfaces and let them dry. Excellent results are obtained by keeping the carpet as dry as possible.

**■ Handling the seat belts**

Clean with mild soap and lukewarm water using a cloth or sponge. Also check the belts periodically for excessive wear, fraying or cuts.

**⚠ WARNING**

■ **Water in the vehicle**

- Do not splash or spill liquid in the vehicle. Doing so may cause electrical components, etc. to malfunction or catch fire.
- Do not get any of the SRS components or wiring in the vehicle interior wet. (→P.31)  
An electrical malfunction may cause the airbags to deploy or not function properly, resulting in death or serious injury.
- Vehicles with wireless charger: Do not let the wireless charger (→P.435) get wet. Failure to do so may cause the charger to become hot and cause burns or could cause electric shock resulting in death or serious injury.

■ **Cleaning the interior (especially instrument panel)**

Do not use polish wax or polish cleaner. The instrument panel may reflect off the windshield, obstructing the driver's view and leading to an accident, resulting in death or serious injury.

**⚠ NOTICE**

■ **Cleaning detergents**

- Do not use the following types of detergent, as they may discolor the vehicle interior or cause streaks or damage to painted surfaces:
  - Areas other than the seats and steering wheel: Organic substances such as benzene or gasoline, alkaline or acidic solutions, dye, and bleach

- Seats: Alkaline or acidic solutions, such as thinner, benzene, and alcohol
- Steering wheel: Organic substances, such as thinner, and cleaner that contains alcohol
- Do not use polish wax or polish cleaner. The instrument panel's or other interior part's painted surface may be damaged.

■ **Preventing damage to leather surfaces**

Observe the following precautions to avoid damage to and deterioration of leather surfaces:

- Remove any dust or dirt from leather surfaces immediately.
- Do not expose the vehicle to direct sunlight for extended periods of time. Park the vehicle in the shade, especially during summer.
- Do not place items made of vinyl, plastic, or containing wax on the upholstery, as they may stick to the leather surface if the vehicle interior heats up significantly.

■ **Water on the floor**

Do not wash the vehicle floor with water. Vehicle systems such as the audio system may be damaged if water comes into contact with electrical components such as the audio system above or under the floor of the vehicle. Water may also cause the body to rust.

■ **When cleaning the inside of the windshield**

Do not allow glass cleaner to contact the lens. Also, do not touch the lens. (→P.196)

**NOTICE****■ Cleaning the inside of the rear window**

- Do not use glass cleaner to clean the rear window, as this may cause damage to the rear window defogger heater wires or antenna. Use a cloth dampened with lukewarm water to gently wipe the window clean. Wipe the window in strokes running parallel to the heater wires or antenna.
- Be careful not to scratch or damage the heater wires or antenna.

**■ Cleaning the areas with satin-finish metal accents**

- Remove dirt using a water-dampened soft cloth or synthetic chamois.
- Wipe the surface with a dry, soft cloth to remove any remaining moisture.

**■ Cleaning the areas with satin-finish metal accents**

The metal areas use a layer of real metal for the surface. It is necessary to clean them regularly. If dirty areas are left uncleaned for long periods of time, they may be difficult to clean.

**■ Cleaning the leather areas**

- Remove dirt and dust using a vacuum cleaner.
- Wipe off any excess dirt and dust with a soft cloth dampened with diluted detergent.

Use a diluted water solution of approximately 5% neutral wool detergent.

- Wring out any excess water from the cloth and thoroughly wipe off all remaining traces of detergent.
- Wipe the surface with a dry, soft cloth to remove any remaining moisture. Allow the leather to dry in a shaded and ventilated area.

**■ Caring for leather areas**

Toyota recommends cleaning the interior of the vehicle at least twice a year to maintain the quality of the vehicle's interior.

**■ Cleaning the synthetic leather areas**

- Remove dirt and dust using a vacuum cleaner.
- Wipe it off with a soft cloth dampened with neutral detergent diluted to approximately 1%.
- Wring out any excess water from the cloth and thoroughly wipe off remaining traces of detergent and water.

Maintenance requirements

**To ensure safe and economical driving, day-to-day care and regular maintenance are essential. It is the owner's responsibility to perform regular checks. Toyota recommends the maintenance below.**

■ **Repair and replacement**

It is recommended that genuine Toyota parts be used for repairs to ensure performance of each system. If non-Toyota parts are used in replacement or if a repair shop other than a Toyota dealer performs repairs, confirm the warranty coverage.

■ **Allow inspection and repairs to be performed by a Toyota dealer**

- Toyota technicians are well-trained specialists and are kept up to date with the latest service information. They are well informed about the operation of all systems on your vehicle.
- Keep a copy of the repair order. It proves that the maintenance that has been performed is under warranty coverage. If any problem should arise while your vehicle is under warranty, your Toyota dealer will promptly take care of it.

 **WARNING**

■ **If your vehicle is not properly maintained**

Improper maintenance could result in serious damage to the vehicle and possible death or serious injury.

■ **Handling of the battery**

- Engine exhaust, some of its constituents, and a wide variety of automobile components contain or emit chemicals known to the State of California to cause cancer and birth defects and other reproductive harm. Work in a well ventilated area.
- Oils, fuels and fluids contained in vehicles as well as waste produced by component wear contain or emit chemicals known to the State of California to cause cancer and birth defects or other reproductive harm. Avoid exposure and wash any affected area immediately.
- Battery posts, terminals and related accessories contain lead and lead compounds which are known to cause brain damage. Wash your hands after handling. (→P.472)

**General maintenance**

General maintenance should be performed on a daily basis. This can be done by yourself or by a Toyota dealer.

**Scheduled maintenance**

Scheduled maintenance should be performed at specified intervals according to the maintenance schedule.

For details about maintenance items and schedules, refer to the "Scheduled Maintenance Guide" or "Owner's Manual Supplement".

**Resetting the message indicating maintenance is required**

After the required maintenance is performed according to the maintenance schedule, please reset the message.

To reset the message, follow the procedure described below:

- 1 Press **<** or **>** of the meter control switch to select .
- 2 Press **^** or **v** to select "Vehicle Settings" and then press and hold **OK**.
- 3 Press **^** or **v** to select "Scheduled Maintenance" and then press **OK**.
- 4 Press **^** or **v** to select "Yes" and then press **OK**.

A message will be displayed on the multi-information display when the reset procedure has been completed.

**Do-it-yourself maintenance**

You can perform some maintenance procedures by yourself. Please be aware that do-it-yourself maintenance may affect warranty coverage.

The use of Toyota repair manuals is recommended.

For details about warranty coverage, refer to the separate "Owner's Warranty Information Booklet" or "Owner's Manual Supplement".

**General maintenance**

Listed below are the general maintenance items that should be performed at the intervals specified in the "Owner's Warranty Information Booklet" or "Owner's Manual Supplement/Scheduled Maintenance Guide". It is recommended that any problem you notice should be brought to the attention of your Toyota dealer or qualified service shop for advice.

**! WARNING****■ If the engine is running**

Turn the engine off and ensure that there is adequate ventilation before performing maintenance checks.

**Engine compartment**

Items	Check points
Battery	Check the connections. (→P.472)
Brake fluid	Is the brake fluid at the correct level? (→P.471)
Engine coolant	Is the engine coolant at the correct level? (→P.470)
Engine oil	Is the engine oil at the correct level? (→P.467)

Items	Check points
Exhaust system	There should not be any fumes or strange sounds.
Radiator/condenser	The radiator and condenser should be free from foreign objects. (→P.471)
Washer fluid	Is there sufficient washer fluid? (→P.474)

**Vehicle interior**

Items	Check points
Accelerator pedal	The accelerator pedal should move smoothly (without uneven pedal effort or catching).
Continuously variable transmission "Park" mechanism	When parked on a slope and the shift lever is in P, is the vehicle securely stopped?
Brake pedal	<ul style="list-style-type: none"> <li>• Does the brake pedal move smoothly?</li> <li>• Does the brake pedal have appropriate clearance from the floor? (→P.563)</li> <li>• Does the brake pedal have the correct amount of free play? (→P.563)</li> </ul>

Items	Check points
Clutch pedal	<ul style="list-style-type: none"> <li>• Does the clutch pedal move smoothly?</li> <li>• Does the clutch pedal have appropriate clearance from the floor? (→P.563)</li> <li>• Does the clutch pedal have the correct amount of free play? (→P.563)</li> </ul>
Brakes	<ul style="list-style-type: none"> <li>• The vehicle should not pull to one side when the brakes are applied.</li> <li>• The brakes should work effectively.</li> <li>• The brake pedal should not feel spongy.</li> <li>• The brake pedal should not get too close to the floor when the brakes are applied.</li> </ul>
Head restraints	Do the head restraints move smoothly and lock securely?
Indicators/buzzers	Do the indicators and buzzers function properly?
Lights	Do all the lights come on?

Items	Check points
Parking brake	<ul style="list-style-type: none"> <li>• Does the parking brake operate normally?</li> <li>• When parked on a slope and the parking brake is on, is the vehicle securely stopped?</li> </ul>
Seat belts	<ul style="list-style-type: none"> <li>• Do the seat belts operate smoothly?</li> <li>• The seat belts should not be damaged.</li> </ul>
Seats	Do the seat controls operate properly?
Steering wheel	<ul style="list-style-type: none"> <li>• Does the steering wheel rotate smoothly?</li> <li>• Does the steering wheel have the correct amount of free play?</li> <li>• There should not be any strange sounds coming from the steering wheel.</li> </ul>

Items	Check points
Fluid leaks	There should not be any signs of fluid leakage after the vehicle has been parked.
Tires	<ul style="list-style-type: none"> <li>• Is the tire inflation pressure correct?</li> <li>• The tires should not be damaged or excessively worn.</li> <li>• Have the tires been rotated according to the maintenance schedule?</li> <li>• The wheel nuts should not be loose.</li> </ul>
Windshield wipers	<ul style="list-style-type: none"> <li>• The wiper blades should not show any signs of cracking, splitting, wear, contamination or deformation.</li> <li>• The wiper blades should clear the windshield without streaking or skipping.</li> </ul>

**Vehicle exterior**

Items	Check points
Doors/trunk	Do the doors/trunk operate smoothly?
Engine hood	Does the engine hood lock system work properly?



### Emission inspection and maintenance (I/M) programs

**Some states have vehicle emission inspection programs which include OBD (On Board Diagnostics) checks. The OBD system monitors the operation of the emission control system.**

### If the malfunction indicator lamp comes on

The OBD system determines that a problem exists somewhere in the emission control system. Your vehicle may not pass the I/M test and may need to be repaired. Contact your Toyota dealer to service the vehicle.

### Your vehicle may not pass the I/M test in the following situations:

- When the battery is disconnected or discharged

Readiness codes that are set during ordinary driving are erased. Also, depending on your driving habits, the readiness codes may not be completely set.

- When the fuel tank cap is loose

The malfunction indicator lamp comes on indicating a temporary malfunction and your vehicle may not pass the I/M test.

### When the malfunction indicator lamp still remains on after several driving trips

The error code in the OBD system will not be cleared unless the vehicle is driven 40 or more times.

### If your vehicle does not pass the I/M test

Contact your Toyota dealer to prepare the vehicle for re-testing.

**Do-it-yourself service precautions**

**If you perform maintenance by yourself, be sure to follow the correct procedure as given in these sections.**

**Maintenance**

Items	Parts and tools
Battery condition (→P.472)	<ul style="list-style-type: none"> <li>• Warm water</li> <li>• Baking soda</li> <li>• Grease</li> <li>• Conventional wrench (for terminal clamp bolts)</li> </ul>
Brake fluid level (→P.471)	<ul style="list-style-type: none"> <li>• FMVSS No.116 DOT 3 or SAE J1703 brake fluid</li> <li>• FMVSS No.116 DOT 4 or SAE J1704 brake fluid</li> <li>• Rag or paper towel</li> <li>• Funnel (used only for adding brake fluid)</li> </ul>

Items	Parts and tools
Engine coolant level (→P.470)	<ul style="list-style-type: none"> <li>• “Toyota Super Long Life Coolant” or a similar high quality ethylene glycol-based non-silicate, non-amine, non-nitrite and non-borate coolant with long-life hybrid organic acid technology</li> <li>For the U.S.A.: “Toyota Super Long Life Coolant” is pre-mixed with 50% coolant and 50% deionized water.</li> <li>For Canada: “Toyota Super Long Life Coolant” is pre-mixed with 55% coolant and 45% deionized water.</li> <li>• Funnel (used only for adding coolant)</li> </ul>
Engine oil level (→P.467)	<ul style="list-style-type: none"> <li>• “Toyota Genuine Motor Oil” or equivalent</li> <li>• Rag or paper towel</li> <li>• Funnel (used only for adding engine oil)</li> </ul>
Fuses (→P.492)	<ul style="list-style-type: none"> <li>• Fuse with same amperage rating as original</li> </ul>
Light bulbs (→P.495)	<ul style="list-style-type: none"> <li>• Bulb with same number and wattage rating as original</li> <li>• Flathead screwdriver</li> <li>• Wrench</li> </ul>

Items	Parts and tools
Radiator and condenser (→P.471)	—
Tire inflation pressure (→P.484)	<ul style="list-style-type: none"> <li>• Tire pressure gauge</li> <li>• Compressed air source</li> </ul>
Washer fluid (→P.474)	<ul style="list-style-type: none"> <li>• Water or washer fluid containing anti-freeze (for winter use)</li> <li>• Funnel (used only for adding water or washer fluid)</li> </ul>

● Be extremely cautious when working on the battery. It contains poisonous and corrosive sulfuric acid.

■ **When working near the electric cooling fan or radiator grille**

Be sure the engine switch is OFF. With the engine switch in ON, the electric cooling fan may automatically start to run if the air conditioning is on and/or the coolant temperature is high. (→P.471)

■ **Safety glasses**

Wear safety glasses to prevent flying or falling material, fluid spray, etc. from getting in your eyes.

 **WARNING**

The engine compartment contains many mechanisms and fluids that may move suddenly, become hot, or become electrically energized. To avoid death or serious injury, observe the following precautions.

■ **When working on the engine compartment**

- Keep hands, clothing and tools away from the moving fan and engine drive belt.
- Be careful not to touch the engine, radiator, exhaust manifold, etc. right after driving as they may be hot. Oil and other fluids may also be hot.
- Do not leave anything that may burn easily, such as paper and rags, in the engine compartment.
- Do not smoke, cause sparks or expose an open flame to fuel or the battery. Fuel and battery fumes are flammable.

 **NOTICE**

■ **If you remove the air cleaner filter**

Driving with the air cleaner filter removed may cause excessive engine wear due to dirt in the air.

Hood

Opening the hood

- 1 Pull the hood lock release lever.

The hood will pop up slightly.

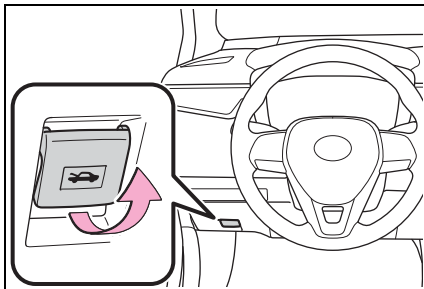

- 2 Pull the auxiliary catch lever to the left and lift the hood.

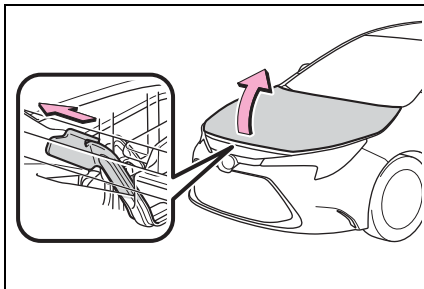

- 3 Hold the hood open by inserting the support rod into the slot.

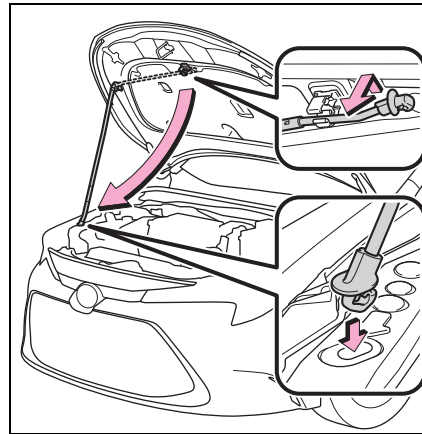

**⚠ WARNING**

■ **Pre-driving check**

Check that the hood is fully closed and locked. If the hood is not locked properly, it may open while the vehicle is in motion and cause an accident, which may result in death or serious injury.

■ **After installing the support rod into the slot**

Make sure the rod supports the hood securely preventing it from falling down onto your head or body.

**⚠ NOTICE**

■ **When closing the hood**

Be sure to return the support rod to its clip before closing the hood. Closing the hood with the support rod not clipped could cause the hood to bend.

**Positioning a floor jack**

**When using a floor jack, follow the instructions in the manual provided with the jack and perform the operation safely.**

**When raising your vehicle with a floor jack, position the jack correctly. Improper placement may damage your vehicle or cause injury.**

**Location of the jack point**

■ **Front**

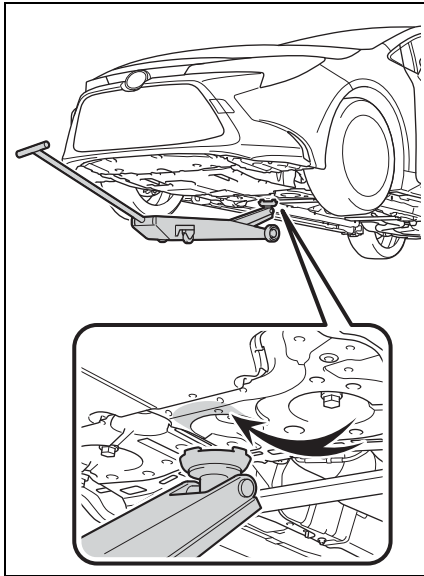

■ **Rear**

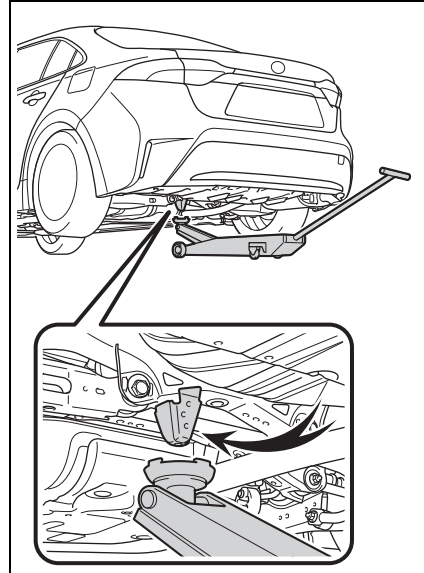

Engine compartment

Components

► 1.8 L 4-cylinder (2ZR-FAE) engine

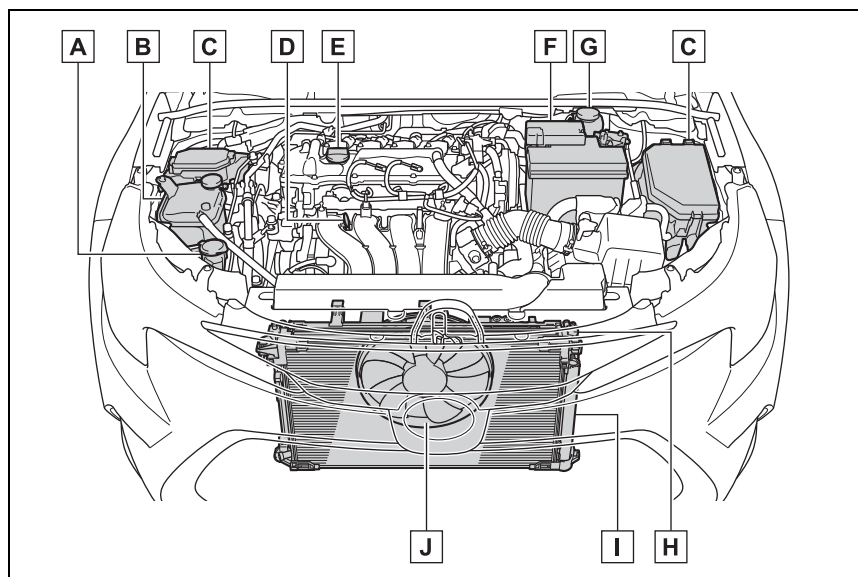

- A** Washer fluid tank (→P.474)
- B** Engine coolant reservoir (→P.470)
- C** Fuse boxes (→P.492)
- D** Engine oil level dipstick (→P.467)
- E** Engine oil filler cap (→P.468)
- F** Battery (→P.472)
- G** Brake fluid reservoir (→P.471)
- H** Radiator (→P.471)
- I** Condenser (→P.471)
- J** Electric cooling fan

► 2.0 L 4-cylinder (M20A-FKS) engine

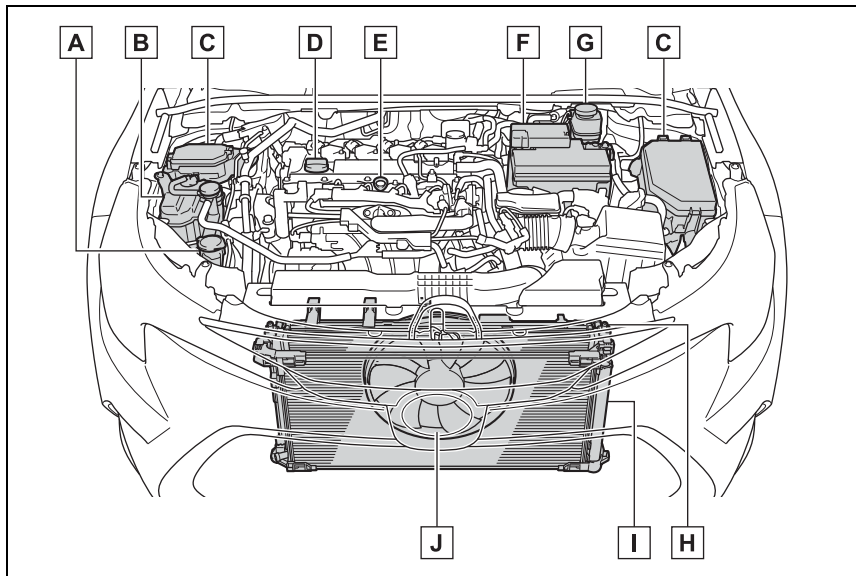

- A** Washer fluid tank (→P.474)
- B** Engine coolant reservoir (→P.470)
- C** Fuse boxes (→P.492)
- D** Engine oil filler cap (→P.468)
- E** Engine oil level dipstick (→P.467)
- F** Battery (→P.472)
- G** Brake fluid reservoir (→P.471)
- H** Radiator (→P.471)
- I** Condenser (→P.471)
- J** Electric cooling fan

**Checking and adding the engine oil**

With the engine at operating temperature and turned off, check the oil level on the dipstick.

■ **Checking the engine oil**

- 1 Park the vehicle on level ground. After warming up the engine and turning it off, wait more than 5 minutes for the oil to drain back into the bottom of the engine.

2 Holding a rag under the end, pull the dipstick out.

▶ 1.8 L 4-cylinder (2ZR-FAE) engine

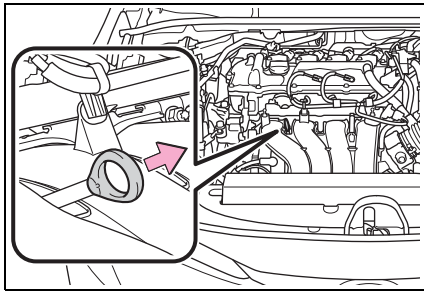

▶ 2.0 L 4-cylinder (M20A-FKS) engine

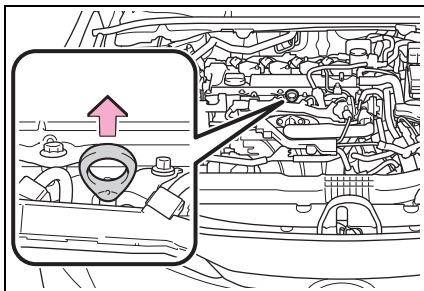

3 Wipe the dipstick clean.

4 Reinsert the dipstick fully.

5 Holding a rag under the end, pull the dipstick out and check the oil level.

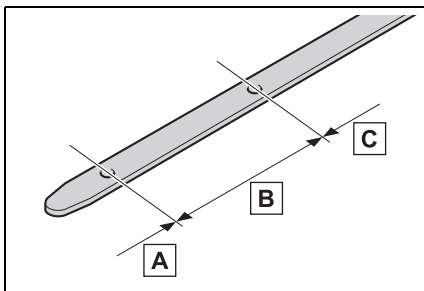

**A** Low

**B** Normal

**C** Excessive

The shape of the dipstick may differ depending on the type of vehicle or engine.

6 Wipe the dipstick and reinsert it fully.

■ **Checking the oil type and preparing the item needed**

Make sure to check the oil type and prepare the items needed before adding oil.

● Engine oil selection  
→P.558, 559

● Oil quantity (Low → Full)  
1.6 qt. (1.5 L, 1.3 Imp. qt.)

● Item  
Clean funnel

■ **Adding engine oil**

If the oil level is below or near the low level mark, add engine oil of the same type as that already in the engine.

▶ 1.8 L 4-cylinder (2ZR-FAE) engine

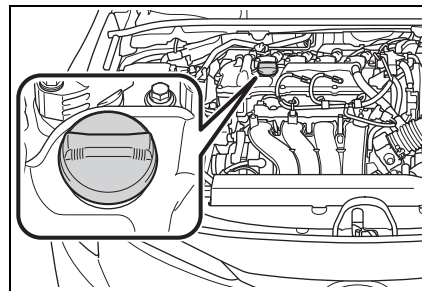



▶ 2.0 L 4-cylinder (M20A-FKS) engine

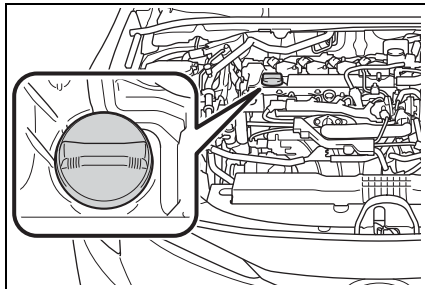

- 1 Remove the oil filler cap by turning it counterclockwise.
- 2 Add engine oil slowly, checking the dipstick.
- 3 Install the oil filler cap by turning it clockwise.

■ Engine oil consumption

A certain amount of engine oil will be consumed while driving. In the following situations, oil consumption may increase, and engine oil may need to be refilled in between oil maintenance intervals.

- When the engine is new, for example directly after purchasing the vehicle or after replacing the engine
- If low quality oil or oil of an inappropriate viscosity is used
- When driving at high engine speeds or with a heavy load, or when driving while accelerating or decelerating frequently
- When leaving the engine idling for a long time, or when driving frequently through heavy traffic

**⚠ WARNING**

■ Used engine oil

- Used engine oil contains potentially harmful contaminants which may cause skin disorders such as inflammation and skin cancer, so care should be taken to avoid prolonged and repeated contact. To remove used engine oil from your skin, wash thoroughly with soap and water.
- Dispose of used oil and filters only in a safe and acceptable manner. Do not dispose of used oil and filters in household trash, in sewers or onto the ground. Call your Toyota dealer, service station or auto parts store for information concerning recycling or disposal.
- Do not leave used engine oil within the reach of children.

**⚠ NOTICE**

■ To prevent serious engine damage

Check the oil level on a regular basis.

■ When replacing the engine oil

- Be careful not to spill engine oil on the vehicle components.
- Avoid overfilling, or the engine could be damaged.
- Check the oil level on the dipstick every time you refill the vehicle.
- Be sure the engine oil filler cap is properly tightened.

### Checking the engine coolant

The coolant level is satisfactory if it is between the “FULL” and “LOW” lines (type A) or “MAX” and “MIN” lines (type B) on the reservoir when the engine is cold.

► Type A

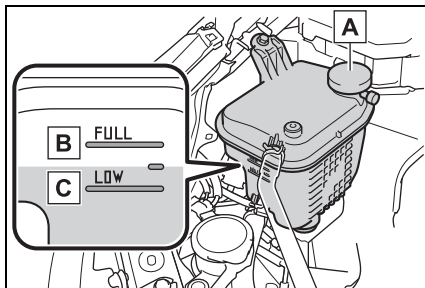

A Reservoir cap

B “FULL” line

C “LOW” line

If the level is on or below the “LOW” line, add coolant up to the “FULL” line. (→P.550)

► Type B

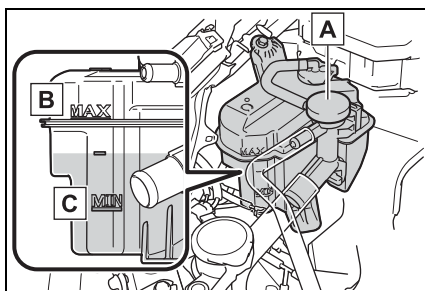

A Reservoir cap

B “MAX” line

C “MIN” line

If the level is on or below the “MIN” line, add coolant up to the “MAX” line. (→P.550)

#### ■ Coolant selection

Only use “Toyota Super Long Life Coolant” or a similar high quality ethylene glycol based non-silicate, non-amine, non-nitrite, and non-borate coolant with long-life hybrid organic acid technology.

U.S.A.:

“Toyota Super Long Life Coolant” is a mixture of 50% coolant and 50% deionized water. (Minimum temperature: -31°F [-35°C])

Canada:

“Toyota Super Long Life Coolant” is a mixture of 55% coolant and 45% deionized water. (Minimum temperature: -44°F [-42°C])

For more details about coolant, contact your Toyota dealer.

#### ■ If the coolant level drops within a short time of replenishing

Visually check the radiator, hoses, engine coolant reservoir caps, drain cock and water pump.

If you cannot find a leak, have your Toyota dealer test the cap and check for leaks in the cooling system.

#### ⚠ WARNING

##### ■ When the engine is hot

Do not remove the engine coolant reservoir cap.

The cooling system may be under pressure and may spray hot coolant if the cap is removed, causing serious injuries, such as burns.

 **NOTICE**

■ **When adding coolant**  
Coolant is neither plain water nor straight antifreeze. The correct mixture of water and antifreeze must be used to provide proper lubrication, corrosion protection and cooling. Be sure to read the antifreeze or coolant label.

■ **If you spill coolant**  
Be sure to wash it off with water to prevent it from damaging parts or paint.

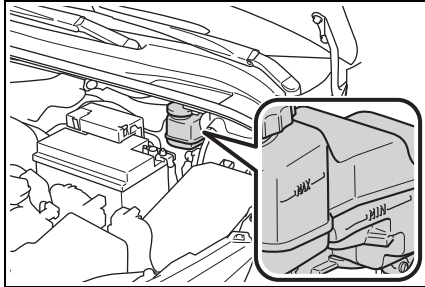

- **Adding fluid**
- 1 Slide and lift up the rubber strip to partly remove it as shown.

**Checking the radiator and condenser**

Check the radiator and condenser and clear away any foreign objects. If either of the above parts is extremely dirty or you are not sure of their condition, have your vehicle inspected by your Toyota dealer.

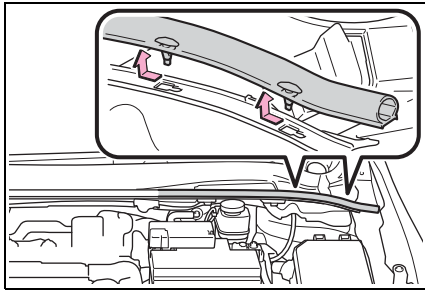

- 2 Disconnect the claws and remove the service cover.

 **WARNING**

■ **When the engine is hot**  
Do not touch the radiator or condenser as they may be hot and cause serious injuries, such as burns.

**Checking and adding the brake fluid**

- **Checking fluid level**
- The brake fluid level should be between the “MAX” and “MIN” lines on the tank.

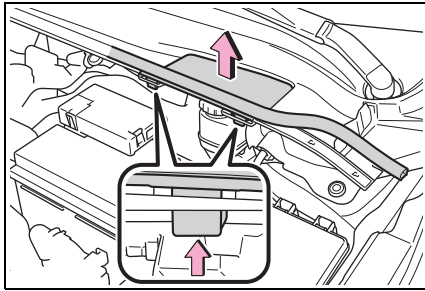

3 Remove the reservoir cap.

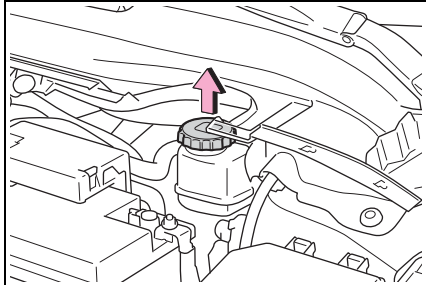

4 Add brake fluid slowly while checking the fluid level.

Make sure to check the fluid type and prepare the necessary item.

● Fluid type

FMVSS No.116 DOT 3 or SAE J1703 brake fluid

FMVSS No.116 DOT 4 or SAE J1704 brake fluid

● Item

Clean funnel

■ Brake fluid can absorb moisture from the air

Excess moisture in the brake fluid can cause a dangerous loss of braking efficiency. Use only newly opened brake fluid.

**⚠ WARNING**

■ When filling the reservoir

Take care as brake fluid can harm your hands and eyes and damage painted surfaces.

If fluid gets on your hands or in your eyes, flush the affected area with clean water immediately.

If you still experience discomfort, see a doctor.

**⚠ NOTICE**

■ If the fluid level is low or high

It is normal for the brake fluid level to go down slightly as the brake pads wear out or when the fluid level in the accumulator is high. If the reservoir needs frequent refilling, there may be a serious problem.

**Battery**

Check the battery as follows.

■ Battery exterior

Make sure that the battery terminals are not corroded and that there are no loose connections, cracks, or loose clamps.

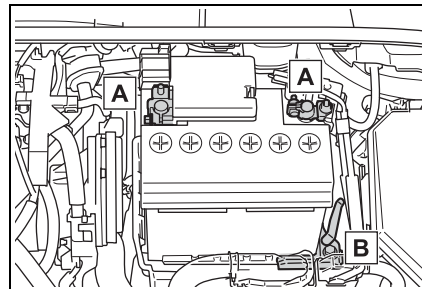

A Terminals

B Hold-down clamp

■ Before recharging

When recharging, the battery produces hydrogen gas which is flammable and explosive. Therefore, observe the following precautions before recharging:

- If recharging with the battery installed on the vehicle, be sure to disconnect the ground cable.
- Make sure the charger is off when connecting and disconnecting the charger cables to the battery.

■ **After recharging/reconnecting the battery (vehicles with a smart key system)**

- Unlocking the doors using the smart key system may not be possible immediately after reconnecting the battery. If this happens, use the wireless remote control or the mechanical key to lock/unlock the doors.
- Start the engine with the engine switch in ACC. The engine may not start with the engine switch turned off. However, the engine will operate normally from the second attempt.
- The engine switch mode is recorded by the vehicle. If the battery is reconnected, the vehicle will return the engine switch mode to the status it was in before the battery was disconnected. Make sure to turn off the engine before disconnecting the battery. Take extra care when connecting the battery if the engine switch mode prior to discharge is unknown.

If the system will not start even after multiple attempts, contact your Toyota dealer.

 **WARNING**

■ **Chemicals in the battery**

The battery contains poisonous and corrosive sulfuric acid and may produce hydrogen gas which is flammable and explosive. To reduce the risk of death or serious injury, take the following precautions while working on or near the battery:

- Do not cause sparks by touching the battery terminals with tools.
- Do not smoke or light a match near the battery.
- Avoid contact with eyes, skin and clothes.

- Never inhale or swallow electrolyte.

- Wear protective safety glasses when working near the battery.

- Keep children away from the battery.

■ **Where to safely charge the battery**

Always charge the battery in an open area. Do not charge the battery in a garage or closed room where there is insufficient ventilation.

■ **Emergency measures regarding electrolyte**

- If electrolyte gets in your eyes  
Flush your eyes with clean water for at least 15 minutes and get immediate medical attention. If possible, continue to apply water with a sponge or cloth while traveling to the nearest medical facility.

- If electrolyte gets on your skin  
Wash the affected area thoroughly. If you feel pain or burning, get medical attention immediately.

- If electrolyte gets on your clothes  
It can soak through clothing on to your skin. Immediately take off the clothing and follow the procedure above if necessary.

- If you accidentally swallow electrolyte  
Drink a large quantity of water or milk. Get emergency medical attention immediately.

**⚠ WARNING****■ When disconnecting the battery**

Do not disconnect the negative (-) terminal on the body side. The disconnected negative (-) terminal may touch the positive (+) terminal, which may cause a short and result in death or serious injury.

**⚠ NOTICE****■ When recharging the battery**

Never recharge the battery while the engine is running. Also, be sure all accessories are turned off.

**⚠ NOTICE****■ Do not use any fluid other than washer fluid**

Do not use soapy water or engine antifreeze instead of washer fluid. Doing so may cause streaking on the vehicle's painted surfaces, as well as damaging the pump leading to problems of the washer fluid not spraying.

**■ Diluting washer fluid**

Dilute washer fluid with water as necessary. Refer to the freezing temperatures listed on the label of the washer fluid bottle.

**Adding the washer fluid**

Add washer fluid in the following situations:

- A washer does not work.
- The warning message appears on the multi-information display.

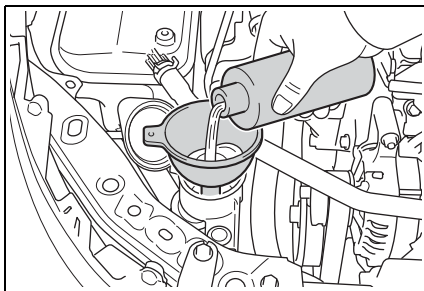
**⚠ WARNING****■ When adding washer fluid**

Do not add washer fluid when the engine is hot or running as washer fluid contains alcohol and may catch fire if spilled on the engine, etc.

**Tires**

**Replace or rotate tires in accordance with maintenance schedules and treadwear.**

**Checking tires**

Check if the treadwear indicators are showing on the tires. Also check the tires for uneven wear, such as excessive wear on one side of the tread.

Check the spare tire condition and pressure if not rotated.

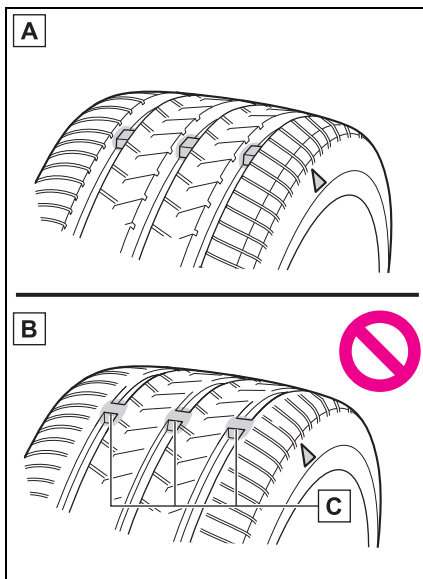

**A** New tread  
**B** Worn tread  
**C** Treadwear indicator  
 The location of treadwear indicators is shown by a "TWI" or "△" mark,

etc., molded into the sidewall of each tire.

Replace the tires if the treadwear indicators are showing on a tire.

**When to replace your vehicle's tires**

Tires should be replaced if:

- The treadwear indicators are showing on a tire
- You have tire damage such as cuts, splits, cracks deep enough to expose the fabric, and bulges indicating internal damage
- A tire goes flat repeatedly or cannot be properly repaired due to the size or location of a cut or other damage

If you are not sure, consult with your Toyota dealer.

**Tire life**

Any tire over 6 years old must be checked by a qualified technician even if it has seldom or never been used or damage is not obvious.

**Low profile tires (18-inch tires)**

Generally, low profile tires will wear more rapidly and tire grip performance will be reduced on snowy and/or icy roads when compared to standard tires. Be sure to use snow tires or tire chains on snowy and/or icy roads and drive carefully at a speed appropriate for road and weather conditions.

**Maximum load of tire**

Check that the maximum load of the replacement tire is greater than 1/2 of the Gross Axle Weight Ratings (GAWR) of either the front axle or the rear axle, whichever is greater.

For the GAWR, see the Certification Label.

For the maximum load of the tire, see the load limit at maximum cold tire inflation pressure mentioned on the sidewall of the tire. (→P.570)



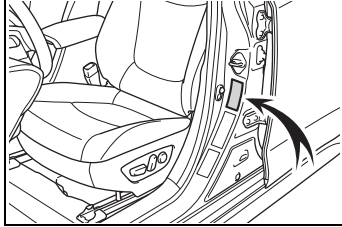

### ■ Tire types

#### ● Summer tires

Summer tires are high-speed performance tires best suited to highway driving under dry conditions. Since summer tires do not have the same traction performance as snow tires, summer tires are inadequate for driving on snow-covered or icy roads. For driving on snow-covered roads or icy roads, the use of snow tires is recommended. When installing snow tires, be sure to replace all four tires.

#### ● All season tires

All season tires are designed to provide better traction in snow and to be adequate for driving in most winter conditions as well as for use year-round. All season tires, however, do not have adequate traction performance compared with snow tires in heavy or loose snow. Also, all season tires fall short in acceleration and handling performance compared with summer tires in highway driving.

#### ● Snow tires

For driving on snow-covered roads or icy roads, we recommend using snow tires. If you need snow tires, select tires of the same size, construction and load capacity as the originally installed tires. Since your vehicle has radial tires as original equipment, make sure your snow

tires also have radial construction. Do not install studded tires without first checking local regulations for possible restrictions. Snow tires should be installed on all wheels. (→P.277)

### ■ If the tread on snow tires wears down below 0.16 in. (4 mm)

The effectiveness of the tires as snow tires is lost.

### ■ Checking the tire valves

When replacing the tires, check the tire valves for deformation, cracks, and other damage.

### ⚠ WARNING

#### ■ When inspecting or replacing tires

Observe the following precautions to prevent accidents.

Failure to do so may cause damage to parts of the drive train as well as dangerous handling characteristics, which may lead to an accident resulting in death or serious injury.

- Do not mix tires of different makes, models or tread patterns. Also, do not mix tires of remarkably different treadwear.
- Do not use tire sizes other than those recommended by Toyota.
- Do not mix differently constructed tires (radial, bias-belted or bias-ply tires).
- Do not mix summer, all season and snow tires.
- Do not use tires that have been used on another vehicle. Do not use tires if you do not know how they were used previously.



 **NOTICE**

■ **Low profile tires (18-inch tires)**

Low profile tires may cause greater damage than usual to the tire wheel when sustaining impact from the road surface. Therefore, pay attention to the following:

- Be sure to use proper tire inflation pressure. If tires are under-inflated, they may be damaged more severely.
- Avoid potholes, uneven pavement, curbs and other road hazards. Failure to do so may lead to severe tire and wheel damage.

■ **If tire inflation pressure of each tire becomes low while driving**

Do not continue driving, or your tires and/or wheels may be ruined.

■ **Driving on rough roads**

Take particular care when driving on roads with loose surfaces or potholes. These conditions may cause losses in tire inflation pressure, reducing the cushioning ability of the tires. In addition, driving on rough roads may cause damage to the tires themselves, as well as the vehicle's wheels and body.

**Tire rotation**

Rotate the tires in the order shown.

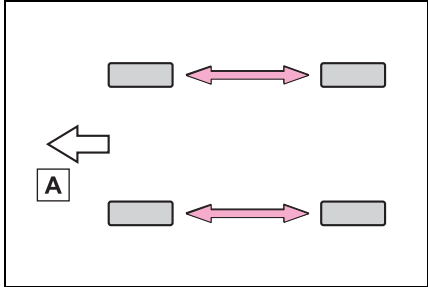

**A** Front

To equalize tire wear and extend tire life, Toyota recommends that tire rotation is carried out at the same interval as tire inspection.

Vehicles with a tire pressure warning system: Do not fail to initialize the tire pressure warning system after tire rotation.

**Tire pressure warning system (if equipped)**

Your vehicle is equipped with a tire pressure warning system that uses tire pressure warning valves and transmitters to detect low tire inflation pressure before serious problems arise.

If the tire pressure drops below a predetermined level, the driver is warned by a warning light. (→P.515)

■ **Routine tire inflation pressure checks**

The tire pressure warning system does not replace routine tire inflation pressure checks. Make sure to check tire inflation pressure as part of your routine of daily vehicle checks.

#### ■ Situations in which the tire pressure warning system may not operate properly

- In the following cases, the tire pressure warning system may not operate properly.
  - If non-genuine Toyota wheels are used.
  - A tire has been replaced with a tire that is not an OE (Original Equipment) tire.
  - A tire has been replaced with a tire that is not of the specified size.
  - Tire chains, etc. are equipped.
  - An auxiliary-supported run-flat tire is equipped.
  - If a window tint that affects the radio wave signals is installed.
  - If there is a lot of snow or ice on the vehicle, particularly around the wheels or wheel housings.
  - If the tire inflation pressure is extremely higher than the specified level.
  - If tires not equipped with tire pressure warning valves and transmitters are used.
  - If the ID code on the tire pressure warning valves and transmitters is not registered in the tire pressure warning computer.

- Performance may be affected in the following situations.
  - Near a TV tower, electric power plant, gas station, radio station, large display, airport or other facility that generates strong radio waves or electrical noise.
  - When carrying a portable radio, cellular phone, cordless phone or other wireless communication device.
- When the vehicle is parked, the time taken for the warning to start or go off could be extended.
- When tire inflation pressure declines rapidly for example when a tire has burst, the warning may not function.

#### ■ Warning performance of the tire pressure warning system

The warning of the tire pressure warning system will change in accordance with driving conditions. For this reason, the system may give a warning even if the tire pressure does not reach a low enough level, or if the pressure is higher than the pressure that was adjusted to when the system was initialized.

#### ■ Tire pressure warning system certification

FCC ID: PAXPMVE000

##### NOTE

This device complies with part 15 of the FCC Rules. Operation is subject to the following two conditions:  
 (1) This device may not cause harmful interference, and (2) this device must accept any interference received, including interference that may cause undesired operation.

##### FCC WARNING

Changes or modifications not expressly approved by the party responsible for compliance could void the user's authority to operate the equipment.

FCC ID: PAXPMVE100

**NOTE**

This device complies with part 15 of the FCC Rules. Operation is subject to the following two conditions:  
(1) This device may not cause harmful interference, and (2) this device must accept any interference received, including interference that may cause undesired operation.

**FCC WARNING**

Changes or modifications not expressly approved by the party responsible for compliance could void the user's authority to operate the equipment.

"Perchlorate Material – special handling may apply, See [www.dtsc.ca.gov/hazardouswaste/perchlorate](http://www.dtsc.ca.gov/hazardouswaste/perchlorate)."

US

FCC ID:HYQ23ABG

**NOTE:**

This device complies with part 15 of the FCC Rules. Operation is subject to the following two conditions: (1) This device may not cause harmful interference, and (2) this device must accept any interference received, including interference that may cause undesired operation.

**FCC WARNING:**

Changes or modifications not expressly approved by the party responsible for compliance could void the user's authority to operate the equipment.

**NOTE**

This device complies with Industry Canada licence-exempt RSS standard(s). Operation is subject to the following two conditions: (1) this device may not cause interference, and (2) this device must accept any interference, including interference that may cause undesired operation of the device.

**NOTE**

Le présent appareil est conforme aux CNR d'Industrie Canada applicables aux appareils radio exempts de licence. L'exploitation est autorisée aux deux conditions suivantes : (1) l'appareil ne doit pas produire de brouillage, et (2) l'utilisateur de l'appareil doit accepter tout brouillage radioélectrique subi, même si le brouillage est susceptible d'en compromettre le fonctionnement.

### Installing tire pressure warning valves and transmitters (vehicles with a tire pressure warning system)

When replacing tires or wheels, tire pressure warning valves and transmitters must also be installed.

When new tire pressure warning valves and transmitters are installed, new ID codes must be registered in the tire pressure warning computer and the tire pressure warning system must be initialized. Have tire pressure warning valves and transmitter ID codes registered by your Toyota dealer. (→P.482)

### ■ Replacing tires and wheels

If the ID code of the tire pressure warning valve and transmitter is not registered, the tire pressure warning system will not work properly. After driving for about 20 minutes, the tire pressure warning light blinks for 1 minute and stays on to indicate a system malfunction.

#### NOTICE

#### ■ **Repairing or replacing tires, wheels, tire pressure warning valves, transmitters and tire valve caps**

- When removing or fitting the wheels, tires or the tire pressure warning valves and transmitters, contact your Toyota dealer as the tire pressure warning valves and transmitters may be damaged if not handled correctly.

 NOTICE

● Make sure to install the tire valve caps. If the tire valve caps are not installed, water could enter the tire pressure warning valves and the tire pressure warning valves could be bound.

● When replacing tire valve caps, do not use tire valve caps other than those specified. The cap may become stuck.

■ **To avoid damage to the tire pressure warning valves and transmitters**

When a tire is repaired with liquid sealants, the tire pressure warning valve and transmitter may not operate properly. If a liquid sealant is used, contact your Toyota dealer or other qualified service shop as soon as possible. Make sure to replace the tire pressure warning valve and transmitter when replacing the tire. (→P.480)

### Initializing the tire pressure warning system (if equipped)

■ **The tire pressure warning system must be initialized in the following circumstances:**

- When rotating front and rear tires which have different tire inflation pressures.
- When changing the tire size.
- When the tire inflation pressure is changed such as when changing traveling speed or load weight.
- When changing between two

registered wheel sets.

When the tire pressure warning system is initialized, the current tire inflation pressure is set as the benchmark pressure.

■ **How to initialize the tire pressure warning system**

- 1 Park the vehicle in a safe place and turn the engine switch off.

Initialization cannot be performed while the vehicle is moving.

- 2 Adjust the tire inflation pressure to the specified cold tire inflation pressure level. (→P.564)

Make sure to adjust the tire pressure to the specified cold tire inflation pressure level. The tire pressure warning system will operate based on this pressure level.

- 3 Turn the engine switch to ON.
- 4 Press < or > of the meter control switch to select .
- 5 Press ^ or v to select "Vehicle Settings" and then press and hold OK .
- 6 Press ^ or v to select "TPWS" and then press OK .
- 7 Press ^ or v to select "Set Pressure". Then press and hold OK until the tire pres-

sure warning light blinks 3 times.

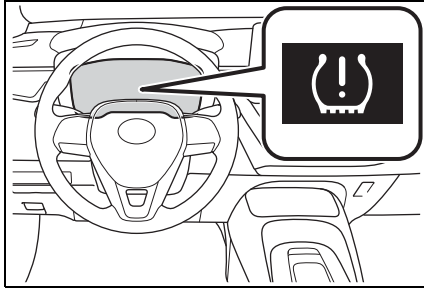

#### ■ Initialization procedure

- Make sure to carry out initialization after adjusting the tire inflation pressure. Also, make sure the tires are cold before carrying out initialization or tire inflation pressure adjustment.
- If you have accidentally turned the engine switch off during initialization, it is not necessary to press the reset switch again as initialization will restart automatically when the engine switch to ON for the next time.
- If initialization has accidentally been started when it is not necessary, adjust the tire inflation pressure to the specified level when the tires are cold, and then perform the initialization procedure again.

#### ■ When initialization of the tire pressure warning system has failed

Initialization can be completed in a few minutes. However, in the following cases, the settings have not been recorded and the system will not operate properly. If repeated attempts to record tire inflation pressure settings are unsuccessful, have the vehicle inspected by your Toyota dealer.

- When attempting to start initialization, the tire pressure warning light does not blink 3 times.

- After driving for a certain period of time since the initialization has been completed, the warning light comes on after blinking for 1 minute.

#### ⚠ WARNING

##### ■ When initializing the tire pressure warning system

Do not initialize the tire pressure warning system without first adjusting the tire inflation pressure to the specified level. Otherwise, the tire pressure warning light may not come on even if the tire inflation pressure is low, or it may come on when the tire inflation pressure is actually normal.

#### Registering ID codes

The tire pressure warning valve and transmitter is equipped with a unique ID code. When replacing a tire pressure warning valve and transmitter, it is necessary to register the ID code. Have the ID code registered by your Toyota dealer.

#### Selecting wheel set

Your vehicle is equipped with tire pressure warning system with the function to have ID codes registered for a second wheel set, for example a winter set, by Toyota dealer.

After registration of a second wheel set, either of these two wheel sets can be selected for usage with the tire pressure warning system.

■ **Operating conditions for the function**

- This function will perform the change of wheel set only if a second wheel set has been registered. If no second wheel set has been registered, no change will be made when selecting this function in the menu.
- Only a change between both registered wheel set is possible, mixing between these wheel sets is not supported.

■ **How to change between wheel sets**

- 1 Have the vehicle fitted with the preferred wheel set.
- 2 Press < or > of the meter control switch to select .
- 3 Press ^ or v to select "Vehicle Settings" and then press OK .
- 4 Press ^ or v to select "TPWS" and then press OK .
- 5 Press ^ or v to select "Change Wheel". Then press and hold OK until the tire

pressure warning light blinks slowly 3 times.

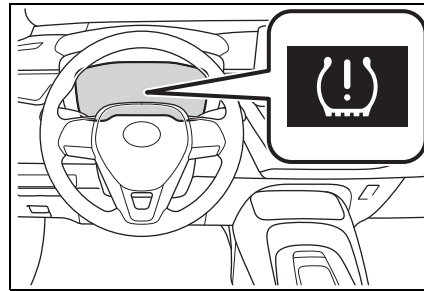

- 6 Initialize the tire pressure warning system. (→P.481)



**Tire inflation pressure**

**Checking the specified tire inflation pressure**

The recommended cold tire inflation pressure and tire size are displayed on the tire and loading information label. (→P.564)

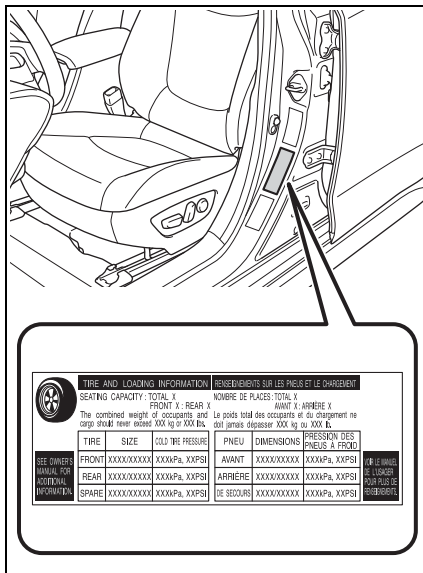

**B** Tire pressure gauge

- 1 Remove the tire valve cap.
- 2 Press the tip of the tire pressure gauge onto the tire valve.
- 3 Read the pressure using the gauge gradations.
- 4 If the tire inflation pressure is not at the recommended level, adjust the pressure. If you add too much air, press the center of the valve to deflate.
- 5 After completing the tire inflation pressure measurement and adjustment, apply soapy water to the valve and check for leakage.
- 6 Put the tire valve cap back on.

**■ Tire inflation pressure check interval**

You should check tire inflation pressure every two weeks, or at least once a month. Do not forget to check the spare.

**■ Effects of incorrect tire inflation pressure**

Driving with incorrect tire inflation pressure may result in the following:

- Reduced fuel economy
- Reduced driving comfort and poor handling
- Reduced tire life due to wear
- Reduced safety
- Damage to the drive train

If a tire needs frequent inflating, have it checked by your Toyota dealer.

**Inspection and adjustment procedure**

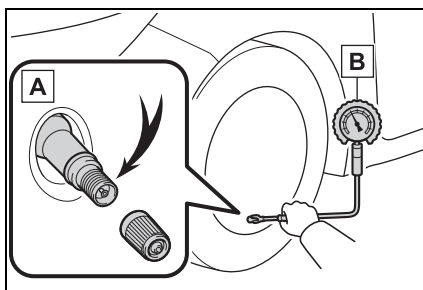

**A** Tire valve



**■ Instructions for checking tire inflation pressure**

When checking tire inflation pressure, observe the following:

- Check only when the tires are cold.  
If your vehicle has been parked for at least 3 hours or has not been driven for more than 1 mile or 1.5 km, you will get an accurate cold tire inflation pressure reading.
- Always use a tire pressure gauge. It is difficult to judge if a tire is properly inflated based only on its appearance.
- It is normal for the tire inflation pressure to be higher after driving as heat is generated in the tire. Do not reduce tire inflation pressure after driving.
- Never exceed the vehicle capacity weight.  
Passengers and luggage weight should be placed so that the vehicle is balanced.

- Greater possibility of tire damage while driving (due to road hazards, expansion joints, sharp edges in the road, etc.)

 NOTICE

**■ When inspecting and adjusting tire inflation pressure**

Be sure to put the tire valve caps back on.  
If a valve cap is not installed, dirt or moisture may get into the valve and cause an air leak, resulting in decreased tire inflation pressure.

 **WARNING**

**■ Proper inflation is critical to save tire performance**

Keep your tires properly inflated. If the tires are not properly inflated, the following conditions may occur which could lead to an accident resulting in death or serious injury:

- Excessive wear
- Uneven wear
- Poor handling
- Possibility of blowouts resulting from overheated tires
- Air leaking from between tire and wheel
- Wheel deformation and/or tire damage

## Wheels

**If a wheel is bent, cracked or heavily corroded, it should be replaced. Otherwise, the tire may separate from the wheel or cause a loss of handling control.**

### Wheel selection

When replacing wheels, care should be taken to ensure that they are equivalent to those removed in load capacity, diameter, rim width and inset\*.

Replacement wheels are available at your Toyota dealer.

\*: Conventionally referred to as offset.

Toyota does not recommend using the following:

- Wheels of different sizes or types
- Used wheels
- Bent wheels that have been straightened

#### ■ When replacing wheels (vehicles with a tire pressure warning system)

The wheels of your vehicle are equipped with tire pressure warning valves and transmitters that allow the tire pressure warning system to provide advance warning in the event of a loss in tire inflation pressure. Whenever wheels are replaced, the tire pressure warning valves and transmitters must be installed. (→P.480)

### WARNING

#### ■ When replacing wheels

- Do not use wheels that are a different size from those recommended in the Owner's Manual, as this may result in a loss of handling control.
- Never use an inner tube in a leaking wheel which is designed for a tubeless tire. Doing so may result in an accident, causing death or serious injury.

#### ■ When installing the wheel nuts

- Be sure to install the wheel nuts with the tapered ends facing inward. (P.539) Installing the nuts with the tapered ends facing outward can cause the wheel to break and eventually cause the wheel to come off while driving, which could lead to an accident resulting in death or serious injury.
- Never use oil or grease on the wheel bolts or wheel nuts. Oil and grease may cause the wheel nuts to be excessively tightened, leading to bolt or disc wheel damage. In addition, the oil or grease can cause the wheel nuts to loosen and the wheel may fall off, causing an accident and resulting in death or serious injury. Remove any oil or grease from the wheel bolts or wheel nuts.

#### ■ Use of defective wheels prohibited

Do not use cracked or deformed wheels. Doing so could cause the tire to leak air during driving, possibly causing an accident.

 **NOTICE**

- **Replacing tire pressure warning valves and transmitters (vehicles with a tire pressure warning system)**
  - Because tire repair or replacement may affect the tire pressure warning valves and transmitters, make sure to have tires serviced by your Toyota dealer or other qualified service shop. In addition, make sure to purchase your tire pressure warning valves and transmitters at your Toyota dealer.
  - Ensure that only genuine Toyota wheels are used on your vehicle. Tire pressure warning valves and transmitters may not work properly with non-genuine wheels.

**Aluminum wheel precautions (if equipped)**

- Use only Toyota wheel nuts and wheel nut wrenches designed for use with your aluminum wheels.
- When rotating, repairing or changing your tires, check that the wheel nuts are still tight after driving 1000 miles (1600 km).
- Be careful not to damage the aluminum wheels when using tire chains.
- Use only Toyota genuine balance weights or equivalent and a plastic or rubber hammer when balancing your wheels.

**Air conditioning filter**

**The air conditioning filter must be changed regularly to maintain air conditioning efficiency.**

**Removing the air conditioning filter**

- 1 Turn the engine switch off.
- 2 Open the glove box. Slide off the damper (if equipped).

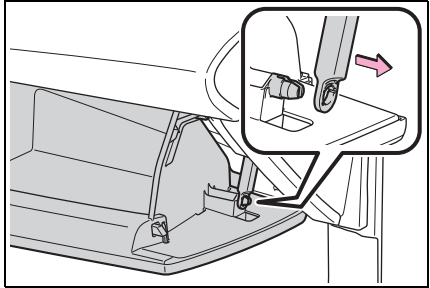

- 3 Push in the glove box on the vehicle's outer side to disconnect the claws. Then pull out the glove box and disconnect the lower claws.

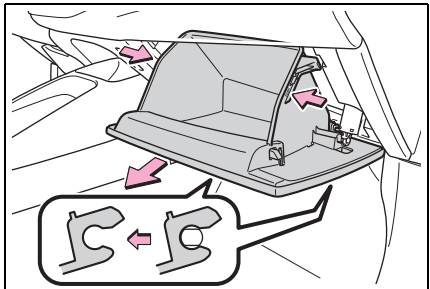

- 4 Unlock the filter cover (A), pull the filter cover out of the

7  
Maintenance and care

claws (B), and remove the filter cover.

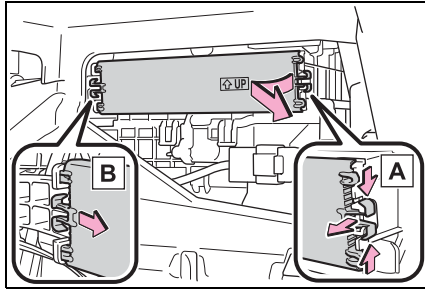

5 Remove the filter case.

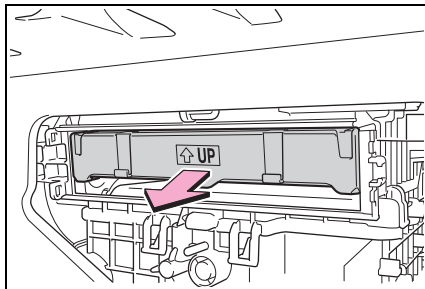

6 Remove the air conditioning filter from the filter case and replace it with a new one.

The “↑ UP” marks shown on the filter and the filter case should be pointing up.

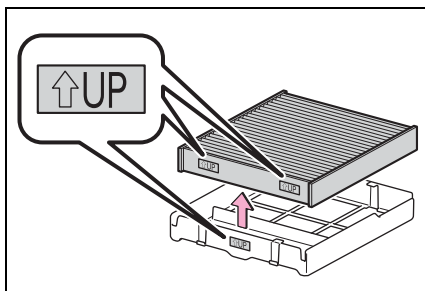

■ **Checking interval**

Replace the air conditioning filter according to the maintenance schedule. In dusty areas or areas with heavy traffic flow, early replace-

ment may be required. (For scheduled maintenance information, please refer to the “Scheduled Maintenance Guide” or “Owner’s Manual Supplement”.)

■ **If air flow from the vents decreases dramatically**

The filter may be clogged. Check the filter and replace if necessary.

⚠ NOTICE

■ **When using the air conditioning system**

Make sure that a filter is always installed. Using the air conditioning system without a filter may cause damage to the system.

■ **To prevent damage to the filter cover**

When moving the filter cover in the direction of arrow to release the fitting, pay attention not to apply excessive force to the claws. Otherwise, the claws may be damaged.

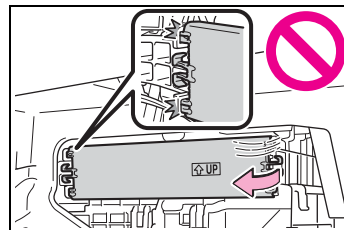

Wireless remote control/electronic key battery\*

\*: If equipped

**Replace the battery with a new one if it is depleted. As the key may be damaged if the following procedure is not performed properly, it is recommended that key battery replacement be performed by your Toyota dealer.**

**■ If the key battery is depleted**

The following symptoms may occur:

- The smart key system (if equipped) and wireless remote control will not function properly.
- The operational range will be reduced.

**Items to prepare**

- Flathead screwdriver
- Small flathead screwdriver
- Lithium battery CR2032

**■ Use a CR2032 lithium battery**

- Batteries can be purchased at your Toyota dealer, local electrical appliance shops or camera stores.
- Replace only with the same or equivalent type recommended by the manufacturer.
- Dispose of used batteries according to local laws.

**Replacing the battery**

- ▶ Vehicles without a smart key system

1 Remove the key cover.

To prevent damage to the key, cover the tip of the flathead screwdriver with a rag.

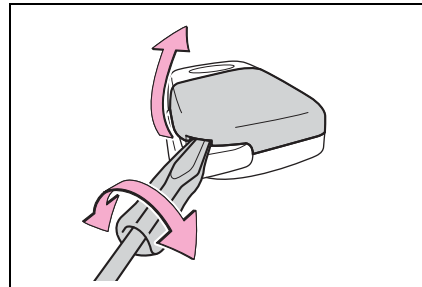

2 Remove the battery cover.

If the battery cover is difficult to remove, lift the edge to remove it.

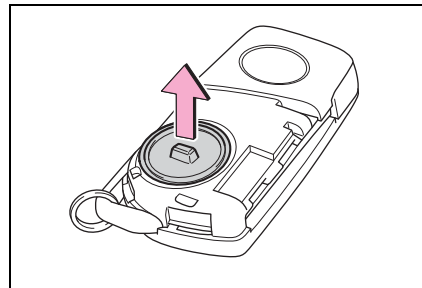

3 Remove the depleted battery using a small flathead screwdriver.

Insert a new battery with the “+” ter-

terminal facing up.

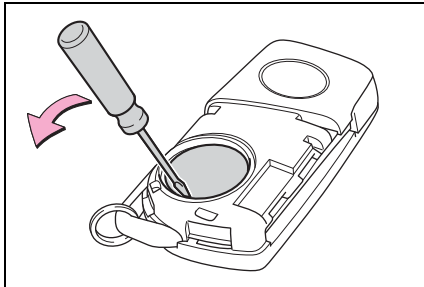

4 Install the battery cover with the tab facing up.

Push the entire edge of the battery cover into the key.

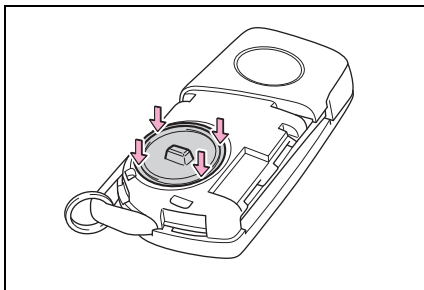



5 Install the key cover.

Align the key cover with the key and then press it straight into the key.

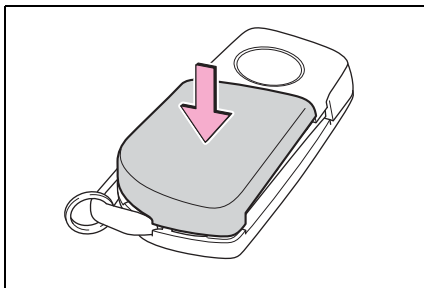
Make sure that the key cover is securely installed without any gaps between it and the key.



6 Operate the  or  switch and check that the doors can be locked/unlocked.

► Vehicles with a smart key system

1 Release the lock and remove the mechanical key.

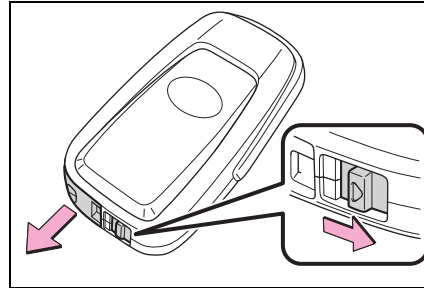

2 Remove the key cover.

To prevent damage to the key, cover the tip of the flathead screwdriver with a rag.

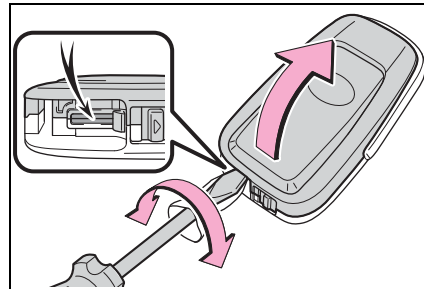



3 Remove the depleted battery using a small flathead screwdriver.

When removing the cover, the electronic key module may stick to the cover and the battery may not be visible. In this case, remove the electronic key module in order to remove the battery.

Insert a new battery with the “+” ter-

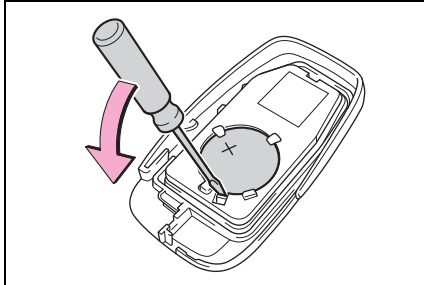
terminal facing up.



- 4 When installing the key cover and mechanical key, install by conducting step 2 and step 1 with the directions reversed.
- 5 Operate the  or  switch and check that the doors can be locked/unlocked.

 **WARNING**

■ **Battery precautions**

Observe the following precautions. Failure to do so may result in death or serious injury.

- Do not swallow the battery. Doing so may cause chemical burns.
- A coin battery or button battery is used in the key. If a battery is swallowed, it may cause severe chemical burns in as little as 2 hours and may result in death or serious injury.
- Keep away new and removed batteries from children.
- If the cover cannot be firmly closed, stop using the key and stow the key in the place where children cannot reach, and then contact your Toyota dealer.

● If you accidentally swallow a battery or put a battery into a part of your body, get emergency medical attention immediately.

■ **To prevent battery explosion or leakage of flammable liquid or gas**

- Replace the battery with a new battery of the same type. If a wrong type of battery is used, it may explode.
- Do not expose batteries to extremely low pressure due to high altitude or extremely high temperatures.
- Do not burn, break or cut a battery.

 **NOTICE**

■ **When replacing the battery**

Use a flathead screwdriver of appropriate size. Applying excessive force may deform or damage the cover.

■ **For normal operation after replacing the battery**

Observe the following precautions to prevent accidents:

- Always work with dry hands. Moisture may cause the battery to rust.
- Do not touch or move any other component inside the remote control.
- Do not bend either of the battery terminals.



**NOTICE**

**When removing the battery cover (vehicles without a smart key system)**

Do not forcibly remove the battery cover, otherwise it may be damaged.

If the battery cover is difficult to remove, lift the edge to remove it.

**Checking and replacing fuses**

**If any of the electrical components do not operate, a fuse may have blown. If this happens, check and replace the fuses as necessary.**

**Checking and replacing fuses**

- 1 Turn the engine switch off.
- 2 Open the fuse box cover.
  - ▶ Engine compartment: type A fuse box

Push the tabs in and lift the lid off.

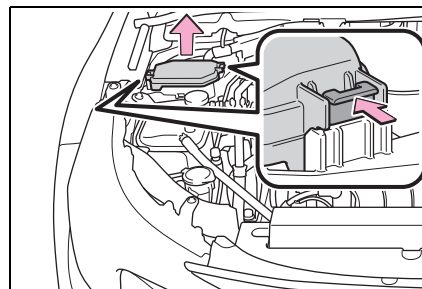

- ▶ Engine compartment: type B fuse box

Push the tabs in and lift the lid off.

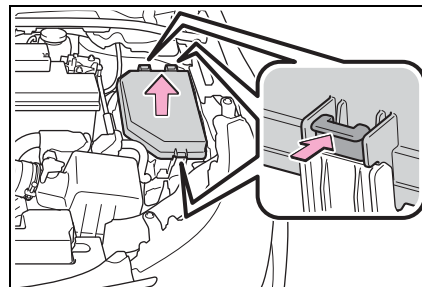



- ▶ Under the driver's side instrument panel

Remove the lid.

Make sure to push the claw when removing/installing the lid.

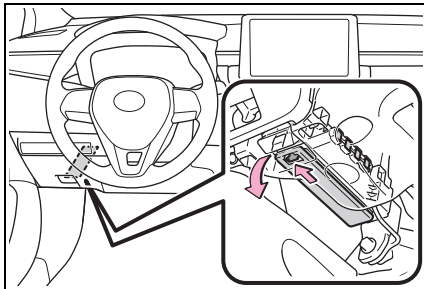

- 3 Remove the fuse with the pullout tool. Only type A fuse can be removed using the pullout tool.

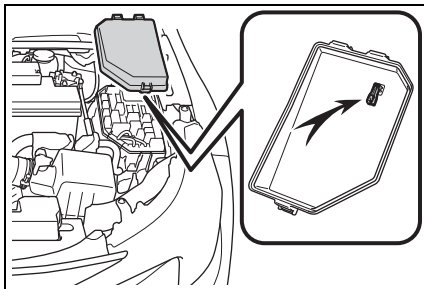

- 4 Check if the fuse is blown. Replace the blown fuse with a new fuse of an appropriate amperage rating. The amperage rating can be found on the fuse box lid.

- ▶ Type A

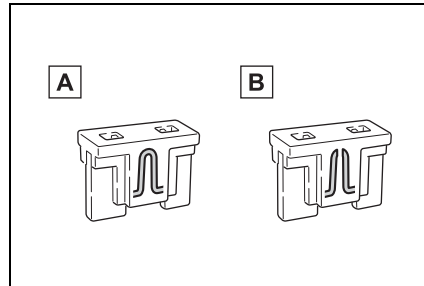

- A Normal fuse
- B Blown fuse

- ▶ Type B

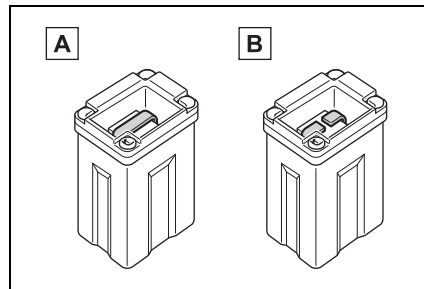

- A Normal fuse
- B Blown fuse

- ▶ Type C

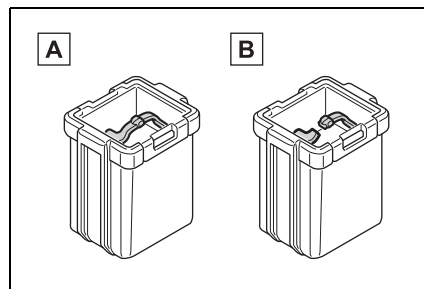

- A Normal fuse
- B Blown fuse

► Type D

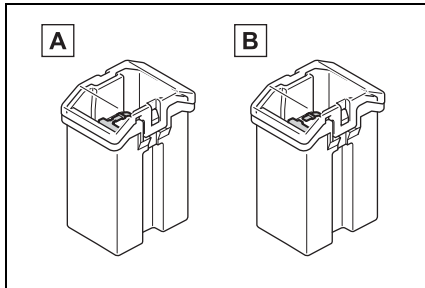

**A** Normal fuse

**B** Blown fuse

► Type E

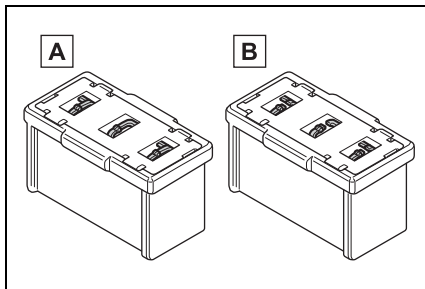

**A** Normal fuse

**B** Blown fuse

■ **After a fuse is replaced**

- When installing the lid, make sure that the tab is installed securely.
- If the lights do not turn on even after the fuse has been replaced, a bulb may need replacement. (→P.495)
- If the replaced fuse blows again, have the vehicle inspected by your Toyota dealer.

■ **If there is an overload in a circuit**

The fuses are designed to blow, protecting the wiring harness from damage.

■ **When replacing light bulbs**

Toyota recommends that you use genuine Toyota products designed for this vehicle. Because certain bulbs are connected to circuits designed to prevent overload, non-genuine parts or parts not designed for this vehicle may be unusable.

**! WARNING**

■ **To prevent system breakdowns and vehicle fire**

Observe the following precautions.

Failure to do so may cause damage to the vehicle, and possibly a fire or injury.

- Never use a fuse of a higher amperage rating than that indicated, or use any other object in place of a fuse.
- Always use a genuine Toyota fuse or equivalent. Never replace a fuse with a wire, even as a temporary fix.
- Do not modify the fuses or fuse boxes.

**! NOTICE**

■ **Before replacing fuses**

Have the cause of electrical overload determined and repaired by your Toyota dealer as soon as possible.

**Light bulbs**

You may replace the following bulbs yourself. The difficulty level of replacement varies depending on the bulb. If necessary bulb replacement seems difficult to perform, contact your Toyota dealer.

For more information about replacing other light bulbs, contact your Toyota dealer.

**Preparing for light bulb replacement**

Check the wattage of the light bulb to be replaced. (→P.566)

**Bulb locations**

■ **Front**

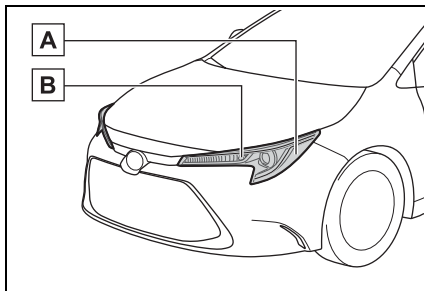

- A** Front side marker lights
- B** Front turn signal/parking lights (vehicles without side turn signal lights)

■ **Rear**

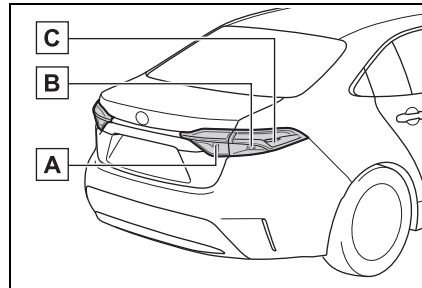

- A** Back-up lights
- B** Rear turn signal lights
- C** Rear side marker lights (bulb type)

■ **Bulbs that need to be replaced by your Toyota dealer**

- Headlights/daytime running lights
- Parking lights (vehicles with side turn signal lights)
- Front turn signal lights (vehicles with side turn signal lights)
- LED accent lights (if equipped)
- Side turn signal lights (if equipped)
- Tail lights
- Stop lights
- Rear side marker lights (LED type)
- High mounted stoplight
- License plate lights

### ■ LED light bulbs

The lights other than the front turn signal lights/parking lights (vehicles without side turn signal lights), front side marker lights, rear turn signal lights, rear side marker lights (bulb type) and back-up lights consist of a number of LEDs. If any of the LEDs burn out, take your vehicle to your Toyota dealer to have the light replaced.

### ■ Condensation build-up on the inside of the lens

In certain situations, such as when driving in the rain or when washing the vehicle, condensation may form on the inner side of the headlight lens and other lights. As each light has a ventilation hole, moist air may enter. If the ambient temperature is low, condensation may form temporarily, but it will dissipate as the inside of the light is warmed up. As the condensation is due to a phenomenon similar to windows fogging in the rain, it does not indicate a malfunction.

Contact your Toyota dealer for more information in the following situations:

- Large drops of water have built up on the inside of the lens.
- Water has built up inside the headlight.

### ■ When replacing light bulbs

→P.494

## Replacing light bulbs

### ■ Front turn signal/parking lights (vehicles without side turn signal lights)

- 1 Turn the bulb base counter-clockwise.

#### ▶ Type A

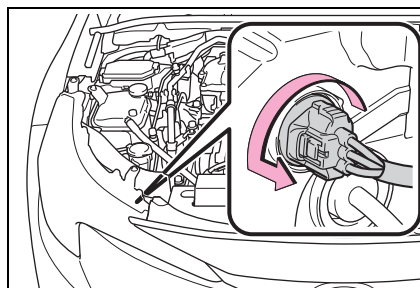

#### ▶ Type B

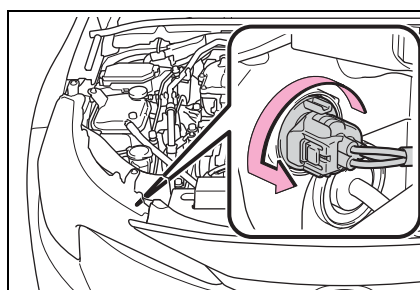

- 2 Remove the light bulb.

#### ▶ Type A

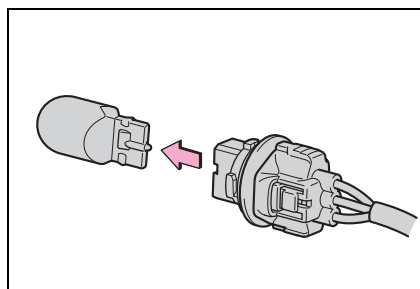

► Type B

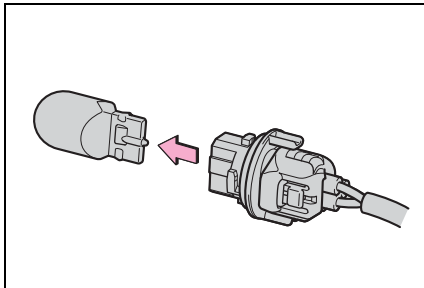

3 When installing, reverse the steps listed.

■ Front side marker lights

1 Turn the bulb base counter-clockwise.

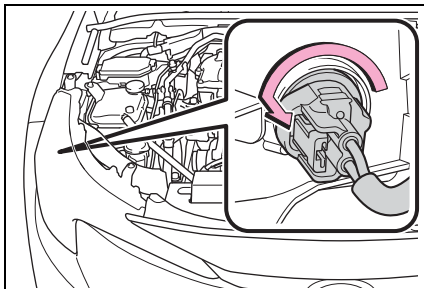

2 Remove the light bulb.

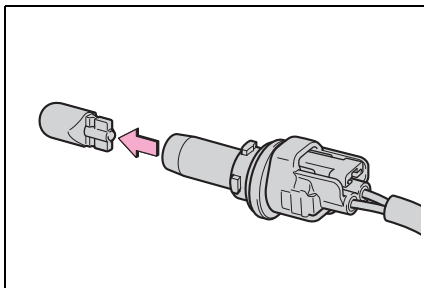

3 When installing, reverse the steps listed.

■ Rear turn signal lights and rear side marker lights (vehicles with blub type rear side marker lights)

- 1 Open the trunk lid.
- 2 Insert a flathead screwdriver between the cover and the light assembly and pry up the cover to disengage the claws (indicated by a dotted line).

To prevent scratching the vehicle, wrap the tip of the flathead screwdriver with a cloth, etc.

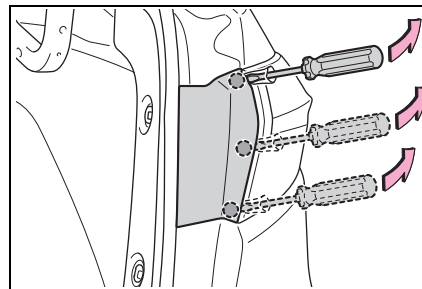

3 Pull the cover toward the rear of the vehicle and remove the cover.

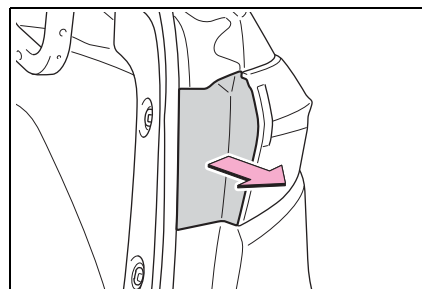

- 4 Remove the 2 screws and then remove the light assembly by pulling it straight back.

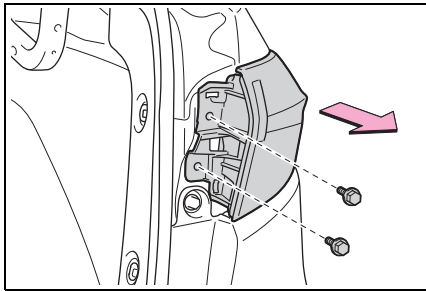

- 5 Turn the bulb base counter-clockwise.

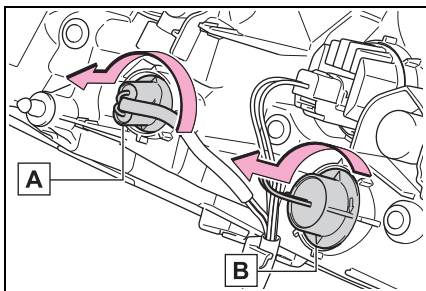

- A** Rear side marker lights
  - B** Rear turn signal lights
- 6 Remove the light bulb.

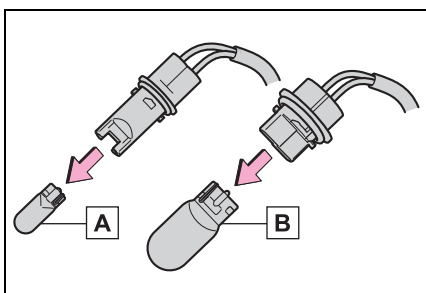

- A** Rear side marker lights
- B** Rear turn signal lights

- 7 When installing the light bulb, install it by conducting steps

- 6 and 5 with the directions reversed.

- 8 Install the light assembly and then install the 2 screws.

Align the guide **A** and pin **B** on the light assembly with the mounting when installing it.

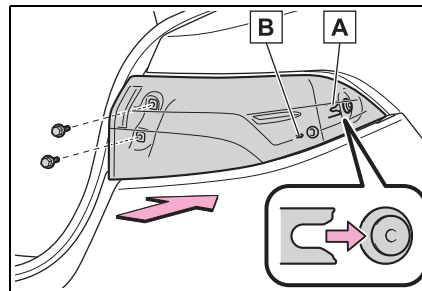

- 9 Install the cover.

■ **Rear turn signal lights (vehicles with LED type rear side marker lights)**

- 1 Open the trunk lid.
- 2 Insert a flathead screwdriver between the cover and the light assembly and pry up the cover to disengage the claws (indicated by a dotted line).

To prevent scratching the vehicle, wrap the tip of the flathead screwdriver with a cloth, etc.

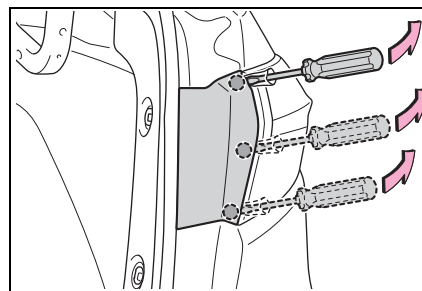

- 3 Pull the cover toward the rear of the vehicle and remove the cover.

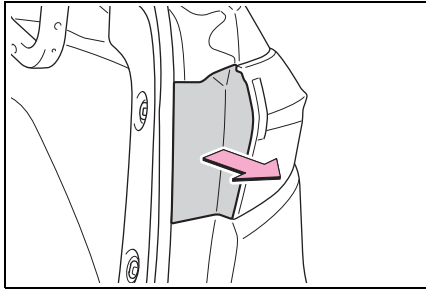

- 4 Remove the 2 screws and then remove the light assembly by pulling it straight back.

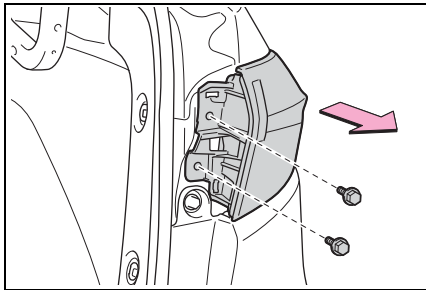

- 5 Turn the bulb base counter-clockwise.

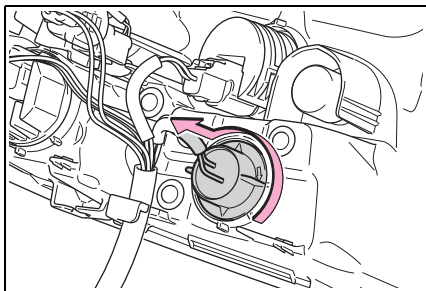

- 6 Remove the light bulb.

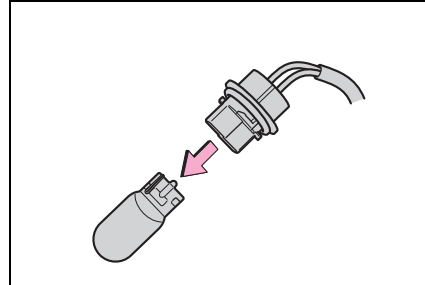

- 7 When installing the light bulb, install it by conducting steps 6 and 5 with the directions reversed.

- 8 Install the light assembly and then install the 2 screws.

Align the guide **A** and pin **B** on the light assembly with the mounting when installing it.

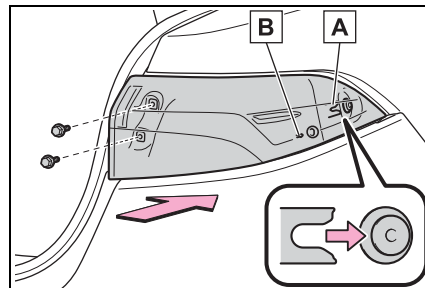

- 9 Install the cover.

■ **Back-up lights**

- 1 Open the trunk lid, remove the clips, and pull back the cover.

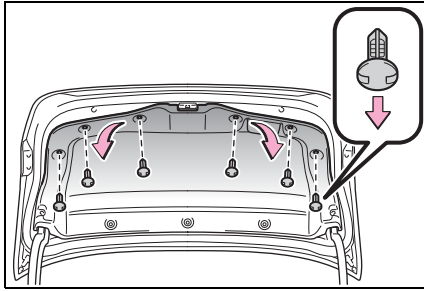

- 2 Turn the bulb base counter-clockwise and remove it.

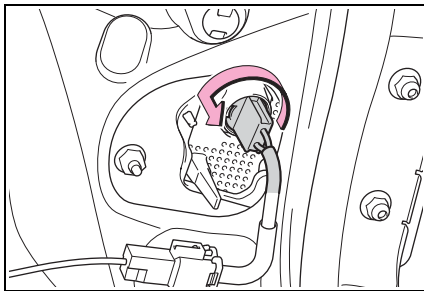

- 3 Remove the light bulb.

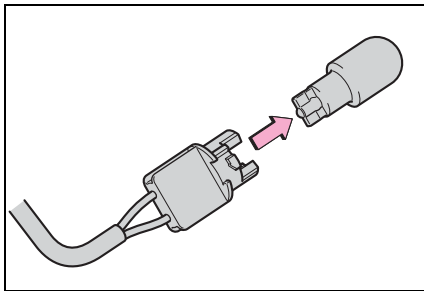

- 4 When installing, reverse the steps listed.

**! WARNING**

■ **Replacing light bulbs**

- Turn off the lights. Do not attempt to replace the bulb immediately after turning off the lights. The bulbs become very hot and may cause burns.
- Do not touch the glass portion of the light bulb with bare hands. When it is unavoidable to hold the glass portion, use and hold with a clean dry cloth to avoid getting moisture and oils on the bulb. Also, if the bulb is scratched or dropped, it may blow out or crack.
- Fully install light bulbs and any parts used to secure them. Failure to do so may result in heat damage, fire, or water entering the light unit. This may damage the lights or cause condensation to build up on the lens.

■ **To prevent damage or fire**

Make sure bulbs are fully seated and locked.



**When trouble arises****8****8-1. Essential information**

Emergency flashers .... 502

If your vehicle has to be  
stopped in an emergency  
..... 502If the vehicle is trapped in  
rising water..... 504**8-2. Steps to take in an emergency**If your vehicle needs to be  
towed..... 505If you think something is  
wrong ..... 509Fuel pump shut off system  
..... 510If a warning light turns on or  
a warning buzzer sounds  
..... 511

If a warning message is displayed..... 521

If you have a flat tire (vehicles  
without spare tire)  
..... 523If you have a flat tire (vehicles  
with a spare tire)  
..... 534If the engine will not start  
..... 542

If you lose your keys ... 544

If the electronic key does  
not operate properly.. 544

If the vehicle battery is discharged ..... 546

If your vehicle overheats  
..... 550If the vehicle becomes stuck  
..... 553

## Emergency flashers

**The emergency flashers are used to warn other drivers when the vehicle has to be stopped on the road due to a breakdown, etc.**

### Operating instructions

Press the switch.

All the turn signal lights will flash.

To turn them off, press the switch once again.

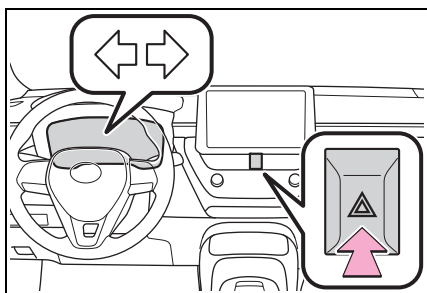

### Emergency flashers

- If the emergency flashers are used for a long time while the engine is not operating, the battery may discharge.
- If any of the SRS airbags deploy (inflate) or in the event of a strong rear impact, the emergency flashers will turn on automatically. The emergency flashers will turn off automatically after operating for approximately 20 minutes. To manually turn the emergency flashers off, press the switch twice.  
(The emergency flashers may not turn on automatically depending on the force of the impact and conditions of the collision.)

**If your vehicle has to be stopped in an emergency**

**Only in an emergency, such as if it becomes impossible to stop the vehicle in the normal way, stop the vehicle using the following procedure:**

### Stopping the vehicle

- 1 Steadily step on the brake pedal with both feet and firmly depress it.  
Do not pump the brake pedal repeatedly as this will increase the effort required to slow the vehicle.
- 2 Shift the shift lever to N.
  - ▶ If the shift lever is shifted to N
- 3 After slowing down, stop the vehicle in a safe place by the road.
- 4 Stop the engine.
  - ▶ If the shift lever cannot be shifted to N
- 3 Keep depressing the brake pedal with both feet to reduce vehicle speed as much as possible.
- 4 Vehicles without a smart key system: Stop the engine by

turning the engine switch to ACC.

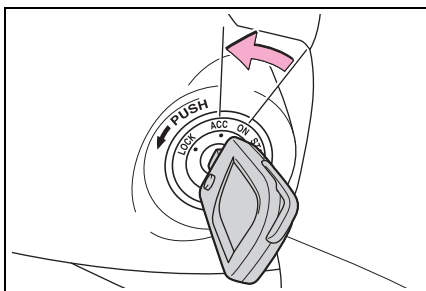

- Vehicles without a smart key system: Never attempt to remove the key, as doing so will lock the steering wheel.

- 4 Vehicles with a smart key system: To stop the engine, press and hold the engine switch for 2 consecutive seconds or more, or press it briefly 3 times or more in succession.

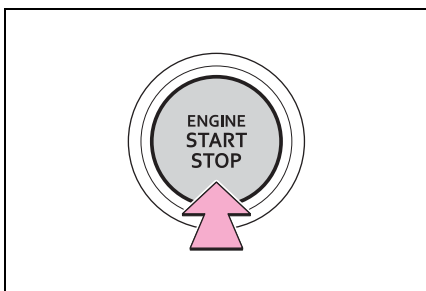

- 5 Stop the vehicle in a safe place by the road.

**⚠ WARNING**

■ **If the engine has to be turned off while driving**

- Power assist for the brakes and steering wheel will be lost, making the brake pedal harder to depress and the steering wheel heavier to turn. Decelerate as much as possible before turning off the engine.

**If the vehicle is trapped in rising water**

**In the event the vehicle is submerged in water, remain calm and perform the following.**

- Remove the seat belt first.
- If the door can be opened, open the door and exit the vehicle.
- If the door can not be opened, open the window using the power window switch and exit the vehicle through the window.
- If the window can not be opened using the power window switch, remain calm, wait until the water level inside the vehicle rises to the point that the water pressure inside of the vehicle equals the water pressure outside of the vehicle, and then open the door and exit the vehicle.

 **WARNING****■ Using an emergency hammer\* for emergency escape**

The front side windows and rear side windows, as well as the rear window can be shattered with an emergency hammer\* used for emergency escape. However, an emergency hammer\* can not shatter the windshield as it is laminated glass.

\*: Contact your Toyota dealer or aftermarket accessory manufacturer for further information about an emergency hammer.

**■ Escaping the vehicle from the window**

There are cases where escaping the vehicle from the window is not possible due to seating position, passenger body type, etc. When using an emergency hammer, consider your seat location and the size of the window opening to ensure that the opening is accessible and large enough to escape.

**If your vehicle needs to be towed**

**If towing is necessary, we recommend having your vehicle towed by your Toyota dealer or commercial towing service, using a wheel-lift type truck or flat-bed truck.**

**Use a safety chain system for all towing, and abide by all state/provincial and local laws.**

**⚠ WARNING**

Observe the following precautions. Failure to do so may result in death or serious injury.

**■ When towing the vehicle**

Be sure to transport the vehicle with the front wheels raised or with all four wheels raised off the ground. If the vehicle is towed with the front wheels contacting the ground, the drivetrain and related parts may be damaged.

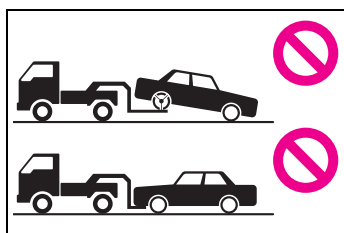

**■ While towing**

● When towing using cables or chains, avoid sudden starts, etc. which place excessive stress on the towing eyelets, cables or chains. The towing eyelets, cables or chains may become damaged, broken debris may hit people, and cause serious damage.

● Do not turn the engine switch off. There is a possibility that the steering wheel is locked and cannot be operated.

**■ Installing towing eyelets to the vehicle**

Make sure that towing eyelets are installed securely. If not securely installed, towing eyelets may come loose during towing.

**⚠ NOTICE**

**■ To prevent damage to the vehicle when towing using a wheel-lift type truck**

● Vehicles without a smart key system: Do not tow the vehicle from the rear when the engine switch is off or the key is removed. The steering lock mechanism is not strong enough to hold the front wheels straight.

● Vehicles with a smart key system: Do not tow the vehicle from the rear when the engine switch is off. The steering lock mechanism is not strong enough to hold the front wheels straight.

 **NOTICE**

- When raising the vehicle, ensure adequate ground clearance for towing at the opposite end of the raised vehicle. Without adequate clearance, the vehicle could be damaged while being towed.
- **To prevent damage to the vehicle when towing with a sling-type truck**  
Do not tow with a sling-type truck, either from the front or rear.
- **To prevent damage to the vehicle during emergency towing**  
Do not secure cables or chains to the suspension components.

**Situations when it is necessary to contact dealers before towing**

The following may indicate a problem with your transmission. Contact your Toyota dealer or commercial towing service before towing.

- The engine is running but the vehicle does not move.
- The vehicle makes an abnormal sound.

**Towing with a wheel-lift type truck**

► From the front

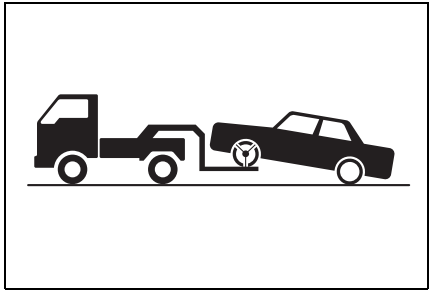

Release the parking brake.  
Vehicles with electric parking brake: Turn automatic mode off. (→P.182)

► From the rear

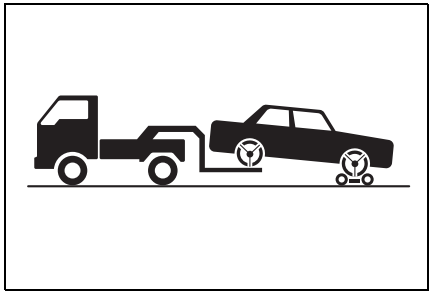

Use a towing dolly under the front wheels.

**NOTICE****■ Towing with a sling-type truck**

Do not tow with a sling-type truck to prevent body damage.

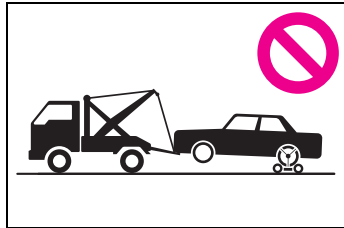
**Using a flatbed truck**

When using a flat-bed truck to transport the vehicle, use tire strapping belts. Refer to the owner's manual of the flat-bed truck for the tire strapping method.

In order to suppress vehicle movement during transportation, set the parking brake and turn the engine switch off.

**Emergency towing (vehicles with a towing eyelet)**

If a tow truck is not available in an emergency, your vehicle may be temporarily towed using cables or chains secured to the emergency towing eyelets. This should only be attempted on hard surfaced roads for at most 50 miles (80 km) at under 18 mph (30 km/h).

A driver must be in the vehicle to steer and operate the brakes. The vehicle's wheels, drive train,

axles, steering and brakes must be in good condition.

For vehicles with a continuously variable transmission, only the front towing eyelets may be used.

**Emergency towing procedure (vehicles with a towing eyelet)**

To have your vehicle towed by another vehicle, the towing eyelet must be installed to your vehicle. Install the towing eyelet using the following procedure.

- 1 Take out the wheel nut wrench (if equipped) and towing eyelet. (→P.525, 535)
- 2 Remove the eyelet cover using a flathead screwdriver.

To protect the bodywork, place a rag between the screwdriver and the vehicle body as shown in the illustration.

- ▶ 1.8 L 4-cylinder (2ZR-FAE) engine

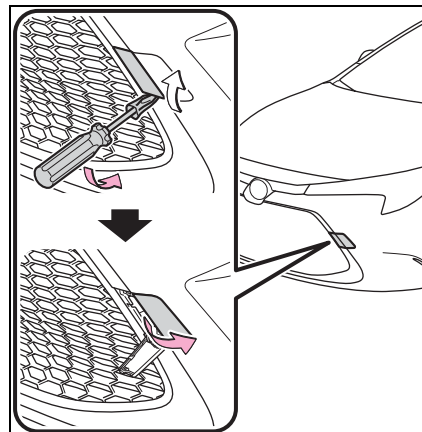

- ▶ 2.0 L 4-cylinder (M20A-FKS) engine

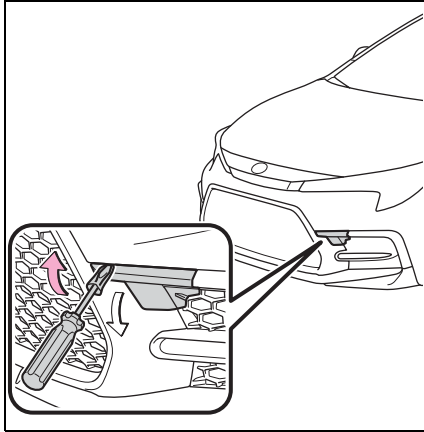

- 3 Insert the towing eyelet into the hole and tighten partially by hand.

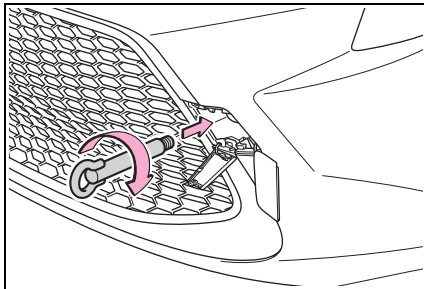

- 4 Tighten down the towing eyelet securely using a wheel nut wrench (if equipped) or hard metal bar.

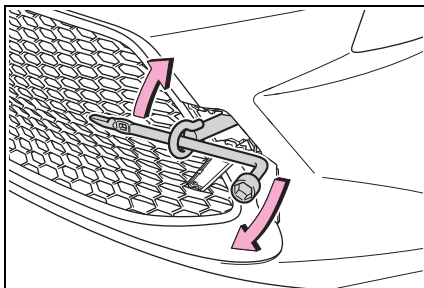

- 5 Securely attach cables or chains to the towing eyelet.

Take care not to damage the vehicle body.

- 6 Enter the vehicle being towed and start the engine.

If the engine does not start, turn the engine switch to ON.

- 7 Shift the shift lever to N and release the parking brake.  
 Vehicles with electric parking brake: Turn automatic mode off. (→P.182)  
 Continuously variable transmission: When the shift lever cannot be shifted: →P.171

■ **While towing (vehicles with a towing eyelet)**

If the engine is not running, the power assist for the brakes and steering will not function, making steering and braking more difficult.

■ **Wheel nut wrench (vehicles with a towing eyelet)**

Vehicle without wheel nut wrench: Wheel nut wrench can be purchased at your Toyota dealer.

Vehicle with wheel nut wrench: Wheel nut wrench is installed in trunk. (→P.535)



### If you think something is wrong

**If you notice any of the following symptoms, your vehicle probably needs adjustment or repair. Contact your Toyota dealer as soon as possible.**

#### Visible symptoms

- Fluid leaks under the vehicle. (Water dripping from the air conditioning after use is normal.)
- Flat-looking tires or uneven tire wear
- Engine coolant temperature gauge needle continually points higher than normal.

#### Audible symptoms

- Changes in exhaust sound
- Excessive tire squeal when cornering
- Strange noises related to the suspension system
- Pinging or other noises related to the engine

#### Operational symptoms

- Engine missing, stumbling or running roughly
- Appreciable loss of power
- Vehicle pulls heavily to one

side when braking

- Vehicle pulls heavily to one side when driving on a level road
- Loss of brake effectiveness, spongy feeling, pedal almost touches the floor

### Fuel pump shut off system

**To minimize the risk of fuel leakage when the engine stalls or when an airbag inflates upon collision, the fuel pump shut off system stops the supply of fuel to the engine.**

### Restarting the engine

Follow the procedure below to restart the engine after the system is activated.

- 1 Turn the engine switch to ACC or OFF.
- 2 Restart the engine.



#### NOTICE

#### ■ Before starting the engine



Inspect the ground under the vehicle.  
If you find that fuel has leaked onto the ground, the fuel system has been damaged and is in need of repair. Do not restart the engine.

If a warning light turns on or a warning buzzer sounds

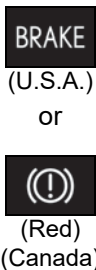

Calmly perform the following actions if any of the warning lights comes on or flashes. If a light comes on or flashes, but then goes off, this does not necessarily indicate a malfunction in the system. However, if this continues to occur, have the vehicle inspected by your Toyota dealer.

Actions to the warning lights or warning buzzers



■ Brake system warning light (warning buzzer)

Warning light	Details/Actions
 <p><b>BRAKE</b> (U.S.A.) or  (Red) (Canada)</p>	<p>Indicates that:</p> <ul style="list-style-type: none"> <li>● The brake fluid level is low; or</li> <li>● The brake system is malfunctioning</li> </ul> <p>→ <b>Immediately stop the vehicle in a safe place and contact your Toyota dealer. Continuing to drive the vehicle may be dangerous.</b></p>

■ Brake system warning light

Warning light	Details/Actions
 <p> (Yellow)</p>	<p>Indicates a malfunction in the parking brake system</p> <p>→ <b>Have the vehicle inspected by your Toyota dealer immediately.</b></p>

■ High coolant temperature warning light\* (warning buzzer)

Warning light	Details/Actions
 <p></p>	<p>Indicates that the engine coolant temperature is excessively high</p> <p>→ <b>Immediately stop the vehicle in a safe place. Handling method (→P.550)</b></p>

\*: This light illuminates on the multi-information display.

■ **Charging system warning light**



Warning light	Details/Actions
	Indicates a malfunction in the vehicle's charging system → <b>Immediately stop the vehicle in a safe place and contact your Toyota dealer.</b>

■ **Low engine oil pressure warning light\* (warning buzzer)**

Warning light	Details/Actions
	Indicates that the engine oil pressure is excessively low → <b>Immediately stop the vehicle in a safe place and contact your Toyota dealer.</b>

\*: This light illuminates on the multi-information display.



■ **Malfunction indicator lamp (warning buzzer)**

Warning light	Details/Actions
 (U.S.A.) or  (Canada)	Indicates a malfunction in: <ul style="list-style-type: none"> <li>● The electronic engine control system;</li> <li>● The electronic throttle control system; or</li> <li>● The electronic continuously variable transmission control system (if equipped)</li> </ul> → <b>Immediately stop the vehicle in a safe place and contact your Toyota dealer.</b>

■ **SRS warning light (warning buzzer)**

Warning light	Details/Actions
	Indicates a malfunction in: <ul style="list-style-type: none"> <li>● The SRS airbag system;</li> <li>● The front passenger occupant classification system; or</li> <li>● The seat belt pretensioner system</li> </ul> → <b>Have the vehicle inspected by your Toyota dealer immediately.</b>

■ **ABS warning light**



Warning light	Details/Actions
 <p>(U.S.A.) or</p>  <p>(Canada)</p>	<p>Indicates a malfunction in:</p> <ul style="list-style-type: none"> <li>● The ABS; or</li> <li>● The brake assist system</li> </ul> <p>→ <b>Have the vehicle inspected by your Toyota dealer immediately.</b></p>

■ **Brake Override System warning light/Drive-Start Control warning light\* (warning buzzer)**

Warning light	Details/Actions
	<p>When a buzzer sounds:</p> <p>Indicates a malfunction in:</p> <ul style="list-style-type: none"> <li>● The Brake Override System; or</li> <li>● The Drive-Start Control (if equipped)</li> </ul> <p>→ <b>Have the vehicle inspected by your Toyota dealer immediately.</b></p> <p>Indicates that the shift position was changed and Drive-Start Control (if equipped) was operated while depressing the accelerator pedal.</p> <p>→ <b>Momentarily release the accelerator pedal.</b></p> <p>When a buzzer does not sound:</p> <p>Indicates that the accelerator and brake pedals are being depressed simultaneously, and the Brake Override System is operating.</p> <p>→ <b>Release the accelerator pedal and depress the brake pedal.</b></p>

\* : This light illuminates on the multi-information display.

### ■ Electric power steering system warning light (warning buzzer)

Warning light	Details/Actions
 (Red) or  (Yellow)	Indicates a malfunction in the EPS (Electric Power Steering) system → <b>Have the vehicle inspected by your Toyota dealer immediately.</b>

### ■ Low fuel level warning light

Warning light	Details/Actions
	Indicates that remaining fuel is approximately 2 gal. (7.5 L, 1.6 Imp. gal.) or less → <b>Refuel the vehicle.</b>

### ■ Driver's and front passenger's seat belt reminder light (warning buzzer)\*

Warning light	Details/Actions
	Warns the driver and/or front passenger to fasten their seat belts → <b>Fasten the seat belt.</b> <b>If the front passenger's seat is occupied, the front passenger's seat belt also needs to be fastened to make the warning light (warning buzzer) turn off.</b>

\*: Driver's seat belt warning buzzer:

The driver's seat belt warning buzzer sounds to alert the driver that his or her seat belt is not fastened. Once the engine switch is turned to ON, the buzzer sounds. If the seat belt is still unfastened, the buzzer sounds intermittently for a certain period of time after the vehicle reaches a certain speed.

Front passenger's seat belt warning buzzer:

The front passenger's seat belt warning buzzer sounds to alert the front passenger that his or her seat belt is not fastened. If the seat belt is unfastened, the buzzer sounds intermittently for a certain period of time after the vehicle reaches a certain speed.

■ **Rear passengers' seat belt reminder lights (warning buzzer)\***

Warning light	Details/Actions
	Warns the rear passengers to fasten their seat belts → <b>Fasten the seat belt.</b>

\*: Rear passengers' seat belt warning buzzer:

The rear passengers' seat belt warning buzzer sounds to alert the rear passenger that his or her seat belt is not fastened. If the seat belt is unfastened, the buzzer sounds intermittently for a certain period of time, after the seat belt is fastened and unfastened and the vehicle reaches a certain speed.

■ **Tire pressure warning light**

Warning light	Details/Actions
 (if equipped)	When the light comes on after blinking for approximately 1 minute: Malfunction in the tire pressure warning system → <b>Have the system checked by your Toyota dealer.</b>  When the light comes on: Low tire inflation pressure such as ● Natural causes ● Flat tire → <b>Immediately stop the vehicle in a safe place.</b> <b>Handling method (→P.518)</b>

■ **LTA indicator/LDA indicator (warning buzzer)**

Warning light	Details/Actions
 (Orange)	Indicates a malfunction in the LTA (Lane Tracing Assist) or LDA (Lane Departure Alert with steering control) → <b>Follow the instructions displayed on the multi-information display. (→P.220, 228)</b>

■ RCTA OFF indicator (warning buzzer)

Warning light	Details/Actions
 <p>(Flashes) (if equipped)</p>	<p>Indicates a malfunction in the RCTA (Rear Cross Traffic Alert) function → <b>Have the vehicle inspected by your Toyota dealer immediately.</b></p> <p>Indicates that the rear bumper around the radar sensor is covered with dirt, etc. (→P.255) → <b>Follow the instructions displayed on the multi-information display. (→P.259)</b></p>

■ PCS warning light

Warning light	Details/Actions
 <p>(Flashes or illuminates)</p>	<p>When a buzzer sounds simultaneously: Indicates a malfunction has occurred in the PCS (Pre-Collision System). → <b>Have the vehicle inspected by your Toyota dealer immediately.</b></p> <p>If a buzzer does not sound: The PCS (Pre-Collision System) has become temporarily unavailable, corrective action may be necessary. → <b>Follow the instructions displayed on the multi-information display. (→P.201)</b></p> <p>If the PCS (Pre-Collision System) or VSC (Vehicle Stability Control) system is disabled, the PCS warning light will illuminate. → <b>P.210</b></p>

■ Slip indicator

Warning light	Details/Actions
	<p>Indicates a malfunction in:</p> <ul style="list-style-type: none"> <li>● The VSC system;</li> <li>● The TRAC system; or</li> <li>● The hill-start assist control system</li> </ul> <p>→ <b>Have the vehicle inspected by your Toyota dealer immediately.</b></p>



■ **Parking brake indicator**

Warning light	Details/Actions
 <p><b>PARK</b> (Flashes) (U.S.A.) or <b>(P)</b> (Flashes) (Canada)</p>	<p>It is possible that the parking brake is not fully engaged or released → <b>Operate the parking brake once again.</b></p> <p>This light comes on when the parking brake is not released. If the light turns off after the parking brake is fully released, the system is operating normally.</p>

■ **Brake hold operated indicator**

Warning light	Details/Actions
 <p><b>HOLD</b> (Flashes) (if equipped)</p>	<p>Indicates a malfunction in the brake hold system → <b>Have the vehicle inspected by your Toyota dealer immediately.</b></p>

■ **iMT indicator**

Warning light	Details/Actions
 <p><b>iMT</b> (Orange) (if equipped)</p>	<p>Indicates a malfunction in the iMT → <b>Have the vehicle inspected by your Toyota dealer immediately.</b></p>

■ **Warning buzzer**

In some cases, the buzzer may not be heard due to being in a noisy location or audio sound.

■ **Front passenger detection sensor, seat belt reminder and warning buzzer**

- If luggage is placed on the front passenger seat, the front passenger detection sensor may cause the warning light to flash and the warning buzzer to sound even if a passenger is not sitting in the seat.
- If a cushion is placed on the seat, the sensor may not detect a pas-

senger, and the warning light may not operate properly.

■ **Operation of rear passengers' seat belt reminder lights**

- The rear passengers' seat belt reminder lights will illuminate for approximately 60 seconds after either rear door has been opened and closed.
- If any rear seat belt is fastened and then unfastened, the corresponding light for that seat will illuminate continuously. If either rear door is opened and closed while a rear passengers' seat belt light is illuminated, it will turn off approximately 60 seconds after the door

is closed.

#### ■ SRS warning light

This warning light system monitors the airbag sensor assembly, front impact sensors, side impact sensors (front door), side impact sensors (front), side impact sensors (rear), driver's seat position sensor, driver's seat belt buckle switch, front passenger occupant classification system (ECU and sensors), "AIR BAG ON" indicator light, "AIR BAG OFF" indicator light, seat belt pretensioners, airbags, interconnecting wiring and power sources. (→P.32)

#### ■ Electric power steering system warning light (warning buzzer)

When the battery charge becomes insufficient or the voltage temporarily drops, the electric power steering system warning light may come on and the warning buzzer may sound.

#### ■ When the tire pressure warning light comes on (vehicles with a tire pressure warning system)

Inspect the tires to check if a tire is punctured.

If a tire is punctured: →P.523, 534

If none of the tires are punctured: Turn the engine switch off then turn it to ON. Check if the tire pressure warning light comes on or blinks.

- ▶ If the tire pressure warning light blinks for approximately 1 minute then stays on

There may be a malfunction in the tire pressure warning system. Have the vehicle inspected by your Toyota dealer immediately.

- ▶ If the tire pressure warning light comes on
  - 1 After the temperature of the tires has lowered sufficiently, check the inflation pressure of each tire and adjust them to the specified level.
  - 2 If the warning light does not turn off even after several minutes have elapsed, check that the

inflation pressure of each tire is at the specified level and perform initialization. (→P.481)

#### ■ The tire pressure warning light may come on due to natural causes (vehicles with a tire pressure warning system)

The tire pressure warning light may come on due to natural causes such as natural air leaks and tire inflation pressure changes caused by temperature. In this case, adjusting the tire inflation pressure will turn off the warning light (after a few minutes).

#### ■ When a tire is replaced with a spare tire (vehicles with a tire pressure warning system)

Vehicles with a compact spare tire: The compact spare tire is not equipped with a tire pressure warning valve and transmitter. If a tire goes flat, the tire pressure warning light will not turn off even though the flat tire has been replaced with the spare tire. Replace the spare tire with the repaired tire and adjust the tire inflation pressure. The tire pressure warning light will go off after a few minutes.

#### ■ Conditions that the tire pressure warning system may not function properly (vehicles with a tire pressure warning system)

→P.478

#### WARNING

#### ■ If both the ABS and the brake system warning lights remain on

Stop your vehicle in a safe place immediately and contact your Toyota dealer.

The vehicle will become extremely unstable during braking, and the ABS system may fail, which could cause an accident resulting in death or serious injury.

**⚠ WARNING****■ When the electric power steering system warning light comes on**

When the light comes on yellow, the assist to the power steering is restricted. When the light comes on red, the assist to the power steering is lost and handling operations of the steering wheel become extremely heavy.

When steering wheel operations are heavier than usual, grip the steering wheel firmly and operate it using more force than usual.

**■ If the tire pressure warning light comes on (vehicles with a tire pressure warning system)**

Be sure to observe the following precautions.

Failure to do so could cause a loss of vehicle control and result in death or serious injury.

- Stop your vehicle in a safe place as soon as possible. Adjust the tire inflation pressure immediately.
- Vehicles with a compact spare tire: If the tire pressure warning light comes on even after tire inflation pressure adjustment, it is probable that you have a flat tire. Check the tires. If a tire is flat, change it with the spare tire and have the flat tire repaired by the nearest Toyota dealer.
- Vehicles with emergency tire puncture repair kit: If the tire pressure warning light comes on even after tire inflation pressure adjustment, it is probable that you have a flat tire. Check the tires. If a tire is flat, repair the flat tire by using emergency tire puncture repair kit.

- Avoid abrupt maneuvering and braking.  
If the vehicle tires deteriorate, you could lose control of the steering wheel or the brakes.

**■ If a blowout or sudden air leakage should occur (vehicles with a tire pressure warning system)**

The tire pressure warning system may not activate immediately.

**■ Maintenance of the tires**

Each tire, including the spare (if provided), should be checked monthly when cold and inflated to the inflation pressure recommended by the vehicle manufacturer on the vehicle placard or tire inflation pressure label (tire and load information label). (If your vehicle has tires of a different size than the size indicated on the vehicle placard or tire inflation pressure label [tire and load information label], you should determine the proper tire inflation pressure for those tires.)

As an added safety feature, your vehicle has been equipped with a tire pressure monitoring system (TPMS-tire pressure warning system) that illuminates a low tire pressure telltale (tire pressure warning light) when one or more of your tires is significantly under-inflated. Accordingly, when the low tire pressure telltale (tire pressure warning light) illuminates, you should stop and check your tires as soon as possible, and inflate them to the proper pressure. Driving on a significantly under-inflated tire causes the tire to overheat and can lead to tire failure. Under-inflation also reduces fuel efficiency and tire tread life, and may affect the vehicle's handling and stopping ability.

 **WARNING**

Please note that the TPMS (tire pressure warning system) is not a substitute for proper tire maintenance, and it is the driver's responsibility to maintain correct tire pressure, even if under-inflation has not reached the level to trigger illumination of the TPMS low tire pressure telltale (tire pressure warning light).

Your vehicle has also been equipped with a TPMS (tire pressure warning system) malfunction indicator to indicate when the system is not operating properly. The TPMS (tire pressure warning system) malfunction indicator is combined with the low tire pressure telltale (tire pressure warning light). When the system detects a malfunction, the telltale will flash for approximately one minute and then remain continuously illuminated. This sequence will continue upon subsequent vehicle start-ups as long as the malfunction exists. When the malfunction indicator is illuminated, the system may not be able to detect or signal low tire pressure as intended.

TPMS (tire pressure warning system) malfunctions may occur for a variety of reasons, including the installation of replacement or alternate tires or wheels on the vehicle that prevent the TPMS (tire pressure warning system) from functioning properly. Always check the TPMS (tire pressure warning system) malfunction telltale after replacing one or more tires or wheels on your vehicle to ensure that the replacement or alternate tires and wheels allow the TPMS (tire pressure warning system) to continue to function properly.

 **NOTICE**

■ **To ensure the tire pressure warning system operates properly (vehicles with a tire pressure warning system)**

Do not install tires with different specifications or makers, as the tire pressure warning system may not operate properly.

### If a warning message is displayed

**The multi-information display shows warnings for system malfunctions and incorrectly performed operations, and messages that indicate a need for maintenance. When a message is displayed, perform the appropriate corrective action for the message.**

**If a warning message is displayed again after the appropriate actions have been performed, contact your Toyota dealer.**

**Additionally, if a warning light comes on or flashes at the same time that a warning message is displayed, take the appropriate corrective action for the warning light. (→P.511)**

#### ■ Warning messages

The warning messages explained below may differ from the actual messages according to operation conditions and vehicle specifications.

#### ■ Warning buzzer

A buzzer may sound when a message is displayed. The buzzer may not be audible if the vehicle is in a noisy location or if the audio system volume is high.

#### ■ If “Engine Oil Level Low Add or Replace” is displayed

The engine oil level is low. Check

the level of the engine oil, and add if necessary.

This message may appear if the vehicle is stopped on a slope. Move the vehicle to a level surface and check to see if the message disappears.

#### ■ If “Engine Stopped Steering Power Low” is displayed

This message is displayed if the engine is stopped while driving.

When steering wheel operations are heavier than usual, grip the steering wheel firmly and operate it using more force than usual.

#### ■ If “Auto Power OFF to Conserve Battery” is displayed

Power was cut off due to the automatic power off function. Next time when starting the engine, increase the engine speed slightly and maintain that level for approximately 5 minutes to recharge the battery.

#### ■ If “Headlight System Malfunction Visit Your Dealer” is displayed

The following systems may be malfunctioning. Have the vehicle inspected by your Toyota dealer immediately.

- The LED headlight system
- AFS (Adaptive Front-lighting System) (if equipped)
- The automatic headlight leveling system (if equipped)
- Automatic High Beam

#### ■ If a message that indicates the malfunction of front camera is displayed

The following systems may be suspended until the problem shown in the message is resolved. (→P.201, 511)

- PCS (Pre-Collision system)
- LTA (Lane Tracing Assist) (if equipped)
- LDA (Lane Departure Alert with

steering control) (if equipped)

- Automatic High Beam
- RSA (Road Sign Assist) (if equipped)
- Dynamic radar cruise control with full-speed range (if equipped)
- Dynamic radar cruise control (if equipped)

■ **If “Radar Cruise Control Unavailable See Owner’s Manual” is displayed**

The dynamic radar cruise control with full-speed range system or dynamic radar cruise control system is suspended temporarily or until the problem shown in the message is resolved. (causes and coping methods: →P.201)

■ **If “Radar Cruise Control Unavailable” is displayed**

The dynamic radar cruise control with full-speed range system or dynamic radar cruise control system cannot be used temporarily. Use the system when it becomes available again.

■ **If “Maintenance Required Soon” is displayed**

Indicates that all maintenance according to the driven distance on the maintenance schedule\* should be performed soon.

Comes on approximately 4500 miles (7200 km) after the message has been reset. If necessary, perform maintenance. Please reset the message after the maintenance is performed. (→P.458)

\*: Refer to the separate “Scheduled Maintenance” or “Owner’s Manual Supplement” for the maintenance interval applicable to your vehicle.

■ **If “Maintenance Required Visit Your Dealer” is displayed**

Indicates that all maintenance is required to correspond to the driven

distance on the maintenance schedule\*.

Comes on approximately 5000 miles (8000 km) after the message has been reset. (The indicator will not work properly unless the message has been reset.) Perform the necessary maintenance. Please reset the message after the maintenance is performed. (→P.458)

\*: Refer to the separate “Scheduled Maintenance” or “Owner’s Manual Supplement” for the maintenance interval applicable to your vehicle.

■ **If a message that indicates the need for visiting your Toyota dealer is displayed**

The system or part shown on the multi-information display is malfunctioning. Have the vehicle inspected by your Toyota dealer immediately.

■ **If a message that indicates the need for referring to Owner’s Manual is displayed**

- If “Engine Coolant Temp High” is displayed, follow the instructions accordingly. (→P.550)
- If the following message is displayed on the multi-information display, it may indicate a malfunction. Have the vehicle inspected by your Toyota dealer immediately.
  - “Smart Key System Malfunction”
- If any of the following messages are displayed on the multi-information display, it may indicate a malfunction. Immediately stop the vehicle and contact your Toyota dealer.
  - “Braking Power Low”
  - “Charging System Malfunction”
  - “Oil Pressure Low”

 NOTICE

■ If “High Power Consumption Partial Limit on AC/Heater Operation” is displayed frequently

There is a possible malfunction relating to the charging system or the battery may be deteriorating. Have the vehicle inspected by your Toyota dealer.

**If you have a flat tire (vehicles without spare tire)**

**Your vehicle is not equipped with a spare tire, but instead is equipped with an emergency tire puncture repair kit.**

A puncture caused by a nail or screw passing through the tire tread can be repaired temporarily using the emergency tire puncture repair kit. (The kit contains a bottle of sealant. The sealant can be used only once to temporarily repair one tire without removing the nail or screw from the tire.) After temporarily repairing the tire with the kit, have the tire repaired or replaced by your Toyota dealer.

 WARNING

■ If you have a flat tire

Do not continue driving with a flat tire. Driving even a short distance with a flat tire can damage the tire and the wheel beyond repair, which could result in an accident.

**Before repairing the tire**

- Stop the vehicle in a safe place on a hard, flat surface.
- Set the parking brake.
- Shift the shift lever to P (con-

8 When trouble arises

tinuously variable transmission) or N (manual transmission).

- Stop the engine.
- Turn on the emergency flashers.
- Check the degree of the tire damage.

A tire should only be repaired with the emergency tire puncture repair kit if the damage is caused by a nail or screw passing through the tire tread.

- Do not remove the nail or screw from the tire. Removing the object may widen the opening and make emergency repair with the repair kit impossible.
- To avoid sealant leakage, move the vehicle until the area of the puncture, if known, is positioned at the top of the tire.

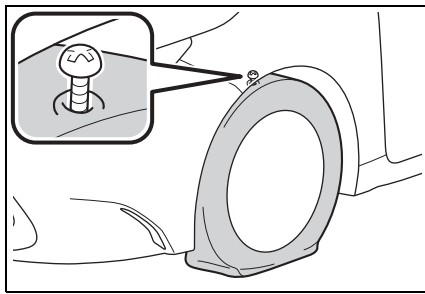

■ **A flat tire that cannot be repaired with the emergency tire puncture repair kit**

In the following cases, the tire cannot be repaired with the emergency tire puncture repair kit. Contact your Toyota dealer.

- When the tire is damaged due to driving without sufficient air pressure
- When there are any cracks or damage at any location on the tire, such as on the side wall, except the tread
- When the tire is visibly separated from the wheel
- When the cut or damage to the tread is 0.16 in. (4 mm) long or more
- When the wheel is damaged
- When 2 or more tires have been punctured
- When 2 or more sharp objects such as nails or screws have passed through the tread on a single tire
- When the sealant has expired



**Location of the emergency tire puncture repair kit and towing eyelet**

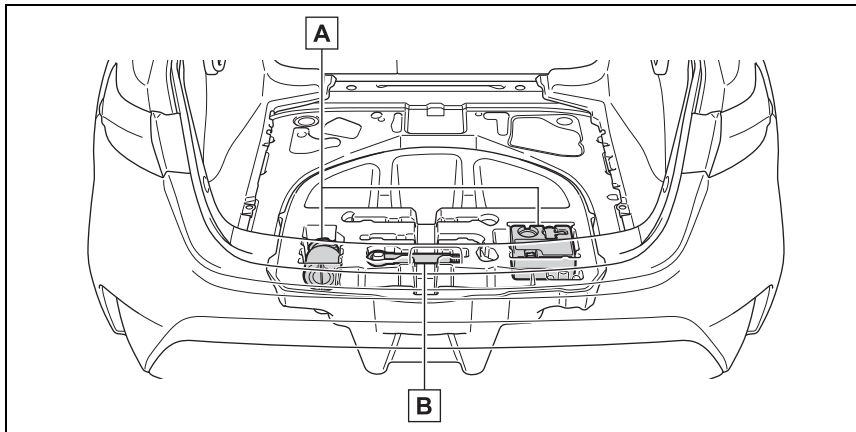

- A** Emergency tire puncture repair kit
- B** Towing eyelet

**Emergency tire puncture repair kit components**

► Bottle

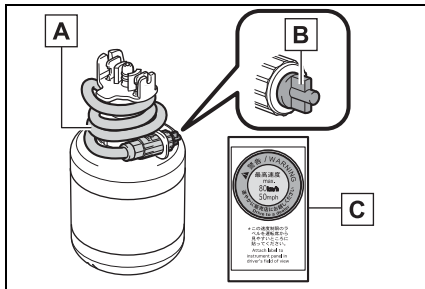

- A** Hose
- B** Air release cap
- C** Sticker

► Compressor

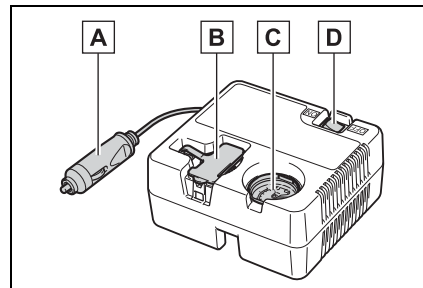

- A** Power plug
- B** Rubber stopper
- C** Air pressure gauge
- D** Compressor switch

■ **Note for checking the emergency tire puncture repair kit**

Check the sealant expiry date occasionally. The expiry date is shown on the bottle. Do not use sealant whose expiry date has already passed. Other-

wise, repairs conducted using the emergency tire puncture repair kit may not be performed properly.

#### ■ Emergency tire puncture repair kit

- The emergency tire puncture repair kit is for filling the car tire with air.
- The sealant has a limited life span. The expiry date is marked on the bottle. The sealant should be replaced before the expiry date. Contact your Toyota dealer for replacement.
- The sealant stored in the emergency tire puncture repair kit can be used only once to temporarily repair a single tire. If the sealant in the bottle and other parts of the kit have been used and need to be replaced, contact your Toyota dealer.
- The compressor can be used repeatedly.
- The sealant can be used when the outside temperature is from -40°F (-40°C) to 140°F (60°C).
- The kit is exclusively designed for size and type of tires originally installed on your vehicle. Do not use it for tires that a different size than the original ones, or for any other purposes.
- If the sealant gets on your clothes, it may stain.
- If the sealant adheres to a wheel or the surface of the vehicle body, the stain may not be removable if it is not cleaned at once. Immediately wipe away the sealant with a wet cloth.
- During operation of the repair kit, a loud operation noise is produced. This does not indicate a malfunction.
- Do not use to check or to adjust the tire pressure.

#### ⚠ WARNING

##### ■ Caution while driving

- Store the repair kit in the trunk. Injuries may result in the event of an accident or sudden braking.
- The repair kit is exclusively only for your vehicle. Do not use repair kit on other vehicles, which could lead to an accident causing death or serious injury.
- Do not use repair kit for tires that are different size than the original ones, or for any other purpose. If the tires have not been completely repaired, it could lead to an accident causing death or serious injury.

##### ■ Precautions for use of the sealant

- Ingesting the sealant is hazardous to your health. If you ingest sealant, consume as much water as possible, and then immediately consult a doctor.
- If sealant gets in eyes or adheres to skin, immediately wash it off with water. If discomfort persists, consult a doctor.

#### Taking out the emergency tire puncture repair kit

- 1 Lift the deck mat. (→P.433)
- 2 Take out the emergency tire puncture repair kit. (→P.525)

#### Emergency repair method

- 1 Take out the repair kit from the plastic bag.

- 2 Remove the valve cap from the valve of the punctured tire.

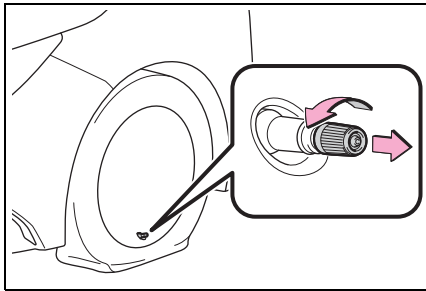

- 3 Extend the hose. Remove the air release cap from the hose.

Attach the sticker enclosed with the bottle on the specified locations. (See step 10.) You will use the air release cap again. Therefore keep it in a safe place.

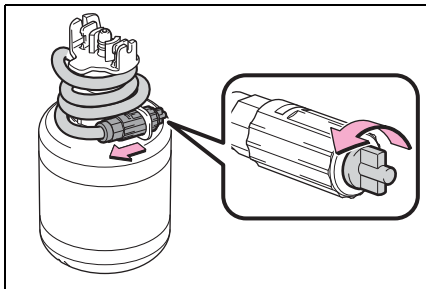

- 4 Connect the hose to the valve.

Screw the end of the hose clock-

wise as far as possible.

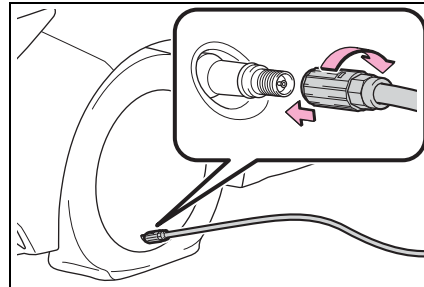

- 5 Make sure that the compressor switch is off.

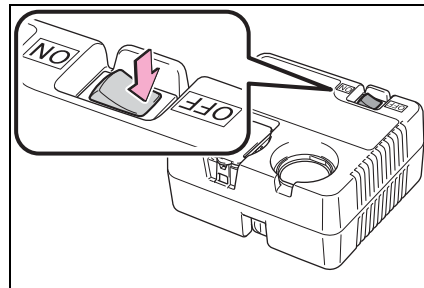

- 6 Lift the rubber stopper on the compressor.

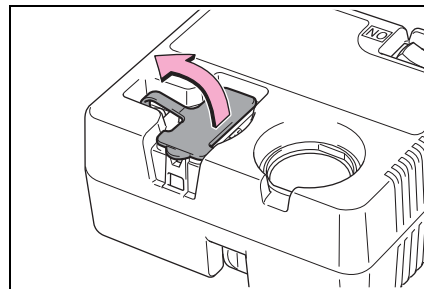

- 7 Remove the power plug from the compressor.

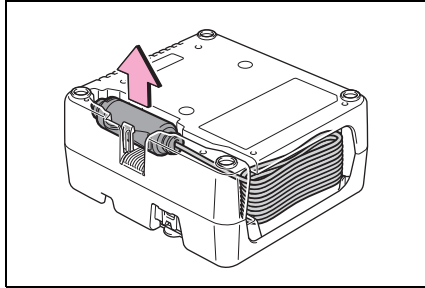

- 8 Connect the power plug to the power outlet socket. (→P.435)

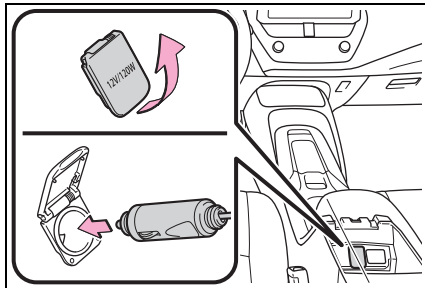

- 9 Connect the bottle to the compressor.

As shown in the illustration, insert the bottle securely into the compressor until the upper side of the mark on the bottle is aligned with

the upper end of the notch.

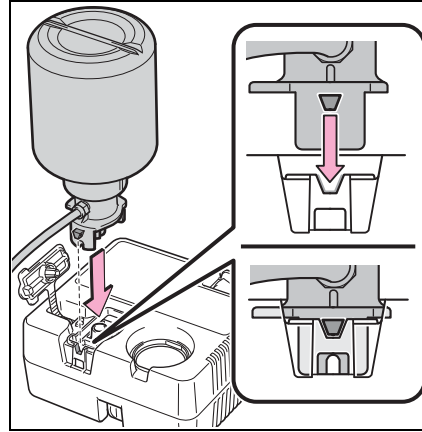

- 10 Attach the sticker provided with the tire puncture repair kit to a position easily seen from the driver's seat.

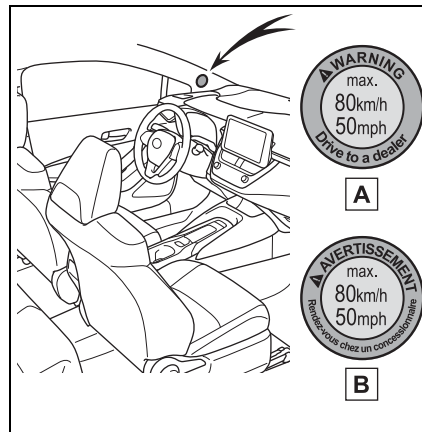

**A** U.S.A.

**B** Canada

- 11 Check the specified tire inflation pressure.

Tire inflation pressure is specified on the label on the driver's side pil-

lar as shown. (→P.564)

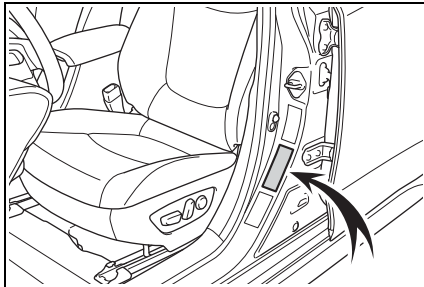

12 Start the engine.

13 To inject the sealant and inflate the tire, turn the compressor switch on.

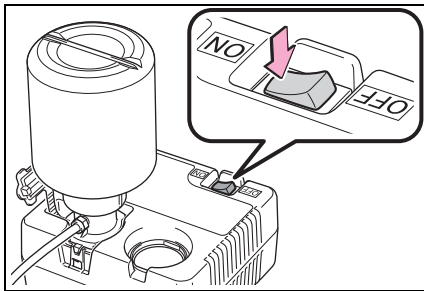

14 Inflate the tire until the specified air pressure is reached.

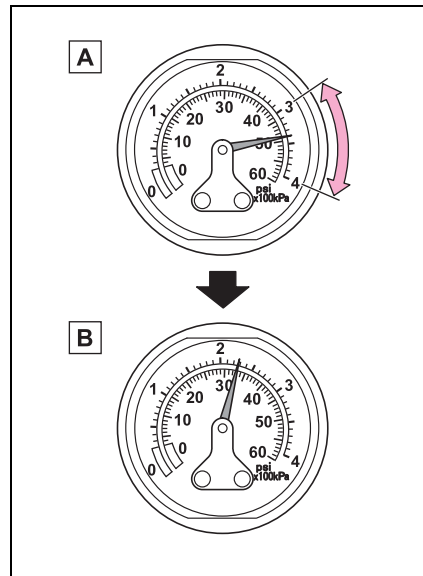

**A** The sealant will be injected and the pressure will spike to between 44 psi (300 kPa, 3.0 kgf/cm<sup>2</sup> or bar) and 58 psi (400 kPa, 4.0 kgf/cm<sup>2</sup> or bar), then gradually decrease.

**B** The air pressure gauge will display the actual tire inflation pressure about 1 to 5 minutes after the switch is turned on.

Turn the compressor switch off and then check the tire inflation pressure. Being careful not to over inflate, check and repeat the inflation procedure until the specified tire inflation pressure is reached.

The tire can be inflated for about 5 to 20 minutes (depending on the outside temperature). If the tire inflation pressure is still lower than the specified point after inflation for 25 minutes, the tire is too damaged

to be repaired. Turn the compressor switch off and contact your Toyota dealer.

If the tire inflation pressure exceeds the specified air pressure, let out some air to adjust the tire inflation pressure. (→P.531, 564)

15 With the compressor switch off, disconnect the hose from the valve on the tire and then pull out the power plug from the power outlet socket.

Some sealant may leak when the hose is removed.

16 Install the valve cap onto the valve of the emergency repaired tire.

17 Attach the air release cap to the end of the hose.

If the air release cap is not attached, the sealant may leak and the vehicle may get dirty.

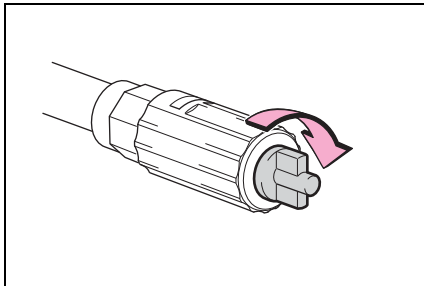

18 Temporarily store the bottle in the trunk while it is connected to the compressor.

19 To spread the liquid sealant evenly within the tire, immediately drive safely for about 3 miles (5 km) below 50 mph (80 km/h).

20 After driving, stop your vehicle in a safe place on a hard,

flat surface and reconnect the repair kit.

Remove the air release cap from the hose before reconnecting the hose.

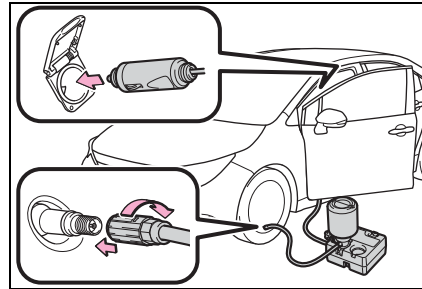

21 Turn the compressor switch on and wait for several seconds, then turn it off. Check the tire inflation pressure.

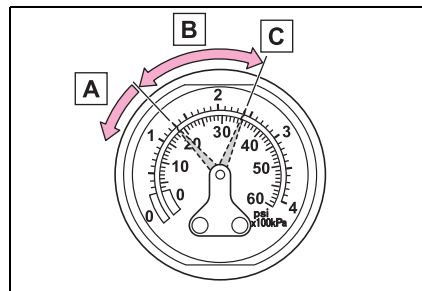

**A** If the tire inflation pressure is under 19 psi (130 kPa, 1.3 kgf/cm<sup>2</sup> or bar): The puncture cannot be repaired. Contact your Toyota dealer.

**B** If the tire inflation pressure is 19 psi (130 kPa, 1.3 kgf/cm<sup>2</sup> or bar) or higher, but less than the specified air pressure: Proceed to step 22.

**C** If the tire inflation pressure is the specified air pressure

(→P.564): Proceed to step 23.

22 Turn the compressor switch on to inflate the tire until the specified air pressure is reached. Drive for about 3 miles (5 km) and then perform step 20.

23 Attach the air release cap to the end of the hose.

If the air release cap is not attached, the sealant may leak and the vehicle may get dirty.

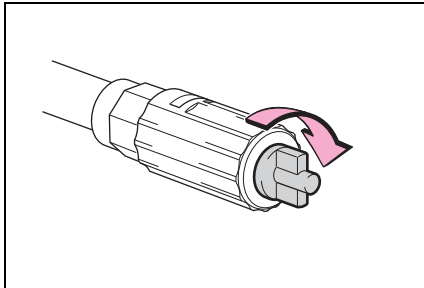

24 Store the bottle in the trunk while it is connected to the compressor.

25 Taking precautions to avoid sudden braking, sudden acceleration and sharp turns, drive carefully at under 50 mph (80 km/h) to the nearest Toyota dealer that is less than 62 miles (100 km) away for tire repair or replacement.

When having the tire repaired or replaced, make sure to tell the Toyota dealer that the sealant is injected.

■ **If the tire is inflated to more than the specified air pressure**

- 1 Disconnect the hose from the valve.
- 2 Install the air release cap to the end of the hose and push the protrusion on the air release cap into the tire valve to let some air out.

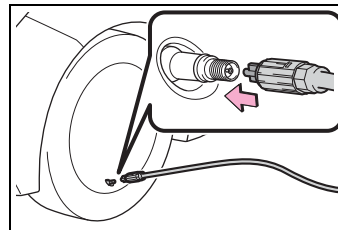

- 3 Disconnect the hose from the valve, remove the air release cap from the hose and then reconnect the hose.
- 4 Turn the compressor switch on and wait for several seconds, and then turn it off. Check that the air pressure indicator shows the specified air pressure. (→P.564)

If the air pressure is under the designated pressure, turn the compressor switch on again and repeat the inflation procedure until the specified air pressure is reached.

■ **The valve of a tire that has been repaired (vehicles without a tire pressure warning system)**

After a tire is repaired with the emergency tire puncture repair kit, the valve should be replaced.

■ **After a tire is repaired with the emergency tire puncture repair kit (vehicles with a tire pressure warning system)**

- The tire pressure warning valve and transmitter should be replaced.
- Even if the tire inflation pressure is at the recommended level, the tire pressure warning light may come

on/flash.



### WARNING

#### ■ Do not drive the vehicle with a flat tire

Do not continue driving with a flat tire.

Driving even a short distance with a flat tire can damage the tire and the wheel beyond repair.

Driving with a flat tire may cause a circumferential groove on the side wall. In such a case, the tire may explode when using a repair kit.

#### ■ When fixing the flat tire

- Stop your vehicle in a safe and flat area.
- Do not touch the wheels or the area around the brakes immediately after the vehicle has been driven.  
After the vehicle has been driven, the wheels and the area around the brakes may be extremely hot. Touching these areas with hands, feet or other body parts may result in burns.
- Connect the valve and hose securely with the tire installed on the vehicle. If the hose is not properly connected to the valve, air leakage may occur as sealant may be sprayed out.
- If the hose comes off the valve while inflating the tire, there is a risk that the hose will move abruptly due to air pressure.
- After inflation of the tire has completed, the sealant may splatter when the hose is disconnected or some air is let out of the tire.
- Follow the operation procedure to repair the tire. If the procedures not followed, the sealant may spray out.

- Keep back from the tire while it is being repaired, as there is a chance of it bursting while the repair operation is being performed. If you notice any cracks or deformation of the tire, turn off the compressor switch and stop the repair operation immediately.

- The repair kit may overheat if operated for a long period of time. Do not operate the repair kit continuously for more than 40 minutes.

- Parts of the repair kit become hot during operation. Be careful handling the repair kit during and after operation. Do not touch the metal part connecting the bottle and the compressor. It will be extremely hot.

- Do not attach the vehicle speed warning sticker to an area other than the one indicated. If the sticker is attached to an area where an SRS airbag is located, such as the pad of the steering wheel, it may prevent the SRS airbag from operating properly.

#### ■ Driving to spread the liquid sealant evenly

Observe the following precautions to reduce the risk of accidents. Failing to do so may result in a loss of vehicle control and cause death or serious injury.

- Drive the vehicle carefully at a low speed. Be especially careful when turning and cornering.
- If the vehicle does not drive straight or you feel a pull through the steering wheel, stop the vehicle and check the following.
  - Tire condition. The tire may have separated from the wheel.



**⚠ WARNING**

- Tire inflation pressure. If the tire inflation pressure is 19 psi (130 kPa, 1.3 kgf/cm<sup>2</sup> or bar) or less, the tire may be severely damaged.

**⚠ NOTICE****■ When performing an emergency repair**

- A tire should only be repaired with the emergency tire puncture repair kit if the damage is caused by a sharp object such as nail or screw passing through the tire tread.  
Do not remove the sharp object from the tire. Removing the object may widen the opening and disable emergency repair with the repair kit.
- The repair kit is not waterproof. Make sure that the repair kit is not exposed to water, such as when it is being used in the rain.
- Do not put the repair kit directly onto dusty ground such as sand at the side of the road. If the repair kit vacuums up dust etc., a malfunction may occur.
- **Precautions for the emergency tire puncture repair kit**
- The repair kit power source should be 12 V DC suitable for vehicle use. Do not connect the repair kit to any other source.
- If fuel splatters on the repair kit, the repair kit may deteriorate. Take care not to allow fuel to contact it.
- Place the repair kit in a storage to prevent it from being exposed to dirt or water.
- Store the repair kit in the trunk out of reach of children.

- Do not disassemble or modify the repair kit. Do not subject parts such as the air pressure indicator to impacts. This may cause a malfunction.

**■ To avoid damage to the tire pressure warning valves and transmitters (vehicles with a tire pressure warning system)**

When a tire is repaired with liquid sealants, the tire pressure warning valve and transmitter may not operate properly. If a liquid sealant is used, contact your Toyota dealer or other qualified service shop as soon as possible. After use of liquid sealant, make sure to replace the tire pressure warning valve and transmitter when repairing or replacing the tire. (→P.480)

If you have a flat tire  
(vehicles with a spare  
tire)

**Your vehicle is equipped with a spare tire. The flat tire can be replaced with the spare tire.**

**For details about tires:**  
→P.475

 **WARNING**

**If you have a flat tire**

Do not continue driving with a flat tire. Driving even a short distance with a flat tire can damage the tire and the wheel beyond repair, which could result in an accident.

**Before jacking up the vehicle**

- Stop the vehicle in a safe place on a hard, flat surface.
- Set the parking brake.
- Shift the shift lever to P (continuously variable transmission) or R (manual transmission).
- Stop the engine.
- Turn on the emergency flashers.

**Location of the spare tire, jack and tools**

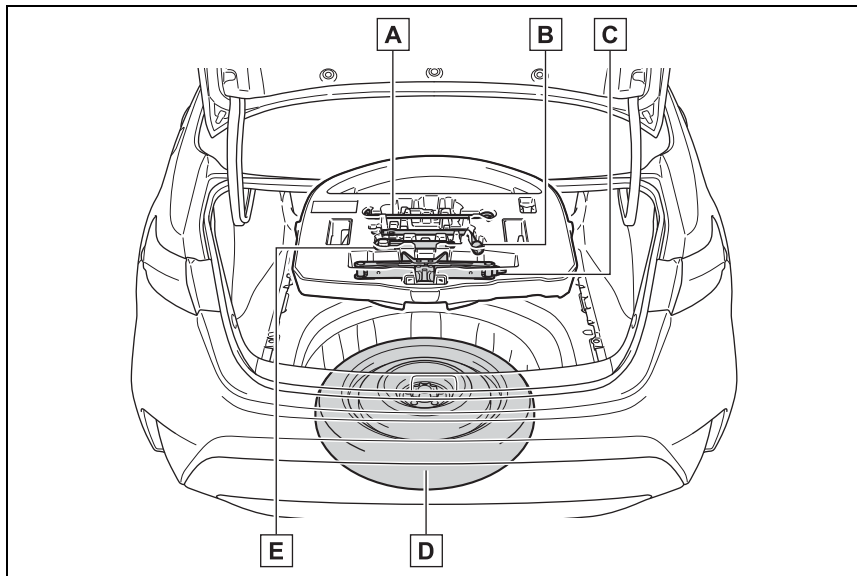

- A** Jack handle
- B** Wheel nut wrench
- C** Jack
- D** Spare tire
- E** Towing eyelet (if equipped)

**⚠ WARNING**

**■ Using the tire jack**

Observe the following precautions. Improper use of the tire jack may cause the vehicle to suddenly fall off the jack, leading to death or serious injury.

- Do not use the tire jack for any purpose other than replacing tires or installing and removing tire chains.

- Only use the tire jack that comes with this vehicle for replacing a flat tire. Do not use it on other vehicles, and do not use other tire jacks for replacing tires on this vehicle.
- Put the jack properly in its jack point.

8 When trouble arises

**⚠ WARNING**

- Do not put any part of your body under the vehicle while it is supported by the jack.
- Do not start the engine or drive the vehicle while the vehicle is supported by the jack.
- Do not raise the vehicle while someone is inside.
- When raising the vehicle, do not put an object on or under the jack.
- Do not raise the vehicle to a height greater than that required to replace the tire.
- Use a jack stand if it is necessary to get under the vehicle.
- When lowering the vehicle, make sure that there is no-one near the vehicle. If there are people nearby, warn them vocally before lowering.

**Taking out the jack**

- 1 Remove the deck mat.

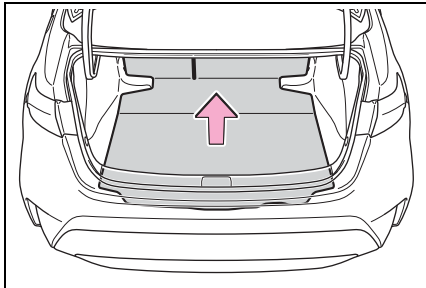

- 2 Take out the jack.

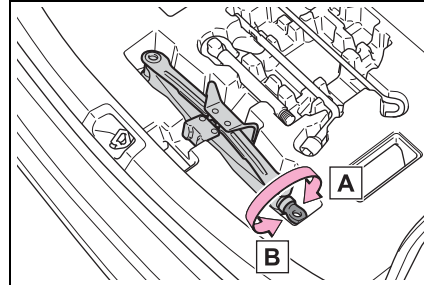

- A** For tightening
- B** For loosening

**Taking out the spare tire**

- 1 Remove the deck mat. (→P.536)
- 2 Remove the tool tray.

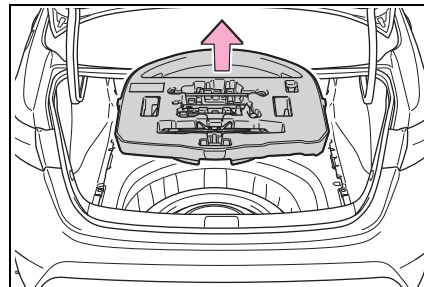

- 3 Loosen the center fastener that secures the spare tire.

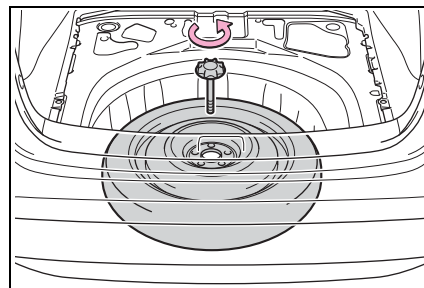

**⚠ WARNING**  
**■ When storing the spare tire**  
 Be careful not to catch fingers or other body parts between the spare tire and the body of the vehicle.

**Replacing a flat tire**

1 Chock the tires.

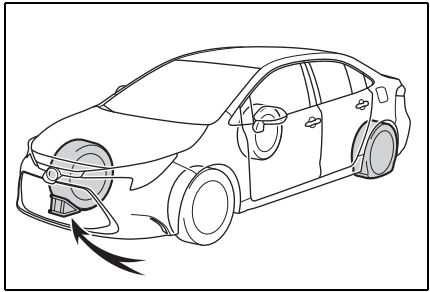

Flat tire	Wheel chock positions
Front left-hand side	Behind the rear right-hand side tire
Front right-hand side	Behind the rear left-hand side tire
Rear left-hand side	In front of the front right-hand side tire
Rear right-hand side	In front of the front left-hand side tire

2 Vehicles with a steel wheel:  
 Remove the wheel ornament (if equipped) using the wrench.

Insert the wrench into the notch **A** on the wheel cap.  
 To protect the wheel ornament,

place a rag between the wrench and the wheel ornament.

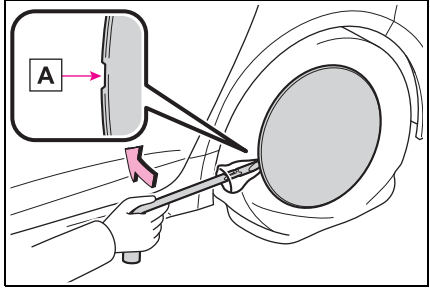

3 Slightly loosen the wheel nuts (one turn).

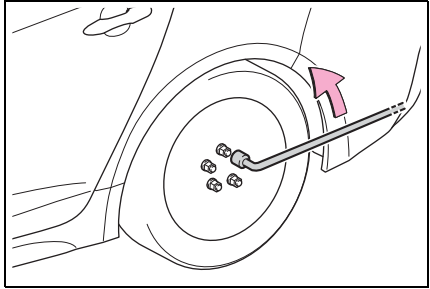

4 Turn the tire jack portion **A** by hand until the center of the recessed portion of the jack is in contact with the center of the jack point.

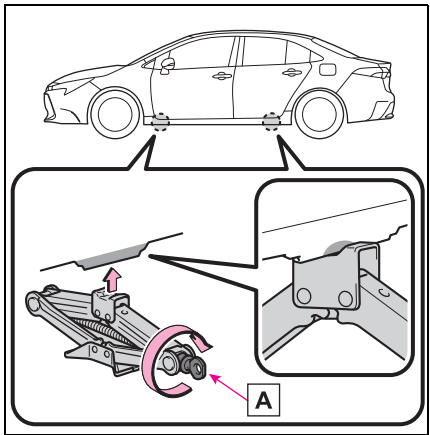

8

When trouble arises

5 Assemble the jack handle extension.

▶ Type A

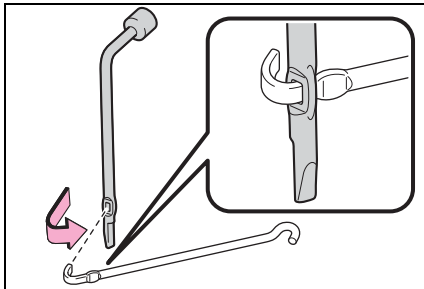

▶ Type B

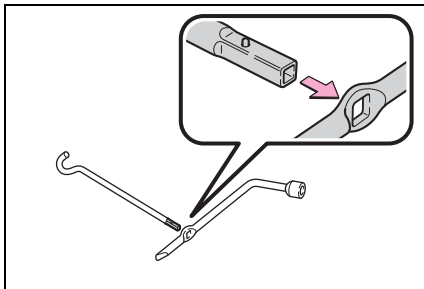

6 Raise the vehicle until the tire is slightly raised off the ground.

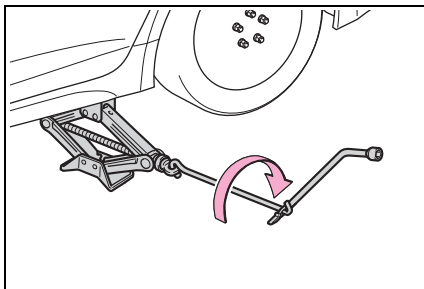

7 Remove all the wheel nuts and the tire.

When resting the tire on the ground, place the tire so that the wheel design faces up to avoid

scratching the wheel surface.

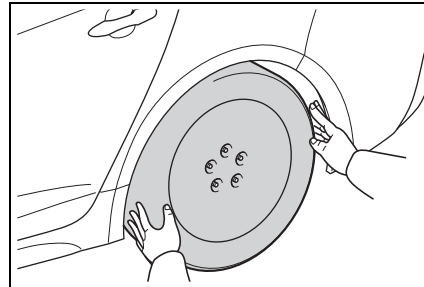

**⚠ WARNING**

**■ Replacing a flat tire**

- Do not touch the disc wheels or the area around the brakes immediately after the vehicle has been driven. After the vehicle has been driven the disc wheels and the area around the brakes will be extremely hot. Touching these areas with hands, feet or other body parts while changing a tire, etc. may result in burns.
- Failure to follow these precautions could cause the wheel nuts to loosen and the tire to fall off, resulting in death or serious injury.
- Have the wheel nuts tightened with a torque wrench to 76 ft•lbf (103 N•m, 10.5 kgf•m) as soon as possible after changing wheels.
- Do not attach a heavily damaged wheel ornament, as it may fly off the wheel while the vehicle is moving.
- When installing a tire, only use wheel nuts that have been specifically designed for that wheel.

**⚠ WARNING**

- If there are any cracks or deformations in the bolt screws, nut threads or bolt holes of the wheel, have the vehicle inspected by your Toyota dealer.
- When installing the wheel nuts, be sure to install them with the tapered ends facing inward.

**Installing the spare tire**

- 1 Remove any dirt or foreign matter from the wheel contact surface.

If foreign matter is on the wheel contact surface, the wheel nuts may loosen while the vehicle is in motion, causing the tire to come off.

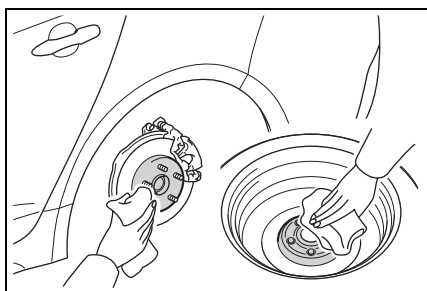

- 2 Install the tire and loosely tighten each wheel nut by hand by approximately the same amount.

When replacing a steel wheel with a steel wheel (including a compact spare tire), tighten the wheel nuts until the tapered portion **A** comes into loose contact with the disc

wheel seat **B**.

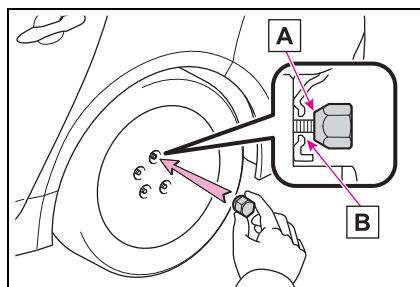

When replacing an aluminum wheel with a steel wheel (including a compact spare tire), tighten the wheel nuts until the tapered portion **A** comes into loose contact with the disc wheel seat **B**.

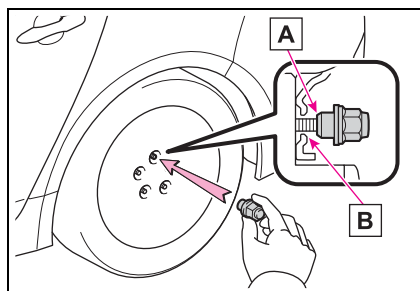

- 3 Lower the vehicle.

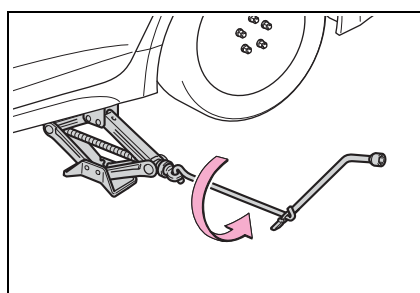

- 4 Firmly tighten each wheel nut two or three times in the order shown in the illustration.

Tightening torque:

76 ft•lbf (103 N•m, 10.5 kgf•m)

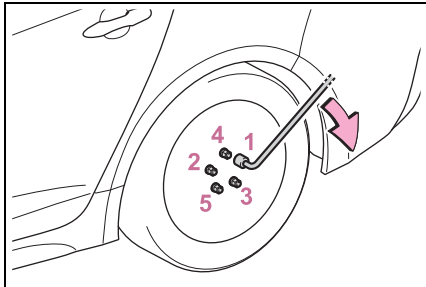

5 Stow the flat tire, tire jack and all tools.

■ **The compact spare tire**

- The compact spare tire is identified by the label “TEMPORARY USE ONLY” on the tire sidewall. Use the compact spare tire temporarily, and only in an emergency.
- Make sure to check the tire inflation pressure of the compact spare tire. (→P.564)

■ **When the compact spare tire is equipped**

The vehicle becomes lower when driving with the compact spare tire compared to when driving with standard tires.

■ **After completing the tire change (vehicles with a tire pressure warning system)**

The tire pressure warning system must be reset. (→P.481)

■ **When using the compact spare tire (vehicles with a tire pressure warning system)**

As the compact spare tire is not equipped with a tire pressure warning valve and transmitter, low inflation pressure of the spare tire will not be indicated by the tire pressure warning system. Also, if you replace the compact spare tire after the tire pressure warning light comes on, the light remains on.

■ **If you have a flat front tire on a road covered with snow or ice**

Install the compact spare tire on one of the rear wheels of the vehicle. Perform the following steps and fit tire chains to the front tires:

- 1 Replace a rear tire with the compact spare tire.
- 2 Replace the flat front tire with the tire removed from the rear of the vehicle.
- 3 Fit tire chains to the front tires.

■ **When reinstalling the wheel ornament (steel wheels except compact spare tire)**

Align the cutout of the wheel ornament with the valve stem as shown in the illustration.

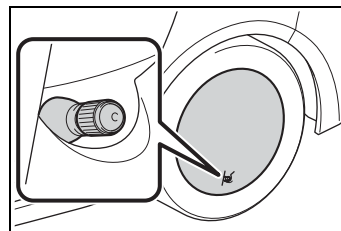

⚠ **WARNING**

■ **When using the compact spare tire**

- Remember that the compact spare tire provided is specifically designed for use with your vehicle. Do not use your compact spare tire on another vehicle.
- Do not use more than one compact spare tires simultaneously.
- Replace the compact spare tire with a standard tire as soon as possible.
- Avoid sudden acceleration, abrupt steering, sudden braking and shifting operations that cause sudden engine braking.



**⚠ WARNING****■ When the compact spare tire is attached**

The vehicle speed may not be correctly detected, and the following systems may not operate correctly:

- ABS & Brake assist
- VSC
- TRAC
- Automatic High Beam
- AFS (Adaptive Front-lighting System) (if equipped)
- Dynamic radar cruise control with full-speed range (if equipped)
- Dynamic radar cruise control (if equipped)
- EPS
- PCS (Pre-Collision System)
- LDA (Lane Departure Alert with steering control) (if equipped)
- LTA (Lane Tracing Assist) (if equipped)
- Tire pressure warning system (if equipped)
- BSM (Blind Spot Monitor) (if equipped)
- RCTA (Rear Cross Traffic Alert) function (if equipped)
- Rear view monitor system
- Navigation system (if equipped)

**■ Speed limit when using the compact spare tire**

Do not drive at speeds in excess of 50 mph (80 km/h) when a compact spare tire is installed on the vehicle.

The compact spare tire is not designed for driving at high speeds. Failure to observe this precaution may lead to an accident causing death or serious injury.

**■ After using the tools and jack**

Before driving, make sure all the tools and jack are securely in place in their storage location to reduce the possibility of personal injury during a collision or sudden braking.

**⚠ NOTICE****■ Be careful when driving over bumps with the compact spare tire installed on the vehicle.**

The vehicle becomes lower when driving with the compact spare tire compared to when driving with standard tires. Be careful when driving over uneven road surfaces.

**■ Driving with tire chains and the compact spare tire**

Do not fit tire chains to the compact spare tire. Tire chains may damage the vehicle body and adversely affect driving performance.

**■ When replacing the tires (vehicles with a tire pressure warning system)**

When removing or fitting the wheels, tires or the tire pressure warning valve and transmitter, contact your Toyota dealer as the tire pressure warning valve and transmitter may be damaged if not handled correctly.



## NOTICE

**■ To avoid damage to the tire pressure warning valves and transmitters (vehicles with a tire pressure warning system)**

When a tire is repaired with liquid sealants, the tire pressure warning valve and transmitter may not operate properly. If a liquid sealant is used, contact your Toyota dealer or other qualified service shop as soon as possible. Make sure to replace the tire pressure warning valve and transmitter when replacing the tire.

**If the engine will not start**

**If the engine will not start even though correct starting procedures are being followed (→P.163, 164), consider each of the following points:**

**The engine will not start even though the starter motor operates normally.**

One of the following may be the cause of the problem:

- There may not be sufficient fuel in the vehicle's tank.  
Refuel the vehicle.
- The engine may be flooded.  
Try to restart the engine again following correct starting procedures. (→P.163, 164)
- There may be a malfunction in the engine immobilizer system. (→P.80)

**The starter motor turns over slowly, the interior lights and headlights are dim, or the horn does not sound or sounds at a low volume.**

One of the following may be the cause of the problem:

- The battery may be discharged. (→P.546)

- The battery terminal connections may be loose or corroded. (→P.472)

### **The starter motor does not turn over (vehicles with a smart key system)**

The engine starting system may be malfunctioning due to an electrical problem such as electronic key battery depletion or a blown fuse. However, an interim measure is available to start the engine. (→P.543)

### **The starter motor does not turn over, the interior lights and headlights do not turn on, or the horn does not sound.**

One of the following may be the cause of the problem:

- The battery may be discharged. (→P.546)
- One or both of the battery terminals may be disconnected. (→P.472)
- There may be a malfunction in the steering lock system.

Contact your Toyota dealer if the problem cannot be repaired, or if repair procedures are unknown.

### **Emergency start function (vehicles with a smart key system)**

When the engine does not start, the following steps can be used as an interim measure to start the engine if the engine switch is functioning normally.

Do not use this starting procedure except in case of emergency.

- 1 Set the parking brake. (→P.180, 181)
- 2 Check that the shift lever is in P (continuously variable transmission) or N (manual transmission).
- 3 Turn the engine switch to ACC.
- 4 Press and hold the engine switch for about 15 seconds while depressing the brake pedal (continuously variable transmission) or clutch pedal (manual transmission) firmly.

Even if the engine can be started using the above steps, the system may be malfunctioning. Have the vehicle inspected by your Toyota dealer.

If you lose your keys

**New genuine keys can be made by your Toyota dealer using the other key (vehicles without a smart key system) or mechanical key (vehicles with a smart key system) and the key number stamped on your key number plate.**

**Keep the plate in a safe place such as your wallet, not in the vehicle.**

 NOTICE

**■ When an electronic key is lost (vehicles with a smart key system)**

If the electronic key remains lost, the risk of vehicle theft increases significantly. Visit your Toyota dealer immediately with all remaining electronic keys that were provided with your vehicle.

If the electronic key does not operate properly (vehicles with a smart key system)

**If communication between the electronic key and vehicle is interrupted (→P.127) or the electronic key cannot be used because the battery is depleted, the smart key system and wireless remote control cannot be used. In such cases, the doors can be opened and the engine can be started by following the procedure below.**

**■ When the electronic key does not work properly**

- Make sure that the smart key system has not been deactivated in the customization setting. If it is off, turn the function on. (Customizable features: →P.581)
- Check if battery-saving mode is set. If it is set, cancel the function. (→P.127)

 NOTICE

**■ In case of a smart key system malfunction or other key-related problems**

Take your vehicle with all the electronic keys provided with your vehicle to your Toyota dealer.

**Locking and unlocking the doors**

Use the mechanical key (→P.114) in order to perform the

following operations:

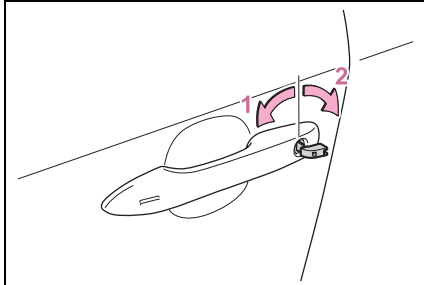

- 1 Locks all the doors
- 2 Unlocks all the doors

Turning the key unlocks the driver's door. Turning the key again unlocks the other doors.

■ Key linked functions

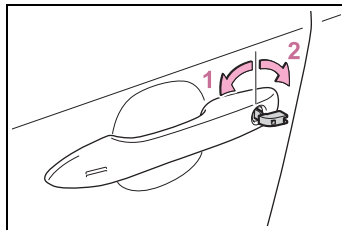

- 1 Closes the windows and moon roof\*1 (turn and hold)\*2
- 2 Opens the windows and moon roof\*1 (turn and hold)\*2

\*1: If equipped

\*2: This setting must be customized at your Toyota dealer.

**⚠ WARNING**

■ When using the mechanical key and operating the power windows or moon roof (if equipped)

Operate the power window or moon roof after checking to make sure that there is no possibility of any passenger having any of their body parts caught in the window or moon roof.

Also, do not allow children to operate the mechanical key. It is possible for children and other passengers to get caught in the power window or moon roof.

**Starting the engine**

- 1 Vehicles with a continuously variable transmission: Ensure that the shift lever is in P and depress the brake pedal. Vehicles with a manual transmission: Shift the shift lever to N and depress the clutch pedal.
- 2 Touch the Toyota emblem side of the electronic key to the engine switch.

When the electronic key is detected, a buzzer sounds and the engine switch will turn to ON.

When the smart key system is deactivated in customization setting, the engine switch will turn to

ACC.

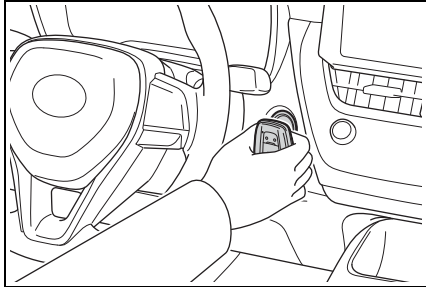

- 3 Firmly depress the brake pedal (continuously variable transmission) or clutch pedal (manual transmission) and check that  is shown on the multi-information display.
- 4 Press the engine switch shortly and firmly.

In the event that the engine still cannot be started, contact your Toyota dealer.

---

#### ■ Stopping the engine

Shift the shift lever to P (continuously variable transmission) or N (manual transmission) and press the engine switch as you normally do when stopping the engine.

#### ■ Electronic key battery

As the above procedure is a temporary measure, it is recommended that the electronic key battery be replaced immediately when the battery is depleted. (→P.489)

#### ■ Changing engine switch modes

Release the brake pedal (continuously variable transmission) or clutch pedal (manual transmission) and press the engine switch in step 3 above.

The engine does not start and modes will be changed each time the switch is pressed. (→P.167)

If the vehicle battery is discharged

The following procedures may be used to start the engine if the vehicle's battery is discharged. You can also call your Toyota dealer or a qualified repair shop.

**Restarting the engine**

If you have a set of jumper (or booster) cables and a second vehicle with a 12-volt battery, you can jump start your vehicle by following the steps below.

- 1 Vehicles with an alarm (→P.82): Confirm that the electronic key (vehicles with a smart key system) or key (vehicles without a smart key system) is being carried.
  - 2 Open the hood. (→P.464)
  - 3 Connect a positive jumper cable clamp to **A** on your vehicle and connect the clamp on the other end of the positive cable to **B** on the second vehicle. Then, connect a negative cable clamp to **C** on the second vehicle and connect the clamp at the other end of the negative cable to **D**.
- ▶ 1.8 L 4-cylinder (2ZR-FAE) engine

When connecting the jumper (or booster) cables, depending on the situation, the alarm may activate and doors locked. (→P.83)

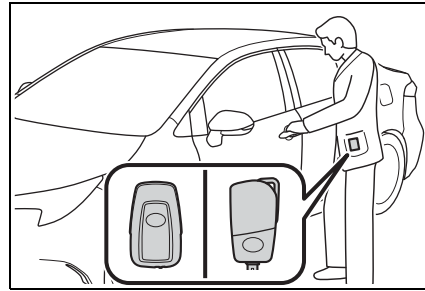

- 2 Open the hood. (→P.464)

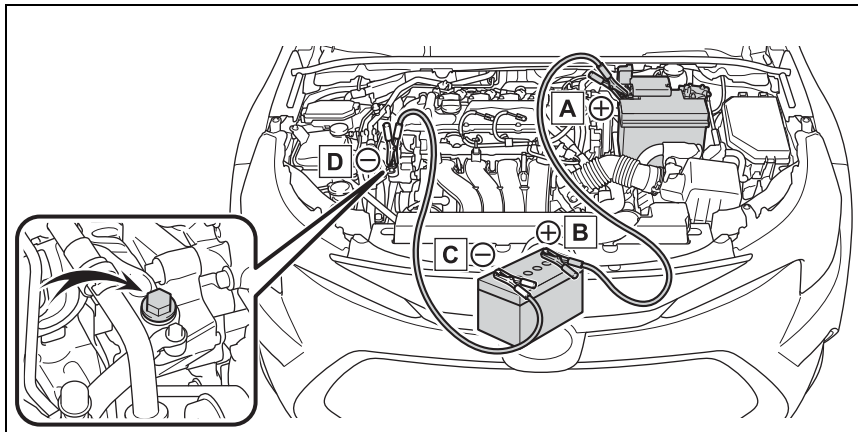

- A** Positive (+) battery terminal (your vehicle)
- B** Positive (+) battery terminal (second vehicle)
- C** Negative (-) battery terminal (second vehicle)
- D** Solid, stationary, unpainted metallic point away from the battery and any moving parts as shown in the illustration

▶ 2.0 L 4-cylinder (M20A-FKS) engine

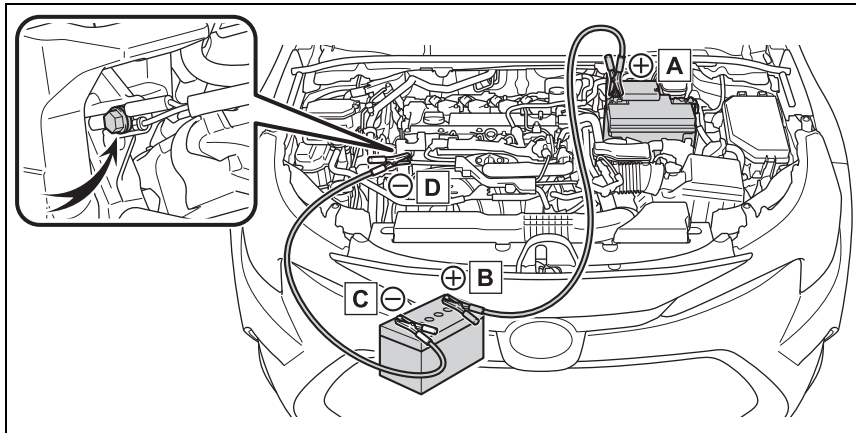

- A** Positive (+) battery terminal (your vehicle)
- B** Positive (+) battery terminal (second vehicle)
- C** Negative (-) battery terminal (second vehicle)
- D** Solid, stationary, unpainted metallic point away from the battery and any moving parts as shown in the illustration

- 4 Start the engine of the second vehicle. Increase the engine speed slightly and maintain at that level for approximately 5 minutes to recharge the battery of your vehicle.
- 5 Vehicles with a smart key system: Open and close any of the doors of your vehicle with the engine switch OFF.
- 6 Maintain the engine speed of the second vehicle and start the engine of your vehicle by turning the engine switch to ON.
- 7 Once the vehicle's engine has started, remove the jumper cables in the exact

reverse order from which they were connected.

Once the engine starts, have the vehicle inspected at your Toyota dealer as soon as possible.

■ **Starting the engine when the battery is discharged**

The engine cannot be started by push-starting.

■ **To prevent battery discharge**

- Turn off the headlights and the audio system while the engine is off.
- Turn off any unnecessary electrical components when the vehicle is running at a low speed for an extended period, such as in heavy traffic.

■ **When the battery is removed or discharged**

- Information stored in the ECU is



cleared. When the battery is depleted, have the vehicle inspected at your Toyota dealer.

- Some systems may require initialization. (→P.589)

#### ■ When removing the battery terminals

When the battery terminals are removed, the information stored in the ECU is cleared. Before removing the battery terminals, contact your Toyota dealer.

#### ■ Charging the battery

The electricity stored in the battery will discharge gradually even when the vehicle is not in use, due to natural discharge and the draining effects of certain electrical appliances. If the vehicle is left for a long time, the battery may discharge, and the engine may be unable to start. (The battery recharges automatically during driving.)

#### ■ When recharging or replacing the battery (vehicles with a smart key system)

- In some cases, it may not be possible to unlock the doors using the smart key system when the battery is discharged. Use the wireless remote control or the mechanical key to lock or unlock the doors.
- The engine may not start on the first attempt after the battery has recharged but will start normally after the second attempt. This is not a malfunction.
- The engine switch mode is memorized by the vehicle. When the battery is reconnected, the system will return to the mode it was in before the battery was discharged. Before disconnecting the battery, turn the engine switch off. If you are unsure what mode the engine switch was in before the battery discharged, be especially careful when reconnecting the battery.

#### ■ When replacing the battery

- Use a battery that conforms to European regulations.
- Use a battery with the same case size as the previous battery and an equivalent 20 hour rate capacity (20HR) or greater.
  - If the sizes differ, the battery cannot be properly secured.
  - If the 20 hour rate capacity is low, even if the time period where the vehicle is not used is a short time, the battery may discharge and the engine may not be able to start.
- For details, consult your Toyota dealer.

#### ⚠ WARNING

##### ■ When removing the battery terminals

Always remove the negative (-) terminal first. If the positive (+) terminal contacts any metal in the surrounding area when the positive (+) terminal is removed, a spark may occur, leading to a fire in addition to electrical shocks and death or serious injury.

##### ■ Avoiding battery fires or explosions

Observe the following precautions to prevent accidentally igniting the flammable gas that may be emitted from the battery:

- Make sure each jumper cable is connected to the correct terminal and that it is not unintentionally in contact with any other than the intended terminal.
- Do not allow the other end of the jumper cable connected to the "+" terminal to come into contact with any other parts or metal surfaces in the area, such as brackets or unpainted metal.

 **WARNING**

- Do not allow the + and - clamps of the jumper cables to come into contact with each other.
- Do not smoke, use matches, cigarette lighters or allow open flame near the battery.

■ **Battery precautions**

The battery contains poisonous and corrosive acidic electrolyte, while related parts contain lead and lead compounds. Observe the following precautions when handling the battery:

- When working with the battery, always wear safety glasses and take care not to allow any battery fluids (acid) to come into contact with skin, clothing or the vehicle body.
- Do not lean over the battery.
- In the event that battery fluid comes into contact with the skin or eyes, immediately wash the affected area with water and seek medical attention. Place a wet sponge or cloth over the affected area until medical attention can be received.
- Always wash your hands after handling the battery support, terminals, and other battery-related parts.
- Do not allow children near the battery.

 **NOTICE**

■ **When handling jumper cables**

When connecting the jumper cables, ensure that they do not become entangled in the cooling fan or engine drive belt.

**If your vehicle overheats**

**The following may indicate that your vehicle is overheating.**

- The engine coolant temperature gauge (→P.91, 95) is in the red zone or a loss of engine power is experienced. (For example, the vehicle speed does not increase.)
- “Engine Coolant Temp High Stop in a Safe Place See Owner’s Manual” is shown on the multi-information display.
- Steam comes out from under the hood.

**Correction procedures**

- 1 Stop the vehicle in a safe place and turn off the air conditioning system, and then stop the engine.
- 2 If you see steam: Carefully lift the hood after the steam subsides.  
If you do not see steam: Carefully lift the hood.
- 3 After the engine has cooled down sufficiently, inspect the

hoses and radiator core (radiator) for any leaks.

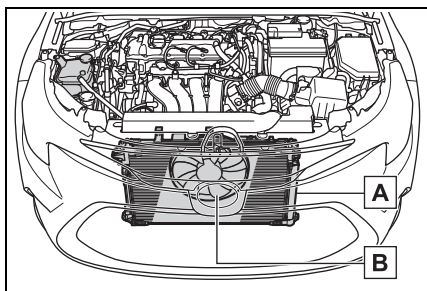

- A** Radiator
- B** Cooling fan

If a large amount of coolant leaks, immediately contact your Toyota dealer.

- 4 The coolant level is satisfactory if it is between the "FULL" and "LOW" lines (type A) or "MAX" and "MIN" lines (type B) on the reservoir.

► Type A

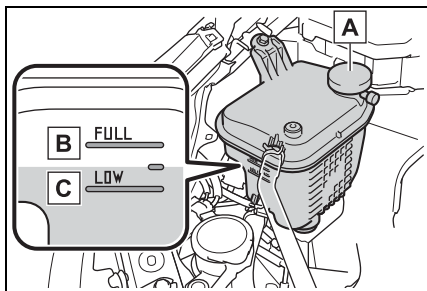

- A** Reservoir cap
- B** "FULL" line
- C** "LOW" line

► Type B

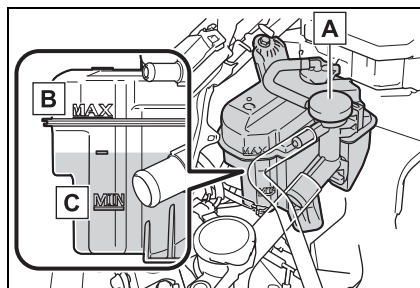

- A** Reservoir cap
- B** "MAX" line
- C** "MIN" line

- 5 Add engine coolant if necessary.

Water can be used in an emergency if engine coolant is unavailable.

► Type A

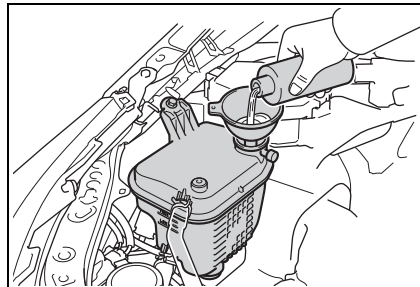

► Type B

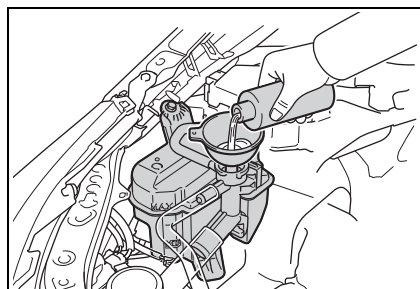

- 6 Start the engine and turn the air conditioning system on to

check that the radiator cooling fan operates and to check for coolant leaks from the radiator or hoses.

The fan operates when the air conditioning system is turned on immediately after a cold start. Confirm that the fan is operating by checking the fan sound and air flow. If it is difficult to check these, turn the air conditioning system on and off repeatedly. (The fan may not operate in freezing temperatures.)

- 7 If the fan is not operating:  
Stop the engine immediately and contact your Toyota dealer.
- If the fan is operating: Have the vehicle inspected at the nearest Toyota dealer.

### WARNING

#### ■ When inspecting under the hood of your vehicle

Observe the following precautions. Failure to do so may result in serious injury such as burns.

- If steam is seen coming from under the hood, do not open the hood until the steam has subsided. The engine compartment may be very hot.
- Keep hands and clothing (especially a tie, a scarf or a muffler) away from the fan and belts. Failure to do so may cause the hands or clothing to be caught, resulting in serious injury.
- Do not loosen the coolant reservoir cap while the engine and radiator are hot. High temperature steam or coolant could spray out.

### NOTICE

#### ■ When adding engine coolant

Add coolant slowly after the engine has cooled down sufficiently. Adding cool coolant to a hot engine too quickly can cause damage to the engine.

#### ■ To prevent damage to the cooling system

Observe the following precautions:

- Avoid contaminating the coolant with foreign matter (such as sand or dust etc.).
- Do not use any coolant additive.

If the vehicle becomes stuck

Carry out the following procedures if the tires spin or the vehicle becomes stuck in mud, dirt or snow:

Recovering procedure

- 1 Stop the engine. Set the parking brake and shift the shift lever to P (continuously variable transmission) or N (manual transmission).
- 2 Remove the mud, snow or sand from around the front wheels.
- 3 Place wood, stones or some other material under the front wheels to help provide traction.
- 4 Restart the engine.
- 5 Shift the shift lever to D or R (continuously variable transmission) or 1 or R (manual transmission) and release the parking brake. Then, while exercising caution, depress the accelerator pedal.

When it is difficult to free the vehicle

Press the  switch to turn off TRAC.

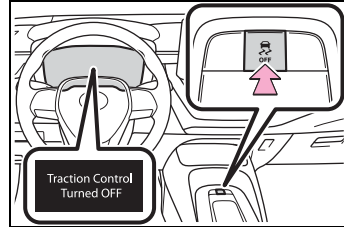

**WARNING**

When attempting to free a stuck vehicle

If you choose to push the vehicle back and forth to free it, make sure the surrounding area is clear to avoid striking other vehicles, objects or people. The vehicle may also lunge forward or lunge back suddenly as it becomes free. Use extreme caution.

When shifting the shift lever (vehicles with a continuously variable transmission)

Be careful not to shift the shift lever with the accelerator pedal depressed. This may lead to unexpected rapid acceleration of the vehicle that may cause an accident resulting in death or serious injury.

**NOTICE**

To avoid damaging the transmission and other components

- Avoid spinning the front wheels and depressing the accelerator pedal more than necessary.
- If the vehicle remains stuck even after these procedures are performed, the vehicle may require towing to be freed.



## Vehicle specifications

9

555

### 9-1. Specifications

- Maintenance data (fuel, oil level, etc.) ..... 556
- Fuel information ..... 568
- Tire information ..... 570

### 9-2. Customization

- Customizable features ..... 581

### 9-3. Initialization

- Items to initialize ..... 589

9

Vehicle specifications

## Maintenance data (fuel, oil level, etc.)

## Dimensions and weight

Overall length		182.3 in. (4630 mm) <sup>*2</sup>
		182.5 in. (4635 mm) <sup>*3, 4</sup>
		182.8 in. (4643 mm) <sup>*5</sup>
Overall width		70.1 in. (1780 mm) <sup>*4</sup>
		70.1 in. (1781 mm) <sup>*5</sup>
Overall height <sup>*1</sup>		55.9 in. (1420 mm) <sup>*5</sup>
		56.5 in. (1435 mm) <sup>*4</sup>
		57.3 in. (1455 mm) <sup>*4, 6</sup>
Wheelbase		106.3 in. (2700 mm)
Tread	Front	60.1 in. (1527 mm) <sup>*4, 6</sup>
		60.3 in. (1531 mm)
	Rear	60.0 in. (1525 mm) <sup>*2, 6</sup>
		60.1 in. (1526 mm) <sup>*3, 4, 6</sup>
Vehicle capacity weight (Occupants + luggage)		825 lb. (375 kg) <sup>*2</sup>
		860 lb. (390 kg) <sup>*3</sup>

<sup>\*1</sup>: Unladen vehicles

<sup>\*2</sup>: 1.8 L 4-cylinder (2ZR-FAE) engine

<sup>\*3</sup>: 2.0 L 4-cylinder (M20A-FKS) engine

<sup>\*4</sup>: Except for APEX models

<sup>\*5</sup>: For APEX models

<sup>\*6</sup>: For Guam and Saipan

## Seating capacity

Seating capacity	5 (Front 2, Rear 3)
------------------	---------------------



**Vehicle identification**

■ **Vehicle identification number**

The vehicle identification number (VIN) is the legal identifier for your vehicle. This is the primary identification number for your Toyota. It is used in registering the ownership of your vehicle.

On some models: This number is stamped under the right-hand front seat.

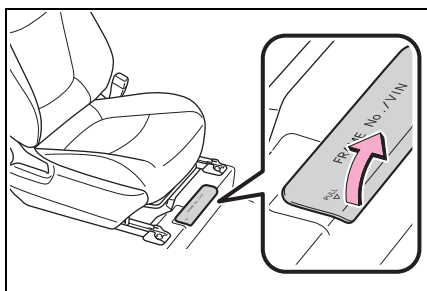

This number is also stamped on the top left of the instrument panel.

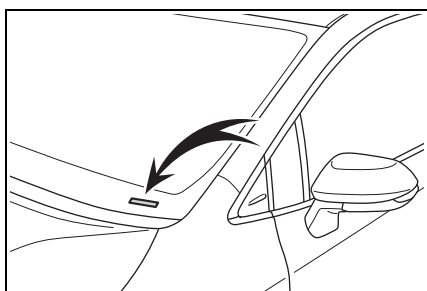

This number is also on the Certification Label.

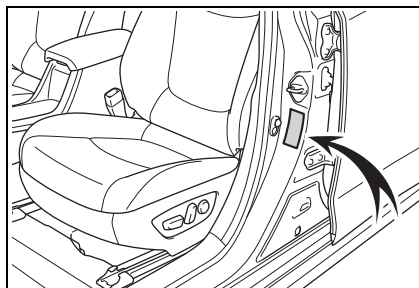

■ **Engine number**

The engine number is stamped on the engine block as shown.

- ▶ 1.8 L 4-cylinder (2ZR-FAE) engine

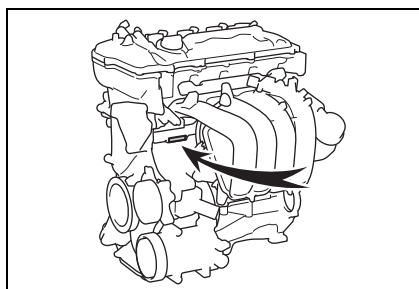

- ▶ 2.0 L 4-cylinder (M20A-FKS) engine

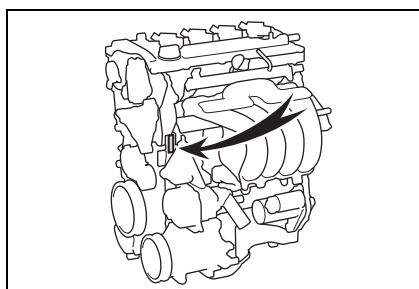

**Engine**

Model	1.8 L 4-cylinder (2ZR-FAE)	2.0 L 4-cylinder (M20A-FKS)
Type	4-cylinder in line, 4-cycle, gasoline	4-cylinder in line, 4-cycle, gasoline
Bore and stroke	3.17 × 3.48 in. (80.5 × 88.3 mm)	3.17 × 3.84 in. (80.5 × 97.6 mm)
Displacement	109.7 cu. in. (1798 cm <sup>3</sup> )	121.3 cu. in. (1987 cm <sup>3</sup> )
Valve clearance	Automatic adjustment	
Drive belt tension	Automatic adjustment	

**Fuel**

Fuel type	Unleaded gasoline only
Octane Rating	87 (Research Octane Number 91) or higher
Fuel tank capacity (Reference)	13.2 gal. (50.0 L, 11.0 Imp. gal.)

**Lubrication system (1.8 L 4-cylinder [2ZR-FAE] engine)****Oil capacity (Drain and refill [Reference\*])**

With filter	4.4 qt. (4.2 L, 3.7 Imp. qt.)
Without filter	4.1 qt. (3.9 L, 3.4 Imp. qt.)

\*: The engine oil capacity is a reference quantity to be used when changing the engine oil. Warm up and turn off the engine, wait more than 5 minutes, and check the oil level on the dipstick.

**Engine oil selection**

“Toyota Genuine Motor Oil” is used in your Toyota vehicle. Use Toyota approved “Toyota Genuine Motor Oil” or equivalent to satisfy the following grade and viscosity.

Oil grade: ILSAC GF-5 multi-grade engine oil

Recommended viscosity: SAE 0W-20

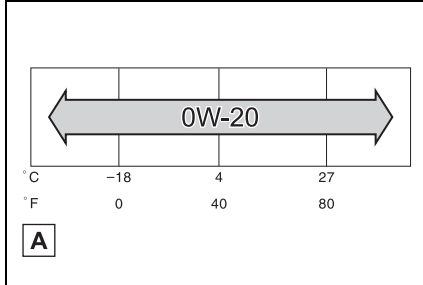

**A** Outside temperature

SAE 0W-20 is the best choice for good fuel economy and good starting in cold weather.

If SAE 0W-20 is not available, SAE 5W-20 oil may be used. However, it must be replaced with SAE 0W-20 at the next oil change.

Oil viscosity (0W-20 is explained here as an example):

- The 0W in 0W-20 indicates the characteristic of the oil which allows cold startability. Oils with a lower value before the W allow for easier starting of the engine in cold weather.
- The 20 in 0W-20 indicates the viscosity characteristic of the oil when the oil is at high temperature. An oil with a higher viscosity (one with a higher value) may be better suited if the vehicle is operated at high speeds, or under extreme load conditions.

How to read oil container label:

The International Lubricant Specification Advisory Committee (ILSAC) Certification Mark is

added to some oil containers to help you select the oil you should use.



**Lubrication system (2.0 L 4-cylinder [M20A-FKS] engine)**

■ **Oil capacity (Drain and refill [Reference \*])**

With filter	4.9 qt. (4.6 L, 4.0 Imp. qt.)
Without filter	4.5 qt. (4.3 L, 3.8 Imp. qt.)

\*: The engine oil capacity is a reference quantity to be used when changing the engine oil. Warm up and turn off the engine, wait more than 5 minutes, and check the oil level on the dipstick.

■ **Engine oil selection**

“Toyota Genuine Motor Oil” is used in your Toyota vehicle. Use Toyota approved “Toyota Genuine Motor Oil” or equivalent to satisfy the following grade and viscosity.

Oil grade: API SN/RC multi-grade engine oil

Recommended viscosity: SAE

0W-16

select the oil you should use.

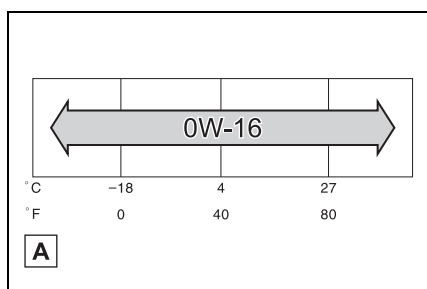
**A** Outside temperature

SAE 0W-16 is the best choice for good fuel economy and good starting in cold weather.

If SAE 0W-16 is not available, SAE 0W-20 oil may be used. However, it must be replaced with SAE 0W-16 at the next oil change.

Oil viscosity (0W-16 is explained here as an example):

- The 0W in 0W-16 indicates the characteristic of the oil which allows cold startability. Oils with a lower value before the W allow for easier starting of the engine in cold weather.
- The 16 in 0W-16 indicates the viscosity characteristic of the oil when the oil is at high temperature. An oil with a higher viscosity (one with a higher value) may be better suited if the vehicle is operated at high speeds, or under extreme load conditions.

How to read oil container label:

API registered mark is added to some oil containers to help you

**Cooling system**

Capacity (Reference)	<p>▶ 1.8 L 4-cylinder (2ZR-FAE) engine</p> <p>Continuously variable transmission: 6.1 qt. (5.8 L, 5.1 Imp. qt.)</p> <p>Manual transmission: 5.9 qt. (5.6 L, 4.9 Imp. qt.)</p> <p>▶ 2.0 L 4-cylinder (M20A-FKS) engine (vehicles with a type A engine coolant reservoir)*</p> <p>Continuously variable transmission: 6.6 qt. (6.2 L, 5.5 Imp. qt.)</p> <p>Manual transmission: 6.2 qt. (5.9 L, 5.2 Imp. qt.)</p> <p>▶ 2.0 L 4-cylinder (M20A-FKS) engine (vehicles with a type B engine coolant reservoir)*</p> <p>Continuously variable transmission: 6.8 qt. (6.4 L, 5.6 Imp. qt.)</p> <p>Manual transmission: 6.4 qt. (6.1 L, 5.4 Imp. qt.)</p>
Coolant type	<p>Use either of the following:</p> <ul style="list-style-type: none"> <li>• “Toyota Super Long Life Coolant”</li> <li>• Similar high-quality ethylene glycol-based non-silicate, non-amine, non-nitrite, and non-borate coolant with long-life hybrid organic acid technology</li> </ul> <p>Do not use plain water alone.</p>

\*: To determine if your vehicle's engine coolant reservoir is type A or type B, refer to "Checking the engine coolant". (→P.470)

**Ignition system (spark plug)**

Make	<p>▶ 1.8 L 4-cylinder (2ZR-FAE) engine DENSO FC16HR-Q8</p> <p>▶ 2.0 L 4-cylinder (M20A-FKS) engine DENSO FC20HR-Q8</p>
Gap	0.032 in. (0.8 mm)

**NOTICE****■ Iridium-tipped spark plugs**

Use only iridium-tipped spark plugs. Do not adjust the spark plug gap.

**Electrical system (battery)**

Open voltage at 68°F (20°C):	12.3 V or higher (Turn the engine switch off and turn on the high beam headlights for 30 seconds.)
Charging rates	
Quick charge	15 A max.
Slow charge	5 A max.

**Continuously variable transmission**

Fluid capacity*	<ul style="list-style-type: none"> <li>▶ 1.8 L 4-cylinder (2ZR-FAE) engine 7.9 qt. (7.5 L, 6.6 Imp. qt.)</li> <li>▶ 2.0 L 4-cylinder (M20A-FKS) engine 9.0 qt. (8.5 L, 7.5 Imp. qt.)</li> </ul>
Fluid type	Toyota Genuine CVT Fluid FE

\*: The fluid capacity is a reference quantity.  
If replacement is necessary, contact your Toyota dealer.

**NOTICE****■ Continuously variable transmission fluid type**

Using continuously variable transmission fluid other than the above type may cause abnormal noise or vibration, or damage the continuously variable transmission of your vehicle.

**Manual transmission**

Gear oil capacity (Reference)	<ul style="list-style-type: none"> <li>▶ 1.8 L 4-cylinder (2ZR-FAE) engine 2.5 qt. (2.4 L, 2.1 Imp. qt.)</li> <li>▶ 2.0 L 4-cylinder (M20A-FKS) engine 1.6 qt. (1.5 L, 1.3 Imp. qt.)</li> </ul>
Gear oil type	“TOYOTA Genuine Manual Transmission Gear Oil LV GL-4 75W” or equivalent

 NOTICE

**Manual transmission gear oil type**

- Please be aware that depending on the particular characteristics of the gear oil used or the operating conditions, idle sound, shift feeling and/or fuel efficiency may be different or affected and, in the worst case, damage to the vehicle's transmission.  
Toyota recommends to use "TOYOTA Genuine Manual Transmission Gear Oil LV GL-4 75W" to achieve optimal performance.
- Your Toyota vehicle is filled with "TOYOTA Genuine Manual Transmission Gear Oil LV GL-4 75W" at the factory.  
Use Toyota approved "TOYOTA Genuine Manual Transmission Gear Oil LV GL-4 75W" or an equivalent oil of matching quality that satisfies the above specifications.  
Please contact your Toyota dealer for further details.

**Clutch**

Pedal free play	0.1 — 0.6 in. (3 — 15 mm)
Fluid type	FMVSS No.116 DOT 3 or SAE J1703 FMVSS No.116 DOT 4 or SAE J1704

**Brakes**

Pedal clearance <sup>*1</sup>	4.1 in. (105 mm) Min.
Pedal free play	0.04 — 0.24 in. (1 — 6 mm)
Parking brake lever travel <sup>*2, 3</sup>	5 — 8 clicks
Brake pad wear limit	<ul style="list-style-type: none"> <li>▶ Front 0.06 in. (1.5 mm)</li> <li>▶ Rear Vehicles without a electric parking brake: 0.06 in. (1.5 mm)</li> <li>Vehicles with a electric parking brake: 0.08 in. (2.0 mm)</li> </ul>

Parking brake indicator *4	When pulling the parking brake switch for 1 to 2 seconds: comes on When pushing the parking brake switch for 1 to 2 seconds: turns off
Fluid type	FMVSS No.116 DOT 3 or SAE J1703 FMVSS No.116 DOT 4 or SAE J1704

\*1: Minimum pedal clearance when depressed with a force of 67.4 lbf (300 N, 30.6 kgf) while the engine is running.

\*2: If equipped

\*3: Parking brake lever travel when pulled up with a force of 45.0 lbf (200 N, 20.4 kgf)

\*4: Make sure to confirm that the brake system warning light (yellow) does not illuminate. (If the brake system warning light illuminates, refer to P.511.)

## Steering

Free play	Less than 1.2 in. (30 mm)
-----------	---------------------------

## Tires and wheels

### ► Type A

Tire size	195/65R15 91S, T125/70D17 98M
Tire inflation pressure (Recommended cold tire inflation pressure)	► Front 38 psi (260 kPa, 2.6 kgf/cm <sup>2</sup> or bar) ► Rear 36 psi (250 kPa, 2.5 kgf/cm <sup>2</sup> or bar) ► Spare 60 psi (420 kPa, 4.2 kgf/cm <sup>2</sup> or bar)
Wheel size	15 × 6 1/2J, 17 × 4T (compact spare)
Wheel nut torque	76 ft•lbf (103 N•m, 10.5 kgf•m)



► Type B

Tire size	205/55R16 91H, T125/70D17 98M
Tire inflation pressure (Recommended cold tire inflation pressure)	► Front 35 psi (240 kPa, 2.4 kgf/cm <sup>2</sup> or bar) ► Rear 33 psi (230 kPa, 2.3 kgf/cm <sup>2</sup> or bar) ► Spare 60 psi (420 kPa, 4.2 kgf/cm <sup>2</sup> or bar)
Wheel size	16 × 7J, 17 × 4T (compact spare)
Wheel nut torque	76 ft•lbf (103 N•m, 10.5 kgf•m)

► Type C

Tire size	225/40R18 88V, T125/70D17 98M
Tire inflation pressure (Recommended cold tire inflation pressure)	► Front 33 psi (230 kPa, 2.3 kgf/cm <sup>2</sup> or bar) ► Rear 30 psi (210 kPa, 2.1 kgf/cm <sup>2</sup> or bar) ► Spare 60 psi (420 kPa, 4.2 kgf/cm <sup>2</sup> or bar)
Wheel size	18 × 8J, 17 × 4T (compact spare)
Wheel nut torque	76 ft•lbf (103 N•m, 10.5 kgf•m)

► Type D

Tire size	195/65R15 91S
Tire inflation pressure (Recommended cold tire inflation pressure)	► Front 38 psi (260 kPa, 2.6 kgf/cm <sup>2</sup> or bar) ► Rear 36 psi (250 kPa, 2.5 kgf/cm <sup>2</sup> or bar) ► Spare None
Wheel size	15 × 6 1/2J
Wheel nut torque	76 ft•lbf (103 N•m, 10.5 kgf•m)

## ► Type E

Tire size	205/55R16 91H
Tire inflation pressure (Recommended cold tire inflation pressure)	► Front 35 psi (240 kPa, 2.4 kgf/cm <sup>2</sup> or bar) ► Rear 33 psi (230 kPa, 2.3 kgf/cm <sup>2</sup> or bar) ► Spare None
Wheel size	16 × 7J
Wheel nut torque	76 ft•lbf (103 N•m, 10.5 kgf•m)

## ► Type F

Tire size	225/40R18 88W, T125/70D17 98M
Tire inflation pressure (Recommended cold tire inflation pressure)	► Front 33 psi (230 kPa, 2.3 kgf/cm <sup>2</sup> or bar) ► Rear 30 psi (210 kPa, 2.1 kgf/cm <sup>2</sup> or bar) ► Spare 60 psi (420 kPa, 4.2 kgf/cm <sup>2</sup> or bar)
Wheel size	18 × 8J, 17 × 4T (compact spare)
Wheel nut torque	76 ft•lbf (103 N•m, 10.5 kgf•m)

**Light bulbs**

	Light bulbs	Bulb No.	W	Type
Exterior	Front side marker lights	—	5	A
	Front turn signal /parking lights (vehicles without side turn signal lights)	7444NA	28/8	B
	Rear side marker lights (bulb type)	—	5	A
	Rear turn signal lights	—	21	B
	Back-up lights	—	16	A

	Light bulbs	Bulb No.	W	Type
Interior	Front interior lights/personal lights	—	5	A
	Vanity lights (if equipped)	—	8	A
	Rear interior light	—	8	C
	Trunk light	—	5	A

- A: Wedge base bulbs (clear)
- B: Wedge base bulbs (amber)
- C: Double end bulbs

## Fuel information

**You must only use unleaded gasoline.**

**Select octane rating of 87 (Research Octane Number 91) or higher. Use of unleaded gasoline with an octane rating lower than 87 may result in engine knocking. Persistent knocking can lead to engine damage.**

At minimum, the gasoline you use should meet the specifications of ASTM D4814 in the U.S.A.

### Gasoline quality

In very few cases, driveability problems may be caused by the brand of gasoline you are using. If driveability problems persist, try changing the brand of gasoline. If this does not correct the problem, consult your Toyota dealer.

### Recommendation of the use of gasoline containing detergent additives

- Toyota recommends the use of gasoline that contains detergent additives to avoid the build-up of engine deposits.
- All gasoline sold in the U.S.A. contains minimum detergent additives to clean and/or keep clean intake systems, per EPA's lowest additives concentration program.
- Toyota strongly recommends the use of Top Tier Detergent Gasoline. For more information on Top Tier Detergent Gasoline and a list of marketers, please go to the official website [www.toptiergas.com](http://www.toptiergas.com).

### Recommendation of the use of low emissions gasoline

Gasolines containing oxygenates such as ethers and ethanol, as well as reformulated gasolines, are available in some cities. These fuels are typically acceptable for use, providing they meet other fuel requirements.

Toyota recommends these fuels, since the formulations allow for reduced vehicle emissions.

### Non-recommendation of the use of blended gasoline

- Use only gasoline containing up to 15% ethanol.  
DO NOT use any flex-fuel or gasoline that could contain more than 15% ethanol, including from any pump labeled E30 (30% ethanol [A]), E50 (50% ethanol [B]), E85 (85% ethanol [C]) (which are only some examples of fuel containing more than 15% ethanol).

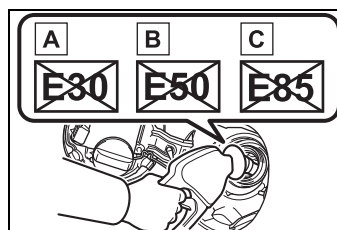

- If you use gasohol in your vehicle, be sure that it has an octane rating no lower than 87.
- Toyota does not recommend the use of gasoline containing methanol.

### Non-recommendation of the use of gasoline containing MMT

Some gasoline contains an octane enhancing additive called MMT (Methylcyclopentadienyl Manganese Tricarbonyl).

Toyota does not recommend the use of gasoline that contains MMT. If fuel containing MMT is used, your emission control system may be

adversely affected.

The malfunction indicator lamp on the instrument cluster may come on. If this happens, contact your Toyota dealer for service.

#### ■ If your engine knocks

- Consult your Toyota dealer.
- You may occasionally notice light knocking for a short time while accelerating or driving uphill. This is normal and there is no need for concern.



#### NOTICE

##### ■ Notice on fuel quality

- Do not use improper fuels. If improper fuels are used, the engine will be damaged.
- Do not use leaded gasoline. Leaded gasoline can cause damage to your vehicle's three-way catalytic converters causing the emission control system to malfunction.
- Do not use gasohol other than the type previously stated. Other gasohol may cause fuel system damage or vehicle performance problems.
- Using unleaded gasoline with an octane number or rating lower than the level previously stated will cause persistent heavy knocking. At worst, this will lead to engine damage.

##### ■ Fuel-related poor driveability

If poor driveability (poor hot starting, vaporization, engine knocking, etc.) is encountered after using a different type of fuel, discontinue the use of that type of fuel.

##### ■ When refueling with gasohol

Take care not to spill gasohol. It can damage your vehicle's paint.

## Tire information

## Typical tire symbols

## ► Full-size tire

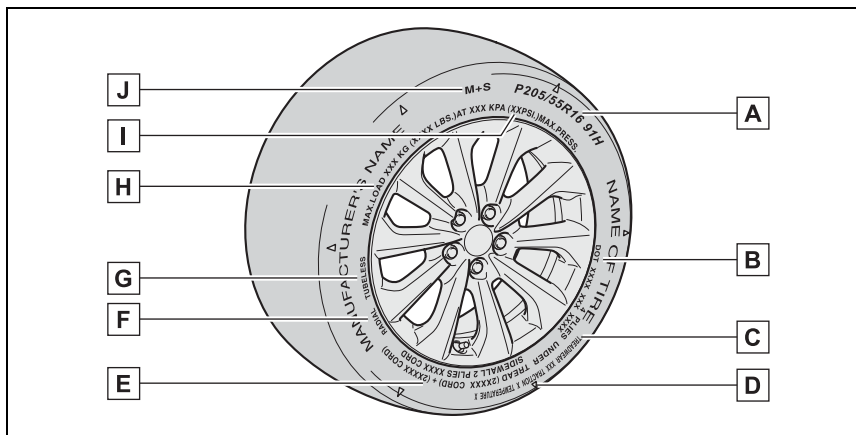

**A** Tire size (→P.572)

**B** DOT and Tire Identification Number (TIN) (→P.572)

**C** Uniform tire quality grading

For details, see “Uniform Tire Quality Grading” that follows.

**D** Location of treadwear indicators (→P.475)

**E** Tire ply composition and materials

Ply is a layer of rubber-coated parallel cords. Cords are the strands which form the plies in a tire.

**F** Radial tires or bias-ply tires

A radial tire has “RADIAL” on the sidewall. A tire not marked “RADIAL” is a bias-ply tire.

**G** TUBELESS or TUBE TYPE

A tubeless tire does not have a tube and air is directly put into the tire. A tube type tire has a tube inside the tire and the tube maintains the air pressure.

**H** Load limit at maximum cold tire inflation pressure (→P.475)

**I** Maximum cold tire inflation pressure (→P.564)

This means the pressure to which a tire may be inflated.

**J** Summer tires or all season tires (→P.476)

An all season tire has “M+S” on the sidewall. A tire not marked “M+S” is a summer tire.

► Compact spare tire

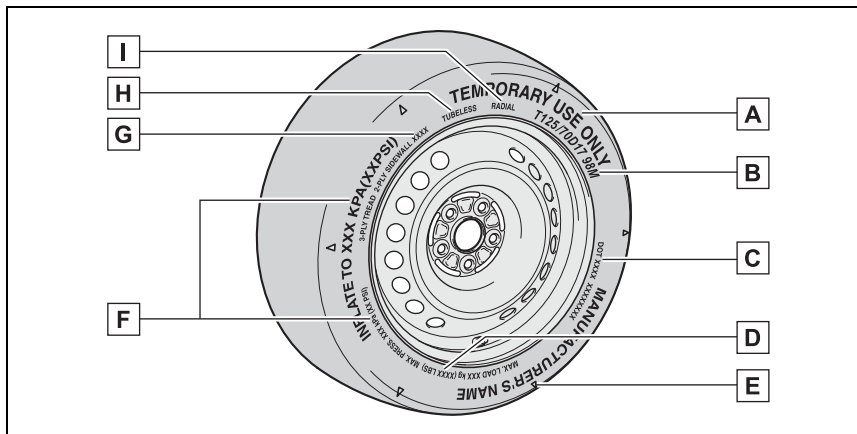

**A** “TEMPORARY USE ONLY”

A compact spare tire is identified by the phrase “TEMPORARY USE ONLY” molded on its sidewall. This tire is designed for temporary emergency use only.

**B** Tire size (→P.572)

**C** DOT and Tire Identification Number (TIN) (→P.572)

**D** Load limit at maximum cold tire inflation pressure (→P.475)

**E** Location of treadwear indicators (→P.475)

**F** Maximum cold tire inflation pressure (→P.564)

This means the pressure to which a tire may be inflated.

**G** Tire ply composition and materials

Plies are layers of rubber-coated parallel cords. Cords are the strands which form the plies in a tire.

**H** TUBELESS or TUBE TYPE

A tubeless tire does not have a tube and air is directly put into the tire. A tube type tire has a tube inside the tire and the tube maintains the air pressure.

**I** Radial tires or bias-ply tires

A radial tire has “RADIAL” on the sidewall. A tire not marked “RADIAL” is a bias-ply tire.

**Typical DOT and Tire Identification Number (TIN)**

► Type A

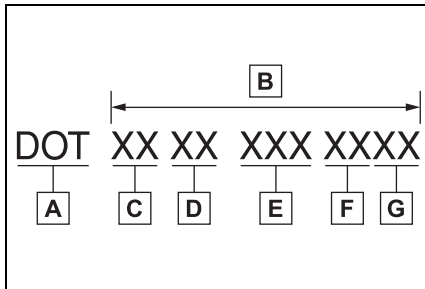

- A** DOT symbol\*
- B** Tire Identification Number (TIN)
- C** Tire manufacturer's identification mark
- D** Tire size code
- E** Manufacturer's optional tire type code (3 or 4 letters)
- F** Manufacturing week
- G** Manufacturing year

\*: The DOT symbol certifies that the tire conforms to applicable Federal Motor Vehicle Safety Standards.

► Type B

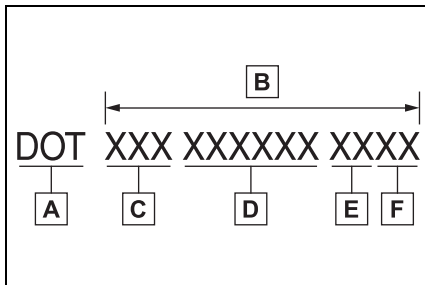

- A** DOT symbol\*
- B** Tire Identification Number (TIN)
- C** Tire manufacturer's identification mark
- D** Manufacturer's code
- E** Manufacturing week
- F** Manufacturing year

\*: The DOT symbol certifies that the tire conforms to applicable Federal Motor Vehicle Safety Standards.

**Tire size**

■ Typical tire size information

The illustration indicates typical tire size.

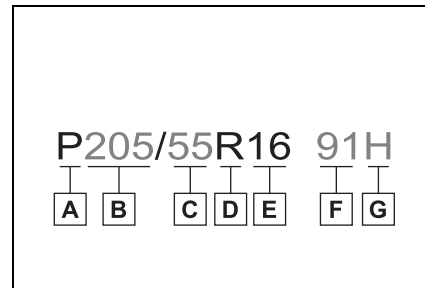

- A** Tire use (P = Passenger car, T = Temporary use)
- B** Section width (millimeters)
- C** Aspect ratio (tire height to section width)
- D** Tire construction code (R = Radial, D = Diagonal)
- E** Wheel diameter (inches)
- F** Load index (2 digits or 3 digits)



**G** Speed symbol (alphabet with one letter)

**K** Chafer

■ **Tire dimensions**

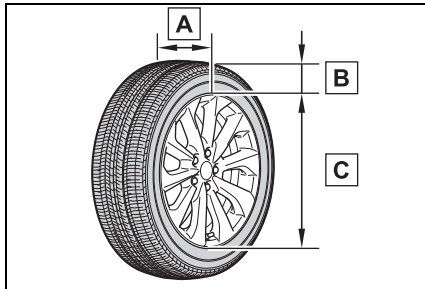

**A** Section width

**B** Tire height

**C** Wheel diameter

**Tire section names**

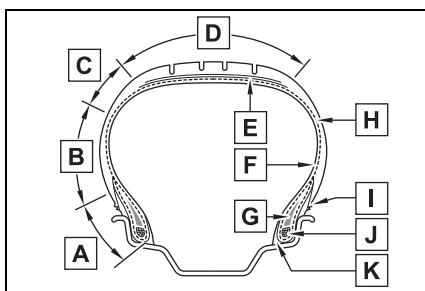

**A** Bead

**B** Sidewall

**C** Shoulder

**D** Tread

**E** Belt

**F** Inner liner

**G** Reinforcing rubber

**H** Carcass

**I** Rim lines

**J** Bead wires

**Uniform Tire Quality Grading**

This information has been prepared in accordance with regulations issued by the National Highway Traffic Safety Administration of the U.S. Department of Transportation.

It provides the purchasers and/or prospective purchasers of Toyota vehicles with information on uniform tire quality grading.

Your Toyota dealer will help answer any questions you may have as you read this information.

■ **DOT quality grades**

All passenger vehicle tires must conform to Federal Safety Requirements in addition to these grades. Quality grades can be found where applicable on the tire sidewall between tread shoulder and maximum section width.

For example: Treadwear 200 Traction AA Temperature A

■ **Treadwear**

The treadwear grade is a comparative rating based on the wear rate of the tire when tested under controlled conditions on a specified government test course.

For example, a tire graded 150

would wear one and a half (1 - 1/2) times as well on the government course as a tire graded 100.

The relative performance of tires depends upon the actual conditions of their use. Performance may differ significantly from the norm due to variations in driving habits, service practices and differences in road characteristics and climate.

#### ■ Traction AA, A, B, C

The traction grades, from highest to lowest, are AA, A, B and C, and they represent the tire's ability to stop on wet pavement as measured under controlled conditions on specified government test surfaces of asphalt and concrete.

A tire marked C may have poor traction performance.

Warning: The traction grade assigned to this tire is based on braking (straight ahead) traction tests and does not include cornering (turning) traction.

#### ■ Temperature A, B, C

The temperature grades are A

(the highest), B, and C, representing the tire's resistance to the generation of heat and its ability to dissipate heat when tested under controlled conditions on a specified indoor laboratory test wheel.

Sustained high temperature can cause the material of the tire to degenerate and reduce tire life, and excessive temperature can lead to sudden tire failure.

Grade C corresponds to a level of performance which all passenger car tires must meet under the Federal Motor Vehicle Safety Standard No. 109.

Grades B and A represent higher levels of performance on the laboratory test wheel than the minimum required by law.

Warning: The temperature grades of a tire assume that it is properly inflated and not overloaded.

Excessive speed, underinflation, or excessive loading, either separately or in combination, can cause heat buildup and possible tire failure.

### Glossary of tire terminology

Tire related term	Meaning
Cold tire inflation pressure	Tire pressure when the vehicle has been parked for three hours or more, or has not been driven more than 1 mile or 1.5 km under that condition
Maximum inflation pressure	The maximum cold inflated pressure to which a tire may be inflated, shown on the sidewall of the tire

Tire related term	Meaning
Recommended inflation pressure	Cold tire inflation pressure recommended by a manufacturer
Accessory weight	The combined weight (in excess of those standard items which may be replaced) of automatic transmission, power steering, power brakes, power windows, power seats, radio and heater, to the extent that these items are available as factory-installed equipment (whether installed or not)
Curb weight	The weight of a motor vehicle with standard equipment, including the maximum capacity of fuel, oil and coolant, and if so equipped, air conditioning and additional weight optional engine
Maximum loaded vehicle weight	The sum of: (a) Curb weight (b) Accessory weight (c) Vehicle capacity weight (d) Production options weight
Normal occupant weight	150 lb. (68 kg) times the number of occupants specified in the second column of Table 1* that follows
Occupant distribution	Distribution of occupants in a vehicle as specified in the third column of Table 1* below
Production options weight	The combined weight of installed regular production options weighing over 5 lb. (2.3 kg) in excess of the standard items which they replace, not previously considered in curb weight or accessory weight, including heavy duty brakes, ride levelers, roof rack, heavy duty battery, and special trim
Rim	A metal support for a tire or a tire and tube assembly upon which the tire beads are seated

Tire related term	Meaning
Rim diameter (Wheel diameter)	Nominal diameter of the bead seat
Rim size designation	Rim diameter and width
Rim type designation	The industry manufacturer's designation for a rim by style or code
Rim width	Nominal distance between rim flanges
Vehicle capacity weight (Total load capacity)	The rated cargo and luggage load plus 150 lb. (68 kg) times the vehicle's designated seating capacity
Vehicle maximum load on the tire	The load on an individual tire that is determined by distributing to each axle its share of the maximum loaded vehicle weight, and dividing by two
Vehicle normal load on the tire	The load on an individual tire that is determined by distributing to each axle its share of curb weight, accessory weight, and normal occupant weight (distributed in accordance with Table 1 <sup>*</sup> below), and dividing by two
Weather side	The surface area of the rim not covered by the inflated tire
Bead	The part of the tire that is made of steel wires, wrapped or reinforced by ply cords and that is shaped to fit the rim
Bead separation	A breakdown of the bond between components in the bead
Bias ply tire	A pneumatic tire in which the ply cords that extend to the beads are laid at alternate angles substantially less than 90 degrees to the centerline of the tread
Carcass	The tire structure, except tread and sidewall rubber which, when inflated, bears the load
Chunking	The breaking away of pieces of the tread or sidewall
Cord	The strands forming the plies in the tire

Tire related term	Meaning
Cord separation	The parting of cords from adjacent rubber compounds
Cracking	Any parting within the tread, sidewall, or innerliner of the tire extending to cord material
CT	A pneumatic tire with an inverted flange tire and rim system in which the rim is designed with rim flanges pointed radially inward and the tire is designed to fit on the underside of the rim in a manner that encloses the rim flanges inside the air cavity of the tire
Extra load tire	A tire designed to operate at higher loads and at higher inflation pressures than the corresponding standard tire
Groove	The space between two adjacent tread ribs
Innerliner	The layer(s) forming the inside surface of a tubeless tire that contains the inflating medium within the tire
Innerliner separation	The parting of the innerliner from cord material in the carcass
Intended outboard sidewall	(a) The sidewall that contains a whitewall, bears white lettering, or bears manufacturer, brand, and/or model name molding that is higher or deeper than the same molding on the other sidewall of the tire, or (b) The outward facing sidewall of an asymmetrical tire that has a particular side that must always face outward when mounted on a vehicle
Light truck (LT) tire	A tire designated by its manufacturer as primarily intended for use on lightweight trucks or multipurpose passenger vehicles
Load rating	The maximum load that a tire is rated to carry for a given inflation pressure
Maximum load rating	The load rating for a tire at the maximum permissible inflation pressure for that tire

Tire related term	Meaning
Maximum permissible inflation pressure	The maximum cold inflation pressure to which a tire may be inflated
Measuring rim	The rim on which a tire is fitted for physical dimension requirements
Open splice	Any parting at any junction of tread, sidewall, or innerliner that extends to cord material
Outer diameter	The overall diameter of an inflated new tire
Overall width	The linear distance between the exteriors of the sidewalls of an inflated tire, including elevations due to labeling, decorations, or protective bands or ribs
Passenger car tire	A tire intended for use on passenger cars, multipurpose passenger vehicles, and trucks, that have a gross vehicle weight rating (GVWR) of 10,000 lb. or less.
Ply	A layer of rubber-coated parallel cords
Ply separation	A parting of rubber compound between adjacent plies
Pneumatic tire	A mechanical device made of rubber, chemicals, fabric and steel or other materials, that, when mounted on an automotive wheel, provides the traction and contains the gas or fluid that sustains the load
Radial ply tire	A pneumatic tire in which the ply cords that extend to the beads are laid at substantially 90 degrees to the centerline of the tread
Reinforced tire	A tire designed to operate at higher loads and at higher inflation pressures than the corresponding standard tire
Section width	The linear distance between the exteriors of the sidewalls of an inflated tire, excluding elevations due to labeling, decoration, or protective bands
Sidewall	That portion of a tire between the tread and bead

Tire related term	Meaning
Sidewall separation	The parting of the rubber compound from the cord material in the sidewall
Snow tire	A tire that attains a traction index equal to or greater than 110, compared to the ASTM E-1136 Standard Reference Test Tire, when using the snow traction test as described in ASTM F-1805-00, Standard Test Method for Single Wheel Driving Traction in a Straight Line on Snow-and Ice-Covered Surfaces, and which is marked with an Alpine Symbol (  ) on at least one sidewall
Test rim	The rim on which a tire is fitted for testing, and may be any rim listed as appropriate for use with that tire
Tread	That portion of a tire that comes into contact with the road
Tread rib	A tread section running circumferentially around a tire
Tread separation	Pulling away of the tread from the tire carcass
Treadwear indicators (TWI)	The projections within the principal grooves designed to give a visual indication of the degrees of wear of the tread
Wheel-holding fixture	The fixture used to hold the wheel and tire assembly securely during testing

\* : Table 1 -Occupant loading and distribution for vehicle normal load for various designated seating capacities

Designated seating capacity, Number of occupants	Vehicle normal load, Number of occupants	Occupant distribution in a normally loaded vehicle
2 through 4	2	2 in front
5 through 10	3	2 in front, 1 in second seat

580 **9-1. Specifications**

---

Designated seating capacity, Number of occupants	Vehicle normal load, Number of occupants	Occupant distribution in a normally loaded vehicle
11 through 15	5	2 in front, 1 in second seat, 1 in third seat, 1 in fourth seat
16 through 20	7	2 in front, 2 in second seat, 2 in third seat, 1 in fourth seat



**Customizable features**

**Your vehicle includes a variety of electronic features that can be personalized to suit your preferences. The settings of these features can be changed using the multi-information display, the audio system screen, or at your Toyota dealer.**

**Customizing vehicle features**

■ **Changing by using the audio system screen**

- 1 Press the "MENU" button.
- 2 Select "Setup" on the "Menu" screen.
- 3 Select "General" or "Vehicle" on the "Setup" screen.

Various setting can be changed. Refer to the list of settings that can be changed for details.

■ **Changing by using the meter control switches**

- 1 Press < or > of the meter control switch to select .

- 2 Press ^ or v of the meter control switch to select the desired item to be customized.
- 3 Press or press and hold OK .

The available settings will differ depending on if OK is pressed or pressed and held. Follow the instructions on the display.

**⚠ WARNING**

■ **During customization**

As the engine needs to be running during customization, ensure that the vehicle is parked in a place with adequate ventilation. In a closed area such as a garage, exhaust gases including harmful carbon monoxide (CO) may collect and enter the vehicle. This may lead to death or a serious health hazard.

**⚠ NOTICE**

■ **During customization**

To prevent battery discharge, ensure that the engine is running while customizing features.

**Customizable features**

Some function settings are changed simultaneously with other functions being customized. Contact your Toyota dealer for further details.

- A** Settings that can be changed using the audio system screen
- B** Settings that can be changed using the meter control switches

**C** Settings that can be changed by your Toyota dealer

Definition of symbols: O = Available, — = Not available

■ **Gauges, meters and multi-information display (→P.86, 91, 95, 100)**

Function <sup>*1</sup>	Default setting	Customized setting	A	B	C
Language	English	French	O	O	—
		Spanish			
Units <sup>*2</sup>	miles (MPG)	km (km/L)			
		km (L/100 km)	—	O	—
		miles (MPG Imperial)			
Speedometer display <sup>*3</sup>	Analog	Digital	—	O	—
Eco Driving Indicator Light <sup>*4</sup>	On	Off	—	O	—
Fuel economy display	Total average (Average fuel consumption [after reset])	Trip average (Average fuel consumption [after start])			
		Tank average (Average fuel consumption [after refuel])	—	O	—
Audio system linked display	On	Off	—	O	—
Drive information type	After start	After reset	—	O	—
Drive information items (First item)	Distance	Average vehicle speed	—	O	—
		Elapsed time			
Drive information items (Second item)	Elapsed time	Average vehicle speed	—	O	—
		Distance			
Pop-up display	On	Off	—	O	—

<sup>\*1</sup>: For details about each function: →P.104

<sup>\*2</sup>: The default setting varies according to country.

\*3: 7-inch display

\*4: If equipped

■ Door lock (→P.117, 122, 544)

Function	Default setting	Customized setting	A	B	C
Unlocking using a key	Driver's door unlocked in one step, all doors unlocked in two step	All doors unlocked in one step	—	—	O
Automatic door locking function*	Shift position linked door locking operation	Off			
		Speed linked door locking operation	O	—	O
Automatic door unlocking function*	Shift position linked door unlocking operation	Off			
		Driver's door linked door unlocking operation	O	—	O
Locking/unlocking of the trunk when all doors are locked/unlocked	On	Off	—	—	O

\*: Vehicles with a continuously variable transmission

■ Smart key system\* and wireless remote control\* (→P.117, 125)

Function	Default setting	Customized setting	A	B	C
Operating signal (Buzzers)	5	Off	O	—	O
		1 to 7			
Operation signal (Emergency flashers)	On	Off	O	—	O
Time elapsed before automatic door lock function is activated if door is not opened after being unlocked	60 seconds	Off			
		30 seconds	O	—	O
		120 seconds			
Open door warning buzzer	On	Off	—	—	O

\*: If equipped

## ■ Smart key system\* (→P.117, 125)

Function	Default setting	Customized setting	A	B	C
Smart key system	On	Off	—	—	○
Smart door unlocking	Driver's door	All the doors	○	—	○
Time elapsed before unlocking all the door when gripping and holding the driver's door handle	2.0 seconds	Off	—	—	○
		1.5 seconds			
		2.5 seconds			
Number of consecutive door lock operations	2 times	As many as desired	—	—	○

\*: If equipped

## ■ Wireless remote control\* (→P.112, 117, 122)

Function	Default setting	Customized setting	A	B	C
Wireless remote control	On	Off	—	—	○
Unlocking operation	Driver's door unlocked in one step, all doors unlocked in two step	All doors unlocked in one step	○	—	○
Trunk unlocking operation	Press and hold (short)	One short press	—	—	○
		Push twice			
		Press and hold (long)			
		Off			
Theft deterrent panic mode	On	Off	—	—	○
Locking operation when door opened	On	Off	○	—	○

\*: If equipped

■ **Power windows and moon roof\*** (→P.142, 145)

Function	Default setting	Customized setting	A	B	C
Mechanical key linked operation	Off	On	—	—	O
Wireless remote control linked operation	Off	On (open only)	—	—	O
Wireless remote control linked operation signal (buzzer)	On	Off	—	—	O

\*: If equipped

■ **Moon roof\*** (→P.145)

Function	Default setting	Customized setting	A	B	C
Linked operation of components when key is used (open only)	Slide only	Tilt only	—	—	O
Linked operation of components when wireless remote control is used	Slide only	Tilt only	—	—	O

\*: If equipped

■ **Automatic light control system (→P.186)**

Function	Default setting	Customized setting	A	B	C
Light sensor sensitivity	Standard	-2 to 2	O	—	O
Time elapsed before headlights automatically turn off after doors are closed	30 seconds	Off	O	—	O
		60 seconds			
		90 seconds			
Windshield wiper linked headlight illumination	On	Off	—	—	O

### ■ Lights (→P.186)

Function	Default setting	Customized setting	A	B	C
Daytime running light system	On	Off <sup>*1</sup>	<input type="radio"/>	<input type="checkbox"/>	<input type="radio"/>
AFS (Adaptive Front-lighting System) <sup>*2</sup>	On	Off	<input type="checkbox"/>	<input type="checkbox"/>	<input type="radio"/>

<sup>\*1</sup>: Except for Canada

<sup>\*2</sup>: If equipped

### ■ PCS (Pre-Collision System) (→P.203)

Function	Default setting	Customized setting	A	B	C
PCS (Pre-Collision System)	On	Off	<input type="checkbox"/>	<input type="radio"/>	<input type="checkbox"/>
Adjust alert timing	Middle	Far	<input type="checkbox"/>	<input type="radio"/>	<input type="checkbox"/>
		Near	<input type="checkbox"/>	<input type="radio"/>	<input type="checkbox"/>

### ■ LTA (Lane Tracing Assist)<sup>\*</sup>/LDA (Lane Departure Alert with steering control)<sup>\*</sup> (→P.211, 221)

Function	Customized setting	A	B	C
Lane centering function <sup>*</sup>	On, Off	<input type="checkbox"/>	<input type="radio"/>	<input type="checkbox"/>
Steering assist function	On, Off	<input type="checkbox"/>	<input type="radio"/>	<input type="checkbox"/>
Alert sensitivity	High, Standard	<input type="checkbox"/>	<input type="radio"/>	<input type="checkbox"/>
Vehicle sway warning function	On, Off	<input type="checkbox"/>	<input type="radio"/>	<input type="checkbox"/>
Vehicle sway warning sensitivity	High, Standard, Low	<input type="checkbox"/>	<input type="radio"/>	<input type="checkbox"/>

<sup>\*</sup>: If equipped

### ■ RSA (Road Sign Assist)<sup>\*</sup> (→P.250)

Function	Default setting	Customized setting	A	B	C
RSA (Road Sign Assist)	On	Off	<input type="checkbox"/>	<input type="radio"/>	<input type="checkbox"/>

Function	Default setting	Customized setting	A	B	C
Excess speed notification method	Display only	No notification	—	O	—
		Display and buzzer	—	O	—
Excess speed notification level	1 mph (2 km/h)	3 mph (5 km/h)	—	O	—
		5 mph (10 km/h)	—	O	—
Other notifications method (No-entry notification)	Display only	No notification	—	O	—
		Display and buzzer	—	O	—

\* : If equipped

■ **BSM (Blind Spot Monitor)\* (→P.253)**

Function	Default setting	Customized setting	A	B	C
BSM (Blind Spot Monitor)	On	Off	—	O	—
Outside rear view mirror indicator brightness	Bright	Dim	—	O	—
Alert timing for presence of approaching vehicle (sensitivity)	Intermediate	Early	—	O	—
		Late			
		Only when vehicle detected in blind spot			

\* : If equipped

■ **RCTA (Rear Cross Traffic Alert) function\* (→P.258)**

Function	Default setting	Customized setting	A	B	C
RCTA (Rear Cross Traffic Alert) function	On	Off	—	O	—
Buzzer volume	Level 2	Level 1	—	—	O
		Level 3	—	—	O

\* : If equipped

### ■ Automatic air conditioning system\* (→P.421)

Function	Default setting	Customized setting	A	B	C
A/C auto switch operation	On	Off	O	—	O

\*: If equipped

### ■ Illumination (→P.428)

Function	Default setting	Customized setting	A	B	C
Time elapsed before the interior lights turn off	15 seconds	Off	O	—	O
		7.5 seconds			
		30 seconds			
Operation after the engine switch is turned off	On	Off	—	—	O
Operation when the doors are unlocked	On	Off	—	—	O
Operation when you approach the vehicle with the electronic key on your person*	On	Off	—	—	O
Cup holder lights* and center tray light*	On	Off	—	—	O
Door trim lights*	On	Off	—	—	O

\*: If equipped

#### ■ Vehicle customization

- When the smart key system is off, Smart door unlocking cannot be customized.
- When the doors remain closed after unlocking the doors and the automatic door lock function is activated, the signals will be generated in accordance with the operation signal (buzzer) and the operation signal (emergency flashers) settings.

#### ■ In the following situations, customize mode in which the settings can be changed through the multi-information display will automatically be turned off

- The engine switch is turned off.
- The vehicle begins to move while the customize mode screen is displayed.



Items to initialize

The following items must be initialized for normal system operation after such cases as the battery being reconnected, or maintenance being performed on the vehicle:

List of items to initialize

Item	When to initialize	Reference
Message indicating maintenance is required	<ul style="list-style-type: none"> <li>• After maintenance is performed</li> </ul>	P.458
Tire pressure warning system*	<ul style="list-style-type: none"> <li>• When rotating front and rear tires which have different tire inflation pressures</li> <li>• When changing the tire size</li> <li>• When the tire inflation pressure is changed such as when changing traveling speed or load weight</li> <li>• When changing between two registered wheel sets</li> </ul>	P.481

\*: If equipped



**For owners**

**10**

591

**10-1.For owners**

- Reporting safety defects for U.S. owners..... 592
- Seat belt instructions for Canadian owners (in French)..... 592
- SRS airbag instructions for Canadian owners (in French)..... 594

**10**

**For owners**

### Reporting safety defects for U.S. owners

If you believe that your vehicle has a defect which could cause a crash or could cause injury or death, you should immediately inform the National Highway Traffic Safety Administration (NHTSA) in addition to notifying Toyota Motor Sales, U.S.A., Inc. (Toll-free: 1-800-331-4331).

If NHTSA receives similar complaints, it may open an investigation, and if it finds that a safety defect exists in a group of vehicles, it may order a recall and remedy campaign. However, NHTSA cannot become involved in individual problems between you, your dealer, or Toyota Motor Sales, U.S.A., Inc.

To contact NHTSA, you may call the Vehicle Safety Hotline toll-free at 1-888-327-4236 (TTY: 1-800-424-9153); go to <http://www.safercar.gov>; or write to: Administrator, NHTSA, 1200 New Jersey Ave. SE., Washington, DC 20590. You can also obtain other information about motor vehicle safety from <http://www.safercar.gov>.

### Seat belt instructions for Canadian owners (in French)

**The following is a French explanation of seat belt instructions extracted from the seat belt section in this manual.**

See the seat belt section for more detailed seat belt instructions in English.

### Utilisation correcte des ceintures de sécurité

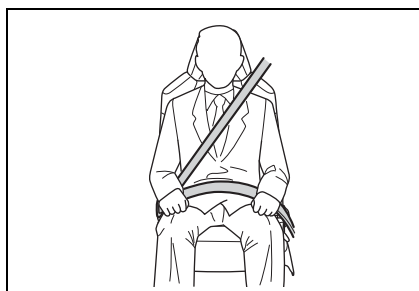

- Déroulez la sangle diagonale de telle sorte qu'elle passe bien sur l'épaule, sans pour autant être en contact avec le cou ou glisser de l'épaule.
- Placez la sangle abdominale le plus bas possible sur les hanches.
- Réglez la position du dossier de siège. Asseyez-vous le dos droit et calez-vous bien dans le siège.
- Ne vrillez pas la ceinture de

sécurité.

### Entretien et soin

#### ■ Traitement des ceintures de sécurité

Nettoyez avec un chiffon ou une éponge humidifiés avec de l'eau savonneuse tiède. Vérifiez régulièrement que les ceintures ne sont pas usées, effilochées ou entaillées excessivement.

#### WARNING

##### ■ Détérioration et usure des ceintures de sécurité

Inspectez le système de ceintures de sécurité régulièrement. Contrôlez l'absence de coupures, d'effilochages et de pièces desserrées. N'utilisez pas une ceinture de sécurité endommagée avant qu'elle ne soit remplacée. Une ceinture de sécurité endommagée ne permet pas de protéger un occupant de blessures graves ou mortelles.

## SRS airbag instructions for Canadian owners (in French)

The following is a French explanation of SRS airbag instructions extracted from the SRS airbag section in this manual.

See the SRS airbag section for more detailed SRS airbag instructions in English.

### Système de coussins gonflables SRS

#### ■ Emplacement des coussins gonflables SRS

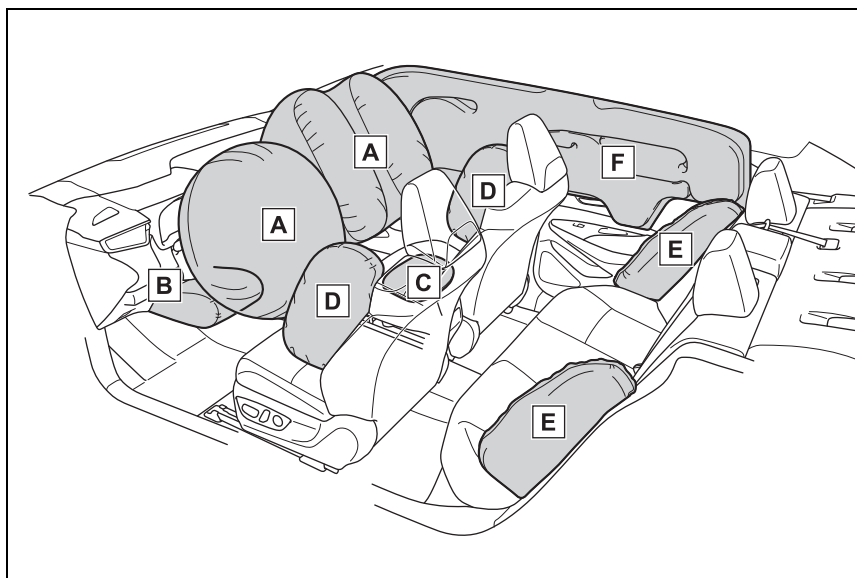

#### ► Coussins gonflables frontaux SRS

- A** Coussin gonflable conducteur/coussin gonflable du passager avant SRS

Participe à la protection de la tête et du thorax du conducteur et du passager avant contre les chocs contre les éléments de l'habitacle

- B** Coussin gonflable de genoux SRS

Participe à la protection du conducteur

- C** Coussin gonflable de coussin de siège SRS

Contribue à retenir le passager avant

► Coussins gonflables latéraux et rideaux SRS

**D** Coussins gonflables latéraux avant SRS

Participent à la protection du torse des occupants de siège avant

**E** Coussins gonflables latéraux arrière SRS

Participent à la protection du torse des occupants des sièges latéraux arrière

**F** Coussins gonflables rideaux SRS

- Participent principalement à la protection de la tête des occupants des sièges latéraux
- Peut contribuer à empêcher les occupants d'être éjectés du véhicule en cas de tonneau

■ Composants du système de coussins gonflables SRS

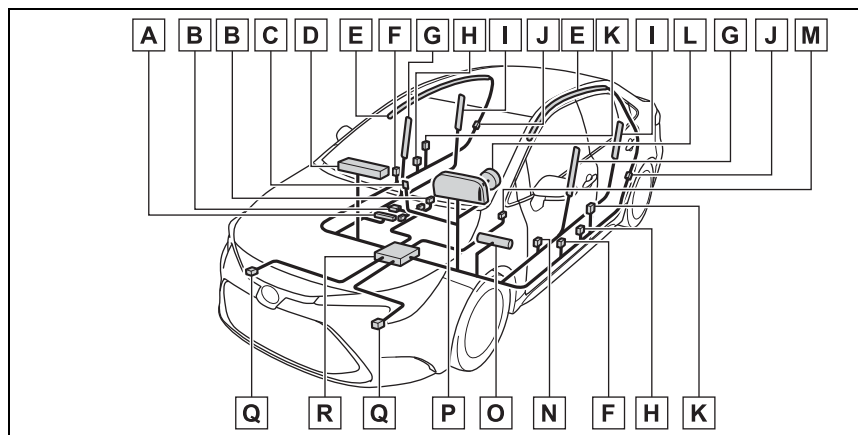

**A** Coussin gonflable de coussin de siège

**B** Système de classification de l'occupant du siège passager avant (ECU et capteurs)

**C** Témoins indicateurs "AIR BAG ON" et "AIR BAG OFF"

**D** Coussin gonflable passager avant

**E** Coussins gonflables rideaux

**F** Capteurs d'impact latéral (portes avant)

**G** Coussins gonflables latéraux avant

**H** Prétensionneurs de ceintures de sécurité et limiteurs de force

**I** Coussins gonflables latéraux arrière

**J** Capteurs d'impact latéral (arrière)

- K** Capteurs d'impact latéral (avant)
- L** Coussin gonflable conducteur
- M** Contact de boucle de ceinture de sécurité conducteur
- N** Capteur de position du siège conducteur
- O** Coussin gonflable de genoux du conducteur
- P** Témoin d'avertissement SRS
- Q** Capteurs d'impact avant
- R** Ensemble de capteurs de coussins gonflables

Votre véhicule est équipé de COUSSINS GONFLABLES INTELLIGENTS conçus selon les normes de sécurité américaines applicables aux véhicules à moteur (FMVSS208). L'ensemble de capteurs de coussins gonflables (ECU) régule le déploiement des coussins gonflables sur la base des informations qu'il reçoit des capteurs, etc., indiqués ci-dessus dans le schéma illustrant les composants du système. Parmi ces informations figurent la gravité du choc et l'occupation du véhicule par les passagers. Le déploiement rapide des coussins gonflables est obtenu au moyen d'une réaction chimique dans les dispositifs pyrotechniques, qui produit un gaz inoffensif permettant d'amortir le mouvement des occupants.

**WARNING****■ Précautions relatives aux coussins gonflables SRS**

Respectez les précautions suivantes concernant les coussins gonflables SRS.

Le non-respect de ces précautions peut occasionner des blessures graves, voire mortelles.

- Le conducteur et tous les passagers du véhicule doivent porter correctement leur ceinture de sécurité.

Les coussins gonflables SRS sont des dispositifs supplémentaires à utiliser avec les ceintures de sécurité.



**⚠ WARNING**

- Le coussin gonflable conducteur SRS se déploie avec une force considérable, pouvant occasionner des blessures graves, voire mortelles, si le conducteur se trouve très près du coussin gonflable. L'autorité fédérale chargée de la sécurité routière aux États-Unis (NHTSA) conseille:

La zone à risque du coussin gonflable conducteur se situant dans les premiers 2 à 3 in. (50 à 75 mm) de déploiement, vous placer à 10 in. (250 mm) de votre coussin gonflable conducteur vous garantit une marge de sécurité. Cette distance est à mesurer entre le centre du volant et le sternum. Si vous êtes assis à moins de 10 in. (250 mm), vous pouvez changer votre position de conduite de plusieurs façons:

- Reculez votre siège le plus possible, de manière à pouvoir encore atteindre confortablement les pédales.
- Inclinez légèrement le dossier du siège.  
Bien que les véhicules aient une conception différente, un grand nombre de conducteurs peuvent s'asseoir à une distance de 10 in. (250 mm), même avec le siège conducteur complètement avancé, simplement en inclinant un peu le dossier de siège. Si vous avez des difficultés à voir la route après avoir incliné le dossier de votre siège, utilisez un coussin ferme et antidérapant pour vous rehausser ou remontez le siège si votre véhicule est équipé de cette fonction.

- Si votre volant est réglable, inclinez-le vers le bas. Cela a pour effet d'orienter le coussin gonflable en direction de votre poitrine plutôt que de votre tête et de votre cou.

Régalez votre siège selon les recommandations de la NHTSA ci-dessus, tout en conservant le contrôle des pédales, du volant et la vue des commandes du tableau de bord.

- Si vous attachez une rallonge de ceinture de sécurité aux boucles de ceinture de sécurité avant, sans l'attacher au pêne de la ceinture de sécurité, les coussins gonflables frontaux SRS déterminent que le conducteur et le passager avant ont attaché leur ceinture de sécurité, bien que la ceinture de sécurité ne soit pas attachée. Dans ce cas, les coussins gonflables frontaux SRS peuvent ne pas se déployer correctement en cas de collision, pouvant occasionner des blessures graves, voire mortelles. Veillez à porter la ceinture de sécurité avec la rallonge de ceinture de sécurité.

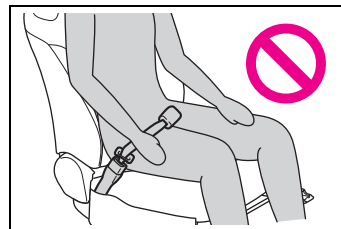

**⚠ WARNING**

- Le coussin gonflable passager avant SRS se déploie également avec une force considérable, pouvant occasionner des blessures graves, voire mortelles, si le passager avant se trouve très près du coussin gonflable. Le siège du passager avant doit être éloigné le plus possible du coussin gonflable en réglant le dossier de siège de façon à ce que le passager avant soit assis bien droit dans le siège.
- Les nourrissons et les enfants qui ne sont pas correctement assis et/ou attachés peuvent être grièvement blessés ou tués par le déploiement d'un coussin gonflable. Un nourrisson ou un enfant trop petit pour utiliser une ceinture de sécurité doit être correctement attaché au moyen d'un siège de sécurité enfant. Toyota recommande vivement d'installer tous les nourrissons et enfants sur les sièges arrière du véhicule et de prévoir pour eux des systèmes de retenue adaptés. Les sièges arrière sont plus sûrs pour les nourrissons et les enfants que le siège du passager avant.
- Ne vous asseyez pas sur le bord du siège et ne vous appuyez pas contre la planche de bord.

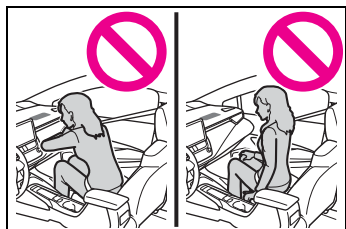

- Ne laissez pas un enfant rester debout devant le coussin gonflable passager avant SRS ou s'asseoir sur les genoux du passager avant.

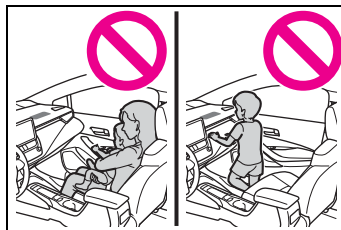

- Ne laissez pas les occupants des sièges avant voyager avec un objet sur les genoux.
- Ne vous appuyez pas contre la porte, le rail latéral de toit ou les montants avant, latéraux et arrière.

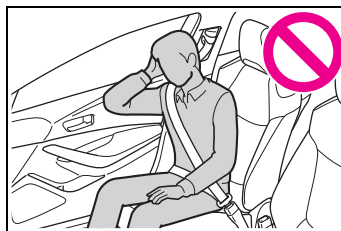

- Ne laissez personne s'agenouiller sur les sièges passagers en appui contre la porte ou sortir la tête ou les mains à l'extérieur du véhicule.

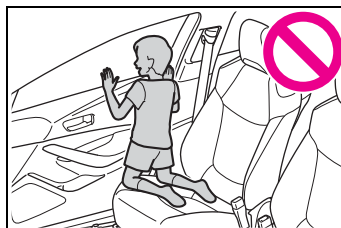

**⚠ WARNING**

- Ne fixez rien et ne posez rien sur des emplacements tels que la planche de bord, la garniture du volant et la partie inférieure du tableau de bord. Ces éléments peuvent se transformer en projectiles lorsque les coussins gonflables conducteur, passager avant et genoux SRS se déploient.

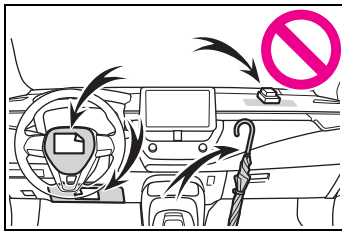

- Ne fixez rien aux portes, à la vitre du pare-brise, aux vitres latérales, aux montants avant et arrière, au rail latéral de toit et à la poignée de maintien. (Sauf pour l'étiquette de limitation de vitesse)

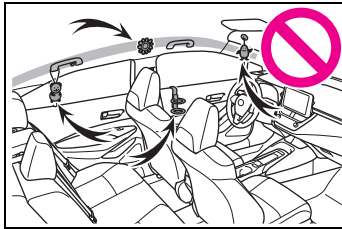

- Véhicules sans système d'accès et de démarrage mains libres: Ne fixez pas d'objets lourds, pointus ou très durs, tels que des clés et des accessoires aux clés. Ces objets risquent d'entraver le déploiement du coussin gonflable de genoux SRS ou d'être projetés vers le siège conducteur par la force de déploiement du coussin gonflable, constituant ainsi un danger potentiel.

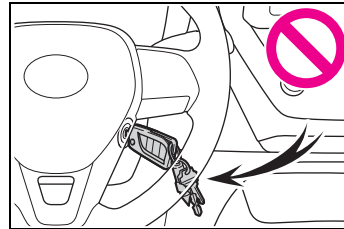

- Ne suspendez aucun cintre ou objet dur aux crochets à vêtements. Tous ces objets pourraient se transformer en projectiles et causer des blessures graves, voire mortelles en cas de déploiement des coussins gonflables rideaux SRS.
- Si un cache en vinyle est placé sur la zone où le coussin gonflable de genoux du conducteur SRS se déploie, assurez-vous de le retirer.

**WARNING**

- N'utilisez aucun accessoire de siège recouvrant les zones de déploiement des coussins gonflables latéraux SRS et du coussin gonflable de coussin de siège SRS, car il risque de gêner le déploiement des coussins gonflables SRS. De tels accessoires peuvent empêcher les coussins gonflables latéraux et le coussin gonflable de coussin de siège de s'activer correctement, désactiver le système ou entraîner le déploiement accidentel des coussins gonflables latéraux et du coussin gonflable de coussin de siège, occasionnant des blessures graves, voire mortelles.
- Évitez de faire subir des chocs ou des pressions excessives aux parties renfermant les composants de coussins gonflables SRS ou aux portes avant. En effet, cela pourrait entraîner un dysfonctionnement des coussins gonflables SRS.
- Ne touchez aucun composant immédiatement après le déploiement (gonflage) des coussins gonflables SRS, car ils peuvent être chauds.
- Si vous avez des difficultés à respirer après le déploiement des coussins gonflables SRS, ouvrez une porte ou une vitre pour faire entrer de l'air frais, ou bien descendez du véhicule si cela ne présente pas de danger. Essayez tout résidu dès que possible afin d'éviter d'éventuelles irritations de la peau.

● Si les parties renfermant les coussins gonflables SRS, comme les garnitures du volant et des montants avant et arrière, sont endommagées ou craquelées, faites-les remplacer par votre concessionnaire Toyota.

● Ne placez rien sur le siège du passager avant, comme un coussin par exemple. Cela a pour conséquence de répartir le poids du passager sur toute la surface du siège, ce qui empêche le capteur de détecter correctement le poids du passager. En conséquence, les coussins gonflables frontaux SRS du passager avant risquent de ne pas se déployer en cas de collision.

■ **Modification et mise au rebut des composants du système de coussins gonflables SRS**

Ne mettez pas votre véhicule au rebut et ne procédez à aucune des modifications suivantes sans consulter votre concessionnaire Toyota. Les coussins gonflables SRS peuvent ne pas fonctionner correctement ou se déployer (se gonfler) accidentellement, provoquant la mort ou de graves blessures.

- Installation, dépose, démontage et réparation des coussins gonflables SRS
- Réparations, modifications, démontage ou remplacement du volant, du tableau de bord, de la planche de bord, des sièges ou de leur garnissage, des montants avant, latéraux et arrière, des rails latéraux de toit, des panneaux de porte avant, des garnitures de porte avant ou des haut-parleurs de porte avant

**WARNING**

- Modifications du panneau de porte avant (par exemple, perçage d'un trou dans le panneau)
- Réparations ou modifications des ailes avant, du pare-chocs avant ou des flancs de l'habitacle
- Installation d'un protège-calandre (pare-buffle, pare-kangourou, etc.), de chasse-neige, de treuils ou d'un porte-bagages de toit
- Modifications du système de suspension du véhicule
- Installation d'appareils électroniques tels que les émetteurs/récepteurs radios mobiles et les lecteurs CD
- Modifications de votre véhicule pour une personne atteinte d'un handicap physique



**Index**

603

What to do if... (Trouble-  
shooting) ..... 604  
Alphabetical Index..... 607

## What to do if... (Troubleshooting)

**If you have a problem, check the following before contacting your Toyota dealer.**

**The doors cannot be locked, unlocked, opened or closed**



### You lose your keys

- If you lose your keys or mechanical keys, new genuine keys or mechanical keys can be made by your Toyota dealer. (→P.544)
- If you lose your keys or electronic keys, the risk of vehicle theft increases significantly. Contact your Toyota dealer immediately. (→P.544)



### The doors cannot be locked or unlocked

- Is the key battery weak or depleted? (→P.489)
- Vehicles with a smart key system: Is the engine switch in ON?

When locking the doors, turn the engine switch off. (→P.166)

- Vehicles with a smart key system: Is the electronic key left inside the vehicle?

When locking the doors, make sure that you have the electronic key on your person.

- The function may not operate properly due to the condition of the radio wave. (→P.113, 127)



### The rear door cannot be opened

- Is the child-protector lock set?

The rear door cannot be opened from inside the vehicle when the lock is set. Open the rear door from outside and then unlock the child-protector lock. (→P.121)

**If you think something is wrong**



### The engine does not start (vehicles without a smart key system)

- Continuously variable transmission: Is the shift lever in P? (→P.163)
- Manual transmission: Do you turn the key with the clutch pedal depressed firmly? (→P.163)
- Is the steering wheel unlocked? (→P.163)
- Is the battery discharged? (→P.546)





**The engine does not start (vehicles with a smart key system)**

- Continuously variable transmission: Did you press the engine switch while firmly depressing the brake pedal? (→P.164)
- Manual transmission: Did you press the engine switch while firmly depressing the clutch pedal? (→P.164)
- Continuously variable transmission: Is the shift lever in P? (→P.164)
- Is the electronic key anywhere detectable inside the vehicle? (→P.126)
- Is the steering wheel unlocked? (→P.165)
- Is the electronic key battery weak or depleted?

In this case, the engine can be started in a temporary way. (→P.545)

- Is the battery discharged? (→P.546)



**The shift lever cannot be shifted from P even if you depress the brake pedal (continuously variable transmission)**

- Is the engine switch in ON?

If you cannot release the shift lever by depressing the brake pedal with the engine switch in ON. (→P.171)



**The steering wheel cannot be turned after the engine is stopped**

- Vehicles without a smart key system: It is locked to prevent theft of the vehicle if the key is pulled from the engine switch. (→P.163)
- Vehicles with a smart key system: It is locked automatically to prevent theft of the vehicle. (→P.165)



**The windows do not open or close by operating the power window switches**

- Is the window lock switch pressed?

The power window except for the one at the driver's seat cannot be operated if the window lock switch is pressed. (→P.144)



**The engine switch is turned off automatically (vehicles with a smart key system)**

- The auto power off function will be operated if the vehicle is left in ACC or ON (the engine is not running) for a period of time. (→P.168)



**A warning buzzer sounds during driving**

- The seat belt reminder light is flashing

Are the driver and the passenger wearing the seat belts? (→P.514)

- The parking brake indicator is on

Is the parking brake released? (→P.180, 181)

Depending on the situation, other types of warning buzzer may also sound. (→P.511, 521)



#### **An alarm is activated and the horn sounds (vehicles with an alarm)**

- Did anyone inside the vehicle open a door during setting the alarm?

The sensor detects it and the alarm sounds. (→P.82)

Do one of the following to deactivate or stop the alarms:

- Unlock the doors.
- Turn the engine switch to ACC or ON, or start the engine. (The alarm will be deactivated or stopped after a few seconds.)



#### **A warning buzzer sounds when leaving the vehicle (vehicles with a smart key system)**

- Is the electronic key left inside the vehicle?

Check the message on the multi-information display. (→P.521)



#### **A warning light turns on or a warning message is displayed**

- When a warning light turns on or a warning message is displayed, refer to P.511, 521.

### **When a problem has occurred**



#### **If you have a flat tire**

- Vehicles with an emergency tire puncture repair kit: Stop the vehicle in a safe place and repair the flat tire temporarily with the emergency tire puncture repair kit. (→P.523)
- Vehicles with a spare tire: Stop the vehicle in a safe place and replace the flat tire with the spare tire. (→P.534)



#### **The vehicle becomes stuck**

- Try the procedure for when the vehicle becomes stuck in mud, dirt, or snow. (→P.553)

## Alphabetical Index

### A

#### A/C

- Air conditioning filter ..... 487
- Automatic air conditioning system ..... 421
- Manual air conditioning system ..... 416

#### ABS (Anti-lock Brake System)

- ..... 272
- Warning light ..... 513

#### ACA (Active Cornering Assist)

- ..... 272

#### Active Cornering Assist (ACA)

- ..... 272

#### Adaptive Front-lighting System (AFS)

- ..... 188

#### AFS (Adaptive Front-lighting System)

- ..... 188

#### Air conditioning filter ..... 487

#### Air conditioning system

- Air conditioning filter ..... 487
- Automatic air conditioning system ..... 421
- Manual air conditioning system ..... 416

#### Airbags

- Airbag operating conditions.... 33
- Airbag precautions for your child ..... 36
- Correct driving posture ..... 25
- Curtain shield airbag operating conditions ..... 34
- Curtain shield airbag precautions ..... 36
- Front passenger occupant classification system ..... 41
- General airbag precautions.... 36
- Locations of airbags ..... 31
- Modification and disposal of airbags ..... 40

#### Side airbag operating conditions

- ..... 34

#### Side airbag precautions..... 36

#### Side and curtain shield airbags

- operating conditions ..... 34

#### Side and curtain shield airbags

- precautions ..... 36

#### SRS airbags ..... 31

#### SRS warning light ..... 512

#### Alarm

- Alarm ..... 82
- Warning buzzer ..... 511

#### AM ..... 333

#### Anchor brackets ..... 50, 68

#### Android Auto ..... 344

#### Antennas (smart key system) 125

#### Anti-lock Brake System (ABS)

- ..... 272

#### Warning light..... 513

#### Apple CarPlay/Android Auto . 314

- Troubleshooting ..... 317

#### Approach warning ..... 236, 246

#### Apps button (Menu screen) .. 285

#### Armrest ..... 443

#### Assist grips ..... 443

#### Audio ..... 328

- Audio source ..... 329

- Operating information ..... 352

- Reordering the audio source 329

- Screen adjustment ..... 331

- Some basics ..... 329

- Sound settings..... 330

- Turning the system on and off

- ..... 329

- USB port ..... 330

- Voice command system ..... 332

#### AUDIO button ..... 283

#### Audio button (Menu screen) .. 285

#### Audio buttons overview ..... 283

#### Audio settings ..... 351

- Common settings ..... 351

- Radio settings ..... 351

**Audio source** .....329  
**Audio system-linked display** .104  
**Automatic air conditioning system**.....421  
**Automatic headlight leveling system**.....187  
**Automatic High Beam**.....189  
**Automatic light control system** .....187  
**Average fuel economy** .....102  
**Average vehicle speed**.....104

## B

**Back-up lights**  
 Replacing light bulbs ..... 500  
 Wattage ..... 566  
**Battery**  
 Battery checking.....472  
 If the battery is discharged ... 546  
 Preparing and checking before winter.....277  
 Warning light ..... 512  
**Blind Spot Monitor (BSM)**.....253  
**Bluetooth® audio**.....345  
 Registering/Connecting a Bluetooth® device.....347  
**Bluetooth® button (Setup screen)** .....288  
**Bluetooth® details settings** ... 302  
 Bluetooth® setup screen ..... 303  
 Connecting a Bluetooth® device ..... 303  
 Deleting a Bluetooth® device 305  
 Detailed settings screen ..... 307  
 Displaying the Bluetooth® setup screen ..... 302  
 Editing the Bluetooth® device information ..... 306  
 Registering a Bluetooth® device ..... 305  
**Bluetooth® device information** .....306

**Bluetooth® hands-free system** .....373  
**Bluetooth® phone message function** .....384  
 Calling the message sender .387  
 Checking received messages .....385  
 Displaying the message screen .....384  
 Receiving a message .....384  
 Replying to a message (dictation reply).....386  
 Replying to a message (quick reply) .....386  
**Bottle holders** .....431  
**Brake**  
 Brake hold .....184  
 Fluid.....471, 563  
 Parking brake ..... 180, 181  
 Warning light.....511  
**Brake assist** .....272  
**Break-in tips**.....152  
**Brightness control**  
 Instrument panel light control 93, 98  
**BSM (Blind Spot Monitor)** .....253

## C

**Care**  
 Exterior .....452  
 Interior .....454  
 Seat belts .....454  
 Wheels and wheel ornaments .....452  
**Cargo capacity**.....161  
**Chains**.....278  
**Child restraint system**  
 Fixed with a LATCH system ...64  
 Fixed with a seat belt.....59  
 Front passenger occupant classification system .....41  
 Points to remember .....48

Riding with children ..... 47  
 Types of child restraint system  
 installation method ..... 50  
 Using an anchor bracket ..... 68

**Child safety**  
 Airbag precautions ..... 36  
 Battery precautions ..... 473, 550  
 Child restraint system ..... 50  
 Heated steering wheel and seat  
 heater precautions ..... 426  
 How your child should wear the  
 seat belt ..... 28  
 Moon roof precautions ..... 146  
 Power window lock switch .... 144  
 Power window precautions .. 143  
 Rear door child-protectors .... 121  
 Removed electronic key battery  
 precautions ..... 491  
 Seat belt extender precautions  
 ..... 28  
 Seat belt precautions ..... 47  
 Trunk precautions ..... 122

**Child-protectors ..... 121**

**Cleaning**  
 Exterior ..... 452  
 Interior ..... 454  
 Radar sensor ..... 197  
 Seat belts ..... 454  
 Wheels and wheel ornaments  
 ..... 452

**Clock ..... 91, 93, 95, 98, 322**

**Coat hooks ..... 443**

**Command list ..... 367**

**Condenser ..... 471**

**Console box ..... 432**

**Consumption screen ..... 106**

**Continuously variable transmis-  
 sion ..... 169, 172**  
 If the shift lever cannot be shifted  
 from P ..... 171, 173  
 M mode ..... 175  
 Paddle shift switches .... 174, 175

**Cooling system ..... 470**  
 Engine overheating ..... 550

**Cruise control**  
 Dynamic radar cruise control 240  
 Dynamic radar cruise control  
 with full-speed range ..... 229

**Cup holders ..... 431**

**Current fuel consumption ..... 102**

**Curtain shield airbags ..... 31**

**Customizable features ..... 581**

**D**

**Daytime running light system 186**

**DCM ..... 406, 407**

**Defogger**  
 Outside rear view mirrors ... 418,  
 422  
 Rear window ..... 418, 422  
 Windshield ..... 417, 422

**Dimensions ..... 556**

**Dinghy towing ..... 162**

**Display**  
 Dynamic radar cruise control 240  
 Dynamic radar cruise control  
 with full-speed range ..... 229  
 LDA (Lane Departure Alert with  
 steering control) ..... 226  
 LTA (Lane Tracing Assist) ..... 217  
 Multi-information display ..... 100  
 RCTA ..... 258  
 Warning message ..... 521

**Display change button ..... 92, 97**

**Do-it-yourself maintenance ... 458**

**Door lock**  
 Doors ..... 117  
 Key ..... 118  
 Smart key system ..... 125  
 Wireless remote control ..... 112

**Doors**  
 Automatic door locking and  
 unlocking system ..... 121  
 Door glasses ..... 142

Door lock .....	117
Open door warning buzzer .	119, 121
Outside rear view mirrors .....	140
Rear door child-protectors....	121
Side doors .....	117
<b>Drive distance.....</b>	<b>104</b>
<b>Drive information .....</b>	<b>104</b>
<b>Drive-start control .....</b>	<b>152</b>
<b>Driving</b>	
Break-in tips .....	152
Correct driving posture .....	25
Driving mode select switch...	271
Procedures.....	150
Winter drive tips .....	277
<b>Driving information display... </b>	<b>101</b>
<b>Driving range .....</b>	<b>102</b>
<b>Driving support system information display .....</b>	<b>103</b>
<b>Dynamic radar cruise control</b>	<b>240</b>
Warning message .....	248
<b>Dynamic radar cruise control with full-speed range .....</b>	<b>229</b>
Warning message .....	238

## E

<b>Eco Driving Indicator .....</b>	<b>102</b>
<b>Eco Driving Indicator Light ...</b>	<b>102</b>
<b>EDR (Event data recorder).....</b>	<b>9</b>
<b>Elapsed time .....</b>	<b>104</b>
<b>Electric Power Steering (EPS)</b>	
.....	<b>272</b>
Warning light .....	514
<b>Electronic key .....</b>	<b>110</b>
Battery-saving function.....	126
If the electronic key does not operate properly .....	544
Replacing the battery .....	489
<b>Emergency flashers .....</b>	<b>502</b>
<b>Emergency tire puncture repair kit.....</b>	<b>523</b>

**Emergency, in case of**

If a warning buzzer sounds ..	511
If a warning light turns on .....	511
If a warning message is displayed.....	521
If the battery is discharged ...	546
If the electronic key does not operate properly .....	544
If the engine will not start.....	542
If the vehicle is trapped in rising water.....	504
If you have a flat tire .....	523, 534
If you lose your keys.....	544
If you think something is wrong .....	509
If your vehicle becomes stuck .....	553
If your vehicle has to be stopped in an emergency.....	502
If your vehicle needs to be towed .....	505
If your vehicle overheats .....	550

**Engine**

ACCESSORY mode .....	167
Compartment.....	466
Engine switch .....	163, 164
Fuel pump shut off system ...	510
Hood .....	464
How to start the engine	163, 164
Identification number .....	557
If the engine will not start.....	542
If your vehicle has to be stopped in an emergency.....	502
Ignition switch (engine switch) .....	163, 164
Overheating .....	550
Tachometer.....	91, 95

**Engine coolant**

Capacity .....	561
Checking .....	470
Preparing and checking before winter .....	277

**Engine coolant temperature gauge**.....91, 95  
**Engine immobilizer system**.....80  
**Engine oil**  
 Capacity .....558, 559  
 Checking .....467  
 Preparing and checking before winter.....277  
 Warning light .....512  
**Engine switch** .....163, 164  
 Auto power off function .....168  
 Changing the engine switch modes .....167  
 If your vehicle has to be stopped in an emergency.....502  
**Enhanced VSC**.....272  
**Entering letters and numbers/list screen operation ...**293  
 Entering letters and numbers293  
 List screen .....294  
**EPS (Electric Power Steering)** .....272  
 Warning light .....514  
**Establishing an Android Auto connection** .....315  
**Establishing an Apple CarPlay connection** .....314  
**Event data recorder (EDR)**.....9

**F**

**Flat tire**  
 Tire pressure warning system .....477  
 Vehicles with a spare tire .....534  
 Vehicles without a spare tire 523  
**Floor mats** .....24  
**Fluid**  
 Brake .....563  
 Clutch .....563  
 Continuously variable transmission.....562  
 Washer .....474

**FM** .....333  
**Front passenger occupant classification system** .....41  
**Front seats**  
 Adjustment .....133  
 Cleaning .....454  
 Correct driving posture .....25  
 Head restraints .....136  
 Seat heaters .....426  
**Front side marker lights**  
 Light switch.....186  
 Replacing light bulbs .....497  
 Wattage .....566  
**Front turn signal lights**  
 Replacing light bulbs .....496  
 Turn signal lever .....179  
 Wattage .....566  
**Front turn signal/parking lights**  
 Replacing light bulbs .....496  
**Fuel**  
 Capacity .....558  
 Fuel gauge .....91, 95  
 Fuel pump shut off system ...510  
 Information .....568  
 Refueling .....194  
 Type.....558  
 Warning light.....514  
**Fuel consumption**  
 Average fuel economy .....102  
 Current fuel consumption .....102  
**Fuel economy** .....102  
**Fuel filler door**  
 Refueling .....194  
**Fuel gauge**.....91, 95  
**Fuel pump shut off system**....510  
**Functional overview** .....402  
**Fuses** .....492

**G**

**Garage door opener** .....444  
**Gauges** .....91, 95

**General button (Setup screen)**  
.....288, 321

**General settings** ..... 321

- Displaying the general settings screen ..... 321
- General settings screen ..... 321

**Glove box** .....431

**Glove box light** .....431

## H

**Hands-free system** ..... 373

**Head restraints** ..... 136

**Headlights**

- Adaptive Front-lighting System (AFS)..... 188
- Automatic High Beam system ..... 189
- Light switch ..... 186

**Headlights/daytime running lights**

- Replacing light bulbs ..... 496

**Heated steering wheel** ..... 426

**Heaters**

- Automatic air conditioning system ..... 421
- Heated steering wheel ..... 426
- Manual air conditioning system ..... 416
- Outside rear view mirrors ... 418, 422
- Seat heaters ..... 426

**High mounted stoplight**

- Replacing light bulbs ..... 496

**Hill-start assist control** ..... 272

**HOME button** ..... 292

**Home screen**..... 292

**Hood**

- Open ..... 464

**Hooks**

- Coat hooks ..... 443
- Retaining hooks (floor mat) .... 24

**Horn**..... 138

## I

**I/M test** .....461

**Identification**

- Engine .....557
- Vehicle .....557

**Ignition switch (engine switch)**  
..... 163, 164

- Auto power off function ..... 168
- Changing the engine switch modes ..... 167
- If your vehicle has to be stopped in an emergency ..... 502

**Illuminated entry system** .....429

**Indicators** .....88

**Info button (Menu screen)** ....285

**Initial screen**.....289

- Caution screen ..... 289
- Restarting the system ..... 289

**Initialization**

- Items to initialize ..... 589
- Maintenance ..... 458
- Power windows ..... 142
- Tire pressure warning system ..... 481

**Inside rear view mirror** ..... 139

**Instrument panel light control** 93, 98

**Interior lights**.....428

- Front interior light ..... 428
- Rear interior light ..... 428
- Wattage ..... 566

**Internet radio**.....338

**iPod/iPhone(Apple Carplay)** ..341

## J

**Jack**

- Positioning a floor jack ..... 465
- Vehicle-equipped jack ..525, 535

**Jack handle** .....525, 535

**Jam protection function**

- Moon roof ..... 145



Power windows ..... 142

**K**

**Keyless entry**

Smart key system..... 125  
 Wireless remote control ..... 112

**Keys**

Battery-saving function..... 126  
 Electronic key ..... 110  
 Engine switch ..... 163, 164  
 If the electronic key does not  
 operate properly ..... 544  
 If you lose your keys ..... 544  
 Key number plate ..... 110  
 Keyless entry..... 117, 125  
 Mechanical key ..... 110  
 Replacing the battery ..... 489  
 Warning buzzer ..... 126  
 Wireless remote control ..... 112

**Knee airbags..... 31**

**L**

**Lane Departure Alert with steering control (LDA)**

Operation ..... 221  
 Warning messages..... 228

**Lane Tracing Assist (LTA)**

Operation ..... 211  
 Warning messages..... 220

**Language (multi-information display)..... 104**

**LATCH anchors ..... 64**

**LDA (Lane Departure Alert with steering control)**

Operation ..... 221  
 Warning messages..... 228

**LDA (Lane Departure Alert with steering control) switch..... 225**

**LED accent lights**

Light switch ..... 186  
 Replacing light bulbs ..... 496

**Lever**

Auxiliary catch lever ..... 464  
 Hood lock release lever ..... 464  
 Internal trunk release lever... 125  
 Shift lever ..... 169, 172, 176  
 Turn signal lever ..... 179  
 Wiper lever ..... 192

**License plate lights**

Light switch..... 186  
 Replacing light bulbs ..... 496  
 Wattage ..... 566

**Light bulbs**

Replacing ..... 495

**Lights**

Automatic High Beam system  
 ..... 189  
 Front interior lights..... 428  
 Headlight switch ..... 186  
 Interior lights ..... 428  
 Interior lights list ..... 428  
 Personal lights ..... 429  
 Rear interior lights ..... 428  
 Replacing light bulbs ..... 496  
 Trunk light..... 124  
 Turn signal lever ..... 179  
 Vanity lights ..... 442  
 Wattage ..... 566

**Linking multi-information display and the system ..... 297**

**Lock steering column .... 163, 165**

**LTA (Lane Tracing Assist)**

Operation..... 211  
 Warning messages..... 220

**M**

**Maintenance**

Do-it-yourself maintenance .. 462  
 General maintenance ..... 458  
 Maintenance data ..... 556  
 Maintenance requirements... 457

**Malfunction indicator lamp.... 512**

**Manual air conditioning system** .....416  
**Manual transmission** .....176  
 iMT .....178  
**Media button (Menu screen)**..285  
**Menu icons** .....100  
**Menu screen** .....285  
 Menu screen operation .....285  
**Meter**  
 Clock .....91, 95  
 Indicators.....88  
 Instrument panel light control93,  
 98  
 Meter control switches .....101  
 Meters .....91, 95  
 Multi-information display .....100  
 Settings .....104  
 Warning lights.....511  
 Warning message .....521  
**Microphone**.....376  
**Mirrors**  
 Inside rear view mirror.....139  
 Outside rear view mirror defog-  
 gers .....418, 422  
 Outside rear view mirrors .....140  
 Vanity mirrors .....442  
**Mobile Assistant**.....371  
 Connectable devices and avail-  
 able functions .....371  
 Mobile Assistant operation ...371  
**Moon roof**  
 Door lock linked moon roof oper-  
 ation .....145  
 Jam protection function .....145  
 Operation .....145  
**Multi-information display**  
 Audio system-linked display .104  
 Clock .....93, 98  
 Driving information display ...101  
 Driving support system informa-  
 tion display .....103  
 Dynamic radar cruise control240

Dynamic radar cruise control  
 with full-speed range .....229  
 Eco Driving Indicator .....102  
 Fuel economy .....102  
 LDA (Lane Departure Alert with  
 steering control).....226  
 LTA (Lane Tracing Assist) ....217  
 Menu icons .....100  
 Meter control switches.....101  
 Navigation system-linked display  
 .....103  
 Settings .....104  
 Tire pressure .....477  
 Vehicle information display...104  
 Warning message.....521

**N**

**Navigation system-linked display**  
 .....103  
**Noise from under vehicle**.....7

**O**

**Odometer**.....92, 97  
**Odometer and trip meter display**  
 Display change button.....92, 97  
 Display items .....92, 97  
**Oil**  
 Engine oil.....558, 559  
 Manual transmission .....562  
**Open trays**.....432  
**Opener**  
 Fuel filler door.....194  
 Hood .....464  
 Trunk .....123  
**Outside rear view mirrors**  
 Adjustment .....140  
 BSM (Blind Spot Monitor) ....253  
 Folding.....141  
 Outside rear view mirror defog-  
 gers .....418, 422  
 RCTA function.....258

**Outside temperature** .....91, 95  
**Overheating** ..... 550

**P**

**Paddle shift switches**..... 174, 175  
**Panic mode** ..... 113  
**Parking brake**  
 Operation ..... 180, 181  
 Parking brake engaged warning  
 buzzer ..... 180, 183  
 Warning light ..... 517  
 Warning message ..... 180, 183  
**Parking lights**  
 Light switch ..... 186  
 Replacing light bulbs ..... 496  
 Wattage ..... 566  
**PCS (Pre-Collision System)**  
 Function ..... 203  
 Warning light ..... 516  
**Personal lights** ..... 428  
 Wattage ..... 566  
**Phone** ..... 373  
 About the contacts in the contact  
 list ..... 377  
 Phone screen operation ..... 373  
 Registering/Connecting a Blue-  
 tooth® phone ..... 375  
 Some basics ..... 374  
 Troubleshooting ..... 398  
 Voice command system ..... 377  
 When selling or disposing of the  
 vehicle ..... 377  
**Phone button** ..... 373  
**Phone button (Menu screen)**.285  
**Phone button (Setup screen)** 288  
**Phone settings** ..... 388  
 Contacts/Call history settings 390  
 Message settings ..... 396  
 Notifications settings ..... 389  
 Sounds settings ..... 388

**Placing a call using the Blue-  
 tooth® hands-free system**....378  
 By call history .....378  
 By contacts list .....379  
 By favorites list .....378  
 By home screen .....380  
 By keypad .....380  
**Power outlet**.....435  
**Power steering (Electric power  
 steering system)** .....272  
 Warning light .....514  
**POWER VOLUME knob** .....329  
**Power windows**  
 Door lock linked window opera-  
 tion .....143  
 Jam protection function ..... 142  
 Operation .....142  
 Window lock switch ..... 144  
**Pre-Collision System (PCS)**  
 Function .....203  
 Warning light .....516

**R**

**Radar cruise control**.....240  
**Radar cruise control (dynamic  
 radar cruise control with  
 full-speed range)**.....229  
**Radiator** .....471  
**Radio**.....333  
 Displaying the radio ID .....336  
 How to subscribe to SiriusXM  
 Radio Services .....335  
 Presetting a station .....333  
 Radio broadcast data system 334  
 Refer to the table below to iden-  
 tify the problem and take the  
 suggested corrective action 336  
**RCTA**  
 Function .....258  
 Warning message .....259  
**RCTA function**.....260

**Rear Cross Traffic Alert (RCTA)** .....258

**Rear seats** ..... 134  
Head restraints ..... 136

**Rear side marker lights**  
Light switch ..... 186  
Replacing light bulbs .... 496, 497  
Wattage ..... 566

**Rear turn signal lights**  
Replacing light bulbs .... 497, 498  
Turn signal lever ..... 179  
Wattage ..... 566

**Rear view mirror**  
Inside rear view mirror ..... 139  
Outside rear view mirrors ..... 140

**Rear view monitor system**.....263  
If you notice any symptoms..268

**Rear window defogger**...418, 422

**Receiving a call using the Bluetooth® hands-free system** ...381

**Refueling**  
Capacity .....558  
Fuel types.....558  
Opening the fuel tank cap .... 194

**Registering/Connecting a Bluetooth® device** .....298  
Profiles .....301  
Registering a Bluetooth® audio player for the first time.....301  
Registering a Bluetooth® phone for the first time .....298

**Replacing**  
Electronic key battery ..... 489  
Fuses .....492  
Light bulbs .....495  
Tires .....534  
Wireless remote control battery .....489

**Reporting safety defects for U.S. owners**.....592

**Resetting the message indicating maintenance is required**458

**Road Sign Assist** .....250  
**RSA (Road Sign Assist)** .....250

## S

**Safety Connect** .....73

**Screen adjustment** .....296

**Seat belt reminder light**..514, 515

**Seat belts**.....27  
Adjusting the seat belt .....29  
Automatic Locking Retractor ..29  
Child restraint system installation .....50  
Cleaning and maintaining the seat belt.....454  
Emergency Locking Retractor 29  
How to wear your seat belt.....28  
How your child should wear the seat belt.....28  
Pregnant women, proper seat belt use .....27  
Reminder light and buzzer .514, 515  
Seat belt extender .....28  
Seat belt pretensioners .....30  
SRS warning light .....512

**Seat heaters** .....426

**Seating capacity** ..... 161, 556

**Seats**  
Adjustment .....133  
Adjustment precautions .....133  
Child seats/child restraint system installation .....48  
Cleaning .....454  
Head restraints .....136  
Properly sitting in the seat .....25  
Seat heaters .....426

**Secondary Collision Brake**....272

**Sensor**  
Automatic headlight system .187  
Automatic High Beam system .....189  
BSM (Blind Spot Monitor) .....253

Inside rear view mirror.....	140	<b>Specifications</b> .....	<b>556</b>
LDA (Lane Departure Alert with steering control) .....	221	<b>Speedometer</b> .....	<b>91, 95</b>
LTA (Lane Tracing Assist).....	211	<b>Status icon</b> .....	<b>286</b>
Radar sensor.....	196, 255	Status icon explanation .....	286
RCTA.....	259	<b>Steering lock</b>	
<b>Service Connect</b> .....	<b>407</b>	Column lock release .....	163, 165
<b>Service reminder message</b> ....	<b>458</b>	Steering lock system warning message .....	165
<b>Setup button (Menu screen)</b> 285, 288		<b>Steering switch</b> .....	<b>349, 364</b>
<b>Setup screen</b> .....	<b>288</b>	Audio switch .....	349
<b>Shift lever</b>		Talk switch .....	364
Continuously variable transmission.....	169, 172	<b>Steering wheel</b>	
If the shift lever cannot be shifted from P.....	171, 173	Adjustment .....	138
Manual transmission .....	176	Heated steering wheel.....	426
<b>Shift lock system</b> .....	<b>171, 173</b>	Meter control switches.....	101
<b>Side airbags</b> .....	<b>31</b>	<b>Stop lights</b>	
<b>Side marker lights</b>		Replacing light bulbs .....	496
Light switch .....	186	<b>Storage features</b> .....	<b>430</b>
Replacing light bulbs .....	497	<b>Stuck</b>	
Wattage .....	566	If the vehicle becomes stuck	553
<b>Side mirrors</b>		<b>Sun visors</b> .....	<b>442</b>
Adjustment .....	140	<b>Sunshade</b>	
BSM (Blind Spot Monitor).....	253	Roof.....	145
Folding .....	141	<b>Switches</b>	
RCTA function .....	258	Automatic High Beam system .....	189
<b>Side turn signal lights</b>		Brake Hold switch.....	184
Replacing light bulbs .....	496	Display change button .....	92, 97
Turn signal lever.....	179	Door lock switches .....	120
<b>Side windows</b> .....	<b>142</b>	Driving mode select switch...271	
<b>SiriusXM (SXM)</b> .....	<b>333</b>	Dynamic radar cruise control switch .....	240
<b>Smart key system</b>		Dynamic radar cruise control with full-speed range switch	230
Antenna location .....	125	Emergency flashers switch...502	
Entry functions .....	117	Engine switch .....	163, 164
Starting the engine .....	164	Garage door opener switches .....	444
<b>Snow tires</b> .....	<b>277</b>	Heated steering wheel switch .....	426
<b>Spare tire</b> .....	<b>534</b>	Ignition switch .....	163, 164
Inflation pressure.....	564		
Storage location .....	535		
<b>Spark plug</b> .....	<b>561</b>		

Instrument panel light control  
switches ..... 93, 98  
Light switches..... 186  
LTA (Lane Tracing Assist) switch  
..... 216  
Meter control switches ..... 101  
Moon roof switches ..... 145  
Outside rear view mirror  
switches ..... 140  
Paddle shift switches.... 174, 175  
Parking brake switch ..... 181  
Power door lock switch ..... 120  
Power window switches ..... 142  
Rear window and outside rear  
view mirror defoggers switch  
..... 421  
Seat heater switches..... 426  
“SOS” button ..... 73  
Vehicle-to-vehicle distance  
switch ..... 230, 240  
VSC OFF switch..... 273  
Window lock switch ..... 144  
Windshield wiper and washer  
switch ..... 192  
**SXM (SiriusXM)..... 333**

**T**

**Tachometer ..... 91, 95**  
**Tail lights**  
Light switch ..... 186  
Replacing light bulbs ..... 496  
**Talking on the Bluetooth®**  
**hands-free system ..... 382**  
Call screen operation ..... 382  
Incoming call waiting ..... 383  
Sending tones ..... 382  
Transmit volume setting ..... 383  
**Theft deterrent system**  
Alarm..... 82  
Engine immobilizer system .... 80  
**Tire inflation pressure..... 484**  
Maintenance data..... 564

Warning light..... 515  
**Tire information ..... 570**  
Glossary ..... 574  
Size ..... 572  
Tire identification number .... 572  
Uniform Tire Quality Grading 573  
**Tire pressure warning system**  
Function..... 477  
Initializing..... 481  
Installing tire pressure warning  
valves and transmitters ..... 480  
Registering ID codes ..... 482  
Warning light..... 515  
**Tires**  
Chains ..... 278  
Checking ..... 475  
Emergency tire puncture repair  
kit..... 523  
If you have a flat tire .... 523, 534  
Inflation pressure ..... 484  
Information ..... 570  
Replacing ..... 534  
Rotating tires ..... 477  
Size ..... 564  
Snow tires..... 277  
Spare tire ..... 534  
Tire pressure warning system  
..... 477  
Warning light..... 515  
**Tools ..... 525, 535**  
**Top tether strap ..... 68**  
**Total load capacity ..... 556**  
**Touch screen ..... 290**  
Touch screen gestures ..... 290  
Touch screen operation ..... 290  
**Towing**  
Dinghy towing ..... 162  
Emergency towing..... 505  
Towing eyelet..... 507  
Trailer towing ..... 161  
**Toyota apps..... 409**

**Toyota apps**  
 Entering keyword ..... 411

**Toyota apps button (Setup screen) ..... 288**

**Toyota apps settings..... 413**

**Toyota Safety Sense 2.0**  
 Automatic High Beam ..... 189  
 Dynamic radar cruise control 240  
 Dynamic radar cruise control with full-speed range ..... 229  
 LDA (Lane Departure Alert with steering control) ..... 221  
 LTA (Lane Tracing Assist)..... 211  
 PCS (Pre-Collision System) . 203  
 RSA (Road Sign Assist) ..... 250

**TRAC (Traction Control) ..... 272**

**Traction Control (TRAC) ..... 272**

**Trailer towing ..... 161**

**Transmission**  
 Continuously variable transmission..... 169, 172  
 Driving mode select switch... 271  
 If the shift lever cannot be shifted from P..... 171, 173  
 iMT ..... 178  
 M mode ..... 175  
 Manual transmission ..... 176  
 Paddle shift switches.... 174, 175

**Trip meters ..... 92, 97**

**Trunk ..... 122**  
 Internal trunk release lever... 125  
 Smart key system..... 123  
 Trunk light..... 124  
 Trunk opener ..... 123  
 Wireless remote control ..... 124

**Trunk features ..... 433**

**Trunk light..... 124**  
 Wattage ..... 566

**Turn signal lights**  
 Replacing light bulbs ..... 496  
 Turn signal lever..... 179  
 Wattage ..... 566

**U**

**USB charging port..... 434**

**USB memory ..... 339**

**USB port..... 330**

**V**

**Vanity lights ..... 442**  
 Wattage ..... 566

**Vanity mirrors ..... 442**

**Vehicle button (Setup screen) ..... 288, 326**

**Vehicle data recording ..... 8**

**Vehicle identification number 557**

**Vehicle information display ... 104**

**Vehicle settings ..... 326**  
 Displaying the vehicle settings screen..... 326  
 Valet mode setting ..... 326  
 Vehicle settings screen..... 326

**Vehicle Stability Control (VSC) ..... 272**

**Voice button (Setup screen) 288, 325**

**Voice command system..... 364**  
 Using the voice command system ..... 364  
 Voice command system operation..... 365

**Voice settings ..... 325**  
 Displaying the voice settings screen..... 325  
 Voice settings screen ..... 325

**VSC (Vehicle Stability Control) ..... 272**

**W**

**Warning buzzers**  
 ABS ..... 513  
 Airbags ..... 512  
 Approach warning ..... 236, 246

- Brake hold ..... 517
- Brake Override System ..... 513
- Brake system ..... 511
- Charging system ..... 512
- Downshifting ..... 175
- Drive-Start Control ..... 513
- Electric power steering ..... 514
- Engine ..... 512
- High coolant temperature ..... 511
- Key reminder ..... 164
- LDA (Lane Departure Alert with steering control) ..... 221, 515
- Low engine oil pressure ..... 512
- LTA (Lane Tracing Assist) ... 211, 515
- Open door ..... 119, 121
- RCTA (Rear Cross Traffic Alert) ..... 516
- Seat belt ..... 514, 515
- Warning lights ..... 511**
  - ABS ..... 513
  - Brake hold operated indicator ..... 517
  - Brake Override System ..... 513
  - Brake system ..... 511
  - Charging system ..... 512
  - Drive-Start Control ..... 513
  - Electric power steering ..... 514
  - High coolant temperature ..... 511
  - iMT indicator ..... 517
  - LDA indicator ..... 515
  - Low engine oil pressure ..... 512
  - Low fuel level ..... 514
  - LTA indicator ..... 515
  - Malfunction indicator lamp ... 512
  - Parking brake indicator ..... 517
  - Pre-collision system ..... 516
  - RCTA OFF indicator ..... 516
  - Seat belt reminder light 514, 515
  - Slip indicator ..... 516
  - SRS ..... 512
  - Tire pressure ..... 515
- Warning messages ..... 521**
- Washer**
  - Checking ..... 474
  - Preparing and checking before winter ..... 277
  - Switch ..... 192
- Washing and waxing ..... 452**
- Weight**
  - Cargo capacity ..... 161
  - Load limits ..... 161
- Wheels ..... 486**
  - Replacing ..... 486
  - Size ..... 564
- Wi-Fi® ..... 310**
  - Connecting a device to the in-vehicle access point ..... 310
  - Operating hints ..... 313
- Wi-Fi® button (Setup screen) 288**
- Wi-Fi® Hotspot ..... 310**
- Window lock switch ..... 144**
- Windows**
  - Power windows ..... 142
  - Rear window defogger .418, 422
  - Washer ..... 192
- Windshield wiper de-icer ..... 425**
- Windshield wipers ..... 192**
- Winter driving tips ..... 277**
- Wireless charger ..... 435**
- Wireless remote control**
  - Battery-Saving Function ..... 126
  - Locking/Unlocking ..... 112
  - Replacing the battery ..... 489



---

---

For vehicles with Audio Plus or Premium Audio, refer to "NAVIGATION AND MULTIMEDIA SYSTEM OWNER'S MANUAL" for information regarding the equipment listed below.

- Navigation system
- Audio/visual system
- Rear view monitor system





## GAS STATION INFORMATION

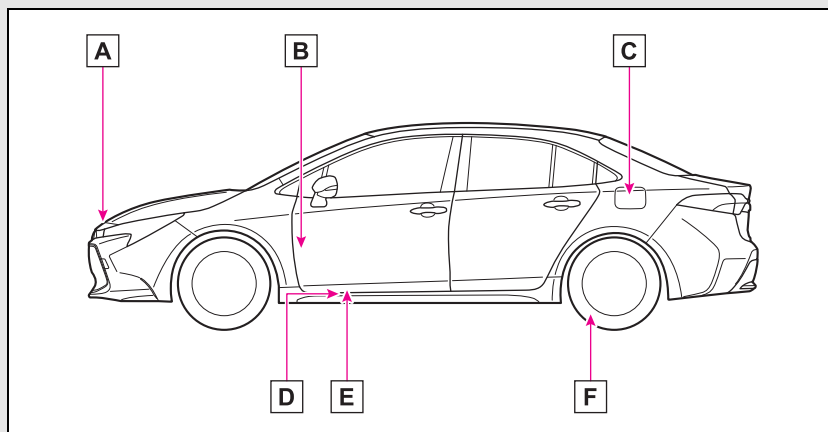

- A** Auxiliary catch lever (→P.464)
- B** Hood lock release lever (→P.464)
- C** Fuel filler door (→P.195)
- D** Trunk opener (→P.123)
- E** Fuel filler door opener (→P.195)
- F** Tire inflation pressure (→P.564)

Fuel tank capacity (Reference)	13.2 gal. (50.0 L, 11.0 Imp. gal.)	
Fuel type		P.558 P.568
Cold tire inflation pressure		P.564
Engine oil capacity (Drain and refill — reference)		P.558 P.559
Engine oil type	“Toyota Genuine Motor Oil” or equivalent	P.558 P.559