

LINK:
CONTENT & A-Z



The Ultimate
Driving Machine®



OWNER'S MANUAL.

THE BMW X5.



WELCOME TO BMW.

Owner's Manual.

BMW X5.

Thank you for choosing a BMW.

The more familiar you are with your vehicle, the better control you will have on the road. We therefore strongly suggest:

Read this Owner's Manual before starting off in your new BMW. Also use the Integrated Owner's Manual in your vehicle. It contains important information on vehicle operation that will help you make full use of the technical features available in your BMW. The manual also contains information designed to enhance operating reliability and road safety, and to contribute to maintaining the value of your BMW.

At the time of production at the plant, the printed Owner's Manual is the most current resource. After a vehicle software update – such as, a Remote Software Upgrade – the Integrated Owner's Manual for the vehicle will contain the latest information.

You can find supplementary information in the additional brochures in the on-board literature.

We wish you a safe and enjoyable ride.

TABLE OF CONTENTS

After a vehicle software update – such as, a Remote Software Upgrade – the Integrated Owner's Manual for the vehicle will contain the latest information.

! NOTES

Information	6
Owner's Manual media	14

⚡ QUICK REFERENCE

Entering	16
Set-up and use	20
On the road	24

↓ CONTROLS

Cockpit	32
Operating state of the vehicle	37
iDrive	40
BMW Remote Software Upgrade	57
General settings	60
Personal settings	65
Connections	70
Opening and closing	78
Seats, mirrors, and steering wheel	111
Transporting children safely	128
Driving	134
Displays	152
Lights	170
Safety	178
Driving stability control systems	219
Driver assistance systems	225
Driving comfort	272
Climate control	279

Interior equipment	297
Storage compartments	308
Cargo area	313

DRIVING TIPS

Things to remember when driving	322
Trailer towing	327
Saving fuel	331

MOBILITY

Refueling	338
Wheels and tires	340
Engine compartment	375
Operating materials	378
Maintenance	385
Replacing components	387
Breakdown assistance	391
Care	398

REFERENCE

Technical data	402
Appendix	407
Everything from A to Z	408

© 2019 Bayerische Motoren Werke

Aktiengesellschaft

Munich, Germany

Reprinting, including excerpts, only with the written consent of BMW AG, Munich.

US English ID7 X/19, 11 19 490

Printed on environmentally friendly paper, bleached without chlorine, suitable for recycling.

Information

Using this Owner's Manual

Orientation

The fastest way to find information on a particular topic is by using the index.

An initial overview of the vehicle is provided in the first chapter.

Validity of the Owner's Manual

Production of the vehicle

At the time of production at the plant, the printed Owner's Manual is the most current resource. Due to updates after the editorial deadline, differences may exist between the printed Owner's Manual and the Integrated Owner's Manual in the vehicle.

Notes on updates can be found in the appendix of the printed Owner's Manual for the vehicle.

After a software update in the vehicle

After a vehicle software update – such as, a Remote Software Upgrade – the Integrated Owner's Manual for the vehicle will contain the latest information.

Owner's Manual for Navigation, Entertainment, Communication

The Owner's Manual for Navigation, Entertainment, and Communication can be obtained as a printed book from the service center.

The topics are also discussed in the Integrated Owner's Manual in the vehicle.

Additional sources of information

Service center

A service center will be glad to answer questions at any time.

Internet

Vehicle information and general information on BMW, for instance, on technology, are available on the Internet: www.bmwusa.com.

Integrated Owner's Manual in the vehicle

The Integrated Owner's Manual specifically describes features and functions found in the vehicle. The Integrated Owner's Manual can be displayed on the Control Display.

BMW Driver's Guide app



The BMW Driver's Guide app specifically describes features and functions found in the vehicle. The app can be displayed on smartphones and tablets.

BMW Driver's Guide Web

Driver's Guide Web shows the most suitable information for the selected vehicle. If possible, only equipment and functions that are actually installed in the vehicle will be explained. Driver's Guide Web can be displayed in any current browser.

Symbols and displays

Symbols in the Owner's Manual

Symbol	Meaning
	Precautions that must be followed in order to avoid the possibility of injury to yourself and to others as well as serious damage to the vehicle.
	Measures that can be taken to help protect the environment.
"..."	Texts in vehicle used to select individual functions.
>...<	Verbal instructions to use with the voice activation system.
>>...<<	Responses generated by the voice activation system.

Action steps

Action steps to be carried out are presented as a numbered list. The steps must be carried out in the defined order.

1. First action step.
2. Second action step.

Enumerations

Enumerations without mandatory order or alternative possibilities are presented as a list with bullet points.

- First possibility.
- Second possibility.

Symbols on vehicle components

 This symbol on a vehicle component indicates that further information on the component is available in the Owner's Manual.

Vehicle features and options

This Owner's Manual describes all models and all standard, country-specific and optional equipment that is offered in the model series. Therefore, this Owner's Manual also describes and illustrates features and functions that are not available in a vehicle, for example because of the selected optional features or the country-specific version.

This also applies to safety-related functions and systems.

When using these functions and systems, the applicable laws and regulations must be observed.

For any options and equipment not described in this Owner's Manual, refer to the Supplementary Owner's Manuals.

Your BMW service center is happy to answer any questions that you may have about the features and options applicable to your vehicle.

Status of the Owner's Manual

Basic information

The manufacturer of your vehicle pursues a policy of constant development that is conceived to ensure that our vehicles continue to embody the highest quality and safety standards. In rare cases, therefore, the features described in this Owner's Manual may differ from those in your vehicle.

Validity of the Owner's Manual

Production of the vehicle

At the time of production at the plant, the printed Owner's Manual is the most current resource. Due to updates after the editorial deadline, differences may exist between the printed Owner's

Manual and the Integrated Owner's Manual in the vehicle.

Notes on updates can be found in the appendix of the printed Owner's Manual for the vehicle.

After a software update in the vehicle

After a vehicle software update – such as, a Remote Software Upgrade – the Integrated Owner's Manual for the vehicle will contain the latest information.

For Your Own Safety

Intended use

Heed the following when using the vehicle:

- ▷ Owner's Manual.
- ▷ Information on the vehicle. Do not remove stickers.
- ▷ Technical vehicle data.
- ▷ The traffic, speed, and safety laws where the vehicle is driven.
- ▷ Vehicle documents and statutory documents.

Warranty

Your vehicle is technically configured for the operating conditions and registration requirements applying in the country of first delivery, also known as homologation. If your vehicle is to be operated in a different country it might be necessary to adapt your vehicle to potentially differing operating conditions and registration requirements. If your vehicle does not comply with the homologation requirements in a certain country you may not be able to lodge warranty claims for your vehicle there. Further information on warranty is available from a service center.

Maintenance and repairs

Advanced technology, for instance the use of modern materials and high-performance elec-

tronics, requires suitable maintenance and repair work.

The manufacturer of the vehicle recommends that you entrust corresponding procedures to a BMW center. If you choose to use another service facility, BMW recommends use of a facility that performs work, e.g., maintenance and repair, according to BMW specifications with properly trained personnel, referred to in the Owner's Manual as "another qualified service center or repair shop".

If work is performed improperly, for instance maintenance and repair, there is a risk of subsequent damage and related safety risks.

Improperly performed work on the vehicle paint can lead to a failure or malfunction of components, e.g., the radar sensors, and thereby result in a safety risk.

Parts and accessories

BMW recommends the use of parts and accessory products approved by BMW.

Approved parts and accessories, and advice on their use and installation are available from a BMW center.

BMW parts and accessories have been tested by BMW for their safety and suitability in BMW vehicles.

BMW warrants genuine BMW parts and accessories.

BMW does not evaluate whether each individual product from another manufacturer can be used with BMW vehicles without presenting a safety hazard, even if a country-specific official approval was issued. BMW does not evaluate whether these products are suitable for BMW vehicles under all usage conditions.

California Proposition 65 Warning

For vehicles sold in California, the law requires vehicle manufacturers to provide the following warning:

⚠ Warning

Engine exhaust and a wide variety of Automobile components and parts, including components found in the interior furnishings in a vehicle, contain or emit chemicals known to the State of California to cause cancer and birth defects and reproductive harm. In addition, certain fluids contained in vehicles and certain products of component wear contain or emit chemicals known to the State of California to cause cancer and birth defects or other reproductive harm. Battery posts, terminals and related accessories contain lead and lead compounds. Batteries also contain other chemicals known to the State of California to cause cancer. Wash your hands after handling. Used engine oil contains chemicals that have caused cancer in laboratory animals. Always protect your skin by washing thoroughly with soap and water. For more information go to www.P65Warnings.ca.gov/passenger-vehicle.

⚠ Warning

Operating, servicing and maintaining a passenger vehicle or off-highway motor vehicle can expose you to chemicals including engine exhaust, carbon monoxide, phthalates, and lead, which are known to the State of California to cause cancer and birth defects or other reproductive harm. To minimize exposure, avoid breathing exhaust, do not idle the engine except as necessary, service your vehicle in a well-ventilated area and wear gloves or wash your hands frequently when servicing your vehicle. For more information go to www.P65Warnings.ca.gov/passenger-vehicle.

Service and warranty

We recommend that you read this publication thoroughly. Your vehicle is covered by the following warranties:

- ▶ New Vehicle Limited Warranty.

- ▶ Rust Perforation Limited Warranty.
- ▶ Federal Emissions System Defect Warranty.
- ▶ Federal Emissions Performance Warranty.
- ▶ California Emission Control System Limited Warranty.

Detailed information about these warranties is listed in the Service and Warranty Information Booklet for US models or in the Warranty and Service Guide Booklet for Canadian models.

Your vehicle has been specifically adapted and designed to meet the particular operating conditions and homologation requirements in your country and continental region in order to deliver the full driving pleasure while the vehicle is operated under those conditions. If you wish to operate your vehicle in another country or region, you may be required to adapt your vehicle to meet different prevailing operating conditions and homologation requirements. You should also be aware of any applicable warranty limitations or exclusions for such country or region. In such case, please contact Customer Relations for further information.

Maintenance

Maintain the vehicle regularly to sustain the road safety, operational reliability and the New Vehicle Limited Warranty.

Specifications for maintenance measures:

- ▶ BMW Maintenance system.
- ▶ Service and Warranty Information Booklet for US models.
- ▶ Warranty and Service Guide Booklet for Canadian models.

If the vehicle is not maintained or is improperly maintained, this could result in serious damage to the vehicle. Such damage is not covered by the BMW New Vehicle Limited Warranty.

Refer to chapter engine oil change regarding recommended service intervals for oil changes.

Data memory

General information

Electronic control devices are installed in the vehicle. Electronic control units process data they receive from vehicle sensors, self-generate or exchange with each other. Some control units are necessary for the vehicle to function safely or provide assistance during driving, for instance driver assistance systems. Furthermore, control units facilitate comfort or infotainment functions.

Information about stored or exchanged data can be requested from the manufacturer of the vehicle, in a separate booklet, for example.

Personal reference

Each vehicle is marked with a unique vehicle identification number. Depending on the country, the vehicle owner can be identified with the vehicle identification number, license plate and corresponding authorities. In addition, there are other options to track data collected in the vehicle to the driver or vehicle owner, for instance, via the ConnectedDrive account that is used.

Operating data in the vehicle

Control units process data to operate the vehicle.

For example, this includes:

- ▶ Status messages for the vehicle and its individual components, e.g., wheel rotational speed, wheel speed, deceleration, transverse acceleration, engaged safety belt indicator.
- ▶ Ambient conditions, e.g., temperature, rain sensor signals.

The processed data is only processed in the vehicle itself and generally volatile. The data is not stored beyond the operating period.

Electronic components, e.g. control units and ignition keys, contain components for storing technical information. Information about the vehicle condition, component usage, maintenance requirements events or faults can be stored temporarily or permanently.

This information generally records the state of a component, a module, a system, or the environment, for instance:

- ▶ Operating states of system components, for instance, fill levels, tire inflation pressure, battery status.
- ▶ Malfunctions and faults in important system components, for instance lights and brakes.
- ▶ Responses by the vehicle to special situations such as airbag deployment or engagement of the driving stability control systems.
- ▶ Information on vehicle-damaging events.

The data is required to perform the control unit functions. Furthermore, it also serves to recognize and correct malfunctions, and helps the vehicle manufacturer to optimize vehicle functions.

The majority of this data is volatile and is only processed within the vehicle itself. Only a small share of the data is stored event-related in event or fault memories.

When servicing, for instance during repairs, service processes, warranty cases, and quality assurance measures, this technical information can be read out from the vehicle together with the vehicle identification number.

A dealer's service center or another qualified service center or repair shop can read out the information. The socket for OBD Onboard Diagnosis required by law in the vehicle is used to read out the data.

The data is collected, processed, and used by the relevant organizations in the service network. The data documents technical conditions of the vehicle, helps with the identification of the fault, compliance with warranty obligations and quality improvement.

Furthermore, the manufacturer has product monitoring duties to meet in line with product liability law. To fulfill these duties, the vehicle manufacturer needs technical data from the vehicle. The data from the vehicle can also be used to check customer claims for warranty and guaranty.

Fault and event memories in the vehicle can be reset when a dealer's service center or another qualified service center or repair shop performs repair or servicing work.

Data entry and data transfer into the vehicle

General information

Depending on the vehicle equipment, comfort and individual settings can be stored in the vehicle and modified or reset at any time.

For example, this includes:

- ▶ Settings for the seat and steering wheel positions.
- ▶ Suspension and climate control settings.

If necessary, data can be transferred to the entertainment and communication system of the vehicle, for instance via smartphone.

This includes the following depending on the respective equipment:

- ▶ Multimedia data such as music, films or photos for playback in an integrated multimedia system.
- ▶ Address book data for use in conjunction with an integrated hands-free system or an integrated navigation system.
- ▶ Entered navigation destinations.
- ▶ Data on the use of Internet services.

This data can be stored locally in the vehicle or is found on a device that has been connected to the vehicle, e.g., a smartphone, USB stick or MP3 player. If this data is stored in the vehicle, it can be deleted at any time.

This data is only transmitted to third parties upon personal request as part of the use of online services. The transmission depends on the selected settings for the use of the services.

Incorporation of mobile devices

Depending on the vehicle equipment, mobile devices connected to the vehicle, for instance

smartphones, can be controlled via the vehicle control elements.

The sound and picture from the mobile device can be played back and displayed through the multimedia system. Certain information is transferred to the mobile device at the same time. Depending on the type of incorporation, this includes, for instance position data and other general vehicle information. This optimizes the way in which selected apps, for instance navigation or music playback, work.

There is no further interaction between the mobile device and the vehicle, such as active access to vehicle data.

How the data will be processed further is determined by the provider of the particular app being used. The extent of the possible settings depends on the respective app and the operating system of the mobile device.

Services

General information

If the vehicle has a wireless network connection, this enables data to be exchanged between the vehicle and other systems. The wireless network connection is realized via an in-vehicle transmitter and receiver unit or via personal mobile devices brought into the vehicle, for instance smartphones. This wireless network connection enables 'online functions' to be used. These include online services and apps supplied by the vehicle manufacturer or by other providers.

Services from the vehicle manufacturer

Where online services from the vehicle manufacturer are concerned, the corresponding functions are described in the appropriate place, for instance the Owner's Manual or manufacturer's website. The relevant legal information pertaining to data protection is provided there too. Personal data may be used to perform online services. Data is exchanged over a secure connection,

for instance with the IT systems of the vehicle manufacturer intended for this purpose.

Any collection, processing, and use of personal data above and beyond that needed to provide the services must always be based on a legal permission, contractual arrangement or consent. It is also possible to activate or deactivate the data connection as a whole. That is, with the exception of functions and services required by law such as Assist systems.

Services from other providers

When using online services from other providers, these services are the responsibility of the relevant provider and subject to their data privacy conditions and terms of use. The vehicle manufacturer has no influence on the content exchanged during this process. Information on the way in which personal data is collected and used in relation to services from third parties, the scope of such data, and its purpose, can be obtained from the relevant service provider.

Event Data Recorder EDR

This vehicle is equipped with an event data recorder EDR. The main purpose of an EDR is to record, in certain crash or near crash-like situations, such as an air bag deployment or hitting a road obstacle, data that will assist in understanding how a vehicle's systems performed. The EDR is designed to record data related to vehicle dynamics and safety systems for a short period of time, typically 30 seconds or less.

The EDR in this vehicle is designed to record such data as:

- ▶ How various systems in your vehicle were operating.
- ▶ Whether or not the driver and passenger safety belts were fastened.
- ▶ How far, if at all, the driver was depressing the accelerator and/or brake pedal.
- ▶ How fast the vehicle was traveling.

This data can help provide a better understanding of the circumstances in which crashes and injuries occur.

EDR data is recorded by your vehicle only if a nontrivial crash situation occurs; no data is recorded by the EDR under normal driving conditions and no personal data, for instance name, gender, age, and crash location, are recorded.

However, other parties, such as law enforcement, could combine the EDR data with the type of personally identifying data routinely acquired during a crash investigation.

To read data recorded by an EDR, special equipment is required, and access to the vehicle or the EDR is needed. In addition to the vehicle manufacturer, other parties, such as law enforcement, that have the special equipment, can read the information if they have access to the vehicle or the EDR.

Vehicle identification number

Engine compartment



The vehicle identification number can be found in the engine compartment, on the right-hand side of the vehicle.

Windshield



The vehicle identification number can also be found behind the windshield.

iDrive

It is also possible to display the vehicle identification number via iDrive, refer to page 71.

Reporting safety defects

For US customers

The following only applies to vehicles owned and operated in the US.

If you believe that your vehicle has a defect which could cause a crash or could cause injury or death, you should immediately inform the National Highway Traffic Safety Administration NHTSA, in addition to notifying BMW of North America, LLC, P.O. Box 1227, Westwood, New Jersey 07675-1227, Telephone 1-800-831-1117.

If NHTSA receives similar complaints, it may open an investigation, and if it finds that a safety defect exists in a group of vehicles, it may order a recall and remedy campaign.

However, NHTSA cannot become involved in individual problems between you, your dealer, or BMW of North America, LLC.

To contact NHTSA, you may call the Vehicle Safety Hotline toll-free at 1-888-327-4236 (TTY: 1-800-424-9153); go to <http://www.safercar.gov>; or write to: Administrator, NHTSA, 1200 New Jersey Avenue, SE., Washington, DC 20590.

You can also obtain other information about motor vehicle safety from <http://www.safercar.gov>.

For Canadian customers

Canadian customers who wish to report a safety-related defect to Transport Canada, Defect Investigations and Recalls, may call the toll-free hotline 1-800-333-0510. You can also obtain other information about motor vehicle safety from <http://www.tc.gc.ca/roadsafety>.

Owner's Manual media

Vehicle features and options

This chapter describes all standard, country-specific and optional features offered with the series. It also describes features and functions that are not necessarily available in your vehicle, e.g., due to the selected options or country versions. This also applies to safety-related functions and systems. When using these functions and systems, the applicable laws and regulations must be observed.

General information

Media at a glance

You can use various media formats to call up the content in the Owner's Manual. The following Owner's Manual media formats are available:

- ▷ Printed Owner's Manual.
- ▷ Integrated Owner's Manual in the vehicle.

Validity of the Owner's Manual

Production of the vehicle

At the time of production at the plant, the printed Owner's Manual is the most current resource. Due to updates after the editorial deadline, differences may exist between the printed Owner's Manual and the Integrated Owner's Manual in the vehicle.

Notes on updates can be found in the appendix of the printed Owner's Manual for the vehicle.

After a software update in the vehicle

After a vehicle software update – such as, a Remote Software Upgrade – the Integrated Own-

er's Manual for the vehicle will contain the latest information.

Printed Owner's Manual

Concept

The printed Owner's Manual describes all standard, country-specific, and optional features offered with the series.

General information

The Owner's Manual for Navigation, Entertainment, and Communication can be obtained as a printed book from the service center.

Supplementary Owner's Manuals

Also follow the Supplementary Owner's Manuals, which are included in addition to the onboard literature.

Integrated Owner's Manual in the vehicle

Concept

The Integrated Owner's Manual specifically describes features and functions found in the vehicle.

The Integrated Owner's Manual can be displayed on the Control Display.

Selecting the Owner's Manual

1.  Press the button.
2. "CAR"
3. "Owner's Manual"
4. Select the desired method of accessing the contents.

Scrolling through the Owner's Manual

Turn the Controller, until the next or previous contents are displayed.

Context help

General information

The section of the Owner's Manual relating to the function that is currently selected can be displayed directly.

Opening via iDrive

Change directly to the Options menu from the function on the Control Display:

1.  Press the button.
2. "Help"

Opening when a Check Control message is displayed

Directly from the Check Control message on the Control Display:

1.  "Owner's Manual"

Programmable memory buttons

General information

The entry points into the Owner's Manual can be stored on the programmable memory buttons and called up directly.

Storing

1. Select the desired entry point via iDrive:
 - ▶ "Keyword search"
 - ▶ "Picture search"
 - ▶ "User help"
 - ▶ "Quick reference"
 - ▶ "Topics"
 - ▶ "Quick link"

2.  Press the desired programmable memory button and hold for more than 2 seconds.

Executing

1.  Press the corresponding button.
The owner's manual is directly displayed at the selected entry point.

Entering

Opening and closing

Buttons on the vehicle key

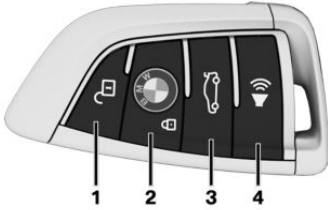

- 1 Unlocking
- 2 Locking
- 3 To open the tailgate
- 4 Press and hold or press three times in quick succession: panic mode
Press briefly: headlight courtesy delay feature

Unlocking the vehicle



Press the button on the vehicle key.

Depending on the settings, either only the driver's door or all vehicle access points are unlocked.

If only the driver's door is unlocked, press the button on the vehicle key again to unlock the other vehicle access points.



Press and hold the button on the vehicle key after unlocking.

The windows and the glass sunroof are opened, as long as the button on the vehicle key is pressed.

Locking the vehicle

1. Close the driver's door.

2.  Press the button on the vehicle key. All vehicle access points are locked.

Buttons for the central locking system

Overview



Buttons for the central locking system.

Locking



Press the button with the front doors closed.

The fuel filler flap remains unlocked.

Unlocking



Press the button.

Panic mode

You can trigger the alarm system if you find yourself in a dangerous situation.



- ▶ Press the button on the vehicle key and hold for at least 3 seconds.
- ▶ Briefly press the button on the vehicle key three times in succession.

To switch off the alarm: press any button.

Comfort Access

Concept

The vehicle can be accessed without operating the vehicle key.

Carrying the vehicle key with you, e.g., in your pants pocket, is sufficient.

The vehicle automatically detects the vehicle key when it is in close proximity or in the car's interior.

Unlocking the vehicle

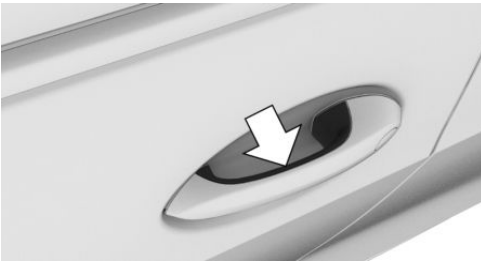

Grasp the handle of a vehicle door completely.

Locking the vehicle

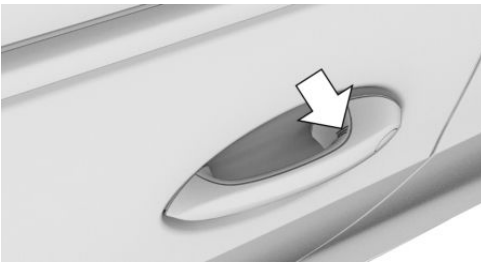

Touch the grooved surface on the handle of a closed vehicle door with your finger for approx. 1 second without grasping the door handle.

Opening and closing the tailgate with no-touch activation

Concept

The tailgate can be opened and closed with no-touch activation using the vehicle key you are carrying.

Performing the foot movement

1. Stand in the middle behind the vehicle at approx. one arm's length away from the rear of the vehicle.
2. Wave a foot under the vehicle in the direction of travel and immediately pull it back. With this movement, the leg must pass through the ranges of both sensors.

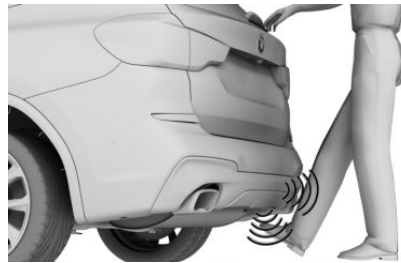

Tailgate

Opening

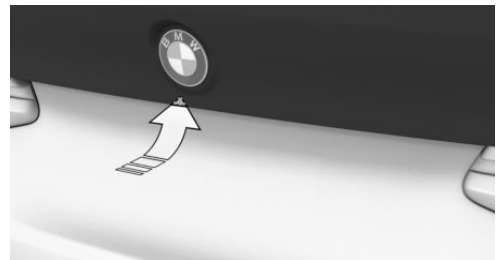

- ▷ Unlock the vehicle and then press the button on the outside of the tailgate.
- ▷  Press and hold the button on the vehicle key for approx. 1 second.

With Comfort Access: Depending on the settings, the bottom tailgate also opens.

Closing

1. Without Comfort Access: closing the lower tailgate manually.

With Comfort Access: the lower tailgate will be closed automatically with the upper tailgate.

2. Press the button on the inside of the upper tailgate.



Displays and control elements

In the vicinity of the steering wheel



- 1 Light switch element
- 2 Turn signal indicator, high beams
- 3 Instrument cluster
- 4 Wipers

Indicator/warning lights

Instrument cluster

The indicator/warning lights can light up in a variety of combinations and colors.

Several of the lights are checked for proper functioning and light up temporarily when the engine is started or standby state is switched on.

Driver's door

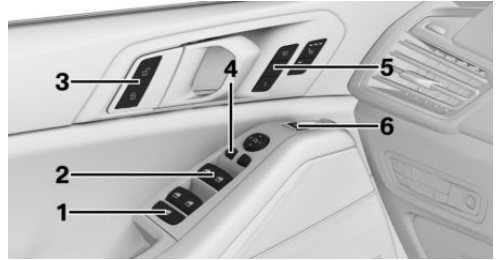

- 1 Safety switch
- 2 Power windows
- 3 Central locking system
- 4 Exterior mirrors
- 5 Seats, comfort features
- 6 Opening/closing the tailgate

Switch console

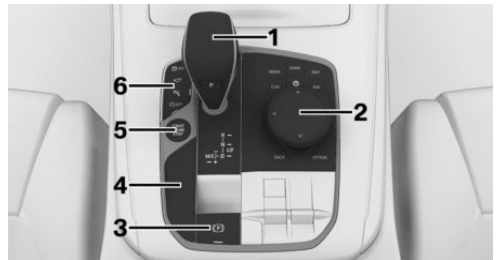









- 1 Selector lever
- 2 Controller
- 3 Parking brake, Automatic Hold
- 4 Driving Dynamics Control
- 5 Start/Stop button
- 6 Assistance systems

iDrive

Concept

The iDrive combines the functions of many switches. These functions can be operated via the Controller.

Buttons on the Controller

Button	Function
	Opens the main menu.
	Opens the Apps menu.
	Opens the Communication menu.
	Opens the Media/Radio menu.
	Opens destination input menu for navigation.
	Opens navigation map.
	Opens the previous display.
	Opens the Options menu.

Voice activation

Activating the voice activation system

-  Press the button on the steering wheel.
- Wait for the signal.
- Say the command.

 This symbol indicates that the voice activation system is active.

If no other commands are possible, operate the function via iDrive.

Terminating the voice activation system

 Press the button on the steering wheel or >Cancel.

 This symbol indicates that the voice activation system is deactivated.

Set-up and use

Seats, mirrors, and steering wheel

Electrically adjustable seats

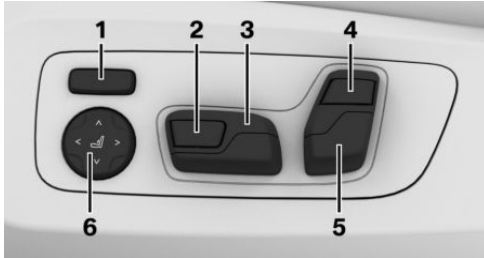

- 1 Backrest width
- 2 Thigh support
- 3 Forward/backward, height, seat tilt
- 4 Upper backrest
- 5 Backrest tilt, head restraint
- 6 Lumbar support

Adjusting the head restraint

Height

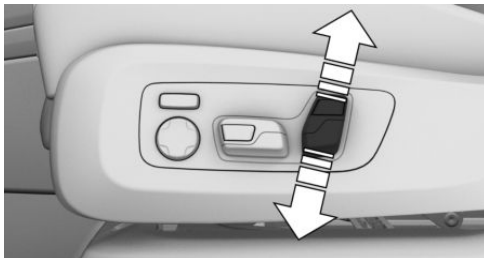

Push switch up or down.

Distance to the back of the head

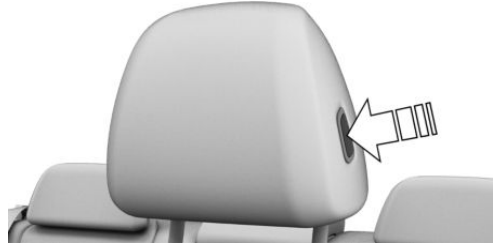

- ▷ Back: press the button and push the head restraint toward the rear.
- ▷ Forward: pull the head restraint toward the front.

Side extensions



Fold the side extensions forward to increase lateral support.

Adjusting the exterior mirrors

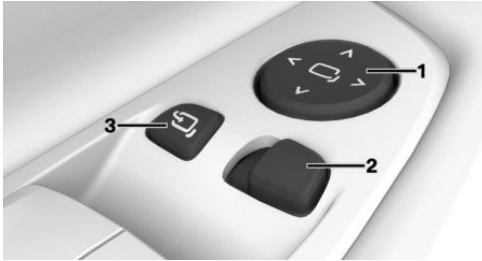

- 1 Adjusting
- 2 Selecting a mirror, Automatic Curb Monitor
- 3 Folding in and out

Adjusting the steering wheel

Electrical steering wheel adjustment

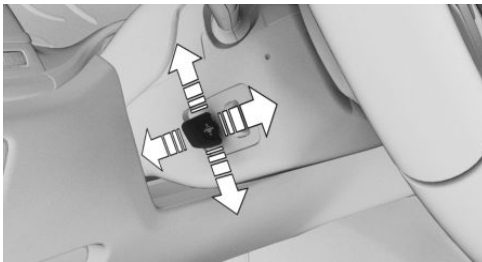

Move the steering wheel to the preferred height and angle to suit your seating position by pressing the switch.

Memory function

Concept

The following settings can be stored and, if necessary, retrieved using the memory function:

- ▶ Seat position.
- ▶ Exterior mirror position.
- ▶ Steering wheel position.
- ▶ Height of the Head-up Display.

Storing

1. Set the desired position.
2.  Press button on the door. The writing on the button lights up.
3. Press the desired button 1 or 2 at the door while the writing is lit. A signal sounds.

Calling up settings

Press the desired button 1 or 2.

Infotainment

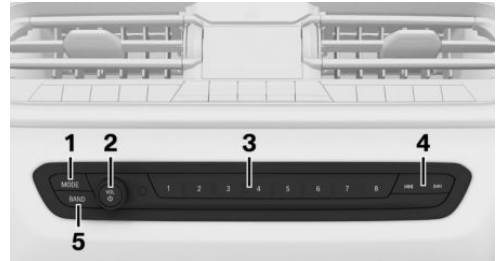

Radio



- 1 Changing the entertainment source
- 2 Sound output on/off, volume
- 3 Programmable memory buttons
- 4 Changing the station/track
- 5 Waveband/satellite radio

Navigation destination entry

Entering a destination via quick search

1.  Press the button on the Controller.
2.  "Where to?"
3. Enter at least two letters or characters.
The search term may be completed automatically in gray print.

Press or move the controller up to apply the suggested search term.

4. **OK** Select the symbol, if needed.
Results are displayed in a list.
5. "Search location": select search location.
6. Move the Controller to the right.
7. Select desired destination.

Connecting a mobile phone

General information

After the mobile phone is connected once to the vehicle, the mobile phone can be operated using iDrive and the steering wheel buttons.

Connecting the mobile phone via Bluetooth

Via iDrive:

1. "COM"
2. If necessary, select the following setting:
"Telephone"
3. "Connect new phone"
4. To perform additional steps on the mobile phone, refer to the mobile phone owner's manual: e.g., search for or connect the Bluetooth device or a new device.

The Bluetooth name of the vehicle appears on the mobile phone display. Select the Bluetooth name of the vehicle.



5. Depending on the mobile device, a control number is displayed or the control number must be entered.
 - ▶ Compare the control number displayed on the Control Display with the control number on the display of the device.
Confirm the control number on the device and on the Control Display.
 - ▶ Enter and confirm the same control number on the device and via iDrive.

The device is connected and displayed in the device list.

Using the phone

Accepting a call

Depending on the equipment, incoming calls can be answered in several ways.

- ▶ Via iDrive:
 -  "Accept"
 - ▶  Press the button on the steering wheel.
 - ▶ Via the selection list in the instrument cluster: Use the thumbwheel on the steering wheel to select: "Accept"
 - ▶ Via touch screen: tap on the corresponding entry on the Control Display.
 - ▶ Via gestures: point the index finger into the direction of the Control Display.

Dialing a number

Via iDrive:

1. "COM"
2. If necessary, "Telephone"
3. "Dial number"
4. Enter the numbers.
5.  Select the symbol. The connection is established via the mobile phone to which this function has been assigned.

Establish the connection via the additional phone:

1.  Press the button.
2. "Call via"

Apple CarPlay preparation

Concept

CarPlay allows certain functions of a compatible Apple iPhone to be used via Siri voice operation and iDrive.

Functional requirements

- ▶ Compatible iPhone.
iPhone 5 or later with iOS 7.1 or later.
- ▶ Corresponding mobile contract.
- ▶ Bluetooth, WiFi, and Siri voice operation are activated on the iPhone.

Switching on Bluetooth and CarPlay

Via iDrive:

1. "COM"
2. "Mobile devices"
3. Move the Controller to the right.
4. "Settings"
5. Select the following setting:
"Apple CarPlay"
6. Activate the function.

Pairing the iPhone with CarPlay

Pair iPhone via Bluetooth with the vehicle.

Select CarPlay as the function:

- ▶ "Apple CarPlay"

The iPhone is connected to the vehicle and displayed in the device list.

On the road

Driving

Drive-ready state

Switching on drive-ready state



1. Depress the brake pedal.
2. Press the Start/Stop button.

Switching off drive-ready state

Steptronic transmission:

1. Engage selector lever position P with the vehicle stopped.
2. Press the Start/Stop button.
The engine is switched off.
3. Set the parking brake.

Auto Start/Stop function

The Auto Start/Stop function switches the engine off automatically while stationary to save fuel. The engine starts automatically under the following preconditions:

Steptronic transmission:

- ▷ By releasing the brake pedal.
- ▷ When Automatic Hold is activated: step on the accelerator pedal.

Parking brake

Setting



Pull the switch.

The LED on the switch and the indicator light in the instrument cluster are illuminated.

Releasing



With drive-ready state switched on:

Press the switch while stepping on the brake pedal or selector lever position P is set.

The LED and indicator light go out.

The parking brake is released.

Parking

The parking brake is automatically set if the vehicle is being held by Automatic Hold and the drive-ready state is switched off or the vehicle is exited.

Steptronic transmission

Engaging selector lever position D, N, R



- ▷ Drive mode D.
- ▷ Neutral N.
- ▷ R is reverse.

With the driver's safety belt fastened, briefly push the selector lever in the desired direction, past a resistance point, if needed. The selector lever returns to the center position in each case.

To prevent the vehicle from creeping after you select a drive mode or reverse, maintain pressure on the brake pedal until you are ready to start.

A selector lever lock prevents the inadvertent shifting to selector lever position R or the inadvertent shifting from selector lever position P. Engage selector lever position R only when the vehicle is stationary.

Releasing the selector lever lock

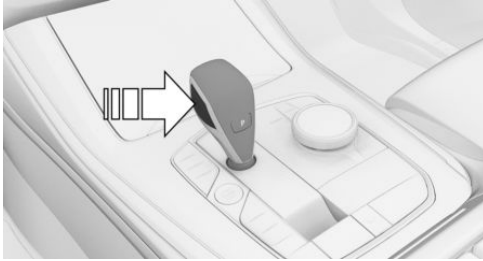

Press the button.

Engaging P

Engage selector lever position P only when the vehicle is stationary.



Press button P.

Steptronic transmission, Sport program and manual mode

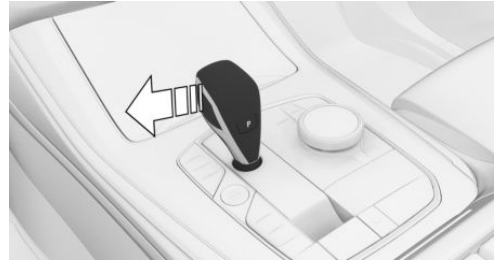

Activate the Sport program/manual mode:

Press the selector lever to the left from selector lever position D.

Manual mode:

- ▶ To shift down: press the selector lever forward.
- ▶ To shift up: pull the selector lever rearwards.

End the sport program/manual mode:

Push the selector lever to the right.

High beams, headlight flasher, turn signal

High beams, headlight flasher

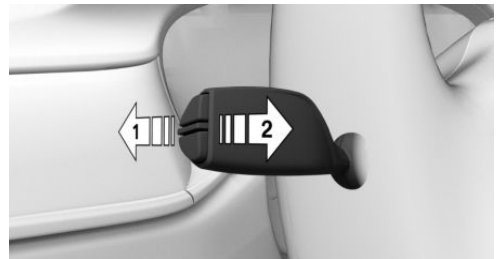

Push the lever forward or pull it backward.

- ▶ High beams on, arrow 1.
The high beams light up when the low beams are switched on.
- ▶ High beams off/headlight flasher, arrow 2.

Turn signal

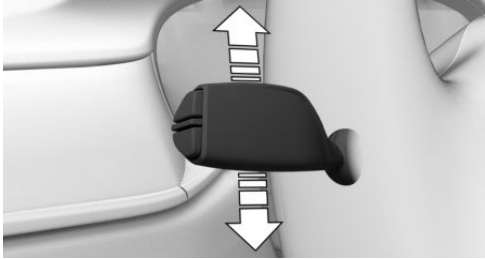

- ▷ On: press the lever past the resistance point.
- ▷ Off: press the lever past the resistance point in the opposite direction.
- ▷ Triple turn signal activation: lightly tap the lever up or down.
- ▷ Brief signaling: press the lever to the resistance point and hold it there for as long as you want the turn signal to flash.

Lights and lighting

Light functions

Symbol	Function
	Front fog lights.
	Night vision.
	Lights off. Daytime running lights.
	Parking lights.
	Automatic headlight control. Adaptive light functions.
	Low beams.

Symbol	Function
	Instrument lighting.
	Right roadside parking light.
	Left roadside parking light.

Wiper system

Switching the wipers on/off and brief wipe

Switching on

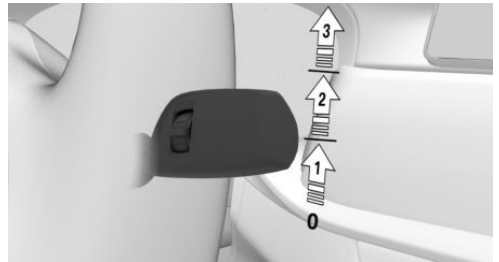

Press the lever up until the desired position is reached.

- ▷ Resting position of the wipers: position 0.
- ▷ Rain sensor: position 1.
- ▷ Normal wiper speed: position 2.
- ▷ Fast wiper speed: position 3.

Brief wipe and switching off

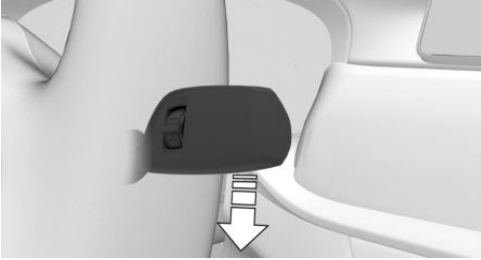

Press the lever down.

- ▶ Switching off: press the lever down until it reaches its standard position.
- ▶ Brief wipe: press the lever down from the standard position.

Rain sensor

Activating/deactivating

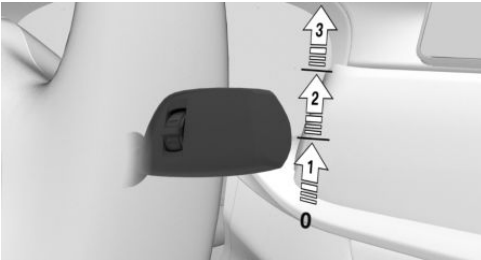

To activate: press the lever up once from its standard position, arrow 1.

To deactivate: press the lever back into the standard position.

Adjusting the sensitivity

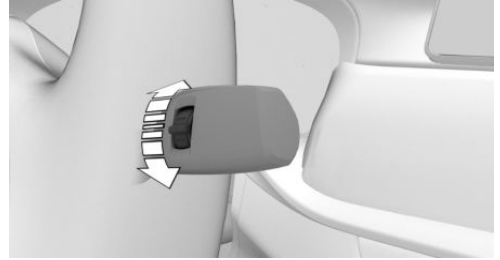

Turn the thumbwheel on the wiper lever.

Cleaning the windshield



Pull the wiper lever towards you.

Rear window wiper

Switching on

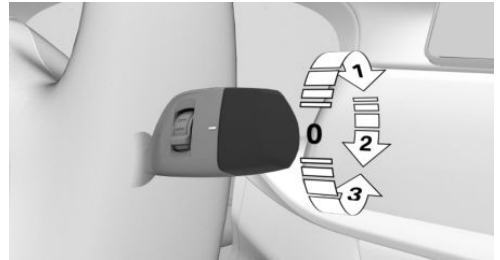

Turn the outer switch upward.

- ▶ Resting position of the wiper, position 0.
- ▶ Intermittent mode, arrow 1. When reverse gear is engaged, the system switches to continuous operation.









Clean the rear window



Turn the outer switch in the desired direction.

- ▷ In resting position: turn the switch downward, arrow 3. The switch automatically returns to its idle position when released.
- ▷ In intermittent mode: turn the switch further, arrow 2. The switch automatically returns to its interval position when released.

Climate control

Automatic climate control

Button	Function
	Temperature.
	Maximum cooling.
	AUTO program.
	Recirculated-air mode.
	Air flow, manual.
	Air distribution, manual.
	Defrost and defog the windshield.
	Rear window defroster.
	Active seat ventilation.

Button	Function
	Seat and armrest heating.
	Climate control operation. Opening the Climate menu. For example, for the following settings: upper body temperature adjustment, parked-car ventilation.

Refueling

Refueling

Fuel cap

1. To open the fuel filler flap, press on the rear edge, arrow. The fuel filler flap opens.



2. Turn the fuel cap counterclockwise.
3. Place the fuel cap in the bracket attached to the fuel filler flap.

Gasoline

For the best fuel efficiency, the gasoline should be sulfur-free or very low in sulfur content.

Fuels that are marked on the gas pump as containing metal must not be used.

Wheels and tires

Tire inflation pressure specifications

The tire inflation pressure specifications can be found in the tire inflation pressure table in the printed Owner's Manual.

After correcting the tire inflation pressure

With runflat tires:

Reinitialize the Flat Tire Monitor.

With Tire Pressure Monitor TPM:

The corrected tire inflation pressures are applied automatically. Make sure that the correct tire settings have been made.

With tires that cannot be found in the tire pressure values on the Control Display, reset the Tire Pressure Monitor TPM.

Checking the tire inflation pressure

Regularly check the tire inflation pressure and correct it as needed:

- At least twice a month.
- Before embarking on an extended trip.

Cleaning the wheels

The friction during hard braking may produce brake dust and make the rims dirty. Brake dust can be removed by cleaning the rims. BMW recommends using vehicle care and cleaning products from BMW.

Electronic oil measurement

Functional requirements

A current measured value is available after approx. 30 minutes of normal driving with the combustion engine running.

Displaying the engine oil level

Via iDrive:

1. "CAR"
2. "Vehicle status"
3.  "Engine oil level"

Different messages appear on the Control Display depending on the engine oil level. Pay attention to these messages.

Adding engine oil

General information

Safely park the vehicle and switch off drive-ready state before adding engine oil.

Adding



Only add engine oil when the message is displayed in the instrument cluster.

Observe the quantity to be added in the message.

Take care not to add too much engine oil.

Observe recommended engine oil types.

Providing assistance

Hazard warning flashers



The button is located in the center console.

Breakdown assistance

BMW Roadside Assistance

Via iDrive:

1. "APPS"
2. "Installed apps"
3. "BMW Assist"
4. If necessary, "BMW Roadside Assistance"

A voice connection is established.

ConnectedDrive

Concierge service

The BMW Assist Concierge service offers information on events, gas stations or hotels, and provides phone numbers and addresses. Many hotels can be booked directly by the BMW Concierge service. The Concierge service is part of the optional BMW Assist Response Center.

Via iDrive:

1. "COM"
2. "BMW Assist"
3. If necessary, select the entry for the Concierge Service.

A voice connection to the Concierge service is established.

Teleservices

Teleservices are services that help to maintain vehicle mobility.

Teleservices can comprise the following services:

- ▷ BMW Roadside Assistance.
- ▷ BMW Accident Assistance.
- ▷ Service Request.
- ▷ Teleservice Report.
- ▷ Teleservice Battery Guard.
- ▷ Your dealer's service center.

Cockpit

Vehicle features and options

This chapter describes all standard, country-specific and optional features offered with the series. It also describes features and functions that are

not necessarily available in your vehicle, e.g., due to the selected options or country versions. This also applies to safety-related functions and systems. When using these functions and systems, the applicable laws and regulations must be observed.

In the vicinity of the steering wheel

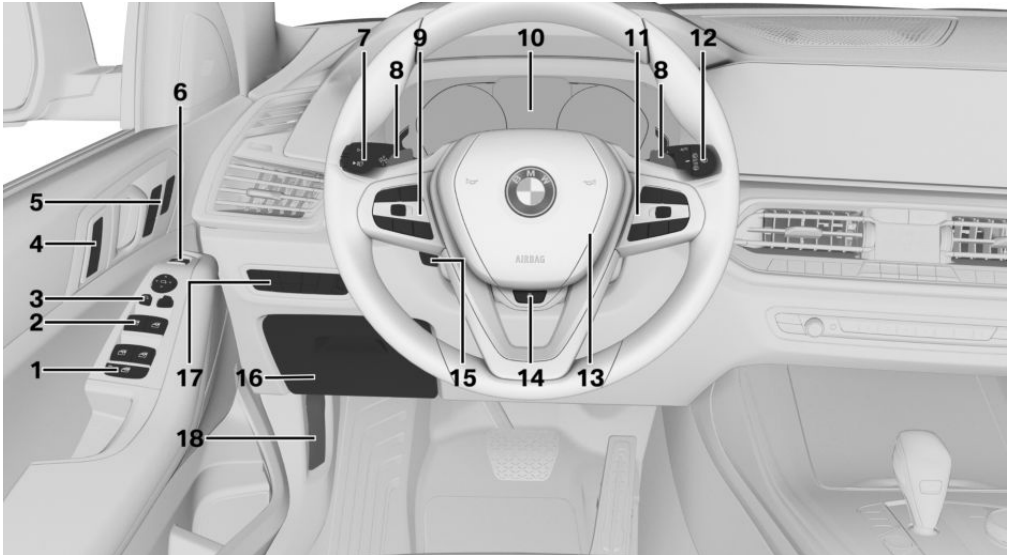

1  Window safety switch 107

2  Power windows 106

























3 Exterior mirror operation 122

4 Central locking system 88

 Unlocking

 Locking

5 Seating comfort features

-  Gentleman function [114](#)
-  Memory function [124](#)
-  Massage function [125](#)
- 6**  Opening and closing the tail-gate [98](#)
- 7** Steering column stalk, left
-  Turn signal [142](#)
-  High beams, head-light flasher [143](#)
-  High-beam Assistant [173](#)
-  Widgets in the instrument cluster [154](#)
- Trip data [165](#)
- 8** Shift paddle
- 9** Steering wheel buttons, left
-  Speed Limiter [225](#)
-  Depending on the equipment:
Cruise control on/off [227](#)
-  Depending on the equipment:
Active Cruise Control on/off [229](#)
-  With steering and traffic jam assistant [239](#):
- Cruise control, distance control and lane guidance on/off
-  Cruise control: to store the speed
-  Speed Limit Assist: take over suggested speed [238](#)
-  Pause or continue cruise control
-  Active Cruise Control: increase distance
-  Active Cruise Control: reduce distance
- Cruise control rocker switch
- 10** Instrument cluster [152](#)
- 11** Steering wheel buttons, right
-  Selection lists [164](#)
-  Volume, see Owner's Manual for Navigation, Entertainment and Communication [6](#)
-  Voice activation system [48](#)
-  Telephone, see Owner's Manual for Navigation, Entertainment and Communication [6](#)
- Thumbwheel for selection lists [164](#)
- 12** Steering column stalk, right
-  Wipers [143](#)
-  Rain sensor [144](#)
-  Cleaning the windshield [144](#)
-  Rear window wiper in Canadian models [145](#)



Rear window wiper 145



Clean the rear window 145



Horn, entire surface



Heated steering wheel 124

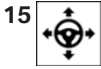

Adjusting the steering wheel 123

16 Glove compartment 309

17 Lights



Front fog lights 175



Night Vision 197



Light switch 170



Lights off

Daytime running lights 172



Parking lights 171



Automatic headlight control 170

Adaptive light functions 173

High-beam Assistant 173



Low beams 171



Instrument lighting 176



Right roadside parking light 171





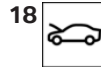





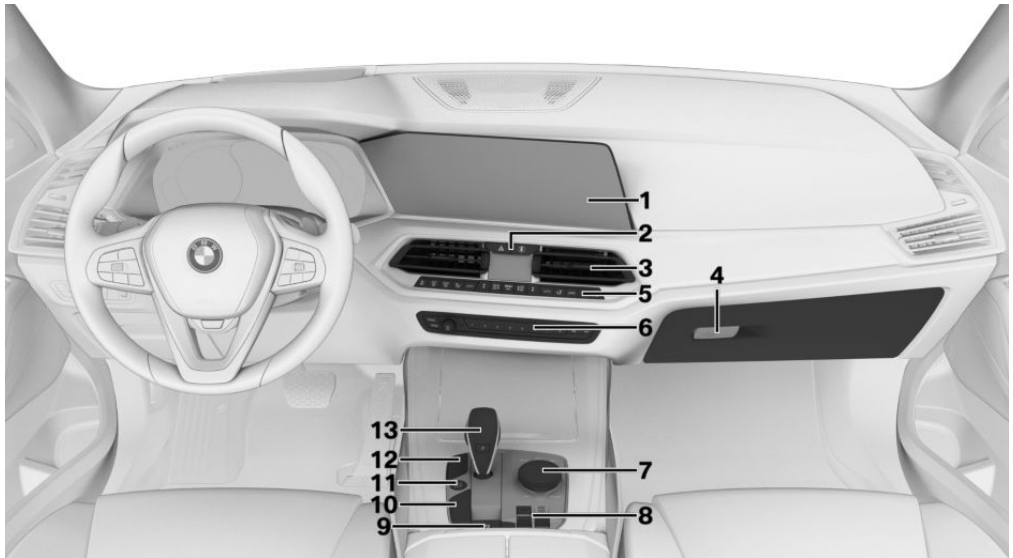

Left roadside parking light 171



Unlocking the hood 376

In the vicinity of the center console



- | | |
|--|--|
| <p>1 Control Display 43</p> <p>2  Hazard warning system 391</p> <p> Intelligent Safety 182</p> <p>3 Ventilation 284</p> <p>4 Glove compartment 308</p> <p>5 Automatic climate control 279</p> <p>6 Radio/multimedia, see Owner's Manual for Navigation, Entertainment, and Communication 6</p> <p>7 Controller with buttons 43</p> <p>8  Air suspension level adjustment 272</p> <p> xOffroad driving mode 275</p> <p> HDC Hill Descent Control 222</p> | <p>9  Parking brake 139</p> <p> Automatic Hold 140</p> <p>10  Driving Dynamics Control 137</p> <p>SPORT driving mode</p> <p>COMFORT driving mode</p> <p>ECO PRO driving mode</p> <p>ADAPTIVE driving mode</p> <p>11  Switching drive-ready state on/off 134</p> |
|--|--|

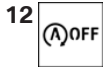

12 Auto Start/Stop function 134



PDC Park Distance Control 247

Without Surround View: rearview camera 252

Surround View 254

Cross traffic warning 268

Parking Assistant 262



Surround View: Panorama View 254



DSC Dynamic Stability Control 219

13 Steptronic transmission selector lever 146

In the vicinity of the roofliner

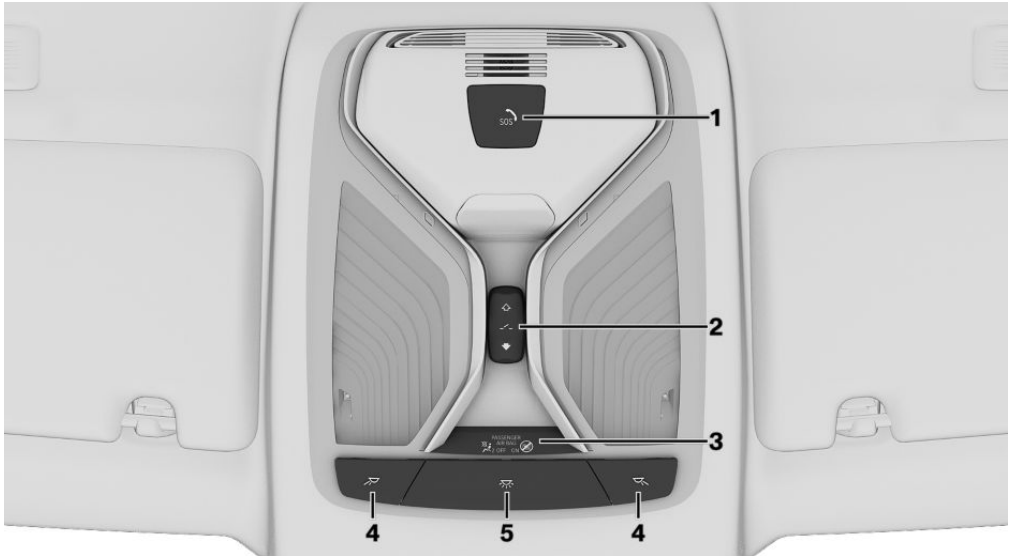

1 Emergency Request, SOS 393

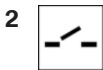

2 Glass sunroof 108



3 Indicator light, front-seat passenger airbag 181



4 Reading lights 176



5 Interior lights 176

Operating state of the vehicle

Vehicle features and options

This chapter describes all standard, country-specific and optional features offered with the series. It also describes features and functions that are not necessarily available in your vehicle, e.g., due to the selected options or country versions. This also applies to safety-related functions and systems. When using these functions and systems, the applicable laws and regulations must be observed.

General information

Depending on the situation, the vehicle is in one of the three states:

- ▷ Idle state.
- ▷ Standby state.
- ▷ Drive-ready state.

Idle state

Concept

When the vehicle is in idle state, it is switched off. All power consumers are deactivated.

General information

The vehicle is in idle state prior to opening from the outside and after exiting and locking.

Safety information

Warning

An unsecured vehicle can begin to move and possibly roll away. There is a risk of accident. Before exiting, secure the vehicle against rolling.

In order to ensure that the vehicle is secured against rolling away, follow the following:

- ▷ Set the parking brake.
- ▷ On uphill grades or on a downhill slope, turn the front wheels in the direction of the curb.
- ▷ On uphill grades or on a downhill slope, also secure the vehicle, for instance with a wheel chock.

Warning

Unattended children or animals in the vehicle can cause the vehicle to move and endanger themselves and traffic, for instance due to the following actions:

- ▷ Pressing the Start/Stop button.
- ▷ Releasing the parking brake.
- ▷ Opening and closing the doors or windows.
- ▷ Engaging selector lever position N.
- ▷ Using vehicle equipment.

There is a risk of accidents or injuries. Do not leave children or animals unattended in the vehicle. Take the vehicle key with you when exiting and lock the vehicle.

Automatic idle state

The idle state is automatically established under the following conditions:

- ▷ After several minutes, if no operation takes place on the vehicle.
- ▷ If the charge state of the vehicle battery is low.
- ▷ Depending on the setting via iDrive, if one of the front doors is opened when exiting the vehicle.

The idle state is not automatically established while a phone call is active.

Establishing idle state when opening the front doors

Via iDrive:

1. "CAR"
2. "Settings"
3. "Doors/Access"
4. "Turn off vehicle after opening door"

Manual idle state

To establish idle state in the vehicle after end of trip:

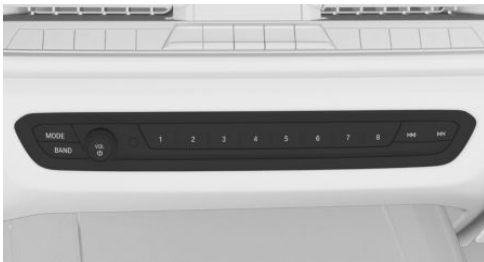

Press and hold the button until the OFF indicator on the instrument cluster goes out.

Standby state

Concept

When standby state is switched on, most functions can be used while the vehicle is stationary. Desired settings can be adjusted.

General information

The vehicle is in the standby state after the front doors are opened from the outside.

Display in the instrument cluster



OFF is displayed in the instrument cluster. The drivetrain is switched off and standby state switched on.

Drive-ready state

Concept

Switching on drive-ready state corresponds to starting the engine.

General information

Some functions, such as DSC Dynamic Stability Control, can only be used with drive-ready state switched on.

Safety information

DANGER

If the exhaust pipe is blocked or ventilation is insufficient, harmful exhaust gases can enter into the vehicle. The exhaust gases contain pollutants which are colorless and odorless. In enclosed areas, exhaust gases can also accumulate outside of the vehicle. There is danger to life. Keep the exhaust pipe free and ensure sufficient ventilation.

⚠ Warning

An unsecured vehicle can begin to move and possibly roll away. There is a risk of accident. Before exiting, secure the vehicle against rolling.

In order to ensure that the vehicle is secured against rolling away, follow the following:

- ▷ Set the parking brake.
- ▷ On uphill grades or on a downhill slope, turn the front wheels in the direction of the curb.
- ▷ On uphill grades or on a downhill slope, also secure the vehicle, for instance with a wheel chock.

⚠ NOTICE

In the case of repeated starting attempts or repeated starting in quick succession, the fuel is not burned or is inadequately burned. The catalytic converter can overheat. There is a risk of damage to property. Avoid repeated starting in quick succession.

Gasoline engine

Depending on the motorization, the full drive power may not be available for approximately 30 seconds after starting the engine. In this case, the vehicle will not accelerate as usual.

Display in the instrument cluster

When drive-ready state is switched on, the tachometer shows the current engine speed.

Switching off drive-ready state**Steptronic transmission**

1. Engage selector lever position P with the vehicle stopped.
2. Press the Start/Stop button.
The engine is switched off. The vehicle switches into standby state.
3. Set the parking brake.

Switching on drive-ready state**Concept**

Drive-ready state is switched on via the Start/Stop button:

Steptronic transmission

1. Depress the brake pedal.
2. Press the Start/Stop button.

The ignition is activated automatically for a brief time and is stopped as soon as the engine starts.

Most of the indicator/warning lights in the instrument cluster light up for a varied length of time.

iDrive

Vehicle features and options

This chapter describes all standard, country-specific and optional features offered with the series. It also describes features and functions that are not necessarily available in your vehicle, e.g., due to the selected options or country versions. This also applies to safety-related functions and systems. When using these functions and systems, the applicable laws and regulations must be observed.

Operating concept

Concept

iDrive includes a large number of functions. These functions can be operated via the Controller and, depending on the equipment version, via touchscreen, voice activation system or gesture control.

Safety information

Warning

Operating the integrated information systems and communication devices while driving can distract from traffic. It is possible to lose control of the vehicle. There is a risk of accident. Only use the systems or devices when the traffic situation allows. As warranted, stop and use the systems and devices while the vehicle is stationary.

Input and display

Main menu

General information

The main menu is divided into two areas. The left area contains menu items that can be used to call up all the iDrive functions. The right area contains widgets that provide quick access to certain functions.

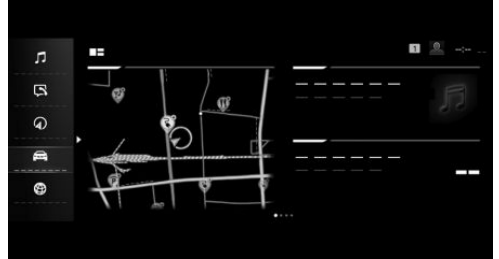

Media/Radio

 All functions of the entertainment system, e.g., radio and TV stations, connection with external devices and music collection.

Communication

 Phone and message functions, e-mail and calendar, and also the connection and management of mobile devices, such as smartphones.

Navigation

 Access to the navigation system, destination input and traffic bulletins. Configurable map views and other functions, such as Points of Interest and areas to be avoided.

My Car

 Information about vehicle status and trips. Access to the Integrated Owner's Manual and also administration of driver profiles and range of adjustments for vehicle and iDrive.

Apps

 Management of apps, access to apps and vehicle functions. Additional apps can be purchased from the BMW Store.



Widgets

 Widgets provide quick access to frequently used functions. The configured widgets display dynamic contents such as the navigation map, and serve as interfaces at the same time.

Letters and numbers

Letters and numbers can be selected when the destination is entered, for example.

Letters and numbers can be entered using the Controller and, depending on the equipment version, via touchscreen or voice activation system. The keyboard's display changes automatically.

Symbol	Function
abc or ABC	Change between capital and lower-case letters.
	Enter a blank space.
EN	Switching between languages.
	Use voice activation.
OK	Confirm entry.
	Slide the input area to the left or right.

Entry comparison

When entering names and addresses, the choice is narrowed down with every letter and number and added automatically as needed.

Entries are continuously compared with data stored in the vehicle.

- ▶ Only those letters and numbers are offered during entry for which data is available.
- ▶ Destination search: place names can be entered in all languages that are available in iDrive.

Activating/deactivating the functions

Several menu items are preceded by a checkbox. The checkbox indicates whether the function is activated or deactivated. Selecting the menu item activates or deactivates the function.



- Function is activated.
- Function is deactivated.

Status information











General information

The status field can be found in the upper area of the Control Display. Status information is displayed in the form of symbols.



Radio symbols

Symbol	Meaning
	HD Radio station is being received.
	Satellite radio is switched on.

Telephone symbols



Symbol	Meaning
	Incoming or outgoing call.
	Missed call.
	Signal strength of cellular network.
	Network search.
	Cellular network is not available.
	The critical charge state of the mobile phone has been reached.
	Roaming is active.
	Locating is active.
	SMS text message received.
	Message received.

Symbol Meaning

	Reminder.
	Sending not possible.











Entertainment symbols

Symbol Meaning

	Bluetooth audio.
	USB audio interface.
	WiFi.

Other symbols

Symbol Meaning

	Check Control message.
	The sound output has been switched off.
	Request for the current vehicle position.
	Checking the current vehicle position.
	Driver profile.
	Messages.
	Service notifications.
	Information.
	Stop.
	Data protection.

Programmable memory buttons

General information

The iDrive functions can be stored on the programmable memory buttons and called up directly, for instance radio stations, navigation destinations, phone numbers and menu entries or pages in the Integrated Owner's Manual.

Settings are stored for the driver profile currently used.

Overview

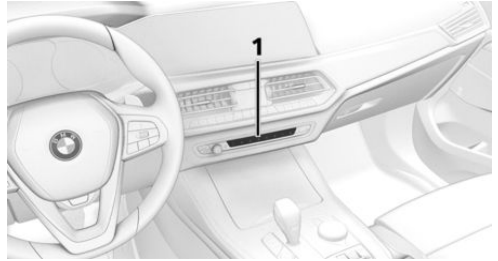

1 Programmable memory buttons

Storing a function

A function can be stored on a programmable memory button. A button with a stored function can be overwritten with another function.

1. Select function via iDrive.
2.  Press and hold the desired button until the displayed bar on the Control Display has loaded completely.

Executing a function

- 1...8  Press the button.

The function will work immediately. This means, for instance that the number is dialed when a phone number is selected.

Displaying the key assignment

Touch buttons with finger. Do not wear gloves or use objects.

The button assignment is displayed at the top edge of screen.

Deleting all button assignments

All button assignments can be deleted.

1. Press and hold buttons 1 and 8 at the same time.
2. "OK"

Control Display and Controller

Concept

The iDrive functions are displayed on the Control Display. The Control Display can be operated using the Controller, touchpad, and touch screen.

Overview

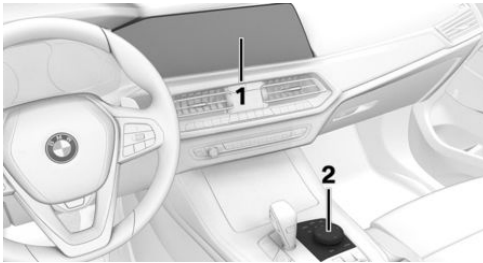

- 1 Control Display with touchscreen
- 2 Controller with buttons and touchpad

Control Display

Safety information

⚠ NOTICE

Objects in the area in the front of the Control Display can shift and damage the Control Display. There is a risk of damage to property. Do not place objects in the area in front of the Control Display.

Switching on/off automatically

The Control Display is switched on automatically after unlocking.

In certain situations, the Control Display is switched off automatically, for instance if no operation is performed on the vehicle for several minutes.

Switching on/off manually

The Control Display can also be switched off manually.

1. Tip the Controller up.
2. "Screen off"

Press the Controller or any button on the Controller to switch it back on again.

System limits

In the case of very high temperatures on the Control Display, for instance due to intense solar radiation, the brightness may be reduced down to complete deactivation. Once the temperature is reduced, for instance through shade or air conditioning, the normal functions are restored.

Controller

General information

The buttons can be used to open the menus directly. The Controller can be used to select menu items and enter the settings.

Some iDrive functions can be operated using the touchpad on the Controller.

Operation

- ▶ Turn to switch between menu items, for example.

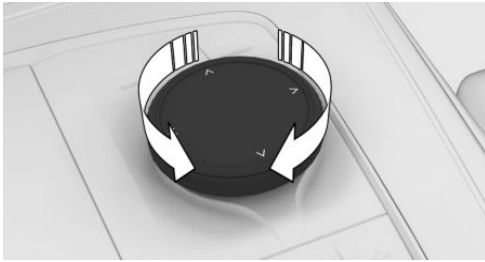





▷ Press to select a menu item, for example.

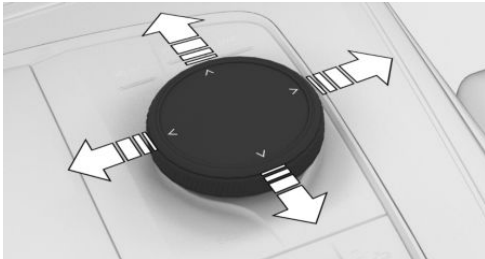





▷ Tilt in four directions to switch between displays, for example.



Buttons on the Controller

Button	Function
	Opens the main menu.
	Opens the Apps menu.
	Opens the Communication menu.
	Opens the Media/Radio menu.

Button	Function
	Opens destination input menu for navigation.
	Opens navigation map.
	Opens the previous display.
	Opens the Options menu.

Operating via the Controller

Opening the main menu

 Press the button.

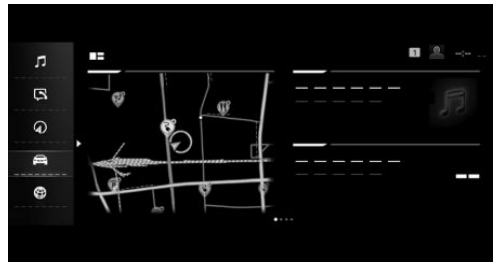

The main menu is displayed.

Selecting a menu

Selecting menu items

1. Turn the Controller until the desired menu item is highlighted.
2. Press the Controller.

Select a widget

1. Move the Controller to the right.
2. Turn the Controller until the desired widget is selected.
3. Press the Controller.

It is also possible to select widgets in the instrument cluster.

Adjusting the menu

Adjusting widgets

The widgets can be adjusted in the main menu. It is possible to create multiple pages with widgets and switch between pages. The adjustments can only be performed when the vehicle is stationary.

Via iDrive:

1. Select the desired page in the main menu. Only the currently selected page can be adjusted.
2. Tip the Controller up.
3. "Adjust main menu"
4. Select the desired adjustment:
 - ▷ Add new widget: **+** select symbol and select desired widget.
The requested widget will be inserted in the relevant position. A maximum of four widgets can be displayed per page.
 - ▷ Delete selected widget: **X** select symbol.
 - ▷ Add new page: "Add page".
 - ▷ Delete selected page: "Delete page".
 - ▷ Adjust the content of the widget: select widget.
5. "Done"

Adjusting menu contents

The display of menus "MEDIA", "COM" and "NAV" can be adjusted, for instance to remove the entries of functions that are not used from the menu.

Via iDrive:

1. Select the menu.
2. "Personalize menu"
3. Select desired menu contents to be displayed.

Changing between displays

After a menu item is selected, for instance "Settings", a new display appears.

- ▷ Move the Controller to the left.
The current display closes and the previous display is shown.

- ▷  Press the button.
The previous display re-opens.

- ▷ Move the Controller to the right.
The new display opens.

An arrow indicates that additional displays can be opened.

Opening the Options menu

- ▷  Press the button.

The "Options" menu is displayed.

The menu consists of various areas:

- ▷ Help for the selected menu, for instance "Help".
- ▷ System settings, for instance "Turn off screen".
- ▷ Control options for the selected main menu, for instance for "Media/Radio".

Changing settings

Settings, such as brightness, can be entered.

Via iDrive:



1. "CAR"
2. "Settings"
3. "Displays"
4. "Control display"
5. "Brightness at night"
6. Press the Controller.
7. Turn the Controller until the desired setting is displayed.
8. Press the Controller.

Entering letters and numbers

Input

1. Turn the Controller: select letter or number.
2. **OK** : confirm entry.

Deleting

Symbol	Function
	Press the Controller: delete letter or number.
	Hold the Controller down: delete all letters or numbers.

Using alphabetical lists

For alphabetical lists with more than 30 entries, the letters for which an entry exists can be displayed in a text box.

1. Turn the Controller to the left or right quickly.
2. Select the first letter of the desired entry.
The first entry of the selected letter is displayed in the list.

Operation via touchpad

General information

Some iDrive functions can be operated using the touchpad on the Controller.

Selecting functions

Via iDrive:

1. "CAR"
2. "Settings"
3. "General settings"
4. "Touchpad"
5. Select the desired setting:
 - ▷ "Character input": enter letters and numbers.
 - ▷ "Map": use the map.

- ▷ "Search fields": to write letters without selecting the list field.
- ▷ "Audio confirmation": pronounces entered letters and numbers.

Entering letters and numbers

- ▷ Enter characters as they are displayed on the Control Display.
- ▷ Always enter associated characters, such as accents or periods so that the letter can be clearly recognized.
- ▷ The set language determines what input is possible. Where necessary, enter special characters via the Controller.

Entering special characters

Input	Operation
Delete a character.	Swipe to the left on the touchpad.
Enter a blank space.	Swipe to the right in the center of the touchpad.
Enter a hyphen.	Swipe to the right in the upper area of the touchpad.
Enter an underscore.	Swipe to the right in the lower area of the touchpad.

Using the map

The map in the navigation system can be moved via the touchpad.

Function	Operation
Move map.	Swipe in the appropriate direction.
Enlarge/shrink map.	Drag in or out on the touchpad with fingers.
Display menu.	Tap once.

Operation via touchscreen

General information

The Control Display is equipped with a touchscreen.

You can tap on menu items and widgets. Touch the screen with your fingers. Do not use any objects.

Opening the main menu

Tap on the symbol.

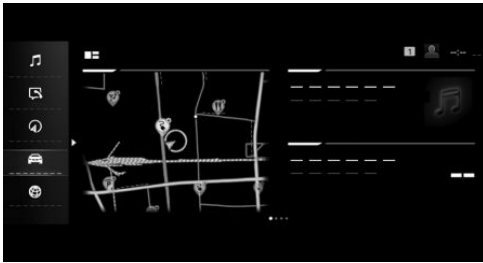

The main menu is displayed.

Adjusting widgets

The widgets can be adjusted in the main menu. It is possible to create multiple pages with widgets and switch between pages. The adjustments can only be performed when the vehicle is stationary.

Via iDrive:

1. Select the desired page in the main menu. Only the currently selected page can be adjusted.
2. Tap the symbol in the main menu.
3. Select the desired adjustment:
 - ▶ Add new widget: Tap symbol and select desired widget.
The requested widget will be inserted in the relevant position. A maximum of four widgets can be displayed per page.
 - ▶ Delete selected widget: Tap symbol.
 - ▶ Add new page: tap "Add page".

- ▶ Delete selected page: tap "Delete page".
- ▶ Adjust content of the widget: tap center of widget.

4. Tap "Done".

Showing/hiding the display bar

At the top edge of the screen, it is possible to show or hide a display bar with additional functions.

- ▶ To show the display bar, pull down the display bar at the top edge of the screen.
- ▶ To hide the display bar, pull up the display bar at the top edge of the screen.

Changing between displays

After a menu item is selected, a new display opens.

An arrow indicates that additional displays can be opened.

- ▶ Swipe to the left.
- ▶ Tap arrow.

The new display opens.

Changing settings

Settings such as brightness can be changed via the touchscreen.

Via iDrive:



1. "CAR"
2. "Settings"
3. "Displays"
4. "Control display"
5. "Brightness at night"
6. To perform the desired setting:
 - ▶ Slide in the selected field to the right or left, until the desired setting is displayed.
 - ▶ Tap on the symbol.

Entering letters and numbers

Input

1.  Tap the symbol on the touchscreen.
A keyboard appears in the Control Display.
2. Enter letters and numbers.

Deleting

Symbol	Function
	Tapping the symbol: deletes the letter or number.
	Tapping and holding the symbol all letters: deletes all letters or numbers.

Using the map

The navigation map can be moved using the touchscreen.

Function	Operation
Move map.	Swipe in the appropriate direction.
Enlarge/shrink map.	Drag in or out with the fingers.
Display menu.	Tap once.

Voice activation system

Concept

The voice activation system can be used to operate functions with spoken commands. The system supports you with announcements during input.

The voice control system and the feedback it provides are not a substitute for the printed or Integrated Owner's Manual.

General information

- ▷ Functions that can only be used when the vehicle is stationary can only be operated via

the voice activation system to a limited extent.

- ▷ The system includes special microphones on the driver side and the front passenger side.
- ▷ ›...‹ denotes commands to use with the voice activation system.

Functional requirements

- ▷ A language must be set via iDrive that is supported by the voice activation system. To set the language, refer to page 62.
- ▷ Always say commands in the language of the voice activation system.

Activating the voice activation system

General information

There are various methods for activating the voice activation feature:

- ▷  Press the button on the steering wheel.
- ▷ Say the wake word ›Hello BMW‹ or a personal wake word.

 This symbol indicates that the voice activation system is active.

Then say the command. No other commands may be available. In this case, operate the function via iDrive.

The voice activation can be terminated:

- ▷  Press the button on the steering wheel again.
- ▷ Say ›Cancel‹.

 This symbol indicates that the voice activation system is deactivated.

Button on the steering wheel

1.  Press the button on the steering wheel.
2. Wait for the signal.
3. Say the command.

Wake word

General information

Speaking the wake word ›Hello BMW‹ or the personal wake word will start the system.

Activating/deactivating

1. Say the wake word ›Hello BMW‹ or a personal wake word.
2. Say the command.

Preset wake word

The preset wake word ›Hello BMW‹ can be activated and deactivated. The ›Hello BMW‹ option activates the preset and personal wake word.

Via iDrive:

1. "CAR"
2. "Settings"
3. "General settings"
4. "Language"
5. "Activation with "Hello BMW""

Personal wake word

In addition to a preset wake word ›Hello BMW‹, a personal wake word can be set up.

Via iDrive:

1. "CAR"
2. "Settings"
3. "General settings"
4. "Language"
5. "Personal wake word"
6. "Start recording"

For the "Start recording" option, online speech processing must be available and activated. Alternatively, the personal wake word can be entered using the Controller.

7. Follow the instructions on the Control Display.

Possible commands

General information

Most contents on the Control Display can be spoken as commands, e.g. menu items or list entries. Speak these list entries out loud exactly as they are shown in the list.

Say the commands and numbers with normal volume, emphasis, and speed.

The status of the voice recognition is displayed in the upper area of the Control Display.

Function examples

Menu items

The commands of the menu items are spoken just as they are selected via the Controller.

1.  Press the button on the steering wheel.
2. ›Media and radio‹
3. ›Presets‹

The stored stations are displayed on the Control Display.

Navigation

Destinations can be entered in the navigation system using the voice activation system. It is also possible to say Points of Interest or have traffic reports announced.

- ▶ ›Drive me to 300 Chestnut Ridge Road, Woodcliff Lake in New Jersey.‹
- ▶ ›Take me home.‹
- ▶ ›Are there any traffic messages.‹

Communication

For example, when a mobile phone is connected, the voice activation system can be used to start calls or send SMS.

- ▷ ›Call John Doe on cell phone‹.
- ▷ ›Dial the number 1 8 0 0 8 3 1 1 1 1 7‹.
- ▷ ›New text message to John Doe: I'll be right there‹.

Media and Radio

Most radio functions can be used via voice operation.

- ▷ ›Turn on music‹.
- ▷ ›Music off‹.
- ▷ ›Next title‹.

Climate control

Most climate control functions can be used via voice.

- ▷ ›Activate climate control‹.
- ▷ ›Deactivate ... air recirculation‹.
- ▷ ›Temperature [...] at ...‹.

Help on the voice activation system

- ▷ To have the available spoken instructions read out loud: ›Voice commands‹.
- ▷ To have information on the operating principle of the voice activation system read out loud: ›General information on voice control‹.
- ▷ To have help for the current menu read out loud: ›Help‹.

Information for Emergency Requests

Do not use the voice activation system to initiate an Emergency Request. In stressful situations, the voice and vocal pitch can change. This can unnecessarily delay the establishment of a phone connection.

Instead, use the SOS button, refer to page [393](#), close to the interior mirror.

Adjusting

Setting the language

The language to be used for voice activation and system announcements can be set.

Via iDrive:

1. "CAR"
2. "Settings"
3. "General settings"
4. "Language"
5. "System language"
6. Select the desired language.

Setting the voice dialog

You can set the system to use standard dialog or a short version.

The short version of the voice dialog plays back short messages in abbreviated form.

Via iDrive:

1. "CAR"
2. "Settings"
3. "General settings"
4. "Language"
5. "Response length"
6. Select the desired setting.

Speaking during voice output

It is possible to answer during inquiries of the voice activation system. The function can be deactivated if inquiries are often undesirably interrupted, for instance due to background noise or talking.

Via iDrive:

1. "CAR"
2. "Settings"
3. "General settings"
4. "Language"
5. "Speaking during voice output"

Online speech processing

Online speech processing provides a dictation function, a natural method of entering destinations and improves the quality of voice recognition. To use the functions, data is transmitted to a service provider via an encrypted connection and stored locally there.

Via iDrive:

1. "CAR"
2. "Settings"
3. "General settings"
4. "Language"
5. "Online speech processing"

Adjusting the volume

Turn the volume button during the spoken instructions until the desired volume is set.

- ▶ The volume remains constant even if the volume of other audio sources is changed.
- ▶ The volume is stored for the driver profile currently used.



System limits

- ▶ Certain noises can be detected and may lead to problems. Keep the doors, windows, and glass sunroof closed.
- ▶ Noises from the front passenger or the rear seat bench can impair the system. Avoid making other noise in the vehicle while speaking.
- ▶ Major language dialects can cause problems with the voice recognition feature. Speak loud and clear.

Using the voice activation system of the smartphone

A smartphone connected to the vehicle can be used via voice activation.

Activate voice command response on the smartphone for this purpose.

1.  Press and hold the button on the steering wheel for approx. 3 seconds.
Voice command response is activated on the smartphone.
2.  Release the button.
If activation is successful, a confirmation appears on the Control Display.

If it was not possible to activate voice command response, the list of Bluetooth devices appears on the Control Display.

Amazon Alexa Car Integration

Concept

Alexa is a digital assistant by Amazon. With Amazon Alexa Car Integration, Alexa can be used in the vehicle.

General information

Some of the Alexa functions are limited in the vehicle to prevent any impairment of safety while driving.

Functional requirements

- ▶ Amazon Alexa Car Integration purchased via ConnectedDrive Store.
- ▶ The ConnectedDrive account in the vehicle is the same as in the BMW Connected app.
- ▶ The vehicle is connected in the BMW Connected app.
- ▶ Amazon account and BMW account are connected in the BMW Connected app.
- ▶ The Bluetooth connection or USB connection between the vehicle and the mobile device is active.

Activation in the BMW Connected app

The Amazon Alexa Car Integration is activated in the BMW Connected app.

Follow the instructions in the app.

Activation in the vehicle

An authorization for the use of Amazon Alexa Car Integration is required every time before starting a trip.

1. Authorizing Amazon Alexa Car Integration:
 - ▷ Pair mobile device with the vehicle via Bluetooth.
 - ▷ Select driver profile, refer to page 66.
2. Say activation word ›Alexa‹ and desired command.

Information about the active function is displayed on the Control Display.

Malfunction

In case of a malfunction, switch off the engine and start the engine again.

BMW Intelligent Personal Assistant

Concept

BMW Intelligent Personal Assistant is the personal assistant that expands the voice activation function to include additional functions that improve interaction in the vehicle.

General information

BMW Intelligent Personal Assistant is available depending on the national-market version. The use of the personal assistant is based on voice operation. The voice operation is enhanced with personal recommendations and messages as well as the automation of routines.

The personal assistant is connected to other digital services such as the Concierge service and is continually being developed. The full scope requires an active driver profile.

The BMW Intelligent Personal Assistant is available in two variants:

- ▷ In the Guest profile: the variant is linked to a vehicle and cannot be personalized. Not all described functions are available to the full extent.
- ▷ With active Driver profile: the variant can be used and personalized in different vehicles. All described functions are available to the full extent.

Functional requirement

Activate the following settings to access the full range of functions:

- ▷ The Driver profile is activated.
- ▷ The ConnectedDrive Service has been requested at a service partner or was purchased via the ConnectedDrive Store.
- ▷ Registered in the ConnectedDrive Store.
- ▷ "Online speech processing" is activated.
- ▷ "Synchronize driver profile" under "Personalization" in the data protection menu is activated.
- ▷ All settings under "BMW ConnectedDrive" in the data protection menu are activated.

Example for function

1. Say the wake word ›Hello BMW‹ or a personal wake word.
2. ›Is my engine oil level still OK?‹

The personal assistant provides information about the engine oil level.

Adjusting

Situational adaptation

General information

Depending on the situation, different conditions can be activated.

Condition	Description
"Do not disturb"	Incoming calls and some messages are not displayed.
"Deactivate learning"	Routines are no longer learned.
"Passenger on board"	Personalized variant only: private contents, e.g., e-mails, are not displayed.

Activating/deactivating

1. "APPS"
2. "Installed apps"
3. "Personal assistant"
4. "Situational adjustment"
5. Select the desired setting.

Automating routines

General information

The personal assistant can learn routines, e.g., the automatic activation of the heated steering wheel from a specific external temperature. Rules are created for this purpose, which can be activated and deactivated at any time.

Creating a rule

1. "APPS"
2. "Installed apps"
3. "Personal assistant"
4. "Automate habits"
5. Select the desired setting.

Functions

Experience Modes

General information

The Experience Modes combine different vehicle functions in the car's interior. For example, the selection of a mode harmonizes the ambient light and seat climate control.

Selecting a mode

1. "CAR"
2. "Experience Modes"
3. Select the desired mode.

Deactivating

1. "CAR"
2. "Experience Modes"
3. "END MODE"

Adjusting the mode

1. "CAR"
2. "Experience Modes"
3. Select the desired mode.
4. "SETTINGS"
5. Make the desired setting.

Caring Car

General information

Different vehicle functions in the car's interior are harmonized in a short-term program. A program takes 3 minutes.

Activating/deactivating

1. "CAR"
2. "Caring Car"
3. Select the desired channel.

The program can be stopped prematurely: "End program"

Connected Command

General information

Connected Command enables passengers to control different functions in the vehicle via smartphone and the BMW Connected App and receive information about the trip.

Functional requirements

- ▷ The smartphone is connected to the vehicle via Bluetooth and WiFi.
- ▷ The Connected app is installed on the smartphone.

Managing rights

1. "COM"
2. "Mobile devices"
3. Select the desired setting for the respective device.

Owner's Manual via voice operation

Concept

You can ask simple questions about vehicle functions and the operation of the vehicle.

General information

The voice control system and the feedback it provides are not a substitute for the printed or Integrated Owner's Manual. The voice recognition and quality of the feedback may vary.

The system supports questions that begin with How or What.

Example for function

1.  Press the button on the steering wheel.
2. ›How can the passenger airbag be deactivated?‹

The voice activation system returns a feedback. When stationary, the section of the integrated

Owner's Manual is displayed on the Control Display.

BMW Gesture Control

Concept

Several iDrive functions can be operated by hand motion using BMW Gesture Control.

Overview

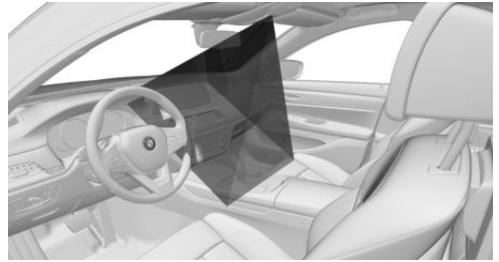

The camera in the roofliner detects gestures that are carried out in the area of the center console at the height of the Control Display.

Activating/deactivating

Via iDrive:

1. "CAR"
2. "Settings"
3. "General settings"
4. "Gesture control"
5. "Gesture control"

Adjusting

Via iDrive:





1. "CAR"
2. "Settings"
3. "General settings"
4. "Gesture control"
5. Select the desired setting:

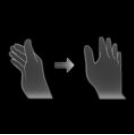

- ▷ "User help display": the possible gesture is shown on the Control Display.
 - ▷ "Audio confirmation": an acoustic signal is emitted once the gesture is recognized.
- Execute gestures clearly.
The gestures can also be executed from the front-passenger side.

Carrying out gestures

Perform gestures underneath the interior mirror and next to the steering wheel.

Possible gestures

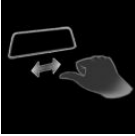
Gesture	Operation	Function
	Move index finger forward and backward in the direction of the screen.	Accept call. Select a highlighted entry in a list during voice activation. Confirm pop-up.
	Move hand across the width of the Control Display in the direction of the front-passenger side.	Reject call. Close pop-up. Terminate voice activation.
	Slowly move hand clockwise in a circular pattern with the index finger stretched out forward. Gesture is detected after one circular motion.	The volume is increased.
	Slowly move hand counterclockwise with the index finger stretched out forward. Gesture is detected after one circular motion.	The volume is reduced.
	Pinch with thumb and index finger and move hand horizontally to the right or left.	Surround View: turn camera view. This gesture can only be executed while the vehicle is stationary.

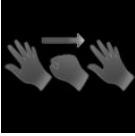
Gesture	Operation	Function
	Move stretched out index and middle finger forward.	Individually assignable gesture. Possible functions: Mute. Control Display on/off Voice command response.
	Move fist with thumb extended to the left back and forth.	Reverse Skip function. The previous music track is played.
	Move fist with thumb extended to right left back and forth.	Forward Skip function. The next music track is played.
	Stretch out five fingers, form a fist and stretch five fingers out again.	Individually assignable gesture. Possible functions: Destination guidance to home address. Notifications. Last calls.

Assigning gesture individually

Via iDrive:

1. "CAR"
2. "Settings"
3. "General settings"
4. "Gesture control"
5. "Function assignment gesture 1" or "Function assignment gesture 2"
6. Select the desired setting.

- ▶ The camera lens is dirty. Clean the camera lenses, refer to page 401.
- ▶ The gesture is executed outside of the detection range.
- ▶ Wearing of gloves or jewelry.
- ▶ Smoking in the car's interior.

System limits

Gesture recognition by the camera in the roof-liner can be disturbed by the following circumstances:

- ▶ The camera lens is covered.
- ▶ Objects are located on the interior mirror.

BMW Remote Software Upgrade

Vehicle features and options

This chapter describes all standard, country-specific and optional features offered with the series. It also describes features and functions that are not necessarily available in your vehicle, e.g., due to the selected options or country versions. This also applies to safety-related functions and systems. When using these functions and systems, the applicable laws and regulations must be observed.

BMW Remote Software Upgrade

Concept

Remote Software Upgrade can be used to update the software of the vehicle. Remote Software Upgrade makes new functions, functional enhancements or quality improvements available.

General information

BMW recommends performing the Remote Software Upgrade as soon as it becomes available.

The available data for Remote Software Upgrade is automatically loaded into the vehicle.

For reasons of safety, the loaded upgrade can only be installed when the vehicle is stationary. The installation is not installed until it was confirmed on the vehicle.

- ▶ The installation may take around 20 minutes.
- ▶ The installation cannot be terminated.
- ▶ The vehicle cannot be used during the installation.

- ▶ The vehicle can be exited during the installation.

Validity of the Owner's Manual

Production of the vehicle

At the time of production at the plant, the printed Owner's Manual is the most current resource.

After a software update in the vehicle

After a vehicle software update – such as, a Remote Software Upgrade – the Integrated Owner's Manual for the vehicle will contain the latest information.

Functional requirement

The use of the Remote Software Upgrade requires an active ConnectedDrive contract.

Information about the version

General information

The information about the version contains a description of the updates that are included in the Remote Software Upgrade. During the download and after the installation has been completed successfully, the information about the version can be displayed on the Control Display. The information is available in the ConnectedDrive customer portal at any time.

Logging on to the ConnectedDrive customer portal on the Internet under: www.bmw-connecteddrive.com.

Displaying information about the version

Via iDrive:

1. "CAR"
2. "Settings"
3. "General settings"
4. "Remote Software Upgrade"
5. "Installed version:"

Safety information

Warning

Unattended children or animals in the vehicle can cause the vehicle to move and endanger themselves and traffic, for instance due to the following actions:

- ▷ Pressing the Start/Stop button.
- ▷ Releasing the parking brake.
- ▷ Opening and closing the doors or windows.
- ▷ Engaging selector lever position N.
- ▷ Using vehicle equipment.

There is a risk of accidents or injuries. Do not leave children or animals unattended in the vehicle. Take the vehicle key with you when exiting and lock the vehicle.

Search for and download of an upgrade

General information

There are various options to search for and download an upgrade:

- ▷ Automatic.
- ▷ Via iDrive.
- ▷ Via BMW Connected app.

Automatic download

The available data for Remote Software Upgrade is automatically loaded into the vehicle. The download does not require an approval.

Via iDrive

1. "CAR"
2. "Settings"
3. "General settings"
4. "Remote Software Upgrade"
5. "Search for upgrades"
6. Follow the instructions on the Control Display.

Via BMW Connected app

1. Download the available upgrade to the smartphone in the BMW Connected app.
2. Follow the instructions in the BMW Connected app.
3. Establish a simultaneous WiFi and Bluetooth connection between the smartphone and the vehicle.

The data transfer of the upgrade from the smartphone to the vehicle occurs only while driving.

4. Follow the instructions on the Control Display.

Install the upgrade

General information

After successful download completion, installation is offered once the vehicle is parked. The installation can be carried out immediately following the download or at a later time.

Follow the instructions on the Control Display.

After the successful completion of the upgrade, booked services, for example RTTI, will be reactivated automatically while driving.

Functional requirements

- ▷ The battery is sufficiently charged.
- ▷ The external temperature is above 14 °F/-10 °C.
- ▷ Vehicle is parked in a horizontal position.
- ▷ Hazard warning system is switched off.
- ▷ Selector lever position P is engaged.
- ▷ Engine is sufficiently cooled down.
- ▷ Automatic engine start for stationary climate control is not activated via iDrive.

Preparing the vehicle

- ▷ Park the vehicle safely away from the public road.
- ▷ Cellular network reception must be ensured so that an error message can be sent, for instance if the installation is terminated.
- ▷ Close the windows.
- ▷ Close the glass sunroof.
- ▷ Close the tailgate.
- ▷ Remove energy consuming devices, such as a mobile phone.
- ▷ Unhitch any trailer or load carrier.
- ▷ The vehicle key is in the vehicle at the start of the installation.
- ▷ Switch off the exterior lighting.

Additional vehicle related functional requirements are shown on the Control Display.

Install the upgrade later

Via iDrive:

1. "CAR"
2. "Settings"
3. "General settings"
4. "Remote Software Upgrade"
5. "Start upgrade now"

Follow the instructions on the Control Display.

Functional limitations

During the upgrade, the majority of functions is temporarily unavailable, for instance:

- ▷ Hazard warning system.
- ▷ Central locking system.
- ▷ Parking lights.
- ▷ Horn.
- ▷ Alarm system.
- ▷ Emergency Request.
- ▷ Power windows.
- ▷ Glass sunroof.
- ▷ Checking the fuel filler flap lock.

The driver's door can be locked and unlocked from the outside using the integrated key.

Malfunction

In the event of a malfunction, follow the instructions on the Control Display or in the BMW Connected app.

If the malfunction cannot be remedied, contact a dealer's service center or another qualified service center or repair shop.

General settings

Vehicle features and options

This chapter describes all standard, country-specific and optional features offered with the series. It also describes features and functions that are not necessarily available in your vehicle, e.g., due to the selected options or country versions. This also applies to safety-related functions and systems. When using these functions and systems, the applicable laws and regulations must be observed.

Messages

Concept

The menu centrally displays all messages arriving in the vehicle in list form.

General information

The following messages can be displayed:

- ▷ Traffic messages.
- ▷ Check Control messages.
- ▷ Messages on service notifications.
- ▷ Communication messages, for example e-mails, SMS text messages or reminders.
- ▷ Messages from, e.g., the Concierge service or the BMW Connected app.
- ▷ Messages from the vehicle manufacturer.

The number of messages is additionally displayed in the status field.

The Messages menu can also be created as Widget.

Retrieving messages

Via iDrive:

1. Tip the Controller up.
2. "Notifications"
3. Select the desired message.

Deleting messages

All messages, except Check Control messages or messages from the vehicle manufacturer, can be deleted from the list.

Check Control messages or messages from the vehicle manufacturer are displayed as long as they are relevant.

Via iDrive:

1. Tip the Controller up.
2. "Notifications"
3. Select desired message, for instance. SMS.
4.  Press the button.
5. ▷ "Delete this notification"
▷ "Delete all notifications"

Adjusting

The following settings can be adjusted:

- ▷ Select the applications, from which messages will be permitted.
- ▷ All messages or a limited time period for received messages.

Via iDrive:

1. Tip the Controller up.
2. "Notifications"
3. Move the Controller to the right.
4. "Settings"
5. Select the desired setting.

Time

Setting the time zone

Via iDrive:

1. "CAR"
2. "Settings"
3. "General settings"
4. "Date and time"
5. "Time zone:"
6. Select the desired setting.

The setting is stored for the driver profile currently used.

Setting the time

Via iDrive:

1. "CAR"
2. "Settings"
3. "General settings"
4. "Date and time"
5. "Time:"
6. Turn the Controller until the desired hours are displayed.
7. Press the Controller.
8. Turn the Controller until the desired minutes are displayed.
9. "OK"

Setting the time format

Via iDrive:

1. "CAR"
2. "Settings"
3. "General settings"
4. "Date and time"
5. "Time format:"
6. Select the desired setting.

The setting is stored for the driver profile currently used.

Automatic time setting

Depending on your vehicle's optional features, the time, date and, if needed, the time zone are updated automatically.

Via iDrive:

1. "CAR"
2. "Settings"
3. "General settings"
4. "Date and time"
5. "Automatic time setting"

The setting is stored for the driver profile currently used.

Date

Setting the date

Via iDrive:

1. "CAR"
2. "Settings"
3. "General settings"
4. "Date and time"
5. "Date:"
6. Turn the Controller until the desired day is displayed.
7. Press the Controller.
8. Make the settings for the month and year.
9. "OK"

Setting the date format

Via iDrive:

1. "CAR"
2. "Settings"
3. "General settings"
4. "Date and time"
5. "Date format:"
6. Select the desired setting.

The setting is stored for the driver profile currently used.

Language

Setting the language

Via iDrive:

1. "CAR"
2. "Settings"
3. "General settings"
4. "Language:"
5. "System language"
6. Select the desired setting.

The setting is stored for the driver profile currently used.

Setting the voice dialog

For voice dialog for the voice activation system, refer to page [50](#).

Setting the units of measurement

Depending on the country version, you can set the units of measurement for some values, for instance consumption, distances, and temperature.

Via iDrive:

1. "CAR"
2. "Settings"
3. "General settings"
4. "Units"
5. Select the desired menu item.
6. Select the desired setting.

The setting is stored for the driver profile currently used.

Trip data settings

Concept

The intervals in which the trip data will be reset can be configured.

Resetting trip data

Via iDrive:

1. "CAR"
2. "Settings"
3. "General settings"
4. "Reset trip data"
5. Select the desired setting.

Speed warning

Concept

A speed limit can be set that when reached will cause a warning to be issued.

General information

The warning is repeated if the vehicle speed exceeds the set speed limit again, after it has dropped below it by 3 mph/5 km/h.

Adjusting

Via iDrive:

1. "CAR"
2. "Settings"
3. "General settings"
4. "Speed warning"
5. "Warning at:"
6. Turn the Controller until the desired speed is displayed.
7. Press the Controller.

Activating/deactivating

Via iDrive:

1. "CAR"
2. "Settings"
3. "General settings"
4. "Speed warning"
5. "Speed warning"

Setting your current speed as the speed warning

Via iDrive:

1. "CAR"
2. "Settings"
3. "General settings"
4. "Speed warning"
5. "Select current speed"

Driver Attention Camera

Concept

A camera that monitors driver activity is located in the instrument cluster. The camera evaluates the head position and eye opening and uses the data to analyze the attention of the driver. This system supports various vehicle assistance systems, e.g.:

- ▶ Fatigue alert.
- ▶ Steering and traffic jam assistant with Extended Traffic Jam Assistant.

Activating/deactivating

Via iDrive:

1. "CAR"
2. "Settings"
3. "General settings"
4. "Driver Attention Camera"
5. Select the desired setting.

System limits

The Driver Attention Camera may not be fully functional in the following situations:

- ▶ When the Driver Attention Camera is covered by the steering wheel rim.
- ▶ When the driver is wearing infrared impermeable sunglasses.

Activating/deactivating popup windows

For some functions, popup windows are displayed automatically on the Control Display. Some of these popup windows can be activated or deactivated.

Via iDrive:

1. "CAR"
2. "Settings"
3. "General settings"
4. "Pop-ups"
5. Select the desired setting.

The setting is stored for the driver profile currently used.

Activating/deactivating the display of the current vehicle position

Concept

If vehicle tracking has been activated, the current vehicle position can be displayed in the BMW Connected app or in the ConnectedDrive customer portal.

Activating/deactivating

Via iDrive:

1. "CAR"
2. "Settings"

3. "General settings"
4. "Data privacy"
5. "Configure services"
6. Select the desired setting.

these settings will remain in the ConnectedDrive account.

Control Display

Brightness

Via iDrive:

1. "CAR"
2. "Settings"
3. "Displays"
4. "Control display"
5. "Brightness at night"
6. Press the Controller.
7. Turn the Controller until the desired brightness is set.
8. Press the Controller.

The setting is stored for the driver profile currently used.

Depending on the light conditions, the brightness settings may not be clearly visible.

Resetting the vehicle configuration

All individual settings can be reset to the factory settings when the drive-ready state is switched off.

Via iDrive:

1. "CAR"
2. "Settings"
3. "General settings"
4. "Reset vehicle data"
5. "Reset vehicle data"

When the stored settings in a driver profile are synchronized with the ConnectedDrive account,

Personal settings

Vehicle features and options

This chapter describes all standard, country-specific and optional features offered with the series. It also describes features and functions that are not necessarily available in your vehicle, e.g., due to the selected options or country versions. This also applies to safety-related functions and systems. When using these functions and systems, the applicable laws and regulations must be observed.

Data protection

Data transfer

Concept

The vehicle offers different services, whose use requires a data transfer to BMW or a service provider. The data transfer can be deactivated for some services.

General information

When the data transfer is deactivated, the respective service cannot be used.

Only make these settings while stationary.

Adjusting

The data transfer can be configured in different stages or individually for separate services.

Via iDrive:

1. "CAR"
2. "Settings"
3. "General settings"
4. "Data privacy"
5. Select the desired setting.

Deleting personal data in the vehicle

Concept

Depending on the usage, the vehicle stores personal data, such as stored radio stations. This personal data can be permanently deleted using iDrive.

General information

Depending on the equipment package, the following data can be deleted:

- ▷ Driver profile settings.
- ▷ Stored radio stations.
- ▷ Stored programmable memory buttons.
- ▷ Travel and Onboard Computer information.
- ▷ Music hard disk.
- ▷ Navigation, for instance stored destinations.
- ▷ Phone book.
- ▷ Online data, for instance Favorites, cookies.
- ▷ Office data, for instance voice notes.
- ▷ Login accounts.

Altogether, the deletion of the data can take up to 15 minutes.

Functional requirement

Data can only be deleted while stationary.

Deleting data

The personal data in the vehicle will be deleted when the vehicle is reset to the factory settings. For resetting the vehicle to factory settings, refer to page 64.

Driver profiles

Concept

Driver profiles can be created to store personal vehicle settings. If the vehicle is used by multiple drivers, each driver can create his personal driver profile. When a driver profile is selected, the vehicle will automatically apply the stored settings in the driver profile.

General information

Three personal driver profiles can be created.

In addition, a guest profile is available that can be selected by any driver. The guest profile is active when a personal driver profile has not been selected.

Changes to the vehicle settings are automatically stored in the active driver profile or in the guest profile.

The recognition via vehicle key and a digital key can be assigned to a driver profile so that the vehicle will apply the settings as soon as the driver unlocks the car. As soon as the vehicle detects the vehicle key or the digital key, the corresponding driver profile will be activated.

ConnectedDrive countries: The settings stored in the driver's profile can be synchronized with the personal BMW ConnectedDrive account. It is thereby possible to use these settings in other BMW vehicles as well.

Functional requirements

When switching the driver profile, the vehicle must move at a maximum of walking speed.

Welcome screen

After the Control Display is switched on, the Welcome screen will be displayed.

The following actions can be carried out on the Welcome screen:

- ▷ Switching the driver profile.
- ▷ Starting the set-up assistant.

This option is offered in new vehicle for a limited period of time.

As soon as the engine is started or any button is pressed, the Welcome screen will be hidden.

Setup assistant

The setup assistant is offered in new vehicles for a limited period of time on the Welcome screen to configure the most important settings for the vehicle.

"Getting started" Select to start the set-up assistant.

The set-up assistant can be started via iDrive at any time.

1. "CAR"
2. "Settings"
3. "General settings"
4. "Getting started"

The driver is guided step by step through the following functions:

- ▷ Setting the system language.
- ▷ ConnectedDrive countries:
 - If the set-up assistant was opened in the guest profile: create driver profile.
- ▷ Pairing mobile devices with the vehicle.
- ▷ If the set-up assistant was opened from an already defined driver profile: set up personal assistant.
- ▷ Depending on whether the set-up assistant was opened from an already defined driver profile or a guest profile: set up services or confirm the explanation for the transmission of vehicle related data.
- ▷ Set up other methods for use.

The selected settings are stored in the active driver's profile.

Guest profile

The guest profile can be activated by any driver. Vehicle settings that are entered when the guest profile is active will be stored in the guest profile.

In the following cases the guest profile is automatically active:

- ▷ A driver profile has not been created yet.
- ▷ No driver profile has been assigned to the vehicle key that was used to unlock the vehicle.
- ▷ No driver profile has been assigned to the digital key that was used to unlock the vehicle.

The following limitations apply:

- ▷ The guest profile cannot be renamed.
- ▷ It is not possible to assign the recognition to the guest profile.
- ▷ It is not possible to assign a PIN to the guest profile.
- ▷ ConnectedDrive countries: It is not possible to synchronize with a ConnectedDrive account.

The guest profile is selected on the Welcome screen or via iDrive:

1. "CAR"
2. "Driver profiles"
3. "Guest"
4. "OK"

Creating a driver profile

A driver profile is created or via iDrive:

1. "CAR"
2. "Driver profiles"
3. Move the Controller to the right.

As an alternative for Steps 1 to 3, the profile image can be tapped in the top status bar.

4. "Add driver profile"

ConnectedDrive countries: An existing ConnectedDrive account must be assigned to a driver profile. If a ConnectedDrive account has not yet been created, the account can be created via a smartphone. A QR code will be displayed on the Control Display for this purpose. The creation of

the driver profile can continue with the access data of the created ConnectedDrive account.

Selecting recognition

The settings for the recognition are entered via iDrive:

1. "CAR"
2. "Driver profiles"
3. Move the Controller to the right.

As an alternative for Steps 1 to 3, the profile image can be tapped in the top status bar.

4. "Driver recognition"
5. Select the desired setting:
 - ▷ "with vehicle key"

The vehicle key that is recognized in the car's interior is assigned to the driver profile. If multiple vehicle keys are detected, the unintended vehicle keys must be removed from the car's interior.

- ▷ "With Digital Key"

The digital key that is recognized in the car's interior is assigned to the driver profile. If multiple digital keys are detected, the unintended digital keys must be removed from the car's interior.

6. "Activate linkage"

As soon as the vehicle detects the vehicle key or the digital key, the corresponding driver profile will be activated. If the vehicle key or the smartphone with the digital key is not carried with you or the vehicle key or digital key is not recognized, the driver profile can only be selected on the Welcome screen when a PIN has been set up.

Setting up a PIN

A driver profile with recognition cannot be activated without vehicle key and without digital key. In this case, a PIN can be set up to activate the driver profile.

Non-ConnectedDrive countries: If a PIN was not set up or the PIN is not known, the driver's profile cannot be activated.

ConnectedDrive countries: If a PIN was not set up or the PIN is not known, the driver's profile can be activated with the access data of the corresponding ConnectedDrive account.

Via iDrive:

1. "CAR"
2. "Driver profiles"
3. Move the Controller to the right.
As an alternative for Steps 1 to 3, the profile image can be tapped in the top status bar.
4. "Driver recognition"
5. "using PIN"

Changing/canceling the recognition function

When another vehicle key or another digital key is assigned to a driver profile, the current assignment must be canceled first.

Via iDrive:

1. "CAR"
2. "Driver profiles"
3. Move the Controller to the right.
As an alternative for Steps 1 to 3, the profile image can be tapped in the top status bar.
4. "Driver recognition"
5. "with vehicle key"
or
"With Digital Key"
6. "Activate linkage"

When the vehicle and vehicle key will be handed over, such as for maintenance, carry out the following steps first:

- ▶ Setting up PIN.
- ▶ Canceling recognition using the vehicle key.
- ▶ Switching to the guest profile.

The handed over vehicle key can then no longer be used to access the personal driver profile.

Selecting a driver profile

Depending on the recognition setting, the driver profile will be selected automatically.

If the guest profile is active, the driver profile will be selected on the Welcome screen or via iDrive: A PIN may have to be entered.

1. "CAR"
2. "Driver profiles"
As an alternative for Steps 1 and 2, the profile image can be tapped in the top status bar.
3. Select driver profile.
4. "OK"

All settings stored in the selected driver profile are automatically applied.

Switching synchronization with the ConnectedDrive account on/off

ConnectedDrive countries:

The settings stored in the driver's profile are synchronized with the personal ConnectedDrive account. This means that it is possible to use the personal settings in other BMW vehicles with ConnectedDrive access as well, if this function is supported.

The synchronization with the ConnectedDrive account is enabled when a driver profile is created or via iDrive:

1. "CAR"
2. "Driver profiles"
3. Move the Controller to the right.
As an alternative for Steps 1 to 3, the profile image can be tapped in the top status bar.
4. "Settings"
5. "Synchronize driver profile"
6. "Synchronize driver profile"

Renaming a driver profile

Countries in which ConnectedDrive is not available:

The name that was assigned when the driver profile was set up can be changed via iDrive:

1. "CAR"
2. "Driver profiles"
 - As an alternative for Steps 1 and 2, the profile image can be tapped in the top status bar.
3. Select driver profile.
4. "Settings"
5. Enter a profile name.
6. **OK** Select the symbol.

Selecting a profile picture

Countries in which ConnectedDrive is available:

The profile image is transferred from the ConnectedDrive customer portal or the BMW Connected app.

Countries in which ConnectedDrive is not available:

Via iDrive:

1. "CAR"
2. "Driver profiles"
3. Move the Controller to the right.
 - As an alternative for Steps 1 to 3, the profile image can be tapped in the top status bar.
4. "Avatar"
5. Select the desired profile picture.

Deleting the driver profile

Via iDrive:

1. "CAR"
2. "Driver profiles"
3. Move the Controller to the right.
 - As an alternative for Steps 1 to 3, the profile image can be tapped in the top status bar.
4. "Settings"
5. "Remove driver profile"
6. Select the desired driver profile.
7. "Delete now"

ConnectedDrive countries: If the driver profile was synchronized with a ConnectedDrive account, the stored data in the ConnectedDrive account will be retained.

System limits

A clear detection of the desired vehicle key may not be possible in the following cases, e.g.:

- ▶ The driver unlocks the vehicle via Comfort Access.
- ▶ The driver changes, but the vehicle is not locked and unlocked.
- ▶ When multiple vehicle keys are located outside on the driver's side of the vehicle.

ConnectedDrive countries:

A driver profile can only be created and synchronized with the ConnectedDrive account when cellular network reception is available.

The use of personal settings that are stored in the ConnectedDrive account in other vehicles is subject to technical limitations. For example, settings may be stored for a system that is not available, or available in a non-compatible version, in other vehicles.

Connections

Vehicle features and options

This chapter describes all standard, country-specific and optional features offered with the series. It also describes features and functions that are not necessarily available in your vehicle, e.g., due to the selected options or country versions. This also applies to safety-related functions and systems. When using these functions and systems, the applicable laws and regulations must be observed.

Connecting mobile devices to the vehicle

Concept

Various connection types are available for using mobile devices in the vehicle. The connection type to select depends on the mobile device and the desired function.

General information

The following overview shows possible functions and the suitable connection types for them. The scope of functions depends on the mobile device.

Function	Connection type
Making calls via the hands-free system.	Bluetooth.
Using phone functions via iDrive or touchscreen.	
Other functions, e.g. Contacts or SMS.	
Playing music from the smartphone or the audio player.	Bluetooth or USB.

Function	Connection type
USB storage device:	USB.
Playing music.	
Playing videos from the smartphone or the USB storage device.	USB.
Using the vehicle Internet access.	WiFi hotspot via WiFi.
Using Apple CarPlay apps via iDrive and voice operation.	Bluetooth and WiFi.
Screen Mirroring:	WiFi.
Showing the smartphone display on the Control Display.	

The following connection types require one-time pairing with the vehicle:

- ▷ Bluetooth.
- ▷ WiFi hotspot.
- ▷ Apple CarPlay.
- ▷ Screen Mirroring.

Paired devices are automatically recognized later on and connected to the vehicle.

Safety information

Warning

Operating the integrated information systems and communication devices while driving can distract from traffic. It is possible to lose control of the vehicle. There is a risk of accident. Only use the systems or devices when the traffic situation allows. As warranted, stop and use the systems and devices while the vehicle is stationary.

Compatible devices

General information

Information on mobile devices compatible with the vehicle can be found at www.bmwusa.com/bluetooth.

Malfunctions may occur with devices not listed or deviating software versions.

Displaying the vehicle identification number and software part number

When looking for compatible devices, you may have to state the vehicle identification number and the software part number. These numbers can be displayed in the vehicle.

Via iDrive:

1. "COM"
2. "Mobile devices"
3. Move the Controller to the right.
4. "Settings"
5. "Bluetooth@ info"
6. "System information"

Bluetooth connection

Functional requirements

- ▶ Compatible device, refer to page 71, with Bluetooth interface.
- ▶ The vehicle key or BMW display key is in the vehicle.
- ▶ The device is ready for operation.
- ▶ Bluetooth is switched on in the vehicle and on the device.
- ▶ The pairing readiness is displayed on the Control Display.
- ▶ Bluetooth presets, such as visibility, may be required on the device; refer to the owner's manual of the device.

Switching on Bluetooth

Via iDrive:

1. "COM"
2. "Mobile devices"
3. Move the Controller to the right.
4. "Settings"
5. "Bluetooth@"
6. Select setting.

Activating/deactivating telephone functions

To use all supported functions of a mobile phone, activate the desired functions in the vehicle prior to pairing the mobile phone with the vehicle as needed.

Via iDrive:

1. "COM"
2. "Personalize menu"
3. Select the desired settings, for instance "Text messages".

Pairing the mobile device with the vehicle

Via iDrive:

1. "COM"
2. "Mobile devices"
3. Move the Controller to the right.
4. "New device"
5. "Phone calls and audio"
The vehicle's Bluetooth name is displayed on the Control Display.
6. On the mobile device, search for Bluetooth devices in the vicinity and select the vehicle.
A control number is displayed.
7. Compare the control number displayed on the Control Display with the control number

on the display of the mobile device, and confirm that the two match.

8. Select Bluetooth connection if necessary: "Use BMW iDrive for phone calls, Bluetooth® audio, and apps."

The mobile device is connected to the vehicle and displayed in the device list.

Frequently Asked Questions

All requirements are met and all required steps were completed in the specified order. Despite that, the mobile device does not function as expected.

In this case, the following explanations can help:

Why could the mobile phone not be paired or connected?

- ▷ There are too many Bluetooth devices connected to the mobile phone or vehicle.

In the vehicle, delete Bluetooth connections with other devices.

Delete the Bluetooth connection from the device list on the mobile phone and start a new device search.

Too many Bluetooth devices with the same function are paired.

- ▷ The mobile phone is in power-save mode or has only a limited remaining battery life.

Charge the mobile phone and deactivate the power-save mode where required.

Why does the mobile phone no longer react?

- ▷ The applications on the mobile phone do not function anymore.

Switch the mobile phone off and on again.

- ▷ Too high or too low ambient temperature for mobile phone operation.

Do not subject the mobile phone to extreme ambient temperatures.

Why can phone functions not be used via iDrive?

- ▷ Phone functions are not configured for the mobile phone.

Connect the mobile phone with the telephone function.

Why are no or not all phone book entries displayed or why are they incomplete?

- ▷ Transmission of the phone book entries is not yet complete.
- ▷ It is possible that only the phone book entries of the mobile phone or the SIM card are transmitted.
- ▷ It may not be possible to display phone book entries with special characters.
- ▷ It may not be possible to transmit contacts from social networks.
- ▷ The number of phone book entries to be transmitted is too high.
- ▷ Data volume of the contact too large, for instance due to stored information such as notes.

Reduce the data volume of the contact.

- ▷ A mobile phone can only be connected as audio source or as telephone.

Configure the mobile phone and connect it with the telephone function.

- ▷ Contact was created in the contact list of the phone after the last synchronization.

Synchronize contacts again: "Reload contacts"

How can the phone connection quality be improved?

- ▷ Adjust the strength of the Bluetooth signal on the mobile phone, depending on the mobile phone.
- ▷ Insert the mobile phone into the wireless charging tray.
- ▷ Adjust the volume of the microphone separately in the sound settings.

If all points in this list have been checked and the required function is still not available, contact the hotline, a dealer's service center or another qualified service center or repair shop.

USB connection

General information

Mobile devices with a USB port are connected to the USB interface.

- ▶ Mobile phones.
- ▶ Audio devices such as MP3 players.
- ▶ USB storage devices.

Common file systems are supported. FAT32 and exFAT are the recommended formats.

A connected USB storage device will be supplied with charge current via the USB interface if the device supports this. Follow the maximum charge current of the USB interface.

The following uses are possible on USB interfaces with data transfer:

- ▶ Playing music files.
- ▶ Playing videos.

Follow the following when connecting:

- ▶ Do not use force when plugging the connector into the USB interface.
- ▶ Use a flexible adapter cable.
- ▶ Protect the USB storage device against mechanical damage.
- ▶ Due to the large number of USB storage devices available on the market, it cannot be guaranteed that every device is operable on the vehicle.
- ▶ Do not expose USB storage devices to extreme environmental conditions, such as very high temperatures; refer to the owner's manual of the device.
- ▶ Due to the many different compression techniques, proper playback of the media stored on the USB storage device cannot be guaranteed in all cases.
- ▶ To ensure proper transmission of the stored data, do not charge a USB storage device via the onboard socket, when it is connected to the USB interface.

- ▶ Depending on how the USB storage device is being used, settings may be required on the USB storage device, refer to the owner's manual of the device.

Not compatible USB media:

- ▶ USB hard drives.
- ▶ USB hubs.
- ▶ USB memory card readers with multiple slots.
- ▶ HFS-formatted USB storage devices.
- ▶ Devices such as fans or lamps.

Functional requirement

Compatible device, refer to page 71, with USB interface.

Connecting the device

Connect the USB storage device using a suitable adapter cable to a USB interface, refer to page 303.

The USB storage device is displayed in the device list.

WiFi hotspot

Concept

Compatible devices with WiFi interface can use the Internet connection of the vehicle via the WiFi hotspot.

General information

Up to 10 devices can be connected to the WiFi hotspot simultaneously.

Functional requirements

- ▶ Compatible device, refer to page 71, with activated WiFi interface.
- ▶ WiFi is activated on the vehicle.
- ▶ Internet use is activated for the vehicle.
- ▶ Registration and data contract with a service provider where required.

- ▷ Standby state is switched on.

Connecting a device to the Internet via the WiFi hotspot

Using the Internet for the first time via the WiFi hotspot requires registration and possibly a data volume purchase from a service provider.

Depending on the country version, data volume can be purchased via the connected mobile device or from the ConnectedDrive Store.

Via iDrive:

1. "COM"
2. "Mobile devices"
3. Move the Controller to the right.
4. "New device"
5. "Internet, apps"
 - Hotspot name and hotspot code are displayed on the Control Display.
6. Activate Internet usage via WiFi if necessary.
 - "Open settings"
7. Activate Internet usage.
 - "Internet connection"
8. Move the Controller to the left.
9. Search for WiFi networks on the mobile device. Select network name on the device.
10. Enter hotspot code on the device and connect.

The device is displayed in the device list.

Additionally, a QR code will be displayed on the Control Display. Alternatively, this QR code can be used to pair the mobile device with the hotspot.

All devices connected via the hotspot use this data volume.

Deactivating Internet usage via the WiFi hotspot

Internet usage may be deactivated if the data volume is used up, for instance.

Via iDrive:

1. "COM"
2. "Mobile devices"
3. Move the Controller to the right.
4. "Settings"
5. "Internet connection"
6. Select the desired setting.

Apple CarPlay preparation

Concept

CarPlay allows certain functions of a compatible Apple iPhone to be used via Siri voice operation and iDrive.

Functional requirements

- ▷ Compatible iPhone, refer to page 71.
 - iPhone 5 or later with iOS 7.1 or later.
- ▷ Corresponding mobile contract.
- ▷ Bluetooth, WiFi, and Siri voice operation are activated on the iPhone.
- ▷ Booking the ConnectedDrive service: Apple CarPlay preparation.

Switching on Bluetooth and CarPlay

Via iDrive:

1. "COM"
2. "Mobile devices"
3. Move the Controller to the right.
4. "Settings"
5. Select the following setting:
 - "Apple CarPlay"
6. Activate the function.

Pairing the iPhone with CarPlay

Via iDrive:

1. "COM"
2. "Mobile devices"
3. Move the Controller to the right.
4. "New device"
5. "Phone calls and audio"

The vehicle's Bluetooth name is displayed on the Control Display.

6. On the mobile device, search for Bluetooth devices in the vicinity and select the vehicle. A control number is displayed.

7. Compare the control number displayed on the Control Display with the control number on the display of the mobile device, and confirm that the two match.

8. Select CarPlay:

"Confirm note and connect to Apple CarPlay"

The iPhone is connected to the vehicle and displayed in the device list.

Operation

For more information, refer to the Integrated Owner's Manual or the Owner's Manual for Navigation, Entertainment, Communication.

Frequently Asked Questions

All requirements are met and all required steps were completed in the specified order. Despite that, the mobile device does not function as expected.

In this case, the following explanations can help:

The iPhone has already been paired with Apple CarPlay. When a new connection is established, CarPlay can no longer be selected.

- ▶ Delete the iPhone concerned from the device list.
- ▶ On the iPhone, delete the vehicle concerned from the list of stored connections under Bluetooth and under WiFi.

- ▶ Pair the iPhone as a new device.

If the steps listed have been carried out and the required function is still not available: contact the hotline, a dealer's service center or another qualified service center or repair shop.

Screen Mirroring

General information

Screen Mirroring enables mirroring (outputting) of the smartphone display on the Control Display.

Functional requirements

- ▶ Compatible smartphone, refer to page 71, with Screen Mirroring interface.
- ▶ Screen Mirroring is switched on on the smartphone.
- ▶ WiFi is switched on in the vehicle.

Activate WiFi in the vehicle

Via iDrive:

1. "COM"
2. "Mobile devices"
3. Move the Controller to the right.
4. "Settings"
5. "Wi-Fi@"

Pairing a smartphone with Screen Mirroring

Via iDrive:

1. "COM"
2. "Mobile devices"
3. Move the Controller to the right.
4. "New device"
5.  "Screen Mirroring"

The WiFi name of the vehicle is displayed on the Control Display.

6. Search for WiFi devices in the surroundings of the smartphone.

The WiFi name of the vehicle appears on the device display. Select the WiFi name of the vehicle.

7. Confirm the connection via iDrive.

The device is connected and displayed in the device list.

Managing mobile devices

General information

- ▷ After one-time pairing, the devices are automatically recognized and reconnected when standby state is switched on.
- ▷ After stored content on the SIM card or the mobile phone, such as contacts, has been detected, the data is transmitted to the vehicle and can be used via iDrive.
- ▷ For some devices, certain settings are necessary, for instance authorization; see the owner's manual of the device.

Displaying the device list

All devices paired with or connected to the vehicle are displayed in the device list.





A maximum of 4 devices can be connected to the vehicle via Bluetooth, and a maximum of 10 devices can be connected to the vehicle via WiFi.

A maximum of 20 devices will be detected.

Via iDrive:

1. "COM"
2. "Mobile devices"

A symbol indicates, for which function a device is used. When the icon is displayed in white, this function is actively connected to the vehicle. The icon is displayed in gray when the function of the device is inactive.

Symbol	Meaning
	Telephone.
	Bluetooth audio.
	WiFi hotspot.
	Apple CarPlay.
	Screen Mirroring.

Configuring the device

Functions can be activated or deactivated for paired and connected devices.

If a function is assigned to a device, the function will be deactivated where appropriate for a device that is already connected and the device will be disconnected. Follow the information on the Control Display.

Via iDrive:

1. "COM"
2. "Mobile devices"
3. Select the desired device.
4. Select the desired setting:

- ▷ "Disconnect device"

The device remains paired and can be connected again.

- ▷ "Connect device"

The functions that were assigned to the device before disconnecting are assigned to the device when it is reconnected. The functions may be deactivated on a device already connected.

- ▷ "Delete device"

The device is disconnected and removed from the device list.

Priority of the phones

When two mobile phones are connected to the vehicle, you can specify the priority of the mobile phones for reconnection.

Via iDrive:

1. "COM"
2. "Mobile devices"
3. Move the Controller to the right.
4. "Settings"
5. "Priorities for telephones"
6. Select the desired device.
7. Turn the controller to select the priority for the selected mobile phone.
Select the desired priority by sliding.

Opening and closing

Vehicle features and options

This chapter describes all standard, country-specific and optional features offered with the series. It also describes features and functions that are not necessarily available in your vehicle, e.g., due to the selected options or country versions. This also applies to safety-related functions and systems. When using these functions and systems, the applicable laws and regulations must be observed.

Vehicle key

General information

Depending on the equipment version, the vehicle is delivered with two vehicle keys or one vehicle key and the BMW display key.

Each vehicle key contains a replaceable battery.

Depending on the equipment and country version, various settings can be configured for the button functions.

A driver profile with personal settings can be assigned to a vehicle key.

To provide information on maintenance requirements, the service data is stored in the vehicle key.

To prevent possible locking in of the vehicle key, take the vehicle key with you when exiting the vehicle.

Safety information

Warning

People or animals in the vehicle can lock the doors from the inside and lock themselves in. In this case, the vehicle cannot be opened from the outside. There is a risk of injury. Take the vehicle key with you so that the vehicle can be opened from the outside.

Warning

For some country versions, unlocking from the inside is only possible with special knowledge. Persons who spend a lengthy time in the vehicle while being exposed to extreme temperatures are at risk of injury or death. Do not lock the vehicle from the outside when there are people in it.

Warning

Unattended children or animals in the vehicle can cause the vehicle to move and endanger themselves and traffic, for instance due to the following actions:

- ▷ Pressing the Start/Stop button.
- ▷ Releasing the parking brake.
- ▷ Opening and closing the doors or windows.
- ▷ Engaging selector lever position N.
- ▷ Using vehicle equipment.

There is a risk of accidents or injuries. Do not leave children or animals unattended in the vehicle. Take the vehicle key with you when exiting and lock the vehicle.

Overview

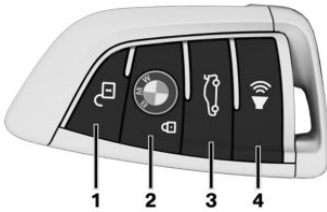

- 1 Unlocking
- 2 Locking
Stationary climate control through Remote Engine Start [290](#)
- 3 To open the tailgate
- 4 Press and hold or press three times in quick succession: panic mode
Press briefly: headlight courtesy delay feature

Unlocking

General information

The behavior of the vehicle during unlocking using the vehicle key depends on the following settings:

- ▶ If only the driver's door and the fuel filler flap or all access to the vehicle will be unlocked.
- ▶ If the unlocking of the vehicle is confirmed with a light signal or a sound signal.
- ▶ If the welcome light is switched on when the vehicle is being unlocked.

Unlocking the vehicle



Press the button on the vehicle key.

If, due to the settings, only the driver's door and fuel filler flap were unlocked, press the button on the vehicle key again to unlock the other vehicle access points.

In addition, the following functions are executed:

- ▶ If a driver profile was assigned to the vehicle key, this driver profile will be activated and the settings that are stored in it will be applied.
- ▶ The interior lights are switched on, unless they were manually switched off.
- ▶ Folded in exterior mirrors are folded out.
If the exterior mirrors were folded in via the button in the car's interior, they will not be folded out when unlocking.
- ▶ With alarm system: The alarm system will be switched off.

After opening one of the front doors, the vehicle is ready for operation.

The light functions may depend on the ambient brightness.

Convenient opening



Press and hold the button on the vehicle key after unlocking.

The windows and the glass sunroof with sun protection are opened, as long as the button on the vehicle key is pressed.

Locking

General information

The behavior of the vehicle during locking using the vehicle key depends on the following settings:

- ▶ If the locking of the vehicle is confirmed with a light signal or a sound signal.
- ▶ If the exterior mirrors are automatically folded in when the vehicle is locked. The exterior mirrors are not folded in when the hazard warning flashers are switched on.
- ▶ If the headlight courtesy delay feature is activated during locking.

Locking the vehicle

1. Close the driver's door.



2. Press the button on the vehicle key.

The following functions are executed:

- ▷ All doors, the tailgate, and the fuel filler flap are locked.
- ▷ With alarm system: The alarm system will be switched on.

If the drive-ready state is still switched on when you lock the vehicle, the vehicle horn honks twice. In this case, the drive-ready state must be switched off by means of the Start/Stop button.

With Comfort Access: convenient closing

Safety information

Warning

With convenient closing, body parts can be jammed. There is a risk of injury. Make sure that the area of movement of the doors is clear during convenient closing.

Closing

 Press and hold the button on the vehicle key in the area close to the vehicle after locking.

The windows and the glass sunroof with sun protection are closed, as long as the button on the vehicle key is pressed.

Switching on the interior and exterior lights

 Press the button on the vehicle key with the vehicle locked.

The function is not available for the first 10 seconds after locking.

- ▷ The interior lights are switched on, unless they were manually switched off. For switching the interior lights on/off manually, refer to page 176.

- ▷ Depending on the settings, the exterior lighting, refer to page 172, will be switched on.

The light functions may depend on the ambient brightness.

Tailgate

General information

To avoid locking the vehicle key in the vehicle, do not place the vehicle key in the cargo area.

The following settings are available for the operation of the tailgate with the vehicle key:

- ▷ Whether the vehicle key opens only the upper tailgate or the upper and lower tailgate at the same time.
- ▷ Determines if the doors will be unlocked when the tailgate is opened with the vehicle key.

When the trailer power socket is in use, the tailgate cannot be opened with the vehicle key.

Safety information

Warning

Body parts can be jammed when operating the tailgate. There is a risk of injury. Make sure that the area of movement of the tailgate is clear during opening and closing.

Warning

The tailgate pivots out when it opens. There is a risk of injury or risk of damage to property. Make sure that the area of movement of the tailgate is clear during opening and closing.

⚠ NOTICE

Sharp-edged or pointed objects can hit the windows and heat conductors while driving. There is a risk of damage to property. Cover the edges and ensure that pointed objects do not hit the windows.

Opening

Press and hold the button on the vehicle key for approx. 1 second.

Panic mode

You can trigger the alarm system if you find yourself in a dangerous situation.



▶ Press the button on the vehicle key and hold for at least 3 seconds.

▶ Briefly press the button on the vehicle key three times in succession.

To switch off the alarm: press any button.

Headlight courtesy delay feature on

Press and hold the button on the vehicle key for approx. 1 second.

It is possible to adjust the duration of the headlight courtesy delay feature, refer to page 172.

Replacing the battery

1. Remove the integrated key from the vehicle key, refer to page 87.
2. Place the integrated key underneath the battery compartment cover, arrow 1, and lift the

cover with a lever movement of the integrated key, arrow 2.

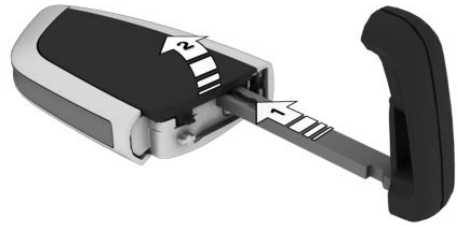

3. Push battery in the direction of the arrow using a pointed object and lift it out.

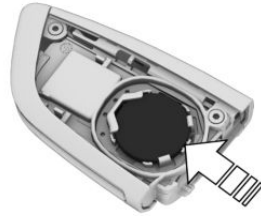

4. Insert a type CR 2032 battery with the positive side facing up.
5. Press the cover closed.
6. Push the integrated key into the vehicle key until the integrated key engages.



Have old batteries disposed of by a dealer's service center or another qualified service center or repair shop or take them to a collection point.

Additional vehicle keys

Additional vehicle keys are available from a service center or another qualified service center or repair shop.

Loss of vehicle keys

A lost vehicle key can be blocked and replaced by a dealer's service center or another qualified service center or repair shop.

If the lost vehicle key has an assigned driver profile, the connection to this vehicle key must be deleted. A new vehicle key can then be assigned to the driver profile.

Malfunƙion

General information

A Check Control message is displayed.

Vehicle key recognition by the vehicle may malfunction under the following circumstances:

- ▶ The battery of the vehicle key is discharged.
- ▶ Interference of the radio connection from transmission towers or other equipment with high transmitting power.
- ▶ Shielding of the vehicle key due to metal objects.
Do not transport the vehicle key together with metal objects.
- ▶ Interference of the radio connection from mobile phones or other electronic devices in direct proximity to the vehicle key.
Do not transport the vehicle key together with electronic devices.
- ▶ Interference of radio transmission by a charging process of mobile devices, for instance charging of a mobile phone.
- ▶ The vehicle key is in direct proximity of the wireless charging tray.
Place the vehicle key in a different location.

In the case of interference, the vehicle can be unlocked and locked from the outside with the integrated key, refer to page 87.

Switching the drive-ready state on via emergency detection of the vehicle key

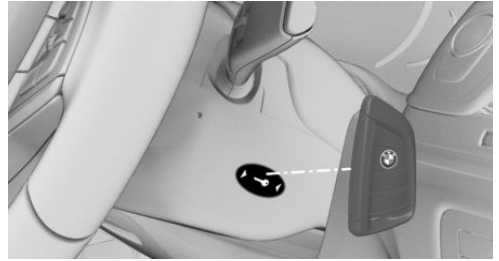

It is not possible to switch on the drive-ready state if the vehicle key has not been detected.

Proceed as follows in this case:

1. Hold the back of the vehicle key against the marked area on the steering column. Pay attention to the display in the instrument cluster.
2. If the vehicle key is detected:
Switch on drive-ready state within 10 seconds.

If the vehicle key is not recognized, slightly change the position of the vehicle key and repeat the procedure.

Frequently Asked Questions

What precautions can be taken to be able to open a vehicle with an accidentally locked in vehicle key?

- ▶ The options provided by the Remote Services of the BMW Connected app include the ability to lock and unlock a vehicle.
This requires an active BMW ConnectedDrive contract and the BMW Connected app must be installed on a smartphone.
- ▶ Unlocking the vehicle can be requested via the BMW ConnectedDrive Call Center.
An active BMW ConnectedDrive contract is required.

BMW display key

General information

The BMW display key is supplied with an additional mechanical key. If the display key is used, the mechanical key should be carried with you, for instance in the wallet. The mechanical key is used like the integrated key, refer to page 87.

The display key supports all functions of the standard vehicle key.

In addition, the following functions are also available:

- ▷ Display status of doors and windows.
- ▷ Display status of the anti-theft warning system.
- ▷ Display service information.
- ▷ Call up range with available fuel.
- ▷ With parked-car heating: operate parked-car heating.
Without parked-car heating: operate parked-car ventilation.
- ▷ Stationary climate control through Remote Engine Start
- ▷ Level setting of the vehicle when stationary.

Safety information

Warning

People or animals in the vehicle can lock the doors from the inside and lock themselves in. In this case, the vehicle cannot be opened from the outside. There is a risk of injury. Take the vehicle key with you so that the vehicle can be opened from the outside.

Warning

For some country versions, unlocking from the inside is only possible with special knowledge.

Persons who spend a lengthy time in the vehicle while being exposed to extreme temperatures are at risk of injury or death. Do not lock the vehicle from the outside when there are people in it.

Warning

Unattended children or animals in the vehicle can cause the vehicle to move and endanger themselves and traffic, for instance due to the following actions:

- ▷ Pressing the Start/Stop button.
- ▷ Releasing the parking brake.
- ▷ Opening and closing the doors or windows.
- ▷ Engaging selector lever position N.
- ▷ Using vehicle equipment.

There is a risk of accidents or injuries. Do not leave children or animals unattended in the vehicle. Take the vehicle key with you when exiting and lock the vehicle.

Overview



- 1 To open the tailgate
- 2 Unlocking
- 3 Press and hold or press three times in quick succession: panic mode
Press briefly: headlight courtesy delay feature
- 4 Locking
- 5 Display

- 6 Back
- 7 Switch the display on/off
- 8 Micro-USB charging socket

Reception range

The number of available display key functions depends on the distance from the vehicle.

- ▶ When you are in close proximity to the vehicle, all functions of the display key are available.
- ▶ The status information can be called up in the extended reception range.
 - With parked-car heating: the parked-car heating can be operated.
 - Without parked-car heating: the parked-car ventilation can be operated.
- ▶ Outside of the reception range of the vehicle, you can display the last transmitted status information from the vehicle.

 The symbol is shown on the display if one of the buttons is pressed outside of the reception range.



Display

General information

The display is divided into the upper status line, the information area, and the lower status line.

Upper status line

The upper status line displays the following information:

- ▶  /  Vehicle secured/vehicle unsecured.
- ▶ Set time in the vehicle.
- ▶  Charge state of the display key battery.

Information area

The information area can be used to access information and perform additional functions.

If the information area contains more than one page, then page indicators are shown beneath the information.

 A solid indicator denotes the current page.

Swipe to the right or left with a finger to change between the pages.

If further information is available on a page, tap the appropriate symbol.

To return to the original page:  tap on the symbol beneath the display.

Lower status line

The lower status line indicates whether or not the display key is within reception range.

- ▶ "Connected": the display key is within reception range.
- ▶ "Updated": the display key is not within reception range. It indicates when the last data transfer from the vehicle took place.

Switching on/off

The display will go out automatically after a brief period to conserve battery power.

To hide the display manually:

Press the button on the left side of the display key.

To show the display:

1. Press the button on the left side of the display key.
2. Then, swipe with your finger from bottom to top to unlock the screen lock.

To switch off the display to increase the usable battery life:





1. If necessary, cancel the screen lock.
2. Press and hold the button on the left side of the display key for longer than 4 seconds.
3. "OK"

To switch the display on:

Press the button on the left side of the display key.

Operating concept

The following information shows how to access the information and functions using the main menus.

Main menu	Information/Function
"Security information"	 /  Door status. Alarm system status. After alarm triggering: date, time, and reason for triggering the alarm.
	<hr/>  Window status. Glass sunroof status.
"Entry level"	 "Height control" Set vehicle level.
"Vehicle information"	Maintenance indicators of Condition Based Service CBS. Status of the roadside parking lights.
"Mobility info"	Range with available fuel.
"Preconditioning setting"	With parked-car heating: operate parked-car heating. Without parked-car heating: operate parked-car ventilation. Stationary climate control through Remote Engine Start.

Display key battery

General information

Follow the following information:

- ▶ If the charge state of the display key battery declines, the display is switched off automatically. The battery must be recharged so that the display can be switched back on. The operability of the standard buttons is retained until the battery is completely discharged.
- ▶ Charge the battery for at least three hours before using the display key for the first time or if the key has not been used for an extended period.
- ▶ The display key can be used while it is being charged via the USB port. If the battery is fully discharged, it may take some time before the display key can be used again.
- ▶ Due to the large number of USB chargers available on the market, it cannot be guaranteed that every charger will function properly. The charging duration depends on the charger used.
- ▶ Charging via the USB port may heat up the charger and the display key.
Charging in the wireless charging tray may heat up the tray and the display key.
At higher temperatures, the charge current through the display key may be reduced, and in isolated cases the charge process may be interrupted temporarily.
- ▶ When inserting the display key into the wireless charging tray, make sure there are no objects between it and the wireless charging tray.

Safety information

Warning

When charging a device that meets the Qi standard in the wireless charging tray, any metal objects located between the device and the tray can become very hot. Placing storage devices or electronic cards, such as chip cards, cards with magnetic strips or cards for signal transmission, between the device and the tray may impair the card function. There is a risk of injury and risk of damage to property. When

charging mobile devices, make sure there are no objects between the device and the tray.

Charging

Via USB

Connect the display key via the micro-USB charging socket to a USB port.

With thermoelectric cup holder: centered in the center console



1. Open the tray cover.
2. Place display key flush into the recess of the wireless charging tray.
Ensure that the display is facing up.
3. Close the tray cover.

Without thermoelectric cup holder: on the left in the center console



1. Open the tray cover.
2. Place the display key into the middle of the wireless charging tray in front of the left cup holder.
Ensure that the display is facing up.

3. Close the tray cover.

Malfuction

General information

A Check Control message is displayed.

BMW display key detection by the vehicle may malfunction under the following circumstances:

- ▷ The battery of the display key is discharged.
- ▷ Interference of the radio connection from transmission towers or other equipment with high transmitting power.
- ▷ Shielding of the display key due to metal objects.
- ▷ Interference of the radio connection from mobile phones or other electronic devices in direct proximity.
- ▷ Interference of radio transmission by a charging process of mobile devices, for instance charging of a mobile phone.

Do not transport the display key together with metal objects or electronic devices.

In the case of interference, the vehicle can also be unlocked and locked from the outside with the mechanical key.

Switching on drive-ready state via emergency detection of the BMW display key

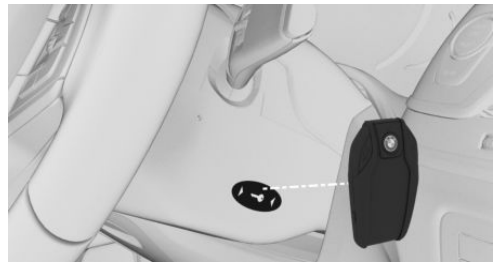

It is not possible to switch on the drive-ready state if the display key has not been detected.

Proceed as follows in this case:

1. Hold the display key with its back against the marked area on the steering column. Pay attention to the display in the instrument cluster.
2. If the display key is detected:
 - Switch on drive-ready state within 10 seconds.

If the display key is not detected, slightly change the position of the display key and repeat the procedure.

Resetting the BMW display key

If the charged display key cannot be switched on anymore or if the display does not respond to entries anymore, the display key can be reset.

Press and hold the following buttons on the display key at the same time for at least 10 seconds until the display is switched off and then on again:



Integrated key

General information

The driver's door can be locked and unlocked without the vehicle key using the integrated key. The integrated key also fits the glove compartment.

Safety information

Warning

For some country versions, unlocking from the inside is only possible with special knowledge.

Persons who spend a lengthy time in the vehicle while being exposed to extreme temperatures are at risk of injury or death. Do not lock the vehicle from the outside when there are people in it.

NOTICE

The door lock is permanently joined with the door. The door handle can be moved. When pulling the door handle with the integrated key inserted, paint or the integrated key can be damaged. There is a risk of damage to property. Remove the integrated key before pulling the outside door handle.

Removing



Press the button, arrow 1, and pull out the integrated key, arrow 2.

Locking/unlocking via the door lock

1. Pull and hold the door handle outward with one hand.

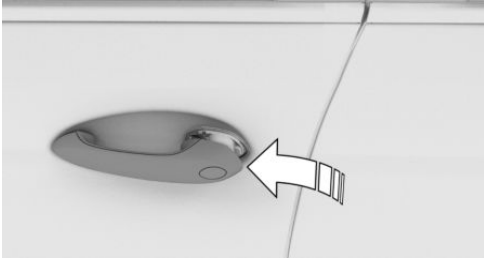

2. Guide one finger of your other hand from the back under the cover and push the cover out. Use the thumb for counter support to prevent the cover from falling out of the door handle.



3. Remove the cover.
4. Unlock or lock the door lock using the integrated key.

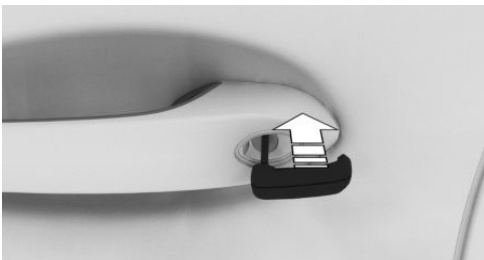

The other doors must be unlocked or locked from the inside.

Alarm system

The activated alarm system is triggered when the door is opened, if the vehicle has been unlocked via the door lock.

The alarm system is not switched on if the vehicle is locked with the integrated key.

Buttons for the central locking system

General information

In the event of a severe accident, the vehicle is automatically unlocked. The hazard warning system and interior lights come on.

Overview



Buttons for the central locking system.

Locking

 Press the button with the front doors closed.

- ▷ The fuel filler flap remains unlocked.
- ▷ The vehicle is not secured against theft when locking.

Unlocking

 Press the button.

Opening

- ▶  Press the button to unlock all the doors.

Pull the door opener above the armrest.

- ▶ Front doors: pull the door handle on the door to open the door. The other doors remain locked.
- ▶ Back doors: pull twice on the door handle on the door to be opened; the first time unlocks the door, the second time opens it. The other doors remain locked.

Comfort Access

Concept

The vehicle can be accessed without operating the vehicle key.

Carrying the vehicle key with you, e.g., in your pants pocket, is sufficient.

The vehicle automatically detects the vehicle key when it is in close proximity or in the car's interior.

General information

Comfort Access supports the following functions:

- ▶ Unlocking and locking the vehicle from the door handle.
- ▶ Convenient closing.
- ▶ Touchless unlocking and locking of the vehicle.
- ▶ Unlocking and locking the vehicle using the BMW Digital Key.
- ▶ Open the tailgate.
- ▶ Open and close the tailgate with no-touch activation.

Functional requirements

- ▶ To lock the vehicle, the vehicle key must be outside of the vehicle near the doors.

- ▶ The next unlocking and locking cycle is not possible until after approx. 2 seconds.

Unlocking

General information

The behavior of the vehicle during unlocking via the Comfort Access depends on the following settings:

- ▶ If the unlocking of the vehicle is confirmed with a light signal or a sound signal.
- ▶ If the welcome light is switched on when the vehicle is being unlocked.

Unlocking the vehicle



Grasp the handle of a vehicle door completely.

In addition, the following functions are executed:

- ▶ If a driver profile was assigned to the vehicle key, this driver profile will be activated and the settings that are stored in it will be applied.
- ▶ The interior lights are switched on, unless they were manually switched off.
- ▶ Folded in exterior mirrors are folded out.
If the exterior mirrors were folded in via the button in the car's interior, they will not be folded out when unlocking.
- ▶ With alarm system: The alarm system will be switched off.

Locking

General information

The behavior of the vehicle during locking via the Comfort Access depends on the following settings:

- ▶ If the locking of the vehicle is confirmed with a light signal or a sound signal.
- ▶ If the exterior mirrors are automatically folded in when the vehicle is locked. The exterior mirrors are not folded in when the hazard warning flashers are switched on.
- ▶ If the headlight courtesy delay feature is activated during locking.

Locking the vehicle

Close the driver's door.

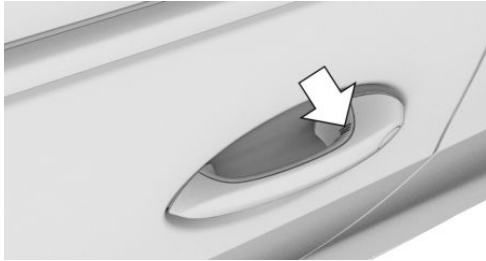

Touch the grooved surface on the handle of a closed vehicle door with your finger for approx. 1 second without grasping the door handle.

The following functions are executed:

- ▶ All doors, the tailgate, and the fuel filler flap are locked.
- ▶ With alarm system: The alarm system will be switched on.

Convenient closing

Safety information

Warning

With convenient closing, body parts can be jammed. There is a risk of injury. Make sure that the area of movement of the doors is clear during convenient closing.

Closing

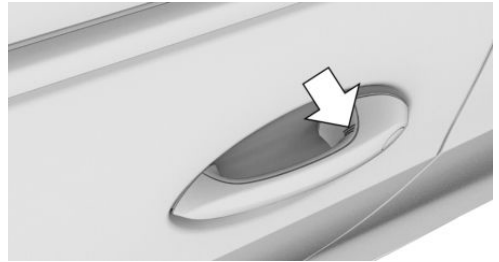

Touch the grooved surface on the handle of a closed vehicle door with your finger and hold it there without grasping the door handle.

In addition to locking, the windows and glass sunroof with sun protection will be closed.

Opening the tailgate

General information

If the tailgate is opened via Comfort Access, locked doors are not unlocked.

To avoid locking the vehicle key in the vehicle, do not place the vehicle key in the cargo area.

Safety information

Warning

Body parts can be jammed when operating the tailgate. There is a risk of injury. Make sure that the area of movement of the tailgate is clear during opening and closing.

Warning

The tailgate pivots out when it opens. There is a risk of injury or risk of damage to property. Make sure that the area of movement of the tailgate is clear during opening and closing.

NOTICE

Sharp-edged or pointed objects can hit the windows and heat conductors while driving. There is a risk of damage to property. Cover the edges and ensure that pointed objects do not hit the windows.

Opening

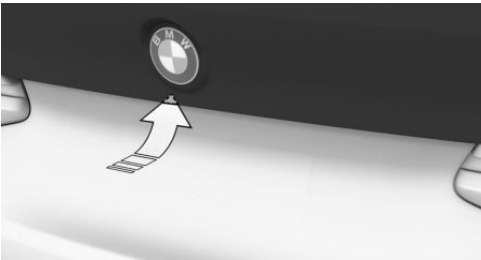

Press the button on tailgate's exterior.

Without trailer hitch: touchless opening and closing of the tailgate

Concept

The tailgate can be opened and closed with no-touch activation using the vehicle key you are carrying. Two sensors detect a forward-directed foot motion in the central rear area and the tailgate is opened and closed.

General information

To avoid locking the vehicle key in the vehicle, do not place the vehicle key in the cargo area.

If the vehicle key is in the sensor area, the tailgate may open or close inadvertently if you unintentionally move your foot or if a foot movement is detected.

The sensor has an approximate range of 5 ft/1.5 m extending from the rear of the vehicle.

If the tailgate is opened with no-touch activation, locked doors are not unlocked.

You can configure if only the upper tailgate will open or if the upper and lower tailgate opens. When closing, the upper and lower tailgate will always be closed.

Safety information

Warning

During no-touch activation, vehicle parts may be touched, such as the hot exhaust gas system. There is a risk of injury. When moving your foot, make sure you have a firm stance and do not touch the vehicle.

Warning

Body parts can be jammed when operating the tailgate. There is a risk of injury. Make sure that the area of movement of the tailgate is clear during opening and closing.

Warning

The tailgate pivots out when it opens. There is a risk of injury or risk of damage to property. Make sure that the area of movement of the tailgate is clear during opening and closing.

NOTICE

Sharp-edged or pointed objects can hit the windows and heat conductors while driving. There is a risk of damage to property. Cover the edges and ensure that pointed objects do not hit the windows.

Performing the foot movement

1. Stand in the middle behind the vehicle at approx. one arm's length away from the rear of the vehicle.
2. Wave a foot under the vehicle in the direction of travel and immediately pull it back. With this movement, the leg must pass through the ranges of both sensors.

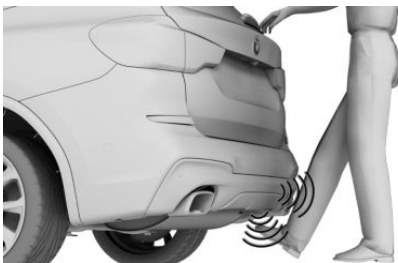
**Opening**

Perform the foot movement described earlier.

Before the tailgate opens, the hazard warning system flashes.

Moving your foot again will stop the opening motion, and moving it one more time after that will close the tailgate.

Closing

Perform the foot movement described earlier.

The hazard warning system flashes and an acoustic signal sounds.

Moving your foot again will stop the closing motion, and moving it one more time after that will re-open the tailgate.

Touchless unlocking and locking of the vehicle**Concept**

The vehicle will be unlocked when the driver approaches the locked vehicle with the vehicle key.

When the driver walks away from the unlocked vehicle with the vehicle key, the vehicle will be locked.

General information

The vehicle will be unlocked when an authorized vehicle key is detected in the unlocking zone.

The unlocking zone is located within a radius of approx. 3 ft/1 m around the door handles.

The vehicle will be locked when the vehicle key leaves the locking zone.

The locking zone is located within a radius of approx. 7 ft/2 m around the door handles.

If the vehicle key is located in the unlocking zone for an extended period of time without movement, the vehicle will be locked automatically.

If a passenger is detected in the front passenger seat during locking and the safety belt of the front passenger is engaged in the safety belt buckle during locking:

- ▶ The vehicle will be locked but not secured against theft.

- ▶ The fuel filler flap remains unlocked.

The behavior of the vehicle during touchless unlocking/locking depends on the following settings:

- ▶ If the automatic unlocking is active.
- ▶ If the automatic locking is active.
- ▶ If only the driver's door and the fuel filler flap or all access to the vehicle will be unlocked.

Only driver's door and fuel filler flap: the driver's door and fuel filler flap will only be unlocked when the driver approaches the vehicle on the driver's side.

All vehicle entry points: the vehicle will be unlocked regardless of the side on which the driver approaches the vehicle.

- ▶ If the unlocking and locking of the vehicle is confirmed with a light signal or a sound signal.
- ▶ If the welcome light is switched on when the vehicle is being unlocked.
- ▶ If the headlight courtesy delay feature is activated during locking.
- ▶ If the exterior mirrors are automatically folded out and in when the vehicle is unlocked and locked.

Functional requirements

- ▶ The drive-ready state must be turned off.
- ▶ Unlocking: when entering the unlocking zone, the doors and tailgate must be closed.
- ▶ Locking: when leaving the locking zone, the doors and tailgate must be closed.
- ▶ If the vehicle was locked with the vehicle key, it cannot be unlocked touchless. In this case, unlock the vehicle using the outside door handle.
- ▶ If the vehicle was unlocked with the vehicle key, it cannot be locked touchless without driving the vehicle first. In this case, lock the vehicle using the outside door handle.

- ▶ For touchless locking of the vehicle, no second vehicle key can be located in the locking zone.
- ▶ If the vehicle has been in the idle state for several days, touchless unlocking/locking is not possible until after the vehicle has been driven.

BMW Digital Key

Concept

BMW Digital Key allows the vehicle to be unlocked and locked, as well as started, with a compatible smartphone, refer to page 71.

General information

BMW Digital Key varies by country and may be unavailable.

To unlock and start a vehicle with a compatible smartphone, a digital key must be installed on this smartphone. Digital keys are installed, managed and forwarded via the BMW Connected app.

A driver profile with individual settings can be assigned to a digital key.

When using a smartphone with a digital key, always carry a vehicle key with you too, so the vehicle can still be accessed even if your smartphone is not working. It is also useful to carry the vehicle key with you if the vehicle has to be handed over to another person or a service center. You can then hand over the vehicle key, instead of your smartphone.

Safety information

Warning

People or animals in the vehicle can lock the doors from the inside and lock themselves in. In this case, the vehicle cannot be opened from the outside. There is a risk of injury. Take the vehicle key with you so that the vehicle can be opened from the outside.

Warning

For some country versions, unlocking from the inside is only possible with special knowledge.

Persons who spend a lengthy time in the vehicle while being exposed to extreme temperatures are at risk of injury or death. Do not lock the vehicle from the outside when there are people in it.

Warning

Unattended children or animals in the vehicle can cause the vehicle to move and endanger themselves and traffic, for instance due to the following actions:

- ▷ Pressing the Start/Stop button.
- ▷ Releasing the parking brake.
- ▷ Opening and closing the doors or windows.
- ▷ Engaging selector lever position N.
- ▷ Using vehicle equipment.

There is a risk of accidents or injuries. Do not leave children or animals unattended in the vehicle. Take the vehicle key with you when exiting and lock the vehicle.

Key card

The vehicle is delivered with a key card. The key card can be used in the same way as a compatible smartphone with a digital key.

A digital key that has already been paired with the vehicle is installed on the key card. The digital key must be activated via iDrive.

When you exit the vehicle, take the key card with you, as it can be used to start the vehicle.

Connection to the vehicle

The communication between the vehicle and the smartphone uses near-field communication, NFC.

The vehicle is unlocked with the outside door handle on the driver's side. The smartphone must be placed into the smartphone tray to pair a digital key and to start the engine.

The vehicle also detects a digital key when the smartphone is switched off.

Functional requirements

- ▷ Active ConnectedDrive contract.
- ▷ The BMW Connected app is installed on a compatible smartphone.
- ▷ The rechargeable battery of the smartphone has a sufficient charge. The necessary minimum charge of the rechargeable battery depends on the smartphone.
- ▷ A digital key for the vehicle is installed on the smartphone.
- ▷ BMW Digital Key is activated for the vehicle.

Proving authorization

The vehicle owner must present proof of authorization for his vehicle at the service center to be able to use BMW Digital Key. It is possible to use the key card without proving authorization.

The vehicle owner configures a digital key code at the service center so that digital keys can be transferred at a later time.

Purchasing digital keys

An initial digital key is provided in the BMW Connected app when the vehicle is purchased.

Additional digital keys can be purchased via the BMW ConnectedDrive Store. The purchase of digital keys can cause costs.

The period of validity of a digital key is limited.

The expiration date of the validity can be checked in the BMW Connected app and in the vehicle.

If a digital key has expired, the vehicle can only be unlocked and locked for a limited period and a limited number of engine starts is possible. The corresponding information is shown on the Control Display.

Transferring digital keys

The vehicle owner can transfer a digital key for his/her vehicle to another person with a compatible smartphone via the BMW Connected app.

When a digital key is transferred, a transaction number TAN will be generated. Another person can pair the digital key in the vehicle with this TAN and the Digital Key Code. This makes it possible to allow another person to use the vehicle without having to be at the vehicle.

The TAN and the Digital Key Code should only be disclosed in person or by phone.

The Safe Share function is available depending on the software version of the BMW Connected app. If this function is activated prior to hand off, the digital key is subject to certain restrictions. For example, some of the driving stability systems can no longer be activated. For more information, refer to the ConnectedDrive portal.

The transferred digital key can be removed in the vehicle or via the BMW Connected app at any time.

If the digital key has been removed via the BMW Connected App, the vehicle can still be unlocked and locked for a limited period of time and only a limited number of engine starts will be possible. If the vehicle is then used with another digital key or with a vehicle key, the removed digital key can no longer be used.

The corresponding information is shown on the Control Display.

Pairing digital keys in the vehicle

To pair a digital key, a vehicle key must be located in the vehicle or an active digital key of the vehicle owner must be in the smartphone tray.

If the digital key was transferred by the vehicle owner, it may not be possible to meet this requirement. In this case, it is necessary to enter the Digital Key Code and the TAN. The vehicle can already be unlocked with the transferred digital key before it is paired.

Place the smartphone with the digital key to be paired into the smartphone tray.

Via iDrive:

1. "CAR"
2. "Settings"
3. "Doors/Access"
4. "BMW Digital Key"
5. "Activate Digital Key"
6. If necessary, enter the Digital Key Code and the TAN.

After the digital key has been paired, its name will be displayed in the list of digital keys.

Activating/deactivating digital keys in the vehicle

A digital key can be deactivated temporarily.

To activate or deactivate a digital key, a vehicle key must be located in the vehicle or an active digital key of the vehicle owner must be in the smartphone tray.

Via iDrive:

1. "CAR"
2. "Settings"
3. "Doors/Access"
4. "BMW Digital Key"
5. Select the desired digital key.
6. "Digital Key active"

A deactivated digital key remains in the list of paired digital keys.

Removing digital keys in the vehicle

To remove a digital key, a vehicle key must be located in the vehicle or another active digital key of the vehicle owner must be in the smartphone tray. To remove all digital keys, a vehicle key must be located in the vehicle.

The key card cannot be removed.

Via iDrive:

1. "CAR"
2. "Settings"
3. "Doors/Access"
4. "BMW Digital Key"
5. If necessary, select the digital key.
6. > "Remove Digital Key"
 - The digital key will be removed from the list of paired digital keys.
 - > "Remove all Digital Keys"

Resetting BMW Digital Key

To reset BMW Digital Key, an authorized vehicle key must be located in the vehicle.

After the reset, the vehicle can no longer be unlocked, locked or started with a digital key.

The vehicle owner must present proof of authorization for his vehicle again at the service center to be able to use BMW Digital Key again.

Via iDrive:

1. "CAR"
2. "Settings"
3. "Doors/Access"
4. "BMW Digital Key"
5. "Reset function"

Unlocking and locking the vehicle

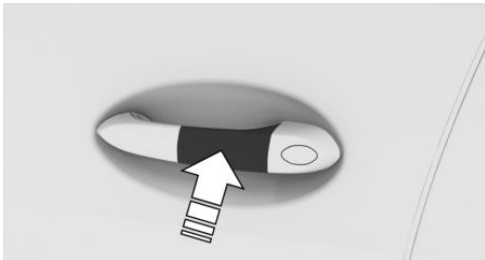

Hold the smartphone or key card directly on the outside door handle of the driver's door.

Starting the engine

Tray with thermoelectric cup holder:

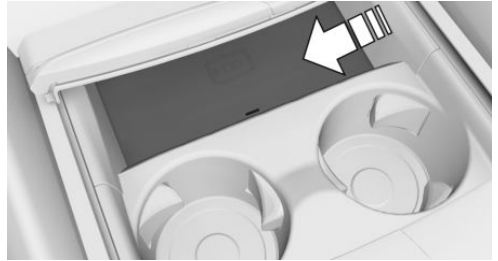

Tray without thermoelectric cup holder:

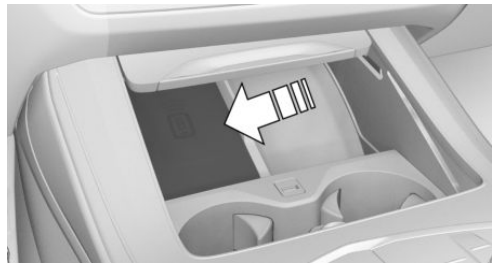

1. Open the cover of the smartphone tray.
2. Place the smartphone or key card centered into the smartphone tray in front of the cup holders.
3. After the digital key has been detected as authorized, the engine can be started.

With wireless charging tray: Take key card out of the tray to make tray available for charging compatible smartphones.

Sale of the smartphone/vehicle

When a smartphone with a digital key is sold, all digital keys should be deleted from this smartphone.

When a vehicle is sold, BMW Digital Key should be reset in this vehicle. The new vehicle owner should make sure that BMW Digital Key has been reset. This ensures that the previous vehicle owner no longer has access to the vehicle.

Malfunction

Vehicle key recognition by the vehicle may malfunction under the following circumstances:

- ▷ The battery of the vehicle key is discharged. For replacing the battery, refer to page 81.
- ▷ Interference of the radio connection from transmission towers or other equipment with high transmitting power.
- ▷ Shielding of the vehicle key due to metal objects.
Do not transport the vehicle key together with metal objects.
- ▷ Interference of the radio connection from mobile phones or other electronic devices in direct proximity to the vehicle key.
Do not transport the vehicle key together with electronic devices.

Wet or snowy conditions may disrupt the locking request recognition function on the door handles.

In the case of a malfunction, unlock and lock the vehicle using the buttons of the vehicle key or use the integrated key, refer to page 87.

Tailgate

General information

To avoid locking the vehicle key in the vehicle, do not place the vehicle key in the cargo area.

The tailgate consists of the upper and the lower tailgate. The lower tailgate opens downward to make loading the cargo area easier.

The following settings are available for the operation of the tailgate:

- ▷ The opening height of the upper tailgate.
- ▷ With Comfort Access: Whether the vehicle key opens only the upper tailgate or the upper and lower tailgate at the same time.

- ▷ With Comfort Access: Whether the button in the driver's door opens only the upper or the upper and lower tailgate together.
- ▷ Determines if the doors will be unlocked when the tailgate is opened with the vehicle key.

Safety information

Warning

Body parts can be jammed when operating the tailgate. There is a risk of injury. Make sure that the area of movement of the tailgate is clear during opening and closing.

Warning

The tailgate pivots out when it opens. There is a risk of injury or risk of damage to property. Make sure that the area of movement of the tailgate is clear during opening and closing.

NOTICE

Foreign objects, such as sand or icing, between the bumper and tailgate may cause damage when operating the lower tailgate. There is a risk of damage to property. If necessary, remove foreign objects from the bumper and the lower tailgate before operating the lower tailgate.

NOTICE

Sharp-edged or pointed objects can hit the windows and heat conductors while driving. There is a risk of damage to property. Cover the edges and ensure that pointed objects do not hit the windows.

NOTICE

Manual operation of the tailgate in the wrong sequence can damage the tailgate. There is a risk of damage to property. Close the lower tailgate first before closing the upper tailgate manually.

Upper tailgate**Opening****General information**

It may not be possible to open the tailgate when the vehicle is in valet parking mode, refer to page 100.

When the trailer socket is in use, the tailgate cannot be opened with the vehicle key or with the button in the car's interior.

The upper tailgate will be opened to the configured opening height.

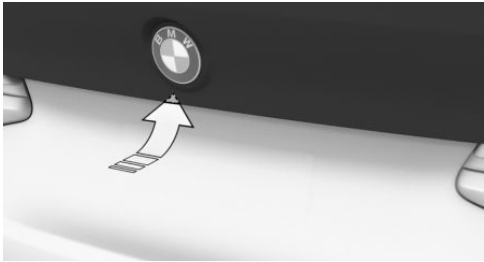
From the outside

- ▶ Unlock the vehicle and then press the button on the outside of the tailgate.
- ▶ With Comfort Access: carry the vehicle key with you and press the button on the outside of the tailgate.
- ▶  Press and hold the button on the vehicle key for approx. 1 second.
With Comfort Access: If necessary, the lower tailgate will also be opened.

From the inside

Press the button in the driver's door.

If the vehicle is locked, selector lever position P must be engaged first.

With Comfort Access: If necessary, the lower tailgate will also be opened.

Interruption of the opening procedure

The opening procedure is interrupted in the following situations:

- ▶ When the vehicle starts moving.
- ▶ By pressing the used button used again.

Closing**Functional requirement**

Without Comfort Access: The lower tailgate must be closed; otherwise, a Check Control message will be displayed.

From the outside

Without Comfort Access:

1. Closing the lower tailgate manually.
2. Press the button on the inside of the upper tailgate.



With Comfort Access:

- ▶  Press the button on the inside of the upper tailgate.

The lower tailgate will be closed automatically with the upper tailgate.

- ▶  Press the button on the inside of the upper tailgate.

The vehicle will be locked after closing the tailgate. The driver's door must be closed for this purpose and the vehicle key must be outside of the vehicle in the area of the tailgate.

The lower tailgate will be closed automatically with the upper tailgate.

From the inside

Without Comfort Access:

1. Closing the lower tailgate manually.
2.  Pull and hold the button in the driver door.

The vehicle key must be located in the car's interior for this function.

With Comfort Access:

-  Pull and hold the button in the driver door.
The vehicle key must be located in the car's interior for this function.

The lower tailgate will be closed automatically with the upper tailgate.

An acoustic signal sounds before the tailgate is closed.

Interruption of the closing procedure

The closing procedure is interrupted in the following situations:

- ▷ If the vehicle starts off with a jerky movement.
- ▷ By pressing the used button used again.

Lower tailgate**Opening****General information**

When open, the lower tailgate can support loads of up to 550 lbs/250 kg.

Functional requirement

The upper tailgate must be open.

From the outside

Without Comfort Access:

-  Press the button on the lower tailgate and fold the lower tailgate down.

With Comfort Access:



Press the button on the lower tailgate.

With Comfort Access: from the inside

Depending on the settings, the lower tailgate will be opened automatically with the upper tailgate.

With Comfort Access: terminating the opening procedure

The opening procedure is interrupted in the following situations:

- ▷ When the vehicle starts moving.
- ▷ By pressing the button on the lower tailgate. Pressing again closes the tailgate.

Closing**Functional requirements**

There is no cargo on the lower tailgate.

From the outside

Without Comfort Access:

Closing the lower tailgate manually.

With Comfort Access:



Press the button on the lower tailgate.

With Comfort Access: from the inside

The lower tailgate will be closed automatically with the upper tailgate.

With Comfort Access: terminating the closing procedure

The closing procedure is interrupted in the following situations:

- ▷ If the vehicle starts off with a jerky movement.
- ▷ By pressing the button in the lower tailgate.

System limits

Without Comfort Access: The upper tailgate is designed for electric operation via the provided operating points.

With Comfort Access: The upper tailgate and the lower tailgate are designed for electric operation via the provided operating points.

A manual operation of the tailgate can produce system states in which an electric operation is no longer possible.

For instance, this type of system state applies when there is a danger of collision between the upper and lower tailgate. In this case, an acoustic signal will sound and the upper tailgate must be completely opened manually.

Operate the tailgate manually in exceptional cases only such as in the event of a malfunction.

Malfunction

Warning

With manual operation of a blocked tailgate, it can release itself unexpectedly from the blockage. There is a risk of injury or risk of damage to property. Do not operate the tailgate manually if it is blocked. Have it checked by a dealer's service center or another qualified service center or repair shop.

Without Comfort Access: Operate the unlocked upper tailgate manually and slowly without jerking.

With Comfort Access: Operate the unlocked upper or lower tailgate manually and slowly without jerking. When closing, make sure the lower tailgate is closed first.

To close the tailgate fully, press down lightly only. Closing occurs automatically.

Automatic Soft Closing

Safety information

Warning

Body parts can be jammed while operating the doors. There is a risk of injury. Make sure that the area of movement of the doors is clear during opening and closing.

Closing

To close the doors, push lightly.

Closing occurs automatically.

Valet parking mode

Concept

In the valet parking mode, the Control Display is locked and operation via iDrive is no longer possible.

E.g., this mode can be used when the vehicle is handed over for valet parking.

General information

In the valet parking mode, it is not possible to change vehicle settings via iDrive. Personal settings cannot be changed and personal data cannot be displayed.

Additionally, the following actions are carried out:

- ▶ The volume of the audio system is limited.
- ▶ The integrated remote control is deactivated.
- ▶ DSC cannot be switched off.
- ▶ Depending on the vehicle, the tailgate can be locked and disconnected from the central locking system.

Functional requirements

- ▶ At least one driver profile has been created.

- ▷ A driver profile or the guest profile is active.
- ▷ At least one driver profile has an assigned ConnectedDrive account.

Accessing the menu for the valet parking mode

Via the switch-off screen

After switching off drive-ready state the switch-off screen will be displayed. Select the entry for the valet parking mode on the switch-off screen.

Via the display bar at the upper edge of the Control Display

1. Tip the Controller up
2. "Valet parking mode"

Via the vehicle settings

Via iDrive:

1. "CAR"
2. "Settings"
3. "General settings"
4. "Valet parking mode"

Activating the valet parking mode

General information

Before activating the valet parking mode, a PIN must be set up to be able to deactivate the valet parking mode at a future time.

The procedure for entering the PIN varies depending on the active driver profile.

Driver profile with PIN

A PIN has been stored for the active driver profile.

It is not necessary to enter another PIN.

1. Depending on the vehicle, select the desired setting, if necessary:

"Lock tailgate as well"

The tailgate will be locked and disconnected from the central locking system.

2. "Activate now"

Driver profile without PIN

A PIN must be assigned to the driver profile.

1. "PIN"
2. Enter PIN.
3. Depending on the vehicle, select the desired setting, if necessary:

▷ "Lock tailgate as well"

The tailgate will be locked and disconnected from the central locking system.

▷ "Activate linkage"

This PIN will be stored for the active driver profile.

4. "Activate now"

Guest profile

The guest profile is the active driver profile.

A PIN must be entered.

1. "PIN"
2. Enter PIN.
3. Select the desired setting:
"Lock tailgate as well"

The tailgate will be locked and disconnected from the central locking system.

4. "Activate now"

This PIN can be used once to deactivate the valet parking mode for the active guest profile.

Deactivating valet parking mode

General information

The lock screen of the valet parking mode is displayed on the Control Display.

The deactivation of the valet parking mode depends on which driver profile is selected on the lock screen.

Driver profile with PIN

Regardless of which driver activated the valet parking mode, a driver can deactivate the valet parking mode by entering his/her PIN.

1. Select driver profile.
2. Enter the assigned PIN for the driver profile.

If you forgot the PIN, the valet parking mode must be deactivated by entering the assigned ConnectedDrive access data.

Driver profile without PIN

The valet parking mode was activated by another person. To deactivate the valet parking mode, a driver without a PIN has to enter the access data for his ConnectedDrive account.

1. Select driver profile.
2. Enter the ConnectedDrive access data assigned to the driver profile.

Guest profile

In the guest profile, the valet parking mode can only be deactivated if the valet parking mode was activated in the guest profile.

1. Select guest profile.
2. Enter the PIN that was specified during activation.

If the PIN has been forgotten, the valet parking mode must be deactivated via a personal driver profile.

Adjusting

General information

Depending on the vehicle equipment and country version, various settings for opening and closing are possible.

These settings are stored for the driver profile currently used.

Unlocking and locking

Doors

Via iDrive:

1. "CAR"
2. "Settings"
3. "Key button settings"
4.  Select the symbol.
5. Select the desired setting:

- ▷ "Driver's door only"

Only the driver's door and the fuel filler flap are unlocked. Pressing again unlocks the entire vehicle.

- ▷ "All doors"

The entire vehicle is unlocked.

Confirmation signals from the vehicle

Via iDrive:

1. "CAR"
2. "Settings"
3. "Doors/Access"
4. Deactivate or activate the desired confirmation signals:

- ▷ "Flash when locking/unlocking"

Unlocking is signaled by two flashes, locking by one.

- ▷ With alarm system:

"Sound when locking/unlocking"

Unlocking is confirmed with two sound signals, locking is confirmed with one sound signal.

Folding mirrors automatically

Via iDrive:

1. "CAR"
2. "Settings"
3. "Doors/Access"
4. "Fold mirrors in when locked"

The exterior mirrors are automatically folded in during locking.

Automatic unlocking

Via iDrive:

1. "CAR"
2. "Settings"
3. "Doors/Access"
4. "Unlock at end of trip"

After drive-ready state is switched off by pressing the Start/Stop button, the locked vehicle is automatically unlocked.

Automatic locking

Via iDrive:

1. "CAR"
2. "Settings"
3. "Doors/Access"
4. Select the desired setting:

- ▶ "Lock automatically"

The vehicle locks automatically after a while if no door is opened after unlocking.
- ▶ "Lock after starting to drive"

The vehicle locks automatically after you drive off.

Tailgate

Opening height of the upper tailgate

You can set how far the upper tailgate can be opened.

When adjusting the opening height, make sure the clearance above the tailgate is at least 4 in/10 cm.

Via iDrive:

1. "CAR"
2. "Settings"
3. "Doors/Access"
4. "Tailgate"
5. "Opening height"
6. Monitor the tailgate and set the desired opening height.

With Comfort Access: upper or both tailgates



The button in the car's interior can be set up to open only the upper tailgate or the upper and lower tailgate together:

Via iDrive:

1. "CAR"
2. "Settings"
3. "Doors/Access"
4. "Tailgate"
5. Select the desired setting:
 - ▶ "Upper tailgate"

Only the upper tailgate opens.
 - ▶ "Both tailgates"

The upper and lower tailgate will be opened together.

To open the upper and lower tailgate at the same time, the upper tailgate must be closed when the button is pressed.

This setting also applies to the touchless opening of the tailgate.

Tailgate and doors

The button of the vehicle key can be configured to control which part of the tailgate will be opened and if the doors will be unlocked at the same time.



Via iDrive:

1. "CAR"
2. "Settings"
3. "Key button settings"
4.  Select the symbol.
5. Select the desired setting:
 - ▷ "Upper tailgate"

The upper tailgate is opened.
 - ▷ "Upper tailgate + door(s)"

The tailgate is opened and the doors unlocked.
 - ▷ "Both tailgates"

The upper and lower tailgate will be opened.
 - ▷ "Both tailgates + door(s)"

The upper and lower tailgate will be opened and the doors unlocked.

Comfort Access

Touchless locking and unlocking

1. "CAR"
2. "Settings"
3. "Doors/Access"
4. "Comfort access"
5. Select the desired setting:
 - ▷ "Unlock when approaching"
 - ▷ "Lock when walking away"

Touchless opening of the tailgate

For touchless unlocking, a setting can be entered to open only the upper tailgate or the upper and lower tailgate together:

Via iDrive:

1. "CAR"
2. "Settings"

3. "Doors/Access"
4. "Tailgate"
5. Select the desired setting:
 - ▷ "Upper tailgate"

Only the upper tailgate opens.
 - ▷ "Both tailgates"

The upper and lower tailgate will be opened together.

To open the upper and lower tailgate at the same time, the upper tailgate must be closed when the button is pressed.

This setting also applies to opening the tailgate in the interior.

Establishing idle state after opening the front doors

Via iDrive:

1. "CAR"
2. "Settings"
3. "Doors/Access"
4. "Turn off vehicle after opening door"

Opening the front doors establishes the idle state, refer to page 37.

Alarm system

General information

When the vehicle is locked, the vehicle alarm system reacts to the following changes:

- ▷ Opening a door, the hood, or the tailgate.
- ▷ Movements in the car's interior.
- ▷ Changes in the vehicle tilt, for instance, during attempts at stealing a wheel or when towing the vehicle.
- ▷ Disconnected battery voltage.
- ▷ Improper use of the socket for OBD Onboard Diagnosis.

- ▶ Locking the vehicle while a device is connected to the socket for the OBD Onboard-Diagnosis.

The alarm system signals these changes visually and acoustically:

- ▶ Acoustic alarm:
Depending on local regulations, the acoustic alarm may be suppressed.
- ▶ Visual alarm:
By flashing of the hazard warning system and headlights, where required.

Do not modify the system to ensure function of the alarm system.

Switching on/off

When you unlock and lock the vehicle, either with the vehicle key or via Comfort Access, the alarm system is switched off and on at the same time.

Opening the doors with the alarm system switched on

The alarm system is triggered when a door is opened if the door was unlocked using the integrated key in the door lock.

Opening the tailgate with the alarm system switched on

The tailgate can be opened even when the alarm system is switched on.

After the tailgate is closed, it is locked and monitored again provided the doors are locked. The hazard warning system flashes once.

Panic mode

You can trigger the alarm system if you find yourself in a dangerous situation.



- ▶ Press the button on the vehicle key and hold for at least 3 seconds.
- ▶ Briefly press the button on the vehicle key three times in succession.

To switch off the alarm: press any button.

Indicator light on the interior mirror



- ▶ The indicator light flashes briefly every 2 seconds:
The alarm system is switched on.
- ▶ Indicator light flashes for approx. 10 seconds, then it flashes briefly every 2 seconds:
Interior motion sensor and tilt alarm sensor are not active, as doors, hood, or tailgate are not correctly closed. Correctly closed access points are secured.
When the still open access points are closed, the interior motion sensor and tilt alarm sensor will be switched on.
- ▶ The indicator light goes out after unlocking:
The vehicle has not been tampered with.
- ▶ The indicator light flashes after unlocking until drive-ready state is switched on, but no longer than approx. 5 minutes:
An alarm has been triggered.

Tilt alarm sensor

The tilt of the vehicle is monitored.

The alarm system responds in situations such as attempts to steal a wheel or when the vehicle is towed.

Interior motion sensor

The windows and the glass sunroof must be closed for the system to function properly.

Avoiding unintentional alarms

General information

The tilt alarm sensor and interior motion sensor can trigger an alarm, although no unauthorized action occurred.

Possible situations for an unwanted alarm:

- ▷ In automatic vehicle washes.
- ▷ In duplex garages.
- ▷ During transport on trains carrying vehicles, at sea or on a trailer.
- ▷ With animals in the vehicle.
- ▷ When the vehicle is locked after start of fueling.

The tilt alarm sensor and the interior motion sensor can be switched off in such situations.

Switching off the tilt alarm sensor and interior motion sensor

 Press the button on the vehicle key within 10 seconds as soon as the vehicle is locked.

The indicator light lights up for approx. 2 seconds and then continues to flash.

The tilt alarm sensor and interior motion sensor are switched off until the vehicle is locked again.

Switching off the alarm

- ▷ Unlock the vehicle with the vehicle key.
- ▷ Unlock the vehicle with the integrated key and activate the drive-ready state via emergency detection of the vehicle key, refer to page 82.
- ▷ With Comfort Access: when carrying the vehicle key, grasp the driver's door or front passenger door handle completely.

Power windows

General information

The windows can be opened with the vehicle key from the outside as well as closed with Comfort Access.

With Comfort Access: The windows can be closed from the outside via Comfort Access.

Safety information

Warning

When operating the windows, body parts and objects can be jammed. There is a risk of injury or risk of damage to property. Make sure that the area of movement of the windows is clear during opening and closing.

Overview



 Power windows

 Safety switch



Functional requirements

The windows can be operated under the following conditions.



- ▷ Standby state is switched on.
- ▷ Drive-ready state is switched on.

The vehicle key must be in the car's interior.

Opening

- ▷  Press the switch to the resistance point.
The window opens while the switch is being held.
- ▷  Press the switch beyond the resistance point.
The window opens automatically. Pressing the switch again stops the motion.

Closing

- ▷  Pull the switch to the resistance point.
The window closes while the switch is being held.
- ▷  Pull the switch beyond the resistance point.
The window closes automatically if the door is closed. Pulling again stops the motion.

Jam protection system

Concept

The jam protection prevents objects or body parts becoming jammed between the door frame and window while a window is being closed.

General information

If resistance or a blockage is detected while a window is being closed, the closing action is interrupted.

The window opens slightly.



Safety information

Warning

Accessories on the windows such as antennas can impact jam protection. There is a risk of injury. Do not install accessories in the area of movement of the windows.

Closing without the jam protection system

In case of danger from the outside or if ice might prevent normal closing, proceed as follows:

1.  Pull the switch past the resistance point and hold it there.
The window closes with limited jam protection. If the closing force exceeds a specific threshold, closing is interrupted.
2.  Pull the switch past the resistance point again within approx. 4 seconds and hold it there.
The window closes without jam protection.

Safety switch

Concept

With the safety switch, it is possible to block particular functions in the rear. This makes sense, for instance if children or animals are carried in the rear.

The safety switch can be used to prevent children, for instance from opening and closing the rear windows using the switches in the rear.

If an accident of a certain severity occurs, the safety function is switched off automatically.

General information

The following functions can be locked by pressing the safety switch:

- ▷ Seat adjustments in the rear.
- ▷ Opening and closing of the rear windows using the switches in the rear.

Switching on/off

-  Press the button.
The LED lights up if the safety function is switched on.

Roller sunblinds, rear side windows

Safety information

Warning

With closed roller sunblinds and open windows, the roller sunblinds may be strained while driving due to the wind. The roller sunblinds may be damaged and vehicle occupants may be harmed. There is a risk of injury. Do not open the windows while driving if the roller sunblinds are closed.

Pull out the roller sunblind at the strap and hook it onto the bracket.

Glass sunroof

General information

The glass sunroof and the sun protection are operated using the same switch.

The glass sunroof can be opened from the outside with the vehicle key and also closed with Comfort Access.

With Comfort Access: The glass sunroof can be closed from the outside via Comfort Access.

Safety information

Warning

Body parts can be jammed when operating the glass sunroof. There is a risk of injury. Make sure that the area of movement of the glass sunroof is clear during opening and closing.

Overview



Opening/closing the glass sunroof.

Functional requirements

The glass sunroof and the sun protection can be operated under the following conditions.

- ▶ Standby state is switched on.
- ▶ Drive-ready state is switched on.

The vehicle key must be in the car's interior.

Lifting/closing glass sunroof

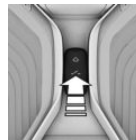

Push switch briefly upward.

- ▶ The closed glass sunroof tilts and the sun protection opens slightly.
- ▶ The opened glass sunroof closes until it is in the tilted position. The sun protection does not move.
- ▶ The tilted glass sunroof closes.

Opening/closing the glass sunroof and sun protection separately

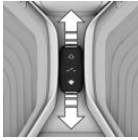

- ▶ Press the switch in the desired direction to the resistance point and hold it there.

Holding down the switch opens the sun protection. If the sun protection is already fully open, the glass sunroof opens.

The glass sunroof closes while the switch is being held. If the glass sunroof is already closed or in the tilted position, the sun protection closes.

- ▶ Press the switch in the desired direction past the resistance point.

The sun protection opens automatically. If the sun protection is already fully open, the glass sunroof opens automatically.

The glass sunroof closes automatically. If the glass sunroof is already closed or in the tilted position, the sun protection closes automatically.

Pressing the switch upward stops the motion.

Opening/closing the glass sunroof and sun protection together

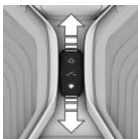

Briefly press the switch twice in succession in the desired direction past the resistance point.

The glass sunroof and sun protection move together. Pressing the switch upward stops the motion.

Comfort position

In some models, the wind noises in the car's interior are lowest when the glass sunroof is not fully open. In these models, the automatic func-

tion initially only opens the glass sunroof up to this comfort position.

Pressing the switch again opens the glass sunroof fully.

Jam protection system

Concept

The jam protection prevents objects or body parts from becoming jammed between the roof and glass sunroof while the glass sunroof is closing.

General information

If a resistance or blockage is detected while the glass sunroof is closing, the closing operation is interrupted once the roof reaches the half-open position, or it is stopped when closing from the tilted position.

Closing from the open position without jam protection

In case of danger from the outside or if ice might prevent normal closing, proceed as follows:

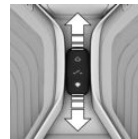

1. Close all doors.
2. Push the switch forward past the resistance point and hold.

The glass sunroof closes with limited jam protection. If the closing force exceeds a specific threshold, closing is interrupted.

3. Push the switch forward again past the resistance point and hold until the glass sunroof closes without jam protection. Make sure that the closing area is clear.

Closing from the lifted position without jam protection

In case of danger from the outside or if ice might prevent normal closing, proceed as follows:

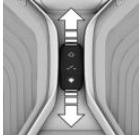

1. Close all doors.
2. Push the switch forward past the resistance point and hold.

- ▶ If the glass sunroof is open, it first closes, then opens and closes again.

Initialization is complete once the glass sunroof and sun protection have opened then closed again.

Initializing after a power interruption

General information

After a power failure during the opening or closing process, the glass sunroof can only be operated to a limited extent. Initializing the system can help in this case.

The system can be initialized under the following conditions:

- ▶ The vehicle is parked in a horizontal position.
- ▶ The drive-ready state is established.
- ▶ The external temperature is above 41 °F/5 °C.

During initialization, the glass sunroof closes without jam protection.

Make sure that the closing area is clear.

Initializing the system



Press the switch up and hold it until the initialization is complete:

Initialization begins within 15 seconds.

- ▶ If the glass sunroof is closed, it opens then closes again.

Seats, mirrors, and steering wheel

Vehicle features and options

This chapter describes all standard, country-specific and optional features offered with the series. It also describes features and functions that are not necessarily available in your vehicle, e.g., due to the selected options or country versions. This also applies to safety-related functions and systems. When using these functions and systems, the applicable laws and regulations must be observed.

Sitting safely

An ideal seating position that meets the needs of the occupants can make a vital contribution to relaxed, fatigue-free driving.

In the event of an accident, the correct seating position plays an important role. Follow the information in the following chapters:

- Seats, refer to page 111.
- Safety belts, refer to page 117.
- Head restraints, refer to page 119.
- Airbags, refer to page 178.

Seats, front

General information

The seat adjustment for the driver's seat is stored for the driver profile currently used. When a driver profile is selected, the stored position is called up automatically.

The current seat position can be stored using the memory function.

Safety information

Warning

Seat adjustments while driving can lead to unexpected movements of the seat. Vehicle control could be lost. There is a risk of accident. Only adjust the seat on the driver's side when the vehicle is stationary.

Warning

With a backrest inclined too far to the rear, the efficacy of the safety belt can no longer be ensured. There is a risk of sliding under the safety belt in an accident. There is a risk of injuries or danger to life. Adjust the seat prior to starting the trip. Adjust the backrest so that it is in the most upright position as possible and do not adjust again while driving.

Warning

There is a risk of jamming when moving the seats. There is a risk of injury or risk of damage to property. Make sure that the area of movement of the seat is clear prior to any adjustment.

Overview

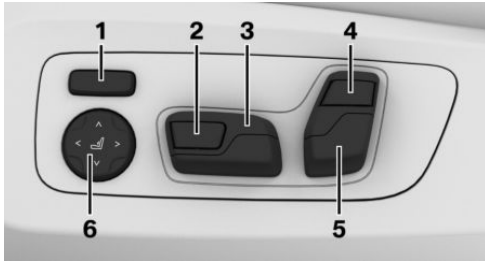

- 1 Backrest width
- 2 Thigh support
- 3 Forward/backward, height, seat tilt
- 4 Upper backrest
- 5 Backrest tilt, head restraint
- 6 Lumbar support

Forward/backward

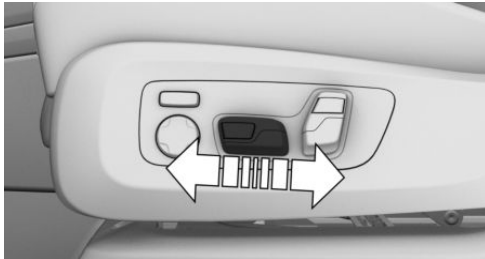

Push switch forward or backward.

Height

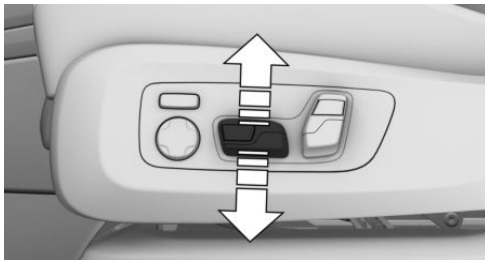

Push switch up or down.

Seat tilt

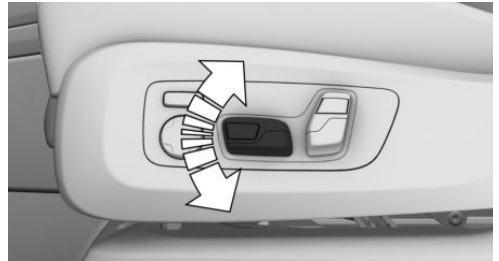

Move switch up or down.

Backrest tilt

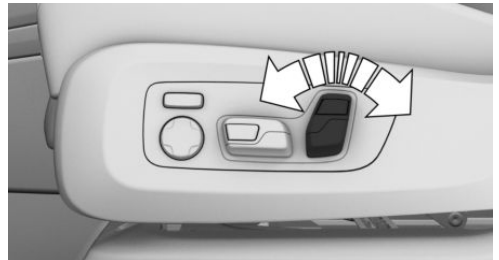

Move switch forward or backward.

Thigh support

Multifunctional seat

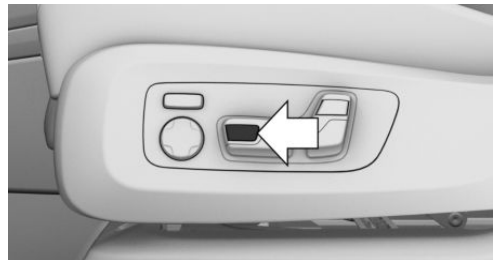

Push the switch in the front or back.

Sport seat

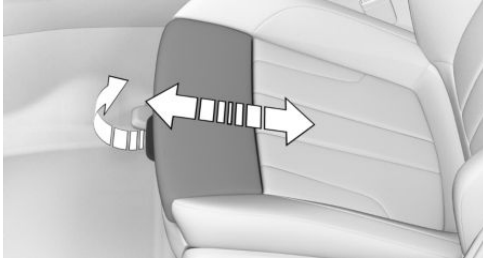

Pull the lever at the front of the seat and push the thigh support forward or back.

Lumbar support

Concept

The curvature of the seat backrest can be adjusted in a way that it supports the lumbar region of the spine. The lower back and the spine are supported for upright posture.

Adjusting



- ▶ Press the front/rear section of the button:
The curvature is increased/ decreased.
- ▶ Press the upper/lower section of the button:
The curvature is shifted up/ down.

Backrest width

Concept

Adjusting the backrest width may improve lateral support when taking corners.

General information

You can change the backrest width by adjusting the side wings of the backrest.

To make it easier to enter and exit the vehicle, the backrest width temporarily opens fully.

Adjusting



- ▶ Press the front section of the button:
The backrest width decreases.
- ▶ Press the rear section of the button:
The backrest width increases.

Upper backrest

Concept

The upper backrest supports the back in the shoulder area. A correct setting leads to a relaxed seating position and reduces strain on the shoulder muscles.

General information

If the driver's door is opened when the drive-ready state is switched off, the upper backrest moves into the standard position.

Adjusting

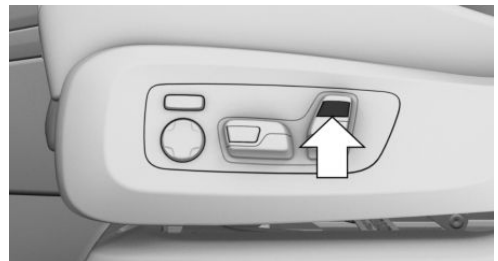

- ▶ Press the front section of the button:
The upper backrest is inclined forward.
- ▶ Press the rear section of the button:
The upper backrest is inclined backward.

Gentleman function

Concept

The front passenger seat can be adjusted with the switches of the driver's seat, for instance to increase the legroom in the rear.

Overview



 Gentleman function

Switching on

-  Press the button. The LED lights up.
- Adjust the front passenger seat on the driver's seat.

If needed, store the memory position for the front passenger seat.

Switching off

 Press the button. The LED goes out.
The function deactivates itself automatically after some time.

Rear seats

Second row of seats

General information

The seats of the second row of seats can be adjusted forward and backward including the backrest tilt.

The backrest tilt for the center section is adjusted together with the left rear seat backrest.

Safety information

Warning

There is a risk of jamming when moving the seats. There is a risk of injury or risk of damage to property. Make sure that the area of movement of the seat is clear prior to any adjustment.

Warning

There is a risk of jamming when folding down the center armrest in the rear. There is a risk of injury. Make sure that the area of movement of the center armrest is clear during folding down.

Warning

When folding back the second row of seats, there is a danger of jamming. There is a risk of injury or risk of damage to property. Make sure that the area of movement of the second row of seats is clear prior to folding down.

Warning

Seats in the second row of seats are not locked when they are folded down and they can move. There is a risk of injury and risk of damage to property. Only fold the seats in the second row down while loading. When driving without a load, fold back and lock the seats in the second row before driving away.

Overview

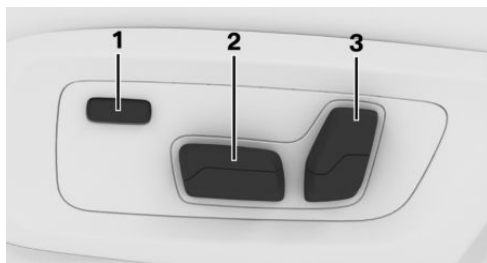

- 1 Resetting to standard position
- 2 Forward/backward
- 3 Backrest tilt

Resetting to standard position

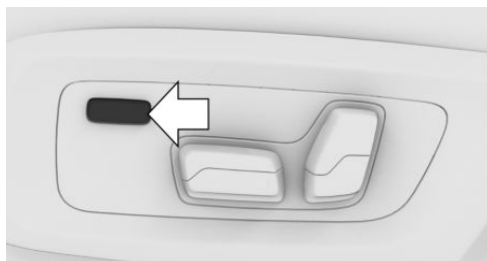

Press the button to reset to standard position. The process is canceled if the button is pressed again.

Forward/backward

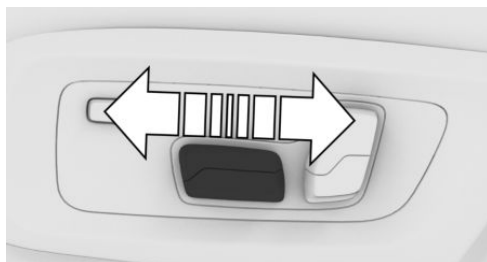

Push switch forward or backward.

Backrest tilt

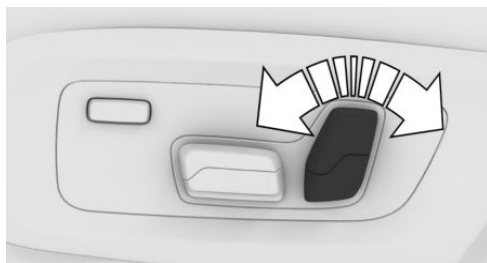

Move switch forward or backward.

Access to the third row of seats

Safety information

Warning

If a rear seat backrest is not locked, unsecured cargo can be thrown about the car's interior; for instance, in the event of an accident, braking or an evasive maneuver. There is a risk of injury. Make sure that the rear seat backrest is locked after folding it back.

Fold down rear seat backrest

1. Fold middle section of the second seat row up as necessary.
2. Push the switch once forward or backward.

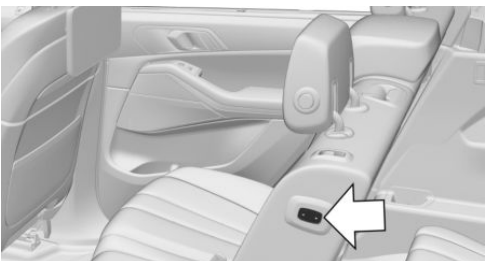

The seat automatically moves to the respective end position.

To avoid a collision, the position of the front seats may be adjusted automatically.

If the second row of seats is not locked, an acoustic signal will sound and a warning symbol will be displayed in the instrument cluster.

Third row of seats

General information

The third row of seats consists of two divided seats.

Fold up the backrest

Safety information

Warning

If a rear seat backrest is not locked, unsecured cargo can be thrown about the car's interior; for instance, in the event of an accident, braking or an evasive maneuver. There is a risk of injury. Make sure that the rear seat backrest is locked after folding it back.

1. Fold up and engage the backrest.

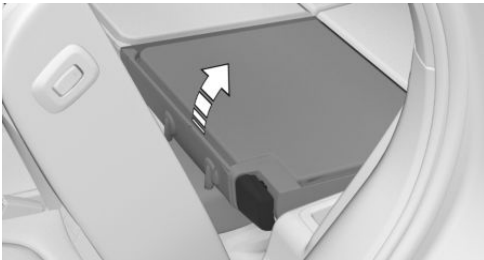

2. Adjust the head restraint correctly as needed.

Fold down rear seat backrest

1. Move the head restraints down, refer to page 120.

2. Slide the lever forward to unlock the backrest.



3. Fold the backrest down.

Exiting from the third row of seats

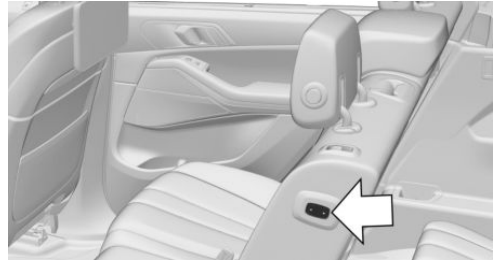

The second row of seats can be folded down with the switch, refer to page 115.

Emergency unlocking rear seat backrest

General information

The two outer backrests of the second seat row can be folded down manually, such as in the event of an electrical fault.

Unlocking from the second seat row



Pull the loop and fold the rear seat backrest forward.

Unlocking from the third seat row

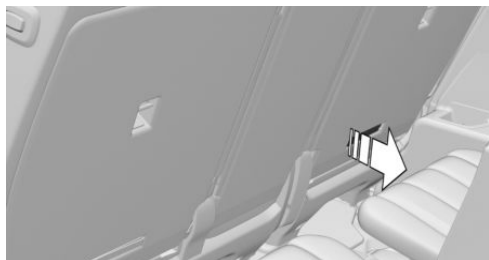

Pull the loop and fold the rear seat backrest forward.

Safety switch for the rear



Press the button on the driver's door.

This locks various functions so that they cannot be operated from the rear. Safety switch, refer to page [107](#).

Safety belts

Number of safety belts and safety belt buckles

The vehicle is fitted with five or seven safety belts to ensure occupant safety. However, they can only offer protection when adjusted correctly.

The two outer safety belt buckles of the second row of seats are intended for the persons sitting on the left and right.

The center safety belt buckle of the second row of seats is intended for the person sitting in the middle.

General information

Always make sure that safety belts are being worn by the occupants before driving off. The airbags supplement the safety belts as an additional safety device. The airbags are not a substitute for safety belts.

The upper shoulder strap's anchorage point will be correct for adult seat occupants of every build if the seat is correctly adjusted.

Safety information

Warning

Use of a safety belt to buckle more than one person will potentially defeat the ability of the safety belt to serve its protective function. There is a risk of injuries or danger to life. Do not allow more than one person to wear a single safety belt. Infants and children are not allowed on an occupant's lap, but must be transported and secured in designated child restraint systems.

Warning

The efficacy of safety gear, including safety belts, can be limited or lost when safety belts are fastened incorrectly. An incorrectly fastened safety belt can cause additional injuries, for instance in the event of an accident or during braking and evasive maneuvers. There is a risk of injuries or danger to life. Make sure that all occupants are wearing safety belts correctly.

Warning

With a rear backrest that is not locked, the protective function of the middle safety belt is not guaranteed. There is a risk of injuries or danger to life. If you are using the middle safety belt, lock the wider rear seat backrest.

Warning

The efficacy of safety gear, including safety belts, may not be fully functional or fail in the following situations:

- ▷ The safety belts or safety belt buckles are damaged, soiled, or changed in any other way.
- ▷ Belt tensioners or belt retractors were modified.

Safety belts can be imperceptibly damaged in the event of an accident. There is a risk of injuries or danger to life. Do not modify safety belts, safety belt buckles, belt tensioners, belt retractors or belt anchors and keep them clean. Have the safety belts checked after an accident at the dealer's service center or another qualified service center or repair shop.

Correct use of safety belts

- ▷ Wear the safety belt twist-free and tight to your body over your lap and shoulders.
- ▷ Wear the safety belt deep on your hips over your lap. The safety belt may not press on your stomach.
- ▷ Do not rub the safety belt against sharp edges, or guide it or jam it in across hard or fragile objects.
- ▷ Avoid thick clothing.
- ▷ Re-tighten the safety belt frequently upward around your upper body.

Buckling the safety belt

1. Guide the safety belt slowly over shoulder and hip to put it on.
2. Insert the tongue plate into the safety belt buckle. The safety belt buckle must engage audibly.

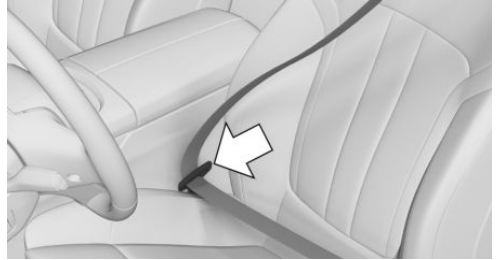

To ease accessibility to the safety belt buckle, an adjustable slider is available on the belt to help position the buckle when not in use.

When the safety belt is fastened, the driver's and passenger's belt straps are automatically tightened once after driving away.

Unbuckling the safety belt

1. Hold the safety belt firmly.
2. Press the red button in the safety belt buckle.
3. Guide the safety belt back into its roll-up mechanism.

Safety belt reminder for driver's seat and front passenger seat**Display in the instrument cluster**

The indicator light lights up and a signal sounds. Make sure that the safety belts are positioned correctly. The safety belt reminder can also be activated if objects are placed on the front passenger seat.

Safety belt reminder for rear seats



General information

The safety belt reminder is automatically activated each time the engine starts.

The safety belt reminder is also activated when a passenger unbuckles a rear seat safety belt during the trip.

Display in the instrument cluster

The indicator light in the instrument cluster illuminates after the engine is started.

Symbol	Description
	Green: the safety belt is buckled on the corresponding rear seat.
	Red: the safety belt is not buckled on the corresponding rear seat.

Safety mode

In critical situations, for instance during an emergency stop, the front safety belts tighten automatically.

If the situation passes without an accident occurring, the belt tension relaxes.

If the belt tension does not loosen automatically, stop the vehicle and unbuckle the safety belt using the red button in the safety belt buckle. Fasten the safety belt before continuing on your trip.

Front head restraints

General information

The current head restraint position can be stored using the memory function.

Safety information

Warning

A missing protective effect due to removed or not correctly adjusted head restraints can cause injuries in the head and neck area. There is a risk of injury.

- ▷ Before driving, install the removed head restraints on the occupied seats.
- ▷ Adjust the head restraint so its center supports the back of the head at as close to eye level as possible.
- ▷ Adjust the distance so that the head restraint is as close as possible to the back of the head. Adjust the distance via the backrest tilt as needed.

Warning

Body parts can be jammed when moving the head restraint. There is a risk of injury. Make sure that the area of movement is clear when moving the head restraint.

Warning

Objects on the head restraint reduce the protective effect in the head and neck area. There is a risk of injury.

- ▷ Do not use seat or head restraint covers.
- ▷ Do not hang objects, for instance clothes hangers, directly on the head restraint.
- ▷ Only use accessories that have been determined to be safe for attachment to a head restraint.
- ▷ Do not use any accessories, for instance pillows, while driving.

Active head restraint

In the event of a rear-end collision with a certain severity, the active head restraint automatically reduces the distance from the head.

Have the active head restraint checked and if necessary replaced in the case of damage or if it was exposed to an accident.

Adjusting the height

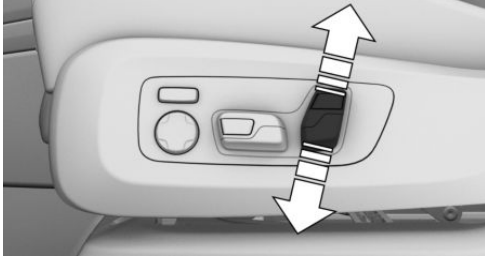

Push switch up or down.

Adjusting distance



- ▷ Back: press the button and push the head restraint toward the rear.
- ▷ Forward: pull the head restraint toward the front.

After setting the distance, make sure that the head restraint engages correctly.

Adjusting the side extensions



Fold the side extensions on the head restraint forward for increased lateral support in the resting position.

Removing

The head restraints cannot be removed.

Rear head restraints

Safety information

Warning

A missing protective effect due to removed or not correctly adjusted head restraints can cause injuries in the head and neck area. There is a risk of injury.

- ▷ Before driving, install the removed head restraints on the occupied seats.
- ▷ Adjust the head restraint so its center supports the back of the head at as close to eye level as possible.
- ▷ Adjust the distance so that the head restraint is as close as possible to the back of the head. Adjust the distance via the backrest tilt as needed.

⚠ Warning

Body parts can be jammed when moving the head restraint. There is a risk of injury. Make sure that the area of movement is clear when moving the head restraint.

⚠ Warning

Objects on the head restraint reduce the protective effect in the head and neck area. There is a risk of injury.

- ▷ Do not use seat or head restraint covers.
- ▷ Do not hang objects, for instance clothes hangers, directly on the head restraint.
- ▷ Only use accessories that have been determined to be safe for attachment to a head restraint.
- ▷ Do not use any accessories, for instance pillows, while driving.

Folding down the head restraints

To improve the view to the rear, the outside head restraints can be folded back. Only fold the head restraint back if no one will be sitting in the corresponding seat.

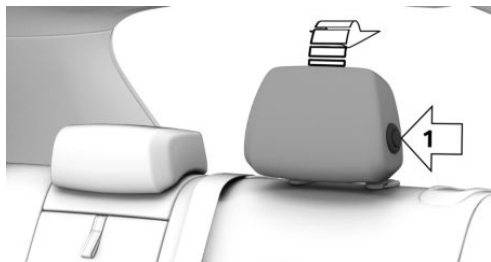

- ▷ To the rear: press the button, arrow 1, and fold the head restraint backward.
- ▷ Forward: fold the head restraint toward the front as far as it will go. Make sure that the head restraint engages correctly.

Adjusting the height

- ▷ To lower: press the button, arrow 1, and push the head restraint down.
- ▷ To raise: push the head restraint up.

After setting the height, make sure that the head restraint engages correctly.

Removing

The head restraints cannot be removed.

Cushions for head restraints in the rear

Only use the pillow when the vehicle is switched off.

1. Bring the head restraint to a sufficiently high position.
2. Attach the pillow and place the pillow band around the back of the head restraint, arrow 1.

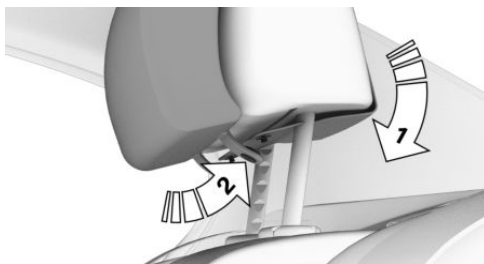

3. Close pushbuttons, arrow 2.

Exterior mirrors

General information

The mirror on the front passenger side is more curved than the driver's side mirror.

The mirror setting is stored for the driver profile currently in use. When a driver profile is selected, the stored position is called up automatically.

The current exterior mirror position can be stored using the memory function.

Safety information

Warning

Objects reflected in the mirror are closer than they appear. The distance to the traffic behind could be incorrectly estimated, for instance while changing lanes. There is a risk of accident. Estimate the distance to the traffic behind by looking over your shoulder.

Overview

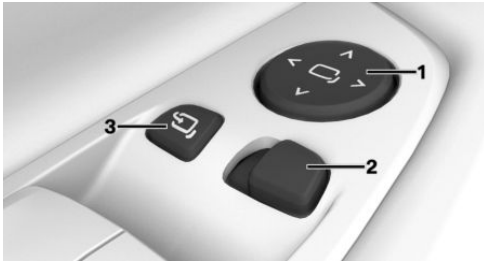

- 1 Adjusting
- 2 Selecting a mirror, Automatic Curb Monitor
- 3 Folding in and out

Adjusting electrically



Press the button.

The selected mirror moves along with the button movement.

Selecting a mirror



To change over to the other mirror:

Slide the switch.

Malfunction

In case of an electrical malfunction, adjust the mirror by pressing the edges of the mirror glass.

Folding in and out

NOTICE

Depending on the vehicle width, the vehicle can be damaged in vehicle washes. There is a risk of damage to property. Before washing, fold in the mirrors by hand or with the button.



Press the button.

Folding is only possible up to a speed of approx. 15 mph/20 km/h.

Folding the mirrors in and out is helpful in the following situations:

- ▷ In vehicle washes.
- ▷ On narrow roads.

Mirrors that were folded in are folded out automatically at a speed of approx. 25 mph/40 km/h.

Automatic heating

Both exterior mirrors are automatically heated as needed and when the drive-ready state is switched on.

Automatic dimming feature

The exterior mirror on the driver's side is automatically dimmed. Photocells in the car's interior mirror, refer to page 123, are used to control this.

Automatic Curb Monitor, exterior mirror

Concept

If reverse gear is engaged, the mirror glass on the front passenger side is tilted downward. This improves your view of the curb and other formatting issue - low-lying obstacles when parking, for instance.

Activating

-  slide the switch to the driver's side mirror position.
- Engage selector lever position R.

When the trailer socket is in use or trailer towing is activated, the Automatic Curb Monitor is deactivated.

Deactivating

Slide the switch to the passenger's side mirror position.

Interior mirror

General information

The interior mirror is dimmed automatically.

Photocells are used for control:

- ▷ In the mirror glass.
- ▷ On the back of the mirror.

Overview

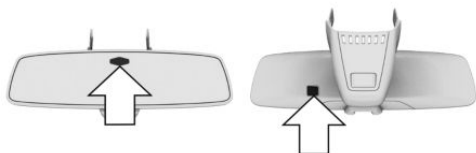

Functional requirements

- ▷ Keep the photocells clean.
- ▷ Do not cover the area between the interior mirror and the windshield.

Steering wheel

Safety information

Warning

Steering wheel adjustments while driving can lead to unexpected steering wheel movements. Vehicle control could be lost. There is a risk of accident. Adjusting the steering wheel while the vehicle is stationary only.

Electric steering wheel adjustment

General information

The steering wheel setting is stored for the driver profile currently in use. When a driver profile is selected, the position is accessed automatically when the drive-ready state is switched on.

The current steering wheel position can be stored using the memory function.

Adjusting

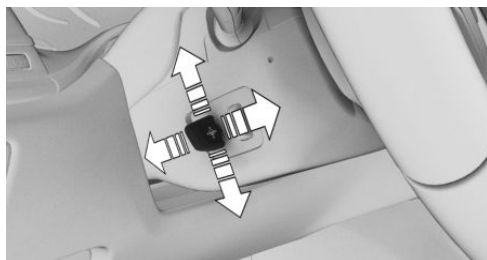

Move the steering wheel to the preferred height and angle to suit your seating position by pressing the switch.

Assistance getting in and out

The steering wheel temporarily moves into the highest position to make it easier to enter and exit the vehicle.

Heated steering wheel

Overview



Button for heated steering wheel

Switching on/off



Press the button.

A Check Control message is displayed.

If the trip is resumed within approx. 15 minutes after an intermediate stop, the heated steering wheel activates automatically if the function was switched on at the end of the last trip.

Memory function

Concept

The following settings can be stored and, if necessary, retrieved using the memory function:

- ▷ Seat position.
- ▷ Exterior mirror position.
- ▷ Steering wheel position.
- ▷ Height of the Head-up Display.

General information

Two memory locations with different settings can be set for each driver profile.

The following settings are not stored:

- ▷ Backrest width.
- ▷ Lumbar support.

Safety information

Warning

Using the memory function while driving can lead to unexpected seat or steering wheel movements. Vehicle control could be lost. There is a risk of accident. Only retrieve the memory function when the vehicle is stationary.

Warning

There is a risk of jamming when moving the seats. There is a risk of injury or risk of damage to property. Make sure that the area of movement of the seat is clear prior to any adjustment.

Overview



The memory buttons are located on the front doors.

Storing

1. Set the desired position.
2.  Press the button. The writing on the button lights up.
3. Press desired button 1 or 2 while the LED is lit. A signal sounds.

Calling up settings

Press the desired button 1 or 2.

The stored position is called up.

The procedure stops when a switch for setting the seat is pressed or one of the memory buttons is pressed again.

Once underway, adjustment of the seat position on the driver's side is disabled after a short while.

Massage function

Concept

Depending on the program, the massage function ensures relaxed muscles and better blood circulation and can avoid fatigue.

General information

Eight different massage programs can be selected:

- ▶ Pelvis activation.
- ▶ Upper body activation.
- ▶ Full body activation.
- ▶ Back massage.
- ▶ Shoulder massage.
- ▶ Lumbar massage.
- ▶ Upper body training.
- ▶ Full body training.

Overview



Massage function

Switching on



Press the button once for each intensity level.

The maximum intensity level is reached when three LEDs are lit.

Switching off



Press and hold the button until the LEDs go out.

Adjusting the massage program

Via iDrive:

1. "CAR"
2. "Settings"
3. "Seat comfort"
4. Select desired seat.
5. "Seat massage"
6. Select the desired setting.

Seat and armrest heating

Concept

The system heats seats and armrests as needed.

General information

Seat heating can also be used without armrest heating. Deactivate the armrest heating as needed.

Overview

Front

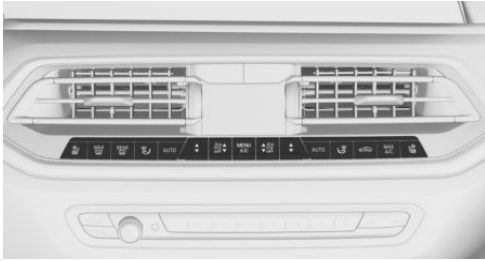

Seat and armrest heating

Rear



Seat heating

Switching on

1.  Press the button.
2. Select the temperature level:
 - ▶ Press the button once for each level.
 - ▶ Turn the Controller until the desired level is reached. Press the Controller.
 - ▶ Select the desired level on the touch-screen.

Highest level reached when three red LEDs light up on the button or three red bars are shown on the Control Display.

When ECO PRO is activated, refer to page 332, the heating output is reduced.

If the trip is continued within approx. 15 minutes after a stop, functions are activated automatically with the temperature selected last.

Switching off



Press and hold the button, until the LEDs go out.

Seat heating distribution

The heating action in the seat cushion and the seat backrest can be distributed in different ways.

Via iDrive:

1. "CAR"
2. "Settings"
3. "Climate control"
4. Select the desired menu item.
5. Select desired seat.
6. Press the Controller and turn it to set the seat heating distribution.

Switching armrest heating on/off

Via iDrive:

1. "CAR"
2. "Settings"
3. "Climate control"
4. "Seat and armrest heating"
5. Select desired seat.
6. "Heat armrests with seat"

Active seat ventilation

Concept

Integrated fans in the seat and armrest areas provide a comfortable seat temperature.

Overview

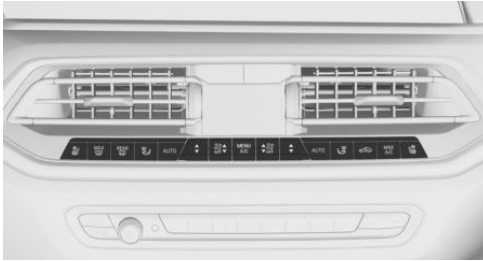

 Active seat ventilation

Switching on

-  Press the button.
- Select the ventilation level:
 - ▶ Press the button once for each level.
 - ▶ Turn the Controller until the desired level is reached. Press the Controller.
 - ▶ Select the desired level on the touch-screen.

Highest level reached when three blue LEDs light up on the button or three blue bars are shown on the Control Display.

Switching off

 Press and hold the button, until the LEDs go out.

Seat climate control

Concept

The seat climate control combines the functions of the seat heating and active seat ventilation.

General information

The seat heating and active seat ventilation are operated with a common button on the climate control panel.

When both systems are active, a push of the button reduces the intensity of both functions by one level each.

The last active function or function that is configured with higher intensity will be activated directly when the system is switched on again. When both functions with the same intensity configuration are deactivated, the system will automatically activate the seat heating.

Overview

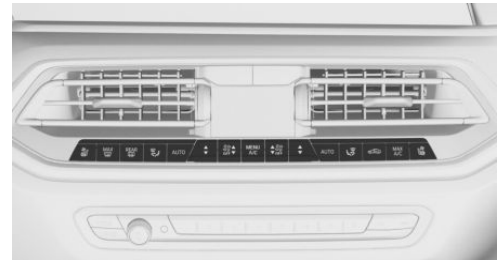

 Seat climate control

Switching on

-  Press the button.
- Select the desired setting via the touch-screen.

One red and one blue LED each will illuminate.

Switching off

 Press and hold the button, until the LEDs go out.

Transporting children safely

Vehicle features and options

This chapter describes all standard, country-specific and optional features offered with the series. It also describes features and functions that are not necessarily available in your vehicle, e.g., due to the selected options or country versions. This also applies to safety-related functions and systems. When using these functions and systems, the applicable laws and regulations must be observed.

The right place for children

Safety information

Warning

Unattended children or animals in the vehicle can cause the vehicle to move and endanger themselves and traffic, for instance due to the following actions:

- ▷ Pressing the Start/Stop button.
- ▷ Releasing the parking brake.
- ▷ Opening and closing the doors or windows.
- ▷ Engaging selector lever position N.
- ▷ Using vehicle equipment.

There is a risk of accidents or injuries. Do not leave children or animals unattended in the vehicle. Take the vehicle key with you when exiting and lock the vehicle.

Warning

A heated vehicle may result in death to persons, especially children and animals. There is a risk of injuries or danger to life. Do not leave persons, especially children and animals unattended in the vehicle.

Warning

Exposure to intense sunlight can cause child restraint systems and their components to become very hot. Persons may sustain burn injuries when touching the hot components. There is a risk of injury. Do not expose the child restraint system to direct sunlight or cover where necessary. If necessary, let the child restraint system cool down before transporting a child. Do not leave children unattended in the vehicle.

Always transport children in the rear seat

General information

Accident research shows that the safest place for children is in the rear seat.

Transport children younger than 13 years of age or shorter than 5 ft/150 cm only in the rear seat in suitable child restraint systems designed for the age, weight and size of the child. Children 13 years of age or older must wear a safety belt as soon as a suitable child restraint system can no longer be used due to their age, weight, or size.

Safety information

Warning

The safety belt cannot be fastened correctly on children shorter than 5 ft, 150 cm without suitable additional child restraint systems. The efficacy of safety gear, including safety belts, can be limited or lost when safety belts are fastened incorrectly. An incorrectly fastened safety belt can cause additional injuries, for instance in the event of an accident or during braking and evasive maneuvers. There is a risk of injuries or danger to life. Secure children shorter than 5 ft, 150 cm using suitable child restraint systems.

Children on the front passenger seat

General information

Before using a child restraint system on the front passenger seat, ensure that the front, knee, and side airbags on the front passenger side are deactivated. For automatic deactivation of front-seat passenger airbags, refer to page 181.

Safety information

Warning

Active front-seat passenger airbags can injure a child in a child restraint system when the airbags are activated. There is a risk of injury. Make sure that the front-seat passenger airbags are deactivated and that the PASSENGER AIRBAG OFF indicator light lights up.

Installing child restraint systems

General information

Pay attention to the specifications and the operating and safety information of the child restraint system manufacturer when selecting, installing, and using child restraint systems.

Safety information

Warning

The protective effect of child restraint systems and their fastening systems which have been damaged or exposed to an accident can be limited or lost. A child cannot be properly restrained in the event of an accident or braking and evasive maneuvers. There is a risk of injuries or danger to life.

Do not use child restraint systems which have been damaged or exposed to an accident.

If a child restraint system and its fastening system has been damaged or exposed to an accident, have these systems checked and replaced by the dealer's service center or another qualified service center or repair shop.

Warning

The stability of the child restraint system is limited or compromised with incorrect seat adjustment or improper installation of the child seat. There is a risk of injuries or danger to life. Make sure that the child restraint system fits securely against the backrest. If possible, adjust the backrest tilt for all affected backrests and correctly adjust the seats. Make sure that seats and backrests are securely engaged or locked. If possible, adjust the height of the head restraints or remove them.

Before mounting

Before mounting child restraint systems, ensure that the rear seat backrests are locked.

Move the rear seats into the rearmost position to facilitate assembly of the child restraint system.

Third row of seats

Before installing a child restraint system on the third row of seats, note the following:

- ▷ Roll up the cargo cover and remove the case.
- ▷ Depending on the equipment version: lower the electric cargo cover.
- ▷ Remove the cargo area partition net.
- ▷ Bring seats and backrests of the second row of seats into the most forward position.
- ▷ Fold down the respective backrest of the second row of seats and lock.
- ▷ Raise the head restraints of the third row of seats into the highest position.

Do not change the settings that have been made after this.

On the front passenger seat

Deactivating airbags

Warning

Active front-seat passenger airbags can injure a child in a child restraint system when the airbags are activated. There is a risk of injury. Make sure that the front-seat passenger airbags are deactivated and that the PASSENGER AIRBAG OFF indicator light lights up.

Before installing a child restraint system in the front passenger seat, make sure that the front, knee and side airbags on the front passenger side are deactivated.

Deactivate the front-seat passenger airbags automatically, refer to page 181.

Seat position and height

Before installing a child restraint system, move the front passenger seat as far back as it will go and, if possible, bring it up to medium height. This seat position and height ensure the best possible position for the belt and offers optimal protection in the event of an accident.

If the upper anchor of the safety belt is located in front of the belt guide of the child seat, move the front passenger seat carefully forward until the best possible belt guide position is reached.

Backrest width

Adjustable backrest width: before installing a child restraint system in the front passenger seat, open the backrest width completely. Do not change the backrest width again and do not call up a memory position.

Child seat security



The safety belts in the rear and the front passenger safety belt can be permanently locked to fasten child restraint systems.

Locking the safety belt

1. Pull out the belt strap completely.
2. Secure the child restraint system with the safety belt.
3. Allow the belt strap to be pulled in and pull it tight against the child restraint system. The safety belt is locked.

Unlocking the safety belt

1. Unbuckle the safety belt buckle.
2. Remove the child restraint system.
3. Allow the belt strap to be pulled in completely.

LATCH child restraint fixing system

General information

LATCH: Lower Anchors and Tether for Children.

Pay attention to the specifications and the operating and safety information from the child restraint system manufacturer when selecting, installing, and using LATCH child restraint fixing systems.

Mounts for the lower LATCH anchors

General information

The lower anchors may be used to attach the CRS to the vehicle seat up to a combined child and CRS weight of 65 lbs/30 kg when the child is restrained by the internal harnesses.

Safety information

Warning

If the LATCH child restraint fixing systems are not correctly engaged, the protective effect of the LATCH child restraint fixing system can be limited. There is a risk of injuries or danger to life. Make sure that the lower anchors are securely engaged and that the LATCH child restraint fixing system fits securely against the backrest.

Position

Symbol Meaning

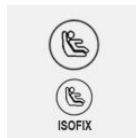

The corresponding symbol shows the mounts for the lower LATCH anchors.

Seats equipped with lower anchors are marked with a pair, (2), of LATCH symbols.

For vehicles equipped with a middle seat:

It is not recommended to use the inner lower anchors of standard outer LATCH positions to fasten a child restraint system on the middle seat. Use the vehicle safety belt instead for the middle seat.

Before installing LATCH child restraint fixing systems

Pull the safety belt away from the area of the child restraint system.

Assembly of LATCH child restraint fixing systems

1. Install child restraint system, see manufacturer's information.
2. Ensure that both LATCH anchors are properly engaged.

Child restraint systems with tether strap

Safety information

Warning

If the upper retaining strap is incorrectly used for the child restraint system, the protective effect can be reduced. There is a risk of injury. Make sure that the upper retaining strap does not run over sharp edges and is not twisted as it passes the upper anchor.

Warning

If the rear backrest is not locked, the protective effect of the child restraint system is limited or there is none. In certain situations, for instance braking maneuvers or in case of an accident, the rear backrest can fold forward. There is a risk of injuries or danger to life. Make sure that the rear backrests are locked.

NOTICE

The anchors for the upper retaining straps of child restraint systems are only provided for these retaining straps. When other objects are mounted, the anchors can be damaged. There is a risk of damage to property. Only mount child restraint systems to the upper anchors.

Anchors

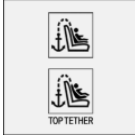
Symbol	Meaning
	The respective symbol shows the anchor for the upper retaining strap. Seats with an upper top tether are marked with this symbol. It can be found on the rear seat backrest or the rear window shelf.

Routing the retaining strap

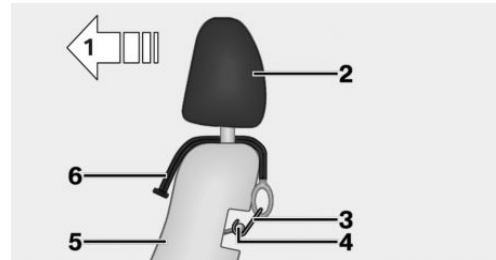

- 1 Direction of travel
- 2 Head restraint
- 3 Hook for upper retaining strap
- 4 Anchor
- 5 Seat backrest
- 6 Upper retaining strap

Attaching the upper retaining strap to the anchor

1. Bring the seat of the second seat row into the base position.
Reset to standard position, refer to page 115.
2. Raise the head restraint, if needed.
3. Guide the upper retaining strap between or along both sides of the supports for the head restraint to the anchor.

Middle seat: raise the head restraint, if needed, press the button on the mounts for this purpose. Guide the upper retaining strap

between or along both sides of the supports of the head restraint to the anchor.

4. If there is a retaining strap, run it between the backrest and the cargo cover.
5. Attach the hook of the retaining strap to the anchor.
6. Tighten the retaining strap by pulling it down.
7. Lower and engage head restraint as needed.

Locking the doors and windows in the rear

General information

In certain situations it may be advisable to secure the rear doors and windows, for instance when transporting children.

Doors



Push the locking lever on the rear doors up.

The door can now be opened from the outside only.

Safety switch for the rear



Press the button on the driver's door.

This locks various functions so that they cannot be operated from the rear. Safety switch, refer to page [107](#).

Driving

Vehicle features and options

This chapter describes all standard, country-specific and optional features offered with the series. It also describes features and functions that are not necessarily available in your vehicle, e.g., due to the selected options or country versions. This also applies to safety-related functions and systems. When using these functions and systems, the applicable laws and regulations must be observed.

Start/Stop button

Concept



Pressing the Start/Stop button switches drive-ready state on or off, refer to page 37.

Drive-ready state is switched on when you depress the brake

pedal while pressing the Start/Stop button.

Pressing the Start/Stop button again switches the drive-ready state back off and standby state, refer to page 37, is switched back on.

Driving away

1. Switch on drive-ready state.
2. Apply drive mode.
3. Release the parking brake.
4. Drive away.

Auto Start/Stop function

Concept

The Auto Start/Stop function helps save fuel. The system switches off the engine during a stop, for instance in traffic congestion or at traffic lights. Drive-ready state remains switched on. The engine starts automatically for driving off.

General information

After each engine start using the Start/Stop button, the Auto Start/Stop function is ready. The function is activated from speeds of approx. 3 mph/5 km/h.

Depending on the selected driving mode, the system is automatically activated or deactivated.

Engine stop

Functional requirements

Steptronic transmission

The engine is switched off automatically during a stop under the following conditions:

- ▷ The selector lever is in selector lever position D.
- ▷ The brake pedal remains pressed while the vehicle is stationary or the vehicle is held by Automatic Hold.
- ▷ The driver's safety belt is buckled or the driver's door is closed.

Manual engine stop

If the engine was not switched off automatically when the vehicle stopped, the engine can be switched off manually:

- ▷ Press the brake pedal forcefully again from the current pedal position.
- ▷ Engage selector lever position P.

When all functional preconditions are fulfilled, the engine switches off.

Air conditioner when the engine is switched off

The air flow from the air conditioner is reduced when the engine is switched off.

Displays in the instrument cluster

General information



The display in the tachometer indicates that the Auto Start/Stop function is ready for an Automatic engine start.



The display indicates that the conditions for an automatic engine stop have not been met.

Total time with switched-off engine

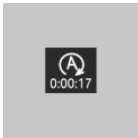

ECO PRO, refer to page 332, driving mode: depending on the vehicle equipment, the total time that the engine has been switched off using the Auto Start/

Stop function is displayed on an automatic engine stop.

The total time can be reset via the trip data.

Functional limitations

The engine is not switched off automatically in the following situations:

- ▷ In case of a steep downhill grade.
- ▷ Brake not engaged strongly enough.
- ▷ The external temperature is high and automatic climate control is running.
- ▷ The car's interior has not yet been heated or cooled to the required level.

- ▷ Where there is a risk of window condensation when the automatic climate control is switched on.
- ▷ Engine or other parts not at operating temperature.
- ▷ Engine cooling is required.
- ▷ The wheels are at a sharp angle or the steering wheel is being turned.
- ▷ Vehicle battery is heavily discharged.
- ▷ At higher elevations.
- ▷ The hood is unlocked.
- ▷ HDC Hill Descent Control is activated.
- ▷ The parking assistant is activated.
- ▷ Stop-and-go traffic.
- ▷ Selector lever position in N or R.
- ▷ After driving in reverse.
- ▷ Use of fuel with high ethanol content.

Starting the engine

Functional requirements

Steptronic transmission

The engine starts automatically under the following preconditions:

- ▷ By releasing the brake pedal.
- ▷ When Automatic Hold is activated: press the accelerator pedal.

Driving off

After the engine starts, accelerate as usual.

Safety mode

After the engine switches off automatically, it will not start again automatically if any one of the following conditions are met:

- ▷ The driver's safety belt is unbuckled and the driver's door is open.
- ▷ The hood was unlocked.

Some indicator lights light up for a varied length of time.

The engine can only be started via the Start/Stop button.

System limits

Even if driving off was not intended, the deactivated engine starts up automatically in the following situations:

- ▷ Excessive warming of the car's interior when the air conditioning is switched on.
- ▷ Excessive cooling of the car's interior when the heating is switched on.
- ▷ Where there is a risk of window condensation when the automatic climate control is switched on.
- ▷ When the steering wheel is turned.
- ▷ Change from selector lever position D to N or R.
- ▷ Change from selector lever position P to N, D, or R.
- ▷ Vehicle battery is heavily discharged.
- ▷ Start of an oil level measurement.

Intelligent Auto Start/Stop function

Depending on the vehicle equipment and country-specific version, the vehicle features a variety of sensors for assessing the traffic situation. The Intelligent Auto Start/Stop function uses this information to adapt to various traffic situations in a proactive manner.

For instance, this applies to the following situations:

- ▷ When a situation is detected in which the stopping time is expected to be very short, the engine is not switched off automatically. A message appears on the Control Display, depending on the situation.
- ▷ When a situation is detected in which the vehicle needs to drive off immediately, the engine is started automatically.

The function may be restricted if the navigation data is invalid, outdated or not available, for example.

Deactivate/activate the system manually

Concept

The engine is not automatically switched off.

The engine is started during an automatic engine stop.

Using the button



 Press the button.

Via selector lever position or Driving Dynamics Control

The Auto Start/Stop function is also deactivated in selector lever position M/S or in SPORT driving mode of the Driving Dynamics Control.

Display

- ▷ LED comes on: auto Start/Stop function is deactivated.
- ▷ LED goes out: auto Start/Stop function is activated.

Switching off the vehicle during an automatic engine stop

General information

During an automatic engine stop, the vehicle can be switched off permanently, for instance when leaving it.

Steptronic transmission

1. Press the Start/Stop button.
 - ▷ Drive-ready state is switched off.
 - ▷ Standby state is switched on.
 - ▷ Selector lever position P is engaged automatically.
2. Set the parking brake.

Automatic deactivation

General information

In certain situations, the Auto Start/Stop function is deactivated automatically for safety reasons, for instance if no driver is detected.

Malfunction

The Auto Start/Stop function no longer switches off the engine automatically. A Check Control message is displayed. It is possible to continue driving. Have the system checked by a dealer's service center or another qualified service center or repair shop.

Driving Dynamics Control

Concept

The Driving Dynamics Control influences the driving dynamics properties of the vehicle.

The vehicle can be adjusted depending on the situation using various driving modes.

General information

The following systems are affected, for instance:

- ▷ Engine characteristics.
- ▷ Steptronic transmission.
- ▷ Steering.
- ▷ Integral Active Steering.
- ▷ Adaptive M chassis.
- ▷ Adaptive M Chassis Professional.
- ▷ Two-axle ride level control.
- ▷ Display in the instrument cluster.
- ▷ Cruise control.

Overview



Displays in the instrument cluster



The selected driving mode is displayed in the instrument cluster.

Driving modes



Buttons in the vehicle

Button	Driving mode	Configuration
SPORT	SPORT	INDIVIDUAL
SPORT	SPORT PLUS	

Button	Driving mode	Configuration
COMFORT	COMFORT	
ECO PRO	ECO PRO	INDIVIDUAL
ADAPTIVE	ADAPTIVE	

When drive-ready state is switched on, the COMFORT driving mode is selected automatically.

Driving modes in detail

COMFORT

Concept

Balanced tuning between dynamic and efficient driving.

Switching on

 Press the button repeatedly until COMFORT is displayed in the instrument cluster.

SPORT

Concept

Dynamic tuning for higher agility with an optimized chassis and suspension.

Switching on

 Press the button repeatedly until SPORT is displayed in the instrument cluster.

SPORT INDIVIDUAL

Concept

Individual settings can be adjusted in the SPORT INDIVIDUAL driving mode.

Configuration

Via iDrive:

1. "CAR"
2. "Settings"
3. "Driving mode"
4. "SPORT INDIVIDUAL"
5. Select the desired setting:

The setting is stored for the driver profile currently used.

Reset SPORT INDIVIDUAL to the standard settings:

"Reset to SPORT STANDARD".

SPORT PLUS

Concept

Dynamic tuning for maximum agility with an adjusted drive.

Switching on

 Press the button repeatedly until SPORT PLUS is displayed in the instrument cluster.

ECO PRO

Concept

Efficient driving setting.

Switching on

 Press the button repeatedly until ECO PRO is displayed in the instrument cluster.

ECO PRO INDIVIDUAL

Concept

Individual settings can be adjusted in the ECO PRO INDIVIDUAL driving mode.

Configuration

Via iDrive:

1. "CAR"
2. "Settings"
3. "Driving mode"
4. "ECO PRO INDIVIDUAL"
5. Select the desired setting.

The setting is stored for the driver profile currently used.

Reset ECO PRO INDIVIDUAL to the standard settings:

"Reset to ECO PRO STANDARD".

ADAPTIVE

Concept

Comfort-oriented driving mode, whose tuning is automatically modified to the driving situation and driving style.

If the navigation system is active, upcoming road sections are considered.

Switching on

 Press the button. ADAPTIVE is displayed in the instrument cluster.

INDIVIDUAL configuration

General information

The individual configuration of the driving mode is stored for the active driver profile. The last set configuration is activated directly when the driving mode is called up again.

Activating configuration of the driving mode

Press the button for the desired driving mode several times.

Parking brake

Concept

The parking brake is used to prevent the vehicle from rolling when it is parked.

Safety information

Warning

An unsecured vehicle can begin to move and possibly roll away. There is a risk of accident. Before exiting, secure the vehicle against rolling.

In order to ensure that the vehicle is secured against rolling away, follow the following:

- ▷ Set the parking brake.
- ▷ On uphill grades or on a downhill slope, turn the front wheels in the direction of the curb.
- ▷ On uphill grades or on a downhill slope, also secure the vehicle, for instance with a wheel chock.

Warning

Unattended children or animals in the vehicle can cause the vehicle to move and endanger themselves and traffic, for instance due to the following actions:

- ▷ Pressing the Start/Stop button.
- ▷ Releasing the parking brake.
- ▷ Opening and closing the doors or windows.
- ▷ Engaging selector lever position N.
- ▷ Using vehicle equipment.

There is a risk of accidents or injuries. Do not leave children or animals unattended in the vehicle. Take the vehicle key with you when exiting and lock the vehicle.

Overview



 Parking brake

Setting

With a stationary vehicle

 Pull the switch.
The LED lights up.

 The indicator light in the instrument cluster illuminates red. The parking brake is set.

While driving

General information

To use as emergency brake while driving.

 Pull the switch and hold it. The vehicle brakes hard while the switch is being pulled.

 The indicator light in the instrument cluster illuminates red, a signal sounds, and the brake lights illuminate.

A Check Control message is displayed.

The parking brake is engaged when the vehicle is stationary.

With Emergency Stop Assistant

 Pull the switch briefly to activate the emergency stop function, refer to page 212.

Releasing

Releasing manually

1. Switch on drive-ready state.
2.  Press the switch while stepping on the brake pedal or selector lever position P is set.
The LED and indicator light go out.
The parking brake is released.

Automatic release

The parking brake is released automatically when you drive away.

The LED and indicator light go out.

Automatic Hold

Concept

This system assists the driver by automatically setting and releasing the brake, such as when moving in stop-and-go traffic.

The vehicle is automatically held in place when it is stationary.

On uphill grades the system prevents the vehicle from rolling backward when driving off.

General information

Under the following conditions, the parking brake is automatically engaged:

- ▷ Drive-ready state is switched off.
- ▷ The driver's door is opened while the vehicle is stationary.
- ▷ The moving vehicle is brought to a standstill using the parking brake.

Display

 The indicator light changes from green to red.

Safety information

Warning

An unsecured vehicle can begin to move and possibly roll away. There is a risk of accident. Before exiting, secure the vehicle against rolling.

In order to ensure that the vehicle is secured against rolling away, follow the following:

- ▷ Set the parking brake.
- ▷ On uphill grades or on a downhill slope, turn the front wheels in the direction of the curb.
- ▷ On uphill grades or on a downhill slope, also secure the vehicle, for instance with a wheel chock.

Warning

Unattended children or animals in the vehicle can cause the vehicle to move and endanger themselves and traffic, for instance due to the following actions:

- ▷ Pressing the Start/Stop button.
- ▷ Releasing the parking brake.
- ▷ Opening and closing the doors or windows.
- ▷ Engaging selector lever position N.
- ▷ Using vehicle equipment.

There is a risk of accidents or injuries. Do not leave children or animals unattended in the vehicle. Take the vehicle key with you when exiting and lock the vehicle.

NOTICE

If the vehicle is stationary, Automatic Hold engages the parking brake and prevents the vehicle from rolling in a vehicle wash. There is a risk of damage to property. Deactivate Automatic Hold prior to entering the vehicle wash.

Overview



 Automatic Hold

Establishing function readiness of Automatic Hold

1. Switch on drive-ready state.
2.  Press the button.

The LED lights up.

 The indicator light lights up green.
Automatic Hold is functional.

After every new vehicle start, the last selected setting is active.

Automatic Hold holding the vehicle

Function readiness is established and the driver's door is closed.

After stepping on the brake pedal, for instance when stopping at a traffic light, the vehicle is automatically secured against rolling.

 The indicator light lights up green.

Driving off

Step on the accelerator pedal to drive off.

The brake is released automatically and the indicator light of the parking brake is no longer illuminated.

Activating the parking brake automatically

The parking brake is automatically set if drive-ready state is switched off while the vehicle is being held by Automatic Hold or if the vehicle is exited.



The indicator light changes from green to red.

The parking brake is not set automatically, if the drive-ready state is switched off, while the vehicle is coasting to a halt. Automatic Hold is deactivated.

Switching function readiness off

AUTO H

Press the button.

The LED goes out.

AUTO H

The indicator light goes out.

Automatic Hold is switched off.

If the vehicle is being held by Automatic Hold, press additionally on the brake pedal, when switching off.

Malfunction

If the parking brake fails or malfunctions, secure the vehicle against rolling before exiting.

A Check Control message is displayed.

Secure the vehicle against rolling away, for instance with a wheel chock, after existing the vehicle.

After a power failure

To reestablish parking brake functionality after a power failure:

1. Switch on standby state.



2. Pull the switch while stepping on the brake pedal or selector lever position P is set and then push.

This process may take a few seconds. Some mechanical sounds associated with this process are normal.



The indicator light is no longer illuminated as soon as the parking brake is ready for operation again.

Turn signal

Turn signal in exterior mirror

When driving and during operation of the turn signals or hazard warning system, do not fold in the exterior mirrors, so that the signal lights on the exterior mirror are easy to see.

Using turn signals

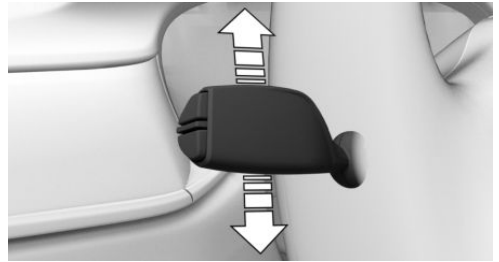

Press the lever past the resistance point.

Triple turn signal activation

Lightly tap the lever up or down.

The triple turn signal duration can be adjusted.

Via iDrive:

1. "CAR"
2. "Settings"
3. "Exterior lighting"
4. "One-touch turn signal"
5. Select the desired setting.

The setting is stored for the driver profile currently used.

Signaling briefly

Press the lever to the resistance point and hold it there for as long as you want the turn signal to flash.

High beams, headlight flasher

Push the lever forward or pull it backward.

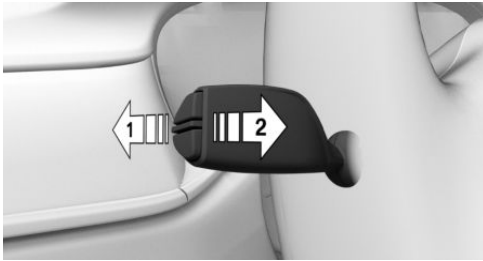

- ▷ High beams on, arrow 1.
The high beams light up when the low beams are switched on.
- ▷ High beams off/headlight flasher, arrow 2.

Wiper system

General information

Do not use the wipers if the windshield is dry, as this may damage the wiper blades or cause them to become worn more quickly.

Safety information

Warning

If the wipers start moving in the folded away state, body parts can be jammed or damage may occur to parts of the vehicle. There is a risk of injury or risk of damage to property. Make sure that the vehicle is switched off when the

wipers are in the folded away state and the wipers are folded in when switching on.

NOTICE

If the wipers are frozen to the windshield, the wiper blades can be torn off and the wiper motor can overheat when switching on. There is a risk of damage to property. Defrost the windshield prior to switching the wipers on.

Switching on

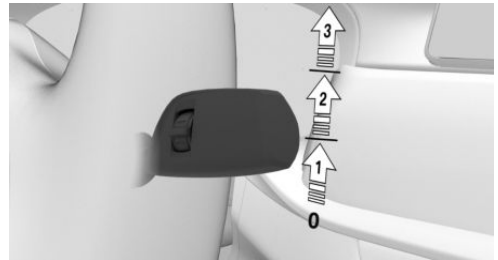

Press the lever up until the desired position is reached.

- ▷ Resting position of the wipers, position 0.
- ▷ Rain sensor, position 1.
- ▷ Normal wiper speed, position 2.
- ▷ Fast wiper speed, position 3.

When travel is interrupted with the wiper system switched on: when travel continues, the wipers resume at their previous speed.

Switching off and brief wipe

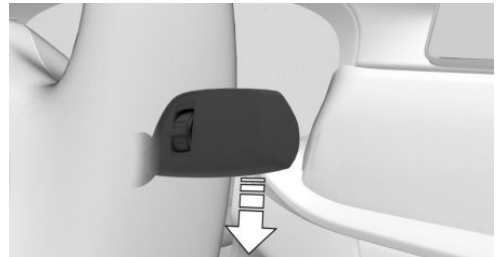

Press the lever down.

- ▷ Switching off: press the lever down until it reaches its standard position.
- ▷ Brief wipe: press the lever down from the standard position.
The lever automatically returns to its initial position when released.

Rain sensor

Concept

The rain sensor automatically controls the time between wipes depending on the intensity of the rainfall.

General information

The sensor is located on the windshield, directly in front of the interior mirror.

Safety information

NOTICE

If the rain sensor is activated, the wipers can accidentally start moving in vehicle washes. There is a risk of damage to property. Deactivate the rain sensor in vehicle washes.

Activating

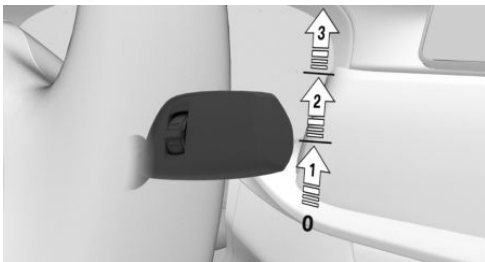

Press the lever up once from its standard position, arrow 1.

Wiping is started.

The LED in the wiper lever is illuminated.

In frosty conditions, wiper operation may not start.

Deactivating

Press the lever back into the standard position.

Adjusting the rain sensor sensitivity

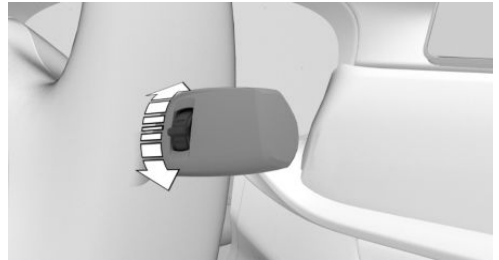

Turn the thumbwheel to adjust the sensitivity of the rain sensor.

Upward: high rain sensor sensitivity.

Downward: low rain sensor sensitivity.

Windshield washer system

Safety information

Warning

The washer fluid can freeze onto the window at low temperatures and obstruct the view. There is a risk of accident. Only use the washer systems, if the washer fluid cannot freeze. Use washer fluid with antifreeze, if needed.

NOTICE

When the washer fluid reservoir is empty, the wash pump cannot work as intended. There is a risk of damage to property. Do not use the washer system when the washer fluid reservoir is empty.

Cleaning the windshield



Pull the lever.

The system sprays washer fluid on the windshield and activates the wipers briefly.

Windshield washer nozzles

The windshield washer nozzles are automatically heated while standby state is switched on.

Rear window wiper

Overview

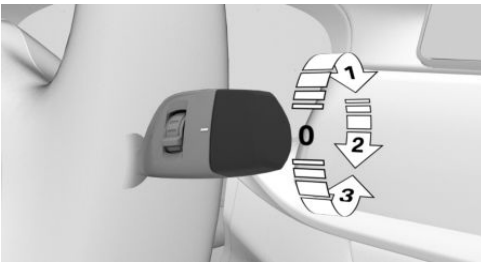

Switching on

Turn the outer switch upward.

- ▶ Resting position of the wiper, position 0.
- ▶ Intermittent mode, arrow 1. When reverse gear is engaged, the system switches to continuous operation.

Clean the rear window

Turn the outer switch in the desired direction.

- ▶ In resting position: turn the switch downward, arrow 3. The switch automatically returns to its idle position when released.
- ▶ In intermittent mode: turn the switch further, arrow 2. The switch automatically returns to its interval position when released.

The function is deactivated if the washer fluid reservoir level is low.

Fold-away position of the wipers

Concept

The fold-away position enables the wipers to be folded away from the windshield.

General information

Important, for instance when changing the wiper blades or for folding away under frosty conditions.

Safety information

Warning

If the wipers start moving in the folded away state, body parts can be jammed or damage may occur to parts of the vehicle. There is a risk of injury or risk of damage to property. Make sure that the vehicle is switched off when the wipers are in the folded away state and the wipers are folded in when switching on.

NOTICE

If the wipers are frozen to the windshield, the wiper blades can be torn off and the wiper motor can overheat when switching on. There is a risk of damage to property. Defrost the windshield prior to switching the wipers on.

Folding away the wipers

1. Switch on standby state.

2. Press and hold the wiper lever down, until the wipers stop in a close to vertical position.

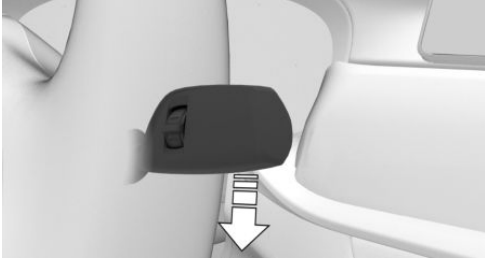

3. Fold the wipers all the way away from the windshield.



Folding down the wipers

After the wipers are folded back down, the wiper system must be reactivated.

1. Fold the wipers back down onto the windshield.
2. Switch on standby state and press and hold the wiper lever down again.
3. Wipers return to their resting position and are ready again for operation.

Steptronic transmission

Concept

The Steptronic transmission combines the functions of an automatic transmission with the possibility of manual shifting, if needed.

Safety information

Warning

An unsecured vehicle can begin to move and possibly roll away. There is a risk of accident. Before exiting, secure the vehicle against rolling, for instance with the parking brake.

Selector lever positions

Drive mode D

Selector lever position for normal vehicle operation. All gears for forward travel are activated automatically.

R is reverse

Engage selector lever position R only when the vehicle is stationary.

Neutral N

The vehicle may be pushed or roll without power, for instance in vehicle washes in selector lever position N.

Parking position P

General information

Selector lever position, for instance for parking the vehicle. The transmission blocks the drive wheels in selector lever position P.

Engage selector lever position P only when the vehicle is stationary.

P is engaged automatically

Selector lever position P is engaged automatically in situations such as the following:

- ▶ After the drive-ready state is switched off and selector lever position R, D or M/S is engaged.
- ▶ After the standby state has been switched off when selector lever position N is engaged.

- ▶ If the driver's safety belt is unbuckled, the driver's door is opened, and the brake pedal is not pressed while the vehicle is stationary and selector lever position D, M/S or R is engaged.

Engaging selector lever positions

General information

To prevent the vehicle from creeping after you select a drive mode, maintain pressure on the brake pedal until you are ready to start.

Functional requirements

Only when the drive-ready state is switched on and the brake pedal is depressed is it possible to change from selector lever position P to another selector lever position.

The selection lever position P cannot be changed until all technical requirements are met.

Engaging selector lever position D, N, R

A selector lever lock prevents the following faulty operation:

- ▶ Unintentional shifting into selector lever position R.
 - ▶ Unintentional shifting from selector lever position P into another selector lever position.
1. Fasten driver's safety belt.
 2. Press and hold the button to release the selector lever lock.

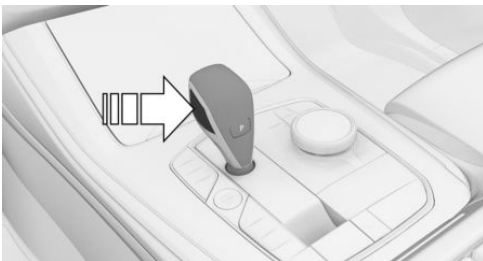

3. Push the selector lever in the desired direction, past a resistance point, if needed. The selector lever automatically returns to the center position when released.

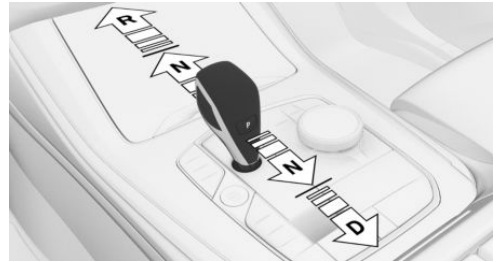

Engaging selector lever position P



Press button P.

Rolling or pushing the vehicle

General information

In some situations, the vehicle is to roll without its own power for a short distance, for instance in a vehicle wash, or be pushed.

Engaging selector lever position N

1. Switch on drive-ready state while pressing on the brake pedal.
2. If necessary, release the parking brake.
3. If necessary, switch off Automatic Hold, refer to page 140.
4. Depress the brake pedal.

- Touch the selector lever lock and engage selector lever position N.
- Switch off drive-ready state.

In this way, standby state remains switched on, and a Check Control message is displayed.

The vehicle can roll.

⚠ NOTICE

Selector lever position P is automatically engaged when standby state is switched off. There is a risk of damage to property. Do not switch standby state off in vehicle washes.

Selector lever position P is engaged automatically after approximately 35 minutes.

If there is a malfunction, you may not be able to change the selector lever position.

Electronically unlock the transmission lock, if needed, refer to page 150.

Kickdown

Kickdown is used to achieve maximum driving performance.

Step on the accelerator pedal beyond the resistance point at the full throttle position.

Sport program M/S

Concept

The shifting points and shifting times in the Sport program are designed for a sportier driving style. The transmission, for instance shifts up later and the shifting times are shorter.

Activating the Sport program

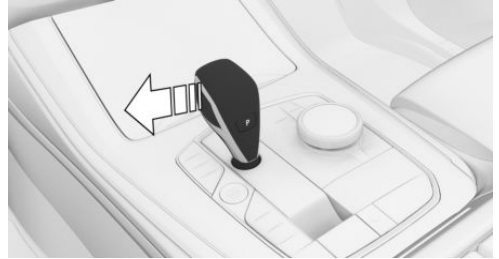

Press the selector lever to the left from selector lever position D.

The engaged gear is displayed in the instrument cluster, for instance S1.

The sport program of the transmission is activated.

Ending the Sport program

Push the selector lever to the right.

D is displayed in the instrument cluster.

Manual mode M/S

Concept

Manual gear-shifting is possible in manual mode.

Activating manual mode

- Press the selector lever to the left from selector lever position D, arrow 1.

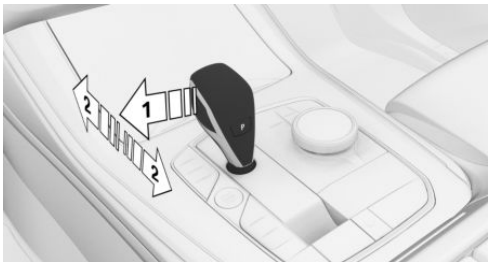

- Push the selector lever forward or pull it backward, arrows 2.

Manual mode becomes active and the gear is changed.

The engaged gear is displayed in the instrument cluster, for instance M1.

Shifting

- ▶ To shift down: press the selector lever forward.
- ▶ To shift up: pull the selector lever rearwards.

The transmission continues shifting automatically in certain situations, for instance when speed limits are reached.

Steptronic Sport transmission: prevent automatic upshifting in M/S manual mode

If driving mode SPORT, refer to page 138, is selected, the Steptronic Sport transmission does not automatically upshift in M/S manual mode once the maximum speed is reached.

Depending on the BMW M drive configuration, this function is active independently of the driving mode.

In addition, there is no downshifting for kick-down.

Ending the manual mode

Push the selector lever to the right.

D is displayed in the instrument cluster.

Shift paddles

Concept

The shift paddles on the steering wheel allow you to shift gears quickly while keeping both hands on the steering wheel.

General information

Shifting

The vehicle only shifts at suitable engine and road speeds.

Short-term manual mode

In selector lever position D, actuating a shift paddle switches into manual mode temporarily.

After conservative driving in manual mode without acceleration or shifting via the shift paddles for a certain amount of time, the transmission switches back to automatic mode.

It is possible to switch into automatic mode as follows:

- ▶ Keep the right shift paddle pulled until D is displayed in the instrument cluster.
- ▶ In addition to the pulled right shift paddle, pull the left shift paddle.

Continuous manual mode

In selector lever position S, actuating a shift paddle switches into manual mode permanently.

Steptronic Sport transmission

With the appropriate transmission version, the lowest possible gear can be selected by simultaneously activating kickdown and operating the left shift paddles. This is not possible in short-term manual mode.

Shifting



- ▶ Shifting up: pull the right shift paddle.
- ▶ Shifting down: pull left shift paddle.
- ▶ Downshifting to the lowest possible gear: keep the left shift paddle pulled.

The selected gear is briefly displayed in the instrument cluster, followed by the current gear.

Displays in the instrument cluster

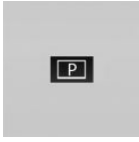

The selector lever position is displayed, for example P.

Electronic unlocking of the transmission lock

General information

Electronically unlock the transmission lock to maneuver vehicle from a danger area.

Before unlocking the transmission lock, set the parking brake to prevent the vehicle from rolling away.

Engage selector lever position N

Unlocking is possible, if the starter can spin the engine.

1. Press and hold down brake pedal.
2. Press the Start/Stop button. The starter must audibly start. Hold the Start/Stop button pressed.
3. With your free hand, press the button on the selector lever, arrow 1, and press the selector lever into selector lever position N and hold, arrow N, until selector lever position N is displayed in the instrument cluster.

A Check Control message is displayed.



4. Release Start/Stop button and selector lever.

5. Release brake, as soon as the starter stops.
6. Maneuver the vehicle from the danger area and secure it against moving on its own.

For additional information, see the chapter on tow-starting and towing, refer to page 395.

Launch Control

Concept

Launch Control enables optimum acceleration on surfaces with good traction under dry surrounding conditions.

General information

The use of Launch Control causes premature component wear since this function represents a very heavy load for the vehicle.

Do not use Launch Control during the break-in, refer to page 322, period.

Do not steer the steering wheel when driving off with Launch Control.

Functional requirement

Launch Control is available when the engine is at operating temperature. The engine is at operating temperature after an uninterrupted trip of at least 6 miles/10 km.

Start with launch control

1. Switch on drive-ready state.

2.  Press the button.

TRACTION is displayed in the instrument cluster and the indicator light for DSC OFF lights up.

3. Engage selector lever position S.
4. With the left foot, forcefully press down on the brake.
5. Press and hold down the accelerator pedal beyond the resistance point at the full throttle position, kickdown.

A flag symbol is displayed in the instrument cluster.

6. The starting engine speed adjusts. Within 3 seconds, release the brake.

Repeated use during a trip

After Launch Control has been used, the transmission must cool down for approx. 5 minutes before Launch Control can be used again.

Launch Control adjusts to the surrounding conditions, when used again.

After using Launch Control

To increase vehicle stability, activate DSC Dynamic Stability Control again as soon as possible.

System limits

An experienced driver may be able to achieve better acceleration values in DSC OFF mode.

Displays

Vehicle features and options

This chapter describes all standard, country-specific and optional features offered with the series. It also describes features and functions that are not necessarily available in your vehicle, e.g., due to the selected options or country versions. This also applies to safety-related functions and systems. When using these functions and systems, the applicable laws and regulations must be observed.

Instrument cluster

Concept

The instrument cluster is a variable display. When you change to a different program via Driving Dynamics Control, the displays in the instrument cluster adapt to the respective driving mode.

General information

The display change in the instrument cluster can be deactivated via iDrive.

Some of the displays in the instrument cluster may differ from the illustrations in the Owner's Manual.

Overview

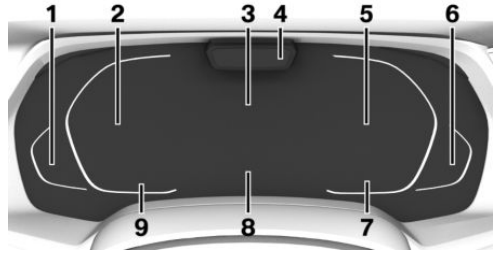

- 1 Fuel gauge [159](#)
Range [161](#)
- 2 Speedometer
- 3 Central display area [152](#)
Service notifications [161](#)
Navigation display
- 4 Depending on the equipment: Driver Attention Camera
- 5 Tachometer [160](#)
Selection lists [164](#)
Widgets in the instrument cluster [154](#)
Trip odometer, see Trip data [165](#)
ECO PRO displays [332](#)
Status, Driving Dynamics Control [137](#)
Transmission display [146](#)
- 6 Engine temperature [161](#)
- 7 External temperature [161](#)
- 8 Check Control [155](#)
- 9 Speed Limit Assist [238](#)
Speed Limit Info [163](#)
Time [61](#)

Central display area

Depending on the equipment and configuration, the following is displayed in the central display area of the instrument cluster:

- ▷ Navigation displays such as the map view or, if destination guidance is active, a route preview with destination guidance information.
- ▷ Displays showing service notifications.
- ▷ Assisted Driving View. Information about the assist systems is displayed in an animated surrounding area of the vehicle.

Some displays in the central display area can be configured individually.

The displays may vary depending on the equipment version and country variant.

Driving mode view

Concept

When the driving mode view is deactivated, the displays in the instrument cluster remain unchanged and do not adapt to the respective driving mode when the program is changed via Driving Dynamics Control.

Activating/deactivating

Via iDrive:

1. "CAR"
2. "Settings"
3. "Displays"
4. "Driving mode view"

Adjusting

Individual displays in the instrument cluster can be configured individually.

1. "CAR"
2. "Settings"
3. "Displays"
4. "Instrument panel"
5. Select the desired setting.

Assisted Driving View

Concept

With active driving assistance, the assist system displays information using figures in the instrument cluster.

General information

Depending on the settings, Assisted Driving View can be displayed permanently or temporarily with active driving assistance in the instrument cluster.

Safety information

Warning

The system cannot serve as a substitute for the driver's personal judgment in assessing visibility and traffic situation. There is a risk of accident. Adjust driving style to traffic conditions. Watch traffic closely and actively intervene where appropriate.

Adjusting

Permanent display

Via iDrive:

1. "CAR"
2. "Settings"
3. "Displays"
4. "Instrument panel"
5. "Central display area"
6. "Assisted Driving View"

Temporary display

Via iDrive:

1. "CAR"
2. "Settings"
3. "Displays"

4. "Instrument panel"
5. "Display Assisted Driving View when Driver Assistance is active"

Display

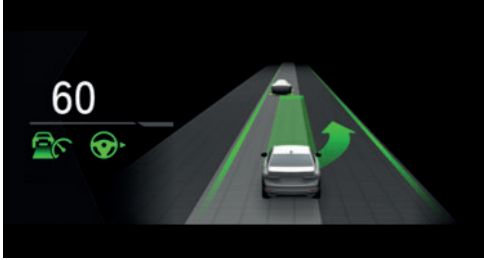

Example: the indicator/warning lights for the Active Cruise Control with Stop & Go function ACC and the Lane Change Assistant indicate a lane change to the next lane. At the same time, the lane change to the next lane is shown with animation in the Assisted Driving View.

System limits

The system's detection potential is limited.

Only objects that are detected by the system are taken into account.

Widgets in the instrument cluster

Concept

Displays for specific functions can be displayed in the instrument cluster.

The following displays can be selected:

- ▷ Current entertainment source, e.g., radio.
- ▷ Torque and power.
- ▷ Acceleration power, G meter.
- ▷ Trip data.
- ▷ Efficiency display.

Selecting

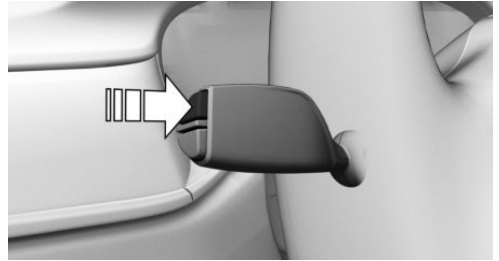

Continue to press the button on the turn signal lever until the desired widget is selected.

Display



Efficiency display

Concept

Information about driving style and consumption can be displayed in the form of a consumption display as a widget in the instrument cluster, for example.

General information

Depending on the activated driving mode, different information will be displayed:

Driving mode	Display
COMFORT	Average consumption.
SPORT	Current consumption. Energy recovery.
ECO PRO	ECO PRO bonus range. Distance traveled in Coasting mode. Current consumption.

Average consumption

The average consumption indicates the fuel consumption when driving a specific route.

Current consumption

The current consumption displays the current consumption of fuel. Check whether you are currently driving in an efficient and environmentally-friendly manner.

Energy recovery

During energy recovery, the kinetic energy of the vehicle is converted into electric energy during coasting. The vehicle battery is partially charged and fuel consumption can be reduced.

ECO PRO bonus range

In the ECO PRO driving mode, the yielded extension of the range as a result of fuel-efficient driving is displayed as ECO PRO bonus range.

Check Control

Concept

The Check Control system monitors functions in the vehicle and notifies you of malfunctions in the monitored systems.

General information

A Check Control message is displayed as a combination of indicator or warning lights and text messages in the instrument cluster and, if applicable, in the Head-up Display.

In addition, an acoustic signal may sound and a text message may appear on the Control Display.

Hiding Check Control messages

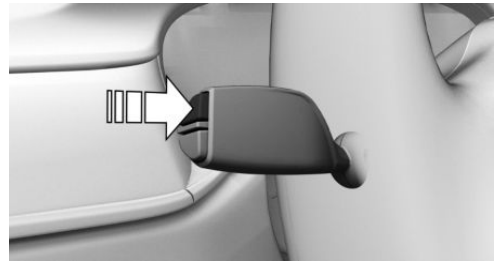

Press the button on the turn signal lever.

Continuous display

Some Check Control messages are displayed continuously and are not cleared until the malfunction is eliminated. If several malfunctions occur at once, the messages are displayed consecutively.

The messages can be hidden for approx. 8 seconds. After this time, they are displayed again automatically.

Temporary display

Some Check Control messages are hidden automatically after approx. 20 seconds. The Check Control messages are stored and can be displayed again later.

Displaying stored Check Control messages

Via iDrive:

1. "CAR"
2. "Vehicle status"

3.  "Check Control messages"
4. Select the SMS text message.

Display

Check Control



At least one Check Control message is displayed or stored.

SMS text messages

SMS text messages in combination with a symbol in the instrument cluster explain a Check Control message and the meaning of the indicator/warning lights.

Supplementary SMS text messages

Additional information, such as the reason for an error or malfunction or the required action, can be called up via Check Control.

With urgent messages the added text will be automatically displayed on the Control Display.

Depending on the Check Control message, further help can be selected.

Via iDrive:

1. "CAR"
2. "Vehicle status"
3.  "Check Control messages"
4. Select the desired text message.
5. Select the desired setting.

Messages after trip completion

Certain messages displayed while driving are displayed again after drive-ready state is switched off.

Indicator/warning lights

Concept

Indicator/warning lights in the instrument cluster display the status of some functions in the vehi-

cle and indicate when a malfunction is present in the monitored systems.

General information

The indicator/warning lights can light up in a variety of combinations and colors.

Several of the lights are checked for proper functioning and light up temporarily when drive-ready state is switched on.

Red lights

Safety belt reminder



Indicator light flashes or is illuminated: safety belt on the driver or passenger side is not buckled. The safety belt reminder can also be activated if objects are placed on the front passenger seat.

Make sure that the safety belts are positioned correctly.

Safety belt reminder for rear seats



The safety belt is not buckled on the corresponding rear seat.

Airbag system



Airbag system and belt tensioner may not be working.

Have the vehicle checked immediately by a dealer's service center or another qualified service center or repair shop.

Parking brake



The parking brake is set.

For releasing the parking brake, refer to page 140.

Brake system



Braking system impaired. Continue to drive moderately.

BRAKE

Have the vehicle checked immediately by a dealer's service center or another qualified service center or repair shop.

Front collision mitigation



The indicator light is illuminated: pre-warning. Brake and increase distance.

Indicator light flashes and an acoustic signal sounds: acute warning. Brake and make an evasive maneuver, if necessary.

Additional information:

Front collision mitigation, refer to page [183](#).

Intersection collision warning



The indicator light is illuminated: risk of collision with crossing vehicle.



Indicator light is illuminated: risk of collision with vehicle without detectable direction of travel or prewarning for vehicles that cross own direction of travel.

Self-intervention such as braking.

Indicator light flashes and an acoustic signal sounds: acute warning when vehicles cross own direction of travel.

Brake and make an evasive maneuver, if necessary.

Additional information:

Intersection collision warning, refer to page [190](#).

Person warning with City braking function



Indicator light flashes and an acoustic signal sounds: imminent collision with a detected person or a cyclist.

Intervene immediately by braking or make an evasive maneuver.

Additional information:

Person warning with City braking function, refer to page [194](#).

Night Vision with pedestrian and animal detection



An infrared camera scans the area in front of the vehicle and issues a warning if it detects pedestrians and animals on the street.



The indicator light is illuminated: pre-warning. Brake and make an evasive maneuver, if necessary.

Indicator light flashes and an acoustic signal sounds: acute warning. Immediate braking or evading maneuver.

Additional information:

Night Vision with pedestrian and animal detection, refer to page [197](#).

Yellow lights

Anti-lock Braking System ABS



The Brake Assistant function may not activate. Avoid abrupt braking. Take the longer braking distance into account.

ABS

Have the system immediately checked by a dealer's service center or another qualified service center or repair shop.

DSC Dynamic Stability Control



The indicator light flashes: DSC controls the drive and braking forces. The vehicle is stabilized. Reduce speed and modify your driving style to the driving circumstances.

The indicator light lights up: DSC has malfunctioned.

Have the system immediately checked by a dealer's service center or another qualified service center or repair shop.

DSC, refer to page 219.

DSC Dynamic Stability Control is deactivated or DTC Dynamic Traction Control is activated



DSC is deactivated or DTC is activated. DSC, refer to page 219, and DTC, refer to page 221.

Flat Tire Monitor FTM



The FTM signals a loss of tire inflation pressure in a tire.

Reduce your speed and stop cautiously. Avoid sudden braking and steering maneuvers. Run-flat tires, refer to page 366.

Tire Pressure Monitor TPM



The indicator light illuminates: the Tire Pressure Monitor reports a low tire inflation pressure or a flat tire. Follow the information in the Check Control message.

The indicator light flashes and is then illuminated continuously: flat tires or tire pressure losses cannot be detected.

- ▶ Interference caused by systems or devices with the same radio frequency: after leaving the area of the interference, the system automatically becomes active again.
- ▶ A wheel without TPM wheel electronics is mounted: have it checked by a dealer's service center or another qualified service center or repair shop as needed.
- ▶ Malfunction: have the system checked by a dealer's service center or another qualified service center or repair shop.

Tire Pressure Monitor TPM, refer to page 359.

Steering system



Steering system may not be working. Have the system checked by a dealer's service center or another qualified service center or repair shop.

Emissions



- ▶ The warning light lights up: Emissions are deteriorating. Have the vehicle checked as soon as possible.
- ▶ The warning light flashes under certain circumstances: This indicates that there is excessive misfiring in the engine. Reduce the vehicle speed and have the system checked immediately; otherwise, serious engine misfiring within a brief period can seriously damage emission control components, in particular the catalytic converter.

Socket for Onboard Diagnosis, refer to page 386.

Green lights

Safety belt reminder for rear seats



The safety belt is buckled on the corresponding rear seat.

Turn signal



Turn signal switched on. Unusually rapid flashing of the indicator light indicates that a turn signal bulb has failed.

Turn signal, refer to page 142.

Parking lights



Parking lights are switched on. Parking lights/low beams, refer to page 171.

Low beams



Low beams are switched on.

Parking lights/low beams, refer to page [171](#).

Lane departure warning



The indicator light lights up: the system is activated. A lane marking was detected on at least one side of the vehicle and warnings can be issued.

Lane departure warning, refer to page [200](#).

Front fog lights



Front fog lights are switched on.

Front fog lights, refer to page [175](#).

High-beam Assistant



High-beam Assistant is switched on.

High beams are switched on and off automatically depending on the traffic situation.

High-beam Assistant, refer to page [173](#).

Automatic Hold



Automatic Hold is activated. The vehicle is automatically held in place when it is stationary.

Automatic Hold, refer to page [140](#).

Speed Limiter



The indicator light lights up: the system is switched on.

The indicator light flashes: the set speed limit has been exceeded.

Additional information:

Manual Speed Limiter, refer to page [225](#).

Cruise control



Indicator light is illuminated: the system is active.

Cruise control, refer to page [227](#).

Active Cruise Control with Stop & Go function



The indicator light lights up: the system is switched on.

Additional information:



Active Cruise Control with Stop&Go function, refer to page [229](#).

Speed Limit Assist



Indicator light illuminates together with the symbol for a cruise control system: Speed Limit Assist is active and detected speed limits can be applied manually for the displayed system.



Indicator light illuminates: the detected speed limit can be applied with the SET button. As soon as the speed limit has been applied, a green checkmark is displayed.

Additional information:

Speed Limit Assist, refer to page [238](#).

Blue lights

High beams



High beams are switched on.

High beams, refer to page [143](#).

Fuel gauge

Concept

The current fill level of the fuel tank is displayed.

General information

Vehicle tilt position may cause the display to vary.

Information on refueling, refer to page 338.

Display



An arrow beside the fuel pump symbol shows which side of the vehicle the fuel filler flap is on.

The current range is displayed as numerical value.

Indicator light in the instrument cluster



The yellow indicator light illuminates, once the fuel reserve is reached.

Tachometer

Always avoid engine speeds in the red warning field. In this range, the fuel supply is reduced to protect the engine.

Shift point indicator

Concept

The shift lights indicate the upshift point at which the best possible acceleration can be achieved.

Functional requirement

Shift lights are shown when the SPORT or SPORT PLUS driving program is activated.

Switching on/off

1. Select SPORT or SPORT PLUS driving mode.
Press Driving Dynamics Control.
2. Activate the M manual mode of the transmission.

Display



- ▶ Current engine speed is displayed in the tachometer.
- ▶ Arrow 1: successive yellow illuminated fields indicate an increase in the speed.
- ▶ Arrow 2: successive orange illuminated fields indicate the upcoming shift moment.
- ▶ Arrow 3: the field lights up red. Do not wait any further to shift.

When the maximum speed is reached, the entire display flashes red and the supply of fuel is interrupted in order to protect the engine.

Standby state and drive-ready state



The letters OFF in the tachometer indicate that drive-ready state is switched off and standby state is switched on.



The letters READY in the tachometer indicate that the Auto Start/Stop function is ready to start the engine automatically.

For further information, see Idle state, standby state, and drive-ready state, refer to page 37.

Engine oil temperature

Display



- ▶ Cold engine: the pointer is at the low temperature end. Drive at moderate engine and vehicle speeds.
- ▶ Normal operating temperature: the pointer is in the middle or in the lower half of the temperature display.
- ▶ Hot engine: the pointer is at the high end of the temperature range. In addition, a Check Control message is displayed.

To check the coolant level, refer to page 383.

Indicator light in the instrument cluster



A red indicator light is displayed.

External temperature

General information

If the indicator drops to $+37\text{ }^{\circ}\text{F}/+3\text{ }^{\circ}\text{C}$ or lower, a signal sounds.

A Check Control message is displayed.

There is an increased risk of ice on roads.

Safety information

Warning

Even at temperatures above $+37\text{ }^{\circ}\text{F}/+3\text{ }^{\circ}\text{C}$ there can be a risk of icy roads, for instance on bridges or shady sections of the road. There is a risk of accident. Modify your driving style to the weather conditions at low temperatures.

Range

Concept

The range indicates the distance that can still be covered with the current fuel level.

General information

The estimated range available with the remaining fuel is permanently displayed in the instrument cluster.

With a low remaining range, a Check Control message is briefly displayed. With a dynamic driving style, for instance fast cornering, the engine function is not always ensured.

The Check Control message appears continuously below a range of approx. 30 miles/50 km.

Safety information

NOTICE

With a driving range of less than 30 miles/50 km the engine may no longer have sufficient fuel. Engine functions are not ensured anymore. There is a risk of damage to property. Refuel promptly.

Display



The current range is displayed as numerical value next to the fuel gauge.

Service notifications

Concept

The function displays the service notifications and the corresponding maintenance scopes.

General information

After switching on drive-ready state, the instrument cluster briefly displays available driving distance or time to the next scheduled maintenance.

A service advisor can read out the current service notifications from your vehicle key.

Some information on service notifications can also be shown on the BMW display key.

Display



Detailed information on service notifications

More information on the type of service required may be displayed on the Control Display.

Via iDrive:

1. "CAR"
2. "Vehicle status"
3.  "Service schedule"
Maintenance and service measures and legally mandated inspections are displayed.
4. Select an entry to call up detailed information.

Symbols

Symbols	Description
	No service is currently required.
	The time for recommended maintenance or a legally mandated inspection is approaching.
	The time for recommended maintenance has already passed.

Entering appointment dates

Enter the dates for the mandatory vehicle inspections.

Make sure that the vehicle's date and time are set correctly.

Via iDrive:

1. "CAR"
2. "Vehicle status"
3.  "Service schedule"
4. "BMW Service"
5. "Date:"
6. Select the desired setting.

Gear shift indicator

Concept

The system recommends the most efficient gear for the current driving situation.



General information

Depending on the design and country version, the gear shift indicator may be active in the M manual mode of the Steptronic transmission.

Steptronic transmission: displaying

Suggestions to shift up or down are displayed in the instrument cluster.

On vehicles without a gear shift indicator, the engaged gear is displayed.

Example	Description
	Efficient gear is set.
	Shift into efficient gear.

Speed Limit Info

Speed Limit Info

Concept

Speed Limit Info shows the currently valid speed limit in the instrument cluster and, if necessary, the Head-up Display.

General information

The camera in the area of the interior mirror detects traffic signs at the edge of the road as well as overhead sign posts.

Traffic signs with extra symbols are considered and compared with the vehicle's onboard data. The traffic sign will then be either displayed or ignored depending on the situation in the instrument cluster and the Head-up Display.

The system takes into account any information that is stored in the navigation system and also displays speed limits present on routes without signs.

Speed limits for trailer towing will be displayed when the trailer power socket is in use or trailer towing was activated via iDrive.

Safety information

Warning

The system cannot serve as a substitute for the driver's personal judgment in assessing visibility and traffic situation. There is a risk of accident. Adjust driving style to traffic conditions. Watch traffic closely and actively intervene where appropriate.

Overview

Camera

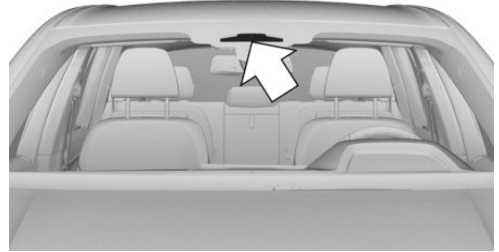

The camera is installed near the interior mirror. Keep the windshield in front of the interior mirror clean and clear.

Displaying Speed Limit Info

General information

Depending on the vehicle equipment, Speed Limit Info is displayed permanently in the instrument cluster or via iDrive.

Activating

Via iDrive:

1. "CAR"
2. "Settings"
3. "Driver Assistance"
4. If necessary, "Driving"
5. "Speed Limit Assistance"
6. "Speed limits"
7. "Show current limit"

Display

Speed Limit Info



Current speed limit.



Depending on the equipment, Speed Limit Info not available.



If the detected speed limit has been exceeded, the indicator light will flash.

Adjusting

Via iDrive:

1. "CAR"
2. "Settings"
3. "Driver Assistance"
4. If necessary, "Driving"
5. "Speed Limit Assistance"
6. Select the desired setting:
 - ▷ "Warn when speeding": activate/deactivate the flashing of the Speed Limit Info display in the instrument cluster and, where applicable, the Head-up Display when the currently valid speed limit is exceeded. The warning that is issued when a speed limit is exceeded may depend on the Speed Limit Assist settings.
 - ▷ "Excess speed display": the speed limit that is detected by the Speed Limit Info is displayed with a marking in the speedometer in the instrument cluster.

- ▷ When driving very close to the vehicle in front of you.
- ▷ When driving toward bright lights or strong reflections.
- ▷ When the windshield in front of the interior mirror is fogged over, dirty or covered by a sticker, etc.
- ▷ If the camera has overheated and been temporarily switched off due to excessively high temperatures.
- ▷ In the event of incorrect detection by the camera.
- ▷ If the speed limits or road data stored in the navigation system are incorrect.
- ▷ If the speed limits vary with the time of day and the day of the week.
- ▷ In areas not covered by the navigation system.
- ▷ When roads differ from the navigation, such as due to changes in road routing.
- ▷ In case of electronic traffic signs.
- ▷ When passing buses or trucks with traffic signs applied to them.
- ▷ If the traffic signs are non-conforming.
- ▷ When traffic signs that are valid for a parallel road are detected.
- ▷ In the presence of country-specific signs and road configurations.
- ▷ During calibration of the camera immediately after vehicle delivery.

System limits

The system may not be fully functional and may provide incorrect information in the following situations:

- ▷ In heavy fog, wet conditions, or snowfall.
- ▷ When traffic signs are fully or partially concealed by objects, stickers or paint.

Selection lists

Concept

Lists can be displayed and, if necessary, used for certain functions in the instrument cluster or the Head-up Display.

- ▷ Entertainment source.
- ▷ Current audio source.
- ▷ List of most recent telephone calls.



If necessary, the corresponding menu will open on the Control Display.

Display



Depending on the equipment version, the list in the instrument cluster may differ from the illustration.

Displaying and using the list

Button	Function
	<p>Change the entertainment source.</p> <p>Pressing the button again will close the currently displayed list.</p>
	<p>Show list of most recent telephone calls.</p>
	<p>Turn the thumbwheel to select the desired setting.</p> <p>Press the thumbwheel to confirm the setting.</p> <p>The currently selected list can be displayed in the instrument cluster by turning the thumbwheel.</p>

Trip data

Concept

Values for the trip, such as the average consumption or trip miles, are displayed.

General information

The trip data can be displayed on the Control Display and in the instrument cluster.

The values can be displayed and reset depending on various intervals, such as after refueling.

Display on the Control Display

Overview

The following information is displayed based on the configured interval:

- ▷ Configured interval for displaying trip data.
- ▷ Average fuel consumption depending on the configured interval.
- ▷ Average speed.
- ▷ Total time for shut off engine through the Auto Start/Stop function.
- ▷ Distance traveled in Coasting mode.
- ▷ Consumption history in form of a chart.

Displays

Via iDrive:

1. "CAR"
2. "Driving information"
3. "Trip data"

Consumption history

The average consumption is shown in the consumption history in form of a chart based on the distance traveled and the driving mode.

Display in the instrument cluster

Information about the route can be displayed as widget in the tachometer. Selecting and setting

widgets in the instrument cluster. Further information: Widgets in the instrument cluster, refer to page 154.

The following information is displayed:

- ▷ Total mileage.
- ▷ Configured interval for displaying trip data.
- ▷ Distance traveled depending on the configured interval.
- ▷ Average speed.

Adjusting the display of the trip data

The intervals for the display of the trip data in the instrument cluster and on the Control Display are adjustable.

Via iDrive:

1. "CAR"
2. "Driving information"
3. "Trip data"
4. "Data since"
5. Select the desired setting:
 - ▷ "Start of trip ()": the values are automatically reset approx. four hours after the vehicle has come to a standstill.
 - ▷ "Refueling ()": the values are automatically reset after refueling with a larger quantity of fuel.
 - ▷ "Factory": the values since the time of the factory delivery are displayed.
 - ▷ "Individual ()": the values since the last manual reset are displayed. The values can be reset at any time.

Resetting average values manually

The following interval can be reset manually at any time: "Individual ()".

With the button on the turn signal lever:

1. Continue to press the button on the turn signal lever until the widget for the trip data is selected.

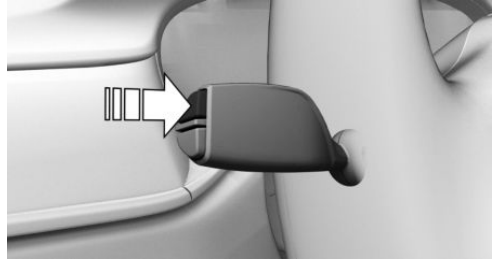

2. Press and hold the button on the turn signal lever.

Via iDrive:

1. "CAR"
2. "Driving information"
3. "Trip data"
4. "Data since"
5. "Reset individual"

The average values and counters are reset. Once the average values and counters have been reset, the following interval is automatically set: "Individual ()".

Sport displays

Concept

The Sport displays especially support a sporty driving style.

Display on the Control Display

Overview

The following information is displayed:

- ▷ Boost pressure.
- ▷ Engine oil temperature.
- ▷ Acceleration power, G meter.

- ▷ Torque.
- ▷ Power.

Displays

Via iDrive:

1. "CAR"
2. "Driving information"
3. "Sport displays"

Display in the instrument cluster

The Sport displays can be displayed in form of widgets in the instrument cluster, refer to page [154](#).

The following widgets can be selected:

- ▷ Widget for torque and power.
- ▷ Widget for acceleration power, G meter.

Vehicle status

General information



The status can be displayed and actions performed for several systems.



Opening the vehicle status

Via iDrive:

1. "CAR"
2. "Vehicle status"

Information at a glance

Symbols	Description
	"Flat Tire Monitor": status of the run-flat tires, refer to page 366 .
	"Tire Pressure Monitor": status of the Tire Pressure Monitor TPM, refer to page 359 .

Symbols	Description
	"Engine oil level": electronic oil measurement, refer to page 379 .
	"Check Control messages": displaying stored Check Control messages, refer to page 155 .
	"Service schedule": displaying service notifications, refer to page 161 .

Head-up Display

Concept

This system projects important information into the driver's field of vision, for instance the speed.

The driver can get information without averting his or her eyes from the road.

General information

Follow the information on cleaning the Head-up Display.

Overview



Switching on/off

Via iDrive:

1. "CAR"
2. "Settings"
3. "Displays"

4. "Head-up display"
5. "Head-up display"

Display

Overview

The following information is displayed on the Head-up Display:

- ▷ Vehicle speed.
- ▷ Navigation instructions.
- ▷ Check Control messages.
- ▷ Selection list in the instrument cluster.
- ▷ Driver assistance systems.
- ▷ Sport displays.
- ▷ xOffroad displays

Some of this information is only displayed briefly as needed.

Selecting displays in the Head-up Display

Via iDrive:

1. "CAR"
2. "Settings"
3. "Displays"
4. "Head-up display"
5. Select the desired setting.

The setting is stored for the driver profile currently used.

Setting the brightness

The brightness is automatically adjusted to the ambient brightness.

The basic setting can be adjusted manually.

Via iDrive:

1. "CAR"
2. "Settings"
3. "Displays"
4. "Head-up display"

5. "Brightness"
6. Turn the Controller until the desired brightness is set.
7. Press the Controller.

When the low beams are switched on, the brightness of the Head-up Display can be additionally influenced using the instrument lighting.

Adjusting the height

Via iDrive:

1. "CAR"
2. "Settings"
3. "Displays"
4. "Head-up display"
5. "Height"
6. Turn the Controller until the desired height is reached.
7. Press the Controller.

The setting is stored for the driver profile currently used.

The height of the Head-up Display can also be stored using the memory function.

Setting the rotation

The Head-up Display view can be rotated.

Via iDrive:

1. "CAR"
2. "Settings"
3. "Displays"
4. "Head-up display"
5. "Rotation"
6. Turn the Controller until the desired setting is selected.
7. Press the Controller.

Additional settings

Via iDrive:

1. "CAR"
2. "Settings"
3. "Displays"
4. "Head-up display"
5. Select the desired setting:
 - ▷ "Speed Limit Assistance": access the settings for the speed assistant.
 - ▷ "Display infotainment lists in": set up if the selection lists are displayed in the instrument cluster or the Head-up Display.
 - ▷ "Sport displays": display tachometer and Shift Lights in the Head-up Display.
 - ▷ "Off": the Sport displays are not displayed in the Head-up Display.
 - ▷ "In SPORT mode": the Sport displays are only displayed in SPORT driving mode.
 - ▷ "Always": the Sport displays are continuously displayed in the Head-up Display.
 - ▷ "Reduced height": if not all of the information is in the driver's field of vision, the information can be displayed in the lower section of the Head-up Display.

Visibility of the display

The visibility of the displays in the Head-up Display is influenced by the following factors:

- ▷ Seat position.
- ▷ Objects on the cover of the Head-up Display.
- ▷ Sunglasses with certain polarization filters.
- ▷ Wet roads.
- ▷ Unfavorable light conditions.

If the image is distorted, have the basic settings checked by a dealer's service center or another qualified service center or repair shop.

Special windshield

The windshield is part of the system.

The shape of the windshield makes it possible to display a precise image.

A film in the windshield prevents double images from being generated.

For this reason, it is strongly suggested to have the special windshield replaced by a dealer's service center or another qualified service center or repair shop, if necessary.

Lights

Vehicle features and options



This chapter describes all standard, country-specific and optional features offered with the series. It also describes features and functions that are not necessarily available in your vehicle, e.g., due to the selected options or country versions. This also applies to safety-related functions and systems. When using these functions and systems, the applicable laws and regulations must be observed.







Lights and lighting

Switches in the vehicle



The light switch element is located next to the steering wheel.

Symbol	Function
	Front fog lights.
	Night vision.
	Lights off. Daytime running lights.

Symbol	Function
	Parking lights.
	Automatic headlight control. Adaptive light functions.
	Low beams.
	Instrument lighting.
	Right roadside parking light.
	Left roadside parking light.

Automatic headlight control

Concept

The low beams are switched on and off automatically depending on the ambient brightness, for example in tunnels, in twilight or if there is precipitation.

General information

A blue sky with the sun low on the horizon can cause the lights to be switched on.

If the low beams are switched on manually, the automatic headlight control is deactivated.

Activating

 Press the button on the light switch element.

The LED in the button lights up.



The indicator light in the instrument cluster is illuminated when the low beams are switched on.

System limits

The automatic headlight control cannot serve as a substitute for your personal judgment of lighting conditions.

For example, the sensors are unable to detect fog or hazy weather. In these situations, switch the lights on manually.

Parking lights, low beams and roadside parking lights

General information

If the driver's door is opened when the drive-ready state is switched off, the exterior lighting is automatically switched off after a period of time.

Parking lights

General information

The parking lights can only be switched on in the low speed range.

Switching on



Press the button on the light switch element.



The indicator light in the instrument cluster lights up.

The vehicle is illuminated on all sides.

Do not use the parking lights for extended periods; otherwise, they might drain the battery and it would then be impossible to switch on drive-ready state.

Switching off



Press the button on the light switch element or switch on the drive-ready state.

After the drive-ready state is switched on, the automatic headlight control will be activated.

Low beams

Switching on



Press the button on the light switch element.

The low beams illuminate when drive-ready state is switched on.



The indicator light in the instrument cluster lights up.

Press the button again to switch on the low beams when the standby state is switched on.

Switching off



Depending on the country variant, the low beams can be switched off in the low speed range.



Press the button on the light switch element.

Roadside parking lights

When the vehicle is parked, a one-sided roadside parking light can be switched on.

Button	Function
	Right roadside parking light on.
	Left roadside parking light off.

Switching off the roadside parking light:



Press the button on the light switch element or switch on the drive-ready state.

Welcome lights

General information

Depending on the equipment, the exterior lighting of the vehicle can be set individually.

Activating/deactivating

Via iDrive:

1. "CAR"
2. "Settings"
3. "Exterior lighting"
4. Select the desired setting:
 - ▷ "Welcome and goodbye"
When unlocking the vehicle, individual light functions are switched on for a limited time.
 - ▷ "Door handle lights"
Door handles and the ground in front of the doors are illuminated for a limited time.
 - ▷ "Welcome Light Carpet"
The area next to the vehicle is illuminated for a limited time.

LED light carpet

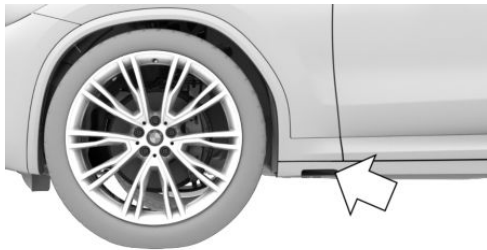

The light source is located in the position indicated.

Keep the light source clean and unobstructed.

Headlight courtesy delay feature

General information

The low beams stay illuminated for a particular time if the high beams are switched on after the drive-ready state is switched off.

Setting the duration

Via iDrive:

1. "CAR"
2. "Settings"
3. "Exterior lighting"
4. "Pathway lighting"
5. Select the desired setting.
6. "OK"

Daytime running lights

General information

The daytime running lights light up when drive-ready state is switched on.

Activating/deactivating

In some countries, daytime running lights are mandatory, so it may not be possible to deactivate the daytime running lights in front.

Via iDrive:

1. "CAR"
2. "Settings"
3. "Exterior lighting"
4. Depending on country specifications: "Daytime driving lights" or "Daytime driving lights, rear"

The setting is stored for the driver profile currently used.

Adaptive light functions

Concept

Adaptive light functions enable dynamic illumination of the roadway.

General information

The adaptive light functions may consist of one system or multiple systems, depending on the equipment version:

- Adaptive Light Control.
- Cornering light.

Activating

 Press the button on the light switch element.

The LED in the button lights up.

The adaptive light functions are active when the drive-ready state is switched on.

Adaptive Light Control

General information

Depending on the steering angle and other parameters, the light from the headlight follows the course of the road.

To avoid blinding oncoming traffic, the Adaptive Light Control does not swivel to the opposite lane when the vehicle is at a standstill.

Cornering light

In tight curves, for instance on mountainous roads or when turning, an additional, cornering light is switched on that lights up the inside of the curve when the vehicle is moving below a certain speed.

The cornering light is automatically switched on depending on the steering angle or, where applicable, the use of turn signals.

When driving in reverse, the cornering lights may be automatically switched on regardless of the steering angle.

Adaptive headlight range control

The adaptive headlight range control feature balances out acceleration and braking processes as well as the vehicle load conditions in order to avoid dazzling oncoming traffic. Illumination of the road is optimized.

High-beam Assistant

Concept

The high-beam Assistant detects other traffic participants early on and automatically switches the high beams on or off depending on the traffic situation.

General information

The high-beam Assistant ensures that the high beams are switched on, whenever the traffic situation allows. In the low speed range, the high beams are not switched on by the system.

The system responds to light from oncoming traffic and traffic driving ahead of you, and to ambient lighting, for instance in towns and cities.

The high beams can be switched on and off manually at any time.

Activating

1.  Press the button on the light switch element.

The LED in the button lights up.

2. Press the button on the turn signal lever.

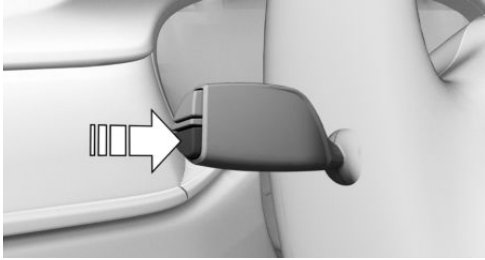

The indicator light in the instrument cluster is illuminated when the low beams are switched on.

The headlights are automatically switched between low beams and high beams.



The blue indicator light in the instrument cluster lights up when the system switches on the high beams.

Driving interruption with activated high-beam Assistant: the High-Beam Assistant remains activated when driving continues.

The high-beam Assistant is deactivated when manually switching the high beams on and off.

To reactivate the high-beam Assistant, press the button on the turn signal lever.

Deactivating

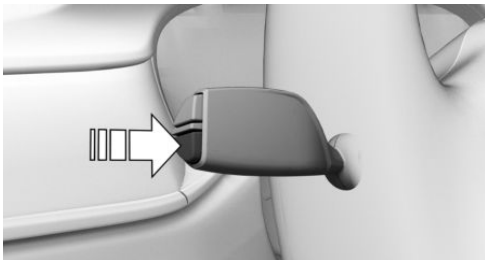

Press the button on the turn signal lever.

Sensitivity of the high-beam Assistant

General information

The sensitivity of the high-beam Assistant can be adjusted.

Safety information

Warning

If adjustments have been made or the sensitivity has been modified, oncoming traffic may be momentarily blinded. There is a risk of accident. If adjustments have been made and the sensitivity has been modified, make sure that oncoming traffic is not momentarily blinded. Switch off the high beams manually if required.

Functional requirements

The setting can only be performed when the vehicle is stationary. The drive-ready state must be switched on and the light must be turned off.

Adjusting the sensitivity

Push the turn signal lever to the front for approximately 10 seconds. The system responds more sensitively.

A Check Control message is displayed.

Resetting the sensitivity

Push the turn signal lever to the front again for approx. 10 seconds or switch off the drive-ready state.

The sensitivity of the high-beam Assistant is reset to the factory settings.

System limits

The high-beam Assistant cannot serve as a substitute for the driver's personal judgment of when to use the high beams. In situation that require this, therefore switch off manually.

The system is not fully functional in the following situations, and driver intervention may be necessary:

- ▶ In very unfavorable weather conditions, such as fog or heavy precipitation.
- ▶ When detecting poorly-lit road users such as pedestrians, cyclists, horseback riders and wagons; when driving close to train or ship traffic; or at animal crossings.
- ▶ In tight curves, on hilltops or in depressions, in crossing traffic or half-observed oncoming traffic on highways.
- ▶ In poorly-lit towns and cities or in the presence of highly reflective signs.
- ▶ When the windshield in front of the interior mirror is fogged over, dirty or covered with stickers, etc.

Laser high beams

Concept

The range of the high beams is increased and ensures an even better illumination of the road.

General information

When the high beams are switched-on, starting with a speed of approx. 37 mph/60 km/h, the laser high beams in the headlight are automatically switched on in addition to the LED high beams.

Depending on the country variant, further information can be obtained from the laser label on the headlight.

Safety information



The label is in the headlight and is visible from the outside.

Fog lights

Front fog lights

Concept

The front fog lights work alongside the low beams to illuminate a wider area of the roadway.

Functional requirement

The low beams must be switched on before switching on the front fog lights.

Switching on/off



Press the button.



The green indicator light in the instrument cluster lights up if the front fog lights are switched on.

If the automatic headlight control is activated, the low beams will come on automatically when you switch on the front fog lights.

When the high beams or headlight flasher are activated, the front fog lights are not switched on.

Instrument lighting

Functional requirement

The parking lights or low beams must be switched on to adjust the brightness.

Adjusting



Adjust the brightness with the thumbwheel.

Interior lights

General information

Depending on the equipment version, interior lights, footwell lights, entry lights, ambient lighting, and speaker lighting are automatically controlled.

Overview

Buttons in the vehicle



Interior lights



Reading lights

Switching the interior lights on/off



Press the button.

To switch off permanently: press the button and hold for approx. 3 seconds.

The interior lights in the rear of the vehicle can be switched on and off independently. The button is located in the rear roofliner.

Switching the reading lights on/off



Press the button.

Depending on the vehicle equipment, the reading lights are located next to the interior lights in the front and rear.

Ambient light

General information

Depending on the equipment version, lighting can be adjusted for some lights in the car's interior.

Switching on/off

The ambient light is switched on when the vehicle is unlocked, and switched off when the vehicle is locked.

If the ambient light was deactivated via iDrive, it will not be switched on when the vehicle is unlocked.

Via iDrive:

1. "CAR"
2. "Settings"
3. "Interior lighting"
4. "Ambient lighting"

The selected setting is stored for the driver profile currently used.

Selecting the color scheme

Via iDrive:

1. "CAR"
2. "Settings"
3. "Interior lighting"
4. "Color"
5. Select the desired setting.

Setting the brightness

Via iDrive:

1. "CAR"
2. "Settings"
3. "Interior lighting"
4. "Brightness"
5. Select the desired setting.

Dynamic light

Individual actions, for example incoming calls or opened doors, are indicated by light effects.

Via iDrive:

1. "CAR"
2. "Settings"
3. "Interior lighting"
4. "Dynamic light"
5. Select the desired setting.

Dimmed while driving

Some lights of the interior lighting are dimmed when the vehicle is driven in the dark.

Via iDrive:

1. "CAR"
2. "Settings"
3. "Interior lighting"
4. "Dimmed for night driving"

The selected setting is stored for the driver profile currently used.

Panoramic glass sunroof, lighting

If the panoramic glass sunroof is opened or the sun protection is closed, the lighting is switched off.

Bowers & Wilkins Diamond Surround Sound System

General information

Some speakers in the vehicle are illuminated. Brightness can be individually set.

If the speakers are muted, speaker lighting will be switched off.

Switching on/off

The speaker lighting is switched on when the vehicle is unlocked, and switched off when the vehicle is locked.

Via iDrive:

1. "CAR"
2. "Settings"
3. "Interior lighting"
4. "Bowers & Wilkins"

The selected setting is stored for the driver profile currently used.

Setting the brightness

Via iDrive:

1. "CAR"
2. "Settings"
3. "Interior lighting"
4. "Bowers & Wilkins"
5. "Brightness"
6. Select the desired setting.

Safety

Vehicle features and options

This chapter describes all standard, country-specific and optional features offered with the series. It also describes features and functions that are

not necessarily available in your vehicle, e.g., due to the selected options or country versions. This also applies to safety-related functions and systems. When using these functions and systems, the applicable laws and regulations must be observed.

Airbags

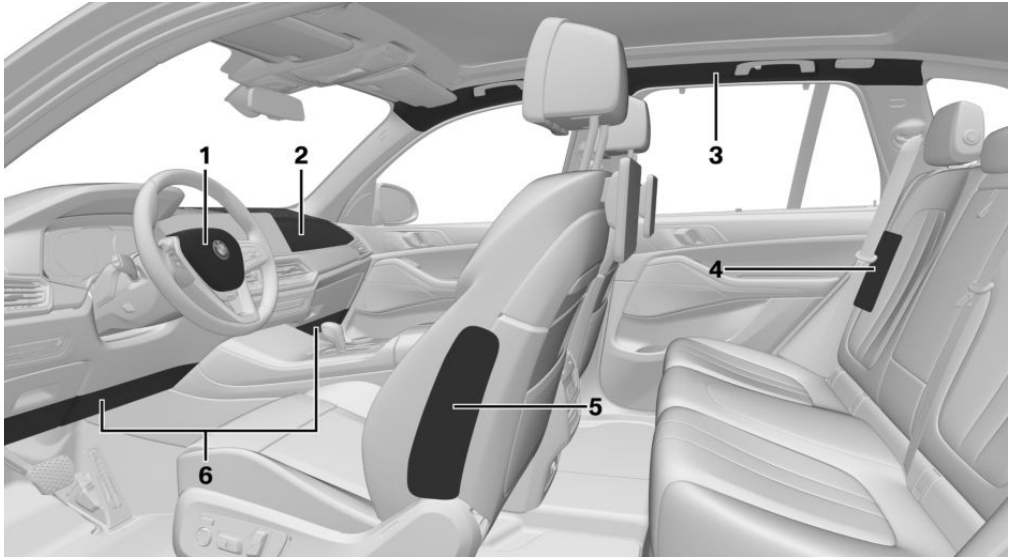

- | | |
|---------------------------------|---------------------------|
| 1 Front airbag, driver | 4 Side airbag In the rear |
| 2 Front airbag, front passenger | 5 Side airbag |
| 3 Head airbag | 6 Knee airbag |

Front airbags

Front airbags help protect the driver and the front passenger by responding to frontal impacts in which safety belts alone would not provide adequate protection.

Side airbag

In the event of a side impact, the side airbag protects the side of the body in the chest and lap area.

Depending on the equipment:

In the event of a side impact, the side airbag in the rear protects the chest and lap area on the side of the bodies of the occupants in the outer rear seats.

Head airbag

In the event of a side impact, the head airbag protects the head.

Ejection Mitigation

The head airbag system is designed as an ejection mitigation countermeasure to reduce the likelihood of ejections of vehicle occupants through side windows during rollovers or side impact events.

Knee airbag

The knee airbag protects the legs in the event of a frontal impact.

Protective effect

General information

Airbags are not triggered in every impact situation, e.g., in less severe accidents.

Information on optimum effect of the airbags

Warning

If the seat position is incorrect or the deployment area of the airbags is impaired, the airbag system cannot provide protection as intended and may cause additional injuries due to triggering. There is a risk of injuries or danger to life. Follow the information on achieving the optimum protective effect of the airbag system.

- ▷ Keep a distance from the airbags.
- ▷ Always grasp the steering wheel on the steering wheel rim. Hold your hands at the 3 o'clock and 9 o'clock positions, to keep the

risk of injury to your hands or arms as low as possible when the airbag is triggered.

- ▷ Make sure that the front passenger is sitting correctly, i.e., keeps his or her feet and legs in the floor area and does not support them on the dashboard.
- ▷ Make sure that occupants keep their heads away from the side airbag.
- ▷ There should be no additional persons, animals or objects between an airbag and a person.
- ▷ Dashboard and windshield on the front passenger side must stay clear - do not attach adhesive labels or coverings and do not attach brackets or cables, for instance for GPS devices or mobile phones.
- ▷ Do not apply adhesive materials to the airbag cover panels, do not cover them or modify them in any way.
- ▷ Do not use the cover of the front airbag on the front passenger side as a storage area.
- ▷ Do not attach slip covers, seat cushions or other objects to the front passenger seat that are not specifically suited for seats with integrated side airbags.
- ▷ Do not hang pieces of clothing, such as jackets, over the backrests.
- ▷ Never modify either the individual components or the wiring in the airbag system. This also applies to steering wheel covers, the dashboard, and the seats.
- ▷ Do not remove the airbag system.

Even when you follow all instructions very closely, injury from contact with the airbags cannot be fully ruled out in certain situations.

The ignition and inflation noise may lead to short-term and, in most cases, temporary hearing impairment in sensitive occupants.

Vehicle modifications for a person with disabilities may affect the air bag system; contact BMW Customer Relations for further information.

Warnings and information on the airbags are also found on the sun visors.

Functional readiness of the airbag system

Safety information

Warning

Individual components can be hot after triggering of the airbag system. There is a risk of injury. Do not touch individual components.

Warning

Improperly executed work can lead to failure, malfunction or unintentional triggering of the airbag system. In the case of a malfunction, the airbag system might not trigger as intended despite the accident severity. There is a risk of injuries or danger to life. Have the airbag system checked, repaired, dismantled and scrapped by a dealer's service center or another qualified service center or repair shop.

Display in the instrument cluster



When drive-ready state is switched on, the warning light in the instrument cluster lights up briefly and thereby indicates the function readiness of the entire airbag system and the belt tensioners.

Malfunction



- ▶ Warning light does not come on when drive-ready state is switched on.
- ▶ The warning light lights up continuously. Have the system checked.

Strength of the driver's and front-seat passenger airbag

General information

The explosive power that activates driver's/front-seat passenger airbags very much depends on the positions of the driver's/front passenger seat.

To maintain the accuracy of this function over the long term, calibrate the front seats as soon as a respective message appears on the Control Display.

Calibrating the front seats

Warning

There is a risk of jamming when moving the seats. There is a risk of injury or risk of damage to property. Make sure that the area of movement of the seat is clear prior to any adjustment.

A corresponding message appears on the Control Display.

1. Press the switch and move the respective seat all the way forward, until it stops.
2. Press the switch forward again. The seat still moves forward slightly.
3. Readjust the seat to the desired position.

The calibration procedure is completed when the message on the Control Display disappears.

If the message continues to be displayed, repeat the calibration.

If the message does not disappear after a repeat calibration, have the system checked as soon as possible.

Automatic deactivation of the front-seat passenger airbags

Concept

The system reads if the front passenger seat is occupied by measuring the human body's resistance.

Front, knee, and side airbag on the front passenger's side are activated or deactivated.

General information

Before transporting a child on the front passenger seat, refer to the safety information and instructions for children on the front passenger seat, see Children.

Safety information

Warning

To ensure the front-seat passenger airbag function, the system must be able to detect whether a person is sitting in the front passenger seat. The entire seat cushion area must be used for this purpose. There is a risk of injuries or danger to life. Make sure that the front passenger keeps his or her feet in the floor area.

Malfunction of the automatic deactivation system

When transporting older children and adults, the front-seat passenger airbags may be deactivated in certain sitting positions. In this case, the indicator light for the front-seat passenger airbags lights up.

In this case, change the sitting position so that the front-seat passenger airbags are activated and the indicator light goes out.

If it is not possible to activate the airbags, have the person sit in the rear.

To enable correct recognition of the occupied seat cushion:

- ▷ Do not attach covers, cushions, ball mats or other items to the front passenger seat unless they are specifically determined to be safe for use on the front passenger seat.
- ▷ Do not place any electronic devices on the front passenger seat if a child restraint system is to be installed on it.
- ▷ Do not place objects under the seat that can push against the seat from below.
- ▷ No moisture in or on the seat.

Indicator light for the front-seat passenger airbags

The indicator light for the front-seat passenger airbag in the roofliner indicates the operating state of the front-seat passenger airbag.

The light indicates whether the airbags are either activated or deactivated.

After drive-ready state is switched on, the light briefly lights up and then indicates whether the airbags are either activated or deactivated.

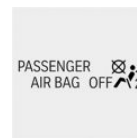

- ▷ The indicator light lights up when a child is properly seated in a child restraint system or when the seat is empty. The airbags on the front passenger side are not activated.
- ▷ The indicator light does not light up when, for instance a correctly seated person of sufficient size is detected on the seat. The airbags on the front passenger side are activated.

Detected child restraint systems

The system generally detects children seated in a child restraint system, particularly in child restraint systems required by NHTSA at the point in time when the vehicle was manufactured. After installing a child restraint system, make sure

that the indicator light for the front-seat passenger airbags lights up. This indicates that the child restraint system has been detected and the front-seat passenger airbags are not activated.

Intelligent Safety

Concept

Intelligent Safety enables central operation of the driver assistance systems.

General information

Depending on how the vehicle is equipped, Intelligent Safety consists of one or more systems that can help prevent an imminent collision.

- ▷ Front collision mitigation.
- ▷ Evasion Assistant.
- ▷ Intersection collision warning.
- ▷ Person warning with City braking function.
- ▷ Night Vision with pedestrian and animal detection.
- ▷ Lane departure warning.
- ▷ Blind spot collision warning.
- ▷ Side collision mitigation.

Safety information

Warning

The system cannot serve as a substitute for the driver's personal judgment in assessing visibility and traffic situation. There is a risk of accident. Adjust driving style to traffic conditions. Watch traffic closely and actively intervene where appropriate.

Warning

Indicators and warnings cannot serve as a substitute for the driver's personal judgment. Due to its limits, the system may not issue warnings or reactions, or these may be issued late or in a manner that is not consistent with their normal use. There is a risk of accident. Adjust driving style to traffic conditions. Watch traffic closely and actively intervene where appropriate.

Warning

Due to system limits, individual functions can malfunction during tow-starting/towing with the Intelligent Safety systems activated. There is a risk of accident. Switch all Intelligent Safety systems off prior to tow-starting/towing.

Overview

Button in the vehicle



 Intelligent Safety

Switching on/off

Some Intelligent Safety systems are automatically active after every departure. Some Intelligent Safety systems activate according to the last setting.

Button	Status
	Button lights up green: all Intelligent Safety systems are switched on.
	Button lights up orange: some Intelligent Safety systems are switched off or currently unavailable.
	Button does not light up: all Intelligent Safety systems are switched off.

 Press the button.

The menu for the Intelligent Safety system is displayed.

If all Intelligent Safety systems were switched off, all systems are now switched on.

"Configure INDIVIDUAL": depending on the equipment version, the Intelligent Safety systems can be individually configured. The individual settings are activated and stored for the driver profile currently used. As soon as a setting is changed on the menu, all settings of the menu are activated.

 Press the button repeatedly. The following settings are switched between:

"ALL ON": all Intelligent Safety systems are switched on. Basic settings are activated for the sub-functions, for instance setting for warning time.

"INDIVIDUAL": the Intelligent Safety systems are switched on according to the individual settings. Some Intelligent Safety systems cannot be individually switched off.

 Press and hold this button.

All Intelligent Safety systems are switched off.

Front collision mitigation

Concept

The system may prevent some accidents. In the event of an accident, the system may reduce impact speed.

The system sounds a warning before an imminent collision and activates brakes independently, if needed.

General information

Depending on the equipment version, the system is controlled by the following sensors:

- ▷ Camera in the area of the interior mirror.
- ▷ Radar sensor in the front bumper.

The system issues a two-phase warning of a possible risk of collision with vehicles at speeds above approx. 3 mph/5 km/h. The timing of warnings may vary with the current driving situation.

With the vehicle approaching another vehicle intentionally, the approach control warning and braking are delayed in order to avoid false system reactions.

Depending on the vehicle equipment, the Driver Attention Camera in the instrument cluster captures the driver's field of vision. Additionally, the system checks for visual impairments. Field of vision and visibility also affect the timing of the warnings.

Safety information

Warning

The system cannot serve as a substitute for the driver's personal judgment in assessing visibility and traffic situation. There is a risk of accident. Adjust driving style to traffic conditions. Watch traffic closely and actively intervene where appropriate.

Warning

Indicators and warnings cannot serve as a substitute for the driver's personal judgment. Due to its limits, the system may not issue warnings or reactions, or these may be issued late or in a manner that is not consistent with their normal use. There is a risk of accident. Adjust driving style to traffic conditions. Watch traffic closely and actively intervene where appropriate.

Warning

Due to system limits, individual functions can malfunction during tow-starting/towing with the Intelligent Safety systems activated. There is a risk of accident. Switch all Intelligent Safety systems off prior to tow-starting/towing.

Overview

Button in the vehicle



 Intelligent Safety

Camera

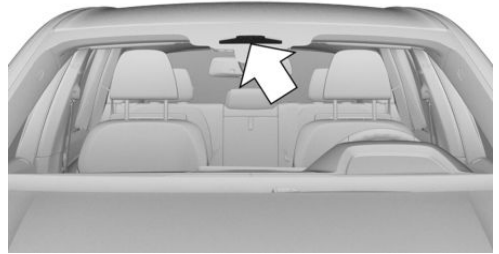

The camera is installed near the interior mirror. Keep the windshield in front of the interior mirror clean and clear.

With radar sensor

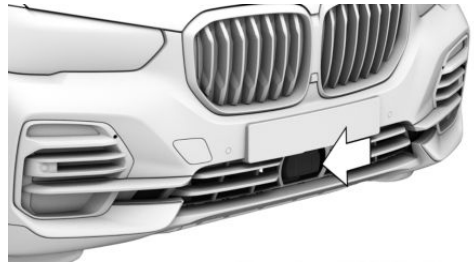

The radar sensor is located in the lower area of the front bumper.

Always keep radar sensor clean and unobstructed.

Switching on/off

Switching on automatically

The system is automatically active after every driving off.

Switching on manually

 Press the button. The menu for the Intelligent Safety system is displayed.

If all Intelligent Safety systems were switched off, all systems are now switched on.

"Configure INDIVIDUAL": depending on the equipment version, the Intelligent Safety systems can be individually configured. The individual settings are activated and stored for the driver profile currently used. As soon as a setting is changed on the menu, all settings of the menu are activated.



Press the button repeatedly.

The following settings are switched between:

"ALL ON": all Intelligent Safety systems are switched on. Basic settings are activated for the subfunctions.

"INDIVIDUAL": the Intelligent Safety systems are switched on according to the individual settings. Some Intelligent Safety systems cannot be individually switched off.

Manual switching off



Press and hold this button.

All Intelligent Safety systems are switched off.

Button Status



Button lights up green: all Intelligent Safety systems are switched on.



Button lights up orange: some Intelligent Safety systems are switched off or currently unavailable.



Button does not light up: all Intelligent Safety systems are switched off.

Setting the warning time

Via iDrive:

1. "CAR"
2. "Settings"
3. "Driver Assistance"
4. "Safety and warnings"

5. "Front collision mitigation"
6. Select the desired setting:
 - ▷ "Early"
 - ▷ "Medium"
 - ▷ "Late": only acute warnings are displayed.

The selected time is stored for the driver profile currently used.

Warning with braking function

Display

A warning symbol appears in the instrument cluster and in the Head-up Display, where available, if a collision with a detected vehicle is imminent.

Symbol Measure



Symbol lights up red: prewarning.
Brake and increase distance.



Symbol flashes red and an acoustic signal sounds: acute warning.
Brake and make an evasive maneuver, if necessary.

Prewarning

This warning is provided, for instance when there is impending danger of a collision or the distance to the vehicle ahead is too small.

If a prewarning is provided, respond by braking as warranted.

Acute warning with braking function

An acute warning is displayed in case of the imminent danger of a collision when the vehicle approaches another object at a high differential speed.

Intervene in the case of an acute warning. Depending on the driving situation and the equipment version, the acute warning may be accompanied by a brief activation of the braking system.

With the warning time setting "Late" the brief activation of the braking system is omitted.

If an acute warning is provided, the system may also provide assistance, such as through braking, when there is risk of collision.

Acute warnings may be provided even when there has been no prior warning.

Braking intervention

The warning prompts the driver to intervene. If a warning is active, the maximum braking force is used when the brake is applied. The brake pedal must be applied sufficiently quickly and forcefully.

The system may also assist in braking if there is a risk of collision.

When the vehicle is traveling at a low speed, the vehicle may come to a complete stop.

City brake function: the braking intervention occurs to up to approx. 50 mph/80 km/h.

With radar sensor: the braking intervention occurs to up to approx. 155 mph/250 km/h.

At speeds above approx. 130 mph/210 km/h, the braking intervention occurs as a brief braking pressure. No automatic delay occurs.

The braking intervention occurs only if vehicle stability has not been restricted, for instance by deactivating the DSC Dynamic Stability Control.

The driver may interrupt the braking intervention function by stepping on the accelerator pedal or by actively moving the steering wheel.

The system's ability to detect objects may be limited in some circumstances. Refer to the information in this Owner's Manual regarding the limitations of the system and actively intervene as warranted.

System limits

Safety information

Warning

The system is designed to operate in certain conditions and circumstances. Due to conditions or other factors, the system may not respond. There may be a risk of accident or risk of damage to property. Actively intervene as warranted. Refer to the information in this Owner's Manual regarding the scope of the system's operation and limitations.

Detection range

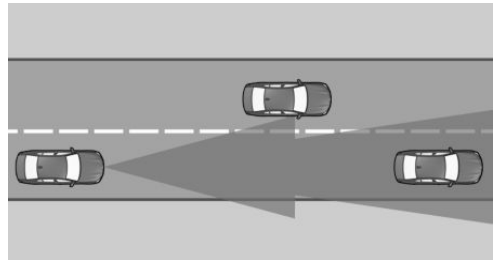

The system's detection potential is limited.

Only objects that are detected by the system are taken into account.

Thus, a system reaction might not come or might come late.

The following situations may not be detected, for instance:

- ▶ Slow moving vehicles when you approach them at high speed.
- ▶ Vehicles that suddenly swerve in front of you, or sharply decelerating vehicles.
- ▶ Vehicles with an unusual rear appearance.
- ▶ Two-wheeled vehicles ahead of you.

Upper speed limit

If the vehicle speed exceeds approx. 155 mph/250 km/h, the system is deactivated

temporarily. When the vehicle slows down to below this speed, the system is reactivated.

Functional limitations

The system may not be fully functional in the following situations:

- ▶ In heavy fog, wet conditions, or snowfall.
- ▶ In tight curves.
- ▶ If the driving stability control systems are limited or deactivated, for instance DSC OFF.
- ▶ If the field of view of the camera or the windshield is dirty or covered in the area of the interior mirror.
- ▶ If the camera has overheated and been temporarily switched off due to excessively high temperatures.
- ▶ Up to 10 seconds after the start of the engine via the Start/Stop button.
- ▶ During calibration of the camera immediately after vehicle delivery.
- ▶ If there are constant blinding effects because of oncoming light, for instance from the sun low in the sky.
- ▶ When it is dark outside.
- ▶ Depending on the equipment: if the radar sensors are dirty or covered.
- ▶ Depending on the equipment version: after improperly performed work on the vehicle paint in the area of the radar sensors.

Attaching any objects such as stickers or film in the beam area of the radar sensors will also limit the function of the radar sensors and may even cause them to fail.

Warning sensitivity

The more sensitive the warning settings are, for example the warning time, the more warnings are displayed. Therefore, there may also be an excess of premature or unjustified warnings and reactions.

Evasion Assistant

Concept

The system supports the driver in making evasive maneuvers in certain situations, such as when obstacles or persons suddenly appear.

General information

The system issues a warning and intervenes to support the driver if a lateral evasive maneuver is possible. Sensors monitor and detect the clearance around the vehicle. If the system identifies space alongside the vehicle, it supports an evasive maneuver begun by the driver by safely providing targeted steering support.

Safety information

Warning

The system cannot serve as a substitute for the driver's personal judgment in assessing visibility and traffic situation. There is a risk of accident. Adjust driving style to traffic conditions. Watch traffic closely and actively intervene where appropriate.

Warning

Indicators and warnings cannot serve as a substitute for the driver's personal judgment. Due to its limits, the system may not issue warnings or reactions, or these may be issued late or in a manner that is not consistent with their normal use. There is a risk of accident. Adjust driving style to traffic conditions. Watch traffic closely and actively intervene where appropriate.

Overview

Radar sensors

The radar sensors are located in the bumpers.

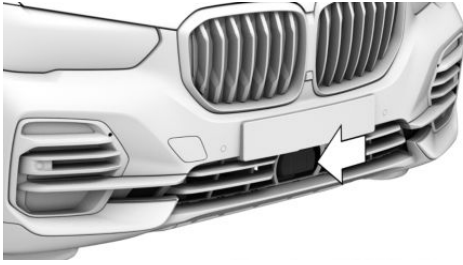

Front center bumper.



Front side bumper.

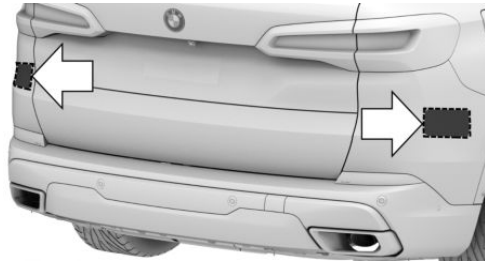

Rear bumper.

Always keep the bumper in the area of the radar sensors clean and unobstructed.

Camera

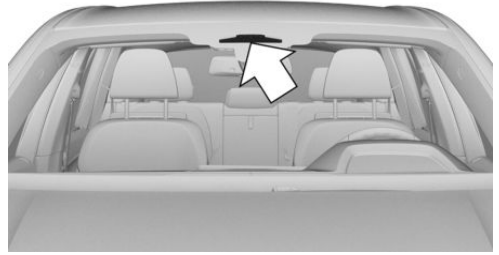

The camera is installed near the interior mirror.

Keep the windshield in front of the interior mirror clean and clear.

Functional requirements

- ▶ Pedestrian warning with braking function, refer to page 194, is switched on.
- ▶ Front collision mitigation, refer to page 183, is switched on.
- ▶ Sensors detect sufficient clearance around the vehicle.

Switching on/off

The system is automatically active after every driving off.

Warning with evasion support

Display in the instrument cluster

A warning symbol appears in the instrument cluster and in the Head-up Display if a collision with a detected vehicle is imminent.

Symbol	Measure
	Symbol lights up red: prewarning. Brake and increase distance.
	Symbol flashes red and an acoustic signal sounds: acute warning for obstacles. Brake and make an evasive maneuver, if necessary.
	Symbol flashes red and an acoustic signal sounds: acute warning for pedestrians. Brake and make an evasive maneuver, if necessary.



Acute warning with evasion support

An acute warning is displayed when there is an imminent danger of collision due to the vehicle approaching another object at a high speed.

Intervene in the case of an acute warning. The system is designed to provide assistance by taking evasive action when there is a risk of collision.

Acute warnings may be provided even when there has been no prior warning.

System limits

Safety information

Warning

The system is designed to operate in certain conditions and circumstances. Due to conditions or other factors, the system may not respond. There may be a risk of accident or risk of damage to property. Actively intervene as warranted. Refer to the information in this Owner's Manual regarding the scope of the system's operation and limitations.

Detection range

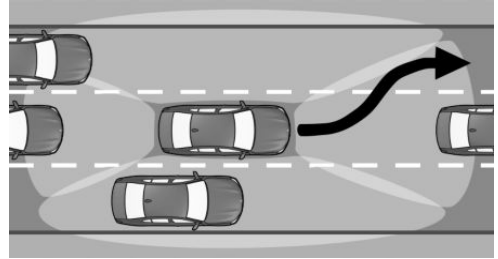

The system's detection potential is limited.

Only objects that are detected by the system are taken into account.

Thus, a system reaction might not come or might come late.

The following situations may not be detected, for example:

- ▷ Slow moving vehicles when you approach them at high speed.
- ▷ Vehicles that suddenly swerve in front of you, or sharply decelerating vehicles.
- ▷ Vehicles with an unusual rear appearance.
- ▷ Two-wheeled vehicles ahead of you.

Functional limitations

The system may not be fully functional in the following situations:

- ▷ In heavy fog, wet conditions, or snowfall.
- ▷ In tight curves.
- ▷ If the driving stability control systems are limited or deactivated, for instance DSC OFF.
- ▷ If the field of view of the camera or the windshield is dirty or covered in the area of the interior mirror.
- ▷ If the camera has overheated and been temporarily switched off due to excessively high temperatures.
- ▷ Up to 10 seconds after the start of the engine via the Start/Stop button.
- ▷ During calibration of the camera immediately after vehicle delivery.

- ▷ If there are constant blinding effects because of oncoming light, for instance from the sun low in the sky.
- ▷ When it is dark outside.
- ▷ Depending on the equipment: if the radar sensors are dirty or covered.
- ▷ Depending on the equipment version: after improperly performed work on the vehicle paint in the area of the radar sensors.

Attaching any objects such as stickers or film in the beam area of the radar sensors will also limit the function of the radar sensors and may even cause them to fail.

Intersection collision warning

Concept

The system may prevent some accidents with cross traffic at intersections and junctions. In the event of an accident, the system may reduce impact speed.

The system sounds a warning in the city speed range before an imminent collision and activates brakes independently, if needed.

General information

The system is controlled by the following sensors:

- ▷ Camera in the area of the interior mirror.
- ▷ Radar sensors on the side in the front bumper.
- ▷ Radar sensor in the center in the front bumper.

At intersections and junctions, a warning is issued when a danger of collision with crossing traffic is detected.

The system issues a two-phase warning of a possible risk of collision with vehicles at speeds above approx. 6 mph/10 km/h. The timing of

warnings may vary with the current driving situation.

The Driver Attention Camera in the instrument cluster captures the driver's field of vision. Additionally, the system checks for visual impairments. Field of vision and visibility also affect the timing of the warnings.

Detection range

Vehicles that cross your direction of travel can be detected by the system as soon as these vehicles enter into the detection range of the system.

Safety information

Warning

The system cannot serve as a substitute for the driver's personal judgment in assessing visibility and traffic situation. There is a risk of accident. Adjust driving style to traffic conditions. Watch traffic closely and actively intervene where appropriate.

Warning

Indicators and warnings cannot serve as a substitute for the driver's personal judgment. Due to its limits, the system may not issue warnings or reactions, or these may be issued late or in a manner that is not consistent with their normal use. There is a risk of accident. Adjust driving style to traffic conditions. Watch traffic closely and actively intervene where appropriate.

Warning

Due to system limits, individual functions can malfunction during tow-starting/towing with the Intelligent Safety systems activated. There is a risk of accident. Switch all Intelligent Safety systems off prior to tow-starting/towing.

Overview

Button in the vehicle



 Intelligent Safety

Camera

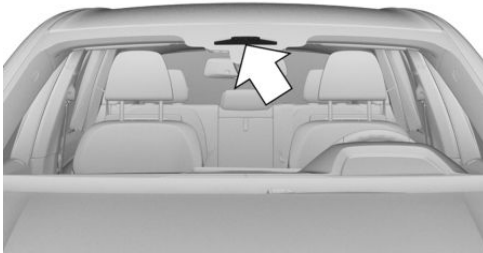

The camera is installed near the interior mirror.
Keep the windshield in front of the interior mirror clean and clear.

Radar sensors

The radar sensors are located in the front bumper.



Front side bumper.

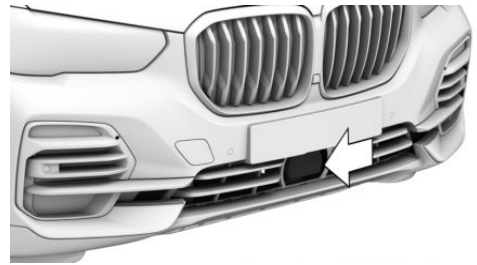

Front center bumper.

Keep the radar sensors clean and unobstructed.

Switching on/off

Switching on automatically

The system is automatically active after every driving off.

Switching on manually

 Press the button.

The menu for the Intelligent Safety system is displayed.

If all Intelligent Safety systems were switched off, all systems are now switched on.

"Configure INDIVIDUAL": depending on the equipment version, the Intelligent Safety systems can be individually configured. The individual settings are activated and stored for the driver profile currently used. As soon as a setting is changed on the menu, all settings of the menu are activated.

 Press the button repeatedly.



The following settings are switched between:

"ALL ON": all Intelligent Safety systems are switched on. Basic settings are activated for the subfunctions.

"INDIVIDUAL": the Intelligent Safety systems are switched on according to the individual settings. Some Intelligent Safety systems cannot be individually switched off.

Manual switching off

 Press and hold this button.
All Intelligent Safety systems are switched off.

Button	Status
	Button lights up green: all Intelligent Safety systems are switched on.
	Button lights up orange: some Intelligent Safety systems are switched off or currently unavailable.
	Button does not light up: all Intelligent Safety systems are switched off.

Setting the warning time

Via iDrive:



1. "CAR"
2. "Settings"
3. "Driver Assistance"
4. "Safety and warnings"
5. "Front collision mitigation"
6. Select the desired setting:
 - ▷ "Early"
 - ▷ "Medium"
 - ▷ "Late": only acute warnings are displayed.

The selected time is stored for the driver profile currently used.

Warning with braking function

Display

A warning symbol appears in the instrument cluster and in the Head-up Display, where available, if a collision with a detected vehicle is imminent.

Sym- bol	Measure
	Danger of collision with vehicle crossing from the right.
	Danger of collision with vehicle crossing from the left.
	Danger of collision with vehicle for which the direction of travel cannot be determined.
	Prewarning: Symbol lights up red: prewarning for vehicles that cross your direction of travel. Intervene yourself, for instance by braking.
	Acute warning: Symbol flashes red and an acoustic signal sounds: acute warning when vehicles cross your direction of travel. Brake and make an evasive maneuver, if necessary.

Prewarning

For example, a prewarning is displayed when a danger of collision with a crossing vehicle is detected.

If a prewarning is provided, respond by braking as warranted.

Acute warning with braking function

An acute warning is displayed in the event of an immediate danger of collision with a crossing vehicle.

Intervene in the case of an acute warning. If an acute warning is provided, the system may provide assistance, such as through braking, when there is risk of collision.

Acute warnings may be provided even when there has been no prior warning.

Braking intervention

The warning prompts the driver to intervene.

The system may also assist in braking if there is a risk of collision.

The vehicle can be decelerated to a standstill.

The braking intervention occurs only if vehicle stability has not been restricted, for instance by deactivating the DSC Dynamic Stability Control.

The driver may interrupt the braking intervention function by stepping on the accelerator pedal or by actively moving the steering wheel.

The system's ability to detect objects may be limited in some circumstances. Refer to the information in this Owner's Manual regarding the limitations of the system and actively intervene as warranted.

System limits

Safety information

Warning

The system is designed to operate in certain conditions and circumstances. Due to conditions or other factors, the system may not respond. There may be a risk of accident or risk of damage to property. Actively intervene as warranted. Refer to the information in this Owner's Manual regarding the scope of the system's operation and limitations.

Upper speed limit

The system responds to crossing vehicles when your own speed is below approx. 50 mph/80 km/h.

Detection range

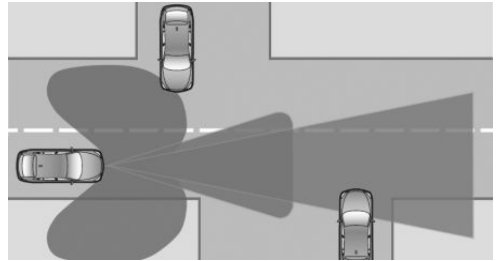

The system's detection potential is limited.

Thus, a system reaction might not come or might come late.

The following situations may not be detected, for instance:

- ▷ Crossing vehicles when they are hidden by buildings, for instance.
- ▷ Vehicles that suddenly swerve in front of you, or sharply decelerating vehicles.
- ▷ Crossing bicycles.
- ▷ Vehicles with an unusual side appearance.

Functional limitations

The system may not be fully functional in the following situations:

- ▷ In heavy fog, wet conditions, or snowfall.
- ▷ In tight curves.
- ▷ If the driving stability control systems are limited or deactivated, for instance DSC OFF.
- ▷ If the field of view of the camera or the windshield is dirty or covered in the area of the interior mirror.
- ▷ If the camera has overheated and been temporarily switched off due to excessively high temperatures.
- ▷ Up to 10 seconds after the start of the engine via the Start/Stop button.
- ▷ During calibration of the camera immediately after vehicle delivery.

- ▷ If there are constant blinding effects because of oncoming light, for instance from the sun low in the sky.
- ▷ When it is dark outside.
- ▷ Depending on the equipment: if the radar sensors are dirty or covered.
- ▷ Depending on the equipment version: after improperly performed work on the vehicle paint in the area of the radar sensors.

Attaching any objects such as stickers or film in the beam area of the radar sensors will also limit the function of the radar sensors and may even cause them to fail.

Warning sensitivity

The more sensitive the warning settings are, for example the warning time, the more warnings are displayed. Therefore, there may also be an excess of premature or unjustified warnings and reactions.

Person warning with City braking function

Concept

The system can help prevent accidents involving pedestrians and cyclists. In the event of an accident, the system may reduce impact speed.

The system sounds a warning in the city speed range before an imminent collision and activates brakes independently, if needed.

General information

The system issues a warning of a possible risk of collision with pedestrians and cyclists at speeds above approx. 3 mph/5 km/h.

The system reacts to pedestrians and cyclists who are within the detection range of the system.

Depending on the equipment version, the system is controlled by the following sensors:

- ▷ Camera in the area of the interior mirror.
- ▷ Radar sensor in the front bumper.

Detection range

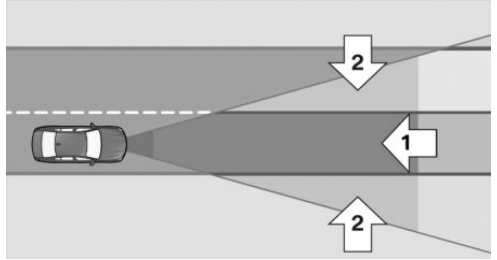

The detection area in front of the vehicle is divided into two areas:

- ▷ Central area, arrow 1, directly in front of the vehicle.
- ▷ Expanded area, arrows 2, to the right and left of the central area.

A collision is imminent if pedestrians are located within the central area. A warning is issued about pedestrians who are located within the extended area only if they are moving in the direction of the central area.

Safety information

Warning

The system cannot serve as a substitute for the driver's personal judgment in assessing visibility and traffic situation. There is a risk of accident. Adjust driving style to traffic conditions. Watch traffic closely and actively intervene where appropriate.

Warning

Indicators and warnings cannot serve as a substitute for the driver's personal judgment. Due to its limits, the system may not issue warnings or reactions, or these may be issued late or in a manner that is not consistent with their normal

use. There is a risk of accident. Adjust driving style to traffic conditions. Watch traffic closely and actively intervene where appropriate.

Warning

Due to system limits, individual functions can malfunction during tow-starting/towing with the Intelligent Safety systems activated. There is a risk of accident. Switch all Intelligent Safety systems off prior to tow-starting/towing.

Overview

Button in the vehicle



 Intelligent Safety

Camera

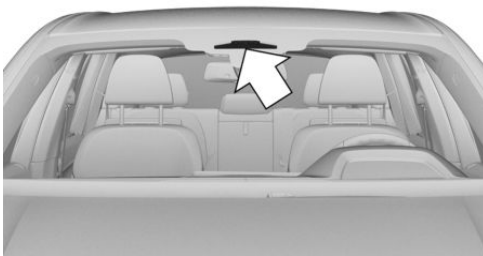

The camera is installed near the interior mirror. Keep the windshield in front of the interior mirror clean and clear.

With radar sensor

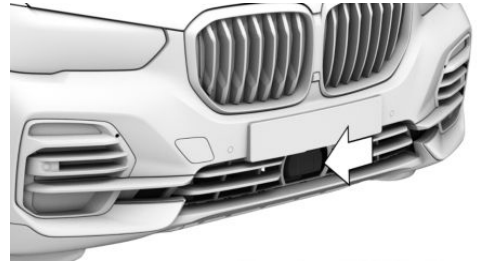

The radar sensor is located in the lower area of the front bumper.

Always keep radar sensor clean and unobstructed.

Switching on/off

Switching on automatically

The system is automatically active after every driving off.

Switching on manually



Press the button.

The menu for the Intelligent Safety system is displayed.

If all Intelligent Safety systems were switched off, all systems are now switched on.

"Configure INDIVIDUAL": depending on the equipment version, the Intelligent Safety systems can be individually configured. The individual settings are activated and stored for the driver profile currently used. As soon as a setting is changed on the menu, all settings of the menu are activated.



Press the button repeatedly.

The following settings are switched between:

"ALL ON": all Intelligent Safety systems are switched on. Basic settings are activated for the subfunctions.

"INDIVIDUAL": the Intelligent Safety systems are switched on according to the individual settings. Some Intelligent Safety systems cannot be individually switched off.

Manual switching off



Press and hold this button.

All Intelligent Safety systems are switched off.

Button Status



Button lights up green: all Intelligent Safety systems are switched on.



Button lights up orange: some Intelligent Safety systems are switched off or currently unavailable.



Button does not light up: all Intelligent Safety systems are switched off.

Warning with braking function

Display

If a collision with a pedestrian or a cyclist is imminent, a warning symbol appears on the instrument cluster and in the Head-up Display.



The red symbol is displayed and a signal sounds.

Intervene immediately by braking or make an evasive maneuver.

Braking intervention

The warning prompts the driver to intervene. If a warning is active, the maximum braking force is used when the brake is applied. This requires the brake pedal to be depressed sufficiently quickly and forcefully.

If there is a risk of collision, the system may also assist with braking.

When the vehicle is traveling at a low speed, the vehicle may come to a complete stop.

The braking intervention occurs only if vehicle stability has not been restricted, for instance by deactivating the DSC Dynamic Stability Control.

The driver may interrupt the braking intervention function by stepping on the accelerator pedal or by actively moving the steering wheel.

The system's ability to detect objects may be limited in some circumstances. Refer to the information in this Owner's Manual regarding the limitations of the system and actively intervene as warranted.

System limits

Safety information

Warning

The system is designed to operate in certain conditions and circumstances. Due to conditions or other factors, the system may not respond. There may be a risk of accident or risk of damage to property. Actively intervene as warranted. Refer to the information in this Owner's Manual regarding the scope of the system's operation and limitations.

Upper speed limit

The system responds to pedestrians and cyclists when the speed of the vehicle is below approx. 50 mph/80 km/h.

Detection range

The system's detection potential is limited.

Thus, a warning might not be issued or be issued late.

The following situations may not be detected, for instance:

- ▶ Partially covered pedestrians.
- ▶ Pedestrians that are not detected as such because of the viewing angle or contour.
- ▶ Pedestrians outside of the detection range.

- ▶ Pedestrians having a body size less than 32 in/80 cm.

Functional limitations

The system may not be fully functional or may not be available in the following situations:

- ▶ In heavy fog, wet conditions, or snowfall.
- ▶ In tight curves.
- ▶ If the driving stability control systems are deactivated, for instance DSC OFF.
- ▶ If the field of view of the camera or the windshield is dirty or covered in the area of the interior mirror.
- ▶ If the camera has overheated and been temporarily switched off due to excessively high temperatures.
- ▶ Up to 10 seconds after the start of the engine via the Start/Stop button.
- ▶ During calibration of the camera immediately after vehicle delivery.
- ▶ If there are constant blinding effects because of oncoming light, for instance from the sun low in the sky.
- ▶ When it is dark outside.
- ▶ Depending on the equipment: if the radar sensors are dirty or covered.
- ▶ Depending on the equipment version: after improperly performed work on the vehicle paint in the area of the radar sensors.

Attaching any objects such as stickers or film in the beam area of the radar sensors will also impact the function of the radar sensors and may even cause them to fail.

Night Vision with pedestrian and animal detection

Concept

Night Vision with pedestrian and animal detection is a night vision system.

An infrared camera scans the area in front of the vehicle and issues a warning if it detects pedestrians and animals on the street. The system detects warm objects that are similar in shape to human beings or animals. If necessary, the thermal image can be displayed on the Control Display.

General information

Thermal image



The image shows the heat radiated by objects in the field of view of the camera.

Warm objects have a light appearance and cold objects a dark appearance.

The ability to detect an object depends on the temperature difference between the object and the background and on the level of heat radiation emitted by the object. Objects that are similar in temperature to the environment or that radiate very little heat are difficult to detect.

For safety reasons, when driving at speeds above approx. 3 mph/5 km/h and in low ambient light, the image is only displayed when the low beams are switched on.

A still image is displayed at regular intervals for a fraction of a second.

Pedestrian and animal detection



Object detection and warning only functions in darkness.

Objects whose form is similar to people with sufficient heat radiation are detected.

In addition, the system also detects animals above a certain minimum size, for instance deer.

Display on the Control Display with thermal image activated:

- ▶ People detected by the system: in light yellow.
- ▶ Animals detected by the system: in dark yellow.

Range of object detection, with good ambient conditions:

- ▶ Pedestrian detection: up to approx. 330 ft/100 m.
- ▶ Detection of large animals: up to approx. 490 ft/150 m.
- ▶ Detection of medium animals: up to approx. 230 ft/70 m.

Environmental influences can limit the availability of object detection.

If the vehicle systems detect that the vehicle is located in a residential area, the animal detection is temporarily switched off.

Safety information

Warning

The system cannot serve as a substitute for the driver's personal judgment in assessing visibility and traffic situation. There is a risk of accident. Adjust driving style to traffic conditions. Watch traffic closely and actively intervene where appropriate.

Warning

Indicators and warnings cannot serve as a substitute for the driver's personal judgment. Due to its limits, the system may not issue warnings or reactions, or these may be issued late or in a manner that is not consistent with their normal use. There is a risk of accident. Adjust driving style to traffic conditions. Watch traffic closely and actively intervene where appropriate.

Overview

Buttons in the vehicle



 Intelligent Safety



Thermal image

Camera

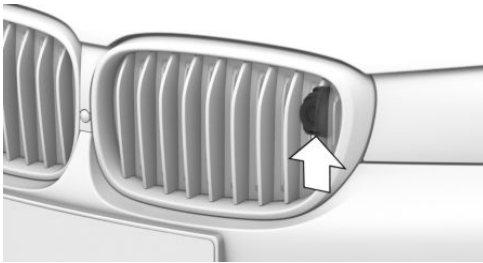

The camera is automatically heated when the external temperatures are low.

When the vehicle lighting is switched on, the camera objective is cleaned at regular intervals when the windshield washer system is activated.

Switching on

Switching on automatically

When it is dark outside, the system is automatically active after every driving off.

Switching on the thermal image

The thermal image from the Night Vision camera can be displayed on the Control Display in addition to the warning function. This function has no effect on object detection.



Press the button.

The image from the camera is displayed on the Control Display.

Adjusting the thermal image

Brightness and contrast can be adjusted, when the thermal image is switched on.

Via iDrive:

1. Select brightness or contrast:
 - ▷ ☀ "Brightness".
 - ▷ 🌑 "Contrast".
2. Set the desired value.

Warning function

Display

Symbol	Meaning
	Person warning.
	Animal warning.
Symbol lights up red.	Prewarning.
Symbol flashes red and a signal sounds.	Acute warning.

The displayed symbol may vary and shows the side of the road on which the person or animal was detected.

Warning of people or animals in danger

If a collision with a person or an animal detected in this way is imminent, a warning symbol appears on the instrument cluster and in the Head-up Display.

Although both the shape and the heat radiation are analyzed, false warnings cannot be ruled out.

Warning area in front of the vehicle

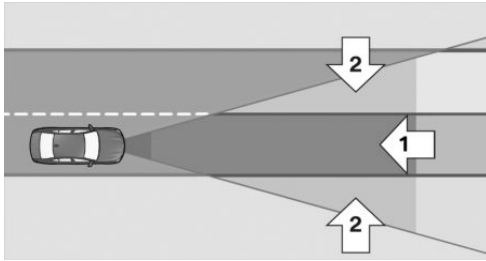

The warning area for the person warning consists of two parts:

- ▷ Central area, arrow 1, directly in front of the vehicle.
- ▷ Expanded area, arrows 2, to the right and left of the central area.

With animal warnings, no distinction is made between the central or expanded area.

The entire area moves along with the vehicle in the direction of the steering angle and changes with the vehicle speed. As the vehicle speed increases, the area becomes, for instance longer and wider.

Prewarning

Prewarning for persons is displayed when a person is detected in the central area immediately in front of the vehicle as well as on the left or right side in the extended area.

Prewarning for animals is displayed when an animal is detected in the front of the vehicle.

If a prewarning is issued, intervene by braking or making an evasive maneuver.

Acute warning

Acute warning is displayed if a person or an animal is detected in direct proximity in front of the vehicle.

If an acute warning is issued, brake or make an evasive maneuver immediately.

Display in the Head-up Display

The warning is displayed simultaneously in the Head-up Display and on the instrument cluster.

System limits

Basic limits

The system may not be fully functional in the following situations:

- ▷ On steep hills, in steep depressions or in tight curves.
- ▷ If the camera is soiled or damaged.
- ▷ In heavy fog, wet conditions, or snowfall.
- ▷ At very high external temperatures.

Limits of pedestrian and animal detection

In some situations, it may occur that pedestrians are detected as animals or animals as pedestrians.

Small animals are not detected by the object detection function, even if they are clearly visible in the image.

Limited detection, for instance in the following circumstances:

- ▷ People or animals who are fully or partially covered, especially when their heads are covered.
- ▷ People who are not in an upright position, for instance lying down.
- ▷ Cyclists on unconventional bicycles (e.g., recumbent bicycles).
- ▷ After physical damage to the system, for instance after an accident.

Lane departure warning

Concept

The lane departure warning alerts when the vehicle is about to run off the road or exit the lane.

General information

This camera-based system warns starting at a minimum speed.

The minimum speed is country-specific and is displayed in the menu for the intelligent Safety systems.

Warnings are issued by means of a steering wheel vibration. The severity of the steering wheel vibration can be adjusted.

The system does not provide a warning if the turn signal is set in the respective direction before leaving the lane.

Depending on the equipment version, if in the speed range up to 130 mph/210 km/h a lane marking is crossed, the system may intervene with a brief active steering intervention in addition to vibrating. The system thus helps keep the vehicle in the lane.

Safety information

Warning

The system cannot serve as a substitute for the driver's personal judgment in assessing road and traffic safety. There is a risk of accident. Adjust driving style to traffic conditions. Watch traffic closely and actively intervene where appropriate. Do not jerk the steering wheel in response to a warning.

Warning

Indicators and warnings cannot serve as a substitute for the driver's personal judgment. Due to its limits, the system may not issue warnings or reactions, or these may be issued late or in a manner that is not consistent with their normal use. There is a risk of accident. Adjust driving style to traffic conditions. Watch traffic closely and actively intervene where appropriate.

Functional requirement

The camera must detect the lane markings for the lane departure warning to be active.

Overview

Button in the vehicle



 Intelligent Safety

Camera

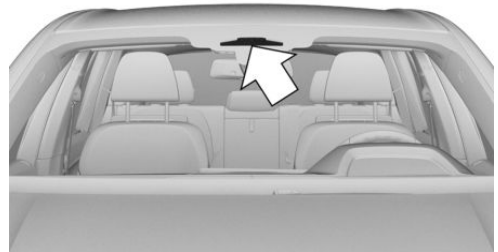

The camera is installed near the interior mirror.

Keep the windshield in front of the interior mirror clean and clear.

Switching on/off

Switching on automatically

The lane departure warning activates automatically after departure if the function was switched on at the end of the last trip.

Switching on manually



Press the button.

The menu for the Intelligent Safety system is displayed.

If all Intelligent Safety systems were switched off, all systems are now switched on.

"Configure INDIVIDUAL": depending on the equipment version, the Intelligent Safety systems can be individually configured. The individual settings are activated and stored for the driver profile currently used. As soon as a setting is changed on the menu, all settings of the menu are activated.



Press the button repeatedly.

The following settings are switched between:

"ALL ON": all Intelligent Safety systems are switched on. Basic settings are activated for the subfunctions.

"INDIVIDUAL": the Intelligent Safety systems are switched on according to the individual settings. Some Intelligent Safety systems cannot be individually switched off.

Manual switching off



Press and hold this button.

All Intelligent Safety systems are switched off.

Button Status



Button lights up green: all Intelligent Safety systems are switched on.



Button lights up orange: some Intelligent Safety systems are switched off or currently unavailable.



Button does not light up: all Intelligent Safety systems are switched off.

Setting the warning time

Via iDrive:

1. "CAR"
2. "Settings"
3. "Driver Assistance"
4. "Safety and warnings"
5. "Lane Departure Warning"
6. Select the desired setting:
 - ▷ "Early"
 - ▷ "Medium"
 - ▷ "Reduced": some warnings are suppressed depending on the situation, for instance during passing without a turn signal or when purposely driving over lane markings in curves.
 - ▷ "Off": no warnings are issued.

The selected setting is stored for the driver profile currently used.

Setting the intensity of the steering wheel vibration

Via iDrive:

1. "CAR"
2. "Settings"
3. "Driver Assistance"
4. "Steering wheel feedback"
5. "Vibration intensity"
6. Select the desired setting.

The setting is applied to all Intelligent Safety systems and stored for the driver profile currently used.

Switch steering intervention on/off

The steering intervention can be switched on and off separately for blind spot collision warning and lane departure warning.

Via iDrive:

1. "CAR"
2. "Settings"
3. "Driver Assistance"
4. "Safety and warnings"
5. "Lane Departure Warning"
6. "Steering intervention"

The selected setting is stored for the driver profile currently used.

Display in the instrument cluster



The symbol illuminates green: at lane marking was detected on at least one side of the vehicle and warnings can be issued.

Warning function

If you leave the lane

If you leave the lane and if a lane marking has been detected, the steering wheel vibrates in accordance with the steering wheel vibration setting.

When the turn signal is switched on in the corresponding direction before changing the lane, a warning is not issued.

Steering intervention

Depending on the equipment version: if, in the speed range up to 130 mph/210 km/h a lane marking is crossed, the system may intervene with a brief active steering intervention in addition to vibrating. The steering intervention helps keep the vehicle in the lane. The steering intervention can be noticed on the steering wheel and can be manually overridden at any time. During an active steering intervention, the display in the instrument cluster will blink.

Warning signal

Depending on the equipment version: in the event of multiple active steering interventions by

the system within 3 minutes without the driver's intervention at the steering wheel, an acoustic warning will sound. A short warning signal will sound at the second steering intervention. Beginning with the third steering intervention, an continuous warning will sound.

In addition, a Check Control message is displayed.

The warning signal and Check-Control message are an encouragement to pay closer attention to the lane.

With trailer towing

If the trailer power socket is in use or trailer towing is activated, for instance during operation with trailer or bicycle rack, no steering intervention takes place.

End of warning

For instance, the warning will be canceled in the following situations:

- ▷ Automatically after a few seconds.
- ▷ When returning to your own lane.
- ▷ When braking hard.
- ▷ When using the turn signal.
- ▷ If DSC Dynamic Stability Control intervenes.

System limits

Safety information

Warning

The system is designed to operate in certain conditions and circumstances. Due to conditions or other factors, the system may not respond. There may be a risk of accident or risk of damage to property. Actively intervene as warranted. Refer to the information in this Owner's Manual regarding the scope of the system's operation and limitations.

Functional limitations

The system may not be fully functional in the following situations:

- ▶ In heavy fog, wet conditions, or snowfall.
- ▶ In the event of missing, worn, poorly visible, merging, diverging, or multiple lane markings such as in construction areas.
- ▶ When lane markings are covered in snow, ice, dirt or water.
- ▶ In tight curves or on narrow lanes.
- ▶ When lane markings are covered by objects.
- ▶ When driving very close to the vehicle in front of you.
- ▶ If there are constant blinding effects because of oncoming light, for instance from the sun low in the sky.
- ▶ If the field of view of the camera or the windshield is dirty or covered in the area of the interior mirror.
- ▶ If the camera has overheated and been temporarily switched off due to excessively high temperatures.
- ▶ Up to 10 seconds after the start of the engine via the Start/Stop button.
- ▶ During calibration of the camera immediately after vehicle delivery.

A Check Control message may be displayed when the system is not fully functional.

Blind spot collision warning

Concept

Blind spot collision warning detects vehicles in the blind spot or vehicles approaching from behind in the adjacent lane. A warning is issued in various gradations in these situations.

General information

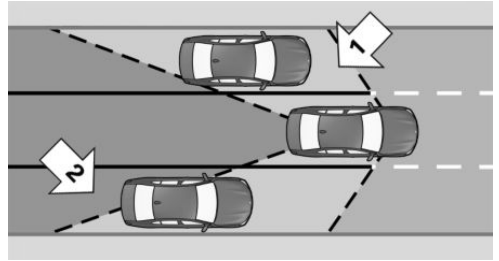

Two radar sensors in the rear bumper monitor the area behind and next to the vehicle when traveling faster than a minimum speed.

The minimum speed is country-specific and is displayed in the menu for the intelligent Safety systems.

The system indicates whether there are vehicles in the blind spot, arrow 1, or approaching from behind in the adjacent lane, arrow 2.

The light in the exterior mirror lights up dimmed.

Before you change lanes after setting the turn signal, the system issues a warning in the situations described above.

The light in the exterior mirror flashes and the steering wheel vibrates.

Vehicles with side collision mitigation: at speeds of up to 130 mph/210 km/h, the system can intervene with a brief active steering intervention and help guide the vehicle back into the lane. The steering intervention occurs when a minimum speed is reached. This minimum speed is displayed on the Control Display in the menu for the steering intervention.

Safety information

Warning

The system cannot serve as a substitute for the driver's personal judgment in assessing visibility and traffic situation. There is a risk of accident. Adjust driving style to traffic conditions. Watch

traffic closely and actively intervene where appropriate.

Warning

Indicators and warnings cannot serve as a substitute for the driver's personal judgment. Due to its limits, the system may not issue warnings or reactions, or these may be issued late or in a manner that is not consistent with their normal use. There is a risk of accident. Adjust driving style to traffic conditions. Watch traffic closely and actively intervene where appropriate.

Overview

Button in the vehicle



 Intelligent Safety

Radar sensors

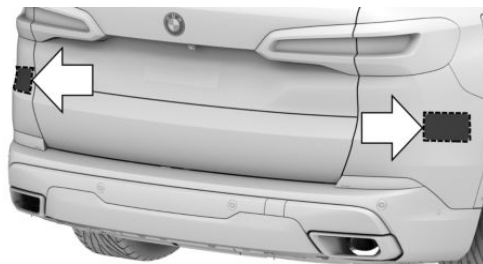

The radar sensors are located in the rear bumper.

Always keep the bumper in the area of the radar sensors clean and unobstructed.

Switching on/off

Switching on automatically

Blind spot collision warning is automatically activated after departure if the function was switched on at the end of the last trip.

Switching on manually

 Press the button.

The menu for the Intelligent Safety system is displayed.

If all Intelligent Safety systems were switched off, all systems are now switched on.

"Configure INDIVIDUAL": depending on the equipment version, the Intelligent Safety systems can be individually configured. The individual settings are activated and stored for the driver profile currently used. As soon as a setting is changed on the menu, all settings of the menu are activated.

 Press the button repeatedly.

The following settings are switched between:

"ALL ON": all Intelligent Safety systems are switched on. Basic settings are activated for the subfunctions.

"INDIVIDUAL": the Intelligent Safety systems are switched on according to the individual settings. Some Intelligent Safety systems cannot be individually switched off.

Manual switching off

 Press and hold this button.

All Intelligent Safety systems are switched off.

Button Status

 Button lights up green: all Intelligent Safety systems are switched on.

 Button lights up orange: some Intelligent Safety systems are switched off or currently unavailable.

 Button does not light up: all Intelligent Safety systems are switched off.

Setting the warning time

Via iDrive:

1. "CAR"
2. "Settings"
3. "Driver Assistance"
4. "Safety and warnings"
5. "Active Blind Spot Detection"
6. Select the desired setting:
 - ▷ "Early"
 - ▷ "Medium"
 - ▷ "Late"
 - ▷ "Off": with this setting, no warning is output.

The setting is stored for the driver profile currently used.

Setting the intensity of the steering wheel vibration

Via iDrive:

1. "CAR"
2. "Settings"
3. "Driver Assistance"
4. "Steering wheel feedback"
5. "Vibration intensity"
6. Select the desired setting.

The setting is applied to all Intelligent Safety systems and stored for the driver profile currently used.

Vehicles with side collision mitigation: switching steering intervention on/off

The steering intervention can be switched on and off separately for blind spot collision warning and lane departure warning.

Via iDrive:

1. "CAR"
2. "Settings"
3. "Driver Assistance"
4. "Safety and warnings"
5. "Active Blind Spot Detection"
6. "Steering intervention"

The setting is stored for the driver profile currently used.

Warning function**Light in the exterior mirror****Prewarning**

The dimmed light in the exterior mirror indicates when there are vehicles in the blind spot or approaching from behind.

Acute warning

When the turn signal is switched on while a vehicle is in the critical zone, the steering wheel vibrates briefly and the light in the exterior mirror flashes brightly.

The warning stops when the other vehicle has left the critical area or the turn signal has been deactivated.

Vehicles with side collision mitigation

When there is no response to the vibration of the steering wheel at speeds of up to 130 mph/210 km/h and the lane marking is crossed, the system intervenes with a brief active steering intervention. The steering intervention helps return the vehicle into the lane. The steering intervention can be noticed on the steering wheel and can be manually overridden at any time.

Flashing of the light

A flashing of the light during vehicle unlocking serves as system self-test.

System limits

Safety information

Warning

The system is designed to operate in certain conditions and circumstances. Due to conditions or other factors, the system may not respond. There may be a risk of accident or risk of damage to property. Actively intervene as warranted. Refer to the information in this Owner's Manual regarding the scope of the system's operation and limitations.

Upper speed limit

If the vehicle speed exceeds approx. 155 mph/250 km/h, the system is deactivated temporarily.

If the vehicle speed falls below approx. 155 mph/250 km/h, the system once again responds according to the setting.

Functional limitations

The system may not be fully functional in the following situations:

- ▷ When a vehicle is approaching at a speed much faster than your own.
- ▷ In heavy fog, wet conditions, or snowfall.
- ▷ In tight curves or on narrow lanes.
- ▷ If the bumper is dirty, iced up, or covered, for instance by stickers.
- ▷ After improperly performed work on the vehicle paint.
- ▷ If cargo protrudes.

Attaching any objects such as stickers or film in the beam area of the radar sensors will also impact the function of the radar sensors and may even cause them to fail.

For vehicles with side collision mitigation, the steering intervention can be limited, for instance in the following situation:

- ▷ In the event of missing, worn, poorly visible, merging, diverging, or multiple lane markings such as in construction areas.
- ▷ When lane markings are covered in snow, ice, dirt or water.
- ▷ When lane markings are not white.
- ▷ When lane markings are covered by objects.
- ▷ When driving very close to the vehicle in front of you.
- ▷ If there are constant blinding effects because of oncoming light, for instance from the sun low in the sky.
- ▷ If the field of view of the camera or the windshield is dirty or covered in the area of the interior mirror.
- ▷ If the camera has overheated and been temporarily switched off due to excessively high temperatures.
- ▷ Up to 10 seconds after the start of the engine via the Start/Stop button.
- ▷ During calibration of the camera immediately after vehicle delivery.

A Check Control message is displayed when the system is not fully functional.

If the trailer power socket is in use or trailer towing is activated, for instance during operation with trailer or bicycle rack, the system cannot be switched on. A Check Control message is displayed.

Displaying warnings

Depending on the selected warning settings, e.g., warning time, more or fewer warnings can be displayed. However, there may also be an excess of premature warnings of critical situations.

Side collision mitigation

Concept

The system helps to avoid imminent side collisions.

General information

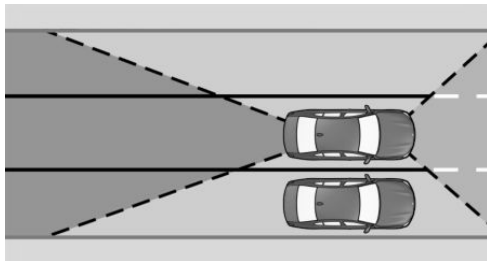

Four radar sensors in the bumpers monitor the space next to the vehicle from a minimum speed of up to approx. 130 mph/210 km/h.

The minimum speed is country-specific and is displayed in the menu for the intelligent Safety systems.

The front camera determines the lane marking positions.

If, for instance, another vehicle is detected next to the vehicle and if there is a risk of collision with this vehicle, the system helps avoid the collision. For this purpose, the system issues a warning with a flashing LED in the exterior mirror and a vi-

brating steering wheel. If necessary, the system will carry out an active steering intervention.

Safety information

Warning

The system cannot serve as a substitute for the driver's personal judgment in assessing visibility and traffic situation. There is a risk of accident. Adjust driving style to traffic conditions. Watch traffic closely and actively intervene where appropriate.

Warning

Indicators and warnings cannot serve as a substitute for the driver's personal judgment. Due to its limits, the system may not issue warnings or reactions, or these may be issued late or in a manner that is not consistent with their normal use. There is a risk of accident. Adjust driving style to traffic conditions. Watch traffic closely and actively intervene where appropriate.

Functional requirement

The camera must detect the lane markings for the side collision mitigation with steering intervention to be active.

Overview

Button in the vehicle



Intelligent Safety

Radar sensors

The radar sensors are located in the bumpers.



Front bumper.

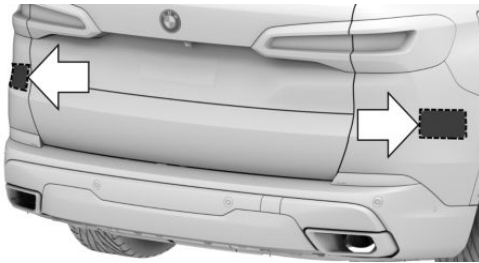

Rear bumper.

Always keep the bumper in the area of the radar sensors clean and unobstructed.

Camera

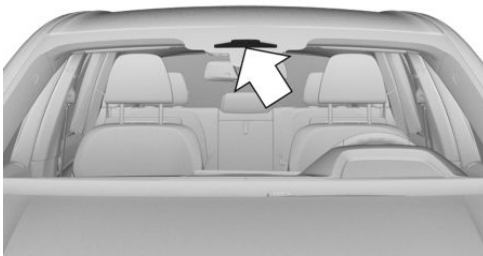

The camera is installed near the interior mirror. Keep the windshield in front of the interior mirror clean and clear.

Switching on/off

Switching on automatically

The side collision mitigation activates automatically after departure if the function was switched on at the end of the last trip.

Switching on manually

 Press the button. The menu for the Intelligent Safety system is displayed.

If all Intelligent Safety systems were switched off, all systems are now switched on.

"Configure INDIVIDUAL": depending on the equipment version, the Intelligent Safety systems can be individually configured. The individual settings are activated and stored for the driver profile currently used. As soon as a setting is changed on the menu, all settings of the menu are activated.

 Press the button repeatedly. The following settings are switched between:

"ALL ON": all Intelligent Safety systems are switched on. Basic settings are activated for the subfunctions.



"INDIVIDUAL": the Intelligent Safety systems are switched on according to the individual settings.

Some Intelligent Safety systems cannot be individually switched off.

Manual switching off

 Press and hold this button. All Intelligent Safety systems are switched off.

Button Status

	Button lights up green: all Intelligent Safety systems are switched on.
	Button lights up orange: some Intelligent Safety systems are switched off or currently unavailable.
	Button does not light up: all Intelligent Safety systems are switched off.

Setting the intensity of the steering wheel vibration

Via iDrive:

1. "CAR"
2. "Settings"
3. "Driver Assistance"
4. "Steering wheel feedback"
5. "Vibration intensity"
6. Select the desired setting.

The setting is applied to all Intelligent Safety systems and stored for the driver profile currently used.

Warning function**Light in the exterior mirror****Acute warning**

If there is a risk of collision, the light in the exterior mirror flashes and the steering wheel vibrates. A Check Control message is displayed at the same time.

If necessary, an active steering intervention takes place to prevent the collision and maintain the vehicle within its own lane.

The steering intervention can be noticed on the steering wheel and can be manually overridden at any time.

System limits**Safety information****⚠ Warning**

The system is designed to operate in certain conditions and circumstances. Due to conditions or other factors, the system may not respond. There may be a risk of accident or risk of damage to property. Actively intervene as warranted. Refer to the information in this Owner's Manual regarding the scope of the system's operation and limitations.

Functional limitations

The system may not be fully functional in the following situations:

- ▶ When a vehicle is approaching at a speed much faster than your own.
- ▶ In heavy fog, wet conditions, or snowfall.
- ▶ In tight curves or on narrow lanes.
- ▶ If the bumper is dirty, iced up, or covered, for instance by stickers.
- ▶ After improperly performed work on the vehicle paint.
- ▶ If cargo protrudes.
- ▶ In the event of missing, worn, poorly visible, merging, diverging, or multiple lane markings such as in construction areas.
- ▶ When lane markings are covered in snow, ice, dirt or water.
- ▶ When lane markings are covered by objects.
- ▶ When driving very close to the vehicle in front of you.

- ▷ If there are constant blinding effects because of oncoming light, for instance from the sun low in the sky.
- ▷ If the field of view of the camera or the windshield is dirty or covered in the area of the interior mirror.
- ▷ If the camera has overheated and been temporarily switched off due to excessively high temperatures.
- ▷ Up to 10 seconds after the start of the engine via the Start/Stop button.
- ▷ During calibration of the camera immediately after vehicle delivery.

Attaching any objects such as stickers or film in the beam area of the radar sensors will also impact the function of the radar sensors and may even cause them to fail.

A Check Control message is displayed when the system is not fully functional.

If the trailer power socket is in use or trailer towing is activated, for instance during operation with trailer or bicycle rack, the system cannot be switched on. A Check Control message is displayed.

Rear collision preparation

Concept

The system reacts to vehicles approaching from behind.

General information

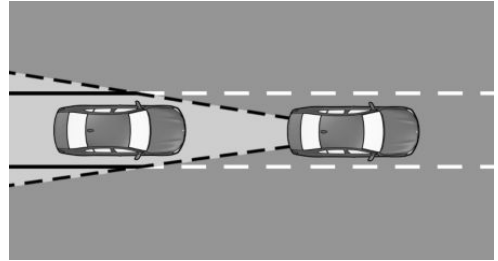

Two radar sensors in the rear bumper monitor the area behind the vehicle.

When a vehicle approaches from the rear at a certain speed, the system responds as follows:

- ▷ Active Protection: when a collision seems to be unavoidable, PreCrash functions are triggered.

Safety information

Warning

The system cannot serve as a substitute for the driver's personal judgment in assessing visibility and traffic situation. There is a risk of accident. Adjust driving style to traffic conditions. Watch traffic closely and actively intervene where appropriate.

Warning

Indicators and warnings cannot serve as a substitute for the driver's personal judgment. Due to its limits, the system may not issue warnings or reactions, or these may be issued late or in a manner that is not consistent with their normal use. There is a risk of accident. Adjust driving style to traffic conditions. Watch traffic closely and actively intervene where appropriate.

Overview

Radar sensors

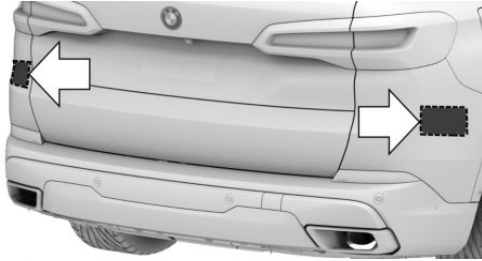

The radar sensors are located in the rear bumper.

Always keep the bumper in the area of the radar sensors clean and unobstructed.

Switching on/off

The system is automatically active after every driving off.

The system is deactivated in the following situations:

- ▷ When driving in reverse.
- ▷ If the trailer power socket is in use or trailer towing is activated, for instance during operation with trailer or bicycle rack.

System limits

The system may not be fully functional in the following situations:

- ▷ When a vehicle is approaching at a speed much faster than your own.
- ▷ When the approaching vehicle approaches slowly.
- ▷ In heavy fog, wet conditions, or snowfall.
- ▷ In tight curves or on narrow lanes.
- ▷ If the bumper is dirty, iced up, or covered, for instance by stickers.
- ▷ If the field of view of the sensors is covered, e.g., by garage walls, hedges or snow hills.
- ▷ If cargo protrudes.

Emergency Stop Assistant

Concept

If the driver is no longer fit to drive, the system helps to safely bring the vehicle to a standstill.

General information

The emergency stop function is not triggered automatically. The emergency stop function can only be triggered manually by the occupants.

When the system is activated, the vehicle is brought to a standstill in its own lane by use of lane guidance.

Depending on the equipment version and national market version, the system includes a lane change function.

With lane change function: On motorways or motorway-like roads, the system steers the vehicle to the side of the road or shoulder where possible. On other roads or under high traffic conditions, the vehicle is brought to a standstill on the actual road.

Overview



 Parking brake

Functional requirements

- ▷ The function can be activated at speeds of approx. 6 mph/10 km/h up to approx. 155 mph/250 km/h.

- ▷ Lane changes are executed at speeds of approx. 43 mph/70 km/h up to approx. 62 mph/100 km/h.

Activating the emergency stop function

 Pull the switch for the parking brake briefly to activate the emergency stop function.

- ▷ With lane change function: Releasing the switch may trigger an automatic lane change.
- ▷ The system will take control of the vehicle for a maximum of 2 minutes.
- ▷ The hazard warning system is switched on.
- ▷ An Emergency Request is triggered.

Canceling the emergency stop function

The driver can cancel the emergency stop function by actively taking control of the vehicle throughout the entire process.

For instance, the emergency stop function will be canceled in the following situations:

- ▷ When steering.
- ▷ When using the turn signal.
- ▷ During acceleration.
- ▷ When switching off the hazard warning system.
- ▷ When canceling the Emergency Request.
- ▷ When switching the selector lever position at standstill.
- ▷ When the driver's foot remains on the accelerator pedal after the function has been triggered.
- ▷ When the switch of the parking brake is pressed.

At standstill

As soon as the vehicle is stationary, the system will carry out the following settings:

- ▷ Selector lever position P is engaged.

- ▷ Parking brake is set.
- ▷ Interior lights are switched on.
- ▷ Central locking system is unlocked.

Displays in the instrument cluster

Symbol Status



Emergency Stop function active.

Without lane change function:

Symbol Status



Green steering wheel symbol:
When lane markings are detected, the system keeps the vehicle in the lane.



Gray steering wheel symbol:
Lane guidance is briefly interrupted.



Yellow steering wheel symbol:
Lane marking driven over.
When lane markings are detected, the system keeps the vehicle in the lane.



Yellow steering wheel symbol:
The hands are not grasping the steering wheel. The system is still active.



Red steering wheel symbol and a signal sounds:
The hands are not grasping the steering wheel. Interruption of lane guidance is imminent.



Red steering wheel symbol and a signal sounds:
Lane guidance is switched off.

System limits

Use the system only in the event of a driver failure.

The system cannot replace the driving performance of a driver who is fit to drive.

BMW Drive Recorder

Concept

The system stores brief video recordings of the surrounding area of the vehicle, e.g., to document traffic events.

Additionally, the following parameters are stored for the trip:

- ▷ Date.
- ▷ Time.
- ▷ Vehicle speed.
- ▷ GPS coordinates.

General information

There are various ways for storing video recordings:

- ▷ Automatic storage of the recording.
The function allows the documentation of the event of an accident.
- ▷ Manual storage of the recording.
The function allows the documentation of traffic situations.

The system records up to 20 seconds before and after the activation of the storage.

Cameras of the assistance systems are used, for instance Panorama View.

Data protection

The permissibility of recording and using video recordings is contingent upon the statutory regulations of the country in which the system is to be used. The user is responsible for the use of the system and compliance with the respective regulations.

The manufacturer of the vehicle recommends confirming there are no statutory or regulatory constraints on use of the system in your state or country prior to the initial use. In addition, the laws with respect to use of the system should be verified in regular intervals, especially when borders are frequently crossed.

Other drivers of the vehicle must be informed about the system. In addition, information about the system is required when handing off the vehicle.

Functional requirements

- ▷ The system is activated.
- ▷ Recording type selected.
- ▷ Recording time selected.

Activating/deactivating

The BMW Drive Recorder must be activated before the first use of the recording function.

Via iDrive:

1. "Apps"
2. "Drive Recorder"
3. "Settings"
4. "Recording allowed"
5. Select the desired setting.

Recording functions

Automatic recording

The recording is stored automatically when the vehicle sensors detect an accident occurrence.

Manual recording

Using the button:



Press and hold this button.

Via iDrive:

1. "Apps"
2. "Drive Recorder"

3. "Start recording"

To stop the recording: "Cancel".

Recording playback and administration

Stored video recordings can be played back, exported and deleted.

For your own safety, the recording is only displayed in front up to approx. 2 mph/3 km/h. In some national-market versions, the recording is only displayed if the parking brake is engaged or if the selector lever is in selector lever position P.

Via iDrive:

1. "Apps"
2. "Drive Recorder"
3. "Saved recordings"
4. Select desired recording.
5. Select the desired setting:
 - ▷ "Play"
 - ▷ "Pause"
 - ▷ "Export"
 - ▷ "Delete"
 - ▷ "Previous. recording"
 - ▷ "Next recording"

If a camera change occurred during the recording, different segments of the video can be selected.

Adjusting

General information

Different settings can be made.

Recording type

Via iDrive:

1. "Apps"
2. "Drive Recorder"
3. "Settings"

4. "RECORDING TYPE"

5. Select the desired setting:
 - ▷ "Manually"
 - ▷ "Automatically"

Recording time

Via iDrive:

1. "Apps"
2. "Drive Recorder"
3. "Settings"
4. Select the desired setting:
 - ▷ "Before trigger"
Recording time before an event.
 - ▷ "After trigger"
Recording time after an event.

Cameras

Via iDrive:

1. "Apps"
2. "Drive Recorder"
3. "Settings"
4. "Camera selection"
5. Select desired camera.

In case of an accident, the system switches automatically to "All" cameras.

System limits

In the event of serious accidents, it may not be possible to store recordings if the damage on the vehicle is too great or the power supply was interrupted.

Active Protection

Concept

Active Protection prepares occupants and the vehicle for a possible accident in critical driving or collision situations.

General information

Active Protection consists of various PreCrash functions, which can vary depending on the equipment.

The system is used to detect certain critical driving situations that might lead to an accident. This includes the following critical driving situations:

- ▷ Emergency stop.
- ▷ Severe understeering.
- ▷ Severe oversteering.

Certain functions of several systems can, within the system limits, lead to Active Protection triggering:

- ▷ Front collision mitigation: automatic brake intervention.
- ▷ Front collision mitigation: Brake Assistant.
- ▷ Night Vision with pedestrian and animal detection: Brake Assistant.
- ▷ Rear collision preparation: detection of imminent rear collisions.

Safety information

Warning

The system cannot serve as a substitute for the driver's personal judgment. Due to the system limits, critical situation could not be detected reliably or in time. There is a risk of accident. Adjust driving style to traffic conditions. Watch traffic closely and actively intervene where appropriate.

Function

When the safety belt is fastened, the driver's and passenger's belt straps are automatically tightened once after driving away.

In accident-critical situations, the following individual functions become active as needed:

- ▷ Automatic pretensioning of the front safety belts.

- ▷ Automatic window closing up to a narrow gap.
- ▷ Automatic closing of the panoramic glass sunroof, including sun protection.
- ▷ For vehicles equipped with comfort seats in the front: automatic positioning of the backrest for the front passenger seat.

After a critical driving situation without an accident, the front safety belts are loosened again.

If the belt tension does not loosen automatically, stop the vehicle and unbuckle the safety belt using the red button in the buckle. Fasten the safety belt before continuing on your trip.

All other systems can be restored to the desired setting.

PostCrash – iBrake

Concept

In the event of an accident, the system can bring the vehicle to a halt automatically without intervention by the driver in certain situations. This can reduce the risk of a further collision and the consequences thereof.

At standstill

After coming to a halt, the brake is released automatically.

Harder vehicle braking

In certain situations, it can be necessary to bring the vehicle to a halt more quickly than the Brake Assistant allows.

To do this, quickly apply extra force to the brake. For a brief period, the braking pressure will be higher than the braking pressure that is achieved by the automatic braking function. Automatic braking is interrupted.

Interrupting automatic braking

It can be necessary to interrupt automatic braking in certain situations, for instance for an evasive maneuver.

Interrupt automatic braking:

- ▷ By pressing the brake pedal.
- ▷ By pressing the accelerator pedal.

Fatigue alert

General information

The system can detect decreasing alertness or fatigue of the driver during long, monotonous trips, for instance on highways. In this situation, it is recommended that the driver takes a break.

Safety information

Warning

The system cannot serve as a substitute for the driver's personal judgment in assessing one's physical state. An increasing lack of alertness or fatigue may not be detected or not be detected in time. There is a risk of accident. Make sure that the driver is rested and alert. Adjust driving style to traffic conditions.

Function

The system is switched on each time drive-ready state is switched on.

After travel has begun, the system monitors certain aspects of the driver's behavior, so that decreasing alertness or fatigue can be detected.

This procedure takes the following criteria into account:

- ▷ Personal driving style, for instance steering behavior.
- ▷ Driving conditions, for instance time, length of trip.

- ▷ Depending on the equipment: attention of the driver through the Driver Attention Camera.

Starting at approx. 43 mph/70 km/h, the system is active and can also display a recommendation to take a break.

Break recommendation

Adjusting

The fatigue alert is active automatically with each switching on of drive-ready state and can thus display a break recommendation.

The break recommendation can also be switched on or off and adjusted via iDrive.

Via iDrive:

1. "CAR"
2. "Settings"
3. "General settings"
4. "Fatigue and Focus Alert"
5. Select the desired setting:
 - ▷ "Standard": the break recommendation is made with a defined value.
 - ▷ "Sensitive": the break recommendation is issued earlier.
 - ▷ "Off": no break recommendation is made.

Display

If the driver becomes less alert or fatigued, a message is displayed in the Control Display with the recommendation to take a break.

During the display, various settings can be selected.

After a break, another recommendation to take a break cannot be displayed until after approximately 45 minutes.

System limits

The function may be limited in the following situations and may issue an incorrect warning or no warning at all:

- ▷ When the clock is set incorrectly.
- ▷ When the vehicle speed is mainly below about 43 mph/70 km/h.
- ▷ With a sporty driving style, such as during rapid acceleration or when cornering fast.
- ▷ In active driving situations, such as when changing lanes frequently.
- ▷ When the road surface is poor.
- ▷ In the event of strong side winds.

The system is reset approx. 45 minutes after parking the vehicle, for instance in the case of a break during longer trips on highways.

Driving stability control systems

Vehicle features and options

This chapter describes all standard, country-specific and optional features offered with the series. It also describes features and functions that are not necessarily available in your vehicle, e.g., due to the selected options or country versions. This also applies to safety-related functions and systems. When using these functions and systems, the applicable laws and regulations must be observed.

Anti-lock Braking System ABS

ABS prevents locking of the wheels during braking.

The vehicle maintains its steering power even during full brake applications, which increases the active safety.

ABS is operational every time you start the engine.

Brake assistant

When you apply the brakes rapidly, this system automatically boosts the vehicle braking capability to the furthest possible extent. It reduces the braking distance to a minimum during an emergency stop. This system utilizes all of the capabilities provided by the Antilock Brake System ABS.

Do not reduce the pressure on the brake pedal for the duration of the emergency stop.

Adaptive brake assistant

In combination with Active Cruise Control ACC, this system ensures that the brakes respond even more rapidly when braking in critical situations.

Drive-off assistant

Concept

This system supports driving off on uphill grades.

Driving off

1. Hold the vehicle in place with the foot brake.
2. Release the foot brake and drive off without delay.

After the foot brake is released, the vehicle is held in place for approx. 2 seconds.

Depending on the vehicle loading or when a trailer is used, the vehicle may roll back slightly.

DSC Dynamic Stability Control

Concept

Within the physical limits, the system helps to keep the vehicle on a steady course by reducing engine speed and by braking the individual wheels.

General information

DSC detects the following unstable driving conditions, for instance:

- ▷ Fishtailing, which can lead to oversteering.
- ▷ Loss of traction of the front wheels, which can lead to understeering.

Safety information

Warning

The system cannot serve as a substitute for the driver's personal judgment in assessing the traffic conditions. Based on the limits of the system, it cannot independently react to all traffic situations. There is a risk of accident. Adjust driving style to traffic conditions. Watch traffic closely and actively intervene where appropriate.

Warning

When driving with a roof load, for instance with roof-mounted luggage rack, the vehicle's center of gravity is higher, which increases the risk of the vehicle tipping in critical driving situations. There may be a risk of accident or risk of damage to property. Do not deactivate DSC Dynamic Stability Control when driving with roof load.

Overview

Button in the vehicle



DSC OFF

Deactivating/activating DSC

General information

When DSC is deactivated, driving stability is reduced during acceleration and when driving in curves.

To increase vehicle stability, activate DSC again as soon as possible.

Deactivating DSC



Hold the button down until DSC OFF is displayed in the instrument cluster and the DSC OFF indicator light is illuminated.

Activating DSC



Press the button. DSC OFF and the DSC OFF indicator light go out.

Display

In the instrument cluster

When DSC is deactivated, DSC OFF is displayed in the instrument cluster.

Indicator/warning lights



The indicator light lights up: DSC is deactivated.



The indicator light flashes: DSC controls the drive and braking forces.

The indicator light lights up: DSC has malfunctioned.

DTC Dynamic Traction Control

Concept

DTC is a version of the DSC Dynamic Stability Control where forward momentum is optimized.

The system ensures maximum headway on special road conditions or loose road surfaces, for instance unplowed snowy roads, but with somewhat limited driving stability.

General information

When DTC is activated, the vehicle has maximum traction. Driving stability is limited during acceleration and when driving in curves.

You may find it useful to briefly activate DTC in the following situations:

- ▷ When driving in slush or on uncleared, snow-covered roads.
- ▷ When driving off from deep snow or loose ground.
- ▷ When driving with snow chains.

Overview

Button in the vehicle



DSC OFF

Activating/deactivating DTC

Activating DTC



Press the button.

TRACTION is displayed in the instrument cluster and the indicator light for DSC OFF lights up.

Deactivating DTC



Press the button again.

TRACTION and the DSC OFF indicator light go out.

Display

Display in the instrument cluster

If DTC is activated, TRACTION is displayed in the instrument cluster.

Indicator/warning lights



The indicator light lights up: DTC is activated.

Automatic program change

In certain situations, the DSC is activated automatically:

- ▷ If Active Cruise Control with Stop&Go function ACC is activated.
- ▷ On a braking intervention by the Intelligent Safety systems.
- ▷ The vehicle has a flat tire.

xDrive

Concept

xDrive is the all-wheel-drive system of the vehicle. The interaction of xDrive and other suspension control systems, such as DSC Dynamic Stability Control, further optimizes traction and

driving dynamics. xDrive variably distributes the driving forces to the front and rear axles as demanded by the driving situation and road surface.

The Driving Dynamics Control is used to change the all-wheel distribution from traction oriented to sport oriented.

With the xOffroad package, the all-wheel-drive system is additionally adjusted for the respective xOffroad driving mode.

Because of the needs-based use of the all-wheel-drive system, Efficient4x4 yields a reduction in consumption.

Display on the Control Display

Display xView display

Via iDrive:

1. "CAR"
 2. "Driving information"
 3. "xOFFROAD"
- or
- "xVIEW"

The following information is displayed:

- ▷ With a navigation system: compass display for the driving direction.
- ▷ With navigation system: elevation for the current position.
- ▷ With navigation system: destination flag in compass direction to the destination.
- ▷ Pitch attitude with degree indication and percentage.
- ▷ Transverse gradient with degree indication.
- ▷ Graphic display for the steering angle.
- ▷ Level setting for the 2-axle air suspension.

With the xOffroad package, the following additional information can be displayed:

- ▷ With Surround View: depending on the speed, terrain-specific camera perspectives.
- ▷ xOffroad driving mode currently active.
- ▷ Distribution of drive torque to the wheels.

Display in the Head-up Display

Some of the information can also be displayed in the Head-up Display.

M sport differential

The active M differential provides for continuously variable locking of the rear axle differential depending on the driving situation. This prevents spinning of a single rear wheel and thereby provides optimal traction in any driving situation.

The driver is responsible adapting his or her driving style to the situation.

Automatic Differential Brake

The system controls the driving force by automatic braking intervention on individual wheels.

The function works in the same way as a differential lock and improves traction on a loose surface, for example. The system detects when a wheel begins to spin and automatically brakes this wheel.

The driving force is diverted to the wheel with better traction.

As a result, the engine force is transferred more efficiently to the wheels during accelerations.

HDC Hill Descent Control

Concept

HDC Hill Descent Control is a downhill control feature that controls the vehicle speed on steep downhill grades, for instance when driving on unpaved roads.

When the system is active, the vehicle moves at the speed set by the driver, without the driver having to depress the brake pedal.

While HTC is controlling the speed, the system automatically distributes the braking force to the individual wheels. This improves vehicle drivability and stability. If necessary, the Antilock Brake System prevents the wheels from locking.

General information

Hill Descent Control can be activated at speeds below approx. 25 mph/40 km/h.

Speeds can be set between approx. 2 mph/3 km/h and approx. 20 mph/30 km/h. When the vehicle is moving downhill, the system reduces the speed to the set value, within the physical limits.

Overview

Button in the vehicle



HDC

Activating HDC



Press the button. The LED on the button lights up.

Speeds between approx. 2 mph/3 km/h and approx. 20 mph/30 km/h are adopted as the desired speed.

Emergency braking function, Active PDC: the emergency braking function, refer to page 249, is deactivated.

Display in the instrument cluster

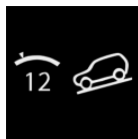

A symbol and the selected desired speed are displayed.

- ▶ Indicator green: HDC is active. The system is actively braking the vehicle.
- ▶ Gray display: HDC is on standby.

Display in the Head-up Display

The HDC status can also be displayed in the Head-up Display.

Increasing or decreasing vehicle speed

Using the cruise control rocker switch

The desired speed can be changed using the cruise control rocker switch on the steering wheel.

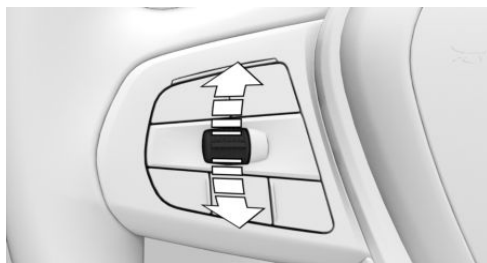

- ▶ Press the rocker switch up: the speed increases gradually.
- ▶ Press the rocker switch up and hold: the speed increases while the rocker switch is pressed.
- ▶ Press the rocker switch down: the speed decreases gradually.
- ▶ Press the rocker switch down and hold: the speed decreases while the rocker switch is pressed.

Using the brake pedal

While HDC is controlling the speed, the set desired speed can be reduced by depressing the brake pedal.

Deactivating HDC



Press the button again. The LED goes out.

HDC is automatically deactivated above approx. 25 mph/40 km/h.

Malfunction

If a malfunction occurs, a message is displayed in the instrument cluster.

Integral Active Steering

Concept

The Integral Active Steering increases the maneuverability and makes a more direct steering response possible.

General information

Integral Active Steering is a combination of variable steering ratio and rear axle steering.

The steering is more direct because the variable steering ratio amplifies the wheel angle while maneuvering. The rear axle steering acts to increase maneuverability at low speeds by turning the rear wheels slightly in the opposite direction to the front wheels.

At higher speeds, the rear wheels are turned in the same direction as the front wheels. This results in, for instance better directional stability and a more harmonious change of direction.

In critical driving situations, the Integral Active Steering can stabilize the vehicle through purposeful steering of the rear wheels before the driver intervenes, for instance in case of oversteering.

Tuning

The system offers several different tunings.

Driving mode	Integral Active Steering
COMFORT	Comfortable, for optimal travel comfort.
ECO PRO	
SPORT	Dynamic, for greater agility.

The different tunings are assigned to the different driving modes of the Driving Dynamics Control, refer to page [137](#).

Using snow chains

In order to guarantee free running of the wheels when operating with snow chains, rear axle steering of the integral active steering must be switched off when snow chains are mounted.

Set operation with snow chains, refer to page [358](#).

Malfunction

In the event of a malfunction, the steering wheel must be turned further at lower speeds, while the vehicle responds more sensitively to steering wheel movements in the higher speed range.

The stability-enhancing intervention may be deactivated.

Proceed cautiously and drive defensively.

Have the system checked by a dealer's service center or another qualified service center or repair shop.

Driver assistance systems

Vehicle features and options

This chapter describes all standard, country-specific and optional features offered with the series. It also describes features and functions that are not necessarily available in your vehicle, e.g., due to the selected options or country versions. This also applies to safety-related functions and systems. When using these functions and systems, the applicable laws and regulations must be observed.

Speed Limiter

Concept



The system can be used to set a speed limit, for instance to prevent the vehicle from exceeding speed limits.

General information

The system can limit the speed, starting at a value of 20 mph/30 km/h. The vehicle can be driven at any speed below the set speed limit.

Overview

Buttons on the steering wheel

Button	Function
	System on/off.
	Store current speed. Speed Limit Assist: take over suggested speed manually.
	Rocker switch: Changing the speed limit.

Operation

Switching on



Press the button on the steering wheel.

The current speed is accepted as the speed limit.

If the system is switched on while the vehicle is stationary or driving at low speeds, 20 mph/30 km/h is set as the speed limit.

The marking in the speedometer is set to the corresponding speed.

When the speed limit is switched on, DSC Dynamic Stability Control and COMFORT driving mode may be switched on as well.

Switching off



Press the button on the steering wheel.

The system switches off automatically in the following situations, for example:

- ▷ When the engine is switched off.
- ▷ When cruise control is switched on.
- ▷ When certain programs are activated via the Driving Dynamics Control.

The displays go out.

Interrupting

If the reverse gear is engaged or at idle, the system is interrupted when rolling backwards.

Changing the speed limit

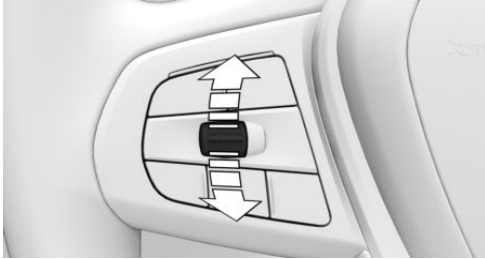

Press the rocker switch up or down repeatedly until the desired speed limit is set.

- ▶ Each time the rocker switch is pressed to the resistance point, the speed limit increases or decreases by 1 mph/1 km/h.
- ▶ Each time the rocker switch is pressed past the resistance point, the desired speed changes by a maximum of 5 mph/10 km/h.

If the set speed limit is reached or unintentionally exceeded, such as when driving downhill, the vehicle is not actively braked.

When the speed limit is set during a trip to a value below the current speed, the vehicle coasts until it drops to the set speed limit.

The current speed can also be stored by pressing a button:

 Press the button on the steering wheel.

Exceeding the speed limit

When the vehicle speed exceeds the set speed limit, a warning is issued.

The speed limit can be exceeded intentionally. There is no warning in this case.

Press the accelerator pedal all the way down to intentionally exceed the set speed limit.

When the vehicle speed drops below the set speed limit, the limit is automatically reactivated.

Warning when the speed limit is exceeded

Visual warning

 If the speed limit is exceeded: the indicator light in the instrument cluster flashes while the vehicle speed is greater than the set speed limit.

Acoustic warning

- ▶ If the speed limit is exceeded unintentionally, a signal sounds.
- ▶ When the speed limit is reduced to below the vehicle speed while driving, the signal sounds after some time.
- ▶ When the speed limit is intentionally exceeded by stepping on the accelerator pedal all the way down, there is no signal.

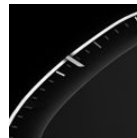

Displays in the instrument cluster

Display in the speedometer



- ▶ Green marking: system is active.
- ▶ Grey marking: system is interrupted.
- ▶ No marking: system is switched off.

Indicator light

-  ▶ The indicator light lights up: the system is switched on.
-  ▶ The indicator light flashes: the set speed limit has been exceeded.
- ▶ Gray indicator light: the system has been interrupted.

Cruise control

Concept

Using this system, a desired speed can be adjusted using the buttons on the steering wheel. The system maintains the desired speed. The system accelerates and brakes automatically as needed.

General information

Depending on the vehicle setting, the cruise control settings may change under certain conditions. For instance, acceleration can change depending on the driving mode.

Safety information

Warning

The system cannot serve as a substitute for the driver's personal judgment in assessing the traffic conditions. Based on the limits of the system, it cannot independently react to all traffic situations. There is a risk of accident. Adjust driving style to traffic conditions. Watch traffic closely and actively intervene where appropriate.

Warning

The use of the system can lead to an increased risk of accidents in the following situations, for instance:

- ▷ On winding roads.
- ▷ In heavy traffic.
- ▷ On slippery roads, in fog, snow, or wet conditions, or on a loose road surface.

There may be a risk of accident or risk of damage to property. Only use the system if driving at constant speed is possible.







Warning

The desired speed can be incorrectly adjusted or called up by mistake. There is a risk of accident. Adjust the desired speed to the traffic conditions. Watch traffic closely and actively intervene where appropriate.

Overview

Buttons on the steering wheel

Button Function

	Cruise control on/off.
	
	Continue cruise control with the last setting.
	Pause cruise control.
	Store current speed.
	Speed Limit Assist: take over suggested speed manually.
	Rocker switch:
	Set speed.

Switching cruise control on/off

Switching on

 Depending on the equipment version, press the relevant button on the steering wheel.



The indicator lights in the instrument cluster light up and the marking on the speedometer is set to the current speed.

Cruise control is active. The current speed is maintained and stored as desired speed.

DSC Dynamic Stability Control is switched on, if necessary.

Switching off



Depending on the equipment version, press the relevant button on the steering wheel.

The displays go out. The stored desired speed is deleted.

Pausing cruise control

Interrupting manually



When active, press the button.

Interrupting automatically

The system is automatically interrupted in the following situations, for example:

- ▶ When the driver applies the brakes.
- ▶ When selector lever position D is disengaged.
- ▶ Dynamic Traction Control DTC is activated or DSC Dynamic Stability Control is deactivated.
- ▶ If DSC Dynamic Stability Control intervenes.
- ▶ When SPORT PLUS is activated with Driving Dynamics Control.

Setting the speed

Maintaining and storing the speed

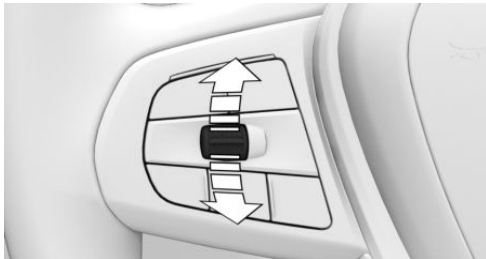

Press the rocker switch up or down once while the system is interrupted.

When the system is switched on, the current speed is maintained and stored as the desired speed.

The stored speed is displayed on the speedometer.

DSC Dynamic Stability Control is switched on, if necessary.

The speed can also be stored by pressing a button.



Press the button.

Changing the speed

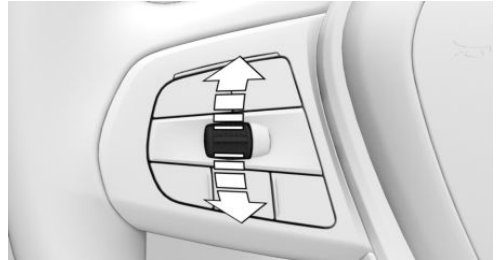

Press the rocker switch up or down repeatedly until the desired speed is set.

If active, the displayed speed is stored and the vehicle reaches the stored speed when the road is clear.

- ▶ Each time the rocker switch is pressed to the resistance point, the desired speed increases or decreases by 1 mph/1 km/h.
- ▶ Each time the rocker switch is pressed past the resistance point, the desired speed changes by a maximum of 5 mph/10 km/h. The maximum speed that can be set depends on the vehicle.
- ▶ Pressing the rocker switch to the resistance point and holding it accelerates or decelerates the vehicle without requiring pressure on the accelerator pedal.

After the rocker switch is released, the vehicle maintains its final speed. Pressing the switch beyond the resistance point causes the vehicle to accelerate more rapidly.

Continuing cruise control

An interrupted cruise control can be continued by calling up the stored speed.

Make sure that the difference between current speed and stored speed is not too large before calling up the stored speed. Otherwise, unintentional braking or accelerating may occur.

 Press the button with the system interrupted.

Cruise control is continued with the stored values.

In the following cases, the stored speed value is deleted and cannot be called up again:

- ▷ When the system is switched off.
- ▷ When drive-ready state is switched off.

Displays in the instrument cluster

Display in the speedometer

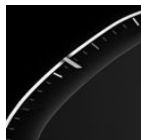

- ▷ Green marking: system is active, the marking indicates the desired speed.
- ▷ Grey marking: system is interrupted, the marking indicates the stored speed.
- ▷ No marking: system is switched off.

Indicator light



- ▷ Indicator light green: system is active.
- ▷ Gray indicator light: the system has been interrupted.
- ▷ No indicator light: system is switched off.

Displays in the Head-up Display

Some system information can also be displayed in the Head-up Display.



The symbol is displayed when the set desired speed is reached.

System limits

The desired speed is also maintained downhill. The speed may not be maintained on uphill grades if the engine power is insufficient.

In ECO PRO driving mode, the vehicle may exceed or drop below the set desired speed in some situations, for instance on downhill or uphill grades.

Active Cruise Control with Stop & Go function ACC

Concept

Using this system, a desired speed and a distance to a vehicle ahead can be adjusted using the buttons on the steering wheel.

The system maintains the desired speed on clear roads. The vehicle accelerates or brakes automatically.

If a vehicle is driving ahead of you, the system adjusts the speed of your vehicle so that the set distance to the vehicle ahead is maintained. The speed is adjusted as far as the given situation allows.

General information

A radar sensor is located in the front bumper and a camera on the interior mirror to detect vehicles driving ahead of you.

Depending on the vehicle setting, the cruise control settings may change under certain conditions. For instance, acceleration can change depending on the driving mode.

The distance can be adjusted in several steps. For safety reasons, it depends on the respective speed.

If the vehicle ahead of you brakes to a halt, and then proceeds to drive again within a brief period, the system is able to detect this within the given system limits.

Safety information

Warning

The system cannot serve as a substitute for the driver's personal judgment in assessing the traffic conditions. Based on the limits of the system, it cannot independently react to all traffic situations. There is a risk of accident. Adjust driving style to traffic conditions. Watch traffic closely and actively intervene where appropriate.

Warning

An unsecured vehicle can begin to move and possibly roll away. There is a risk of accident. Before exiting, secure the vehicle against rolling.

In order to ensure that the vehicle is secured against rolling away, follow the following:

- ▷ Set the parking brake.
- ▷ On uphill grades or on a downhill slope, turn the front wheels in the direction of the curb.
- ▷ On uphill grades or on a downhill slope, also secure the vehicle, for instance with a wheel chock.

Warning

The desired speed can be incorrectly adjusted or called up by mistake. There is a risk of accident. Adjust the desired speed to the traffic conditions. Watch traffic closely and actively intervene where appropriate.

Warning









Risk of accident due to too high speed differences to other vehicles, for instance in the following situations:

- ▷ When fast approaching a slowly moving vehicle.
- ▷ Vehicle suddenly swerving into own lane.
- ▷ When fast approaching standing vehicles.

There is a risk of injuries or danger to life. Watch traffic closely and actively intervene where appropriate.

Overview

Buttons on the steering wheel

Button	Function
	With steering and traffic jam assistant: Cruise control on/off.
	With steering and traffic jam assistant: Select function.
	Without steering and traffic jam assistant: Cruise control on/off.
	Store current speed. Speed Limit Assist: take over suggested speed manually.
	With steering and traffic jam assistant: Pause cruise control. Continue cruise control with the last setting.
	Without steering and traffic jam assistant: Continue cruise control with the last setting.
	Without steering and traffic jam assistant: Pause cruise control.
	Increase the distance. Switch distance control on/off.

Button	Function
	Reduce distance. Switch distance control on/off.
	Rocker switch: Set speed.



Radar sensor

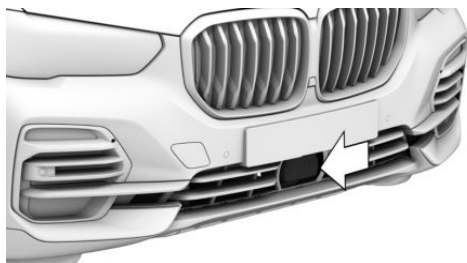

The radar sensor is located in the front bumper. Always keep radar sensor clean and unobstructed.

Camera

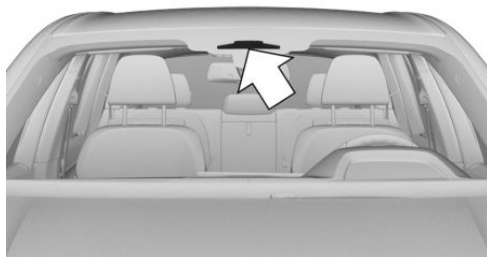

The camera is installed near the interior mirror. Keep the windshield in front of the interior mirror clean and clear.

Area of application

The system is best used on well-constructed roads. The system is functional at speeds beginning at approx. 20 mph/30 km/h.

The maximum speed that can be set is limited and, e.g., depends on the vehicle and the vehicle equipment version.

The system can also be activated when stationary.

Switching on/off and interrupting cruise control

With steering and traffic jam assistant: Assisted Driving Mode

General information



This button is used to switch the configured function on and off.



The button can be used to set the primarily used function.

Set function

1.  When the system is active, press the button repeatedly until the desired function is selected in the function bar. The function bar for Assisted Driving mode is displayed at the bottom of the instrument cluster.



- ▷ Cruise control with distance control.



- ▷ Cruise control with distance control and steering and traffic jam assistant.





- ▷ Cruise control with distance control and steering and traffic jam assistant.

The selected function is shown in green.

The setting is stored for the driver profile currently used.

Switching on

With steering and traffic jam assistant:

-  Press the button on the steering wheel.
-  If necessary, set the cruise control.

Without steering and traffic jam assistant:

 Press the button on the steering wheel.

The indicator lights in the instrument cluster light up and the marking on the speedometer is set to the current speed.

Cruise control is active. The current speed is maintained and stored as desired speed.

DSC Dynamic Stability Control is switched on, if necessary.

Switching off

To switch off the system while standing, step on brake pedal at the same time.

Press the button on the steering wheel:

 Without steering and traffic jam assistant.

 With steering and traffic jam assistant.

The displays go out. The stored desired speed is deleted.

Interrupting manually

When active, press the button on the steering wheel:

 Without steering and traffic jam assistant.

 With steering and traffic jam assistant.

If interrupting the system while stationary, press on the brake pedal at the same time.

Interrupting automatically

The system is automatically interrupted in the following situations:

- ▷ When the driver applies the brakes.
- ▷ When selector lever position D is disengaged.
- ▷ Dynamic Traction Control DTC is activated or DSC Dynamic Stability Control is deactivated.
- ▷ If DSC Dynamic Stability Control intervenes.
- ▷ If the safety belt and the driver's door are opened while the vehicle is standing still.
- ▷ If the system has not detected objects for an extended period, for instance on a road with very little traffic without curb or shoulder markings.
- ▷ If the detection range of the radar is impaired, for instance by dirt or heavy fog.
- ▷ After a longer stationary period when the vehicle has been braked to a stop by the system.

Setting the speed

Maintaining and storing the speed

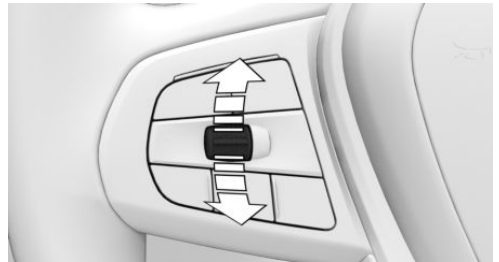

Press the rocker switch up or down once while the system is interrupted. The system will be activated.

The current speed is maintained and stored as desired speed.

The stored speed is displayed on the speedometer.

DSC Dynamic Stability Control is switched on, if necessary.

The speed can also be stored by pressing a button.

 Press the button.

Changing the speed



Press the rocker switch up or down repeatedly until the desired speed is set.

If active, the displayed speed is stored and the vehicle reaches the stored speed when the road is clear.

- ▶ Each time the rocker switch is pressed to the resistance point, the desired speed increases or decreases by 1 mph/1 km/h.
- ▶ Each time the rocker switch is pressed past the resistance point, the desired speed changes by a maximum of 5 mph/10 km/h.

Hold the rocker switch in position to repeat the action.

Adjusting the distance

Safety information

Warning

The system cannot serve as a substitute for the driver's personal judgment. Due to the system limits, braking can be late. There may be a risk of accident or risk of damage to property. Be aware to the traffic situation at all times. Adjust the distance to the traffic and weather conditions and maintain the prescribed safety distance, possibly by braking.

Reduce distance

 Press the button repeatedly until the desired distance is set.

Instrument cluster will display selected distance.

Increase the distance

 Press the button repeatedly until the desired distance is set.

Instrument cluster will display selected distance.

Continuing cruise control

An interrupted cruise control can be continued by calling up the stored speed.

Make sure that the difference between current speed and stored speed is not too large before calling up the stored speed. Otherwise, unintentional braking or accelerating may occur.

Press the button on the steering wheel with the system interrupted:

 Without steering and traffic jam assistant.

 With steering and traffic jam assistant.

Cruise control is continued with the stored values.

In the following cases, the stored speed value is deleted and cannot be called up again:

- ▶ When the system is switched off.
- ▶ When drive-ready state is switched off.

Changing between cruise control with/without distance control

Safety information

Warning

The system does not react to traffic driving ahead of you, but instead maintains the stored speed. There may be a risk of accident or risk of damage to property. Adjust the desired speed to the traffic conditions and brake as needed.

Switch mode of the cruise control

Switching cruise control without distance control off and on:

▷  Press and hold this button.

▷  Press and hold this button.

Without steering and traffic jam assistant: switch on distance control:

▷  Press the button.

▷  Press the button.

With steering and traffic jam assistant: switch on distance control:

 Press the button.

After switching, a Check Control message is displayed.

Displays in the instrument cluster

General information

Depending on the equipment version, the displays in the instrument cluster may vary.



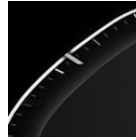

Display in the speedometer

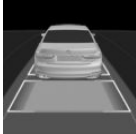

- ▷ Green marking: system is active, the marking indicates the desired speed.
- ▷ Grey marking: system is interrupted, the marking indicates the stored speed.
- ▷ No marking: system is switched off.

Distance to vehicle ahead of you

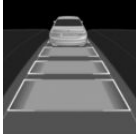
Selected distance to the vehicle ahead of you is shown.

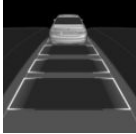
Symbol	Description
	Distance 1
	Distance 2
	Distance 3
	Distance 4 This value is set automatically after the system is switched on.
	No distance control display, as the accelerator pedal is being pressed.

Detected vehicle



Symbol	Description
	Green symbol: A vehicle has been detected ahead of you.



The system maintains the set distance to the vehicle in front.

As soon as the detected vehicle drives off, the vehicle symbol in the distance indicator will move away.



To accelerate, activate ACC, for instance by briefly stepping on the accelerator pedal or pressing the rocker switch.

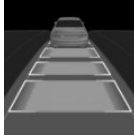

Without Steering and traffic jam assistant: indicator/warning lights

Symbol	Description
	Indicator light green: system is active. No indicator light: system is switched off.
	Vehicle symbol flashes: The conditions are not adequate for the system to work. The system was deactivated but applies the brakes until you actively resume control by pressing on the brake pedal or accelerator pedal.

Symbol	Description
	The vehicle symbol and distance bars flash red and an acoustic signal sounds: Brake and make an evasive maneuver, if necessary.
	System interrupted.

With Steering and traffic jam assistant: indicator/warning lights

Symbol	Description
	Vehicle symbol white: No distance control display, as the accelerator pedal is being pressed.
	Green symbol: A vehicle has been detected ahead of you. The vehicle symbol goes out if no vehicle in front is detected. Vehicle symbol flashes green: Vehicle in front drove off.
	Gray symbol: System interrupted.

Symbol	Description
	<p>Symbol flashes gray:</p> <p>The conditions are not adequate for the system to work.</p> <p>The system was deactivated but applies the brakes until you actively resume control by pressing on the brake pedal or accelerator pedal.</p>
	<p>Vehicle symbol flashes red and a signal sounds:</p> <p>Brake and make an evasive maneuver, if necessary.</p>

Displays in the Head-up Display

Desired speed

Some system information can also be displayed in the Head-up Display.



The symbol is displayed when the set desired speed is reached.

Distance information



The symbol is displayed when the distance from the vehicle traveling ahead is too short.

The distance information is active in the following situations:

- ▷ Active Cruise Control switched off.
- ▷ Display in the Head-up Display selected, refer to page 167.
- ▷ Distance too short.
- ▷ Speed greater than approx. 40 mph/70 km/h.

System limits

Detection range

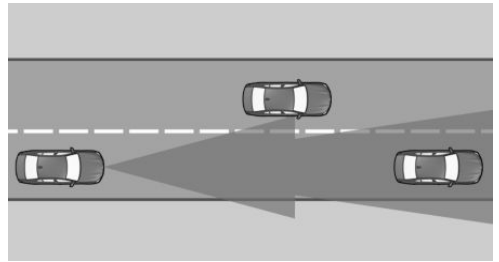

The detection capacity of the system and the automatic braking capacity are limited.

Two-wheeled vehicles for instance might not be detected.

Deceleration

The system does not decelerate in the following situations:

- ▷ For pedestrians or similarly slow-moving road users.
- ▷ For red traffic lights.
- ▷ For cross traffic.
- ▷ For oncoming traffic.

Swerving vehicles

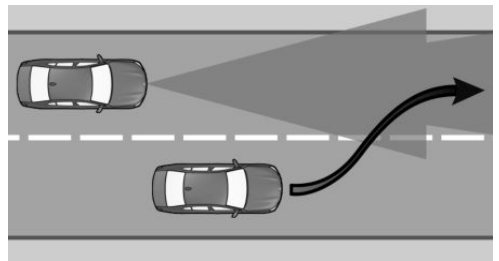

A vehicle driving in front of you is not detected until it is completely within the same lane as your vehicle.

If a vehicle driving ahead of you suddenly swerves into your lane, the system may not be able to automatically restore the selected dis-

tance. It may not be possible to restore the selected distance in certain situations, including if you are driving significantly faster than vehicles driving ahead of you, for instance when rapidly approaching a truck. When a vehicle driving ahead of you is reliably detected, the system requests that the driver intervene by braking and carrying out evasive maneuvers, if needed.

Cornering

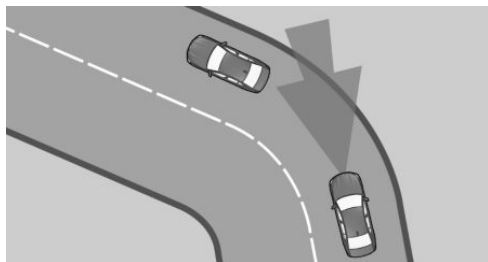

When the desired speed is too high for a curve, the speed is reduced slightly. Because curves may not be anticipated in advance, drive into a curve at an appropriate speed.

The system has a limited detection range. Situations can arise in tight curves where a vehicle driving ahead will not be detected or will be detected very late.

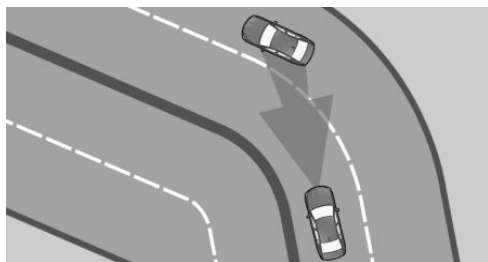

When you approach a curve the system may briefly report vehicles in the next lane due to the bend of the curve. If the system decelerates you may compensate it by briefly accelerating. After releasing the accelerator pedal the system is re-activated and controls speed independently.

Driving off

In some situations, the vehicle cannot drive off automatically; for example:

- ▷ On steep uphill grades.
- ▷ In front of bumps in the road.
- ▷ With a heavy trailer.

In these cases, step on the accelerator pedal.

Weather

The following restrictions can occur under unfavorable weather or light conditions:

- ▷ Poorer vehicle recognition.
- ▷ Short-term interruptions for vehicles that are already recognized.

Examples of unfavorable weather or light conditions:

- ▷ Wet conditions.
- ▷ Snowfall.
- ▷ Slush.
- ▷ Fog.
- ▷ Glare.

Drive attentively, and react to the current traffic situation. If necessary, intervene actively, for instance by braking, steering or evading.

Engine power

The desired speed is also maintained downhill. The speed may not be maintained on uphill grades if the engine power is insufficient.

In ECO PRO driving mode, the vehicle may exceed or drop below the set desired speed in some situations, for instance on downhill or uphill grades.

Malfunction

Radar sensor

The system cannot be activated if the radar sensor is not aligned correctly. This may be caused by damage incurred, for instance during parking.

A Check Control message is displayed if the system fails.

Have the system checked by a dealer's service center or another qualified service center or repair shop.

The system may be impaired when the detection range of the radar sensor is partially covered such as by the license plate holder.

Camera

The function for detecting and responding when approaching stationary vehicles may be limited in the following situations:

- ▷ During calibration of the camera immediately after vehicle delivery.
- ▷ If the camera is malfunctioning or dirty. A Check Control message is displayed.

Speed Limit Assist

Concept

When the systems in the vehicle, e.g., Speed Limit Info, detect a change of the speed limit along the route, this new speed value can be applied for the following systems:

- ▷ Speed Limiter.
- ▷ Cruise control.
- ▷ Active Cruise Control with Stop & Go function ACC.

The speed value is suggested as the new desired speed to be applied. To apply the speed value, the corresponding system must be activated.

Safety information

Warning

The system cannot serve as a substitute for the driver's personal judgment in assessing the traffic conditions. Based on the limits of the system, it cannot independently react to all traf-



fic situations. There is a risk of accident. Adjust driving style to traffic conditions. Watch traffic closely and actively intervene where appropriate.

Warning

The desired speed can be incorrectly adjusted or called up by mistake. There is a risk of accident. Adjust the desired speed to the traffic conditions. Watch traffic closely and actively intervene where appropriate.

Overview

Buttons on the steering wheel

Button	Function
	Apply suggested speed manually.
	Rocker switch: Set speed, refer to Cruise Control.



Switching on/off and adjusting

Via iDrive:

1. "CAR"
2. "Settings"
3. "Driver Assistance"
4. If necessary, "Driving"
5. "Speed Limit Assistance"
6. "Speed limits"
7. Select the desired setting:
 - ▷ "Adjust manually": detected speed limit can be applied manually.
 - ▷ "Show anticipation": detected speed limits are displayed in the instrument cluster without being applied.
 - ▷ "Off": Speed Limit Assist will be switched off.

Displays in the instrument cluster

A message is indicated in the instrument cluster when the system and cruise control are activated.

Symbol	Function
	Depending on the equipment version, the indicator light illuminates green, together with the symbol for a cruise control system: Speed Limit Assist is active and detected speed limits can be applied manually for the displayed system.
	Detected change of a speed limit with immediate effect.
	Indicator light illuminates green: the detected speed limit can be applied with the SET button. As soon as the speed limit has been applied, a green checkmark is displayed.

Apply detected speed limit manually

A detected speed limit can be applied to cruise control manually.

 As soon as the SET icon lights up, press the button.

Adapting to the route

Concept

The system can be configured so that the vehicle adapts the speed automatically to the route.

For instance, the speed will be reduced in the following situations, if necessary:

- ▷ Before making turns.
- ▷ Before a traffic circle.

- ▷ Before a curve.

Adjustment

Via iDrive:

1. "CAR"
2. "Settings"
3. "Driver Assistance"
4. If necessary, "Driving"
5. "Speed Limit Assistance"
6. "adjust to route"

System limits

Speed Limit Assist is based on the Speed Limit Info system.

Consider the system limits of Speed Limit Info, refer to page 164.

Upcoming speed limits can only be applied for the Active Cruise Control ACC.

Steering and traffic jam assistant

Concept

The system assists the driver in keeping the vehicle within the lane. For this purpose, the system executes supporting steering movements, for instance when driving in a curve.

General information

The system determines the position of the lane markings and the vehicle driving ahead using five radar sensors and a camera.

Depending on the speed, the system orients itself according to the lane markings or vehicles in front.

Sensors on the steering wheel detect whether the steering wheel is being touched.

Safety information

Warning

The system cannot serve as a substitute for the driver's personal judgment in assessing the traffic conditions. Based on the limits of the system, it cannot independently react to all traffic situations. There is a risk of accident. Adjust driving style to traffic conditions. Watch traffic closely and actively intervene where appropriate.

Overview

Buttons on the steering wheel

Button	Function
	Steering and traffic jam assistant on/off.
	Switch function on.



Steering and traffic jam assistant on/off.



Switch function on.

Radar sensors

The radar sensors are located in the bumpers.

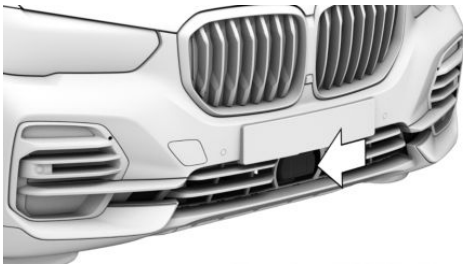

Front center bumper.



Front side bumper.

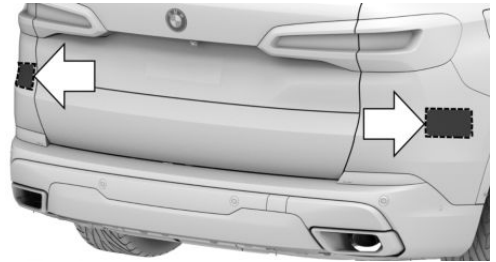

Rear bumper.

Always keep the bumper in the area of the radar sensors clean and unobstructed.

Camera

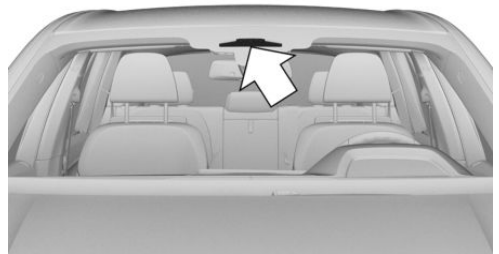

The camera is installed near the interior mirror.

Keep the windshield in front of the interior mirror clean and clear.

Functional requirements

- ▷ Speed below 130 mph/210 km/h.
- ▷ Sufficient lane width.

- ▶ Above approx. 43 mph, 70 km/h: lane marking on both sides is detected.
- ▶ Below approx. 43 mph, 70 km/h: lane marking on both sides or a vehicle driving ahead is detected.
- ▶ Hands on the steering wheel rim.
- ▶ Wide curves.
- ▶ Drive in the center of the lane.
- ▶ Turn signal switched off.
- ▶ The sensor system calibration process is complete.
- ▶ Cruise control with distance control active.
- ▶ Safety belt on the driver's side fastened.
- ▶ Approach control warning.
- ▶ Person warning.
- ▶ Side collision mitigation.

Switching on/off

Assisted Driving Mode

General information



This button is used to switch the configured function on and off.



The button can be used to set the primarily used function.

Set function

1.  When the system is active, press the button repeatedly until the desired function is selected in the function bar. The function bar for Assisted Driving mode is displayed at the bottom of the instrument cluster.



- ▶  Cruise control with distance control.



- ▶  Cruise control with distance control and steering and traffic jam assistant.





- ▶  Cruise control with distance control and steering and traffic jam assistant.

The selected function is shown in green.

The setting is stored for the driver profile currently used.

Switching on

1.  Press the button on the steering wheel.
2.  Adjust the steering and traffic jam assistant if necessary.



Steering wheel symbol lights up gray.

The system is on standby and does not manipulate steering.

System activates automatically as soon as all function conditions are fulfilled.



Steering wheel symbol lights up green.

The system is active.

With the system switched on, the person warning with City braking function and the side collision mitigation are active.

Switching off



Press the button on the steering wheel.

The indicator goes out.

The system does not perform supportive steering wheel movements.

Interrupting automatically

The system is automatically interrupted in the following situations, for example:

- ▶ At a speed above 130 mph/210 km/h.
- ▶ When the steering wheel is released.
- ▶ When the driver applies the brakes.
- ▶ When you manipulate steering.

- ▷ When leaving own lane.
- ▷ When the turn signal is switched on.
- ▷ When the lane is too narrow.
- ▷ If for a particular time no lane marking is detected and there is no vehicle driving in front.
- ▷ When Active Cruise Control ACC is interrupted.
- ▷ If the safety belt on the driver's side is unfastened.



Steering wheel symbol lights up gray.
The system is on standby and does not manipulate steering.

System activates automatically as soon as all function conditions are fulfilled.

Displays in the instrument cluster

Symbol	Description
	Gray steering wheel symbol: The system is on standby.
	Green steering wheel symbol: The system is activated. The system supports the driver in keeping the vehicle within the lane.
	Yellow flashing steering wheel symbol: Lane marking driven over. The steering wheel vibrates where applicable.
	Yellow steering wheel symbol and a signal sounds, if applicable: System interruption is imminent.
	Steering wheel symbol flashes red, signal sounds: System is switching off.

Symbol	Description
	Yellow steering wheel symbol: The hands are not grasping the steering wheel. The system is still active.
	Red steering wheel symbol and a signal sounds: The hands are not grasping the steering wheel. System interruption is imminent. The system reduces the speed to a standstill if applicable. It is possible that the system will not execute any supporting steering movements.

Displays in the instrument cluster

Symbol	Description
	Gray steering wheel symbol: The system is on standby.
	Green steering wheel symbol: The system is activated.
	Yellow steering wheel symbol and a signal sounds, if applicable: System interruption is imminent.
	Green steering wheel symbol and lane marking symbol: The system supports the driver in keeping the vehicle within the lane.

Symbol	Description
--------	-------------



Green steering wheel symbol, gray lane marking symbol:

No lane marking detected, the vehicle follows the vehicle ahead.

The limits of steering support when cornering may have been reached.



Yellow steering wheel symbol:

The hands are not grasping the steering wheel. The system is still active.



Red steering wheel symbol and a signal sounds:

The hands are not grasping the steering wheel. System interruption is imminent.

It is possible that the system will not execute any supporting steering movements.

With Active Cruise Control, the system may reduce the speed.

Displays on the steering wheel



The two LED lights above the buttons illuminate analogously to the displays in the instrument cluster:

- ▶ Yellow: system interruption is imminent.
- ▶ Red: system will be deactivated.

The steering wheel displays can be switched on/off if required.

Via iDrive:

1. "CAR"
2. "Settings"
3. "Driver Assistance"
4. "Steering wheel feedback"
5. "Light elements"

Displays in the Head-up Display

All system information can also be displayed in the Head-up Display.

Lane change assistant

Concept

The system additionally supports the driver when changing lanes on multilane roads.

Functional requirements

- ▶ The functional requirements of the steering and traffic jam assistant are fulfilled, refer to page 240.
- ▶ Driving on a road without pedestrians or cyclists and with physical barriers to oncoming traffic, such as crash barriers.
- ▶ Lane markings have been detected.
- ▶ Maximum speed approx. 110 mph, 180 km/h.
- ▶ The minimum speed is country-specific.

Switching the function on/off

The lane change assistant can be switched on/off.

Via iDrive:

1. "CAR"
2. "Settings"
3. "Driver Assistance"
4. If necessary, "Driving"

5. "Steering Assistance"
6. "Automatic Lane Change"

Changing lanes

1. Ensure that the traffic situation permits changing lanes.
2. Press the turn indicator lever in the required direction to the pressure point for signaling briefly.
Steering support in the required direction can be detected a short time later.

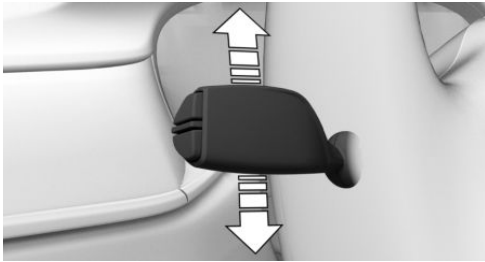

After the lane change, the system helps keep the vehicle in the new lane.



Canceling a lane change

The lane change can be canceled by steering into the opposite direction.

Displays in the instrument cluster

Symbol	Description
	Green steering wheel symbol. Gray line for lane marking on the appropriate side. Green arrow symbol for lane-changing. The system carries out a lane change.
	Green steering wheel symbol. Gray line for lane marking on the appropriate side. No arrow symbol for lane-changing on the display. The system detected the lane change request. Lane change not currently possible.
	Depending on country specifications: Green steering wheel symbol. Gray line for lane marking on the appropriate side. Gray arrow symbol for lane-changing. Lane change not possible; functional requirements not met.

Displays in the instrument cluster

Symbol	Description
	<p>Green steering wheel symbol.</p> <p>Green arrow symbol for lane-changing.</p> <p>The system carries out a lane change.</p>
	<p>Green steering wheel symbol.</p> <p>Gray line for lane marking on the appropriate side.</p> <p>The system detected the lane change request. Lane change not currently possible.</p>
	<p>Depending on country specifications:</p> <p>Green steering wheel symbol.</p> <p>Gray arrow symbol for lane-changing.</p> <p>Lane change not possible; functional requirements not met.</p>

Extended Traffic Jam Assistant

Concept

Extended Traffic Jam Assistant supports the driver with vehicle control in traffic jam situations.

Steering support takes place without the driver actively steering.

Safety information

Warning

The system cannot serve as a substitute for the driver's personal judgment in assessing the traffic conditions. Based on the limits of the system, it cannot independently react to all traffic situations. There is a risk of accident. Adjust driving style to traffic conditions. Watch the traffic situation closely, be ready to take over

steering and braking at any time, and actively intervene where appropriate.

State laws differ and the use of this function may violate the law. Before use, check your state and local laws.

Functional requirements

- ▷ The functional requirements of the steering and traffic jam assistant are fulfilled, refer to page 240.
- ▷ The steering and traffic jam assistant is active.
- ▷ The function is only available on certain street types, e.g. freeways.
- ▷ Driving on a road without pedestrians or cyclists.
- ▷ Sufficient lane width.
- ▷ Lane markings and a vehicle driving ahead are detected.
- ▷ Speed less than approx. 40 mph/60 km/h.
- ▷ The Driver Attention Camera in the instrument cluster detects that the driver is paying attention to the traffic.
- ▷ When traveling to countries outside of the country of origin of the vehicle, Extended Traffic Jam Assistant must be available in the respective country.

Switching on



As soon as all functional requirements are met, Extended Traffic Jam Assistant will be displayed as an additional symbol in the function bar. The toolbar is displayed at the bottom of the instrument cluster.



Select Extended Traffic Jam Assistant with the button on the steering wheel.

The symbol for Extended Traffic Jam Assistant is shown in green.

Two green LED lights are illuminated on the steering wheel.

The indicator light in the instrument cluster is shown in green.

The system begins to assist the driver with vehicle control.

Displays in the instrument cluster

Indicator light	Description
	Indicator light green: system is active.

Displays in the instrument cluster

Symbol	Description
ASSIST PLUS	Indicator light green: system is active.
ASSIST PLUS READY	Indicator light white: system is ready.
ASSIST PLUS	Gray indicator light: the system has been interrupted.

Displays on the steering wheel



The two LED lights above the buttons illuminate analogously to the displays in the instrument cluster:

- ▷ Green: the system is active.
- ▷ Yellow: system will be interrupted.
- ▷ Red: system will be deactivated.

System limits

General information

The system cannot be activated or meaningfully used in certain situations.

Safety information

Warning

The system is designed to operate in certain conditions and circumstances. Due to conditions or other factors, the system may not respond. There may be a risk of accident or risk of damage to property. Actively intervene as warranted. Refer to the information in this Owner's Manual regarding the scope of the system's operation and limitations.

Hands on the steering wheel

The sensors cannot detect hand-steering wheel contact in the following situations:

- ▷ Driving with gloves.
- ▷ Protective covers on the steering wheel.

Narrow lanes

When driving within narrow lanes, the system cannot be activated or effectively used, for instance in the following situations:

- ▷ In construction areas.
- ▷ In rescue lanes.
- ▷ Within city limits.

Weather

The following restrictions can occur under unfavorable weather or light conditions:

- ▷ Poorer recognition of vehicles and lane markings.
- ▷ Short-term interruptions for vehicles that are already recognized.

Examples of unfavorable weather or light conditions:

- ▶ Wet conditions.
- ▶ Snowfall.
- ▶ Slush.
- ▶ Fog.
- ▶ Glare.

Drive attentively, and react to the current traffic situation. If necessary, intervene actively, for instance by braking, steering or evading.

Driver Attention Camera

Always monitor the traffic conditions.

The Driver Attention Camera detects whether or not the driver is paying attention to the traffic conditions.

The Driver Attention Camera may not be fully functional in the following situations:

- ▶ When the Driver Attention Camera is covered by the steering wheel rim.
- ▶ When the driver is wearing infrared impermeable sunglasses.

PDC Park Distance Control

Concept

PDC is a support when parking. Objects that you are approaching slowly in front of or behind the vehicle are indicated by signal tones and a display on the Control Display.

Depending on the equipment version: obstacles at the side of the vehicle that are detected by the side ultrasonic sensors may also be reported by the side protection function.

General information

The ultrasound sensors for distance measurements are located in the bumpers and possibly on the sides of the vehicle.

The range, depending on obstacles and environmental conditions, is approx. 6 ft/2 m.

An acoustic warning sounds in case of an impending collision at a distance to the object of approx. 27 in/70 cm.

For objects behind the vehicle, the acoustic warning is already issued at a distance to the object of approx. 5 ft/1.50 m.

Safety information

Warning

The system cannot serve as a substitute for the driver's personal judgment in assessing the traffic conditions. Based on the limits of the system, it cannot independently react to all traffic situations. There is a risk of accident. Adjust driving style to traffic conditions. Watch traffic closely and actively intervene where appropriate.

Warning

Due to high speeds when PDC Park Distance Control is activated, the warning can be delayed due to physical circumstances. There is a risk of injury or risk of damage to property. Avoid approaching an object too fast. Avoid driving off fast while PDC Park Distance Control is not yet active.

Overview

Button in the vehicle



Park assistance button

Ultrasound sensors

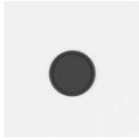

Ultrasound sensors of the PDC, for instance in the bumpers.

Functional requirements

Ensure full functionality:

- ▶ Do not cover sensors, for instance with stickers, bicycle racks.
- ▶ Keep the sensors clean and unobstructed.

Switching on/off

Switching on automatically

The system switches on automatically in the following situations:

- ▶ If selector lever position R is engaged when the engine is running.
- ▶ Depending on the equipment version: while approaching detected obstacles if the speed is slower than approx. 2.5 mph/4 km/h. The activation distance depends on the situation in question.

You may switch automatic activation when obstacles are detected on and off.

Via iDrive:

1. "CAR"
2. "Settings"
3. "Driver Assistance"
4. "Parking and maneuvering"
5. If necessary, "Automatic PDC activation"
6. "Automatic PDC activation"

The setting is stored for the driver profile currently used.

Depending on equipment, an additional camera view is also switched on.

Automatic deactivation during forward travel

The system switches off when a certain driving distance or speed is exceeded.

Switch the system back on, if needed.

Switching on/off manually



Press the park assistance button.

- ▶ On: the LED lights up.
- ▶ Off: the LED goes out.

The rearview camera image is displayed if the reverse gear is engaged when pressing the park assistance button.

Warning

Signal tones

General information

An intermittent tone indicates when the vehicle is approaching an object. E.g., when an object is detected to the left rear of the vehicle, a signal tone sounds from the left rear speaker.

The shorter the distance to the object, the shorter the intervals.

When the distance to a detected object is less than approx. 10 inches/25 cm, a continuous tone is sounded.

When there are objects in front of and behind the vehicle at the same time, with a distance smaller than approx. 10 in/25 cm, an alternating constant tone will sound.

The intermittent tone and constant tone are switched off if the selector lever position P is engaged.

The intermittent tone is switched off after a short time when the vehicle is stationary.

Volume

The PDC signal tone volume can be adjusted.

Via iDrive:

1. "CAR"
2. "Settings"
3. "Driver Assistance"
4. "Parking and maneuvering"
5. "Volume PDC signal"
6. Set the desired value.

The setting is stored for the driver profile currently used.

Visual warning

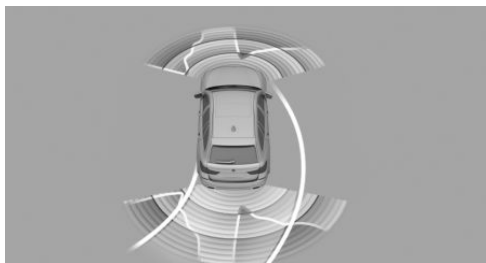

The approach of the vehicle to an object is shown on the Control Display. Objects that are farther away are already displayed on the Control Display before a signal sounds.

The display appears as soon as PDC is activated. The range of the sensors is represented in the colors green, yellow and red when obstacles are detected.

Pathway lines are faded in for better estimation of the required space.

When the image of the rearview camera is displayed, the switch can be made to PDC or to a different view with obstacle markings as needed:

1. Press the Controller to the left, if needed.
2. For instance "Park. sensors only"

Cross traffic warning, refer to page 268: depending on the equipment, it is warned in the PDC display against vehicles approaching in the front or rear from the side.

Depending on the equipment version: emergency brake function, Active PDC

Concept

The emergency braking function of PDC initiates an emergency braking in case of acute risk of collision.

General information

This function may not be available. Contact your authorized dealer's service center or another qualified service center as to whether this additional function is currently in your vehicle or when it can be installed in your vehicle in the future.

Due to system limits, a collision cannot be prevented under all circumstances.

The function is available below walking speed when driving in reverse or rolling backward.

A press of the accelerator pedal interrupts the braking intervention.

After emergency braking to a stop, further creeping toward an obstacle is possible. Proceed with caution. To move forward, lightly press the accelerator pedal and release as needed.

If the accelerator pedal is depressed longer, the vehicle drives off. Manual braking is possible at any time.

The system uses the ultrasound sensors of PDC and parking assistant.

Safety information

Warning

The system cannot serve as a substitute for the driver's personal judgment in assessing the traffic conditions. There is a risk of accident. Adjust driving style to traffic conditions. Watch traffic and vehicle surroundings closely and actively intervene where appropriate.

Temporary switching off

The emergency brake function can be switched off temporarily:

Confirm the message on the Control Display.

During continued driving in this surrounding situation, no further emergency braking will occur.

Adjusting

The system can be activated or deactivated. It is possible to set which areas on the vehicle will be protected by the system.

Via iDrive:

1. "CAR"
2. "Settings"
3. "Driver Assistance"
4. "Parking and maneuvering"
5. Select the desired setting.

The setting is stored for the driver profile currently used.

System limits

The system cannot be used in the following situations, for example:

- ▷ When Hill Descent Control, refer to page 222, is active, the emergency braking function is deactivated.
- ▷ When driving with a trailer.

If required, deactivate the system via iDrive where applicable.

With Parking Assistant: side protection

Concept

The system warns of obstacles on the side of the vehicle.

General information

The system uses the ultrasound sensors of PDC and parking assistant.

Display

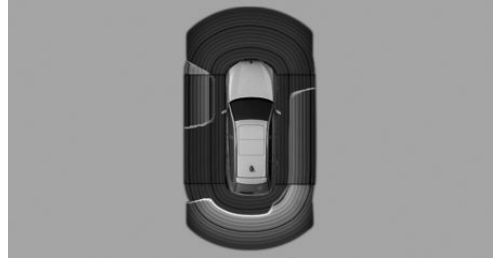

To protect the sides of the vehicle, obstacle markings are displayed on the sides of the vehicle.

- ▷ Color markings: warning against detected obstacles.
- ▷ Gray markings, hatched area: no obstacles were detected.
- ▷ No markings, black area: the area next to the vehicle was not yet captured.

Limits of side protection

The system only displays stationary obstacles that were previously detected by sensors while passing them.

The system does not detect whether an obstacle moves later on. If the vehicle is stationary, the markings are shown in black after a certain time. The area next to the vehicle must be newly captured.

Side protection is not available, if the trailer power socket is in use or trailer towing is activated.

System limits

Safety information

Warning

The system is designed to operate in certain conditions and circumstances. Due to conditions or other factors, the system may not respond. There may be a risk of accident or risk

of damage to property. Actively intervene as warranted. Refer to the information in this Owner's Manual regarding the scope of the system's operation and limitations.

Trailer towing

With a trailer, a trailer power socket in use or when trailer towing is activated, the rear PDC functions will be switched off.



White symbol is displayed.

Depending on the vehicle equipment, the range of the sensors is shown as a shaded area on the Control Display.

Limits of ultrasonic measurement

The detection of objects with ultrasonic measurements can run into physical limits, e.g., in the following situations:

- ▷ For small children and animals.
- ▷ For persons with certain clothing, for instance coats.
- ▷ With external interference of the ultrasound, for instance from passing vehicles or loud machines.
- ▷ When sensors are dirty, iced over, damaged or out of position.
- ▷ Under certain weather conditions, e.g., high relative humidity, wet conditions, snowfall, cold, extreme heat, or strong wind.
- ▷ With tow bars and trailer couplings of other vehicles.
- ▷ With thin or wedge-shaped objects.
- ▷ With moving objects.
- ▷ With elevated, protruding objects such as ledges.
- ▷ With objects with corners, edges, and smooth surfaces.
- ▷ With objects with a fine surface structure such as fences.
- ▷ For objects with porous surfaces.

- ▷ With small and low objects, for instance boxes.
- ▷ With obstacles and persons at the edge of the lane.
- ▷ With soft obstacles or obstacles covered in foam material.
- ▷ With plants and bushes.
- ▷ Low objects already displayed, for instance curbs, can move into the blind area of the sensors before or after a continuous tone sounds.
- ▷ Cargo that extends beyond the perimeter of the vehicle is not taken into account by the system.

False warnings

The system may issue a warning under the following conditions even though there is no obstacle within the detection range:

- ▷ In heavy rain.
- ▷ When sensors are very dirty or covered with ice.
- ▷ When sensors are covered in snow.
- ▷ On rough road surfaces.
- ▷ On uneven surfaces, such as speed bumps.
- ▷ In large buildings with right angles and smooth walls, for instance in underground garages.
- ▷ In automatic vehicle washes.
- ▷ Due to heavy exhaust.
- ▷ When the trailer hitch cover is not on straight.
- ▷ Due to other ultrasound sources, for instance sweeping machines, high pressure steam cleaners or neon lights.

To prevent false alarms, switch off automatic PDC activation on obstacle detection, for instance in automatic vehicle washes.

Malfunction

A Check Control message is displayed.



White symbol is displayed, and the range of the sensors is dimmed on the Control Display.

PDC has failed. Have the system checked by a dealer's service center or another qualified service center or repair shop.

Without Surround View: rearview camera

Concept

The rearview camera provides assistance in parking and maneuvering backwards. The area behind the vehicle is shown on the Control Display.

Additionally, assistance functions can be shown in the display, e.g., help lines.

Safety information

Warning

The system cannot serve as a substitute for the driver's personal judgment in assessing the traffic conditions. There is a risk of accident. Adjust driving style to traffic conditions. Watch traffic and vehicle surroundings closely and actively intervene where appropriate.

Overview

Depending on the vehicle equipment: button in the vehicle



Park assistance button

Camera

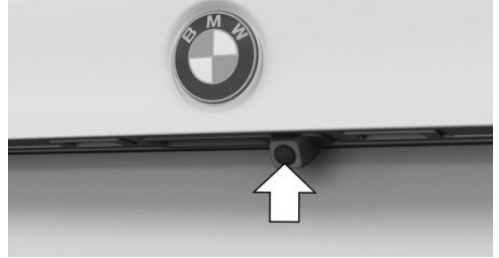

The camera lens is located in the handle of the tailgate.

The image quality may be impaired by dirt. If necessary, clean the camera lens.

Switching on/off

Switching on automatically

The system is switched on automatically if selector lever position R is engaged when the engine is running.

Automatic deactivation during forward travel

The system switches off when a certain driving distance or speed is exceeded.

Switch the system back on, if needed.

Depending on the vehicle equipment: switching on/off manually



Press the park assistance button.

- ▷ On: the LED lights up.
- ▷ Off: the LED goes out.

The parking assistance functions are shown on the Control Display.

Switching the view via iDrive

If the rearview camera view is not displayed, change the view via iDrive:

1. If necessary, tilt the controller to the side.
2.  "Rear view camera"

The rearview camera image is displayed.

Functional requirements



- ▶ The tailgate is fully closed.
- ▶ Keep the recording range of the camera clear. Protruding cargo or carrier systems and trailers that are not connected to a trailer power socket can restrict the visibility range of the camera.

Display on the Control Display

Function bars

The assistance functions can be activated manually via the function bars on the sides of the Control Display.

Via iDrive:

1. Move the Controller to the right, if needed.
2. With corresponding equipment:  "Camera image"
3. ▶  "Parking aid lines".
Pathway lines and turning radius lines are displayed.
 - ▶  "Obstacle mark.".

Depending on the vehicle equipment, the obstacles detected by PDC Park Distance Control are displayed by markings.

Zoom on trailer hitch:

1. Move the Controller to the left, if needed.
2.  "Trailer hitch".
A zoomed image of the trailer hitch is shown.

More than one assistance function can be active at the same time.

Parking aid lines

Pathway lines

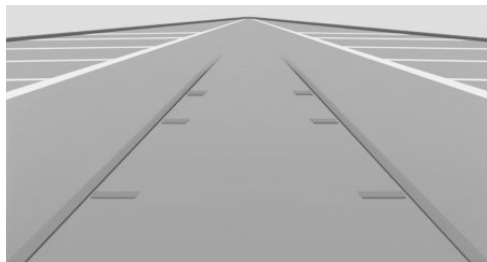

Pathway lines help you to estimate the space required when parking and maneuvering on level roads.

Pathway lines depend on the steering angle and are continuously adjusted to the steering wheel movements.

Turning radius lines

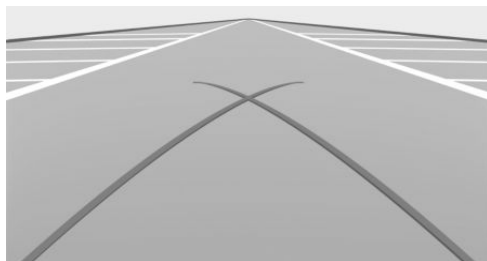

Turning radius lines can only be superimposed on the camera image together with pathway lines.

Turning radius lines show the course of the smallest possible turning radius on a level road.

Only one turning radius line is displayed after the steering wheel is turned past a certain angle.

Parking using pathway and turning radius lines

1. Position the vehicle so that the red turning radius line leads to within the limits of the parking space.

- Turn the steering wheel to the point where the green pathway line covers the corresponding turning radius line.

Obstacle marking

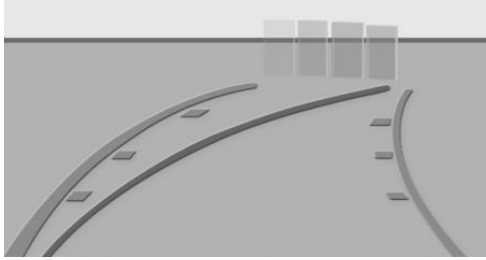

Depending on the vehicle equipment, obstacles behind the vehicle are detected by the PDC Park Distance Control sensors.

Obstacle markings can be faded into the image of the rearview camera.

The colored thresholds of the obstacle markings match the markings of the PDC Park Distance Control.

Zoom on trailer hitch

To make it easier to attach a trailer, you can zoom in on the view of the trailer hitch.

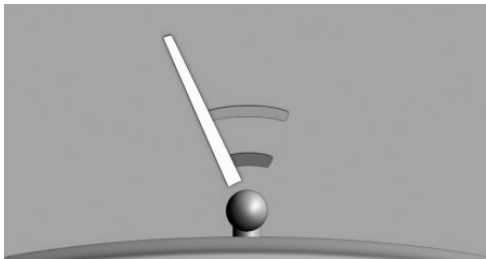



Two static circle segments show the distance between the trailer and the trailer hitch.

A docking line dependent on the steering angle helps with aiming for the trailer with the trailer hitch.

When zooming in, remember that the view may no longer show certain obstacles.

Setting brightness and contrast via iDrive

With the rearview camera switched on:

- Move the Controller to the right, if needed.
-  "Camera image"
- To perform the desired setting:
 - ▷  "Brightness"
 - ▷  "Contrast"

System limits

Deactivated camera

When the camera is deactivated, for instance when the tailgate is open, the camera image is displayed hatched in gray.

Detection of objects

Very low obstacles as well as high, protruding objects such as ledges may not be detected by the system.

Depending on the vehicle equipment, some assistance functions also consider data from the PDC Park Distance Control.

Follow the notes in the PDC Park Distance Control chapter.

The objects displayed on the Control Display may be closer than they appear. Do not estimate the distance from the objects on the display.

With Parking Assistant Plus: Surround View

Concept

The system provides assistance in parking and maneuvering. The area around the vehicle is shown on the Control Display.

General information

Several cameras capture the area from different selectable perspectives.

The following camera perspectives can be displayed:

- ▶ Automatic camera perspective: the system shows the camera perspective suitable for the respective driving situation.
- ▶ Rearview camera: for representing the areas behind the vehicle.
- ▶ Right-hand and left-hand side view: for representing the areas on the sides of the vehicle.
- ▶ Camera perspective movable via iDrive. Available camera.
- ▶ Panorama View: to present cross traffic, for instance at junctions and driveways, depending on the currently engaged gear.

Depending on the view, the environment around the vehicle or a part of it is depicted.

Additionally, assistance functions are shown in the display, e.g., help lines.

More than one assistance function can be active at the same time.

Some assistance functions can be manually activated.

The following assistance functions are automatically displayed:

- ▶ Side protection.
- ▶ Door opening angle.

Safety information

Warning

The system cannot serve as a substitute for the driver's personal judgment in assessing the traffic conditions. There is a risk of accident. Adjust driving style to traffic conditions. Watch traffic and vehicle surroundings closely and actively intervene where appropriate.

Overview

Buttons in the vehicle



Park assistance button



Panorama View

Cameras



Front camera

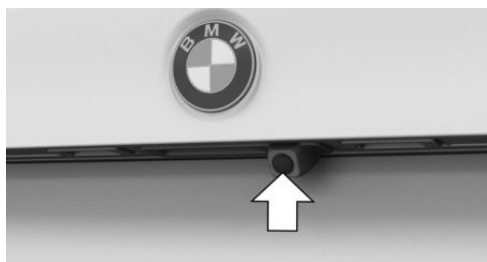

Rearview camera

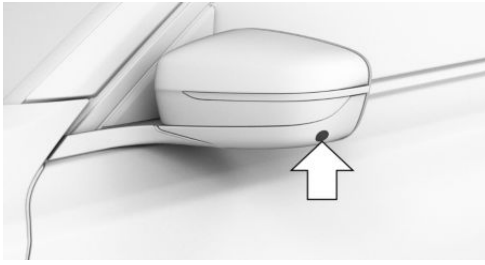

One camera is located at the bottom of each exterior mirror housing.

The image quality may be impaired by dirt on the camera lenses. If required, clean the camera lenses.

Switching on/off

Switching on automatically

The system is switched on automatically, refer to page 248, if selector lever position R is engaged when the engine is running.

The camera perspective suitable for the respective driving situation is displayed.

Switching on/off manually



Press the park assistance button.

- ▷ On: the LED lights up.
- ▷ Off: the LED goes out.

The rearview camera cannot be switched off if the reverse gear is engaged.

Automatic deactivation during forward travel

The system switches off when a certain driving distance or speed is exceeded.

Switch the system back on, if needed.

Display on the Control Display

Overview

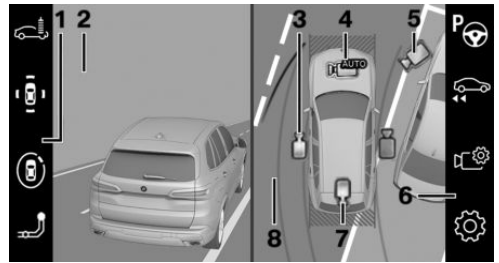

- 1 Function bar, left
- 2 Camera image
- 3 Side view
- 4 Automatic camera perspective
- 5 Movable unobstructed camera perspective
- 6 Function bar, right
- 7 Rearview camera
- 8 Selection window

Function bar on the left

The left function bar can be used for the direct selection of various views via iDrive. Move the Controller to the left, if needed.

- ▷ "Car wash".
- ▷ "Parking": around the vehicle.
- ▷ "3D view": available camera.
- ▷ "Trailer hitch".

Side view

The side view can be selected for the right or left vehicle side.

This view helps when positioning the vehicle at the curb or with other obstacles on the side by displaying the side surroundings.

The side view looks from rear to front and in case of danger, focuses automatically on possible obstacles.

Automatic camera perspective

The automatic camera perspective shows a steering-dependent view in the respective driving direction.

This perspective adapts to the respective driving situation.

As soon as obstacles are detected, the view changes to a fixed display of the area in front or at the rear behind the bumper or, if necessary, changes to a side view.

When reverse gear is engaged, the automatic camera perspective is closed and the system uses a fixed perspective of the rearview camera. If necessary, manually select the automatic camera perspective when reverse gear is engaged. The automatic camera perspective will be retained for the current parking maneuver.

Movable unobstructed camera perspective

With selection of the movable camera perspective, a circle appears on the Control Display.

By turning the Controller or via touch function, specified perspectives on the circle can be selected.

The current perspective is marked with a camera symbol.

To leave the function, move the Controller sideways and select another camera function.

With xOffroad package: when an xOffroad driving mode is activated, terrain-specific views will be displayed.

Function bar on the right

Assistance functions can be activated and settings can be entered via the right function bar via iDrive. Move the Controller to the right, if needed.

- ▶  "Parking aid lines".
- ▶  "Obstacle mark".
- ▶  "Settings": apply settings, for instance to use the activation points for Panorama View.
 - ▶  "Brightness".
 - ▶  "Contrast".

Rearview camera

This view shows the picture of the rearview camera.

Selection window

The individual camera perspectives can be selected in the selection window via iDrive.

Parking aid lines

Pathway lines

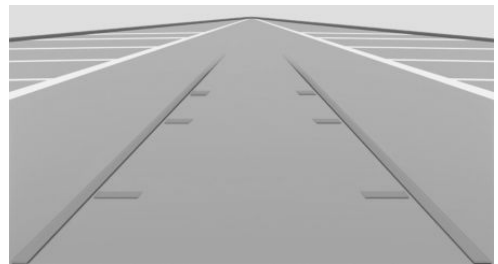

Pathway lines help you to estimate the space required when parking and maneuvering on level roads.

Pathway lines depend on the steering angle and are continuously adjusted to the steering wheel movements.

Turning radius lines

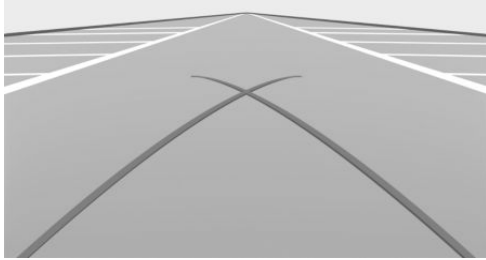

Turning radius lines can only be superimposed on the camera image together with pathway lines.

Turning radius lines show the course of the smallest possible turning radius on a level road.

Only one turning radius line is displayed after the steering wheel is turned past a certain angle.

Parking using pathway and turning radius lines

1. Position the vehicle so that the red turning radius line leads to within the limits of the parking space.
2. Turn the steering wheel to the point where the green pathway line covers the corresponding turning radius line.

Obstacle marking

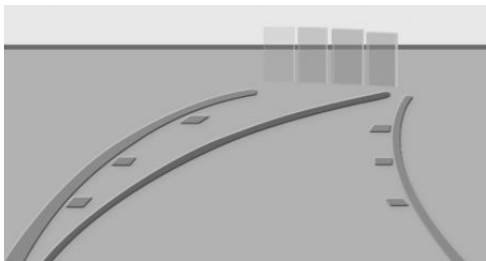

Obstacles behind the vehicle are detected by the PDC Park Distance Control sensors.

Obstacle markings can be shown in the camera image.

The colored thresholds of the obstacle markings match the markings of the PDC Park Distance Control.

Vehicle wash view

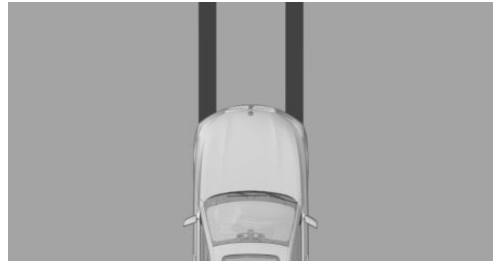

The vehicle wash view assists when entering a vehicle wash by displaying the floor and the vehicle's own track.

Zoom on trailer hitch

To make it easier to attach a trailer, you can zoom in on the view of the trailer hitch.

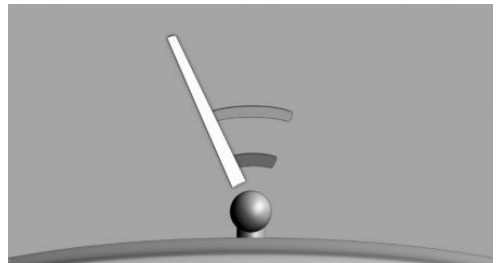

Two static circle segments show the distance between the trailer and the trailer hitch.

A docking line dependent on the steering angle helps with aiming for the trailer with the trailer hitch.

When zooming in, remember that the view may no longer show certain obstacles.

Side protection

Concept

The system warns of obstacles on the side of the vehicle.

Display



To protect the sides of the vehicle, obstacle markings are displayed on the sides of the vehicle.

- No markings: no obstacles were detected.
- Color markings: warning against detected obstacles.

Limits of side protection

The system only displays stationary obstacles that were previously detected by sensors while passing them.

The system does not detect whether an obstacle moves later on. For this reason, at standstill, the markings are not shown anymore in the display after a certain time. The area next to the vehicle must be newly captured.

Door opening angle

Concept

If obstacle marking is activated, the system indicates fixed obstacles that obstruct the opening angles of the doors.

The system does not provide a warning of approaching traffic.

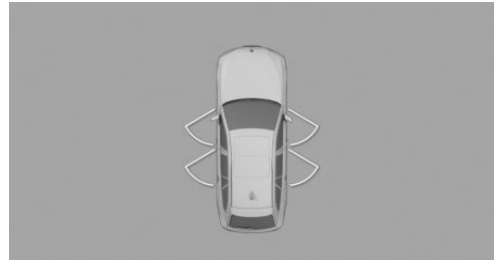

The maximum opening angle of the doors is displayed in selector lever position P.

As soon as the vehicle begins moving, the opening angles are replaced by parking aid lines.

Limits of the display

The vehicle surroundings are displayed with distorted image for technical reasons.

Even if the symbols for the door opening angles do not cross other objects on the Control Display, the following needs to be noted when parking next to other objects:

Because of the perspective, higher, protruding objects may be closer than they appear on the Control Display.

Panorama View

Concept

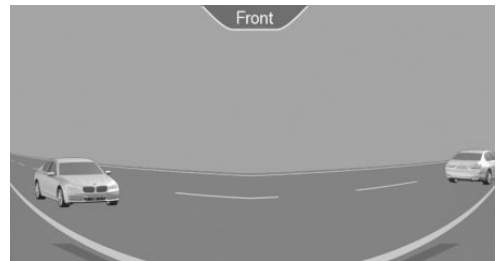

The system provides an early look at cross traffic at blind driveways and intersections.

General information

Road users concealed by obstacles to the left and right of the vehicle can only be detected rel-

actively late from the driver's seat. The cameras in the front and rear capture the sideways traffic area to improve the view.

Yellow lines in the screen display mark the front and rear end of the vehicle.

The camera image shows different levels of distortion in some areas and is thus not suitable for distance estimations.

Display on the Control Display

 Press the button when the engine is running.

Depending on the driving direction, the image of the respective camera is displayed:

- ▷ "Front": front camera image.
- ▷ "Rear": rear camera image.

Depending on the vehicle equipment, cross traffic warning, refer to page 268, can additionally warn of approaching vehicles using radar sensors.

With navigation system: activation points

Concept

Positions where Panorama View should switch on automatically can be stored as activation points provided that a GPS signal is received.

General information

Up to ten activation points can be stored.

Activation points can be used when driving forward for the front camera.

Storing activation points

1. Drive to the position at which the system is to be switched on, and stop.
2.  Press the button.
3. Move the Controller to the right.
4. "Activation point"



The current position is displayed.

5. "Save activation point"



Activation points are, if possible, stored with town/city and street address, or else with the GPS coordinates.

Using activation points



The use of activation points can be switched on and off.

1.  Press the button.
2. Move the Controller to the right.
3.  "Settings"
4. "Panorama View, GPS-based"
5. "Panorama View is displayed automatically when set activation points are reached."

Displaying activation points

1.  Press the button.
2. Move the Controller to the right.
3.  "Manage points"
A list of all activation points is displayed.



Renaming or deleting activation points

1.  Press the button.
2. Move the Controller to the right.
3.  "Manage points"
A list of all activation points is displayed.
4. Select an activation point as needed.
5. To perform the desired setting:
 - ▷ "Rename"
 - ▷ "Delete activation point"
 - ▷ "Delete all activation points"

Setting brightness and contrast

Brightness and contrast can be adjusted with Surround View or Panorama View switched on.

Via iDrive:

1. Move the Controller to the right, if needed.
2.  "Camera image"
3. To perform the desired setting:
 - ▶  "Brightness"
 - ▶  "Contrast"

Functional limitations

The system can be used only to a limited extent in the following situations:

- ▶ In poor light.
- ▶ In case of soiled cameras.
- ▶ With a door open.
- ▶ With the tailgate open.
- ▶ With exterior mirrors folded in.

Gray hatched areas with symbol, for instance open door, in the camera image mark areas that are currently not displayed.

System limits

Non-visible areas

Because of the camera angle, the areas under the vehicle cannot be viewed by the cameras.

Detection of objects

Very low obstacles as well as high, protruding objects such as ledges may not be detected by the system.

Some assistance functions also consider data from the PDC Park Distance Control.

Follow, refer to page 247, the notes in the PDC Park Distance Control chapter.

The objects displayed on the Control Display may be closer than they appear. Do not estimate the distance from the objects on the display.

Malfunction

A camera malfunction is displayed on the Control Display.



A yellow symbol is displayed and the recording range of the malfunctioning camera is displayed in black on the Control

Display.

With Parking Assistant Plus: Remote 3D View

Concept

With the proper equipment, the BMW Connected App and the camera images from Surround View can be used to display the vehicle surroundings on a mobile device such as a smartphone.

The function displays a momentary view of the situation.

Functional requirements

- ▶ Data transmission must be activated, refer to page 65.
- ▶ BMW Connected App must be installed on the mobile device.

Switching the function on/off

Via iDrive:

1. "CAR"
2. "Settings"
3. "General settings"
4. "Data privacy"
5. "Configure services" or "Select services individually"
6. If necessary, "BMW ConnectedDrive"
7. "Remote 3D View"

Functional limitations

The system may not be fully functional or may not be available in the following situations:

- ▶ In poor light.
- ▶ In case of soiled cameras.

- ▷ With a door or the tailgate open. Dark fields in the display indicate areas that are not recorded by the system.
- ▷ With exterior mirrors folded in.
- ▷ When other camera functions are being performed in the vehicle.
- ▷ When the vehicle moves faster than walking speed.
- ▷ It may not be possible to use the function in every country.
- ▷ For reasons of data protection, the function can only be used three times within two hours.

Parking Assistant

Concept

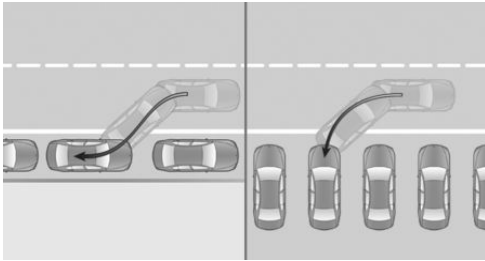

The system supports the driver in the following situations:

- ▷ When parking parallel to the road, parallel parking.
- ▷ When reverse parking diagonally to the road, diagonal parking. The system orients itself with the middle of the parking space during diagonal parking.
- ▷ Depending on the equipment version: when driving out of parallel parking spaces.

General information

Handling

Parking assistant handling is divided into three steps:

- ▷ Switching on and activating.
- ▷ Parking space search.
- ▷ Parking.

System status and instructions on required actions are displayed on the Control Display.

Ultrasound sensors measure parking spaces on both sides of the vehicle.

Steptronic transmission

The parking assistant calculates the best possible parking line and takes control of the following functions during the parking procedure:

- ▷ Steering.
- ▷ Accelerating and braking.
- ▷ Changing the gears.

Parking is automatic.

Safety information

Warning

The system cannot serve as a substitute for the driver's personal judgment in assessing the traffic conditions. Based on the limits of the system, it cannot independently react to all traffic situations. There is a risk of accident. Adjust driving style to traffic conditions. Watch traffic closely and actively intervene where appropriate.

Warning

If the trailer hitch is used, the parking assistant can cause damage due to covered sensors. There may be a risk of accident or risk of damage to property. The parking assistant should

not be used during trailer towing or if the trailer hitch is used, for instance bicycle rack.

⚠ NOTICE

The parking assistant can steer the vehicle over or onto curbs. There is a risk of damage to property. Watch traffic closely and actively intervene where appropriate.

The safety information of the PDC Park Distance Control, refer to page 247, applies in addition.

Overview

Button in the vehicle



 Park assistance button

Ultrasound sensors

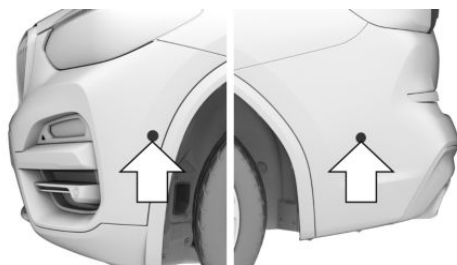

With the four side ultrasound sensors, arrows, and the ultrasound sensors in the bumpers, the parking spaces are measured and the distances to obstacles determined.

Functional requirements

Ultrasound sensors

Ensure full functionality:

- ▷ Do not cover sensors, for instance with stickers.
- ▷ Keep the sensors clean and unobstructed.

For measuring parking spaces

- ▷ Maximum speed while driving forward approx. 22 mph/35 km/h.
- ▷ Maximum distance to row of parked vehicles: 5 ft/1.5 m.

Suitable parking space

General information:

- ▷ Gap behind an object that has a min. length of 1.7 ft/0.5 m.
- ▷ Gap between two objects with a minimum length of approx. 1.7 ft/0.5 m.

Parallel parking to the road:

- ▷ Min. length of gap between two objects: your vehicle's length plus approx. 2.6 ft/0.8 m.
- ▷ Minimum depth: approx. 5 ft/1.5 m.

Diagonal parking:

- ▷ Minimum width of the gap: own vehicle's width plus approx. 2.3 ft/0.7 m.
- ▷ Minimum depth: your vehicle's length.

The depth of diagonal parking spaces must be estimated by the driver. Due to technical limitations, the system is only able to approximate the depth of diagonal parking spaces.

For parking

- ▷ Doors and tailgate are closed.
- ▷ Driver's safety belt is fastened.

Switching on and activating

Switching on with the button



Press the park assistance button.
The LED lights up.

The current status of the parking space search is indicated on the Control Display.

Parking assistant is activated automatically.

Switching on with reverse gear

1. Shift into reverse.

The current status of the parking space search is indicated on the Control Display.

2. If necessary, activate: "Autom. Parking"

Switching on via iDrive

Display of the rearview camera or PDC view must be active.

1. Move the Controller to the right.
2. Activate the parking assistant on the Control Display: "Autom. Parking"

Display on the Control Display

System activated/deactivated

Sym- bol	Meaning
	Gray: the system is not available. White: the system is available but not activated.
	System is activated.
	Parking space search is active.
	The parking procedure is active. The system takes over the steering.

Parking space search and system status

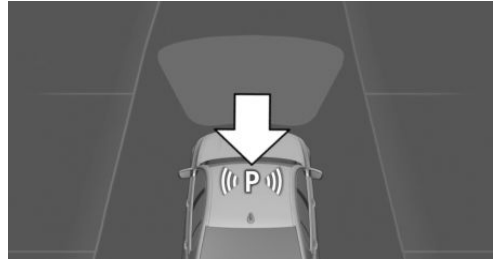

- ▷ Parking assistant is activated and parking space search is active.
- ▷ Control Display shows suitable parking spaces at the edge of the road next to the vehicle symbol. When Park Assistant is active, suitable parking spaces are highlighted and an acoustic signal sounds.
- ▷ If a diagonal or parallel parking space is clearly detected, the system automatically adjusts the suitable parking method. In the case of parking spaces suitable for parallel and diagonal parking, a selection menu is displayed. In this case, the desired parking method must be selected manually.
- ▷ The parking procedure is active. The system takes over the steering.
- ▷ Parking space search is always active whenever the vehicle is moving forward slow and straight, even if the system is deactivated. When the system is deactivated, the displays on the Control Display are shown in gray.

Signal tones

Switching signal tone for suitable parking spaces on/off

Via iDrive:

1. "CAR"
2. "Settings"
3. "Driver Assistance"
4. "Parking and maneuvering"

5. "Automatic Parking"
6. "Alert if parking space detected"

The setting is stored for the driver profile currently used.

Signal tones of the PDC Park Distance Control

During an automatic parking operation, no intermittent tone will sound from the PDC Park Distance Control.

A continuous tone sounds when the distance to a detected object is less than approx. 10 inches/25 cm.

Parking using the parking assistant

Parking

1. Switching on and activating the parking assistant.

Engage the reverse gear and, if necessary, activate the system or press the parking assistance button on the Control Display.

 Parking assistant is activated.

2. Pass the row of parked vehicles at a speed of up to approx. 22 mph/35 km/h and at a distance of maximum 5 ft/1.5 m.

The status of the parking space search and possible parking spaces are displayed on the Control Display.

3. Confirm the suggested parking space for the parking process: select the parking space on the Control Display.

The system takes over the steering.

4. Follow the instructions on the Control Display.



At the end of the parking procedure, the P selector lever position is set.

The end of the parking procedure is indicated on the Control Display.

5. Adjust the parking position yourself, if needed.

Interrupting manually

The parking assistant can be interrupted at any time:

- ▷  Press the park assistance button.
- ▷  "Autom. Parking": select the symbol on the Control Display.

Interrupting automatically

The system is interrupted automatically in the following situations:

- ▷ When the driver grasps the steering wheel or takes over steering.
- ▷ Possibly on snow-covered or slippery road surfaces.
- ▷ When there are obstacles that are hard to overcome, such as curbs.
- ▷ When there are obstacles that suddenly appear.
- ▷ If the PDC Park Distance Control displays clearances that are too small.
- ▷ When a maximum number of parking attempts or the time taken for parking is exceeded.
- ▷ When switching to another function on the Control Display.
- ▷ If the tailgate is open.
- ▷ If doors are open.
- ▷ When setting the parking brake.
- ▷ During acceleration.
- ▷ When the brake pedal remains pressed for an extended period while the vehicle is stationary.
- ▷ When unfastening the driver's safety belt.

A Check Control message is displayed.

Resuming

An interrupted parking procedure can be continued, if needed.

Reactivate the parking assistant and follow the instructions on the Control Display.

Switching off

The system can be switched off manually:



Press the park assistance button.

Depending on the equipment version: driving out of a parking space using the parking assistant

Concept

The system makes driving out of parallel parking spaces easier.

General information

Steptronic transmission

The parking assistant calculates an optimal line for pulling out of a parking space and takes control of the following functions during the maneuver:

- ▷ Steering.
- ▷ Accelerating and braking.
- ▷ Changing the gears.

The vehicle maneuvers automatically until the vehicle reaches a position in which the driver can drive out of the parking space without further steering movements.

Functional requirements

- ▷ The vehicle was parked manually and objects in front of and behind the car are detected. The distance to a detected curb is at least 6 inches/15 cm.
- ▷ The vehicle was parked using the parking assistant and an object is detected in front of the vehicle.
- ▷ The parking space is at least 2.6 ft/0.8 m longer than your vehicle.

Driving out of parking spaces

1. Switch on drive-ready state.
2. Steptronic transmission:

Press the park assistance button or shift into reverse gear when the vehicle is stationary to switch on the parking assistant.
3. Tilt the controller to the right and activate the parking assistant on the Control Display: "Autom. Parking"
4. On the Control Display, confirm the required direction for driving out of the parking space if necessary.
5. Steptronic transmission:

The system takes control of the maneuver. A message will be displayed at the end of the maneuver.
6. Make sure that the traffic situation permits driving out of the parking space and drive off as usual.

The parking assistant is switched off automatically.

Back-up assistant

Concept

The system supports the driver when driving in reverse, for instance when driving out of tight or confusing parking or street situations.

The vehicle stores the driving movements of the last route. This stored route can be driven back with automated steering.

General information

The system takes control of the steering when driving in reverse along the stored route.

The driver controls driving the vehicle via accelerator pedal and brake.

Functional requirements

- ▷ Drive forward without interruption to store the route.

- ▷ A maximum of 165 ft/50 m will be stored.
- ▷ To store the route, do not exceed a driving speed of 22 mph/36 km/h.
- ▷ The return route must be at least 12 in./30 cm wider than your vehicle.

Driving back with automated steering

1. Press the park assistance button or shift into reverse gear when the vehicle is stationary and the drive-ready state is switched on.
2. Move the Controller to the right.
3. "Back-up Assistant"
The system takes over the steering.
4. Follow the instructions on the Control Display where required.
5. Take your hands off the steering wheel and carefully drive off with the accelerator pedal and the brake.

When driving in reverse, pay attention to the vehicle's surroundings, and if you suddenly encounter an obstacle, stop immediately and take over control of the vehicle. Pay attention to the information from the PDC.

6. Stop no later than when normal traffic is reached and take control of the vehicle, such as by shifting to a forward gear.

At the end of the stored route, a signal will sound and a request will be displayed, also with the instruction to take control of the vehicle.

Terminating the system

The system automatically cancels in situations such as the following:

- ▷ When the driver grasps the steering wheel or takes over steering.
- ▷ When engaging a forward gear.
- ▷ During activation or intervention by driving control systems or assist systems.

- ▷ After a few minutes when the vehicle is stationary.
- ▷ If the vehicle leaves the stored lane during reversing; for example, at the maximum steering angle.
- ▷ When the display on the Control Display is cross-faded with messages, e.g., due to incoming calls.

Limits of the back-up assistant

- ▷ When you reach normal road traffic or if you suddenly encounter an obstacle, stop immediately and take over control of the vehicle.
- ▷ The maximum speed for driving in reverse is limited to approximately 6 mph/9 km/h.
If the maximum speed is exceeded, a warning is issued and the function may be canceled.

System limits

Safety information

Warning

The system is designed to operate in certain conditions and circumstances. Due to conditions or other factors, the system may not respond. There may be a risk of accident or risk of damage to property. Actively intervene as warranted. Refer to the information in this Owner's Manual regarding the scope of the system's operation and limitations.

No parking assistance

The parking assistant does not offer assistance in the following situations:

- ▷ In tight curves.
- ▷ When towing a trailer.
- ▷ For diagonal parking spaces.

Functional limitations

The system may not be fully functional in the following situations:

- ▷ On bumpy road surfaces such as gravel roads.
- ▷ On slippery ground.
- ▷ On steep uphill or downhill grades.
- ▷ With accumulations of leaves/snow in the parking space.
- ▷ With a mounted emergency wheel.
- ▷ In case of changes to an already-measured parking space.
- ▷ With ditches or edges, for instance an edge of a port.

Limits of ultrasonic measurement

The detection of objects with ultrasonic measurements can run into physical limits, e.g., in the following situations:

- ▷ For small children and animals.
- ▷ For persons with certain clothing, for instance coats.
- ▷ With external interference of the ultrasound, for instance from passing vehicles or loud machines.
- ▷ When sensors are dirty, iced over, damaged or out of position.
- ▷ Under certain weather conditions, e.g., high relative humidity, wet conditions, snowfall, cold, extreme heat, or strong wind.
- ▷ With tow bars and trailer couplings of other vehicles.
- ▷ With thin or wedge-shaped objects.
- ▷ With moving objects.
- ▷ With elevated, protruding objects such as ledges.
- ▷ With objects with corners, edges, and smooth surfaces.
- ▷ With objects with a fine surface structure such as fences.
- ▷ For objects with porous surfaces.
- ▷ With small and low objects, for instance boxes.

- ▷ With obstacles and persons at the edge of the lane.
- ▷ With soft obstacles or obstacles covered in foam material.
- ▷ With plants and bushes.
- ▷ Low objects already displayed, for instance curbs, can move into the blind area of the sensors before or after a continuous tone sounds.
- ▷ Cargo that extends beyond the perimeter of the vehicle is not taken into account by the system.

Parking spaces that are not suitable may be detected or suitable parking spaces may not be detected at all.

Malfunction

A Check Control message is displayed.

The parking assistant failed. Have the system checked by a dealer's service center or another qualified service center or repair shop.

Cross traffic warning

Concept

At blind driveways or when driving out of diagonal parking spaces, approaching cross traffic is detected sooner by the system than is possible from the driver's seat.

General information

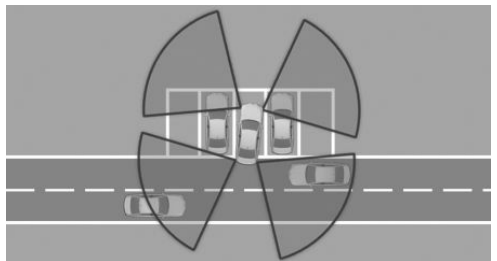

Two radar sensors in the rear bumper monitor the area behind the vehicle.

The system indicates approaching traffic.

Depending on the vehicle equipment, the traffic area in front of the vehicle is monitored as well. Two additional radar sensors are located in the front bumpers.

Safety information

Warning

The system cannot serve as a substitute for the driver's personal judgment in assessing visibility and traffic situation. There is a risk of accident. Adjust driving style to traffic conditions. Watch traffic closely and actively intervene where appropriate.

Overview

Button in the vehicle



Park assistance button

Radar sensors

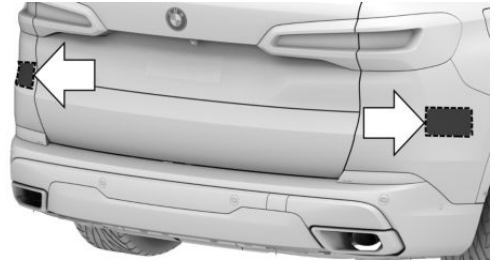

The radar sensors are located in the rear bumper.

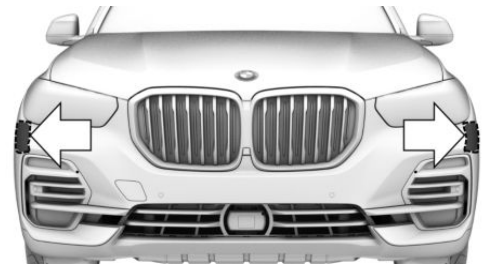



Depending on the vehicle equipment, two additional radar sensors are located in the front bumpers.

Always keep the bumper in the area of the radar sensors clean and unobstructed.

Switching on/off

Activating/deactivating the system

With the button

1.  Press the park assistance button.
2. Move the Controller to the right.
3.  "Settings"
4. "Cross traffic warning"
5. "Activate function"

Via iDrive

1. "CAR"
2. "Settings"
3. "Driver Assistance"
4. "Parking and maneuvering"
5. "Cross traffic warning"
6. "Activate function"

Switching on automatically

If the system was activated on the Control Display, it is automatically switched on as soon as PDC Park Distance Control or Panorama View is active and a gear is engaged.

If reverse gear is engaged, the rear system is switched on.

Depending on the vehicle equipment, the front system is switched on when a forward gear is engaged.

Switching off automatically

The system is automatically switched off in the following situations:

- ▶ When the speed exceeds walking speed.
- ▶ When a certain driving distance is exceeded.
- ▶ With an active parking operation of the parking assistant.

Warning

General information

The respective display is called up on the Control Display. A signal tone may sound and the light in the exterior mirror may flash.

Light in the exterior mirror



The light in the exterior mirror flashes if vehicles are detected by the rear sensors and your own vehicle is moving backwards.

Display in the PDC Park Distance Control view

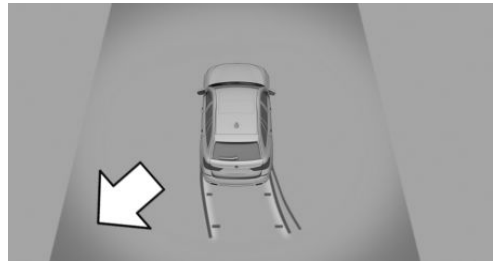

In the PDC Park Distance Control view, the respective boundary area flashes red, if vehicles are detected by the sensors.

Display in the camera view

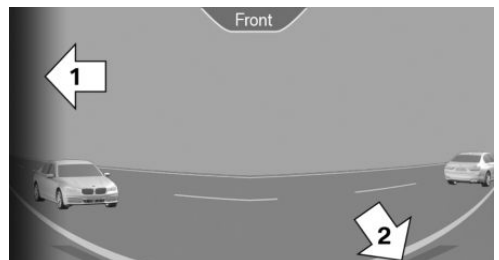

The respective boundary area, arrow 1, in the camera view flashes red, if vehicles are detected by the sensors.

Yellow lines, arrow 2, mark the bumper of your own vehicle.

Acoustic warning

In addition to the optical indicator, a warning signal sounds if your own vehicle moves into the respective direction.

System limits

The system may not be fully functional in the following situations:

- ▶ If the speed of the approaching vehicle is very high.
- ▶ In heavy fog, wet conditions, or snowfall.
- ▶ In tight curves.
- ▶ If the bumper is dirty, iced up, or covered, for instance by stickers.
- ▶ If the field of view of the sensors is covered, e.g., by garage walls, hedges or snow hills.
- ▶ If cargo protrudes.
- ▶ When crossing objects move at a very slow speed.
- ▶ If other objects are in the capture range of the sensors, that hide cross traffic.

If the trailer power socket is in use or trailer towing is activated, for instance during operation with trailer or bicycle rack, cross traffic warning is not available for the area behind the vehicle.

Driving comfort

Vehicle features and options

This chapter describes all standard, country-specific and optional features offered with the series. It also describes features and functions that are not necessarily available in your vehicle, e.g., due to the selected options or country versions. This also applies to safety-related functions and systems. When using these functions and systems, the applicable laws and regulations must be observed.

Chassis components

The chassis components are optimized for the vehicle and its scope of application and thereby ensure the best possible Driving Dynamics.

2-axle air suspension

Concept

Air suspension ensures best possible driving comfort under all load conditions. Due to a variable adjustment of the front and rear axles, the damping is adjusted to the vehicle state.

General information

Regardless of the load, the vehicle will be maintained at the configured vehicle level.

Depending on the driving situation, the vehicle level can be set to five levels.

▷ Entry level:

Lowest vehicle level setting.

The entry level can be set when the vehicle is stationary with the following features:

- ▷ With the rocker switch in the center console.
- ▷ With the BMW display key.
- ▷ With the button in the lower section of the tailgate.

The vehicle will adjust according to the selected driving mode at drive-off.

▷ Sport level:

Lowest driving level for driving at higher speeds.

▷ Normal level:

Standard level for normal roads and speeds.

▷ High level 1:

Slightly elevated vehicle level for easy terrain at reduced speed.

If necessary, the vehicle will be lowered at higher speeds.

▷ High level 2:

Highest driving level for terrains with major uneven surfaces in the lowest speed range.

If necessary, the vehicle will be lowered at higher speeds.

Level adjustment takes place when all doors are closed.

Safety information

Warning

Adjusting the vehicle height may result in trapped body parts or damaged vehicle parts.

There is a risk of injury or risk of damage to property. When adjusting the vehicle height, make sure that the areas of movement around the vehicle and at the wheel housing are free.

Overview

Rocker switch in the vehicle



Setting the level

With the rocker switch in the center console



Up

Push the rocker switch forward.

In the low speed range, the vehicle is raised to next higher level when the rocker switch is pressed.

Down

Pull the rocker switch backward.

The vehicle will lower by one level.

Display

- ▷ LED on the rocker switch lights up: display of the current level.
- ▷ LED on the rocker switch is flashing: adjustment procedure active. The vehicle raises or lowers itself.

- ▷ LED on the rocker switch flashes fast: the selected level is not possible at this time.
- ▷ All LEDs on the rocker switch are flashing: system is initializing. The selected level will be adjusted after the initialization where required.

Automatic

While driving

In the SPORT driving mode, SPORT+ driving mode or at higher speeds, the vehicle lowers itself automatically.

When a set vehicle level is exited due to the speed, the vehicle level will be adjusted according to the selected driving mode.

In the event of a flat tire

When a loss of the tire inflation pressure is detected on a wheel, the wheel load will be reduced automatically to increase the possible range of travel. In this situation, only the normal level is available.

With the BMW display key

Concept

The vehicle level can be adjusted with the BMW display key when the vehicle is stationary, for instance for easier loading or as an entry aid.

Setting the level

1. Apply parking brake and switch drive-ready state off using the Start/Stop button.
2. Closing the doors.
3. If necessary, switch on the display on the BMW display key and cancel the display block, refer to page 83.
4. On the BMW display key, change to the following menu: "Entry level".
5. "Height control"
6. ▷ "Lower": tap the button. The vehicle lowers itself to the entry level.

For safety reasons, lowering is only possible from the normal level or the Sport level.

- ▷ "Raise": tap the button. The vehicle will raise itself from the entry level according to the selected driving mode.

Terminating the adjustment procedure

An adjustment procedure that was started on the BMW display key can be terminated with the BMW display key.

"Cancel": tap the button. The vehicle raises or lowers itself back to the starting level.

With the button in the lower tailgate



When the tailgate is opened, the vehicle can be lowered to the entry level and raised again by pressing the button. The flashing of the LED in the button indicates the level change.

During the raising procedure, the vehicle raises itself from the entry level to the level that was selected last or the normal level.

Terminating the adjustment procedure

An adjustment procedure that was started with the button in the lower tailgate can be terminated with this button.

Press the button again. The vehicle raises or lowers itself back to the starting level.

System limits

- ▷ It may not be possible to change the level during dynamic driving.

- ▷ It may not be possible to change the level if the axles are limited.
- ▷ It may only be possible to lift the vehicle level while the engine is running.
- ▷ If the state of charge of the vehicle battery is too low, a level change may not be possible.
- ▷ If level adjustment is activated frequently in quick succession, the system switches off to prevent overheating and is temporarily unavailable or operates with a delay. Let the system cool, if needed.
The rapidly flashing LED on the rocker switch indicates that the system is unavailable.
- ▷ If the load is increased, the highest driving level may be locked or automatically exited in order to protect the system.
- ▷ When the trailer power socket is in use or when trailer towing is activated, only the normal level is available.

Wheel change

Before a wheel change, deactivate the system:

Press the rocker switch forward or pull it backward for approx. 7 seconds. After the rocker switch is released, the LED indicator on the rocker switch will go out.

Activating the system: press the rocker switch forward or pull it backward for approx. 7 seconds. After the rocker switch is released, the LED indicator will reactivate.

Malfunction

A Check Control message is displayed. The system is impaired. Vehicle handling may be altered and driving comfort may be noticeably reduced. Visit the nearest dealer's service center or another qualified service center or repair shop.

Long periods when vehicle is parked

During long periods when the vehicle is parked, it can lower itself. This is not a malfunction.

When the drive-ready state is switched on with the doors closed, the vehicle is raised to the normal level automatically.

Depending on the state of the vehicle, raising to normal level may take several minutes.

xOffroad package

Concept

The xOffroad package supports the driver when driving away from unpaved roads or with reduced traction. The system offers four different xOffroad driving modes for selection.

xOffroad driving modes and levels

The xOffroad driving modes can be selected based on the ground conditions.

When an xOffroad driving mode is switched on, individual systems in the vehicle are set to the best possible traction and vehicle stability.

With the 2-axle air suspension, the vehicle level is set for the corresponding xOffroad driving mode.

xOffroad driving mode	Level
"xGRAVEL"	High level 1
"xSAND"	High level 1
"xROCKS"	High level 2
"xSNOW"	Normal level.

General information

The system optimizes the driving behavior and the traction on unpaved surfaces within the physical limits.

It is operated with the button and rocker switch in the center console.

Observe the information in the chapter Driving tips, driving on bad roads, refer to page [322](#).

Overview

Button and rocker switch in the center console

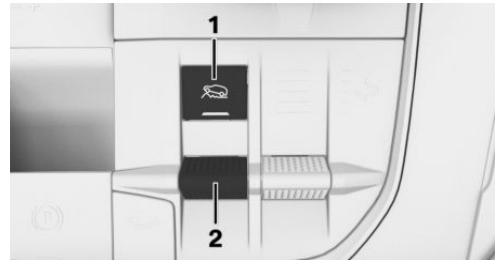

- 1 Switch the xOffroad driving mode on/off.
- 2 Set the xOffroad driving mode.

Switching on

Press button 1 or rocker switch 2 forward or pull back. The xOffroad driving mode "xGRAVEL" is switched on. The LED on the button lights up. The driving mode is displayed in the instrument cluster.

The effective speed range is displayed in the speedometer with a line below the scale.

Setting the xOffroad driving mode



Push the rocker switch forward or pull it back repeatedly until the desired xOffroad driving mode is displayed in the instrument cluster.

xOffroad driving modes in detail

All driving modes

When the xOffroad driving modes are switched on, the following vehicle settings will be applied:

- ▷ Auto Start/Stop function is switched off.
- ▷ Transmission and accelerator pedal: the shifting behavior and response to the accelerator pedal are adjusted.
- ▷ The all-wheel-drive system is set to the best possible traction.
- ▷ Display on the Control Display: the power distribution on the wheels can also be displayed in the xOffroad display.

With the proper equipment, additional terrain-specific camera perspectives can be selected.

"xGRAVEL"

This driving mode is active every time the xOffroad driving modes are switched on.

Setting for: "Optimized vehicle setting for easy terrain."

When switching on, the following additional vehicle settings are carried out, for example:

- ▷ Anti-lock system: the response behavior is adjusted.
- ▷ DSC Dynamic Stability Control: the response behavior is adjusted.
- ▷ 2-axle air suspension: high level 1 is set.

"xSAND"

Setting for: "Optimized vehicle setting for heavy terrain with loose surface. For maximum traction, deactivate DSC."

When switching on, the following additional vehicle settings are carried out, for example:

- ▷ Anti-lock system: the response behavior is adjusted.
- ▷ DSC Dynamic Stability Control: the response behavior is adjusted.

- ▷ 2-axle air suspension: high level 1 is set.

"xROCKS"

Setting for: "Optimized vehicle setting for heavy terrain with strong irregularities. For maximum traction, deactivate DSC."

When switching on, the following additional vehicle settings are carried out, for example:

- ▷ Anti-lock system: the response behavior is adjusted.
- ▷ DSC Dynamic Stability Control: the response behavior is adjusted.
- ▷ 2-axle air suspension: high level 2 is set.

"xSNOW"

Setting for: "Optimized vehicle setting for assured handling on slippery road."

When switching on, the following additional vehicle settings are carried out, for example:

- ▷ 2-axle air suspension: normal level is set.
- ▷ Steptronic transmission: the shift behavior is set to gentle gear changes. The vehicle drives off in second gear.
- ▷ Accelerator pedal: the characteristic of the accelerator pedal is optimized for gentle driving behavior.

Manual switching off

Press button 1. The LED on the button goes out. The last driving mode that was set through the Driving Dynamics Control will be activated.

Display on the Control Display

Display xView display

Via iDrive:

1. "CAR"
 2. "Driving information"
 3. "xOFFROAD"
- or
- "xVIEW"

The following information is displayed:

- ▶ With a navigation system: compass display for the driving direction.
- ▶ With navigation system: elevation for the current position.
- ▶ With navigation system: destination flag in compass direction to the destination.
- ▶ Pitch attitude with degree indication and percentage.
- ▶ Transverse gradient with degree indication.
- ▶ Graphic display for the steering angle.
- ▶ Level setting for the 2-axle air suspension.

With the xOffroad package, the following additional information can be displayed:

- ▶ With Surround View: depending on the speed, terrain-specific camera perspectives.
- ▶ xOffroad driving mode currently active.
- ▶ Distribution of drive torque to the wheels.

System limits

The xOffroad properties may be reduced at higher speeds where required.

Adaptive chassis

Concept

This system reduces undesirable vehicle motion when using a dynamic driving style or traveling on uneven road surfaces.

General information

The driving dynamics and driving comfort are enhanced depending on the road surface condition and driving style.

Active roll stabilization

Concept

The system reduces the lateral tilt of the vehicle that occurs during rapid driving in curves or during quick evasive maneuvers.

General information

The lateral tilt of the vehicle is balanced out by permanent adjustment on the front and rear axles. The vehicle is thus always stabilized.

Agility and driving comfort are increased under all driving conditions.

Tuning

The system offers several different tunings.

The tunings are assigned to the different driving modes of the Driving Dynamics Control, refer to page 137.

Driving mode	Tuning
COMFORT	Comfortable.
ECO PRO	Comfortable.
SPORT	Taut.
SPORT PLUS	Taut.

Adaptive M chassis

Concept

The Adaptive M chassis is a controllable sport chassis/suspension. This system reduces undesirable vehicle motion when using a dynamic driving style or traveling on uneven road surfaces.

General information

The driving dynamics and driving comfort are enhanced depending on the road surface condition and driving style.

Depending on the equipment, the rear axle lock differential will be adjusted for the traction conditions as needed.

Tuning

The system offers several different damping settings.

The damping settings are assigned to the different driving modes of the Driving Dynamics Control, refer to page 137.

Driving mode	Damper tuning
COMFORT	Balanced out.
ECO PRO	Balanced out.
SPORT	Taut.
SPORT PLUS	Taut.

Adaptive M Chassis Professional

Concept

The Adaptive M Suspension Professional is an actively controlled sport chassis/suspension. The system increases driving comfort and minimizes the lateral tilt when driving around curves.

The Adaptive M Suspension Professional encompasses the following systems:

- ▷ Sport suspension.
- ▷ Adaptive chassis.
- ▷ Active roll stabilization.
- ▷ Integral Active Steering.

General information

For active control, this system uses the available information, for instance from the navigation system or the Driving style analysis.

This information influences the control of the following systems, especially in ADAPTIVE driving mode:

- ▷ Adaptive chassis.
- ▷ Active roll stabilization.
- ▷ Integral Active Steering.

This further increases the agility and comfort of the vehicle.

The function may be restricted if the navigation data is invalid, outdated or not available, for example.

Depending on the equipment, the rear axle lock differential will be adjusted for the traction conditions as needed.

Performance Control

Performance Control enhances the agility of the vehicle.

To increase maneuverability, wheels are braked individually when a sporty driving style is used.

Climate control

Vehicle features and options

This chapter describes all standard, country-specific and optional features offered with the series. It also describes features and functions that are not necessarily available in your vehicle, e.g., due to the selected options or country versions. This also applies to safety-related functions and systems. When using these functions and systems, the applicable laws and regulations must be observed.

Interior air quality

The air quality in the vehicle is improved by the following components:

- ▶ Emission tested passenger compartment.
- ▶ Microfilter.
- ▶ Air conditioning system to control the temperature, air flow and recirculated-air mode.

Depending on the equipment:

- ▶ Microfilter/activated-charcoal filter.
- ▶ Ionization.
- ▶ Fragrancing.
- ▶ Automatic recirculated-air control AUC.
- ▶ Parked-car ventilation.

Automatic climate control

Overview

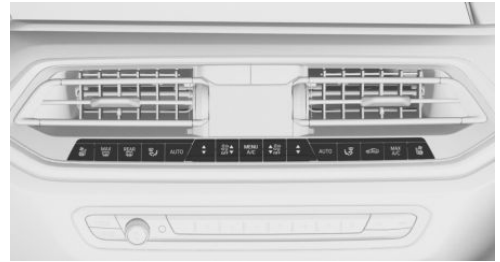

Buttons in the vehicle



Climate control functions

Button	Function
	Temperature.
	Maximum cooling.
	AUTO program.
	Recirculated-air mode.
	Air flow, manual. Intensity AUTO program.
	Air distribution, manual.
	Defrost and defog the windshield.
	Rear window defroster.

Depending on the equipment:

Button	Function
	Seat and armrest heating, refer to page 125.
	or
	Active seat ventilation, refer to page 126.
	Climate control operation. Open Climate menu, such as for the following settings: upper body temperature adjustment, parked-car ventilation.

Some of the functions can also be used via voice, e.g., temperature.

Opening the Climate menu

 Press the button on the upper side.

The Climate menu is displayed.

For example, the following climate control functions can be accessed via the Climate menu:

- ▷ Fragrance.
- ▷ Air quality.
- ▷ Heating/ventilation.
- ▷ Seats/surfaces.
- ▷ Parked-car ventilation/heating

Individual settings can be entered for some of the climate functions, e.g., switching on/off, intensity.

Switching on/off

Switching on

Press any button except for the following:

- ▷ Menu/Climate Cont.
- ▷ Rear window defroster.
- ▷ Lower air flow button side.
- ▷ Seat heating.
- ▷ Seat ventilation.

Switching off

- ▷ Complete system:

 Press and hold the button on the driver's side until the control panel switches off.

- ▷ On the front passenger side:

 Press and hold the lower button on the front passenger side.

Temperature

Concept

The automatic climate control achieves the set temperature as quickly as possible, if needed, by using the maximum cooling or heating capacity, and then keeps it constant.

Adjusting

 Press the upper or lower button side to set the desired temperature.

Via iDrive:

1. "CAR"
2. "Settings"
3. "Climate control"
4. "Heating/ventilation"
5. "Driver" or "Front passenger"
6. "Temperature:"
7. Set the desired temperature.
8. "OK"

Do not rapidly switch between different temperature settings. Otherwise, the automatic climate control will not have sufficient time to adjust the set temperature.

Temperature of the ventilation

General information

The temperature of the ventilation in the upper body region can be adjusted.

The temperature is individually adjusted, e.g. colder toward blue, warmer toward red.

The air flow of the ventilation in the upper body region heats or cools noticeably, depending on the adjusted temperature.

This does not change the set interior temperature for the driver and front passenger.

Adjusting

Via iDrive:

1. "CAR"
2. "Settings"
3. "Climate control"
4. "Heating/ventilation"
5. "Driver" or "Front passenger"
6. "Temperature adjustment"
7. Set the desired temperature:
 - ▷ Toward blue: colder.
 - ▷ Toward red: warmer.

Air conditioning

Concept

The air in the car's interior will be cooled and dehumidified and, depending on the temperature setting, warmed again.

The car's interior can only be cooled with the drive-ready state switched on.

Switching on/off

 Press the button on the lower side.

Via iDrive:

1. "CAR"
2. "Settings"
3. "Climate control"
4. "Heating/ventilation"
5. "A/C"

Air conditioning is switched on with the engine running.

Depending on the weather, the windshield and the side windows may fog up briefly when drive-ready state is switched on.

The cooling function is switched on automatically with the AUTO program.

When using the automatic climate control, condensation water develops and collects underneath the vehicle.

Maximum cooling

Concept

The system is set to the lowest temperature, optimum air flow and recirculated-air mode with the drive-ready state switched on.

General information

The function is available with external temperatures above approx. 32 °F/0 °C and with the drive-ready state switched on.

Switching on/off

 Press the button.
The LED is illuminated when the system is switched on.

Air flows out of the vents to the upper body region. The vents need to be open for this.

The air flow can be adjusted with the program active.

AUTO program

Concept

The AUTO program cools, ventilates or heats the car's interior automatically.

The air distribution and temperature are controlled automatically depending on the temperature in the car's interior and the desired temperature setting including the selected intensity of the air flow.

Switching on/off



Press the button.

The LED is illuminated with the AUTO program switched on.

Via iDrive:

1. "CAR"
2. "Settings"
3. "Climate control"
4. "Heating/ventilation"
5. "Driver" or "Front passenger"
6. "Automatic"

Depending on the selected temperature, the intensity of the AUTO program, and outside influences, the air is directed to the windshield, side windows, upper body, and into the floor area.

The cooling function is switched on automatically with the AUTO program.

Point the side vents toward the side windows.

At the same time, a condensation sensor controls the program so as to prevent window condensation as much as possible.

The AUTO program is switched off automatically, when manual air distribution is set.

Intensity

With the AUTO program switched on, the intensity can be adjusted. This changes the automatic control for the air flow and air distribution.



Press the lower or upper side of the button: decrease or increase intensity.

Via iDrive:

1. "CAR"
2. "Settings"
3. "Climate control"
4. "Heating/ventilation"
5. "Driver" or "Front passenger"
6. "Level"
7. Set the desired intensity.

The air flow and air distribution are controlled automatically depending on the selected intensity.

The selected intensity is shown on the climate control display.

Automatic recirculated-air control AUC

Concept

The automatic recirculated-air control AUC recognizes odors or pollutants in the outside air.

The outside air supply is shut off and the interior air is recirculated.

General information

If the system is activated, a sensor detects pollutants in the outside air and controls the shut-off automatically.

If the system is deactivated, outside air continuously flows into the car's interior.

With constant recirculated-air mode, the air quality in the car's interior deteriorates and window fogging increases.

Switching on/off

Via iDrive:

1. "CAR"
2. "Settings"
3. "Climate control"
4. "Air quality"
5. "Automatic"

If there is window condensation, switch off recirculated-air mode or defog the windows.

Recirculated-air mode

Concept

You may react to unpleasant odors or pollutants in the immediate environment by temporarily suspending the supply of outside air. The system then recirculates the air flow within the vehicle.

Operation



Press the button.

The LED is illuminated when recirculated-air mode is switched on. The supply of outside air is shut off.

When recirculated-air mode is switched off, fresh air is directed into the vehicle's interior.

Via iDrive:

1. "CAR"
2. "Settings"
3. "Climate control"
4. "Air quality"
5. Select the desired setting:
 - ▷ "Air recirculation"
 - ▷ "Automatic"
 - ▷ "Fresh air"

To prevent window fogging, recirculated-air mode switches off automatically after a certain amount of time, depending on the environmental conditions.

With constant recirculated-air mode, the air quality in the car's interior deteriorates and window fogging increases.

If there is window condensation, switch off recirculated-air mode or defog the windows.

Adjusting the air flow manually

Concept

The air flow for climate control can be adjusted manually.

General information

To adjust the air flow manually switch off AUTO program first.

Operation



Press the lower or upper side of the button: decrease or increase air flow.

The selected air flow is shown on the climate control display.

The air flow may be reduced automatically to save battery power.

Adjusting the air distribution manually

Concept

The air distribution for climate control can be adjusted manually.

Operation



Press the button repeatedly to select a program:

- ▷ Windows, upper body region, and floor area.
- ▷ Upper body region and floor area.
- ▷ Floor area.
- ▷ Windows and floor area.
- ▷ Windows.
- ▷ Windows and upper body.
- ▷ Upper body region.

The selected air distribution is shown on the climate control display.

SYNC program

Concept

Depending on the equipment, the following settings of the driver's side can be transferred to the front-passenger side and the rear:

- ▷ Temperature.
- ▷ Air flow.
- ▷ Air distribution.
- ▷ AUTO program.

Switching on/off

Via iDrive:

1. "CAR"
2. "Settings"
3. "Climate control"
4. "Synchronize"

The program is switched off automatically if the settings on the front passenger side or in the rear are changed.

Defrosting windshield and remove condensation

Concept

Ice and condensation are quickly removed from the windshield and the front side windows.

Switching on/off



Press the button.

The LED is illuminated when the system is switched on.

The air flow can be adjusted manually with the system switched on.



If there is window condensation, press the button on the driver's side or switch on air conditioning to utilize the condensation sensor. Make sure that air can flow to the windshield.

Rear window defroster



Press the button. The LED lights up.

The function is available with the engine running.

The rear window defroster switches off automatically after a certain period of time.

Microfilter/activated-charcoal filter

The microfilter removes dust and pollen from the incoming air.

The activated-charcoal filter also removes gaseous pollutants from the outside air that enters the vehicle.

Have this combined filter changed during vehicle maintenance.

Ventilation

Concept

The air flow directions can be individually adjusted.

Adjusting the ventilation

General information

The air flow directions can be adjusted for direct or indirect ventilation.

Open the vents and position them to ensure effective climate control.

Direct ventilation

The air flow is directed towards the passengers. The air flow heats or cools noticeably, depending on the adjusted temperature.

Indirect ventilation

The air flow is not directed towards the passengers. The car's interior is warmed or cooled indirectly, depending on the set temperature.

Front ventilation

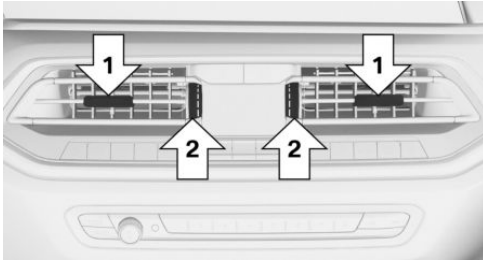

- ▶ Lever for changing the air flow direction, arrow 1.
- ▶ Thumbwheel for variable opening and closing of the vents, arrow 2.

Ventilation in rear, center

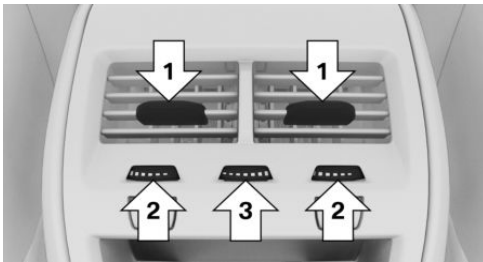

- ▶ Lever for changing the air flow direction, arrow 1.
- ▶ Thumbwheel for variable opening and closing of the vents, arrow 2.
- ▶ Thumbwheel for varying the temperature, arrow 3.
Toward blue: colder.
Toward red: warmer.

Ventilation in the rear, on the side

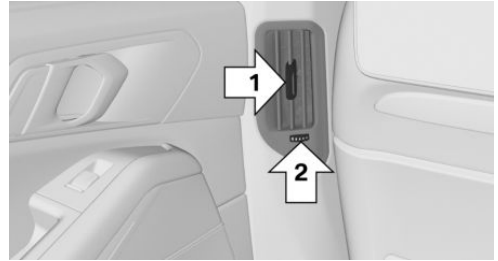

- ▶ Lever for changing the air flow direction, arrow 1.
- ▶ Thumbwheel for variable opening and closing of the vents, arrow 2.

Heating and ventilation, third row of seats

The air in the area of the third row of seats can be heated or circulated. The vents are located in the storage area between the seats and in the floor area of the third row of seats.

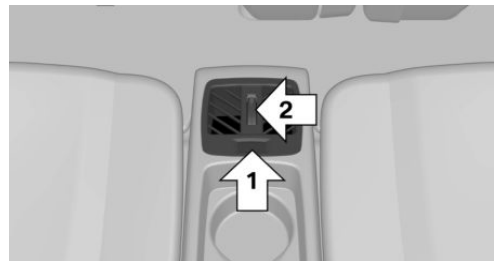

- ▶ Button for switching on the fan, arrow 1. The LED lights up.
- ▶ Thumbwheel for the activation of the heat and distribution of the air, arrow 2.
Turn toward the front: activate the heater and distribute the air in the floor area.
Turn toward the rear: distribute the air in the storage area between the seats.

The heater is not ready for operation without switching on the fan. After the heater is switched

off, the fan can be used to circulate the interior air, for instance at high temperatures. To do this, switch on the fan, arrow 1, and turn the thumb-wheel toward the rear, arrow 2.

Rear automatic climate control

Overview

Buttons in the vehicle



Climate control functions

Button	Function
	Temperature.
	Maximum cooling.
	AUTO program.
	Air flow, manual.
	Air distribution, manual.
	Seat heating, refer to page 125 .

Switching on/off

Via iDrive

1. "CAR"
2. "Settings"
3. "Climate control"
4. "Heating/ventilation"
5. "Second row of seats"
6. "Activate heating/cooling"

The rear automatic climate control is not ready for operation if the automatic climate control is switched off or if the function for defrosting the windows and removing condensation is active.

Using the button: switching on

Press any button except for the following:

- ▷ Lower air flow button side.
- ▷ Seat heating.

Using the button: switching off



Press and hold the bottom of the button.

Temperature

Concept

The automatic climate control achieves the set temperature as quickly as possible, if needed, by using the maximum cooling or heating capacity, and then keeps it constant.

Adjusting



Press the upper or lower button side to set the desired temperature.

Via iDrive:

1. "CAR"
2. "Settings"
3. "Climate control"
4. "Heating/ventilation"

5. "Second row of seats"
6. "Temp. left:" or "Temp. right:"
7. Set the desired temperature.

The selected temperature is shown on the climate control display.

Do not rapidly switch between different temperature settings. Otherwise, the automatic climate control will not have sufficient time to adjust the set temperature.

Maximum cooling

Concept

The system is set to the lowest temperature, optimum air flow and recirculated-air mode with the drive-ready state switched on.

General information

The function is available with external temperatures above approx. 32 °F/0 °C and with the drive-ready state switched on.

Switching on/off

 Press the button.

The LED is illuminated when the system is switched on.

Air flows out of the vents to the upper body region. The vents need to be open for this.

AUTO program

Concept

Air flow, air distribution and temperature are controlled automatically.

Switching on/off

 Press the button.

The LED is illuminated with the AUTO program switched on.

Via iDrive:

1. "CAR"
2. "Settings"
3. "Climate control"
4. "Heating/ventilation"
5. "Second row of seats"
6. "Automatic"

Depending on the selected temperature, the AUTO intensity, and outside influences, the air is directed to the upper body and into the floor area.

Intensity

With the AUTO program activated, the automatic intensity control can be changed:

 Press the lower or upper side of the button: decrease or increase intensity.

Via iDrive:

1. "CAR"
2. "Settings"
3. "Climate control"
4. "Heating/ventilation"
5. "Second row of seats"
6. "Level"
7. Set the desired intensity.

The air flow and air distribution are automatically regulated depending on the selected intensity.

The selected intensity is shown on the climate control display.

Adjusting the air flow manually

Concept

The air flow for climate control can be adjusted manually.

General information

To adjust the air flow manually switch off AUTO program first.

Operation



Press the lower or upper side of the button: decrease or increase air flow.

The selected air flow is shown on the climate control display.

Adjusting the air distribution manually

Concept

The air distribution for climate control can be adjusted manually.

Operation



Press the lower or upper side of the button to select a program:

- ▷ Upper body region.
- ▷ Upper body region and floor area.
- ▷ Floor area.

Locking the control elements

Concept

The control elements of the rear automatic climate control can be locked.

Activating/deactivating

Via iDrive:

1. "CAR"
2. "Settings"
3. "Climate control"
4. "Heating/ventilation"
5. "Second row of seats"
6. "Disable controller"

Parked-car ventilation

Concept

The car's interior can be cooled or heated before driving off with the parked-car ventilation. Depending on set temperature and ambient temperature, the car's interior is ventilated or possibly heated using the residual engine heat.

General information

The system can be switched on and off directly or via a preset departure time.

The activation time is determined based on the external temperature. The system promptly switches on before the selected departure time.

Functional requirements

- ▷ The vehicle is in idle state or standby state and not in drive-ready state.
- ▷ The battery is sufficiently charged.

If parked-car ventilation is switched on, the vehicle battery will be discharged. Thus, limit the maximum activation time to save the vehicle battery. The system will be available again after the engine is started or after a short trip.

- ▷ Make sure that the vehicle's date and time are set correctly.
- ▷ Open the vents to allow air to flow out.

Opening the Climate menu



Press the button on the upper side.

The Climate comfort menu is displayed.

Individual settings can be entered for some of the climate control functions.

Switching on/off directly

General information

There are different ways to switch the system on or off.

The system switches off automatically after a certain period of time. The system continues to run for some time after being switched off.

Using the button

General information

When the vehicle is in standby state, the parked-car ventilation can be switched on or off via the automatic climate control buttons.

Switching on

Press any button except:

- ▶ Rear window defroster.
- ▶ Lower air flow button side.
- ▶ Seat heating.
- ▶ Seat ventilation.
- ▶ Menu.

Switching off



Press and hold the bottom button.



The system switches off after leaving and locking the vehicle.

Via iDrive



1. "CAR"
2. "Settings"
3. "Climate control"
4. "Pre-heating/ventilation"
5. "Start now"

Via BMW display key



Switching on

1. Switch on the display of the BMW display key.
2. "Preconditioning setting"
3. Tap the  symbol or the  symbol.
4. "Activate now"
5. "Start"

Switching off

1. Switch on the display of the BMW display key.
2. "Preconditioning setting"
3. Tap the  symbol or the  symbol.
4. "Stop"

Display

Symbol	Description
	Symbol on the climate control display.
	Flashing: the parked-car ventilation is switched on.

Departure time

Concept

Different departure times can be set to ensure a comfortable interior temperature in the vehicle at the time of departure.

- ▶ One-time departure time: the time can be set.

The system is switched on once.

- ▶ Departure time with weekday: time and day of the week can be set.

On the desired weekdays, the system will be switched on promptly before the set departure time.

The departure time is preselected in two steps:

- ▷ Set departure times.
- ▷ Activate departure times.



A minimum of 10 minutes should pass between setting/activating the departure time and the planned departure time to allow a sufficient period of time for the climate control.

Setting the departure time

Via iDrive

1. "CAR"
2. "Settings"
3. "Climate control"
4. "Pre-heating/ventilation"
5. "Departure schedule"
6. Select the desired departure time.
7. Set the departure time.
8. Select day of the week, if needed.
9. "OK"

Via BMW display key

1. Switch on the display of the BMW display key.
2. "Preconditioning setting"
3. Tap the  symbol or the  symbol.
4. Select the desired departure time.
5. Set the departure time.
6. Select day of the week, if needed.
7. "OK"

Activating the departure time

Functional requirement



If a departure time is to influence the switching on of parked-car ventilation, the respective departure time must be activated first.

Via iDrive



1. "CAR"
2. "Settings"

3. "Climate control"
4. "Pre-heating/ventilation"
5. "Departure schedule"
6. Activate the desired departure time.

Via BMW display key

1. Switch on the display of the BMW display key.
2. "Preconditioning setting"
3. Tap the  symbol or the  symbol.
4.  Tap on the symbol.
5. Activate the desired departure time.

Display

 ,  Symbol on the climate control display signals an activated departure time.

Stationary climate control through Remote Engine Start

Concept

Stationary climate control cools or heats the car's interior prior to departure to a comfortable temperature. The system automatically cools, vents, and heats depending on the interior, external, and set temperature. Snow and ice may be removed more easily.

The system starts the engine automatically and allows it to run for a limited period of time.

Safety information

DANGER

If the exhaust pipe is blocked or ventilation is insufficient, harmful exhaust gases can pollute the area in and around the vehicle or enter into the vehicle. The exhaust gases contain pollutants which are colorless and odorless. In enclosed areas or areas with insufficient ventila-

tion, exhaust gases can also accumulate outside of the vehicle. There is danger to life. Keep the exhaust pipe free and ensure sufficient ventilation. Do not switch on stationary climate control in enclosed areas or areas with insufficient ventilation, e.g. in enclosed garages.

Warning

When stationary climate control is in operation, high temperatures can occur underneath the body, for instance caused by the exhaust gas system. If combustible materials, such as leaves or grass, come in contact with hot parts of the exhaust gas system, these materials can ignite. There is a risk of fire. Make sure that no combustible materials can come in contact with hot vehicle parts during stationary climate control operation, e.g. leaves, grass, gas, gasoline, oil or other combustible objects.

Functional requirements

- ▶ The vehicle is in idle state or standby state and not in drive-ready state.
- ▶ Battery is sufficiently charged.
- ▶ For reasons of safety, the system can only be switched on twice consecutively. The system will be available again as soon as the drive-ready state is activated and deactivated again.
- ▶ The fuel tank capacity is sufficient.
- ▶ Hood is closed.
- ▶ Make sure that the vehicle's date and time are set correctly.
- ▶ Open the vents to allow air to flow out.

Enabling the automatic engine start function

The automatic engine start must be enabled before using the system.

Otherwise, the engine cannot switch on automatically to climatize the car's interior.

Via iDrive:

1. "CAR"
2. "Settings"
3. "Climate control"
4. "Preconditioning/ventilation"
5. If necessary, "Remote Engine Start"
6. "Starting engine for clim. control"
7. Confirm the disclaimer.

Confirmation signals from the vehicle

The activation of the system is confirmed by flashing twice.

The parking lights are switched on as long as the system is switched on.

Opening the Climate menu

 Press the button on the upper side.

The Climate comfort menu is displayed.

Individual settings can be entered for some of the climate control functions.

Switching on/off directly

General information

There are different ways to switch the system on or off:

- ▶ Via iDrive.
- ▶ With the vehicle key.
- ▶ Via BMW display key.

The system can also be switched off directly as follows: pressing the Start/Stop button, without operating the brake pedal.

The system switches off automatically after approx. 15 minutes.

For reasons of safety, the system can only be switched on twice consecutively. The system will be available again as soon as the drive-ready state is activated and deactivated again.

Via iDrive

1. "CAR"
2. "Settings"
3. "Climate control"
4. "Preconditioning/ventilation"
5. "Start now"

Via vehicle key

The system can be switched on and off using the vehicle key.

 Press the button on the vehicle key three times within 1 second.

After operating the vehicle key, it will take approximately 3 seconds until the engine is switched on.

To switch off the system, press the button again three times.

Via BMW display key

Switching on:

1. Switch on the display of the BMW display key.
2. "Preconditioning setting"
3.  Tap on the symbol.
4. "Activate now"
5. "Start"

Switching off:

1. Switch on the display of the BMW display key.
2. "Preconditioning setting"
3.  Tap on the symbol.
4. "Stop"

Display

Symbol	Description
	Symbol on the BMW display key for automatic climate control. The symbol flashes while Remote Engine Start is running.

Climatization for the requested departure time

General information

Scheduled departure times can be set up in the system to ensure a comfortable interior temperature in the vehicle at the time of departure.

- ▶ One-time departure time: the time of the scheduled departure can be set.
The system is switched on once.
- ▶ Departure time with weekday: time and day of the week of the scheduled departure can be set.

The departure time is preselected in two steps:

- ▶ Set departure times.
- ▶ Activate departure times.

The climate control function will start approximately 10 minutes before the set departure time and continue for approximately 5 more minutes after the departure time.

A minimum of 10 minutes should pass between setting/activating the departure time and the planned departure time to allow a sufficient period of time for the climate control.

For reasons of safety, the system can only be switched on once. The system will be available again as soon as the drive-ready state is activated and deactivated again.

Observe the information about the intended use of the vehicle, refer to page 8.

Setting the departure time

Via iDrive

1. "CAR"
2. "Settings"
3. "Climate control"
4. "Preconditioning/ventilation"
5. Select the desired departure time.
6. Set the departure time.
7. Select day of the week, if needed.

Via BMW display key



1. Switch on the display of the BMW display key.
2. "Preconditioning setting"
3.  Tap on the symbol.
4. Select the desired departure time.
5. Set the departure time.
6. Select day of the week, if needed.
7. "OK"

Activating the departure time





Functional requirement

If a requested departure time is to influence the switching on of the system, the respective departure time must be activated first.

Via iDrive

1. "CAR"
 2. "Settings"
 3. "Climate control"
 4. "Preconditioning/ventilation"
 5. Activate the desired departure time.
-  ,  The symbol on the automatic climate control signals an activated departure time

Via BMW display key

1. Switch on the display of the BMW display key.
 2. "Preconditioning setting"
 3.  Tap on the symbol.
 4. Activating the desired departure time:
 -  Tap on the symbol.
-   The symbol on the automatic climate control signals an activated departure time.

Display in the instrument cluster

Symbol	Description
	The engine runs for the purpose of operating the stationary climate control. The vehicle is not ready to drive.

Ambient air package

Concept

The Ambient Air Package can be used to clean and scent the interior air with high-quality fragrances.

Ionization is used to clean the air from suspended particles. Together with the selected fragrance, ionization contributes to well-being and relaxation while driving.

General information

Two different fragrances can be selected in the vehicle. A variety of other fragrances is possible by replacing the fragrance cartridges.

The following criteria can influence the perception of scents in the car's interior:

- ▷ Automatic climate control settings.
- ▷ Temperature and air humidity.
- ▷ Time of day and season.

- ▷ Physical condition of the vehicle occupants, for instance fatigue.

BMW recommends the use of genuine BMW fragrance cartridges.

The genuine BMW fragrance cartridges are not suitable for refilling. When a cartridge is empty, replace it with a new fragrance cartridge.

Safety information

Warning

Refilled genuine BMW fragrance cartridges can cause the emission of harmful substances, malfunctions, and damage to the system. There is a risk of injury or risk of damage to property. Do not refill genuine fragrance cartridges. When a cartridge is empty, replace it with a new fragrance cartridge.

Opening the Climate menu

 Press the button on the upper side.

The Climate comfort menu is displayed.

Individual settings can be entered for some of the climate control functions.

Ionization

Concept

Ionization cleans the car's interior air of suspended particles.

Switching on/off

Via iDrive:

1. "CAR"
2. "Settings"
3. "Climate control"
4. "Air quality"
5. "Ionization"

Fragrancing

General information

Fragrancing is done at intervals in order to avoid a habituation effect.

Two fragrance cartridges in the vehicle allow switching between the fragrances.

The fragrance cartridges are located in the glove compartment.

To ensure a pleasant fragrance inside of the vehicle when starting the trip, fragrancing can occur prior to the trip. The system is automatically switched on with the parked-car ventilation if fragrancing was switched on at the end of the last trip.

Functional requirements

- ▷ The fragrance cartridges are sufficiently filled.
- ▷ The interior temperature is between 41 °F/+5 °C and 104 °F/+40 °C.
- ▷ Open the vents to allow the fragrance to flow out.

Selecting the fragrance

The car's interior is fragranced depending on the selected fragrance.

Two different fragrances can be selected in the vehicle.

Via iDrive:

1. "CAR"
2. "Settings"
3. "Climate control"
4. "Fragrance"
5. "Fragrance"
6. Select the desired fragrance.

The setting is stored for the driver profile currently used.

Switching fragrancing on/off, adjusting intensity

Via iDrive:

1. "CAR"
2. "Settings"
3. "Climate control"
4. "Fragrance"
5. "Fragrance"

Fragrancing is switched on or off.

6. "Level"
7. Select the desired setting.

Highest intensity at Level 3.

Display

The illustrations on the Control Display show the actual filling level of the fragrance cartridges.

Via iDrive:

1. "CAR"
2. "Settings"
3. "Climate control"
4. "Fragrance"

When an empty fragrance cartridge is indicated, the cartridge still contains a fluid carrying the fragrance. However, it is not sufficient for fragrancing.

When the fragrance cartridges are empty, a Check Control message is displayed once.

Inserting fragrance cartridges

The fragrance cartridges are located in the glove compartment.

1. Open the glove compartment, refer to page 308.
2. Press on the bottom of the cartridge holder.

The cartridge holder slides down.

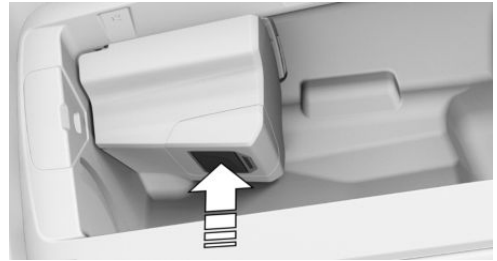

3. Remove the cover of the fragrance cartridge. Hold the cover on the top to slide it from the fragrance cartridge.



4. Insert the removed cover on the back side of the fragrance cartridge.

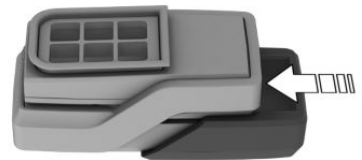

5. Position fragrance cartridge such that the chip faces away from the cartridge holder.

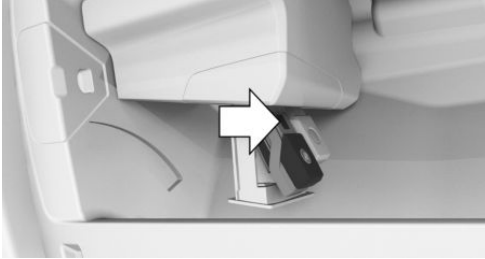

6. Insert the fragrance cartridge without pressure into the cartridge holder. The cartridge snaps lightly into place.

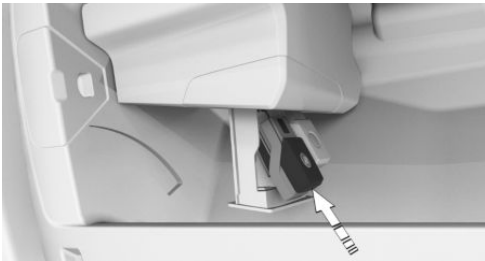

7. Push the cartridge holder up, until it engages. Make sure that no objects press against the cartridge holder from below, otherwise the function of the ambient air package could be impacted.
8. Close the glove compartment.

Removing the fragrance cartridge

The fragrance cartridges are located in the glove compartment.

1. Open the glove compartment, refer to page 308.
2. Press on the bottom of the cartridge holder.

The cartridge holder slides down.

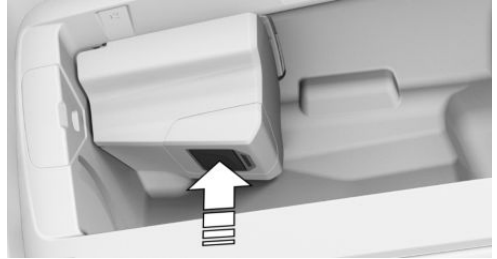

3. Pull desired fragrance cartridge from the holder.

Fragrance cartridge, arrow 1: first fragrance indicated on the Control Display.

Fragrance cartridge, arrow 2: second fragrance indicated on the Control Display.

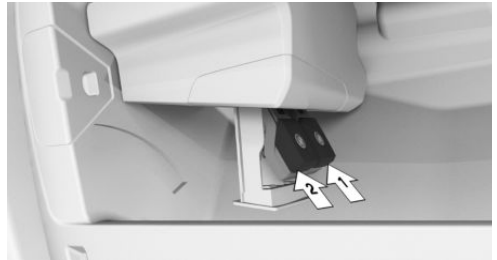

4. Pull desired fragrance cartridge from the holder.

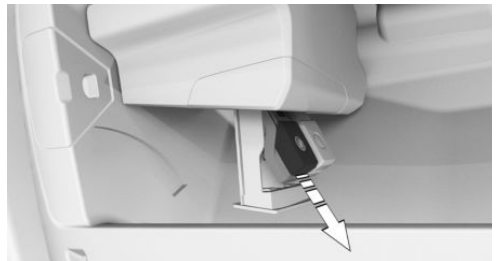

Recycling



Empty fragrance cartridges can be taken to a dealer's service center or another qualified service center or repair shop for recycling.

Interior equipment

Vehicle features and options

This chapter describes all standard, country-specific and optional features offered with the series. It also describes features and functions that are not necessarily available in your vehicle, e.g., due to the selected options or country versions. This also applies to safety-related functions and systems. When using these functions and systems, the applicable laws and regulations must be observed.

Integrated Universal Remote Control

Concept

The integrated Universal Remote Control in the interior mirror can operate up to 3 functions of remote-controlled systems such as garage door drives, barriers, or lighting systems.

General information

The Integrated Universal Remote Control replaces up to 3 different hand-held transmitters. To operate the remote control, the buttons on the interior mirror must be programmed with the desired functions. The hand-held transmitter for the particular system is required in order to program the remote control.

Before selling the vehicle, delete the stored functions for the sake of security.

If possible, do not install the antenna of the remote-controlled system, e.g. the garage door drive, near metal objects to ensure the best possible operation.

Safety information

Warning

The operation of remote-controlled systems with the integrated universal remote control, such as the garage door, may result in injury, for example, body parts becoming jammed in a garage door. There is a risk of injury or risk of damage to property. Make sure that the area of movement of the respective system is clear during programming and operation. Also follow the safety information of the hand-held transmitter.

Compatibility



If this symbol is printed on the packaging or in the owner's manual of the system to be controlled, the system is generally compatible with the integrated Universal Remote Control.

Additional questions are answered by:

- ▷ A dealer's service center or another qualified service center or repair shop.
- ▷ www.homelink.com on the Internet.

HomeLink is a registered trademark of Gentex Corporation.

Control elements on the interior mirror

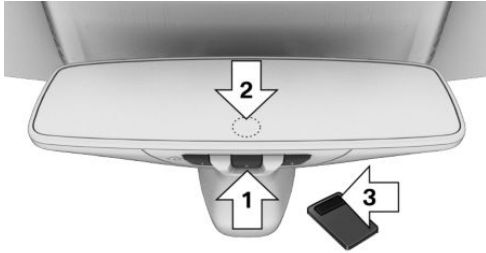

- ▶ Buttons, arrow 1.
- ▶ LED, arrow 2.
- ▶ The hand-held transmitter, arrow 3, is required for programming.

Programming

General information

The battery of the hand-held transmitter must be fully charged at the time of programming to ensure an optimal range of the integrated universal remote control.

1. Switch on standby state.
2. Initial setup:

Press and hold the two outer buttons on the interior mirror simultaneously for approximately 10 seconds until the LED flashes green rapidly. This erases all programming of the buttons on the interior mirror.
3. Press the interior mirror button to be programmed. The LED on the interior mirror will slowly begin flashing orange.
4. Hold the hand-held transmitter for the system to be used approx. 1 to 12 in/2.5 to 30 cm away from the buttons on the interior mirror. The required distance depends on the hand-held transmitter.
5. Press and hold the button of the desired function on the hand-held transmitter.

Canada: if programming with the hand-held transmitter was interrupted, hold down the interior mirror button and repeatedly press and release the hand-held transmitter button for 2 seconds.

6.
 - ▶ The LED lights up green: programming completed.

Release the button.
 - ▶ The LED flashes fast: programming is not complete.

Press the button on the interior mirror for 2 seconds and release. Perform this procedure three times to complete the programming procedure.

If the integrated universal remote control remains nonoperational, continue with the special features for change code wireless systems.
- ▶ LED does not flash green after 60 seconds: programming not completed.

Repeat steps 3 to 6.

To program other functions on other buttons, repeat steps 3 to 5.

Special feature of the rolling code wireless system

If you are unable to operate the remote-controlled system after repeated programming, please check if the system to be controlled features a rolling code radio system.

Refer to the owner's manual for the system.

For systems with a rolling code radio system, the integrated Universal Remote Control and the system also have to be synchronized.

Please read the owner's manual to find out how to synchronize the system.

Synchronizing is easier with the aid of a second person.

Synchronizing the universal remote control with the system:

1. Park the vehicle within range of the remote-controlled system.
2. Program the relevant button on the interior mirror as described.
3. Locate and press the synchronizing button on the system being programmed, e.g. at the garage gate. You have approx. 30 seconds for the next step.
4. Hold down the programmed button on the interior mirror for approximately 3 seconds and then release it. If necessary, repeat this step up to three times in order to finish synchronization. Once synchronization is complete, the programmed function will be carried out.

Reprogramming individual buttons

1. Switch on standby state.
2. Press and hold the interior mirror button to be programmed.
3. As soon as the LED on the interior mirror flashes orange after approx. 20 seconds, release the button.
4. Hold the hand-held transmitter for the system to be used approx. 1 to 12 in/2.5 to 30 cm away from the buttons on the interior mirror. The required distance depends on the hand-held transmitter.
5. Press and hold the button of the desired function on the hand-held transmitter.
Canada: if programming with the hand-held transmitter was interrupted, hold down the interior mirror button and repeatedly press and release the hand-held transmitter button for 2 seconds.
6. The LED can light up in different ways.
 - ▶ The LED lights up green: the programming procedure is completed.
Release the button.

- ▶ The LED flashes fast: the hand-held transmitter was detected but programming is not complete.

Press the button on the interior mirror for 2 seconds and release. Perform this procedure three times to complete the programming procedure.

If the integrated universal remote control remains nonoperational, continue with the special features for change code wireless systems.

- ▶ LED does not flash green after 60 seconds: programming not completed.
Repeat steps 3 to 6.

If the programming procedure is not completed, the previous programming will remain unchanged.

Operation

Warning

The operation of remote-controlled systems with the integrated universal remote control, such as the garage door, may result in injury, for example, body parts becoming jammed in a garage door. There is a risk of injury or risk of damage to property. Make sure that the area of movement of the respective system is clear during programming and operation. Also follow the safety information of the hand-held transmitter.

The system, such as the garage door, can be operated using the button on the interior mirror while the drive-ready or standby state is switched on. To do this, hold down the button within receiving range of the system until the function is activated. The interior mirror LED stays lit while the wireless signal is being transmitted.

Deleting stored functions

All stored functions will be deleted. The functions cannot be deleted individually.

Press and hold the two outer buttons on the interior mirror simultaneously for approximately 10 seconds until the LED on the interior mirror flashes green rapidly.

Sun visor

Glare shield

Fold the sun visor down or up.

Glare shield from the side

Folding out

1. Fold the sun visor down.
2. Unhook it from the holder and swing it to the side.
3. Move it back to the desired position.

Folding up

Proceed in the reverse order to close the sun visor.

Vanity mirror

A vanity mirror is located in the sun visor behind a cover. When the cover is opened, the mirror lighting switches on.

Ashtray

Front center console

Opening

1. Press onto the cover.



2. The ashtray is located in a cup holder. Fold the ashtray cover upward.



Emptying

1. Pull the ashtray with the closed cover out of the cup holder.



- Turn the lid counterclockwise to open it.



- Empty the container.

Always empty the ashtray with the container open to prevent contamination of the lid.

Cigarette lighter

Safety information

Warning

Contact with the hot heating element or the hot socket of the cigarette lighter can cause burns. Flammable materials can ignite if the cigarette lighter falls down or is held against the objects. There is a risk of fire and injuries. There is a risk of damage to property. Take hold of the cigarette lighter by its handle. Make sure that children do not use the cigarette lighter.

NOTICE

If metal objects fall into the socket, they can cause a short circuit. There is a risk of damage to property. Replace the cigarette lighter or socket cover again after using the socket.

Front center console



Press onto the cover.

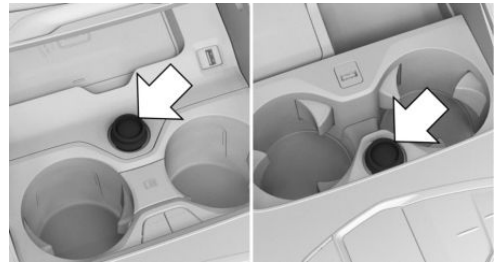

A cigarette lighter is located between the cup holders in one of the marked positions.

Rear center console

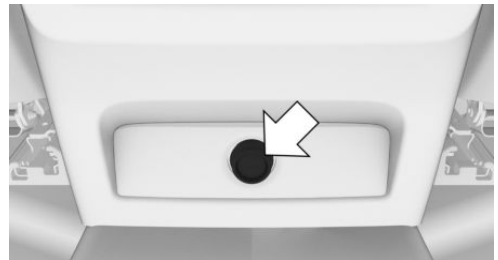

The cigarette lighter is located in the socket.

Operation



Push in the cigarette lighter. The cigarette lighter can be removed as soon as it pops back out.

Sockets

Concept

The lighter socket can be used as a socket for electrical equipment when standby and drive-ready state are switched on.

General information

The total load of all sockets must not exceed 140 watts at 12 volts.

Do not damage the socket by using non-compatible connectors.

Safety information

Warning

Devices and cables in the unfolding area of the airbags, such as portable navigation devices, can hinder the unfolding of the airbag or be thrown around in the car's interior during unfolding. There is a risk of injury. Make sure that devices and cables are not in the airbag's area of unfolding.

NOTICE

Battery chargers for the vehicle battery can work with high voltages and currents, which means that the 12 volt on-board network can be overloaded or damaged. There is a risk of damage to property. Only connect battery chargers for the vehicle battery to the starting aid terminals in the engine compartment.

NOTICE

If metal objects fall into the socket, they can cause a short circuit. There is a risk of damage to property. Replace the cigarette lighter or socket cover again after using the socket.

Front center console



Press onto the cover.

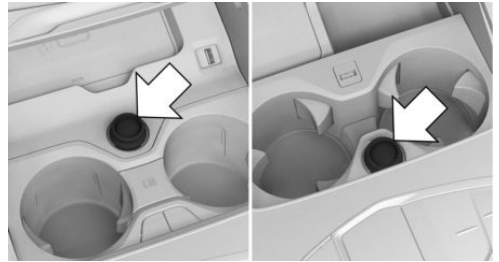

A socket is located between the cup holders in one of the marked positions.

Pull off the cover.

Rear center console

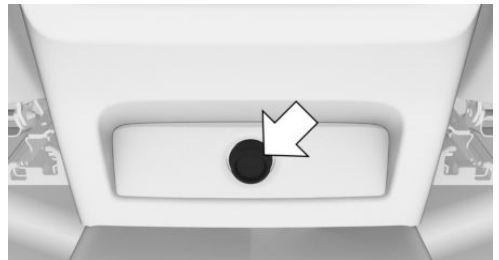

A socket is located in the center console.

Pull off the cover.

In the cargo area

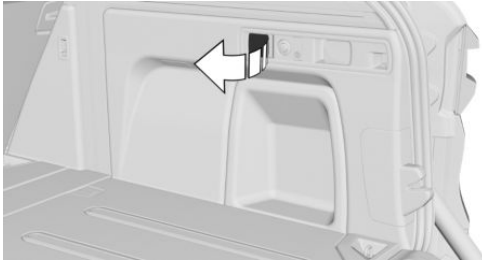

A socket is located on the right side in the cargo area. Unfold the cover.

USB interface

General information

Follow the information regarding the connection of mobile devices to the USB interface in the section on USB connections, refer to page 73.

In the center armrest



A USB interface is located in the center armrest.

Properties:

- ▷ USB port Type C.
- ▷ For charging mobile devices and for data transfer.
- ▷ Charge current: max. 3 A.

In the center console

⚠ NOTICE

Objects in the storage compartment, e.g., large USB connectors, may block or damage the cover when it is being opened or closed. There is a risk of damage to property. Make sure that the area of movement of the cover is clear while opening and closing it.



Press onto the cover.



A USB interface is located in the center console.

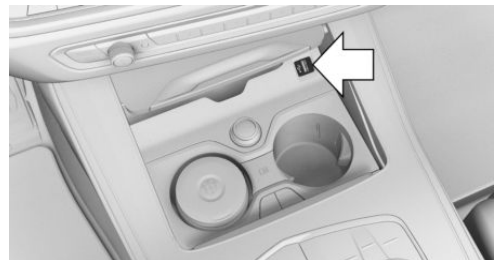

If the vehicle is equipped with thermo-cup holders, a USB interface is located in the center console.

Properties:

- ▷ USB port Type A.
- ▷ For charging mobile devices and for data transfer.
- ▷ Charge current: max. 1.5 A.

Wireless charging tray

Concept

The wireless charging tray enables the following functions to be performed without cables:

- ▷ Charging the rechargeable battery of a mobile phone with Qi capability and of other mobile devices, which support the Qi standard.
- ▷ Charging the BMW Display key.
- ▷ Connect the mobile phone to the external antenna.

Depending on the country, this provides for better network reception and a consistent reproduction quality.

General information

When inserting the mobile phone, make sure there are no objects between it and the wireless charging tray.

During charging, the surface of the tray and the mobile phone may become warm. Higher temperatures may lead to a reduction in the charge current through the mobile phone, and in isolated cases the charging process is paused temporarily. Follow the relevant instructions in the mobile phone owner's manual.

(⚡) The charge indicator shows on the Control Display whether a mobile phone with Qi capability is being charged.

NOTE

This device has been tested for human exposure limits and found compliant at a minimum distance of 2 in/5 cm during operation.

Therefore, a distance of 4 in/10 cm must be maintained in every direction when operating the device.

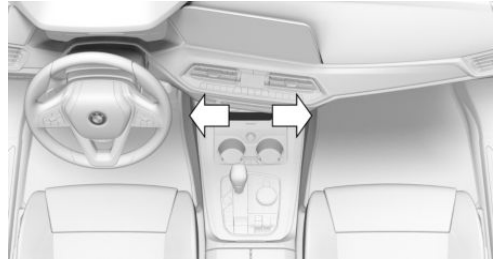

Mounting position of the product.

Safety information

Warning

When charging a device that meets the Qi standard in the wireless charging tray, any metal objects located between the device and the tray can become very hot. Placing storage devices or electronic cards, such as chip cards, cards with magnetic strips or cards for signal transmission, between the device and the tray may impair the card function. There is a risk of injury and risk of damage to property. When charging mobile devices, make sure there are no objects between the device and the tray.

NOTICE

The tray is intended for mobile phones up to a particular size. Forceful inserting of the mobile phone into the tray can damage the tray or the mobile phone. There is a risk of damage to property. Observe the maximum dimensions for mobile phones. Do not force the mobile phone into the tray.

Functional requirements

- ▷ The mobile phone must compatibly support the required Qi standard.

If the mobile phone does not support the Qi standard, the mobile phone can be charged using a special Qi-compatible charging case.

- ▶ Standby state is switched on.
- ▶ Observe the maximum dimensions of the mobile phone.
- ▶ Use only protective jackets and covers up to a maximum thickness of 0.07 in/2 mm; otherwise, the charging function may be impaired.
- ▶ The mobile phone to be charged is located in the center of the tray.

Operation

Overview

Transversely installed tray.

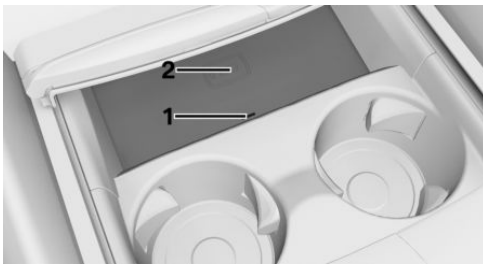

- 1 LED
- 2 Storage area

Tray on the left side.

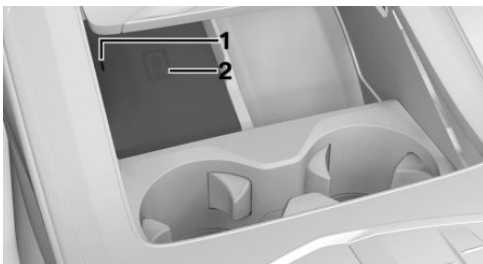

- 1 LED
- 2 Storage area

Inserting the mobile phone

The mobile phone must not exceed the maximum size of approximately 6.0 x 3.1 x 0.7 in/154.5 x 80 x 18 mm.

1. Open the tray cover.
2. Place the mobile phone centered in the tray with the display facing up.
3. Close the tray cover.

Removing the mobile phone

1. Open the tray cover.
2. Remove the mobile phone.

LED displays

Color	Meaning
Blue	The mobile phone is charging. The blue LED stays illuminated once the inserted mobile phone with Qi capability is fully charged.
Orange	The mobile phone is not charging. Temperature on the mobile phone possibly too high or foreign object in charging tray.
Red	The mobile phone is not charging. Contact a dealer's service center or another qualified service center or repair shop.

Forgotten warning

General information

If the vehicle is equipped with the forgotten warning function, a warning can be output if a mobile phone with Qi capability was forgotten in the wireless charging tray when leaving the vehicle.

The forgotten warning is displayed in the instrument cluster.

Activating

Via iDrive:

1. "CAR"
2. "Settings"
3. "General settings"
4. "Wireless charging tray"
5. Activate reminder.

System limits

At high temperatures on the mobile phone or in the vehicle, the charging functions of the mobile phone may be limited and some functions may no longer work.

LTE-Compensator - Information and User Manual

Your car is equipped with a wireless charging tray (WCA) to charge your mobile phone and connect it to the mobile network. To ensure the best possible connection a signal booster (LTE-Compensator) is used in conjunction with the WCA. The following paragraphs refer to this booster:

This is a CONSUMER device.

BEFORE USE, you MUST REGISTER THIS DEVICE with your wireless provider and have your provider's consent. Most wireless providers consent to the use of Compensators. Some providers may not consent to the use of this device on their network. If you are unsure, contact your provider. You MUST operate this device with approved antennas and cables as specified by the manufacturer. Antennas MUST be installed at least 20 cm (8 inches) from any person. You MUST cease operating this device immediately if requested by the FCC or a licensed wireless service provider. Warning E911 location information may not be provided or may be inaccurate for calls served by using this device.

Please observe additionally the following information

- ▶ Sprint Nextel will allow consumers to register their signal boosters by calling their toll-free number.
- ▶ T-Mobile online registration link: (www.T-Mobile.com/BoosterRegistration); (<https://saqat.t-mobile.com/sites/SignalBooster#>).
- ▶ Verizon's online registration link: (<http://www.verizonwireless.com/wcms/consumer/register-signal-booster.html>).
- ▶ AT&T online registration link (<https://securec45.securewebsession.com/attsignal-booster.com/>).
- ▶ U.S.Cellular online registration link (<http://www.uscellular.com/uscellular/support/fcc-booster-registration.jsp>).

Before use you must register your booster device with your wireless provider.

If you should be requested by the FCC to cease operating your booster you are not allowed to insert your mobile phone in the charging tray anymore unless the booster is permanently deactivated by your local BMW dealer.

You must not remove the booster from the car nor use it with any other than the preinstalled coupling device or antenna. Any modification of the existing antenna or coupling device as well as the use of other antennas or coupling devices will cause the cease of the booster's operating license.

The booster device fulfills the network protection standards as required by the FCC, such as inter-modulation limits, oscillation detection and gain limits.

Booster Manufacturer: Kathrein Automotive

Model Number: LTECOMPB0

Part Number: 6803145-01

FCC-ID: 2ACC7LTECOMPB0

BMW Travel & Comfort System

General information

USB interfaces and fixtures for attaching special accessories, for instance coat hangers, are located on the backrests of the front seats.

Features of the USB interfaces:

- ▶ USB port Type C.
- ▶ For charging of mobile devices.
- ▶ Charge current: max. 3 A.

Further information is available from a dealer's service center or another qualified service center or repair shop.

Overview



The fixtures are located behind the marked covers.

Installing special accessories

1. Slide the cover to the side.

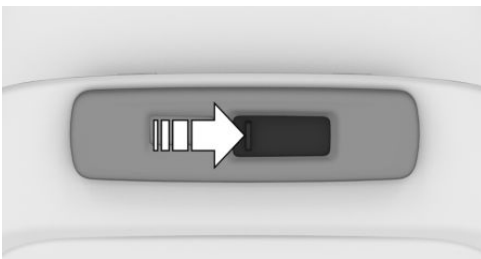

2. Install the special accessories, refer to Installation Instructions.

Storage compartments

Vehicle features and options

This chapter describes all standard, country-specific and optional features offered with the series. It also describes features and functions that are not necessarily available in your vehicle, e.g., due to the selected options or country versions. This also applies to safety-related functions and systems. When using these functions and systems, the applicable laws and regulations must be observed.

Storage compartments

General information

The vehicle interior contains multiple storage compartments for stowing objects.

Safety information

Warning

Loose objects or devices with a cable connection to the vehicle, for instance mobile phones, can be thrown about the car's interior while driving, for instance in the event of an accident, braking or evasive maneuver. There is a risk of injury. Secure loose objects or devices with a cable connection to the vehicle in the car's interior.

NOTICE

Anti-slip pads such as anti-slip mats can damage the dashboard. There is a risk of damage to property. Do not use anti-slip pads.

Front passenger side glove compartment

Safety information

Warning

Folded open, the glove compartment protrudes in the car's interior. Objects in the glove compartment can be thrown into the car's interior while driving, for instance in the event of an accident or during braking and evasive maneuvers. There is a risk of injury. Always close the glove compartment immediately after using it.

Opening



Pull the handle.

The light in the glove compartment switches on.

Closing

Fold cover closed.

Locking

The glove compartment can be locked with an integrated key. This prevents access to the glove compartment.

After the glove compartment is locked, the vehicle key can be handed over without the

integrated key, for instance when the vehicle is parked by valet parking.

Driver's side glove compartment

Safety information

Warning

Folded open, the glove compartment protrudes in the car's interior. Objects in the glove compartment can be thrown into the car's interior while driving, for instance in the event of an accident or during braking and evasive maneuvers. There is a risk of injury. Always close the glove compartment immediately after using it.

Opening



Pull the handle.

Closing

Fold cover closed.

Compartments in the doors

General information

There are storage compartments in the doors.

Safety information

Warning

Breakable objects, such as glass bottles or glasses, can break in the event of an accident or a braking or evasive maneuver. Broken glass can be scattered in the car's interior. There is a risk of injury or risk of damage to property. Do not use any breakable objects while driving. Only stow breakable objects in closed storage compartments.

Storage compartment in the center console

Opening



Press onto the cover.

Closing

Pull the cover on the handle bar back.

Storage compartment in the rear center console

The back of the center console contains one or two storage compartments.

Center armrest, front

General information

A storage compartment is located in the center armrest between the seats.

Opening



Press the button.

Closing

Press cover down until it engages.

Rear center armrest

General information

A storage compartment is located in the center armrest between the seats.

Folding down

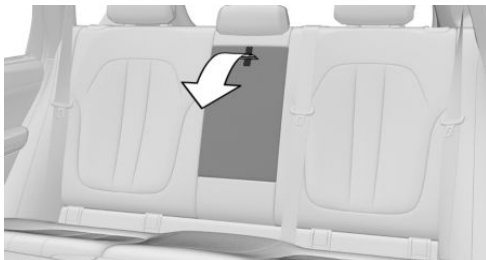

Fold the center armrest forward.

Opening

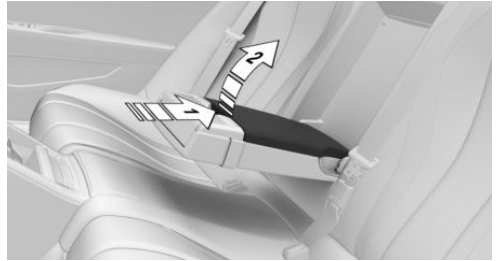

Press the button, arrow 1, and fold the cover up, arrow 2.

Closing

Press cover down until it engages.

Front cup holder

Safety information

Warning

Unsuitable containers in the cup holders may damage the cup holders or be thrown about the car's interior in the event of an accident, an evasive maneuver, or forceful braking. Spilled liquids can distract from the traffic conditions and lead to an accident. Hot drinks can damage the cup holder or lead to scalding. There is a risk of injury or risk of damage to property. Do not force objects into the cup holder. Use lightweight, shatterproof, and sealable containers. Do not transport hot beverages.

Opening



Press onto the cover.



Two cup holders are located in the center console.

Closing

Pull the cover on the handle bar back.

Maintaining the drink temperature

General information

When equipped with thermo-cup holder, drinks can be kept cool or warm.

Safety information

Warning

Contact with the hot metal insert of the thermo-cup holder can cause burn injuries. There is a risk of injury. Do not touch the metal insert when the thermo-cup holder is switched on.

NOTICE

When the thermo-cup holder is switched on and the cover is closed, the thermo-cup holder can overheat. There is a risk of damage to property. Switch the thermo-cup holder off before closing the cover.

NOTICE

Temperature sensitive items may be damaged by the hot metal insert of the thermo-cup holder. There is a risk of damage to property. Use suitable containers only.

Switching on



Press the button for keeping cool or warm once each.

- ▷ Blue LED lights up: keep drinks cool.
- ▷ Red LED lights up: keep drinks warm.

Switching off



Press the button repeatedly until the LEDs go out.

Rear cup holder

Safety information

Warning

Unsuitable containers in the cup holders may damage the cup holders or be thrown about the car's interior in the event of an accident, an evasive maneuver, or forceful braking. Spilled liquids can distract from the traffic conditions and lead to an accident. Hot drinks can damage the cup holder or lead to scalding. There is a risk of injury or risk of damage to property. Do not force objects into the cup holder. Use light-

weight, shatterproof, and sealable containers. Do not transport hot beverages.

NOTICE

With an open cup holder, the center armrest cannot be folded back up. There is a risk of damage to property. Press back the covers before the center armrest is folded up.

Second row of seats

General information

The cup holder can be adjusted for three different container sizes.

Opening

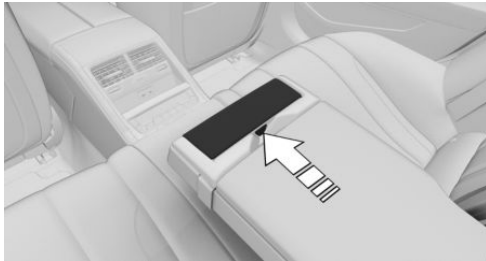

Fold the center armrest forward.

Press the button and fold out the cup holder fully.

Reducing the size

To make it smaller, the cup holder can be folded in in 2 steps.

Enlarging

To make a smaller cup holder bigger, first fold it in completely. Then fold the cup holder out again fully.

Closing

Fold in the cup holder fully, until it engages.

Third row of seats



The cup holders are located between the seats of the third row of seats.

Clothes hooks

General information

The clothes hooks are located in the grab handles in the rear and on the door pillar in the rear.

Safety information

Warning

Clothing articles on the clothes hooks can obstruct the view while driving. There is a risk of accident. When suspending clothing articles from the clothes hooks, ensure that they will not obstruct the driver's view.

Warning

Improper use of the clothes hooks can lead to a risk of objects flying about during braking and evasive maneuvers. There is a risk of injury and risk of damage to property. Only hang light-weight objects, for instance clothing articles, from the clothes hooks.

Cargo area

Vehicle features and options

This chapter describes all standard, country-specific and optional features offered with the series. It also describes features and functions that are not necessarily available in your vehicle, e.g., due to the selected options or country versions. This also applies to safety-related functions and systems. When using these functions and systems, the applicable laws and regulations must be observed.

Loading

Safety information

Warning

High gross weight can overheat the tires, damage them internally and cause a sudden drop in tire inflation pressure. Driving characteristics may be negatively impacted, reducing lane stability, lengthening the braking distances and changing the steering response. There is a risk of accident. Pay attention to the permitted load capacity of the tires and never exceed the permitted gross weight.

Warning

Loose objects or devices with a cable connection to the vehicle, for instance mobile phones, can be thrown about the car's interior while driving, for instance in the event of an accident, braking or evasive maneuver. There is a risk of injury. Secure loose objects or devices with a cable connection to the vehicle in the car's interior.

Warning

Improperly stowed objects can shift and be thrown into the car's interior, for instance in the event of an accident or during braking and evasive maneuver. Vehicle occupants can be hit and injured. There is a risk of injury. Stow and secure objects and cargo properly.

NOTICE

Fluids in the cargo area can cause damage. There is a risk of damage to property. Make sure that no fluids leak in the cargo area.

Steps for Determining Correct Load Limit

1. Locate the statement "The combined weight of occupants and cargo should never exceed XXX kg or XXX lbs" on your vehicle's placard.
2. Determine the combined weight of the driver and passengers that will be riding in your vehicle.
3. Subtract the combined weight of the driver and passengers from XXX kg or XXX lbs
4. The resulting figure equals the available amount of cargo and luggage load capacity. For example, if the "XXX" amount equals 1,400 lbs and there will be five 150 lbs passengers in your vehicle, the amount of available cargo and luggage load capacity is 650 lbs (1,400 - 750 (5 x 150) = 650 lbs)
5. Determine the combined weight of luggage and cargo being loaded on the vehicle. That weight may not safely exceed the available cargo and luggage load capacity calculated in Step 4.
6. If your vehicle will be towing a trailer, load from your trailer will be transferred to your ve-

hicle. Consult this manual to determine how this reduces the available cargo and luggage load capacity of your vehicle.

Load

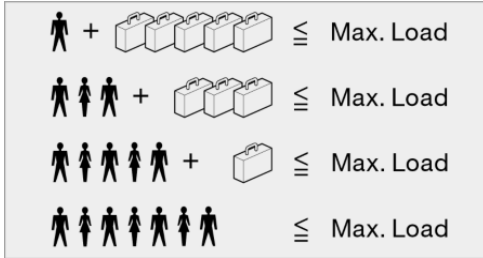

The maximum load is the sum of the weight of the occupants and the cargo.

The greater the weight of the occupants, the less cargo that can be transported.

Stowing and securing cargo

- ▷ Cover sharp edges and corners on the cargo.
- ▷ Heavy cargo: stow as far forward as possible, directly behind and at the bottom of the rear passenger seat backrests.
- ▷ Very heavy cargo: stow as far forward as possible, directly behind and at the bottom of the rear passenger seat backrests. When the rear seat is not occupied, secure each of the outer safety belts in the opposite buckle.
- ▷ If necessary, fold down the rear backrests to stow large cargo.
- ▷ Do not stack cargo above the top edge of the backrests.
- ▷ Use the cargo area partition net to protect occupants. Make sure that objects cannot penetrate the cargo area partition net.
- ▷ Smaller and lighter cargo: secure with ratchet straps or with a cargo net or draw straps.
- ▷ Larger and heavy cargo: secure with cargo straps.

Lashing eyes in the cargo area

General information

Attach load securing aids, such as lashing straps, tensioning straps, draw straps or cargo nets, to the lashing eyes in the cargo area.

Lashing eyes

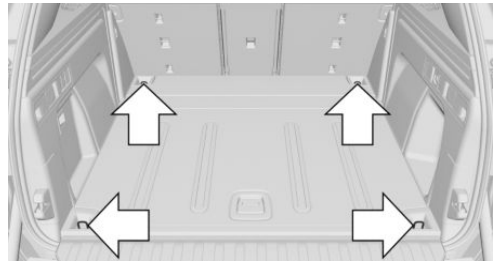

There are four lashing eyes in the cargo area for securing cargo.

The front lashing eyes are located under covers.

Anti-slip rails

Concept

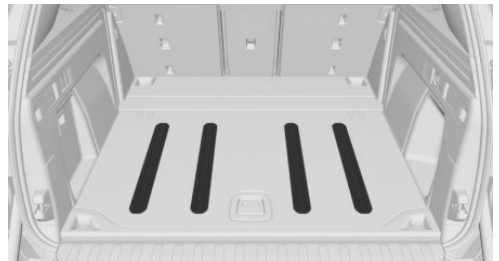

The system prevents slipping of the cargo in the cargo area.

General information

Observe information and notes on loading, refer to page 313.

The system will be activated automatically when one of the following conditions is met:

- ▷ Tailgate is closed.
- ▷ Inclination of the vehicle by more than approximately 13 %.

Multi-function hook

General information

A multi-function hook is located on the left and right side in the cargo area.

Safety information

Warning

Improper use of the multi-function hooks can lead to a risk of objects flying about during braking and evasive maneuvers, for example. There is a risk of injury and risk of damage to property. Only hang lightweight objects, such as shopping bags, from the multi-function hooks. Only transport heavy luggage in the cargo area if it has been appropriately secured.

Folding down

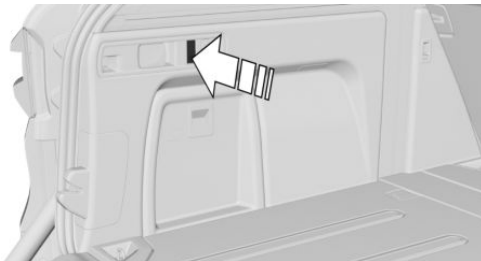

Press on the multi-function hook and turn until it engages.

Net

Small objects can be stowed in the net on the right side.

Storage compartment on the left side

General information

A storage compartment is located on the left side in the cargo area.

Opening

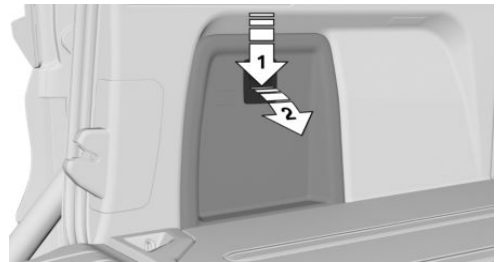

Press the button, arrow 1, and open the cover, arrow 2.

Storage compartments under the cargo floor panel

General information

There are storage compartments beneath the cargo floor panel.

Opening

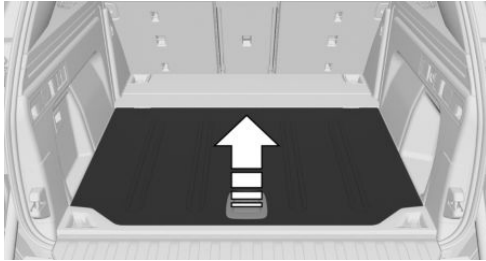

Fold up the cargo floor panel.

Closing

Push the cargo floor panel downward.

Enlarging the cargo area

Concept

The cargo area can be enlarged by folding down the rear seat backrests.

General information

The rear seat backrest of the second seat row is divided at a ratio of 40–20–40. The side rear seat backrests and the center section can be folded down separately.

The rear seat backrests can be folded down from the rear or from the cargo area.

Depending on the equipment version, the rear seat backrests can be folded down either manually or electrically.

Safety information

Warning

Danger of jamming with folding down the backrests. There is a risk of injury or risk of damage to property. Make sure that the area of movement of the rear backrest and the of the head restraint is clear prior to folding down.

Warning

If a rear seat backrest is not locked, unsecured cargo can be thrown about the car's interior; for instance, in the event of an accident, braking or an evasive maneuver. There is a risk of injury. Make sure that the rear seat backrest is locked after folding it back.

Warning

The stability of the child restraint system is limited or compromised with incorrect seat adjustment or improper installation of the child seat. There is a risk of injuries or danger to life. Make sure that the child restraint system fits securely against the backrest. If possible, adjust the backrest tilt for all affected backrests and correctly adjust the seats. Make sure that seats and backrests are securely engaged or locked. If possible, adjust the height of the head restraints or remove them.

Warning

Once the rear seat backrest has been folded down, the locking bracket protrudes into the car's interior. There is a risk of damage to property. When the rear seat backrest is folded down, pay attention to the protruding locking bracket and keep this area unobstructed.

NOTICE

Vehicle parts can be damaged when folding down the rear backrest. There is a risk of damage to property. Make sure that the area of movement of the rear backrest including head restraint is clear when folding down.

Manual reclining of the backrest

From the rear



Pull the lever and fold the rear seat backrest forward.

From the cargo area

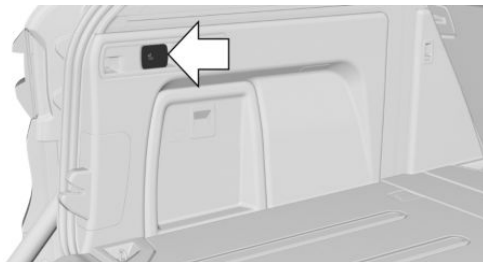

Pull the corresponding lever in the cargo area to release the rear seat backrest.

- ▶ Left lever: fold down the left and middle rear seat backrest.
- ▶ Right lever: fold down the right rear seat backrest.

Folding back the backrest

Return the rear seat backrest to the upright seating position and engage it. The red marking behind the lever disappears completely.

Electric reclining of the backrest

From the rear

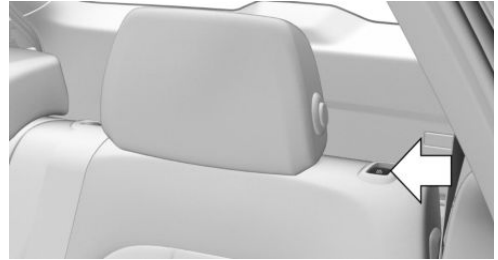

Pull the switch and fold the rear seat backrest forward.

From the cargo area

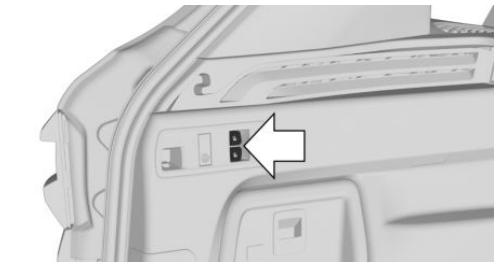

Press the switch in the cargo area.

- ▶ Upper switch: the left and center rear seat backrests fold forward.
- ▶ Lower switch: the right rear seat backrest folds forward.

Folding back the backrest

From the rear

Press the corresponding switch. The rear seat backrest sets itself upright.

From the cargo area

Pull the corresponding switch. The rear seat backrest sets itself upright.

Folding down the center section



Fold down the center armrest and pull on the strap.

Cargo cover

Safety information

Warning

Loose objects or devices with a cable connection to the vehicle, for instance mobile phones, can be thrown about the car's interior while driving, for instance in the event of an accident, braking or evasive maneuver. There is a risk of injury. Secure loose objects or devices with a cable connection to the vehicle in the car's interior.

Warning

A cargo cover that snaps back quickly can jam body parts or cause damage. There is a risk of injury or risk of damage to property. Do not let the cargo cover snap back into place.

Warning

An incorrectly inserted cargo cover can be thrown about the car's interior, such as in the event of an accident or a braking or evasive maneuver. There is a risk of injury and risk of dam-

age to property. Make sure the cargo cover is securely engaged in the brackets.

Closing

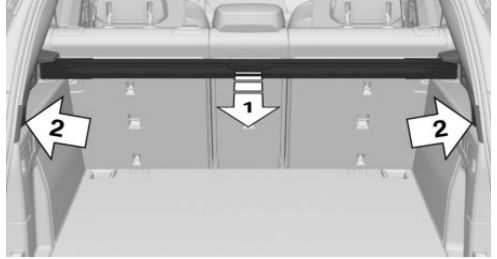

Pull out the cargo cover, arrow 1, and hook both sides into the brackets, arrow 2.

Removing

The cover can be removed to load bulky luggage.

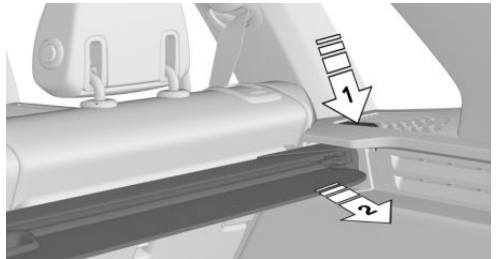

Press the release button, arrow 1, and pull the cargo cover out toward the rear, arrow 2.

Stowing

General information

The cargo cover can be stowed in the storage compartment under the cargo floor panel.

Without third seat row

1. Open the left side storage compartment, refer to page 315.
2. Fold up the cargo floor panel.

- Turn the cargo cover forward with the handle.
- Stow the cargo cover on the left and lower it on the right side.

Make sure the cargo cover is positioned correctly in the right bracket.



- Push the cargo floor down and close the storage compartment on the left side.

With third seat row

- Open the left side storage compartment, refer to page 315.
- Fold up the cargo floor panel.
- Stow the cargo cover on the left and lower it on the right side.

Make sure the cargo cover is positioned correctly in the right bracket.

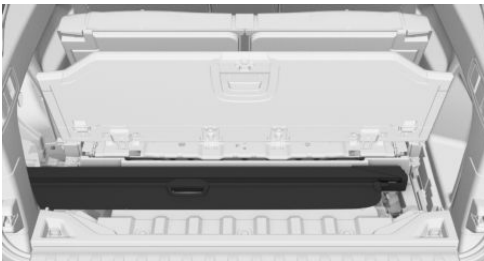

- Push the cargo floor down and close the storage compartment on the left side.

Installing

Slide the cover forward horizontally into the two side brackets. Make sure that the cover audibly engages on both sides.

Electric cargo cover

Concept

The electric cargo cover opens and closes automatically with the tailgate. The cargo cover can be lowered below the cargo floor panel to stow bulky items or luggage.

General information

Items in the range of movement are detected. The cargo cover stops automatically to prevent damage.

Safety information

Warning

Loose objects or devices with a cable connection to the vehicle, for instance mobile phones, can be thrown about the car's interior while driving, for instance in the event of an accident, braking or evasive maneuver. There is a risk of injury. Secure loose objects or devices with a cable connection to the vehicle in the car's interior.

Warning

Pinching of body parts may occur during operation of the electric cargo cover. Items in the range of movement may damage the cargo cover. There is a risk of injury or risk of damage to property. Make sure that the area of movement of the electric cargo cover is clear during opening and closing. In addition, make sure that the area of movement of the cover in the cargo floor is clear during lowering.

NOTICE

Items on the storage shelf may damage it. There is a risk of damage to property. Do not deposit any objects on the cargo cover.

NOTICE

The manual operation of the electric cargo cover by hand may damage the cover. There is a risk of damage to property. Use the buttons in the cargo area for operation.

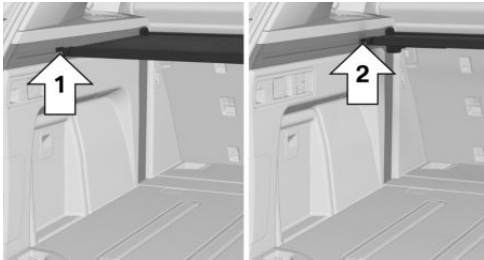
Overview**Positions of the cargo cover**

- ▷ Automatic position, arrow 1.
- ▷ Base position, arrow 2.

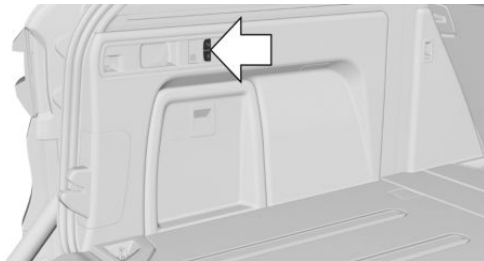
Buttons in the vehicle

The buttons of the cargo cover are located in the cargo area on the left side.

 Switching between automatic and base position.

 Lowering or raising the cargo cover.

Opening the cargo cover

When the tailgate is opened, the cargo cover is opened up to the automatic position.

To open the cargo cover completely up to the base position:

 Press the button.

Closing the cargo cover

 Press the button.

The cargo cover will be closed up to the automatic position.

When the tailgate is closed, the cargo cover will be closed completely.

The cargo cover will not be closed automatically when it is in the base position while the tailgate is closing.

Lowering the cargo cover

The cargo cover can be lowered to stow bulky luggage.

 Press the button.

The cargo cover is lowered below the cargo floor panel.

Raising the cargo cover

▷  Press the button.
The cargo cover is raised to the base position.

▷  Press the button.
The cargo cover is raised to the base position and closes up to the automatic position.

Malfunctions

- ▷ If the closing force exceeds a certain value when closing the cargo cover, for example due to items in the range of motion, the cover

will disengage from the mounting. The cargo cover stops in the guide rail.

Press and hold the button to restart the initialization.

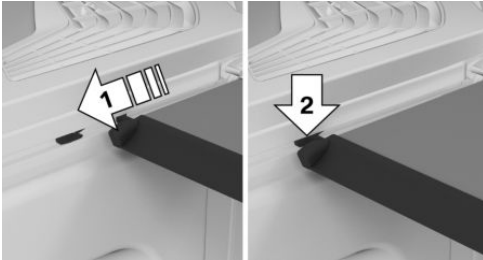

To restore the functionality, close the cargo cover by hand, arrow 1, until it engages in the mounting, arrow 2.

- ▶ Excessive or insufficient ambient temperatures may lead to the deactivation of the cargo cover. When the temperature is within normal range again, such as by switching on the air conditioner, the function will be restored.
- ▶ The function will be deactivated when the system can no longer detect the position of the cargo cover. An initialization is required, refer to page 321.

Initializing

Functional requirements

- ▶ Vehicle is parked in a horizontal position.
- ▶ Drive-ready state is activated.
- ▶ The area of movement of the cargo cover is clear.
- ▶ External temperature is above 41 °F/5 °C.

Initializing the system



Press and hold the button until the initialization is finished.

The cargo cover moves to the different positions. The initialization is finished when a signal sounds.

If the button is released prematurely, the cargo cover will stop. The initialization is terminated.

Things to remember when driving

Vehicle features and options

This chapter describes all standard, country-specific and optional features offered with the series. It also describes features and functions that are not necessarily available in your vehicle, e.g., due to the selected options or country versions. This also applies to safety-related functions and systems. When using these functions and systems, the applicable laws and regulations must be observed.

Breaking-in period

General information

Moving parts need to begin working together smoothly.

The following instructions will help you to achieve a long vehicle life and good efficiency.

During break-in, do not use the Launch Control.

Safety information

Warning

Due to new parts and components, safety and driver assistance systems can react with a delay. There is a risk of accident. After installing new parts or with a new vehicle, drive conservatively and intervene early if necessary. Observe the break-in procedures of the respective parts and components.

Engine, transmission, and axle drive

Up to 1,200 miles/2,000 km

Do not exceed the maximum engine and road speed:

- ▶ For gasoline engine 4,500 rpm and 100 mph/160 km/h.

Avoid full load or kickdown under all circumstances.

From 1,200 miles/2,000 km

The engine and vehicle speed can gradually be increased.

Tires

Tire traction is not optimal due to manufacturing circumstances when tires are brand-new; they achieve their full traction potential after a break-in time.

Drive conservatively for the first 200 miles/300 km.

Brake system

Brake discs and brake pads only reach their full effectiveness after approx. 300 miles/500 km. Drive moderately during this break-in period.

Following part replacement

Observe the break-in procedures again, if components mentioned above are replaced.

Driving on poor roads

Concept

Because of its greater ground clearance, the vehicle can be driven on a variety of road types and qualities.

All-wheel drive can help improve forward momentum.

Safety information

NOTICE

Objects in unpaved areas, for instance stones or branches, can damage the vehicle. There is a risk of damage to property. Do not drive on unpaved terrain.

When driving on poor roads

For your own safety, for the safety of passengers and of the vehicle, heed the following points:

- ▶ Familiarize yourself with the vehicle before driving.
- ▶ Do not take risks when driving.
- ▶ Adjust the speed to the road surface conditions. The steeper and more uneven the road surface, the slower the speed should be.
- ▶ When driving on steep uphill or downhill grades: add engine oil and coolant up to near the MAX mark.
- ▶ On steep downhill grades, use Hill Descent Control HDC.
- ▶ Avoid that the chassis bottom coming in contact with the ground.
The ground clearance is no more than 7.8 inches/20 cm and can vary according to the vehicle's load.
- ▶ When wheels continue to spin, depress the accelerator so that driving stability control systems can distribute the driving force to the wheels. Activate DTC Dynamic Traction Control if available.

After a trip on poor roads

After a trip on poor roads, check wheels and tires for damage to maintain driving safety. Clear heavy soiling from the body.

General driving notes

Closing the tailgate

Safety information

Warning

An open tailgate protrudes from the vehicle and can endanger occupants and other traffic participants or damage the vehicle in the event of an accident, braking or evasive maneuvers. In addition, exhaust fumes may enter the car's interior. There is a risk of injury or risk of damage to property. Do not drive with the tailgate open.

Driving with the tailgate open

If driving with the tailgate open cannot be avoided:

- ▶ Close all windows and the glass sunroof.
- ▶ Greatly increase the air flow from the vents.
- ▶ Drive moderately.

Hot exhaust gas system

Warning

High temperatures can occur underneath the body, for instance caused by the exhaust gas system, while driving. Contact with the exhaust gas system can cause burns. There is a risk of injury. Do not touch the hot exhaust gas system, including the exhaust pipe.

Warning

If combustible materials, such as leaves or grass, come in contact with hot parts of the exhaust gas system, these materials can ignite. There is a risk of fire and injuries. Do not remove the heat shields installed and never apply undercoating to them. Make sure that no combustible materials can come in contact with hot

vehicle parts in driving operation, idle or during parking.

Mobile communication devices in the vehicle

Warning

Vehicle electronics and mobile phones can influence one another. There is radiation due to the transmission operations of mobile phones. There is a risk of injury or risk of damage to property. If possible, in the car's interior use only mobile phones with direct connections to an exterior antenna in order to exclude mutual interference and deflect the radiation from the car's interior.

Hydroplaning

On wet or slushy roads, a wedge of water can form between the tires and road surface.

This phenomenon is referred to as hydroplaning. It is characterized by a partial or complete loss of contact between the tires and the road surface, ultimately undermining your ability to steer and brake the vehicle.

Driving through water

General information

When driving through water, follow the following:

- ▶ Drive through calm water only.
- ▶ Drive through water only if it is not deeper than maximum 19.6 inches/50 cm.
- ▶ Drive through water no faster than walking speed, up to 3 mph/5 km/h.

Safety information

NOTICE

When driving too quickly through too deep water, water can enter into the engine compartment, the electrical system or the transmission. There is a risk of damage to property. When driving through water, do not exceed the maximum indicated water level and the maximum speed for driving through water.

Braking safely

General information

The vehicle is equipped with the Antilock Brake System ABS as a standard feature.

Perform an emergency stop in situations that require such.

Steering is still responsive. You can still avoid any obstacles with a minimum of steering effort.

Pulsation of the brake pedal and sounds from the hydraulic circuits indicate that the Antilock Brake System ABS is in its active mode.

In certain braking situations, the perforated brake discs can emit functional noises. However, functional noises have no effect on the performance and operational reliability of the brake.

Objects in the area around the pedals

Warning

Objects in the driver's floor area can limit the pedal distance or block a depressed pedal. There is a risk of accident. Stow objects in the vehicle such that they are secured and cannot enter into the driver's floor area. Use floor mats that are suitable for the vehicle and can be safely attached to the floor. Do not use loose floor mats and do not layer several floor mats. Make sure that there is sufficient clearance for the pedals. Ensure that the floor mats are se-

curely fastened again after they were removed, for instance for cleaning.

Driving in wet conditions

When roads are wet, salted, or in heavy rain, gently press the brake pedal every few miles.

Ensure that this action does not endanger other traffic.

The heat generated during braking dries brake discs and brake pads and protects them against corrosion.

In this way braking efficiency will be available when you need it.

Hills

General information

Drive long or steep downhill gradients in the gear that requires least braking effort. Otherwise, the brakes may overheat and reduce brake efficiency.

You can increase the engine's braking effect by shifting down, going all the way to first gear, if needed.

Safety information

Warning

Light but consistent brake pressure can lead to high temperatures, brakes wearing out and possibly even brake failure. There is a risk of accident. Avoid placing excessive stress on the brake system.

Warning

In idle state or with the engine switched off, safety functions, for instance engine braking effect, braking assistance and steering assistance, may not be available. There is a risk of accident. Do not attempt to drive in idle state or with the engine switched off.

Brake disc corrosion

Corrosion on the brake discs and contamination on the brake pads are increased by the following circumstances:

- ▷ Low mileage.
- ▷ Extended periods when the vehicle is not used at all.
- ▷ Infrequent use of the brakes.
- ▷ Aggressive, acidic, or alkaline cleaning agents.

Corrosion buildup on the brake discs will cause a pulsating effect on the brakes in their response - generally this cannot be corrected.

Condensation water under the parked vehicle

When using the automatic climate control, condensation water develops and collects underneath the vehicle.

Flag bracket

Safety information

NOTICE

At high speeds, a mounted flag can cause damage to the vehicle, the flag bracket, and the flag itself. There is a risk of damage to property. Do not exceed a speed of 80 mph / 130 km/h. Remove flag before trips at high speeds.

Overview



The flag bracket is located on the side of the vehicle.

Mounting

1. Remove the protective cap.
2. Insert flag horizontally.
3. Turn the flag clockwise by 90° to lock the flag.

Roof-mounted luggage rack

General information

Installation only possible with roof rack.

Roof racks are available as special accessories.

Mounting

Follow the installation instructions of the roof rack.

Be sure that adequate clearance is maintained for tilting and opening the glass sunroof.

Loading

Because roof-mounted luggage racks raise the vehicle's center of gravity when loaded, they have a major effect on vehicle handling and steering response.

Therefore, note the following when loading and driving:

- ▶ Do not exceed the approved roof/axle loads and the approved gross vehicle weight.
- ▶ Be sure that adequate clearance is maintained for tilting and opening the glass sunroof.
- ▶ Distribute the roof load uniformly.
- ▶ The roof load should not extend past the loading area.
- ▶ Always place the heaviest pieces on the bottom.
- ▶ Secure the roof luggage firmly, for instance using ratchet straps.
- ▶ Do not let objects project into the opening path of the tailgate.
- ▶ Drive cautiously and avoid sudden acceleration and braking maneuvers. Take corners gently.

Driving on racetracks

Warning

The vehicle is not designed for use in motor sport type competition. Excessive race track operation in the limit range can result in the sudden failure or malfunction of components. There is a risk of accident. Do not operate the vehicle excessively in the limit range. Pay attention to anomalies of the vehicle, for instance brake grinding, and stop race track operation where required.

Higher mechanical and thermal loads during racetrack operation lead to increased wear. This wear is not covered by the warranty.

Trailer towing

Vehicle features and options

This chapter describes all standard, country-specific and optional features offered with the series. It also describes features and functions that are not necessarily available in your vehicle, e.g., due to the selected options or country versions. This also applies to safety-related functions and systems. When using these functions and systems, the applicable laws and regulations must be observed.

General information

The permissible trailer loads, axle loads, drawbar nose weights, and the permissible gross vehicle weight are specified in the technical data.

The vehicle is equipped with an enhanced suspension system on the rear axle and, depending on the vehicle type, with a more powerful cooling system.

When the trailer power socket is in use, the vehicle will be raised or lowered to the normal level automatically. The adjustment to the normal level can occur when the trailer power socket is plugged in or when driving off.

Before driving

Drawbar nose weight

The maximum load of the towing vehicle is lowered by the weight of the trailer hitch and the drawbar nose weight. The drawbar nose weight increases the vehicle weight. Do not exceed the approved gross vehicle weight of the towing vehicle.

Loading

Distribute cargo as evenly as possible on the cargo area.

Stow the load as low and close to the trailer axle as possible. A low center of gravity in the trailer increases the driving safety of the entire vehicle-trailer combination.

Do not exceed the approved gross vehicle weight of the trailer and the permissible trailer load of the vehicle. The smaller value applies in each case.

Tire inflation pressure

Note the tire inflation pressure of the vehicle and trailer.

For the vehicle, the tire inflation pressure for higher loads applies.

Information regarding the tire inflation pressure, refer to page [340](#).

For the trailer, the specifications of the manufacturer apply.

Flat Tire Monitor FTM

After correcting the tire inflation pressure or hitching/unhitching a trailer, initialize the Flat Tire Monitor, refer to page [366](#).

Tire Pressure Monitor TPM

After correcting the tire inflation pressure or hitching/unhitching a trailer, reset the Tire Pressure Monitor, refer to page [359](#).

Exterior mirrors

Exterior mirrors, which allow the driver to see both rear corners of the trailer, are available as special accessories from a dealer's service center or another qualified service center or repair shop.

Power consumption

General information

Before starting to drive, check the function of the trailer tail lights.

Keep the activation times of the electronic systems/power consumers short when towing a camper to save the vehicle battery power.

Trailer tail lights

- ▷ Turn signals/brake lights: 54 watts per side.
- ▷ Rear lights: 100 watts in total.
- ▷ Backup light: 54 watts in total.

Towing a trailer

General information

If the trailer socket is in use, some driver assistance systems are unavailable, or available to a limited extent. A Check Control message is displayed where applicable.

When driving with a trailer or load carrier and the trailer socket not in use, some driver assistance systems may have functional limitations or may malfunction.

To prevent malfunctions, activate trailer towing, refer to page 329.

When the trailer socket is in use or trailer towing is activated, some driver assistance systems are unavailable, or available to a limited extent. A Check Control message is displayed where applicable.

Safety information

Warning

Depending on the design and loading of trailers, they may begin swinging at speeds exceeding approx. 50 mph/80 km/h. There may be a risk of accident or risk of damage to property.

Adapt your speed when driving with a trailer. Immediately brake in the case of swinging. Apply necessary steering corrections as carefully as possible.

Warning

The tire inflation pressure must be adjusted to the increased axle load in trailer towing. Driving with too low tire inflation pressure can damage the tires. There may be a risk of accident or risk of damage to property. Do not exceed a speed of 60 mph / 100 km/h. Increase the tire inflation pressure of the towing vehicle by 0.2 bar. Note the maximum possible tire inflation pressure indicated on the tire.

Uphill grades

General information

In the interest of safety and to avoid hindering the smooth flow of traffic, the towing of trailers is permissible on uphill grades up to 12 %.

If higher trailer loads are approved at a later point in time, the gradient limit is 8 %.

Starting on uphill grades

The parking brake is automatically released when the accelerator pedal is activated.

In order to prevent rolling back during starting, use the parking brake.

1.  Pull and release switch before starting off.
The parking brake is set.
2. Accelerated enough to start off.

Hills

A vehicle-trailer combination has the tendency to swing more readily on hills.

Manually shift down to the next-lowest gear before driving on a hill and drive downhill slowly.

Trailer stabilization control

Concept

This system supports the driver in stopping the swinging of a trailer.

The trailer stabilization control detects swinging and automatically brakes the vehicle quickly to leave the critical speed range and stabilize the vehicle-trailer combination.

General information

If the trailer power socket is in use but a trailer has not been hitched, the system can become active in certain driving situations, such as when using a bicycle rack with lighting.

Functional requirement

The system is functional at speeds beginning at approx. 40 mph/65 km/h while a trailer is being towed and the trailer power socket is in use.

System limits

The system cannot intervene or not intervene in time in the following situations, for instance:

- ▶ If a trailer jackknives suddenly, for instance on slippery roads or loose surfaces.
- ▶ If a trailer with a high center of gravity tilts, before swinging is detected.
- ▶ If DSC Dynamic Stability Control is deactivated or has malfunctioned.
- ▶ When the power consumption of a trailer is too low, for instance due to tail lights in LED technology, to be detected by the system.

Activating trailer towing

Concept

When driving with a trailer or load carrier and the trailer socket not in use, some driver assistance systems may have functional limitations or may

malfunction. To prevent malfunctions, activate trailer towing.

Activating

Via iDrive:

1. "CAR"
2. "Settings"
3. "General settings"
4. "Trailer mode"
5. Activate trailer towing.

Mount for trailer hitch

General information

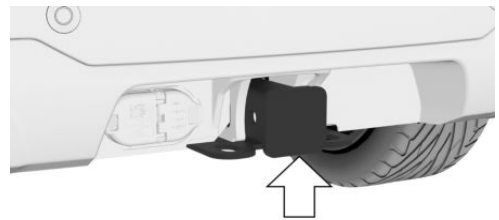

The mount for the trailer hitch is located on the rear of the vehicle.

Information on suitable trailer hitches is found on the underside of the mount, see arrow.

Follow the Maintenance Instructions, refer to page 401.

Safety information

Warning

During driving operation, high temperatures can occur underneath the vehicle body, for instance caused by the exhaust gas system. Contact with the hot components can cause burns. There is a risk of injury. Do not touch hot components. Do not perform work in the vicinity of

hot components until after they have cooled down.

Removing the cover

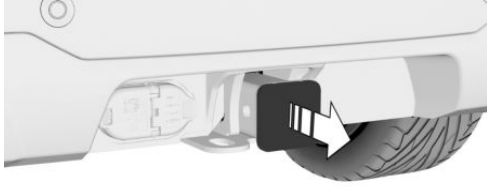

Pull the cover out of the back of the mount, and stow it in the vehicle.

Trailer connector

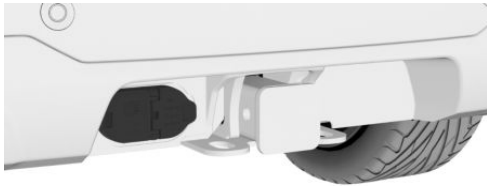

The socket is located to the left of the mount for the trailer hitch.

Fittings for trailer safety chain

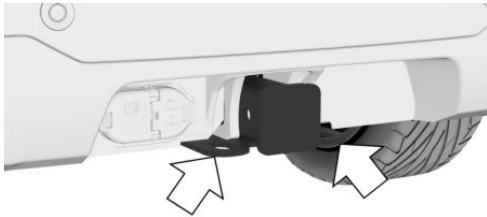

There are two fittings on the mount for the trailer hitch for securing the trailer safety chain.

Secure the trailer safety chain to the fittings for increased safety when driving with a trailer.

Ensure that the trailer safety chain can move freely and is not dragging on the ground.

Brake Controller

The vehicle manufacturer recommends that you have a Brake Controller installed by a dealer's service center or another qualified service center or repair shop.

Information on installing a Brake Controller can be obtained from a dealer's service center or another qualified service center or repair shop.

Saving fuel

Vehicle features and options

This chapter describes all standard, country-specific and optional features offered with the series. It also describes features and functions that are not necessarily available in your vehicle, e.g., due to the selected options or country versions. This also applies to safety-related functions and systems. When using these functions and systems, the applicable laws and regulations must be observed.

Reducing fuel consumption

General information

The vehicle contains advanced technologies for the reduction of consumption and emission values.

Fuel consumption depends on a number of different factors.

Carrying out certain measures, such as a moderate driving style and regular maintenance, can influence fuel consumption and the environmental impact.

Remove unnecessary cargo

Additional weight increases fuel consumption.

Remove attached parts following use

Remove auxiliary mirrors, roof-mounted or rear luggage racks which are no longer required following use.

Attached parts on the vehicle impair the aerodynamics and increase the fuel consumption.

Close the windows and glass sunroof

Driving with the glass sunroof and windows open results in increased air resistance and raises fuel consumption.

Tires

General information

Tires can affect consumption in various ways, for instance tire size may influence consumption.

Check the tire inflation pressure regularly

Check and, if needed, correct the tire inflation pressure at least twice a month and before starting on a long trip.

Low tire inflation pressure increases rolling resistance and thus raises fuel consumption and tire wear.

Drive away without delay

Do not wait for the engine to warm-up while the vehicle remains stationary. Start driving right away, but at moderate engine speeds.

This is the quickest way of warming the cold engine up to operating temperature.

Look well ahead when driving

Driving smoothly and proactively reduces fuel consumption.

Avoid unnecessary acceleration and braking.

By maintaining a suitable distance to the vehicle driving ahead of you.

Avoid high engine speeds

Driving at low engine speeds lowers fuel consumption and reduces wear.

If necessary, observe the vehicle's gear shift indicator.

Use coasting conditions

When approaching a red light, take your foot off the accelerator and let the vehicle coast to a halt.

For going downhill take your foot off the accelerator and let the vehicle roll.

The flow of fuel is interrupted while coasting.

Switch off the engine during longer stops

Switching off the engine

Switch off the engine during longer stops, for instance at traffic lights, railroad crossings or in traffic congestion.

Auto Start/Stop function

The Auto Start/Stop function of the vehicle automatically switches off the engine during a stop.

If the engine is switched off and then restarted rather than leaving the engine running constantly, fuel consumption and emissions are reduced. Savings can begin within a few seconds of switching off the engine.

In addition, fuel consumption is also determined by other factors, such as driving style, road conditions, maintenance or environmental factors.

Switch off any functions that are not currently needed

Functions such as seat heating and the rear window defroster require a lot of energy and increase fuel consumption, especially in city and stop-and-go traffic.

Switch off these functions if they are not needed.

The ECO PRO driving mode supports the energy conserving use of comfort features. These functions are automatically deactivated partially or completely.

Have maintenance carried out

Have the vehicle maintained regularly to achieve optimal vehicle efficiency and service life. BMW recommends that maintenance work be performed by a BMW service center.

For information on the BMW Maintenance System.

ECO PRO

Concept

ECO PRO supports a driving style that saves on consumption. For this purpose, the engine control and comfort features, for instance the climate control output, are adjusted.

Steptronic transmission: under certain conditions the engine is automatically decoupled from the transmission in the D selector lever position. The vehicle continues traveling with the engine idling to reduce consumption. The D selector lever position remains engaged.

In addition, context-sensitive information, ECO PRO tips, can be displayed to assist with a fuel-efficient driving style.

The achieved extended range is displayed in the instrument cluster as bonus range.

General information

The system includes the following EfficientDynamics functions and EfficientDynamics displays:

- ▷ ECO PRO bonus range.
- ▷ ECO PRO seat climate control.
- ▷ ECO PRO climate control.
- ▷ ECO PRO light and sight.
- ▷ Coasting driving condition.
- ▷ Driving style analysis.

Overview



ECO PRO

Button

Activating ECO PRO

ECO PRO

Press the button. ECO PRO is displayed in the instrument cluster.

Configuring ECO PRO INDIVIDUAL

Via the Driving Dynamics Control

1. Activate ECO PRO.
2. "ECO PRO INDIVIDUAL"

Via iDrive

1. "CAR"
2. "Settings"
3. "Driving mode"
4. "ECO PRO INDIVIDUAL"
5. Select the desired setting.

The setting is stored for the driver profile currently used.

Activating/deactivating ECO PRO functions

The following ECO PRO functions can be activated/deactivated:

- ▷ "ECO PRO speed"
- ▷ "Coasting"
- ▷ "ECO PRO seat heating"

- ▷ "ECO PRO climate control"
- ▷ "ECO PRO light and sight"

Settings are stored for the driver profile currently used.

ECO PRO limit

- ▷ Activate the ECO PRO limit:
"ECO PRO speed"

An ECO PRO tip is displayed if the speed of the set ECO PRO limit is exceeded.

- ▷ Adjust the ECO PRO limit speed:
"Notification at:"
Select the desired speed.

Coasting

Efficiency can be optimized by disengaging the engine and coasting with the engine idling.

ECO PRO seat climate control

The output of seat heating and, where applicable, seat ventilation is reduced when ECO PRO is activated.

ECO PRO climate control

Climate control is set to be efficient.

This means, it is possible to deviate slightly from the set temperature or to heat or cool the car's interior more slowly, to economize on consumption.

ECO PRO light and sight

The output of exterior mirror heating and rear window defroster is reduced.

Resetting the settings

Reset ECO PRO INDIVIDUAL to the standard settings:

"Reset to ECO PRO STANDARD"

Display in the instrument cluster

General information

When ECO PRO driving mode is activated, the display switches to a special configuration.

ECO PRO bonus range



A modified driving style helps you extend your driving range.

The range extension can be displayed as the bonus range in the instrument cluster.

The efficiency display includes the bonus range. If the bonus range appears in gray, the current driving style is inefficient.

The display turns blue as soon as all conditions for efficient driving are met.

The intervals for resetting the bonus range depend on the settings of the trip data.

Consumption display

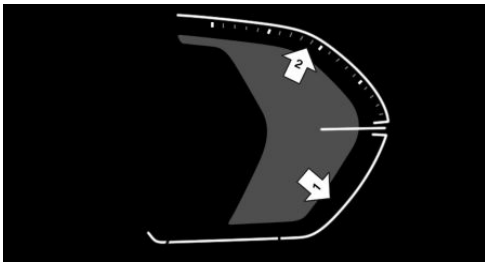

A pointer in the consumption display informs about the current driving style:

- ▷ The current consumption in relation to the average consumption is displayed.
- ▷ Pointer in the area of arrow 1: display of the energy recovered by coasting or when braking.
- ▷ Pointer in the area of arrow 2: display when accelerating.

If the acceleration is inefficient, the area between the average consumption and the current consumption is colored red.

In addition, the following information is displayed, depending on the situation:

- ▷ Depending on the equipment: the total distance driven while coasting.
- ▷ The total time that the engine has been switched off during automatic engine stops.
- ▷ A gear shift indicator recommending the use of a more efficient gear.

Indications on the Control Display

General information

Information about the current effectiveness of the ECO PRO functions can be displayed as energy flow.

Displaying energy flow information

Via iDrive:

1. "CAR"
2. "Driving information"
3. "Energy flow"

The following functions are displayed:

- ▷ Auto Start/Stop function.
- ▷ Energy recovery.
- ▷ Coasting.

Coasting

Concept

Under certain conditions the engine is automatically decoupled from the transmission in the D selector lever position. The vehicle continues traveling with the engine idling to reduce consumption. Selector lever position D remains engaged.

This driving condition is referred to as coasting.

As soon as you step on the brake or accelerator pedal, the engine is automatically coupled again.

General information

Coasting is a component of the ECO PRO driving mode.

Coasting is automatically activated when ECO PRO mode is called via the Driving Dynamics Control.

A proactive driving style helps the driver to use the function often and supports the efficient effect of coasting.

Functional requirements

The function is available in the speed range from approx. 16 mph/25 km/h to 100 mph/160 km/h. The function is active if the following conditions are met:

- ▶ The accelerator pedal is not depressed or the accelerator pedal is released.
- ▶ Brake pedal not depressed or only slightly depressed.
- ▶ The selector lever is in selector lever position D.
- ▶ Engine and transmission are at operating temperature.
- ▶ Active Cruise Control with Stop&Go function, ACC, not activated.

Operation via shift paddles

Concept

The coasting driving condition can be influenced with the shift paddles.

Activating/deactivating coasting via shift paddles

1. Shift to the highest gear by pulling the right shift paddle.
2. To activate coasting mode, actuate the right shift paddle again.

To deactivate, actuate the left shift paddle.

Display

Display in the instrument cluster

 The coasting distance traveled is indicated in coasting mode.

Indications on the Control Display

The coasting mode is displayed under energy flow while driving.

The distance traveled in coasting mode is displayed in the trip data.

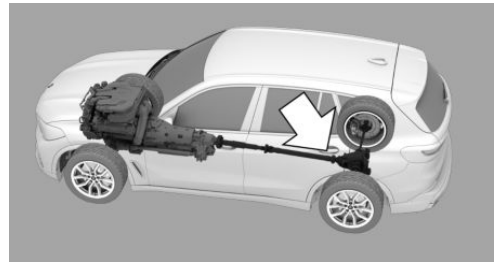

Color code blue: coasting mode.

Displaying energy flow information

Via iDrive:

1. "CAR"
2. "Driving information"
3. "Energy flow"

System limits

The function is not available under one of the following conditions.

- ▶ DSC OFF or TRACTION activated.
- ▶ Driving in the dynamic limit range and on steep uphill or downhill grades.
- ▶ Battery charge status temporarily too low or vehicle electrical system drawing excessive current.
- ▶ Trailer towing.
- ▶ HDC Hill Descent Control activated

Driving style analysis

Concept

The function helps develop an especially efficient driving style and to conserve fuel.

For this purpose, the driving style is analyzed. The assessment is done in various categories and is displayed on the Control Display.

This display will help you adjust your driving style and save some fuel.

General information

The current trip is assessed.

To assist with an efficient driving style, ECO PRO tips are displayed during driving.

The range of the vehicle can be extended by adjusting your driving style.

This gain in range is displayed as a bonus range in the instrument cluster and on the Control Display.

Functional requirement

The function is available in ECO PRO driving mode.

Calling up the Driving style analysis

Via iDrive:

1. "CAR"
2. "Driving information"
3. "Driving style analysis"

Display on the Control Display

The display of the Driving style analysis shows the efficiency of the Driving style.

The more efficient the driving style, the more bars are displayed in color and the faster the bonus range increases.

In contrast, a reduced number of bars will be displayed with an inefficient driving style.

Refueling

Vehicle features and options

This chapter describes all standard, country-specific and optional features offered with the series. It also describes features and functions that are not necessarily available in your vehicle, e.g., due to the selected options or country versions. This also applies to safety-related functions and systems. When using these functions and systems, the applicable laws and regulations must be observed.

Follow the following when refueling

General information

Follow the fuel recommendation, refer to page 378, prior to refueling.

When refueling, insert the filler nozzle completely into the filler pipe. Lifting up the fuel pump nozzle during refueling causes:

- ▷ Premature switching off.
- ▷ Reduced return of the fuel vapors.

The fuel tank is full when the filler nozzle clicks off the first time.

Make sure that the fuel cap is closed properly after refueling, otherwise the emissions warning light may light up.

Follow safety regulations posted at the gas station.

Safety information

NOTICE

With a driving range of less than 30 miles/50 km the engine may no longer have sufficient fuel. Engine functions are not ensured anymore. There is a risk of damage to property. Refuel promptly.

NOTICE

Fuels are toxic and aggressive. Overfilling of the fuel tank can damage the fuel system. Painted surfaces may be damaged by contact with fuel. Escaping fuel can harm the environment. There is a risk of damage to property. Avoid overfilling.

Fuel cap

Opening

1. To open the fuel filler flap, press on the rear edge, arrow. The fuel filler flap opens.



- Turn the fuel cap counterclockwise.

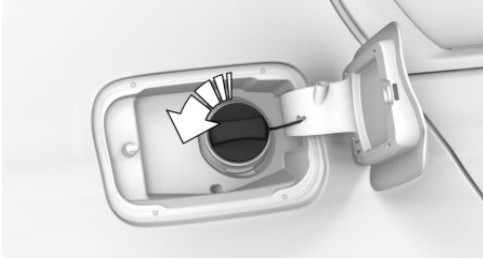

- Place the fuel cap in the bracket attached to the fuel filler flap.

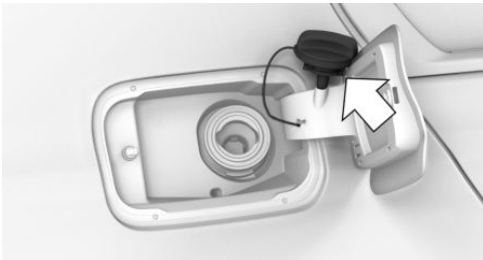

Have fuel filler flap unlocked by a dealer's service center or another qualified service center or repair shop.

Closing

Warning

The retaining strap of the fuel cap can be jammed and crushed during closing. The cap cannot be correctly closed. Fuel or fuel vapors can escape. There is a risk of injury or risk of damage to property. Pay attention that the retaining strap is not jammed or crushed when closing the cap.

- Fit the cap and turn it clockwise until you clearly hear a click.
- Press on the fuel filler flap until it engages.

Emergency unlocking

It may be necessary in certain situations to unlock the fuel filler flap manually, for instance with an electrical fault.

Wheels and tires

Vehicle features and options

This chapter describes all standard, country-specific and optional features offered with the series. It also describes features and functions that are not necessarily available in your vehicle, e.g., due to the selected options or country versions. This also applies to safety-related functions and systems. When using these functions and systems, the applicable laws and regulations must be observed.

Tire inflation pressure

General information

The tire characteristics and tire inflation pressure influence the following:

- ▷ The service life of the tires.
- ▷ Road safety.
- ▷ Driving comfort.
- ▷ Fuel consumption.

Safety information

Warning

A tire with too little or no tire inflation pressure may heat up significantly and sustain damage. This will have a negative impact on aspects of handling, such as steering and braking response. There is a risk of accident. Regularly check the tire inflation pressure, and correct it as needed, for instance twice a month and before a long trip.

Tire inflation pressure specifications

In the tire inflation pressure table

The tire inflation pressure table, refer to page 342, contains all tire inflation pressure specifications for the specified tire sizes at the ambient temperature. The tire inflation pressure values apply to tire sizes approved by the manufacturer of the vehicle for the vehicle type.

To identify the correct tire inflation pressure, please note the following:

- ▷ Tire sizes of your vehicle.
- ▷ Maximum permitted driving speed.

On the Control Display

The current tire inflation pressure values and the intended tire inflation pressure values for the mounted tires can be displayed on the Control Display.

To ensure that they are displayed correctly, the tire sizes must be stored in the system and must have been set for the mounted tires.

The current tire inflation pressure value is located on each tire.

The reference tire inflation pressure value is located in the lower area of the Control Display.

Checking the tire inflation pressure

General information

Tires heat up while driving. The tire inflation pressure increases with the tire temperature.

Tires have a natural, consistent loss of tire inflation pressure.

The displays of inflation devices may under-read by up to 0.1 bar/2 psi.

Checking using tire inflation pressure specifications in the tire inflation pressure table

The tire inflation pressure specifications in the tire inflation pressure table only relate to cold tires or tires at the same temperature as the ambient temperature.

Only check the tire inflation pressure levels when the tires are cold, i.e.:

- ▶ A driving distance of max. 1.25 miles/2 km has not been exceeded.
- ▶ If the vehicle has not moved again for at least 2 hours after a trip.

Check the tire inflation pressure of the emergency wheel in the cargo area regularly, and correct it as needed.

1. Determine the intended tire inflation pressure levels for the mounted tires.
2. Check the tire inflation pressure in all four tires, using a pressure gage, for example.
3. Correct the tire inflation pressure if the actual tire inflation pressure deviates from the intended tire inflation pressure.
4. Check whether all valve caps are screwed onto the tire valves.

Checking using the tire inflation pressure specifications on the Control Display

Via iDrive:

1. "CAR"
2. "Vehicle status"
3. (⚠) "Tire Pressure Monitor"
4. Check whether the current tire inflation pressure levels deviate from the intended tire pressure value.
5. Correct the tire inflation pressure if the actual tire inflation pressure deviates from the intended tire inflation pressure.

After correcting the tire inflation pressure

With runflat tires:

Reinitialize the Flat Tire Monitor.

With Tire Pressure Monitor TPM:

The corrected tire inflation pressures are applied automatically. Make sure that the correct tire settings have been made.

With tires that cannot be found in the tire pressure values on the Control Display, reset the Tire Pressure Monitor TPM.

Tire inflation pressures up to 100 mph/160 km/h

For speeds of up to 100 mph/160 km/h and for optimum driving comfort, note the pressure values in the tire inflation pressure table, refer to page 342, and adjust as necessary.



These pressure values can also be found on the tire inflation pressure label on the driver's door pillar.

Do not exceed a speed of 100 mph/160 km/h.

Tire inflation pressure values up to 100 mph/160 km/h

X5 sDrive40i, X5 xDrive40i, with two rows of seats

Tire size	Pressure specifications in bar/PSI	
Specifications in bar/PSI with cold tires		

265/50 R 19 110 H XL A/S	2.3 / 33	2.8 / 41
275/45 R 20 110 H XL A/S		
255/55 R 18 109 W XL		
265/50 R 19 110 H XL M+S		
275/45 R 20 110 V XL M+S		
Front: 275/45 R 20 110 Y XL	2.3 / 33	-
Rear: 305/40 R 20 112 Y XL	-	2.7 / 39
Front: 275/40 R 21 107 Y XL	2.4 / 35	-
Rear: 315/35 R 21 111 Y XL	-	2.9 / 42
Front: 275/35 R 22 104 Y XL	2.6 / 38	-
Rear: 315/30 R 22 107 Y XL	-	3.1 / 45
Front: 275/40 R 21 107 V XL M+S	2.4 / 35	-

Tire size	Pressure specifications in bar/PSI	
Rear: 315/35 R 21 111 V XL M+S	-	2.9 / 45
Emergency wheel:	Speed up to a max. of 50 mph / 80 km/h	
T 155/80 R 19 114 M	4.2 / 60	

X5 sDrive40i, X5 xDrive40i, with three rows of seats

Tire size	Pressure specifications in bar/PSI	
Specifications in bar/PSI with cold tires		

265/50 R 19 110 H M+S XL A/S	2.3 / 33	2.8 / 41
275/45 R 20 110 H M+S XL A/S		
255/55 R 18 109 W XL		
265/50 R 19 110 H XL M+S		
275/45 R 20 110 V XL M+S		
Front: 275/45 R 20 110 Y XL	2.3 / 33	-
Rear: 305/40 R 20 112 Y XL	-	2.7 / 39
Front: 275/40 R 21 107 Y XL	2.4 / 35	-
Rear: 315/35 R 21 111 Y XL	-	2.9 / 42

Tire size	Pressure specifications in bar/PSI	
Front: 275/40 R 21 107 V M+S XL	2.4 / 35	-
Rear: 315/35 R 21 111 V M+S XL	-	2.9 / 45

X5 xDrive50i

Tire size	Pressure specifications in bar/PSI	
-----------	------------------------------------	--

Specifications in bar/PSI with cold tires

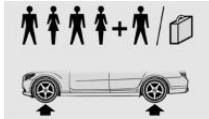

265/50 R 19 110 H M+S XL A/S	2.3 / 33	2.8 / 41
275/45 R 20 110 H M+S XL A/S		
255/55 R 18 109 W XL		
265/50 R 19 110 H XL M+S		
275/45 R 20 110 V XL M+S		
Front: 275/45 R 20 110 Y XL	2.3 / 33	-
Rear: 305/40 R 20 112 Y XL	-	2.7 / 39
Front: 275/40 R 21 107 Y XL	2.4 / 35	-
Rear: 315/35 R 21 111 Y XL	-	2.9 / 42
Front: 275/35 R 22 104 Y XL	2.6 / 38	-
Rear: 315/30 R 22 107 Y XL	-	3.1 / 45

Tire size	Pressure specifications in bar/PSI	
Front: 275/40 R 21 107 V XL M +S	2.4 / 35	-
Rear: 315/35 R 21 111 V XL M +S	-	2.9 / 42

Emergency wheel:	Speed up to a max. of 50 mph / 80 km/h	
T 155/80 R 19 114 M	4.2 / 60	

X5 M50i

Tire size	Pressure specifications in bar/PSI	
-----------	------------------------------------	--

Specifications in bar/PSI with cold tires

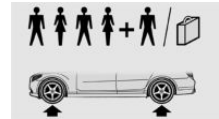

275/45 R 20 110 H XL A/S	2.2 / 32	2.6 / 38
275/45 R 20 110 V XL M+S	2.3 / 33	2.8 / 41
Front: 275/40 R 21 107 Y XL	2.5 / 36	-
Rear: 315/35 R 21 111 Y XL	-	2.9 / 42
Front: 275/35 R 22 104 Y XL	2.7 / 39	-
Rear: 315/30 R 22 107 Y XL	-	3.1 / 45
Front: 275/40 R 21 107 V XL M +S	2.5 / 36	-

Tire size	Pressure specifications in bar/PSI
Rear: 315/35 R 21 111 V XL M +S	- 2.9 / 42
Emergency wheel:	Speed up to a max. of 50 mph / 80 km/h
T 155/80 R 19 114 M	4.2 / 60

Tire inflation pressures at max. speeds above 100 mph/160 km/h

Warning

In order to drive at maximum speeds in excess of 100 mph/160 km/h, please observe, and, if necessary, adjust tire pressures for speeds exceeding 100 mph/160 km/h from the relevant table on the following pages. Otherwise, tire damage and accidents could occur.

For speeds over 100 mph/160 km/h and for optimum driving comfort, note the pressure values in the tire inflation pressure table, refer to page 344, and adjust as necessary.

Tire inflation pressure values over 100 mph/160 km/h

X5 xDrive40i, X5 sDrive40i, with two rows of seats

Without high-speed tuning feature

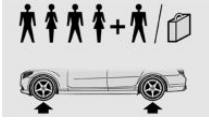
Tire size	Pressure specifications in bar/PSI
Specifications in bar/PSI with cold tires	
265/50 R 19 110 H XL A/S	2.5 / 36 3.0 / 44
275/45 R 20 110 H XL A/S	
255/55 R 18 109 W XL	
265/50 R 19 110 H XL M+S	
275/45 R 20 110 V XL M+S	
Front: 275/45 R 20 110 Y XL	2.3 / 33 -
Rear: 305/40 R 20 112 Y XL	- 2.7 / 39
Front: 275/40 R 21 107 Y XL	2.4 / 35 -
Rear: 315/35 R 21 111 Y XL	- 2.9 / 42
Front: 275/35 R 22 104 Y XL	2.6 / 38 -
Rear: 315/30 R 22 107 Y XL	- 3.1 / 45
Front: 275/40 R 21 107 V XL M +S	2.6 / 38 -
Rear: 315/35 R 21 111 V XL M +S	- 3.1 / 45
Emergency wheel:	Speed up to a max. of 50 mph / 80 km/h
T 155/80 R 19 114 M	4.2 / 60

With high-speed tuning feature

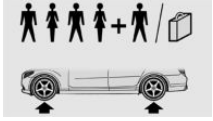
Tire size	Pressure specifications in bar/PSI	
Specifications in bar/PSI with cold tires		
265/50 R 19 110 H XL M+S	2.5 / 36	3.0 / 44
275/45 R 20 110 V XL M+S	2.8 / 41	3.3 / 48
255/55 R 18 109 W XL	2.9 / 42	3.4 / 49
Front: 275/45 R 20 110 Y XL	2.8 / 41	-
Rear: 305/40 R 20 112 Y XL	-	3.1 / 45
Front: 275/40 R 21 107 Y XL	2.8 / 41	-
Rear: 315/35 R 21 111 Y XL	-	3.1 / 45
Front: 275/35 R 22 104 Y XL	2.8 / 41	-
Rear: 315/30 R 22 107 Y XL	-	3.3 / 48
Front: 275/40 R 21 107 V XL M +S	2.8 / 41	-
Rear: 315/35 R 21 111 V XL M +S	-	3.3 / 48
Emergency wheel: T 155/80 R 19 114 M	Speed up to a max. of 50 mph / 80 km/h	
	4.2 / 60	

X5 xDrive40i, X5 sDrive40i, with three rows of seats

Without high-speed tuning feature

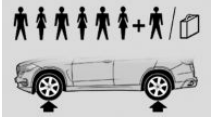
Tire size	Pressure specifications in bar/PSI	
Specifications in bar/PSI with cold tires		
265/50 R 19 110 H XL A/S	2.5 / 36	3.0 / 44
275/45 R 20 110 H XL A/S		
255/55 R 18 109 W XL		
265/50 R 19 110 H XL M+S		
275/45 R 20 110 V XL M+S		
Front: 275/45 R 20 110 Y XL	2.3 / 33	-
Rear: 305/40 R 20 112 Y XL	-	2.7 / 39
Front: 275/40 R 21 107 Y XL	2.4 / 35	-
Rear: 315/35 R 21 111 Y XL	-	2.9 / 42
Front: 275/40 R 21 107 V XL M+S	2.6 / 38	-
Rear: 315/35 R 21 111 V XL M+S	-	3.1 / 45

With high-speed tuning feature

Tire size **Pressure specifications
in bar/PSI**

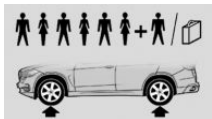
 Specifications in
bar/PSI with cold
tires

265/50 R 19 110 H XL	2.7 / 39	3.2 / 46
-------------------------	----------	----------

275/45 R 20 110 V XL	2.9 / 42	3.4 / 49
-------------------------	----------	----------

Front: 275/45 R 20 110 Y XL	2.9 / 42	-
--------------------------------	----------	---

Rear: 305/40 R 20 112 Y XL	-	3.4 / 49
-------------------------------	---	----------

Front: 275/40 R 21 107 Y XL	2.9 / 42	-
--------------------------------	----------	---

Rear: 315/35 R 21 111 Y XL	-	3.4 / 49
-------------------------------	---	----------

Front: 275/40 R 21 107 V XL M +S	2.9 / 42	-
--	----------	---

Rear: 315/35 R 21 111 V XL M +S	-	3.4 / 49
---------------------------------------	---	----------

X5 xDrive50i

Without high-speed tuning feature

Tire size **Pressure specifications
in bar/PSI**

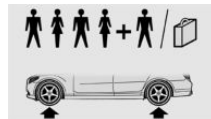
 Specifications in
bar/PSI with cold
tires

265/50 R 19 110 H XL A/S	2.5 / 36	3.0 / 44
-----------------------------	----------	----------

275/45 R 20 110 H XL A/S		
-----------------------------	--	--

255/55 R 18 109 W XL		
-------------------------	--	--

265/50 R 19 110 H XL M+S		
-----------------------------	--	--

275/45 R 20 110 V XL M+S		
-----------------------------	--	--

Front: 275/45 R 20 110 Y XL	2.3 / 33	-
--------------------------------	----------	---

Rear: 305/40 R 20 112 Y XL	-	2.7 / 39
-------------------------------	---	----------

Front: 275/40 R 21 107 Y XL	2.4 / 35	-
--------------------------------	----------	---

Rear: 315/35 R 21 111 Y XL	-	2.9 / 42
-------------------------------	---	----------

Front: 275/35 R 22 104 Y XL	2.6 / 38	-
--------------------------------	----------	---

Rear: 315/30 R 22 107 Y XL	-	3.1 / 45
-------------------------------	---	----------

Front: 275/40 R 21 107 V XL M +S	2.6 / 38	-
--	----------	---

Rear: 315/35 R 21 111 V XL M +S	-	3.1 / 45
---------------------------------------	---	----------

Emergency wheel:	Speed up to a max. of 50 mph / 80 km/h	
---------------------	---	--

T 155/80 R 19 114 M	4.2 / 60	
------------------------	----------	--

With high-speed tuning feature

Tire size	Pressure specifications in bar/PSI	
Specifications in bar/PSI with cold tires		
265/50 R 19 110 H XL M+S	2.5 / 36	3.0 / 44
275/45 R 20 110 V XL M+S	2.8 / 41	3.3 / 48
Front: 275/45 R 20 110 Y XL	2.8 / 41	-
Rear: 305/40 R 20 112 Y XL	-	3.1 / 45
Front: 275/40 R 21 107 Y XL	2.8 / 41	-
Rear: 315/35 R 21 111 Y XL	-	3.1 / 45
Front: 275/35 R 22 104 Y XL	3.0 / 44	-
Rear: 315/30 R 22 107 Y XL	-	3.4 / 49
Front: 275/40 R 21 107 V XL M +S	2.9 / 42	-
Rear: 315/35 R 21 111 V XL M +S	-	3.3 / 48
Emergency wheel: T 155/80 R 19 114 M	Speed up to a max. of 50 mph / 80 km/h	
	4.2 / 60	

X5 M50i

Without high-speed tuning feature

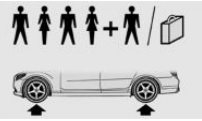
Tire size	Pressure specifications in bar/PSI	
Specifications in bar/PSI with cold tires		
275/45 R 20 110 H XL A/S	2.4 / 35	2.9 / 42
275/45 R 20 110 V XL M+S	2.5 / 36	3.0 / 44
Front: 275/40 R 21 107 Y XL	2.5 / 36	-
Rear: 315/35 R 21 111 Y XL	-	2.9 / 42
Front: 275/35 R 22 104 Y XL	2.7 / 39	-
Rear: 315/30 R 22 107 Y XL	-	3.1 / 45
Front: 275/40 R 21 107 V XL M +S	2.7 / 39	-
Rear: 315/35 R 21 111 V XL M +S	-	3.1 / 45
Emergency wheel: T 155/80 R 19 114 M	Speed up to a max. of 50 mph / 80 km/h	
	4.2 / 60	

With high-speed tuning feature

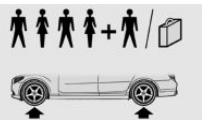
Tire size	Pressure specifications in bar/PSI	
Specifications in bar/PSI with cold tires		
275/45 R 20 110 V XL M+S	2.8 / 41	3.3 / 48

Tire size	Pressure specifications in bar/PSI	
Front: 275/40 R 21 107 Y XL	2.8 / 41	-
Rear: 315/35 R 21 111 Y XL	-	3.1 / 45
Front: 275/35 R 22 104 Y XL	3.1 / 45	-
Rear: 315/30 R 22 107 Y XL	-	3.4 / 49
Front: 275/40 R 21 107 V XL M +S	3.0 / 44	-
Rear: 315/35 R 21 111 V XL M +S	-	3.3 / 48
Emergency wheel:	Speed up to a max. of 50 mph / 80 km/h	
T 155/80 R 19 114 M	4.2 / 60	

Tire identification marks

Tire size

245/45 R 18 96 Y

245: nominal width in mm

45: aspect ratio in %

R: radial tire code

18: rim diameter in inches

96: load rating, not for ZR tires

Y: speed rating, before the R on ZR tires

Maximum tire load

Maximum tire load is the maximum permissible weight for which the tire is approved.

Locate the maximum tire load on the tire sidewall and the Gross Axle Weight Rating – GAWR – on the certification label on the driver door B-pillar.

Divide the tire load by 1.1. It must be greater than one-half of the vehicle's Gross Axle Weight Rating – GAWR. Note, front vs. rear GAWR and tire loads, respectively.

Speed letter

Designation	Maximum speed
Q	up to 100 mph/160 km/h
R	up to 106 mph/170 km/h
S	up to 112 mph/180 km/h
T	up to 118 mph/190 km/h
H	up to 131 mph/210 km/h
V	up to 150 mph/240 km/h
W	up to 167 mph/270 km/h
Y	up to 186 mph/300 km/h

Tire Identification Number

DOT code: DOT xxxx xxx 3819

xxxx: manufacturer code for the tire brand

xxx: tire size and tire design

3819: tire age

Tires with DOT codes meet the guidelines of the U.S. Department of Transportation.

Tire age

Recommendation

Regardless of the tire tread, replace tires at least every 6 years.

Manufacture date

You can find the manufacture date of the tire on the tire's sidewall.

Designation	Manufacture date
DOT ... 3819	38th week, 2019

Uniform Tire Quality Grading

Quality grades can be found where applicable on the tire sidewall between tread shoulder and maximum section width.

E.g.: Treadwear 200; Traction AA; Temperature A

DOT Quality Grades

Treadwear

Traction AA A B C

Temperature A B C

All passenger vehicle tires must conform to Federal Safety Requirements in addition to these grades.

Treadwear

The treadwear grade is a comparative rating based on the wear rate of the tire when tested under controlled conditions on a specified government test course. E.g., a tire graded 150 would wear one and one-half, 1 g, times as well on the government course as a tire graded 100. The relative performance of tires depends upon the actual conditions of their use, however, and may depart significantly from the norm due to variations in driving habits, service practices and differences in road characteristics and climate.

Traction

The traction grades, from highest to lowest, are AA, A, B, and C.

Those grades represent the tire's ability to stop on wet pavement as measured under controlled conditions on specified government test surfaces of asphalt and concrete. A tire marked C may have poor traction performance.

The traction grade assigned to this tire is based on straight-ahead braking traction tests, and does not include acceleration, cornering, hydroplaning, or peak traction characteristics.

Temperature

The temperature grades are A, the highest, B, and C, representing the tire's resistance to the generation of heat and its ability to dissipate heat when tested under controlled conditions on a specified indoor laboratory test wheel. Sustained high temperature can cause the material of the tire to degenerate and reduce tire life, and excessive temperature can lead to sudden tire failure. The grade C corresponds to a level of performance which all passenger car tires must meet under the Federal Motor Vehicle Safety Standard No. 109. Grades Band A represent higher levels of performance on the laboratory test wheel than the minimum required by law.

Warning

The temperature grade for this tire is established for a tire that is properly inflated and not overloaded. Excessive speed, underinflation, or excessive loading, either separately or in combination, can cause heat buildup and possible tire failure.

RSC – Run-flat tires

Run-flat tires, refer to page 352, are labeled with a circular symbol containing the letters RSC marked on the sidewall.

M+S

Winter and all-season tires with better cold weather performance than summer tires.

Tire tread

Summer tires

Do not drive with a tire tread of less than 0.12 in/3 mm, otherwise there is an increased risk of hydroplaning.

Winter tires

Do not drive with a tire tread of less than 0.16 in/4 mm, as such tires are less suitable for winter operation.

Minimum tread depth

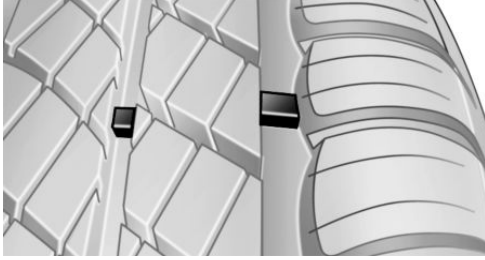

Wear indicators are distributed around the tire circumference. They have the legally required minimum height of 0.063 in/1.6 mm.

The positions of the wear indicators are marked on the tire sidewall with TWI, Tread Wear Indicator.

Tire damage

General information

Inspect your tires regularly for damage, foreign objects lodged in the tread, and tread wear.

Driving over rough or damaged road surfaces, as well as debris, curbs and other obstacles can cause serious damage to wheels, tires and suspension parts. This is more likely to occur with low-profile tires, which provide less cushioning between the wheel and the road. Be careful to avoid road hazards and reduce your speed, especially if your vehicle is equipped with low-profile tires.

Indications of tire damage or other vehicle malfunctions:

- ▷ Unusual vibrations.
- ▷ Unusual tire or running noises.

- ▷ Unusual handling such as a strong tendency to pull to the left or right.

Damage can be caused by the following situations, for instance:

- ▷ Driving over curbs.
- ▷ Road damage.
- ▷ Tire inflation pressure too low.
- ▷ Vehicle overloading.
- ▷ Incorrect tire storage.

Safety information

Warning

Damaged tires can lose tire inflation pressure, which can lead to loss of vehicle control. There is a risk of accident. If tire damage is suspected while driving, immediately reduce speed and stop. Have wheels and tires checked. For this purpose, drive carefully to the nearest dealer's service center or another qualified service center or repair shop. Have vehicle towed or transported as needed. Do not repair damaged tires, but have them replaced.

Warning

Tires can become damaged by driving over obstacles, e.g., curbs or road damage, at high speed. Larger wheels have a smaller tire cross-section. The smaller the tire cross-section, the higher the risk of tire damage. There is a danger of accidents and property damage. If possible, avoid driving over objects or road conditions that may damage tires, or drive over them slowly and carefully.

Changing wheels and tires

Mounting and wheel balancing

Have mounting and wheel balancing carried out by a dealer's service center or another qualified service center or repair shop.

Wheel and tire combination

General information

You can ask the dealer's service center or another qualified service center or repair shop about the correct wheel/tire combination and wheel rim versions for the vehicle.

Safety information

Warning

Wheels and tires which are not suitable for your vehicle can damage parts of the vehicle, for instance due to contact with the body due to tolerances despite the same official size rating. There is a risk of an accident. The manufacturer of your vehicle strongly suggests that you use wheels and tires that have been recommended by the vehicle manufacturer for your vehicle type.

Warning

Mounted steel wheels can cause technical problems, for instance unexpected loosening of the lug bolts and damage to the brake discs. There is a risk of accident. Do not mount steel wheels.

Warning

Incorrect wheel/tire combinations will have a negative impact on the vehicle's handling and on the function of a variety of systems, such as the ABS Anti-lock Brake System or DSC Dynamic Stability Control. There is a risk of acci-

dent. To maintain good handling and vehicle response, use only tires with a single tread configuration from a single manufacturer. The manufacturer of the vehicle recommends that you use wheels and tires that have been recommended by the vehicle manufacturer for your vehicle type. Following tire damage, have the original wheel/tire combination remounted on the vehicle as soon as possible.

Warning

Unsuitable wheel studs, such as single-section wheel studs, may loosen or come off. The wheel may come loose during driving. There is a risk of accident. Use only two-section wheel studs that have been categorized as suitable for the respective wheel type by the manufacturer of the vehicle.

Recommended tire brands



For each tire size, the manufacturer of the vehicle recommends certain tire brands. The tire brands can be identified by a star on the tire sidewall.

New tires

Tire traction is not optimal due to manufacturing circumstances when tires are brand-new; they achieve their full traction potential after a break-in time.

Drive conservatively for the first 200 miles/300 km.

Retreaded tires

Warning

Retreaded tires can have different tire casing structures. With advanced age the service life can be limited. There is a risk of an accident. The manufacturer of your vehicle does not recommend the use of retreaded tires.

The manufacturer of the vehicle does not recommend the use of retreaded tires.

Winter tires

General information

Winter tires are recommended for operating on winter roads.

Although so-called all-season M+S tires provide better winter traction than summer tires, they usually do not provide the same level of performance as winter tires.

Maximum speed of winter tires

If the maximum speed of the vehicle is higher than the permissible speed for the winter tires, then attach a label showing the permissible maximum speed in the field of view. The label is available from a dealer's service center or another qualified service center or repair shop.

With winter tires mounted, observe and do not exceed the permissible maximum speed.

Changing runflat tires

For your own safety, use only runflat tires. Further information is available from a dealer's service center or another qualified service center or repair shop.

Rotating wheels between axles

Warning

Rotating tires between the axles on vehicles with different tire sizes or rim sizes on the front and rear axles can cause damage to the tires and the vehicle. There is a risk of accident. Do not rotate the tires between the axles on vehicles with different tire sizes or rim sizes on the front and rear axles.

Different wear patterns can occur on the front and rear axles depending on individual driving conditions. The tires can be rotated in pairs between the axles to achieve even wear. Further information is available from a dealer's service center or another qualified service center or repair shop. After rotating, check the tire pressure and correct, if needed.

Storing tires

Tire inflation pressure

Do not exceed the maximum tire inflation pressure indicated on the side wall of the tire.

Storage

- ▶ Store wheels and tires in a cool, dry and dark place.
- ▶ Always protect tires against all contact with oil, grease, and solvents.
- ▶ Do not leave tires in plastic bags.
- ▶ Remove dirt from wheels or tires.

Run-flat tires

Concept

Run-flat tires permit continued driving under restricted conditions even in the event of a complete loss of tire inflation pressure.

General information

The wheels consist of tires that are self-supporting, to a limited degree, and possibly special rims.

The support of the sidewall allows the tire to remain drivable to a restricted degree in the event of a tire inflation pressure loss.

Follow the instructions for continued driving with a flat tire.

Safety information

Warning

The vehicle handles differently when a run-flat tire has insufficient or no tire pressure; for instance, reduced lane stability when braking, braking distances are longer and the self-steering properties will change. There is a risk of accident. Drive moderately and do not exceed a speed of 50 mph/80 km/h.

Warning

Heavy trailers can start swinging when continuing to drive with a flat tire. There may be a risk of accident or risk of damage to property. Do not exceed a speed of 35 mph/60 km/h when driving with a trailer and a flat tire. Immediately brake in the case of swinging. Apply necessary steering corrections as carefully as possible.

Label



The tires are marked on the tire sidewall with Run-flat System Component RSC.

Repairing a flat tire

Safety measures

- ▶ Park the vehicle as far away as possible from passing traffic and on solid ground.
- ▶ Switch on the hazard warning system.
- ▶ Secure the vehicle against rolling away by setting the parking brake.
- ▶ Turn the steering wheel until the front wheels are in the straight-ahead position and engage the steering wheel lock.
- ▶ Have all vehicle occupants get out of the vehicle and ensure that they remain outside the immediate area in a safe place, such as behind a guardrail.
- ▶ If necessary, set up a warning triangle at an appropriate distance.

Mobility System

Concept

With the Mobility System, minor tire damage can be sealed temporarily to enable continued travel. To accomplish this, sealant is pumped into the tires, which seals the damage from the inside.

General information

- ▷ Follow the instructions on using the Mobility System found on the compressor and sealant container.
- ▷ Use of the Mobility System may be ineffective if the tire puncture measures approx. 1/8 inches/4 mm or more.
- ▷ Contact a dealer's service center or another qualified service center or repair shop if the tire cannot be made drivable.
- ▷ Do not remove foreign bodies that have penetrated the tire. Remove foreign objects only when they are visibly protruding from the tire.
- ▷ Pull the speed limit sticker off the sealant container and apply it to the steering wheel.
- ▷ The use of a sealant can damage the TPM wheel electronics. In this case, have the electronics checked and replaced at the next opportunity.
- ▷ The compressor can be used to check the tire inflation pressure.

Overview

Storage

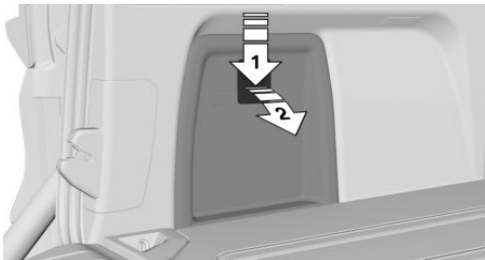

The Mobility System is in the left storage compartment of the cargo area.

Sealant container

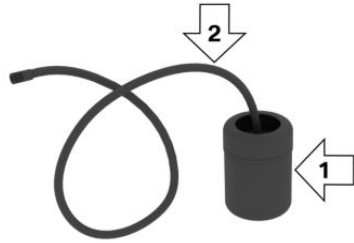

- ▷ Sealant container, arrow 1.
- ▷ Filling hose, arrow 2.

Observe use-by date on the sealant container.

Compressor

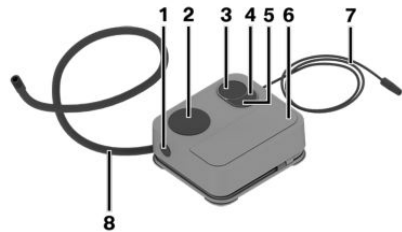

- 1 Sealant container unlocking
- 2 Sealant container holder
- 3 Tire pressure gage
- 4 Reduce tire inflation pressure button
- 5 On/off switch
- 6 Compressor
- 7 Connector/cable for socket
- 8 Connection hose

Safety measures

- ▷ Park the vehicle as far away as possible from passing traffic and on solid ground.
- ▷ Switch on the hazard warning system.
- ▷ Secure the vehicle against rolling away by setting the parking brake.

- ▶ Turn the steering wheel until the front wheels are in the straight-ahead position and engage the steering wheel lock.
 - ▶ Have all vehicle occupants get out of the vehicle and ensure that they remain outside the immediate area in a safe place, such as behind a guardrail.
 - ▶ If necessary, set up a warning triangle at an appropriate distance.
2. Pull filling hose completely out of the cover of the sealant container. Do not kink the hose.

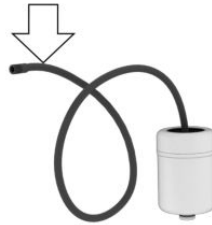

Filling the tire with sealant

Safety information

DANGER

If the exhaust pipe is blocked or ventilation is insufficient, harmful exhaust gases can enter into the vehicle. The exhaust gases contain pollutants which are colorless and odorless. In enclosed areas, exhaust gases can also accumulate outside of the vehicle. There is danger to life. Keep the exhaust pipe free and ensure sufficient ventilation.

NOTICE

The compressor can overheat during extended operation. There is a risk of damage to property. Do not run the compressor for more than 10 minutes.

3. Slide the sealant container into the holder on the compressor housing, ensuring that it engages audibly.

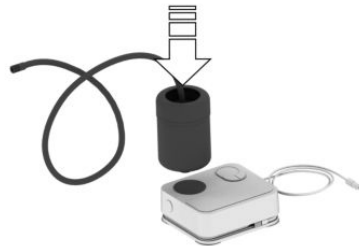

4. Screw the filling hose of the sealant container onto the tire valve of the nonworking wheel.

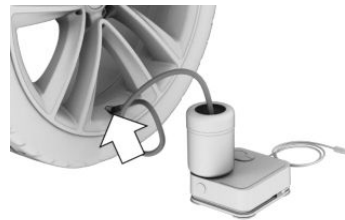

Filling

1. Shake the sealant container.



- With the compressor switched off, insert the plug into the power socket inside the vehicle.



- With standby state switched on or the engine running, switch on the compressor.

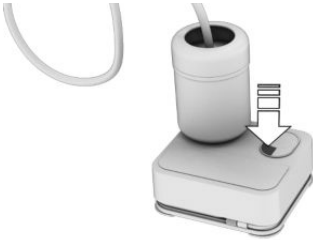

Let the compressor run for max. 10 minutes to fill the tire with sealant and achieve a tire inflation pressure of approx. 2.0 bar.

While the tire is being filled with sealant, the tire inflation pressure may sporadically reach approx. 5 bar. Do not switch off the compressor at this point.

Checking and adjusting the tire inflation pressure

Checking

- Switch off the compressor.
- Read the tire inflation pressure on the tire pressure gage.

To continue the trip, a tire inflation pressure of at least 2 bar must be reached.

Removing and stowing the sealant container

- Unscrew the filling hose of the sealant container from the tire valve.
- Press the red unlocking device.
- Remove the sealant container from the compressor.
- Wrap and store the sealant container in suitable material to avoid dirtying the cargo area.

Minimum tire inflation pressure is not reached

- Pull the connector out of the power socket inside the vehicle.
- Drive 33 ft/10 m forward and back to distribute the sealant in the tire.
- Screw the connection hose of the compressor directly onto the tire valve stem.

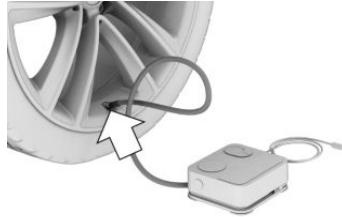

- Insert the connector into the power socket inside the vehicle.



- With standby state switched on or the engine running, switch on the compressor.
When the tire pressure does not reach at least 2 bar, contact a manufacturer service

center or another qualified service center or repair shop.

When a tire pressure of at least 2 bar is reached, see Minimum tire inflation pressure is reached.

6. Unscrew the connection hose of the compressor from the tire valve.
7. Pull the connector out of the power socket inside the vehicle.
8. Stow the Mobility System in the vehicle.

Minimum tire inflation pressure is reached

1. Unscrew the connection hose of the compressor from the tire valve.
2. Pull the connector out of the power socket inside the vehicle.
3. Stow the Mobility System in the vehicle.
4. Immediately drive approx. 5 miles/10 km to ensure that the sealant is evenly distributed in the tire.

Do not exceed a speed of 50 mph/80 km/h.
If possible, do not drive at speeds less than 12 mph/20 km/h.

Adjustment

1. Stop at a suitable location.
2. Screw the connection hose of the compressor directly onto the tire valve stem.

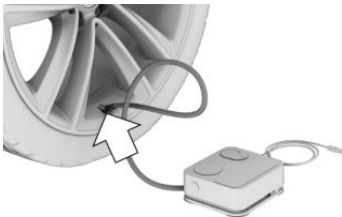

3. Insert the connector into the power socket inside the vehicle.



4. Correct the tire inflation pressure to at least 2.0 bar:
 - ▶ Increase tire inflation pressure: with standby state switched on or the engine running, switch on the compressor.
 - ▶ Reduce tire inflation pressure: press the button on the compressor.
5. Unscrew the connection hose of the compressor from the tire valve.
6. Pull the connector out of the power socket inside the vehicle.
7. Stow the Mobility System in the vehicle.

Continuing the trip

Do not exceed the maximum permissible speed of 50 mph/80 km/h.

Reinitialize the run-flat tires, refer to page [366](#).

Reset the Tire Pressure Monitor TPM, refer to page [359](#).

Replace the nonworking tire and the sealant container of the Mobility System promptly.

Snow chains

Safety information

Warning

With the mounting of snow chains on unsuitable tires, the snow chains can come into contact with vehicle parts. There may be a risk of accident or risk of damage to property. Only mount snow chains on tires that are designated by their manufacturer as suitable for the use of snow chains.

Warning

Insufficiently tight snow chains may damage tires and vehicle components. There may be a risk of accident or risk of damage to property. Make sure that the snow chains are always sufficiently tight. Re-tighten as needed according to the snow chain manufacturer's instructions.

Fine-link snow chains

The manufacturer of the vehicle recommends the use of fine-link snow chains. Certain types of fine-link snow chains have been tested by the manufacturer of the vehicle and recommended as road-safe and suitable.

Information regarding suitable snow chains is available from a dealer's service center or another qualified service center or repair shop.

Use

Use only in pairs on the rear wheels, equipped with the tires of the following size:

- ▷ 255/55 R18.
- ▷ 265/50 R19.
- ▷ 275/45 R20.

Follow the snow chain manufacturer's instructions.

Do not initialize the Flat Tire Monitor after mounting snow chains, as doing so may result in incorrect readings.

Do not reset the Tire Pressure Monitor TPM after mounting snow chains, as doing so may result in incorrect readings.

When driving with snow chains, briefly activate Dynamic Traction Control DTC to optimize the forward momentum.

Maximum speed with snow chains

Do not exceed a speed of 30 mph/50 km/h when using snow chains.

Rear axle steering during operation with snow chains

General information

In order to guarantee free running of the wheels when operating with snow chains, rear axle steering of the integral active steering must be switched off when snow chains are mounted.

Safety information

Warning

When rear axle steering is switched on and snow chains are mounted, there can be contact between snow chains and the chassis. There may be a risk of accident or risk of damage to property. With mounted snow chains, switch off the rear axle steering.

Switching off rear axle steering

The rear axle steering is switched off by specifying that snow chains are installed.

Via iDrive:

1. "CAR"
2. "Settings"
3. "General settings"

4. "Tire chains"
5. "Snow chains installed"

Starting with the permissible maximum speed with snow chains of 30 mph/50 km/h the rear axle steering will be switched on again automatically.

Tire Pressure Monitor TPM

Concept

The system monitors tire inflation pressure in the four mounted tires. The system warns you if there is a loss of pressure in one or more tires.

General information

Sensors in the tire valves measure the tire inflation pressure and tire temperature.

Using the tire settings in iDrive, the system can automatically display the specified target pressures and compare them with the actual tire inflation pressures.

If tires are being used that are not specified on the tire inflation pressure details on the vehicle, such as tires with special approval, the system needs to be actively reset. The system will then take over the actual tire inflation pressures as the target pressures.

When operating the system, also note the additional information found in the Tire inflation pressure, refer to page 340, chapter.

Safety information

Warning

The display of the target pressures is not a substitute for the tire inflation pressure details on the vehicle. Incorrect entries in the tire settings can lead to incorrect target tire inflation pressure values. In this case, it cannot be guaranteed that the notification of a loss of tire inflation pressure will be reliable. There is a risk of injury and risk of damage to property. Ensure

that the tire sizes of the mounted tires are displayed correctly and match the details on the tires and on the vehicle.

Functional requirements

The following conditions must be met for the system; otherwise, reliable flagging of a loss of tire inflation pressure is not assured:

- ▷ Every time a tire or wheel is changed, the correct details on the mounted tires must be entered in the tire settings.
- ▷ TPM does not activate until after driving for a few minutes:
 - ▷ After a tire or wheel replacement.
 - ▷ After a reset, for tires with special approval.
 - ▷ After changing the tire setting.
- ▷ For tires with special approval:
 - ▷ After a tire or wheel replacement, a reset was performed with the correct tire inflation pressure.
 - ▷ After the tire inflation pressure was adjusted to a new value, a reset was performed.
- ▷ Wheels with TPM wheel electronics.

Tire settings

General information

The tire sizes of the mounted tires can be gathered from the tire inflation pressure details on the vehicle or directly on the tires.

The tire details do not need to be re-entered when the tire inflation pressure is corrected.

For summer and winter tires, the tire details entered last are stored. After a tire or wheel replacement, the settings of the tire sets used last can be selected.

Changing settings

Via iDrive:

1. "CAR"
2. "Vehicle status"
3.  "Tire Pressure Monitor"
4. "Tire settings"
5. "Tire selection"
6. "Manual"
7. "Tire type"
 - ▷ "Summer"
 - ▷ "Winter/All-year"
8. Select the tire type that is mounted on the rear axle:
 - ▷ Tire size, e.g., 245/45 R18 96 Y.
 - ▷ For tires with special approval: "Other tires".
Observe further proceeding in the perform a reset section.
9. Select the maximum road speed that will be used with the tires.
10. "Save tire settings"

The measurement of the current tire inflation pressure is started. The measurement progress is displayed.

Status display

Current status

The system status can be displayed on the Control Display, e.g., whether or not the system is active.

Via iDrive:

1. "CAR"
2. "Vehicle status"
3.  "Tire Pressure Monitor"

The current status is displayed.

Current tire inflation pressure

The current tire inflation pressure is displayed for each tire.

The current tire inflation pressures may change during driving operation or depending on the external temperature.

Current tire temperature

Depending on the model, the current tire temperatures are displayed.

The current tire temperatures may change while driving or due to the external temperature.

Target pressure

The target pressure for the tires on the front and rear axles is displayed.

The specified target pressures take the influence of driving operation and external temperature on the tire temperature into account. The appropriate target pressure is always displayed, independent of the weather situation, tire temperatures and driving times.

The displayed target pressure may change and may differ from the tire inflation pressure details on the door pillar of the driver's door. The tire inflation pressure can thus be corrected to the value of the displayed target pressures.

The target pressure is immediately adjusted if the vehicle load is changed in the tire settings.

Tire conditions

General information

Tire and system status are indicated by the color of the wheels and a SMS text message on the Control Display.

Any existing messages may not be deleted if the displayed target pressure is not reached after the tire inflation pressure is corrected.

All wheels green

- ▶ The system is active and bases warnings on the displayed target pressures.
- ▶ For tires with special approval: the system is active and bases warnings on the tire inflation pressures stored during the last reset.

One to four yellow wheels

A flat tire or major drop in the tire inflation pressure has occurred in the indicated tires.

Gray wheels

It may not be possible to identify tire inflation pressure losses.

Possible causes:

- ▶ Malfunction.
- ▶ During tire inflation pressure measurement, after confirmation of the tire settings.
- ▶ For tires with special approval: a reset is performed for the system.

For tires with special approval: perform a reset

Via iDrive:

1. "CAR"
2. "Vehicle status"
3. "Tire Pressure Monitor"
4. Make sure that correct tire settings, refer to page 359, have been made.
5. Switch on drive-ready state and do not drive off.
6. Reset tire inflation pressure: "Perform reset".
7. Drive away.

The wheels are displayed in gray and the following is displayed "Resetting tire pressure...".

After a travel time of several minutes, the set tire inflation pressures are accepted as the target tire inflation pressures. The reset is completed automatically while driving.

After a successfully completed reset, the wheels on the Control Display are shown in green and the following is displayed: "Reset successful."

You may interrupt this trip at any time. When you continue the reset resumes automatically.

Messages: for tires without special approval

General information

A low tire inflation pressure may cause the DSC Dynamic Stability Control to be switched on.

Safety information

Warning

A damaged regular tire with low or missing tire inflation pressure impacts handling, such as steering and braking response. Run-flat tires can maintain limited stability. There is a risk of accident. Do not continue driving if the vehicle is equipped with normal tires. Follow the information on run-flat tires and continued driving with these tires.

If a tire inflation pressure check is required

Message

A symbol with a Check Control message appears on the Control Display.

Symbol	Possible cause
	Inflation was not carried out according to specifications, for instance when the tire has not been sufficiently inflated or in the case of a natural steady tire pressure loss.



Measure

Check the tire pressure and correct as needed.

If the tire inflation pressure is too low

Message



A yellow warning light is illuminated in the instrument cluster.

In addition, a symbol with a Check Control message appears on the Control Display.

Symbol	Possible cause
	There is a tire inflation pressure loss.



There is a tire inflation pressure loss.

Measure

1. Reduce the vehicle speed. Do not exceed a speed of 80 mph/130 km/h.
2. At the next opportunity, for instance at a gas station, check the tire inflation pressure in all four tires and correct if necessary.

If there is a significant loss of tire inflation pressure

Message



A yellow warning light is illuminated in the instrument cluster.

In addition, a symbol with the affected tire appears in a Check Control message on the Control Display.

Symbol	Possible cause
	There is a flat tire or a major loss in tire inflation pressure.



There is a flat tire or a major loss in tire inflation pressure.

Measure

1. Reduce your speed and stop cautiously. Avoid sudden braking and steering maneuvers.
2. Check whether the vehicle is fitted with normal tires or run-flat tires.

Run-flat tires, refer to page 352, are labeled with a circular symbol containing the letters RSC marked on the tire's sidewall.

3. Read the description on What to do in case of a flat tire, refer to page 363.

Messages: for tires with special approval

General information

A low tire inflation pressure may cause the DSC Dynamic Stability Control to be switched on.

Safety information

Warning

A damaged regular tire with low or missing tire inflation pressure impacts handling, such as steering and braking response. Run-flat tires can maintain limited stability. There is a risk of accident. Do not continue driving if the vehicle is equipped with normal tires. Follow the information on run-flat tires and continued driving with these tires.

If a tire inflation pressure check is required

Message

A symbol with a Check Control message appears on the Control Display.

Sym- bol	Possible cause
-------------	----------------



Inflation was not carried out according to specifications, e.g., the tire has not been sufficiently inflated.

The system has detected a wheel change, but no reset was done.

The tire inflation pressure has fallen below the level of the last reset.

No reset was performed for the system. The system issues a warning based on the tire inflation pressures stored during the last reset.

Measure

1. Check the tire pressure and correct as needed.
2. Perform a system reset.

If the tire inflation pressure is too low

Message



A yellow warning light is illuminated in the instrument cluster.

In addition, a symbol with a Check Control message appears on the Control Display.

Symbol	Possible cause
--------	----------------



There is a tire inflation pressure loss. No reset was performed for the system. The system issues a warning based on the tire inflation pressures stored during the last reset.

Measure

1. Reduce the vehicle speed. Do not exceed a speed of 80 mph/130 km/h.
2. At the next opportunity, for instance at a gas station, check the tire inflation pressure in all four tires and correct if necessary.

3. Reset the system.

If there is a significant loss of tire inflation pressure

Message



A yellow warning light is illuminated in the instrument cluster.

In addition, a symbol with the affected tire appears in a Check Control message on the Control Display.

Symbol	Possible cause
--------	----------------



There is a flat tire or a major loss in tire inflation pressure.

No reset was performed for the system. The system issues a warning based on the tire inflation pressures stored during the last reset.

Measure

1. Reduce your speed and stop cautiously. Avoid sudden braking and steering maneuvers.
2. Check whether the vehicle is fitted with normal tires or run-flat tires. Run-flat tires, refer to page 352, are labeled with a circular symbol containing the letters RSC marked on the tire's sidewall.
3. Read the description on What to do in case of a flat tire, refer to page 363.

Actions in the event of a flat tire

Normal tires

1. Identify the damaged tire.

Check the tire inflation pressure in all four tires, for instance using the tire pressure gage of a flat tire kit.

For tires with special approval: when the tire inflation pressure in all four tires is correct, the

TPM may not have been reset. In this case, perform the reset.

If tire damage cannot be found, contact a dealer's service center or another qualified service center or repair shop.

2. Repair the flat tire, e.g., with a flat tire kit or by changing the wheel.

Use of sealant, for instance from the flat tire kit, may damage the TPM wheel electronics. Have the electronics replaced at the next opportunity.

Run-flat tires

Safety information

Warning

The vehicle handles differently when a run-flat tire has insufficient or no tire pressure; for instance, reduced lane stability when braking, braking distances are longer and the self-steering properties will change. There is a risk of accident. Drive moderately and do not exceed a speed of 50 mph/80 km/h.

Warning

Heavy trailers can start swinging when continuing to drive with a flat tire. There may be a risk of accident or risk of damage to property. Do not exceed a speed of 35 mph/60 km/h when driving with a trailer and a flat tire. Immediately brake in the case of swinging. Apply necessary steering corrections as carefully as possible.

Maximum speed

You may continue driving with a damaged tire at speeds up to 50 mph/80 km/h.

Continued driving with a flat tire

Follow the following when continuing to drive with a damaged tire:

1. Avoid sudden braking and steering maneuvers.
2. Do not exceed a speed of 50 mph/80 km/h.
3. Check the tire inflation pressure in all four tires at the next opportunity.

Possible driving range with a depressurized tire

The distance for which it may be possible to drive safely varies depending on how the vehicle is loaded and used, e.g., speed, road conditions, external temperature. The driving range may be less but may also be more if an economical driving style is used.

If the vehicle is loaded with an average weight and used under favorable conditions, the distance for which it may be safe to drive may be up to 50 miles/80 km.

Vehicle handling with damaged tires

Vehicles driven with a damaged tire will handle differently, potentially leading to conditions such as the following:

- ▶ Greater likelihood of swerving off course.
- ▶ Longer braking distances.
- ▶ Changed self-steering properties.

Modify your driving style. Avoid abrupt steering maneuvers or driving over obstacles, for instance curbs or potholes.

Final tire failure

Vibrations or loud noises while driving can indicate the final failure of a tire.

Reduce speed and stop; otherwise, pieces of the tire could come loose and cause an accident.

Do not continue driving. Contact a dealer's service center or another qualified service center or repair shop.

System limits

Temperature

The tire inflation pressure depends on the tire's temperature.

Driving or exposure to the sun will increase the tire's temperature, thus increasing the tire inflation pressure.

The tire inflation pressure is reduced when the tire temperature falls again.

These circumstances may cause a warning when temperatures fall very sharply.

Following a temperature-related warning, the target pressures are displayed on the Control Display again after a short distance.

Sudden tire pressure loss

The system cannot indicate sudden serious tire damage caused by external circumstances.

Failure performing a reset

Tires with special approval: the system will not function correctly if a reset was not performed, for example a flat tire may be indicated although the tire inflation pressures are correct.

Malfaction

Message



The yellow warning light flashes and is then illuminated continuously. A Check Control message is displayed. It may not be possible to identify tire pressure losses.

Measure

- ▷ A wheel without TPM wheel electronics, such as an emergency wheel, is mounted: have the wheels checked, if needed.
- ▷ Interference caused by systems or devices with the same radio frequency: after leaving the area of the interference, the system automatically becomes active again.

- ▷ For tires with special approval: the system was unable to complete the reset. Perform a system reset again.

Malfaction: have the system checked.

Declaration according to NHTSA/ FMVSS 138 Tire Pressure Monitoring System

Each tire, including the spare (if provided) should be checked monthly when cold and inflated to the inflation pressure recommended by the vehicle manufacturer on the vehicle placard or tire inflation pressure label. (If your vehicle has tires of a different size than the size indicated on the vehicle placard or tire inflation pressure label, you should determine the proper tire inflation pressure for those tires.) As an added safety feature, your vehicle has been equipped with a tire pressure monitoring system (TPMS) that illuminates a low tire pressure telltale when one or more of your tires is significantly under-inflated. Accordingly, when the low tire pressure telltale illuminates, you should stop and check your tires as soon as possible, and inflate them to the proper pressure. Driving on a significantly under-inflated tire causes the tire to overheat and can lead to tire failure. Under-inflation also reduces fuel efficiency and tire tread life, and may affect the vehicle's handling and stopping ability. Please note that the TPMS is not a substitute for proper tire maintenance, and it is the driver's responsibility to maintain correct tire pressure, even if under-inflation has not reached the level to trigger illumination of the TPMS low tire pressure telltale. Your vehicle has also been equipped with a TPMS malfunction indicator to indicate when the system is not operating properly. The TPMS malfunction indicator is combined with the low tire pressure telltale. When the system detects a malfunction, the telltale will flash for approximately one minute and then remain continuously illuminated. This sequence will continue upon subsequent vehicle start-ups as long as the malfunction exists. When the malfunction indicator is illuminated, the system may not be able to detect or signal low tire pressure as intended.

TPMS malfunctions may occur for a variety of reasons, including the installation of replacement or alternate tires or wheels on the vehicle that prevent the TPMS from functioning properly. Always check the TPMS malfunction telltale after replacing one or more tires or wheels on your vehicle to ensure that the replacement or alternate tires and wheels allow the TPMS to continue to function properly.

Flat Tire Monitor FTM

Concept

The system detects tire inflation pressure loss on the basis of rotation speed differences between the individual wheels while driving.

In the event of a tire inflation pressure loss, the diameter and therefore the rotational speed of the corresponding wheel changes. The difference will be detected and reported as a flat tire.

The system does not measure the actual inflation pressure in the tires.

Functional requirements

The following conditions must be met for the system; otherwise, reliable flagging of a loss of tire inflation pressure is not assured:

- ▷ After a tire or wheel replacement, an initialization was performed with the correct tire inflation pressure.
- ▷ After the tire pressure was adjusted to a new value, an initialization was performed.

Status display

The current status of the Flat Tire Monitor FTM can be displayed, for instance whether the FTM is active.

Via iDrive:

1. "CAR"
2. "Vehicle status"
3. (⚠) "Flat Tire Monitor"

The status is displayed.

Initialization required

An initialization must be performed in the following situations:

- ▷ After the tire inflation pressure has been adjusted.
- ▷ After a tire or wheel replacement.

Performing initialization

When initializing, the set tire inflation pressures serve as reference values in order to detect a flat tire. Initialization is started by confirming the tire inflation pressures.

Do not initialize the system when driving with snow chains.

Via iDrive:

1. "CAR"
2. "Vehicle status"
3. "Flat Tire Monitor"
4. Switch on drive-ready state and do not drive off.
5. Start the initialization with: "Perform reset"
6. Drive away.

The initialization is completed while driving, which can be interrupted at any time.

The initialization automatically continues when driving resumes.

Messages

General information

When a flat tire is indicated, DSC Dynamic Stability Control is switched on, if needed.

Safety information

Warning

A damaged regular tire with low or missing tire inflation pressure impacts handling, such as steering and braking response. Run-flat tires can maintain limited stability. There is a risk of accident. Do not continue driving if the vehicle is equipped with normal tires. Follow the information on run-flat tires and continued driving with these tires.

Indication of a flat tire



A yellow warning light is illuminated in the instrument cluster.

In addition, a symbol with a Check Control message appears on the Control Display.

Symbol Possible cause



There is a flat tire or a major loss in tire inflation pressure.

Measure

1. Reduce your speed and stop cautiously. Avoid sudden braking and steering maneuvers.
2. Check whether the vehicle is fitted with normal tires or run-flat tires.
Run-flat tires, refer to page 352, are labeled with a circular symbol containing the letters RSC marked on the tire's sidewall.

Actions in the event of a flat tire

Normal tires

1. Identify the damaged tire.
To do this, check the tire inflation pressure in all four tires, for instance using the tire pressure gage of a flat tire kit.

When the tire inflation pressure in all four tires is correct, the Flat Tire Monitor FTM may not have been initialized. In this case, initialize the system.

If identification of flat tire damage is not possible, please contact a dealer's service center or another qualified service center or repair shop.

2. Repair the flat tire, e.g., with a flat tire kit or by changing the wheel.

Run-flat tires

Safety information

Warning

The vehicle handles differently when a run-flat tire has insufficient or no tire pressure; for instance, reduced lane stability when braking, braking distances are longer and the self-steering properties will change. There is a risk of accident. Drive moderately and do not exceed a speed of 50 mph/80 km/h.

Warning

Heavy trailers can start swinging when continuing to drive with a flat tire. There may be a risk of accident or risk of damage to property. Do not exceed a speed of 35 mph/60 km/h when driving with a trailer and a flat tire. Immediately brake in the case of swinging. Apply necessary steering corrections as carefully as possible.

Maximum speed

You may continue driving with a damaged tire at speeds up to 50 mph/80 km/h.

Continued driving with a flat tire

Follow the following when continuing to drive with a damaged tire:

1. Avoid sudden braking and steering maneuvers.
2. Do not exceed a speed of 50 mph/80 km/h.
3. Check the tire inflation pressure in all four tires at the next opportunity.
When the tire inflation pressure in all four tires is correct, the Flat Tire Monitor may not have been initialized. In this case, initialize the system.

Possible driving range with a depressurized tire

The distance for which it may be possible to drive safely varies depending on how the vehicle is loaded and used, e.g., speed, road conditions, external temperature. The driving range may be less but may also be more if an economical driving style is used.

If the vehicle is loaded with an average weight and used under favorable conditions, the distance for which it may be safe to drive may be up to 50 miles/80 km.

Vehicle handling with damaged tires

Vehicles driven with a damaged tire will handle differently, potentially leading to conditions such as the following:

- ▷ Greater likelihood of swerving off course.
- ▷ Longer braking distances.
- ▷ Changed self-steering properties.

Modify your driving style. Avoid abrupt steering maneuvers or driving over obstacles, for instance curbs or potholes.

Final tire failure

Vibrations or loud noises while driving can indicate the final failure of a tire.

Reduce speed and stop; otherwise, pieces of the tire could come loose and cause an accident.

Do not continue driving. Contact a dealer's service center or another qualified service center or repair shop.

System limits

The system could be delayed or malfunction in the following situations:

- ▷ A natural, even tire inflation pressure loss in all four tires will not be recognized. Therefore, check the tire inflation pressure regularly.
- ▷ Sudden serious tire damage caused by external circumstances cannot be recognized in advance.
- ▷ The system has not been initialized.
- ▷ When driving on a snowy or slippery road surface.
- ▷ Sporty driving style: spinning traction wheels, high lateral acceleration (drifting).
- ▷ When driving with snow chains.

Changing wheels/tires

General information

When using run-flat tires or a flat tire kit, a wheel does not always need to be changed immediately when there is a loss of tire inflation pressure due to a flat tire.

If needed, the tools for changing wheels are available as accessories from a dealer's service center or another qualified service center or repair shop.

Safety information

DANGER

The vehicle jack is only provided for short-term lifting of the vehicle for wheel changes. Even if all safety measures are observed, there is a risk of the raised vehicle falling, if the vehicle jack tips over. There is a risk of injuries or danger to

life. If the vehicle is raised, do not lie under the vehicle and do not start the engine.

⚠ DANGER

Supports such as wooden blocks under the vehicle jack reduce the capacity of the vehicle jack to bear weight. They have the potential to exert too much strain on the vehicle jack, causing it to tip over and the vehicle to fall. There is a risk of injuries or danger to life. Do not place supports under the vehicle jack.

⚠ Warning

The jack, issued by the vehicle manufacturer, is provided in order to perform a wheel change in the event of a breakdown. The jack is not designed for frequent use; for example, changing from summer to winter tires. Using the jack frequently may cause it to become jammed or damaged. There is a risk of injury and risk of damage to property. Only use the jack to attach an emergency or spare wheel in the event of a breakdown.

⚠ Warning

On soft, uneven or slippery ground, for example snow, ice, tiles, etc., the vehicle jack can slip away. There is a risk of injury. If possible, change the wheel on a flat, solid, and slip-resistant surface.

⚠ Warning

The vehicle jack is optimized for lifting the vehicle and for the jacking points on the vehicle only. There is a risk of injury. Do not lift any other vehicle or cargo using the vehicle jack.

⚠ Warning

When the vehicle jack is not inserted into the jacking point provided for this purpose, the vehicle may be damaged or the vehicle jack may slip when it is being cranked up. There is a risk of injury or risk of damage to property. When cranking up the vehicle jack, ensure that it is inserted in the jacking point next to the wheel housing.

⚠ Warning

A vehicle that is raised on a vehicle jack may fall off of the jack if lateral forces are exerted on it. There is a risk of injury and risk of damage to property. While the vehicle is raised, do not exert lateral forces on the vehicle or pull abruptly on the vehicle. Have a stuck wheel removed by a dealer's service center or another qualified service center or repair shop.

Securing the vehicle against rolling

General information

The vehicle manufacturer recommends to additionally secure the vehicle against rolling away when changing a wheel.

On a level surface



Place wheel chocks or other suitable objects in front and behind the wheel that is diagonal to the wheel to be changed.

On a slight downhill gradient



If you need to change a wheel on a slight downhill grade, place chocks and other suitable objects, for instance a rock, under the wheels of both the front and rear axles against the rolling direction.

Lug bolt lock

Concept

The wheel lug bolts have a special coding. The lug bolts can only be released with the adapter which matches the coding.

Overview

The adapter of the lug bolt lock is in the onboard vehicle tool kit or in a storage compartment close to the onboard vehicle tool kit.

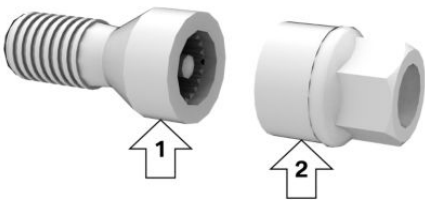

- ▷ Lug bolt, arrow 1.
- ▷ Adapter, arrow 2.

Unscrewing

1. Attach the adapter to the lug bolt.
2. Unscrew the lug bolt.

3. Remove the adapter after unscrewing the lug bolt.

Screwing on

1. Attach the adapter to the lug bolt. If necessary, turn the adapter until it fits on the lug bolt.
2. Screw on the lug bolt. The tightening torque is 140 Nm.
3. Remove the adapter and stow it after screwing on the lug bolt.

Preparing the vehicle

- ▷ Park the vehicle on solid and non-slip ground at a safe distance from traffic.
- ▷ Switch on the hazard warning system.
- ▷ Set the parking brake.
- ▷ Engage a gear or move the selector lever to position P.
- ▷ As soon as permitted by the traffic flow, have all vehicle occupants get out of the vehicle and ensure that they remain outside the immediate area in a safe place, such as behind a guardrail.
- ▷ Depending on the vehicle equipment, get wheel change tools and, if necessary, the emergency wheel from the vehicle.
- ▷ If necessary, set up a warning triangle or portable hazard warning light at an appropriate distance.
- ▷ Secure the vehicle additionally against rolling.
- ▷ Loosen the lug bolts a half turn.
- ▷ Deactivate the air suspension level adjustment, refer to page [272](#).

Jacking points for the vehicle jack

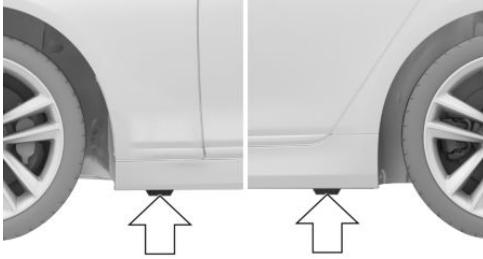

The jacking points for the vehicle jack are located at the indicated positions.

Jacking up the vehicle

Warning

Hands and fingers can be jammed when using the vehicle jack. There is a risk of injury. Comply with the described hand position and do not change this position while using the vehicle jack.

1. Hold the vehicle jack with one hand, arrow 1, and grasp the vehicle jack crank or lever with your other hand, arrow 2.

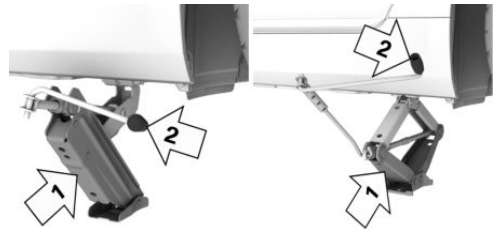

2. Insert the vehicle jack into the rectangular recess of the jacking point closest to the wheel to be changed.

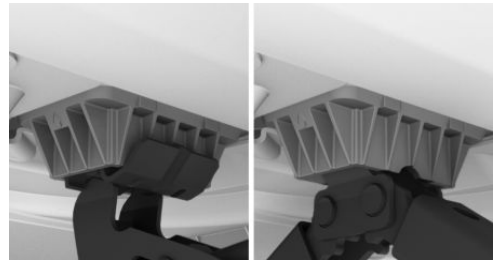

- Extend the vehicle jack by turning the vehicle jack crank or lever clockwise.



- Take your hand away from the vehicle jack as soon as the vehicle jack is under load and continue turning the vehicle jack crank or lever with one hand.
- Make sure that the vehicle jack foot stands vertically and at a right angle beneath the jacking point.

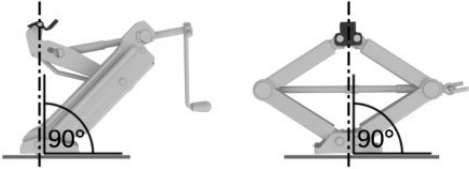

- Make sure that the vehicle jack foot stands vertically and perpendicularly beneath the jacking point after extending the vehicle jack.

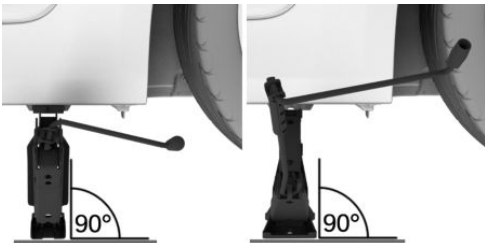

- Crank the vehicle up, until the vehicle jack is with the entire surface on the ground and the relevant wheel is maximum 1.2 inches/3 cm above ground.

Mounting a wheel

Warning

Unsuitable wheel studs, such as single-section wheel studs, may loosen or come off. The wheel may come loose during driving. There is a risk of accident. Use only two-section wheel studs that have been categorized as suitable for the respective wheel type by the manufacturer of the vehicle.

Mount one emergency wheel only, as required.

- Unscrew the lug bolts.
- Remove the wheel.
- Put the new wheel or emergency wheel on and screw in at least two lug bolts in a crosswise pattern until hand-tight.

When non-original light-alloy wheels of the vehicle manufacturer are mounted, the accompanying lug bolts may have to be used as well.

- Hand-tighten the remaining lug bolts and tighten all lug bolts well in a crosswise pattern.
- Turn the vehicle jack crank counterclockwise to retract the vehicle jack and lower the vehicle.
- Remove the vehicle jack and stow it securely.

After the wheel change

- Tighten the lug bolts crosswise. The tightening torque is 101 lbs ft/140 Nm.
- Stow the nonworking wheel in the cargo area, if necessary.

The nonworking wheel cannot be stored under the cargo floor panel because of its size.

- Check tire inflation pressure at the next opportunity and correct as needed.
- Reinitialize the Flat Tire Monitor.
Reset the Tire Pressure Monitor TPM.

5. Check to make sure the lug bolts are tight with a calibrated torque wrench.
6. Have the damaged tire replaced at the nearest dealer's service center or another qualified service center or repair shop.

Emergency wheel

Concept

In the event of a flat tire, the emergency wheel can be used in place of the wheel with the defective tire. The emergency wheel is only intended for temporary use until the defective tire/wheel has been replaced.

General information

Mount one emergency wheel only.

Also check the tire inflation pressure of the emergency wheel in the cargo area regularly, and correct it as needed.

Safety information

Warning

The emergency wheel has particular dimensions. When driving with an emergency wheel, changed driving properties may occur, for instance reduced lane stability when braking, longer braking distance, and changed self-steering properties in the limit area. There is a risk of accident. Drive moderately and do not exceed a speed of 50 mph/80 km/h.

Overview

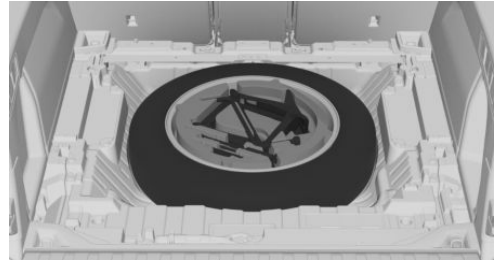

The emergency wheel and the wheel change tools are located in the cargo area under the cargo floor panel.

Removing the emergency wheel

1.  Depending on the vehicle equipment: press the button. The electric cargo cover travels up.
2. Fold up the cargo floor panel.
3. Depending on the equipment version: remove the crossmember. For this purpose, remove the wingnuts on both sides of the crossmember.
4. Remove the tool holder from the emergency wheel.
5. Unscrew the butterfly screw, arrow 1.

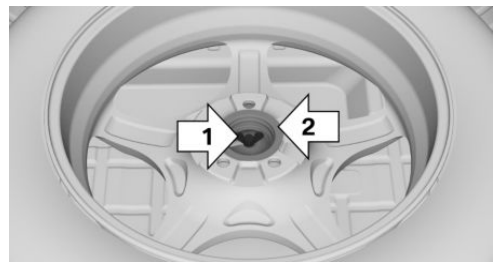

6. Remove retaining plate, arrow 2.
7. If necessary, open the lower tailgate.
8. Remove the emergency wheel from the storage well.

Inserting the emergency wheel

1.  Depending on the vehicle equipment: press the button. The electric cargo cover travels up.
2. Fold up the cargo floor panel.
3. Open the lower tailgate.
4. Place the emergency wheel in the storage well.
5. Position the retaining plate.
6. Screw on and tighten the butterfly screw.
7. Insert the tool holder.
8. Depending on the vehicle equipment: insert the crossmember and screw it tight with the wingnuts.
9. Push the cargo floor panel downward.

Engine compartment

Vehicle features and options

This chapter describes all standard, country-specific and optional features offered with the series. It also describes features and functions that are

not necessarily available in your vehicle, e.g., due to the selected options or country versions. This also applies to safety-related functions and systems. When using these functions and systems, the applicable laws and regulations must be observed.

Overview

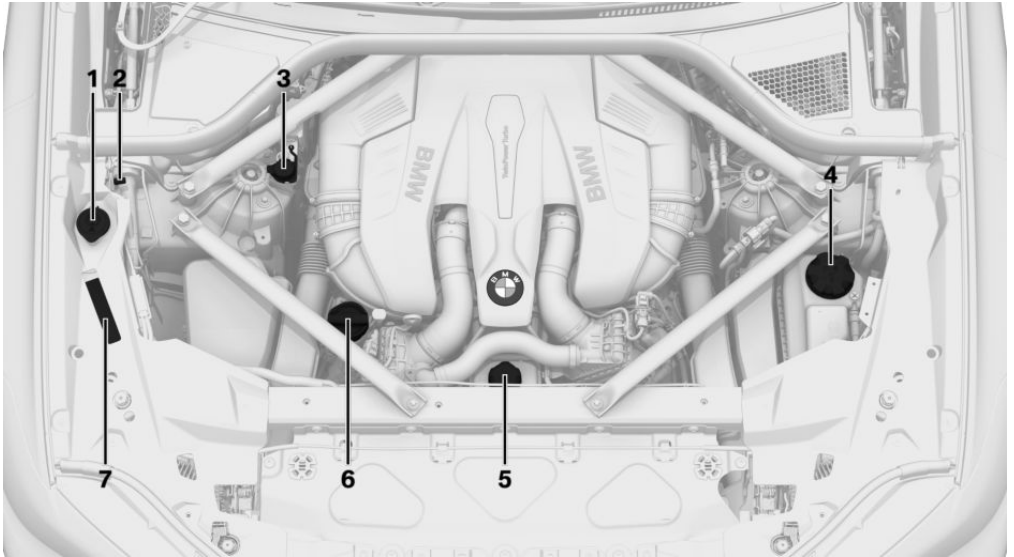

- | | |
|---|--|
| <ul style="list-style-type: none"> 1 Filler neck for washer fluid 2 Jump-starting, negative battery terminal 3 Jump-starting, positive battery terminal 4 Coolant reservoir, engine | <ul style="list-style-type: none"> 5 Gasoline engine only: coolant reservoir, auxiliary cooling 6 Oil filler neck 7 Vehicle identification number |
|---|--|

Hood

Safety information

Warning

Improperly executed work in the engine compartment can damage vehicle components and impair vehicle functions. There is a risk of an accident and damage to property. Have work in the engine compartment performed by a dealer's service center or another qualified service center or repair shop.

Warning

The engine compartment accommodates moving components. Certain components in the engine compartment can also move with the vehicle switched off, for instance the radiator fan. There is a risk of injury. Do not reach into the area of moving parts. Keep articles of clothing and hair away from moving parts.

Warning

There are protruding parts, for instance locking hook, on the inside of the hood. There is a risk of injury. If the hood is open, pay attention to protruding parts and keep clear of these areas.

Warning

An incorrectly locked hood can open while driving and restrict visibility. There is a risk of accident. Stop immediately and correctly close the hood.

Warning

Body parts can be jammed when opening and closing the hood. There is a risk of injury. Make sure that the area of movement of the hood is clear during opening and closing.

NOTICE

Folded-away wipers can be jammed when the hood is opened. There is a risk of damage to property. Make sure that the wipers with the wiper blades mounted are folded down onto the windshield before opening the hood.

NOTICE

When the hood is closed, it must engage on both sides. Pressing again can damage the hood. There is a risk of damage to property. Open the hood again and then close it energetically. Avoid pressing again.

Opening

1. Pull lever, arrow 1.

Hood is unlocked.



2. After the lever is released, pull the lever again, arrow 2.
Hood can be opened.
3. Be careful of protruding parts on the hood.

Closing

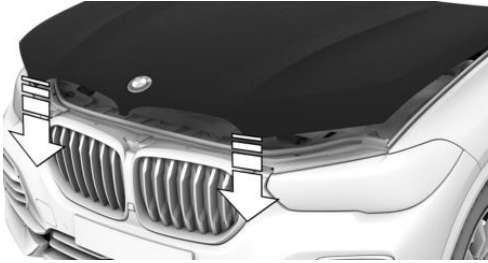

Energetically close the hood from approx.
20 in/50 cm.

The hood must engage on both sides.

Operating materials

Vehicle features and options

This chapter describes all standard, country-specific and optional features offered with the series. It also describes features and functions that are not necessarily available in your vehicle, e.g., due to the selected options or country versions. This also applies to safety-related functions and systems. When using these functions and systems, the applicable laws and regulations must be observed.

Fuel recommendation

General information

Depending on the region, many gas stations sell fuel that has been customized to winter or summer conditions. Fuel that is available in winter, for instance helps make a cold start easier.

Gasoline

General information

For the best fuel efficiency, the gasoline should be sulfur-free or very low in sulfur content.

Fuels that are marked on the gas pump as containing metal must not be used.

Fuels with a maximum ethanol content of 25 %, i. e. E10 or E25, may be used for refueling.

Ethanol should meet the following quality standards:

US: ASTM 4806–xx

CAN: CGSB-3.511–xx

xx: comply with the current standard in each case.

Safety information

CAUTION

The use of poor-quality fuels may result in harmful engine deposits or damage. Additionally, problems relating to drivability, starting and stalling, especially under certain environmental conditions such as high ambient temperature and high altitude, may occur.

If drivability problems are encountered, we recommend switching to a high quality gasoline brand and a higher octane grade — AKI number — for a few tank fills. To avoid harmful engine deposits, it is highly recommended to purchase gasoline from Top Tier retailers.

Failure to comply with these recommendations may result in the need for unscheduled maintenance.

NOTICE

Even small quantities of the wrong fuel or wrong fuel additives can damage the fuel system and engine. Furthermore, the catalytic converter is permanently damaged. There is a risk of damage to property. Do not refuel or add the following in the case of gasoline engines:

- ▷ Leaded gasoline.
- ▷ Metallic additives, for instance manganese or iron.

Do not press the Start/Stop button after refueling with the wrong fuel. Contact a dealer's service center or another qualified service center or repair shop.

⚠ NOTICE

Incorrect fuels can damage the fuel system and the engine. There is a risk of damage to property. Do not use fuels with a higher percentage of ethanol than recommended. Do not refuel with fuels containing methanol, e.g. M5 to M100.

⚠ NOTICE

Fuel that does not comply with the minimum quality can compromise engine function or cause engine damage. There is a risk of damage to property. Do not fill with fuel that does not comply with the minimum quality.

Recommended fuel grade

BMW recommends AKI 91.

Refuel with this gasoline to achieve the rated performance and consumption values.

Minimum fuel grade

BMW recommends AKI 89.

If you use gasoline with this minimum AKI Rating, the engine may produce knocking sounds when starting at high external temperatures. This has no effect on the engine life.

BMW recommends
Shell Quality Fuels 

Engine oil

General information

The engine oil consumption is dependent on your driving style and driving conditions.

Therefore, regularly check the engine oil level after refueling by taking a detailed measurement.

The engine oil consumption can increase in the following situations, for instance:

- ▷ Sporty driving style.
- ▷ Break-in of the engine.
- ▷ Idling of the engine.
- ▷ With use of engine oil types that are classified as not suitable.

Different Check Control messages appear on the Control Display depending on the engine oil level.

Safety information

⚠ NOTICE

An engine oil level that is too low causes engine damage. There is a risk of damage to property. Immediately add engine oil.

⚠ NOTICE

Too much engine oil can damage the engine or the catalytic converter. There is a risk of damage to property. Do not add too much engine oil. When too much engine oil is added, have the engine oil level corrected by a dealer's service center or another qualified service center or repair shop.

Electronic oil measurement

General information

The electronic oil measurement has two measuring principles:

- ▷ Monitoring.
- ▷ Detailed measurement.

When making frequent short-distance trips or using a dynamic driving style, for instance when taking curves aggressively, regularly perform a detailed measurement.

Monitoring

Concept

The engine oil level is monitored electronically while driving and can be shown on the Control Display.

If the engine oil level is outside its permissible operating range, a Check Control message is displayed.



A red indicator light indicates that the engine oil pressure is too low.

Functional requirements

A current measured value is available after approx. 30 minutes of normal driving.

Displaying the engine oil level

Via iDrive:

1. "CAR"
2. "Vehicle status"
3.  "Engine oil level"

The engine oil level is displayed.

System limits

When making frequent short-distance trips or using a dynamic driving style, it may not be possible to calculate a measured value. In this case, the measured value for the last, sufficiently long trip is displayed.

Detailed measurement

Concept

The engine oil level is checked when the vehicle is stationary and displayed via a scale.

If the engine oil level is outside its permissible operating range, a Check Control message is displayed.

General information

During the measurement, the idle speed is increased somewhat.

Functional requirements

- ▷ Vehicle is parked in a horizontal position.
- ▷ Selector lever in selector lever position N or P and accelerator pedal not depressed.
- ▷ The drive-ready state is switched on by pressing the Start/Stop button.
- ▷ Engine is running and is at operating temperature.

Performing a detailed measurement

Via iDrive:

1. "CAR"
2. "Vehicle status"
3.  "Engine oil level"
4. "Engine oil measurement"
5. "Start measurement"

The engine oil level is checked and displayed via a scale.

Adding engine oil

General information

Only add engine oil when the message is displayed in the instrument cluster. The quantity to be added is indicated in the message shown on the Control Display.

Only add suitable types of engine oil.

Safely park the vehicle and switch off drive-ready state before adding engine oil.

Take care not to add too much engine oil.

Safety information

Warning

Operating materials, for instance oils, greases, coolants, fuels, can contain harmful ingredients. There is a risk of injuries or danger to life. Follow the instructions on the containers. Avoid the contact of articles of clothing, skin or eyes with operating materials. Do not refill operating materials into different bottles. Store operating materials out of reach of children.

NOTICE

An engine oil level that is too low causes engine damage. There is a risk of damage to property. Immediately add engine oil.

NOTICE

Too much engine oil can damage the engine or the catalytic converter. There is a risk of damage to property. Do not add too much engine oil. When too much engine oil is added, have the engine oil level corrected by a dealer's service center or another qualified service center or repair shop.

Overview

The oil filler neck is located in the engine compartment, refer to page 375.

Adding engine oil

1. Open the hood, refer to page 376.
2. Open the lid counterclockwise.



3. Add engine oil.
4. Close the lid.

Engine oil types to add

General information

The engine oil quality is critical for the life of the engine.

Only add the types of engine oil which are listed.

Safety information

NOTICE

Oil additives can damage the engine. There is a risk of damage to property. Do not use oil additives.

NOTICE

Incorrect engine oil can cause malfunctions in the engine or damage it. There is a risk of damage to property. When selecting an engine oil, make sure that the engine oil has the correct oil rating.

Suitable engine oil types

Add engine oils that meet the following oil rating standards:

Gasoline engine

BMW Longlife-01 FE.

BMW Longlife-14 FE+.

BMW Longlife-17 FE+.

The BMW Longlife-14 FE+ and BMW Longlife-17 FE+ oil ratings are not suitable for the 50i gasoline engine.

Alternative engine oil types

If an engine oil suitable for continuous use is not available, up to 1 US quart/liter of an engine oil with the following oil rating can be added:

Oil rating

API SL.

API SM.

API SN.

Viscosity grades

Viscosity grades

SAE 0W-20.

SAE 0W-30.

The viscosity grade SAE 0W-20 is not suitable for gasoline engine 50i.

More information about suitable oil ratings and viscosity grades of engine oils can be requested from a dealer's service center or another qualified service center or repair shop.

Engine oil change

NOTICE

Engine oil that is not changed in timely fashion can cause increased engine wear and thus engine damage. There is a risk of damage to property. It is recommended that you do not

exceed the service intervals indicated in the vehicle.

The vehicle manufacturer recommends that you have a dealer's service center or another qualified service center or repair shop change the engine oil.

BMW recommends Original BMW Engine Oil.

Coolant

General information

Coolant consists of water and additives.

Not all commercially available additives are suitable for the vehicle. Do not mix additives of different colors. Observe the water - additive mixing ratio of 50:50. Information about suitable additives is available from a dealer's service center or another qualified service center or repair shop.

Safety information

Warning

With the engine hot and the cooling system open, coolant can escape and lead to scalding. There is a risk of injury. Only open the cooling system with the engine cooled down.

Warning

Additives are harmful and incorrect additives can damage the engine. There is a risk of injury and risk of damage to property. Do not allow additives to come into contact with skin, eyes

or articles of clothing. Use suitable additives only.

Coolant level

General information

Vehicles with gasoline engine feature two cooling circuits. Always check the coolant levels of both coolant reservoirs and refill as needed.

The coolant level is indicated using minimum and maximum markings in the filler neck of the coolant reservoir.

Depending on the engine installation, the coolant reservoir is located on the right side or the left side of the engine compartment, refer to page 375.

Checking the coolant level

1. Let the engine cool.
2. Open the hood, refer to page 376.
3. Turn the lid of the coolant reservoir slightly counterclockwise to allow any excess pressure to dissipate, then open it.
4. Open the coolant reservoir lid.
5. The coolant level is correct if it lies between the minimum and maximum marks in the filler neck.

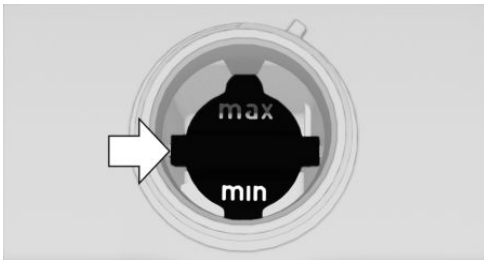

6. Close the lid.

Adding

1. Let the engine cool.
2. Open the hood, refer to page 376.

3. Turn the lid of the coolant reservoir slightly counterclockwise to allow any excess pressure to dissipate, then open it.
4. Open the coolant reservoir lid.
5. If the coolant is low, slowly add coolant up to the specified level; do not overfill.
6. Close the lid.
7. Have the cause of the coolant loss eliminated as soon as possible.

Disposal



Comply with the relevant environmental protection regulations when disposing of coolant and coolant additives.

Washer fluid

General information

All washer nozzles are supplied from one reservoir.

Use a mixture of tap water and windshield washer concentrate. If desired, a windshield washer concentrate containing antifreeze can be used.

Recommended minimum fill quantity:
0.2 US gal/1 liter.

Safety information

Warning

Some antifreeze agents can contain harmful substances and are flammable. There is a risk of fire and a risk of injury. Follow the instructions on the containers. Keep antifreeze away from ignition sources. Do not refill operating materials into different bottles. Store operating materials out of reach of children.

United States: the washer fluid mixture ratio is regulated by the U.S. EPA and many individual states; do not exceed the allowable washer fluid dilution ratio limits that apply. Follow the usage instructions on the washer fluid container.

Use of BMW's Windshield Washer Concentrate or the equivalent is recommended.

Overview



The washer fluid reservoir is located in the engine compartment.

Malfunction

The use of undiluted windshield washer concentrate or alcohol-based antifreeze can lead to incorrect readings at temperatures below +5 °F/-15 °C.

Warning

Washer fluid can ignite and catch fire on contact with hot engine parts. There is a risk of injury or risk of damage to property. Only add washer fluid when the engine is cooled down. Next, fully close the lid of the washer fluid reservoir.

NOTICE

Silicon-containing additives in the washer fluid for the water-repelling effect on the windows can lead to damage to the washing system. There is a risk of damage to property. Do not add silicon-containing additives to the washer fluid.

NOTICE

Mixing different windshield washer concentrates or antifreeze can damage the washing system. There is a risk of damage to property. Do not mix different windshield washer concentrates or antifreeze. Follow the information and mixing ratios provided on the containers.

Maintenance

Vehicle features and options

This chapter describes all standard, country-specific and optional features offered with the series. It also describes features and functions that are not necessarily available in your vehicle, e.g., due to the selected options or country versions. This also applies to safety-related functions and systems. When using these functions and systems, the applicable laws and regulations must be observed.

BMW maintenance system

The maintenance system provides service notifications and thereby provides support in maintaining road safety and the operational reliability of the vehicle.

In some cases, scopes and intervals of the maintenance system may vary according to the country version. Replacement work, spare parts, fuels and lubricants, and wear materials are calculated separately. Further information is available from a dealer's service center or another qualified service center or repair shop.

Condition Based Service CBS

Concept

Sensors and special algorithms take into account the driving conditions of the vehicle. CBS uses these to calculate the need for maintenance.

The system makes it possible to adapt the amount of maintenance corresponding to your user profile.

General information

Information on service notifications, refer to page 161, can be displayed on the Control Display.

Service data in the vehicle key

Information on the service notifications is continuously stored in the vehicle key. The service center can read this data out and suggest a maintenance scope for the vehicle.

Therefore, hand the service advisor the vehicle key with which the vehicle was driven most recently.

Storage periods

Storage periods during which the vehicle battery was disconnected are not taken into account.

If this occurs, have a dealer's service center or another qualified service center or repair shop update the time-dependent maintenance procedures, such as checking brake fluid and, if necessary, changing the engine oil and the microfilter/activated-charcoal filter.

Maintenance Manual and Service and Warranty Information Booklet for US models and Warranty and Service Guide Booklet for Canadian models

Please consult your Maintenance Manual and Service and Warranty Information Booklet for US models and Warranty and Service Guide Booklet for Canadian models for additional information on the performance of service and maintenance work.

The manufacturer of your vehicle recommends that maintenance and repair be performed by a service center or another qualified service center or repair shop. Records of regular maintenance and repair work should be retained.

Socket for OBD Onboard Diagnosis

General information

Devices connected to the OBD socket trigger the alarm system when the vehicle is locked. Remove any devices connected at the OBD socket before locking the vehicle.

Safety information

NOTICE

The socket for Onboard Diagnosis is an intricate component intended to be used in conjunction with specialized equipment to check the vehicle's primary emissions system. Improper use of the socket for Onboard Diagnosis, or contact with the socket for Onboard Diagnosis for other than its intended purpose, can cause vehicle malfunctions and creates risks of personal and property damage. Given the foregoing, the manufacture of your vehicle strongly recommends that access to the socket for Onboard Diagnosis be limited to a dealer's service center or another qualified service center or repair shop or other persons that have the specialized training and equipment for purposes of properly utilizing the socket for Onboard Diagnosis.

Position



There is an OBD socket on the driver's side for checking the primary components in the vehicle's emissions.

Emissions



- ▶ The warning light lights up: Emissions are deteriorating. Have the vehicle checked as soon as possible.
- ▶ The warning light flashes under certain circumstances: This indicates that there is excessive misfiring in the engine. Reduce the vehicle speed and have the system checked immediately; otherwise, serious engine misfiring within a brief period can seriously damage emission control components, in particular the catalytic converter.

Replacing components

Vehicle features and options

This chapter describes all standard, country-specific and optional features offered with the series. It also describes features and functions that are not necessarily available in your vehicle, e.g., due to the selected options or country versions. This also applies to safety-related functions and systems. When using these functions and systems, the applicable laws and regulations must be observed.

Vehicle tool kit

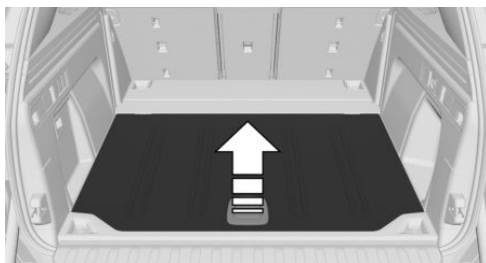

The onboard vehicle tool kit is located under the cargo floor panel.

Wiper blades

Safety information

⚠ NOTICE

The window may sustain damage if the wiper falls onto it without the wiper blade installed. There is a risk of damage to property. Hold the wiper firmly when changing the wiper blade. Do

not fold or switch on the wiper without a wiper blade installed.

⚠ NOTICE

Folded-away wipers can be jammed when the hood is opened. There is a risk of damage to property. Make sure that the wipers with the wiper blades mounted are folded down onto the windshield before opening the hood.

Replace front wiper blades

1. To change the wiper blades, fold up the wiper arms, refer to page 145.
2. Lift the wiper off of the windshield and hold.



3. Press the button, arrow 1, and pull out the wiper blade, arrow 2.

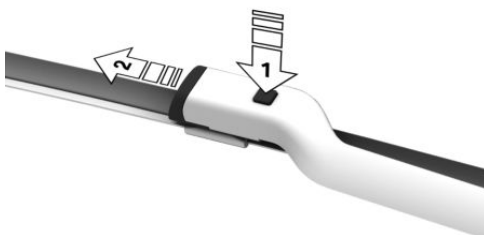

4. Insert the new wiper blade and press it on until it you hear it snap into the holder.
5. Fold down the wipers.

Replacing the rear wiper blade

The wiper blade is engaged at the end of the wiper arm.

1. Lift off the wiper fully and pull off the wiper blade, arrow.



2. Attach a new wiper blade. The wiper blade must engage audibly.
3. Fold down the wipers.

Lights and bulbs

General information

Lights and bulbs make an essential contribution to vehicle safety.

All headlights and lights are made using LED or laser technology.

Some items of equipment use light-emitting diodes installed behind a cover as a light source. These light-emitting diodes are related to conventional lasers and are officially designated as Class 1 light-emitting diodes.

The manufacturer of the vehicle recommends that you let a dealer's service center or another qualified service center or repair shop perform the work in case of a malfunction.

Safety information

⚠ Warning

Focused laser light can irritate or permanently damage the retina of the eye. There is a risk of injury. The manufacturer of your vehicle recommends that the work on the lighting system including bulb replacement be performed by a dealer's service center or another qualified service center or repair shop.

⚠ Warning

Intensive brightness can irritate or damage the retina of the eye. There is a risk of injury. Do not look directly into the headlights or other light sources. Do not remove the LED covers.

Headlight glass

Condensation can form on the inside of the headlight glass in cool or humid weather. When driving with the lights switched on, the condensation evaporates after a short time. The headlight glass does not need to be changed.

If despite driving with the headlights switched on, increasing humidity forms, for instance water droplets in the light, have the headlights checked.

Vehicle battery

General information

The battery is maintenance-free.

More information about the battery can be requested from a dealer's service center or another qualified service center or repair shop.

Safety information

Warning

Vehicle batteries that are not compatible can damage vehicle systems and impair vehicle functions. There is a risk of an accident and damage to property. Only vehicle batteries that are compatible with your vehicle type should be installed in your vehicle. Information on compatible vehicle batteries is available at your dealer's service center.

Register the battery to the vehicle

The manufacturer of the vehicle recommends that you have a service center or another qualified service center or repair shop register the vehicle battery to the vehicle after the battery has been replaced. Once the battery has been registered again, all comfort features will be available without restriction and any Check Control messages displayed which relate to comfort features will disappear.

Charging the battery

General information

Make sure that the battery is always sufficiently charged to guarantee that the battery remains usable for its full service life.



A discharged battery is indicated by a red indicator light.

Charge the battery in the following situations:

- ▶ When the inspection glass on the top of the battery is black.
- ▶ When the take-off performance is insufficient.

The following circumstances can have a negative effect on the performance of the battery:

- ▶ Frequent short-distance drives.
- ▶ The vehicle is not used for more than a month.

Safety information

NOTICE

Battery chargers for the vehicle battery can work with high voltages and currents, which means that the 12 volt on-board network can be overloaded or damaged. There is a risk of damage to property. Only connect battery chargers for the vehicle battery to the starting aid terminals in the engine compartment.

Charging the battery

Charge the battery only when the engine is off and via the starting aid terminals, refer to page 395, in the engine compartment.

Power failure

After a power loss, some equipment needs to be newly initialized or individual settings updated, for example:

- ▶ With Memory function: store the positions again.
- ▶ Time: update.
- ▶ Date: update.
- ▶ Glass sunroof: initialize the system.

Disposing of old batteries



Have old batteries disposed of by a dealer's service center or another qualified service center or repair shop or take them to a collection point.

Maintain the filled battery in an upright position for transport and storage. Secure the battery so that it does not tip over during transport.

Fuses

General information

The fuses are located at different places in the vehicle.

Information on the fuse types and locations and the positions of the fuse boxes is available on the Internet: www.bmw.com/fusecard.

Safety information

Warning

Incorrect and repaired fuses can overload electrical lines and components. There is a risk of fire. Never attempt to repair a blown fuse. Do not replace a nonworking fuse with a substitute of another color or amperage rating.

Replacing fuses

The vehicle manufacturer recommends that you have a dealer's service center or another qualified service center or repair shop replace the fuses.

Breakdown assistance

Vehicle features and options

This chapter describes all standard, country-specific and optional features offered with the series. It also describes features and functions that are not necessarily available in your vehicle, e.g., due to the selected options or country versions. This also applies to safety-related functions and systems. When using these functions and systems, the applicable laws and regulations must be observed.

Hazard warning flashers



The button is located in the center console.

The red light in the button flashes when the hazard warning flashers are activated.

Warning triangle

1. Unlock the cover of the left side panel, arrow 1, and fold open, arrow 2.

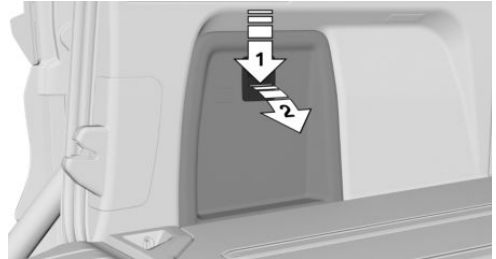

2. Take the warning triangle out in the direction of the car's interior.



First-aid kit

General information

Some of the articles have a limited service life.

Check the expiration dates of the contents regularly and replace any expired items promptly.

Storage

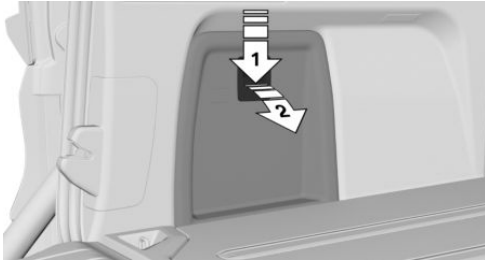

The first-aid kit is located in the left storage compartment of the cargo area.

Unlock the cover of the left side panel, arrow 1, and fold open, arrow 2.

BMW Roadside Assistance

Concept

Contact the BMW Group Roadside Assistance if assistance is needed in the event of a breakdown.

General information

In the event of a breakdown, data on the vehicle's condition is transmitted to the BMW Roadside Assistance.

There are various ways of contacting BMW Roadside Assistance.

- ▷ Via a Check Control message, refer to page 156.
- ▷ Calling with a mobile phone.
- ▷ Via the BMW Connected app.

Functional requirements

- ▷ Active ConnectedDrive contract, equipment with intelligent emergency call or BMW ConnectedDrive services.
- ▷ Cellular network reception.
- ▷ Standby state is switched on.

Starting manually

If the vehicle is equipped with Teleservices, support is offered through Teleservice Diagnosis.

Via iDrive:

1. "APPS"
2. "Installed apps"
3. "BMW Assist"
4. If necessary, "BMW Roadside Assistance"

A voice connection is established.

Teleservice Diagnosis

Teleservice Diagnosis enables the wireless transmission of detailed vehicle data that is important for vehicle diagnosis. This data is transmitted automatically. It may be necessary to approve this on the Control Display.

Teleservice Help

Depending on the country, Teleservice Help enables an in-depth diagnosis of the vehicle by BMW Roadside Assistance via wireless transmission.

You can launch Teleservice Help by requesting it through BMW Roadside Assistance.

1. Park the vehicle in a safe place.
2. Set the parking brake.
3. Control Display is switched on.
4. Confirm Teleservice Help.

BMW Accident Assistance

Concept

BMW Group Accident Assistance can be contacted if assistance is needed in the event of an accident.

General information

If the vehicle sensors detect a minor to moderately severe accident, which did not trigger any

airbags, a Check Control message appears on the instrument cluster. In addition, a text message appears on the Control Display.

When BMW Accident Assistance is activated, data on the vehicle's condition is sent to BMW.

Functional requirements

- ▶ Active ConnectedDrive contract, equipment with intelligent emergency call or BMW ConnectedDrive services.
- ▶ Cellular network reception.
- ▶ Standby state is switched on.

Starting BMW Accident Assistance

If an accident is detected automatically

A text message relating to BMW Accident Assistance appears on the Control Display.

The connection can be established directly:

"Call BMW Accident Assistance"

The Check Control message for BMW Accident Assistance can also be called up from the stored Check Control messages, refer to page 155, for a certain length of time.

Starting manually

BMW Accident Assistance can also be contacted independently of the automatic accident detection function.

Via iDrive:

1. "APPS"
2. "Installed apps"
3. "BMW Assist"
4. "Call BMW Accident Assistance"

Follow the displays on the Control Display. A voice connection is established.

Emergency Request

Intelligent emergency call

Concept

In case of an emergency, an Emergency Request can be triggered automatically by the system or manually.

General information

Only press the SOS button in an emergency.

The Intelligent Assist system establishes a connection with the BMW Response Center.

For technical reasons, the Emergency Request cannot be guaranteed under unfavorable conditions.

Overview

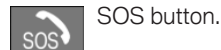

SOS button.

Functional requirements

- ▶ Standby state is switched on.
- ▶ The Assist system is functional.
- ▶ If the vehicle is equipped with intelligent emergency call: the SIM card integrated in the vehicle has been activated.

Automatic triggering

Under certain conditions, for instance if the airbags trigger, an Emergency Request is automatically initiated immediately after an accident of corresponding severity. Automatic Collision Noti-

fication is not affected by pressing the SOS button.

Manual triggering

1. Tap the cover.
2. Press and hold the SOS button until the LED in the area of the button illuminates green.
 - ▶ The LED is illuminated green when an Emergency Request has been initiated.

If a cancel prompt appears on the Control Display, the Emergency Request can be aborted.

If the situation allows, wait in your vehicle until the voice connection has been established.

- ▶ The LED flashes green when a connection to the BMW Response Center has been established.

The BMW Response Center then makes contact with the occupants of the vehicle and initiates further steps to help.

Even if you are unable to respond, the BMW Response Center can take further steps to help you under certain circumstances.

For this, data is transmitted to the BMW Response Center which serves to determine the necessary rescue measures. For instance, the current position of the vehicle, if it can be established.

Even if the BMW Response Center is no longer heard through the loudspeakers, the BMW Response Center may still be able to hear the occupants of the vehicle.

The BMW Response Center ends the Emergency Request.

Jump-starting

General information

If the battery is discharged, the engine can be started using the battery of another vehicle and two jumper cables. Only use jumper cables with fully insulated clamp handles.

Safety information

DANGER

Contact with live components can lead to an electric shock. There is a risk of injuries or danger to life. Do not touch any components that are under voltage.

Warning

If the jumper cables are connected in the incorrect order, sparking may occur. There is a risk of injury. Pay attention to the correct order during connection.

NOTICE

In the case of body contact between the two vehicles, a short circuit can occur during jump-starting. There is a risk of damage to property. Make sure that no body contact occurs.

Preparation

1. Check whether the battery of the other vehicle has a voltage of 12 volts. The voltage information can be found on the battery.
2. Switch off the engine of the assisting vehicle.
3. Switch off any electronic systems/power consumers in both vehicles.

Starting aid terminals

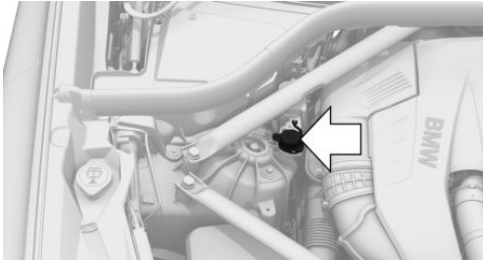

The starting aid terminal in the engine compartment acts as the battery's positive terminal.

Open the cover of the starting aid terminal.

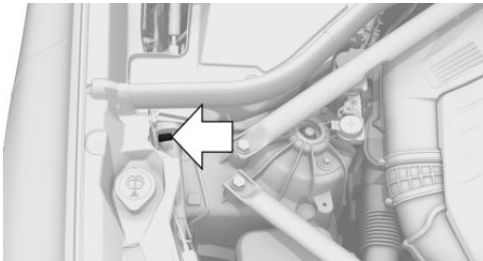

A special connection on the body acts as the battery negative terminal.

Connecting the cables

Before you begin, switch off all unnecessary electronic systems/power consumers, such as the radio, on the assisting and receiving vehicle.

1. Open the cover of the starting aid terminal.
2. Attach one terminal clamp of the positive jumper cable to the positive terminal of the battery, or to the corresponding starting aid terminal of the vehicle providing assistance.
3. Attach the terminal clamp on the other end of the cable to the positive terminal of the battery, or to the corresponding starting aid terminal of the vehicle to be started.
4. Attach one terminal clamp of the negative jumper cable to the negative terminal of the

battery, or to the corresponding engine or body ground of assisting vehicle.

5. Attach the second terminal clamp to the negative terminal of the battery, or to the corresponding engine or body ground of the vehicle to be started.

Starting the engine

Never use spray fluids to start the engine.

1. Start the engine of the assisting vehicle and let it run for several minutes at an increased idle speed.
2. Start the engine of the vehicle that is to be started in the usual way.

If the first starting attempt is not successful, wait a few minutes before making another attempt in order to allow the discharged battery to recharge.

3. Let both engines run for several minutes.
4. Disconnect the jumper cables in the reverse order.

Check the battery and recharge, if needed.

Tow-starting and towing

Safety information

Warning

Due to system limits, individual functions can malfunction during tow-starting/towing with the Intelligent Safety systems activated. There is a risk of accident. Switch all Intelligent Safety systems off prior to tow-starting/towing.

Transporting the vehicle

General information

The vehicle is not permitted to be towed.

Safety information

NOTICE

The vehicle can be damaged when towing the vehicle with a single lifted axle. There is a risk of damage to property. The vehicle should only be transported on a loading platform.

NOTICE

The vehicle can become damaged when lifting and securing it.

There is a risk of damage to property.

- ▶ Lift the vehicle using suitable means.
- ▶ Do not lift or secure the vehicle by its tow fitting, body parts, or suspension parts.

Pushing the vehicle

To remove a broken-down vehicle from the danger area, it can be pushed for a short distance.

For rolling or pushing the vehicle, refer to page 147.

Tow truck

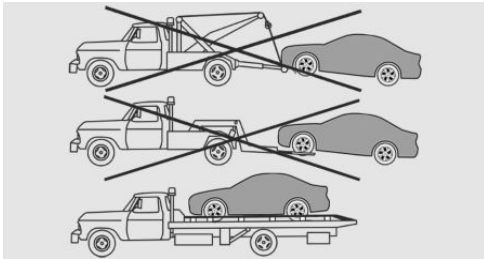

The vehicle should only be transported on a loading platform.

Towing other vehicles

General information

Switch on the hazard warning system, depending on local regulations.

If the electrical system has failed, clearly identify the vehicle being towed by placing a sign or a warning triangle in the rear window.

With Safe Share function: to remove a broken-down vehicle from the danger area, tow it for a short distance at a speed of no more than 6 mph/10 km/h.

Safety information

Warning

If the approved gross vehicle weight of the towing vehicle is lighter than the vehicle to be towed, the tow fitting can tear off or it will not be possible to control the vehicle's response. There is a risk of accident. Make sure that the gross vehicle weight of the towing vehicle is heavier than the vehicle to be towed.

NOTICE

If the tow bar or tow rope is attached incorrectly, damage to other vehicle parts can occur. There is a risk of damage to property. Correctly attach the tow bar or tow rope to the tow fitting.

Tow bar

The tow fittings used should be on the same side on both vehicles.

Should it prove impossible to avoid mounting the tow bar at an offset angle, please follow the following:

- ▶ Maneuvering capability is limited going around corners.
- ▶ The tow bar will generate lateral forces if it is secured with an offset.

Tow rope

Observe the following notes when using the tow rope:

- ▶ Use nylon ropes or straps, which will enable the vehicle to be towed without jerking.

- ▶ Make sure the tow rope is not twisted when fastening.
- ▶ Check the fastening of the tow fitting and tow rope in regular intervals.
- ▶ Do not exceed a towing speed of 30 mph/50 km/h.
- ▶ Do not exceed a towing distance of 3 miles/5 km.
- ▶ When starting to tow the vehicle, make sure that the tow rope is taut.

Tow fitting

General information



The screw-in tow fitting should always be carried in the vehicle.

The tow fitting can be screwed in at the front or rear of the vehicle.

The tow fitting is located beneath the cargo floor panel.

- ▶ Use only the tow fitting provided with the vehicle and screw it all the way in.
- ▶ Use the tow fitting for towing on paved roads only.
- ▶ Avoid lateral loading of the tow fitting, for instance do not lift the vehicle by the tow fitting.

Safety information

NOTICE

If the tow fitting is not used as intended, there may be damage to the vehicle or to the tow fitting. There is a risk of damage to property. Follow the notes on using the tow fitting.

Screw thread for tow fitting



Press on the mark on the edge of the cover to push it out.

Tow-starting

Do not tow-start the vehicle.

Start the engine by jump-starting, refer to page 394, if possible.

Have the reasons for the starting difficulties corrected by a dealer's service center or another qualified service center or repair shop.

Care

Vehicle features and options

This chapter describes all standard, country-specific and optional features offered with the series. It also describes features and functions that are not necessarily available in your vehicle, e.g., due to the selected options or country versions. This also applies to safety-related functions and systems. When using these functions and systems, the applicable laws and regulations must be observed.

Washing the vehicle

General information

Regularly remove foreign objects such as leaves in the area below the windshield when the hood is raised.

Wash your vehicle frequently, particularly in winter. Intense soiling and road salt can damage the vehicle.

Steam blaster and high-pressure washer

Safety information

NOTICE

When cleaning with high-pressure washers, components can be damaged due to the pressure or temperatures being too high. There is a risk of damage to property. Maintain sufficient distance and do not spray too long continuously. Follow the operating instructions for the high-pressure washer.

Distances and temperature

- ▷ Maximum temperature: 140 °F/60 °C.
- ▷ Minimum distance from sensors, cameras, seals: 12 inches/30 cm.
- ▷ Minimum distance from glass sunroof: 31.5 in/80 cm.

Automatic vehicle washes

Safety information

NOTICE

Improper use of automatic vehicle washes can cause damage to the vehicle. There is a risk of damage to property. Follow the following instructions:

- ▷ Give preference to cloth vehicle washes or those that use soft brushes in order to avoid paint damage.
- ▷ Before driving into the vehicle wash, make sure that the vehicle is not too large.
- ▷ Avoid vehicle washes with guide rails higher than 4 in/10 cm to avoid damage to the chassis.
- ▷ Observe the tire width of the guide rail to avoid damage to tires and rims.
- ▷ Fold in exterior mirrors to avoid damage to the exterior mirrors.
- ▷ Deactivate the wiper and, if necessary, rain sensor to avoid damage to the wiper system.

Driving into a vehicle wash with a Steptronic transmission

Safety information

NOTICE

Selector lever position P is automatically engaged when standby state is switched off. There is a risk of damage to property. Do not switch standby state off in vehicle washes.

General information

In a vehicle wash, the vehicle must be able to roll freely.

To roll or push the vehicle, refer to page 147.

Some vehicle washes do not permit persons in the vehicle. The vehicle cannot be locked from the outside when in selector lever position N. A signal sounds when an attempt is made to lock the vehicle.

Driving out of a vehicle wash

Ensure that the vehicle key is in the car.

Switch on drive-ready state, refer to page 38.

Headlights

Do not rub wet headlights dry and do not use abrasive or acidic cleaning agents.

Soak areas that have been dirtied, for instance from insects, with shampoo and wash off with water.

Thaw ice with de-icing spray; do not use an ice scraper.

After washing the vehicle

After washing the vehicle, apply the brakes briefly to dry them; otherwise, braking action can be reduced. The heat generated during braking dries brake discs and brake pads and protects them against corrosion.

Completely remove all residues on the windows, to minimize loss of visibility due to smearing and to reduce wiper noises and wiper blade wear.

Vehicle care

Vehicle care products

General information

BMW recommends using vehicle care and cleaning products from BMW. Suitable care products are available from a dealer's service center or another qualified service center or repair shop.

Safety information

Warning

Cleansers can contain substances that are dangerous and harmful to your health. There is a risk of injury. When cleaning the interior, open the doors or windows. Only use products intended for cleaning vehicles. Follow the instructions on the container.

Vehicle paint

General information

Regular care contributes to driving safety and value retention. Environmental influences in areas with elevated air pollution or natural contaminants, such as tree resin or pollen can affect the vehicle's paintwork. Tailor the frequency and extent of your vehicle care to these influences.

Aggressive substances such as spilled fuel, oil, grease or bird droppings, must be removed immediately to prevent the finish from being altered or discolored.

Matte finish

Only use cleaning and care products suitable for vehicles with matte finish.

Leather care

Remove dust from the leather regularly, using a cloth or vacuum cleaner.

Otherwise, particles of dust and road grime chafe in pores and folds, and lead to increased wear and premature degradation of the leather surface.

To guard against discoloration, such as from clothing, clean leather and provide leather care roughly every two months.

Clean light-colored leather more frequently because soiling on such surfaces is substantially more visible.

Use leather care products; otherwise, dirt and grease will gradually break down the protective layer of the leather surface.

Upholstery material care

General information

Vacuum the upholstery regularly with a vacuum cleaner.

If upholstery is very dirty, for instance with beverage stains, use a soft sponge or microfiber cloth with a suitable interior cleaner.

Clean the upholstery down to the seams using large sweeping motions. Avoid rubbing the material vigorously.

Safety information

NOTICE

Open Velcro® fasteners on articles of clothing can damage the seat covers. There is a risk of damage to property. Ensure that any Velcro® fasteners are closed.

Caring for special components

Light-alloy wheels

When cleaning the vehicle, use only neutral wheel cleaners having a pH value from 5 to 9. Do

not use abrasive cleaning agents or steam jets above 140 °F/60 °C. Follow the manufacturer's instructions.

Aggressive, acidic or alkaline cleaning agents can destroy the protective layer of adjacent components, such as the brake disc.

After cleaning, apply the brakes briefly to dry them. The heat generated during braking dries brake discs and brake pads and protects them against corrosion.

Chrome surfaces

Carefully clean Chrome surfaces, especially in case of exposure to road salt, with plenty of water and added cleanser as needed.

Rubber components

Environmental influences can cause surface soiling of rubber parts and a loss of gloss. Use only water and suitable cleaning agents for cleaning.

Treat especially worn rubber parts with rubber care agents at regular intervals. When cleaning rubber seals, do not use any silicon-containing vehicle care products in order to avoid damage or noises.

Fine wood parts

Clean fine wood facing and fine wood components only with a moist rag. Then dry with a soft cloth.

Kenaf

Only treat parts made of Kenaf fibers using suitable care products.

Plastic components

NOTICE

Cleansers that contain alcohol or solvents, such as lacquer thinners, heavy-duty grease removers, fuel, or such, can damage plastic parts. There is a risk of damage to property. Clean

with a microfiber cloth. Dampen the cloth lightly with water, if needed.

Clean with a microfiber cloth.

Dampen the cloth lightly with water, if needed.

Do not soak the roofliner.

Safety belts

Warning

Chemical cleansers can destroy the safety belt webbing. Missing protective effect of the safety belts. There is a risk of injuries or danger to life. Use only a mild soapy solution for cleaning the safety belts.

Dirty belt straps impede the reeling action and thus have a negative impact on safety.

Use only a mild soapy solution for cleaning the installed belt straps.

Safety belts should only be allowed to retract if they are dry.

Carpets and floor mats

Warning

Objects in the driver's floor area can limit the pedal distance or block a depressed pedal. There is a risk of accident. Stow objects in the vehicle such that they are secured and cannot enter into the driver's floor area. Use floor mats that are suitable for the vehicle and can be safely attached to the floor. Do not use loose floor mats and do not layer several floor mats. Make sure that there is sufficient clearance for the pedals. Ensure that the floor mats are securely fastened again after they were removed, for instance for cleaning.

The floor mats can be removed from the car's interior for cleaning.

If the floor carpets are very dirty, clean with a microfiber cloth and water or a textile cleaner. To

prevent matting of the carpet, rub back and forth in the direction of travel only.

Mount for trailer hitch

Keep the mount clean.

Regularly grease or oil bearings and sliding surfaces with resin-free greases or oils.

Before using steam cleaners or high pressure cleaners on the vehicle, remove the ball head and insert the cover into the mount.

Sensors and camera lenses

To clean sensors and camera lenses, use a cloth moistened with a small amount of glass detergent.

Displays, screens, and protective glass of the Head-up Display

NOTICE

Chemical cleansers, moisture or fluids of any kind can damage the surface of displays and screens. There is a risk of damage to property. Clean with a clean, antistatic microfiber cloth.

NOTICE

The surface of displays can be damaged with improper cleaning. There is a risk of damage to property. Avoid pressure that is too high and do not use any scratching materials.

Clean with a clean, antistatic microfiber cloth.

Clean the protective glass of the Head-up Display using a microfiber cloth and commercially available dish-washing soap.

Long-term vehicle storage

When the vehicle is shut down for longer than three months, special measures must be taken. Further information is available from a dealer's service center or another qualified service center or repair shop.

Technical data

Vehicle features and options

This chapter describes all standard, country-specific and optional features offered with the series. It also describes features and functions that are

not necessarily available in your vehicle, e.g., due to the selected options or country versions. This also applies to safety-related functions and systems. When using these functions and systems, the applicable laws and regulations must be observed.

General information

The technical data and specifications in the Owner's Manual are used as guidance values. The vehicle-specific data can deviate from this, for instance due to the selected special equipment, country version or country-specific meas-

urement method. Detailed values can be found in the approval documents, on labels on the vehicle or can be obtained from a dealer's service center or another qualified service center or repair shop.

Dimensions

The dimensions can vary depending on the model version, equipment or country-specific measurement method.

The specified heights do not take into account attached parts, for instance a roof antenna, roof

racks or spoiler. The heights can deviate, for instance due to the selected special equipment, tires, load and chassis version.

BMW X5

Width with mirrors	in/mm	87.3/2,218
Width without mirrors	in/mm	78.9/2,004
Height	in/mm	68.7-69/1,744-1,753
Length	in/mm	194.3/4,936
Wheelbase	in/mm	117.1/2,975
Smallest turning radius diam.	ft/m	41.3/12.6

Weights

X5 sDrive40i with two rows of seats

Approved gross vehicle weight	lbs/kg	6,052/2,745
Load	lbs/kg	827/375
Approved front axle load	lbs/kg	2,822/1,280
Approved rear axle load	lbs/kg	3,527/1,600

X5 sDrive40i with three rows of seats

Approved gross vehicle weight	lbs/kg	6,581/2,985
Load	lbs/kg	1,246/565
Approved front axle load	lbs/kg	2,855/1,295
Approved rear axle load	lbs/kg	3,858/1,750

X5 xDrive40i with two rows of seats

Approved gross vehicle weight	lbs/kg	6,162/2,795
Load	lbs/kg	849/385
Approved front axle load	lbs/kg	2,921/1,325
Approved rear axle load	lbs/kg	3,616/1,640

X5 xDrive40i with three rows of seats

Approved gross vehicle weight	lbs/kg	6,691/3,035
Load	lbs/kg	1,246/565
Approved front axle load	lbs/kg	2,943/1,335
Approved rear axle load	lbs/kg	3,858/1,750

X5 xDrive50i

Approved gross vehicle weight	lbs/kg	6,460/2,930
Load	lbs/kg	871/395

X5 xDrive50i

Approved front axle load	lbs/kg	3,175/1,440
Approved rear axle load	lbs/kg	3,737/1,695

X5 M50i powered by BMW M

Approved gross vehicle weight	lbs/kg	6,559/2,975
Load	lbs/kg	882/400
Approved front axle load	lbs/kg	3,241/1,470
Approved rear axle load	lbs/kg	3,660/1,660

Trailer towing**X5 sDrive40i with two rows of seats**

Trailer load without brakes	lbs/kg	1,653/750
a) Trailer load with brakes on uphill grades of up to 12 %	lbs/kg	5,952/2,700
b) Trailer load with brakes on uphill grades of up to 12 %	lbs/kg	7,209/3,270
Maximum drawbar nose weight	lbs/kg	551/250
Approved rear axle load	lbs/kg	3,527/1,600
Approved gross vehicle weight	lbs/kg	6,052/2,745

a) The trailer load only applies to vehicles with a mount for trailer hitches retrofitted by BMW.

b) The trailer load only applies to vehicles with a factory-installed mount for trailer hitches.

X5 sDrive40i with three rows of seats

Trailer load without brakes	lbs/kg	1,653/750
a) Trailer load with brakes on uphill grades of up to 12 %	lbs/kg	5,952/2,700
b) Trailer load with brakes on uphill grades of up to 12 %	lbs/kg	7,209/3,270
Maximum drawbar nose weight	lbs/kg	551/250

X5 sDrive40i with three rows of seats

Approved rear axle load	lbs/kg	3,858/1,750
Approved gross vehicle weight	lbs/kg	6,581/2,985

a) The trailer load only applies to vehicles with a mount for trailer hitches retrofitted by BMW.

b) The trailer load only applies to vehicles with a factory-installed mount for trailer hitches.

X5 xDrive40i with two rows of seats

Trailer load without brakes	lbs/kg	1,653/750
a) Trailer load with brakes on uphill grades of up to 12 %	lbs/kg	5,952/2,700
	lbs/kg	7,209/3,270
b) Trailer load with brakes on uphill grades of up to 12 %		
Maximum drawbar nose weight	lbs/kg	551/250
Approved rear axle load	lbs/kg	3,616/1,640
Approved gross vehicle weight	lbs/kg	6,162/2,795

a) The trailer load only applies to vehicles with a mount for trailer hitches retrofitted by BMW.

b) The trailer load only applies to vehicles with a factory-installed mount for trailer hitches.

X5 xDrive40i with three rows of seats

Trailer load without brakes	lbs/kg	1,653/750
a) Trailer load with brakes on uphill grades of up to 12 %	lbs/kg	5,952/2,700
	lbs/kg	7,209/3,270
b) Trailer load with brakes on uphill grades of up to 12 %		
Maximum drawbar nose weight	lbs/kg	551/250
Approved rear axle load	lbs/kg	3,858/1,750
Approved gross vehicle weight	lbs/kg	6,691/3,035

a) The trailer load only applies to vehicles with a mount for trailer hitches retrofitted by BMW.

b) The trailer load only applies to vehicles with a factory-installed mount for trailer hitches.

X5 xDrive50i

Trailer load without brakes	lbs/kg	1,653/750
a) Trailer load with brakes on uphill grades of up to 12 %	lbs/kg	5,952/2,700
b) Trailer load with brakes on uphill grades of up to 12 %	lbs/kg	7,209/3,270
Maximum drawbar nose weight	lbs/kg	551/250
Approved rear axle load	lbs/kg	3,737/1,695
Approved gross vehicle weight	lbs/kg	6,460/2,930
a) The trailer load only applies to vehicles with a mount for trailer hitches retrofitted by BMW.		
b) The trailer load only applies to vehicles with a factory-installed mount for trailer hitches.		

X5 M50i powered by BMW M

Trailer load without brakes	lbs/kg	1,653/750
a) Trailer load with brakes on uphill grades of up to 12 %	lbs/kg	5,952/2,700
b) Trailer load with brakes on uphill grades of up to 12 %	lbs/kg	7,209/3,270
Maximum drawbar nose weight	lbs/kg	551/250
Approved rear axle load	lbs/kg	3,660/1,660
Approved gross vehicle weight	lbs/kg	6,559/2,975
a) The trailer load only applies to vehicles with a mount for trailer hitches retrofitted by BMW.		
b) The trailer load only applies to vehicles with a factory-installed mount for trailer hitches.		

Capacities

BMW X5

Fuel tank, approx.	US gal/liters	21.9/83.0
--------------------	---------------	-----------

Observe further information on fuel quality, refer to page [378](#).

Appendix

General information

Any updates to the Owner's Manual of the vehicle are listed here.

Updates made after the editorial deadline

The following chapters were updated in the printed version of the Owner's Manual after the editorial deadline for the Integrated Owner's Manual in the vehicle had closed:

- ▶ Notes: own safety; maintenance.
- ▶ Operation: safety: Lane Departure Warning; warning function.
- ▶ Operation: driver assistant systems: parking assistant: driving out of a parking space using the parking assistant.
- ▶ Driving tips: observe when driving; driving on a race track.
- ▶ Mobility: wheels and tires: changing wheels and tires: changing runflat tires.
- ▶ Mobility: operating fluids: engine oil: engine oil change.

Everything from A to Z

Index

0-9

2-axle air suspension [272](#)

A

A/C button, see Air conditioning [281](#)

ABS, Antilock Brake System [219](#)

Acceleration Assistant, see Launch Control [150](#)

Accessories and parts [8](#)

Accident Assistance [392](#)

Accident prevention, see Active Protection [215](#)

ACC, see Active Cruise Control [229](#)

Activated charcoal filter [284](#)

Activation, trailer towing [329](#)

Active Cruise Control with Stop&Go function
ACC [229](#)

Active damping control, see Adaptive M chassis/
suspension [277](#)

Active damping control, see Adaptive suspen-
sion [277](#)

Active Guard Plus, see Intelligent Safety [182](#)

Active Guard, see Intelligent Safety [182](#)

Active M sport differential [222](#)

Active PDC, see Emergency brake function [249](#)

Active Protection [215](#)

Active roll stabilization [277](#)

Active seat ventilation [126](#)

Active Steering, integral [224](#)

Adaptive brake assistant [219](#)

Adaptive Light Control [173](#)

Adaptive M chassis/suspension [277](#)

Adaptive M suspension Professional [278](#)

ADAPTIVE, see Driving Dynamics Control [139](#)

Adaptive suspension [277](#)

Additives, engine oil types [381](#)

Airbags [178](#)

Airbags, indicator and warning light [180](#)

Air circulation, see Recirculated-air mode [282](#)

Air conditioning [281](#)

Air distribution, manual [283](#)

Air flow, automatic climate control [283](#)

Air outlets, see Ventilation [284](#)

Air pressure, tires [340](#)

Air quality [279](#)

Air suspension [272](#)

Alarm system [104](#)

Alarm, unintentional [106](#)

All-season tires, see Winter tires [352](#)

All-wheel-drive, see xDrive [221](#)

Amazon Alexa Car Integration [51](#)

Ambient air package [293](#)

Ambient light [176](#)

Animal detection, see Night Vision [197](#)

Antifreeze, see Washer fluid [383](#)

Antilock Brake System, ABS [219](#)

Anti-slip control, see DSC [219](#)

Anti-slip rails [314](#)

Anti-theft protection, see Lug bolt lock [370](#)

Apple CarPlay preparation, connection to the ve-
hicle [74](#)

Approach control warning with City braking func-
tion [183](#)

Approved axle load [403](#)

Apps, see Owner's Handbook for Navigation, En-
tertainment, Communication [6](#)

Armrest heating [125](#)

Ashtray [300](#)

Assistance, Roadside, see Roadside Assis-
tance [392](#)

Assistance when driving off, see Drive-off assis-
tant [219](#)

Assistance with breakdown [391](#)

AUC Automatic Recirculating Air Control [282](#)

Audio, see Owner's Manual for Navigation, En-
tertainment and Communication [6](#)

AUTO H button, see Parking brake [139](#)

Automatic climate control [279](#)

Automatic Curb Monitor, exterior mirror [123](#)

- Automatic deactivation, front-seat passenger airbags [181](#)
- Automatic Differential Brake [222](#)
- Automatic headlight control [170](#)
- Automatic Hold, see Parking brake [139](#)
- Automatic locking [103](#)
- Automatic parking [262](#)
- Automatic Recirculating Air Control AUC [282](#)
- Automatic Soft Closing [100](#)
- Automatic tailgate [98](#)
- Automatic transmission, see Steptronic transmission [146](#)
- Automatic unlocking [103](#)
- Automating routines [53](#)
- AUTO program, automatic climate control [281](#)
- AUTO program, intensity [282](#)
- Auto Start/Stop function [134](#)
- Average consumption, see Trip data [165](#)
- Axle loads, weights [403](#)
- ## B
- Backrest curvature, see Lumbar support [113](#)
- Backrest, seats [111](#)
- Backrest tilt [112](#)
- Backrest tilt, rear seats [115](#)
- Backrest, width [113](#)
- Back-up assistant, see Parking Assistant [262](#)
- Bad road trips [322](#)
- Bandages, see First-aid kit [391](#)
- Bar for tow-starting/towing [396](#)
- Basic position, rear seats [115](#)
- Battery, disposing of [389](#)
- Battery, vehicle [388](#)
- Being towed, see Tow-starting and towing [395](#)
- Belts, see Safety belts [117](#)
- Beverage holder, see Cup holders [310](#)
- Blind spot collision warning [204](#)
- Blocking, power window, see Safety switch [107](#)
- Bluetooth connection [71](#)
- Blu-ray, see Owner's Handbook for Navigation, Entertainment, Communication [6](#)
- BMW Assist, see Owner's Manual for Navigation, Entertainment and Communication [6](#)
- BMW Digital Key [93](#)
- BMW display key [83](#)
- BMW display key, malfunction [86](#)
- BMW Drive Recorder [214](#)
- BMW Gesture Control [54](#)
- BMW Intelligent Personal Assistant [52](#)
- BMW maintenance system [385](#)
- Bonus range, ECO PRO [334](#)
- Bottle holder, see Cup holders [310](#)
- Bracket, flag [325](#)
- Brake assistant [219](#)
- Brake assistant, adaptive [219](#)
- Brake Controller [330](#)
- Brake discs, see Brake system [322](#)
- Brake pads, see Brake system [322](#)
- Brake system [322](#)
- Braking, information [324](#)
- Breakdown assistance [391](#)
- Breakdown, see FTM Flat Tire Monitor [366](#)
- Breaking in [322](#)
- Break recommendation, see Fatigue alert [217](#)
- Brightness, Control Display [64](#)
- Buttons on the steering wheel [32](#)
- Button, SOS, see Intelligent emergency call [393](#)
- Button, Start/Stop [134](#)
- Bypassing, see Jump-starting [394](#)
- ## C
- Cable for tow-starting/towing [396](#)
- California Proposition 65 Warning [8](#)
- Call, gesture control [55](#)
- Camera-based assistance systems, see Intelligent Safety [182](#)
- Camera lenses, care [401](#)
- Camera, rearview camera, without Surround View [252](#)
- Camera, see Surround View [254](#)
- CANCEL button, see Active Cruise Control [229](#)
- CANCEL button, see Cruise control [227](#)
- Can holder, see Cup holders [310](#)
- Care, Head-up Display [401](#)
- Care of displays, screens [401](#)
- Care, see Vehicle washing [398](#)
- Care, vehicle [399](#)
- Cargo area [313](#)
- Cargo area, enlarging [316](#)
- Cargo cover [318](#)

- Cargo cover electric [319](#)
Cargo, stowing and securing [314](#)
Cargo straps, see Lashing eyes in the cargo area [314](#)
Caring Car [53](#)
Car key, see Vehicle key [78](#)
Carpet, care [401](#)
CarPlay, connection to the vehicle [74](#)
Car seats, see Transporting children safely [128](#)
Cartridge replacement, see Ambient air package [293](#)
Car wash lines [398](#)
Car wash systems [398](#)
Catalytic converter, see Hot exhaust gas system [323](#)
CBS Condition Based Service [385](#)
Cell phone, see Owner's Manual for Navigation, Entertainment and Communication [6](#)
Center armrest [310](#)
Center armrest, front [310](#)
Center armrest, rear [310](#)
Center console [35](#)
Central Information Display (CID), see Control Display [43](#)
Central locking system [88](#)
Central screen, see Control Display [43](#)
Changes, technical, see For Your Own Safety [8](#)
Changing parts [387](#)
Changing wheels [368](#)
Changing wheels/tires [351](#)
Charging smartphone, see Wireless charging tray [304](#)
Charging tray for smartphones, see Wireless charging tray [304](#)
Chassis/suspension, electronic, see Adaptive M chassis/suspension [277](#)
Chassis number, see Vehicle identification number [12](#)
Check Control [155](#)
Checking the engine oil level electronically [379](#)
Children, seating position [128](#)
Children, transporting safely [128](#)
Child restraint system LATCH [131](#)
Child restraint systems, mounting [129](#)
Child restraint systems, see Transporting children safely [128](#)
Child safety locks [133](#)
Child seat, mounting [129](#)
Child seats, see Transporting children safely [128](#)
Chrome-plated surfaces, care [400](#)
Chrome surfaces, care [400](#)
Cigarette lighter [301](#)
Cigarette lighter, front [301](#)
Cigarette lighter, rear [301](#)
Cleaning displays, screens [401](#)
Cleaning, Head-up Display [401](#)
Climate control [279](#)
Closing with the smartphone, see BMW Digital Key [93](#)
Clothes hooks [312](#)
Coasting [334](#)
Coasting with engine decoupled, see Coasting [334](#)
Coasting with idling engine [334](#)
Combination switch, see Turn signals [142](#)
Combination switch, see Washer/wiper system [143](#)
Comfort Access [89](#)
COMFORT, see Driving Dynamics Control [137](#)
Communication, see Owner's Manual for Navigation, Entertainment and Communication [6](#)
Compact wheel, see Emergency wheel [373](#)
Comparison of entries, see Entry comparison [41](#)
Compartments, doors [309](#)
Compatible devices, see Suitable devices [71](#)
Compressor [354](#)
Concierge Service, see Owner's Handbook for Navigation, Entertainment, Communication [6](#)
Condensation water under the parked vehicle [325](#)
Condensation, windshield [284](#)
Condition Based Service CBS [385](#)
Confirmation signal from the vehicle [102](#)
Connected Command [54](#)
ConnectedDrive, see Owner's Manual for Navigation, Entertainment and Communication [6](#)
Connecting device [70](#)
Connecting, electrical devices, see Sockets [302](#)
Connecting, mobile devices [70](#)
Connections, Screen Mirroring [75](#)
Consumption display, ECO PRO [334](#)

- Consumption display, widget in the instrument cluster [154](#)
- Consumption, see Current consumption [154](#)
- Consumption, see Trip data [165](#)
- Contacts, see Owner's Handbook for Navigation, Entertainment, Communication [6](#)
- Container for washer fluid [383](#)
- Continued driving with a flat tire [364](#), [368](#)
- Control Display [43](#)
- Control Display, brightness [64](#)
- Controller [43](#)
- Control systems, driving stability [219](#)
- Convenient closing, vehicle key [80](#)
- Convenient opening, vehicle key [79](#)
- Coolant [382](#)
- Coolant level [383](#)
- Coolant temperature, see Engine temperature [161](#)
- Cooling, maximum [281](#)
- Cooling system [382](#)
- Cornering light [173](#)
- Corrosion on brake discs [325](#)
- Cosmetic mirror [300](#)
- Cross-country mobility, see xOffroad package [275](#)
- Cross traffic warning [268](#)
- Cruise control [227](#)
- Cruise control, active with Stop&Go function [229](#)
- Cruise control, see Active Cruise Control [229](#)
- Cruise control with distance control, see Active Cruise Control with Stop&Go function [229](#)
- Cruise control without distance control, see Cruise control [227](#)
- Cruising range [161](#)
- Cup holder [310](#)
- Cup holder, front [310](#)
- Cup holder, rear [311](#)
- Cup holder, third row of seats [312](#)
- Current consumption [154](#)
- Customer service, see Owner's Manual for Navigation, Entertainment, Communication [6](#)
- D**
- Damage, tires [350](#)
- Damping control active, see Adaptive M chassis/suspension [277](#)
- Damping control, active, see Adaptive suspension [277](#)
- Dashcam, see BMW Drive Recorder [214](#)
- Data memory [10](#)
- Data protection, settings [65](#)
- Data, see Deleting personal data [65](#)
- Data, technical [402](#)
- Date [61](#)
- Daytime running lights [172](#)
- DCC, see Cruise control [227](#)
- Defrosting, see Defrosting windshield [284](#)
- Defrosting, windshield [284](#)
- Deleting personal data [65](#)
- Departure schedule, see Parked-car ventilation [288](#)
- Departure time, parked-car ventilation [289](#)
- Departure time, stationary climate control [292](#)
- Device list [76](#)
- Diagnosis connection [386](#)
- Differential lock [222](#)
- Digital Key [93](#)
- Digital Key, see BMW Digital Key [93](#)
- Dimensions [402](#)
- Dimensions, see Technical data [402](#)
- Dimmable exterior mirrors [122](#)
- Dimmable interior mirror [123](#)
- Direct dial buttons, see Programmable memory buttons [42](#)
- Direction indicator, see Turn signals [142](#)
- Display and input [40](#)
- Display in the windshield, see Head-up Display [167](#)
- Display key [83](#)
- Display key, malfunction [86](#)
- Display key, see BMW display key [83](#)
- Display lighting, see Instrument lighting [176](#)
- Displays [152](#)
- Displays and symbols [7](#)
- Displays, ECO PRO [334](#)
- Displays, screens [401](#)
- Disposal, coolant [383](#)
- Disposal, vehicle battery [389](#)
- Distance control, see PDC [247](#)
- Door handle lighting, see Welcome lights [172](#)

- Door opening angle, Surround View [256](#)
- Downhill control, see HDC Hill Descent Control [222](#)
- Drawbar nose weight [404](#)
- Drive-off assistant [219](#)
- Drive-off assistant, see DSC [219](#)
- Driver activity, see Driver Attention Camera [63](#)
- Driver assistance, driving, see Intelligent Safety [182](#)
- Driver assistance, see Intelligent Safety [182](#)
- Driver Attention Camera [63](#)
- Drive-ready state, engine start [38](#)
- Drive-ready state, idle state, and standby state [37](#)
- Driver profiles [66](#)
- Driver profile, setting up [66](#)
- Driver profiles, welcome screen [66](#)
- Driving [134](#)
- Driving Assistant, see Intelligent Safety [182](#)
- Driving comfort [272, 277](#)
- Driving Dynamics Control [137](#)
- Driving instructions, breaking in [322](#)
- Driving mode, ECO PRO [332](#)
- Driving mode, see Driving Dynamics Control [137](#)
- Driving notes, general [323](#)
- Driving on bad roads [322](#)
- Driving out of a parking space, see Parking Assistant [262](#)
- Driving stability control systems [219](#)
- Driving style analysis, ECO PRO [336](#)
- Driving through water [324](#)
- Driving tips [323](#)
- Drying air, see Air conditioning [281](#)
- DSC Dynamic Stability Control [219](#)
- DTC Dynamic Traction Control [221](#)
- Dynamic damping, see Adaptive M chassis/suspension [277](#)
- Dynamic damping, see Adaptive suspension [277](#)
- Dynamic Stability Control DSC [219](#)
- Dynamic Traction Control DTC [221](#)
- E**
- ECO PRO [332](#)
- ECO PRO, bonus range [334](#)
- ECO PRO, Driving style analysis [336](#)
- ECO PRO INDIVIDUAL, see Driving Dynamics Control [137](#)
- ECO PRO, see Driving Dynamics Control [137](#)
- Efficiency display, widget in the instrument cluster [154](#)
- Efficient4x4, see xDrive [221](#)
- Electronic oil measurement [379](#)
- Electronic Stability Program ESP, see DSC [219](#)
- E-mail, see Owner's Handbook for Navigation, Entertainment, Communication [6](#)
- Emergency brake function when parking, Active PDC [249](#)
- Emergency brake, see Emergency stop assistant [212](#)
- Emergency service, see Accident Assistance [392](#)
- Emergency service, see Roadside Assistance [392](#)
- Emergency stop assistant [212](#)
- Emergency unlocking, fuel filler flap [339](#)
- Emergency unlocking, rear seat backrest [116](#)
- Emergency unlocking, transmission lock [150](#)
- Emergency wheel [373](#)
- Energy recovery [154](#)
- Energy savings, see Gear shift indicator [162](#)
- Engine, automatic Start/Stop function [134](#)
- Engine compartment [375](#)
- Engine coolant [382](#)
- Engine idling when driving, see Coasting [334](#)
- Engine oil, adding [380](#)
- Engine oil change [382](#)
- Engine oil filler neck [380](#)
- Engine oil temperature [161](#)
- Engine oil types to add [381](#)
- Engine start, jump-starting [394](#)
- Engine start, see Drive-ready state [38](#)
- Engine temperature [161](#)
- Entering a destination, see Owner's Handbook for Navigation, Entertainment, Communication [6](#)
- Entering an address, navigation, see Owner's Manual for Navigation, Entertainment and Communication [6](#)

Entertainment, see Owner's Manual for Navigation, Entertainment and Communication [6](#)
Entry comparison, navigation [41](#)
Equipment, interior [297](#)
Error indicators, see Check Control [155](#)
ESP Electronic Stability Program, see DSC [219](#)
Evasion Assistant [187](#)
Exchanging wheels and tires [351](#)
Exhaust gas system [323](#)
Exhaustion warner [217](#)
Exhaust, see Exhaust gas system [323](#)
Experience Modes [53](#)
Exterior lighting during unlocking [79](#)
Exterior lighting with the vehicle locked [80](#)
Exterior mirror, Automatic Curb Monitor [123](#)
Exterior mirror, automatic dimming feature [122](#)
Exterior mirrors [122](#)
Exterior mirrors, malfunction [122](#)
External start [394](#)
External temperature [161](#)
Eyelet for towing [397](#)
Eyes, see Lashing eyes in the cargo area [314](#)

F

Factory settings, see Reset vehicle configuration [64](#)
Failure message, see Check Control [155](#)
False alarm, see Avoiding unintentional alarms [106](#)
Fan, see Air flow [283](#)
Fastening safety belts, see Safety belts [117](#)
Fatigue alert [217](#)
Fault indicators, see Check Control [155](#)
Filler neck for engine oil [380](#)
Fine wood parts, care [400](#)
First-aid kit [391](#)
Fittings for trailer safety chain, trailer towing [330](#)
Flag bracket [325](#)
Flat tire, changing wheels [368](#)
Flat tire, continued driving [364](#), [368](#)
Flat tire message, FTM [366](#)
Flat tire message, TPM [362](#)
Flat Tire Monitor FTM [366](#)
Flat tire, repairing [353](#)
Flat tire, see Tire Pressure Monitor TPM [359](#)

Flat tire warning light, FTM [366](#)
Flat tire warning light, TPM [362](#)
Flooding [324](#)
Floor carpet, care [401](#)
Floor mats, care [401](#)
Fold-away position of the wipers [145](#)
Foot brake [324](#)
Fording depth [324](#)
Forward collision mitigation, see Intelligent Safety [182](#)
For Your Own Safety [8](#)
Fragrance cartridge, see Ambient air package [293](#)
Fragrance, see Ambient air package [293](#)
Fragrancing, see Ambient air package [293](#)
Front airbags [178](#)
Front collision mitigation [183](#)
Front fog lights [175](#)
Front fog lights, replacing, see Lights and bulbs [388](#)
Front lights, replacing, see Lights and bulbs [388](#)
Front passenger seat function, see Gentleman function [114](#)
Front-seat passenger airbags, automatic deactivation [181](#)
Front-seat passenger airbags, indicator light [181](#)
Front seats [111](#)
FTM Flat Tire Monitor [366](#)
Fuel [378](#)
Fuel cap [338](#)
Fuel filler flap [338](#)
Fuel filler flap, unlocking manually [339](#)
Fuel gauge [159](#)
Fuel quality [378](#)
Fuel recommendation [378](#)
Fuel, tank capacity [406](#)
Fuel, tank capacity, see Technical data [402](#)
Fuses [389](#)

G

Garage door opener, see Integrated Universal Remote Control [297](#)
Gasoline [378](#)
Gear change, Steptronic transmission [146](#)
Gear shift indicator [162](#)

General driving notes [323](#)
 General settings [60](#)
 Gentleman function [114](#)
 Gesture Control [54](#)
 Gestures, see BMW Gesture Control [54](#)
 Glare shield, see Sun visor [300](#)
 Glass sunroof, electric [108](#)
 Glass sunroof, initialize the system [110](#)
 Glove compartment [308](#)
 GPS geolocation, vehicle position [63](#)
 GPS, navigation, see Owner's Handbook for Navigation, Entertainment, Communication [6](#)
 Gross vehicle weight, approved [403](#)
 Gross weight, permissible for trailer towing [404](#)
 Ground clearance, see xOffroad package [275](#)

H

Handbrake, see Parking brake [139](#)
 Hand-held transmitter, alternating code [298](#)
 Hands-free device, see Owner's Handbook for Navigation, Entertainment, Communication [6](#)
 Hazard warning flashers [391](#)
 HDC Hill Descent Control [222](#)
 Head airbags [179](#)
 Headlight control, automatic [170](#)
 Headlight courtesy delay feature [172](#)
 Headlight courtesy delay feature, switching on [81](#)
 Headlight flasher [143](#)
 Headlight glass [388](#)
 Headlights, care [399](#)
 Headlights, replacing, see Lights and bulbs [388](#)
 Head restraint pillow [121](#)
 Head restraints and seats [111](#)
 Head restraints, front [119](#)
 Head restraints, rear [120](#)
 Head-up Display [167](#)
 Head-up Display, care [401](#)
 Head-up Display, store position, see Memory function [124](#)
 Heated steering wheel [124](#)
 Heavy cargo, stowing [314](#)
 High-beam Assistant [173](#)
 High beams [143](#)

High beams/low beams, see High-beam Assistant [173](#)
 Hill Descent Control HDC [222](#)
 Hills [325](#)
 Hill start assistant, see Drive-off assistant [219](#)
 Holder for beverages, see Cup holders [310](#)
 HomeLink, see Integrated Universal Remote Control [297](#)
 Homepage, see Internet [6](#)
 Hood [376](#)
 Horn [32](#)
 Hotel function, see Valet parking mode [100](#)
 Hot exhaust gas system [323](#)
 Humidity in the headlight, see Headlight glass [388](#)
 Hydroplaning [324](#)

I

iBrake – PostCrash [216](#)
 Ice warning, see External temperature [161](#)
 Icy roads, see External temperature [161](#)
 Identification marks, tires [348](#)
 Identification number, see Vehicle identification number [12](#)
 Idle state, standby state, and drive-ready state [37](#)
 iDrive [40](#)
 ID transmitter, see Vehicle key [78](#)
 Ignition key, see Vehicle key [78](#)
 Indicator/warning lights [156](#)
 Individual air distribution [283](#)
 Individual settings, see Driver profiles [66](#)
 Inductive charging, smartphone, see Wireless charging tray [304](#)
 Inflation pressure monitor, see Tire Pressure Monitor TPM [359](#)
 Inflation pressure, tires [340](#)
 Inflation pressure warning FTM, tires [366](#)
 Information [6](#)
 Information window, Control Display [63](#)
 Initialization, Flat Tire Monitor FTM [366](#)
 Initialization, Tire Pressure Monitor TPM [361](#)
 Input and display [40](#)
 Instrument cluster [152](#)
 Instrument lighting [176](#)

Integral Active Steering [224](#)
Integrated key [87](#)
Integrated Owner's Manual in the vehicle [14](#)
Integrated Universal Remote Control [297](#)
Intelligent Auto Start/Stop function [136](#)
Intelligent emergency call [393](#)
Intelligent Personal Assistant [52](#)
Intelligent Safety [182](#)
Intended use [8](#)
Intensity, AUTO program [282](#)
Interior camera, see Driver Attention Camera [63](#)
Interior equipment [297](#)
Interior lights [176](#)
Interior lights during unlocking [79](#)
Interior lights with the vehicle locked [80](#)
Interior mirror, automatic dimming feature [123](#)
Interior motion sensor [105](#)
Internet connection [73](#)
Internet hotspot [73](#)
Internet page [6](#)
Intersection collision warning [190](#)
Interval display, see Service notifications [161](#)
Ionization, see Ambient air package [293](#)

J

Jacking points for the vehicle jack [371](#)
Jam protection system, glass sunroof [109](#)
Jam protection system, windows [107](#)
Joystick, Steptronic transmission [146](#)
Jump-starting [394](#)
Jump-starting terminals [395](#)

K

Kenaf, care [400](#)
Key Card, see BMW Digital Key [93](#)
Keyless Go, see Comfort Access [89](#)
Key, mechanical [87](#)
Key, see BMW Digital Key [93](#)
Key, see BMW display key [83](#)
Key, see Vehicle key [78](#)
Kickdown, Steptronic transmission [146](#)
Knee airbag [179](#)

L

Label on recommended tires [351](#)
Lane control assistant [239](#)
Lane departure warning [200](#)
Lane lines, Surround View [256](#)
Lane threshold, warning [200](#)
Language, set on Control Display [62](#)
Laser headlights, replacing, see Lights and bulbs [388](#)
Laser high beams [175](#)
Lashing eyes in the cargo area [314](#)
LATCH child restraint fixing system [131](#)
Launch Control [150](#)
Leather care [400](#)
LED front fog lights, replacing, see Lights and bulbs [388](#)
LED headlights, replacing, see Lights and bulbs [388](#)
LED light carpet, see Welcome light [172](#)
LEDs, replacing, see Lights and bulbs [388](#)
Letters and numbers, entering [41](#)
Light-alloy wheels, care [400](#)
Light control, adaptive [173](#)
Light-emitting diodes, replacing LEDs, see Lights and bulbs [388](#)
Lighter, cigarettes [301](#)
Lighting [170](#)
Lighting, loudspeaker, see Bowers & Wilkins [177](#)
Light in the exterior mirror, see Blind spot collision warning [204](#)
Light in the exterior mirror, see Cross traffic warning [268](#)
Light replacement, see Lights and bulbs [388](#)
Lights [170](#)
Lights and bulbs [388](#)
Light switch [170](#)
LIM button, see Manual Speed Limiter [225](#)
List of all messages [60](#)
Load [314](#)
Loading [313](#)
Loading the cargo area, see Stowing cargo [314](#)
Location, vehicle position [63](#)
Lock control elements, rear automatic climate control [288](#)

Locking, automatic [103](#)
Locking, see [Opening and Closing 78](#)
Locking, settings [102](#)
Locking the tailgate, see [Valet parking mode 100](#)
Locking, vehicle key [79](#)
Lock, lug bolts [370](#)
Loudspeaker lighting, see [Bowers & Wilkins 177](#)
Low beams [171](#)
Low beams, automatic, see [High-beam Assistant 173](#)
Lower back support [113](#)
Lower tailgate [99](#)
Lug bolt lock [370](#)
Luggage rack, see [Roof-mounted luggage rack 326](#)
Lumbar support [113](#)

M

Maintenance [385](#)
Maintenance requirements, see [Condition Based Service CBS 385](#)
Maintenance, see [Service notifications 161](#)
Maintenance system, BMW [385](#)
Make-up mirror [300](#)
Malfunction, BMW display key [86](#)
Malfunction, vehicle key [82](#)
Managing devices [76](#)
Manual air distribution [283](#)
Manual air flow [283](#)
Manual brake, see [Parking brake 139](#)
Manual mode, Steptronic transmission [146](#)
Manual operation, fuel filler flap [339](#)
Manual Speed Limiter [225](#)
Map update, see [Owner's Handbook for Navigation, Entertainment, Communication 6](#)
Marking, run-flat tire [352](#)
Massage seat, front [125](#)
Matte finish [399](#)
Maximum cooling [281](#)
Maximum speed display, see [Speed Limit Info 163](#)
Maximum speed of winter tires [352](#)
M chassis/suspension, adaptive, see [Adaptive M chassis/suspension 277](#)

Measurement, units of [62](#)
Media of the Owner's Manual [14](#)
Medical supplies, see [First-aid kit 391](#)
Memory function [124](#)
Menu, instrument cluster, see [Selection lists 164](#)
Menu, operating, iDrive [40](#)
Messages [60](#)
Messages, see [Check Control 155](#)
Microfilter [284](#)
Minimum tread depth, tires [350](#)
Mirrors [123](#)
Mobile communication devices in the vehicle [324](#)
Mobile devices, managing [76](#)
Mobile phone, connecting [70](#)
Mobile phone, see [Owner's Manual for Navigation, Entertainment and Communication 6](#)
Mobility System [353](#)
MODE button, see [Active Cruise Control 229](#)
Mode, ECO PRO [332](#)
Modifications, technical, see [For Your Own Safety 8](#)
Monitor, see [Control Display 43](#)
Mount for trailer hitch, care [401](#)
Mounting for trailer hitch [329](#)
Mounting of child restraint systems [129](#)
MP3 player, see [Owner's Handbook for Navigation, Entertainment, Communication 6](#)
M sport differential, active [222](#)
Multi-function hook [315](#)
Multifunction steering wheel, buttons [32](#)
Multimedia, see [Owner's Manual for Navigation, Entertainment and Communication 6](#)
Music hard disk, see [Owner's Handbook for Navigation, Entertainment, Communication 6](#)
Music track, gesture control [55](#)

N

Navigation, see [Owner's Manual for Navigation, Entertainment and Communication 6](#)
Neck restraints, front, see [Head restraints 119](#)
Neck restraints, rear, see [Head restraints 120](#)
Net, cargo area [315](#)
Neutral cleaner, see [Light-alloy wheels 400](#)

New wheels and tires [351](#)
Night Vision device, see Night Vision [197](#)
Night Vision with pedestrian and animal detection [197](#)
Nose weight, see Drawbar nose weight [404](#)
No-touch opening and closing of the tailgate [91](#)
Nylon rope for tow-starting/towing [396](#)

O

OBD Onboard Diagnosis [386](#)
Object detection, see Night Vision [197](#)
Obstacle marking, rearview camera [253](#)
Obstacle marking, Surround View [256](#)
Octane rating, see Recommended fuel grade [379](#)
Odometer, see Trip data [165](#)
Oil, adding [380](#)
Oil change [382](#)
Oil change interval, see Service notifications [161](#)
Oil filler neck [380](#)
Oil level, checking electronically [379](#)
Oil types to add, engine [381](#)
Onboard Computer, see Trip data [165](#)
Onboard Diagnosis OBD [386](#)
Onboard literature, printed [14](#)
Onboard vehicle tool kit [387](#)
On-call service, see Accident Assistance [392](#)
On-call service, see Roadside Assistance [392](#)
Opening and closing [78](#)
Opening with the smartphone, see BMW Digital Key [93](#)
Operating concept, iDrive [40](#)
Operation, app [54](#)
Outside air, see AUC [282](#)
Overheating of the engine, see Engine temperature [161](#)
Overwintering, see Long-term vehicle storage [401](#)
Owner's Manual, printed [14](#)
Owner's Manual via voice operation [54](#)

P

Paint, vehicle [399](#)
Pairing, mobile devices, see Connections [70](#)
Panic alarm, see Panic mode [105](#)
Panic mode [105](#)
Panorama View, see Surround View [254](#)
Panoramic glass sunroof, see Glass sunroof [108](#)
Park Distance Control PDC [247](#)
Parked-car ventilation [288](#)
Parking aid, see PDC [247](#)
Parking Assistant [262](#)
Parking assistant Plus, see Surround View [254](#)
Parking Assistant, see Parking Assistant [262](#)
Parking, Automatic Hold, see Parking brake [139](#)
Parking brake [139](#)
Parking lights [171](#)
Parts and accessories [8](#)
Passenger's side mirror, tilting, see Automatic Curb Monitor [123](#)
Pathway lines, rearview camera [253](#)
PDC Park Distance Control [247](#)
Pedestrian detection, see Night Vision [197](#)
Performance Control [278](#)
Performance display, see Sport displays [166](#)
Personal data, deleting [65](#)
Personal profile, see Driver profiles [66](#)
Personal settings [65](#)
Person warning with braking function [194](#)
Phone, connecting [70](#)
Pillow for head restraints in the rear [121](#)
Plastic parts, care [400](#)
PostCrash – iBrake [216](#)
Power failure [389](#)
Power windows [106](#)
Pressure monitor, see Tire Pressure Monitor TPM [359](#)
Pressure, tires [340](#)
Pressure warning FTM, tires [366](#)
Printed onboard literature [14](#)
Profiles, see Driver profiles [66](#)
Programmable memory buttons, iDrive [42](#)
Protective function, glass sunroof, see Jam protection system [109](#)
Protective function, windows, see Jam protection system [107](#)
Push-and-turn reel, see Controller [43](#)

Paint, vehicle [399](#)
Pairing, mobile devices, see Connections [70](#)

Q

Queuing Assistant, see Steering and traffic jam assistant [239](#)

R

Racing track [326](#)

Radiator fluid [382](#)

Radio, see Owner's Manual for Navigation, Entertainment and Communication [6](#)

Rain sensor [144](#)

Rear automatic climate control [286](#)

Rear automatic climate control, lock control elements [288](#)

Rear axle steering, see Integral Active Steering [224](#)

Rear collision preparation [211](#)

Rear collision warning, see Rear collision preparation [211](#)

Rear lights, replacing, see Lights and bulbs [388](#)

Rear seat backrests, folding down [316](#)

Rear seat backrest tilt [115](#)

Rear seats [114](#)

Rear ventilation, third row of seats, ventilation, third row of seats [285](#)

Rearview camera, see Surround View [254](#)

Rearview camera, without Surround View [252](#)

Rear-view mirror, internal [123](#)

Rearview mirrors, exterior [122](#)

Rear window defroster [284](#)

Rear window wiper, operation [145](#)

Recirculated-air filter, see Microfilter/activated-charcoal filter [284](#)

Recirculated-air mode [282](#)

Recommended fuel grade [379](#)

Recommended tire brands [351](#)

Refueling [338](#)

Remote 3D View [261](#)

Remote control for audio, see Owner's Handbook for Navigation, Entertainment, Communication [6](#)

Remote control, see Vehicle key [78](#)

Remote control, universal [297](#)

Remote Engine Start, see Stationary climate control [290](#)

Remote services, app, see Owner's Handbook for Navigation, Entertainment, Communication [6](#)

Remote Software Upgrade [57](#)

Removable ball head [329](#)

Replacing bulbs, see Lights and bulbs [388](#)

Replacing parts [387](#)

Replacing the battery, vehicle key [81](#)

Replacing wheels and tires [351](#)

Reporting safety malfunctions [13](#)

Reserve warning, see Range [161](#)

Resetting, Tire Pressure Monitor TPM [361](#)

Reset, vehicle configuration [64](#)

Reset vehicle settings [64](#)

RESUME button, see Active Cruise Control [229](#)

RESUME button, see Cruise control [227](#)

Retreaded tires [352](#)

Roadside Assistance [392](#)

Roadside Assistance, see Accident Assistance [392](#)

Roadside parking lights [171](#)

Roller sunblinds, rear side windows [108](#)

Rolling code hand-held transmitter [298](#)

RON recommended fuel grade [379](#)

Roofliner [36](#)

Roof-mounted luggage rack [326](#)

Rope for tow-starting/towing [396](#)

Route, navigation, see Owner's Handbook for Navigation, Entertainment, Communication [6](#)

RSC Runflat System, see Runflat tire [352](#)

RTTI, see Owner's Handbook for Navigation, Entertainment, Communication [6](#)

Rubber components, care [400](#)

Run-flat tire [352](#)

S

Safe braking [324](#)

Safe Share function, see BMW Digital Key/Key Card [93](#)

Safety belt reminder for driver's seat and front passenger seat [118](#)

Safety belt reminder for the rear seats [119](#)

Safety belts [117](#)

Safety belts, care [401](#)

Safety locks, doors and windows [133](#)

- Safety package, see Active Protection [215](#)
- Safety switch, windows [107](#)
- Safety systems, see Airbags [178](#)
- Safety systems, see Intelligent Safety [182](#)
- Saving fuel [331](#)
- Screen Mirroring, connection [75](#)
- Screen, see Control Display [43](#)
- Sealant, see Mobility System [353](#)
- Seat and armrest heating [125](#)
- Seat heating [125](#)
- Seating position for children [128](#)
- Seats and head restraints [111](#)
- Seats, front [111](#)
- Seats, rear [114](#)
- Seat ventilation, active [126](#)
- Securing, cargo [314](#)
- Selection list in instrument cluster [164](#)
- Selector lever, Steptronic transmission [146](#)
- Self-leveling suspension, see 2-axle air suspension [272](#)
- Self-supporting tires, see Run-flat tires [352](#)
- Sensors, care [401](#)
- Service and warranty [9](#)
- Service Center, see Accident Assistance [392](#)
- Service notifications [161](#)
- Service requirements, see Condition Based Service CBS [385](#)
- Services, ConnectedDrive, see Owner's Manual for Navigation, Entertainment and Communication [6](#)
- SET button, see Active Cruise Control with Stop&Go function [229](#)
- SET button, see Cruise control [227](#)
- Set speed, see Active Cruise Control with Stop&Go function [229](#)
- Setting, Control Display [64](#)
- Settings, general [60](#)
- Settings, locking/unlocking [102](#)
- Settings, seats and head restraints [111](#)
- Settings vehicle configuration, reset [64](#)
- Setup assistant [66](#)
- Shift paddles on the steering wheel [146](#)
- Shift point indicator, tachometer [160](#)
- Side airbag [178](#)
- Side protection, Surround View [256](#)
- Side protection without Surround View [250](#)
- Signaling, horn [32](#)
- Signals when unlocking, see Confirmation signals from the vehicle [102](#)
- Sitting safely [111](#)
- Situational adaptation [53](#)
- Size [402](#)
- Sizes, see Technical data [402](#)
- Slide/tilt glass roof, see Glass sunroof [108](#)
- Smartphone, connecting [70](#)
- Smartphone, see Owner's Manual for Navigation, Entertainment and Communication [6](#)
- Smartphone, using via voice activation [51](#)
- Smoker's package [300](#)
- SMS, see Short messages, see Owner's Handbook for Navigation, Entertainment, Communication [6](#)
- SMS text message, supplementary [156](#)
- Snow chains [358](#)
- Socket for OBD Onboard Diagnosis [386](#)
- Sockets [302](#)
- Software Update, see Remote Software Upgrade [57](#)
- Software Upgrade, see Remote Software Upgrade [57](#)
- SOS button, see Intelligent emergency call [393](#)
- Sound output, see Owner's Handbook for Navigation, Entertainment, Communication [6](#)
- Spare tire, see Emergency wheel [373](#)
- Special equipment, see Vehicle features and options [7](#)
- Speed Limit Assist [238](#)
- Speed Limit Device, Speed Limiter [225](#)
- Speed limit display, see Speed Limit Info [163](#)
- Speed Limit Info [163](#)
- Speed warning [62](#)
- Sport chassis/suspension, see Adaptive M chassis/suspension [277](#)
- Sport displays [166](#)
- SPORT INDIVIDUAL, see Driving Dynamics Control [137](#)
- SPORT PLUS, see Driving Dynamics Control [137](#)
- Sport program, Steptronic transmission [146](#)
- SPORT, see Driving Dynamics Control [137](#)
- Sport suspension, see Adaptive M suspension Professional [278](#)

- Stability control systems [219](#)
- Standard equipment, see [Vehicle features and options 7](#)
- Standby state, idle state and drive-ready state [37](#)
- Start/stop, automatic function [134](#)
- Start/Stop button [134](#)
- Starting aid terminals [395](#)
- Starting, see [Drive-ready state 38](#)
- Starting the engine, see [Drive-ready state 38](#)
- Stationary climate control via Remote Engine Start [290](#)
- Stations, AM/FM, see [Owner's Handbook for Navigation, Entertainment, Communication 6](#)
- Status control display, tires [360](#)
- Status information, iDrive [41](#)
- Status of Owner's Manual [7](#)
- Status, vehicle [167](#)
- Steering and traffic jam assistant [239](#)
- Steering, see [Integral Active Steering 224](#)
- Steering wheel, adjusting [123](#)
- Steering wheel, buttons [32](#)
- Steptronic Sport transmission, see [Steptronic transmission 146](#)
- Steptronic transmission [146](#)
- Storage compartment, cargo area [315](#)
- Storage compartment, center console [309](#)
- Storage compartments [308](#)
- Storage compartments, locations [308](#)
- Storage, tires [352](#)
- Store Mirror position, see [Memory function 124](#)
- Store seat position, see [Memory function 124](#)
- Store steering wheel position, see [Memory function 124](#)
- Storing the vehicle [401](#)
- Stowing, cargo [314](#)
- Straps for cargo, see [Lashing eyes in the cargo area 314](#)
- Suitable devices [71](#)
- Suitable mobile phones [71](#)
- Summer tires, tread [349](#)
- Sun visor [300](#)
- Sun visor, sliding [300](#)
- Supplementary Owner's Manuals [14](#)
- Supplementary SMS text message [156](#)
- Surface heating, see [Seat and armrest heating 125](#)
- Surround View [254](#)
- Surround View, gesture control [55](#)
- Suspension settings, see [Driving Dynamics Control 137](#)
- Swinging of trailer, see [Trailer stabilization control 329](#)
- Switches, see [Cockpit 32](#)
- Switch for driving dynamics, see [Driving Dynamics Control 137](#)
- Switching off the engine, see [Drive-ready state 38](#)
- Symbols and displays [7](#)
- SYNC program, automatic climate control [283](#)
- ## T
- Tachometer [160](#)
- Tailgate, automatic [98](#)
- Tailgate, opening and closing with no-touch activation [91](#)
- Tailgate, vehicle key [80](#)
- Tail lights, replacing, see [Lights and bulbs 388](#)
- Technical changes, see [For Your Own Safety 8](#)
- Technical data [402](#)
- Telephone, see [Owner's Manual for Navigation, Entertainment and Communication 6](#)
- Teleservices, see [Owner's Handbook for Navigation, Entertainment, Communication 6](#)
- Temperature, automatic climate control [280](#)
- Temperature display, see [External temperature 161](#)
- Temperature, engine oil [161](#)
- Theft alarm system, see [Alarm system 104](#)
- Thermal camera, see [Night Vision 197](#)
- Thigh support [112](#)
- Third row of seats [116](#)
- Tilt alarm sensor [105](#)
- Tilt, backrest [112](#)
- Tilting, passenger's side mirror, see [Automatic Curb Monitor 123](#)
- Time [61](#)
- Tire brands, recommended [351](#)
- Tire damage [350](#)
- Tire identification marks [348](#)

- Tire inflation pressure [340](#)
Tire inflation pressure monitor, see FTM Flat Tire Monitor [366](#)
Tire pressure [340](#)
Tire Pressure Monitor TPM [359](#)
Tire repair kit, see Mobility System [353](#)
Tires and wheels [340](#)
Tires, changing [351](#)
Tire sealant, see Mobility System [353](#)
Tire settings [359](#)
Tires, run-flat [352](#)
Tire tread [349](#)
Tone, see Owner's Manual for Navigation, Entertainment and Communication [6](#)
Tools [387](#)
Torque display, see Sport displays [166](#)
Total vehicle weight [403](#)
Touchpad, Controller [46](#)
Tow bar [396](#)
Tow fitting [397](#)
Towing [395](#)
Tow rope [396](#)
Tow-starting [395](#)
TPM Tire Pressure Monitor [359](#)
Traction control [221](#)
TRACTION, driving dynamics [221](#)
Traffic bulletins, see Owner's Handbook for Navigation, Entertainment, Communication [6](#)
Traffic Jam Assist, see Steering and traffic jam assistant [239](#)
Trailer hitch, care [401](#)
Trailer hitch, removable ball head [329](#)
Trailer hitch, view of rearview camera [253](#)
Trailer hitch, view of Surround View [256](#)
Trailer loads [404](#)
Trailer stabilization control [329](#)
Trailer towing [327](#)
Trailer towing, activation [329](#)
Trailer towing, data [404](#)
Transmission lock, electronic unlocking [150](#)
Transmission, see Steptronic transmission [146](#)
Transporting children safely [128](#)
Travel & Comfort System [307](#)
Tread, tires [349](#)
Trip data [165](#)
Triple turn signal activation [142](#)
Trip odometer, see Trip data [165](#)
Turning circle line, Surround View [256](#)
Turning radius lines, rearview camera [253](#)
Turn signal, indicator light [158](#)
Turn signal, replacing bulbs, see Lights and bulbs [388](#)
Turn signals, high beams, headlight flasher [142](#)
- ## U
- Unintentional alarm, avoiding [106](#)
Units of measurement [62](#)
Universal remote control [297](#)
Unlock button, Steptronic transmission [146](#)
Unlocking, automatic [103](#)
Unlocking, see Opening and Closing [78](#)
Unlocking, settings [102](#)
Unlocking, vehicle key [79](#)
Unpaved roads, cross-country trips [322](#)
Updates made after the editorial deadline [7](#)
Upgrade, see Remote Software Upgrade [57](#)
Upholstery material care [400](#)
Upper backrest, front [113](#)
USB connection [73](#)
USB interface, position in vehicle [303](#)
Used battery, disposing of [389](#)
Use, intended [8](#)
- ## V
- Valet parking mode [100](#)
Vanity mirror [300](#)
Variable steering, see Integral Active Steering [224](#)
Vehicle battery [388](#)
Vehicle breakdown, see Breakdown assistance [391](#)
Vehicle, breaking in [322](#)
Vehicle care [399](#)
Vehicle care products [399](#)
Vehicle configuration, reset [64](#)
Vehicle features and options [7](#)
Vehicle identification number [12](#)
Vehicle key [78](#)
Vehicle key, additional [81](#)
Vehicle key, integrated key [87](#)

- Vehicle key, loss [81](#)
 - Vehicle key, malfunction [82](#)
 - Vehicle key, replacing the battery [81](#)
 - Vehicle key with display, malfunction [86](#)
 - Vehicle key with display, see BMW display key [83](#)
 - Vehicle paint [399](#)
 - Vehicle position, vehicle location [63](#)
 - Vehicle status [167](#)
 - Vehicle storage [401](#)
 - Vehicle washing [398](#)
 - Ventilation [284](#)
 - Ventilation, see Parked-car ventilation [288](#)
 - Venting, see Ventilation [284](#)
 - Vent, see Ventilation [284](#)
 - Version Software, see Remote Software Upgrade [57](#)
 - Video recording, see BMW Drive Recorder [214](#)
 - Video, see Owner's Manual for Navigation, Entertainment and Communication [6](#)
 - VIN, see Vehicle identification number [12](#)
 - Voice activation [48](#)
 - Voice activation, gesture control [55](#)
 - Voice activation, see BMW Intelligent Personal Assistant [52](#)
 - Voice activation system [48](#)
 - Voice command response [48](#)
 - Volume, gesture control [55](#)
- ## W
- Wake word [49](#)
 - Warning/indicator lights [156](#)
 - Warning against cross traffic [268](#)
 - Warning light in the exterior mirror, see Blind spot collision warning [204](#)
 - Warning light in the exterior mirror, see Cross traffic warning [268](#)
 - Warning messages, see Check Control [155](#)
 - Warning triangle [391](#)
 - Warranty [8](#)
 - Washer fluid [383](#)
 - Washer nozzles, windshield [145](#)
 - Washer system [143](#)
 - Washing systems, automatic [398](#)
 - Washing, vehicle [398](#)
 - Wash view, Surround View [256](#)
 - Water on roads [324](#)
 - Water, see Condensation water under the parked vehicle [325](#)
 - Website, see Internet [6](#)
 - Weights [403](#)
 - Weights, see Technical data [402](#)
 - Welcome light during unlocking [79](#)
 - Welcome lights [172](#)
 - Welcome screen, driver profiles [66](#)
 - Wheel cleaner, light-alloy wheels [400](#)
 - Wheels and tires [340](#)
 - Wheels and tires, replacing [351](#)
 - Wheels, changing [351](#)
 - Wheels, see FTM Flat Tire Monitor [366](#)
 - Widgets, iDrive [41](#)
 - WiFi connection [73](#)
 - WiFi connection, see WLAN connection [73](#)
 - WiFi hotspot, see Internet connection [73](#)
 - Window, defrosting [284](#)
 - Windows, powered [106](#)
 - Windshield, defrosting [284](#)
 - Windshield washer fluid, see Washer fluid [383](#)
 - Windshield washer nozzles [145](#)
 - Windshield washer system, see Washer/wiper system [143](#)
 - Windshield wiper, see Wiper system [143](#)
 - Winter storage, see Long-term vehicle storage [401](#)
 - Winter tires [352](#)
 - Winter tires, tread [350](#)
 - Wiper blades, replacing [387](#)
 - Wiper fluid, see Washer fluid [383](#)
 - Wiper, fold-away position [145](#)
 - Wiper, see Washer/wiper system [143](#)
 - Wiper system [143](#)
 - Wireless charging, smartphone, see Wireless charging tray [304](#)
 - Wireless charging tray for smartphones [304](#)
 - WLAN connection [73](#)
 - Wood parts, care [400](#)
 - Wordmatch principle, see Entry comparison [41](#)
 - Working in, engine compartment [376](#)
 - Wrench, see Onboard vehicle tool kit [387](#)

X

xDrive [221](#)

xOffroad package [275](#)



01402913686 ue

California Proposition 65 Warning

For vehicles sold in California:

California Proposition 65 Warning



WARNING

Operating, servicing and maintaining a passenger vehicle or off-highway motor vehicle can expose you to chemicals including engine exhaust, carbon monoxide, phthalates, and lead, which are known to the State of California to cause cancer and birth defects or other reproductive harm. To minimize exposure, avoid breathing exhaust, do not idle the engine except as necessary, service your vehicle in a well-ventilated area and wear gloves or wash your hands frequently when servicing your vehicle. For more information go to www.P65Warnings.ca.gov/passenger-vehicle.



The Ultimate
Driving Machine®



BMW DRIVER'S GUIDE APP.

Your customized information about the vehicle in an app.
Optimized for smartphones & tablets. Can be used offline.



Download on the
App Store



GET IT ON
Google Play



01402913686 ue

Online Edition for Part no. 01402913686 - X/19