

**LINK:**  
**CONTENT & A-Z**



The Ultimate  
Driving Machine®



# OWNER'S MANUAL.

## THE BMW X5.





# **WELCOME TO BMW.**

## **Owner's Manual.**

### **BMW X5.**

Thank you for choosing a BMW.

The more familiar you are with your vehicle, the better control you will have on the road. We therefore strongly suggest:

Read this Owner's Manual before starting off in your new BMW. Also use the Integrated Owner's Manual in your vehicle. It contains important information on vehicle operation that will help you make full use of the technical features available in your BMW. The manual also contains information designed to enhance operating reliability and road safety, and to contribute to maintaining the value of your BMW.

At the time of production at the plant, the printed Owner's Manual is the most current resource. After a vehicle software update – for example, a Remote Software Upgrade – the Integrated Owner's Manual for the vehicle will contain updated information.

You can find supplementary information in the additional brochures in the on-board literature.

We wish you a safe and enjoyable ride.

# TABLE OF CONTENTS

## **!** NOTES

Information .....	8
Owner's Manual media .....	16

## **⚡** QUICK REFERENCE

Entering .....	20
Set-up and use .....	24
In transit .....	28

## **↓** CONTROLS

Cockpit .....	38
Operating state of the vehicle .....	43
iDrive .....	46
BMW Remote Software Upgrade .....	60
General Settings .....	63
Opening and closing .....	76
Seats, mirrors, and steering wheel .....	111
Transporting children safely .....	128
Driving .....	133
Displays .....	151
Lights .....	168
Safety .....	176
Driving stability control systems .....	213
Driver assistance systems .....	219
Driving comfort .....	262
Climate control .....	269
Interior equipment .....	287
Storage compartments .....	295
Cargo area .....	301

**After a vehicle software update – for example, a Remote Software Upgrade – the Integrated Owner's Manual for the vehicle will contain updated information.**

## **DRIVING TIPS**

Things to remember when driving .....	312
Trailer towing .....	317
Saving fuel .....	321

## **MOBILITY**

Refueling .....	330
Wheels and tires .....	332
Engine compartment .....	364
Operating materials .....	367
Maintenance .....	374
Replacing components .....	376
Breakdown assistance .....	380
Care .....	387

## **REFERENCE**

Technical data .....	394
Appendix .....	397
Everything from A to Z .....	398

---

© 2018 Bayerische Motoren Werke

Aktiengesellschaft

Munich, Germany

Reprinting, including excerpts, only with the written consent of BMW AG, Munich.

US English ID7 X/18, 11 18 490

Printed on environmentally friendly paper, bleached without chlorine, suitable for recycling.



# ! NOTES

Information .....	8
Owner's Manual media .....	16

# Information

## Using this Owner's Manual

### Orientation

The fastest way to find information on a particular topic is by using the index.

An initial overview of the vehicle is provided in the first chapter.

### Validity of the Owner's Manual

#### Production of the vehicle

At the time of production at the plant, the printed Owner's Manual is the most current resource. Due to updates after the editorial deadline, differences may exist between the printed Owner's Manual and the Integrated Owner's Manual in the vehicle.

Notes on updates can be found in the appendix of the printed Owner's Manual for the vehicle.

#### After a software update in the vehicle

After a vehicle software update – for example, a Remote Software Upgrade – the Integrated Owner's Manual for the vehicle will contain updated information.

### Owner's Manual for Navigation, Entertainment, Communication

The Owner's Manual for Navigation, Entertainment, and Communication can be obtained as printed book from the service center.

The topics are also discussed in the Integrated Owner's Manual in the vehicle.

## Additional sources of information

### Dealer's service center

A dealer's service center will be glad to answer questions at any time.

### Internet

The Owner's Manual and general information on BMW, for example on technology, are available on the Internet: [www.bmwusa.com](http://www.bmwusa.com).

### Integrated Owner's Manual in the vehicle

The Integrated Owner's Manual specifically describes features and functions found in the vehicle. The Integrated Owner's Manual can be displayed on the Control Display. Additional information, refer to page 16.

### BMW Driver's Guide App

The BMW Driver's Guide app specifically describes features and functions found in the vehicle. The app can be displayed on smartphones and tablets.



### BMW Driver's Guide Web

Driver's Guide Web shows the most suitable information for the selected vehicle. If possible, only equipment and functions that are actually installed in the vehicle will be explained. Driver's Guide Web can be displayed in any current browser.



## Symbols and displays

### Symbols in the Owner's Manual

Symbol	Meaning
	Precautions that must be followed in order to avoid the possibility of injury to yourself and to others as well as serious damage to the vehicle.
	Measures that can be taken to help protect the environment.
"..."	Texts in vehicle used to select individual functions.
>...<	Verbal instructions to use with the voice activation system.
>>...<<	Responses generated by the voice activation system.

### Action steps

Action steps to be carried out are presented as numbered list. The steps must be carried out in the defined order.

1. First action step.
2. Second action step.

### Enumerations

Enumerations without mandatory order or alternative possibilities are presented as list with bullet points.

- First possibility.
- Second possibility.

### Symbols on vehicle components

 This symbol on a vehicle component indicates that further information on the component is available in the Owner's Manual.

## Vehicle features and options

This Owner's Manual describes all models and all standard, country-specific and optional equipment that is offered in the model series. Therefore, this Owner's Manual also describes and illustrates features and functions that are not available in a vehicle, for example because of the selected optional features or the country-specific version.

This also applies to safety-related functions and systems.

When using these functions and systems, the applicable laws and regulations must be observed.

For any options and equipment not described in this Owner's Manual, refer to the Supplementary Owner's Manuals.

Your BMW dealer's service center is happy to answer any questions that you may have about the features and options applicable to your vehicle.

## Status of the Owner's Manual

### Basic information

The manufacturer of your vehicle pursues a policy of constant development that is conceived to ensure that our vehicles continue to embody the highest quality and safety standards. In rare cases, therefore, the features described in this Owner's Manual may differ from those in your vehicle.

## Validity of the Owner's Manual

### Production of the vehicle

At the time of production at the plant, the printed Owner's Manual is the most current resource. Due to updates after the editorial deadline, differ-

ences may exist between the printed Owner's Manual and the Integrated Owner's Manual in the vehicle.

Notes on updates can be found in the appendix of the printed Owner's Manual for the vehicle.

### After a software update in the vehicle

After a vehicle software update – for example, a Remote Software Upgrade – the Integrated Owner's Manual for the vehicle will contain updated information.

## For Your Own Safety

### Intended use

Follow the following when using the vehicle:

- ▶ Owner's Manual.
- ▶ Information on the vehicle. Do not remove stickers.
- ▶ Technical vehicle data.
- ▶ The traffic, speed, and safety laws where the vehicle is driven.
- ▶ Vehicle documents and statutory documents.

### Warranty

Your vehicle is technically configured for the operating conditions and registration requirements applying in the country of first delivery, also known as homologation. If your vehicle is to be operated in a different country it might be necessary to adapt your vehicle to potentially differing operating conditions and registration requirements. If your vehicle does not comply with the homologation requirements in a certain country you may not be able to lodge warranty claims for your vehicle there. Further information on warranty is available from a dealer's service center.

## Maintenance and repairs

### WARNING

Improperly performed work on the vehicle paint can lead to a failure or malfunction of the radar sensors and thereby result in a safety risk.

There is a risk of accidents or risk of damage to property. Have paintwork or paintwork repairs on bumpers of vehicles with radar sensors performed by a dealer's service center or another qualified service center or repair shop only.

Advanced technology, e. g. the use of modern materials and high-performance electronics, requires suitable maintenance and repair work.

The manufacturer of the vehicle recommends that you entrust corresponding procedures to a BMW dealer's service center. If you choose to use another service facility, BMW recommends use of a facility that performs work, for instance maintenance and repair, according to BMW specifications with properly trained personnel, referred to in this Owner's Manual as "another qualified service center or repair shop".

If work is performed improperly, for instance maintenance and repair, there is a risk of subsequent damage and related safety risks.

### Parts and accessories

BMW recommends the use of parts and accessory products approved by BMW.

Approved parts and accessories, and advice on their use and installation are available from a BMW dealer's service center.

BMW parts and accessories have been tested by BMW for their safety and suitability in BMW vehicles.

BMW warrants genuine BMW parts and accessories.

BMW does not evaluate whether each individual product from another manufacturer can be used with BMW vehicles without presenting a safety hazard, even if a country-specific official approval

was issued. BMW does not evaluate whether these products are suitable for BMW vehicles under all usage conditions.

## California Proposition 65 Warning

California law requires vehicle manufacturers provide the following warning:

### WARNING

Engine exhaust and a wide variety of Automobile components and parts, including components found in the interior furnishings in a vehicle, contain or emit chemicals known to the State of California to cause cancer and birth defects and reproductive harm. In addition, certain fluids contained in vehicles and certain products of component wear contain or emit chemicals known to the State of California to cause cancer and birth defects or other reproductive harm. Battery posts, terminals and related accessories contain lead and lead compounds. Batteries also contain other chemicals known to the State of California to cause cancer. Wash your hands after handling. Used engine oil contains chemicals that have caused cancer in laboratory animals. Always protect your skin by washing thoroughly with soap and water. For more information go to [www.P65Warnings.ca.gov/passenger-vehicle](http://www.P65Warnings.ca.gov/passenger-vehicle).

### WARNING

Operating, servicing and maintaining a passenger vehicle or off-highway motor vehicle can expose you to chemicals including engine exhaust, carbon monoxide, phthalates, and lead, which are known to the State of California to cause cancer and birth defects or other reproductive harm. To minimize exposure, avoid breathing exhaust, do not idle the engine except as necessary, service your vehicle in a well-ventilated area and wear gloves or wash your hands frequently when servicing your ve-

hicle. For more information go to [www.P65Warnings.ca.gov/passenger-vehicle](http://www.P65Warnings.ca.gov/passenger-vehicle).

## Service and warranty

We recommend that you read this publication thoroughly. Your vehicle is covered by the following warranties:

- ▷ New Vehicle Limited Warranty.
- ▷ Rust Perforation Limited Warranty.
- ▷ Federal Emissions System Defect Warranty.
- ▷ Federal Emissions Performance Warranty.
- ▷ California Emission Control System Limited Warranty.

Detailed information about these warranties is listed in the Service and Warranty Information Booklet for US models or in the Warranty and Service Guide Booklet for Canadian models.

Your vehicle has been specifically adapted and designed to meet the particular operating conditions and homologation requirements in your country and continental region in order to deliver the full driving pleasure while the vehicle is operated under those conditions. If you wish to operate your vehicle in another country or region, you may be required to adapt your vehicle to meet different prevailing operating conditions and homologation requirements. You should also be aware of any applicable warranty limitations or exclusions for such country or region. In such case, please contact Customer Relations for further information.

## Maintenance

Maintain the vehicle regularly to sustain the road safety, operational reliability and the New Vehicle Limited Warranty.

Specifications for required maintenance measures:

- ▷ BMW Maintenance system.
- ▷ Service and Warranty Information Booklet for US models.

- ▶ Warranty and Service Guide Booklet for Canadian models.

If the vehicle is not maintained according to these specifications, this could result in serious damage to the vehicle. Such damage is not covered by the BMW New Vehicle Limited Warranty.

## Data memory

### General information

Electronic control devices are installed in the vehicle. Electronic control units process data they receive from vehicle sensors, self-generate or exchange with each other. Some control units are necessary for the vehicle to function safely or provide assistance during driving, for instance driver assistance systems. Furthermore, control devices facilitate comfort or infotainment functions.

Information about stored or exchanged data can be requested from the manufacturer of the vehicle, in a separate booklet, for example.

### Personal reference

Each vehicle is marked with a unique vehicle identification number. Depending on the country, the vehicle owner can be identified with the vehicle identification number, license plate and corresponding authorities. In addition, there are other options to track data collected in the vehicle to the driver or vehicle owner, e.g. via the ConnectedDrive account that is used.

### Operating data in the vehicle

Control units process data to operate the vehicle. For example, this includes:

- ▶ Status messages for the vehicle and its individual components, e.g., wheel rotational speed, wheel speed, deceleration, transverse acceleration, engaged safety belt indicator.
- ▶ Ambient conditions, e.g., temperature, rain sensor signals.

The processed data is only processed in the vehicle itself and generally volatile. The data is not stored beyond the operating period.

Electronic components, e.g. control units and ignition keys, contain components for storing technical information. Information about the vehicle condition, component usage, maintenance requirements or faults can be stored temporarily or permanently.

This information generally records the state of a component, a module, a system, or the environment, for instance:

- ▶ Operating states of system components, e.g., fill levels, tire inflation pressure, battery status.
- ▶ Malfunctions and faults in important system components, for instance lights and brakes.
- ▶ Responses by the vehicle to special situations such as airbag deployment or engagement of the driving stability control systems.
- ▶ Information on vehicle-damaging events.

The data is required to perform the control device functions. Furthermore, it also serves to recognize and correct malfunctions, and helps the vehicle manufacturer to optimize vehicle functions.

The majority of this data is transient and is only processed within the vehicle itself. Only a small share of the data is stored event-related in event or fault memories.

When servicing, for instance during repairs, service processes, warranty cases, and quality assurance measures, this technical information can be read out from the vehicle together with the vehicle identification number.

A dealer's service center or another qualified service center or repair shop can read out the information. The socket for OBD Onboard Diagnosis required by law in the vehicle is used to read out the data.

The data is collected, processed, and used by the relevant organizations in the service network. The data documents technical conditions of the

vehicle, helps with the identification of the fault, compliance with warranty obligations and quality improvement.

Furthermore, the manufacturer has product monitoring duties to meet in line with product liability law. To fulfill these duties, the vehicle manufacturer needs technical data from the vehicle. The data from the vehicle can also be used to check customer claims for warranty and guaranty.

Fault and event memories in the vehicle can be reset when a dealer's service center or another qualified service center or repair shop performs repair or servicing work.

## Data entry and data transfer into the vehicle

### General information

Depending on the vehicle equipment, comfort and individual settings can be stored in the vehicle and modified or reset at any time.

For example, this includes:

- ▶ Settings for the seat and steering wheel positions.
- ▶ Suspension and climate control settings.

If necessary, data can be transferred to the entertainment and communication system of the vehicle, e.g. via smartphone.

This includes the following depending on the respective equipment:

- ▶ Multimedia data such as music, films or photos for playback in an integrated multimedia system.
- ▶ Address book data for use in conjunction with an integrated hands-free system or an integrated navigation system.
- ▶ Entered navigation destinations.
- ▶ Data on the use of Internet services.

This data can be stored locally in the vehicle or is found on a device that has been connected to the vehicle, e.g., a smartphone, USB stick or

MP3 player. If this data is stored in the vehicle, it can be deleted at any time.

This data is only transmitted to third parties upon personal request as part of the use of online services. The transmission depends on the selected settings for the use of the services.

### Incorporation of mobile end devices

Depending on the vehicle equipment, mobile devices connected to the vehicle, for instance smartphones, can be controlled via the vehicle control elements.

The sound and picture from the mobile device can be played back and displayed through the multimedia system. Certain information is transferred to the mobile device at the same time. Depending on the type of incorporation, this includes, for instance position data and other general vehicle information. This optimizes the way in which selected apps, for instance navigation or music playback, work.

There is no further interaction between the mobile device and the vehicle, for instance active access to vehicle data.

How the data will be processed further is determined by the provider of the particular app being used. The extent of the possible settings depends on the respective app and the operating system of the mobile device.

## Services

### General information

If the vehicle has a wireless network connection, this enables data to be exchanged between the vehicle and other systems. The wireless network connection is realized via an in-vehicle transmitter and receiver unit or via personal mobile devices brought into the vehicle, for instance smartphones. This wireless network connection enables 'online functions' to be used. These include online services and apps supplied by the vehicle manufacturer or by other providers.

## Services from the vehicle manufacturer

Where online services from the vehicle manufacturer are concerned, the corresponding functions are described in the appropriate place, for instance the Owner's Manual or manufacturer's website. The relevant legal information pertaining to data protection is provided there too. Personal data may be used to perform online services. Data is exchanged over a secure connection, for instance with the IT systems of the vehicle manufacturer intended for this purpose.

Any collection, processing, and use of personal data above and beyond that needed to provide the services must always be based on a legal permission, contractual arrangement or consent. It is also possible to activate or deactivate the data connection as a whole. That is, with the exception of functions and services required by law such as Assist systems.

## Services from other providers

When using online services from other providers, these services are the responsibility of the relevant provider and subject to their data privacy conditions and terms of use. The vehicle manufacturer has no influence on the content exchanged during this process. Information on the way in which personal data is collected and used in relation to services from third parties, the scope of such data, and its purpose, can be obtained from the relevant service provider.

## Event Data Recorder EDR

This vehicle is equipped with an event data recorder EDR. The main purpose of an EDR is to record, in certain crash or near crash-like situations, such as an air bag deployment or hitting a road obstacle, data that will assist in understanding how a vehicle's systems performed. The EDR is designed to record data related to vehicle dynamics and safety systems for a short period of time, typically 30 seconds or less.

The EDR in this vehicle is designed to record such data as:

- ▶ How various systems in your vehicle were operating.
- ▶ Whether or not the driver and passenger safety belts were fastened.
- ▶ How far, if at all, the driver was depressing the accelerator and/or brake pedal.
- ▶ How fast the vehicle was traveling.

This data can help provide a better understanding of the circumstances in which crashes and injuries occur.

EDR data is recorded by your vehicle only if a nontrivial crash situation occurs; no data is recorded by the EDR under normal driving conditions and no personal data, for instance name, gender, age, and crash location, are recorded.

However, other parties, such as law enforcement, could combine the EDR data with the type of personally identifying data routinely acquired during a crash investigation.

To read data recorded by an EDR, special equipment is required, and access to the vehicle or the EDR is needed. In addition to the vehicle manufacturer, other parties, such as law enforcement, that have the special equipment, can read the information if they have access to the vehicle or the EDR.

## Vehicle identification number

### Engine compartment



The vehicle identification number can be found in the engine compartment, on the right-hand side of the vehicle.

### Windshield



The vehicle identification number can also be found behind the windshield.

### iDrive

It is also possible to display the vehicle identification number via iDrive, refer to page 69.

## Reporting safety defects

### For US customers

The following only applies to vehicles owned and operated in the US.

If you believe that your vehicle has a defect which could cause a crash or could cause injury or death, you should immediately inform the National Highway Traffic Safety Administration NHTSA, in addition to notifying BMW of North America, LLC, P.O. Box 1227, Westwood, New Jersey 07675-1227, Telephone 1-800-831-1117.

If NHTSA receives similar complaints, it may open an investigation, and if it finds that a safety defect exists in a group of vehicles, it may order a recall and remedy campaign.

However, NHTSA cannot become involved in individual problems between you, your dealer, or BMW of North America, LLC.

To contact NHTSA, you may call the Vehicle Safety Hotline toll-free at 1-888-327-4236 (TTY: 1-800-424-9153); go to <http://www.safercar.gov>; or write to: Administrator, NHTSA, 400 Seventh Street, SW., Washington, DC 20590. You can also obtain other information about motor vehicle safety from <http://www.safercar.gov>.

### For Canadian customers

Canadian customers who wish to report a safety-related defect to Transport Canada, Defect Investigations and Recalls, may call the toll-free hotline 1-800-333-0510. You can also obtain other information about motor vehicle safety from <http://www.tc.gc.ca/roadsafety>.

# Owner's Manual media

## Vehicle features and options

---

This chapter describes all standard, country-specific and optional features offered with the series. It also describes features and functions that are not necessarily available in your vehicle, e.g., due to the selected options or country versions. This also applies to safety-related functions and systems. When using these functions and systems, the applicable laws and regulations must be observed.

## General information

---

### Media at a glance

You can use various media formats to call up the content in the Owner's Manual. The following Owner's Manual media formats are available:

- ▶ Printed Owner's Manual, refer to page 16.
- ▶ Integrated Owner's Manual in the vehicle, refer to page 16.

## Validity of the Owner's Manual

### Production of the vehicle

At the time of production at the plant, the printed Owner's Manual is the most current resource. Due to updates after the editorial deadline, differences may exist between the printed Owner's Manual and the Integrated Owner's Manual in the vehicle.

Notes on updates can be found in the appendix of the printed Owner's Manual for the vehicle.

### After a software update in the vehicle

After a vehicle software update – for example, a Remote Software Upgrade – the Integrated Owner's Manual for the vehicle will contain updated information.

## Printed Owner's Manual

---

### Concept

The printed Owner's Manual describes all standard, country-specific, and optional features offered with the series.

### General information

The Owner's Manual for Navigation, Entertainment, and Communication can be obtained as printed book from the service center.

### Supplementary Owner's Manuals

Also follow the instructions of the Supplementary Owner's Manuals, which are included in addition to the onboard literature.

## Integrated Owner's Manual in the vehicle

---

### Concept

The Integrated Owner's Manual specifically describes features and functions found in the vehicle.

The Integrated Owner's Manual can be displayed on the Control Display.



## Selecting the Owner's Manual

1.  Press the button.
2. "CAR"
3. "Owner's Manual"
4. Select the required method of accessing the contents.

## Scrolling through the owner's manual

Turn the Controller, until the next or previous contents are displayed.

## Context help

### General information

The section of the Owner's Manual relating to the function that is currently selected can be displayed directly.

### Opening via iDrive

Change directly to the Options menu from the function on the Control Display:

1.  Press the button.
2. "Owner's Manual"

### Opening when a Check Control message is displayed



Directly from the Check Control message on the Control Display:

-  "Owner's Manual"

### Changing between a function and the Owner's Manual

To switch from a function, for instance radio, to the Owner's Manual on the Control Display and to alternate between the two displays:

1.  Press the button.
2. "Owner's Manual"

3. Select the desired page in the Owner's Manual.
4.  Press the button again to return to last displayed function.
5.  Press the button to return to the page of the Owner's Manual displayed last.

To alternate continuously between the last displayed function and the last displayed page of the Owner's Manual, repeat steps 4 & 5. Opens a new display every time.

## Programmable memory buttons

### General information

The jumps into the Owner's Manual can be stored on the programmable memory buttons, refer to page 48, and called up directly.

### Storing

1. Select the desired entry point via iDrive:
  - ▷ "Keyword search"
  - ▷ "Picture search"
  - ▷ "Quick reference"
  - ▷ "User help"
  - ▷ "Topics"
  - ▷ "Quick link"
2.  Press desired programmable memory button and hold for more than 2 seconds.

### Executing

-  Press the corresponding button.  
The owner's manual is directly displayed at the selected entry point.





## ⚡ QUICK REFERENCE

Entering .....	20
Set-up and use .....	24
In transit .....	28

# Entering

## Opening and closing

### Buttons on the remote control

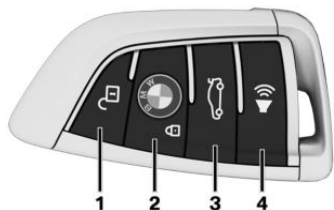

- 1 Unlocking
- 2 Locking
- 3 Open tailgate
- 4 Press and hold or press three times in quick succession: panic mode  
Press briefly: headlight courtesy delay feature

### Unlocking the vehicle

 Press the button on the remote control.

Depending on the settings, either only the driver's door or all vehicle access points are unlocked.

If only the driver's door is unlocked, press the button on the remote control again to unlock the other vehicle access points.

 Press and hold the button on the remote control after unlocking.

The windows and the glass sunroof are opened, as long as the button on the remote control is pressed.

### Locking the vehicle

1. Close the driver's door.

2.  Press the button on the remote control. All vehicle access points are locked.

### Buttons for the central locking system

#### Overview



Buttons for the central locking system.

#### Locking

 Pressing the button locks the vehicle if the front doors are closed.

The fuel filler flap remains unlocked.

#### Unlocking

 Pressing the button unlocks the vehicle.

#### Panic mode

You can trigger the alarm system if you find yourself in a dangerous situation.

-  ▶ Press the button on the remote control and hold for at least 3 seconds.
- ▶ Briefly press the button on the remote control three times in succession.

To switch off the alarm: press any button.

## Comfort Access

### Concept

The vehicle can be accessed without activating the remote control.

All you need to do is to have the remote control with you, such as in your pants pocket.

The vehicle automatically detects the remote control when it is in close proximity or in the car's interior.

### Unlocking the vehicle

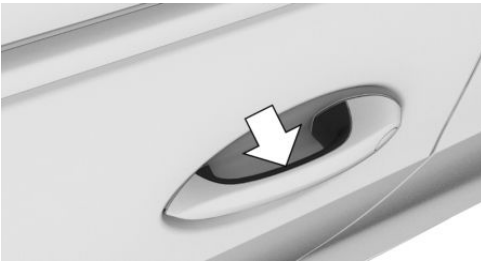

Grasp the handle of a vehicle door completely.

### Locking the vehicle

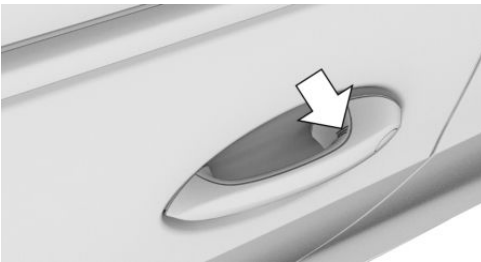

Touch the grooved surface on the handle of a closed vehicle door with your finger for approx. 1 second without grasping the door handle.

## Opening and closing the tailgate with no-touch activation

### Concept

The tailgate can be opened and closed with no-touch activation using the remote control you are carrying.

### Performing the foot movement

1. Stand in the middle behind the vehicle at approx. one arm's length away from the rear of the vehicle.
2. Wave a foot under the vehicle in the direction of travel and immediately pull it back. With this movement, the leg must pass through the ranges of both sensors.

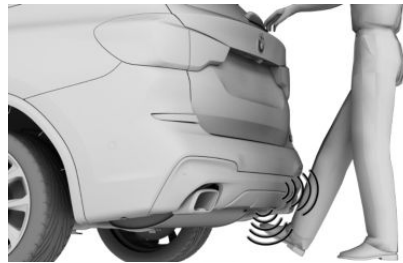

## Tailgate

### Opening

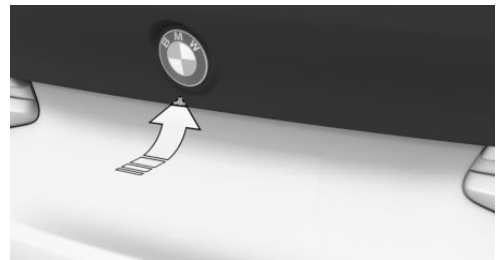

- ▷ Unlock the vehicle and then press the button on the outside of the tailgate.
- ▷  Press and hold the button on the remote control for approx. 1 second.

With Comfort Access: Depending on the settings, the lower tailgate may also be opened.

## Closing

1. Without Comfort Access: closing the lower tailgate manually.

With Comfort Access: the lower tailgate will be closed automatically with the upper tailgate.

2. Press the button on the inside of the upper tailgate.



## Displays and control elements

### In the vicinity of the steering wheel

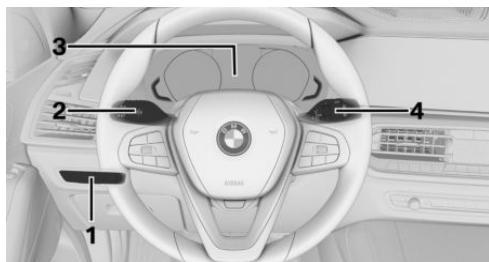

- 1 Light switch element
- 2 Turn signal indicator, high beams
- 3 Instrument cluster
- 4 Wipers

### Indicator/warning lights

#### Instrument cluster

The indicator/warning lights can light up in a variety of combinations and colors.

Several lights indicate function checks and light up only temporarily when standby state or standby state are activated.

### Driver's door

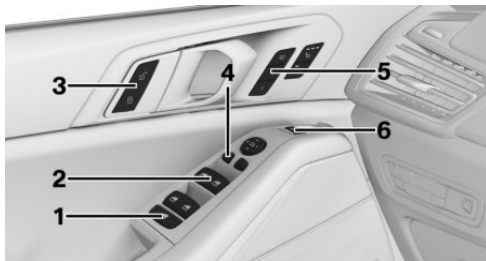

- 1 Safety switch
- 2 Power windows
- 3 Central locking system
- 4 Exterior mirrors
- 5 Seats, comfort features
- 6 Opening/closing the tailgate

### Switch console

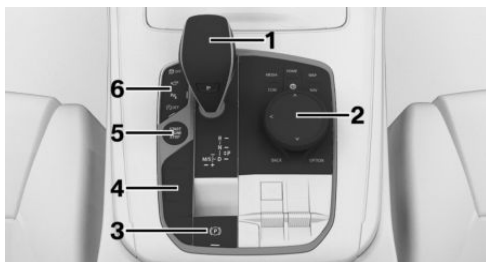

- 1 Selector lever
- 2 Controller
- 3 Parking brake, Automatic Hold
- 4 Driving Dynamics Control
- 5 Start/Stop button
- 6 Assistance systems

## iDrive

### Concept

iDrive includes a large number of functions. These functions can be operated via the Controller and, depending on the equipment version, via touchscreen, voice activation system or gesture control.









If no other commands are possible, operate the function via iDrive.

### Terminating the voice activation system



Press the button on the steering wheel or >Cancel.

### Buttons on the Controller

Button	Function
	Opens the main menu.
	Open the Apps menu.
	Open the Communication menu.
	Open the Media/Radio menu.
	Open destination input menu for navigation.
	Open navigation map.
	Open the previous display.
	Open the Options menu.

### Voice activation

#### Activating the voice activation system

-  Press the button on the steering wheel.
- Wait for the signal.
- Say the command.



The symbol on the Control Display indicates that voice activation system is active.

# Set-up and use

## Seats, mirrors, and steering wheel

### Electrically adjustable seats

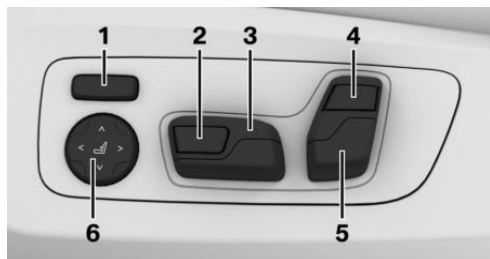

- 1 Backrest width
- 2 Thigh support
- 3 Forward/backward, height, seat tilt
- 4 Upper backrest
- 5 Backrest tilt, head restraint
- 6 Lumbar support

### Adjusting the head restraint

#### Height

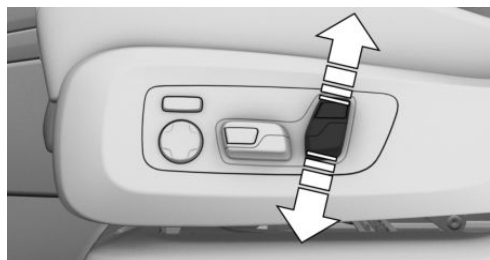

Push switch up or down.

### Distance to back of head



- ▷ Back: press the button and push the head restraint toward the rear.
- ▷ Forward: pull the head restraint toward the front.

### Side extensions



Fold the side extensions forward to increase lateral support.



## Adjusting the exterior mirrors

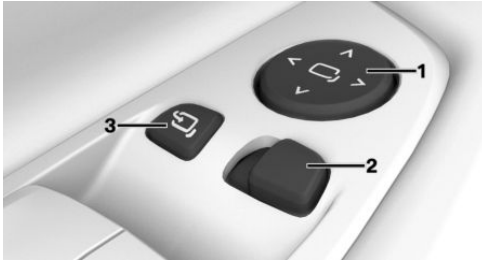

- 1 Settings
- 2 Selecting a mirror, Automatic Curb Monitor
- 3 Folding in and out

## Adjusting the steering wheel

### Electrical steering wheel adjustment

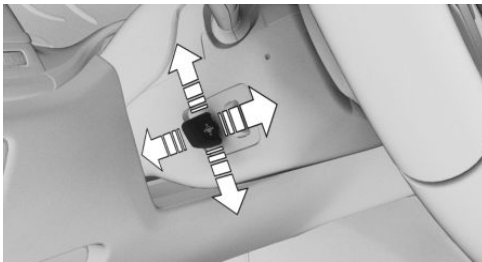

Move the steering wheel to the preferred height and angle to suit your seating position by pressing the switch.

## Memory function

### Concept

The following settings can be stored and, if necessary, retrieved using the memory function:

- ▶ Seat position.
- ▶ Exterior mirror position.
- ▶ Steering wheel position.
- ▶ Height of the Head-up Display.

## Storing

1. Set the desired position.
2.  Press button on the door. The writing on the button lights up.
3. Press selected button 1 or 2 at the door while the writing is lit. A signal sounds.

## Calling up settings

Press selected button 1 or 2.

## Infotainment

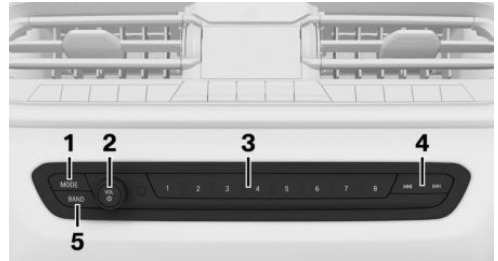

### Radio



- 1 Changing the entertainment source
- 2 Sound output on/off, volume
- 3 Programmable memory buttons
- 4 Change station/track
- 5 Waveband/satellite radio

## Navigation destination entry

### Entering a destination via quick search

1.  Press the button on the Controller.
2.  "Where to?"
3. Enter at least two letters or characters.  
The search term may be completed automatically in gray print.

Press or move the controller up to apply the suggested search term.

4. **OK** Select the symbol, if needed.  
Results are displayed in a list.
5. "Search location": select search location.
6. Move the Controller to the right.
7. Select desired destination.

## Connecting a mobile phone

### General information

After the mobile phone is connected once to the vehicle, the mobile phone can be operated using iDrive, the steering wheel buttons, voice activation, and gestures.

### Connecting the mobile phone via Bluetooth

Via iDrive:

1. "COM"
2. If necessary, select the following setting:  
"Telephone"
3. "Connect new phone"
4. To perform additional steps on the mobile phone, refer to the mobile phone owner's manual: e.g., search for or connect the Bluetooth device or a new device.

The Bluetooth name of the vehicle appears on the mobile phone display. Select the Bluetooth name of the vehicle.



5. Depending on the mobile device, a control number is displayed or the control number must be entered.
  - ▶ Compare the control number displayed on the Control Display with the control number on the display of the device.  
Confirm the control number on the device and on the Control Display.
  - ▶ Enter and confirm the same control number on the device and via iDrive.

The device is connected and displayed in the device list.

## Using the phone

### Accepting a call

Depending on the equipment, incoming calls can be answered in several ways.

- ▶ Via iDrive:
  -  "Accept"
  - ▶  Press the button on the steering wheel.
  - ▶ Via the selection list in the instrument cluster:  
Use the thumbwheel on the steering wheel to select: "Accept"
  - ▶ Via touch screen: tap on the corresponding entry on the Control Display.
  - ▶ Via gestures: point the index finger into the direction of the Control Display.

### Dialing a number

Via iDrive:

1. "COM"
2. "Dial number"
3. Enter the numbers.
4.  Select the symbol. The connection is established via the mobile phone to which this function has been assigned.

If connection is to be set up via the additional phone:

1.  Press the button.
2. "Call via"

## Apple CarPlay preparation

### Concept

CarPlay allows certain functions of a compatible Apple iPhone to be used via Siri voice operation and iDrive.

## Functional requirements

- ▶ Compatible iPhone.  
iPhone 5 or later with iOS 7.1 or later.
- ▶ Corresponding mobile wireless contract.
- ▶ Bluetooth, WiFi, and Siri voice operation are activated on the iPhone.

## Switching on Bluetooth and CarPlay

Via iDrive:

1. "COM"
2. "Mobile devices"
3. Move the Controller to the right.
4. "Settings"
5. Select the following setting:  
"Apple CarPlay"
6. Activate the function.

## Pairing iPhone with CarPlay

Pair iPhone via Bluetooth with the vehicle.

Select CarPlay as the function:

- ▶ "Apple CarPlay"

The iPhone is connected to the vehicle and displayed in the device list.

# In transit

## Driving

### Drive-ready state

#### Switching on drive-ready state



- ▷ Depress the brake pedal.
- ▷ Press the Start/Stop button.

#### Switching off drive-ready state

Steptronic transmission:

1. Engage selector lever position P with the vehicle stopped.
2. Press the Start/Stop button.  
The engine is switched off.
3. Set the parking brake.

### Auto Start/Stop function

The Auto Start/Stop function switches the engine off automatically while stationary to save fuel. The engine starts automatically under the following preconditions:

Steptronic transmission:

- ▷ By releasing the brake pedal.
- ▷ When Automatic Hold is activated: step on the accelerator pedal.

### Parking brake

#### Setting



Pull the switch.  
The LED and indicator light light up.

### Releasing



With drive-ready state switched on:  
Press the switch while stepping on the brake pedal or selector lever position P is set.  
The LED and indicator light go out.  
The parking brake is released.

### Parking

The parking brake is automatically set if the vehicle is being held by Automatic Hold and the drive-ready state is switched off or the vehicle is exited.

### Steptronic transmission

#### Engaging selector lever position D, N, R



- ▷ Drive mode D.
- ▷ Neutral N.
- ▷ Reverse R.

With the driver's safety belt fastened, briefly push the selector lever in the desired direction, past a resistance point, if needed. The selector lever returns to the center position in each case.

To prevent the vehicle from creeping after you select a drive mode or reverse, maintain pressure on the brake pedal until you are ready to start.

A selector lever lock prevents the inadvertent shifting to selector lever position R or the inadvertent shifting from selector lever position P. Engage selector lever position R only when the vehicle is stationary.

### Releasing the selector lever lock

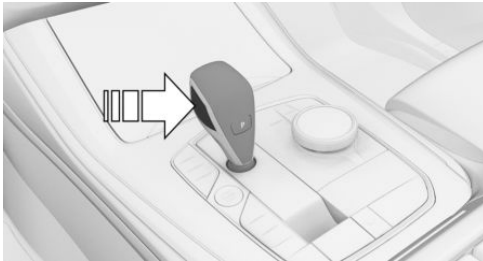

Press the button.

### Engaging P

Engage selector lever position P only when the vehicle is stationary.



Press button P.

### Steptronic transmission, Sport program and manual mode

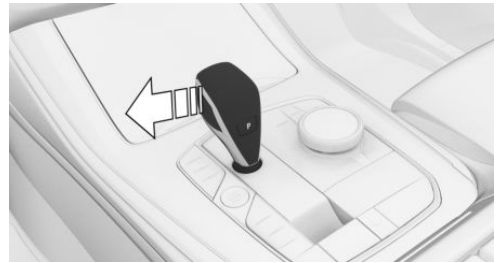

Activate the sport program/manual mode:

Press the selector lever to the left out of selector lever position D.

Manual mode:

- ▶ To shift down: press the selector lever forward.
- ▶ To shift up: pull the selector lever rearwards.

End the sport program/manual mode:

Push the selector lever to the right.

### High beams, headlight flasher, turn signal

#### High beams, headlight flasher

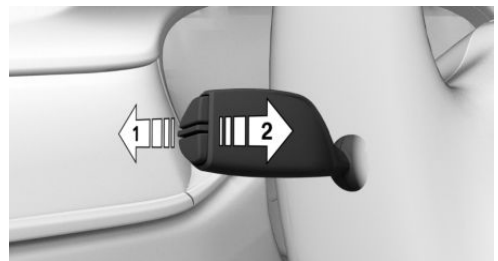

Push the lever forward or pull it backward.

- ▶ High beams on, arrow 1.  
The high beams light up when the low beams are switched on.
- ▶ High beams off/headlight flasher, arrow 2.

## Turn signal

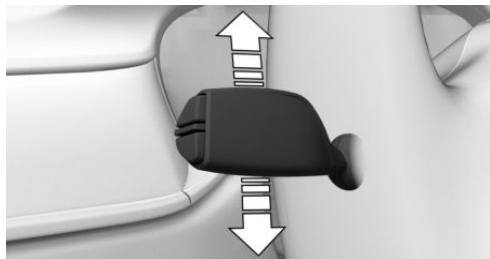

- ▷ On: press the lever past the resistance point.
- ▷ Off: press the lever past the resistance point in the opposite direction.
- ▷ Triple turn signal activation: lightly tap the lever up or down.
- ▷ Brief signaling: press the lever to the resistance point and hold it there for as long as you want the turn signal to flash.

## Lights and lighting

### Light functions

Symbol	Function
	Front fog lights.
	Night vision.
	Lights off. Daytime running lights.
	Parking lights.
	Automatic headlight control. Adaptive light functions.
	Low beams.

Symbol	Function
	Instrument lighting.
	Right roadside parking light.
	Left roadside parking light.

## Washer/wiper system

### Switching the wipers on/off and brief wipe

#### Switching on

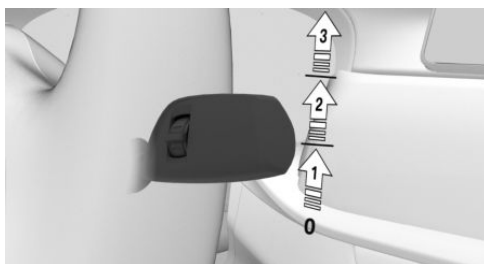

Press the lever up until the desired position is reached.

- ▷ Resting position of the wipers: position 0.
- ▷ Rain sensor: position 1.
- ▷ Normal wiper speed: position 2.
- ▷ Fast wiper speed: position 3.

### Brief wipe and switching off

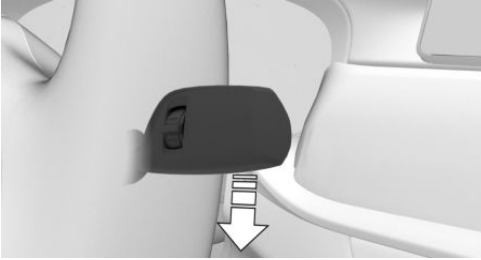

Press the lever down.

- ▶ Switching off: press the lever down until it reaches its standard position.
- ▶ Brief wipe: press the lever down from the standard position.

### Rain sensor

#### Activating/deactivating

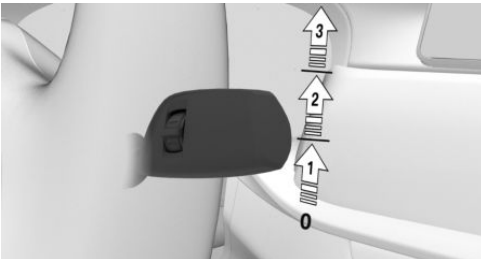

To activate: press the lever up once from its standard position, arrow 1.

To deactivate: press the lever back into the standard position.

### Adjusting the sensitivity

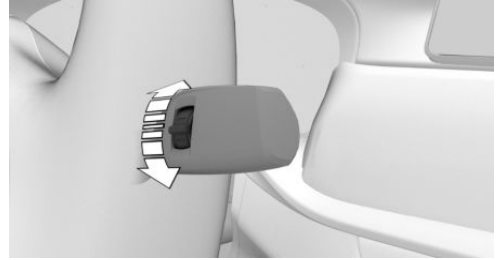

Turn the thumbwheel on the wiper lever.

### Cleaning the windshield



Pull the wiper lever towards you.

### Rear window wiper

#### Switching on

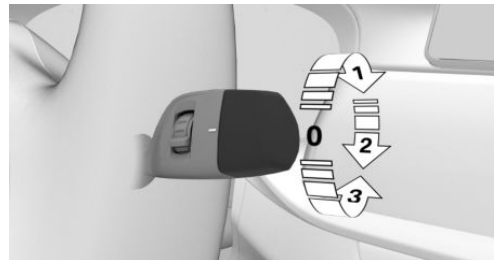

Turn the outer switch upward.

- ▶ Resting position of the wiper, position 0.
- ▶ Intermittent mode, arrow 1. When reverse gear is engaged, the system switches to continuous operation.











### Clean the rear window



Turn the outer switch in the desired direction.

- ▶ In resting position: turn the switch downward, arrow 3. The switch automatically returns to its idle position when released.
- ▶ In intermittent mode: turn the switch further, arrow 2. The switch automatically returns to its interval position when released.

## Climate control

### Automatic climate control

Button	Function
	Temperature.
	Climate control operation.
	Maximum cooling.
	AUTO program.
	Recirculated-air mode.
	Air flow, manual.
	Air distribution, manual.
	Defrost and defog the windshield.
	Rear window defroster.
	Active seat ventilation.

Button	Function
	Seat and armrest heating.
	Open the Climate menu. For the following settings, for instance: upper body temperature adjustment, parked-car ventilation.

## Refueling

### Refueling

#### Fuel cap

1. Press the rear edge of the fuel filler flap to open it.



2. Turn the fuel cap counterclockwise.
3. Place the fuel cap in the bracket attached to the fuel filler flap.

#### Gasoline

For the best fuel efficiency, the gasoline should be sulfur-free or very low in sulfur content.

Fuels that are marked on the gas pump as containing metal must not be used.

## Wheels and tires

### Tire inflation pressure specifications

The tire inflation pressure specifications can be found in the tire inflation pressure table in the printed Owner's Manual.





## After correcting the tire inflation pressure

With runflat tires:

Reinitialize the Flat Tire Monitor.

With Tire Pressure Monitor TPM:

With tires that cannot be found in the tire pressure values on the Control Display, reset the Tire Pressure Monitor TPM.

## Checking the tire inflation pressure

Regularly check the tire inflation pressure and correct it as needed:

- ▶ At least twice a month.
- ▶ Before embarking on an extended trip.

## Cleaning the wheels

The friction during hard braking may produce brake dust and make the rims dirty. Brake dust can be removed by cleaning the rims. BMW recommends using vehicle care and cleaning products from BMW.

## Electronic oil measurement

### Functional requirements

A current measured value is available after approx. 30 minutes of normal driving.

### Displaying the engine oil level

Via iDrive:

1. "CAR"
2. "Vehicle status"
3.  "Engine oil level"

Different messages appear on the Control Display depending on the engine oil level. Pay attention to these messages.

## Adding engine oil

### General information

Safely park the vehicle and switch off drive-ready state before adding engine oil.

### Adding



Only add engine oil when the message is displayed in the instrument cluster.

Observe the quantity to be added in the message.

Take care not to add too much engine oil.

Observe recommended engine oil types.

## Providing assistance

### Hazard warning flashers



The button is located in the center console.

## Breakdown assistance

### BMW Roadside Assistance

Via iDrive:

1. "COM"
2. "BMW Assist"
3. If necessary, "BMW Roadside Assistance"  
A voice connection is established.

## ConnectedDrive

### Concierge service

The BMW Assist Concierge service offers information on events, gas stations or hotels, and provides phone numbers and addresses. Many hotels can be booked directly by the BMW Concierge service. The Concierge service is part of the optional BMW Assist Response Center.

Via iDrive:

1. "COM"
2. "BMW Assist"
3. If necessary, "Concierge"

A voice connection to the Concierge service is established.

### Teleservices

Teleservices are services that help to maintain vehicle mobility.

Teleservices can comprise the following services:

- ▷ BMW Roadside Assistance.
- ▷ BMW Accident Assistance.
- ▷ Service Request.
- ▷ Manual Service Request.
- ▷ Automatic Service Request.
- ▷ Teleservice Report.
- ▷ Teleservice Battery Guard.
- ▷ Your dealer's service center.







## ↓ CONTROLS

Cockpit .....	38
Operating state of the vehicle .....	43
iDrive .....	46
BMW Remote Software Upgrade .....	60
General Settings .....	63
Opening and closing .....	76
Seats, mirrors, and steering wheel .....	111
Transporting children safely .....	128
Driving .....	133
Displays .....	151
Lights .....	168
Safety .....	176
Driving stability control systems .....	213
Driver assistance systems .....	219
Driving comfort .....	262
Climate control .....	269
Interior equipment .....	287
Storage compartments .....	295
Cargo area .....	301

# Cockpit



## Vehicle features and options



This chapter describes all standard, country-specific and optional features offered with the series. It also describes features and functions that are

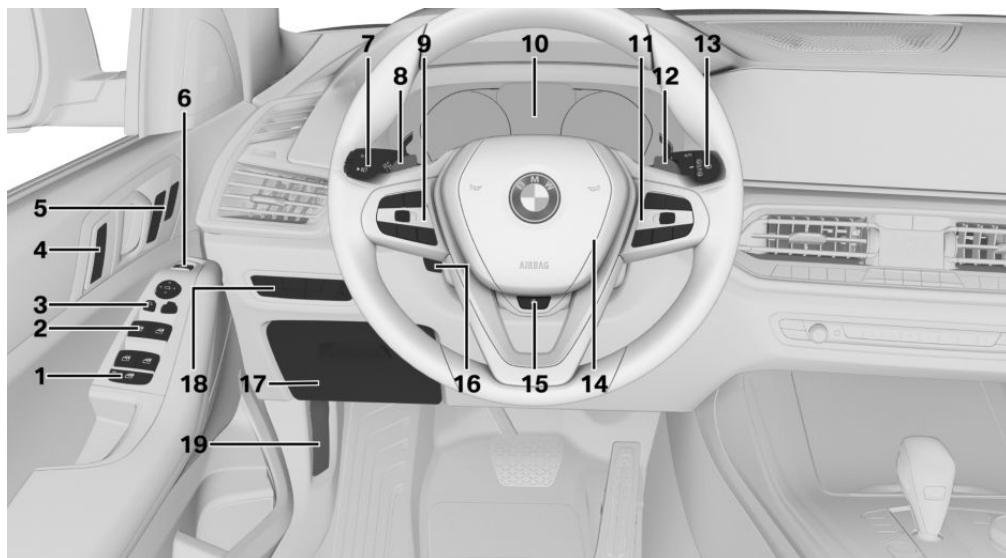



























not necessarily available in your vehicle, e.g., due to the selected options or country versions. This also applies to safety-related functions and systems. When using these functions and systems, the applicable laws and regulations must be observed.

## In the vicinity of the steering wheel



- 1  Safety switch for the windows and roller sunblinds 108
- 2  Power windows 107
- 3 Exterior mirror operation 121
- 4 Central locking system

-  Unlock 86
-  Lock 86
- 5 Seating comfort features

-  Gentleman function [114](#)
-  Memory function [124](#)
-  Massage function [125](#)
- 6**  Opening and closing the tail-gate [95](#)
- 7** Steering column stalk, left
-  Turn signal [139](#)
-  High beams, head-light flasher [139](#)
-  High-beam Assistant [171](#)
-  Widgets in the instrument cluster [152](#)
- Trip data [163](#)
- 8** Shift paddle, left
- 9** Steering wheel buttons, left
-  Manual Speed Limiter [219](#)
-  Cruise control on/off [221](#)
-  Active Cruise Control on/off [223](#)
-  With steering and lane control assistant [231](#):
-  Cruise control, distance control and lane guidance on/off
-  Cruise control: store speed
-  Pause or continue cruise control
-  Active Cruise Control: increase distance
-  Active Cruise Control: reduce distance
- Cruise control rocker switch
- 10** Instrument cluster [151](#)
- 11** Steering wheel buttons, right
-  Selection lists [162](#)
-  Volume, see Owner's Manual for Navigation, Entertainment and Communication [8](#)
-  Voice activation system [54](#)
-  Telephone, see Owner's Manual for Navigation, Entertainment and Communication [8](#)
- Thumbwheel for selection lists [162](#)
- 12** Shift paddle, right
- 13** Steering column stalk, right
-  Wiper [140](#)
-  Rain sensor [141](#)
-  Clean the windshield and headlights [141](#)
-  Rear window wiper in Canadian models [142](#)
-  Rear window wiper [142](#)
-  Clean the rear window [142](#)
- 14**  Horn, entire surface

15  Heated steering wheel 124

16  Adjust steering wheel 123

17 Glove compartment 296

18 Lights

 Front fog lights 173

 Night Vision 194

 Light switch 168

 Lights off  
Daytime running lights 170

 Parking lights 169

 Automatic headlight control 168  
Adaptive light functions 171

 High-beam Assistant 171  
Low beams 169

 Low beams 169

 Instrument lighting 173

 Right roadside parking light 169







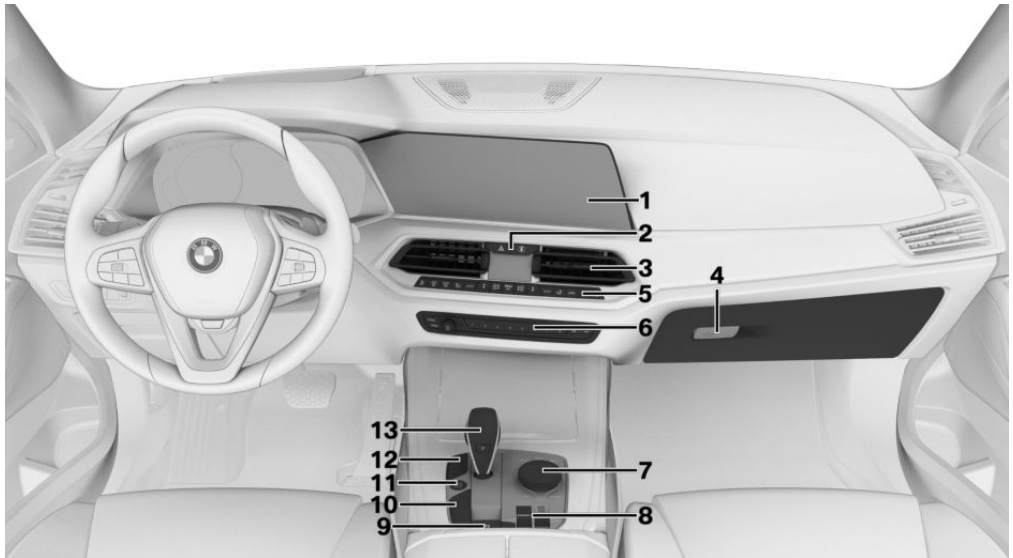

 Left roadside parking light 169



19  Unlock hood 365





## In the vicinity of the center console



- |                                                                                                                                                                                                                                                                                                                                                                                                                                                                                                                                                                                                                                                                                                                                                                                                                                                                                                                                                                                                                                                                                                                            |                                                                                                                                                                                                                                                                                                                                                                                                                                                                                                                                                                                                                                                                                         |
|----------------------------------------------------------------------------------------------------------------------------------------------------------------------------------------------------------------------------------------------------------------------------------------------------------------------------------------------------------------------------------------------------------------------------------------------------------------------------------------------------------------------------------------------------------------------------------------------------------------------------------------------------------------------------------------------------------------------------------------------------------------------------------------------------------------------------------------------------------------------------------------------------------------------------------------------------------------------------------------------------------------------------------------------------------------------------------------------------------------------------|-----------------------------------------------------------------------------------------------------------------------------------------------------------------------------------------------------------------------------------------------------------------------------------------------------------------------------------------------------------------------------------------------------------------------------------------------------------------------------------------------------------------------------------------------------------------------------------------------------------------------------------------------------------------------------------------|
| <p><b>1</b> Control Display <a href="#">49</a></p> <p><b>2</b>  Hazard warning system <a href="#">380</a></p> <p> Intelligent Safety <a href="#">179</a></p> <p><b>3</b> Ventilation <a href="#">274</a></p> <p><b>4</b> Glove compartment <a href="#">295</a></p> <p><b>5</b> Automatic climate control <a href="#">269</a></p> <p><b>6</b> Radio/multimedia, see Owner's Manual for Navigation, Entertainment, and Communication <a href="#">8</a></p> <p><b>7</b> Controller with buttons <a href="#">49</a></p> <p><b>8</b>  Air suspension level adjustment <a href="#">262</a></p> <p> xOffroad driving mode <a href="#">264</a></p> <p> HDC Hill Descent Control <a href="#">216</a></p> | <p><b>9</b>  Parking brake <a href="#">136</a></p> <p> Automatic Hold <a href="#">137</a></p> <p><b>10</b>  Driving Dynamics Control <a href="#">148</a></p> <p>SPORT driving mode</p> <p>COMFORT driving mode</p> <p>ECO PRO driving mode</p> <p>ADAPTIVE driving mode</p> <p><b>11</b>  Switch drive-ready state on/off <a href="#">133</a></p> |
|----------------------------------------------------------------------------------------------------------------------------------------------------------------------------------------------------------------------------------------------------------------------------------------------------------------------------------------------------------------------------------------------------------------------------------------------------------------------------------------------------------------------------------------------------------------------------------------------------------------------------------------------------------------------------------------------------------------------------------------------------------------------------------------------------------------------------------------------------------------------------------------------------------------------------------------------------------------------------------------------------------------------------------------------------------------------------------------------------------------------------|-----------------------------------------------------------------------------------------------------------------------------------------------------------------------------------------------------------------------------------------------------------------------------------------------------------------------------------------------------------------------------------------------------------------------------------------------------------------------------------------------------------------------------------------------------------------------------------------------------------------------------------------------------------------------------------------|



- 12  Auto Start/Stop function [133](#)
-  PDC Park Distance Control [237](#)  
Without Surround View: rearview camera [242](#)  
Surround View [245](#)  
Crossing traffic warning [259](#)  
Parking Assistant [252](#)



-  Surround View: Panorama View [245](#)
-  DSC Dynamic Stability Control [213](#)

13 Steptronic transmission selector lever [143](#)

## In the vicinity of the roofliner



- 1  Emergency Request, SOS [382](#)
- 2  Glass sunroof [108](#)
- 3  Indicator light, front-seat passenger airbag [179](#)

- 4  Reading lights [174](#)
- 5  Interior lights [174](#)

# Operating state of the vehicle

## Vehicle features and options

This chapter describes all standard, country-specific and optional features offered with the series. It also describes features and functions that are not necessarily available in your vehicle, e.g., due to the selected options or country versions. This also applies to safety-related functions and systems. When using these functions and systems, the applicable laws and regulations must be observed.

## General information

Depending on the situation, the vehicle is in one of the three states:

- ▷ Idle state.
- ▷ Standby state.
- ▷ Drive-ready state.

## Idle state

### Concept

If the vehicle is in idle state, it is switched off. All power consumers are deactivated.

### General information

The vehicle is in idle state prior to opening from the outside and after exiting and locking.

## Safety information

### WARNING

An unsecured vehicle can begin to move and possibly roll away. There is a risk of an accident. Before exiting, secure the vehicle against rolling.

In order to ensure that the vehicle is secured against rolling away, follow the following:

- ▷ Set the parking brake.
- ▷ On uphill grades or on a downhill slope, turn the front wheels in the direction of the curb.
- ▷ On uphill grades or on a downhill slope, also secure the vehicle, for instance with a wheel chock.

### WARNING

Unattended children or animals can cause the vehicle to move and endanger themselves and traffic, for instance due to the following actions:

- ▷ Pressing the Start/Stop button.
- ▷ Releasing the parking brake.
- ▷ Opening and closing the doors or windows.
- ▷ Engaging selector lever position N.
- ▷ Using vehicle equipment.

There is a risk of accidents or injuries. Do not leave children or animals unattended in the vehicle. Take the remote control with you when exiting and lock the vehicle.

## Automatic idle state

The idle state is automatically established under the following conditions:

- ▷ After several minutes, if no operation takes place on the vehicle.
- ▷ If the charge state of the vehicle battery is low.
- ▷ Depending on the setting via iDrive, if one of the front doors is opened when exiting the vehicle.

The idle state is not automatically established while a phone call is active.

## Establishing idle state when opening the front doors

Via iDrive:

1. "CAR"
2. "Settings"
3. "Doors/Access"
4. "Turn off vehicle after opening door"

## Manual idle state

To establish idle state in the vehicle after end of trip:

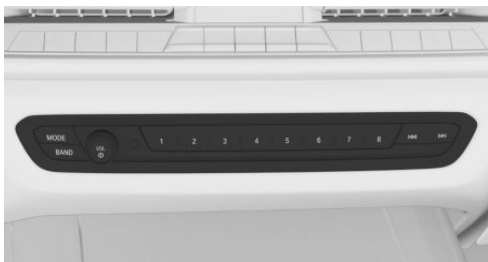

Press and hold the button until the OFF indicator on the instrument cluster goes out.

## Standby state

### Concept

When standby state is switched on, most functions can be used while the vehicle is stationary. Desired settings can be adjusted.

### General information

The vehicle is in the standby state after the front doors are opened from the outside.

### Display in the instrument cluster



OFF is displayed in the instrument cluster. The drivetrain is switched off and standby state switched on.

## Drive-ready state

### Concept

Switching on drive-ready state corresponds to starting the engine.

### General information

Some functions, such as DSC Dynamic Stability Control, can only be used with drive-ready state switched on.

### Safety information

#### **! DANGER**

If the exhaust pipe is blocked or ventilation is insufficient, harmful exhaust gases can enter into the vehicle. The exhaust gases contain pollutants which are colorless and odorless. In enclosed areas, exhaust gases can also accumulate outside of the vehicle. There is danger to life. Keep the exhaust pipe free and ensure sufficient ventilation.

**⚠ WARNING**

An unsecured vehicle can begin to move and possibly roll away. There is a risk of an accident. Before exiting, secure the vehicle against rolling.

In order to ensure that the vehicle is secured against rolling away, follow the following:

- ▷ Set the parking brake.
- ▷ On uphill grades or on a downhill slope, turn the front wheels in the direction of the curb.
- ▷ On uphill grades or on a downhill slope, also secure the vehicle, for instance with a wheel chock.

**⚠ NOTICE**

In the case of repeated starting attempts or repeated starting in quick succession, the fuel is not burned or is inadequately burned. The catalytic converter can overheat. There is a risk of damage to property. Avoid repeated starting in quick succession.

**Gasoline engine**

Depending on the motorization, the full drive power may not be available for approximately 30 seconds after starting the engine. In this case, the vehicle will not accelerate as usual.

**Display in the instrument cluster**

When drive-ready state is switched on, the tachometer shows the current engine speed.

**Switching off drive-ready state****Steptronic transmission**

1. Engage selector lever position P with the vehicle stopped.
2. Press the Start/Stop button.  
The engine is switched off. The vehicle switches into standby state.
3. Set the parking brake.

**Switching on drive-ready state****Concept**

Drive-ready state is switched on via the Start/Stop button:

**Steptronic transmission**

1. Depress the brake pedal.
2. Press the Start/Stop button.

The ignition is activated automatically for a brief time and is stopped as soon as the engine starts.

Most of the indicator/warning lights in the instrument cluster light up for a varied length of time.

# iDrive

## Vehicle features and options

This chapter describes all standard, country-specific and optional features offered with the series. It also describes features and functions that are not necessarily available in your vehicle, e.g., due to the selected options or country versions. This also applies to safety-related functions and systems. When using these functions and systems, the applicable laws and regulations must be observed.

## Operating concept

### Concept

iDrive includes a large number of functions. These functions can be operated via the Controller and, depending on the equipment version, via touchscreen, voice activation system or gesture control.

## Safety information

### WARNING

Operating the integrated information systems and communication devices while driving can distract from traffic. It is possible to lose control of the vehicle. There is a risk of an accident. Only use the systems or devices when the traffic situation allows. As warranted, stop and use the systems and devices while the vehicle is stationary.

## Input and display

### Main menu

#### General information

Menu items with access to all iDrive functions are available on the left side of the main menu.

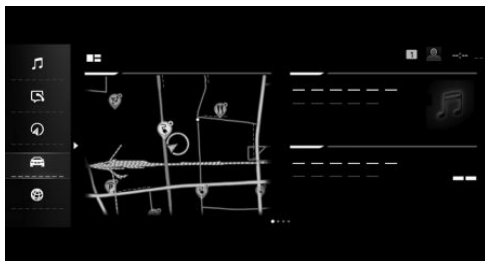

#### Media/Radio

 All functions of the entertainment system, e.g., radio and TV stations, connection with external devices and music collection.

#### Communication

 Phone and SMS functions, e-mail and calendar and also the connection and management of mobile devices, such as smartphones.

#### Navigation

 Access to the navigation system, destination input and traffic bulletins. Configurable map views and other functions, such as Points of Interest and areas to be avoided.

#### My Car

 Information about vehicle status and trips. Access to the Integrated Owner's Manual and also administration of driver profiles and range of adjustments for vehicle and iDrive.

## Apps



 Management and access to apps and vehicle functions. Additional apps can be purchased from the BMW Store.

## Widgets

 The widgets are located in the right section of the main menu. The configured widgets display dynamic contents, for example the navigation map, and serve as interfaces at the same time.

## Letters and numbers

Letters and numbers can be entered using the Controller, touchscreen or the voice activation system. The keyboard's display changes automatically.

Symbol	Function
abc or ABC	Change between capital and lower-case letters.
	Enter a blank space.
	Use voice activation.
OK	Confirm entry.
	Slide the input area to the left or right.

## Entry comparison

When entering names and addresses, the choice is narrowed down with every letter and number and added automatically as needed.

Entries are continuously compared with data stored in the vehicle.

- ▶ Only those letters and numbers are offered during entry for which data is available.
- ▶ Destination search: place names can be entered in all languages that are available in iDrive.

## Activating/deactivating the functions

Several menu items are preceded by a checkbox. The checkbox indicates whether the function is activated or deactivated. Selecting the menu item activates or deactivates the function.



- Function is activated.
- Function is deactivated.

## Status information











### General information

The status field can be found in the upper area of the Control Display. Status information is displayed in the form of symbols.



### Radio symbols

Symbol	Meaning
	HD Radio station is being received.
	Satellite radio is switched on.

### Telephone symbols



Symbol	Meaning
	Incoming or outgoing call.
	Missed call.
	Signal strength of cellular network.
	Network search.
	Cellular network is not available.
	The critical charge state of the mobile phone has been reached.
	Roaming is active.
	Locating active.
	SMS text message received.
	Message received.

**Symbol Meaning**

	Reminder.
	Sending not possible.









**Entertainment symbols**

**Symbol Meaning**

	Bluetooth audio.
	USB audio interface.
	WiFi.

**Other symbols**

**Symbol Meaning**

	Check Control message.
	The sound output has been switched off.
	Request for the current vehicle position.
	Checking the current vehicle position.
	Driver profile.
	Messages.
	Service requirements.
	Information.
	Stop.

**Programmable memory buttons**

**General information**

The iDrive functions can be stored on the programmable memory buttons and called up directly, for instance radio stations, navigation destinations, phone numbers and menu entries or pages in the Integrated Owner's Manual.

Settings are stored for the driver profile currently used.

**Overview**



1 Programmable memory buttons

**Storing a function**

A function can be stored on a programmable memory button. A button with a stored function can be overwritten with another function.

1. Select function via iDrive.
2.  Press and hold the desired button until the displayed bar on the Control Display has loaded completely.

**Running a function**

1.  Press the button.

The function will work immediately. This means, for instance that the number is dialed when a phone number is selected.

**Displaying the key assignment**

Touch buttons with finger. Do not wear gloves or use objects.

The button assignment is displayed at the top edge of screen.



## Delete all button assignments

All button assignments can be deleted.

1. Press and hold buttons 1 and 8 at the same time.
2. "OK"

# Control Display and Controller

## Overview

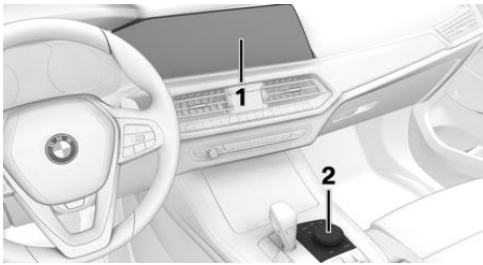

- 1 Control Display with touchscreen
- 2 Controller with buttons and touchpad

## Control Display

### General information

To clean the Control Display, follow the care instructions, refer to page [391](#).

In the case of very high temperatures on the Control Display, for instance due to intense solar radiation, the brightness may be reduced down to complete deactivation. Once the temperature is reduced, for instance through shade or air conditioning, the normal functions are restored.

## Safety information

### NOTICE

Objects in the area in the front of the Control Display can shift and damage the Control Display. There is a risk of damage to property. Do not place objects in the area in front of the Control Display.

### Switching on/off automatically

The Control Display is switched on automatically after unlocking.

In certain situations, the Control Display is switched off automatically, for instance if no operation is performed on the vehicle for several minutes.

### Switching on/off manually

The Control Display can also be switched off manually.

1. Tip the Controller up.
2. "Screen off"

Press the Controller or any button on the Controller to switch it back on again.

## Controller

### General information

The buttons can be used to open the menus directly. The Controller can be used to select menu items and enter the settings.

Some iDrive functions can be operated using the touchpad on the Controller, refer to page [52](#).

### Operation

- ▶ Turn to switch between menu items, for example.

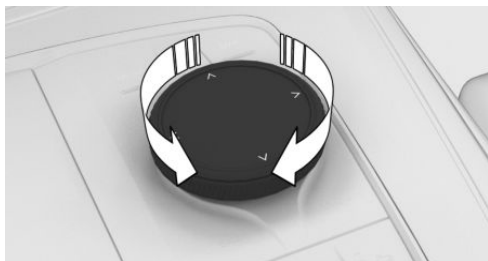





▷ Press to select a menu item, for example.

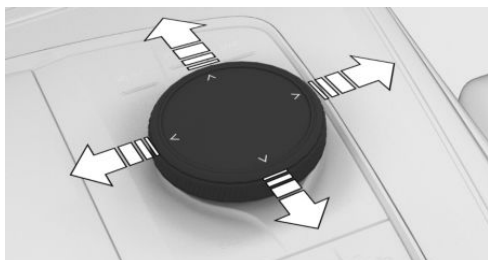





▷ Tilt in four directions to switch between displays, for example.



### Buttons on the Controller

Button	Function
	Opens the main menu.
	Open the Apps menu.
	Open the Communication menu.
	Open the Media/Radio menu.

Button	Function
	Open destination input menu for navigation.
	Open navigation map.
	Open the previous display.
	Open the Options menu.

## Operating with the Controller

### Opening the main menu

 Press the button.



The main menu is displayed.

All iDrive functions can be called up via the main menu.

### Select menu

#### Select menu items

1. Turn the Controller until the desired menu item is highlighted.
2. Press the Controller.

#### Select widgets

1. Move the Controller to the right.
2. Select widgets.
3. Press the Controller.

It is also possible to select widgets in the instrument cluster, refer to page 152.

## Adapting the menu

### Adjusting widgets

The widgets can be adjusted in the main menu. It is possible to create multiple pages with widgets and switch between pages. The adjustments can only be performed when the car is stationary.

Via iDrive:

1. Select the desired page in the main menu.  
Only the currently selected page can be adjusted.
2. Tip the Controller up.
3. "Adjust main menu"
4. Select the desired adjustment:
  - ▶ Add new widget: "Add widget".  
A maximum of four widgets can be displayed per page.
  - ▶ Add new page: "Add page".
  - ▶ Delete selected page: "Delete page".
  - ▶ Adjust the content of the widget: select widget.
5. "Done"

### Adjust menu contents

The display of the menus of "MEDIA", "COM" and "NAV" can be adjusted, e.g. to remove the entries of functions that are not used from the menu.

1. Select the menu.
2. "Personalize menu"
3. Select desired menu contents to be displayed.

### Changing between displays

After a menu item is selected, for instance "Settings", a new display appears.

- ▶ Move the Controller to the left.  
Closes the current display and shows the previous display.

- ▶  Press the button.  
The previous display opens.
- ▶ Move the Controller to the right.  
New display is opened.

An arrow indicates that additional displays can be opened.

### Opening the Options menu

- ▶  Press the button.

The "Options" menu is displayed.

The menu consists of various areas:

- ▶ Help for the selected menu, e.g. "Help".
- ▶ System settings, e.g. "Control display off".
- ▶ Control options for the selected main menu, for instance for "Media/Radio".

### Changing settings

Settings, such as brightness, can be entered.

Via iDrive:

1. "CAR"
2. "Settings"
3. "Displays"
4. "Control display"
5. "Brightness at night"
6. Turn the Controller until the desired setting is displayed.
7. Press the Controller.



### Entering letters and numbers

#### Input

1. Turn the Controller: select letters or numbers.
2. **OK** : confirm entry.

**Deleting**

**Symbol Function**

	Press the Controller: delete letters or number.
	Hold the Controller down: delete all letters or numbers.

**Using alphabetical lists**

For alphabetical lists with more than 30 entries, the letters for which an entry exists can be displayed in a text box.

1. Turn the Controller to the left or right quickly.
2. Select the first letter of the desired entry.  
The first entry of the selected letter is displayed in the list.

**Operation via touchpad**

**General information**

Some iDrive functions can be operated using the touchpad on the Controller.

**Selecting functions**

Via iDrive:

1. "CAR"
2. "Settings"
3. "General settings"
4. "Touchpad"
5. Select desired setting:
  - ▷ "Character input": enter letters and numbers.
  - ▷ "Map": using the map.
  - ▷ "Search fields": write letters without selecting the list field.
  - ▷ "Audio confirmation": pronounces entered letters and numbers.

**Entering letters and numbers**

Entering letters requires some practice at the beginning. When entering, pay attention to the following:

- ▷ The system distinguishes between upper and lower-case letters and numbers. The entry may require switching between letters and numbers, refer to page 46.
- ▷ Enter characters as they are displayed on the Control Display.
- ▷ Always enter associated characters, such as accents or periods so that the letter can be clearly recognized. The set language determines what input is possible. Where necessary, enter special characters via the Controller.

**Entering special characters**

Input	Operation
Delete a character.	Swipe to the left on the touchpad.
Enter a blank space.	Swipe to the right in the center of the touchpad.
Enter a hyphen.	Swipe to the right in the upper area of the touchpad.
Enter an underscore.	Swipe to the right in the lower area of the touchpad.

**Using the map**

The map in the navigation system can be moved via the touchpad.

Function	Operation
Move map.	Swipe in the appropriate direction.
Enlarge/shrink map.	Drag in or out on the touchpad with fingers.
Display menu.	Tap once.

## Operating via touchscreen

### General information

The Control Display is equipped with a touchscreen.

You can tap on menu items and widgets. Touch screen with your fingers. Do not use any objects.

### Opening the main menu

 Tap on symbol.

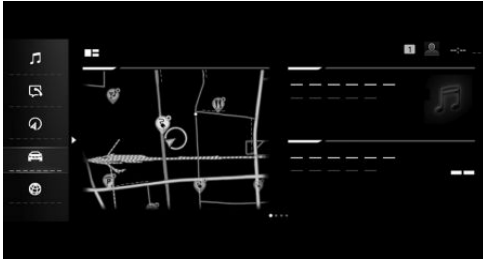



The main menu is displayed.

All iDrive functions can be called up via the main menu.

### Adjusting widgets

The widgets can be adjusted in the main menu. It is possible to create multiple pages with widgets and switch between pages. The adjustments can only be performed when the car is stationary.

Via iDrive:

1. Select the desired page in the main menu.  
Only the currently selected page can be adjusted.
2.  Tap the symbol in the main menu.
3. Select the desired adjustment:
  - ▶ Add new widget:  Tap symbol and select desired widget.  
The requested widget will be inserted in the relevant position. A maximum of four widgets can be displayed per page.
  - ▶ Delete selected widget:  Tap symbol.
  - ▶ Add new page: tap "Add page".

- ▶ Delete selected page: tap "Delete page".
- ▶ Adjust content of the widget: tap center of widget.

4. Tap "Done".

### Changing between displays

After a menu item is selected, a new display opens.

An arrow indicates that additional displays can be opened.



- ▶ Swipe to the left.
- ▶ Tap arrow.

New display is opened.

### Changing settings

Settings such as brightness can be changed via the touchscreen.

Via iDrive:

1. "CAR"
2. "Settings"
3. "Displays"
4. "Control display"
5. "Brightness at night"
6. To create the desired setting:
  - ▶ Slide in the selected field to the right or left, until the desired setting is displayed.
  - ▶  ,  Tap on symbol.

### Entering letters and numbers

#### Input

1.  Touch the symbol on the touchscreen.  
A keyboard is displayed in the Control Display.
2. Enter letters and numbers.

## Deleting

Symbol	Function
	Tapping the symbol: delete the letter or number.
	Tapping and holding the symbol for an extended period: delete all letters or numbers.

## Using the map

The navigation map can be moved with the touchscreen.

Function	Operation
Enlarge/shrink map.	Drag in or out with the fingers.

## Voice activation system

### Concept

Most functions displayed on the Control Display can be operated by voice commands via the voice activation system. The system supports you with announcements during input.

The voice control system and the feedback it provides are not a substitute for the printed or Integrated Owner's Manual.

### General information

- ▷ Functions that can only be used when the vehicle is stationary can only be operated via the voice activation system to a limited extent.
- ▷ The system includes a special microphone on the driver's side and the front passenger side.
- ▷ ›...‹ in the Owner's Manual denotes verbal instructions to use with the voice activation system.

## Functional requirements

To enable voice command recognition, a language must be set via iDrive that is supported by the voice activation system.

To set the language, refer to page 65.

## Activating the voice activation system

### General information

There are various methods for activating the voice activation feature:

- ▷  Press the button on the steering wheel.
- ▷ Say wake word ›Hello BMW‹ or a personal wake word.

No other commands may be available. In this case, operate the function via iDrive.

The voice activation can be terminated:

- ▷  Press the button on the steering wheel again or press ›Cancel‹.

### Button on the steering wheel

1.  Press the button on the steering wheel.
2. Wait for the signal.
3. Say the command.

 The symbol on the Control Display indicates that voice activation system is active.

### Wake word

#### General information

Speaking the wake word ›Hello BMW‹ will start the system. Immediately following, the voice activation can be continued with voice commands.

1. Speak the wake word ›Hello BMW‹.

- Say the command.

### Personal wake word

In addition to a preset wake word ›Hello BMW‹, a personal wake word can be set up.

Via iDrive:

- "CAR"
- "Settings"
- "General settings"
- "Language"
- "Personal keyword"
- "Start recording"
- Follow the instructions on the Control Display.

### Preset wake word

The preset wake word ›Hello BMW‹ can be activated and deactivated. A personal activation word that may have been set up previously will remain active.

Via iDrive:

- "CAR"
- "Settings"
- "General settings"
- "Language"
- "Activation with "Hello BMW""

## Possible commands

### General information

Most contents on the Control Display can be spoken as commands, e.g. menu items or list entries. Speak these list entries out loud exactly as they are shown in the list.

Say the commands, numbers, and letters smoothly and with normal volume, emphasis, and speed.

Always say commands in the language of the voice activation system.

The status of the voice recognition is displayed in the upper area of the Control Display.

### Example for function

The commands of the menu items are spoken just as they are selected via the Controller.

-  Press the button on the steering wheel.
- ›Media and radio‹
- ›Presets‹

The stored stations are displayed on the Control Display.

The voice activation system can also be used to operate most climate control functions, refer to page [286](#).

The voice activation system can be used to enter the destination, refer to Owner's Manual for Navigation, Entertainment, Communication.

### Help on the voice activation system

- ▶ To have the available spoken instructions read out loud: ›Voice commands‹.
- ▶ To have information on the operating principle of the voice activation system read out loud: ›General information on voice control‹.
- ▶ To have help for the current menu read out loud: ›Help‹.

### Information for Emergency Requests

Do not use the voice activation system to initiate an Emergency Request. In stressful situations, the voice and vocal pitch can change. This can unnecessarily delay the establishment of a phone connection.

Instead, use the SOS button, refer to page [382](#), close to the interior mirror.



## Settings

### Setting the voice dialog

You can set the system to use standard dialog or a short version.

The short version of the voice dialog plays back short messages in abbreviated form.

Via iDrive:

1. "CAR"
2. "Settings"
3. "General settings"
4. "Language"
5. "Speech mode"
6. Select the desired setting.

### Online speech processing

Online speech processing provides a dictation function, a natural method of entering destinations and improves the quality of voice recognition. To use the functions, data is transmitted to a service provider via an encrypted connection and stored locally there.

Via iDrive:

1. "CAR"
2. "Settings"
3. "General settings"
4. "Language"
5. "Online speech processing"

### Speaking during voice output

It is possible to answer during inquiries of the voice activation system. The function can be deactivated if inquiries are often undesirably interrupted, for instance due to background noise or talking.

Via iDrive:

1. "CAR"
2. "Settings"
3. "General settings"

4. "Language"
5. "Speaking during voice output"

### Setting the language

The language to be used for voice activation and system announcements can be set.

Via iDrive:

1. "CAR"
2. "Settings"
3. "General settings"
4. "Language"
5. "System language"
6. Select the desired language.

### Adjusting the volume

Turn the volume button during the spoken instructions until the desired volume is set.

- ▷ The volume remains constant even if the volume of other audio sources is changed.
- ▷ The volume is stored for the driver profile currently used.

### System limits



- ▷ Certain noises can be detected and may lead to problems. Keep the doors, windows, and glass sunroof closed.
- ▷ Noises from the front passenger or the rear seat bench can impair the system. Avoid making other noise in the vehicle while speaking.
- ▷ Major language dialects can cause problems with the voice recognition feature. Speak loud and clear.

### Using the voice activation system of the smartphone

A smartphone connected to the vehicle can be used via voice activation.



Activate voice command response on the smartphone for this purpose.

1. Press and hold the  button on the steering wheel for approx. 3 seconds.  
Voice command response is activated on the smartphone.
2. Release the  button.  
If activation is successful, a confirmation appears on the Control Display.

If it was not possible to activate voice command response, the list of Bluetooth devices appears on the Control Display.

## BMW Gesture Control

### Concept

Several iDrive functions can be operated by hand motion using BMW Gesture Control.

### Overview



The gestures that are performed underneath the interior mirror are captured by a camera in the roofliner.

### Activating/deactivating

Via iDrive:



1. "CAR"
2. "Settings"
3. "General settings"
4. "Gesture control"
5. "Gesture control"



### Settings

Via iDrive:

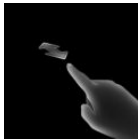
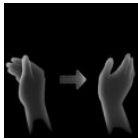
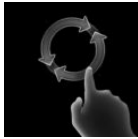
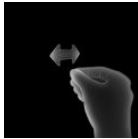
1. "CAR"
2. "Settings"
3. "General settings"
4. "Gesture control"
5. Select desired setting:
  - ▶ "User help display": the possible gesture is shown on the Control Display.
  - ▶ "Audio confirmation": an acoustic signal is emitted once the gesture is recognized.

## Possible gestures

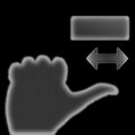
Gesture	Operation	Function
	Move index finger forward and backward in the direction of the screen.	Accept call. Select a highlighted entry in a list during voice activation. Confirm the pop-up.
	Swipe with the hand across the width of the Control Display in the direction of the front-passenger side.	Reject call. Close the pop-up. Terminate voice activation.
	Slowly move your hand in a circular pattern with the index finger stretched out forward. Gesture is detected after one circular motion.	Depending on the direction of movement, increase the volume or decrease the volume.
	Pinch with thumb and index finger and move hand horizontally to the right or left.	Surround View: turn camera view. This gesture can only be executed while the vehicle is stationary.
	Move stretched out index and middle finger forward.	Individually assignable gesture.
	Hold your stretched out thumb to the left.	Reverse Skip function.

Gesture	Operation	Function
	Hold your stretched out thumb to the right.	Forward Skip function.
	Stretch out five fingers, form a fist and stretch five fingers out again.	Individually assignable gesture.

## Carrying out gestures

Perform gestures underneath the interior mirror and next to the steering wheel.

Execute gestures clearly.

The gestures can also be executed from the front-passenger side.

## Assigning gesture individually

Via iDrive:

1. "CAR"
2. "Settings"
3. "General settings"
4. "Gesture control"
5. "Function assignment gesture 1" or "Function assignment gesture 2"
6. Select the desired setting.

## System limits

Gesture recognition by the camera can be disturbed by the following circumstances:

- ▶ The camera lens is covered.
- ▶ Objects are located on the interior mirror.
- ▶ The camera lens is dirty. Clean the camera lenses, refer to page [390](#).
- ▶ The gesture is executed outside of the detection range.
- ▶ Wearing of gloves or jewelry.
- ▶ Smoking in the car's interior.

# BMW Remote Software Upgrade

## Vehicle features and options

This chapter describes all standard, country-specific and optional features offered with the series. It also describes features and functions that are not necessarily available in your vehicle, e.g., due to the selected options or country versions. This also applies to safety-related functions and systems. When using these functions and systems, the applicable laws and regulations must be observed.

## BMW Remote Software Upgrade

### Concept

Remote Software Upgrade can be used to update the software of the vehicle. Remote Software Upgrade makes new functions, functional enhancements or quality improvements available.

### General information

BMW recommends performing the Remote Software Upgrade as soon as it becomes available.

The upgrade will not be installed until it was confirmed on the vehicle.

- ▶ The installation may take up to 20 minutes.
- ▶ The installation can be terminated.
- ▶ The vehicle cannot be used during the installation.
- ▶ The vehicle can be exited used during the installation.

## Validity of the Owner's Manual

### Production of the vehicle

At the time of production at the plant, the printed Owner's Manual is the most current resource.

### After a software update in the vehicle

After a vehicle software update – for example, a Remote Software Upgrade – the Integrated Owner's Manual for the vehicle will contain updated information.

### Functional requirement

The use of the Remote Software Upgrade requires an active ConnectedDrive contract.

## Information about the version

### General information

The information about the version contains a description of the updates that are included in the Remote Software Upgrade. During the download and after the installation has been completed successfully, the information about the version can be displayed on the Control Display. The information is available in the ConnectedDrive customer portal at any time.

### Displaying information about the version

Via iDrive:

1. "CAR"
2. "Settings"
3. "General settings"
4. "Remote Software Upgrade"
5. "Installed version:"

## Safety information

### WARNING

Unattended children or animals can cause the vehicle to move and endanger themselves and traffic, for instance due to the following actions:

- ▷ Pressing the Start/Stop button.
- ▷ Releasing the parking brake.
- ▷ Opening and closing the doors or windows.
- ▷ Engaging selector lever position N.
- ▷ Using vehicle equipment.

There is a risk of accidents or injuries. Do not leave children or animals unattended in the vehicle. Take the remote control with you when exiting and lock the vehicle.

## Search for and download of an upgrade

### General information

There are various options to search for and download an upgrade:

- ▷ Automatic.
- ▷ Via iDrive.
- ▷ Via BMW Connected app.

### Automatic

The available data for Remote Software Upgrade is automatically loaded into the vehicle.

### Via iDrive

1. "CAR"
2. "Settings"
3. "General settings"
4. "Remote Software Upgrade"
5. "Search for upgrades"
6. Follow the instructions on the Control Display.

## Via BMW Connected app

1. Download the available upgrade to the smartphone in the BMW Connected app.
2. Follow the instructions in the BMW Connected app.
3. Establish a WiFi and Bluetooth connection between the smartphone and the vehicle.  
The data transfer of the upgrade from the smartphone to the vehicle occurs while driving.
4. Follow the instructions on the Control Display.

## Install the upgrade

### General information

After the successful completion the download, the installation will be offered after the vehicle is parked.

Follow the instructions on the Control Display.

After the successful completion of the upgrade, booked services, for example RTTI, will be reactivated automatically while driving.

### Functional requirements

- ▷ The battery is sufficiently charged.
- ▷ The external temperature is above 14 °F/- 10 °C.
- ▷ Vehicle is parked in a horizontal position.
- ▷ Hazard warning system is switched off.
- ▷ Transmission position P is engaged.

### Preparing the vehicle

- ▷ Park the vehicle safely away from the public road.
- ▷ Ensure cellular network reception so that an error message can be sent, for example if the installation is terminated.
- ▷ Close the windows.
- ▷ Close the glass sunroof.
- ▷ Close the tailgate.

- ▷ Remove energy consuming devices, for example a mobile phone.
- ▷ Unhitch the trailer or load carrier.
- ▷ The remote control is in the vehicle at the start of the installation.
- ▷ Switch off the exterior lighting.

Additional vehicle related functional requirements are shown on the Control Display.

If the malfunction cannot be remedied, contact a dealer's service center or another qualified service center or repair shop.

## Install the upgrade later

Via iDrive:

1. "CAR"
2. "Settings"
3. "General settings"
4. "Remote Software Upgrade"
5. "Start upgrade now"

Follow the instructions on the Control Display.

## Functional limitations

During the upgrade, the majority of functions are temporarily unavailable, for example:

- ▷ Hazard warning system.
- ▷ Central locking system.
- ▷ Parking lights.
- ▷ Horn.
- ▷ Alarm system.
- ▷ Emergency Request.
- ▷ Power windows.
- ▷ Glass sunroof.

The driver's door can be locked and unlocked from the outside using the integrated key.

## Malfunction

In the event of a malfunction, follow the instructions on the Control Display or in the BMW Connected app.

# General Settings

## Vehicle features and options

This chapter describes all standard, country-specific and optional features offered with the series. It also describes features and functions that are not necessarily available in your vehicle, e.g., due to the selected options or country versions. This also applies to safety-related functions and systems. When using these functions and systems, the applicable laws and regulations must be observed.

## Messages

### Concept

The menu centrally displays all messages arriving in the vehicle in list form.

### General information

The following messages can be displayed:

- ▶ Traffic messages.
- ▶ Check Control messages.
- ▶ Communication messages, for example e-mails, SMS text messages or reminders.
- ▶ Service requirements messages.

The number of messages is additionally displayed in the status field.

The Messages menu can also be created as Widget, refer to page 50.

### Retrieving messages

Via iDrive:

1. Tip the Controller up.
2. "Notifications"
3. Select the desired message.

### Deleting messages

All messages, except Check Control messages, can be deleted from the list. Check Control messages are displayed as long as they are relevant.

Via iDrive:

1. Tip the Controller up.
2. "Notifications"
3. Select desired message, e.g. SMS.
4.  Press the button.
5. "Delete"

### Settings

The following settings can be adjusted:

- ▶ Select the applications, from which messages will be permitted.
- ▶ All messages or a limited time period for received messages.

Via iDrive:

1. Tip the Controller up.
2. "Notifications"
3. "Settings"
4. Move the Controller to the right.
5. Select the desired setting.

## Time

### Setting the time zone

Via iDrive:

1. "CAR"
2. "Settings"
3. "General settings"
4. "Date and time"



5. "Time zone:"
6. Select the desired setting.

The setting is stored for the driver profile currently used.

## Setting the time

Via iDrive:

1. "CAR"
2. "Settings"
3. "General settings"
4. "Date and time"
5. "Time"
6. Turn the Controller until the desired hours are displayed.
7. Press the Controller.
8. Turn the Controller until the desired minutes are displayed.
9. "OK"

## Setting the time format

Via iDrive:

1. "CAR"
2. "Settings"
3. "General settings"
4. "Date and time"
5. "Time format:"
6. Select the desired setting.

The setting is stored for the driver profile currently used.

## Automatic time setting

Depending on your vehicle's optional features, the time, date and, if needed, the time zone are updated automatically.

Via iDrive:

1. "CAR"
2. "Settings"
3. "General settings"

4. "Date and time"
5. "Automatic time setting"

The setting is stored for the driver profile currently used.

## Date

---

### Setting the date

Via iDrive:

1. "CAR"
2. "Settings"
3. "General settings"
4. "Date and time"
5. "Date:"
6. Turn the Controller until the desired day is displayed.
7. Press the Controller.
8. Make the settings for the month and year.
9. "OK"

### Setting the date format

Via iDrive:

1. "CAR"
2. "Settings"
3. "General settings"
4. "Date and time"
5. "Date format:"
6. Select the desired setting.

The setting is stored for the driver profile currently used.



## Language

---

### Setting the language

Via iDrive:

1. "CAR"
2. "Settings"
3. "General settings"
4. "Language:"
5. "System language"
6. Select the desired setting.

The setting is stored for the driver profile currently used.

### Setting the voice dialog

Voice dialog for the voice activation system, refer to page 56.

## Setting the units of measurement

---

Depending on the country version, you can set the units of measurement for some values, for instance consumption, distances, and temperature.

Via iDrive:

1. "CAR"
2. "Settings"
3. "General settings"
4. "Units"
5. Select the desired menu item.
6. Select the desired setting.

The setting is stored for the driver profile currently used.

## Trip data settings

---

### Concept

The intervals in which the trip data, refer to page 163, will be reset can be configured.

### Resetting trip data

1. "CAR"
2. "Settings"
3. "General settings"
4. "Reset trip data"
5. Select the desired setting.

## Speed warning

---

### Concept

A speed limit can be set that when reached will cause a warning to be issued.

### General information

The warning is repeated if the vehicle speed exceeds the set speed limit again, after it has dropped below it by 3 mph/5 km/h.

### Configuring the speed limit warning

Via iDrive:

1. "CAR"
2. "Settings"
3. "General settings"
4. "Speed warning"
5. "Warning at:"
6. Turn the Controller until the desired speed is displayed.
7. Press the Controller.

## Activating/deactivating the speed warning

Via iDrive:

1. "CAR"
2. "Settings"
3. "General settings"
4. "Speed warning"
5. "Speed warning"

## Setting your current speed as the speed warning

Via iDrive:

1. "CAR"
2. "Settings"
3. "General settings"
4. "Speed warning"
5. "Select current speed"

## Driver Attention Camera

### Concept

A camera that monitors driver activity is located in the instrument cluster. The camera evaluates the head position and eye opening and uses the data to analyze the attention of the driver. This system supports various vehicle assistance systems, e.g.:

- ▷ Alertness assistant, refer to page 211.
- ▷ Steering and lane control assistant with Assisted Driving Plus, refer to page 231.

Position in the instrument cluster, refer to page 151.

### Activating/deactivating

Via iDrive:

1. "CAR"
2. "Settings"
3. "General settings"

4. "Driver Attention Camera"
5. Select the desired setting.

### System limits

The Driver Attention Camera may not be fully functional in the following situations:

- ▷ When the Driver Attention Camera is covered by the steering wheel rim.
- ▷ When the driver is wearing infrared impermeable sunglasses.

## Activating/deactivating popup windows

For some functions, popup windows are displayed automatically on the Control Display. Some of these popup windows can be activated or deactivated.

Via iDrive:

1. "CAR"
2. "Settings"
3. "General settings"
4. "Pop-ups"
5. Select the desired setting.

The setting is stored for the driver profile currently used.

## Activating/deactivating the display of the current vehicle position

### Concept

If vehicle location has been activated, the current vehicle position can be displayed in the BMW Connected app or in the ConnectedDrive customer portal.

## Activating/deactivating

Via iDrive:

1. "CAR"
2. "Settings"
3. "General settings"
4. "Vehicle tracking"
5. Select the desired setting.

## Control Display

### Brightness

Via iDrive:

1. "CAR"
2. "Settings"
3. "Displays"
4. "Control display"
5. "Brightness at night"
6. Turn the Controller until the desired brightness is set.
7. Press the Controller.

The setting is stored for the driver profile currently used.

Depending on the light conditions, the brightness settings may not be clearly visible.

## Data protection

### Data transfer

#### Concept

The vehicle offers different services, whose use requires a data transfer to BMW or a service provider. The data transfer can be deactivated for some services.

#### General information

When the data transfer is deactivated, the respective service cannot be used.

Only make these settings while stationary.

### Activating/deactivating

Follow the instructions on the Control Display.

Via iDrive:

1. "CAR"
2. "Settings"
3. "General settings"
4. "Data privacy"
5. "Agree to everything and activate"

All services and functions that are relevant for data protection will be activated or deactivated.

### Configuring the data transfer

The data transfer can be configured individually for separate services.

Via iDrive:

1. "CAR"
2. "Settings"
3. "General settings"
4. "Data privacy"
5. "Manual configuration"
6. Select the desired setting.

## Deleting personal data in the vehicle

### Concept

Depending on the usage, the vehicle stores personal data, such as stored radio stations. This personal data can be permanently deleted using iDrive.

### General information

Depending on the equipment package, the following data can be deleted:

- ▶ Driver profile settings.
- ▶ Stored radio stations.

- ▷ Stored programmable memory buttons.
- ▷ Travel and Onboard Computer information.
- ▷ Music hard disk.
- ▷ Navigation, for instance stored destinations.
- ▷ Phone book.
- ▷ Online data, for instance Favorites, cookies.
- ▷ Office data, for instance voice notes.
- ▷ Login accounts.

Altogether, the deletion of the data can take up to 15 minutes.

### Functional requirement

Data can only be deleted while stationary.

### Deleting data

The personal data in the vehicle will be deleted when the vehicle is reset to the factory settings.

Reset vehicle to factory settings, refer to page 75.

## Connecting mobile devices to the vehicle

### Concept

Various connection types are available for using mobile devices in the vehicle. The connection type to select depends on the mobile device and the desired function.

### General information

The following overview shows possible functions and the suitable connection types for them. The scope of functions depends on the mobile device.

Function	Connection type
Making calls via the hands-free system.	Bluetooth.
Using phone functions via iDrive or touchscreen.	
Other functions, e.g. Contacts or SMS.	
Playing music from the smartphone or the audio player.	Bluetooth or USB.
USB storage device: Playing music.	USB.
Playing videos from the smartphone or the USB storage device.	USB.
Using the vehicle Internet access.	WiFi hotspot via WiFi.
Use Apple CarPlay apps via iDrive and voice operation.	Bluetooth and WiFi.
Screen Mirroring: Showing the smartphone display on the Control Display.	WiFi.

The following connection types require one-time pairing with the vehicle:

- ▷ Bluetooth.
- ▷ WiFi hotspot.
- ▷ Apple CarPlay.
- ▷ Screen Mirroring.

Paired devices are automatically recognized later on and connected to the vehicle.

## Safety information

### WARNING

Operating the integrated information systems and communication devices while driving can distract from traffic. It is possible to lose control of the vehicle. There is a risk of an accident. Only use the systems or devices when the traffic situation allows. As warranted, stop and use the systems and devices while the vehicle is stationary.

## Compatible devices

### General information

Information on mobile devices compatible with the vehicle can be found at [www.bmwusa.com/bluetooth](http://www.bmwusa.com/bluetooth).

Malfunctions may occur with devices not listed or deviating software versions.

### Displaying the vehicle identification number and software part number

When looking for compatible devices, you may have to state the vehicle identification number and the software part number. These numbers can be displayed in the vehicle.

Via iDrive:

1. "COM"
2. "Mobile devices"
3. Move the Controller to the right.
4. "Settings"
5. "Bluetooth@ info"
6. "System information"

## Bluetooth connection

### Functional requirements

- ▷ Compatible device, refer to page 69, with Bluetooth interface.
- ▷ The remote control or BMW display key is in the vehicle.
- ▷ The device is ready for operation.
- ▷ Bluetooth is switched on in the vehicle, refer to page 69, and on the device.
- ▷ The pairing readiness is displayed on the Control Display.
- ▷ Bluetooth presets, such as visibility, may be required on the device; refer to the owner's manual of the device.

### Switching on Bluetooth

Via iDrive:

1. "COM"
2. "Mobile devices"
3. Move the Controller to the right.
4. "Settings"
5. "Bluetooth@"
6. Select setting.

### Activating/deactivating telephone functions

To use all supported functions of a mobile phone, activate the desired functions in the vehicle prior to pairing the mobile phone with the vehicle as needed.

Via iDrive:

1. "COM"
2. "Personalize menu"
3. Select desired settings, e.g. "Text messages".
4. Select the desired setting.

## Pairing the mobile device with the vehicle

Via iDrive:

1. "COM"
2. "Mobile devices"
3. Move the Controller to the right.
4. "New device"
5. Select the desired function:
  - ▷ "Phone calls and Bluetooth® audio"
  - ▷ "Audio"

The Bluetooth name of the vehicle is displayed on the Control Display.
6. On the mobile device, search for Bluetooth devices in the vicinity and select the vehicle.
 

A control number is displayed.
7. Compare the control number displayed on the Control Display with the control number on the display of the mobile device, and confirm that the two match.
8. Select Bluetooth connection if necessary:
 

"Use BMW iDrive for phone calls, Bluetooth® audio, and apps."

The smartphone is connected to the vehicle and displayed in the device list, refer to page 74.

## Frequently asked questions

All requirements are met and all required steps were completed in the specified order. Despite that, the mobile device does not function as expected.

In this case, the following explanations can help:

Why could the mobile phone not be paired or connected?

- ▷ There are too many Bluetooth devices connected to the mobile phone or vehicle.
 

In the vehicle, delete Bluetooth connections with other devices.

Delete the Bluetooth connection from the device list on the mobile phone and start a new device search.

Too many Bluetooth devices with the same function are paired.

- ▷ The mobile phone is in power-save mode or has only a limited remaining battery life.
 

Charge the mobile phone and deactivate the power-save mode where required.

Why does the mobile phone no longer react?

- ▷ The applications on the mobile phone do not function anymore.
 

Switch the mobile phone off and on again.
- ▷ Too high or too low ambient temperature for mobile phone operation.
 

Do not subject the mobile phone to extreme ambient temperatures.

Why can phone functions not be used via iDrive?

- ▷ Phone functions are not configured for the mobile phone.
 

Connect the mobile phone with the telephone function.

Why are no or not all phone book entries displayed or why are they incomplete?

- ▷ Transmission of the phone book entries is not yet complete.
- ▷ It is possible that only the phone book entries of the mobile phone or the SIM card are transmitted.
- ▷ It may not be possible to display phone book entries with special characters.
- ▷ It may not be possible to transmit contacts from social networks.
- ▷ The number of phone book entries to be transmitted is too high.
 

Reduce the data volume of the contact.
- ▷ A mobile phone can only be connected as audio source or as telephone.
 

Configure the mobile phone and connect it with the telephone function.

- ▶ Contact was created in the contact list of the phone after the last synchronization.  
Synchronize contacts again: "Reload contacts"

How can the phone connection quality be improved?

- ▶ Adjust the strength of the Bluetooth signal on the mobile phone, depending on the mobile phone.
- ▶ Insert mobile phone into the wireless charging tray.
- ▶ Adjust the volume of the microphone separately in the sound settings.

If all points in this list have been checked and the required function is still not available, contact the hotline, a dealer's service center or another qualified service center or repair shop.

## USB connection

### General information

Mobile devices with a USB port are connected to the USB interface.

- ▶ Mobile phones.
- ▶ Audio devices such as MP3 players.
- ▶ USB storage devices.  
Common file systems are supported. FAT32 and exFAT are the recommended formats.

A connected USB storage device will be supplied with charging current via the USB interface if the device supports this. Observe the maximum charge current of the USB interface.

The following uses are possible on USB interfaces with data transfer:

- ▶ Playing music files.
- ▶ Playing videos.

Follow the following when connecting:

- ▶ Do not use force when plugging the connector into the USB interface.
- ▶ Use a flexible adapter cable.

- ▶ Protect the USB storage device against mechanical damage.
- ▶ Due to the large number of USB media available on the market, it cannot be guaranteed that every device is operable on the vehicle.
- ▶ Do not expose USB media to extreme environmental conditions, such as very high temperatures; refer to the owner's manual of the device.
- ▶ Due to the many different compression techniques, proper playback of the media stored on the USB storage device cannot be guaranteed in all cases.
- ▶ To ensure proper transmission of the stored data, do not charge a USB storage device via the onboard socket, when it is connected to the USB interface.
- ▶ Depending on how the USB storage device is being used, settings may be required on the USB storage device, refer to the owner's manual of the device.

Not compatible USB media:

- ▶ USB hard drives.
- ▶ USB hubs.
- ▶ USB memory card readers with multiple inserts.
- ▶ HFS-formatted USB media.
- ▶ Devices such as fans or lamps.

### Functional requirement

Compatible device, refer to page 69, with USB interface.

### Connecting the device

Connect the USB storage device using a suitable adapter cable to a USB interface, refer to page 293.

The USB storage device is displayed in the device list, refer to page 74.



## WiFi hotspot

### Concept

Compatible devices with WiFi interface can use the Internet connection of the vehicle via the WiFi hotspot.

### General information

Up to 10 devices can be connected with the hotspot of the vehicle at the same time.

### Functional requirements

- ▷ Compatible device, refer to page 69, with WiFi interface.
- ▷ WiFi activated on the device.
- ▷ Registration and data contract with a service provider where required.
- ▷ Internet use is activated for the vehicle.
- ▷ Standby state switched on.

### Activate WiFi in the vehicle

Via iDrive:

1. "COM"
2. "Mobile devices"
3. Move the Controller to the right.
4. "Settings"
5. "Wi-Fi@"

### Connecting device to WiFi hotspot

Via iDrive:

1. "COM"
2. "Mobile devices"
3. Move the Controller to the right.
4. "New device"
5.  "Internet"

6. Hotspot name and hotspot code are displayed on the Control Display. Additionally, a QR code will be displayed.
7. Search for WiFi networks on the device. Select network name on the device.
8. Enter hotspot code on the device and connect. Alternatively, the QR code can be used.

The device is displayed in the device list, refer to page 74.

The initial Internet use via the hotspot requires a registration and possibly a data volume purchase from a service provider.

Depending on the country version, data volume can be purchased via the connected mobile device or from the ConnectedDrive Store.

All devices connected via the hotspot use this data volume.

## Apple CarPlay preparation

### Concept

CarPlay allows certain functions of a compatible Apple iPhone to be used via Siri voice operation and iDrive.

### Functional requirements

- ▷ Compatible iPhone, refer to page 69.  
iPhone 5 or later with iOS 7.1 or later.
- ▷ Corresponding mobile wireless contract.
- ▷ Bluetooth, WiFi, and Siri voice operation are activated on the iPhone.
- ▷ Booking the ConnectedDrive service: Apple CarPlay preparation.

### Switching on Bluetooth and CarPlay

Via iDrive:

1. "COM"
2. "Mobile devices"
3. Move the Controller to the right.



4. "Settings"
5. Select the following setting:  
"Apple CarPlay"
6. Activate the function.

## Pairing iPhone with CarPlay

Via iDrive:

1. "COM"
2. "Mobile devices"
3. Move the Controller to the right.
4. "New device"
5. "Phone calls and Bluetooth® audio"  
The Bluetooth name of the vehicle is displayed on the Control Display.
6. On the mobile device, search for Bluetooth devices in the vicinity and select the vehicle.  
A control number is displayed.
7. Compare the control number displayed on the Control Display with the control number on the display of the mobile device, and confirm that the two match.
8. Select CarPlay:  
"Confirm note and connect to Apple CarPlay"

The iPhone is connected to the vehicle and displayed in the device list, refer to page 74.

## Operation

For more information, refer to the Integrated Owner's Manual or the Owner's Manual for navigation, entertainment, communication.

## Frequently asked questions

All requirements are met and all required steps were completed in the specified order. Despite that, the mobile device does not function as expected.

In this case, the following explanations can help:  
The iPhone has already been paired with Apple CarPlay. When a new connection is established, CarPlay can no longer be selected.

- ▷ Delete the iPhone concerned from the device list.
- ▷ On the iPhone, delete the vehicle concerned from the list of stored connections under Bluetooth and under WiFi.
- ▷ Pair the iPhone as a new device.

If the steps listed have been carried out and the required function is still not available: contact the hotline, a dealer's service center or another qualified service center or repair shop.

## Screen Mirroring

### General information

Screen Mirroring enables mirroring (outputting) of the smartphone display on the Control Display.

### Functional requirements

- ▷ Compatible smartphone, refer to page 69, with Screen Mirroring interface.
- ▷ Screen Mirroring is switched on on the smartphone.
- ▷ WiFi is switched on in the vehicle.

### Activate WiFi in the vehicle

Via iDrive:

1. "COM"
2. "Mobile devices"
3. Move the Controller to the right.
4. "Settings"
5. "Wi-Fi®"

### Pairing a smartphone with Screen Mirroring

Via iDrive:

1. "COM"
2. "Mobile devices"
3. "New device"

4.  "Screen Mirroring"  
The WiFi name of the vehicle is displayed on the Control Display.
5. Search for WiFi devices in the surroundings of the smartphone.  
The WiFi name of the vehicle appears on the device display. Select the WiFi name of the vehicle.
6. Confirm the connection via iDrive.  
The device is connected and displayed in the device list, refer to page 74.

## Managing mobile devices

### General information

- ▶ After one-time pairing, the devices are automatically recognized and reconnected when standby state is switched on.
- ▶ After stored content on the SIM card or the mobile phone, such as contacts, has been detected, the data is transmitted to the vehicle and can be used via iDrive.
- ▶ For some devices, certain settings are necessary, for instance authorization; see the owner's manual of the device.

### Displaying the device list





All devices paired with or connected to the vehicle are displayed in the device list.

A maximum of 4 devices can be connected to the vehicle via Bluetooth, and a maximum of 10 devices can be connected to the vehicle via WiFi. A maximum of 20 devices will be detected.

Via iDrive:

1. "COM"
2. "Mobile devices"

A symbol indicates, for which function a device is used. When the icon is displayed in white, this function is actively connected to the vehicle. The icon is displayed in gray when the function of the device is inactive.

Symbol	Meaning
	Telephone.
	Bluetooth audio.
	WiFi hotspot.
	Apple CarPlay.
	Screen Mirroring.

### Configuring the device

Functions can be activated or deactivated for paired and connected devices.

Via iDrive:

1. "COM"
2. "Mobile devices"
3. Select the desired device.
4. Select the desired setting.

If a function is assigned to a device, the function will be deactivated where appropriate for a device that is already connected and the device will be disconnected. Observe the information on the Control Display.

### Disconnecting the device

Via iDrive:

1. "COM"
2. "Mobile devices"
3. Select device.
4. "Disconnect device"

The device remains paired and can be connected again, refer to page 74.

### Connecting the device

A disconnected device can be reconnected.

Via iDrive:

1. "COM"
2. "Mobile devices"

3. Select device.
4. "Connect device"

The functions that were assigned to the device before disconnecting are assigned to the device when it is reconnected. If the device is already connected, these functions are deactivated.

## Deleting the device

Via iDrive:

1. "COM"
2. "Mobile devices"
3. Select device.
4. "Delete device"

The device is disconnected and removed from the device list.

## Priority of the phones

When two mobile phones are connected to the vehicle, you can specify the priority of the mobile phones for reconnection.

Via iDrive:

1. "COM"
2. "Mobile devices"
3. Move the Controller to the right.
4. "Settings"
5. "Priorities for telephones"
6. Select the desired device.
7. Turn the controller to select the priority for the selected mobile phone.

Select the desired priority by sliding.

## Resetting the vehicle configuration

---

All individual settings can be reset to the factory settings when the drive-ready state is switched off.

Via iDrive:

1. "CAR"
2. "Settings"
3. "General settings"
4. "Reset vehicle data"
5. "Reset vehicle data"

When the stored settings in a driver profile are synchronized with the ConnectedDrive account, these settings will remain in the ConnectedDrive account.

# Opening and closing

## Vehicle features and options

This chapter describes all standard, country-specific and optional features offered with the series. It also describes features and functions that are not necessarily available in your vehicle, e.g., due to the selected options or country versions. This also applies to safety-related functions and systems. When using these functions and systems, the applicable laws and regulations must be observed.

## Remote control

### General information

Depending on the equipment version, the vehicle is delivered with two remote controls or one remote control and the BMW display key, refer to page 81.

Each remote control contains a replaceable battery. Replacing the battery, refer to page 79.

You may set the button functions, depending on the vehicle equipment and country version. Settings, refer to page 103.

A driver profile, refer to page 97, with personal settings can be assigned to a remote control.

The remote controls hold information about required maintenance. Service data in the remote control, refer to page 374.

To prevent possible locking in of the remote control, take the remote control with you when exiting the vehicle.

## Safety information

### WARNING

People or animals in the vehicle can lock the doors from the inside and lock themselves in. In this case, the vehicle cannot be opened from the outside. There is a risk of injury. Take the remote control with you so that the vehicle can be opened from the outside.

### WARNING

For some country versions, unlocking from the inside is only possible with special knowledge. Persons who spend a lengthy time in the vehicle while being exposed to extreme temperatures are at risk of injury or death. Do not lock the vehicle from the outside when there are people in it.

### WARNING

Unattended children or animals can cause the vehicle to move and endanger themselves and traffic, for instance due to the following actions:

- ▷ Pressing the Start/Stop button.
- ▷ Releasing the parking brake.
- ▷ Opening and closing the doors or windows.
- ▷ Engaging selector lever position N.
- ▷ Using vehicle equipment.

There is a risk of accidents or injuries. Do not leave children or animals unattended in the vehicle. Take the remote control with you when exiting and lock the vehicle.

## Overview

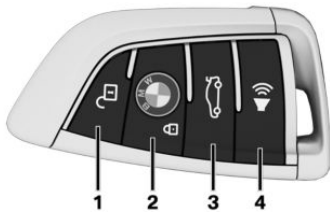

- 1 Unlocking
- 2 Locking  
Stationary climate control through Remote Engine Start [280](#)
- 3 Open tailgate
- 4 Press and hold or press three times in quick succession: panic mode  
Press briefly: headlight courtesy delay feature

## Unlocking

### General information

The behavior of the vehicle when unlocking with the remote control depends on the following settings, refer to page [103](#), for unlocking and locking:

- ▷ If only the driver's door and the fuel filler flap or all access to the vehicle will be unlocked.
- ▷ If the unlocking of vehicle is confirmed with a light signal or a sound signal.
- ▷ If the welcome light, refer to page [170](#), is switched on when the vehicle is being unlocked.
- ▷ If the exterior mirrors are automatically folded out and in when the vehicle is unlocked and locked.

### Unlocking the vehicle



Press the button on the remote control.

If, due to the settings, only the driver's door and fuel filler flap were unlocked, press the button on the remote control again to unlock the other vehicle access points.

In addition, the following functions are executed:

- ▷ If a driver profile, refer to page [97](#), was assigned to the remote control, this driver profile will be activated and the settings that are stored in it will be applied.
- ▷ The interior lights are switched on, unless they were manually switched off. Switch the interior lights on/off manually, refer to page [174](#).
- ▷ With alarm system: The alarm system, refer to page [105](#), will be switched off.

After opening one of the front doors, the vehicle is ready for operation, refer to page [44](#).

The light functions may depend on the ambient brightness.

## Convenient opening



Press and hold the button on the remote control after unlocking.

The windows and the glass sunroof are opened, as long as the button on the remote control is pressed.

## Locking

### General information

The behavior of the vehicle during locking with the remote control depends on the following settings, refer to page [103](#):

- ▷ If the locking of the vehicle is confirmed with a light signal or a sound signal.
- ▷ If the exterior mirrors are automatically folded in and out when the vehicle is locked and unlocked.
- ▷ If the headlight courtesy delay feature, refer to page [170](#), is activated during locking.



## Locking the vehicle

1. Close the driver's door.
2.  Press the button on the remote control.

The following functions are executed:

- ▷ All doors, the tailgate, and the fuel filler flap are locked.
- ▷ With alarm system: The alarm system, refer to page 105, will be switched on.

If the drive-ready state is still switched on when you lock the vehicle, the vehicle horn honks twice. In this case, the drive-ready state must be switched off by means of the Start/Stop button.

## With Comfort Access: convenient closing

### Safety information

#### WARNING

With convenient closing, body parts can be jammed. There is a risk of injury. Make sure that the area of movement of the doors is clear during convenient closing.

### Closing

-  Press and hold the button on the remote control in the area close to the vehicle after locking.

The windows and the glass sunroof are closed, as long as the button on the remote control is pressed.

## Switching on the interior and exterior lights

-  Press the button on the remote control with the vehicle locked.

The function is not available for the first 10 seconds after locking.

- ▷ The interior lights are switched on, unless they were manually switched off. Switch the interior lights on/off manually, refer to page 174.
- ▷ Depending on the settings, the exterior lighting, refer to page 170, will be switched on.

The light functions may depend on the ambient brightness.

## Tailgate

### General information

To avoid locking it in the vehicle, do not place the remote control in the cargo area.

The following settings, refer to page 104, are available for the operation of the tailgate with the remote control:

- ▷ Whether the remote control opens only the upper tailgate or the upper and lower tailgate at the same time.
- ▷ Determines if the doors will be unlocked when the tailgate is opened with the remote control.

### Safety information

#### WARNING

Body parts can be jammed when operating the tailgate. There is a risk of injury. Make sure that the area of movement of the tailgate is clear during opening and closing.

#### WARNING

The tailgate pivots out when it opens. There is a risk of injury or risk of damage to property. Make sure that the area of movement of the tailgate is clear during opening and closing.

**⚠ NOTICE**

Sharp-edged or pointed objects can hit the windows and heat conductors while driving. There is a risk of damage to property. Cover the edges and ensure that pointed objects do not hit the windows.

**Opening**

Press and hold the button on the remote control for approx. 1 second.

**Panic mode**

You can trigger the alarm system if you find yourself in a dangerous situation.



▶ Press the button on the remote control and hold for at least 3 seconds.

▶ Briefly press the button on the remote control three times in succession.

To switch off the alarm: press any button.

**Switching on the headlight courtesy delay feature**

Press and hold the button on the remote control for approx. 1 second.

Set the duration, refer to page [170](#).

**Replacing the battery**

1. Remove the integrated key from the remote control, refer to page [85](#).
2. Place the integrated key underneath the battery compartment cover, arrow 1, and lift the

cover with a lever movement of the integrated key, arrow 2.

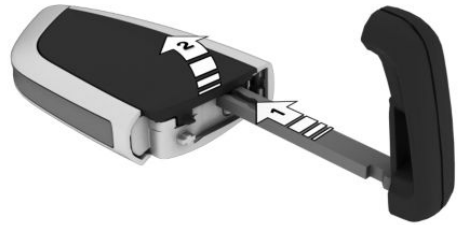

3. Push battery in the direction of the arrow using a pointed object and lift it out.

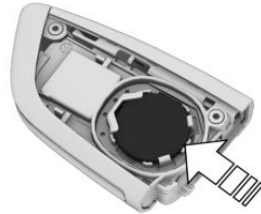

4. Insert a type CR 2032 battery with the positive side facing up.
5. Press the cover closed.



Have old batteries disposed of by a dealer's service center or another qualified service center or repair shop or take them to a collection point.

**Additional remote controls**

Additional remote controls are available from a dealer's service center or another qualified service center or repair shop.

**Loss of the remote controls**

A lost remote control can be blocked and replaced by a dealer's service center or another qualified service center or repair shop.

If the lost remote control has an assigned driver profile, refer to page [97](#), the connection to this

remote control must be deleted. A new remote control can then be assigned to the driver profile.

## Malfuction

### General information

A Check Control message, refer to page 153, is displayed.

Remote control detection by the vehicle may malfunction under the following circumstances:

- ▶ The battery of the remote control is discharged. Replacing the battery, refer to page 79.
- ▶ Interference of the radio connection from transmission towers or other equipment with high transmitting power.
- ▶ Shielding of the remote control due to metal objects.  
Do not transport the remote control together with metal objects.
- ▶ Interference of the radio connection from mobile phones or other electronic devices in direct proximity to the remote control.  
Do not transport the remote control together with electronic devices.
- ▶ Interference of radio transmission by a charging process of mobile devices, for instance charging of a mobile phone.
- ▶ The remote control is in direct proximity of the wireless charging tray.  
Place the remote control down at a different location.

In the case of interference, the vehicle can be unlocked and locked from the outside with the integrated key, refer to page 85.

## Switching the drive-ready state on via emergency detection of the remote control

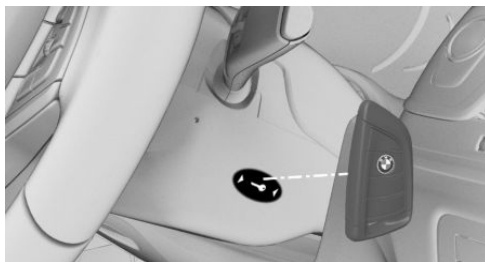

It is not possible to switch on the drive-ready state if the remote control has not been detected.

Proceed as follows in this case:

1. Hold the remote control with its back against the marked area on the steering column. Pay attention to the display in the instrument cluster.
2. If the remote control is detected:  
Switch on drive-ready state within 10 seconds.

If the remote control is not detected, slightly change the position of the remote control and repeat the procedure.

## Frequently asked questions

What precautions can be taken to be able to open a vehicle with an accidentally locked in remote control?

- ▶ The options provided by the Remote Services of the BMW Connected app include the ability to lock and unlock a vehicle.  
This requires an active BMW ConnectedDrive contract and the BMW Connected app must be installed on a smartphone.
- ▶ Unlocking the vehicle can be requested via the BMW ConnectedDrive Call Center.  
An active BMW ConnectedDrive contract is required.



## BMW display key

### General information

The BMW display key is supplied with an additional mechanical key. If the display key is used, the mechanical key should be carried with you, for instance in the wallet. The mechanical key is used like the integrated key, refer to page 85.

The display key supports all functions of the standard remote control.

In addition, the following functions are also available:

- ▷ Display status of doors and windows.
- ▷ Display status of the anti-theft warning system.
- ▷ Display service information.
- ▷ Call up range with available fuel.
- ▷ Stationary climate control/Remote Engine Start
- ▷ Level setting of the vehicle when stationary.

### Safety information

#### WARNING

People or animals in the vehicle can lock the doors from the inside and lock themselves in. In this case, the vehicle cannot be opened from the outside. There is a risk of injury. Take the remote control with you so that the vehicle can be opened from the outside.

#### WARNING

For some country versions, unlocking from the inside is only possible with special knowledge. Persons who spend a lengthy time in the vehicle while being exposed to extreme temperatures are at risk of injury or death. Do not lock the vehicle from the outside when there are people in it.

#### WARNING

Unattended children or animals can cause the vehicle to move and endanger themselves and traffic, for instance due to the following actions:

- ▷ Pressing the Start/Stop button.
- ▷ Releasing the parking brake.
- ▷ Opening and closing the doors or windows.
- ▷ Engaging selector lever position N.
- ▷ Using vehicle equipment.

There is a risk of accidents or injuries. Do not leave children or animals unattended in the vehicle. Take the remote control with you when exiting and lock the vehicle.

### Overview



- 1 Open tailgate
- 2 Unlocking
- 3 Press and hold or press three times in quick succession: panic mode  
Press briefly: headlight courtesy delay feature
- 4 Locking
- 5 Display
- 6 Back
- 7 Switch the display on/off
- 8 Micro-USB charging socket

### Reception range

The number of available display key functions depends on the distance from the vehicle.

- ▶ When you are in close proximity to the vehicle, all functions of the display key are available.
- ▶ The status information can be called up in the extended reception range.  
With parked-car heating: the parked-car heating can be operated.  
Without parked-car heating: the parked-car ventilation can be operated.
- ▶ Outside of the reception range of the vehicle, you can display the last transmitted status information from the vehicle.

 The symbol is shown on the display if one of the buttons is pressed outside of the reception range.



## Display

### General information

The display is divided into the upper status line, the information area, and the lower status line.

### Upper status line

The upper status line displays the following information:

- ▶  Vehicle secured.  
 Vehicle not secured.
- ▶ Set time in the vehicle.
- ▶  Charge state of the display key battery.

### Information area

The information area can be used to access information and perform additional functions.

If the information area contains more than one page, then page indicators are shown beneath the information.

 The indicator for the current page has been filled in.

Swipe to the right or left with a finger to change between the pages.

If further information is available on a page, tap the appropriate symbol.

To return to the original page:  tap on the symbol beneath the display.

### Lower status line

The lower status line indicates whether or not the display key is within reception range, refer to page 81.

- ▶ "Connected": the display key is within reception range.
- ▶ "Updated": the display key is not within reception range. It indicates when the last data transfer from the vehicle took place.

### Switching on/off

The display will go out automatically after a brief period to conserve battery power.

To hide the display manually:

Press the button on the left side of the display key. Overview, refer to page 81.

To show the display:

1. Press the button on the left side of the display key.
2. Then, swipe with your finger from bottom to top to unlock the screen lock.

To switch off the display to increase the usable battery life:





1. If necessary, cancel the screen lock.
2. Press and hold the button on the left side of the display key for longer than 4 seconds.
3. "OK"

To switch the display on:

Press the button on the left side of the display key.

### Operating concept

The relevant submenus can be accessed from the following main menus:

Main menu	Information/Function
"Security information"	 /  Door status.  Alarm system status. After alarm triggering: date, time, and reason for triggering the alarm.
	<hr/>  Window status.  Glass sunroof status.
"Entry level"	 "Height control" Set vehicle level, refer to page <a href="#">262</a> .
"Vehicle information"	Maintenance indicators of Condition Based Service CBS, refer to page <a href="#">374</a> .  Status of the roadside parking lights.
"Mobility info"	Range with available fuel.
"Precondit. setting"	With parked-car heating: operate parked-car heating, refer to page <a href="#">278</a> .  Without parked-car heating: operate parked-car ventilation, refer to page <a href="#">278</a> .  Stationary climate control/ Remote Engine Start, refer to page <a href="#">280</a>

## Display key battery

### General information

Follow the following information:

- ▶ If the charge state of the display key battery declines, the display is switched off automatically. The battery must be recharged so that the display can be switched back on. The operability of the standard buttons is retained until the battery is completely discharged.

- ▶ Charge the battery for at least three hours before using the display key for the first time or if the key has not been used for an extended period.
- ▶ The display key can be used while it is being charged via the USB port. If the battery is fully discharged, it may take some time before the display key can be used again.
- ▶ Due to the large number of USB chargers available on the market, it cannot be guaranteed that every charger will function properly. The charging duration depends on the charger used.
- ▶ Charging via the USB port may heat up the charger and the display key.  
Charging in the wireless charging tray may heat up the tray and the display key.  
At higher temperatures, the display key may cause a reduction in the charging current, and in isolated cases the charging process may be interrupted temporarily.
- ▶ When inserting the display key into the wireless charging tray, make sure there are no objects between it and the wireless charging tray.

## Safety information

### WARNING

When charging a device that meets the Qi standard in the wireless charging tray, any metal objects located between the device and the tray can become very hot. If smart cards, memory cards or cards with magnetic strips are placed between the device and the tray, this may impair card function. There is a risk of injury and risk of damage to property. When charging mobile devices, make sure there are no objects between the device and the tray.

## Charging

### Via USB

Connect the display key via the micro-USB charging socket to a USB port.

### In the wireless charging tray



1. Open the tray cover.
2. Place the display key into the middle of the wireless charging tray in front of the left cup holder.

Ensure that the display is facing up.

3. Close the tray cover.

### With thermo-cup holder: in the wireless charging tray



1. Open the tray cover.
2. Place display key flush into the recess of the wireless charging tray.

Ensure that the display is facing up.

3. Close the tray cover.

## Malfunction

### General information

A Check Control message is displayed.

BMW display key detection by the vehicle may malfunction under the following circumstances:

- ▶ The battery of the display key is discharged. Charge the battery, refer to page 83.
- ▶ Interference of the radio connection from transmission towers or other equipment with high transmitting power.
- ▶ Shielding of the display key due to metal objects.
- ▶ Interference of the radio connection from mobile phones or other electronic devices in direct proximity.
- ▶ Interference of radio transmission by a charging process of mobile devices, for instance charging of a mobile phone.

Do not transport the display key together with metal objects or electronic devices.

In the case of interference, the vehicle can also be unlocked and locked from the outside with the mechanical key.

### Switching on drive-ready state via emergency detection of the BMW display key

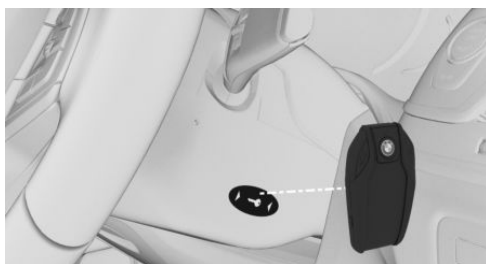

It is not possible to switch on the drive-ready state if the display key has not been detected.

Proceed as follows in this case:

1. Hold the display key with its back against the marked area on the steering column. Pay attention to the display in the instrument cluster.
2. If the display key is detected:  
Switch on drive-ready state within 10 seconds.

If the display key is not detected, slightly change the position of the display key and repeat the procedure.

### Resetting the BMW display key

If the charged display key cannot be switched on anymore or if the display does not respond to entries anymore, the display key can be reset.

Press and hold the button on the left side of the display key for at least 20 seconds, until something appears on the display.

## Integrated key

### General information

The driver's door can be locked and unlocked without remote control using the integrated key. The integrated key also fits the glove compartment.

### Safety information

#### WARNING

For some country versions, unlocking from the inside is only possible with special knowledge.

Persons who spend a lengthy time in the vehicle while being exposed to extreme temperatures are at risk of injury or death. Do not lock the vehicle from the outside when there are people in it.

#### NOTICE

The door lock is permanently joined with the door. The door handle can be moved. When pulling the door handle with the integrated key inserted, paint or the integrated key can be damaged. There is a risk of damage to property. Remove the integrated key before pulling the outside door handle.

### Removing

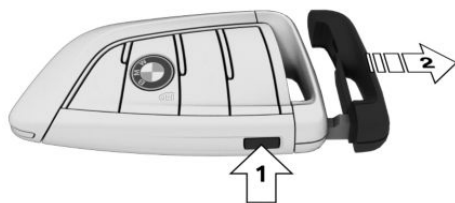

Press the button, arrow 1, and pull out the integrated key, arrow 2.

### Locking/unlocking via the door lock

1. Pull and hold the door handle outward with one hand.

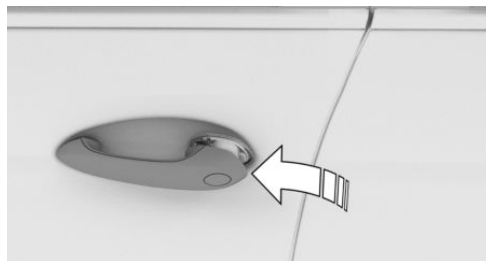

2. Guide one finger of your other hand from the back under the cover and push the cover out.

Use the thumb for counter support to prevent the cover from falling out of the door handle.



3. Remove the cover.
4. Unlock or lock the door lock using the integrated key.

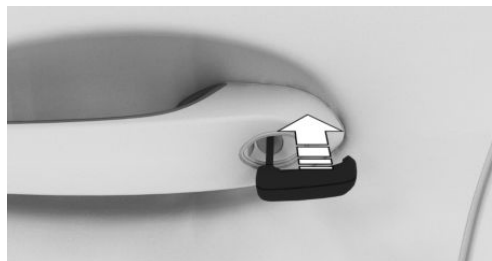

The other doors must be unlocked or locked from the inside.

## Alarm system

The alarm system is not switched on if the vehicle is locked with the integrated key.

The alarm system is triggered when the door is opened, if the vehicle has been unlocked via the door lock.

In order to stop the alarm, unlock the vehicle with the remote control, if necessary through emergency detection of the remote control, refer to page 80.

## Buttons for the central locking system

### General information

In the event of a severe accident, the vehicle is automatically unlocked. The hazard warning system and interior lights come on.

### Overview



Buttons for the central locking system.

### Locking

 Press the button with the front doors closed.

- ▷ The fuel filler flap remains unlocked.
- ▷ The vehicle is not secured against theft when locking.

### Unlocking

 Press the button.

### Opening

- ▷  Press the button to unlock all the doors.

Pull the door opener above the armrest.

- ▷ Front doors: pull the door handle on the door to open the door. The other doors remain locked.
- ▷ Back doors: pull twice on the door handle on the door to be opened; the first time unlocks

the door, the second time opens it. The other doors remain locked.

## Comfort Access

### Concept

The vehicle can be accessed without activating the remote control.

All you need to do is to have the remote control with you, such as in your pants pocket.

The vehicle automatically detects the remote control when it is in close proximity or in the car's interior.

### General information

Comfort Access supports the following functions:

- ▶ Unlocking and locking the vehicle from the door handle.
- ▶ Convenient closing.
- ▶ Touchless unlocking and locking of the vehicle.
- ▶ Unlocking and locking the vehicle using the BMW Digital Key.
- ▶ Open the tailgate.
- ▶ Open and close the tailgate with no-touch activation.

### Functional requirements

- ▶ To lock the vehicle, the remote control must be located outside of the vehicle near the doors.
- ▶ The next unlocking and locking cycle is not possible until after approx. 2 seconds.

## Unlocking

### General information

The behavior of the vehicle during unlocking via the Comfort Access depends on the following settings, refer to page 103:

- ▶ If the unlocking of vehicle is confirmed with a light signal or a sound signal.
- ▶ If the welcome light, refer to page 170, is switched on when the vehicle is being unlocked.
- ▶ If the exterior mirrors are automatically folded out and in when the vehicle is unlocked and locked.

### Unlocking the vehicle



Grasp the handle of a vehicle door completely.

## Locking

### General information

The behavior of the vehicle during locking via the Comfort Access depends on the following settings, refer to page 103:

- ▶ If the locking of the vehicle is confirmed with a light signal or a sound signal.
- ▶ If the exterior mirrors are automatically folded out and in when the vehicle is unlocked and locked.
- ▶ If the headlight courtesy delay feature, refer to page 170, is activated during locking.

### Locking the vehicle

Close the driver's door.

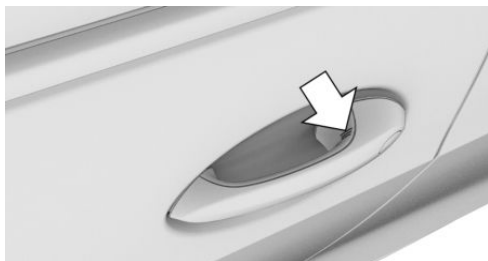

Touch the grooved surface on the handle of a closed vehicle door with your finger for approx. 1 second without grasping the door handle.

## Convenient closing

### Safety information

#### **WARNING**

With convenient closing, body parts can be jammed. There is a risk of injury. Make sure that the area of movement of the doors is clear during convenient closing.

## Closing

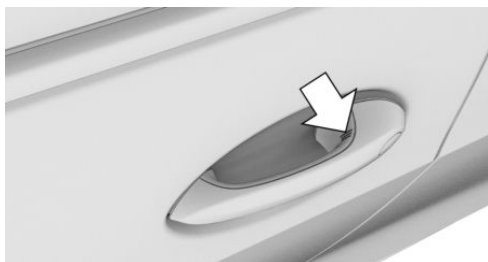

Touch the grooved surface on the handle of a closed vehicle door with your finger and hold it there without grasping the door handle.

In addition to locking, the windows and glass sunroof will be closed.

## Opening the tailgate

### General information

If the tailgate is opened via Comfort Access, locked doors are not unlocked.

To avoid locking it in the vehicle, do not place the remote control in the cargo area.

### Safety information

#### **WARNING**

Body parts can be jammed when operating the tailgate. There is a risk of injury. Make sure that the area of movement of the tailgate is clear during opening and closing.

#### **WARNING**

The tailgate pivots out when it opens. There is a risk of injury or risk of damage to property. Make sure that the area of movement of the tailgate is clear during opening and closing.

#### **NOTICE**

Sharp-edged or pointed objects can hit the windows and heat conductors while driving. There is a risk of damage to property. Cover the edges and ensure that pointed objects do not hit the windows.



## Opening

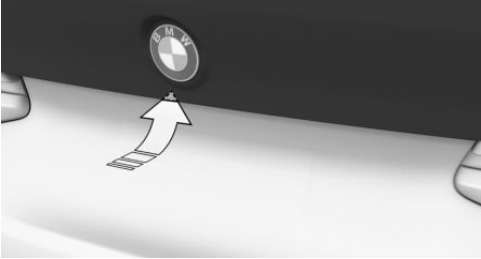

Press the button on tailgate's exterior.

## Without trailer hitch: touchless opening and closing of the tailgate

### Concept

The tailgate can be opened and closed with no-touch activation using the remote control you are carrying. Two sensors detect a forward-directed foot motion in the central rear area and the tailgate is opened and closed.

### General information

To avoid locking it in the vehicle, do not place the remote control in the cargo area.

If the remote control is in the sensor area, the tailgate can be opened or closed inadvertently by an unconscious or alleged recognized foot movement.

The sensor has an approximate range of 5 ft/1.50 m extending from the rear of the vehicle.

If the tailgate is opened with no-touch activation, locked doors are not unlocked.

You can configure if only the upper tailgate will open or if the upper and lower tailgate opens. Settings, refer to page 103. When closing, the upper and lower tailgate will always be closed.

## Safety information

### WARNING

During no-touch activation, vehicle parts may be touched, such as the hot exhaust gas system. There is a risk of injury. When moving your foot, make sure you have a firm stance and do not touch the vehicle.

### WARNING

Body parts can be jammed when operating the tailgate. There is a risk of injury. Make sure that the area of movement of the tailgate is clear during opening and closing.

### WARNING

The tailgate pivots out when it opens. There is a risk of injury or risk of damage to property. Make sure that the area of movement of the tailgate is clear during opening and closing.

### NOTICE

Sharp-edged or pointed objects can hit the windows and heat conductors while driving. There is a risk of damage to property. Cover the edges and ensure that pointed objects do not hit the windows.

## Performing the foot movement

1. Stand in the middle behind the vehicle at approx. one arm's length away from the rear of the vehicle.
2. Wave a foot under the vehicle in the direction of travel and immediately pull it back. With

this movement, the leg must pass through the ranges of both sensors.

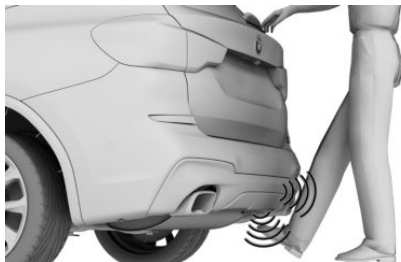

### Opening

Perform the foot movement described earlier.

Before the tailgate opens, the hazard warning system flashes.

Moving your foot again will stop the opening motion, and moving it one more time after that will close the tailgate.

### Closing

Perform the foot movement described earlier.

The hazard warning system flashes and an acoustic signal sounds.

Moving your foot again will stop the closing motion, and moving it one more time after that will re-open the tailgate.

## Touchless unlocking and locking of the vehicle

### Concept

The vehicle will be unlocked when the driver approaches the locked vehicle with the remote control.

When the driver walks away from the unlocked vehicle with the remote control, the vehicle will be locked.

### General information

The vehicle will be unlocked when an authorized remote control is detected in the unlocking zone.

The unlocking zone is located within a radius of approx. 3 ft/1 m around the door handles.

The vehicle will be locked when the remote control leaves the locking zone.

The locking zone is located within a radius of approx. 7 ft/2 m around the door handles.

If the remote control is located in the unlocking zone for an extended period of time without movement, the vehicle will be locked automatically.

If a passenger is detected in the front passenger seat during locking and the safety belt of the front passenger is engaged in the safety belt buckle during locking:

- ▶ The vehicle will be locked but not secured against theft.
- ▶ The fuel filler flap remains unlocked.

The behavior of the vehicle during touchless unlocking and locking depends on the following settings, refer to page 103:

- ▶ If the automatic unlocking is active.
- ▶ If the automatic locking is active.
- ▶ If only the driver's door and the fuel filler flap or all access to the vehicle will be unlocked.

Only driver's door and fuel filler flap: the driver's door and fuel filler flap will only be unlocked when the driver approaches the vehicle on the driver's side.

All vehicle entry points: the vehicle will be unlocked depending on the side on which the driver approaches the vehicle.

- ▶ If the unlocking and locking of the vehicle is confirmed with a light signal or a sound signal.
- ▶ If the welcome light, refer to page 170, is switched on when the vehicle is being unlocked.
- ▶ If the headlight courtesy delay feature, refer to page 170, is activated during locking.
- ▶ If the exterior mirrors are automatically folded out and in when the vehicle is unlocked and locked.

## Functional requirements

- ▷ The drive-ready state must be turned off.
- ▷ Unlocking: when entering the unlocking zone, the doors and tailgate must be closed.
- ▷ Locking: when leaving the locking zone, the doors and tailgate must be closed.
- ▷ If the vehicle was locked with the remote control, it cannot be unlocked touchless.
- ▷ If the vehicle was unlocked with the remote control, it cannot be locked touchless without driving the vehicle first.
- ▷ For touchless locking of the vehicle, no second remote control can be located in the locking zone.
- ▷ If the vehicle has been in the idle state for several days, touchless unlocking and locking is not possible until after the vehicle has been driven.

## BMW Digital Key

### Concept

BMW Digital Key allows the vehicle to be unlocked and locked, as well as started, with a compatible smartphone, refer to page 68.

### General information

BMW Digital Key varies by country and may be unavailable.

To unlock and start a vehicle with a compatible smartphone, a digital key must be installed on this smartphone. Digital keys are installed, managed and forwarded via the BMW Connected app.

A driver profile, refer to page 97, with individual settings can be assigned to a digital key.

When using a digital key, always carry a remote control with you too, so the vehicle can still be accessed even if your smartphone is not working. It is also useful to carry the remote control with you if the vehicle has to be handed over to another person or a Service Center. You can

then hand over the remote control, instead of your smartphone.

### Key card

The vehicle is delivered with a key card. The key card can be used in the same way as a compatible smartphone with a digital key.

This key card may not be available. Contact your authorized dealer's service center or another qualified service center as to whether this additional function is currently in your vehicle or when it can be installed in your vehicle in the future.

A digital key that has already been paired with the vehicle is installed on the key card. The digital key must be activated via iDrive, refer to page 92.

When you exit the vehicle, take the key card with you, as it can be used to start the vehicle.

### Connection to the vehicle

The communication between the vehicle and the smartphone uses near-field communication, NFC.

The vehicle is unlocked with the outside door handle of the vehicle. The smartphone must be placed into the smartphone tray to pair a digital key and to start the engine.

The vehicle also detects a digital key when the smartphone is switched off.

### Functional requirements

- ▷ The BMW Connected app is installed on a compatible smartphone.
- ▷ The rechargeable battery of the smartphone has a sufficient charge. The necessary minimum charge of the rechargeable battery depends on the smartphone.
- ▷ A digital key for the vehicle is installed on the smartphone.
- ▷ BMW Digital Key is activated for the vehicle.

## Activate BMW Digital Key

The vehicle owner must present proof of authorization for his vehicle at the service center to be able to use BMW Digital Key.

The vehicle owner configures a digital key code at the service center to be able to enable additional digital keys at a later time.

## Purchasing digital keys

An initial digital key is provided in the BMW Connected app when the vehicle is purchased.

Additional digital keys can be purchased via the BMW ConnectedDrive Store. The purchase of digital keys can cause costs.

The period of validity of a digital key is limited. The expiration date of the validity can be checked in the BMW Connected app and in the vehicle.

If a digital key has expired, the vehicle can only be unlocked and locked for a limited period and a limited number of engine starts is possible. The corresponding information is shown on the Control Display.

## Transferring digital keys

The vehicle owner can transfer a digital key for his vehicle to another person via the BMW Connected app.

When a digital key is transferred, a transaction number TAN will be generated. Another person can pair the digital key in the vehicle with this TAN and the Digital Key Code. This makes it possible to allow another person to use the vehicle without having to be at the vehicle.

The TAN and the Digital Key Code should only be disclosed in person or by phone.

The transferred digital key can be removed in the vehicle or via the BMW Connected app at any time.

If the digital key has been removed via the BMW Connected App, the vehicle can still be unlocked and locked for a limited period of time and only a limited number of engine starts will be possible.

The corresponding information is shown on the Control Display.

As soon as the vehicle is used with another digital key or with a remote control, the removed digital key can no longer be used.

## Pairing digital keys in the vehicle

To pair a digital key, a remote control must be located in the vehicle or an active digital key of the vehicle owner must be in the smartphone tray.

If the digital key was transferred by the vehicle owner, it may not be possible to meet this requirement. In this case, it is necessary to enter the Digital Key Code and the TAN. The vehicle can already be unlocked with the transferred digital key before it is paired.

Place the smartphone with the digital key to be paired into the smartphone tray.

Via iDrive:

1. "CAR"
2. "Settings"
3. "Doors/Access"
4. "BMW Digital Key"
5. "Add new digital key"
6. If necessary, enter the Digital Key Code and the TAN.

After the digital key has been paired, its name will be displayed in the list of digital keys.

## Activating/deactivating digital keys in the vehicle

A digital key can be deactivated temporarily.

To activate or deactivate a digital key, a remote control must be located in the vehicle or an active digital key of the vehicle owner must be in the smartphone tray.

Via iDrive:

1. "CAR"
2. "Settings"
3. "Doors/Access"

4. "BMW Digital Key"
5. Select the desired digital key.
6. "Digital key active"

A deactivated digital key remains in the list of paired digital keys.

### Removing digital keys in the vehicle

To remove a digital key, a remote control must be located in the vehicle or another active digital key of the vehicle owner must be in the smartphone tray. To remove all digital keys, a remote control must be located in the vehicle.

Via iDrive:

1. "CAR"
2. "Settings"
3. "Doors/Access"
4. "BMW Digital Key"
5. If necessary, select the digital key.
6. **▶** "Remove digital key"
  - The digital key will be removed from the list of paired digital keys.
  - ▶** "Remove all digital keys"

### Resetting BMW Digital Key

To reset BMW Digital Key, an authorized remote control must be located in the vehicle.

After the reset, the vehicle can no longer be unlocked, locked or started with a digital key.

The vehicle owner must present proof of authorization for his vehicle again at the service center to be able to use BMW Digital Key again.

Via iDrive:

1. "CAR"
2. "Settings"
3. "Doors/Access"
4. "BMW Digital Key"
5. "Reset function"

### Unlocking and locking the vehicle

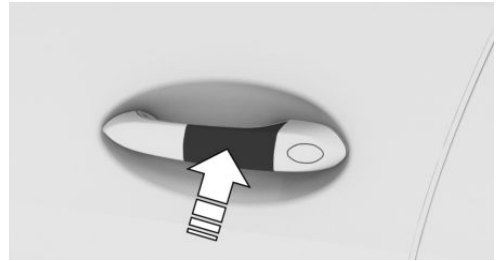

Hold the smartphone directly on the outside door handle of the driver's door.

### Starting the engine

Smartphone tray without thermo-cup holder:

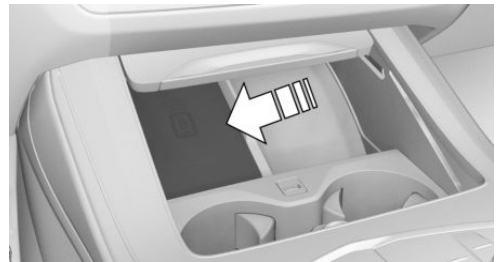

Smartphone tray with thermo-cup holder:



1. Open the cover of the smartphone tray.
2. Place smartphone centered into the smartphone tray.
3. After the digital key has been detected as authorized, the engine can be started.



## Sale of the smartphone/vehicle

When a smartphone with a digital key is sold, all digital keys should be deleted from this smartphone.

When a vehicle is sold, BMW Digital Key should be reset in this vehicle. The new vehicle owner should make sure that BMW Digital Key has been reset. This ensures that the previous vehicle owner no longer has access to the vehicle.

## Malfunction

Remote control detection by the vehicle may malfunction under the following circumstances:

- ▶ The battery of the remote control is discharged. Replacing the battery, refer to page 79.
- ▶ Interference of the radio connection from transmission towers or other equipment with high transmitting power.
- ▶ Shielding of the remote control due to metal objects.  
Do not transport the remote control together with metal objects.
- ▶ Interference of the radio connection from mobile phones or other electronic devices in direct proximity to the remote control.  
Do not transport the remote control together with electronic devices.

Wet or snowy conditions may disrupt the locking request recognition function on the door handles.

In the case of a malfunction, unlock and lock the vehicle using the buttons of the remote control or using the integrated key, refer to page 85.

## Tailgate

### General information

To avoid locking it in the vehicle, do not place the remote control in the cargo area.

The tailgate consists of the upper and the lower tailgate. The lower tailgate opens downward to make loading the cargo area easier.

The following settings, refer to page 104, are available for the operation of the tailgate:

- ▶ The opening height of the upper tailgate.
- ▶ With Comfort Access: Whether the remote control opens only the upper tailgate or the upper and lower tailgate at the same time.
- ▶ With Comfort Access: Whether the button in the driver's door opens only the upper or the upper and lower tailgate together.
- ▶ Determines if the doors will be unlocked when the tailgate is opened with the remote control.

## Safety information

### WARNING

Body parts can be jammed when operating the tailgate. There is a risk of injury. Make sure that the area of movement of the tailgate is clear during opening and closing.

### WARNING

The tailgate pivots out when it opens. There is a risk of injury or risk of damage to property. Make sure that the area of movement of the tailgate is clear during opening and closing.

### NOTICE

Foreign objects, such as sand or icing, between the bumper and tailgate may cause damage when operating the lower tailgate. There is a risk of damage to property. If necessary, remove foreign objects from the bumper and the lower tailgate before operating the lower tailgate.

**⚠ NOTICE**

Sharp-edged or pointed objects can hit the windows and heat conductors while driving. There is a risk of damage to property. Cover the edges and ensure that pointed objects do not hit the windows.

**⚠ NOTICE**

Manual operation of the tailgate in the wrong sequence can damage the tailgate. There is a risk of damage to property. Close the lower tailgate first before closing the upper tailgate manually.

## Upper tailgate

### Opening

#### General information

The tailgate cannot be opened when the vehicle is in valet parking mode, refer to page 101.

When the trailer socket is in use, the tailgate cannot be opened with the remote control or with the button in the car's interior.

The upper tailgate will be opened to the configured opening height.

#### From the outside

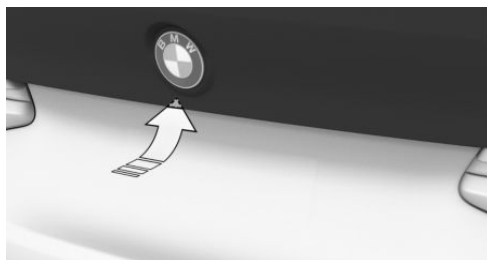

- ▷ Without Comfort Access: unlock the vehicle, then press the button on the outside of the tailgate.

With Comfort Access: unlock the vehicle or carry the remote control with you and then press the button on the outside of the tailgate.

- ▷  Press and hold the button on the remote control for approx. 1 second.

With Comfort Access: If necessary, the lower tailgate will also be opened.

#### From the inside

- ▷  Press the button in the driver's door.

If the vehicle is locked, selector lever position P must be engaged first.

With Comfort Access: If necessary, the lower tailgate will also be opened.

#### Interruption of the opening procedure

The opening procedure is interrupted in the following situations:

- ▷ When the vehicle starts moving.
- ▷ By pressing the button that is used again.

### Closing

#### Functional requirement

Without Comfort Access: The lower tailgate must be closed; otherwise, a Check Control message will be displayed.

#### From the outside

Without Comfort Access:

1. Closing the lower tailgate manually.
2. Press the button on the inside of the upper tailgate.



With Comfort Access:

- ▷  Press the button on the inside of the upper tailgate.

The lower tailgate will be closed automatically with the upper tailgate.

- ▷  Press the button on the inside of the upper tailgate.

The vehicle will be locked after closing the tailgate. The driver's door must be closed for this purpose and the remote control must be outside of the vehicle in the area of the tailgate.

The lower tailgate will be closed automatically with the upper tailgate.

### From the inside

Without Comfort Access:

1. Closing the lower tailgate manually.
2.  Pull and hold the button in the driver door.

The remote control must be located in the car's interior for this function.

With Comfort Access:

-  Pull and hold the button in the driver door. The remote control must be located in the car's interior for this function.

The lower tailgate will be closed automatically with the upper tailgate.

An acoustic signal sounds before the tailgate is closed.

### Interruption of the closing procedure

The closing procedure is interrupted in the following situations:

- ▷ If the vehicle starts off with a jerky movement.
- ▷ By pressing the button that is used again.

## Lower tailgate

### Opening

#### General information

When open, the lower tailgate can support loads of up to 550 lbs/250 kg.

#### Functional requirement

The upper tailgate must be open.

#### From the outside

Without Comfort Access:

-  Press the button on the lower tailgate and fold the lower tailgate down.

With Comfort Access:

-  Press the button on the lower tailgate.

#### With Comfort Access: from the inside

Depending on the settings, the lower tailgate will be opened automatically with the upper tailgate.

#### With Comfort Access: terminating the opening procedure

The opening procedure is interrupted in the following situations:

- ▷ When the vehicle starts moving.
- ▷ By pressing the button on the lower tailgate. Pressing again closes the tailgate.

### Closing

#### Functional requirements

There is no cargo on the lower tailgate.

#### From the outside

Without Comfort Access:

Closing the lower tailgate manually.

With Comfort Access:





Press the button on the lower tailgate.

### With Comfort Access: from the inside

The lower tailgate will be closed automatically with the upper tailgate.

### With Comfort Access: terminating the closing procedure

The closing procedure is interrupted in the following situations:

- ▷ If the vehicle starts off with a jerky movement.
- ▷ By pressing the button in the lower tailgate.

## System limits

Without Comfort Access: The upper tailgate is designed for electric operation via the provided operating points.

With Comfort Access: The upper tailgate and the lower tailgate are designed for electric operation via the provided operating points.

A manual operation of the tailgate can produce system states in which an electric operation is no longer possible.

For example, this type of system state applies when there is a danger of collision between the upper and lower tailgate. In this case, an acoustic signal will sound and the upper tailgate must be completely opened manually.

Operate the tailgate manually in exceptional cases only such as in the event of a malfunction, refer to page 97.

## Malfunction

### WARNING

With manual operation of a blocked tailgate, it can release itself unexpectedly from the blockage. There is a risk of injury or risk of damage to property. Do not operate the tailgate manually if it is blocked. Have it checked by a deal-

er's service center or another qualified service center or repair shop.

Without Comfort Access: Operate the unlocked upper tailgate manually and slowly without jerking.

With Comfort Access: Operate the unlocked upper or lower tailgate manually and slowly without jerking. When closing, make sure the lower tailgate is closed first.

To close the tailgate fully, press down lightly only. Closing occurs automatically.

## Automatic Soft Closing

### Safety information

#### WARNING

Body parts can be jammed while operating the doors. There is a risk of injury. Make sure that the area of movement of the doors is clear during opening and closing.

### Closing

To close the doors, push lightly.  
Closing occurs automatically.

## Driver profile

### Concept

Driver profiles can be created to store personal vehicle settings. If the vehicle is used by multiple drivers, each driver can create his personal driver profile. When a driver profile is selected, the vehicle will automatically apply the stored settings in the driver profile.

### General information

Three personal driver profiles can be created. Each driver profile can be protected with a PIN to

prevent other drivers from viewing and modifying the stored settings.

In addition, a guest profile is available that can be selected by any driver. The guest profile is active when a personal driver profile has not been selected.

Changes to the vehicle settings are automatically stored in the active driver profile or in the guest profile.

The recognition via remote control and a digital key, refer to page 91, can be assigned to a driver profile so that the vehicle will apply the settings as soon as the driver unlocks the car. As soon as the vehicle detects the remote control or the digital key, the corresponding driver profile will be activated.

**ConnectedDrive countries:** The stored settings in the driver profile can be synchronized with the personal BMW ConnectedDrive account. It is thereby possible to use these settings in other BMW vehicles as well.

## Functional requirements

When switching the driver profile, the vehicle must move at a maximum of walking speed.

## Welcome screen

After the Control Display is switched on, the Welcome screen will be displayed.

The following actions can be carried out on the Welcome screen:

- ▷ Selecting a driver profile.
- ▷ Accessing the Settings menu for driver profiles.
- ▷ Starting the set-up assistant.

This option is offered in new vehicle for a limited period of time.

As soon as the engine is started or any button is pressed, the Welcome screen will be hidden.

## Setup assistant

The setup assistant is offered in new vehicles for a limited period time on the Welcome screen to configure the most important properties of a new driver profile.

The driver is guided step by step through the following functions:

- ▷ Setting the system language.
- ▷ Pairing mobile devices with the vehicle.
- ▷ Non-ConnectedDrive countries: Assigning profile names.
- ▷ ConnectedDrive countries:

Enabling the continuous synchronization between the ConnectedDrive account and the driver profile.

Stored settings in the ConnectedDrive account are transferred to the vehicle. If a ConnectedDrive account has not been created, it must be created in the ConnectedDrive portal.

- ▷ Confirm the consent for the transmission of vehicle related data.
- ▷ Configure the voice command to start the voice command response.
- ▷ Switch on the gesture control.

## Guest profile

The guest profile can be activated by any driver. Vehicle settings that are entered when the guest profile is active will be stored in the guest profile.

In the following cases the guest profile is automatically active:

- ▷ A driver profile has not been created yet.
- ▷ No driver profile has been assigned to the remote control that was used to unlock the vehicle.
- ▷ No driver profile has been assigned to the digital key that was used to unlock the vehicle.
- ▷ It is not clear which driver profile must be activated.

The following limitations apply:

- ▶ The guest profile cannot be renamed.
- ▶ It is not possible to assign the recognition to the guest profile.
- ▶ PIN protection is not possible.
- ▶ ConnectedDrive countries: The synchronization with a ConnectedDrive account is not possible.

The guest profile is selected on the Welcome screen or via iDrive:

1. "CAR"
2. "Driver profiles"
3. "Guest"
4. "Log in"

## Creating a driver profile

A driver profile is created on the Welcome screen or via iDrive:

1. "CAR"
2. "Driver profiles"
3. Move the Controller to the right.
4. "Create driver profile"

ConnectedDrive countries: A ConnectedDrive account must be assigned to a driver profile. An existing account can be used or a new account must be created.

## Selecting recognition

The settings for the recognition are entered on the Welcome screen or via iDrive:

1. "CAR"
2. "Driver profiles"
3. Move the Controller to the right.
4. "Driver recognition"
5. Select desired setting:
  - ▶ "with vehicle key"

A remote control is assigned to the driver profile. As soon as the vehicle detects the

remote control, the corresponding driver profile will be activated.

If the remote control is not carried with you or the remote control is not recognized, the driver profile can only be selected on the Welcome screen when the PIN protection has been set up.

- ▶ "with Digital key"

A digital key is assigned to the driver profile. As soon as the vehicle recognizes the digital key, the corresponding driver profile will be activated.

If the smartphone with the digital key is not carried with you or the digital key is not recognized, the driver profile can only be selected on the Welcome screen when the PIN protection has been set up.

6. "Activate linkage"

## Setting up PIN protection

A driver profile without recognition and without PIN protection can be activated and changed by any driver.

A driver profile with recognition cannot be activated without remote control and without digital key if the PIN protection was not set up.

Non-ConnectedDrive countries: If PIN protection was not set up or the PIN is not known, the driver profile cannot be activated.

ConnectedDrive countries: If PIN protection was not set up or the PIN is not known, the driver profile can be activated with the access data of the corresponding ConnectedDrive account.

The setup is carried out on the Welcome screen or via iDrive:

1. "CAR"
2. "Driver profiles"
3. "Driver recognition"
4. "using PIN"

## Changing/canceling the recognition function

If the vehicle and remote control will be handed over for maintenance, for example, the recognition function should be canceled with the remote control. The handed over remote control can then no longer be used to access the personal driver profile. If the driver profile was protected with a PIN, undesired access will no longer be possible.

If another remote control or another digital key is assigned to a driver profile, the current assignment must be canceled first.

Via iDrive:

1. "CAR"
2. "Driver profiles"
3. "Driver recognition"
4. "with vehicle key"  
or  
"with Digital key"
5. "Activate linkage"

## Selecting a driver profile

Depending on the recognition setting, the driver profile will be selected automatically.

If the guest profile is active, the driver profile will be selected on the Welcome screen or via iDrive:

1. "CAR"
2. "Driver profiles"
3. Select driver profile.
4. "Log in"

All settings stored in the called-up driver profile are automatically applied.

## Switching the synchronization with the ConnectedDrive account on/off

ConnectedDrive countries:

The stored settings in the personal driver profile can additionally be stored in the personal Con-

nectedDrive account. It is thereby possible to use the personal settings in other BMW vehicles with ConnectedDrive access as well.

The synchronization with the ConnectedDrive account is enabled in the set-up assistant or via iDrive:

1. "CAR"
2. "Driver profiles"
3. "Settings"
4. "Synchronize driver profile"
5. "Synchronize driver profile"

## Renaming a driver profile

Non-ConnectedDrive countries:

The name that was assigned when the driver profile was set up can be changed via iDrive:

1. "CAR"
2. "Driver profiles"
3. Select driver profile.
4. "Settings"
5. Enter a profile name.
6. **OK** Select the symbol.

## Selecting a profile picture

Via iDrive:

1. "CAR"
2. "Driver profiles"
3. "Avatar"
4. Select the desired profile picture.

## Deleting the driver profile

Via iDrive:

1. "CAR"
2. "Driver profiles"
3. "Settings"
4. "Remove driver profile"
5. Select the desired driver profile.
6. "Delete now"

ConnectedDrive countries: If the driver profile was synchronized with a ConnectedDrive account, the stored data in the ConnectedDrive account will be retained.

## System limits

A clear detection of the desired remote control may not be possible in the following cases, for example:

- ▷ The driver unlocks the vehicle via Comfort Access and has multiple remote controls with him or her.
- ▷ The driver changes, but the vehicle is not locked and unlocked.
- ▷ When multiple remote controls are located outside on the driver's side of the vehicle.

If the remote control was not detected clearly, unlock the vehicle by pressing button for the desired remote control.

ConnectedDrive countries:

A driver profile can only be created and synchronized with the ConnectedDrive account when cellular reception is available.

The use of personal settings that are stored in the ConnectedDrive account in other vehicles is subject to technical limitations. For example, settings may be stored for a system that is not available, or available in a non-compatible version, in other vehicles.

## Valet parking mode

### Concept

In the valet parking mode, the Control Display is locked and operation via iDrive is no longer possible.

For example, this mode can be used when the vehicle is handed over for valet parking.

### General information

In the valet parking mode, it is not possible to change vehicle settings via iDrive. Personal set-

tings cannot be changed and personal settings cannot be displayed.

Additionally, the following actions are carried out:

- ▷ The volume of the audio system is limited.
- ▷ The integrated remote control is deactivated.
- ▷ DSC cannot be switched off.
- ▷ The tailgate can be locked and disconnected from the central locking system.

## Functional requirements

- ▷ At least one driver profile has been created.
- ▷ A driver profile or the guest profile is active.
- ▷ At least one driver profile has an assigned ConnectedDrive account.

## Accessing the menu for the valet parking mode

### Via the switch-off screen

After switching off drive-ready state the switch-off screen will be displayed. Select the entry for the valet parking mode on the switch-off screen.

### Via the display bar at the upper edge of the Control Display

1. Tip the Controller up
2. "Valet parking mode"

### Via the vehicle settings

Via iDrive:

1. "CAR"
2. "Settings"
3. "General settings"
4. "Valet parking mode"



## Activating the valet parking mode

### General information

Before activating the valet parking mode, a PIN must be set up to be able to deactivate the valet parking mode at a future time.

The procedure for entering the PIN varies depending on the active driver profile.

### Driver profile with PIN

A PIN has been stored for the active driver profile.

It is not necessary to enter another PIN.

1. Select desired setting:

"Lock tailgate as well"

The tailgate will be locked and disconnected from the central locking system.

2. "Activate now"

### Driver profile without PIN

A PIN must be assigned to the driver profile.

1. "PIN"
2. Enter PIN.
3. Select desired setting:

▷ "Lock tailgate as well"

The tailgate will be locked and disconnected from the central locking system.

▷ "Activate linkage"

This PIN will be stored for the active driver profile.

4. "Activate now"

### Guest profile

The guest profile is the active driver profile.

A PIN must be entered.

1. "PIN"
2. Enter PIN.
3. Select desired setting:

"Lock tailgate as well"

The tailgate will be locked and disconnected from the central locking system.

4. "Activate now"

This PIN can be used once to deactivate the valet parking mode for the active guest profile.

## Deactivating valet parking mode

### General information

The lock screen of the valet parking mode is displayed on the Control Display.

The deactivation of the valet parking mode depends on which driver profile is selected on the lock screen.

### Driver profile with PIN

Regardless of which driver activated the valet parking mode, a driver can deactivate the valet parking mode by entering his PIN.

1. Select driver profile.
2. Enter the assigned PIN for the driver profile.

If you forgot the PIN, the valet parking mode must be deactivated by entering the assigned ConnectedDrive access data.

### Driver profile without PIN

The valet parking mode was activated by another person. To deactivate the valet parking mode, a driver without a PIN has to enter the access data for his ConnectedDrive account.

1. Select driver profile.
2. Enter the ConnectedDrive access data assigned to the driver profile.

### Guest profile

In the guest profile, the valet parking mode can only be deactivated if the valet parking mode was activated in the guest profile.

1. Select guest profile.

2. Enter the PIN that was specified during activation.

If the PIN has been forgotten, the valet parking mode must be deactivated via a personal driver profile.

## Settings

### General information

Depending on the vehicle equipment and country version, various settings for opening and closing are possible.

These settings are stored for the driver profile currently used.

### Unlocking and locking

#### Doors

Via iDrive:

1. "CAR"
2. "Settings"
3. "Key button settings"
4.  Select the symbol.
5. Select desired setting:
  - ▶ "Driver's door only"
 

Only the driver's door and the fuel filler flap are unlocked. Pressing again unlocks the entire vehicle.
  - ▶ "All doors"
 

The entire vehicle is unlocked.

#### Confirmation signals from the vehicle

Via iDrive:

1. "CAR"
2. "Settings"
3. "Doors/Access"
4. Deactivate or activate the desired confirmation signals:

- ▶ "Flash when locking/unlocking"
 

Unlocking is signaled by two flashes, locking by one.
- ▶ With alarm system:
 

"Sound when locking/unlocking"

Unlocking is confirmed with two sound signals, locking is confirmed with one sound signal.

### Folding mirrors automatically

Via iDrive:

1. "CAR"
2. "Settings"
3. "Doors/Access"
4. "Fold mirrors in when locked"
 

Locking the vehicle folds in the exterior mirrors automatically. Unlocking the vehicle automatically folds out the exterior mirrors.

### Automatic unlocking

Via iDrive:

1. "CAR"
2. "Settings"
3. "Doors/Access"
4. "Unlock at end of trip"
 

After drive-ready state is switched off by pressing the Start/Stop button, the locked vehicle is automatically unlocked.

### Automatic locking

Via iDrive:

1. "CAR"
2. "Settings"
3. "Doors/Access"
4. Select desired setting:
  - ▶ "Lock automatically"
 

The vehicle locks automatically after a short period of time if no door is opened after unlocking.



- ▷ "Lock after starting to drive"  
The vehicle locks automatically after you drive off.

## Tailgate

### Opening height of the upper tailgate

You can set how far the upper tailgate can be opened.

When adjusting the opening height, make sure the clearance above the tailgate is at least 4 in/10 cm.

Via iDrive:

1. "CAR"
2. "Settings"
3. "Doors/Access"
4. "Tailgate"
5. "Opening height"
6. Monitor the tailgate and set the desired opening height.

### With Comfort Access: upper or both tailgates



The button in the car's interior can be set up to open only the upper tailgate or the upper and lower tailgate together:

Via iDrive:

1. "CAR"
2. "Settings"
3. "Key button settings"
4. "Tailgate"
5. Select desired setting:
  - ▷ "Upper tailgate"  
Only the upper tailgate opens.
  - ▷ "Both tailgates"  
The upper and lower tailgate will be opened together.

To open the upper and lower tailgate at the same time, the upper tailgate must be closed when the button is pressed.

This setting also applies to the touchless opening of the tailgate.

### Tailgate and doors

The button of the remote control can be configured to control which part of the tailgate will be opened and if the doors will be unlocked at the same time.



Via iDrive:

1. "CAR"
2. "Settings"
3. "Key button settings"
4. Select the symbol.
5. Select desired setting:
  - ▷ "Upper tailgate"  
The upper tailgate is opened.
  - ▷ "Upper tailgate + door(s)"  
The tailgate is opened and the doors unlocked.
  - ▷ "Both tailgates"  
The upper and lower tailgate will be opened.
  - ▷ "Both tailgates + door(s)"  
The upper and lower tailgate will be opened and the doors unlocked.

## Comfort Access

### Touchless locking/unlocking

1. "CAR"
2. "Settings"
3. "Doors/Access"
4. "Comfort Access"
5. Select desired setting:



- ▷ "Unlock when approaching"
- ▷ "Lock when walking away"

## Touchless opening of the tailgate

For touchless unlocking, a setting can be entered to open only the upper tailgate or the upper and lower tailgate together:

Via iDrive:

1. "CAR"
2. "Settings"
3. "Key button settings"
4. "Tailgate"
5. Select desired setting:
  - ▷ "Upper tailgate"
 

Only the upper tailgate opens.
  - ▷ "Both tailgates"
 

The upper and lower tailgate will be opened together.

To open the upper and lower tailgate at the same time, the upper tailgate must be closed when the button is pressed.

This setting also applies to the opening of the tailgate in the interior.

## Establishing idle state after opening the front doors

Via iDrive:

1. "CAR"
  2. "Settings"
  3. "Doors/Access"
  4. "Turn off vehicle after opening door"
- Opening the front doors establishes the idle state, refer to page 43.

## Alarm system

### General information

When the vehicle is locked, the vehicle alarm system reacts to the following changes:

- ▷ Opening a door, the hood, or the tailgate.
- ▷ Movements in the car's interior.
- ▷ Changes in the vehicle tilt, e. g., during attempts at stealing a wheel or when towing the vehicle.
- ▷ Disconnected battery voltage.
- ▷ Improper use of the socket for OBD Onboard Diagnosis.

The alarm system signals the following changes visually and acoustically:

- ▷ Acoustic alarm:
 

Depending on local regulations, the acoustic alarm may be suppressed.
- ▷ Visual alarm:
 

By flashing the exterior lighting.

### Switching on/off

When you unlock and lock the vehicle, either with the remote control or with Comfort Access, the alarm system is switched off and on at the same time.

### Opening the doors with the alarm system switched on

The alarm system is triggered when a door is opened if the door was unlocked using the integrated key in the door lock.

Switching off the alarm, refer to page 107.

### Opening the tailgate with the alarm system switched on

The tailgate can be opened even when the alarm system is switched on.



After the tailgate is closed, it is locked and monitored again provided the doors are locked. The hazard warning system flashes once.

## Panic mode

You can trigger the alarm system if you find yourself in a dangerous situation.



▶ Press the button on the remote control and hold for at least 3 seconds.

- ▶ Briefly press the button on the remote control three times in succession.

To switch off the alarm: press any button.

## Indicator light on the interior mirror



- ▶ The indicator light flashes briefly every 2 seconds:

The alarm system is switched on.

- ▶ Indicator light flashes for approx. 10 seconds, then it flashes briefly every 2 seconds:

Interior motion sensor and tilt alarm sensor are not active, as doors, hood, or tailgate are not correctly closed. Correctly closed access points are secured.

When the still open access points are closed, interior motion sensor and tilt alarm sensor will be switched on.

- ▶ The indicator light goes out after unlocking:  
The vehicle has not been tampered with.
- ▶ The indicator light flashes after unlocking until drive-ready state is switched on, but no longer than approx. 5 minutes:

An alarm has been triggered.

## Tilt alarm sensor

The tilt of the vehicle is monitored.

The alarm system responds in situations such as attempts to steal a wheel or when the vehicle is towed.

## Interior motion sensor

The windows and the glass sunroof must be closed for the system to function properly.

## Avoiding unintentional alarms

### General information

The tilt alarm sensor and interior motion sensor can trigger an alarm, although no unauthorized action occurred.

Possible situations for an unwanted alarm:

- ▶ In automatic vehicle washes.
- ▶ In duplex garages.
- ▶ During transport on trains carrying vehicles, at sea or on a trailer.
- ▶ With animals in the vehicle.
- ▶ When the vehicle is locked after start of fueling.

The tilt alarm sensor and the interior motion sensor can be switched off in such situations.

## Switching off the tilt alarm sensor and interior motion sensor



Press the button on the remote control within 10 seconds as soon as the vehicle is locked.

The indicator light lights up for approx. 2 seconds and then continues to flash.

The tilt alarm sensor and interior motion sensor are switched off until the vehicle is locked again.

## Switching off the alarm

- ▷ Unlock the vehicle using the remote control, if needed, through emergency detection of the remote control, refer to page 80.
- ▷ With Comfort Access: if you are carrying the remote control on your person, grasp the driver side or front passenger side door handle completely.

## Power windows

### Safety information

#### **WARNING**

When operating the windows, body parts and objects can be jammed. There is a risk of injury or risk of damage to property. Make sure that the area of movement of the windows is clear during opening and closing.

### Overview



 Power windows

 Safety switch



### Functional requirements

The windows can be operated under the following conditions.

- ▷ Standby state is established.
- ▷ Drive-ready state is established.



- ▷ The remote control is in the car's interior.

### Opening

- ▷  Press the switch to the resistance point.  
The window opens while the switch is being held.
- ▷  Press the switch beyond the resistance point.  
The window opens automatically. Pressing the switch again stops the motion.

Convenient opening via the remote control, refer to page 77.

### Closing

- ▷  Pull the switch to the resistance point.  
The window closes while the switch is being held.
- ▷  Pull the switch beyond the resistance point.  
The window closes automatically if the door is closed. Pulling again stops the motion.

Convenient closing via the remote control, refer to page 78.

Closing via Comfort Access, refer to page 87.

### Jam protection system

#### General information

If closing force exceeds a specific threshold as a window closes, closing is interrupted.

The window opens slightly.

### Safety information



#### **WARNING**

Accessories on the windows such as antennas can impact jam protection. There is a risk of injury. Do not install accessories in the area of movement of the windows.



## Closing without the jam protection system

In case of danger from the outside or if ice might prevent normal closing, proceed as follows:

-  Pull the switch past the resistance point and hold it there.  
The window closes with limited jam protection. If the closing force exceeds a specific threshold, closing is interrupted.
-  Pull the switch past the resistance point again within approx. 4 seconds and hold it there.  
The window closes without jam protection.

## Safety switch

### Concept

With the safety switch, it is possible to block particular functions in the rear. This makes sense, for instance if children or animals are carried in the rear.

If an accident of a certain severity occurs, the safety function is switched off automatically.

### General information

The following functions can be locked by pressing the safety switch:

- ▶ Seat adjustments in the rear.
- ▶ Opening and closing of the rear windows using the switches in the rear.

### Switching on/off



Press the button.

The LED lights up if the safety function is switched on.

## Roller sunblinds, rear side windows

### Safety information

#### **WARNING**

With closed roller sunblinds and open windows, the roller sunblinds may be strained while driving due to the wind. The roller sunblinds may be damaged and vehicle occupants may be harmed. There is a risk of injury. Do not open the windows while driving if the roller sunblinds are closed.

Pull out the roller sunblind at the strap and hook it onto the bracket.

## Glass sunroof

### General information

The glass sunroof and the sun protection are operated using the same switch.

### Safety information

#### **WARNING**

Body parts can be jammed when operating the glass sunroof. There is a risk of injury. Make sure that the area of movement of the glass sunroof is clear during opening and closing.

## Overview



Opening/closing the glass sunroof.

## Functional requirements

The glass sunroof and the sun protection can be operated under the following conditions.

- ▶ Standby state is established.
- ▶ Drive-ready state is established.
- ▶ The remote control is in the car's interior.

## Lifting/closing glass sunroof

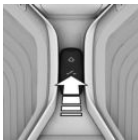

Push switch briefly upward.

- ▶ The closed glass sunroof tilts and the sun protection opens slightly.
- ▶ The opened glass sunroof closes until it is in the tilted position. The sun protection does not move.
- ▶ The tilted glass sunroof closes.

## Opening/closing the glass sunroof and sun protection separately

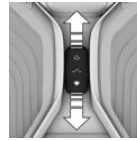

- ▶ Press the switch in the desired direction to the resistance point and hold it there.

Holding down the switch opens the sun protection. If the sun protection is already fully open, the glass sunroof opens.

The glass sunroof closes while the switch is being held. If the glass sunroof is already closed or in the tilted position, the sun protection closes.

- ▶ Press the switch in the desired direction past the resistance point.

The sun protection opens automatically. If the sun protection is already fully open, the glass sunroof opens automatically.

The glass sunroof closes automatically. If the glass sunroof is already closed or in the tilted position, the sun protection closes automatically.

Pressing the switch upward stops the motion.

## Opening/closing the glass sunroof and sun protection together

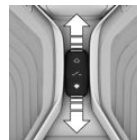

Briefly press the switch twice in succession in the desired direction past the resistance point.

The glass sunroof and sun protection move together. Pressing the switch upward stops the motion.

Convenient opening via the remote control, refer to page [77](#).

Closing via Comfort Access, refer to page [87](#).

## Comfort position

In some models, the wind noises in the car's interior are lowest when the glass sunroof is not fully open. In these models, the automatic function initially only opens the glass sunroof up to this comfort position.

Pressing the switch again opens the glass sunroof fully.

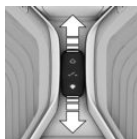

1. Close all doors.
2. Push the switch forward past the resistance point and hold.

The glass sunroof closes without jam protection.

## Jam protection system

### General information

If the closing force exceeds a certain value when closing the glass sunroof, the closing operation is interrupted once the roof reaches the half-open position, or it is stopped when closing from the tilted position.

The glass sunroof opens slightly.

### Closing from the open position without jam protection

If there is an external danger, proceed as follows:

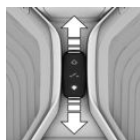

1. Close all doors.
2. Push the switch forward past the resistance point and hold.  
The glass sunroof closes with limited jam protection. If the closing force exceeds a specific threshold, closing is interrupted.
3. Push the switch forward again past the resistance point and hold until the glass sunroof closes without jam protection. Make sure that the closing area is clear.

### Closing from the raised position without jam protection

In the event of danger, proceed as follows:

## Initializing after a power interruption

### General information

After a power failure during the opening or closing process, the glass sunroof can only be operated to a limited extent.

The system can be initialized under the following conditions.

- ▷ The vehicle is parked in a horizontal position.
- ▷ The drive-ready state is established.
- ▷ The external temperature is above 41 °F/5 °C.

During initialization, the glass sunroof closes without jam protection.

Make sure that the closing area is clear.

### Initializing the system



Press the switch up and hold it until the initialization is complete:

Initialization begins within 15 seconds.

- ▷ If the glass sunroof is closed, it opens then closes again.
- ▷ If the glass sunroof is open, it first closes, then opens and closes again.

Initialization is complete once the glass sunroof and sun protection have opened then closed again.

# Seats, mirrors, and steering wheel

## Vehicle features and options

This chapter describes all standard, country-specific and optional features offered with the series. It also describes features and functions that are not necessarily available in your vehicle, e.g., due to the selected options or country versions. This also applies to safety-related functions and systems. When using these functions and systems, the applicable laws and regulations must be observed.

## Sitting safely

An ideal seating position that meets the needs of the occupants can make a vital contribution to relaxed, fatigue-free driving.

In the event of an accident, the correct seating position plays an important role. Follow the information in the following chapters:

- Seats, refer to page 111.
- Safety belts, refer to page 117.
- Head restraints, refer to page 119.
- Airbags, refer to page 176.

## Seats, front

### General information

The seat adjustment for the driver's seat is stored for the driver profile, refer to page 97, currently used. When a driver profile is selected, the stored position is called up automatically.

The current seat position can be stored using the memory function, refer to page 124.

## Safety information

### WARNING

Seat adjustments while driving can lead to unexpected movements of the seat. Vehicle control could be lost. There is a risk of an accident. Only adjust the seat on the driver's side when the vehicle is stationary.

### WARNING

With a backrest inclined too far to the rear, the efficacy of the safety belt can no longer be ensured. There is a risk of sliding under the safety belt in an accident. There is a risk of injuries or danger to life. Adjust the seat prior to starting the trip. Adjust the backrest so that it is in the most upright position as possible and do not adjust again while driving.

### WARNING

There is a risk of jamming when moving the seats. There is a risk of injury or risk of damage to property. Make sure that the area of movement of the seat is clear prior to any adjustment.

## Overview

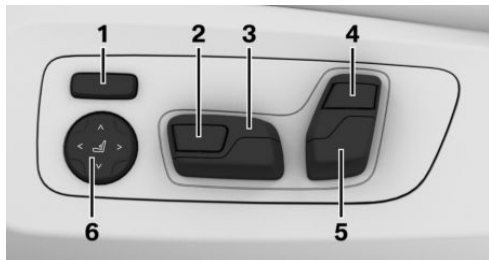

- 1 Backrest width
- 2 Thigh support
- 3 Forward/backward, height, seat tilt
- 4 Upper backrest
- 5 Backrest tilt, head restraint
- 6 Lumbar support

## Forward/backward

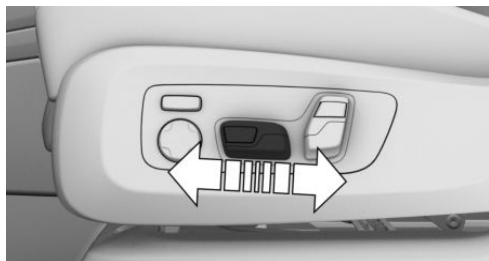

Push switch forward or backward.

## Height

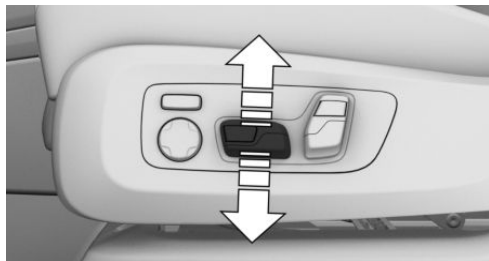

Push switch up or down.

## Seat tilt

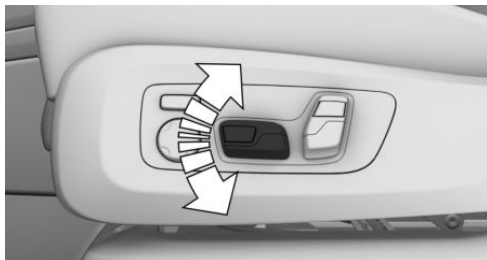

Move switch up or down.

## Backrest tilt

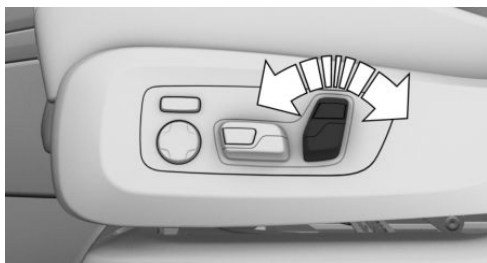

Move switch forward or backward.

## Thigh support

## Multifunction seat

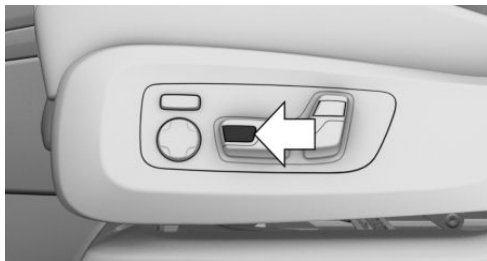

Press the switch.



## Sport seat

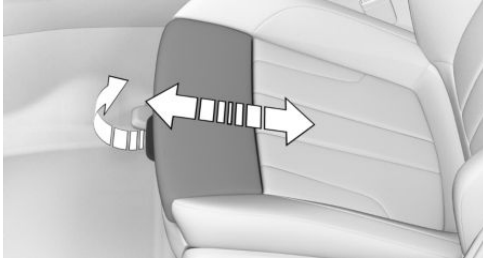

Pull the lever at the front of the seat and push the thigh support forward or back.

## Lumbar support

### Concept

The curvature of the seat backrest can be adjusted in a way that it supports the lumbar region of the spine. The lower back and the spine are supported for upright posture.

### Settings



- ▶ Press the front/rear section of the button:  
The curvature is increased/decreased.
- ▶ Press the upper/lower section of the button:  
The curvature is shifted up/down.

## Backrest width

### Concept

Adjusting the backrest width may improve lateral support when taking corners.

### General information

You can change the backrest width by adjusting the side wings of the backrest.

To make it easier to enter and exit the vehicle, the backrest width temporarily opens fully.

### Settings



- ▶ Press the front section of the button:  
The backrest width decreases.
- ▶ Press the rear section of the button:  
The backrest width increases.

## Upper backrest

### Concept

The upper backrest supports the back in the shoulder area. A correct setting leads to a relaxed seating position and reduces strain on the shoulder muscles.

### General information

If the driver's door is opened when the drive-ready state is switched off, the upper backrest moves into the standard position.

### Settings

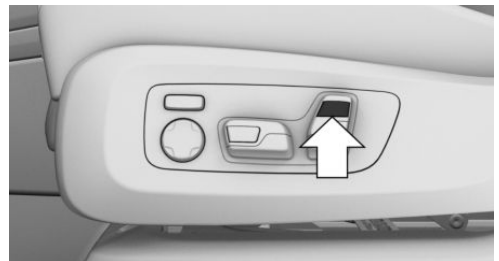

- ▶ Press the front section of the button:  
The upper backrest is inclined forward.
- ▶ Press the rear section of the button:  
The upper backrest is inclined backward.

## Gentleman function

### Concept

The front passenger seat can be adjusted with the switches of the driver's seat, for instance to increase the legroom in the rear.

### Overview



 Gentleman function

### Switching on

-  Press the button. The LED lights up.
- Adjust the front passenger seat on the driver's seat.

If needed, store the memory position, refer to page 124, for the front passenger seat.

### Switching off

 Press and hold the button until the LED goes out.

The function deactivates itself automatically after some time.

## Rear seats

### Second row of seats

#### General information

The seats of the second row of seats can be adjusted forward and backward including the back-

rest tilt. The backrest tilt for the center section is adjusted together with the left rear seat backrest.

### Safety information

#### WARNING

There is a risk of jamming when folding down the center armrest in the rear. There is a risk of injury. Make sure that the area of movement of the center armrest is clear during folding down.

#### WARNING

When folding back the second row of seats, there is a danger of jamming. There is a risk of injury or risk of damage to property. Make sure that the area of movement of the second row of seats is clear prior to folding down.

#### WARNING

Seats in the second row of seats are not locked when they are folded down and they can move. There is a risk of injury and risk of damage to property. Only fold the seats in the second row down while loading. When driving without a load, fold back and lock the seats in the second row before driving away.

### Overview

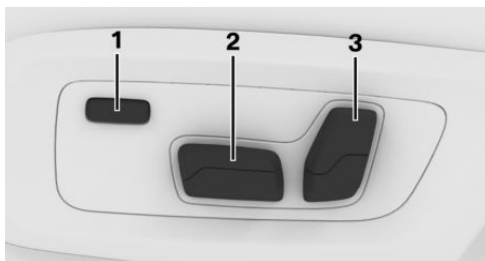

- 1 Resetting to standard position
- 2 Forward/backward
- 3 Backrest tilt

## Resetting to standard position

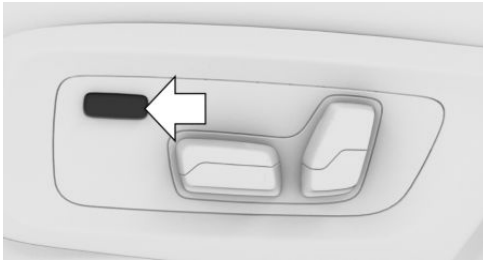

Press the button to reset to standard position. The process is canceled if the button is pressed again.

## Forward/backward

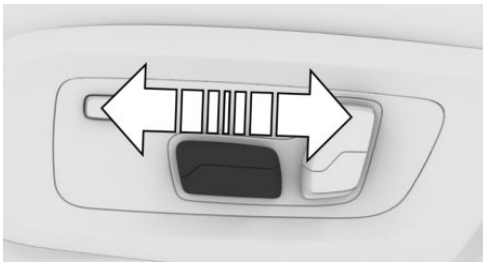

Push switch forward or backward.

## Backrest tilt

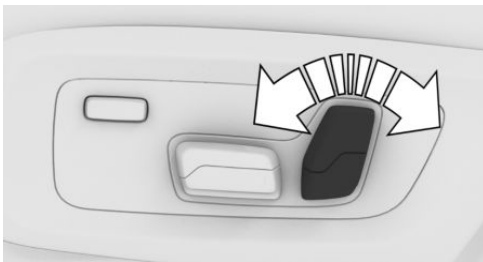

Move switch forward or backward.

## Access to the third row of seats

### NOTICE

Vehicle parts can be damaged when folding down the second row of seats with folded down center part. There is a risk of damage to property. Before folding down the second row of seats, fold the center armrest up.

1. Fold middle section of the second seat row up as necessary.
2. Push the switch once forward or backward.

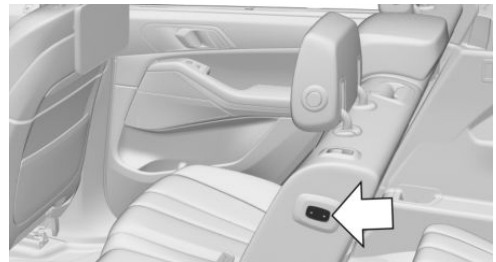

The seat automatically moves to the respective end position.

To avoid a collision, the position of the front seats may be adjusted automatically.

If the second row of seats is not locked, an acoustic signal will sound and a warning symbol will be displayed in the instrument cluster.

## Third row of seats

### General information

The third row of seats consists of two divided seats.

## Fold up the backrest

### Safety information

#### **⚠ WARNING**

If a rear seat backrest is not locked, unsecured cargo can be thrown about the car's interior; for instance, in the event of an accident, braking or an evasive maneuver. There is a risk of injury. Make sure that the rear seat backrest is locked after folding it back.

1. Fold up and engage the backrest.

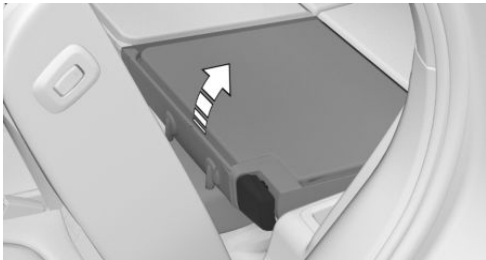

2. Adjust the head restraint correctly as needed.

## Fold the backrest down

1. Move the head restraints down, refer to page 121.
2. Slide the lever forward to unlock the backrest.



3. Fold the backrest down.

## Exiting from the third row of seats

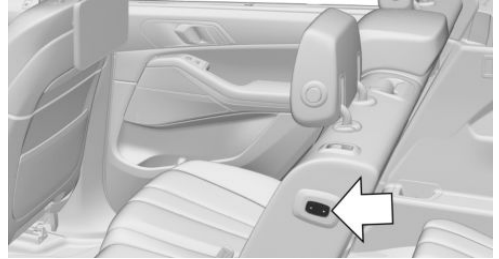

The second row of seats can be folded down with the switch, refer to page 115.

## Emergency release of rear seat backrest

### General information

The two outer backrests of the second seat row can be folded down manually, such as in the event of an electrical fault.

### Unlocking from the second seat row



Pull the loop and fold the rear seat backrest forward.

## Unlocking from the third seat row

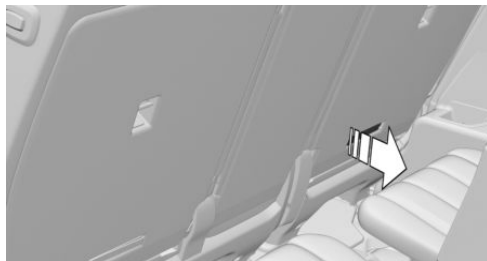

Pull the loop and fold the rear seat backrest forward.

## Safety switch for the rear



Press the button on the driver's door.

This locks various functions so that they cannot be operated from the rear. Safety switch, refer to page 108.

## Safety belts

### Number of safety belts and safety belt buckles

The vehicle is fitted with five or seven safety belts to ensure occupant safety. However, they can only offer protection when adjusted correctly.

The two outer safety belt buckles of the second row of seats are intended for the persons sitting on the left and right.

The center safety belt buckle of the second row of seats is intended for the person sitting in the middle.

### General information

Always make sure that safety belts are being worn by the occupants before driving off. The airbags supplement the safety belts as an additional safety device. The airbags are not a substitute for safety belts.

The upper shoulder strap's anchorage point will be correct for adult seat occupants of every build if the seat is correctly adjusted.

## Safety information

### WARNING

Use of a safety belt to buckle more than one person will potentially defeat the ability of the safety belt to serve its protective function. There is a risk of injuries or danger to life. Do not allow more than one person to wear a single safety belt. Infants and children are not allowed on an occupant's lap, but must be transported and secured in designated child restraint systems.

### WARNING

The efficacy of safety gear, including safety belts, can be limited or lost when safety belts are fastened incorrectly. An incorrectly fastened safety belt can cause additional injuries, for instance in the event of an accident or during braking and evasive maneuvers. There is a risk of injuries or danger to life. Make sure that all occupants are wearing safety belts correctly.

### WARNING

With a rear backrest that is not locked, the protective function of the middle safety belt is not guaranteed. There is a risk of injuries or danger to life. If you are using the middle safety belt, lock the wider rear seat backrest.

### WARNING

The efficacy of safety gear, including safety belts, may not be fully functional or fail in the following situations:

- ▷ The safety belts or safety belt buckles are damaged, soiled, or changed in any other way.
- ▷ Belt tensioners or belt retractors were modified.

Safety belts can be imperceptibly damaged in the event of an accident. There is a risk of injuries or danger to life. Do not modify safety belts, safety belt buckles, belt tensioners, belt retractors or belt anchors and keep them clean. Have the safety belts checked after an accident at the dealer's service center or another qualified service center or repair shop.

## Correct use of safety belts

- ▷ Wear the safety belt twist-free and tight to your body over your lap and shoulders.
- ▷ Wear the safety belt deep on your hips over your lap. The safety belt may not press on your stomach.
- ▷ Do not rub the safety belt against sharp edges, or guide it or jam it in across hard or fragile objects.
- ▷ Avoid thick clothing.
- ▷ Re-tighten the safety belt frequently upward around your upper body.

## Buckling the safety belt

1. Guide the safety belt slowly over shoulder and hip to put it on.
2. Insert the tongue plate into the safety belt buckle. The safety belt buckle must engage audibly.



To ease accessibility to the safety belt buckle, an adjustable slider is available on the belt to help position the buckle when not in use.

When the safety belt is fastened, the driver's and passenger's belt straps are automatically tightened once after driving away.

## Unbuckling the safety belt

1. Hold the safety belt firmly.
2. Press the red button in the safety belt buckle.
3. Guide the safety belt back into its roll-up mechanism.

## Safety belt reminder for driver's seat and front passenger seat

### Display in the instrument cluster



The indicator light lights up and a signal sounds. Make sure that the safety belts are positioned correctly. The safety belt reminder can also be activated if objects are placed on the front passenger seat.

## Safety belt reminder for rear seats

### General information

The safety belt reminder is automatically activated each time the engine starts.

The safety belt reminder is also activated when a passenger unbuckles a rear seat safety belt during the trip.

### Display in the instrument cluster

The indicator light in the instrument cluster illuminates after the engine is started.

**Symbol Description**

Green: the safety belt is buckled on the corresponding rear seat.



Red: the safety belt is not buckled on the corresponding rear seat.

## Safety mode

In critical situations, for instance during an emergency stop, the front safety belts tighten automatically.

If the situation passes without an accident occurring, the belt tension relaxes.

If the belt tension does not loosen automatically, stop the vehicle and unbuckle the safety belt using the red button in the safety belt buckle. Fasten the safety belt before continuing on your trip.

## Front head restraints

### General information

The current head restraint position can be stored using the memory function, refer to page 124.

### Safety information

** WARNING**

A missing protective effect due to removed or not correctly adjusted head restraints can cause injuries in the head and neck area. There is a risk of injury.

- ▷ Before driving, install the removed head restraints on the occupied seats.
- ▷ Adjust the head restraint so its center supports the back of the head at as close to eye level as possible.
- ▷ Adjust the distance so that the head restraint is as close as possible to the back of the head. Adjust the distance via the backrest tilt as needed.

** WARNING**

Body parts can be jammed when moving the head restraint. There is a risk of injury. Make sure that the area of movement is clear when moving the head restraint.

** WARNING**

Objects on the head restraint reduce the protective effect in the head and neck area. There is a risk of injury.

- ▷ Do not use seat or head restraint covers.
- ▷ Do not hang objects, for instance clothes hangers, directly on the head restraint.
- ▷ Only use accessories that have been determined to be safe for attachment to a head restraint.
- ▷ Do not use any accessories, for instance pillows, while driving.

## Active head restraint

In the event of a rear-end collision with a certain severity, the active head restraint automatically reduces the distance from the head.

Have the active head restraint checked and if necessary replaced in the case of damage or if it was exposed to an accident.

## Adjusting the height

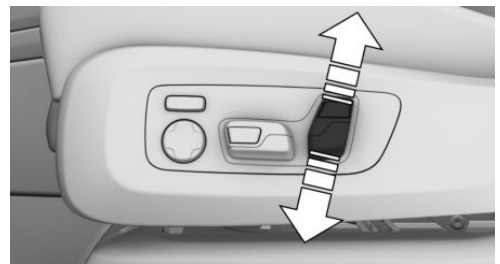

Push switch up or down.



## Adjusting the distance

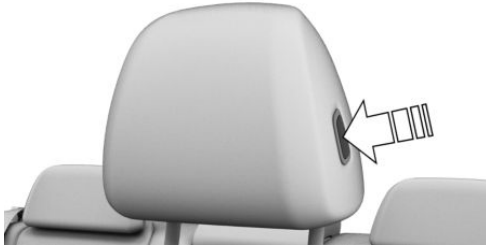

- ▷ Back: press the button and push the head restraint toward the rear.
- ▷ Forward: pull the head restraint toward the front.

After setting the distance, move the head restraint forward or backward slightly, making sure it engages properly.

## Adjusting the side extensions



Fold the side extensions on the head restraint forward for increased lateral support in the resting position.

## Removing

The head restraints cannot be removed.

## Rear head restraints

### Safety information

#### **WARNING**

A missing protective effect due to removed or not correctly adjusted head restraints can cause injuries in the head and neck area. There is a risk of injury.

- ▷ Before driving, install the removed head restraints on the occupied seats.
- ▷ Adjust the head restraint so its center supports the back of the head at as close to eye level as possible.
- ▷ Adjust the distance so that the head restraint is as close as possible to the back of the head. Adjust the distance via the backrest tilt as needed.

#### **WARNING**

Body parts can be jammed when moving the head restraint. There is a risk of injury. Make sure that the area of movement is clear when moving the head restraint.

#### **WARNING**

Objects on the head restraint reduce the protective effect in the head and neck area. There is a risk of injury.

- ▷ Do not use seat or head restraint covers.
- ▷ Do not hang objects, for instance clothes hangers, directly on the head restraint.
- ▷ Only use accessories that have been determined to be safe for attachment to a head restraint.
- ▷ Do not use any accessories, for instance pillows, while driving.



## Folding down the head restraints

To improve the view to the rear, the outside head restraints can be folded back. Only fold the head restraint back if no one will be sitting in the corresponding seat.

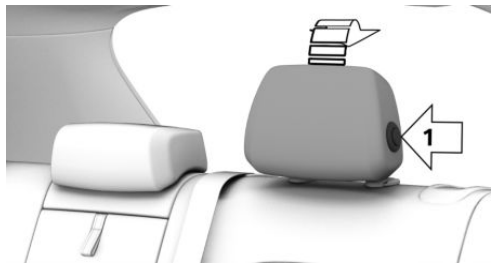

- ▶ To the rear: press the button, arrow 1, and fold the head restraint backward.
- ▶ Forward: fold the head restraint toward the front as far as it will go. Make sure that the head restraint engages correctly.

## Adjusting the height

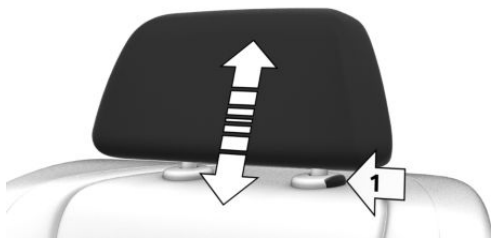

- ▶ To lower: press the button, arrow 1, and push the head restraint down.
- ▶ To raise: push the head restraint up.

After setting the height, move the head restraint up or down slightly, making sure it engages properly.

## Removing

The head restraints cannot be removed.

## Cushions for head restraints in the rear

Only use the pillow when the vehicle is switched off.

1. Push the head restraint to a sufficiently high position.
2. Attach the pillow and place the pillow band around the back of the head restraint, arrow 1.

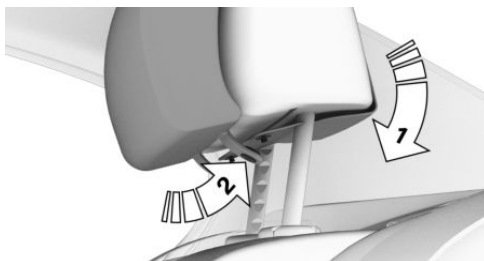

3. Close pushbuttons, arrow 2.

## Exterior mirrors

### General information

The mirror on the front passenger side is more curved than the driver's side mirror.

The mirror setting is stored for the driver profile, refer to page 97, currently in use. When a driver profile is selected, the stored position is called up automatically.

The current exterior mirror position can be stored using the memory function, refer to page 124.

### Safety information

#### WARNING

Objects reflected in the mirror are closer than they appear. The distance to the traffic behind could be incorrectly estimated, for instance while changing lanes. There is a risk of an acci-

dent. Estimate the distance to the traffic behind by looking over your shoulder.

## Overview

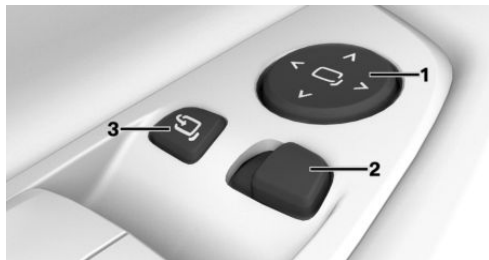

- 1 Settings
- 2 Selecting a mirror, Automatic Curb Monitor
- 3 Folding in and out

## Adjusting electrically

- 1 Press the button.  
The selected mirror moves along with the button movement.

## Selecting a mirror

- 1 To change over to the other mirror:  
Slide the switch.

## Malfunction

In case of an electrical malfunction, adjust the mirror by pressing the edges of the mirror glass.

## Folding in and out

### **NOTICE**

Depending on the vehicle width, the vehicle can be damaged in vehicle washes. There is a risk of damage to property. Before washing, fold in the mirrors by hand or with the button.

- 1 Press the button.

Folding is only possible up to a speed of approx. 15 mph/20 km/h.

Folding the mirrors in and out is helpful in the following situations:

- ▶ In vehicle washes.
- ▶ On narrow roads.

Mirrors that were folded in are folded out automatically at a speed of approx. 25 mph/40 km/h.

## Automatic heating

Both exterior mirrors are automatically heated as needed and when the drive-ready state is switched on.

## Automatic dimming feature

The exterior mirror on the driver's side is automatically dimmed. Photocells in the car's interior mirror, refer to page 123, are used to control this.

## Automatic Curb Monitor, exterior mirror

### Concept

If reverse gear is engaged, the mirror glass on the front passenger side is tilted downward. This improves your view of the curb and other low-lying obstacles when parking, for instance.

### Activating

1. Slide the switch to the driver's side mirror position.
2. Engage selector lever position R.

When the trailer socket is in use or trailer towing is activated, the Automatic Curb Monitor is deactivated.

## Deactivating



Slide the switch to the passenger's side mirror position.

## Interior mirror

### General information

The interior mirror is dimmed automatically.

Photocells are used for control:

- ▶ In the mirror glass.
- ▶ On the back of the mirror.

### Overview

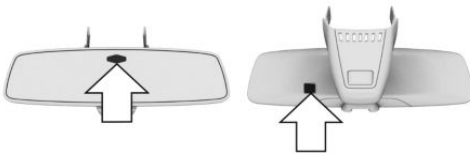

### Functional requirements

- ▶ Keep the photocells clean.
- ▶ Do not cover the area between the interior mirror and the windshield.

## Steering wheel

### Safety information

#### **WARNING**

Steering wheel adjustments while driving can lead to unexpected steering wheel movements. Vehicle control could be lost. There is a risk of an accident. Adjust the steering wheel while the vehicle is stationary only.

## Electric steering wheel adjustment

### General information

The steering wheel setting is stored for the driver profile, refer to page 97, currently in use. When a driver profile is selected, the position is accessed automatically when the drive-ready state is switched on.

The current steering wheel position can be stored using the memory function, refer to page 124.

### Settings

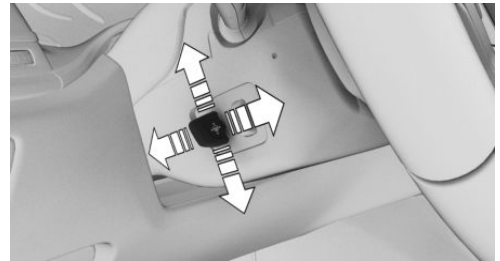

Move the steering wheel to the preferred height and angle to suit your seating position by pressing the switch.

### Assistance getting in and out

The steering wheel temporarily moves into the highest position to make it easier to enter and exit the vehicle.

## Heated steering wheel

### Overview



Heated steering wheel

### Switching on/off



Press the button.

A Check Control message is displayed.

If the trip is resumed within approx. 15 minutes after an intermediate stop, the heated steering wheel activates automatically if the function was switched on at the end of the last trip.

## Memory function

### Concept

The following settings can be stored and, if necessary, retrieved using the memory function:

- ▷ Seat position.
- ▷ Exterior mirror position.
- ▷ Steering wheel position.
- ▷ Height of the Head-up Display.

### General information

Two memory locations with different settings can be set for each driver profile, refer to page 97.

The following settings are not stored:

- ▷ Backrest width.
- ▷ Lumbar support.

## Safety information

### **! WARNING**

Using the memory function while driving can lead to unexpected seat or steering wheel movements. Vehicle control could be lost. There is a risk of an accident. Only retrieve the memory function when the vehicle is stationary.

### **! WARNING**

There is a risk of jamming when moving the seats. There is a risk of injury or risk of damage to property. Make sure that the area of movement of the seat is clear prior to any adjustment.

### Overview



The memory buttons are located on the front doors.

### Storing

1. Set the desired position.
2.  Press the button. The writing on the button lights up.
3. Press desired button 1 or 2 while the LED is lit. A signal sounds.

### Calling up settings

Press selected button 1 or 2.

The stored position is called up.

The procedure stops when a switch for setting the seat is pressed or one of the memory buttons is pressed again.

While driving, the seat position adjustment on the driver's side is interrupted after a short time.

## Massage function

### Concept

Depending on the program, the massage function ensures relaxed muscles and better blood circulation and can avoid fatigue.

### General information

Eight different massage programs can be selected:

- ▷ Pelvis activation.
- ▷ Upper body activation.
- ▷ Full body activation.
- ▷ Back massage.
- ▷ Shoulder massage.
- ▷ Lumbar massage.
- ▷ Upper body training.
- ▷ Full body training.

### Overview



Massage function

### Switching on



Press the button once for each intensity level.

The maximum intensity level is reached when three LEDs are lit.

### Switching off



Press and hold the button until the LEDs go out.

### Adjusting the massage program

Via iDrive:

1. "CAR"
2. "Settings"
3. "Seat comfort"
4. Select desired seat.
5. "Seat massage"
6. Select the desired setting.

## Seat and armrest heating

### Concept

The system heats seats and armrests as needed.

### General information

Seat heating can also be used without armrest heating. Deactivate the armrest heating as needed.

## Overview

### Front

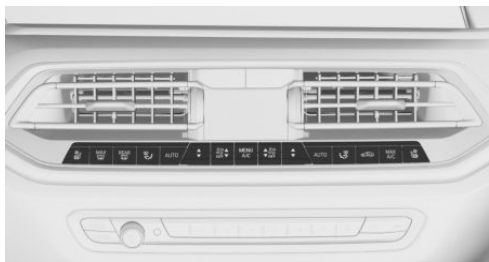

 Seat and armrest heating

### Rear



 Seat heating

## Switching on

1.  Press the button.
2. Select the temperature level:
  - ▶ Press the button once for each level.
  - ▶ Turn the controller until the desired level is reached. Press the Controller.
  - ▶ Select the desired level on the touch-screen.

Highest level reached when three red LEDs light up on the button or three red bars are shown on the control display.

When ECO PRO is activated, refer to page [322](#), the heater output is reduced.

If the trip is continued within approx. 15 minutes after a stop, functions are activated automatically with the temperature selected last.

## Switching off

 Press and hold the button until the LEDs go out.

## Seat heating distribution

The heating action in the seat cushion and the seat backrest can be distributed in different ways.

Via iDrive:

1. "CAR"
2. "Settings"
3. "Climate control"
4. "Seat and armrest heating"
5. Select desired seat.
6. Press the Controller and turn it to set the seat heating distribution.

## Switching armrest heating on/off

Via iDrive:

1. "CAR"
2. "Settings"
3. "Climate control"
4. "Seat and armrest heating"
5. Select desired seat.
6. "Heat armrests together with seat"

## Active seat ventilation

### Concept

Integrated fans in the seat and armrest areas provide a comfortable seat temperature.

## Overview

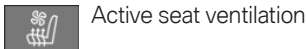
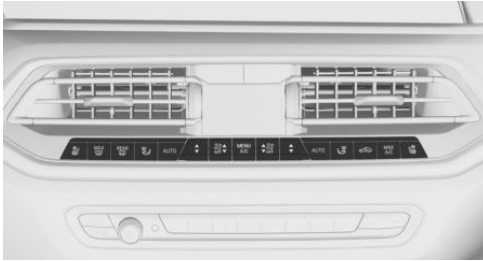

Active seat ventilation

## Switching on

-  Press the button.
- Select the ventilation level:
  - ▶ Press the button once for each level.
  - ▶ Turn the controller until the desired level is reached. Press the Controller.
  - ▶ Select the desired level on the touch-screen.

Highest level reached when three blue LEDs light up on the button or three blue bars are shown on the control display.

## Switching off

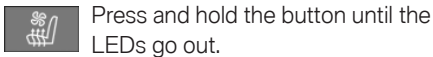

Press and hold the button until the LEDs go out.

## Seat climate control

### Concept

The seat climate control combines the functions of the seat heating and active seat ventilation.

### General information

The seat heating and active seat ventilation are operated with a common button on the climate control panel.

When both systems are active, a push of the button reduces the intensity of both functions by one level each.

The last active function or function that is configured with higher intensity will be activated directly when the system is switched on again. When both functions with the same intensity configuration are deactivated, the system will automatically activate the seat heating.

## Overview

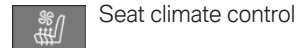
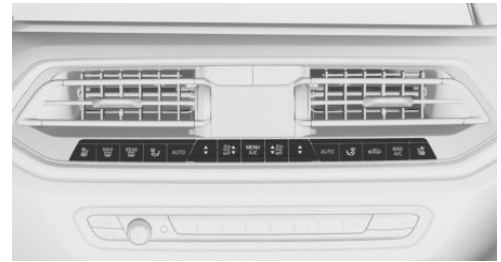

Seat climate control

## Switching on

-  Press the button.
- Select the desired setting via the touch-screen.

One red and one blue LED each will light up.

## Switching off

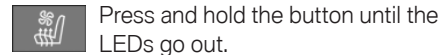

Press and hold the button until the LEDs go out.

# Transporting children safely

## Vehicle features and options

This chapter describes all standard, country-specific and optional features offered with the series. It also describes features and functions that are not necessarily available in your vehicle, e.g., due to the selected options or country versions. This also applies to safety-related functions and systems. When using these functions and systems, the applicable laws and regulations must be observed.

## The right place for children

### Safety information

#### WARNING

Unattended children or animals can cause the vehicle to move and endanger themselves and traffic, for instance due to the following actions:

- ▷ Pressing the Start/Stop button.
- ▷ Releasing the parking brake.
- ▷ Opening and closing the doors or windows.
- ▷ Engaging selector lever position N.
- ▷ Using vehicle equipment.

There is a risk of accidents or injuries. Do not leave children or animals unattended in the vehicle. Take the remote control with you when exiting and lock the vehicle.

## Always transport children in the rear seat

### General information

Accident research shows that the safest place for children is in the rear seat.

Transport children younger than 13 years of age or shorter than 5 ft/150 cm only in the rear seat in suitable child restraint systems designed for the age, weight and size of the child. Children 13 years of age or older must wear a safety belt as soon as a suitable child restraint system can no longer be used due to their age, weight and size.

### Safety information

#### WARNING

The safety belt cannot be fastened correctly on children shorter than 5 ft, 150 cm without suitable additional child restraint systems. The efficacy of safety gear, including safety belts, can be limited or lost when safety belts are fastened incorrectly. An incorrectly fastened safety belt can cause additional injuries, for instance in the event of an accident or during braking and evasive maneuvers. There is a risk of injuries or danger to life. Secure children shorter than 5 ft, 150 cm using suitable child restraint systems.

## Children on the front passenger seat

### General information

Before using a child restraint system on the front passenger seat, ensure that the front, knee, and side airbags on the front passenger side are deactivated. Automatic deactivation of front-seat passenger airbags, refer to page 178.



## Safety information

### WARNING

Active front-seat passenger airbags can injure a child in a child restraint system when the airbags are activated. There is a risk of injury. Make sure that the front-seat passenger airbags are deactivated and that the PASSENGER AIRBAG OFF indicator light lights up.

## Installing child restraint systems

### General information

Pay attention to the specifications and the operating and safety information of the child restraint system manufacturer when selecting, installing, and using child restraint systems.

### Safety information

#### WARNING

The protective effect of damaged child restraint systems or of child restraint systems exposed to an accident and their fastening systems can be limited or lost. A child can e.g., not sufficiently restrained, for instance in the event of an accident or braking and evasive maneuvers. There is a risk of injuries or danger to life. Have damaged child restraint systems or of child restraint systems exposed to an accident and their fastening systems checked and possibly replaced by the dealer's service center or another qualified service center or repair shop.

#### WARNING

The stability of the child restraint system is limited or compromised with incorrect seat adjustment or improper installation of the child seat. There is a risk of injuries or danger to life. Make

sure that the child restraint system fits securely against the backrest. If possible, adjust the backrest tilt for all affected backrests and correctly adjust the seats. Make sure that seats and backrests are securely engaged or locked. If possible, adjust the height of the head restraints or remove them.

### Before mounting

Before mounting child restraint systems, ensure that the rear seat backrests are locked.

Move the rear seats into the rearmost position to facilitate assembly of the child restraint system.

### On the front passenger seat

#### Deactivating airbags

#### WARNING

Active front-seat passenger airbags can injure a child in a child restraint system when the airbags are activated. There is a risk of injury. Make sure that the front-seat passenger airbags are deactivated and that the PASSENGER AIRBAG OFF indicator light lights up.

After installing a child restraint system in the front passenger seat, make sure that the front, knee and side airbags on the front passenger side are deactivated.

Deactivate the front-seat passenger airbags automatically, refer to page [178](#).

#### Seat position and height

Before installing a child restraint system, move the front passenger seat as far back as it will go and, if possible, bring it up to medium height. This seat position and height ensures the best possible position for the belt and offers optimal protection in the event of an accident.

If the upper anchor of the safety belt is located in front of the belt guide of the child seat, move the

front passenger seat carefully forward until the best possible belt guide position is reached.

### Backrest width

Adjustable backrest width: before installing a child restraint system in the front passenger seat, open the backrest width completely. Do not change the backrest width again and do not call up a memory position.

### Child seat security



The safety belts in the rear and the front passenger safety belt can be permanently locked to fasten child restraint systems.

### Locking the safety belt

1. Pull out the belt strap completely.
2. Secure the child restraint system with the safety belt.
3. Allow the belt strap to be pulled in and pull it tight against the child restraint system. The safety belt is locked.

### Unlocking the safety belt

1. Unbuckle the safety belt buckle.
2. Remove the child restraint system.
3. Allow the belt strap to be pulled in completely.

## LATCH child restraint fixing system

### General information

LATCH: Lower Anchors and Tether for Children. Pay attention to the specifications and the operating and safety information of the LATCH child restraint fixing system manufacturer when selecting, installing, and using child restraint systems.

### Mounts for the lower LATCH anchors

#### General information

The lower anchors may be used to attach the CRS to the vehicle seat up to a combined child and CRS weight of 65 lbs/30 kg when the child is restrained by the internal harnesses.



### Safety information

#### **⚠ WARNING**

If the LATCH child restraint fixing systems are not correctly engaged, the protective effect of the LATCH child restraint fixing system can be limited. There is a risk of injuries or danger to life. Make sure that the lower anchors are securely engaged and that the LATCH child restraint fixing system fits securely against the backrest.



## Position

Symbol	Meaning
	The corresponding symbol shows the mounts for the lower LATCH anchors.
	Seats equipped with lower anchors are marked with a pair, 2, of LATCH symbols. For vehicles equipped with a middle seat: It is not recommended to use the inner lower anchors of standard outer LATCH positions to fasten a child restraint system on the middle seat. Use the vehicle safety belt instead for the middle seat.

## Before installing LATCH child restraint fixing systems

Pull the safety belt away from the area of the child restraint system.

## Assembly of LATCH child restraint fixing systems

1. Install child restraint system, see manufacturer's information.
2. Ensure that both LATCH anchors are properly connected.

## Child restraint systems with tether strap

### Safety information

#### **WARNING**

If the upper retaining strap is incorrectly used for the child restraint system, the protective effect can be reduced. There is a risk of injury. Make sure that the upper retaining strap is not guided across sharp edges and without twisting to the upper retaining strap.

#### **WARNING**

If the rear backrest is not locked, the protective effect of the child restraint system is limited or there is none. In particular situations, for instance braking maneuvers or in case of an accident, the rear backrest can fold forward. There is a risk of injuries or danger to life. Make sure that the rear backrests are locked.

#### **NOTICE**

The anchors for the upper retaining straps of child restraint systems are only provided for these retaining straps. When other objects are mounted, the anchors can be damaged. There is a risk of damage to property. Only mount child restraint systems to the upper retaining straps.

## Anchors

### Symbol Meaning



The respective symbol shows the anchor for the upper retaining strap. Seats with an upper top tether are marked with this symbol. It can be found on the rear seat backrest or the rear window shelf.

4. If there is a retaining strap, run it between the backrest and the cargo cover.
5. Attach the hook of the retaining strap to the anchor.
6. Tighten the retaining strap by pulling it down.
7. Lower and lock head restraints as needed.

## Locking the doors and windows in the rear

### Routing the retaining strap

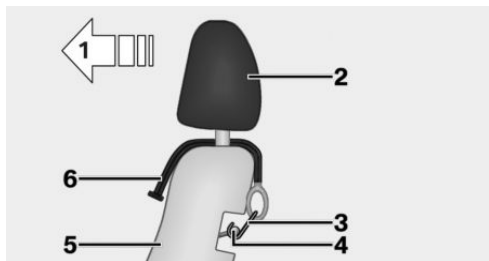

- 1 Direction of travel
- 2 Head restraint
- 3 Hook for upper retaining strap
- 4 Anchor
- 5 Seat backrest
- 6 Upper retaining strap

### Attaching the upper retaining strap to the anchor

1. Bring the seat of the second seat row into the base position, refer to page 115.
2. Raise the head restraint, if needed.
3. Guide the upper retaining strap between or along both sides of the supports for the head restraint to the anchor.

For the middle seat, guide it over or along both sides of the head restraint to the anchor where applicable.

### General information

In certain situations it may be advisable to secure the rear doors and windows, for instance when transporting children.

### Doors



Push the locking lever on the rear doors up.

The door can now be opened from the outside only.

### Safety switch for the rear



Press the button on the driver's door.

This locks various functions so that they cannot be operated from the rear. Safety switch, refer to page 108.

# Driving

## Vehicle features and options

This chapter describes all standard, country-specific and optional features offered with the series. It also describes features and functions that are not necessarily available in your vehicle, e.g., due to the selected options or country versions. This also applies to safety-related functions and systems. When using these functions and systems, the applicable laws and regulations must be observed.

## Start/Stop button

### Concept



Pressing the Start/Stop button switches drive-ready state on or off, refer to page 43.

Drive-ready state is switched on when you depress the brake pedal while pressing the Start/Stop button.

Pressing the Start/Stop button again switches drive-ready state back off and standby state, refer to page 43, is switched back on.

## Auto Start/Stop function

### Concept

The Auto Start/Stop function helps save fuel. The system switches off the engine during a stop, for instance in traffic congestion or at traffic lights. Drive-ready state remains switched on. The engine starts automatically for driving off.

## General information

After each engine start using the Start/Stop button, the Auto Start/Stop function is ready. The function is activated from speeds of approx. 3 mph/5 km/h.

Depending on the selected driving mode, refer to page 148, the system is automatically activated or deactivated.

## Engine stop

### Functional requirements

#### Steptronic transmission

The engine is switched off automatically during a stop under the following conditions:

- ▷ The selector lever is in selector lever position D.
- ▷ The brake pedal remains pressed while the vehicle is stationary or the vehicle is held by Automatic Hold.
- ▷ The driver's safety belt is buckled or the driver's door is closed.

#### Manual engine stop

If the engine was not switched off automatically when the vehicle stopped, the engine can be switched off manually:

- ▷ Press the brake pedal forcefully again from the current pedal position.
- ▷ Engage selector lever position P.

If all functional preconditions are fulfilled, the engine switches off.

#### Air conditioner when the engine is switched off

The air flow from the air conditioner is reduced when the engine is switched off.

## Displays in the instrument cluster

### General information



The display in the tachometer indicates that the Auto Start/Stop function is ready for an Automatic engine start.



The display indicates that the conditions for an automatic engine stop have not been met.

### Total time with switched-off engine

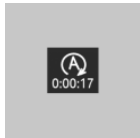

ECO PRO, refer to page 322, driving mode: depending on the vehicle equipment, the total time that the engine has been switched off using the Auto Start/

Stop function is displayed on an automatic engine stop.

The total time is automatically reset every time the vehicle is refueled.

### Functional limitations

The engine is not switched off automatically in the following situations:

- ▷ In case of a steep downhill grade.
- ▷ Brake not engaged strongly enough.
- ▷ The external temperature is high and automatic climate control is running.
- ▷ The car's interior has not yet been heated or cooled to the required level.
- ▷ Where there is a risk of window condensation when the automatic climate control is switched on.
- ▷ Engine or other parts not at operating temperature.
- ▷ Engine cooling is required.

- ▷ The wheels are at a sharp angle or the steering wheel is being turned.
- ▷ Vehicle battery is heavily discharged.
- ▷ At higher elevations.
- ▷ The hood is unlocked.
- ▷ HDC Hill Descent Control is activated.
- ▷ The parking assistant is activated.
- ▷ Stop-and-go traffic.
- ▷ Selector lever position in N or R.
- ▷ After driving in reverse.
- ▷ Use of fuel with high ethanol content.

## Starting the engine

### Functional requirements

#### Steptronic transmission

The engine starts automatically under the following preconditions:

- ▷ By releasing the brake pedal.
- ▷ When Automatic Hold is activated: press the accelerator pedal.

### Driving off

After the engine starts, accelerate as usual.

### Safety mode

After the engine switches off automatically, it will not start again automatically if any one of the following conditions are met:

- ▷ The driver's safety belt is unbuckled and the driver's door is open.
- ▷ The hood was unlocked.

Some indicator lights light up for a varied length of time.

The engine can only be started via the Start/Stop button.

## System limits

Even if driving off was not intended, the deactivated engine starts up automatically in the following situations:

- ▶ Excessive warming of the car's interior when the air conditioning is switched on.
- ▶ Excessive cooling of the car's interior when the heating is switched on.
- ▶ Where there is a risk of window condensation when the automatic climate control is switched on.
- ▶ The steering wheel is turned.
- ▶ Change from selector lever position D to N or R.
- ▶ Change from selector lever position P to N, D, or R.
- ▶ Vehicle battery is heavily discharged.
- ▶ Start of an oil level measurement.

## Intelligent Auto Start/Stop function

Depending on the vehicle equipment and country-specific version, the vehicle features a variety of sensors for assessing the traffic situation. The Intelligent Auto Start/Stop function uses this information to adapt to various traffic situations in a proactive manner.

For instance, this applies to the following situations:

- ▶ If a situation is detected in which the stopping time is expected to be very short, the engine is not switched off automatically. A message appears on the Control Display, depending on the situation.
- ▶ If a situation is detected in which the vehicle needs to drive off immediately, the engine is started automatically.

The function may be restricted if the navigation data is invalid, outdated or not available, for example.

## Activating/deactivating the system manually

### Concept

The engine is not automatically switched off.

The engine is started during an automatic engine stop.

### Using the button



 Press the button.

### Via selector lever position or Driving Dynamics Control

The Auto Start/Stop function is also deactivated in selector lever position M/S or in SPORT driving mode of the Driving Dynamics Control.

### Display

- ▶ LED comes on: auto Start/Stop function is deactivated.
- ▶ LED goes out: auto Start/Stop function is activated.

### Switching off the vehicle during an automatic engine stop

#### General information

During an automatic engine stop, the vehicle can be switched off permanently, for instance when leaving it.

### Steptronic transmission

1. Press the Start/Stop button.
  - ▷ Drive-ready state is switched off.
  - ▷ Standby state is switched on.
  - ▷ Selector lever position P is engaged automatically.
2. Set the parking brake.

## Automatic deactivation

### General information

In certain situations, the Auto Start/Stop function is deactivated automatically for safety reasons, for instance if no driver is detected.

### Malfunction

The Auto Start/Stop function no longer switches off the engine automatically. A Check Control message is displayed. It is possible to continue driving. Have the system checked by a dealer's service center or another qualified service center or repair shop.

## Parking brake

### Concept

The parking brake is used to prevent the vehicle from rolling when it is parked.

### Safety information

#### **! WARNING**

An unsecured vehicle can begin to move and possibly roll away. There is a risk of an accident. Before exiting, secure the vehicle against rolling.

In order to ensure that the vehicle is secured against rolling away, follow the following:

- ▷ Set the parking brake.

- ▷ On uphill grades or on a downhill slope, turn the front wheels in the direction of the curb.
- ▷ On uphill grades or on a downhill slope, also secure the vehicle, for instance with a wheel chock.

#### **! WARNING**

Unattended children or animals can cause the vehicle to move and endanger themselves and traffic, for instance due to the following actions:

- ▷ Pressing the Start/Stop button.
- ▷ Releasing the parking brake.
- ▷ Opening and closing the doors or windows.
- ▷ Engaging selector lever position N.
- ▷ Using vehicle equipment.

There is a risk of accidents or injuries. Do not leave children or animals unattended in the vehicle. Take the remote control with you when exiting and lock the vehicle.

### Overview



Parking brake

### Setting

#### With a stationary vehicle

- Pull the switch.
- The LED lights up.





The indicator light in the instrument cluster illuminates red. The parking brake is set.

## While driving

### General information

To use as emergency brake while driving.

Pull the switch and hold it. The vehicle brakes hard while the switch is being pulled.



The indicator light in the instrument cluster illuminates red, a signal sounds, and the brake lights illuminate.

A Check Control message is displayed.

The parking brake is engaged when the vehicle is stationary.

### With Emergency Stop Assistant

Pull the switch for the parking brake briefly to activate the emergency stop function, refer to page 209.

## Releasing

### Releasing manually

1. Switch on drive-ready state.
2.  Press the switch while stepping on the brake pedal or selector lever position P is set. The LED and indicator light go out. The parking brake is released.

### Automatic release

The parking brake is released automatically when you drive away.

The LED and indicator light go out.

## Automatic Hold

### Concept

This system assists the driver by automatically setting and releasing the brake, such as when moving in stop-and-go traffic.

The vehicle is automatically held in place when it is stationary.

On uphill grades the system prevents the vehicle from rolling backward when driving off.

### General information

Under the following conditions, the parking brake is automatically engaged:

- ▷ Drive-ready state is switched off.
- ▷ The driver's door is opened while the vehicle is stationary.
- ▷ The moving vehicle is brought to a standstill using the parking brake.

### Display



The indicator light changes from green to red.

## Safety information

### WARNING

An unsecured vehicle can begin to move and possibly roll away. There is a risk of an accident. Before exiting, secure the vehicle against rolling.

In order to ensure that the vehicle is secured against rolling away, follow the following:

- ▷ Set the parking brake.
- ▷ On uphill grades or on a downhill slope, turn the front wheels in the direction of the curb.
- ▷ On uphill grades or on a downhill slope, also secure the vehicle, for instance with a wheel chock.

**WARNING**

Unattended children or animals can cause the vehicle to move and endanger themselves and traffic, for instance due to the following actions:

- ▷ Pressing the Start/Stop button.
- ▷ Releasing the parking brake.
- ▷ Opening and closing the doors or windows.
- ▷ Engaging selector lever position N.
- ▷ Using vehicle equipment.

There is a risk of accidents or injuries. Do not leave children or animals unattended in the vehicle. Take the remote control with you when exiting and lock the vehicle.

**NOTICE**

If the vehicle is stationary, Automatic Hold engages the parking brake and prevents the vehicle from rolling in a vehicle wash. There is a risk of damage to property. Deactivate Automatic Hold prior to entering the vehicle wash.

**Overview**



**AUTO H** Automatic Hold

**Establishing function readiness of Automatic Hold**

1. Switch on drive-ready state.

2. **AUTO H** Press the button.  
The LED lights up.

The indicator light lights up green.  
**AUTO H** Automatic Hold is functional.

After every new vehicle start, the last selected setting is active.

**Automatic Hold holding the vehicle**

Function readiness is established and the driver's door is closed.

After stepping on the brake pedal, for instance when stopping at a traffic light, the vehicle is automatically secured against rolling.

The indicator light lights up green.  
**PARK (P)**

**Driving off**

Step on the accelerator pedal to drive off.

The brake is released automatically and the indicator light is no longer illuminated.

**Activating the parking brake automatically**

The parking brake is automatically set if drive-ready state is switched off while the vehicle is being held by Automatic Hold or if the vehicle is exited.

The indicator light changes from green to red.  
**PARK (P)**

The parking brake is not set automatically, if the drive-ready state is switched off, while the vehicle is coasting to a halt. Automatic Hold is deactivated.

**Switching function readiness off**

- AUTO H** Press the button.  
The LED goes out.

The indicator light goes out.

### AUTO H

Automatic Hold is switched off.

If the vehicle is being held by Automatic Hold, press additionally on the brake pedal, when switching off.

## Malfunction

In the event of a failure or malfunction of the parking brake:

Secure the vehicle against rolling away, for instance with a wheel chock, after existing the vehicle.

## After a power failure

To reestablish parking brake functionality after a power failure:

1. Switch on standby state.
2.  Pull the switch while stepping on the brake pedal or selector lever position P is set and then push.

This process may take a few seconds. Any sounds associated with this are normal.



The indicator light is no longer illuminated as soon as the parking brake is ready for operation again.

## Turn signal

### Turn signal in exterior mirror

When driving and during operation of the turn signals or hazard warning system, do not fold in the exterior mirrors, so that the signal lights on the exterior mirror are easy to see.

## Using turn signals

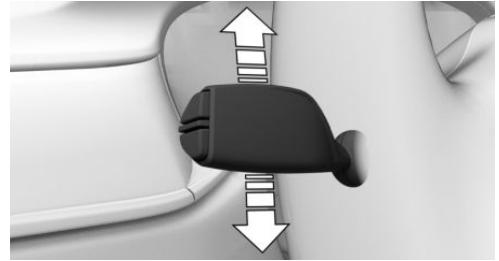

Press the lever past the resistance point.

## Triple turn signal activation

Lightly tap the lever up or down.

The triple turn signal duration can be adjusted.

Via iDrive:

1. "CAR"
2. "Settings"
3. "Exterior lighting"
4. "One-touch turn signal"
5. Select the desired setting.

The setting is stored for the driver profile currently used.

## Signaling briefly

Press the lever to the resistance point and hold it there for as long as you want the turn signal to flash.

## High beams, headlight flasher

Push the lever forward or pull it backward.

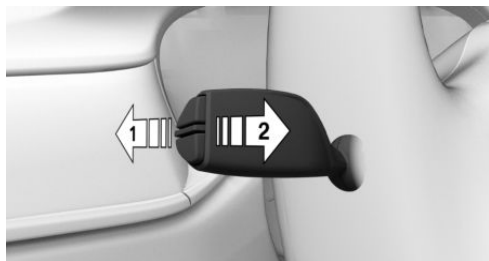

- ▷ High beams on, arrow 1.  
The high beams light up when the low beams are switched on.
- ▷ High beams off/headlight flasher, arrow 2.

## Washer/wiper system

### General information

Do not use the wipers if the windshield is dry, as this may damage the wiper blades or cause them to become worn more quickly.

### Safety information

#### WARNING

If the wipers start moving in the folded away state, body parts can be jammed or damage may occur to parts of the vehicle. There is a risk of injury or risk of damage to property. Make sure that the vehicle is switched off when the wipers are in the folded away state and the wipers are folded in when switching on.

#### NOTICE

If the wipers are frozen to the windshield, the wiper blades can be torn off and the wiper motor can overheat when switching on. There is a risk of damage to property. Defrost the windshield prior to switching the wipers on.

## Switching on

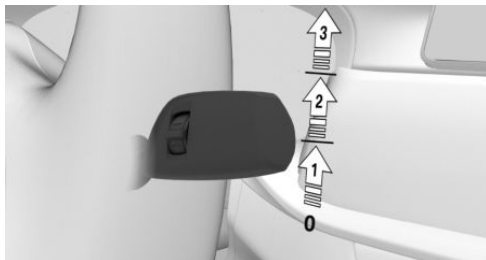

Press the lever up until the desired position is reached.

- ▷ Resting position of the wipers, position 0.
- ▷ Rain sensor, position 1.
- ▷ Normal wiper speed, position 2.
- ▷ Fast wiper speed, position 3.

When travel is interrupted with the wiper system switched on: when travel continues, the wipers resume at their previous speed.

## Switching off and brief wipe

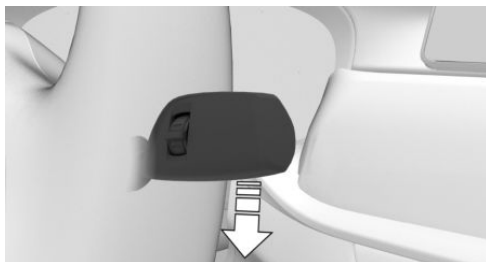

Press the lever down.

- ▷ Switching off: press the lever down until it reaches its standard position.
- ▷ Brief wipe: press the lever down from the standard position.

The lever automatically returns to its initial position when released.

## Rain sensor

### Concept

The rain sensor automatically controls the time between wipes depending on the intensity of the rainfall.

### General information

The sensor is located on the windshield, directly in front of the interior mirror.

### Safety information

#### NOTICE

If the rain sensor is activated, the wipers can accidentally start moving in vehicle washes. There is a risk of damage to property. Deactivate the rain sensor in vehicle washes.

### Activating

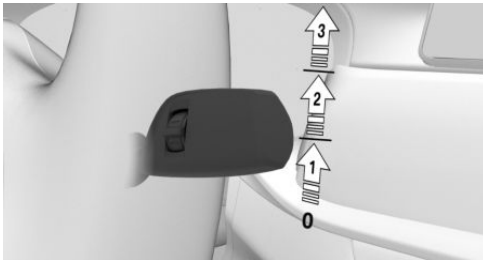

Press the lever up once from its standard position, arrow 1.

Wiping is started.

The LED in the wiper lever is illuminated.

If wipers are frozen to windshield, wiper operation is deactivated.

### Deactivating

Press the lever back into the standard position.

## Adjusting the rain sensor sensitivity

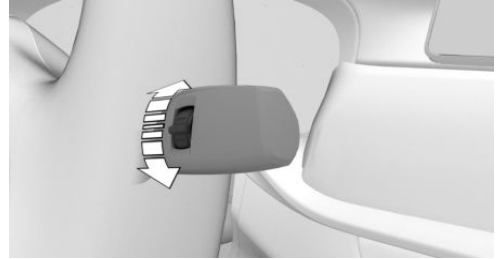

Turn the thumbwheel to adjust the sensitivity of the rain sensor.

Upward: high rain sensor sensitivity.

Downward: low rains sensor sensitivity.

## Windshield washer system

### Safety information

#### WARNING

The washer fluid can freeze onto the window at low temperatures and obstruct the view. There is a risk of an accident. Only use the washer systems, if the washer fluid cannot freeze. Use washer fluid with antifreeze, if needed.

#### NOTICE

When the washer fluid reservoir is empty, the wash pump cannot work as intended. There is a risk of damage to property. Do not use the washer system when the washer fluid reservoir is empty.



## Cleaning the windshield



Pull the lever.

The system sprays washer fluid on the windshield and activates the wipers briefly.

## Windshield washer nozzles

The windshield washer nozzles are automatically heated while standby state is switched on.

## Rear window wiper

### Overview

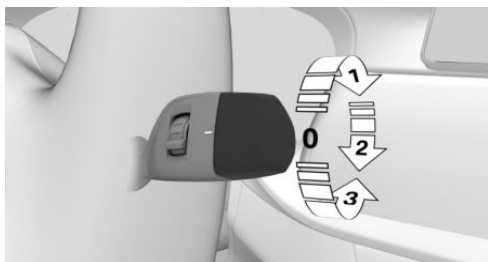

### Switching on

Turn the outer switch upward.

- ▶ Resting position of the wiper, position 0.
- ▶ Intermittent mode, arrow 1. When reverse gear is engaged, the system switches to continuous operation.

### Clean the rear window

Turn the outer switch in the desired direction.

- ▶ In resting position: turn the switch downward, arrow 3. The switch automatically returns to its idle position when released.
- ▶ In intermittent mode: turn the switch further, arrow 2. The switch automatically returns to its interval position when released.

## Fold-away position of the wipers

### Concept

The fold-out position enables the wipers to be folded away from the windshield.

### General information

Important, for instance when changing the wiper blades or when folding out under frosty conditions.

### Safety information

#### **WARNING**

If the wipers start moving in the folded away state, body parts can be jammed or damage may occur to parts of the vehicle. There is a risk of injury or risk of damage to property. Make sure that the vehicle is switched off when the wipers are in the folded away state and the wipers are folded in when switching on.

#### **NOTICE**

If the wipers are frozen to the windshield, the wiper blades can be torn off and the wiper motor can overheat when switching on. There is a risk of damage to property. Defrost the windshield prior to switching the wipers on.

### Folding away the wipers

1. Switch on standby state.

2. Press and hold the wiper level down, until the wipers stop in a close to vertical position.

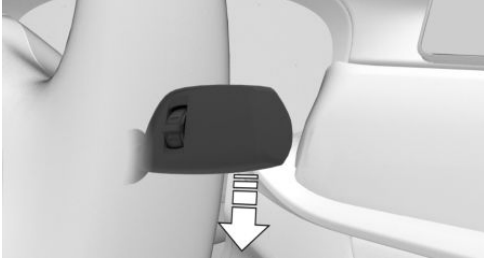

3. Fold the wipers all the way away from the windshield.



## Folding down the wipers

After the wipers are folded back down, the wiper system must be reactivated.

1. Fold the wipers back down onto the windshield.
2. Switch on standby state and press and hold the wiper lever down again.
3. Wipers return to their resting position and are ready again for operation.

## Steptronic transmission

### Concept

The Steptronic transmission combines the functions of an automatic transmission with the possibility of manual shifting, if needed.

## Safety information

### WARNING

An unsecured vehicle can begin to move and possibly roll away. There is a risk of an accident. Before exiting, secure the vehicle against rolling, for instance with the parking brake.

## Selector lever positions

### Drive mode D

Selector lever position for normal vehicle operation. All gears for forward travel are activated automatically.

### Reverse R

Engage selector lever position R only when the vehicle is stationary.

### Neutral N

The vehicle may be pushed or roll without power, for instance in vehicle washes, refer to page 144, in selector lever position N.

### Parking position P

Selector lever position, for instance for parking the vehicle. The transmission blocks the drive wheels in selector lever position P.

Engage selector lever position P only when the vehicle is stationary.

### P is engaged automatically

Selector lever position P is engaged automatically in situations such as the following:

- ▶ After the drive-ready state is switched off and selector lever position R, D or M/S is engaged.
- ▶ After the standby state has been switched off when selector lever position N is engaged.
- ▶ If the driver's safety belt is unbuckled, the driver's door is opened, and the brake pedal is not pressed while the vehicle is stationary

and selector lever position D, M/S or R is engaged.

## Engaging selector lever positions

### General information

To prevent the vehicle from creeping after you select a drive mode, maintain pressure on the brake pedal until you are ready to start.

### Functional requirements

Only when the drive-ready state is switched on and the brake pedal is depressed is it possible to change from selector lever position P to another selector lever position.

The selection lever position P cannot be changed until all technical requirements are met.

### Engaging selector lever position D, N, R

A selector lever lock prevents the following faulty operation:

- ▶ Unintentional shifting into selector lever position R.
  - ▶ Unintentional shifting from selector lever position P into another selector lever position.
1. Fasten driver's safety belt.
  2. Press and hold the button to release the selector lever lock.

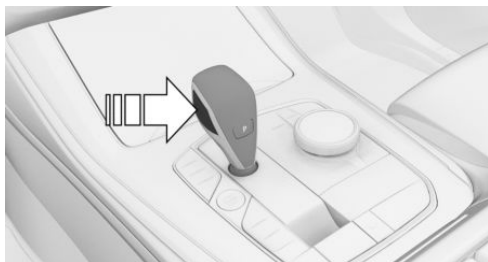

3. Push the selector lever in the desired direction, past a resistance point, if needed. The

selector lever automatically returns to the center position when released.



### Engaging selector lever position P



Press button P.

## Rolling or pushing the vehicle

### General information

In some situations, the vehicle is to roll without its own power for a short distance, for instance in a vehicle wash, or be pushed.

### Engaging selector lever position N

1. Switch on drive-ready state while pressing on the brake pedal.
2. If necessary, release the parking brake.
3. If necessary, switch off Automatic Hold, refer to page 137.
4. Depress the brake pedal.
5. Touch the selector lever lock and engage selector lever position N.
6. Switch off drive-ready state.



In this way, standby state remains switched on, and a Check Control message is displayed.

The vehicle may roll.

### NOTICE

Selector lever position P is automatically engaged when standby state is switched off. There is a risk of damage to property. Do not switch standby state off in vehicle washes.

Irrespective of standby state, the selector lever position P is automatically engaged after approx. 35 minutes.

If there is a malfunction, you may not be able to change the selector lever position.

Electronically unlock the transmission lock, if needed, refer to page 147.

## Kickdown

Kickdown is used to achieve maximum driving performance.

Step on the accelerator pedal beyond the resistance point at the full throttle position.

## Sport program M/S

### Concept

The shifting points and shifting times in the Sport program are designed for a sportier driving style. The transmission, for instance shifts up later and the shifting times are shorter.

## Activating the sport program

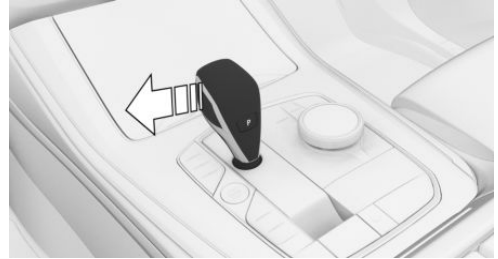

Press the selector lever to the left out of selector lever position D.

The engaged gear is displayed in the instrument cluster, for instance S1.

The sport program of the transmission is activated.

## Ending the Sport program

Push the selector lever to the right.

D is displayed in the instrument cluster.

## Manual mode M/S

### Concept

Manual gear-shifting is possible in manual mode.

## Activating manual mode

1. Press the selector lever to the left out of selector lever position D, arrow 1.

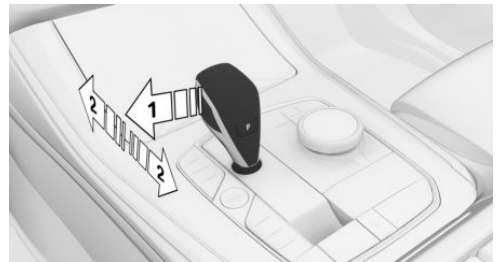

2. Push the selector lever forward or pull it backward, arrows 2.

Manual mode becomes active and the gear is changed.

The engaged gear is displayed in the instrument cluster, for instance M1.

## Shifting

- ▷ To shift down: press the selector lever forward.
- ▷ To shift up: pull the selector lever rearwards.

The transmission continues shifting automatically in certain situations, for instance when speed limits are reached.

## Steptronic Sport transmission: prevent automatic upshifting in M/S manual mode

If driving mode SPORT, refer to page 149, is selected, the Steptronic Sport transmission does not automatically upshift in M/S manual mode once the maximum speed is reached.

Depending on the BMW M drive configuration, this function is active independently of the driving mode.

In addition, there is no downshifting for kick-down.

## Ending the manual mode

Push the selector lever to the right.

D is displayed in the instrument cluster.

## Shift paddles

### Concept

The shift paddles on the steering wheel allow you to shift gears quickly while keeping both hands on the steering wheel.

### General information

#### Shifting

The vehicle only shifts at suitable engine and road speeds.

### Short-term manual mode

In selector lever position D, actuating a shift paddle switches into manual mode temporarily.

After conservative driving in manual mode without acceleration or shifting via the shift paddles for a certain amount of time, the transmission switches back to automatic mode.

It is possible to switch into automatic mode as follows:

- ▷ Pull and hold right shift paddle.
- ▷ In addition to the briefly pulled right shift paddle, briefly pull the left shift paddle.

### Continuous manual mode

In selector lever position S, actuating a shift paddle switches into manual mode permanently.

### Steptronic Sport transmission

With the appropriate transmission version, the lowest possible gear can be selected by simultaneously activating kickdown and operating the left shift paddles. This is not possible in short-term manual mode.

## Shifting



- ▷ To shift up: briefly pull right shift paddle.
- ▷ To shift down: briefly pull left shift paddle.
- ▷ The lowest possible gear can be selected by pulling and holding the left shift paddle.

The selected gear is briefly displayed in the instrument cluster, followed by the current gear.

## Displays in the instrument cluster

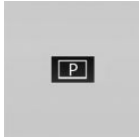

The selector lever position is displayed, for example P.

## Electronic unlocking of the transmission lock

### General information

Electronically unlock the transmission lock to maneuver vehicle from a danger area.

Unlocking is possible, if the starter can spin the engine.

Before unlocking the transmission lock, set the parking brake to prevent the vehicle from rolling away.

### Engaging selector lever position N

1. Press and hold down brake pedal.
2. Press the Start/Stop button. The starter must audibly start. Hold the Start/Stop button pressed.
3. With your free hand, press the button on the selector lever, arrow 1, and press the selector lever into selector lever position N and hold, arrow N, until selector lever position N is displayed in the instrument cluster.

A Check Control message is displayed.



4. Release Start/Stop button and selector lever.

5. Release brake, as soon as the starter stops.
6. Maneuver the vehicle from the danger area and secure it against moving on its own.

For additional information, see the chapter on tow-starting and towing, refer to page 384.

## Launch Control

### Concept

Launch Control enables optimum acceleration on surfaces with good traction under dry surrounding conditions.

### General information

The use of Launch Control causes premature component wear since this function represents a very heavy load for the vehicle.

Do not use Launch Control during the break-in, refer to page 312, period.

Do not steer the steering wheel when driving off with Launch Control.

### Functional requirements

Launch Control is available when the engine is at operating temperature. The engine is at operating temperature after an uninterrupted trip of at least 6 miles/10 km.

### Start with launch control

1. Switch on drive-ready state.

2.  Press the button.

TRACTION is displayed in the instrument cluster and the indicator light for DSC OFF lights up.

3. Engage selector lever position S.
4. With the left foot, forcefully press down on the brake.
5. Press and hold down the accelerator pedal beyond the resistance point at the full throttle position, kickdown.

A flag symbol is displayed in the instrument cluster.

6. The starting engine speed adjusts. Within 3 seconds, release the brake.

### Repeated use during a trip

After Launch Control has been used, the transmission must cool down for approx. 5 minutes before Launch Control can be used again.

Launch Control adjusts to the surrounding conditions, when used again.

### After using Launch Control

To increase vehicle stability, activate DSC Dynamic Stability Control again as soon as possible.

### System limits

An experienced driver may be able to achieve better acceleration values in DSC OFF mode.

## Driving Dynamics Control

### Concept

The Driving Dynamics Control influences the driving dynamics properties of the vehicle. The vehicle can be adjusted depending on the situation using various driving modes.

### General information

The following systems are affected, for instance:

- ▷ Engine characteristics.
- ▷ Steptronic transmission.
- ▷ Adaptive chassis.
- ▷ Steering.
- ▷ Integral Active Steering.
- ▷ Adaptive M chassis.
- ▷ Adaptive M Chassis Professional.
- ▷ Executive Drive Pro.
- ▷ 2-axle air suspension.
- ▷ Display in the instrument cluster.

- ▷ Cruise control.

### Overview



### Displays in the instrument cluster

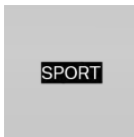

The selected driving mode is displayed in the instrument cluster.

### Driving modes



Button in the vehicle

Button	Driving mode	Configuration
SPORT	SPORT	INDIVIDUAL
SPORT	SPORT PLUS	
COMFORT	COMFORT	
ECO PRO	ECO PRO	INDIVIDUAL
ADAPTIVE	ADAPTIVE	

When drive-ready state is switched on, the COMFORT driving mode is selected automatically.

## Driving modes in detail

### COMFORT

#### Concept

Balanced tuning between dynamic and efficient driving.

#### Switching on

 Press the button repeatedly until COMFORT is displayed in the instrument cluster.

### SPORT

#### Concept

Dynamic tuning for higher agility with an optimized chassis and suspension.

#### Switching on

 Press the button repeatedly until SPORT is displayed in the instrument cluster.

### SPORT INDIVIDUAL

#### Concept

Individual settings can be adjusted in the SPORT INDIVIDUAL driving mode.

#### Configuration

Via iDrive:

1. "CAR"
2. "Settings"
3. "Driving mode"
4. "SPORT INDIVIDUAL"
5. Select the desired setting.

The setting is stored for the driver profile currently used.

Reset SPORT INDIVIDUAL to the standard settings:

"Reset to SPORT STANDARD".

### SPORT PLUS

#### Concept

Dynamic tuning for maximum agility with an adjusted drive.

#### Switching on

 Press the button repeatedly until SPORT PLUS is displayed in the instrument cluster.

### ECO PRO

#### Concept

Efficient driving setting.

#### Switching on

 Press the button repeatedly until ECO PRO is displayed in the instrument cluster.

### ECO PRO INDIVIDUAL

#### Concept

Individual settings can be adjusted in the ECO PRO INDIVIDUAL driving mode.

#### Configuration

Via iDrive:

1. "CAR"
2. "Settings"
3. "Driving mode"
4. "ECO PRO INDIVIDUAL"
5. Select the desired setting.

The setting is stored for the driver profile currently used.

Reset ECO PRO INDIVIDUAL to the standard settings:

"Reset to ECO PRO STANDARD".



## ADAPTIVE

### Concept

Comfort-oriented driving mode, whose tuning is automatically modified to the driving situation and driving style.

If the navigation system is active, upcoming road sections are considered.

### Switching on



Press the button. ADAPTIVE is displayed in the instrument cluster.

## INDIVIDUAL configuration

### General information

The individual configuration of the driving mode is stored for the active driver profile. The last set configuration is activated directly when the driving mode is called up again.

### Activating configuration of the driving mode

Press the button for the desired driving mode several times.

# Displays

## Vehicle features and options

This chapter describes all standard, country-specific and optional features offered with the series. It also describes features and functions that are not necessarily available in your vehicle, e.g., due to the selected options or country versions. This also applies to safety-related functions and systems. When using these functions and systems, the applicable laws and regulations must be observed.

## Instrument cluster

### Concept

The instrument cluster is a variable display. When you change to a different program via Driving Dynamics Control, the displays in the instrument cluster adapt to the respective driving mode.

### General information

The display change in the instrument cluster can be deactivated via iDrive.

Some of the displays in the instrument cluster may differ from the illustrations in this Owner's Manual.

## Overview

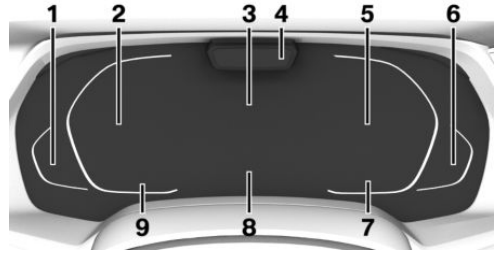

- 1** Fuel gage [157](#)  
Range [159](#)
- 2** Speedometer
- 3** Variable displays [151](#)  
Service requirements [159](#)  
Navigation display
- 4** Depending on the equipment: Driver Attention Camera
- 5** Tachometer [157](#)  
Selection lists [162](#)  
Widgets in the instrument cluster [152](#)  
ECO PRO displays [322](#)  
Status, Driving Dynamics Control [148](#)  
Transmission display [143](#)
- 6** Engine temperature [158](#)
- 7** External temperature [158](#)
- 8** Check Control [153](#)
- 9** Variable displays [151](#)  
Speed Limit Info [160](#)  
Time [63](#)

## Variable displays

In some areas of the instrument cluster, various assistance systems, for example the cruise control, can be displayed. The displays may vary de-

pending on the equipment version and country variant.

## Setting the display mode

### Concept

In addition to the driving modes, various display modes can be set up for the instrument cluster.

### Settings

Via iDrive:

1. "CAR"
2. "Settings"
3. "Displays"
4. "Instrument panel"
5. "Display mode"
6. Select the desired setting.

### Configuring Individual

1. "CAR"
2. "Settings"
3. "Displays"
4. "Instrument panel"
5. "Configure Individual"
6. Select the desired setting.

### Driving mode view

#### Concept

When the driving mode view is deactivated, the displays in the instrument cluster remain unchanged and do not adapt to the respective driving mode when the program is changed via Driving Dynamics Control.

#### Activating/deactivating

Via iDrive:

1. "CAR"
2. "Settings"

3. "Displays"
4. "Driving mode view"

### Additional settings

1. "CAR"
2. "Settings"
3. "Displays"
4. "Instrument panel"
5. Select the desired setting.

## Widgets in the instrument cluster

### Concept

Displays for specific functions can be displayed in the tachometer in the instrument cluster.

The following displays can be selected:

- ▷ Trip data, refer to page [163](#).
- ▷ Sport displays, refer to page [164](#).
- ▷ Current entertainment source, e.g., radio, refer to Owner's Manual for Navigation, Entertainment and Communication.
- ▷ Efficiency display, refer to page [153](#).

### Selecting

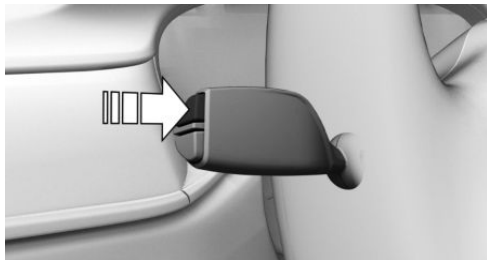

Continue to press the button on the turn signal lever until the desired widget is selected.



## Display



## Efficiency display

### Concept

Information about driving style and consumption can be displayed in form of a bar display as widget in the instrument cluster, for examples.

### General information

Depending on the activated driving mode, different information will be displayed:

Driving mode	Display
COMFORT	Current consumption.
SPORT	Average consumption. Energy recovery.
ECO PRO	ECO PRO bonus range. Distance traveled in Coasting mode. Current consumption.

## Information in detail

### Average consumption

The average consumption indicates the fuel consumption when driving a specific route.

### Current consumption

The current consumption displays the current consumption of fuel. Check whether you are cur-

rently driving in an efficient and environmentally-friendly manner.

### Energy recovery

During energy recovery, the kinetic energy of the vehicle is converted into electric energy during coasting. The vehicle battery is partially charged and fuel consumption can be reduced.

### ECO PRO bonus range

In the ECO PRO driving mode, the yielded extension of the range as a result of fuel-efficient driving is displayed as ECO PRO bonus range, refer to page 322.

## Check Control

### Concept

The Check Control system monitors functions in the vehicle and notifies you of malfunctions in the monitored systems.

### General information

A Check Control message is displayed as a combination of indicator or warning lights and SMS text messages in the instrument cluster and, if applicable, in the Head-up Display.

In addition, an acoustic signal may sound and an SMS text message may appear on the Control Display.

## Hiding Check Control messages

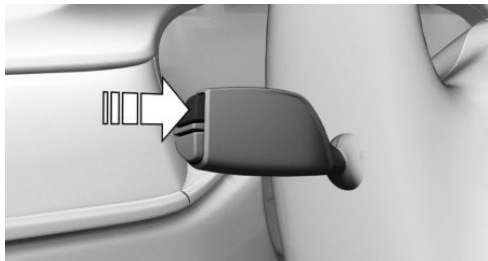

Press and hold the button on the turn signal lever.

### Continuous display

Some Check Control messages are displayed continuously and are not cleared until the malfunction is eliminated. If several malfunctions occur at once, the messages are displayed consecutively.

The messages can be hidden for approx. 8 seconds. After this time, they are displayed again automatically.

### Temporary display

Some Check Control messages are hidden automatically after approx. 20 seconds. The Check Control messages are stored and can be displayed again later.

## Displaying stored Check Control messages

Via iDrive:

1. "CAR"
2. "Vehicle status"
3.  "Check Control"
4. Select the SMS text message.

## Display

### Check Control



At least one Check Control message is displayed or is stored.

### SMS text messages

SMS text messages in combination with a symbol in the instrument cluster explain a Check Control message and the meaning of the indicator/warning lights.

### Supplementary SMS text messages

Additional information, such as the reason for an error or malfunction or the required action, can be called up via Check Control.

With urgent messages the added text will be automatically displayed on the Control Display.

Depending on the Check Control message, further help can be selected.

Via iDrive:

1. "CAR"
2. "Vehicle status"
3.  "Check Control"
4. Select the desired text message.
5. Select desired setting:
  - ▶ "Call BMW Accident Assistance"  
Contact BMW Group Accident Assistance.
  - ▶ "Service request"  
Contact Roadside Assistance.
  - ▶ "BMW Roadside Assistance"  
Contact a dealer's service center or another qualified service center or repair shop.
  - ▶ "Owner's Manual"  
Display additional information about the Check Control message in the Integrated Owner's Manual.

## Messages after trip completion

Special messages displayed while driving are displayed again after drive-ready state is switched off.

## Indicator/warning lights

### Concept

Indicator/warning lights in the instrument cluster display the status of some functions in the vehicle and indicate when a malfunction is present in the monitored systems.

### General information

The indicator/warning lights can light up in a variety of combinations and colors.

Several of the lights are checked for proper functioning and light up temporarily when drive-ready state is switched on.

### Red lights

#### Safety belt reminder



Indicator light flashes or is illuminated: safety belt on the driver or passenger side is not buckled. The safety belt reminder can also be activated if objects are placed

on the front passenger seat.

Make sure that the safety belts are positioned correctly.

#### Safety belt reminder for rear seats



The safety belt is not buckled on the corresponding rear seat.

### Airbag system



Airbag system and belt tensioner are not working.

Have the vehicle checked immediately by a dealer's service center or another qualified service center or repair shop.

### Parking brake



The parking brake is set.

Release the parking brake, refer to page 137.

### Brake system



Braking system impaired. Continue to drive moderately.

Have the vehicle checked immediately by a dealer's service center or another qualified service center or repair shop.

**BRAKE**

### Yellow lights

#### Anti-lock Braking System ABS



Braking force boost may not be working. Avoid abrupt braking. Take the longer braking distance into account.

**ABS**

Have the system immediately checked by a dealer's service center or another qualified service center or repair shop.

#### DSC Dynamic Stability Control



The indicator light flashes: DSC controls the drive and braking forces. The vehicle is stabilized. Reduce speed and modify your driving style to the driving circumstances.

The indicator light lights up: DSC has malfunctioned.

Have the system immediately checked by a dealer's service center or another qualified service center or repair shop.

DSC, refer to page 213.

## DSC Dynamic Stability Control is deactivated or DTC Dynamic Traction Control is activated



DSC is deactivated or DTC is activated.

DSC, refer to page 213, and DTC, refer to page 215.

## Flat Tire Monitor FTM



The Flat Tire Monitor signals a loss of tire inflation pressure in a tire.

Reduce your speed and stop cautiously. Avoid sudden braking and steering maneuvers. Flat Tire Monitor, refer to page 355.

## Tire Pressure Monitor TPM



The indicator light lights up: the Tire Pressure Monitor reports a low tire inflation pressure or a flat tire. Follow the information in the Check Control message.

The indicator light flashes and then continuously lights up: no flat tire or loss of tire inflation pressure can be detected.

- ▷ Interference caused by systems or devices with the same radio frequency: after leaving the area of the interference, the system automatically becomes active again.
- ▷ A wheel without TPM wheel electronics is mounted: have it checked by a dealer's service center or another qualified service center or repair shop as needed.
- ▷ Malfunction: have the system checked by a dealer's service center or another qualified service center or repair shop.

Tire Pressure Monitor, refer to page 348.

## Steering system



Steering system may not be working. Have the system checked by a dealer's service center or another qualified service center or repair shop.

## Emissions



- ▷ The warning light lights up: Emissions are deteriorating. Have the vehicle checked as soon as possible.
- ▷ The warning light flashes under certain circumstances:

This indicates that there is excessive misfiring in the engine.

Reduce the vehicle speed and have the system checked immediately; otherwise, serious engine misfiring within a brief period can seriously damage emission control components, in particular the catalytic converter.

Socket for Onboard Diagnosis, refer to page 375.

## Green lights

### Safety belt reminder for rear seats



The safety belt is buckled on the corresponding rear seat.

### Turn signal



Turn signal switched on. Unusually rapid flashing of the indicator light indicates that a turn signal bulb has failed.

Turn signal, refer to page 139.

### Parking lights



Parking lights are switched on. Parking lights/low beams, refer to page 169.

### Low beams



Low beams are switched on. Parking lights/low beams, refer to page 169.

## Lane departure warning



The indicator light lights up: the system is activated. A lane marking was detected on at least one side of the vehicle and warnings can be issued.

Lane departure warning, refer to page [198](#).

## Front fog lights



Front fog lights are switched on.

Front fog lights, refer to page [173](#).

## High-beam Assistant



High-beam Assistant is switched on.

High beams are switched on and off automatically depending on the traffic situation.

High-beam Assistant, refer to page [171](#).

## Automatic Hold



Automatic Hold is activated. The vehicle is automatically held in place when it is stationary.

Automatic Hold, refer to page [137](#).

## Blue lights

### High beams



High beams are switched on.

High beams, refer to page [139](#).

## Fuel gage

### Concept

The current fill level of the fuel tank is displayed.

## General information

Vehicle tilt position may cause the display to vary.

Information on refueling, refer to page [330](#).

### Display



An arrow beside the fuel pump symbol shows which side of the vehicle the fuel filler flap is on.

The current range is displayed as numerical value.

## Indicator light In the instrument cluster



The yellow indicator light illuminates, once the fuel reserve is reached.

## Tachometer

Always avoid engine speeds in the red warning field. In this range, the fuel supply is reduced to protect the engine.

## Shift point indicator

### Concept

The shift lights indicate the upshift point at which the best possible acceleration can be achieved.

### Functional requirement

Shift lights are shown when the SPORT or SPORT PLUS driving program is activated.

### Switching on shift lights

1. Select SPORT or SPORT PLUS driving mode.  
Press Driving Dynamics Control.
2. Activate the M/S manual mode of the transmission.

## Display



- ▷ Current engine speed is displayed in the tachometer.
- ▷ Arrow 1: successive yellow illuminated fields indicate an increase in the speed.
- ▷ Arrow 2: successive orange illuminated fields indicate the upcoming shift moment.
- ▷ Arrow 3: the field lights up red. Do not wait any further to shift.

When the maximum speed is reached, the entire display flashes red and the supply of fuel is interrupted in order to protect the engine.

## Standby state and drive-ready state

OFF

The letters OFF in the tachometer indicate that drive-ready state is switched off and standby state is switched on.

READY

The letters READY in the tachometer indicate that the Auto Start/Stop function is ready to start the engine automatically.

For further information, see Idle state, standby state, and drive-ready state, refer to page 43.

## Engine temperature

### Display



- ▷ Cold engine: the pointer is at the low temperature end. Drive at moderate engine and vehicle speeds.
- ▷ Normal operating temperature: the pointer is in the middle or in the lower half of the temperature display.
- ▷ Hot engine: the pointer is at the high end of the temperature range. In addition, a Check Control message is displayed.

Check the coolant level, refer to page 371.

### Indicator light In the instrument cluster



A red indicator light is displayed.

## External temperature

### General information

If the indicator drops to +37 °F/+3 °C or lower, a signal sounds.

A Check Control message is displayed.

There is an increased risk of ice on roads.

### Safety information

#### WARNING

Even at temperatures above +37 °F/+3 °C there can be a risk of icy roads, for instance on bridges or shady sections of road. There is a risk of an accident. Modify your driving style to the weather conditions at low temperatures.

## Range

### Concept

The range indicates the distance that can still be covered with the current fuel level.

### General information

The estimated range available with the remaining fuel is permanently displayed in the instrument cluster.

With a low remaining range, a Check Control message is briefly displayed. With a dynamic driving style, for instance taking curves aggressively, the engine function is not always ensured.

The Check Control message appears continuously below a range of approx. 30 miles/50 km.

### Safety information

#### NOTICE

With a driving range of less than 30 miles/50 km the engine may no longer have sufficient fuel. Engine functions are not ensured anymore. There is a risk of damage to property. Refuel promptly.

### Display



The current range is displayed as numerical value next to the fuel gage.

## Service requirements

### Concept

The function displays the service requirements and the corresponding maintenance scopes.

## General information

After switching on drive-ready state, the instrument cluster briefly displays available driving distance or time to the next scheduled maintenance.

A service advisor can read out the current service requirements from your remote control.

Some information on service requirements can also be shown on the BMW display key.

### Display



#### Detailed information on service requirements

More information on the type of service required may be displayed on the Control Display.

Via iDrive:

1. "CAR"
2. "Vehicle status"
3.  "Service schedule"  
Required maintenance procedures and legally mandated inspections are displayed.
4. Select an entry to call up detailed information.

### Symbols

Symbols	Description
	No service is currently required.
	The deadline for scheduled maintenance or a legally mandated inspection is approaching.
	The service deadline has already passed.

### Entering appointment dates

Enter the dates for the mandatory vehicle inspections.

Make sure that the vehicle's date and time are set correctly.

Via iDrive:

1. "CAR"
2. "Vehicle status"
3.  "Service schedule"
4. "BMW Service"
5. "Date:"
6. Select the desired setting.

## Automatic Service Request

Data regarding the service status or legally mandated vehicle inspections is automatically transmitted to your dealer's service center before your vehicle is due for service.

You can check when your dealer's service center was notified.

Via iDrive:

1. "CAR"
2. "Vehicle status"
3.  "TeleService Call"

## Gear shift indicator

### Concept

The system recommends the most efficient gear for the current driving situation.



### General information

Depending on the design and country version, the gear shift indicator may be active in the manual mode of the Steptronic transmission.

### Steptronic transmission: displaying

Suggestions to shift gear up or down are displayed in the instrument cluster.

On vehicles without a gear shift indicator, the engaged gear is displayed.

Example	Description
	Efficient gear is set.
	Shift into efficient gear.

## Speed Limit Info

### Speed Limit Info

#### Concept

Speed Limit Info shows the currently valid maximum permitted speed in the instrument cluster and the Head-up Display.

#### General information

The camera in the area of the interior mirror detects traffic signs at the edge of the road as well as variable overhead sign posts.

Traffic signs with extra symbols are considered and compared with the vehicle's onboard data. The traffic sign will then be either displayed or ignored depending on the situation in the instrument cluster and the Head-up Display.

The system takes into account any information that is stored in the navigation system and also displays speed limits present on routes without signs.

Speed limits for trailer towing will be displayed when the trailer power socket is in use or trailer towing was activated via iDrive.

#### Safety information

#### WARNING

The system cannot serve as a substitute for the driver's personal judgment in assessing visibility and traffic situation. There is a risk of an accident. Adjust driving style to traffic conditions.



Watch traffic closely and actively intervene where appropriate.

## Overview

### Camera

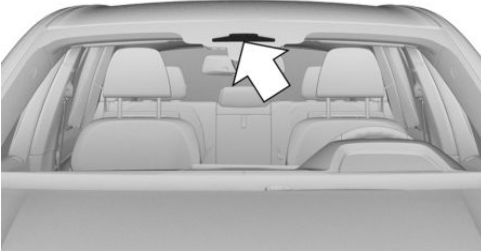

The camera is installed near the interior mirror. Keep the windshield in front of the interior mirror clean and clear.

## Displaying Speed Limit Info

### General information

Depending on the vehicle equipment, Speed Limit Info is displayed permanently in the instrument cluster or via iDrive.

### Display via iDrive

1. "CAR"
2. "Settings"
3. "Driver Assistance"
4. "Driving"
5. "Speed Limit Assistant"
6. "Info on speed limits"
7. "Show current limit"

## Display

### Speed Limit Info



Current speed limit.

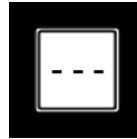

Speed Limit Info not available.

If the detected speed limit has been exceeded, the indicator light will flash.

## Settings

Via iDrive:

1. "CAR"
2. "Settings"
3. "Driver Assistance"
4. "Driving"
5. "Speed Limit Assistant"
6. Select desired setting:
  - ▷ "Warn when speeding": activating/deactivating the flashing of the Speed Limit Info display in the instrument cluster and Head-up Display when the currently valid speed limit is exceeded.
  - ▷ "Excess speed display": the speed limit that is detected by the Speed Limit Info is displayed with a marking in the speedometer in the instrument cluster.

## System limits

The system may not be fully functional and may provide incorrect information in the following situations:

- ▷ In heavy fog, wet conditions, or snowfall.
- ▷ When signs are fully or partially concealed by objects, stickers or paint.

- ▷ When driving very close to the vehicle in front of you.
- ▷ When driving toward bright lights or strong reflections.
- ▷ When the windshield in front of the interior mirror is fogged over, dirty or covered by a sticker, etc.
- ▷ If the camera has overheated and been temporarily switched off due to excessively high temperatures.
- ▷ In the event of incorrect detection by the camera.
- ▷ If the speed limits or road data stored in the navigation system are incorrect.
- ▷ If the speed limits vary with the time of day and the day of the week.
- ▷ In areas not covered by the navigation system.
- ▷ When roads differ from the navigation, such as due to changes in road routing.
- ▷ In case of electronic traffic signs.
- ▷ When passing buses or trucks with traffic signs applied to them.
- ▷ If the traffic signs are non-conforming.
- ▷ When signs that are valid for a parallel road are detected.
- ▷ In the presence of country-specific signs and road configurations.
- ▷ During calibration of the camera immediately after vehicle delivery.

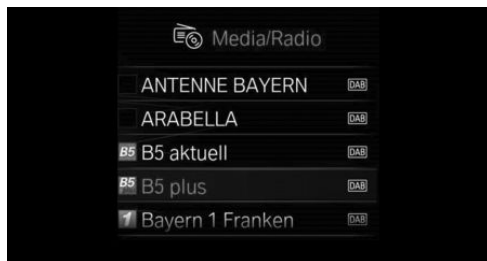

If necessary, the corresponding menu will open on the Control Display.

## Display



Depending on the equipment version, the list in the instrument cluster may differ from the illustration.

## Displaying and using the list

Button	Function
	Change the entertainment source. Pressing the button again will close the currently displayed list.
	Show list of most recent telephone calls.
	Turn the thumbwheel to select the desired setting. Press the thumbwheel to confirm the setting. The currently selected list can be displayed again in the instrument cluster by turning the thumbwheel.

## Selection lists

### Concept

Lists can be displayed and, if necessary, used for certain functions in the instrument cluster or the Head-up Display.

- ▷ Entertainment source.
- ▷ Current audio source.
- ▷ List of most recent telephone calls.

## Trip data

### Concept

Values for the trip, e.g. the average consumption, are displayed.

### General information

The trip data can be displayed on the Control Display and in the instrument cluster.

The values can be displayed and reset depending on various intervals, such as after refueling.

### Display on the Control Display

#### Overview

The following information is displayed:

- ▶ Configured interval for resetting the trip data.
- ▶ Average consumption.
- ▶ Total time for shut off engine through the Auto Start/Stop function.
- ▶ Distance traveled in Coasting mode.
- ▶ Consumption history in form of a chart.

#### Displays

Via iDrive:

1. "CAR"
2. "Driving information"
3. "Trip data"

#### Consumption history

The average consumption is shown in the consumption history in form of a chart based on the distance travelled and the driving mode.

The value for the average consumption is displayed with a line in the graph.

#### Display in the instrument cluster

Information about the route can be displayed as widget in the tachometer. Selecting and setting

widgets in the instrument cluster, refer to page 152.

The following information is displayed:

- ▶ Total number of kilometers.
- ▶ Configured interval for resetting the trip data.
- ▶ Distance travelled depending on the configured interval.
- ▶ Average speed.

### Resetting trip data

The intervals in which the values must be reset can be configured.

Via iDrive:

1. "CAR"
2. "Driving information"
3. "Trip data"
4. "Data since"
5. Select desired setting:
  - ▶ "Start of trip ( )": the values are automatically reset approx. four hours after the vehicle has come to a standstill.
  - ▶ "Refueling ( )": the values are automatically reset after refueling with a larger quantity of fuel.
  - ▶ "Factory ( )": the values since the time of the factory delivery are displayed.
  - ▶ "Individual ( )": the values since the last manual reset are displayed. The values can be reset at any time.

### Resetting average values manually

The following interval can be reset manually at any time: "Individual ( )".

With the button on the turn signal lever:

1. Continue to press the button on the turn signal lever until the widget for the trip data is selected.

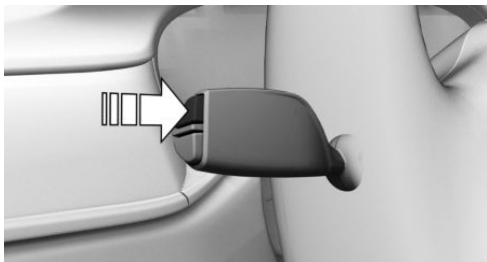

2. Press and hold the button on the turn signal lever.

Via iDrive:

1. "CAR"
2. "Driving information"
3. "Trip data"
4. "Data since"
5. "Reset individual"

The values are reset. If necessary, the setting of the interval for resetting the values will be changed: "Individual ()".

## Sport displays

### Concept

The Sport displays especially support a sporty driving style.

### Display on the Control Display

#### Overview

The following information is displayed:

- ▷ Boost pressure.
- ▷ Engine oil temperature.
- ▷ Acceleration power.
- ▷ Torque.

- ▷ Power.

## Displays

Via iDrive:

1. "CAR"
2. "Driving information"
3. "Sport displays"

## Display in the instrument cluster

The Sport displays can be displayed in form of two widgets in the instrument cluster, refer to page 152.

The following widgets can be selected:

- ▷ Widget for torque and power.
- ▷ Widget for acceleration power.

## Vehicle status

### General information





The status can be displayed and actions performed for several systems.



### Opening the vehicle status

Via iDrive:

1. "CAR"
2. "Vehicle status"

### Information at a glance

- ▷  "Flat Tire Monitor": Status of the Flat Tire Monitor, refer to page 355.
- ▷  "Tire Pressure Monitor": Status of the Tire Pressure Monitor, refer to page 348.
- ▷  "Engine oil level": Electronic oil measurement, refer to page 368.
- ▷  "Check Control": Check Control messages are stored in the background and can be displayed on the Control Display. Displaying stored Check Control messages, refer to page 154.

- ▷  "Service schedule": Displaying service requirements, refer to page 159.
- ▷  "TeleService Call": service request.

## Head-up Display

### Concept

This system projects important information into the driver's field of vision, for instance the speed. The driver can get information without averting his or her eyes from the road.

### General information

Read the information for cleaning the Head-up Display, refer to page 391.

### Overview



### Switching on/off

Via iDrive:

1. "CAR"
2. "Settings"
3. "Displays"
4. "Head-up display"
5. "Head-up display"

### Display

#### Overview

The following information is displayed on the Head-up Display:

- ▷ Speed.
- ▷ Navigation instructions.
- ▷ Check Control messages.
- ▷ Selection list in the instrument cluster.
- ▷ Driver assistance systems.
- ▷ Sport displays.

Some of this information is only displayed briefly as needed.

### Selecting the view

Various views are available for the Head-up Display.

Via iDrive:

1. "CAR"
2. "Settings"
3. "Displays"
4. "Head-up display"
5. "Display mode"
6. Select the desired setting.

The setting is stored for the driver profile currently used.

### Process individually

Via iDrive:

1. "CAR"
2. "Settings"
3. "Displays"
4. "Head-up display"
5. "Configure Individual"
6. Select the desired setting.

The setting is stored for the driver profile currently used.

### Setting the brightness

The brightness is automatically adjusted to the ambient brightness.

The basic setting can be adjusted manually.

Via iDrive:

1. "CAR"
2. "Settings"
3. "Displays"
4. "Head-up display"
5. "Brightness"
6. Turn the Controller until the desired brightness is set.
7. Press the Controller.

When the low beams are switched on, the brightness of the Head-up Display can be additionally influenced using the instrument lighting.

### Adjusting the height

Via iDrive:

1. "CAR"
2. "Settings"
3. "Displays"
4. "Head-up display"
5. "Height"
6. Turn the Controller until the desired height is reached.
7. Press the Controller.

The setting is stored for the driver profile currently used.

The height of the Head-up Display can also be stored using the memory function, refer to page [124](#).

### Setting the rotation

The Head-up Display view can be rotated.

Via iDrive:

1. "CAR"
2. "Settings"
3. "Displays"
4. "Head-up display"
5. "Rotation"

6. Turn the Controller until the desired setting is selected.
7. Press the Controller.

### Additional settings

Via iDrive:

1. "CAR"
2. "Settings"
3. "Displays"
4. "Head-up display"
5. Select desired setting:
  - ▷ "Speed Limit Assistant": access the settings for the speed assistant.
  - ▷ "Display infotainment lists in": set up if the selection lists are displayed in the instrument cluster or the Head-up display.
  - ▷ "Sport displays": display tachometer and Shift Lights in the head-up Display.
    - ▷ "Off": the Sport displays are not displayed in the Head-up Display.
    - ▷ "In SPORT mode": the Sport displays are only displayed in SPORT driving mode.
    - ▷ "Always": the Sport displays are continuously displayed in the Head-up Display.
  - ▷ "Reduced height": if not all of the information is in the driver's field of vision, the information can be displayed in the lower section of the Head-up Display.

### Visibility of the display

The visibility of the displays in the Head-up Display is influenced by the following factors:

- ▷ Seat position.
- ▷ Objects on the cover of the Head-up Display.
- ▷ Sunglasses with certain polarization filters.
- ▷ Wet roads.
- ▷ Unfavorable light conditions.

If the image is distorted, have the basic settings checked by a dealer's service center or another qualified service center or repair shop.

## Special windshield

The windshield is part of the system.

The shape of the windshield makes it possible to display a precise image.

A film in the windshield prevents double images from being generated.

For this reason, it is strongly suggested to have the special windshield replaced by a dealer's service center or another qualified service center or repair shop, if necessary.

# Lights

## Vehicle features and options



This chapter describes all standard, country-specific and optional features offered with the series. It also describes features and functions that are not necessarily available in your vehicle, e.g., due to the selected options or country versions. This also applies to safety-related functions and systems. When using these functions and systems, the applicable laws and regulations must be observed.

## Lights and lighting

### Switches in the vehicle



The light switch element is located next to the steering wheel.

Symbol	Function
	Front fog lights.
	Night Vision, refer to page 194.
	Lights off. Daytime running lights.

Symbol	Function
	Parking lights.
	Automatic headlight control. Adaptive light functions.
	Low beams.
	Instrument lighting.
	Right roadside parking light.
	Left roadside parking light.

## Automatic headlight control

### Concept

The low beams are switched on and off automatically depending on the ambient brightness, for instance in tunnels, in twilight or if there is precipitation.

### General information

A blue sky with the sun low on the horizon can cause the lights to be switched on.

If the low beams are switched on manually, the automatic headlight control is deactivated.

### Activating



Press the button on the light switch element.



The LED in the button lights up.



The indicator light in the instrument cluster is illuminated when the low beams are switched on.

## System limits

The automatic headlight control cannot serve as a substitute for your personal judgment of lighting conditions.

For example, the sensors are unable to detect fog or hazy weather. In these situations, switch the light on manually.

## Parking lights, low beams and roadside parking lights

### General information

If the driver's door is opened when the drive-ready state is switched off, the exterior lighting is automatically switched off.

### Parking lights

#### General information

The parking lights can only be switched on in the low speed range.

#### Switching on



Press the button on the light switch element.



The indicator light in the instrument cluster lights up.

The vehicle is illuminated on all sides.

Do not use the parking lights for extended periods; otherwise, they might drain the battery and it would then be impossible to switch on drive-ready state.

### Switching off



Press the button on the light switch element or switch on the drive-ready state.

After the drive-ready state is switched on, the automatic headlight control will be activated.

### Low beams

#### Switching on



Press the button on the light switch element.

The low beams illuminate when drive-ready state is switched on.



The indicator light in the instrument cluster lights up.

Press the button again to switch on the low beams when the standby state is switched on.

#### Switching off

Depending on the country variant, the low beams can be switched off in the low speed range.



Press the button on the light switch element.

### Roadside parking lights

When the vehicle is parked, a one-sided roadside parking light can be switched on.

Button	Function
	Right roadside parking light on/off.
	Left roadside parking light on/off.



Right roadside parking light on/off.



Left roadside parking light on/off.

## Welcome lights

### General information

Depending on the equipment, the exterior lighting of the vehicle can be set individually.

### Activating/deactivating

Via iDrive:

1. "CAR"
2. "Settings"
3. "Exterior lighting"
4. Select desired setting:
  - ▷ "MGU-416756"  
When unlocking the vehicle, individual light functions are switched on for a limited time.
  - ▷ "Door handle lights"  
Door handles and the ground in front of the doors are illuminated for a limited time.
  - ▷ "Welcome Light Carpet"  
The area next to the vehicle is illuminated for a limited time.

### LED light carpet

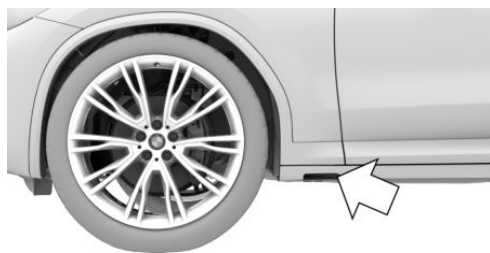

The light source is located in the position indicated.

Keep the light source clean and unobstructed.

## Headlight courtesy delay feature

### General information

The low beams stay lit for a particular time if the high beams are switched on after standby state is switched on.

### Setting the duration

Via iDrive:

1. "CAR"
2. "Settings"
3. "Exterior lighting"
4. "Pathway lighting"
5. Select the desired setting.

## Daytime running lights

### General information

The daytime running lights light up when drive-ready state is switched on.

### Activating/deactivating

In some countries, daytime running lights are mandatory, so it may not be possible to deactivate the daytime running lights.

Via iDrive:

1. "CAR"
2. "Settings"
3. "Exterior lighting"
4. "Daytime driving lights"

The setting is stored for the driver profile currently used.

## Adaptive light functions

---

### Concept

Adaptive light functions enable dynamic illumination of the roadway.

### General information

The adaptive light functions may consist of one system or multiple systems, depending on the equipment version:

- ▶ Adaptive Light Control, refer to page 171.
- ▶ Cornering light, refer to page 171.

### Activating

 Press the button on the light switch element.

The LED in the button lights up.

The adaptive light functions are active when the drive-ready state is switched on.

## Adaptive Light Control

---

### General information

Depending on the steering angle and other parameters, the light from the headlight follows the course of the road.

To avoid blinding oncoming traffic, the Adaptive Light Control does not swivel to the opposite lane when the vehicle is at a standstill.

## Cornering light

---

In tight curves, for instance on mountainous roads or when turning, an additional, cornering light is switched on that lights up the inside of the curve when the vehicle is moving below a certain speed.

The cornering light is automatically switched on depending on the steering angle.

When driving in reverse, the cornering lights may be automatically switched on regardless of the steering angle.

## Adaptive headlight range control

---

The adaptive headlight range control compensates for acceleration and braking operations in order not to blind the oncoming traffic and to achieve optimum illumination of the roadway.

## High-beam Assistant

---

### Concept

The high-beam Assistant detects other traffic participants early on and automatically switches the high beams on or off depending on the traffic situation.

### General information

The high-beam Assistant ensures that the high beams are switched on, whenever the traffic situation allows. In the low speed range, the high beams are not switched on by the system.

The system responds to light from oncoming traffic and traffic driving ahead of you, and to ambient lighting, for instance in towns and cities.

The high beams can be switched on and off manually at any time.

### Activating

1.  Press the button on the light switch element.

The LED in the button lights up.

2. Press and hold the button on the turn signal lever.

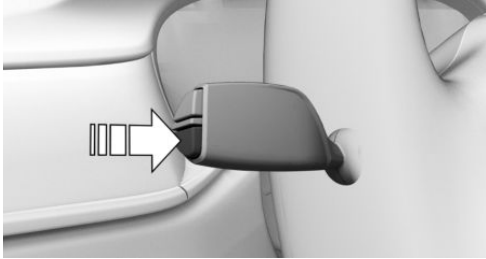

The indicator light in the instrument cluster is illuminated when the low beams are switched on.

The headlights are automatically switched between low beams and high beams.



The blue indicator light in the instrument cluster lights up when the system switches on the high beams.

Driving interruption with activated High-Beam Assistant: the High-Beam Assistant remains activated when driving continues.

The high-beam Assistant is deactivated when manually switching the high beams on and off, refer to page 139.

To reactivate the high-beam Assistant, press the button on the turn signal lever.

## Deactivating

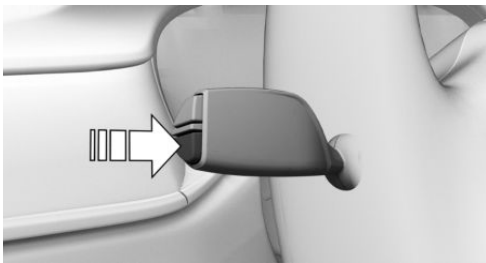

Press and hold the button on the turn signal lever.

## Sensitivity of the high-beam Assistant

### General information

The sensitivity of the high-beam Assistant can be adjusted.

### Safety information

#### **WARNING**

If adjustments have been made or the sensitivity has been modified, oncoming traffic may be momentarily blinded. There is a risk of an accident. If adjustments have been made and the sensitivity has been modified, make sure that oncoming traffic is not momentarily blinded. Switch off the high beams manually if required.

### Adjusting the sensitivity

Pull the turn signal lever for approximately 10 seconds. The system responds more sensitively.

A Check Control message is displayed.

### Resetting the sensitivity

Pull the turn signal lever again for approx. 10 seconds. The sensitivity of the high-beam Assistant is reset to the factory settings.

## System limits

The high-beam Assistant cannot serve as a substitute for the driver's personal judgment of when to use the high beams. In situation that require this, therefore switch off manually.

The system is not fully functional in the following situations, and driver intervention may be necessary:

- ▶ In very unfavorable weather conditions, such as fog or heavy precipitation.
- ▶ When detecting poorly-lit road users such as pedestrians, cyclists, horseback riders and

wagons; when driving close to train or ship traffic; or at animal crossings.

- ▶ In tight curves, on hilltops or in depressions, in cross traffic or half-obscured oncoming traffic on highways.
- ▶ In poorly-lit towns and cities or in the presence of highly reflective signs.
- ▶ When the windshield in front of the interior mirror is fogged over, dirty or covered with stickers, etc.

## Laser high beams

### Concept

The range of the high beams is increased and ensures an even better illumination of the road.

### General information

When the high beams are switched-on, starting with a speed of approx. 37 mph/60 km/h, the laser high beams in the headlight are automatically switched on in addition to the LED high beams.

Depending on the country variant, further information can be obtained from the laser label on the headlight.

### Safety information



The label is in the headlight and is visible from the outside.

## Fog lights

### Front fog lights

#### Concept

The front fog lights work alongside the low beams to illuminate a wider area of the roadway.

#### Functional requirement

The low beams must be switched on before switching on the front fog lights.

#### Switching on/off

 Press the button.

 The green indicator light in the instrument cluster lights up if the front fog lights are switched on.

If the automatic headlight control, refer to page 168, is activated, the low beams will come on automatically when you switch on the front fog lights.

When the high beams or headlight flasher are activated, the front fog lights are not switched on.

## Instrument lighting

### Functional requirement

The parking lights or low beams must be switched on to adjust the brightness.

### Settings



Adjust the brightness with the thumbwheel.

## Interior lights

### General information

Depending on the equipment version, interior lights, footwell lights, entry lights, ambient lighting, and speaker lighting are automatically controlled.

### Overview

#### Buttons in the vehicle



Interior lights



Reading lights

### Switching the interior lights on/off



Press the button.

To switch off permanently: press the button and hold for approx. 3 seconds.

The interior lights in the rear of the vehicle can be switched on and off independently. The button is located in the rear roofliner.

### Switching the reading lights on/off



Press the button.

Depending on the vehicle equipment, the reading lights are located next to the interior lights in the front and rear.

## Ambient light

### General information

Depending on the equipment version, lighting can be adjusted for some lights in the car's interior.

### Switching on/off

The ambient light is switched on when the vehicle is unlocked, and switched off when the vehicle is locked.

If the ambient light was deactivated via iDrive, it will not be switched on when the vehicle is unlocked.

Via iDrive:

1. "CAR"
2. "Settings"
3. "Interior lighting"
4. "Ambient lighting"

The selected setting is stored for the driver profile currently used.

### Selecting color scheme

Via iDrive:

1. "CAR"
2. "Settings"
3. "Interior lighting"
4. "Color"
5. Select the desired setting.

### Setting the brightness

Via iDrive:

1. "CAR"
2. "Settings"

3. "Interior lighting"
4. "Brightness"
5. Select the desired setting.

## Dynamic light

Via iDrive:

1. "CAR"
2. "Settings"
3. "Interior lighting"
4. "Dynamic light"
5. Select the desired setting.

Individual actions, for example incoming calls or opened doors, are indicated by light effects.

## Dimmed while driving

Via iDrive:

1. "CAR"
2. "Settings"
3. "Interior lighting"
4. "Dimmed for night driving"

Some lights of the interior lighting are dimmed when the vehicle is driven in the dark.

The selected setting is stored for the driver profile currently used.

## Panoramic glass sunroof, lighting

If the panoramic glass sunroof is opened or the sun protection is closed, the lighting is switched off.

## Bowers & Wilkins Diamond Surround Sound System

---

### General information

Some speakers in the vehicle are illuminated. Brightness can be individually set.

If the speakers are muted, speaker lighting will be switched off.

## Switching on/off

The speaker lighting is switched on when the vehicle is unlocked, and switched off when the vehicle is locked.

Via iDrive:

1. "CAR"
2. "Settings"
3. "Interior lighting"
4. "Bowers & Wilkins"

The selected setting is stored for the driver profile currently used.

## Setting the brightness

Via iDrive:

1. "CAR"
2. "Settings"
3. "Interior lighting"
4. "Brightness"
5. Select the desired setting.

# Safety

## Vehicle features and options

This chapter describes all standard, country-specific and optional features offered with the series. It also describes features and functions that are

not necessarily available in your vehicle, e.g., due to the selected options or country versions. This also applies to safety-related functions and systems. When using these functions and systems, the applicable laws and regulations must be observed.

## Airbags

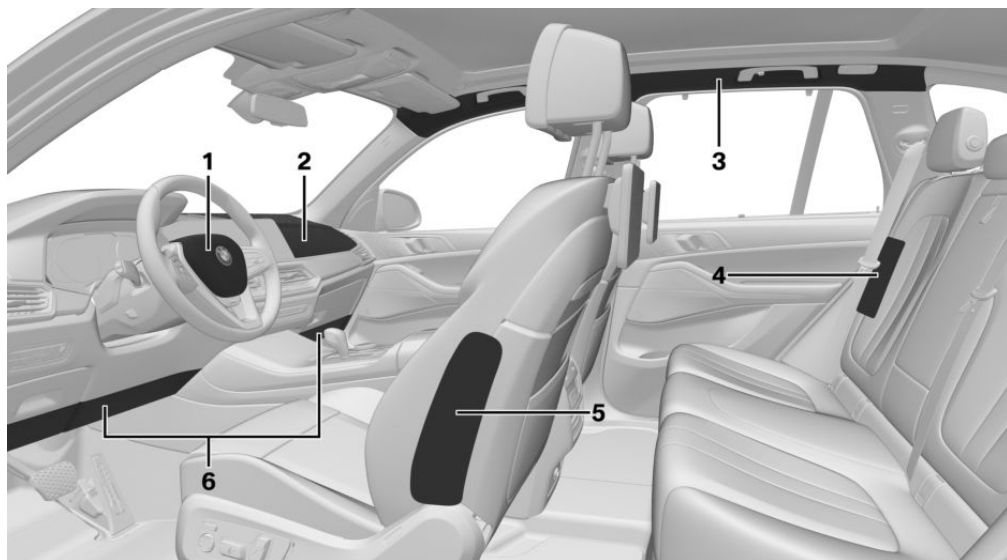

- 1 Front airbag, driver
- 2 Front airbag, front passenger
- 3 Head airbag
- 4 Side airbag In the rear
- 5 Side airbag
- 6 Knee airbag

### Front airbags

Front airbags help protect the driver and the front passenger by responding to frontal impacts in which safety belts alone would not provide adequate protection.

### Side airbag

In a lateral impact, the side airbag supports the side of the body in the chest and lap area.

Depending on the equipment:

In the event of a side impact, the side airbag in the back supports the chest and lap area on the



side of the bodies of the occupants in the outer rear seats.

## Head airbag

In a lateral impact, the head airbag supports the head.

## Ejection Mitigation

The head airbag system is designed as an ejection mitigation countermeasure to reduce the likelihood of ejections of vehicle occupants through side windows during rollovers or side impact events.

## Knee airbag

The knee airbag supports the legs in a frontal impact.

## Protective effect

### General information

Airbags are not triggered in every impact situation, for instance in less severe accidents or rear-end collisions.

### Information on optimum effect of the airbags

#### **WARNING**

If the seat position is incorrect or the deployment area of the airbags is impaired, the airbag system cannot provide protection as intended and may cause additional injuries due to triggering. There is a risk of injuries or danger to life. Follow the information on achieving the optimum protective effect of the airbag system.

- ▷ Make sure that the front passenger is sitting correctly, i.e., keeps his or her feet and legs in the floor area and does not support them on the dashboard.
  - ▷ Make sure that occupants keep their heads away from the side airbag.
  - ▷ There should be no additional persons, animals or objects between an airbag and a person.
  - ▷ Dashboard and windshield on the front passenger side must stay clear - do not attach adhesive labels or coverings and do not attach brackets or cables, for instance for GPS devices or mobile phones.
  - ▷ Do not apply adhesive materials to the airbag cover panels, do not cover them or modify them in any way.
  - ▷ Do not use the cover of the front airbag on the front passenger side as a storage area.
  - ▷ Do not attach slip covers, seat cushions or other objects to the front passenger seat that are not specifically suited for seats with integrated side airbags.
  - ▷ Do not hang pieces of clothing, such as jackets, over the backrests.
  - ▷ Never modify either the individual components or the wiring in the airbag system. This also applies to steering wheel covers, the dashboard, and the seats.
  - ▷ Do not remove the airbag system.
- Even when you follow all instructions very closely, injury from contact with the airbags cannot be fully ruled out in certain situations.
- The ignition and inflation noise may lead to short-term and, in most cases, temporary hearing impairment in sensitive occupants.
- Vehicle modifications for a person with disabilities may affect the air bag system; contact BMW Customer Relations for further information.
- Warnings and information on the airbags are also found on the sun visors.
- ▷ Keep a distance from the airbags.
  - ▷ Always grasp the steering wheel on the steering wheel rim. Hold your hands at the 3 o'clock and 9 o'clock positions, to keep the risk of injury to your hands or arms as low as possible when the airbag is triggered.



## Functional readiness of the airbag system

### Safety information

#### WARNING

Individual components can be hot after triggering of the airbag system. There is a risk of injury. Do not touch individual components.

#### WARNING

Improperly executed work can lead to failure, malfunction or unintentional triggering of the airbag system. In the case of a malfunction, the airbag system might not trigger as intended despite the accident severity. There is a risk of injuries or danger to life. Have the airbag system checked, repaired, dismantled and scrapped by a dealer's service center or another qualified service center or repair shop.

### Display in the instrument cluster



When drive-ready state is switched on, the warning light in the instrument cluster lights up briefly and thereby indicates the function readiness of the entire airbag system and the belt tensioners.

### Malfunction



- ▷ Warning light does not come on when drive-ready state is switched on.
- ▷ The warning light lights up continuously. Have the system checked.

## Strength of the driver's and front-seat passenger airbag

The explosive power that activates driver's/front-seat passenger airbags very much depends on the positions of the driver's/front passenger seat.

To maintain the accuracy of this function over the long term, calibrate the front seats as soon as a respective message appears on the Control Display.

### Calibrating the front seats

#### WARNING

There is a risk of jamming when moving the seats. There is a risk of injury or risk of damage to property. Make sure that the area of movement of the seat is clear prior to any adjustment.

A corresponding message appears on the Control Display.

1. Press the switch and move the respective seat all the way forward, until it stops.
2. Press the switch forward again. The seat still moves forward slightly.
3. Readjust the seat to the desired position.

The calibration procedure is completed when the message on the Control Display disappears.

If the message continues to be displayed, repeat the calibration.

If the message does not disappear after a repeat calibration, have the system checked as soon as possible.

## Automatic deactivation of the front-seat passenger airbags

### Concept

The system reads if the front passenger seat is occupied by measuring the human body's resistance.

Front, knee, and side airbag on the front passenger's side are activated or deactivated.

## General information

Before transporting a child on the front passenger seat, refer to the safety information and instructions for children on the front passenger seat, see Children.

## Safety information

### WARNING

To ensure the front-seat passenger airbag function, the system must be able to detect whether a person is sitting in the front passenger seat. The entire seat cushion area must be used for this purpose. There is a risk of injuries or danger to life. Make sure that the front passenger keeps his or her feet in the floor area.

## Malfunction of the automatic deactivation system

When transporting older children and adults, the front-seat passenger airbags may be deactivated in certain sitting positions. In this case, the indicator light for the front-seat passenger airbags lights up.

In this case, change the sitting position so that the front-seat passenger airbags are activated and the indicator light goes out.

If it is not possible to activate the airbags, have the person sit in the rear.

To enable correct recognition of the occupied seat cushion.

- ▶ Do not attach covers, cushions, ball mats or other items to the front passenger seat unless they are specifically determined to be safe for use on the front passenger seat.
- ▶ Do not place any electronic devices on the front passenger seat if a child restraint system is to be installed on it.
- ▶ Do not place objects under the seat that could press against the seat from below.
- ▶ No moisture in or on the seat.

## Indicator light for the front-seat passenger airbags

The indicator light for the front-seat passenger airbag in the roofliner indicates the operating state of the front-seat passenger airbag.

The light indicates whether the airbags are either activated or deactivated.

After drive-ready state is switched on, the light briefly lights up and then indicates whether the airbags are either activated or deactivated.

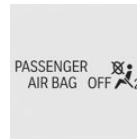

- ▶ The indicator light lights up when a child is properly seated in a child restraint system or when the seat is empty. The airbags on the front passenger side are not activated.

- ▶ The indicator light does not light up when, for instance a correctly seated person of sufficient size is detected on the seat. The airbags on the front passenger side are activated.

## Detected child restraint systems

The system generally detects children seated in a child restraint system, particularly in child restraint systems required by NHTSA at the point in time when the vehicle was manufactured. After installing a child restraint system, make sure that the indicator light for the front-seat passenger airbags lights up. This indicates that the child restraint system has been detected and the front-seat passenger airbags are not activated.

## Intelligent Safety

### Concept

Intelligent Safety enables central operation of the driver assistance system.

## General information

Depending on how the vehicle is equipped, Intelligent Safety consists of one or more systems that can help prevent an imminent collision.

- ▷ Approach control warning with light braking function, refer to page 181.
- ▷ Evasion assistance, refer to page 185.
- ▷ Intersection warning with City light braking function, refer to page 187.
- ▷ Person warning with City light braking function, refer to page 191.
- ▷ Night Vision with pedestrian and animal detection, refer to page 194.
- ▷ Lane departure warning, refer to page 198.
- ▷ Active Blind Spot Detection, refer to page 201.
- ▷ Side collision warning, refer to page 205.

## Safety information

### **WARNING**

The system cannot serve as a substitute for the driver's personal judgment in assessing visibility and traffic situation. There is a risk of an accident. Adjust driving style to traffic conditions. Watch traffic closely and actively intervene where appropriate.

### **WARNING**

Indicators and warnings cannot serve as a substitute for the driver's personal judgment. Due to its limits, the system might not output warnings or reactions or these might be output late, incorrectly, or without justification. There is a risk of an accident. Adjust driving style to traffic conditions. Watch traffic closely and actively intervene where appropriate.

### **WARNING**

Due to system limits, individual functions can malfunction during tow-starting/towing with the Intelligent Safety systems activated. There is a risk of an accident. Switch all Intelligent Safety systems off prior to tow-starting/towing.

## Overview

### Button in the vehicle







 Intelligent Safety

### Switching on/off

Some Intelligent Safety systems are automatically active after every departure. Some Intelligent Safety systems activate according to the last setting.

#### Button Status

-  Button lights up green: all Intelligent Safety systems are switched on.
-  Button lights up orange: some Intelligent Safety systems are switched off or currently unavailable.
-  Button does not light up: all Intelligent Safety systems are switched off.

 Press the button:  
The menu for the intelligent safety system is displayed.

If all Intelligent Safety systems were switched off, all systems are now switched on.

"Configure INDIVIDUAL": depending on the equipment version, the Intelligent Safety systems can be individually configured. The individual settings are activated and stored for the driver profile currently used. As soon as a setting is changed on the menu, all settings of the menu are activated.



Press the button repeatedly. The following settings are switched between:

"ALL ON": all Intelligent Safety systems are switched on. Basic settings are activated for the sub-functions, for instance setting for warning time.

"INDIVIDUAL": the Intelligent Safety systems are switched on according to the individual settings.

Some Intelligent Safety systems cannot be individually switched off.



Press and hold this button:

All Intelligent Safety systems are switched off.

## Approach control warning with light braking function

### Concept

The system can help prevent accidents. If an accident cannot be prevented, the system will help reduce the impact speed.

The system sounds a warning before an imminent collision and activates brakes independently, if needed.

### General information

Depending on the equipment version, the system is controlled by the following sensors:

- ▶ Camera in the area of the interior mirror.
- ▶ Radar sensor in the front bumper.

The system issues a two-phase warning of a possible risk of collision with vehicles at speeds above approx. 3 mph/5 km/h. Time of warnings may vary with the current driving situation.

With the vehicle approaching another vehicle intentionally, the approach control warning and braking are delayed in order to avoid false system reactions.

Depending on the vehicle equipment, the Driver Attention Camera in the instrument cluster captures the driver's gaze behavior. Additionally, the system checks for visual impairments. Gaze behaviour and visibility also affect the timing of the warnings.

## Safety information

### WARNING

The system cannot serve as a substitute for the driver's personal judgment in assessing visibility and traffic situation. There is a risk of an accident. Adjust driving style to traffic conditions. Watch traffic closely and actively intervene where appropriate.

### WARNING

Indicators and warnings cannot serve as a substitute for the driver's personal judgment. Due to its limits, the system might not output warnings or reactions or these might be output late, incorrectly, or without justification. There is a risk of an accident. Adjust driving style to traffic conditions. Watch traffic closely and actively intervene where appropriate.

### WARNING

Due to system limits, individual functions can malfunction during tow-starting/towing with the Intelligent Safety systems activated. There is a risk of an accident. Switch all Intelligent Safety systems off prior to tow-starting/towing.

## Overview

### Button in the vehicle



 Intelligent Safety

### Camera

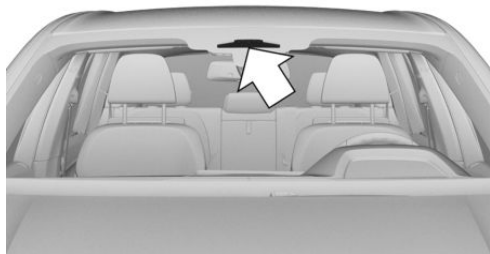

The camera is installed near the interior mirror. Keep the windshield in front of the interior mirror clean and clear.

### With radar sensor

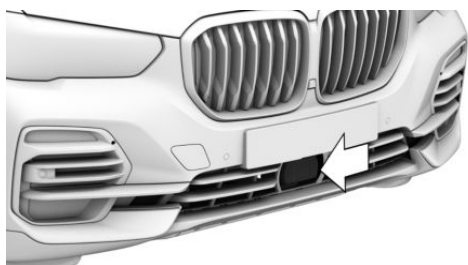

The radar sensor is located in the lower area of the front bumper.

Always keep radar sensor clean and unobstructed.

## Switching on/off

### Switching on automatically

The system is automatically active after every driving off.

### Switching on/off manually

-  Press the button. The menu for the intelligent safety system is displayed.

If all Intelligent Safety systems were switched off, all systems are now switched on.

"Configure INDIVIDUAL": depending on the equipment version, the Intelligent Safety systems can be individually configured. The individual settings are activated and stored for the driver profile currently used. As soon as a setting is changed on the menu, all settings of the menu are activated.

-  Press the button repeatedly. The following settings are switched between:

"ALL ON": all Intelligent Safety systems are switched on. Basic settings are activated for the subfunctions.

"INDIVIDUAL": the Intelligent Safety systems are switched on according to the individual settings. Some Intelligent Safety systems cannot be individually switched off.

-  Press and hold this button. All Intelligent Safety systems are switched off.

**Button Status**

Button lights up green: all Intelligent Safety systems are switched on.



Button lights up orange: some Intelligent Safety systems are switched off or currently unavailable.



Button does not light up: all Intelligent Safety systems are switched off.

**Setting the warning time**

Via iDrive:

1. "CAR"
2. "Settings"
3. "Driver Assistance"
4. "Safety and warnings"
5. "Front collision warning"
6. Select desired setting:
  - ▷ "Early"
  - ▷ "Medium"
  - ▷ "Late": only acute warnings are displayed.

The selected time is stored for the driver profile currently used.

**Warning with braking function****Display**

A warning symbol appears in the instrument cluster and in the Head-up Display, where available, if a collision with a detected vehicle is imminent.

**Symbol Measure**

Symbol lights up red: prewarning.  
Brake and increase distance.



Symbol flashes red and an acoustic signal sounds: acute warning.  
Brake and make an evasive maneuver, if necessary.

**Prewarning**

This warning is provided, for instance when there is impending danger of a collision or the distance to the vehicle ahead is too small.

If a prewarning is provided, respond by braking as warranted.

**Acute warning with braking function**

Acute warning is displayed in case of the imminent danger of a collision when the vehicle approaches another object at a high differential speed.

If an acute warning is issued, intervene in the situation yourself. Depending on the driving situation, the acute warning may be accompanied by a brief activation of the braking system.

With the warning time setting "Late" the brief activation of the braking system is omitted.

If necessary, the system provides additional assistance, such as with an automatic braking intervention, in a possible risk of collision.

Acute warnings can also be triggered without previous forewarning.

**Braking intervention**

The warning prompts the driver to react. During a warning, the maximum required braking force is used when the brake is actuated. Prerequisite is sufficiently quick and hard stepping on the brake pedal.

The system can additionally assist possibly with automatic braking intervention if there is a risk of a collision.

When the vehicle is traveling at a low speed, the vehicle may come to a complete stop.

City brake function: the braking intervention occurs to up to approx. 50 mph/80 km/h.

With radar sensor: the braking intervention occurs to up to approx. 155 mph/250 km/h.

At speeds above approx. 130 mph/210 km/h, the braking intervention occurs as a brief braking pressure. No automatic delay occurs.

The braking intervention occurs only if vehicle stability has not been restricted, for instance by deactivating the DSC Dynamic Stability Control.

The driver may cancel the braking intervention by stepping on the accelerator pedal or by actively moving the steering wheel.

Object detection can be restricted. Follow the limitations of the detection range and functional limitations.

## System limits

### Safety information

#### **WARNING**

The system can react not at all, too late, incorrectly, or without justification due to the system limits. There is a risk of accidents or risk of damage to property. Follow the information regarding the system limits and actively intervene if needed.

### Detection range

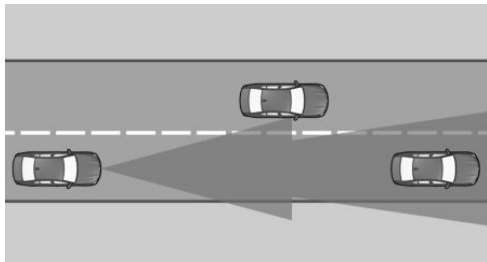

The system's detection potential is limited.

Only objects that are detected by the system are taken into account.

Thus, a system reaction might not come or might come late.

The following situations may not be detected, for instance:

- ▷ Slow moving vehicles when you approach them at high speed.

- ▷ Vehicles that suddenly swerve in front of you, or sharply decelerating vehicles.
- ▷ Vehicles with an unusual rear appearance.
- ▷ Two-wheeled vehicles ahead of you.

### Upper speed limit

If the vehicle speed exceeds approx. 155 mph/250 km/h, the system is deactivated temporarily. When the vehicle slows down to below this speed, the system is reactivated.

### Functional limitations

The system may not be fully functional in the following situations:

- ▷ In heavy fog, wet conditions, or snowfall.
- ▷ In tight curves.
- ▷ If the driving stability control systems are limited or deactivated, for instance DSC OFF.
- ▷ If the field of view of the camera or the windshield is dirty or covered in the area of the interior mirror.
- ▷ If the camera has overheated and been temporarily switched off due to excessively high temperatures.
- ▷ Depending on the equipment: if the radar sensors are dirty or covered.
- ▷ Up to 10 seconds after the start of the engine via the Start/Stop button.
- ▷ During calibration of the camera immediately after vehicle delivery.
- ▷ If there are constant blinding effects because of oncoming light, for instance from the sun low in the sky.

### Warning sensitivity

The more sensitive the warning settings are, for example the warning time, the more warnings are displayed. Therefore, there may also be an excess of premature or unjustified warnings and reactions.



## Evasion assistance

### Concept

The system supports the driver in making evasive maneuvers in certain situations, such as when obstacles or persons suddenly appear.

### General information

The system issues a warning and intervenes to support the driver if a lateral evasive maneuver is possible. Sensors monitor and detect the clearance around the vehicle. If the system identifies space alongside the vehicle, it supports an evasive maneuver begun by the driver by safely providing targeted steering support.

### Safety information

#### WARNING

The system cannot serve as a substitute for the driver's personal judgment in assessing visibility and traffic situation. There is a risk of an accident. Adjust driving style to traffic conditions. Watch traffic closely and actively intervene where appropriate.

#### WARNING

Indicators and warnings cannot serve as a substitute for the driver's personal judgment. Due to its limits, the system might not output warnings or reactions or these might be output late, incorrectly, or without justification. There is a risk of an accident. Adjust driving style to traffic conditions. Watch traffic closely and actively intervene where appropriate.

## Overview

### Radar sensors

The radar sensors are located in the bumpers.

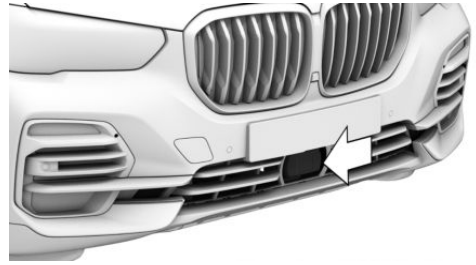

Front center bumper.



Front side bumper.

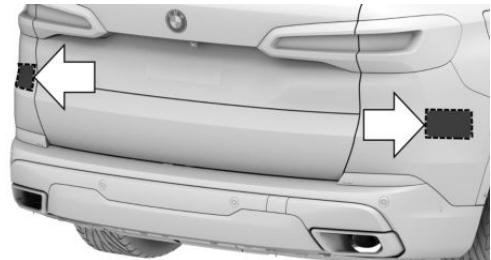

Rear bumper.

Always keep the bumper in the area of the radar sensors clean and unobstructed.

## Camera

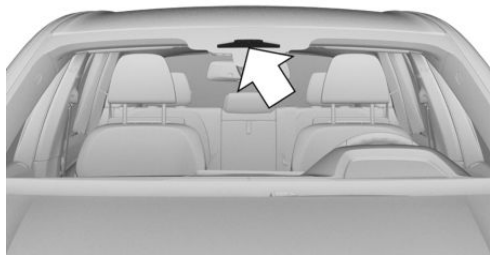

The camera is installed near the interior mirror. Keep the windshield in front of the interior mirror clean and clear.

## Functional requirements

- ▶ Pedestrian warning with braking function, refer to page 191, is switched on.
- ▶ Approach control warning with light braking function, refer to page 181, is switched on.
- ▶ Sensors detect sufficient clearance around the vehicle.

## Switching on/off

The system is automatically active after every driving off.

## Warning with evasion support

### Display in the instrument cluster

A warning symbol appears in the instrument cluster and in the Head-up Display if a collision with a detected vehicle is imminent.

### Symbol Measure



Symbol lights up red: prewarning. Brake and increase distance.



Symbol flashes red and an acoustic signal sounds: acute warning for obstacles.

Brake and make an evasive maneuver, if necessary.



Symbol flashes red and an acoustic signal sounds: acute warning for pedestrians.

Brake and make an evasive maneuver, if necessary.

## Acute warning with evasion support

Acute warning is displayed in case of the imminent danger of a collision when the vehicle approaches another object at a high differential speed.

If an acute warning is issued, intervene in the situation yourself. If there is a risk of collision, the driver's evasive maneuvers are supported by the system.

Acute warnings can also be triggered without previous forewarning.

## System limits

### Safety information

#### WARNING

The system can react not at all, too late, incorrectly, or without justification due to the system limits. There is a risk of accidents or risk of damage to property. Follow the information regarding the system limits and actively intervene if needed.

## Detection range

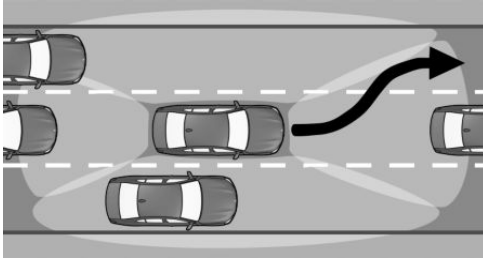

The system's detection potential is limited.

Only objects that are detected by the system are taken into account.

Thus, a system reaction might not come or might come late.

E.g., the following situations may not be detected:

- ▷ Slow moving vehicles when you approach them at high speed.
- ▷ Vehicles that suddenly swerve in front of you, or sharply decelerating vehicles.
- ▷ Vehicles with an unusual rear appearance.
- ▷ Two-wheeled vehicles ahead of you.

## Functional limitations

The system may not be fully functional in the following situations:

- ▷ In heavy fog, wet conditions, or snowfall.
- ▷ In tight curves.
- ▷ If the driving stability control systems are limited or deactivated, for instance DSC OFF.
- ▷ If the field of view of the camera or the windshield is dirty or covered in the area of the interior mirror.
- ▷ If the camera has overheated and been temporarily switched off due to excessively high temperatures.
- ▷ Depending on the equipment: if the radar sensors are dirty or covered.
- ▷ Up to 10 seconds after the start of the engine via the Start/Stop button.

- ▷ During calibration of the camera immediately after vehicle delivery.
- ▷ If there are constant blinding effects because of oncoming light, for instance from the sun low in the sky.

## Intersection warning with City light braking function

### Concept

The system can help prevent accidents with cross traffic at intersections and junctions. If an accident cannot be prevented, the system will help reduce the impact speed.

The system sounds a warning in the city speed range before an imminent collision and activates brakes independently, if needed.

### General information

The system is controlled by the following sensors:

- ▷ Camera in the area of the interior mirror.
- ▷ Radar sensors on the side in the front bumper.
- ▷ Radar sensor in the center in the front bumper

At intersections and junctions, a warning is issued when a danger of collision with crossing traffic is detected.

The system issues a two-phase warning of a possible risk of collision with vehicles at speeds above approx. 6 mph/10 km/h. Time of warnings may vary with the current driving situation.

The driver's gaze behavior is captured by the Driver Attention Camera in the instrument cluster. Additionally, the system checks for visual impairments. Gaze behaviour and visibility also affect the timing of the warnings.

## Detection range

Vehicles that cross your direction of travel can be detected by the system as soon as these vehicles enter into the detection range of the system.

## Safety information

### WARNING

The system cannot serve as a substitute for the driver's personal judgment in assessing visibility and traffic situation. There is a risk of an accident. Adjust driving style to traffic conditions. Watch traffic closely and actively intervene where appropriate.

### WARNING

Indicators and warnings cannot serve as a substitute for the driver's personal judgment. Due to its limits, the system might not output warnings or reactions or these might be output late, incorrectly, or without justification. There is a risk of an accident. Adjust driving style to traffic conditions. Watch traffic closely and actively intervene where appropriate.

### WARNING

Due to system limits, individual functions can malfunction during tow-starting/towing with the Intelligent Safety systems activated. There is a risk of an accident. Switch all Intelligent Safety systems off prior to tow-starting/towing.

## Overview

### Button in the vehicle



 Intelligent Safety

### Camera

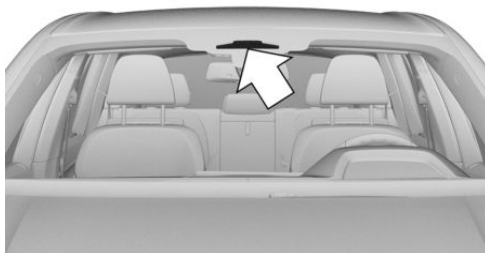

The camera is installed near the interior mirror.

Keep the windshield in front of the interior mirror clean and clear.

### Radar sensors

The radar sensors are located in the front bumper.



Front side bumper.

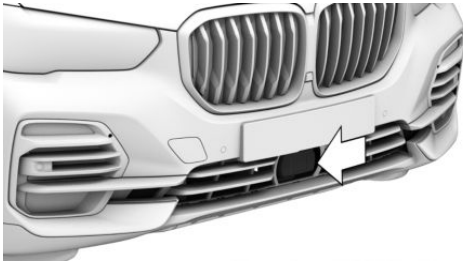

Front center bumper.

Keep the radar sensors clean and unobstructed.

## Switching on/off

### Switching on automatically

The system is automatically active after every driving off.

### Switching on/off manually



Press the button.

The menu for the intelligent safety system is displayed.

If all Intelligent Safety systems were switched off, all systems are now switched on.

"Configure INDIVIDUAL": depending on the equipment version, the Intelligent Safety systems can be individually configured. The individual settings are activated and stored for the driver profile currently used. As soon as a setting is changed on the menu, all settings of the menu are activated.



Press the button repeatedly.

The following settings are switched between:

"ALL ON": all Intelligent Safety systems are switched on. Basic settings are activated for the subfunctions.

"INDIVIDUAL": the Intelligent Safety systems are switched on according to the individual settings. Some Intelligent Safety systems cannot be individually switched off.



Press and hold this button.

All Intelligent Safety systems are switched off.

#### Button Status



Button lights up green: all Intelligent Safety systems are switched on.



Button lights up orange: some Intelligent Safety systems are switched off or currently unavailable.



Button does not light up: all Intelligent Safety systems are switched off.

### Setting the warning time

Via iDrive:



1. "CAR"
2. "Settings"
3. "Driver Assistance"
4. "Safety and warnings"
5. "Front collision warning"
6. Select desired setting:
  - ▷ "Early"
  - ▷ "Medium"
  - ▷ "Late": only acute warnings are displayed.

The selected time is stored for the driver profile currently used.

### Warning with braking function

#### Display

A warning symbol appears in the instrument cluster and in the Head-up Display, where available, if a collision with a detected vehicle is imminent.

Sym- bol	Measure
	Danger of collision with vehicle crossing from the right.
	Danger of collision with vehicle crossing from the left.
	Danger of collision with vehicle for which the direction of travel cannot be determined.
	<p>Prewarning:</p> <p>Symbol lights up red: prewarning for vehicles that cross your direction of travel.</p> <p>Intervene yourself, for instance by braking.</p>
	<p>Acute warning:</p> <p>Symbol flashes red and an acoustic signal sounds: acute warning when vehicles cross your direction of travel.</p> <p>Brake and make an evasive maneuver, if necessary.</p>

### Prewarning

For example, a prewarning is displayed when a danger of collision with a crossing vehicle is detected.

If a prewarning is provided, respond by braking as warranted.

### Acute warning with braking function

An acute warning is displayed in the event of an immediate danger of collision with a crossing vehicle.

If an acute warning is issued, intervene in the situation yourself. If necessary, the system provides assistance, such as with an automatic braking intervention, in a possible risk of collision.

Acute warnings can also be triggered without previous forewarning.

### Braking intervention

The warning prompts the driver to react.

The system can assist with automatic braking intervention if there is a risk of a collision.

The braking intervention can bring the vehicle to a complete stop.

The braking intervention occurs only if vehicle stability has not been restricted, for instance by deactivating the DSC Dynamic Stability Control.

The driver may cancel the braking intervention by stepping on the accelerator pedal or by actively moving the steering wheel.

Object detection can be restricted. Follow the limitations of the detection range and functional limitations.

### System limits

#### Safety information

#### WARNING

The system can react not at all, too late, incorrectly, or without justification due to the system limits. There is a risk of accidents or risk of damage to property. Follow the information regarding the system limits and actively intervene if needed.

### Upper speed limit

The system responds to crossing vehicles when your own speed is below approx. 50 mph/80 km/h.

## Detection range

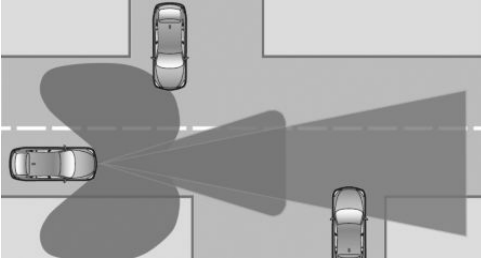

The system's detection potential is limited. Thus, a system reaction might not come or might come late.

The following situations may not be detected, for instance:

- ▷ Crossing vehicles when they are hidden by buildings, for instance.
- ▷ Vehicles that suddenly swerve in front of you, or sharply decelerating vehicles.
- ▷ Crossing bicycles.
- ▷ Vehicles with an unusual side appearance.

## Functional limitations

The system may not be fully functional in the following situations:

- ▷ In heavy fog, wet conditions, or snowfall.
- ▷ In tight curves.
- ▷ If the driving stability control systems are limited or deactivated, for instance DSC OFF.
- ▷ If the field of view of the camera or the windshield is dirty or covered in the area of the interior mirror.
- ▷ If the camera has overheated and been temporarily switched off due to excessively high temperatures.
- ▷ If the radar sensors are dirty or covered.
- ▷ Up to 10 seconds after the start of the engine via the Start/Stop button.
- ▷ During calibration of the camera immediately after vehicle delivery.

- ▷ If there are constant blinding effects because of oncoming light, for instance from the sun low in the sky.

## Warning sensitivity

The more sensitive the warning settings are, for example the warning time, the more warnings are displayed. Therefore, there may also be an excess of premature or unjustified warnings and reactions.

## Person warning with City light braking function

### Concept

The system can help prevent accidents involving pedestrians and cyclists. If an accident cannot be prevented, the system will help reduce the impact speed.

The system sounds a warning in the city speed range before an imminent collision and activates brakes independently, if needed.

### General information

The system issues a warning of a possible risk of collision with pedestrians and cyclists at speeds above approx. 3 mph/5 km/h.

The system reacts to pedestrians and cyclists who are within the detection range of the system.

Depending on the equipment version, the system is controlled by the following sensors:

- ▷ Camera in the area of the interior mirror.
- ▷ Radar sensor in the front bumper.

## Detection range

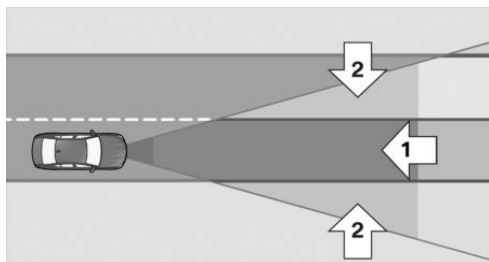

The detection area in front of the vehicle is divided into two areas:

- ▶ Central area, arrow 1, directly in front of the vehicle.
- ▶ Expanded area, arrow 2, to the right and left of the central area.

A collision is imminent if pedestrians are located within the central area. A warning is issued about pedestrians who are located within the extended area only if they are moving in the direction of the central area.

## Safety information

### **! WARNING**

The system cannot serve as a substitute for the driver's personal judgment in assessing visibility and traffic situation. There is a risk of an accident. Adjust driving style to traffic conditions. Watch traffic closely and actively intervene where appropriate.

### **! WARNING**

Indicators and warnings cannot serve as a substitute for the driver's personal judgment. Due to its limits, the system might not output warnings or reactions or these might be output late, incorrectly, or without justification. There is a risk of an accident. Adjust driving style to traffic conditions. Watch traffic closely and actively intervene where appropriate.

### **! WARNING**

Due to system limits, individual functions can malfunction during tow-starting/towing with the Intelligent Safety systems activated. There is a risk of an accident. Switch all Intelligent Safety systems off prior to tow-starting/towing.

## Overview

### Button in the vehicle



 Intelligent Safety

### Camera

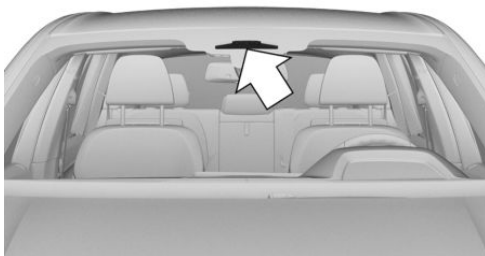

The camera is installed near the interior mirror. Keep the windshield in front of the interior mirror clean and clear.



## With radar sensor

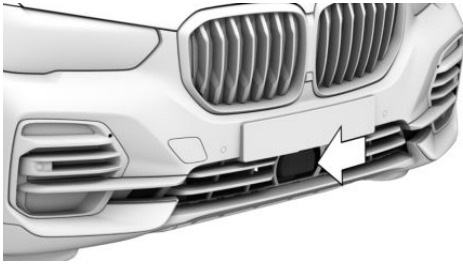

The radar sensor is located in the lower area of the front bumper.

Always keep radar sensor clean and unobstructed.

## Switching on/off

### Switching on automatically

The system is automatically active after every driving off.

### Switching on/off manually



Press the button.

The menu for the intelligent safety system is displayed.

If all Intelligent Safety systems were switched off, all systems are now switched on.

"Configure INDIVIDUAL": depending on the equipment version, the Intelligent Safety systems can be individually configured. The individual settings are activated and stored for the driver profile currently used. As soon as a setting is changed on the menu, all settings of the menu are activated.



Press the button repeatedly.

The following settings are switched between:

"ALL ON": all Intelligent Safety systems are switched on. Basic settings are activated for the subfunctions.

"INDIVIDUAL": the Intelligent Safety systems are switched on according to the individual settings. Some Intelligent Safety systems cannot be individually switched off.



Press and hold this button.

All Intelligent Safety systems are switched off.

### Button Status



Button lights up green: all Intelligent Safety systems are switched on.



Button lights up orange: some Intelligent Safety systems are switched off or currently unavailable.



Button does not light up: all Intelligent Safety systems are switched off.

## Warning with braking function

### Display

If a collision with a pedestrian or a cyclist is imminent, a warning symbol appears on the instrument cluster and in the Head-up Display.



The red symbol is displayed and a signal sounds.

Intervene immediately by braking or make an evasive maneuver.

### Braking intervention

The warning prompts the driver to react. During a warning, the maximum braking force is used when the brake is actuated. Prerequisite for the brake booster is sufficiently quick and hard stepping on the brake pedal.

If there is a risk of collision, the system may also assist with braking.

When the vehicle is traveling at a low speed, the vehicle may come to a complete stop.



The braking intervention occurs only if vehicle stability has not been restricted, for instance by deactivating the DSC Dynamic Stability Control.

The driver may cancel the braking intervention by stepping on the accelerator pedal or by actively moving the steering wheel.

Object detection can be restricted. Follow the limitations of the detection range and functional limitations.

## System limits

### Safety information

#### WARNING

The system can react not at all, too late, incorrectly, or without justification due to the system limits. There is a risk of accidents or risk of damage to property. Follow the information regarding the system limits and actively intervene if needed.

### Upper speed limit

The system responds to pedestrians and cyclists when the speed of the vehicle is below approx. 50 mph/80 km/h.

### Detection range

The system's detection potential is limited.

Thus, a warning might not be issued or be issued late.

The following situations may not be detected, for instance:

- ▷ Partially covered pedestrians.
- ▷ Pedestrians that are not detected as such because of the viewing angle or contour.
- ▷ Pedestrians outside of the detection range.
- ▷ Pedestrians having a body size less than 32 in/80 cm.

### Functional limitations

The system may not be fully functional or may not be available in the following situations:

- ▷ In heavy fog, wet conditions, or snowfall.
- ▷ In tight curves.
- ▷ If the driving stability control systems are deactivated, for instance DSC OFF.
- ▷ If the field of view of the camera or the windshield is dirty or covered in the area of the interior mirror.
- ▷ If the camera has overheated and been temporarily switched off due to excessively high temperatures.
- ▷ Depending on the equipment: if the radar sensors are dirty or covered.
- ▷ Up to 10 seconds after the start of the engine via the Start/Stop button.
- ▷ During calibration of the camera immediately after vehicle delivery.
- ▷ If there are constant blinding effects because of oncoming light, for instance from the sun low in the sky.
- ▷ When it is dark outside.

## Night Vision with pedestrian and animal detection

### Concept

Night Vision with pedestrian and animal detection is a night vision system.

An infrared camera scans the area in front of the vehicle and issues a warning if it detects pedestrians and animals on the street. The system detects warm objects that are similar in shape to human beings or animals. If necessary, the thermal image can be displayed on the Control Display.

## General information

### Thermal image

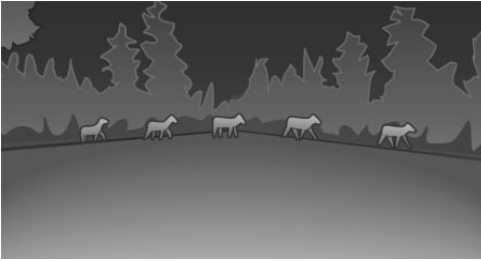

The image shows the heat radiated by objects in the field of view of the camera.

Warm objects have a light appearance and cold objects a dark appearance.

The ability to detect an object depends on the temperature difference between the object and the background and on the level of heat radiation emitted by the object. Objects that are similar in temperature to the environment or that radiate very little heat are difficult to detect.

For safety reasons, when driving at speeds above approx. 3 mph/5 km/h and in low ambient light, the image is only displayed when the low beams are switched on.

A still image is displayed at regular intervals for a fraction of a second.

### Pedestrian and animal detection



Object detection and warning only functions in darkness.

Objects whose form is similar to people with sufficient heat radiation are detected.

In addition, the system also detects animals above a certain minimum size, for instance deer.

Display on the Control Display with thermal image activated:

- ▷ People detected by the system: in light yellow.
- ▷ Animals detected by the system: in dark yellow.

Range of object detection, with good ambient conditions:

- ▷ Pedestrian detection: up to approx. 330 ft/100 m.
- ▷ Detection of large animals: up to approx. 490 ft/150 m.
- ▷ Detection of medium animals: up to approx. 230 ft/70 m.

Environmental influences can limit the availability of object detection.

If the vehicle systems detect that the vehicle is located in a residential area, the animal detection is temporarily switched off.

## Safety information

### WARNING

The system cannot serve as a substitute for the driver's personal judgment in assessing visibility and traffic situation. There is a risk of an accident. Adjust driving style to traffic conditions. Watch traffic closely and actively intervene where appropriate.

### WARNING

Indicators and warnings cannot serve as a substitute for the driver's personal judgment. Due to its limits, the system might not output warnings or reactions or these might be output late, incorrectly, or without justification. There is a risk of an accident. Adjust driving style to traffic

conditions. Watch traffic closely and actively intervene where appropriate.

## Overview

### Buttons in the vehicle



 Intelligent Safety



 Thermal image

### Camera

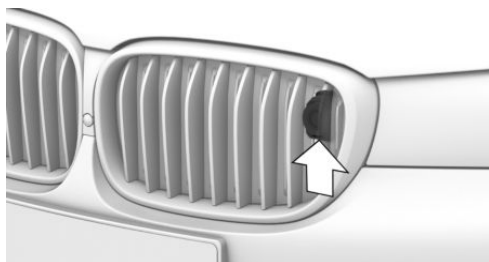

The camera is automatically heated when the external temperatures are low.

When the vehicle lighting is switched on, the camera objective is cleaned at regular intervals when the windshield washer system, refer to page 141, is activated.

## Switching on

### Switching on automatically

When it is dark outside, the system is automatically active after every driving off.

### Switching on the thermal image

The thermal image from the Night Vision camera can be displayed on the Control Display in addition to the warning function. This function has no effect on object detection.





Press the button.

The image from the camera is displayed on the Control Display.

### Adjusting the thermal image



Brightness and contrast can be adjusted, when the thermal image is switched on.

Via iDrive:

1. Select brightness or contrast:
  - ▶  "Brightness".
  - ▶  "Contrast".
2. Set the desired value.

## Warning function

### Display

Symbol	Meaning
	Person warning.
	Animal warning.

Symbol	Meaning
Symbol lights up red.	Prewarning.
Symbol flashes red and a signal sounds.	Acute warning.

The displayed symbol may vary and shows the side of the road on which the person or animal was detected.

## Warning of people or animals in danger

If a collision with a person or an animal detected in this way is imminent, a warning symbol appears on the instrument cluster and in the Head-up Display.

Although both the shape and the heat radiation are analyzed, false warnings cannot be ruled out.

## Warning area in front of the vehicle

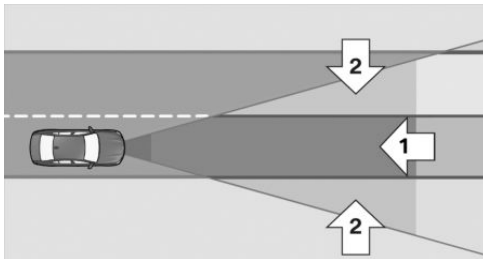

The warning area for the person warning consists of two parts:

- ▶ Central area, arrow 1, directly in front of the vehicle.
- ▶ Expanded area, arrow 2, to the right and left of the central area.

With animal warnings, no distinction is made between the central or expanded area.

The entire area moves along with the vehicle in the direction of the steering angle and changes with the vehicle speed. As the vehicle speed increases, the area becomes, for instance longer and wider.

## Prewarning

Prewarning for persons is displayed when a person is detected in the central area immediately in front of the vehicle as well as on the left or right side in the extended area.

Prewarning for animals is displayed when an animal is detected in the front of the vehicle.

If a prewarning is issued, intervene by braking or making an evasive maneuver.

## Acute warning

Acute warning is displayed if a person or an animal is detected in direct proximity in front of the vehicle.

If an acute warning is issued, brake or make an evasive maneuver immediately.

## Display in the Head-up Display

The warning is displayed simultaneously in the Head-up Display and on the instrument cluster.

## System limits

### Basic limits

The system may not be fully functional in the following situations:

- ▶ On steep hills, in steep depressions or in tight curves.
- ▶ If the camera is soiled or damaged.
- ▶ In heavy fog, wet conditions, or snowfall.
- ▶ At very high external temperatures.

### Limits of pedestrian and animal detection

In some situations, it may occur that pedestrians are detected as animals or animals as pedestrians.

Small animals are not detected by the object detection function, even if they are clearly visible in the image.

Limited detection, for instance in the following circumstances:

- ▶ People or animals who are fully or partially covered, especially when their heads are covered.
- ▶ People who are not in an upright position, for instance lying down.
- ▶ Cyclists on unconventional bicycles (e.g., recumbent bicycles).
- ▶ After physical damage to the system, for instance after an accident.

## Lane departure warning

### Concept

The lane departure warning alerts when the vehicle is about to run off the road or exit the lane.

### General information

This camera-based system warns starting at a minimum speed.

The minimum speed is country-specific and is displayed in the menu for the Intelligent Safety systems.

Warnings are issued by means of a steering wheel vibration. The severity of the steering wheel vibration can be adjusted.

The system does not provide a warning if the turn signal is set before leaving the lane.

If in the speed range up to 130 mph/210 km/h a lane marking is crossed, the system intervenes with a brief active steering intervention in addition to vibrating. The system thus helps keep the vehicle in the lane.

### Safety information

#### **! WARNING**

The system cannot serve as a substitute for the driver's personal judgment in assessing road and traffic safety. There is a risk of an accident. Adjust driving style to traffic conditions. Watch traffic closely and actively intervene where ap-

propriate. Do not jerk the steering wheel in response to a warning.

#### **! WARNING**

Indicators and warnings cannot serve as a substitute for the driver's personal judgment. Due to its limits, the system might not output warnings or reactions or these might be output late, incorrectly, or without justification. There is a risk of an accident. Adjust driving style to traffic conditions. Watch traffic closely and actively intervene where appropriate.

### Functional requirements

The camera must detect the lane markings for the lane departure warning to be active.

### Overview

#### Button in the vehicle



 Intelligent Safety

## Camera

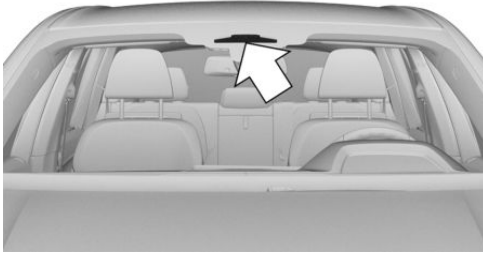

The camera is installed near the interior mirror. Keep the windshield in front of the interior mirror clean and clear.

## Switching on/off

### Switching on automatically

The lane departure warning activates automatically after departure if the function was switched on at the end of the last trip.

### Switching on/off manually



Press the button.

The menu for the intelligent safety system is displayed.

If all Intelligent Safety systems were switched off, all systems are now switched on.

"Configure INDIVIDUAL": depending on the equipment version, the Intelligent Safety systems can be individually configured. The individual settings are activated and stored for the driver profile currently used. As soon as a setting is changed on the menu, all settings of the menu are activated.



Press the button repeatedly.

The following settings are switched between:

"ALL ON": all Intelligent Safety systems are switched on. Basic settings are activated for the subfunctions.

"INDIVIDUAL": the Intelligent Safety systems are switched on according to the individual settings. Some Intelligent Safety systems cannot be individually switched off.



Press and hold this button.

All Intelligent Safety systems are switched off.

### Button Status



Button lights up green: all Intelligent Safety systems are switched on.



Button lights up orange: some Intelligent Safety systems are switched off or currently unavailable.



Button does not light up: all Intelligent Safety systems are switched off.

## Setting the warning time

Via iDrive:

1. "CAR"
2. "Settings"
3. "Driver Assistance"
4. "Safety and warnings"
5. "Lane Departure Warning"
6. Select desired setting:
  - ▷ "Early": the system promptly issues a warning whenever a hazardous situation is detected.
  - ▷ "Medium": the system meets the standardized safety requirements.
  - ▷ "Reduced": some warnings are suppressed depending on the situation, for instance during passing without a turn signal or when purposely driving over lane markings in curves.
  - ▷ "Off": no warnings are issued.

The selected setting is stored for the driver profile currently used.



## Setting the force of the steering wheel vibration

Via iDrive:

1. "CAR"
2. "Settings"
3. "Driver Assistance"
4. "Feedback on the steering wheel"
5. Select the desired setting.

The setting is applied to all Intelligent Safety systems and stored for the driver profile currently used.

## Switching steering intervention on/off

The steering intervention can be switched on and off separately for Active Blind Spot Detection and lane departure warning.

Via iDrive:

1. "CAR"
2. "Settings"
3. "Driver Assistance"
4. "Safety and warnings"
5. "Lane Departure Warning"
6. "Steering intervention"

The selected setting is stored for the driver profile currently used.

## Display in the instrument cluster



The system illuminates green: at lane marking was detected on at least one side of the vehicle and warnings can be issued.

## Warning function

### If you leave the lane

If you leave the lane and if a lane marking has been detected, the steering wheel vibrates in ac-

cordance with the steering wheel vibration setting.

If the turn signal is switched on before a lane change, a warning is not issued.

## Steering intervention

If in the speed range up to 130 mph/210 km/h a lane marking is crossed, the system intervenes with a brief active steering intervention in addition to vibrating. The steering intervention helps keep the vehicle in the lane. The steering intervention can be noticed on the steering wheel and can be manually overridden at any time. During an active steering intervention, the display in the instrument cluster will blink.

## Warning signal

In the event of multiple active steering interventions by the system within 3 minutes without the driver's intervention at the steering wheel, an acoustic warning will sound. A short warning signal will sound at the second steering intervention. Beginning with the third steering intervention, an continuous warning will sound.

In addition, a Check Control message is displayed.

The warning signal and Check-Control message are an encouragement to pay closer attention to the lane.

## With trailer towing

If the trailer power socket is in use or trailer towing is activated, for instance during operation with trailer or bicycle rack, no steering intervention takes place.

## End of warning

The warning is canceled in the following situations:

- ▷ Automatically after approx. 3 seconds.
- ▷ When returning to your own lane.
- ▷ When braking hard.
- ▷ When using the turn signal.



- ▶ If DSC Dynamic Stability Control intervenes.

## System limits

### Safety information

#### WARNING

The system can react not at all, too late, incorrectly, or without justification due to the system limits. There is a risk of accidents or risk of damage to property. Follow the information regarding the system limits and actively intervene if needed.

### Functional limitations

The system may not be fully functional in the following situations:

- ▶ In heavy fog, wet conditions, or snowfall.
- ▶ In the event of missing, worn, poorly visible, merging, diverging, or multiple lane markings such as in construction areas.
- ▶ When lane markings are covered in snow, ice, dirt or water.
- ▶ In tight curves or on narrow lanes.
- ▶ When lane markings are covered by objects.
- ▶ When driving very close to the vehicle in front of you.
- ▶ If there are constant blinding effects because of oncoming light, for instance from the sun low in the sky.
- ▶ If the field of view of the camera or the windshield is dirty or covered in the area of the interior mirror.
- ▶ If the camera has overheated and been temporarily switched off due to excessively high temperatures.
- ▶ Up to 10 seconds after the start of the engine via the Start/Stop button.
- ▶ During calibration of the camera immediately after vehicle delivery.

A Check Control message may be displayed when the system is not fully functional.

## Active Blind Spot Detection

### Concept

Active Blind Spot Detection detects vehicles in the blind spot or vehicles approaching from behind in the adjacent lane. A warning is issued in various gradations in these situations.

### General information

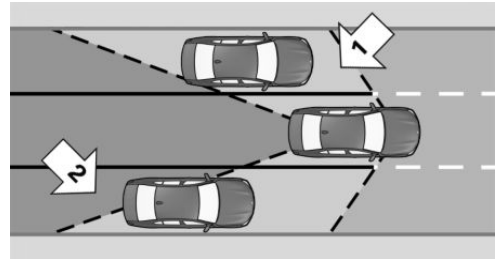

Two radar sensors in the rear bumper monitor the area behind and next to the vehicle when traveling faster than a minimum speed.

The minimum speed is shown in the menu for the Intelligent Safety systems.

The system indicates whether there are vehicles in the blind spot, arrow 1, or approaching from behind in the adjacent lane, arrow 2.

The light in the exterior mirror lights up dimmed.

Before you change lanes after setting the turn signal, the system issues a warning in the situations described above.

The light in the exterior mirror flashes and the steering wheel vibrates.

Vehicles with side collision warning: at speeds of up to 130 mph/210 km/h, the system can intervene with a brief active steering intervention and help guide the vehicle back into the lane. The steering intervention occurs when a minimum

speed is reached. This minimum speed is displayed on the Control Display in the menu for the steering intervention, refer to page 203.

## Safety information

### WARNING

The system cannot serve as a substitute for the driver's personal judgment in assessing visibility and traffic situation. There is a risk of an accident. Adjust driving style to traffic conditions. Watch traffic closely and actively intervene where appropriate.

### WARNING

Indicators and warnings cannot serve as a substitute for the driver's personal judgment. Due to its limits, the system might not output warnings or reactions or these might be output late, incorrectly, or without justification. There is a risk of an accident. Adjust driving style to traffic conditions. Watch traffic closely and actively intervene where appropriate.

## Overview

### Button in the vehicle



 Intelligent Safety

## Radar sensors

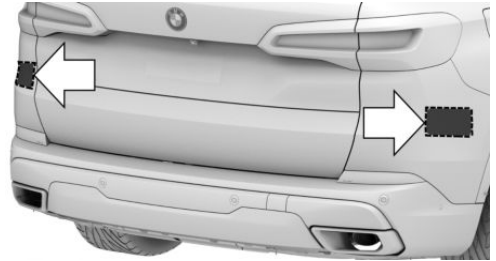

The radar sensors are located in the rear bumper.

Always keep the bumper in the area of the radar sensors clean and unobstructed.

## Switching on/off

### Switching on automatically

The Active Blind Spot Detection is automatically activated after departure if the function was switched on at the end of the last trip.

### Switching on/off manually

 Press the button.

The menu for the intelligent safety system is displayed.

If all Intelligent Safety systems were switched off, all systems are now switched on.

"Configure INDIVIDUAL": depending on the equipment version, the Intelligent Safety systems can be individually configured. The individual settings are activated and stored for the driver profile currently used. As soon as a setting is changed on the menu, all settings of the menu are activated.



 Press the button repeatedly.

The following settings are switched between:

"ALL ON": all Intelligent Safety systems are switched on. Basic settings are activated for the subfunctions.

"INDIVIDUAL": the Intelligent Safety systems are switched on according to the individual settings. Some Intelligent Safety systems cannot be individually switched off.

 Press and hold this button.  
All Intelligent Safety systems are switched off.

Button	Status
	Button lights up green: all Intelligent Safety systems are switched on.
	Button lights up orange: some Intelligent Safety systems are switched off or currently unavailable.
	Button does not light up: all Intelligent Safety systems are switched off.

## Setting the warning time

Via iDrive:

1. "CAR"
2. "Settings"
3. "Driver Assistance"
4. "Safety and warnings"
5. "Blind spot collision warning"
6. Select the desired setting.

"Off": with this setting, no warning is output.

The setting is stored for the driver profile currently used.

## Setting the force of the steering wheel vibration

Via iDrive:

1. "CAR"
2. "Settings"
3. "Driver Assistance"
4. "Feedback on the steering wheel"
5. Select the desired setting.

The setting is applied to all Intelligent Safety systems and stored for the driver profile currently used.

## Vehicles with side collision warning: switching steering intervention on/off

The steering intervention can be switched on and off separately for Active Blind Spot Detection and lane departure warning.

Via iDrive:

1. "CAR"
2. "Settings"
3. "Driver Assistance"
4. "Safety and warnings"
5. "Blind spot collision warning"
6. "Steering intervention"

The setting is stored for the driver profile currently used.

## Warning function

### Light in the exterior mirror



### Prewarning

The dimmed light in the exterior mirror indicates when there are vehicles in the blind spot or approaching from behind.

### Acute warning

If the turn signal is switched on while a vehicle is in the critical zone, the steering wheel vibrates



briefly and the light in the exterior mirror flashes brightly.

The warning stops when the other vehicle has left the critical area or after deactivation of the turn signal.

## Vehicles with side collision warning

If there is no response to the vibration of the steering wheel at speeds of up to 130 mph/210 km/h and the lane marking is crossed, the system intervenes with a brief active steering intervention. The steering intervention helps return the vehicle into the lane. The steering intervention can be noticed on the steering wheel and can be manually overridden at any time.

## Flashing of the light

A flashing of the light during vehicle unlocking serves as system self-test.

## System limits

### Safety information

#### **WARNING**

The system can react not at all, too late, incorrectly, or without justification due to the system limits. There is a risk of accidents or risk of damage to property. Follow the information regarding the system limits and actively intervene if needed.

## Upper speed limit

If the vehicle speed exceeds approx. 155 mph/250 km/h, the system is deactivated temporarily.

If the vehicle speed falls below approx. 155 mph/250 km/h, the system once again responds according to the setting.

## Functional limitations

The system may not be fully functional in the following situations:

- ▶ When a vehicle is approaching at a speed much faster than your own.
- ▶ In heavy fog, wet conditions, or snowfall.
- ▶ In tight curves or on narrow lanes.
- ▶ If the bumper is dirty, iced up, or covered, for instance by stickers.
- ▶ If cargo protrudes.

For vehicles with side collision warning, the steering intervention can be limited, for instance in the following situation:

- ▶ In the event of missing, worn, poorly visible, merging, diverging, or multiple lane markings such as in construction areas.
- ▶ When lane markings are covered in snow, ice, dirt or water.
- ▶ When lane markings are not white.
- ▶ When lane markings are covered by objects.
- ▶ When driving very close to the vehicle in front of you.
- ▶ If there are constant blinding effects because of oncoming light, for instance from the sun low in the sky.
- ▶ If the field of view of the camera or the windshield is dirty or covered in the area of the interior mirror.
- ▶ If the camera has overheated and been temporarily switched off due to excessively high temperatures.
- ▶ Up to 10 seconds after the start of the engine via the Start/Stop button.
- ▶ During calibration of the camera immediately after vehicle delivery.

A Check Control message is displayed when the system is not fully functional.

If the trailer power socket is in use or trailer towing is activated, for instance during operation with trailer or bicycle rack, the system cannot be

switched on. A Check Control message is displayed.

## Displaying warnings

Depending on the selected warning settings, for instance warning time, more warnings can be displayed. However, there may also be an excess of premature warnings of critical situations.

## Side collision warning

### Concept

The system helps to avoid imminent side collisions.

### General information

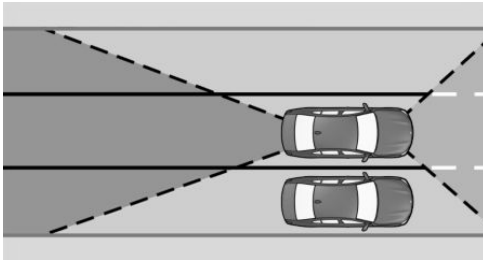

Four radar sensors in the bumpers monitor the space next to the vehicle from a minimum speed of up to approx. 130 mph/210 km/h.

The minimum speed is country-specific and is displayed in the menu for the Intelligent Safety systems.

The front camera determines the lane marking positions.

If, for instance another vehicle is detected next to the vehicle and if there is a risk of collision with this vehicle, the system helps avoid the collision. For this purpose, the system issues a warning with a flashing LED in the exterior mirror, a vibrating steering wheel. If necessary, the system will carry out an active steering intervention.

## Safety information

### WARNING

The system cannot serve as a substitute for the driver's personal judgment in assessing visibility and traffic situation. There is a risk of an accident. Adjust driving style to traffic conditions. Watch traffic closely and actively intervene where appropriate.

### WARNING

Indicators and warnings cannot serve as a substitute for the driver's personal judgment. Due to its limits, the system might not output warnings or reactions or these might be output late, incorrectly, or without justification. There is a risk of an accident. Adjust driving style to traffic conditions. Watch traffic closely and actively intervene where appropriate.

## Functional requirements

The camera must detect the lane markings for the side collision warning with steering intervention to be active.

## Overview

### Button in the vehicle



 Intelligent Safety

## Radar sensors

The radar sensors are located in the bumpers.



Front bumper.

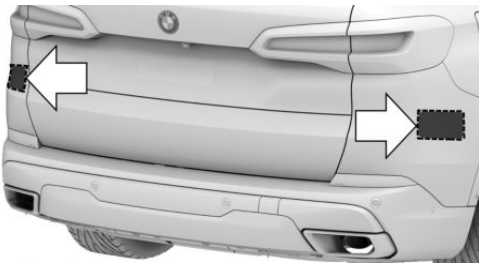

Rear bumper.

Always keep the bumper in the area of the radar sensors clean and unobstructed.

## Camera

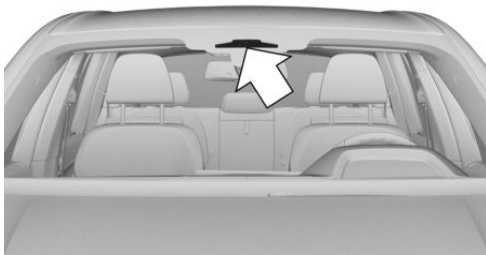

The camera is installed near the interior mirror.

Keep the windshield in front of the interior mirror clean and clear.

## Switching on/off

### Switching on automatically

The side collision warning activates automatically after departure if the function was switched on at the end of the last trip.

### Switching on/off manually



Press the button.

The menu for the intelligent safety system is displayed.

If all Intelligent Safety systems were switched off, all systems are now switched on.

"Configure INDIVIDUAL": depending on the equipment version, the Intelligent Safety systems can be individually configured. The individual settings are activated and stored for the driver profile currently used. As soon as a setting is changed on the menu, all settings of the menu are activated.



Press the button repeatedly.

The following settings are switched between:

"ALL ON": all Intelligent Safety systems are switched on. Basic settings are activated for the subfunctions.

"INDIVIDUAL": the Intelligent Safety systems are switched on according to the individual settings.

Some Intelligent Safety systems cannot be individually switched off.



Press and hold this button.

All Intelligent Safety systems are switched off.

**Button Status**

Button lights up green: all Intelligent Safety systems are switched on.



Button lights up orange: some Intelligent Safety systems are switched off or currently unavailable.



Button does not light up: all Intelligent Safety systems are switched off.

**Setting the force of the steering wheel vibration**

Via iDrive:

1. "CAR"
2. "Settings"
3. "Driver Assistance"
4. "Feedback on the steering wheel"
5. Select the desired setting.

The setting is applied to all Intelligent Safety systems and stored for the driver profile currently used.

**Warning function****Light in the exterior mirror****Acute warning**

If there is a risk of collision, the light in the exterior mirror flashes and the steering wheel vibrates.

If necessary, an active steering intervention then takes place to prevent collisions and maintain the vehicle within its own lane.

The steering intervention can be noticed on the steering wheel and can be manually overridden at any time.

A Check Control message is displayed during steering intervention.

**System limits****Safety information**** WARNING**

The system can react not at all, too late, incorrectly, or without justification due to the system limits. There is a risk of accidents or risk of damage to property. Follow the information regarding the system limits and actively intervene if needed.

**Functional limitations**

The system may not be fully functional in the following situations:

- ▷ When a vehicle is approaching at a speed much faster than your own.
- ▷ In heavy fog, wet conditions, or snowfall.
- ▷ In tight curves or on narrow lanes.
- ▷ If the bumper is dirty, iced up, or covered, for instance by stickers.
- ▷ If cargo protrudes.
- ▷ In the event of missing, worn, poorly visible, merging, diverging, or multiple lane markings such as in construction areas.
- ▷ When lane markings are covered in snow, ice, dirt or water.
- ▷ When lane markings are covered by objects.
- ▷ When driving very close to the vehicle in front of you.

- ▷ If there are constant blinding effects because of oncoming light, for instance from the sun low in the sky.
- ▷ If the field of view of the camera or the windshield is dirty or covered in the area of the interior mirror.
- ▷ If the camera has overheated and been temporarily switched off due to excessively high temperatures.
- ▷ Up to 10 seconds after the start of the engine via the Start/Stop button.
- ▷ During calibration of the camera immediately after vehicle delivery.

A Check Control message is displayed when the system is not fully functional.

If the trailer power socket is in use or trailer towing is activated, for instance during operation with trailer or bicycle rack, the system cannot be switched on. A Check Control message is displayed.

## Rear collision prevention

### Concept

The system reacts to vehicles approaching from behind.

### General information

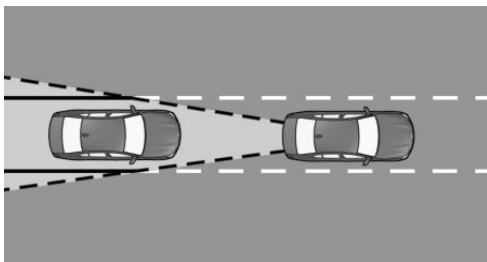

Two radar sensors in the rear bumper monitor the area behind the vehicle.

If a vehicle approaches from the rear at a certain speed, the system responds as follows:

- ▷ Active Protection, refer to page 210: if a collision seems to be unavoidable, PreCrash functions are triggered.

## Safety information

### **⚠ WARNING**

The system cannot serve as a substitute for the driver's personal judgment in assessing visibility and traffic situation. There is a risk of an accident. Adjust driving style to traffic conditions. Watch traffic closely and actively intervene where appropriate.

### **⚠ WARNING**

Indicators and warnings cannot serve as a substitute for the driver's personal judgment. Due to its limits, the system might not output warnings or reactions or these might be output late, incorrectly, or without justification. There is a risk of an accident. Adjust driving style to traffic conditions. Watch traffic closely and actively intervene where appropriate.

## Overview

### Radar sensors

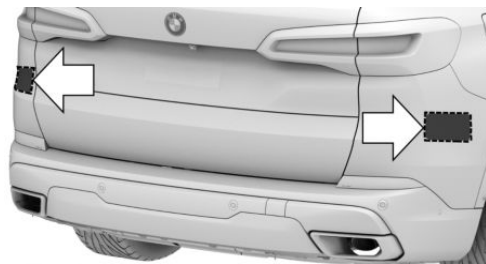

The radar sensors are located in the rear bumper.

Always keep the bumper in the area of the radar sensors clean and unobstructed.



## Switching on/off

The system is automatically active after every driving off.

The system is deactivated in the following situations:

- ▷ When driving in reverse.
- ▷ If the trailer power socket is in use or trailer towing is activated, for instance during operation with trailer or bicycle rack.

## System limits

The system may not be fully functional in the following situations:

- ▷ When a vehicle is approaching at a speed much faster than your own.
- ▷ When the approaching vehicle approaches slowly.
- ▷ In heavy fog, wet conditions, or snowfall.
- ▷ In tight curves or on narrow lanes.
- ▷ If the bumper is dirty, iced up, or covered, for instance by stickers.
- ▷ If cargo protrudes.

## Emergency Stop Assistant

### Concept

If the driver is no longer fit to drive, the system helps to safely bring the vehicle to a standstill.

### General information

On freeways or roads similar to freeways, the system steers the vehicle to the shoulder or breakdown lane on the side of the road. On other roads or under high traffic conditions, the vehicle is brought to a standstill on the actual road.

The emergency stop function is not triggered automatically. The emergency stop function can only be triggered manually by the occupants.

## Overview



 Parking brake

## Functional requirements

- ▷ The function can be activated from speeds of approx. 6 mph/10 km/h.
- ▷ Lane changes are carried out at speeds of approx. 43 mph/70 km/h to 62 mph/100 km/h.

## Activating the emergency stop function

- ▷  Pull the switch for the parking brake briefly to activate the emergency stop function.
- ▷ After the switch is released, an automatic lane change may be initiated where required.
- ▷ The system will take control of the vehicle for a maximum of 2 minutes.
- ▷ The hazard warning system is switched on.
- ▷ An Emergency Request is triggered.

## Canceling the emergency stop function

The driver can cancel the emergency stop function by actively taking control of the vehicle throughout the entire process.

For instance, the emergency stop function will be canceled in the following situations:

- ▷ When steering.
- ▷ When using the turn signal.



- ▷ During acceleration.
- ▷ When switching off the hazard warning system.
- ▷ When canceling the Emergency Request.
- ▷ When switching the selector lever position at standstill.
- ▷ When the driver's foot remains on the accelerator pedal after the function has been triggered.
- ▷ When the switch of the parking brake is pressed.

## At standstill

As soon as the vehicle is stationary, the system will carry out the following settings:

- ▷ Selector lever position P is engaged.
- ▷ Parking brake is locked.
- ▷ Interior lights are switched on.
- ▷ Central locking system is unlocked.

## System limits

Use the system only in the event of a driver failure.

The system cannot replace the driving performance of a driver who is fit to drive.

## Active Protection

### Concept

Active Protection prepares occupants and the vehicle for a possible accident in critical driving or collision situations.

### General information

Active Protection consists of various PreCrash functions, which can vary depending on the equipment.

The system is used to detect certain critical driving situations that might lead to an accident. This includes the following critical driving situations:

- ▷ Emergency stop.
- ▷ Severe understeering.
- ▷ Severe oversteering.

Certain functions of several systems can - within the system limits - lead to Active Protection triggering:

- ▷ Approach control warning with braking function: automatic brake intervention.
- ▷ Approach control warning with braking function: brake booster.
- ▷ Night Vision with pedestrian and animal detection: brake booster.
- ▷ Rear collision prevention: detection of imminent rear collisions.

## Safety information

### WARNING

The system cannot serve as a substitute for the driver's personal judgment. Due to the system limits, critical situation could not be detected reliably or in time. There is a risk of an accident. Adjust driving style to traffic conditions. Watch traffic closely and actively intervene where appropriate.

## Function

When the safety belt is fastened, the driver's and passenger's belt straps are automatically tightened once after driving away.

In accident-critical situations, the following individual functions become active as needed:

- ▷ Automatic pretensioning of the front safety belts.
- ▷ Automatic window closing up to a narrow gap.
- ▷ Automatic closing of the panoramic glass sunroof, including sun protection.
- ▷ For vehicles equipped with comfort seats in the front: automatic positioning of the backrest for the front passenger seat.

After a critical driving situation without an accident, the front safety belts are loosened again.

If the belt tension does not loosen automatically, stop the vehicle and unbuckle the safety belt using the red button in the buckle. Fasten the safety belt before continuing on your trip.

All other systems can be restored to the desired setting.

## PostCrash – iBrake

### Concept

In the event of an accident, the system can bring the vehicle to a halt automatically without intervention by the driver in certain situations. This can reduce the risk of a further collision and the consequences thereof.

### At standstill

After coming to a halt, the brake is released automatically.

### Harder vehicle braking

It can be necessary to bring the vehicle in certain situations to a halt quicker.

To do this, for a short time the braking pressure applied when stepping on the brake pedal must be higher than the braking pressure achieved by the automatic braking function. This interrupts automatic braking.

### Interrupting automatic braking

It can be necessary to interrupt automatic braking in certain situations, for instance for an evasive maneuver.

Interrupt automatic braking:

- ▷ By pressing the brake pedal.
- ▷ By pressing the accelerator pedal.

## Alertness assistant

### General information

The system can detect decreasing alertness or fatigue of the driver during long, monotonous trips, for instance on highways. In this situation, it is recommended that the driver takes a break.

### Safety information

#### WARNING

The system cannot serve as a substitute for the driver's personal judgment in assessing one's physical state. An increasing lack of alertness or fatigue may not be detected or not be detected in time. There is a risk of an accident. Make sure that the driver is rested and alert. Adjust driving style to traffic conditions.

### Function

The system is switched on each time drive-ready state is switched on.

After travel has begun, the system monitors certain aspects of the driver's behavior, so that decreasing alertness or fatigue can be detected.

This procedure takes the following criteria into account:

- ▷ Personal driving style, for instance steering behavior.
- ▷ Driving conditions, for instance length of trip.
- ▷ Depending on the equipment: attention of the driver through the Driver Attention Camera.

Starting at approx. 43 mph/70 km/h, the system is active and can also display a recommendation to take a break.



## Break recommendation

### Settings

The alertness assistant is active automatically with each switching on of drive-ready state and can thus display a break recommendation.

The break recommendation can also be switched on or off and adjusted via iDrive.

Via iDrive:

1. "CAR"
2. "Settings"
3. "General settings"
4. "Fatigue and Focus Alert"
5. Select desired setting:
  - ▷ "Standard": the break recommendation is made with a defined value.
  - ▷ "Sensitive": the break recommendation is issued earlier.
  - ▷ "Off": no break recommendation is made.

### Display

If the driver becomes less alert or fatigued, a message is displayed in the Control Display with the recommendation to take a break.

During the display, the following settings can be selected:

- ▷ "Do not ask again"
- ▷ "Places to stop"
- ▷ "Remind me later"

The break recommendation is repeated after 20 minutes.

After a break, another recommendation to take a break cannot be displayed until after approximately 45 minutes.

### System limits

The function may be limited in the following situations, for instance and will either output an incorrect warning or no warning at all:

- ▷ When the clock is set incorrectly.

- ▷ When the vehicle speed is mainly below about 43 mph/70 km/h.
- ▷ With a sporty driving style, such as during rapid acceleration or when cornering fast.
- ▷ In active driving situations, such as when changing lanes frequently.
- ▷ When the road surface is poor.
- ▷ In the event of strong side winds.

The system is reset approx. 45 minutes after parking the vehicle, for instance in the case of a break during longer trips on highways.

# Driving stability control systems

## Vehicle features and options

---

This chapter describes all standard, country-specific and optional features offered with the series. It also describes features and functions that are not necessarily available in your vehicle, e.g., due to the selected options or country versions. This also applies to safety-related functions and systems. When using these functions and systems, the applicable laws and regulations must be observed.

## Anti-lock Braking System ABS

---

ABS prevents locking of the wheels during braking.

The vehicle maintains its steering power even during full brake applications, thus increasing active safety.

ABS is operational every time you start the engine.

## Brake assistant

---

When you apply the brakes rapidly, the system automatically produces the greatest possible braking force boost. It reduces the braking distance to a minimum during emergency stop. This system utilizes all of the capabilities provided by the Antilock Brake System ABS.

Do not reduce the pressure on the brake pedal for the duration of the emergency stop.

## Adaptive brake assistant

---

In combination with Active Cruise Control, this system ensures that the brakes respond even more rapidly when braking in critical situations.

## Drive-off assistant

---

### Concept

This system supports driving off on uphill grades.

### Driving off

1. Hold the vehicle in place with the foot brake.
2. Release the foot brake and drive off without delay.

After the foot brake is released, the vehicle is held in place for approx. 2 seconds.

Depending on the vehicle loading or when a trailer is used, the vehicle may roll back slightly.

## DSC Dynamic Stability Control

---

### Concept

Within the physical limits, the system helps to keep the vehicle on a steady course by reducing engine speed and by braking the individual wheels.

### General information

DSC detects the following unstable driving conditions, for instance:

- ▷ Fishtailing, which can lead to oversteering.
- ▷ Loss of traction of the front wheels, which can lead to understeering.

## Safety information

### WARNING

The system cannot serve as a substitute for the driver's personal judgment in assessing the traffic situation. Based on the limits of the system, it cannot independently react to all traffic situations. There is a risk of an accident. Adjust driving style to traffic conditions. Watch traffic closely and actively intervene where appropriate.

### WARNING

When driving with a roof load, for instance with roof-mounted luggage rack, the vehicle's center of gravity is higher, which increases the risk of the vehicle tipping in critical driving situations. There is a risk of accidents or risk of damage to property. Do not deactivate DSC Dynamic Stability Control when driving with roof load.

## Overview

### Button in the vehicle



DSC OFF

## Deactivating/activating DSC

### General information

When DSC is deactivated, driving stability is reduced during acceleration and when driving in curves.

To increase vehicle stability, activate DSC again as soon as possible.

### Deactivating DSC



Hold the button down until DSC OFF is displayed in the instrument cluster and the DSC OFF indicator light is illuminated.

### Activating DSC



Press the button. DSC OFF and the DSC OFF indicator light go out.

## Display

### In the instrument cluster

When DSC is deactivated, DSC OFF is displayed in the instrument cluster.

### Indicator/warning lights



The indicator light lights up: DSC is deactivated.



The indicator light flashes: DSC controls the drive and braking forces.

The indicator light lights up: DSC has malfunctioned.

## DTC Dynamic Traction Control

### Concept

DTC is a version of the DSC Dynamic Stability Control where forward momentum is optimized.

The system ensures maximum headway on special road conditions or loose road surfaces, for instance unplowed snowy roads, but with somewhat limited driving stability.

### General information

When DTC is activated, the vehicle has maximum traction. Driving stability is limited during acceleration and when driving in curves.

You may find it useful to briefly activate DTC in the following situations:

- ▷ When driving in slush or on uncleared, snow-covered roads.
- ▷ When driving off from deep snow or loose ground.
- ▷ When driving with snow chains.

### Overview

#### Button in the vehicle



DSC OFF

## Activating/deactivating DTC

### Activating DTC



Press the button.

TRACTION is displayed in the instrument cluster and the indicator light for DSC OFF lights up.

### Deactivating DTC



Press the button again.

TRACTION and the DSC OFF indicator light go out.

### Display

#### Display in the instrument cluster

If DTC is activated, TRACTION is displayed in the instrument cluster.

#### Indicator/warning lights



The indicator light lights up: DTC is activated.

### Automatic program change

In certain situations, the DSC is activated automatically:

- ▷ If Active Cruise Control with Stop&Go function ACC is activated.
- ▷ On a braking intervention by the Intelligent Safety systems.
- ▷ The vehicle has a flat tire.

## xDrive

### Concept

xDrive is the all-wheel-drive system of the vehicle. The interaction of xDrive and other suspension control systems, such as DSC Dynamic Stability Control, further optimizes traction and



driving dynamics. xDrive variably distributes the driving forces to the front and rear axles as demanded by the driving situation and road surface.

The Driving Dynamics Control is used to change the all-wheel distribution from traction oriented to sport oriented.

With the xOffroad package, the all-wheel-drive system is additionally adjusted for the respective xOffroad mode.

Because of the needs-based use of the all-wheel-drive system, Efficient4x4 yields a reduction in consumption.

## Display on the Control Display

### Display xView display

Via iDrive:

1. "CAR"
2. "Driving information"
3. "xOFFROAD"

The following information is displayed:

- ▶ With a navigation system: compass display for the driving direction.
- ▶ With navigation system: height indication for the current position.
- ▶ With navigation system: destination flag in compass direction to the destination.
- ▶ Pitch attitude with degree indication and percentage.
- ▶ Transverse gradient with degree indication.
- ▶ Graphic display for the steering angle.
- ▶ Level setting for the 2-axle air suspension.

With the xOffroad package, the following additional information can be displayed:

- ▶ With Surround View: depending on the speed, terrain-specific camera perspectives.
- ▶ xOffroad mode currently active.
- ▶ Distribution of drive torque to the wheels.

## Display in the Head-up Display

Some of the information can also be displayed in the Head-up Display.

## M sport differential

The active M differential provides for continuously variable locking of the rear axle differential depending on the driving situation. This prevents spinning of a single rear wheel and thereby provides optimal traction in any driving situation.

The driver is responsible adapting his or her driving style to the situation.

## Automatic Differential Brake

The system controls the driving force by automatic braking intervention on individual wheels. The function corresponds to a differential lock: the system detects if a wheel begins to spin, because of loose road surface, for instance and automatically brakes it.

The driving force is diverted to the wheel with better traction.

As a result, the engine force is transferred more efficiently to the wheels during accelerations.

## HDC Hill Descent Control

### Concept

Hill Descent Control, HDC, is a downhill control feature that controls the vehicle speed on steep downhill grades, for instance when driving on unpaved roads.

When the system is active, the vehicle moves at the speed set by the driver, without the driver having to depress the brake pedal.

While HTC is controlling the speed, the system automatically distributes the braking force to the



individual wheels. This improves vehicle drivability and stability. If necessary, the Antilock Brake System prevents the wheels from locking.

## General information

Hill Descent Control can be activated at speeds below approx. 25 mph/40 km/h.

Speeds can be set between approx.

2 mph/3 km/h and approx. 20 mph/30 km/h.

When the vehicle is moving downhill, the system reduces the speed to the set value, within the physical limits.

## Overview

### Button in the vehicle



HDC

## Activating HDC

 Press the button. The LED on the button lights up.

Speeds between approx. 2 mph/3 km/h and approx. 20 mph/30 km/h are adopted as the desired speed.

Emergency braking function, Active PDC: the emergency braking function, refer to page 239, is deactivated.

## Display in the instrument cluster

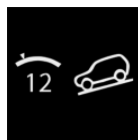

A symbol and the selected desired speed are displayed.

▶ Green display: HDC is active, the system is reducing the vehicle speed.

▶ Gray display: HDC is on standby.

## Display in the Head-up Display

The HDC status can also be displayed in the Head-up Display.

## Increasing or decreasing vehicle speed

### Using the cruise control rocker switch

The desired speed can be changed using the cruise control rocker switch on the steering wheel.



- ▶ Press the rocker switch up: the speed increases gradually.
- ▶ Press the rocker switch up and hold: the speed increases while the rocker switch is pressed.
- ▶ Press the rocker switch down: the speed decreases gradually.
- ▶ Press the rocker switch down and hold: the speed decreases while the rocker switch is pressed.



## Using the brake pedal

While HDC is controlling the speed, the set desired speed can be reduced by depressing the brake pedal.

## Deactivating HDC



Press the button again. The LED goes out. HDC is automatically deactivated above approx. 25 mph/40 km/h.

## Malfunction

If a malfunction occurs, a message is displayed in the instrument cluster.

## Integral Active Steering

### Concept

The Integral Active Steering increases the maneuverability and makes a more direct steering response possible.

### General information

Integral Active Steering is a combination of Active Steering and rear axle steering.

The variable steering ratio amplifies the steering angle when maneuvering, thus making the steering more direct. The rear axle steering acts to increase maneuverability at low speeds by turning the rear wheels slightly in the opposite direction to the front wheels.

At higher speeds, the rear wheels are turned in the same direction as the front wheels. This results in, for instance better directional stability and a more harmonious change of direction.

In critical driving situations, the Integral Active Steering can stabilize the vehicle through purposeful steering of the rear wheels before the driver intervenes, for instance in case of oversteering.

## Tuning

The system offers several different tunings.

Driving mode	Integral Active Steering
COMFORT	comfortable, for optimal travel comfort
ECO PRO	comfortable, for optimal travel comfort
SPORT	dynamic, for greater agility

The different tunings are assigned to the different driving modes of the Driving Dynamics Control, refer to page [148](#).

## Using snow chains

In order to guarantee free running of the wheels when operating with snow chains, rear axle steering of the integral active steering must be switched off when snow chains are mounted.

Set operation with snow chains, refer to page [348](#).

## Malfunction

In the event of a malfunction, the steering wheel must be turned further, while the vehicle responds more sensitively to steering wheel movements in the higher speed range.

The stability-enhancing intervention may be deactivated.

Proceed cautiously and drive defensively.

Have the system checked by a dealer's service center or another qualified service center or repair shop.

# Driver assistance systems

## Vehicle features and options

This chapter describes all standard, country-specific and optional features offered with the series. It also describes features and functions that are not necessarily available in your vehicle, e.g., due to the selected options or country versions. This also applies to safety-related functions and systems. When using these functions and systems, the applicable laws and regulations must be observed.

## Manual Speed Limiter

### Concept



The system can be used to set a speed limit, for instance to prevent the vehicle from exceeding speed limits.

### General information

The system can limit the speed, starting at a value of 20 mph/30 km/h. The vehicle can be driven at any speed below the set speed limit.

### Overview

#### Buttons on the steering wheel

Button	Function
	System on/off, refer to page 219.
	Store current speed.
	Rocker switch: Changing the speed limit, refer to page 220.

## Operation

### Switching on



Press the button on the steering wheel.

The current speed is accepted as the speed limit.

If the system is switched on while the vehicle is stationary or driving at low speeds, 20 mph/30 km/h is set as the speed limit.

The marking in the speedometer is set to the respective speed.

When the speed limit is switched on, DSC Dynamic Stability Control is switched on as well, if needed, and switches to COMFORT driving mode if applicable.

### Switching off



Press the button on the steering wheel.

The system switches off automatically in the following situations, for example:

- ▷ When the engine is switched off.
- ▷ When cruise control is switched on.
- ▷ Several programs can be activated via the Driving Dynamics Control.

The displays go out.

### Interrupting

If the reverse gear is engaged or idle, the system is interrupted.

## Changing the speed limit

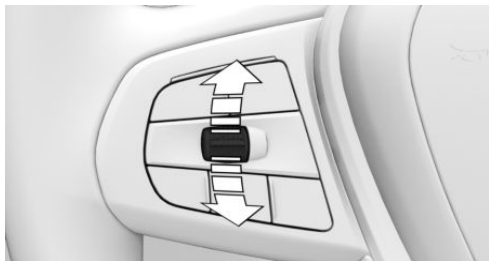

Press the rocker switch up or down repeatedly until the desired speed limit is set.

- ▶ Each time the rocker switch is pressed to the resistance point, the speed limit increases or decreases by 1 mph/1 km/h.
- ▶ Each time the rocker switch is pressed past the resistance point, the desired speed changes by a maximum of 5 mph/10 km/h.

If the set speed limit is reached or unintentionally exceeded, such as when driving downhill, the vehicle is not actively braked.

If the speed limit is set during a trip to a value below the current speed, the vehicle coasts until it drops to the set speed limit.

The current speed can also be stored by pressing a button:



Press the button on the steering wheel.

## Exceeding the speed limit

If the vehicle speed exceeds the set speed limit, a warning is issued.

The speed limit can be exceeded intentionally. There is no warning in this case.

Press the accelerator pedal all the way down to intentionally exceed the set speed limit.

When the vehicle speed drops below the set speed limit, the limit is automatically reactivated.

## Warning when the speed limit is exceeded

### Visual warning



If the speed limit is exceeded: the indicator light in the instrument cluster flashes while the vehicle speed is greater than the set speed limit.

### Acoustic warning

- ▶ If the speed limit is exceeded unintentionally, a signal sounds.
- ▶ If the speed limit is reduced to below the vehicle speed while driving, the signal sounds after some time.
- ▶ If the speed limit is intentionally exceeded by stepping on the accelerator pedal all the way down, there is no signal.

## Displays in the instrument cluster

### Display in the speedometer



- ▶ Green marking: system is active.
- ▶ Grey marking: system is interrupted.
- ▶ No marking: system is switched off.

### Indicator light



- ▶ The indicator light lights up: the system is switched on.
- ▶ The indicator light flashes: the set speed limit has been exceeded.
- ▶ Gray indicator light: the system has been interrupted.

## Cruise control

### Concept

Using this system, a desired speed can be adjusted using the buttons on the steering wheel. The system maintains the desired speed. The system accelerates and brakes automatically as needed.

### General information

Depending on the vehicle setting, the cruise control characteristic can change in certain ranges. For instance, the acceleration in ECO PRO driving mode is more gentle.

### Safety information

#### WARNING

The system cannot serve as a substitute for the driver's personal judgment in assessing the traffic situation. Based on the limits of the system, it cannot independently react to all traffic situations. There is a risk of an accident. Adjust driving style to traffic conditions. Watch traffic closely and actively intervene where appropriate.

#### WARNING

The use of the system can lead to an increased risk of accidents in the following situations, for instance:

- ▷ On winding roads.
- ▷ In heavy traffic.
- ▷ On slippery roads, in fog, snow, or wet conditions, or on a loose road surface.

There is a risk of accidents or risk of damage to property. Only use the system if driving at constant speed is possible.





#### WARNING

The desired speed can be incorrectly adjusted or called up by mistake. There is a risk of an accident. Adjust the desired speed to the traffic conditions. Watch traffic closely and actively intervene where appropriate.

### Overview

#### Buttons on the steering wheel

##### Button Function

	Cruise control on/off, refer to page <a href="#">221</a> .
	Continue cruise control with the last setting, refer to page <a href="#">222</a> .
	Pause cruise control, refer to page <a href="#">222</a> .
	Store current speed.
	Rocker switch: Set speed, refer to page <a href="#">222</a> .

### Switching cruise control on/off

#### Switching on

 Press the button on the steering wheel.

The indicator lights in the instrument cluster light up and the mark in the speedometer is set to the current speed.

Cruise control is active. The current speed is maintained and stored as desired speed.

DSC Dynamic Stability Control is switched on, if necessary.

#### Switching off

 Press the button on the steering wheel.

The displays go out. The stored desired speed is deleted.

## Pausing cruise control

### Interrupting manually

CANCEL

When active, press the button.

### Interrupting automatically

The system is automatically interrupted in the following situations, for example:

- ▶ When the driver applies the brakes.
- ▶ When selector lever position D is disengaged.
- ▶ Dynamic Traction Control DTC is activated or DSC Dynamic Stability Control is deactivated.
- ▶ If DSC Dynamic Stability Control intervenes.
- ▶ When SPORT PLUS is activated with Driving Dynamics Control.

## Setting the speed

### Maintaining and storing the speed

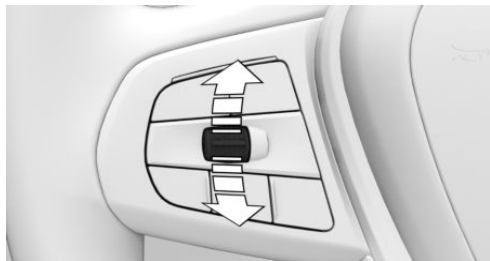

Press the rocker switch up or down once while the system is interrupted.

When the system is switched on, the current speed is maintained and stored as the desired speed.

The stored speed is displayed, refer to page 223, on the speedometer.

DSC Dynamic Stability Control is switched on, if necessary.

The speed can also be stored by pressing a button.

SET

Press the button.

### Changing the speed

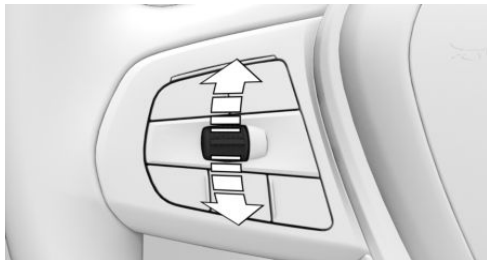

Press the rocker switch up or down repeatedly until the desired speed is set.

If active, the displayed speed is stored and the vehicle reaches the stored speed when the road is clear.

- ▶ Each time the rocker switch is pressed to the resistance point, the desired speed increases or decreases by 1 mph/1 km/h.
- ▶ Each time the rocker switch is pressed past the resistance point, the desired speed changes by a maximum of 5 mph/10 km/h. The maximum speed that can be set depends on the vehicle.
- ▶ Pressing the rocker switch to the resistance point and holding it accelerates or decelerates the vehicle without requiring pressure on the accelerator pedal.

After the rocker switch is released, the vehicle maintains its final speed. Pressing the switch beyond the resistance point causes the vehicle to accelerate more rapidly.

### Continuing cruise control

An interrupted cruise control can be continued by calling up the stored speed.

Make sure that the difference between current speed and stored speed is not too large before

calling up the stored speed. Otherwise, unintentional braking or accelerating may occur.

**RESUME** Press the button with the system interrupted.

Cruise control is continued with the stored values.

In the following cases, the stored speed value is deleted and cannot be called up again:

- ▷ When the system is switched off.
- ▷ When drive-ready state is switched off.

## Displays in the instrument cluster

### Display in the speedometer



- ▷ Green marking: system is active, the marking indicates the desired speed.
- ▷ Grey marking: system is interrupted, the marking indicates the stored speed.
- ▷ No marking: system is switched off.

### Indicator light



- ▷ Indicator light green: system is active.
- ▷ Gray indicator light: the system has been interrupted.
- ▷ No indicator light: system is switched off.

## Displays in the Head-up Display

Some system information can also be displayed in the Head-up Display.



The symbol is displayed when the set desired speed is reached.

## System limits

The desired speed is also maintained downhill. The speed may not be maintained on uphill grades if the engine power is insufficient.

In ECO PRO driving mode, the vehicle may exceed or drop below the set desired speed in some situations, for instance on downhill or uphill grades.

## Active Cruise Control with Stop & Go function ACC

### Concept

Using this system, a desired speed and a distance to a vehicle ahead can be adjusted using the buttons on the steering wheel.

The system maintains the desired speed on clear roads. For this purpose, the vehicle accelerates or brakes automatically.

If a vehicle is driving ahead of you, the system adjusts the speed of your vehicle so that the set distance to the vehicle ahead is maintained. The speed is adjusted as far as the given situation allows.

### General information

A radar sensor is located in the front bumper and a camera on the interior mirror to detect vehicles driving ahead of you.

Depending on the vehicle setting, the cruise control characteristic can change in certain ranges. For instance, the acceleration in ECO PRO driving mode is more gentle.

The distance can be adjusted in several steps. For safety reasons, it depends on the respective speed.

If the vehicle ahead of you brakes to a halt, and then proceeds to drive again within a brief period, the system is able to detect this within the given system limits.

## Safety information

### **WARNING**

The system cannot serve as a substitute for the driver's personal judgment in assessing the traffic situation. Based on the limits of the system, it cannot independently react to all traffic situations. There is a risk of an accident. Adjust driving style to traffic conditions. Watch traffic closely and actively intervene where appropriate.

### **WARNING**

An unsecured vehicle can begin to move and possibly roll away. There is a risk of an accident. Before exiting, secure the vehicle against rolling.

In order to ensure that the vehicle is secured against rolling away, follow the following:

- ▷ Set the parking brake.
- ▷ On uphill grades or on a downhill slope, turn the front wheels in the direction of the curb.
- ▷ On uphill grades or on a downhill slope, also secure the vehicle, for instance with a wheel chock.

### **WARNING**

The desired speed can be incorrectly adjusted or called up by mistake. There is a risk of an accident. Adjust the desired speed to the traffic conditions. Watch traffic closely and actively intervene where appropriate.

### **WARNING**







Risk of accident due to too high speed differences to other vehicles, for instance in the following situations:

- ▷ When fast approaching a slowly moving vehicle.
- ▷ Vehicle suddenly swerving into own lane.
- ▷ When fast approaching standing vehicles.

There is a risk of injuries or danger to life. Watch traffic closely and actively intervene where appropriate.

## Overview

### Buttons on the steering wheel

Button	Function
	With steering and lane control assistant: Cruise control on/off, refer to page <a href="#">225</a> .
	With steering and lane control assistant: Select function.
	Without steering and lane control assistant: Cruise control on/off, refer to page <a href="#">225</a> .
	Store current speed.
	With steering and lane control assistant: Pause cruise control, refer to page <a href="#">226</a> . Continue cruise control with the last setting, refer to page <a href="#">227</a> .
	Without steering and lane control assistant: Continue cruise control with the last setting, refer to page <a href="#">227</a> .



**Button Function**

Without steering and lane control assistant:

Pause cruise control, refer to page 226.



Increase distance, refer to page 227.

Switch distance control on/off.



Reduce distance, refer to page 227.

Switch distance control on/off.



Rocker switch:

Set speed, refer to page 226.

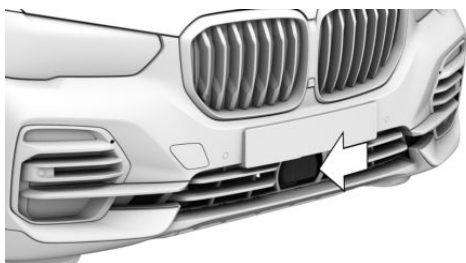
**Radar sensor**

The radar sensor is located in the front bumper.

Always keep radar sensor clean and unobstructed.

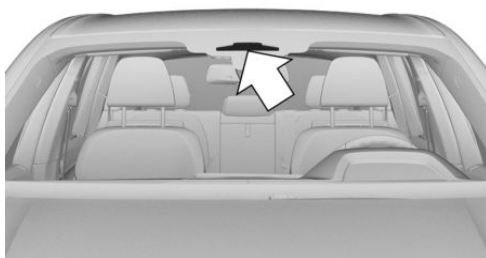
**Camera**

The camera is installed near the interior mirror.

Keep the windshield in front of the interior mirror clean and clear.

**Area of application**

The system is best used on well-constructed roads.

The minimum speed that can be set is 20 mph/30 km/h.

With steering and lane control assistant: the maximum speed setting is 115 mph/180 km/h.

Without steering and lane control assistant: the maximum speed setting is 100 mph/160 km/h.

The system can also be activated when stationary.

**Switching on/off and interrupting cruise control****With steering and lane control assistant: Assisted Driving****General information**

This button is used to switch the configured function on and off.



The button can be used to set the primary used function.

**Set function**

1.  When the system is active, press the button repeatedly until the desired function is selected in the function bar. The function bar for Assisted Driving is displayed at the bottom of the instrument cluster.



- ▶ Cruise control with distance control.





- ▶ Cruise control with distance control and steering and lane control assistant.

The selected function is shown in green.

The setting is stored for the driver profile currently used.

## Switching on

With steering and lane control assistant:

1.  Press the button on the steering wheel.
2.  If necessary, set the cruise control.

Without steering and lane control assistant:

 Press the button on the steering wheel.

The indicator lights in the instrument cluster light up and the mark in the speedometer is set to the current speed.

Cruise control is active. The current speed is maintained and stored as desired speed.

DSC Dynamic Stability Control is switched on, if necessary.

## Switching off

To switch off the system while standing, step on brake pedal at the same time.

Press the following button on the steering wheel again:

 Without steering and lane control assistant.

 With steering and lane control assistant.

The displays go out. The stored desired speed is deleted.

## Interrupting manually

When active, press the following button on the steering wheel:

 Without steering and lane control assistant.

 With steering and lane control assistant.

If interrupting the system while stationary, press on the brake pedal at the same time.

## Interrupting automatically

The system is automatically interrupted in the following situations:

- ▷ When the driver applies the brakes.
- ▷ When selector lever position D is disengaged.
- ▷ Dynamic Traction Control DTC is activated or DSC Dynamic Stability Control is deactivated.
- ▷ If DSC Dynamic Stability Control intervenes.
- ▷ If the safety belt is unbuckled and the driver's door is opened while the vehicle is standing still.
- ▷ If the system has not detected objects for an extended period, for instance on a road with very little traffic without curb or shoulder markings.
- ▷ If the detection range of the radar is impaired, for instance by dirt or heavy fog.
- ▷ After a longer stationary period when the vehicle has been braked to a stop by the system.

## Setting the speed

### Maintaining and storing the speed

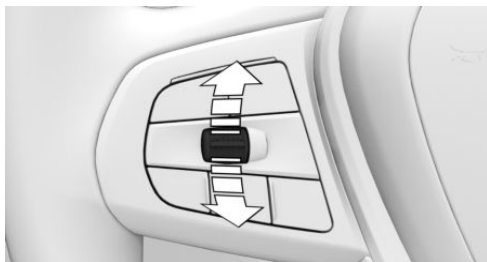

Press the rocker switch up or down once while the system is interrupted. The system will be activated.

The current speed is maintained and stored as desired speed.

The stored speed is displayed on the speedometer.

DSC Dynamic Stability Control is switched on, if necessary.

The speed can also be stored by pressing a button.



Press the button.

## Changing the speed



Press the rocker switch up or down repeatedly until the desired speed is set.

If active, the displayed speed is stored and the vehicle reaches the stored speed when the road is clear.

- ▶ Each time the rocker switch is pressed to the resistance point, the desired speed increases or decreases by 1 mph/1 km/h.
- ▶ Each time the rocker switch is pressed past the resistance point, the desired speed changes by a maximum of 5 mph/10 km/h.

Hold the rocker switch in position to repeat the action.

## Adjusting distance

### Safety information

#### **WARNING**

The system cannot serve as a substitute for the driver's personal judgment. Due to the system limits, braking can be late. There is a risk of accidents or risk of damage to property. Be aware to the traffic situation at all times. Adjust the distance to the traffic and weather conditions

and maintain the prescribed safety distance, possibly by braking.

### Reduce distance



Press the button repeatedly until the desired distance is set.

Instrument cluster will display selected distance, refer to page [228](#).

### Increase distance



Press the button repeatedly until the desired distance is set.

Instrument cluster will display selected distance, refer to page [228](#).

## Continuing cruise control

An interrupted cruise control can be continued by calling up the stored speed.

Make sure that the difference between current speed and stored speed is not too large before calling up the stored speed. Otherwise, unintentional braking or accelerating may occur.

Press the following button on the steering wheel with the system interrupted:



Without steering and lane control assistant.



With steering and lane control assistant.

Cruise control is continued with the stored values.

In the following cases, the stored speed value is deleted and cannot be called up again:

- ▶ When the system is switched off.
- ▶ When drive-ready state is switched off.

## Displays in the instrument cluster

### Display in the speedometer





- ▷ Green marking: system is active, the marking indicates the desired speed.
- ▷ Grey marking: system is interrupted, the marking indicates the stored speed.

▷ No marking: system is switched off.

### Distance to vehicle ahead of you

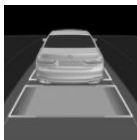
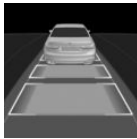
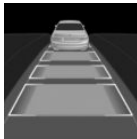
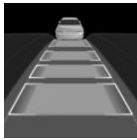
Selected distance to the vehicle ahead of you is shown.

Symbol	Description
	Distance 1
	Distance 2
	Distance 3
	Distance 4 This value is set automatically after the system is switched on.

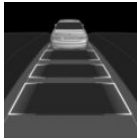
Symbol	Description
	System interrupted.
	No distance control display, as the accelerator pedal is being pressed.

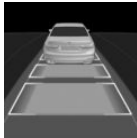

### Detected vehicle

Symbol	Description
	Green symbol: A vehicle has been detected ahead of you. The system maintains the set distance to the vehicle in front.

As soon as the detected vehicle drives off, the vehicle symbol in the distance indicator will move away.

To accelerate, activate ACC, for instance by briefly stepping on the accelerator pedal or pressing the rocker switch.

## Indicator/warning lights

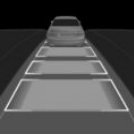
Symbol	Description
	Indicator light green: system is active. No indicator light: system is switched off.
	Vehicle symbol flashes: The conditions are not adequate for the system to work. The system was deactivated but applies the brakes until you actively resume control by pressing on the brake pedal or accelerator pedal.
	The vehicle symbol and distance bars flash red and an acoustic signal sounds: Brake and make an evasive maneuver, if necessary.

## Displays in the Head-up Display

### Desired speed

Some system information can also be displayed in the Head-up Display.



The symbol is displayed when the set desired speed is reached.

### Distance information



The symbol is displayed when the distance from the vehicle traveling ahead is too short.

The distance information is active in the following situations:

- ▷ Active Cruise Control switched off.
- ▷ Display in the Head-up Display selected, refer to page 165.
- ▷ Distance too short.

- ▷ Speed greater than approx. 40 mph/70 km/h.

## System limits

### Detection range

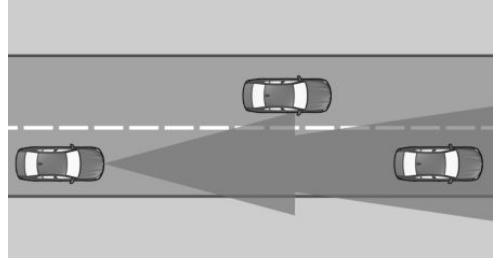

The detection capacity of the system and the automatic braking capacity are limited.

Two-wheeled vehicles for instance might not be detected.

### Deceleration

The system does not decelerate in the following situations:

- ▷ For pedestrians or similarly slow-moving road users.
- ▷ For red traffic lights.
- ▷ For cross traffic.
- ▷ For oncoming traffic.

### Swerving vehicles

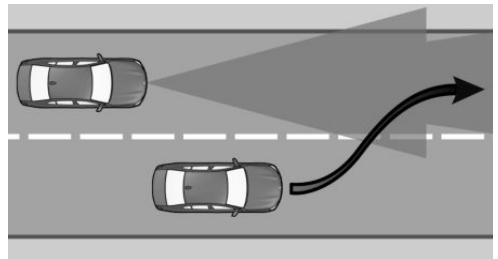

A vehicle driving in front of you is not detected until it is completely within the same lane as your vehicle.

If a vehicle driving ahead of you suddenly swerves into your lane, the system may not be able to automatically restore the selected distance. It may not be possible to restore the selected distance in certain situations, including if you are driving significantly faster than vehicles driving ahead of you, for instance when rapidly approaching a truck. When a vehicle driving ahead of you is reliably detected, the system requests that the driver intervene by braking and carrying out evasive maneuvers, if needed.

### Cornering

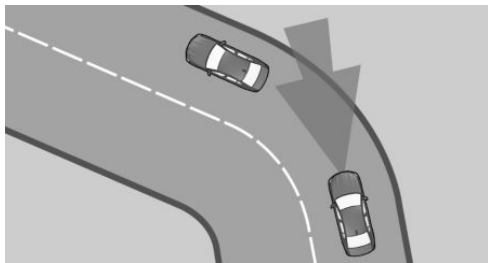

If the desired speed is too high for a curve, the speed is reduced slightly, although curves cannot be anticipated in advance. Therefore, drive into a curve at an appropriate speed.

The system has a limited detection range. Situations can arise in tight curves where a vehicle driving ahead will not be detected or will be detected very late.

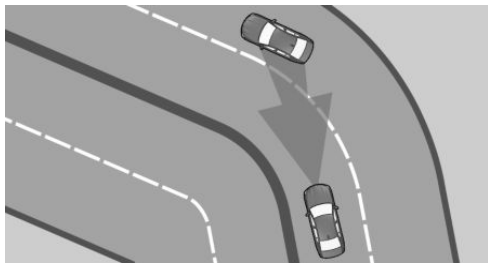

When you approach a curve the system may briefly report vehicles in the next lane due to the bend of the curve. If the system decelerates you may compensate it by briefly accelerating. After

releasing the accelerator pedal the system is re-activated and controls speed independently.

### Driving off

In some situations, the vehicle cannot drive off automatically; for example:

- ▷ On steep uphill grades.
- ▷ From bumps in the road.
- ▷ With a heavy trailer.

In these cases, step on the accelerator pedal.

### Weather

The following restrictions can occur under unfavorable weather or light conditions:

- ▷ Poorer vehicle recognition.
- ▷ Short-term interruptions for vehicles that are already recognized.

Examples of unfavorable weather or light conditions:

- ▷ Wet conditions.
- ▷ Snowfall.
- ▷ Slush.
- ▷ Fog.
- ▷ Glare.

Drive attentively, and react to the current traffic situation. If necessary, intervene actively, for instance by braking, steering or evading.

### Engine power

The desired speed is also maintained downhill. The speed may not be maintained on uphill grades if the engine power is insufficient.

In ECO PRO driving mode, the vehicle may intentionally exceed or drop below the set desired speed in some situations, for instance on downhill or uphill grades.

## Malfunction

### Radar sensor

The system cannot be activated if the radar sensor is not aligned correctly. This may be caused by damage incurred, for instance during parking.

A Check Control message is displayed if the system fails.

Have the system checked by a dealer's service center or another qualified service center or repair shop.

The system may be impaired when the detection range of the radar sensor is partially covered such as by the license plate holder.

### Camera

The function for detecting and responding when approaching stationary vehicles may be limited in the following situations:

- ▷ During calibration of the camera immediately after vehicle delivery.
- ▷ If the camera is malfunctioning or dirty. A Check Control message is displayed.

## Steering and lane control assistant

### Concept

The system assists the driver in keeping the vehicle within the lane. For this purpose, the system executes supporting steering movements, for instance when driving in a curve.

### General information

The system determines the position of the lane markings and the vehicle driving ahead using five radar sensors and a camera.

Depending on the speed, the system orients itself according to the lane markings or vehicles in front.

Sensors on the steering wheel detect whether the steering wheel is being touched.

## Safety information

### WARNING

The system cannot serve as a substitute for the driver's personal judgment in assessing the traffic situation. Based on the limits of the system, it cannot independently react to all traffic situations. There is a risk of an accident. Adjust driving style to traffic conditions. Watch traffic closely and actively intervene where appropriate.

## Overview

### Buttons on the steering wheel

#### Button Function



Steering and lane control assistant incl. Traffic Jam Assist on/off, refer to page 232.



Switch function on, refer to page 232.

### Radar sensors

The radar sensors are located in the bumpers.

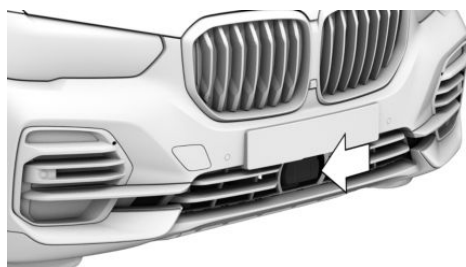

Front center bumper.

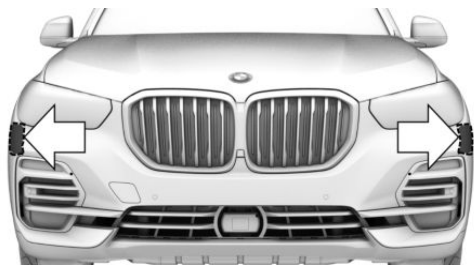

Front side bumper.

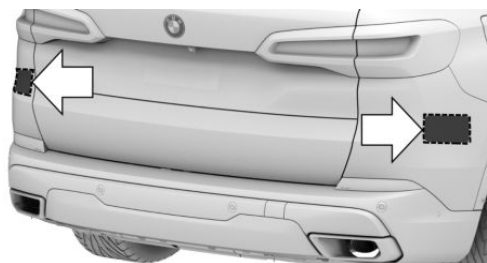

Rear bumper.

Always keep the bumper in the area of the radar sensors clean and unobstructed.

## Camera

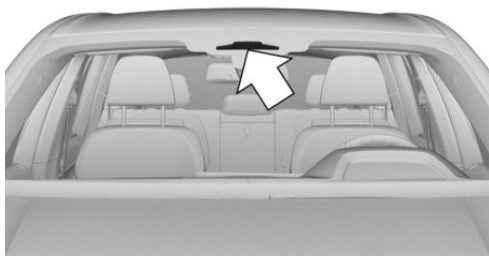

The camera is installed near the interior mirror. Keep the windshield in front of the interior mirror clean and clear.

## Functional requirements

- ▷ Speed below 130 mph/210 km/h.
- ▷ Sufficient lane width.

- ▷ Above approx. 43 mph, 70 km/h: lane marking is detected.
- ▷ Below approx. 43 mph, 70 km/h: lane marking or a vehicle driving ahead is detected.
- ▷ Hands on the steering wheel rim.
- ▷ Wide curves.
- ▷ Drive in the center of the lane.
- ▷ Turn signal switched off.
- ▷ The sensor system calibration process is complete.
- ▷ Cruise control with distance control is active.
- ▷ Safety belt on the driver's side fastened.

Additionally, the following systems must be active:

- ▷ Approach control warning.
- ▷ Person warning.
- ▷ Side collision warning.

## Switching on/off

### Assisted Driving

#### General information



This button is used to switch the configured function on and off.



The button can be used to set the primary used function.

#### Set function

1.  When the system is active, press the button repeatedly until the desired function is selected in the function bar. The function bar for Assisted Driving is displayed at the bottom of the instrument cluster.



- ▷  Cruise control with distance control.





- ▶  Cruise control with distance control and steering and lane control assistant.

The selected function is shown in green.

The setting is stored for the driver profile currently used.

## Switching on

1.  Press the button on the steering wheel.
2.  Adjust the steering and lane control assistant if necessary.

-  Steering wheel symbol lights up gray.  
The system is on standby and does not manipulate steering.

System activates automatically as soon as all function conditions are fulfilled, refer to page [232](#).

-  Steering wheel symbol lights up green.  
The system is active.

With the system switched on, the person warning with City braking function and the side collision warning are active.

## Switching off

-  Press the button on the steering wheel.

The indicator goes out.

The system does not perform supportive steering wheel movements.

## Interrupting automatically

The system is automatically interrupted in the following situations, for example:





- ▶ At a speed above 130 mph/210 km/h.
- ▶ When the steering wheel is released.
- ▶ When the driver applies the brakes.

- ▶ When you manipulate steering.
- ▶ When you leave your own lane.
- ▶ When the turn signal is switched on.
- ▶ When the lane is too narrow.
- ▶ If for a particular time no lane marking is detected and there is no vehicle driving in front.
- ▶ If Active Cruise Control is interrupted.
- ▶ If the safety belt on the driver's side is unfastened.

-  Steering wheel symbol lights up gray.  
The system is on standby and does not manipulate steering.

System activates automatically as soon as all function conditions are fulfilled, refer to page [232](#).

## Displays in the instrument cluster

Symbol	Description
	Gray steering wheel symbol: The system is on standby.
	Green steering wheel symbol: The system is activated.
	Yellow steering wheel symbol and a signal sounds, if applicable: System interruption is imminent.
	Green steering wheel symbol and lane marking symbol: The system supports the driver in keeping the vehicle within the lane.

**Symbol Description**



Yellow steering wheel symbol:  
The hands are not grasping the steering wheel. The system is still active.



Red steering wheel symbol and a signal sounds:  
The hands are not grasping the steering wheel. System interruption is imminent.  
The system reduces the speed to a standstill if applicable.  
It is possible that the system will not execute any supporting steering movements.

**Indicator light Description**



Cruise control with distance control and steering and lane control assistant:  
Indicator light green: system is active.  
No indicator light: system is switched off.

**Displays on the steering wheel**



The two LED lights above the buttons illuminate analogue to the displays in the instrument cluster:

- ▶ Yellow: system interruption is imminent.

- ▶ Red: system will be deactivated.

The steering wheel displays can be configured if required.

Via iDrive:

1. "CAR"
2. "Settings"
3. "Driver Assistance"
4. "Driving"
5. "Steering Assistant"
6. Make the desired setting.

**Displays in the Head-up Display**

All system information can also be displayed in the Head-up Display.

**Lane change assistant**

**Concept**

The system additionally supports the driver when changing lanes on multilane roads.

**Functional requirements**

- ▶ The functional requirements of the steering and lane control assistant are fulfilled, refer to page 232.
- ▶ Depending on country specifications: driving on a road without pedestrians or cyclists and with physical barriers to oncoming traffic, such as crash barriers.
- ▶ Lane markings have been detected.
- ▶ Maximum speed approx. 110 mph, 180 km/h.
- ▶ The minimum speed is country-specific.

**Switching the function on/off**

The lane change assistant can be switched on/off.

Via iDrive:

1. "CAR"
2. "Settings"

3. "Driver Assistance"
4. "Driving"
5. "Steering Assistant"
6. "Automatic Lane Change"

## Changing lanes

1. Ensure that the traffic situation permits changing lanes.
2. Press the turn indicator lever, refer to page 139, in the required direction to the pressure point for signaling briefly and hold it there.

Steering support in the required direction can be detected a short time later.

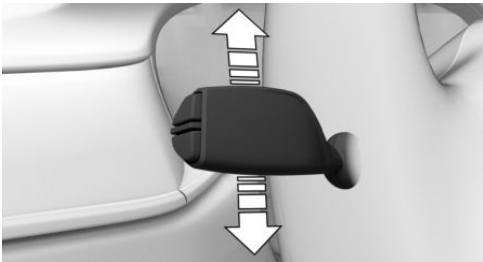



After the lane change, the system helps keep the vehicle in the new lane.

## Canceling a lane change

If the turn signal lever is released too soon, the system helps the driver keep to the original lane.

## Displays in the instrument cluster

Symbol	Description
	Green steering wheel symbol. Green line for lane marking on the appropriate side. Green arrow symbol for lane-changing. The system carries out a lane change.
	Green steering wheel symbol. Green line for lane marking on the appropriate side. No arrow symbol for lane-changing on the display. The system detected the lane change request. Lane change not currently possible.
	Depending on country specifications: Green steering wheel symbol. Green line for lane marking on the appropriate side. Gray arrow symbol for lane-changing. Lane change not possible; functional requirements not met.

## Assisted Driving Plus

### Concept

Assisted Driving Plus supports the driver with vehicle control in traffic jam situations.

## Safety information

### **WARNING**

The system cannot serve as a substitute for the driver's personal judgment in assessing the traffic situation. Based on the limits of the system, it cannot independently react to all traffic situations. There is a risk of an accident. Adjust driving style to traffic conditions. Watch traffic closely and actively intervene where appropriate.

## Functional requirements

- ▷ The functional requirements of the steering and lane control assistant are fulfilled, refer to page [232](#).
- ▷ The steering and lane control assistant is active.
- ▷ The function is only available on certain street types, e.g. freeways.
- ▷ Sufficient lane width.
- ▷ Lane markings and a vehicle driving ahead are detected.
- ▷ Speed less than approx. 40 mph/60 km/h.
- ▷ The Driver Attention Camera in the instrument cluster detects that the driver is paying attention to the traffic.

## Switching on



As soon as all functional requirements are met, Assisted Driving Plus will be displayed as an additional symbol in the function bar. The toolbar is displayed at the bottom of the instrument cluster.



Select Assistant Driving Plus with the button on the steering wheel.

The symbol for Assisted Driving Plus is shown in green.

Two green LED lights, refer to page [236](#), are illuminated on the steering wheel.

The indicator light in the instrument cluster is shown in green.

The system begins to assist the driver with vehicle control.

## Displays in the instrument cluster

Indicator light	Description
	Indicator light green: system is active.

## Displays on the steering wheel



The two LED lights above the buttons illuminate analogue to the displays in the instrument cluster:

- ▷ Green: the system is active.
- ▷ Red: system will be deactivated.

## System limits

### General information

The system cannot be activated or meaningfully used in certain situations.

## Safety information

### **WARNING**

The system can react not at all, too late, incorrectly, or without justification due to the system limits. There is a risk of accidents or risk of damage to property. Follow the information re-

garding the system limits and actively intervene if needed.

## Hands on the steering wheel

The sensors cannot detect hand-steering wheel contact in the following situations:

- ▷ Driving with gloves.
- ▷ Protective covers on the steering wheel.

## Narrow lanes

When driving within narrow lanes, the system cannot be activated or effectively used, for instance in the following situations:

- ▷ In construction areas.
- ▷ In rescue lanes.
- ▷ Within city limits.

## Weather

The following restrictions can occur under unfavorable weather or light conditions:

- ▷ Poorer recognition of vehicles and lane markings.
- ▷ Short-term interruptions for vehicles that are already recognized.

Examples of unfavorable weather or light conditions:

- ▷ Wet conditions.
- ▷ Snowfall.
- ▷ Slush.
- ▷ Fog.
- ▷ Glare.

Drive attentively, and react to the current traffic situation. If necessary, intervene actively, for instance by braking, steering or evading.

## Driver Attention Camera

Always monitor the traffic conditions.

The Driver Attention Camera detects whether or not the driver is paying attention to the traffic conditions.

The Driver Attention Camera may not be fully functional in the following situations:

- ▷ When the Driver Attention Camera is covered by the steering wheel rim.
- ▷ When the driver is wearing infrared impermeable sunglasses.

## PDC Park Distance Control

### Concept

PDC is a support when parking. Objects that you are approaching slowly in front of or behind the vehicle are indicated by signal tones and a display on the Control Display.

Depending on the equipment version: Obstacles at the side of the vehicle that are detected by the side ultrasonic sensors may also be reported by the side protection, refer to page 240, function.

### General information

The ultrasound sensors for distance measurements are located in the bumpers and possibly on the sides of the vehicle.

The maneuvering range, depending on the obstacle and environmental conditions, is approx. 6 ft/2 m.

An acoustic warning sounds in case of an impending collision at a distance to the object of approx. 27 in/70 cm.

For objects behind the vehicle, the acoustic warning is already issued at a distance to the object of approx. 5 ft/1.50 m.

### Safety information

#### **WARNING**

The system cannot serve as a substitute for the driver's personal judgment in assessing the traffic situation. Based on the limits of the system, it cannot independently react to all traffic situations. There is a risk of an accident. Adjust driving style to traffic conditions. Watch traffic

closely and actively intervene where appropriate.

**⚠ WARNING**

Due to high speeds when PDC Park Distance Control is activated, the warning can be delayed due to physical circumstances. There is a risk of injury or risk of damage to property. Avoid approaching an object too fast. Avoid driving off fast while PDC Park Distance Control is not yet active.

**Overview**

**Button in the vehicle**



 Park assistance button

**Ultrasound sensors**



Ultrasound sensors of the PDC, for instance in the bumpers.

**Functional requirements**

Ensure full functionality:

- ▶ Do not cover sensors, for instance with stickers, bicycle racks.
- ▶ Keep the sensors clean and unobstructed.

**Switching on/off**

**Switching on automatically**

The system switches on automatically in the following situations:

- ▶ If selector lever position R is engaged when the engine is running.
- ▶ Depending on the equipment version: while approaching detected obstacles if the speed is slower than approx. 2.5 mph/4 km/h. The activation distance depends on the situation in question.

You may switch automatic activation on and off when obstacles are detected.

Via iDrive:

1. "CAR"
2. "Settings"
3. "Driver Assistance"
4. "Parking and Maneuvering"
5. Where applicable: "Automatic PDC activation"
6. "Automatic PDC activation"

The setting is stored for the driver profile currently used.

Depending on equipment, an additional camera view is also switched on.

**Automatic deactivation during forward travel**

The system switches off when a certain driving distance or speed is exceeded.

Switch the system back on, if needed.

**Switching on/off manually**

 Press park assistance button.

- ▶ On: the LED lights up.
- ▶ Off: the LED goes out.

The rearview camera image is displayed if the reverse gear is engaged when pressing the park assistance button.

## WARNING

### Signal tones

#### General information

When approaching an object, an intermittent sound indicates the position of the object. E.g., if an object is detected to the left rear of the vehicle, a signal tone sounds from the left rear speaker.

The shorter the distance to the object, the shorter the intervals.

If the distance to a detected object is less than approx. 10 inches/25 cm, a continuous tone is sounded.

If there are objects in front of and behind the vehicle at the same time, with a distance smaller than approx. 10 in/25 cm, an alternating constant tone will sound.

The intermittent tone and constant tone are switched off if the selector lever position P is engaged.

The intermittent tone is switched off after a short time when the vehicle is stationary.

#### Volume

The PDC signal tone volume can be adjusted.

Via iDrive:

1. "CAR"
2. "Settings"
3. "Driver Assistance"
4. "Parking and Maneuvering"
5. "Volume PDC signal"
6. Set the desired value.

The setting is stored for the driver profile currently used.

## Visual warning

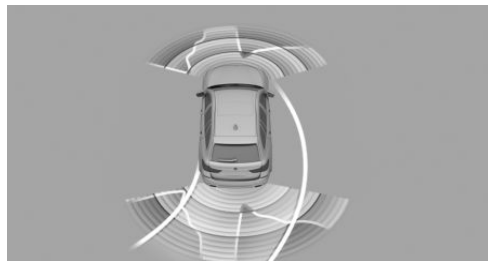

The approach of the vehicle to an object is shown on the Control Display. Objects that are farther away are already displayed on the Control Display before a signal sounds.

The display appears as soon as PDC is activated.

The range of the sensors is represented in the colors green, yellow and red when obstacles are detected.

Pathway lines are faded in for better estimation of the required space.

When the image of the rearview camera is displayed, the switch can be made to PDC or to a different view with obstacle markings as needed:

1. Press the Controller to the left, if needed.
2. E. g. "Park. sensors only"

Crossing traffic warning, refer to page 259: depending on the equipment, it is warned in the PDC display against vehicles approaching in the front or rear from the side.

## Depending on the equipment version: emergency brake function, Active PDC

### Concept

The emergency braking function of PDC initiates an emergency braking in case of acute risk of collision.

### General information

This function may not be available. Contact your authorized dealer's service center or another

qualified service center as to whether this additional function is currently in your vehicle or when it can be installed in your vehicle in the future.

Due to system limits, a collision cannot be prevented under all circumstances.

The function is available from walking speed while backing up or rolling backward.

A press of the accelerator pedal interrupts the braking intervention.

After emergency braking to a stop, further creeping toward an obstacle is possible. To creep toward the obstacle, lightly press the accelerator pedal and release it again.

If the accelerator pedal is heavily depressed, the vehicle drives off as usual. Manual braking is possible at any time.

The system uses the ultrasound sensors of PDC and parking assistant.

## Safety information

### **WARNING**

The system cannot serve as a substitute for the driver's personal judgment in assessing the traffic situation. There is a risk of an accident. Adjust driving style to traffic conditions. Watch traffic and vehicle surroundings closely and actively intervene where appropriate.

## Activating/deactivating the system

Via iDrive:

1. "CAR"
2. "Settings"
3. "Driver Assistance"
4. "Parking and Maneuvering"
5. If necessary, "Active PDC with braking interv."
6. "Active PDC with braking interv."

The setting is stored for the driver profile currently used.

## System limits

The system cannot be used in the following situations, for example:

- ▶ When Hill Descent Control, refer to page 216, is active, the emergency braking function is deactivated.
- ▶ When driving with a trailer.

If required, deactivate the system via iDrive where applicable.

## Depending on the equipment version: side protection

### Concept

The system warns of obstacles on the side of the vehicle.

### General information

This function may not be available. Contact your authorized dealer's service center or another qualified service center as to whether this additional function is currently in your vehicle or when it can be installed in your vehicle in the future.

The system uses the ultrasound sensors of PDC and parking assistant.

### Display

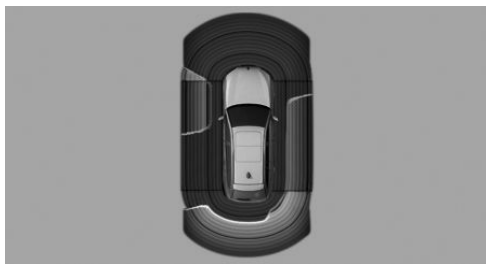

To protect the sides of the vehicle, obstacle markings are displayed on the vehicle at the sides.

- ▶ Color markings: warning against detected obstacles.



- ▷ Gray markings, hatched area: no obstacles were detected.
- ▷ No markings, black area: the area next to the vehicle was not yet captured.

## Limits of side protection

The system only displays stationary obstacles that were previously detected by sensors while passing them.

The system does not detect whether an obstacle moves later on. If the vehicle is stationary, the markings are shown in black after a certain time. The area next to the vehicle must be newly captured.

Side protection is not available, if the trailer power socket is in use or trailer towing is activated.

## System limits

### Safety information

#### **WARNING**

The system can react not at all, too late, incorrectly, or without justification due to the system limits. There is a risk of accidents or risk of damage to property. Follow the information regarding the system limits and actively intervene if needed.

### Trailer towing

With a trailer, a trailer power socket in use or when trailer towing is activated, the two rear PDC functions will be switched off.



White symbol is displayed.

Depending on the vehicle equipment, the range of the sensors is shown as a shaded area on the Control Display.

## Limits of ultrasonic measurement

Ultrasonic measurements might not function in the following situations:

- ▷ For small children and animals.
- ▷ For persons with certain clothing, for instance coats.
- ▷ With external interference of the ultrasound, for instance from passing vehicles or loud machines.
- ▷ When sensors are dirty, iced over, damaged or out of position.
- ▷ Under certain weather conditions such as high relative humidity, wet conditions, snowfall, extreme heat, or strong wind.
- ▷ With tow bars and trailer couplings of other vehicles.
- ▷ With thin or wedge-shaped objects.
- ▷ With moving objects.
- ▷ With elevated, protruding objects such as ledges.
- ▷ With objects with corners, edges, and smooth surfaces.
- ▷ With objects with a fine surface structure such as fences.
- ▷ For objects with porous surfaces.
- ▷ With small and low objects, for instance boxes.
- ▷ With obstacles and persons at the edge of the lane.
- ▷ With soft obstacles or obstacles covered in foam material.
- ▷ With plants and bushes.
- ▷ Low objects already displayed, for instance curbs, can move into the blind area of the sensors before or after a continuous tone sounds.
- ▷ Cargo that extends beyond the perimeter of the vehicle is not taken into account by the system.

## False warnings

The system may issue a warning under the following conditions even though there is no obstacle within the detection range:

- ▷ In heavy rain.
- ▷ When sensors are very dirty or covered with ice.
- ▷ When sensors are covered in snow.
- ▷ On rough road surfaces.
- ▷ On uneven surfaces, such as speed bumps.
- ▷ In large buildings with right angles and smooth walls, for instance in underground garages.
- ▷ In automatic vehicle washes.
- ▷ Due to heavy exhaust.
- ▷ When the trailer hitch cover is not on straight.
- ▷ Due to other ultrasound sources, for instance sweeping machines, high pressure steam cleaners or neon lights.

To prevent false alarms, switch off automatic PDC activation on obstacle detection, refer to page 238, for instance in automatic vehicle washes.

## Malfunction

A Check Control message is displayed.



White symbol is displayed, and the range of the sensors is dimmed on the Control Display.

PDC has failed. Have the system checked by a dealer's service center or another qualified service center or repair shop.

## Without Surround View: rearview camera

### Concept

The rearview camera provides assistance in parking and maneuvering backwards. The area

behind the vehicle is shown on the Control Display.

## Safety information

### **⚠ WARNING**

The system cannot serve as a substitute for the driver's personal judgment in assessing the traffic situation. There is a risk of an accident. Adjust driving style to traffic conditions. Watch traffic and vehicle surroundings closely and actively intervene where appropriate.

## Overview

### Depending on the vehicle equipment: button in the vehicle



 Park assistance button

## Camera

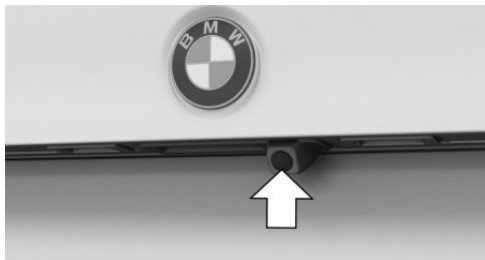

The camera lens is located in the handle of the tailgate.

The image quality may be impaired by dirt. If necessary, clean the camera lens.

## Switching on/off

### Switching on automatically

The system is switched on automatically if selector lever position R is engaged when the engine is running.

### Automatic deactivation during forward travel

The system switches off when a certain driving distance or speed is exceeded.

Switch the system back on, if needed.

### Depending on the vehicle equipment: switching on/off manually



Press park assistance button.

- ▷ On: the LED lights up.
- ▷ Off: the LED goes out.

The parking assistance functions are shown on the Control Display.

### Switching the view via iDrive

If the rearview camera view is not displayed, change the view via iDrive:

1. If necessary, tilt the controller to the side.
2.  "Rear view camera"

The rearview camera image is displayed.

## Functional requirements





- ▷ The rearview camera is switched on.
- ▷ The tailgate is fully closed.
- ▷ Keep the recording range of the camera clear. Protruding cargo or carrier systems and trailers that are not connected to a trailer power socket can restrict the visibility range of the camera.

## Assistance functions

### General information

More than one assistance function can be active at the same time.

The assistance functions can be manually activated.

1. Move the Controller to the right, if needed.
2. With corresponding equipment:  "Camera image"
3. ▷  "Parking aid lines".  
Pathway lines and turning radius lines are displayed, refer to page 243.  
▷  "Obstacle mark."  
Depending on the vehicle equipment, the obstacles detected by PDC Park Distance Control are displayed, refer to page 244, by markings.
1. Move the Controller to the left, if needed.
2.  "Trailer hitch".  
A zoomed image of the trailer hitch is displayed, refer to page 244.

## Parking aid lines

### Pathway lines

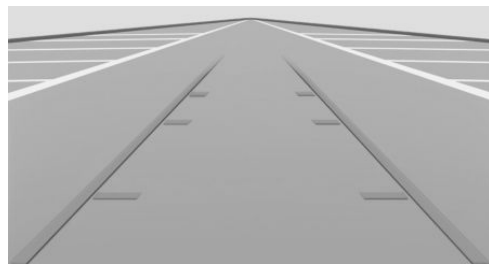

Pathway lines help you to estimate the space required when parking and maneuvering on level roads.

Pathway lines depend on the steering angle and are continuously adjusted to the steering wheel movements.

### Turning radius lines

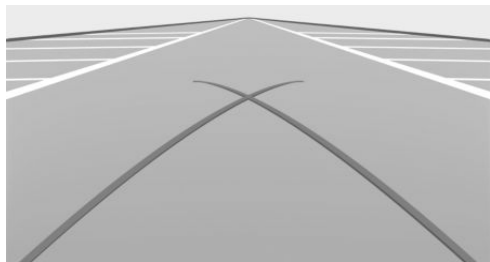

Turning radius lines can only be superimposed on the camera image together with pathway lines.

Turning radius lines show the course of the smallest possible turning radius on a level road.

Only one turning radius line is displayed after the steering wheel is turned past a certain angle.

### Parking using pathway and turning radius lines

1. Position the vehicle so that the red turning radius line leads to within the limits of the parking space.
2. Turn the steering wheel to the point where the green pathway line covers the corresponding turning radius line.

### Obstacle marking

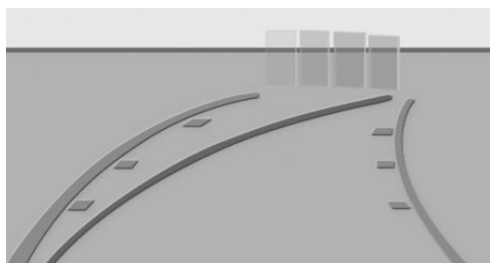

Depending on the vehicle equipment, obstacles behind the vehicle are detected by the PDC Park Distance Control sensors.

Obstacle markings can be faded into the image of the rearview camera.

The colored thresholds of the obstacle markings match the markings of the PDC Park Distance Control.

### Zoom on trailer hitch

To make it easier to attach a trailer, you can zoom in on the view of the trailer hitch.

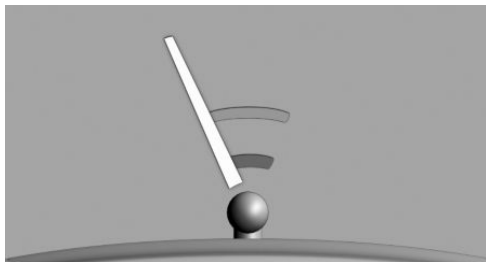

Two static circle segments show the distance between the trailer and the trailer hitch.

A docking line dependent on the steering angle helps with aiming for the trailer with the trailer hitch.

When zooming in, remember that the view may no longer show certain obstacles.

### Setting brightness and contrast via iDrive

With the rearview camera switched on:

1. Move the Controller to the right, if needed.
2. "Camera image"
3. "Brightness"  
 "Contrast"
4. Set the desired value.

### System limits

#### Deactivated camera

If the camera is deactivated, for instance if the tailgate is open, the camera image is displayed hatched in gray.

## Detection of objects

Very low obstacles as well as high, protruding objects such as ledges may not be detected by the system.

Depending on the vehicle equipment, some assistance functions also consider data from the PDC Park Distance Control.

Follow the notes in the PDC Park Distance Control chapter.

The objects displayed on the Control Display may be closer than they appear. Do not estimate the distance from the objects on the display.

## Surround View with Parking Assistant Plus

### Concept

The system provides assistance in parking and maneuvering. The area around the vehicle is shown on the Control Display.

### General information

Several cameras capture the area from different selectable perspectives. In addition, assistance functions, for instance guidelines, can be faded into the display.

The following camera perspectives can be displayed:

- ▶ Automatic camera perspective, refer to page 246: the system shows the camera perspective suitable for the respective driving situation.
- ▶ Rearview camera, refer to page 246: for representing the areas behind the vehicle.
- ▶ Right-hand and left-hand side view, refer to page 249: for representing the areas on the sides of the vehicle.
- ▶ Camera perspective movable via iDrive. Available camera, refer to page 246.
- ▶ Panorama View, refer to page 250: to present cross traffic, for instance at junctions

and driveways, depending on the currently engaged gear.

Depending on the view, the environment around the vehicle or a part of it is depicted.

## Safety information

### WARNING

The system cannot serve as a substitute for the driver's personal judgment in assessing the traffic situation. There is a risk of an accident. Adjust driving style to traffic conditions. Watch traffic and vehicle surroundings closely and actively intervene where appropriate.

## Overview

### Buttons in the vehicle



Park assistance button



Panorama View

## Cameras



Front camera

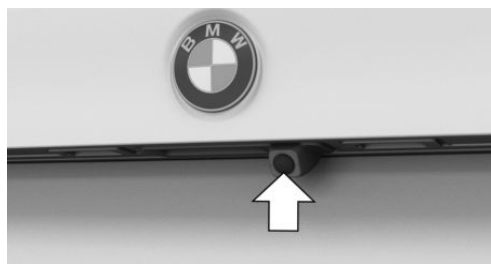

Rearview camera

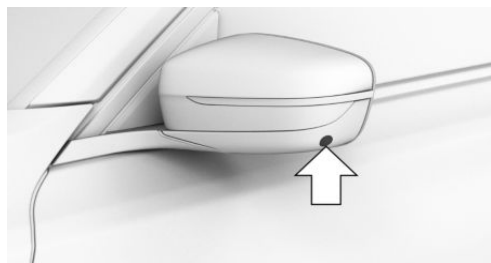

One camera is located at the bottom of each exterior mirror housing.

The image quality may be impaired by dirt on the camera lenses. If required, clean the camera lenses.

## Switching on/off

### Switching on automatically

The system is switched on automatically, refer to page 238, if selector lever position R is engaged when the engine is running.

The camera perspective suitable for the respective driving situation is displayed.

### Switching on/off manually

 Press park assistance button.

- ▷ On: the LED lights up.
- ▷ Off: the LED goes out.

The rearview camera cannot be switched off if the reverse gear is engaged.

### Automatic deactivation during forward travel

The system switches off when a certain driving distance or speed is exceeded.

Switch the system back on, if needed.

## Camera perspective

### Overview

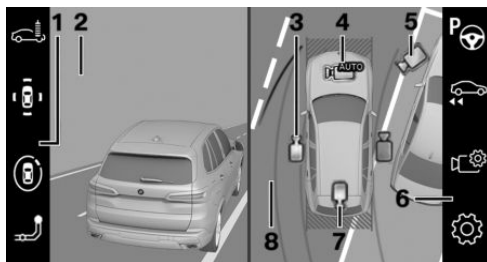

- 1 Function bar, left
- 2 Camera image
- 3 Side view
- 4 Automatic camera perspective
- 5 Movable unobstructed camera perspective
- 6 Function bar, right
- 7 Rearview camera
- 8 Selection window

### Selection window

The individual camera perspectives can be selected in the selection window via iDrive.

## Side view

The side view can be selected for the right or left vehicle side.

This view helps when positioning the vehicle at the curb or with other obstacles on the side by displaying the side surroundings.

The side view looks from rear to front and in case of danger, focuses automatically on possible obstacles.

## Automatic camera perspective

The automatic camera perspective shows a steering-dependent view in the respective driving direction.

This perspective adapts to the respective driving situation.

As soon as obstacles are detected, the view changes to a fixed display of the area in front or at the rear behind the bumper or, if necessary, changes to a side view.

When reverse gear is engaged, the automatic camera perspective is closed and the system uses a fixed perspective of the rearview camera. If necessary, manually select the automatic camera perspective when reverse gear is engaged. The automatic camera perspective will be retained for the current parking maneuver.

## Movable unobstructed camera perspective

With selection of the movable camera perspective, a circle appears on the Control Display.

By turning the Controller or via touch function, specified perspectives on the circle can be selected.

The current perspective is marked with a camera symbol.

With BMW Gesture Control: the movable camera perspective can be moved around the circle using BMW Gesture Control, refer to page 57.

To leave the function, move the Controller sideways and select another camera function.

With xOffroad package: when an xOffroad driving mode is activated, terrain-specific views will be displayed.









## Rearview camera

This view shows the picture of the rearview camera.

## Function bars





### Function bar on the right

Assistance functions, refer to page 247, can be activated via the right function bar and settings can be entered. Move the Controller to the right, if needed.

- ▷  "Autom. Parking", refer to page 252.
- ▷  "Back-up Assistant", refer to page 257.
- ▷  "Camera image"
  - ▷  "Brightness", refer to page 251.
  - ▷  "Contrast", refer to page 251.
  - ▷  "Parking aid lines", refer to page 248.
  - ▷  "Obstacle mark.", refer to page 248.
- ▷  "Settings": apply settings, for instance to use the activation points for Panorama View.

### Function bar on the left

The left function bar can be used for the direct selection of various views. Move the Controller to the left, if needed.





- ▷  Automatic camera perspective, refer to page 247.
- ▷  "Free camera", refer to page 247.
- ▷  "Car wash", refer to page 249.
- ▷  "Trailer hitch", refer to page 249.

## Assistance functions

### General information

More than one assistance function can be active at the same time.

The following assistance functions can be manually activated:

- ▷  "Parking aid lines".
- ▷  "Obstacle mark".
- ▷  "Trailer hitch".
- ▷  "Car wash".

The following assistance functions are automatically displayed:

- ▷ Side protection, refer to page 249.
- ▷ Door opening angle, refer to page 249.

## Parking aid lines

### Pathway lines

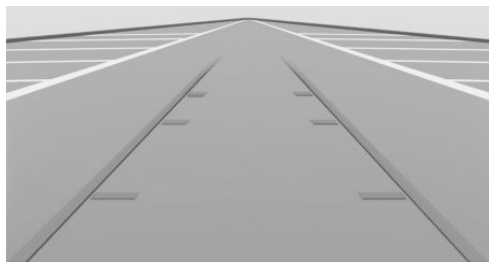

Pathway lines help you to estimate the space required when parking and maneuvering on level roads.

Pathway lines depend on the steering angle and are continuously adjusted to the steering wheel movements.

### Turning radius lines

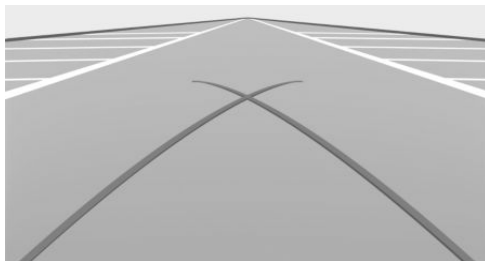

Turning radius lines can only be superimposed on the camera image together with pathway lines.

Turning radius lines show the course of the smallest possible turning radius on a level road.

Only one turning radius line is displayed after the steering wheel is turned past a certain angle.

### Parking using pathway and turning radius lines

1. Position the vehicle so that the red turning radius line leads to within the limits of the parking space.
2. Turn the steering wheel to the point where the green pathway line covers the corresponding turning radius line.

### Obstacle marking

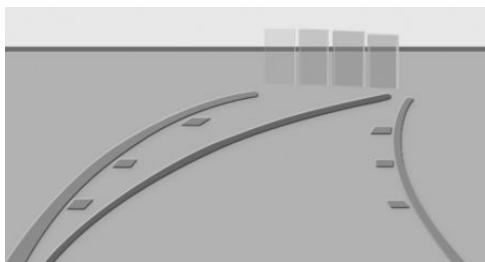

Obstacles behind the vehicle are detected by the PDC Park Distance Control sensors.

Obstacle markings can be shown in the camera image.



The colored thresholds of the obstacle markings match the markings of the PDC Park Distance Control.

## Vehicle wash view

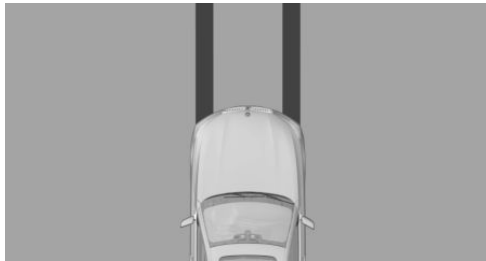

The vehicle wash view assists when entering a vehicle wash by displaying the floor and the vehicle's own track.

## Zoom on trailer hitch

To make it easier to attach a trailer, you can zoom in on the view of the trailer hitch.

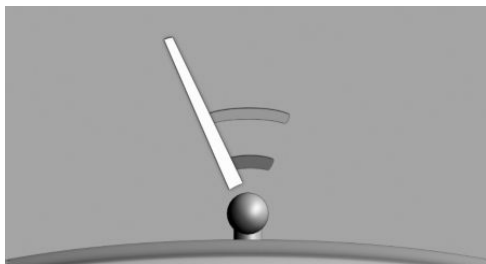

Two static circle segments show the distance between the trailer and the trailer hitch.

A docking line dependent on the steering angle helps with aiming for the trailer with the trailer hitch.

Show the trailer hitch via iDrive, refer to page [247](#).

When zooming in, remember that the view may no longer show certain obstacles.

## Side protection

### Concept

The system warns of obstacles on the side of the vehicle.

### Display



To protect the sides of the vehicle, obstacle markings are displayed on the vehicle at the sides.

- ▷ No markings: no obstacles were detected.
- ▷ Color markings: warning against detected obstacles.

### Limits of side protection

The system only displays stationary obstacles that were previously detected by sensors while passing them.

The system does not detect whether an obstacle moves later on. For this reason, at standstill, the markings are not shown anymore in the display after a certain time. The area next to the vehicle must be newly captured.

## Door opening angle

### Concept

If obstacle marking is activated, the system indicates fixed obstacles that obstruct the opening angles of the doors.

The system does not provide a warning of approaching traffic.



The maximum opening angle of the doors is displayed in selector lever position P.

As soon as the vehicle begins moving, the opening angles are replaced by parking aid lines.

**Limits of the display**

The vehicle surroundings are displayed with distorted image for technical reasons.

Even if the symbols for the door opening angles do not cross other objects on the Control Display, the following needs to be noted when parking next to other objects:

Because of the perspective, higher, protruding objects may be closer than they appear on the Control Display.

**Panorama View**

**Concept**

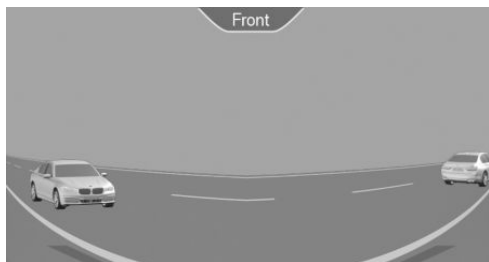

The system provides an early look at cross traffic at blind driveways and intersections.

**General information**

Road users concealed by obstacles to the left and right of the vehicle can only be detected rel-

atively late from the driver's seat. The cameras in the front and rear capture the sideways traffic area to improve the view.

Yellow lines in the screen display mark the front and rear end of the vehicle.

The camera image shows different levels of distortion in some areas and is thus not suitable for distance estimations.

**Display on the Control Display**

 Press the button when the engine is running.

Depending on the driving direction, the image of the respective camera is displayed:

- ▷ "front": front camera image.
- ▷ "rear": rear camera image.

Depending on the vehicle equipment, the crossing traffic warning, refer to page 259, can additionally warn against oncoming vehicles using radar sensors.

**With navigation system: activation points**

**Concept**

Positions where Panorama View should switch on automatically can be stored as activation points provided that a GPS signal is received.

**General information**

Up to ten activation points can be stored.

Activation points can be used when driving forward for the front camera.

**Storing activation points**

1. Drive to the position at which the system is to be switched on, and stop.
2.  Press the button.
3. Move the Controller to the right.
4. "Add activation point".



The current position is displayed.

#### 5. "Activation point".



Activation points are, if possible, stored with town/city and street address, or else with the GPS coordinates.

### Using activation points



The use of activation points can be switched on and off.

1.  Press the button.
2. Move the Controller to the right.
3.  "Settings"
4. "Panorama View, GPS-based"
5. "Panorama View is displayed automatically when set activation points are reached."

### Displaying activation points

1.  Press the button.
2. Move the Controller to the right.
3.  "Manage points"  
A list of all activation points is displayed.



### Renaming or deleting activation points

1.  Press the button.
2. Move the Controller to the right.
3.  "Manage points"  
A list of all activation points is displayed.
4. Select an activation point as needed.
5. > "Rename"  
> "Delete activation point"  
> "Delete all activation points"

## Setting brightness and contrast

Brightness and contrast can be adjusted with Surround View or Panorama View switched on.

Via iDrive:

1. Move the Controller to the right, if needed.
2.  "Camera image"
3. >  "Brightness"  
>  "Contrast"
4. Set the desired value.

## Functional limitations

The system can be used only to a limited extent in the following situations:

- > In poor light.
- > In case of soiled cameras.
- > With a door open.
- > With the tailgate open.
- > With exterior mirrors folded in.

Gray hatched areas with symbol, for instance open door, in the camera image mark areas that are currently not displayed.

## System limits

### Non-visible areas

Because of the camera angle, the areas under the vehicle cannot be viewed by the cameras.

### Detection of objects

Very low obstacles as well as high, protruding objects such as ledges may not be detected by the system.

Some assistance functions also consider data from the PDC Park Distance Control.

Follow, refer to page [237](#), the notes in the PDC Park Distance Control chapter.

The objects displayed on the Control Display may be closer than they appear. Do not estimate the distance from the objects on the display.

## Malfunction

A camera malfunction is displayed on the Control Display.



A yellow symbol is displayed and the recording range of the malfunctioning camera is displayed in black on the Control Display.

Display.

## Remote 3D View

### Concept

With the proper equipment, the BMW Connected App and the camera images from Surround View can be used to display the vehicle surroundings on a mobile device such as a smartphone.

The function displays a momentary view of the situation.

### Functional requirements

- ▶ Data transmission must be activated, refer to page 67.
- ▶ BMW Connected App must be installed on the mobile device.

### Switching the function on/off

Via iDrive:

1. "CAR"
2. "Settings"
3. "General settings"
4. Switch the function on and off in the settings for data protection.

### Functional limitations

The system may not be fully functional or may not be available in the following situations:

- ▶ In poor light.
- ▶ In case of soiled cameras.
- ▶ With a door or the tailgate open. Dark fields in the display indicate areas that are not recorded by the system.
- ▶ With exterior mirrors folded in.
- ▶ When other camera functions are being performed in the vehicle.

- ▶ When the vehicle moves faster than walking speed.
- ▶ It may not be possible to use the function in every country.
- ▶ For reasons of data protection, the function can only be used three times within two hours.

## Parking Assistant

### Concept

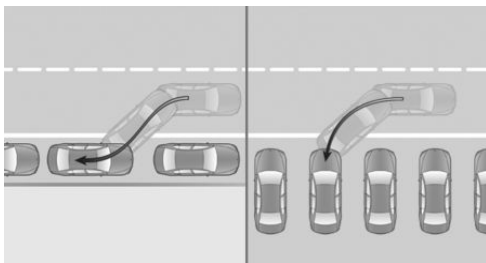

The system supports the driver in the following situations:

- ▶ When parking parallel to the road, parallel parking.
- ▶ Depending on the equipment version: when reverse parking diagonally to the road, diagonal parking. The system orients itself with the middle of the parking space during diagonal parking.
- ▶ Depending on the equipment version: when driving out of parallel parking spaces, refer to page 256.
- ▶ Depending on the equipment version: when exiting tight parking or street situations in reverse, see Reversing Assistant, refer to page 257.

### General information

The functions parking diagonally to the road, driving out of parallel parking spaces and driving Driver assistance systems out in reverse may not be available. Contact your authorized dealer's

service center or another qualified service center as to whether this additional function is currently in your vehicle or when it can be installed in your vehicle in the future.

## Handling

Parking assistant handling is divided into three steps:

- Switching on and activating.
- Parking space search.
- Parking.

System status and instructions on required actions are displayed on the Control Display.

Ultrasound sensors measure parking spaces on both sides of the vehicle.

## Steptronic transmission

The parking assistant calculates the best possible parking line and takes control of the following functions during the parking procedure:

- Steering.
- Accelerating and braking.
- Changing the gears.

Parking is automatic.

## Safety information

### **WARNING**

The system cannot serve as a substitute for the driver's personal judgment in assessing the traffic situation. Based on the limits of the system, it cannot independently react to all traffic situations. There is a risk of an accident. Adjust driving style to traffic conditions. Watch traffic closely and actively intervene where appropriate.

### **WARNING**

If the trailer hitch is used, the parking assistant can cause damage due to covered sensors. There is a risk of accidents or risk of damage to property. The parking assistant should not be used during trailer towing or if the trailer hitch is used, for instance bicycle rack.

### **NOTICE**

The parking assistant can steer the vehicle over or onto curbs. There is a risk of damage to property. Watch traffic closely and actively intervene where appropriate.

The safety information of the PDC Park Distance Control, refer to page 237, applies in addition.

## Overview

### Button in the vehicle



Park assistance button

## Ultrasound sensors

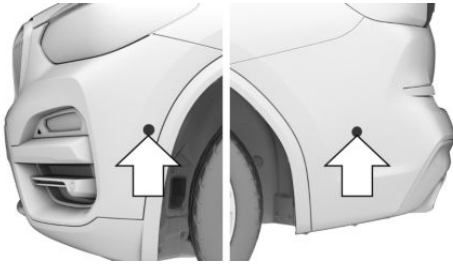

With the four side ultrasound sensors, arrows, and the ultrasound sensors of PDC Park Distance Control in the bumpers, the parking spaces are measured and the distances to obstacles determined.

## Functional requirements

### Ultrasound sensors

Ensure full functionality:

- ▷ Do not cover sensors, for instance with stickers.
- ▷ Keep the sensors clean and unobstructed.

### For measuring parking spaces

- ▷ Maximum speed while driving forward approx. 22 mph/35 km/h.
- ▷ Maximum distance to row of parked vehicles: 5 ft/1.5 m.

### Suitable parking space

General information:

- ▷ Gap behind an object that has a min. length of 1.7 ft/0.5 m.
- ▷ Gap between two objects with a minimum length of approx. 1.7 ft/0.5 m.

Parallel parking to the road:

- ▷ Min. length of gap between two objects: your vehicle's length plus approx. 2.6 ft/0.8 m.
- ▷ Minimum depth: approx. 5 ft/1.5 m.

Depending on the equipment version: diagonal parking:

- ▷ Minimum width of the gap: own vehicle's width plus approx. 2.3 ft/0.7 m.
- ▷ Minimum depth: your vehicle's length.

The depth of diagonal parking spaces must be estimated by the driver. Due to technical limitations, the system is only able to approximate the depth of diagonal parking spaces.

## For parking

- ▷ Doors and tailgate are closed.
- ▷ Driver's safety belt is fastened.

## Switching on and activating

### Switching on with the button



Press park assistance button.  
The LED lights up.

The current status of the parking space search is indicated on the Control Display.

Parking assistant is activated automatically.

### Switching on with reverse gear

Shift into reverse.

The current status of the parking space search is indicated on the Control Display.

To activate: "Autom. Parking"



### Switching on via iDrive

Display of the rearview camera or PDC view must be active.

1. Move the Controller to the right.
2. Activating the parking assistant on the Control Display: "Autom. Parking"

## Display on the Control Display

### System activated/deactivated

Sym- bol	Meaning
	Gray: the system is not available. White: the system is available but not activated.
	The system is activated.
	Parking space search is active.

### Parking space search and system status

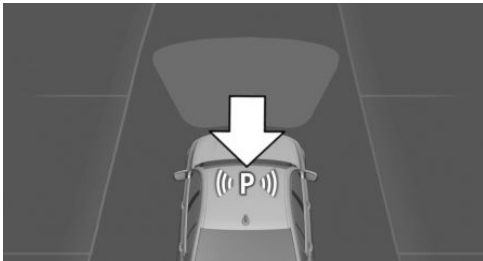

- ▶ Symbol P on the vehicle image: the parking assistant is activated and the parking space search is active.
- ▶ Control Display shows suitable parking spaces at the edge of the road next to the vehicle symbol. When Park Assistant is active, suitable parking spaces are highlighted and an acoustic signal sounds. Switch signal tone on/off, refer to page 256.
- ▶ If a diagonal or parallel parking space is clearly detected, the system automatically adjusts the suitable parking method. In the case of parking spaces suitable for parallel and diagonal parking, a selection menu is displayed. In this case, the desired parking method must be selected manually.

- ▶  The parking procedure is active. Steering control has been taken over by system.

- ▶ Parking space search is always active whenever the vehicle is moving forward slow and straight, even if the system is deactivated. When the system is deactivated, the displays on the Control Display are shown in gray.

## Parking using the parking assistant

### Parking

1. Switching on and activating the parking assistant.

Engage the reverse gear and activate the system or press the parking assistance button, refer to page 254, in the Control Display.

 Parking assistant is activated.

2. Drive by the row of parked vehicles at a speed of up to approx. 22 mph/35 km/h and at a distance of maximum 5 ft/1.5 m.

The status of the parking space search and possible parking spaces are displayed on the Control Display, refer to page 255.

3. Confirm the suggested parking space for the parking process: select the parking space on the Control Display.

The system takes over the steering.

4. Follow the instructions on the Control Display.



At the end of the parking procedure, the P selector lever position is set.

The end of the parking procedure is indicated on the Control Display.

5. Adjust the parking position yourself, if needed.

## Interrupting manually

The parking assistant can be interrupted at any time:

- ▷  Press park assistance button.
- ▷  "Autom. Parking" Select the symbol on the Control Display.

## Interrupting automatically

The system is interrupted automatically in the following situations:

- ▷ If the driver grasps the steering wheel or takes over steering.
- ▷ Possibly on snow-covered or slippery road surfaces.
- ▷ When there are obstacles that are hard to overcome, such as curbs.
- ▷ When there are obstacles that suddenly appear.
- ▷ If the PDC Park Distance Control displays clearances that are too small.
- ▷ If a maximum number of parking attempts or the time taken for parking is exceeded.
- ▷ When switching to another function on the Control Display.
- ▷ If the tailgate is open.
- ▷ If doors are open.
- ▷ When setting the parking brake.
- ▷ During acceleration.
- ▷ When the brake pedal remains pressed for an extended period while the vehicle is stationary.
- ▷ When unfastening the driver's safety belt.

A Check Control message is displayed.

## Resuming

An interrupted parking procedure can be continued, if needed.

Reactivate the parking assistant, refer to page 254, and follow the instructions on the Control Display.

## Switching off

The system can be switched off manually:

-  Press park assistance button.

## Switching signal tone for suitable parking spaces on/off

Via iDrive:

1. "CAR"
2. "Settings"
3. "Driver Assistance"
4. "Parking and Maneuvering"
5. "Automatic Parking"
6. "Alert if parking space detected"

The setting is stored for the driver profile currently used.

## Depending on the equipment version: driving out of a parking space using the parking assistant

### Concept

The system makes driving out of parallel parking spaces easier.

### General information

This function may not be available. Contact your authorized dealer's service center or another qualified service center as to whether this additional function is currently in your vehicle or when it can be installed in your vehicle in the future.

### Steptronic transmission

The parking assistant calculates an optimal line for pulling out of a parking space and takes control of the following functions during the maneuver:

- ▷ Steering.
- ▷ Accelerating and braking.



- ▶ Changing the gears.

The vehicle maneuvers automatically until the vehicle reaches a position in which the driver can drive out of the parking space without further steering movements.

### Functional requirement

- ▶ The vehicle has been parked using the parking assistant.
- ▶ An obstacle has been detected in front of the vehicle.
- ▶ The parking space is at least 2.6 ft/0.8 m longer than your vehicle.

### Driving out of parking spaces

1. Switch on drive-ready state.
2. Steptronic transmission:  
Press the park assistance button or shift into reverse gear when the vehicle is stationary to switch on the parking assistant.
3. Move the Controller to the right.
4. Activating the parking assistant on the Control Display:  "Autom. Parking"
5. Steptronic transmission:  
The system takes control of the maneuver. A message will be displayed at the end of the maneuver.
6. Make sure that the traffic situation permits driving out of the parking space and drive off as usual.  
The parking assistant is switched off automatically.

## Depending on the equipment version: Reversing Assistant

### Concept

The system supports the driver when driving in reverse, for instance when driving out of tight parking or street situations.

The vehicle stores the driving movements of the last route before the vehicle is switched off. This

stored route can be driven back with automated steering.

### General information

This function may not be available. Contact your authorized dealer's service center or another qualified service center as to whether this additional function is currently in your vehicle or when it can be installed in your vehicle in the future.

The system takes control of the steering when driving back along the stored route.

The driver controls driving the vehicle via accelerator pedal and brake.

### Functional requirement

- ▶ Drive forward without interruption to store the route.
- ▶ A maximum of 165 ft/50 meters will be stored.
- ▶ To store the route, do not exceed a driving speed of 22 mph/36 km/h.
- ▶ The return route must be at least 12 in./30 cm wider than your vehicle.

### Driving back with automated steering

1. Press the park assistance button or shift into reverse gear when the vehicle is stationary and the drive-ready state is switched on.
2. Move the Controller to the right.
3. "Back-up Assistant"  
The system takes over the steering.  
The possible route is shown on the Control Display.
4. Take your hands off the steering wheel and carefully drive off with the accelerator pedal and the brake.

When driving in reverse, observe the vehicle's surroundings and pay attention to the information from the PDC. Brake, if necessary.

5. Follow the instructions on the Control Display where required.
6. Stop no later than when normal traffic is reached and take control of the vehicle, such as by shifting to a forward gear.

At the end of the stored route, a signal will sound and a request will be displayed, also with the instruction to take control of the vehicle.

### Terminating the system

The system automatically cancels in situations such as the following:

- ▷ If the driver grasps the steering wheel or takes over steering.
- ▷ When engaging a forward gear.
- ▷ After a few minutes when the vehicle is stationary.
- ▷ If the vehicle leaves the stored lane during reversing; for example, at the maximum steering angle.

### Limits of the reverse driving assistant

- ▷ When you reach normal road traffic or if you suddenly encounter an obstacle, stop immediately and take over control of the vehicle.
- ▷ The maximum speed for driving in reverse is limited to approximately 6 mph/9 km/h.  
If the maximum speed is exceeded, a warning is issued and the function may be canceled.

### System limits

#### Safety information

 **WARNING**

The system can react not at all, too late, incorrectly, or without justification due to the system limits. There is a risk of accidents or risk of damage to property. Follow the information re-

garding the system limits and actively intervene if needed.

### No parking assistance

The parking assistant does not offer assistance in the following situations:

- ▷ In tight curves.
- ▷ When towing a trailer.
- ▷ For diagonal parking spaces.

### Functional limitations

The system may not be fully functional in the following situations:

- ▷ On bumpy road surfaces such as gravel roads.
- ▷ On slippery ground.
- ▷ On steep uphill or downhill grades.
- ▷ With accumulations of leaves/snow in the parking space.
- ▷ With a mounted emergency wheel.
- ▷ In case of changes to an already-measured parking space.
- ▷ With ditches or edges, for instance an edge of a port.

### Limits of ultrasonic measurement

Ultrasonic measurements might not function in the following situations:

- ▷ For small children and animals.
- ▷ For persons with certain clothing, for instance coats.
- ▷ With external interference of the ultrasound, for instance from passing vehicles or loud machines.
- ▷ When sensors are dirty, iced over, damaged or out of position.
- ▷ Under certain weather conditions such as high relative humidity, wet conditions, snowfall, extreme heat, or strong wind.

- ▶ With tow bars and trailer couplings of other vehicles.
- ▶ With thin or wedge-shaped objects.
- ▶ With moving objects.
- ▶ With elevated, protruding objects such as ledges.
- ▶ With objects with corners, edges, and smooth surfaces.
- ▶ With objects with a fine surface structure such as fences.
- ▶ For objects with porous surfaces.
- ▶ With small and low objects, for instance boxes.
- ▶ With obstacles and persons at the edge of the lane.
- ▶ With soft obstacles or obstacles covered in foam material.
- ▶ With plants and bushes.
- ▶ Low objects already displayed, for instance curbs, can move into the blind area of the sensors before or after a continuous tone sounds.
- ▶ Cargo that extends beyond the perimeter of the vehicle is not taken into account by the system.

Parking spaces that are not suitable may be detected or suitable parking spaces may not be detected at all.

## Malfuction

A Check Control message is displayed.

The parking assistant failed. Have the system checked by a dealer's service center or another qualified service center or repair shop.

## Crossing traffic warning

### Concept

At blind driveways or when driving out of diagonal parking spaces, approaching cross traffic is

detected sooner by the system than is possible from the driver's seat.

## General information

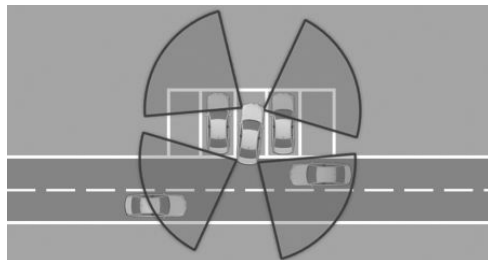

Two radar sensors in the rear bumper monitor the area behind the vehicle.

The system indicates approaching traffic.

Depending on the vehicle equipment, the traffic area in front of the vehicle is monitored as well. Two additional radar sensors are located in the front bumpers.

## Safety information

### WARNING

The system cannot serve as a substitute for the driver's personal judgment in assessing visibility and traffic situation. There is a risk of an accident. Adjust driving style to traffic conditions. Watch traffic closely and actively intervene where appropriate.

## Overview

### Button in the vehicle



 Park assistance button

### Radar sensors

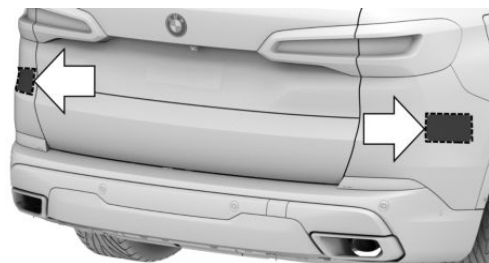

The radar sensors are located in the rear bumper.

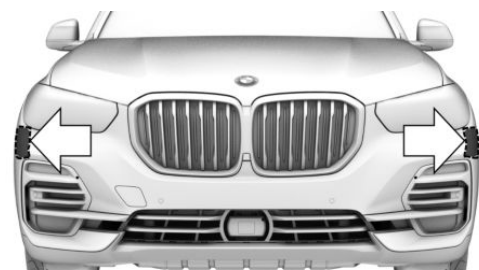



Depending on the vehicle equipment, two additional radar sensors are located in the front bumpers.

Always keep the bumper in the area of the radar sensors clean and unobstructed.

## Switching on/off

### Activating/deactivating the system

-  Press park assistance button.
- Move the Controller to the right.
-  "Settings"
- "Cross traffic warning"
- "Cross traffic warning"

Or via iDrive:

- "CAR"
- "Settings"
- "Driver Assistance"
- "Parking and Maneuvering"
- "Cross traffic warning"
- "Cross traffic warning"

### Switching on automatically

If the system was activated on the Control Display, it is automatically switched on as soon as PDC Park Distance Control or Panorama View is active and a gear is engaged.

If reverse gear is engaged, the rear system is switched on.

Depending on the vehicle equipment, the front system is switched on when a forward gear is engaged.

### Switching off automatically

The system is automatically switched off in the following situations:

- ▷ When the speed exceeds walking speed.
- ▷ When a certain driving distance is exceeded.
- ▷ With an active parking operation of the parking assistant.

## WARNING

### General information

The respective display is called up on the Control Display. A signal tone may sound and the light in the exterior mirror may flash.

### Light in the exterior mirror



The light in the exterior mirror flashes if vehicles are detected by the rear sensors and your own vehicle is moving backwards.

### Display in the PDC Park Distance Control view

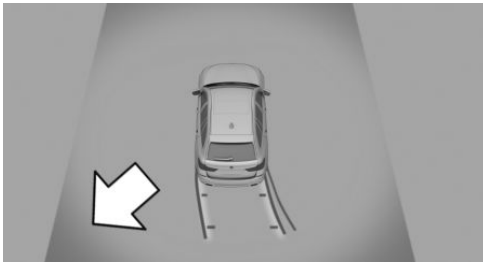

In the PDC Park Distance Control view, the respective boundary area flashes red, if vehicles are detected by the sensors.

### Display in the camera view

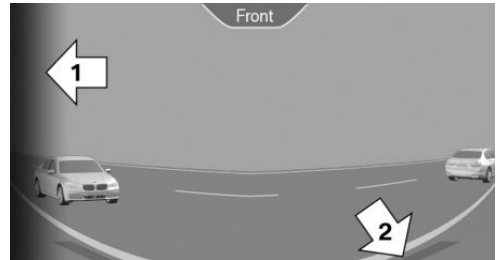

The respective boundary area, arrow 1, in the camera view flashes red, if vehicles are detected by the sensors.

Yellow lines, arrow 2, mark the bumper of your own vehicle.

### Acoustic warning

In addition to the optical indicator, a warning signal sounds if your own vehicle moves into the respective direction.

### System limits

The system may not be fully functional in the following situations:

- ▷ If the speed of the approaching vehicle is very high.
- ▷ In heavy fog, wet conditions, or snowfall.
- ▷ In tight curves.
- ▷ If the bumper is dirty, iced up, or covered, for instance by stickers.
- ▷ If cargo protrudes.
- ▷ If crossing objects move at a very slow speed.
- ▷ If other objects are in the capture range of the sensors, that hide cross traffic.

If the trailer power socket is in use or trailer towing is activated, for instance during operation with trailer or bicycle rack, crossing traffic warning is not available for the area behind the vehicle.

# Driving comfort

## Vehicle features and options

This chapter describes all standard, country-specific and optional features offered with the series. It also describes features and functions that are not necessarily available in your vehicle, e.g., due to the selected options or country versions. This also applies to safety-related functions and systems. When using these functions and systems, the applicable laws and regulations must be observed.

## 2-axle air suspension

### Concept

Air suspension ensures best possible driving comfort under all load conditions. Due to a variable adjustment of the front and rear axles, the damping is adjusted to the vehicle state.

### General information

Regardless of the load, the vehicle will be maintained at the configured vehicle level.

Depending on the driving situation, the vehicle level can be set to five levels.

- ▶ **Entry level:**  
Lowest vehicle level setting.  
The entry level can be set when the vehicle is stationary with the following features:
  - ▶ With the rocker switch in the center console.
  - ▶ With the BMW display key.
  - ▶ With the button in the lower section of the tailgate.

The vehicle will adjust according to the selected driving mode at drive-off.

- ▶ **Sport level:**  
Lowest driving level for driving at higher speeds.
- ▶ **Normal level:**  
Standard level for normal roads and speeds.
- ▶ **High level 1:**  
Slightly elevated vehicle level for easy terrain at reduced speed.  
If necessary, the vehicle will be lowered at higher speeds.
- ▶ **High level 2:**  
Highest driving level for terrains with major uneven surfaces in the lowest speed range.  
If necessary, the vehicle will be lowered at higher speeds.

Level adjustment takes place when all doors are closed.

## Safety information

### **WARNING**

Adjusting the vehicle height may result in trapped body parts or damaged vehicle parts. There is a risk of injury or risk of damage to property. When adjusting the vehicle height, make sure that the areas of movement around the vehicle and at the wheel housing are free.

## Overview

### Rocker switch in the vehicle



## Setting the level

### With the rocker switch in the center console



#### Up

Push the rocker switch forward.

In the low speed range, the vehicle is raised to next higher level when the rocker switch is pressed.

#### Down

Pull the rocker switch backward.

The vehicle will lower by one level.

#### Display

- ▶ LED on the rocker switch lights up: display of the current level.
- ▶ LED on the rocker switch is flashing: adjustment procedure active. The vehicle raises or lowers itself.

- ▶ LED on the rocker switch flashes fast: the selected level is not possible at this time.

## Automatic

### While driving

In the SPORT driving mode, refer to page 148, SPORT+ driving mode or at higher speeds, the vehicle lowers itself automatically.

When a set vehicle level is exited due to the speed, the vehicle level will be adjusted according to the selected driving mode.

### In the event of a flat tire

When a loss of the tire inflation pressure is detected on a wheel, the wheel load will be reduced automatically to increase the possible range of travel. In this situation, only the normal level is available.

## With the BMW display key

### Concept

The vehicle level can be adjusted with the BMW display key when the vehicle is stationary, for instance for easier loading or as an entry aid.

### Setting the level

1. Apply parking brake and switch drive-ready state off using the Start/Stop button.
2. Closing the doors.
3. If necessary, switch on the display on the BMW display key and cancel the display block, refer to page 81.
4. On the BMW display key, change to the following menu: "Entry level".
5. "Height control"
6. ▶ "Lower" tap the button. The vehicle lowers itself to the entry level.
  - ▶ "Raise" tap the button. The vehicle will raise itself from the entry level according to the selected driving mode.

### Terminating the adjustment procedure

An adjustment procedure that was started on the BMW display key can be terminated with the BMW display key.

"Cancel": tap the button. The vehicle raises or lowers itself back to the starting level.

### With the button in the lower tailgate



When the tailgate is opened, the vehicle can be lowered to the entry level and raised again by pressing the button. The flashing of the LED in the button indicates the level change.

During the raising procedure, the vehicle raises itself from the entry level to the level that was selected last or the normal level.

### Terminating the adjustment procedure

An adjustment procedure that was started with the button in the lower tailgate can be terminated with this button.

Press the button again. The vehicle raises or lowers itself back to the starting level.

### System limits

With several manual level changes one after another, the system will temporarily switch itself off, if necessary. The rejection of another level change is indicated by a fast flashing LED on the rocker switch.

When the trailer power socket is in use or when trailer towing is activated, only the normal level is available.

### Wheel change

Before a wheel change, deactivate the system:

Press the rocker switch forward or pull it backward for approx. 7 seconds. After the rocker switch is released, the LED indicator on the rocker switch will go out.

Activating the system: press the rocker switch forward or pull it backward for approx. 7 seconds. After the rocker switch is released, the LED indicator will reactivate.

### Malfunction

A Check Control message is displayed. The system is impaired. Vehicle handling may be altered and driving comfort may be noticeably reduced. Visit the nearest dealer's service center or another qualified service center or repair shop.

### Long periods when vehicle is parked

During long periods when the vehicle is parked, it can lower itself. This is not a malfunction.

If drive-ready state is switched on with the doors closed, the vehicle is raised to the normal level automatically.

Depending on the state of the vehicle, raising to normal level may take several minutes.

## xOffroad package

### Concept

The xOffroad package supports the driver when driving away from unpaved roads or with reduced traction. The system offers four different xOffroad driving modes for selection.

The xOffroad driving modes can be selected based on the ground conditions.

When an xOffroad mode is switched on, individual systems in the vehicle are set to the best possible traction and vehicle stability.



With the 2-axle air suspension, refer to page 262, the vehicle level is set for the corresponding xOffroad driving mode.

## xOffroad driving modes and levels

xOffroad driving mode	Level
"xGRAVEL"	High level 1
"xSAND"	High level 1
"xROCKS"	High level 2
"xSNOW"	Normal level

## General information

The system optimizes the driving behavior and the traction on unpaved surfaces within the physical limits.

This is operated with the button and rocker switch in the center console.

Observe the information in the chapter Driving tips, driving on bad roads, refer to page 312.

## Overview

### Button and rocker switch in the center console

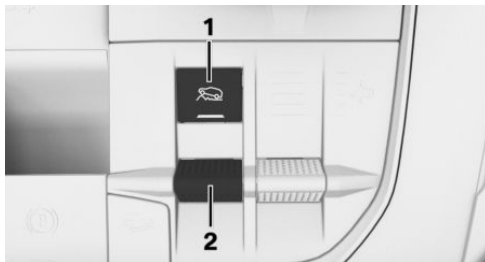

- 1 Switch the xOffroad driving mode on/off.
- 2 Set the xOffroad driving mode.

## Switching on

Press button 1 or rocker switch 2 forward or pull back. The xOffroad driving mode "xGRAVEL" is

switched on. The LED on the button lights up. The driving mode is displayed in the instrument cluster.

The effective speed range is displayed in the speedometer with a line below the scale.

## Setting the xOffroad driving mode



Push the rocker switch forward or pull it back repeatedly until the desired xOffroad driving mode is displayed in the instrument cluster.

## xOffroad driving modes in detail

### All driving modes

When the xOffroad driving modes are switched on, the following vehicle settings will be applied:

- ▷ Auto Start/Stop function is switched off.
- ▷ Transmission and accelerator pedal: the shifting behavior and response to the accelerator pedal are adjusted.
- ▷ The all-wheel-drive system is set to the best possible traction.
- ▷ Display on the Control Display: the power distribution on the wheels can also be displayed in the xOffroad display.

With the proper equipment, additional terrain-specific camera perspectives can be selected.

### "xGRAVEL"

This driving mode is active every time the xOffroad modes are switched on.

Setting for: "Optimized vehicle setting for easy terrain."

When switching on, the following additional vehicle settings are carried out, for example:

- ▷ Anti-lock system: the response behavior is adjusted.
- ▷ DSC: the response behavior is adjusted.
- ▷ 2-axle air suspension: high level 1 is set.

### "xSAND"

Setting for: "Optimized vehicle setting for heavy terrain with loose surface. For maximum traction, deactivate DSC."

When switching on, the following additional vehicle settings are carried out, for example:

- ▷ Anti-lock system: the response behavior is adjusted.
- ▷ DSC: the response behavior is adjusted.
- ▷ 2-axle air suspension: high level 1 is set.

### "xROCKS"

Setting for: "Optimized vehicle setting for heavy terrain with strong irregularities. For maximum traction, deactivate DSC."

When switching on, the following additional vehicle settings are carried out, for example:

- ▷ Anti-lock system: the response behavior is adjusted.
- ▷ DSC: the response behavior is adjusted.
- ▷ 2-axle air suspension: high level 2 is set.

### "xSNOW"

Setting for: "Optimized vehicle setting for assured handling on slippery road."

When switching on, the following additional vehicle settings are carried out, for example:

- ▷ 2-axle air suspension: normal level is set.
- ▷ Steptronic transmission: the shift behavior is set to gentle gear changes. The vehicle drives off in second gear.

- ▷ Accelerator pedal: the characteristic of the accelerator pedal is optimized for gentle driving behavior.

## Manual switching off

Press button 1. The LED on the button goes out. The last driving mode that was set through the Driving Dynamics Control will be activated.

## Display on the Control Display

### Display xView display

Via iDrive:

1. "CAR"
2. "Driving information"
3. "xOFFROAD"

The following information is displayed:

- ▷ With a navigation system: compass display for the driving direction.
- ▷ With navigation system: height indication for the current position.
- ▷ With navigation system: destination flag in compass direction to the destination.
- ▷ Pitch attitude with degree indication and percentage.
- ▷ Transverse gradient with degree indication.
- ▷ Graphic display for the steering angle.
- ▷ Level setting for the 2-axle air suspension.

With the xOffroad package, the following additional information can be displayed:

- ▷ With Surround View: depending on the speed, terrain-specific camera perspectives.
- ▷ xOffroad mode currently active.
- ▷ Distribution of drive torque to the wheels.

## System limits

The xOffroad properties may be reduced at higher speeds where required.

## Adaptive chassis

### Concept

This system reduces undesirable vehicle motion when using a dynamic driving style or traveling on uneven road surfaces.

### General information

This enhances the driving dynamics and driving comfort depending on the road surface condition and driving style.

### Tuning

The system offers several different damping settings.

The damping settings are assigned to the different driving modes of the Driving Dynamics Control, refer to page 148.

Driving mode	Damper tuning
COMFORT	Balanced out
ECO PRO	
SPORT	Firm
SPORT PLUS	

## Active roll stabilization

### Concept

The system reduces the lateral tilt of the vehicle that occurs during rapid driving in curves or during quick evasive maneuvers.

### General information

The lateral tilt of the vehicle is balanced out by permanent adjustment on the front and rear axles. The vehicle is thus always stabilized.

Agility and driving comfort are increased under all driving conditions.

## Tuning

The system offers several different tunings.

The tunings are assigned to the different driving modes of the Driving Dynamics Control, refer to page 148.

Driving mode	Tuning
COMFORT	Comfortable
ECO PRO	
SPORT	Firm
SPORT PLUS	

## Adaptive M chassis

### Concept

The Adaptive M chassis is a controllable sport chassis/suspension. This system reduces undesirable vehicle motion when using a dynamic driving style or traveling on uneven road surfaces.

This enhances the driving dynamics and driving comfort depending on the road surface condition and driving style.

### General information

The system offers several different damping settings.

The damping settings are assigned to the different driving modes of the Driving Dynamics Control, refer to page 148.

Depending on the equipment version, the rear axle lock differential will be adjusted for the respective traction conditions as needed.

Driving mode	Damper tuning
SPORT	Firm
SPORT PLUS	Sporty and tight
COMFORT/ECO PRO	Balanced out



## Adaptive M Chassis Professional

---

The resulting braking power is simultaneously largely compensated by an engine intervention.

### Concept

The Adaptive M Suspension Professional is an actively controlled sport chassis/suspension. The system increases driving comfort and minimizes the lateral tilt when driving around curves.

The Adaptive M Suspension Professional encompasses the following systems:

- ▷ Sport suspension.
- ▷ Adaptive chassis.
- ▷ Active roll stabilization.
- ▷ Integral Active Steering.

### General information

For active control, this system uses the available information, for instance from the navigation system or the driving style analysis.

This information influences the control of the following systems, especially in ADAPTIVE driving mode, refer to page [150](#):

- ▷ Adaptive chassis, refer to page [267](#).
- ▷ Active roll stabilization, refer to page [267](#).
- ▷ Integral Active Steering, refer to page [218](#)

This further increases the agility and comfort of the vehicle.

The function may be restricted if the navigation data is invalid, outdated or not available, for example.

Depending on the equipment, the rear axle lock differential will be adjusted for the traction conditions as needed.

### Performance Control

---

Performance Control enhances the agility of the vehicle.

To increase maneuverability, wheels are braked individually when a sporty driving style is used.

# Climate control

## Vehicle features and options

This chapter describes all standard, country-specific and optional features offered with the series. It also describes features and functions that are not necessarily available in your vehicle, e.g., due to the selected options or country versions. This also applies to safety-related functions and systems. When using these functions and systems, the applicable laws and regulations must be observed.

## Interior air quality

The air quality in the vehicle is improved by the following components:

- ▶ Emission tested car's interior.
- ▶ Microfilter.
- ▶ Air conditioning system to control the temperature, air flow and recirculated-air mode.

Depending on the equipment specification:

- ▶ Microfilter/activated-charcoal filter.
- ▶ Ionization.
- ▶ Fragrancing.
- ▶ Automatic recirculated-air control AUC.
- ▶ Parked-car ventilation.







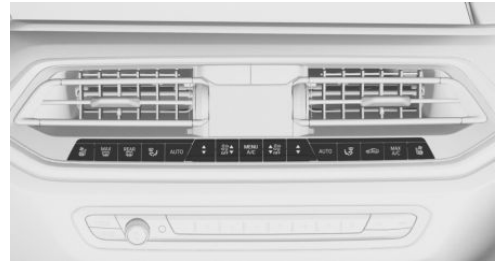

## Automatic climate control



### Overview



### Buttons in the vehicle



### Climate control functions

Button	Function
	Temperature, refer to page <a href="#">270</a> .
	Climate control operation, refer to page <a href="#">271</a> .
	Maximum cooling, refer to page <a href="#">271</a> .
	AUTO program, refer to page <a href="#">271</a> .
	Recirculated-air mode, refer to page <a href="#">272</a> .
	Air flow, manual, refer to page <a href="#">273</a> .
	Air distribution, manual, refer to page <a href="#">273</a> .
	Defrost and defog the windshield, refer to page <a href="#">274</a> .
	Rear window defroster, refer to page <a href="#">274</a> .

Button	Function
	Active seat ventilation, refer to page 126.
	Seat and armrest heating, refer to page 125.
	Open the Climate menu, refer to page 270.  For the following settings, for instance: upper body temperature adjustment, parked-car ventilation.

-  Press and hold the button on the driver's side bottom until the control panel switches off.
- ▷ On the front passenger side:
  -  Press and hold the button on the front passenger side bottom.

## Temperature

### Concept

The automatic climate control achieves the set temperature as quickly as possible, if needed, by using the maximum cooling or heating capacity, and then keeps it constant.

### Settings

-  Press the upper or lower button side to set the desired temperature.

Via iDrive:

1. "CAR"
2. "Settings"
3. "Climate control"
4. "Heating/ventilation"
5. "Driver" or "Front passenger"
6. "Temperature:"
7. Set the desired temperature.

Do not rapidly switch between different temperature settings. Otherwise, the automatic climate control will not have sufficient time to adjust the set temperature.

## Temperature of the ventilation

### General information

The temperature of the ventilation in the upper body area can be adjusted.

The temperature is individually adjusted, e.g. colder toward blue, warmer toward red.

## Opening the Climate menu

-  Push the button up.

The Climate menu is displayed.

For example, the following climate control functions can be accessed via the Climate menu:

- ▷ Fragrance.
- ▷ Heating/ventilation.
- ▷ Air quality.
- ▷ Seats/surfaces.
- ▷ Parked-car ventilation/heating

Individual settings can be entered for some of the climate functions, e.g., switching on/off, intensity.

## Switching on/off

### Switching on

Press any button except for the following:

- ▷ Menu.
- ▷ Rear window defroster.
- ▷ Lower air flow button side.
- ▷ Seat heating.
- ▷ Seat ventilation.

### Switching off

- ▷ Complete system:

The air flow of the ventilation in the upper body range heats or cools noticeably, depending on the adjusted temperature.

This does not change the set interior temperature for the driver and front passenger.

## Settings

Via iDrive:

1. "CAR"
2. "Settings"
3. "Climate control"
4. "Heating/ventilation"
5. "Driver" or "Front passenger"
6. "Temperature adjustment"
7. Set the desired temperature:
  - ▷ Toward blue: colder.
  - ▷ Toward red: warmer.

## Air conditioning

### Concept

The air in the car's interior will be cooled and dehumidified and, depending on the temperature setting, warmed again.

The car's interior can only be cooled with the drive-ready state switched on.

### Switching on/off

 Push the button down.

Via iDrive:

1. "CAR"
2. "Settings"
3. "Climate control"
4. "Heating/ventilation"
5. "A/C"

Air conditioning is switched on with the engine running.

Depending on the weather, the windshield and side windows may fog up briefly when drive-ready state is switched on.

The air conditioning is switched on automatically with the AUTO program.

When using the automatic climate control, condensation water develops and collects underneath the vehicle.

## Maximum cooling

### Concept

The system is set to the lowest temperature, optimum air flow and recirculated-air mode with the drive-ready state switched on.

### General information

The function is available with external temperatures above approx. 32 °F/0 °C and with the drive-ready state switched on.

### Switching on/off

 Press the button.  
The LED is illuminated with the system switched on.

Air flows out of the vents to the upper body region. The vents need to be open for this.

The air flow can be adjusted with the air flow active.

## AUTO program

### Concept

The AUTO program cools, ventilates or heats the car's interior automatically.

The air distribution and temperature are controlled automatically depending on the temperature in the car's interior and the desired temperature setting including the selected intensity of the air flow.



## Switching on/off

**AUTO**

Press the button.

The LED is illuminated with the AUTO program switched on.

Via iDrive:

1. "CAR"
2. "Settings"
3. "Climate control"
4. "Heating/ventilation"
5. "Driver" or "Front passenger"
6. "Automatic"

Depending on the selected temperature, the intensity of the AUTO program, and outside influences, the air is directed to the windshield, side windows, upper body, and into the floor area.

The air conditioning, refer to page 271, is switched on automatically with the AUTO program.

At the same time, a condensation sensor controls the program so as to prevent window condensation as much as possible.

The AUTO program is switched off automatically, when manual air distribution is set.

## Intensity

With the AUTO program switched on, the intensity can be set. This changes the automatic control for the air flow and air distribution.



Press the lower or upper side of the button: decrease or increase intensity.

Via iDrive:

1. "CAR"
2. "Settings"
3. "Climate control"
4. "Heating/ventilation"
5. "Driver" or "Front passenger"
6. "Level"
7. Set the desired intensity.

The air flow and air distribution are controlled automatically depending on the selected intensity.

The selected intensity is shown on the climate control display.

## Automatic recirculated-air control AUC

### Concept

The automatic recirculated-air control AUC recognizes odors or pollutants in the outside air. The outside air supply is shut off and the interior air is recirculated.

### General information

If the system is activated, a sensor detects pollutants in the outside air and controls the shut-off automatically.

If the system is deactivated, outside air continuously flows into the car's interior.

With constant recirculated-air mode, the air quality in the car's interior deteriorates and the fogging of the windows increases.

## Switching on/off

Via iDrive:

1. "CAR"
2. "Settings"
3. "Climate control"
4. "Air quality"
5. "Automatic"

If there is window condensation, switch off recirculated-air mode or defog the windows, refer to page 274.

## Recirculated-air mode

### Concept

You may react to unpleasant odors or pollutants in the immediate environment by temporarily suspending the supply of outside air. The system then recirculates the air flow within the vehicle.



## Operation



Press the button repeatedly to select an operating mode.

The LED is illuminated when the recirculated-air mode is switched on. The supply of outside air is permanently shut off.

Via iDrive:

1. "CAR"
2. "Settings"
3. "Climate control"
4. "Air quality"
5. Select desired setting:
  - ▷ "Fresh air"
  - ▷ "Air recirculation"
  - ▷ "Auto-recirculate"

To prevent window fogging, recirculated-air mode switches off automatically after a certain amount of time, depending on the environmental conditions.

With constant recirculated-air mode, the air quality in the car's interior deteriorates and the fogging of the windows increases.

If there is window condensation, switch off recirculated-air mode or defog the windows, refer to page [274](#).

## Controlling the air flow manually

### Concept

The air flow for climate control can be adjusted manually.

### General information

To manually adjust air flow switch off AUTO program first.

### Operation



Press the lower or upper side of the button: decrease or increase air flow.

The selected air flow is shown on the climate control display.

The air flow may be reduced automatically to save battery power.

## Controlling the air distribution manually

### Concept

The air distribution for climate control can be adjusted manually.

### Operation



Press the button repeatedly to select a program:

- ▷ Windows, upper body region, and floor area.
- ▷ Upper body region and floor area.
- ▷ Floor area.
- ▷ Windows and floor area.
- ▷ Windows.
- ▷ Windows and upper body.
- ▷ Upper body region.

The selected air distribution is shown on the climate control display.

If there is window condensation, defog the windows, refer to page [274](#).

## SYNC program

### Concept

Depending on the equipment, the following settings of the driver's side can be transferred to the front-passenger side and the rear:

- ▷ Temperature.
- ▷ Air flow.
- ▷ Air distribution.
- ▷ AUTO program.



## Switching on/off

Via iDrive:

1. "CAR"
2. "Settings"
3. "Climate control"
4. "Synchronize"

The program is switched off automatically if the settings on the front passenger side or in the rear are changed.

## Defrost windshield and remove condensation

### Concept

Ice and condensation are quickly removed from the windshield and the front side windows.

### Switching on/off



Press the button.

The LED is illuminated with the system switched on.

Point the side vents towards the side windows, as needed. The air flow can be adjusted manually with the system switched on.



If there is window condensation, press the button on the driver's side or switch on air conditioning to utilize the condensation sensor. Make sure that air can flow to the windshield.

## Rear window defroster



Press the button. The LED lights up.

The function is available with the engine running.

The rear window defroster switches off automatically after a certain period of time.

## Microfilter/activated-charcoal filter

The microfilter removes dust and pollen from the incoming air.

The activated-charcoal filter also removes gaseous pollutants from the outside air that enters the vehicle.

Have this combined filter changed during vehicle maintenance, refer to page [374](#).

## Ventilation

### Concept

The air flow directions can be individually adjusted.

### Adjusting the ventilation

#### General information

The air flow directions can be adjusted for direct or indirect ventilation.

#### Direct ventilation

The air flow is directed towards the passengers. The air flow heats or cools noticeably, depending on the adjusted temperature.

#### Indirect ventilation

The air flow is not directed towards the passengers. The car's interior is warmed or cooled indirectly, depending on the set temperature.

## Front ventilation

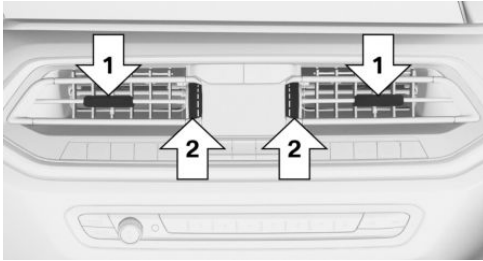

- ▶ Lever for changing the air flow direction, arrow 1.
- ▶ Thumbwheel for variable opening and closing of the vents, arrow 2.

## Ventilation in rear, center

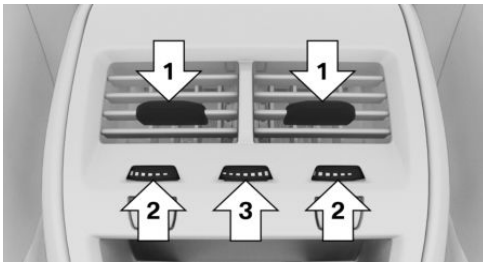

- ▶ Lever for changing the air flow direction, arrow 1.
- ▶ Thumbwheel for variable opening and closing of the vents, arrow 2.
- ▶ Thumbwheel for varying the temperature, arrow 3.  
Toward blue: colder.  
Toward red: warmer.

## Ventilation in the rear, on the side

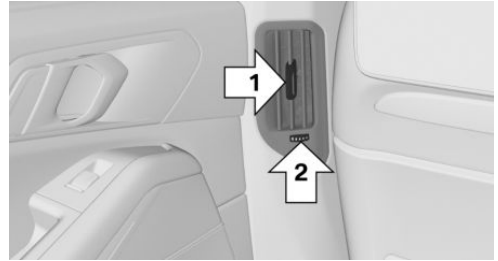

- ▶ Lever for changing the air flow direction, arrow 1.
- ▶ Thumbwheel for variable opening and closing of the vents, arrow 2.

## Heating and ventilation, third row of seats

The air in the area of the third row of seats can be heated or circulated. The vents are located in the storage area between the seats and in the floor area of the third row of seats.

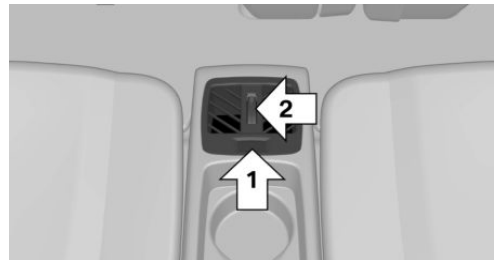

- ▶ Button for switching on the fan, arrow 1. The LED lights up.
- ▶ Thumbwheel for the activation of the heat and distribution of the air, arrow 2.  
Turn toward the front: activate the heater and distribute the air in the floor area.  
Turn toward the rear: distribute the air in the storage area between the seats.

The heater is not ready for operation without switching on the fan. After the heater is switched

off, the fan can be used to circulate the interior air, for instance at high temperatures. To do this, switch on the fan, arrow 1, and turn the thumb-wheel toward the rear, arrow 2.

## Rear automatic climate control

### Overview

#### Buttons in the vehicle



#### Climate control functions

Button	Function
	Temperature, refer to page 276
	Maximum cooling, refer to page 277.
	AUTO program, refer to page 277.
	Air flow, manual, refer to page 277.
	Air distribution, manual, refer to page 278.
	Seat heating, refer to page 126.

## Switching on/off

### Via iDrive

1. "CAR"
2. "Settings"
3. "Climate control"
4. "Heating/ventilation"
5. "Second row of seats"
6. "Activate heating/cooling"

The rear automatic climate control is not ready for operation if the automatic climate control is switched off or if the function for defrosting the windows and removing condensation is active.

### Using the button: switching on

Press any button except for the following:

- ▷ Lower air flow button side.
- ▷ Seat heating.

### Using the button: switching off

Press and hold the bottom of the button.

## Temperature

### Concept

The automatic climate control achieves the set temperature as quickly as possible, if needed, by using the maximum cooling or heating capacity, and then keeps it constant.

### Settings

Press the upper or lower button side to set the desired temperature.

Via iDrive:

1. "CAR"
2. "Settings"
3. "Climate control"
4. "Heating/ventilation"

5. "Second row of seats"
6. "Temperature left:" or "Temperature right:"
7. Set the desired temperature.

The selected temperature is shown on the climate control display.

Do not rapidly switch between different temperature settings. Otherwise, the automatic climate control will not have sufficient time to adjust the set temperature.

## Maximum cooling

### Concept

The system is set to the lowest temperature, optimum air flow and recirculated-air mode with the drive-ready state switched on.

### General information

The function is available with external temperatures above approx. 32 °F/0 °C and with the drive-ready state switched on.

### Switching on/off

 Press the button.  
The LED is illuminated with the system switched on.

Air flows out of the vents to the upper body region. The vents need to be open for this.

## AUTO program

### Concept

Air flow, air distribution and temperature are controlled automatically.

### Switching on/off

 Press the button.  
The LED is illuminated with the AUTO program switched on.

Via iDrive:

1. "CAR"
2. "Settings"
3. "Climate control"
4. "Heating/ventilation"
5. "Second row of seats"
6. "Automatic"

Depending on the selected temperature, the AUTO intensity, and outside influences, the air is directed to the upper body and into the floor area.

### Intensity

With the AUTO program activated, the automatic intensity control can be changed:

 Press the lower or upper side of the button: decrease or increase intensity.

Via iDrive:

1. "CAR"
2. "Settings"
3. "Climate control"
4. "Heating/ventilation"
5. "Second row of seats"
6. "Level"
7. Set the desired intensity.

The air flow and air distribution are controlled automatically depending on the selected intensity.

The selected intensity is shown on the climate control display.

## Controlling the air flow manually

### Concept

The air flow for climate control can be adjusted manually.

### General information

To manually adjust air flow switch off AUTO program first.

## Operation

 Press the lower or upper side of the button: decrease or increase air flow.

The selected air flow is shown on the climate control display.

## Controlling the air distribution manually

### Concept

The air distribution for climate control can be adjusted manually.

### Operation

 Press the lower or upper side of the button to select a program:

- ▷ Upper body region.
- ▷ Upper body region and floor area.
- ▷ Floor area.

## Parked-car ventilation

### Concept

The car's interior can be cooled or heated before driving off with the parked-car ventilation. Depending on set temperature and ambient temperature, the car's interior is ventilated or possibly heated using the residual engine heat.

### General information

The system can be switched on and off directly or via a preset departure time.

The system can also be used via the BMW Connected App.

The activation time is determined based on the external temperature. The system promptly switches on before the selected departure time.

## Functional requirements

- ▷ The vehicle is in idle state or standby state and not in drive-ready state.
- ▷ Battery is sufficiently charged.  
If parked-car ventilation is switched on, the vehicle battery will be discharged. Thus, limit the maximum activation time to save the vehicle battery. The system will be available again after the engine is started or after a short trip.
- ▷ Make sure that the vehicle's date and time are set correctly.
- ▷ Open the vents to allow air to flow out.

## Opening the Climate menu

 Push the button up.

The Climate comfort menu is displayed.

Individual settings can be entered for some of the climate control functions.

## Switching on/off directly

### General information

There are different ways to switch the system on or off.

The system switches off automatically after a certain period of time. The system continues to run for some time after being switched off.

### Using the button

When the vehicle is in standby state, the parked-car ventilation can be switched on or off via the automatic climate control buttons.

Press any button except:

- ▷ Rear window defroster.
- ▷ Lower air flow button side.
- ▷ Seat heating.
- ▷ Seat ventilation.
- ▷ Menu.



The system switches off after leaving and locking the vehicle.

### Via iDrive



1. "CAR"
2. "Settings"
3. "Climate control"
4. "Pre-ventilation" or "Pre-heating/ventilation"
5. "Activate now"

### Via BMW display key

#### Switching on

1. Switch on the display of the BMW display key.
2. "Precondit. setting"
3. Tap the  symbol or the  symbol.
4. "Activate now"
5. "Start"

#### Switching off

1. Switch on the display of the BMW display key.
2. "Precondit. setting"
3. Tap the  symbol or the  symbol.
4. "Stop"

### Display

Symbol	Description
	Symbol on the climate control display. Flashing: the parked-car ventilation is switched on.

## Departure time

### Concept

Different departure times can be adjusted to ensure a comfortable interior temperature in the vehicle at the time of departure.

- ▶ One-time departure time: the time can be set.  
The system is switched on once.
- ▶ Departure time with weekday: time and day of the week can be set.  
On the desired weekdays, the system will be switched on promptly before the set departure time.

The departure time is preselected in two steps:



- ▶ Set departure times.
- ▶ Activate departure times.

## Setting the departure time

### Via iDrive

1. "CAR"
2. "Settings"
3. "Climate control"
4. "Pre-ventilation" or "Pre-heating/ventilation"
5. "Departure schedule"
6. Select the desired departure time.
7. Set the departure time.
8. Select day of the week, if needed.

### Via BMW display key

1. Switch on the display of the BMW display key.
2. "Precondit. setting"
3. Tap the  symbol or the  symbol.
4. Select the desired departure time.
5. Set the departure time.
6. Select day of the week, if needed.
7. "OK"

## Activating the departure time

### Functional requirement



If a departure time is to influence the switching on of parked-car ventilation, the respective departure time must be activated first.





### Via iDrive

1. "CAR"
2. "Settings"
3. "Climate control"
4. "Pre-ventilation" or "Pre-heating/ventilation"
5. "Preconditioning for departure"
6. Activate the desired departure time.

### Via BMW display key

1. Switch on the display of the BMW display key.
2. "Precondit. setting"
3. Tap the  symbol or the  symbol.
4.  Tap on symbol.
5. Activate the desired departure time.

### Display

 ,  Symbol on the climate control display signals an activated departure time.

## Stationary climate control through Remote Engine Start

### Concept

Stationary climate control cools or heats the car's interior prior to departure to a comfortable temperature. The system automatically cools, vents, and heats depending on the interior, external, and set temperature. Snow and ice may be removed more easily.

The system starts the engine automatically and allows it to run for a limited period of time.

## Safety information

### DANGER

If the exhaust pipe is blocked or ventilation is insufficient, harmful exhaust gases can pollute the area in and around the vehicle or enter into the vehicle. The exhaust gases contain pollutants which are colorless and odorless. In enclosed areas or areas with insufficient ventilation, exhaust gases can also accumulate outside of the vehicle. There is danger to life. Keep the exhaust pipe free and ensure sufficient ventilation. Do not switch on stationary climate control in enclosed areas or areas with insufficient ventilation, e.g. in enclosed garages.

### WARNING

When stationary climate control is in operation, high temperatures can occur underneath the body, for instance caused by the exhaust gas system. If combustible materials, such as leaves or grass, come in contact with hot parts of the exhaust gas system, these materials can ignite. There is a risk of fire. Make sure that no combustible materials can come in contact with hot vehicle parts during stationary climate control operation, e.g. leaves, grass, gas, gasoline, oil or other combustible objects.

## Functional requirements

- ▷ The vehicle is in idle state or standby state and not in drive-ready state.
- ▷ Battery is sufficiently charged.
- ▷ For reasons of safety, the system can only be switched on twice consecutively. The system will be available again as soon as the drive-ready state is activated and deactivated again.
- ▷ The fuel tank capacity is sufficient.
- ▷ Hood is closed.



- ▷ Make sure that the vehicle's date and time are set correctly.
- ▷ Open the vents to allow air to flow out.

## Enabling the automatic engine start function

The automatic engine start must be enabled before using the system.

Otherwise, the engine cannot switch on automatically to climatize the car's interior.

Via iDrive:

1. "CAR"
2. "Settings"
3. "Climate control"
4. "Preconditioning/ventilation"
5. If necessary, "Remote Engine Start"
6. "Starting engine for clim. control"
7. Confirm the disclaimer.

## Confirmation signals from the vehicle

The activation of the system is confirmed by flashing twice.

The parking lights are switched on as long as the system is switched on.

## Opening the Climate menu



Push the button up.

The Climate comfort menu is displayed.

Individual settings can be entered for some of the climate control functions.

## Switching on/off directly

### General information

There are different ways to switch the system on or off:

- ▷ Via iDrive.

- ▷ Via remote control.
- ▷ Via BMW display key.

The system switches off automatically after approx. 15 minutes.

For reasons of safety, the system can only be switched on twice consecutively. The system will be available again as soon as the drive-ready state is activated and deactivated again.

### Via iDrive

1. "CAR"
2. "Settings"
3. "Climate control"
4. "Preconditioning/ventilation"
5. "Activate now"

### Via remote control

The system can be switched on and off using the remote control.



Press the button on the remote control three times within 1 second.

After operating the remote control, it will take approximately 3 seconds until the engine is switched on.

To switch off the system, press the button again three times.

### Via BMW display key

Switching on:

1. Switch on the display of the BMW display key.
2. "Precondit. setting"
3.  Tap on symbol.
4. "Activate now"
5. "Start"

Switching off:

1. Switch on the display of the BMW display key.
2. "Precondit. setting"

3.  Tap on symbol.
4. "Stop"

## Display

Symbol	Description
	Symbol on the BMW display key for automatic climate control.  The symbol flashes while Remote Engine Start is running.

## Climatization for the requested departure time

### General information

Scheduled departure times can be set up in the system to ensure a comfortable interior temperature in the vehicle at the time of departure.

- ▶ One-time departure time: the time of the scheduled departure can be set.

The system is switched on once.

- ▶ Departure time with weekday: time and day of the week of the scheduled departure can be set.

On the desired weekdays, the system will be switched on 10 minutes before the set departure time.

The departure time is preselected in two steps:

- ▶ Set departure times.
- ▶ Activate departure times.

The climate control function will start approximately 10 minutes before the set departure time and continue for 5 more minutes after the departure time.

For reasons of safety, the system can only be switched on twice consecutively. The system will be available again as soon as the drive-ready state is activated and deactivated again.

Observe the information about the intended use of the vehicle, refer to page 10.

## Setting the departure time

### Via iDrive

1. "CAR"
2. "Settings"
3. "Climate control"
4. "Preconditioning/ventilation"
5. Select the desired departure time.
6. Set the departure time.
7. Select day of the week, if needed.

### Via BMW display key

1. Switch on the display of the BMW display key.
2. "Precondit. setting"
3.  Tap on symbol.
4. Select the desired departure time.
5. Set the departure time.
6. Select day of the week, if needed.
7. "OK"



## Activating the departure time

### Functional requirement





If a requested departure time is to influence the switching on of the system, the respective departure time must be activated first.

### Via iDrive

1. "CAR"
2. "Settings"
3. "Climate control"
4. "Preconditioning/ventilation"
5. Activate the desired departure time.

 ,  The symbol on the automatic climate control signals an activated departure time

## Via BMW display key

1. Switch on the display of the BMW display key.
  2. "Precondit. setting"
  3.  Tap on symbol.
  4. Activating the desired departure time:
    -  Tap on symbol.
-   The symbol on the automatic climate control signals an activated departure time.

## Ambient air package

### Concept

The Ambient Air Package can be used to clean and scent the interior air with high-quality fragrances.

Ionization is used to clean the air from suspended particles. Together with the selected fragrance, ionization contributes to well-being and relaxation while driving.

### General information

Two different fragrances can be selected in the vehicle. A variety of other fragrances is possible by replacing the fragrance cartridges.

The following criteria can influence the perception of scents in the car's interior:

- ▶ Automatic climate control settings.
- ▶ Temperature and air humidity.
- ▶ Time of day and season.
- ▶ Physical condition of the vehicle occupants, for instance fatigue.

BMW recommends the use of genuine BMW fragrance cartridges.

The genuine BMW fragrance cartridges are not suitable for refilling. When a cartridge is empty, replace it with a new fragrance cartridge.

## Safety information

### WARNING

Refilled genuine BMW fragrance cartridges can cause the emission of harmful substances, malfunctions, and damage to the system. There is a risk of injury or risk of damage to property. Do not refill genuine fragrance cartridges. When a cartridge is empty, replace it with a new fragrance cartridge.

## Opening the Climate menu

 Push the button up.

The Climate comfort menu is displayed.

Individual settings can be entered for some of the climate control functions.

## Ionization

### Concept

Ionization cleans the car's interior air of suspended particles.

### Switching on/off

Via iDrive:

1. "CAR"
2. "Settings"
3. "Climate control"
4. "Air quality"
5. "Ionization"

The climate control display indicates that ionization is switched on.

## Fragrancing

### General information

Fragrancing is done at intervals in order to avoid a habituation effect.

Two fragrance cartridges in the vehicle allow switching between the fragrances.

The fragrance cartridges are located in the glove compartment.

To ensure a pleasant fragrance inside of the vehicle when starting the trip, fragrancing can occur prior to the trip. The system is automatically switched on with the parked-car ventilation if fragrancing was switched on at the end of the last trip.

### Functional requirements

- ▷ Fragrance cartridges are sufficiently filled.
- ▷ Interior temperature between 41 °F/+5 °C and 104 °F/+40 °C.
- ▷ Open the vents to allow the fragrance to flow out.

### Selecting the fragrance

The car's interior is fragranced depending on the selected fragrance.

Two different fragrances can be selected in the vehicle.

Via iDrive:

1. "CAR"
2. "Settings"
3. "Climate control"
4. "Fragrance"
5. Select the desired fragrance.

The setting is stored for the driver profile currently used.

### Switching fragrancing on/off, adjusting intensity

Via iDrive:

1. "CAR"
2. "Settings"
3. "Climate control"
4. "Fragrance"
5. "Fragrance"

Fragrancing is switched on or off.

6. "Level"
7. Select the desired setting.  
Highest intensity at Level 3.

### Display

The illustrations on the Control Display show the actual filling level of the fragrance cartridges.

Via iDrive:

1. "CAR"
2. "Settings"
3. "Climate control"
4. "Fragrance"

The fill level of the fragrance cartridges is displayed.

When an empty fragrance cartridge is indicated, the cartridge still contains a fluid carrying the fragrance. However, it is not sufficient for fragrancing.

When a fragrance cartridge requires replacement, a Check Control message is displayed once

### Inserting fragrance cartridges

The fragrance cartridges are located in the glove compartment.

1. Open the glove compartment, refer to page 296.
2. Press on the bottom of the cartridge holder.  
The cartridge holder slides down.

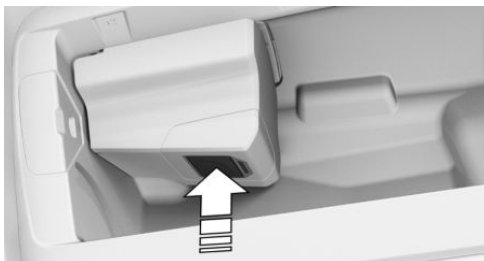

- Remove the cover of the fragrance cartridge. Hold the cover on the top to slide it from the fragrance cartridge.



- Insert the removed cover on the back side of the fragrance cartridge.

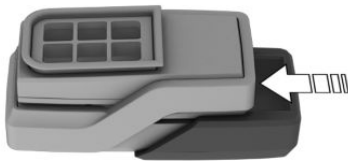

- Position fragrance cartridge such that the chip faces away from the cartridge holder.

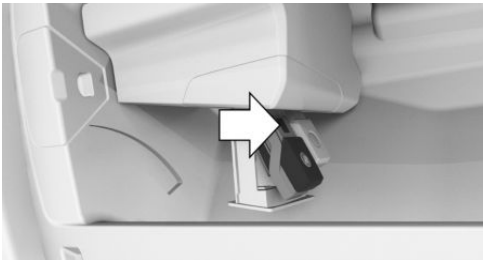

- Insert the fragrance cartridge without pressure into the cartridge holder. The cartridge snaps lightly into place.

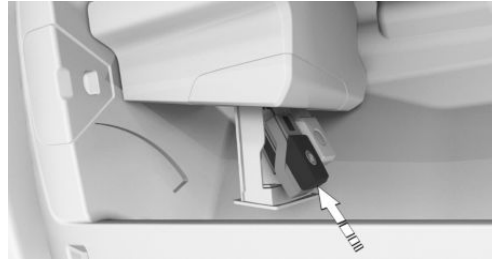

- Push the cartridge holder up, until it engages. Make sure that no objects press against the cartridge holder from below, otherwise the function of the ambient air package could be impacted.
- Close the glove compartment.

### Removing the fragrance cartridge

The fragrance cartridges are located in the glove compartment.

- Open the glove compartment, refer to page 296.
- Press on the bottom of the cartridge holder. The cartridge holder slides down.

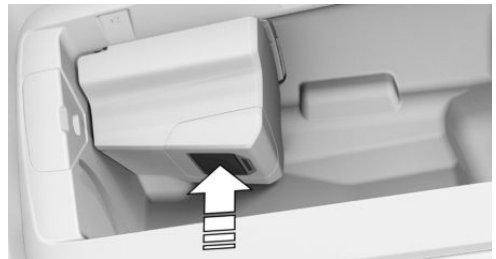

- Pull desired fragrance cartridge from the holder.  
Fragrance cartridge, arrow 1: first fragrance indicated on the Control Display.

Fragrance cartridge, arrow 2: second fragrance indicated on the Control Display.

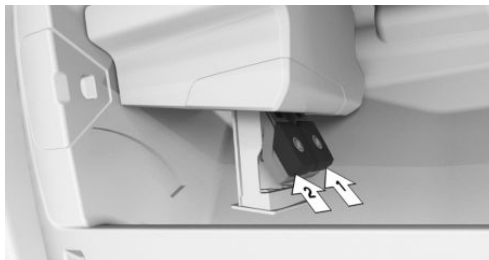

4. Pull desired fragrance cartridge from the holder.

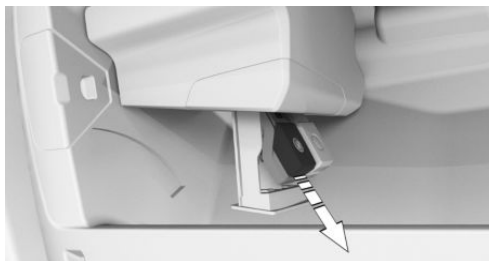

## Using the voice activation system

Most climate control functions can be used via voice in the car's interior, e.g.:

- ▷ Activation of the air conditioner: ›Activate climate control‹.
- ▷ Deactivation of the automatic recirculated-air function: ›Deactivate ... air recirculation‹.
- ▷ Configuration of a specific temperature: ›Temperature [...] at ...‹.

## Recycling



Empty fragrance cartridges can be taken to a dealer's service center or another qualified service center or repair shop for recycling.

## Using climate control functions via voice

### General information

- ▷ Instructions for the voice activation system, refer to page 54.
- ▷ With voice operation, you can change between voice operation, iDrive and buttons.
- ▷ To have the available voice commands read out loud: ›Voice commands‹ or ›Help‹.

# Interior equipment

## Vehicle features and options

This chapter describes all standard, country-specific and optional features offered with the series. It also describes features and functions that are not necessarily available in your vehicle, e.g., due to the selected options or country versions. This also applies to safety-related functions and systems. When using these functions and systems, the applicable laws and regulations must be observed.

## Integrated Universal Remote Control

### Concept

The integrated Universal Remote Control in the interior mirror can operate up to 3 functions of remote-controlled systems, such as garage door drives, barriers or lighting systems.

### General information

The Integrated Universal Remote Control replaces up to 3 different hand-held transmitters. To operate the remote control, the buttons on the interior mirror must be programmed with the desired functions. The hand-held transmitter for the particular system is required in order to program the remote control.

Before selling the vehicle, delete the stored functions for the sake of security.

If possible, do not install the antenna of the remote-controlled system, e.g. the garage gate drive, near metal objects to ensure the best possible operation.

## Safety information

### WARNING

The operation of remote-controlled systems with the integrated universal remote control, such as the garage door, may result in pinched body parts. There is a risk of injury or risk of damage to property. Make sure that the area of movement of the respective system is clear during programming and operation. Also follow the safety information of the hand-held transmitter.

## Compatibility



If this symbol is printed on the packaging or in the owner's manual of the system to be controlled, the system is generally compatible with the integrated Universal Remote Control.

Additional questions are answered by:

- ▶ A dealer's service center or another qualified service center or repair shop.
- ▶ [www.homelink.com](http://www.homelink.com) on the Internet.

HomeLink is a registered trademark of Gentex Corporation.

## Control elements on the interior mirror

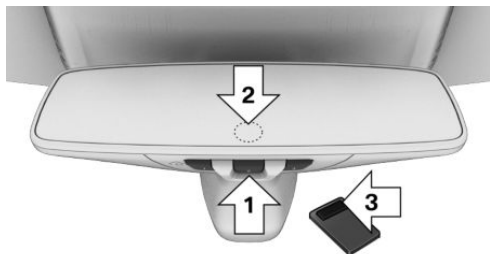

- ▶ Buttons, arrow 1.
- ▶ LED, arrow 2.
- ▶ The hand-held transmitter, arrow 3, is required for programming.

## Programming

### General information

The battery of the hand-held transmitter must be fully charged at the time of programming to ensure an optimal range of the integrated universal remote control.

1. Switch on standby state.
2. Initial setup:
 

Press and hold the two outer buttons on the interior mirror simultaneously for approximately 10 seconds until the LED flashes green rapidly. This erases all programming of the buttons on the interior mirror.
3. Press the interior mirror button to be programmed. The LED on the interior mirror will slowly begin flashing orange.
4. Hold the hand-held transmitter for the system to be used approx. 1 to 12 in/2.5 to 30 cm away from the buttons on the interior mirror. The required distance depends on the hand-held transmitter.
5. Press and hold the button of the desired function on the hand-held transmitter.

Canada: if programming with the hand-held transmitter was interrupted, hold down the interior mirror button and repeatedly press and release the hand-held transmitter button for 2 seconds.

6.
  - ▶ The LED lights up green: programming completed.
 

Release the button.
  - ▶ The LED flashes fast: programming is not complete.
 

Press the button on the interior mirror for 2 seconds and release. Perform this procedure three times to complete the programming procedure.

If the integrated universal remote control remains nonoperational, continue with the special features for change code wireless systems.
- ▶ LED does not flash green after 60 seconds: programming not completed.
 

Repeat steps 3 to 6.

To program other functions on other buttons, repeat steps 3 to 5.

### Special feature of the rolling code wireless system

If you are unable to operate the remote-controlled system after repeated programming, please check if the system to be controlled features a rolling code radio system.

Refer to the owner's manual for the system.

For systems with a rolling code radio system, the integrated Universal Remote Control and the system also have to be synchronized.

Please read the owner's manual to find out how to synchronize the system.

Synchronizing is easier with the aid of a second person.



Synchronizing the universal remote control with the system:

1. Park the vehicle within range of the remote-controlled system.
2. Program the relevant button on the interior mirror as described.
3. Locate and press the synchronizing button on the system being programmed, e.g. at the garage gate. You have approx. 30 seconds for the next step.
4. Hold down the programmed button on the interior mirror for approximately 3 seconds and then release it. If necessary, repeat this step up to three times in order to finish synchronization. Once synchronization is complete, the programmed function will be carried out.

## Reprogramming individual buttons

1. Switch on standby state.
2. Press and hold the interior mirror button to be programmed.
3. As soon as the LED on the interior mirror flashes orange after approx. 20 seconds, release the button.
4. Hold the hand-held transmitter for the system to be used approx. 1 to 12 in/2.5 to 30 cm away from the buttons on the interior mirror. The required distance depends on the hand-held transmitter.
5. Press and hold the button of the desired function on the hand-held transmitter.  
Canada: if programming with the hand-held transmitter was interrupted, hold down the interior mirror button and repeatedly press and release the hand-held transmitter button for 2 seconds.
6. The LED can light up in different ways.
  - ▶ The LED lights up green: the programming procedure is completed.  
Release the button.

- ▶ The LED flashes fast: the hand-held transmitter was detected but programming is not complete.

Press the button on the interior mirror for 2 seconds and release. Perform this procedure three times to complete the programming procedure.

If the universal remote control remains nonoperational, continue with the special features for change code wireless systems.

- ▶ LED does not flash green after 60 seconds: programming not completed.  
Repeat steps 3 to 6.

If the programming procedure is not completed, the previous programming will remain unchanged.

## Operation

### WARNING

The operation of remote-controlled systems with the integrated universal remote control, such as the garage door, may result in pinched body parts. There is a risk of injury or risk of damage to property. Make sure that the area of movement of the respective system is clear during programming and operation. Also follow the safety information of the hand-held transmitter.

The system, such as the garage door, can be operated using the button on the interior mirror while the drive-ready or standby state is switched on. To do this, hold down the button within receiving range of the system until the function is activated. The interior mirror LED stays lit while the wireless signal is being transmitted.

## Deleting stored functions

All stored functions will be deleted. The functions cannot be deleted individually.

Press and hold the two outer buttons on the interior mirror simultaneously for approximately 10 seconds until the LED on the interior mirror flashes green rapidly.

## Sun visor

### Glare shield

Fold the sun visor down or up.

### Glare shield from the side

### Folding out

1. Fold the sun visor down.
2. Unhook it from the holder and swing it to the side.
3. Move it back to the desired position.

### Folding up

Proceed in the reverse order to close the sun visor.

### Vanity mirror

A vanity mirror is located in the sun visor behind a cover. When the cover is opened, the mirror lighting switches on.

## Ashtray

### Front center console

#### Opening

1. Press onto the cover.



2. The ashtray is located in a cup holder. Fold the ashtray cover upward.



#### Emptying

1. Pull the ashtray with the closed cover out of the cup holder.



- Turn the lid counterclockwise to open it.



- Empty the container.

Always empty the ashtray with the container open to prevent contamination of the lid.

## Cigarette lighter

### Safety information

#### WARNING

Contact with the hot heating element or the hot socket of the cigarette lighter can cause burns. Flammable materials can ignite if the cigarette lighter falls down or is held against the respective objects. There is a risk of fire and injuries. Take hold of the cigarette lighter by its handle. Make sure that children do not use the cigarette lighter and burn themselves.

#### NOTICE

If metal objects fall into the socket, they can cause a short circuit. There is a risk of damage to property. Replace the cigarette lighter or socket cover again after using the socket.

## Front center console



Press onto the cover.

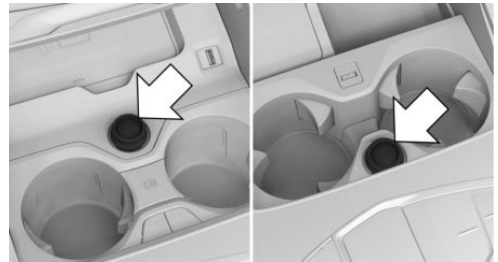

A cigarette lighter is located between the cup holders in one of the marked positions.

## Rear center console

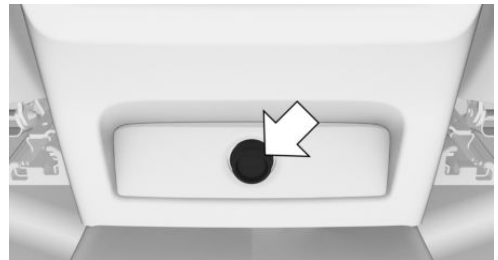

The cigarette lighter is located in the socket.

## Operation



Push in the cigarette lighter. The cigarette lighter can be removed as soon as it pops back out.

## Sockets

### Concept

The lighter socket can be used as a socket for electrical equipment when standby and drive-ready state are switched on.

### General information

The total load of all sockets must not exceed 140 watts at 12 volts.

Do not damage the socket by using non-compatible connectors.

### Safety information

#### WARNING

Devices and cables in the unfolding area of the airbags, such as portable navigation devices, can hinder the unfolding of the airbag or be thrown around in the car's interior during unfolding. There is a risk of injury. Make sure that devices and cables are not in the airbag's area of unfolding.

#### NOTICE

Battery chargers for the vehicle battery can work with high voltages and currents, which means that the 12 volt on-board network can be overloaded or damaged. There is a risk of damage to property. Only connect battery chargers for the vehicle battery to the starting aid terminals in the engine compartment.

#### NOTICE

If metal objects fall into the socket, they can cause a short circuit. There is a risk of damage to property. Replace the cigarette lighter or socket cover again after using the socket.

### Front center console



Press onto the cover.



A socket is located between the cup holders in one of the marked positions.

Pull off the cover.

### Rear center console

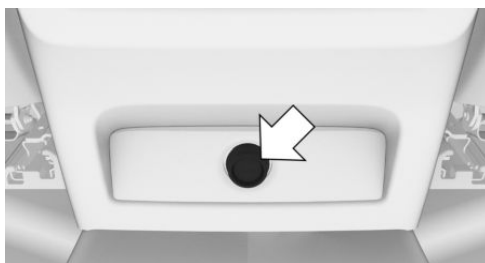

A socket is located in the center console.

Pull off the cover.

## In the cargo area

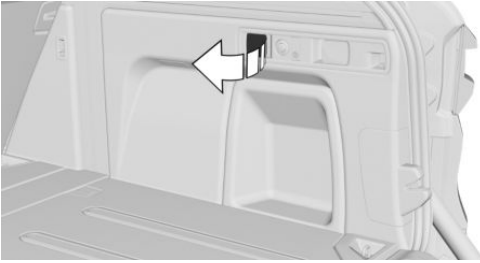

A socket is located on the right side in the cargo area. Unfold the cover.

## USB interface

### General information

Follow the information regarding the connection of mobile devices to the USB interface in the section on USB connections, refer to page 71.

### In the center armrest



A USB interface is located in the center armrest.

Properties:

- ▶ USB port Type C.
- ▶ For charging mobile devices and for data transfer.
- ▶ Charge current: max. 3 A.

## In the center console

### NOTICE

Objects in the storage compartment, e.g., large USB connectors, may block or damage the cover when it is being opened or closed. There is a risk of damage to property. Make sure that the area of movement of the cover is clear while opening and closing it.



Press onto the cover.



A USB interface is located in the center console.



If the vehicle is equipped with thermo-cup holders, a USB interface is located in the center console.

Properties:

- ▷ USB port Type A.
- ▷ For charging mobile devices and for data transfer.
- ▷ Charge current: max. 1.5 A.

## BMW Travel & Comfort System

### General information

USB interfaces and fixtures for attaching special accessories, for instance coat hangers, are located on the backrests of the front seats.

Features of the USB interfaces:

- ▷ USB port Type C.
- ▷ For charging of mobile devices.
- ▷ Charge current: max. 3 A.

Further information is available from a dealer's service center or another qualified service center or repair shop.

### Overview



The fixtures are located behind the marked covers.

### Installing special accessories

1. Slide the cover to the side.

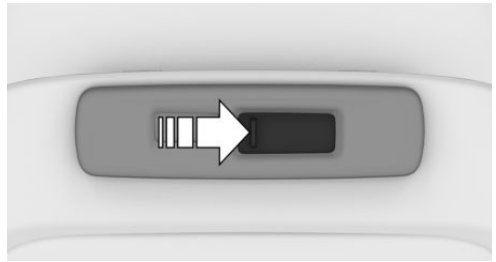

2. Install the special accessories, refer to Installation Instructions.

# Storage compartments

## Vehicle features and options

This chapter describes all standard, country-specific and optional features offered with the series. It also describes features and functions that are not necessarily available in your vehicle, e.g., due to the selected options or country versions. This also applies to safety-related functions and systems. When using these functions and systems, the applicable laws and regulations must be observed.

## Storage compartments

### General information

The following storage compartments are available in the car's interior:

- ▶ Glove compartment on the front passenger side, refer to page [295](#).
- ▶ Glove compartment on the driver's side, refer to page [296](#).
- ▶ Compartments in the doors, refer to page [296](#).
- ▶ Storage compartment in the center console, refer to page [297](#).
- ▶ Center armrest, refer to page [297](#).
- ▶ Storage compartment in the rear center console, refer to page [297](#).
- ▶ Pockets on the backrests of the front seats.
- ▶ Storage compartment in the center armrest in the rear seat, refer to page [297](#).

### Safety information

#### **WARNING**

Loose objects or devices with a cable connection to the vehicle, for instance mobile phones, can be thrown into the car's interior while driving, for instance in the event of an accident or during braking and evasive maneuvers. There is a risk of injury. Secure loose objects or devices with a cable connection to the vehicle in the car's interior.

#### **NOTICE**

Anti-slip pads such as anti-slip mats can damage the dashboard. There is a risk of damage to property. Do not use anti-slip pads.

## Front passenger side glove compartment

### Safety information

#### **WARNING**

Folded open, the glove compartment protrudes in the car's interior. Objects in the glove compartment can be thrown into the car's interior while driving, for instance in the event of an accident or during braking and evasive maneuvers. There is a risk of injury. Always close the glove compartment immediately after using it.

## Opening



Pull the handle.

The light in the glove compartment switches on.

## Closing

Fold cover closed.

## Locking

The glove compartment can be locked with an integrated key. This prevents access to the glove compartment.

After the glove compartment is locked, the remote control can be handed over without the integrated key, for instance when the vehicle is parked by valet parking.

## Driver's side glove compartment

### Safety information

#### WARNING

Folded open, the glove compartment protrudes in the car's interior. Objects in the glove compartment can be thrown into the car's interior while driving, for instance in the event of an accident or during braking and evasive maneuvers. There is a risk of injury. Always close the glove compartment immediately after using it.

## Opening



Pull the handle.

## Closing

Fold cover closed.

## Compartments in the doors

### General information

There are storage compartments in the doors.

### Safety information

#### WARNING

Breakable objects, such as glass bottles or glasses, can break in the event of an accident or a braking or evasive maneuver. Broken glass can be scattered in the car's interior. There is a risk of injury or risk of damage to property. Do not use any breakable objects while driving. Only stow breakable objects in closed storage compartments.



## Storage compartment in the center console

---

### Opening



Press onto the cover.

### Closing

Pull the cover on the handle bar back.

## Storage compartment in the rear center console

---

The back of the center console contains one or two storage compartments.

## Center armrest, front

---

### General information

A storage compartment is located in the center armrest between the seats.

### Opening



Press the button.

### Closing

Press cover down until it engages.

## Rear center armrest

---

### General information

A storage compartment is located in the center armrest between the seats.

### Folding down

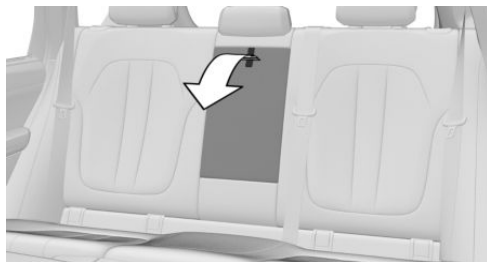

Fold the center armrest forward.

## Opening

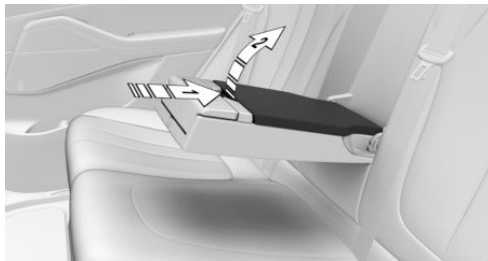

Press the button, arrow 1, and fold the cover up, arrow 2.

## Closing

Press cover down until it engages.

## Front cup holder

### Safety information

#### WARNING

Unsuitable containers in the cup holder may damage the cup holders or be thrown into the car's interior, such as in the event of an accident, braking or evasive maneuver. Spilled liquids can distract from the traffic conditions and lead to an accident. Hot drinks can damage the cup holder or lead to scalding. There is a risk of injury or risk of damage to property. Do not force objects into the cup holder. Use lightweight, unbreakable, and sealable containers. Do not transport hot beverages.

## Opening



Press onto the cover.



Two cup holders are located in the center console.

## Closing

Pull the cover on the handle bar back.

## Maintaining the drink temperature

### General information

When equipped with thermo-cup holder, drinks can be kept cool or warm.

### Safety information

#### WARNING

Contact with the hot metal insert of the thermo-cup holder can cause burn injuries. There is a risk of injury. Do not touch the metal insert when the thermo-cup holder is switched on.

**⚠ NOTICE**

When the thermo-cup holder is switched on and the cover is closed, the thermo-cup holder can overheat. There is a risk of damage to property. Switch the thermo-cup holder off before closing the cover.

**⚠ NOTICE**

Temperature sensitive items may be damaged by the hot metal insert of the thermo-cup holder. There is a risk of damage to property. Use suitable containers only.

**Switching on**

Press the button for keeping cool or warm once each.

- ▷ Blue LED lights up: keep drinks cool.
- ▷ Red LED lights up: keep drinks warm.

**Switching off**

Press the button repeatedly until the LEDs go out.

**Rear cup holder****Safety information****⚠ WARNING**

Unsuitable containers in the cup holder may damage the cup holders or thrown into the car's interior, such as in the event of an accident, braking or evasive maneuver. Spilled liquids can distract from the traffic conditions and lead to an accident. Hot drinks can damage the cup holder or lead to scalding. There is a risk of injury or risk of damage to property. Do not force objects into the cup holder. Use light-

weight, unbreakable, and sealable containers. Do not transport hot beverages.

**⚠ NOTICE**

With an open cup holder, the center armrest cannot be folded back up. There is a risk of damage to property. Press back the covers before the center armrest is folded up.

**Second row of seats****General information**

The cup holder can be adjusted for three different container sizes.

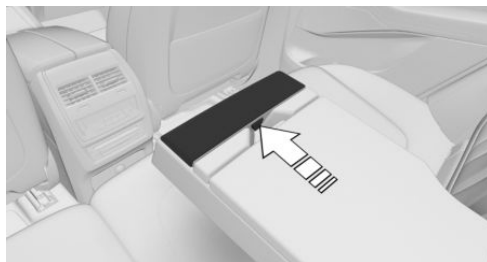
**Opening**

Fold the center armrest forward.

Press the button and fold out the cup holder fully.

**Reducing the size**

To make it smaller, the cup holder can be folded in in 2 steps.

**Enlarging**

To make a smaller cup holder bigger, first fold it in completely. Then fold the cup holder out again fully.

**Closing**

Fold in the cup holder fully, until it engages.

## Third row of seats

### Overview



The cup holders are located between the seats of the third row of seats.

## Clothes hooks

### Safety information

 **WARNING**

Clothing articles on the clothes hooks can obstruct the view while driving. There is a risk of an accident. When suspending clothing articles from the clothes hooks, ensure that they will not obstruct the driver's view.

 **WARNING**

Improper use of the clothes hooks can lead to a risk of objects flying about during braking and evasive maneuvers. There is a risk of injury and risk of damage to property. Only hang light-weight objects, for instance clothing articles, from the clothes hooks.

### General information

The clothes hooks are located in the grab handles in the rear.

# Cargo area

## Vehicle features and options

This chapter describes all standard, country-specific and optional features offered with the series. It also describes features and functions that are not necessarily available in your vehicle, e.g., due to the selected options or country versions. This also applies to safety-related functions and systems. When using these functions and systems, the applicable laws and regulations must be observed.

## Loading

### Safety information

#### **WARNING**

High gross weight can overheat the tires, damage them internally and cause a sudden drop in tire inflation pressure. Driving characteristics may be negatively impacted, reducing lane stability, lengthening the braking distances and changing the steering response. There is a risk of an accident. Pay attention to the permitted load capacity of the tires and never exceed the permitted gross weight.

#### **WARNING**

Loose objects or devices with a cable connection to the vehicle, for instance mobile phones, can be thrown into the car's interior while driving, for instance in the event of an accident or during braking and evasive maneuvers. There is a risk of injury. Secure loose objects or devices with a cable connection to the vehicle in the car's interior.

#### **WARNING**

Improperly stowed objects can shift and be thrown into the car's interior, for instance in the event of an accident or during braking and evasive maneuvers. Vehicle occupants can be hit and injured. There is a risk of injury. Stow and secure objects and cargo properly.

#### **NOTICE**

Fluids in the cargo area can cause damage. There is a risk of damage to property. Make sure that no fluids leak in the cargo area.

## Steps for Determining Correct Load Limit

1. Locate the statement "The combined weight of occupants and cargo should never exceed XXX kg or XXX lbs" on your vehicle's placard.
2. Determine the combined weight of the driver and passengers that will be riding in your vehicle.
3. Subtract the combined weight of the driver and passengers from XXX kg or XXX lbs
4. The resulting figure equals the available amount of cargo and luggage load capacity. For example, if the "XXX" amount equals 1,400 lbs and there will be five 150 lbs passengers in your vehicle, the amount of available cargo and luggage load capacity is 650 lbs (1,400–750 (5 x 150) = 650 lbs)
5. Determine the combined weight of luggage and cargo being loaded on the vehicle. That weight may not safely exceed the available cargo and luggage load capacity calculated in Step 4.
6. If your vehicle will be towing a trailer, load from your trailer will be transferred to your ve-

hicle. Consult this manual to determine how this reduces the available cargo and luggage load capacity of your vehicle.

## Load

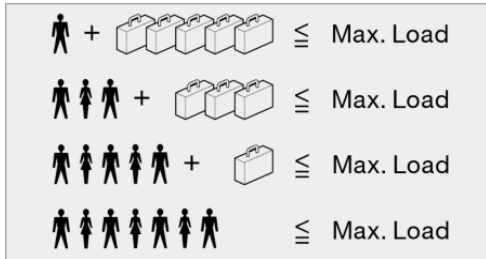

The maximum load is the sum of the weight of the occupants and the cargo.

The greater the weight of the occupants, the less cargo that can be transported.

## Stowing and securing cargo

- ▷ Cover sharp edges and corners on the cargo.
- ▷ Heavy cargo: stow as far forward as possible, directly behind and at the bottom of the rear passenger seat backrests.
- ▷ Very heavy cargo: stow as far forward as possible, directly behind and at the bottom of the rear passenger seat backrests. When the rear seat is not occupied, secure each of the outer safety belts in the opposite buckle.
- ▷ If necessary, fold down the rear backrests to stow large cargo.
- ▷ Do not stack cargo above the top edge of the backrests.
- ▷ Use the cargo area partition net to protect occupants. Make sure that objects cannot penetrate the cargo area partition net.
- ▷ Smaller and lighter cargo: secure with ratchet straps or with a cargo net or draw straps.
- ▷ Larger and heavy cargo: secure with cargo straps.

## Lashing eyes in the cargo area

### General information

Attach load securing aids, such as lashing straps, tensioning straps, draw straps or cargo nets, to the lashing eyes in the cargo area.

### Lashing eyes

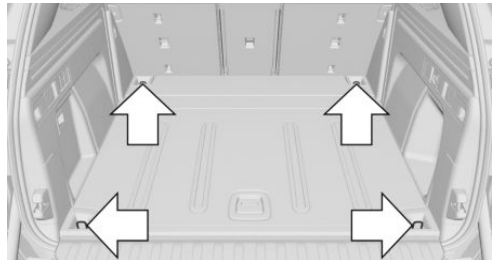

There are four lashing eyes in the cargo area for securing cargo.

The front lashing eyes are located under covers.

## Anti-slip rails

### Concept

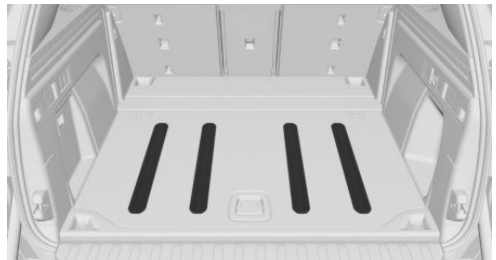

The system prevents slipping of the cargo in the cargo area.

### General information

Observe information and notes on loading, refer to page 301.

The system will be activated automatically when one of the following conditions is met:

- Tailgate is closed.
- Inclination of the vehicle by more than approximately 13 %.

## Multi-function hook

### General information

A multi-function hook is located on the left and right side in the cargo area.

### Safety information

#### WARNING

Improper use of the multi-function hooks can lead to a risk of objects flying about during braking and evasive maneuvers, for example. There is a risk of injury and risk of damage to property. Only hang lightweight objects, such as shopping bags, from the multi-function hooks. Only transport heavy luggage in the cargo area if it has been appropriately secured.

### Folding down

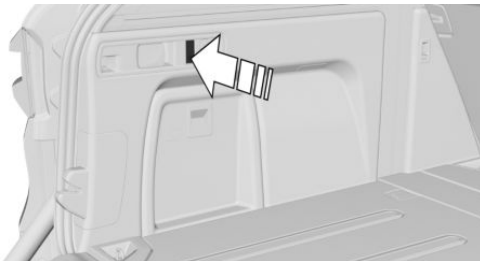

Press on the multi-function hook and turn until it engages.

## Net

Smaller objects can be stowed in the net on the left or right side.

## Left side storage compartment

### General information

A storage compartment is located on the left side in the cargo area.

### Opening

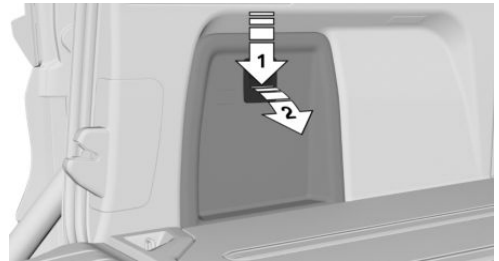

Press the button, arrow 1, and open the cover, arrow 2.

## Storage compartments under the cargo floor panel

### General information

There are storage compartments beneath the cargo floor panel.

## Opening

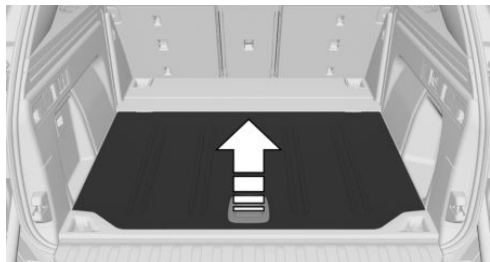

Fold up the cargo floor panel.

## Closing

Push the cargo floor panel downward.

## Cargo net, FlexNet

To secure the cargo, refer to page 301, the flexible cargo net can also be used.

## Enlarging the cargo area

### Concept

The cargo area can be enlarged by folding down the rear seat backrest.

### General information

The rear seat backrest of the second seat row is divided at a ratio of 40–20–40. The side rear seat backrests and the center section can be folded down separately.

The rear seat backrests can be folded down from the rear or from the cargo area.

Depending on the equipment version, the rear seat backrests can be folded down either manually or electrically.

## Safety information

### WARNING

Danger of jamming with folding down the backrests. There is a risk of injury or risk of damage to property. Make sure that the area of movement of the rear backrest and the of the head restraint is clear prior to folding down.

### WARNING

If a rear seat backrest is not locked, unsecured cargo can be thrown about the car's interior; for instance, in the event of an accident, braking or an evasive maneuver. There is a risk of injury. Make sure that the rear seat backrest is locked after folding it back.

### WARNING

The stability of the child restraint system is limited or compromised with incorrect seat adjustment or improper installation of the child seat. There is a risk of injuries or danger to life. Make sure that the child restraint system fits securely against the backrest. If possible, adjust the backrest tilt for all affected backrests and correctly adjust the seats. Make sure that seats and backrests are securely engaged or locked. If possible, adjust the height of the head restraints or remove them.

### WARNING

Once the rear seat backrest has been folded down, the locking bracket protrudes into the car's interior. There is a risk of damage to property. When the rear seat backrest is folded down, pay attention to the protruding locking bracket and keep this area unobstructed.



**⚠ NOTICE**

Vehicle parts can be damaged when folding down the rear backrest. There is a risk of damage to property. Make sure that the area of movement of the rear backrest including head restraint is clear when folding down.

**Manual reclining of the backrest****From the rear**

Pull the lever and fold the rear seat backrest forward.

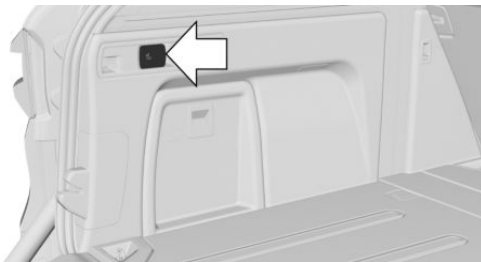
**From the cargo area**

Pull the lever inside the cargo area.

- ▶ Left lever: the left and center rear seat backrests fold forward.
- ▶ Right lever: the right rear seat backrest folds forward.

**Folding back the backrest**

Return the rear seat backrest to the upright seating position and engage it. The red marking behind the lever disappears completely.

**Electric reclining of the backrest****From the rear**

Pull the switch. The rear seat backrest folds forward.

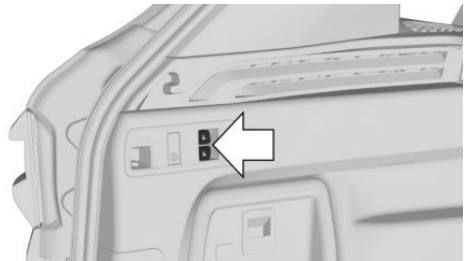
**From the cargo area**

Press the switch in the cargo area.

- ▶ Upper switch: the left and center rear seat backrests fold forward.
- ▶ Lower switch: the right rear seat backrest folds forward.

**Folding back the backrest**

Pull the corresponding switch. The rear seat backrest sets itself upright.

## Fold down the center section



Fold down the center armrest and pull on the strap.

## Closing

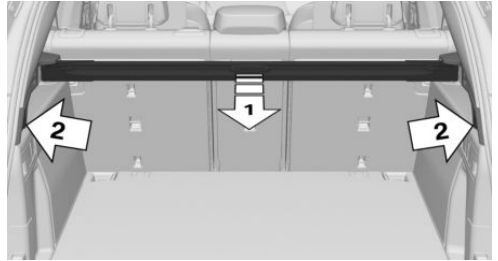

Pull out the cargo cover, arrow 1, and hook both sides into the brackets, arrow 2.

## Cargo cover

### Safety information

#### **WARNING**

Loose objects or devices with a cable connection to the vehicle, for instance mobile phones, can be thrown into the car's interior while driving, for instance in the event of an accident or during braking and evasive maneuvers. There is a risk of injury. Secure loose objects or devices with a cable connection to the vehicle in the car's interior.

#### **WARNING**

A cargo cover that snaps back quickly can jam body parts or cause damage. There is a risk of injury or risk of damage to property. Do not let the cargo cover snap back into place.

#### **NOTICE**

A cargo cover hooked in incorrectly can cause damage. There is a risk of damage to property. Hook the cargo cover on both sides.

## Removing

The cover can be removed to load bulky luggage.

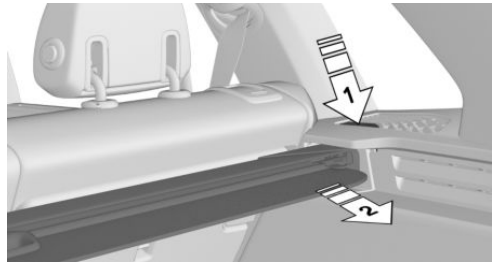

Press the release button, arrow 1, and pull the cargo cover out toward the rear, arrow 2.

## Installing

Slide the cover forward horizontally into the two side brackets. Make sure that the cover audibly engages on both sides.

## Stowing

### General information

The cargo cover can be stowed in the storage compartment under the cargo floor panel.

## Without third seat row

1. Open the left side storage compartment, refer to page 303.
2. Fold up the cargo floor panel.
3. Turn the cargo cover forward with the handle.
4. Stow the cargo cover on the left and lower it on the right side.



5. Push the cargo floor down and close the storage compartment on the left side.

## With third seat row

1. Open the left side storage compartment, refer to page 303.
2. Fold up the cargo floor panel.
3. Stow the cargo cover on the left and lower it on the right side.

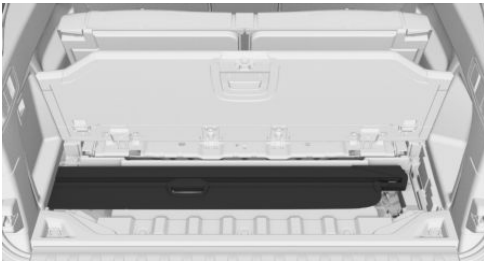

4. Push the cargo floor down and close the storage compartment on the left side.

## Electric cargo cover

### General information

The electric cargo cover opens and closes automatically with the tailgate. The cargo cover can be lowered below the cargo floor panel to stow bulky items or luggage.

Items in the range of movement are detected. The cargo cover stops automatically to prevent damage.

### Safety information

#### **WARNING**

Loose objects or devices with a cable connection to the vehicle, for instance mobile phones, can be thrown into the car's interior while driving, for instance in the event of an accident or during braking and evasive maneuvers. There is a risk of injury. Secure loose objects or devices with a cable connection to the vehicle in the car's interior.

#### **WARNING**

Pinching of body parts may occur during operation of the electric cargo cover. Items in the range of movement may damage the cargo cover. There is a risk of injury or risk of damage to property. Make sure that the area of movement of the electric cargo cover is clear during opening and closing. In addition, make sure that the area of movement of the cover in the cargo floor is clear during lowering.

#### **NOTICE**

Items on the storage shelf may damage it. There is a risk of damage to property. Do not deposit any objects on the cargo cover.

**NOTICE**

The manual operation of the electric cargo cover by hand may damage the cover. There is a risk of damage to property. Use the buttons in the cargo area for operation.

**Overview**

**Buttons in the vehicle**

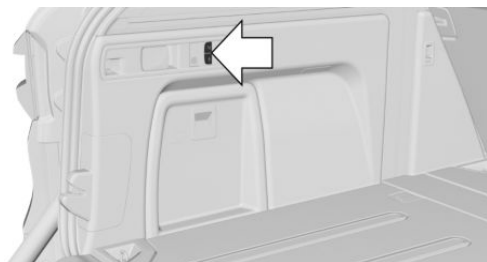

The buttons of the cargo cover are located in the cargo area.

 Opening/closing the cargo cover between automatic and base position.

 Lowering/raising the cargo cover.

**Positions of the cargo cover**

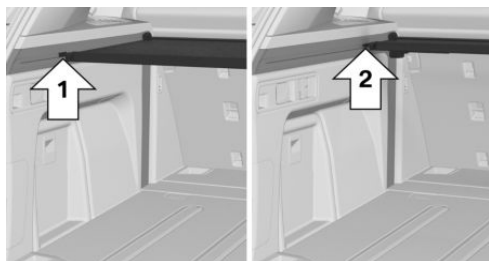

- ▷ Automatic position, arrow 1.
- ▷ Base position, arrow 2.

**Opening and closing the cargo cover**

**Opening**

When the tailgate is opened, the cargo cover is opened up to the automatic position.

To open the cargo cover completely up to the base position:

 Press the button.

**Closing**

 Press the button.

The cargo cover will be closed up to the automatic position.

When the tailgate is closed, the cargo cover will be closed completely.

The cargo cover will not be closed automatically when it is in the base position while the tailgate is closing.

**Lowering the cargo cover**

The cargo cover can be lowered to stow bulky luggage.

 Press the button.

The cargo cover is lowered below the cargo floor panel.

**Raising the cargo cover**

 Press the button.

The cargo cover is raised to the base position.  
Or:

 Press the button.

The cargo cover is raised to the base position and closes up to the automatic position.

## Functional limitations

If the closing force exceeds a certain value when closing the cargo cover, for example due to items in the range of motion, the cover will disengage from the mounting. The cargo cover stops in the guide rail.

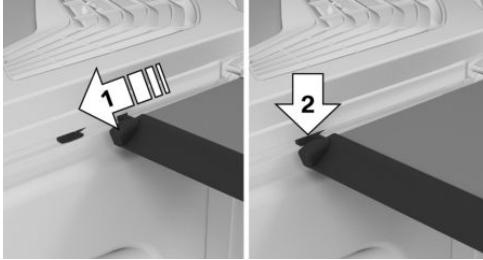

To restore the functionality, close the cargo cover by hand, arrow 1, until it engages in the mounting, arrow 2.

Excessive or insufficient ambient temperatures may lead to the deactivation of the power cargo cover. When the temperature is within normal range again, such as by switching on the air conditioner, the function will be restored.

## Initializing

### General information

The function will be deactivated when the system can no longer detect the position of the cargo cover. An initialization is required.

### Initializing the system



Press and hold the button until the initialization is finished.

The cargo cover moves to the respective end position. The initialization is finished when a signal sounds.

If the button is released prematurely, the cargo cover will stop. The initialization is terminated.

Press and hold the button to restart the initialization.





① **DRIVING TIPS**

Things to remember when driving .....	312
Trailer towing .....	317
Saving fuel .....	321

# Things to remember when driving

## Vehicle features and options

---

This chapter describes all standard, country-specific and optional features offered with the series. It also describes features and functions that are not necessarily available in your vehicle, e.g., due to the selected options or country versions. This also applies to safety-related functions and systems. When using these functions and systems, the applicable laws and regulations must be observed.

## Breaking-in period

---

### General information

Moving parts need to begin working together smoothly.

The following instructions will help you to achieve a long vehicle life and good efficiency.

During break-in, do not use the Launch Control, refer to page 147.

### Safety information

---

#### **WARNING**

Due to new parts and components, safety and driver assistance systems can react with a delay. There is a risk of an accident. After installing new parts or with a new vehicle, drive conservatively and intervene early if necessary. Observe the break-in procedures of the respective parts and components.

## Engine, transmission, and axle drive

### Up to 1,200 miles/2,000 km

Do not exceed the maximum engine and road speed:

- ▶ For gasoline engine 4,500 rpm and 100 mph/160 km/h.

Avoid full load or kickdown under all circumstances.

### From 1,200 miles/2,000 km

The engine and vehicle speed can gradually be increased.

### Tires

Tire traction is not optimal due to manufacturing circumstances when tires are brand-new; they achieve their full traction potential after a break-in time.

Drive conservatively for the first 200 miles/300 km.

### Brake system

Brake discs and brake pads only reach their full effectiveness after approx. 300 miles/500 km. Drive moderately during this break-in period.

### Following part replacement

Observe the break-in procedures again, if components mentioned above are replaced.

## Driving on poor roads

---

### Concept

Because of its greater ground clearance, the vehicle can be driven on a variety of road types and qualities.



All-wheel drive can help improve forward momentum.

## Safety information

### NOTICE

Objects in unpaved areas, for instance stones or branches, can damage the vehicle. There is a risk of damage to property. Do not drive on unpaved terrain.

## When driving on poor roads

For your own safety, for the safety of passengers and of the vehicle, heed the following points:

- ▶ Familiarize yourself with the vehicle before driving.
- ▶ Do not take risks when driving.
- ▶ Adjust the speed to the road surface conditions. The steeper and more uneven the road surface, the slower the speed should be.
- ▶ When driving on steep uphill or downhill grades: add engine oil and coolant up to near the MAX mark.
- ▶ On steep downhill grades, use Hill Descent Control HDC.
- ▶ Avoid that the chassis bottom coming in contact with the ground.  
The ground clearance is no more than 7.8 inches/20 cm and can vary according to the vehicle's load.
- ▶ When wheels continue to spin, depress the accelerator so that driving stability control systems can distribute the driving force to the wheels. Activate DTC Dynamic Traction Control if available.

## After a trip on poor roads

After a trip on poor roads, check wheels and tires for damage to maintain driving safety. Clear heavy soiling from the body.

## General driving notes

### Closing the tailgate

#### Safety information

### WARNING

An open tailgate protrudes from the vehicle and can endanger occupants and other traffic participants or damage the vehicle in the event of an accident, braking or evasive maneuvers. In addition, exhaust fumes may enter the car's interior. There is a risk of injury or risk of damage to property. Do not drive with the tailgate open.

### Driving with the tailgate open

If driving with the tailgate open cannot be avoided:

- ▶ Close all windows and the glass sunroof.
- ▶ Greatly increase the air flow from the vents.
- ▶ Drive moderately.

## Hot exhaust gas system

### WARNING

During driving operation, high temperatures can occur underneath the vehicle body, for instance caused by the exhaust gas system. If combustible materials, such as leaves or grass, come in contact with hot parts of the exhaust gas system, these materials can ignite. There is a risk of injury or risk of damage to property. Do not remove the heat shields installed and never apply undercoating to them. Make sure that no combustible materials can come in contact with hot vehicle parts in driving operation, idle or during parking. Do not touch the hot exhaust gas system.

## Mobile communication devices in the vehicle

### **WARNING**

Vehicle electronics and mobile phones can influence one another. There is radiation due to the transmission operations of mobile phones. There is a risk of injury or risk of damage to property. If possible, in the car's interior use only mobile phones with direct connections to an exterior antenna in order to exclude mutual interference and deflect the radiation from the car's interior.

## Hydroplaning

On wet or slushy roads, a wedge of water can form between the tires and road surface.

This phenomenon is referred to as hydroplaning. It is characterized by a partial or complete loss of contact between the tires and the road surface, ultimately undermining your ability to steer and brake the vehicle.

## Driving through water

### General information

When driving through water, follow the following:

- ▷ Drive through calm water only.
- ▷ Drive through water only if it is not deeper than maximum 19.6 inches/50 cm.
- ▷ Drive through water no faster than walking speed, up to 3 mph/5 km/h.

### Safety information

#### **NOTICE**

When driving too quickly through too deep water, water can enter into the engine compartment, the electrical system or the transmission. There is a risk of damage to property. When driving through water, do not exceed the maxi-

mum indicated water level and the maximum speed for driving through water.

## Braking safely

### General information

The vehicle is equipped with the Antilock Brake System ABS as a standard feature.

Perform an emergency stop in situations that require such.

Steering is still responsive. You can still avoid any obstacles with a minimum of steering effort.

Pulsation of the brake pedal and sounds from the hydraulic circuits indicate that the Antilock Brake System ABS is in its active mode.

In certain braking situations, the perforated brake discs can emit functional noises. However, functional noises have no effect on the performance and operational reliability of the brake.

## Objects in the area around the pedals

### **WARNING**

Objects in the driver's floor area can limit the pedal distance or block a depressed pedal. There is a risk of an accident. Stow objects in the vehicle such that they are secured and cannot enter into the driver's floor area. Use floor mats that are suitable for the vehicle and can be safely attached to the floor. Do not use loose floor mats and do not layer several floor mats. Make sure that there is sufficient clearance for the pedals. Ensure that the floor mats are securely fastened again after they were removed, for instance for cleaning.

## Driving in wet conditions

When roads are wet, salted, or in heavy rain, gently press the brake pedal every few miles.

Ensure that this action does not endanger other traffic.

The heat generated during braking dries brake discs and brake pads and protects them against corrosion.

In this way braking efficiency will be available when you need it.

## Hills

### General information

Drive long or steep downhill gradients in the gear that requires least braking effort. Otherwise, the brakes may overheat and reduce brake efficiency.

You can increase the engine's braking effect by shifting down, going all the way to first gear, if needed.

### Safety information

#### WARNING

Light but consistent brake pressure can lead to high temperatures, brakes wearing out and possibly even brake failure. There is a risk of an accident. Avoid placing excessive stress on the brake system.

#### WARNING

In idle state or with the engine switched off, safety-relevant functions, for instance engine braking effect, braking force boost and steering assistance, are restricted or not available at all. There is a risk of an accident. Do not drive in idle state or with the engine switched off.

## Brake disc corrosion

Corrosion on the brake discs and contamination on the brake pads are increased by the following circumstances:

- ▶ Low mileage.
- ▶ Extended periods when the vehicle is not used at all.

- ▶ Infrequent use of the brakes.
- ▶ Aggressive, acidic, or alkaline cleaning agents.

Corrosion buildup on the brake discs will cause a pulsating effect on the brakes in their response - generally this cannot be corrected.

## Condensation water under the parked vehicle

When using the automatic climate control, condensation water develops and collects underneath the vehicle.

## Roof-mounted luggage rack

### General information

Installation only possible with roof rack.

Roof racks are available as special accessories.

### Mounting

Follow the installation instructions of the roof rack.

Be sure that adequate clearance is maintained for tilting and opening the glass sunroof.

### Loading

Because roof-mounted luggage racks raise the vehicle's center of gravity when loaded, they have a major effect on vehicle handling and steering response.

Therefore, note the following when loading and driving:

- ▶ Do not exceed the approved roof/axle loads and the approved gross vehicle weight.
- ▶ Be sure that adequate clearance is maintained for tilting and opening the glass sunroof.
- ▶ Distribute the roof load uniformly.

- ▷ The roof load should not extend past the loading area.
- ▷ Always place the heaviest pieces on the bottom.
- ▷ Secure the roof luggage firmly, for instance using ratchet straps.
- ▷ Do not let objects project into the opening path of the tailgate.
- ▷ Drive cautiously and avoid sudden acceleration and braking maneuvers. Take corners gently.

## Driving on racetracks

---

Higher mechanical and thermal loads during racetrack operation lead to increased wear. This wear is not covered by the warranty. The vehicle is not designed for use in motor sports competition.

# Trailer towing

## Vehicle features and options

---

This chapter describes all standard, country-specific and optional features offered with the series. It also describes features and functions that are not necessarily available in your vehicle, e.g., due to the selected options or country versions. This also applies to safety-related functions and systems. When using these functions and systems, the applicable laws and regulations must be observed.

## General information

---

The permissible trailer loads, axle loads, drawbar node weights, and the permissible gross vehicle weight are specified in the technical data.

The vehicle is equipped with an enhanced suspension system on the rear axle and, depending on the vehicle type, with a more powerful cooling system.

When the trailer power socket is in use, the vehicle will be raised or lowered to the normal level automatically. The adjustment to the normal level can occur when the trailer power socket is plugged in or when driving off.

## Before driving

---

### Drawbar nose weight

The maximum load of the tractor is lowered by the weight of the trailer hitch and the drawbar nose weight. The drawbar nose weight increases the vehicle weight. Do not exceed the approved gross vehicle weight of the towing vehicle.

### Loading

Distribute cargo as evenly as possible on the cargo area.

Stow the load as low and close to the trailer axle as possible. A low center of gravity in the trailer increases the driving safety of the entire vehicle-trailer combination.

Do not exceed the approved gross vehicle weight of the trailer and the permissible trailer load of the vehicle. The smaller value applies in each case.

### Tire inflation pressure

Note the tire inflation pressure of the vehicle and trailer.

For the vehicle, the tire inflation pressure for higher loads applies.

Information regarding the tire inflation pressure, refer to page [332](#).

For the trailer, the specifications of the manufacturer apply.

### Flat Tire Monitor FTM

After correcting the tire inflation pressure or hitching/unhitching a trailer, initialize the Flat Tire Monitor, refer to page [355](#).

### Tire Pressure Monitor TPM

After correcting the tire inflation pressure or hitching/unhitching a trailer, reset the Tire Pressure Monitor, refer to page [348](#).

### Exterior mirrors

Exterior mirrors, which allow the driver to see both rear corners of the trailer, are available as special accessories from a dealer's service center or another qualified service center or repair shop.

## Power consumption

### General information

Before starting to drive, check the function of the trailer tail lights.

Keep the activation times of the electronic systems/power consumers short when towing a camper to save the vehicle battery power.

### Trailer tail lights

- ▶ Turn signals/brake lights: 54 watts per side.
- ▶ Rear lights: 100 watts in total.
- ▶ Backup light: 54 watts in total.

## Towing a trailer

### General information

If the trailer socket is in use, some driver assistance systems are unavailable, or available to a limited extent. A Check Control message is displayed where applicable.

When driving with a trailer or load carrier and the trailer socket not in use, some driver assistance systems may have functional limitations or may malfunction.

To prevent malfunctions, activate trailer towing, refer to page 319.

When the trailer socket is in use or trailer towing is activated, some driver assistance systems are unavailable, or available to a limited extent. A Check Control message is displayed where applicable.

### Safety information

#### WARNING

Depending on the design and loading of trailers, they may begin swinging at speeds exceeding approx. 50 mph/80 km/h. There is a risk of accidents or risk of damage to property.

Adapt your speed when driving with a trailer. Immediately brake in the case of swinging. Apply necessary steering corrections as carefully as possible.

#### WARNING

The tire inflation pressure must be adjusted to the increased axle load in trailer towing. Driving with too low tire inflation pressure can damage the tires. There is a risk of accidents or risk of damage to property. Do not exceed a speed of 60 mph / 100 km/h. Increase the tire inflation pressure of the towing vehicle by 0.2 bar. Note the maximum possible tire inflation pressure indicated on the tire.

## Uphill grades

### General information

In the interest of safety and to avoid hindering the smooth flow of traffic, the towing of trailers is permissible on uphill grades up to 12 %.

If higher trailer loads are approved at a later point in time, the gradient limit is 8 %.

### Starting on uphill grades

The parking brake is Automatically released when the accelerator pedal is activated.

In order to prevent rolling back during starting, use the parking brake.

1.  Pull and release switch before starting off.  
The parking brake is set.
2. Accelerated enough to start off.

## Hills

A vehicle-trailer combination has the tendency to swing more readily on hills.

Manually shift down to the next lower gear before driving on a hill and drive downhill slowly.

## Trailer stabilization control

### Concept

This system supports the driver in stopping the swinging of a trailer.

The trailer stabilization control detects swinging and automatically brakes the vehicle quickly to leave the critical speed range and stabilize the vehicle-trailer combination.

### General information

If the trailer power socket is in use but a trailer has not been hitched, the system can become active in certain driving situations, such as when using a bicycle rack with lighting.

### Functional requirement

The system is functional at speeds beginning at approx. 40 mph/65 km/h while a trailer is being towed and the trailer power socket is in use.

### System limits

The system cannot intervene or not intervene in time in the following situations, for instance:

- ▶ If a trailer jackknifes suddenly, for instance on slippery roads or loose surfaces.
- ▶ If a trailer with a high center of gravity tilts, before swinging is detected.
- ▶ If DSC Dynamic Stability Control is deactivated or has malfunctioned.

## Activating trailer towing

### Concept

When driving with a trailer or load carrier and the trailer socket not in use, some driver assistance systems may have functional limitations or may malfunction. To prevent malfunctions, activate trailer towing.

### Activating

Via iDrive:

1. "CAR"
2. "Settings"
3. "General settings"
4. "Trailer mode"
5. Activate trailer towing.

## Mount for trailer hitch

### General information

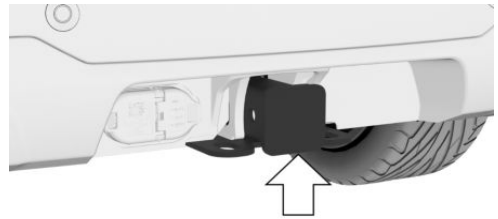

The mount for the trailer hitch is located on the rear of the vehicle.

Information on suitable trailer hitches is found on the underside of the mount, see arrow.

Follow the Maintenance Instructions, refer to page 390.

### Safety information

#### **⚠ WARNING**

During driving operation, high temperatures can occur underneath the vehicle body, for instance caused by the exhaust gas system. Contact with the hot components can cause burns. There is a risk of injury. Do not touch hot components. Do not perform work in the vicinity of hot components until after they have cooled down.

## Removing the cover

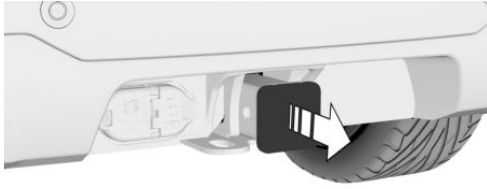

Pull the cover out of the back of the mount, and stow it in the vehicle.

## Trailer connector

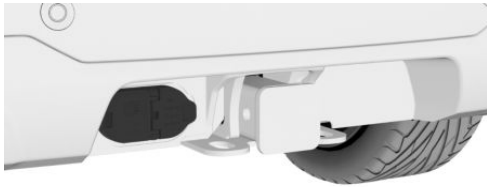

The socket is located to the left of the mount for the trailer hitch.

## Fittings for trailer safety chain

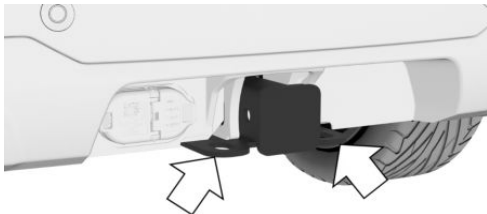

There are two fittings on the mount for the trailer hitch for securing the trailer safety chain.

Secure the trailer safety chain to the fittings for increased safety when driving with a trailer.

Ensure that the trailer safety chain can move freely and is not dragging on the ground.

## Brake Controller

The vehicle manufacturer recommends that you have a Brake Controller installed by a dealer's service center or another qualified service center or repair shop.

Information on installing a Brake Controller can be obtained from a dealer's service center or another qualified service center or repair shop.



# Saving fuel

## Vehicle features and options

This chapter describes all standard, country-specific and optional features offered with the series. It also describes features and functions that are not necessarily available in your vehicle, e.g., due to the selected options or country versions. This also applies to safety-related functions and systems. When using these functions and systems, the applicable laws and regulations must be observed.

## Reducing fuel consumption

### General information

The vehicle contains advanced technologies for the reduction of consumption and emission values.

Fuel consumption depends on a number of different factors.

Carrying out certain measures, such as a moderate driving style and regular maintenance, can influence fuel consumption and the environmental impact.

### Remove unnecessary cargo

Additional weight increases fuel consumption.

### Remove attached parts following use

Remove auxiliary mirrors, roof-mounted or rear luggage racks which are no longer required following use.

Attached parts on the vehicle impair the aerodynamics and increase the fuel consumption.

### Close the windows and glass sunroof

Driving with the glass sunroof and windows open results in increased air resistance and raises fuel consumption.

### Tires

#### General information

Tires can affect consumption in various ways, for instance tire size may influence consumption.

#### Check the tire inflation pressure regularly

Check and, if needed, correct the tire inflation pressure at least twice a month and before starting on a long trip.

Low tire inflation pressure increases rolling resistance and thus raises fuel consumption and tire wear.

#### Drive away without delay

Do not wait for the engine to warm-up while the vehicle remains stationary. Start driving right away, but at moderate engine speeds.

This is the quickest way of warming the cold engine up to operating temperature.

#### Look well ahead when driving

Driving smoothly and proactively reduces fuel consumption.

Avoid unnecessary acceleration and braking.

By maintaining a suitable distance to the vehicle driving ahead of you.

#### Avoid high engine speeds

Driving at low engine speeds lowers fuel consumption and reduces wear.

If necessary, observe the vehicle's gear shift indicator, refer to page [160](#).

## Use coasting conditions

When approaching a red light, take your foot off the accelerator and let the vehicle coast to a halt.

For going downhill take your foot off the accelerator and let the vehicle roll.

The flow of fuel is interrupted while coasting.

## Switch off the engine during longer stops

### Switching off the engine

Switch off the engine during longer stops, for instance at traffic lights, railroad crossings or in traffic congestion.

### Auto Start/Stop function

The Auto Start/Stop function of the vehicle automatically switches off the engine during a stop.

If the engine is switched off and then restarted rather than leaving the engine running constantly, fuel consumption and emissions are reduced. Savings can begin within a few seconds of switching off the engine.

In addition, fuel consumption is also determined by other factors, such as driving style, road conditions, maintenance or environmental factors.

## Switch off any functions that are not currently needed

Functions such as seat heating and the rear window defroster require a lot of energy and increase fuel consumption, especially in city and stop-and-go traffic.

Switch off these functions if they are not needed.

The ECO PRO driving mode supports the energy conserving use of comfort features. These functions are automatically deactivated partially or completely.

## Have maintenance carried out

Have the vehicle maintained regularly to achieve optimal vehicle efficiency and service life. BMW recommends that maintenance work be performed by a BMW dealer's service center.

For information on the BMW Maintenance System, refer to page [374](#).

## ECO PRO

### Concept

ECO PRO supports a driving style that saves on consumption. For this purpose, the engine control and comfort features, for instance the climate control output, are adjusted.

Under certain conditions the engine is automatically decoupled from the transmission in the D selector lever position. The vehicle continues traveling with the engine idling to reduce consumption. The D selector lever position remains engaged.

In addition, context-sensitive information, ECO PRO tips, are displayed to assist with an efficient driving style.

The achieved extended range is displayed in the instrument cluster as bonus range.

### General information

The system includes the following EfficientDynamics functions and EfficientDynamics displays:

- ▷ ECO PRO bonus range, refer to page [324](#).
- ▷ ECO PRO climate control, refer to page [323](#).
- ▷ Coasting driving condition, refer to page [325](#).
- ▷ Driving style analysis, refer to page [326](#).

## Overview



ECO PRO

Button

## Activating ECO PRO

ECO PRO

Press the button. ECO PRO is displayed in the instrument cluster.

## Configuring ECO PRO INDIVIDUAL

### Via the Driving Dynamics Control

1. Activate ECO PRO.
2. "ECO PRO INDIVIDUAL"

### Via iDrive

1. "CAR"
2. "Settings"
3. "Driving mode"
4. "ECO PRO INDIVIDUAL"
5. Select the desired setting.

The setting is stored for the driver profile currently used.

## Activating/deactivating ECO PRO functions

The following ECO PRO functions can be activated/deactivated:

- ▷ "ECO PRO speed"
- ▷ "Coasting"
- ▷ "ECO PRO seat climate control"

- ▷ "ECO PRO climate control"
- ▷ "ECO PRO light and sight"
- ▷ "Damping"
- ▷ "Steering"
- ▷ "Reset to ECO PRO STANDARD"

Settings are stored for the driver profile currently used.

## ECO PRO limit

- ▷ Activate the ECO PRO limit:  
"ECO PRO speed"

An ECO PRO tip is displayed if the speed of the set ECO PRO limit is exceeded.

- ▷ Adjust the ECO PRO limit speed:  
"Notification at:"  
Select the desired speed.

## Coasting

Efficiency can be optimized by disengaging the engine and coasting with the engine idling.

## ECO PRO seat climate control

The output of seat heating and, where applicable, seat ventilation is reduced when ECO PRO is activated.

## ECO PRO climate control

Climate control is set to be efficient.

That is, it is possible to deviate slightly from the set temperature or to heat or cool the car's interior more slowly, to economize on consumption.

The mirror heating is made available when external temperatures are very cold.

## ECO PRO light and sight

The output of exterior mirror heating and rear window defroster is reduced.

## Dampening

The following settings can be selected:

- ▷ "COMFORT"
- ▷ "SPORT"

## Steering

The following settings can be selected:

- ▷ "COMFORT"
- ▷ "SPORT"

## Resetting the settings

Reset ECO PRO INDIVIDUAL to the standard settings:

"Reset to ECO PRO STANDARD"

## Display in the instrument cluster

### General information

When ECO PRO driving mode is activated, the display switches to a special configuration.

### ECO PRO bonus range

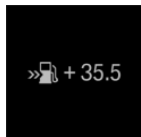

A modified driving style helps you extend your driving range.

The range extension can be displayed as the bonus range in the instrument cluster.

The efficiency display includes the bonus range, refer to page 153.

If the bonus range appears in gray, the current driving style is inefficient.

The display turns blue as soon as all conditions for efficient driving are met.

The intervals for resetting the bonus range depend on the settings of the trip data, refer to page 163.

## Consumption display

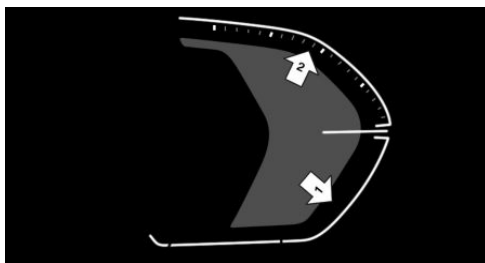

A pointer in the consumption display informs about the current driving style:

- ▷ The current consumption in relation to the average consumption is displayed.
- ▷ Pointer in the area of arrow 1: display of the energy recovered by coasting or when braking.
- ▷ Pointer in the area of arrow 2: display when accelerating.

If the acceleration is inefficient, the area between the average consumption and the current consumption is colored red.

In addition, the following information is displayed, depending on the situation:

- ▷ Depending on the equipment: the total distance driven while coasting, refer to page 325.
- ▷ The total time that the engine has been switched off, refer to page 134, during automatic engine stops.
- ▷ A gear shift indicator, refer to page 160, recommending the use of a more efficient gear.

## Indications on the Control Display

### General information

Information about the current effectiveness of the ECO PRO functions can be displayed as energy flow.

## Displaying energy flow information

Via iDrive:

1. "CAR"
2. "Driving information"
3. "Energy flow"

The following functions are displayed:

- ▷ Auto Start/Stop function.
- ▷ Energy recovery.
- ▷ Coasting.

- ▷ Brake pedal not depressed or only slightly depressed.
- ▷ The selector lever is in selector lever position D.
- ▷ Engine and transmission are at operating temperature.
- ▷ Active Cruise Control with Stop&Go function, ACC, not activated.

## Coasting

### Concept

Under certain conditions the engine is automatically decoupled from the transmission in the D selector lever position. The vehicle continues traveling with the engine idling to reduce consumption. Selector lever position D remains engaged.

This driving condition is referred to as coasting.

As soon as you step on the brake or accelerator pedal, the engine is automatically coupled again.

### General information

Coasting is a component of the ECO PRO driving mode.

Coasting is automatically activated when ECO PRO mode is called via the Driving Dynamics Control.

A proactive driving style helps the driver to use the function often and supports the efficient effect of coasting.

### Functional requirements

The function is available in the speed range from approx. 16 mph/25 km/h to 100 mph/160 km/h.

The function is active if the following conditions are met:

- ▷ Accelerator pedal not depressed.

## Operation via shift paddles

### Concept

The coasting driving condition can be influenced with the shift paddles.

### Activating/deactivating coasting via shift paddles

1. Shift to the highest gear by pulling the right shift paddle.
2. To activate coasting mode, actuate the right shift paddle again.

To deactivate, actuate the left shift paddle.

## Display

### Display in the instrument cluster

 The coasting distance traveled is indicated in coasting mode.

### Indications on the Control Display

The coasting mode is displayed under energy flow while driving.

The distance traveled coasting mode is displayed in the trip data.

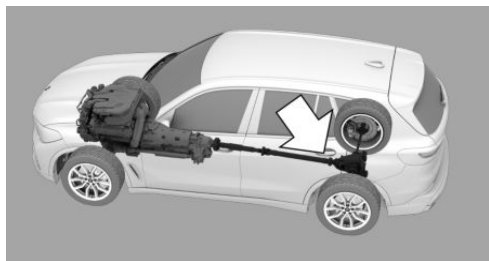

Color code blue: coasting mode.

## Displaying energy flow information

Via iDrive:

1. "CAR"
2. "Driving information"
3. "Energy flow"

## System limits

The function is not available under one of the following conditions.

- ▷ DSC OFF or TRACTION activated.
- ▷ Driving in the dynamic limit range and on steep uphill or downhill grades.
- ▷ Battery charge status temporarily too low or vehicle electrical system drawing excessive current.
- ▷ Trailer towing.
- ▷ Hill Descent Control, HDC, activated.

## Driving style analysis

### Concept

The function helps develop an especially efficient driving style and to conserve fuel.

For this purpose, the driving style is analyzed. The assessment is done in various categories and is displayed on the Control Display.

This display will help you adjust your driving style and save some fuel.

## General information

The current trip is assessed.

To assist with an efficient driving style, ECO PRO tips are displayed during driving.

The range of the vehicle can be extended by adjusting your driving style.

This gain in range is displayed as a bonus range in the instrument cluster and on the Control Display.

## Functional requirement

This function is available in ECO PRO mode.

## Calling up ECO PRO driving style analysis

Via iDrive:

1. "CAR"
2. "Driving information"
3. "Driving style analysis"

## Display on the Control Display

The display of the ECO PRO driving style analysis displays the efficiency of the driving style.

The more efficient the driving style, the more bars are displayed in color and the faster the bonus range increases.

In contrast, a reduced number of bars will be displayed with an inefficient driving style.







 **MOBILITY**

Refueling .....	330
Wheels and tires .....	332
Engine compartment .....	364
Operating materials .....	367
Maintenance .....	374
Replacing components .....	376
Breakdown assistance .....	380
Care .....	387

# Refueling

## Vehicle features and options

This chapter describes all standard, country-specific and optional features offered with the series. It also describes features and functions that are not necessarily available in your vehicle, e.g., due to the selected options or country versions. This also applies to safety-related functions and systems. When using these functions and systems, the applicable laws and regulations must be observed.

## Follow the following when refueling

### General information

Follow the fuel recommendation, refer to page 367, prior to refueling.

When refueling, insert the filler nozzle completely into the filler pipe. Lifting up the fuel pump nozzle during refueling causes:

- ▶ Premature switching off.
- ▶ Reduced return of the fuel vapors.

The fuel tank is full when the filler nozzle clicks off the first time.

Make sure that the fuel cap is closed properly after refueling, otherwise the emissions warning light may light up.

Follow safety regulations posted at the gas station.

## Safety information

### ⚠ NOTICE

With a driving range of less than 30 miles/50 km the engine may no longer have sufficient fuel. Engine functions are not ensured anymore. There is a risk of damage to property. Refuel promptly.

### ⚠ NOTICE

Fuels are toxic and aggressive. Overfilling of the fuel tank can damage the fuel system. Painted surfaces may be damaged by contact with fuel. Escaping fuel can harm the environment. There is a risk of damage to property. Avoid overfilling.

## Fuel cap

### Opening

1. Briefly press the rear edge of the fuel filler flap.



2. Turn the fuel cap counterclockwise.

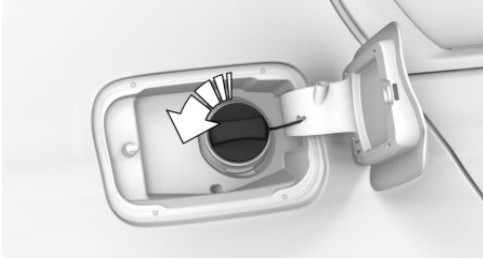

3. Place the fuel cap in the bracket attached to the fuel filler flap.

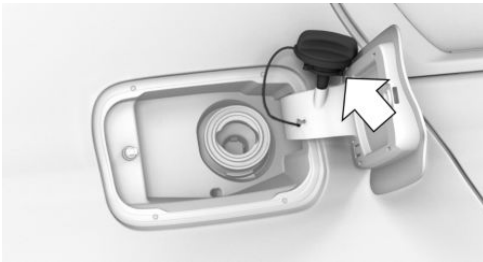

Have fuel filler flap unlocked by a dealer's service center or another qualified service center or repair shop.

## Closing

### **WARNING**

The retaining strap of the fuel cap can be jammed and crushed during closing. The cap cannot be correctly closed. Fuel or fuel vapors can escape. There is a risk of injury or risk of damage to property. Pay attention that the retaining strap is not jammed or crushed when closing the cap.

1. Fit the cap and turn it clockwise until you clearly hear a click.
2. Close the fuel filler flap.

## Manually unlocking fuel filler flap

It may be necessary in certain situations to unlock the fuel filler flap manually, e.g. with an electrical fault.

# Wheels and tires

## Vehicle features and options

This chapter describes all standard, country-specific and optional features offered with the series. It also describes features and functions that are not necessarily available in your vehicle, e.g., due to the selected options or country versions. This also applies to safety-related functions and systems. When using these functions and systems, the applicable laws and regulations must be observed.

## Tire inflation pressure

### General information

The tire characteristics and tire inflation pressure influence the following:

- ▷ The service life of the tires.
- ▷ Road safety.
- ▷ Driving comfort.
- ▷ Fuel consumption.

### Safety information

#### WARNING

A tire with too little or no tire inflation pressure may heat up significantly and sustain damage. This will have a negative impact on aspects of handling, such as steering and braking response. There is a risk of an accident. Regularly check the tire inflation pressure, and correct it as needed, for instance twice a month and before a long trip.

## Tire inflation pressure specifications

### In the tire inflation pressure table

The tire inflation pressure table, refer to page 334, contains all tire inflation pressure specifications for the specified tire sizes at the ambient temperature. The tire inflation pressure values apply to tire sizes approved by the manufacturer of the vehicle for the vehicle type.

To identify the correct tire inflation pressure, please note the following:

- ▷ Tire sizes of your vehicle.
- ▷ Maximum permitted driving speed.

### On the Control Display

The current tire inflation pressure values and the intended tire inflation pressure values for the mounted tires can be displayed on the Control Display.

To ensure that they are displayed correctly, the tire sizes must be stored in the system and must have been set, refer to page 348, for the mounted tires.

The current tire inflation pressure value is located on each tire.

The intended tire inflation pressure value is located in the lower area of the Control Display.

## Checking the tire inflation pressure

### General information

Tires heat up while driving. The tire inflation pressure increases with the tire temperature.

Tires have a natural, consistent loss of tire inflation pressure.

The displays of inflation devices may under-read by up to 0.1 bar/2 psi.

## Checking using tire inflation pressure specifications in the tire inflation pressure table

The tire inflation pressure specifications in the tire inflation pressure table only relate to cold tires or tires at the same temperature as the ambient temperature.

Only check the tire inflation pressure levels when the tires are cold, i.e.:

- ▶ Driving range of max. 1.25 miles/2 km has not been exceeded.
- ▶ If the vehicle has not moved again for at least 2 hours after a trip.

Check the tire inflation pressure of the emergency wheel in the cargo area regularly, and correct it as needed.

1. Determine, refer to page 332, the intended tire inflation pressure levels for the mounted tires.
2. Check the tire inflation pressure in all four tires, using a pressure gage, for example.
3. Correct the tire inflation pressure if the current tire inflation pressure value deviates from the specified value.
4. Check whether all valve caps are screwed onto the tire valves.

## Checking using the tire inflation pressure specifications on the Control Display

Via iDrive:

1. "CAR"
2. "Vehicle status"
3.  "Tire Pressure Monitor"
4. Check whether the current tire inflation pressure levels deviate from the intended tire pressure value.
5. Correct the tire inflation pressure if the current tire inflation pressure value deviates from the intended value.

## After correcting the tire inflation pressure

With runflat tires:

Reinitialize the Flat Tire Monitor.

With Tire Pressure Monitor TPM:

With tires that cannot be found in the tire pressure values on the Control Display, reset the Tire Pressure Monitor TPM.

## Tire inflation pressures up to 100 mph/160 km/h

For speeds of up to 100 mph/160 km/h and for optimum driving comfort, note the pressure values in the tire inflation pressure table, refer to page 334, and adjust as necessary.



These pressure values can also be found on the tire inflation pressure label on the driver's door pillar.

Do not exceed a speed of 100 mph/160 km/h.

## Tire inflation pressure values up to 100 mph/160 km/h

### X5 xDrive40i with two rows of seats

**Tire size**                      **Pressure specifications in bar/PSI**

Specifications in bar/PSI with cold tires

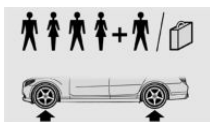

265/50 R 19 110 H M+S XL A/S RSC      2.3 / 33      2.8 / 41

275/45 R 20 110 H M+S XL A/S RSC

255/55 R 18 109 W XL Std

265/50 R 19 110 H M+S XL RSC

275/45 R 20 110 V M+S XL RSC

Front: 275/45 R 20 110 Y XL RSC      2.3 / 33      -

Rear: 305/40 R 20 112 Y XL RSC      -      2.7 / 39

Front: 275/40 R 21 107 Y XL RSC      2.4 / 35      -

Rear: 315/35 R 21 111 Y XL RSC      -      2.9 / 42

Front: 275/35 R 22 104 Y XL Std      2.6 / 38      -

Rear: 315/30 R 22 107 Y XL Std      -      3.1 / 45

Emergency wheel: Speed up to a max. of 50 mph / 80 km/h

T 155/80 R 19 114 M      4.2 / 60

## X5 xDrive40i with three rows of seats

**Tire size**                      **Pressure specifications in bar/PSI**

Specifications in bar/PSI with cold tires

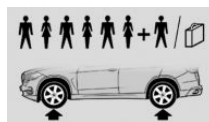

265/50 R 19 110 H M+S XL A/S RSC      2.3 / 33      2.8 / 41

275/45 R 20 110 H M+S XL A/S RSC

255/55 R 18 109 W XL Std

265/50 R 19 110 H M+S XL RSC

275/45 R 20 110 V M+S XL RSC

Front: 275/45 R 20 110 Y XL RSC      2.3 / 33      -

Rear: 305/40 R 20 112 Y XL RSC      -      2.7 / 39

Front: 275/40 R 21 107 Y XL RSC      2.4 / 35      -

Rear: 315/35 R 21 111 Y XL RSC      -      2.9 / 42

**X5 xDrive50i**

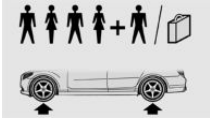
Tire size	Pressure specifications in bar/PSI	
Specifications in bar/PSI with cold tires		
265/50 R 19 110 H M+S XL A/S RSC	2.3 / 33	2.8 / 41
275/45 R 20 110 H M+S XL A/S RSC		
255/55 R 18 109 W XL Std		
265/50 R 19 110 H M+S XL RSC		
275/45 R 20 110 V M+S XL RSC		
Front: 275/45 R 20 110 Y XL RSC	2.3 / 33	-
Rear: 305/40 R 20 112 Y XL RSC	-	2.7 / 39
Front: 275/40 R 21 107 Y XL RSC	2.4 / 35	-
Rear: 315/35 R 21 111 Y XL RSC	-	2.9 / 42
Front: 275/35 R 22 104 Y XL Std	2.6 / 38	-
Rear: 315/30 R 22 107 Y XL Std	-	3.1 / 45
Emergency wheel:	Speed up to a max. of 50 mph / 80 km/h	
T 155/80 R 19 114 M	4.2 / 60	

**Tire inflation pressures at max. speeds above 100 mph/160 km/h****⚠ WARNING**

In order to drive at maximum speeds in excess of 100 mph/160 km/h, please observe, and, if necessary, adjust tire pressures for speeds exceeding 100 mph/160 km/h from the relevant table on the following pages. Otherwise, tire damage and accidents could occur.

For speeds over 100 mph/160 km/h and for optimum driving comfort, note the pressure values in the tire inflation pressure table, refer to page 335, and adjust as necessary.

**Tire inflation pressure values over 100 mph/160 km/h****X5 xDrive40i with two rows of seats**

Without Sport Package

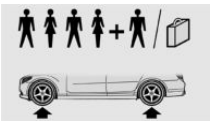
Tire size	Pressure specifications in bar/PSI	
Specifications in bar/PSI with cold tires		
265/50 R 19 110 H M+S XL A/S RSC	2.5 / 36	3.0 / 44
275/45 R 20 110 H M+S XL A/S RSC		
255/55 R 18 109 W XL Std		
265/50 R 19 110 H M+S XL RSC		
275/45 R 20 110 V M+S XL RSC		
Front: 275/45 R 20 110 Y XL RSC	2.3 / 33	-

Tire size	Pressure specifications in bar/PSI	
Rear: 305/40 R 20 112 Y XL RSC	-	2.7 / 39
Front: 275/40 R 21 107 Y XL RSC	2.4 / 35	-
Rear: 315/35 R 21 111 Y XL RSC	-	2.9 / 42
Front: 275/35 R 22 104 Y XL Std	2.6 / 38	-
Rear: 315/30 R 22 107 Y XL Std	-	3.1 / 45
Emergency wheel: T 155/80 R 19 114 M	Speed up to a max. of 50 mph / 80 km/h	4.2 / 60

With Sport Package

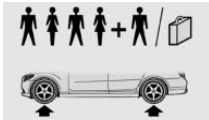
Tire size	Pressure specifications in bar/PSI	
Specifications in bar/PSI with cold tires		
265/50 R 19 110 H M+S XL RSC	2.5 / 36	3.0 / 44
275/45 R 20 110 V M+S XL RSC	2.8 / 41	3.3 / 48
255/55 R 18 109 W XL Std	2.9 / 42	3.4 / 49
Front: 275/45 R 20 110 Y XL RSC	2.8 / 41	-
Rear: 305/40 R 20 112 Y XL RSC	-	3.1 / 45

Tire size	Pressure specifications in bar/PSI	
Front: 275/40 R 21 107 Y XL RSC	2.8 / 41	-
Rear: 315/35 R 21 111 Y XL RSC	-	3.1 / 45
Front: 275/35 R 22 104 Y XL Std	2.8 / 41	-
Rear: 315/30 R 22 107 Y XL Std	-	3.3 / 48
Emergency wheel: T 155/80 R 19 114 M	Speed up to a max. of 50 mph / 80 km/h	4.2 / 60

## X5 xDrive40i with three rows of seats

Without Sport Package

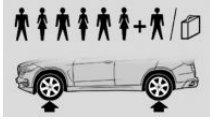
Tire size	Pressure specifications in bar/PSI	
Specifications in bar/PSI with cold tires		
265/50 R 19 110 H M+S XL A/S RSC	2.5 / 36	3.0 / 44
275/45 R 20 110 H M+S XL A/S RSC	2.8 / 41	3.3 / 48
255/55 R 18 109 W XL Std	2.9 / 42	3.4 / 49
265/50 R 19 110 H M+S XL RSC	2.8 / 41	-
275/45 R 20 110 V M+S XL RSC	-	3.1 / 45



Tire size	Pressure specifications in bar/PSI	
Front: 275/45 R 20 110 Y XL RSC	2.3 / 33	-
Rear: 305/40 R 20 112 Y XL RSC	-	2.7 / 39
Front: 275/40 R 21 107 Y XL RSC	2.4 / 35	-
Rear: 315/35 R 21 111 Y XL RSC	-	2.9 / 42

With Sport Package

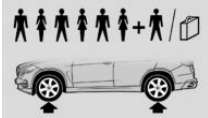
Tire size	Pressure specifications in bar/PSI	
Specifications in bar/PSI with cold tires		
265/50 R 19 110 H M+S XL RSC	2.7 / 39	3.2 / 46
275/45 R 20 110 V M+S XL RSC	2.9 / 42	3.4 / 49
Front: 275/45 R 20 110 Y XL RSC	2.9 / 42	-
Rear: 305/40 R 20 112 Y XL RSC	-	3.4 / 49
Front: 275/40 R 21 107 Y XL RSC	2.9 / 42	-
Rear: 315/35 R 21 111 Y XL RSC	-	3.4 / 49

**X5 xDrive50i**

Without Sport Package

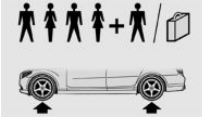
Tire size	Pressure specifications in bar/PSI	
Specifications in bar/PSI with cold tires		
265/50 R 19 110 H M+S XL A/S RSC	2.5 / 36	3.0 / 44
275/45 R 20 110 H M+S XL A/S RSC		
255/55 R 18 109 W XL Std		
265/50 R 19 110 H M+S XL RSC		
275/45 R 20 110 V M+S XL RSC		
Front: 275/45 R 20 110 Y XL RSC	2.3 / 33	-
Rear: 305/40 R 20 112 Y XL RSC	-	2.7 / 39
Front: 275/40 R 21 107 Y XL RSC	2.4 / 35	-
Rear: 315/35 R 21 111 Y XL RSC	-	2.9 / 42
Front: 275/35 R 22 104 Y XL Std	2.6 / 38	-
Rear: 315/30 R 22 107 Y XL Std	-	3.1 / 45
Emergency wheel: T 155/80 R 19 114 M	Speed up to a max. of 50 mph / 80 km/h	

With Sport Package

## Tire size Pressure specifications in bar/PSI

Specifications in bar/PSI with cold tires

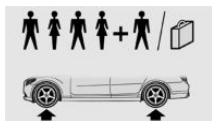

265/50 R 19 110 H M+S XL RSC	2.5 / 36	3.0 / 44
------------------------------------	----------	----------

275/45 R 20 110 V M+S XL RSC	2.8 / 41	3.3 / 48
------------------------------------	----------	----------

Front: 275/45 R 20 110 Y XL RSC	2.8 / 41	-
---------------------------------------	----------	---

Rear: 305/40 R 20 112 Y XL RSC	-	3.1 / 45
--------------------------------------	---	----------

Front: 275/40 R 21 107 Y XL RSC	2.8 / 41	-
---------------------------------------	----------	---

Rear: 315/35 R 21 111 Y XL RSC	-	3.1 / 45
--------------------------------------	---	----------

Front: 275/35 R 22 104 Y XL Std	3.0 / 44	-
------------------------------------	----------	---

Rear: 315/30 R 22 107 Y XL Std	-	3.4 / 49
-----------------------------------	---	----------

Emergency wheel:	Speed up to a max. of 50 mph / 80 km/h	
------------------	----------------------------------------	--

T 155/80 R 19 114 M	4.2 / 60	
------------------------	----------	--

45: aspect ratio in %

R: radial tire code

18: rim diameter in inches

96: load rating, not for ZR tires

Y: speed rating, before the R on ZR tires

## Maximum tire load

Maximum tire load is the maximum permissible weight for which the tire is approved.

Locate the maximum tire load on the tire sidewall and the Gross Axle Weight Rating – GAWR – on the certification label on the driver door B-pillar. Divide the tire load by 1.1. It must be greater than one-half of the vehicle's Gross Axle Weight Rating – GAWR. Note, front vs. rear GAWR and tire loads, respectively.

## Speed letter

Q = up to 100 mph/160 km/h

R = up to 106 mph/170 km/h

S = up to 112 mph/180 km/h

T = up to 118 mph/190 km/h

H = up to 131 mph/210 km/h

V = up to 150 mph/240 km/h

W = up to 167 mph/270 km/h

Y = up to 186 mph/300 km/h

## Tire Identification Number

DOT code: DOT xxxx xxx 3818

xxxx: manufacturer code for the tire brand

xxx: tire size and tire design

3818: tire age

Tires with DOT codes meet the guidelines of the U.S. Department of Transportation.

## Tire age

## Recommendation

Regardless of the tire tread, replace tires at least every 6 years.

## Tire identification marks

### Tire size

245/45 R 18 96 Y

245: nominal width in mm

## Manufacture date

You can find the manufacture date of the tire on the tire's sidewall.

Designation	Manufacture date
DOT ... 3818	38th week, 2018

## Uniform Tire Quality Grading

Quality grades can be found where applicable on the tire sidewall between tread shoulder and maximum section width.

E.g.: Treadwear 200; Traction AA; Temperature A

## DOT Quality Grades

Treadwear

Traction AA A B C

Temperature A B C

All passenger vehicle tires must conform to Federal Safety Requirements in addition to these grades.

## Treadwear

The treadwear grade is a comparative rating based on the wear rate of the tire when tested under controlled conditions on a specified government test course. E.g., a tire graded 150 would wear one and one-half, 1 g, times as well on the government course as a tire graded 100. The relative performance of tires depends upon the actual conditions of their use, however, and may depart significantly from the norm due to variations in driving habits, service practices and differences in road characteristics and climate.

## Traction

The traction grades, from highest to lowest, are AA, A, B, and C.

Those grades represent the tire's ability to stop on wet pavement as measured under controlled conditions on specified government test surfa-

ces of asphalt and concrete. A tire marked C may have poor traction performance.

The traction grade assigned to this tire is based on straight-ahead braking traction tests, and does not include acceleration, cornering, hydroplaning, or peak traction characteristics.

## Temperature

The temperature grades are A, the highest, B, and C, representing the tire's resistance to the generation of heat and its ability to dissipate heat when tested under controlled conditions on a specified indoor laboratory test wheel. Sustained high temperature can cause the material of the tire to degenerate and reduce tire life, and excessive temperature can lead to sudden tire failure. The grade C corresponds to a level of performance which all passenger vehicle tires must meet under the Federal Motor Vehicle Safety Standard No. 109. Grades Band A represent higher levels of performance on the laboratory test wheel than the minimum required by law.

### WARNING

The temperature grade for this tire is established for a tire that is properly inflated and not overloaded. Excessive speed, underinflation, or excessive loading, either separately or in combination, can cause heat buildup and possible tire failure.

## RSC – Run-flat tires

Run-flat tires, refer to page 342, are labeled with a circular symbol containing the letters RSC marked on the sidewall.

## M+S

Winter and all-season tires with better cold weather performance than summer tires.

## Tire tread

### Summer tires

Do not drive with a tire tread of less than 0.12 in/3 mm, otherwise there is an increased risk of hydroplaning.

### Winter tires

Do not drive with a tire tread of less than 0.16 in/4 mm, as such tires are less suitable for winter operation.

### Minimum tread depth



Wear indicators are distributed around the tire's circumference and have the legally required minimum height of 0.063 inches/1.6 mm.

The positions of the wear indicators are marked on the tire sidewall with TWI, Tread Wear Indicator.

## Tire damage

### General information

Inspect your tires regularly for damage, foreign objects lodged in the tread, and tread wear.

Driving over rough or damaged road surfaces, as well as debris, curbs and other obstacles can cause serious damage to wheels, tires and suspension parts. This is more likely to occur with low-profile tires, which provide less cushioning between the wheel and the road. Be careful to avoid road hazards and reduce your speed, es-

pecially if your vehicle is equipped with low-profile tires.

Indications of tire damage or other vehicle malfunctions:

- ▷ Unusual vibrations.
- ▷ Unusual tire or running noises.
- ▷ Unusual handling such as a strong tendency to pull to the left or right.

Damage can be caused by the following situations, for instance:

- ▷ Driving over curbs.
- ▷ Road damage.
- ▷ Tire inflation pressure too low.
- ▷ Vehicle overloading.
- ▷ Incorrect tire storage.

### Safety information

#### WARNING

Damaged tires can lose tire inflation pressure, which can lead to loss of vehicle control. There is a risk of an accident. If tire damage is suspected while driving, immediately reduce speed and stop. Have wheels and tires checked. For this purpose, drive carefully to the nearest dealer's service center or another qualified service center or repair shop. Have vehicle towed or transported as needed. Do not repair damaged tires, but have them replaced.

#### WARNING

Tires can become damaged by driving over obstacles, e.g., curbs or road damage, at high speed. Larger wheels have a smaller tire cross-section. The smaller the tire cross-section, the higher the risk of tire damage. There is a danger of accidents and property damage. If possible, drive around obstacles, or drive over them slowly and carefully.

## Changing wheels and tires

### Mounting and wheel balancing

Have mounting and wheel balancing carried out by a dealer's service center or another qualified service center or repair shop.

### Wheel and tire combination

#### General information

You can ask the dealer's service center or another qualified service center or repair shop about the correct wheel/tire combination and wheel rim versions for the vehicle.

#### Safety information

##### **WARNING**

Wheels and tires which are not suitable for your vehicle can damage parts of the vehicle, for instance due to contact with the body due to tolerances despite the same official size rating. There is a risk of an accident. The manufacturer of your vehicle strongly suggests that you use wheels and tires that have been recommended by the vehicle manufacturer for your vehicle type.

##### **WARNING**

Mounted steel wheels can cause technical problems, for instance independent loosening of the lug bolts, damage to the brake discs. There is a risk of an accident. Do not mount steel wheels.

##### **WARNING**

Incorrect wheel/tire combinations will have a negative impact on the vehicle's handling and on the function of a variety of systems, such as the Anti-lock Brake System or Dynamic Stability Control. There is a risk of an accident. To

maintain good handling and vehicle response, use only tires with a single tread configuration from a single manufacturer. The manufacturer of the vehicle recommends that you use wheels and tires that have been recommended by the vehicle manufacturer for your vehicle type. Following tire damage, have the original wheel/tire combination remounted on the vehicle as soon as possible.

##### **WARNING**

Unsuitable wheel studs, such as single-section wheel studs, may loosen or come off. The wheel may come loose during driving. There is a risk of an accident. Use only two-section wheel studs that have been categorized as suitable for the respective wheel type by the manufacturer of the vehicle.

### Recommended tire brands



For each tire size, the manufacturer of the vehicle recommends certain tire brands. The tire brands can be identified by a star on the tire sidewall.

### New tires

Tire traction is not optimal due to manufacturing circumstances when tires are brand-new; they achieve their full traction potential after a break-in time.

Drive conservatively for the first 200 miles/300 km.

## Retreaded tires

### WARNING

Retreaded tires can have different tire casing structures. With advanced age the service life can be limited. There is a risk of an accident. The manufacturer of your vehicle does not recommend the use of retreaded tires.

The manufacturer of your vehicle does not recommend the use of retreaded tires.

## Winter tires

### General information

Winter tires are recommended for operating on winter roads.

Although so-called all-season M+S tires provide better winter traction than summer tires, they usually do not provide the same level of performance as winter tires.

### Maximum speed of winter tires

If the maximum speed of the vehicle is higher than the permissible speed for the winter tires, then attach a label showing the permissible maximum speed in the field of view. The label is available from a dealer's service center or another qualified service center or repair shop.

With winter tires mounted, observe and do not exceed the permissible maximum speed.

### Changing runflat tires

For your own safety, use only runflat tires. No spare tire is available in the case of a flat tire. Further information is available from a dealer's service center or another qualified service center or repair shop.

### Rotating wheels between axles

Different wear patterns can occur on the front and rear axles depending on individual driving conditions. The tires can be rotated in pairs be-

tween the axles to achieve even wear. Further information is available from a dealer's service center or another qualified service center or repair shop. After rotating, check the tire pressure and correct, if needed.

Rotating the tires is not permissible on vehicles with different tire sizes or rim sizes on the front and rear axles.

## Storing tires

### Tire inflation pressure

Do not exceed the maximum tire inflation pressure indicated on the side wall of the tire.

### Storage

Store wheels and tires in a cool, dry and dark place.

Always protect tires against all contact with oil, grease, and solvents.

Do not leave tires in plastic bags.

Remove dirt from wheels or tires.

## Run-flat tires

### Concept

Run-flat tires permit continued driving under restricted conditions even in the event of a complete loss of tire inflation pressure.

### General information

The wheels consist of tires that are self-supporting, to a limited degree, and possibly special rims.

The support of the sidewall allows the tire to remain drivable to a restricted degree in the event of a tire inflation pressure loss.

Follow the instructions for continued driving with a flat tire.

## Safety information

### WARNING

Your vehicle handles differently with a run-flat with no or low inflation pressure; for instance, your lane stability when braking is reduced, braking distances are longer and the self-steering properties will change. There is a risk of an accident. Drive moderately and do not exceed a speed of 50 mph/80 km/h.

### WARNING

Heavy trailers can start swinging when continuing to drive with a flat tire. There is a risk of accidents or risk of damage to property. Do not exceed a speed of 35 mph/60 km/h when driving with a trailer and a flat tire. Immediately brake in the case of swinging. Apply necessary steering corrections as carefully as possible.

## Label



The tires are marked on the tire sidewall with RSC Run-flat System Component.

## Repairing a flat tire

### Safety measures

- ▷ Park the vehicle as far away as possible from passing traffic and on solid ground.
- ▷ Switch on the hazard warning system.
- ▷ Secure the vehicle against rolling away by setting the parking brake.
- ▷ Turn the steering wheel until the front wheels are in the straight-ahead position and engage the steering wheel lock.
- ▷ Have all vehicle occupants get out of the vehicle and ensure that they remain outside the immediate area in a safe place, such as behind a guardrail.
- ▷ If necessary, set up a warning triangle at an appropriate distance.

## Mobility System

### Concept

With the Mobility System, minor tire damage can be sealed temporarily to enable continued travel. To accomplish this, sealant is pumped into the tires, which seals the damage from the inside.

### General information

- ▷ Follow the instructions on using the Mobility System found on the compressor and sealant container.
- ▷ Use of the Mobility System may be ineffective if the tire puncture measures approx. 1/8 inches/4 mm or more.
- ▷ Contact a dealer's service center or another qualified service center or repair shop if the tire cannot be made drivable.
- ▷ If possible, do not remove foreign bodies that have penetrated the tire. Only remove foreign objects if they are visibly protruding from the tire.
- ▷ Pull the speed limit sticker off the sealant container and apply it to the steering wheel.
- ▷ The use of a sealant can damage the TPM wheel electronics. In this case, have the electronics checked and replaced at the next opportunity.
- ▷ The compressor can be used to check the tire inflation pressure.

## Overview

### Storage

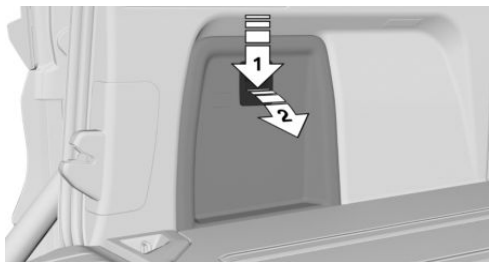

The Mobility System is in the left storage compartment of the cargo area.

### Sealant container

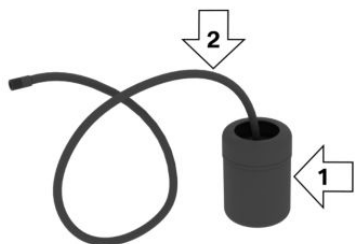

- ▷ Sealant container, arrow 1.
- ▷ Filling hose, arrow 2.

Observe use-by date on the sealant container.

### Compressor

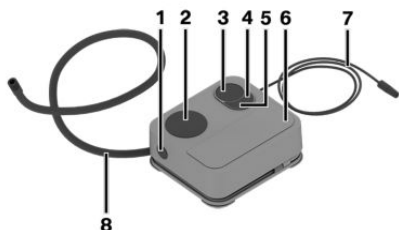

- 1 Sealant container unlocking
- 2 Sealant container holder

- 3 Tire pressure gage
- 4 Reduce tire inflation pressure button
- 5 On/off switch
- 6 Compressor
- 7 Connector/cable for socket
- 8 Connection hose

### Safety measures

- ▷ Park the vehicle as far away as possible from passing traffic and on solid ground.
- ▷ Switch on the hazard warning system.
- ▷ Secure the vehicle against rolling away by setting the parking brake.
- ▷ Turn the steering wheel until the front wheels are in the straight-ahead position and engage the steering wheel lock.
- ▷ Have all vehicle occupants get out of the vehicle and ensure that they remain outside the immediate area in a safe place, such as behind a guardrail.
- ▷ If necessary, set up a warning triangle at an appropriate distance.

### Filling the tire with sealant

### Safety information

#### DANGER

If the exhaust pipe is blocked or ventilation is insufficient, harmful exhaust gases can enter into the vehicle. The exhaust gases contain pollutants which are colorless and odorless. In enclosed areas, exhaust gases can also accumulate outside of the vehicle. There is danger to life. Keep the exhaust pipe free and ensure sufficient ventilation.



**⚠ NOTICE**

The compressor can overheat during extended operation. There is a risk of damage to property. Do not run the compressor for more than 10 minutes.

**Filling**

1. Shake the sealant container.



2. Pull filling hose completely out of the cover of the sealant container. Do not kink the hose.

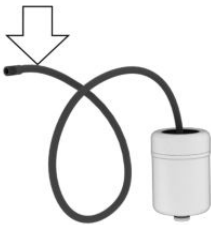

3. Slide the sealant container into the holder on the compressor housing, ensuring that it engages audibly.

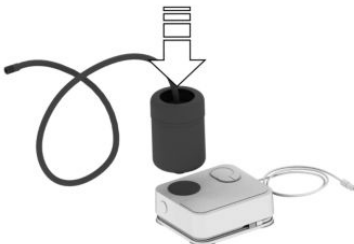

4. Screw the filling hose of the sealant container onto the tire valve of the nonworking wheel.



5. With the compressor switched off, insert the plug into the power socket inside the vehicle.



6. With standby state switched on or the engine running, switch on the compressor.



Let the compressor run for max. 10 minutes to fill the tire with sealant and achieve a tire inflation pressure of approx. 2.0 bar.

While the tire is being filled with sealant, the tire inflation pressure may sporadically reach approx. 5 bar. Do not switch off the compressor at this point.

## Checking and adjusting the tire inflation pressure

### Checking

1. Switch off the compressor.
2. Read the tire inflation pressure on the tire pressure gage.

To continue the trip, a tire inflation pressure of at least 2 bar must be reached.

### Removing and stowing the sealant container

1. Unscrew the filling hose of the sealant container from the tire valve.
2. Press the red unlocking device.
3. Remove the sealant container from the compressor.
4. Wrap and store the sealant container in suitable material to avoid dirtying the cargo area.

### Minimum tire inflation pressure is not reached

1. Pull the connector out of the power socket inside the vehicle.
2. Drive 33 ft/10 m forward and back to distribute the sealant in the tire.
3. Screw the connection hose of the compressor directly onto the tire valve stem.

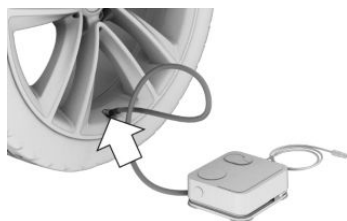

4. Insert the connector into the power socket inside the vehicle.



5. With standby state switched on or the engine running, switch on the compressor.

If a tire inflation pressure of at least 2 bar cannot be reached, contact your dealer's service center or another qualified service center or repair shop.

If a tire inflation pressure of at least 2 bar is reached, see Minimum tire inflation pressure is reached.

6. Unscrew the connection hose of the compressor from the tire valve.
7. Pull the connector out of the power socket inside the vehicle.
8. Stow the Mobility System in the vehicle.

### Minimum tire inflation pressure is reached

1. Unscrew the connection hose of the compressor from the tire valve.
2. Pull the connector out of the power socket inside the vehicle.
3. Stow the Mobility System in the vehicle.
4. Immediately drive approx. 5 miles/10 km to ensure that the sealant is evenly distributed in the tire.

Do not exceed a speed of 50 mph/80 km/h.

If possible, do not drive at speeds less than 12 mph/20 km/h.

## Adjustment

1. Stop at a suitable location.
2. Screw the connection hose of the compressor directly onto the tire valve stem.

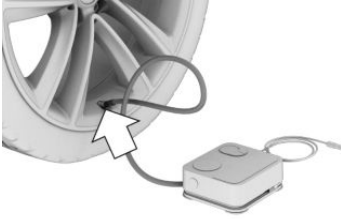

3. Insert the connector into the power socket inside the vehicle.



4. Correct the tire inflation pressure to at least 2.0 bar.
  - ▷ Increase tire inflation pressure: with standby state switched on or the engine running, switch on the compressor.
  - ▷ Reduce tire inflation pressure: press the button on the compressor.
5. Unscrew the connection hose of the compressor from the tire valve.
6. Pull the connector out of the power socket inside the vehicle.
7. Stow the Mobility System in the vehicle.

## Continuing the trip

Do not exceed the maximum permissible speed of 50 mph/80 km/h.

Reinitialize the run-flat tires, refer to page 355.

Reset the Tire Pressure Monitor TPM, refer to page 348.

Replace the nonworking tire and the sealant container of the Mobility System promptly.

## Snow chains

### Safety information

#### WARNING

With the mounting of snow chains on unsuitable tires, the snow chains can come into contact with vehicle parts. There is a risk of accidents or risk of damage to property. Only mount snow chains on tires that are designated by their manufacturer as suitable for the use of snow chains.

#### WARNING

Insufficiently tight snow chains may damage tires and vehicle components. There is a risk of accidents or risk of damage to property. Make sure that the snow chains are always sufficiently tight. Re-tighten as needed according to the snow chain manufacturer's instructions.

### Fine-link snow chains

The manufacturer of your vehicle recommends use of fine-link snow chains. Certain types of fine-link snow chains have been tested by the manufacturer of the vehicle and recommended as road-safe and suitable.

Information regarding suitable snow chains is available from a dealer's service center or another qualified service center or repair shop.

### Use

Use only in pairs on the rear wheels, equipped with the tires of the following size:

- ▷ 255/55 R18.

- ▷ 265/50 R19.
- ▷ 275/45 R20.

Follow the snow chain manufacturer's instructions.

Do not initialize the run-flat tires after mounting snow chains, as doing so may result in incorrect readings.

Do not reset the Tire Pressure Monitor TPM after mounting snow chains, as doing so may result in incorrect readings.

When driving with snow chains, briefly activate Dynamic Traction Control DTC to optimize the forward momentum.

## Maximum speed with snow chains

Do not exceed a speed of 30 mph/50 km/h when using snow chains.

## Rear axle steering during operation with snow chains

### General information

In order to guarantee free running of the wheels when operating with snow chains, rear axle steering of the integral active steering must be switched off when snow chains are mounted.

### Safety information

#### WARNING

When rear axle steering is switched on and snow chains are mounted, there can be contact between snow chains and the chassis. There is a risk of accidents or risk of damage to property. With mounted snow chains, switch off the rear axle steering.

## Switching off rear axle steering

The rear axle steering is switched off by specifying that snow chains are installed.

Via iDrive:

1. "CAR"
2. "Settings"
3. "General settings"
4. "Tire chains"
5. "Snow chains installed"

Starting with the permissible maximum speed with snow chains of 30 mph/50 km/h the rear axle steering will be switched on again automatically.

## Tire Pressure Monitor TPM

### Concept

The system monitors tire inflation pressure in the four mounted tires. The system warns you if there is a loss of pressure in one or more tires.

### General information

Sensors in the tire valves measure the tire inflation pressure and tire temperature.

Using the tire settings in iDrive, the system can automatically display the specified target pressures and compare them with the actual tire inflation pressures.

If tires are being used that are not specified on the tire inflation pressure details on the vehicle, refer to page 332, such as tires with special approval, the system needs to be actively reset.

The system will then take over the actual tire inflation pressures as the target pressures.

When operating the system, also note the additional information found in the Tire inflation pressure, refer to page 332, chapter.

## Safety information

### WARNING

The display of the target pressures is not a substitute for the tire inflation pressure details on the vehicle. Incorrect entries in the tire settings can lead to incorrect target tire inflation pressure values. In this case, it cannot be guaranteed that the notification of a loss of tire inflation pressure will be reliable. There is a risk of injury and risk of damage to property. Ensure that the tire sizes of the mounted tires are displayed correctly and match the details on the tires and on the vehicle.

## Functional requirements

The following conditions must be met for the system; otherwise, reliable flagging of a loss of tire inflation pressure is not assured:

- ▷ Every time a tire or wheel is changed, the correct details on the mounted tires must be entered in the tire settings, refer to page 349.
- ▷ For tires with special approval:
  - ▷ After a tire or wheel replacement, a reset was performed with the correct tire inflation pressure.
  - ▷ After the tire inflation pressure was adjusted to a new value, a reset was performed.
- ▷ Wheels with TPM wheel electronics.

## Tire settings

### General information

The tire sizes of the mounted tires can be gathered from the tire inflation pressure details on the vehicle, refer to page 332, or directly on the tires.

The tire details do not need to be re-entered when the tire inflation pressure is corrected.

For summer and winter tires, the tire details entered last are stored. After a tire or wheel re-

placement, the settings of the tire sets used last can be selected.

### Opening the menu

Via iDrive:

1. "CAR"
2. "Vehicle status"
3.  "Tire Pressure Monitor"

### Changing settings

Via iDrive:

1. "Tire settings"
2. Selecting tires:
  - ▷ "Summer tires"
  - ▷ "Winter/all-year"
3. "Current:"
4. Select the tire type that is mounted on the rear axle:
  - ▷ Tire size, e.g., 245/45 R18 96 Y.
  - ▷ For tires with special approval: "Other tire"
5. Select the maximum road speed that will be used with the tires.
6. "Save tire settings"

The measurement of the current tire inflation pressure is started. The measurement progress is displayed.

## Status display

### Current status

The system status can be displayed on the Control Display, e.g., whether or not the system is active.

Via iDrive:

1. "CAR"
2. "Vehicle status"
3.  "Tire Pressure Monitor"

The current status is displayed.

## Current tire inflation pressure

The current tire inflation pressure is displayed for each tire.

The current tire inflation pressures may change during driving operation or depending on the external temperature.

## Current tire temperature

Depending on the model, the current tire temperatures are displayed.

The current tire temperatures may change while driving or due to the external temperature.

## Target pressure

The target pressure for the tires on the front and rear axles is displayed.

The target pressures are values stored in the vehicle.

The specified target pressures take the influence of driving operation and external temperature on the tire temperature into account. The appropriate target pressure is always displayed, independent of the weather situation, tire temperatures and driving times.

The displayed target pressure may change and may differ from the tire inflation pressure details on the door pillar of the driver's door. The tire inflation pressure can thus be corrected to the value of the displayed target pressures.

The target pressure is immediately adjusted if the vehicle load is changed in the tire settings.

## Tire conditions

### General information

Tire and system status are indicated by the color of the wheels and a SMS text message on the Control Display.

Any existing messages are not deleted if the displayed target pressure is not reached after the tire inflation pressure is corrected.

## All wheels green

- ▶ The system is active and bases warnings on the displayed target pressures.
- ▶ For tires with special approval: the system is active and bases warnings on the tire inflation pressures stored during the last reset.

## One to four yellow wheels

A flat tire or major drop in the tire inflation pressure has occurred in the indicated tires.

## Gray wheels

It may not be possible to identify tire inflation pressure losses.

Possible causes:

- ▶ Malfunction.
- ▶ During tire inflation pressure measurement, after confirmation of the tire settings.
- ▶ For tires with special approval: the system is being reset.

## For tires with special approval: perform a reset

Via iDrive:

1. "CAR"
2. "Vehicle status"
3. "Tire Pressure Monitor"
4. Switch on drive-ready state and do not drive off.
5. Reset tire inflation pressure: "Perform reset".
6. Drive away.

The wheels are displayed in gray and the following is displayed "Resetting Tire Pressure Monitor...".

After driving faster than 19 mph/30 km/h for a short period, the set tire inflation pressures are accepted as the target tire inflation pressures. The reset is completed automatically while driving.

After a successfully completed reset, the wheels on the Control Display are shown in green and

the following is displayed: "Tire Pressure Monitor active. See label for recommended pressure."

You may interrupt this trip at any time. When you continue the reset resumes automatically.

## Messages: for tires without special approval

### General information

A low tire inflation pressure may cause the DSC Dynamic Stability Control to be switched on.

### Safety information

#### WARNING

A damaged regular tire with low or missing tire inflation pressure impacts handling, such as steering and braking response. Run-flat tires can maintain limited stability. There is a risk of an accident. Do not continue driving if the vehicle is equipped with normal tires. Follow the information on run-flat tires and continued driving with these tires.

### If a tire inflation pressure check is required

#### Message

A symbol with a Check Control message appears on the Control Display.

#### Symbol Possible cause



Inflation was not carried out according to specifications, e.g., when the tire has not been sufficiently inflated or in the case of a natural steady tire pressure loss.

#### Measure

Check the tire pressure and correct as needed.

### If the tire inflation pressure is too low

#### Message



A yellow warning light is illuminated in the instrument cluster.

In addition, a symbol with a Check Control message appears on the Control Display.

#### Symbol Possible cause



There is a tire inflation pressure loss.

#### Measure

1. Reduce the vehicle speed. Do not exceed a speed of 80 mph/130 km/h.
2. At the next opportunity, for instance at a gas station, check the tire inflation pressure in all four tires and correct if necessary.

### If there is a significant loss of tire inflation pressure

#### Message



A yellow warning light is illuminated in the instrument cluster.

In addition, a symbol with the affected tire appears in a Check Control message on the Control Display.

#### Symbol Possible cause



There is a flat tire or a major loss in tire inflation pressure.

#### Measure

1. Reduce your speed and stop cautiously. Avoid sudden braking and steering maneuvers.
2. Check whether the vehicle is fitted with normal tires or run-flat tires.

Run-flat tires, refer to page 342, are labeled with a circular symbol containing the letters RSC marked on the tire's sidewall.

## Messages: for tires with special approval

### General information

A low tire inflation pressure may cause the DSC Dynamic Stability Control to be switched on.

### Safety information

#### WARNING

A damaged regular tire with low or missing tire inflation pressure impacts handling, such as steering and braking response. Run-flat tires can maintain limited stability. There is a risk of an accident. Do not continue driving if the vehicle is equipped with normal tires. Follow the information on run-flat tires and continued driving with these tires.

### If a tire inflation pressure check is required

#### Message

A symbol with a Check Control message appears on the Control Display.

#### Symbol Possible cause



Inflation was not carried out according to specifications, e.g., the tire has not been sufficiently inflated.

The system has detected a wheel change, but no reset was done.

The tire inflation pressure has fallen below the level of the last reset.

No reset was performed for the system. The system issues a warning based on the tire inflation pressures stored during the last reset.

#### Measure

1. Check the tire pressure and correct as needed.
2. Perform a system reset.

### If the tire inflation pressure is too low

#### Message



A yellow warning light is illuminated in the instrument cluster.

In addition, a symbol with a Check Control message appears on the Control Display.

#### Symbol Possible cause



There is a tire inflation pressure loss. No reset was performed for the system. The system issues a warning based on the tire inflation pressures stored during the last reset.

#### Measure

1. Reduce the vehicle speed. Do not exceed a speed of 80 mph/130 km/h.
2. At the next opportunity, for instance at a gas station, check the tire inflation pressure in all four tires and correct if necessary.



3. Reset the system.

## If there is a significant loss of tire inflation pressure

### Message



A yellow warning light is illuminated in the instrument cluster.

In addition, a symbol with the affected tire appears in a Check Control message on the Control Display.

### Symbol Possible cause



There is a flat tire or a major loss in tire inflation pressure.

No reset was performed for the system. The system issues a warning based on the tire inflation pressures stored during the last reset.

### Measure

1. Reduce your speed and stop cautiously. Avoid sudden braking and steering maneuvers.
2. Check whether the vehicle is fitted with normal tires or run-flat tires.  
Run-flat tires, refer to page 342, are labeled with a circular symbol containing the letters RSC marked on the tire's sidewall.

## Actions in the event of a flat tire

### Normal tires

1. Identify the damaged tire.  
Check the tire inflation pressure in all four tires, for instance using the tire pressure gage of a flat tire kit.  
For tires with special approval: if the tire inflation pressure in all four tires is correct, the TPM may not have been reset. In this case, perform the reset.

If tire damage cannot be found, contact a dealer's service center or another qualified service center or repair shop.

2. Repair the flat tire, e.g., with a flat tire kit or by changing the wheel.

Use of sealant, for instance from the flat tire kit, may damage the TPM wheel electronics. Have the electronics replaced at the next opportunity.

## Run-flat tires

### Safety information

#### WARNING

Your vehicle handles differently with a run-flat with no or low inflation pressure; for instance, your lane stability when braking is reduced, braking distances are longer and the self-steering properties will change. There is a risk of an accident. Drive moderately and do not exceed a speed of 50 mph/80 km/h.

#### WARNING

Heavy trailers can start swinging when continuing to drive with a flat tire. There is a risk of accidents or risk of damage to property. Do not exceed a speed of 35 mph/60 km/h when driving with a trailer and a flat tire. Immediately brake in the case of swinging. Apply necessary steering corrections as carefully as possible.

### Maximum speed

You may continue driving with a damaged tire at speeds up to 50 mph/80 km/h.

### Continued driving with a flat tire

Follow the following when continuing to drive with a damaged tire:

1. Avoid sudden braking and steering maneuvers.
2. Do not exceed a speed of 50 mph/80 km/h.

3. Check the tire inflation pressure in all four tires at the next opportunity.

For tires with special approval: if the tire inflation pressure in all four tires is correct, the Tire Pressure Monitor may not have been reset. In this case, perform the reset.

### Possible driving range with a depressurized tire

The distance for which it may be possible to drive safely varies depending on how the vehicle is loaded and used, e.g., speed, road conditions, external temperature. The driving range may be less but may also be more if an economical driving style is used.

If the vehicle is loaded with an average weight and used under favorable conditions, the distance for which it may be safe to drive may be up to 50 miles/80 km.

### Vehicle handling with damaged tires

Vehicles driven with a damaged tire will handle differently, potentially leading to conditions such as the following:

- ▶ Greater likelihood of swerving off course.
- ▶ Longer braking distances.
- ▶ Changed self-steering properties.

Modify your driving style. Avoid abrupt steering maneuvers or driving over obstacles, for instance curbs or potholes.

### Final tire failure

Vibrations or loud noises while driving can indicate the final failure of a tire.

Reduce speed and stop; otherwise, pieces of the tire could come loose and cause an accident.

Do not continue driving. Contact a dealer's service center or another qualified service center or repair shop.

## System limits

### Temperature

The tire inflation pressure depends on the tire's temperature.

Driving or exposure to the sun will increase the tire's temperature, thus increasing the tire inflation pressure.

The tire inflation pressure is reduced when the tire temperature falls again.

These circumstances may cause a warning when temperatures fall very sharply.

Following a temperature-related warning, the target pressures are displayed on the Control Display again after a short distance.

### Sudden tire pressure loss

The system cannot indicate sudden serious tire damage caused by external circumstances.

### Failure to perform a reset

Tires with special approval: the system will not function correctly if a reset was not performed, for example a flat tire may be indicated although the tire inflation pressures are correct.

## Malfunction

### Message



The yellow warning light flashes and is then illuminated continuously. A Check Control message is displayed. It may not be possible to identify tire pressure losses.

### Measure

- ▶ A wheel without TPM wheel electronics, such as an emergency wheel, is mounted: have the wheels checked, if needed.
- ▶ Malfunction: have the system checked.
- ▶ Interference caused by systems or devices with the same radio frequency: after leaving

the area of the interference, the system automatically becomes active again.

- ▶ For tires with special approval: the system was unable to complete the reset. Perform a system reset again.

## Declaration according to NHTSA/ FMVSS 138 Tire Pressure Monitoring System

Each tire, including the spare (if provided) should be checked monthly when cold and inflated to the inflation pressure recommended by the vehicle manufacturer on the vehicle placard or tire inflation pressure label. (If your vehicle has tires of a different size than the size indicated on the vehicle placard or tire inflation pressure label, you should determine the proper tire inflation pressure for those tires.) As an added safety feature, your vehicle has been equipped with a tire pressure monitoring system (TPMS) that illuminates a low tire pressure telltale when one or more of your tires is significantly under-inflated. Accordingly, when the low tire pressure telltale illuminates, you should stop and check your tires as soon as possible, and inflate them to the proper pressure. Driving on a significantly under-inflated tire causes the tire to overheat and can lead to tire failure. Under-inflation also reduces fuel efficiency and tire tread life, and may affect the vehicle's handling and stopping ability. Please note that the TPMS is not a substitute for proper tire maintenance, and it is the driver's responsibility to maintain correct tire pressure, even if under-inflation has not reached the level to trigger illumination of the TPMS low tire pressure telltale. Your vehicle has also been equipped with a TPMS malfunction indicator to indicate when the system is not operating properly. The TPMS malfunction indicator is combined with the low tire pressure telltale. When the system detects a malfunction, the telltale will flash for approximately one minute and then remain continuously illuminated. This sequence will continue upon subsequent vehicle start-ups as long as the malfunction exists. When the malfunction indicator is illuminated, the system may not be able to de-

tect or signal low tire pressure as intended. TPMS malfunctions may occur for a variety of reasons, including the installation of replacement or alternate tires or wheels on the vehicle that prevent the TPMS from functioning properly. Always check the TPMS malfunction telltale after replacing one or more tires or wheels on your vehicle to ensure that the replacement or alternate tires and wheels allow the TPMS to continue to function properly.

## FTM Flat Tire Monitor

### Concept

The system detects tire inflation pressure loss on the basis of rotation speed differences between the individual wheels while driving.

In the event of a tire inflation pressure loss, the diameter and therefore the rotational speed of the corresponding wheel changes. The difference will be detected and reported as a flat tire.

The system does not measure the actual inflation pressure in the tires.

### Functional requirements

The following conditions must be met for the system; otherwise, reliable flagging of a loss of tire inflation pressure is not assured:

- ▶ After a tire or wheel replacement, an initialization was performed with the correct tire inflation pressure.
- ▶ After the tire pressure was adjusted to a new value, an initialization was performed.

### Status display

The current status of the flat tire monitor can be displayed, for instance whether the RPA is active.

Via iDrive:

1. "CAR"
2. "Vehicle status"
3.  "Flat Tire Monitor"

The status is displayed.

## Initialization required

An initialization must be performed in the following situations:

- ▶ After the tire inflation pressure has been adjusted.
- ▶ After a tire or wheel replacement.

## Performing initialization

When initializing, the set tire inflation pressures serve as reference values in order to detect a flat tire. Initialization is started by confirming the tire inflation pressures.

Do not initialize the system when driving with snow chains.

Via iDrive:

1. "CAR"
2. "Vehicle status"
3. "Flat Tire Monitor"
4. Switch on drive-ready state and do not drive off.
5. Start the initialization with: "Perform reset"
6. Drive away.

The initialization is completed while driving, which can be interrupted at any time.

The initialization automatically continues when driving resumes.

## Messages

### General information

When a flat tire is indicated, DSC Dynamic Stability Control is switched on, if needed.

## Safety information

### WARNING

A damaged regular tire with low or missing tire inflation pressure impacts handling, such as steering and braking response. Run-flat tires can maintain limited stability. There is a risk of an accident. Do not continue driving if the vehicle is equipped with normal tires. Follow the information on run-flat tires and continued driving with these tires.

### Indication of a flat tire



A yellow warning light is illuminated in the instrument cluster.

In addition, a symbol with a Check Control message appears on the Control Display.

Symbol	Possible cause
	There is a flat tire or a major loss in tire inflation pressure.

## Measure

1. Reduce your speed and stop cautiously. Avoid sudden braking and steering maneuvers.
2. Check whether the vehicle is fitted with normal tires or run-flat tires.

Run-flat tires, refer to page 342, are labeled with a circular symbol containing the letters RSC marked on the tire's sidewall.

## Actions in the event of a flat tire

### Normal tires

1. Identify the damaged tire.

To do this, check the tire inflation pressure in all four tires, for instance using the tire pressure gage of a flat tire kit.

If the tire inflation pressure in all four tires is correct, the Flat Tire Monitor may not have been initialized. In this case, initialize the system.

If identification of flat tire damage is not possible, please contact a dealer's service center or another qualified service center or repair shop.

2. Repair the flat tire, e.g., with a flat tire kit or by changing the wheel.

## Run-flat tires

### Safety information

#### **WARNING**

Your vehicle handles differently with a run-flat with no or low inflation pressure; for instance, your lane stability when braking is reduced, braking distances are longer and the self-steering properties will change. There is a risk of an accident. Drive moderately and do not exceed a speed of 50 mph/80 km/h.

#### **WARNING**

Heavy trailers can start swinging when continuing to drive with a flat tire. There is a risk of accidents or risk of damage to property. Do not exceed a speed of 35 mph/60 km/h when driving with a trailer and a flat tire. Immediately brake in the case of swinging. Apply necessary steering corrections as carefully as possible.

### Maximum speed

You may continue driving with a damaged tire at speeds up to 50 mph/80 km/h.

### Continued driving with a flat tire

Follow the following when continuing to drive with a damaged tire:

1. Avoid sudden braking and steering maneuvers.
2. Do not exceed a speed of 50 mph/80 km/h.
3. Check the tire inflation pressure in all four tires at the next opportunity.

If the tire inflation pressure in all four tires is correct, the Flat Tire Monitor may not have been initialized. In this case, initialize the system.

### Possible driving range with a depressurized tire

The distance for which it may be possible to drive safely varies depending on how the vehicle is loaded and used, e.g., speed, road conditions, external temperature. The driving range may be less but may also be more if an economical driving style is used.

If the vehicle is loaded with an average weight and used under favorable conditions, the distance for which it may be safe to drive may be up to 50 miles/80 km.

### Vehicle handling with damaged tires

Vehicles driven with a damaged tire will handle differently, potentially leading to conditions such as the following:

- ▷ Greater likelihood of swerving off course.
- ▷ Longer braking distances.
- ▷ Changed self-steering properties.

Modify your driving style. Avoid abrupt steering maneuvers or driving over obstacles, for instance curbs or potholes.

### Final tire failure

Vibrations or loud noises while driving can indicate the final failure of a tire.

Reduce speed and stop; otherwise, pieces of the tire could come loose and cause an accident.

Do not continue driving. Contact a dealer's service center or another qualified service center or repair shop.

## System limits

The system could be delayed or malfunction in the following situations:

- ▷ A natural, even tire inflation pressure loss in all four tires will not be recognized. Therefore, check the tire inflation pressure regularly.
- ▷ Sudden serious tire damage caused by external circumstances cannot be recognized in advance.
- ▷ When the system has not been initialized.
- ▷ When driving on a snowy or slippery road surface.
- ▷ Sporty driving style: spinning traction wheels, high lateral acceleration (drifting).
- ▷ When driving with snow chains.

## Changing wheels/tires

### General information

When using run-flat tires or a flat tire kit, a wheel does not always need to be changed immediately when there is a loss of tire inflation pressure due to a flat tire.

If needed, the tools for changing wheels are available as accessories from a dealer's service center or another qualified service center or repair shop.

### Safety information

#### DANGER

The vehicle jack is only provided for short-term lifting of the vehicle for wheel changes. Even if all safety measures are observed, there is a risk of the raised vehicle falling, if the vehicle jack tips over. There is a risk of injuries or danger to

life. If the vehicle is raised, do not lie under the vehicle and do not start the engine.

#### DANGER

Supports such as wooden blocks under the vehicle jack reduce the capacity of the vehicle jack to bear weight. They have the potential to exert too much strain on the vehicle jack, causing it to tip over and the vehicle to fall. There is a risk of injuries or danger to life. Do not place supports under the vehicle jack.

#### WARNING

The jack, issued by the vehicle manufacturer, is provided in order to perform a wheel change in the event of a breakdown. The jack is not designed for frequent use; for example, changing from summer to winter tires. Using the jack frequently may cause it to become jammed or damaged. There is a risk of injury and risk of damage to property. Only use the jack to attach an emergency or spare wheel in the event of a breakdown.

#### WARNING

On soft, uneven or slippery ground, for example snow, ice, tiles, etc., the vehicle jack can slip away. There is a risk of injury. If possible, change the wheel on a flat, solid, and slip-resistant surface.

#### WARNING

The vehicle jack is optimized for lifting the vehicle and for the jacking points on the vehicle only. There is a risk of injury. Do not lift any other vehicle or cargo using the vehicle jack.

**⚠ WARNING**

If the vehicle jack is not inserted into the jacking point provided for this purpose, the vehicle may be damaged or the vehicle jack may slip when it is being cranked up. There is a risk of injury or risk of damage to property. When cranking up the vehicle jack, ensure that it is inserted in the jacking point next to the wheel housing.

**⚠ WARNING**

A vehicle that is raised on a vehicle jack may fall off of the jack if lateral forces are exerted on it. There is a risk of injury and risk of damage to property. While the vehicle is raised, do not exert lateral forces on the vehicle or pull abruptly on the vehicle. Have a stuck wheel removed by a dealer's service center or another qualified service center or repair shop.

## Securing the vehicle against rolling

### General information

The vehicle manufacturer recommends to additionally secure the vehicle against rolling away when changing a wheel.

### On a level surface



Place wheel chocks or other suitable objects in front and behind the wheel that is diagonal to the wheel to be changed.

## On a slight downhill gradient



If you need to change a wheel on a slight downhill grade, place chocks and other suitable objects, for instance a rock, under the wheels of both the front and rear axles against the rolling direction.

## Lug bolt lock

### Concept

The wheel lug bolts have a special coding. The lug bolts can only be released with the adapter which matches the coding.

### Overview

The adapter of the lug bolt lock is in the onboard vehicle tool kit or in a storage compartment close to the onboard vehicle tool kit.

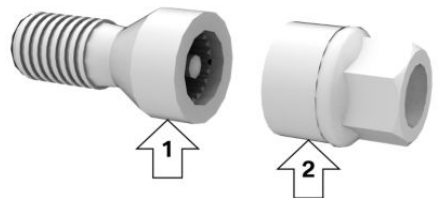

- ▷ Lug bolt, arrow 1.
- ▷ Adapter, arrow 2.

### Unscrewing

1. Attach the adapter to the lug bolt.
2. Unscrew the lug bolt.

3. Remove the adapter after unscrewing the lug bolt.

### Screwing on

1. Attach the adapter to the lug bolt. If necessary, turn the adapter until it fits on the lug bolt.
2. Screw on the lug bolt. The tightening torque is 140 Nm.
3. Remove the adapter and stow it after screwing on the lug bolt.

### Preparing the vehicle

- ▷ Park the vehicle on solid and non-slip ground at a safe distance from traffic.
- ▷ Switch on the hazard warning system.
- ▷ Set the parking brake.
- ▷ Engage a gear or move the selector lever to position P.
- ▷ As soon as permitted by the traffic flow, have all vehicle occupants get out of the vehicle and ensure that they remain outside the immediate area in a safe place, such as behind a guardrail.
- ▷ Depending on the vehicle equipment, get wheel change tools and, if necessary, the emergency wheel from the vehicle.
- ▷ If necessary, set up a warning triangle or portable hazard warning light at an appropriate distance.
- ▷ Secure the vehicle additionally against rolling.
- ▷ Loosen the lug bolts a half turn.
- ▷ Deactivate the air suspension level adjustment, refer to page 262.

### Jacking points for the vehicle jack

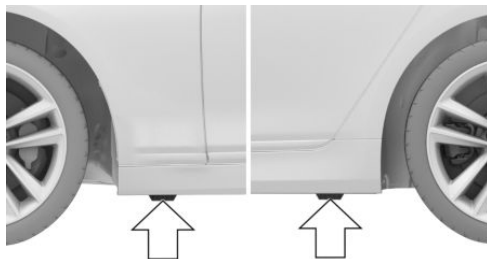

The jacking points for the vehicle jack are located at the indicated positions.



## Jacking up the vehicle

### WARNING

Hands and fingers can be jammed when using the vehicle jack. There is a risk of injury. Comply with the described hand position and do not change this position while using the vehicle jack.

1. Hold the vehicle jack with one hand, arrow 1, and grasp the vehicle jack crank or lever with your other hand, arrow 2.

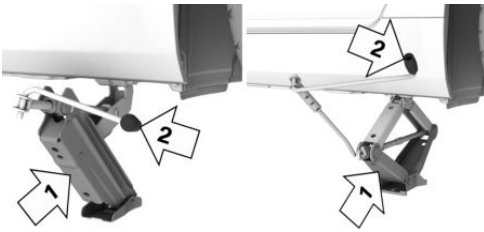

2. Insert the vehicle jack into the rectangular recess of the jacking point closest to the wheel to be changed.

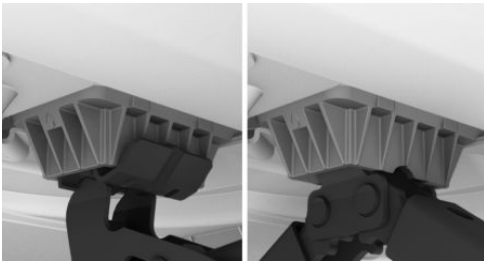

3. Extend the vehicle jack by turning the vehicle jack crank or lever clockwise.



4. Take your hand away from the vehicle jack as soon as the vehicle jack is under load and continue turning the vehicle jack crank or lever with one hand.
5. Make sure that the vehicle jack foot stands vertically and at a right angle beneath the jacking point.

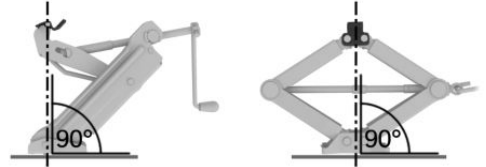

6. Make sure that the vehicle jack foot stands vertically and perpendicularly beneath the jacking point after extending the vehicle jack.

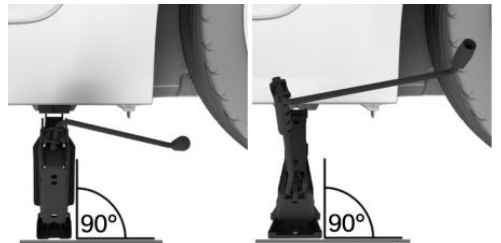

7. Crank the vehicle up, until the vehicle jack is with the entire surface on the ground and the relevant wheel is maximum 1.2 inches/3 cm above ground.

## Mounting a wheel

### WARNING

Unsuitable wheel studs, such as single-section wheel studs, may loosen or come off. The wheel may come loose during driving. There is a risk of an accident. Use only two-section wheel studs that have been categorized as suitable for the respective wheel type by the manufacturer of the vehicle.

Mount one emergency wheel only, as required.

1. Unscrew the lug bolts.
2. Remove the wheel.
3. Put the new wheel or emergency wheel on and screw in at least two lug bolts in a cross-wise pattern until hand-tight.  
If non-original light-alloy wheels of the vehicle manufacturer are mounted, the accompanying lug bolts may have to be used as well.
4. Hand-tighten the remaining lug bolts and tighten all lug bolts well in a crosswise pattern.
5. Turn the vehicle jack crank counterclockwise to retract the vehicle jack and lower the vehicle.
6. Remove the vehicle jack and stow it securely.

## After the wheel change

1. Tighten the lug bolts crosswise. The tightening torque is 101 lbs ft/140 Nm.
2. Stow the nonworking wheel in the cargo area, if necessary.  
The nonworking wheel cannot be stored under the cargo floor panel because of its size.
3. Check tire inflation pressure at the next opportunity and correct as needed.
4. Reinitialize the run-flat tires.  
Reset the Tire Pressure Monitor TPM.

5. Check to make sure the lug bolts are tight with a calibrated torque wrench.
6. Have the damaged tire replaced at the nearest dealer's service center or another qualified service center or repair shop.

## Emergency wheel

### Concept

In the event of a flat tire, the emergency wheel can be used in place of the wheel with the defective tire. The emergency wheel is only intended for temporary use until the defective tire/wheel has been replaced.

### General information

Mount one emergency wheel only.

Also check the tire inflation pressure of the emergency wheel in the cargo area regularly, and correct it as needed.

### Safety information

#### WARNING

The emergency wheel has particular dimensions. When driving with an emergency wheel, changed driving properties may occur, for instance reduced lane stability when braking, longer braking distance, and changed self-steering properties in the limit area. There is a risk of an accident. Drive moderately and do not exceed a speed of 50 mph/80 km/h.

## Overview

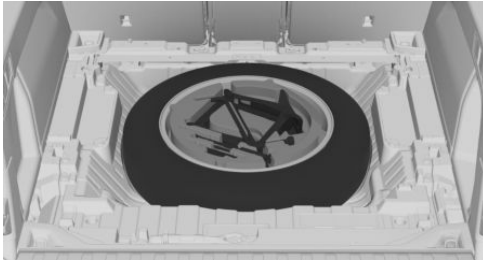

The emergency wheel and the wheel change tools are located in the cargo area under the cargo floor panel.

## Removing the emergency wheel

1.  Depending on the vehicle equipment: press the button. The electric cargo cover travels up.
2. Fold up the cargo floor panel.
3. Depending on the equipment version: remove the crossmember. For this purpose, remove the wingnuts on both sides of the crossmember.
4. Remove the tool holder from the emergency wheel.
5. Unscrew the butterfly screw, arrow 1.

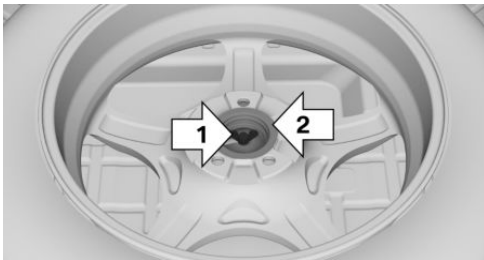

6. Remove retaining plate, arrow 2.
7. If necessary, open the lower tailgate.
8. Remove the emergency wheel from the storage well.

## Inserting the emergency wheel

1.  Depending on the vehicle equipment: press the button. The electric cargo cover travels up.
2. Fold up the cargo floor panel.
3. Open the lower tailgate.
4. Place the emergency wheel in the storage well.
5. Position the retaining plate.
6. Screw on and tighten the butterfly screw.
7. Insert the tool holder.
8. Depending on the vehicle equipment: insert the crossmember and screw it tight with the wingnuts.
9. Push the cargo floor panel downward.

# Engine compartment

## Vehicle features and options

This chapter describes all standard, country-specific and optional features offered with the series. It also describes features and functions that are

not necessarily available in your vehicle, e.g., due to the selected options or country versions. This also applies to safety-related functions and systems. When using these functions and systems, the applicable laws and regulations must be observed.

## Overview

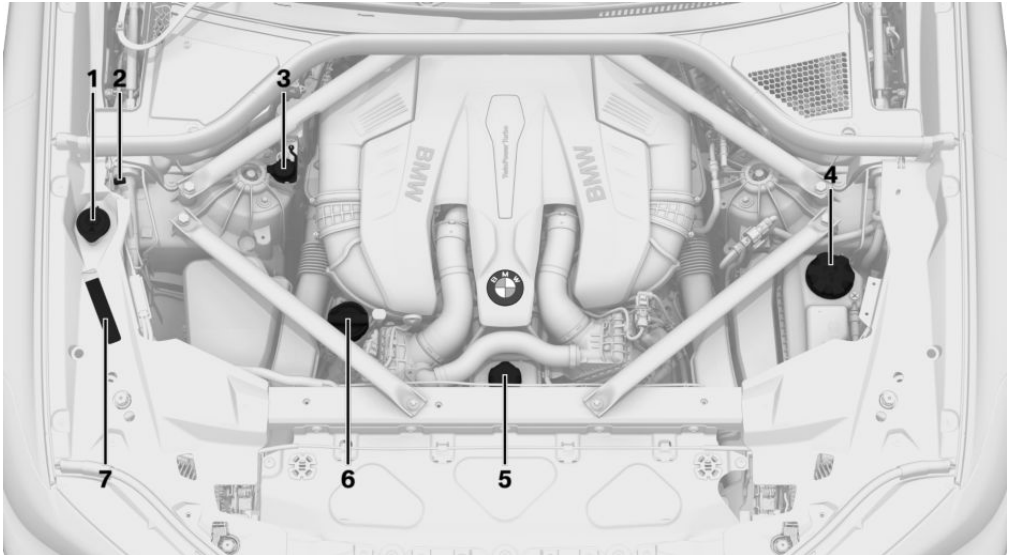

- |                                                                                                                                                                                                                               |                                                                                                                                                                                    |
|-------------------------------------------------------------------------------------------------------------------------------------------------------------------------------------------------------------------------------|------------------------------------------------------------------------------------------------------------------------------------------------------------------------------------|
| <ul style="list-style-type: none"> <li>1 Filler neck for washer fluid</li> <li>2 Jump-starting, negative battery terminal</li> <li>3 Jump-starting, positive battery terminal</li> <li>4 Coolant reservoir, engine</li> </ul> | <ul style="list-style-type: none"> <li>5 Gasoline engine only: coolant reservoir, auxiliary cooling</li> <li>6 Oil filler neck</li> <li>7 Vehicle identification number</li> </ul> |
|-------------------------------------------------------------------------------------------------------------------------------------------------------------------------------------------------------------------------------|------------------------------------------------------------------------------------------------------------------------------------------------------------------------------------|

# Hood

## Safety information

### WARNING

Improperly executed work in the engine compartment can damage vehicle components and impair vehicle functions. There is a risk of personal and property damage. The manufacturer of your vehicle recommends that, in the effort to avoid such risks, work in the engine compartment be performed by a dealer's service center or another qualified service center or repair shop.

### WARNING

The engine compartment accommodates moving components. Certain components in the engine compartment can also move with the vehicle switched off, for instance the radiator fan. There is a risk of injury. Do not reach into the area of moving parts. Keep articles of clothing and hair away from moving parts.

### WARNING

There are protruding parts, for instance locking hook, on the inside of the hood. There is a risk of injury. If the hood is open, pay attention to protruding parts and keep clear of these areas.

### WARNING

An incorrectly locked hood can open while driving and restrict visibility. There is a risk of an accident. Stop immediately and correctly close the hood.

### WARNING

Body parts can be jammed when opening and closing the hood. There is a risk of injury. Make sure that the area of movement of the hood is clear during opening and closing.

### NOTICE

Folded-away wipers can be jammed when the hood is opened. There is a risk of damage to property. Make sure that the wipers with the wiper blades mounted are folded down onto the windshield before opening the hood.

### NOTICE

When the hood is closed, it must engage on both sides. Pressing again can damage the hood. There is a risk of damage to property. Open the hood again and then close it energetically. Avoid pressing again.

## Opening

1. Pull lever, arrow 1.  
Hood is unlocked.



2. After the lever is released, pull the lever again, arrow 2.  
Hood can be opened.
3. Be careful of protruding parts on the hood.

## Closing

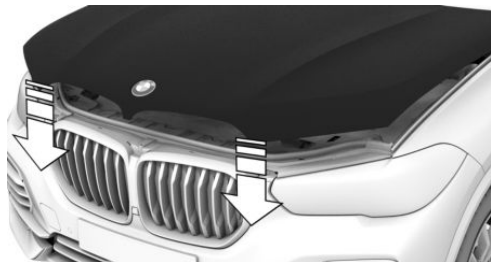

Energetically close the hood from approx.  
20 in/50 cm.

The hood must engage on both sides.

# Operating materials

## Vehicle features and options

This chapter describes all standard, country-specific and optional features offered with the series. It also describes features and functions that are not necessarily available in your vehicle, e.g., due to the selected options or country versions. This also applies to safety-related functions and systems. When using these functions and systems, the applicable laws and regulations must be observed.

## Fuel recommendation

### General information

Depending on the region, many gas stations sell fuel that has been customized to winter or summer conditions. Fuel that is available in winter, for instance helps make a cold start easier.

### Gasoline

#### General information

For the best fuel efficiency, the gasoline should be sulfur-free or very low in sulfur content.

Fuels that are marked on the gas pump as containing metal must not be used.

Fuels with a maximum ethanol content of 10 %, i. e., E10, may be used for refueling.

Ethanol should meet the following quality standards:

US: ASTM 4806–xx

CAN: CGSB-3.511–xx

xx: comply with the current standard in each case.

## Safety information

### CAUTION

The use of poor-quality fuels may result in harmful engine deposits or damage. Additionally, problems relating to drivability, starting and stalling, especially under certain environmental conditions such as high ambient temperature and high altitude, may occur.

If drivability problems are encountered, we recommend switching to a high quality gasoline brand and a higher octane grade — AKI number — for a few tank fills. To avoid harmful engine deposits, it is highly recommended to purchase gasoline from Top Tier retailers.

Failure to comply with these recommendations may result in the need for unscheduled maintenance.

### NOTICE

Even small quantities of the wrong fuel or wrong fuel additives can damage the fuel system and engine. Furthermore, the catalytic converter is permanently damaged. There is a risk of damage to property. Do not refuel or add the following in the case of gasoline engines:

- ▷ Leaded gasoline.
- ▷ Metallic additives, for instance manganese or iron.

Do not press the Start/Stop button after refueling with the wrong fuel. Contact a dealer's service center or another qualified service center or repair shop.

**NOTICE**

Incorrect fuels can damage the fuel system and the engine. There is a risk of damage to property. Do not use fuels with a higher percentage of ethanol than recommended. Do not refuel with fuels containing methanol, e.g. M5 to M100.

**NOTICE**

Fuel that does not comply with the minimum quality can compromise engine function or cause engine damage. There is a risk of damage to property. Do not fill with fuel that does not comply with the minimum quality.

**Recommended fuel grade**

BMW recommends AKI 91.

**Minimum fuel grade**

BMW recommends AKI 89.

If you use gasoline with this minimum AKI Rating, the engine may produce knocking sounds when starting at high external temperatures. This has no effect on the engine life.

**BMW recommends**  
**Shell Quality Fuels** 

**Engine oil****General information**

The engine oil consumption is dependent on your driving style and driving conditions.

Therefore, regularly check the engine oil level after refueling by taking a detailed measurement.

The engine oil consumption can increase in the following situations, for example:

- ▷ Sporty driving style.
- ▷ Break-in of the engine.
- ▷ Idling of the engine.
- ▷ With use of engine oil types that are classified as not suitable.

Different Check Control messages appear on the Control Display depending on the engine oil level.

**Safety information****NOTICE**

An engine oil level that is too low causes engine damage. There is a risk of damage to property. Immediately add engine oil.

**NOTICE**

Too much engine oil can damage the engine or the catalytic converter. There is a risk of damage to property. Do not add too much engine oil. When too much engine oil is added, have the engine oil level corrected by a dealer's service center or another qualified service center or repair shop.

**Electronic oil measurement****General information**

The electronic oil measurement has two measuring principles:

- ▷ Monitoring.
- ▷ Detailed measurement.

When making frequent short-distance trips or using a dynamic driving style, for instance when taking curves aggressively, regularly perform a detailed measurement.



## Monitoring

### Concept

The engine oil level is monitored electronically while driving and can be shown on the Control Display.

If the engine oil level is outside its permissible operating range, a Check Control message is displayed.



A red indicator light indicates that the engine oil pressure is too low.

### Functional requirements

A current measured value is available after approx. 30 minutes of normal driving.

### Displaying the engine oil level

Via iDrive:

1. "CAR"
2. "Vehicle status"
3.  "Engine oil level"

The engine oil level is displayed.

### System limits

When making frequent short-distance trips or using a dynamic driving style, it may not be possible to calculate a measured value. In this case, the measured value for the last, sufficiently long trip is displayed.

## Detailed measurement

### Concept

The engine oil level is checked when the vehicle is stationary and displayed via a scale.

If the engine oil level is outside its permissible operating range, a Check Control message is displayed.

### General information

During the measurement, the idle speed is increased somewhat.

### Functional requirements

- ▷ Vehicle is parked in a horizontal position.
- ▷ Selector lever in selector lever position N or P and accelerator pedal not depressed.
- ▷ Engine is running and is at operating temperature.

### Performing a detailed measurement

Via iDrive:

1. "CAR"
2. "Vehicle status"
3.  "Engine oil level"
4. "Engine oil measurement"
5. "Start measurement"

The engine oil level is checked and displayed via a scale.

## Adding engine oil

### General information

Only add engine oil when the message is displayed in the instrument cluster. The quantity to be added is indicated in the message shown on the Control Display.

Only add suitable types of engine oil, refer to page 370.

Safely park the vehicle and switch off drive-ready state before adding engine oil.

Take care not to add too much engine oil.

## Safety information

### WARNING

Operating materials, for instance oils, greases, coolants, fuels, can contain harmful ingredients. There is a risk of injuries or danger to life. Follow the instructions on the containers. Avoid the contact of articles of clothing, skin or eyes with operating materials. Do not refill operating

materials into different bottles. Store operating materials out of reach of children.

### **NOTICE**

An engine oil level that is too low causes engine damage. There is a risk of damage to property. Immediately add engine oil.

### **NOTICE**

Too much engine oil can damage the engine or the catalytic converter. There is a risk of damage to property. Do not add too much engine oil. When too much engine oil is added, have the engine oil level corrected by a dealer's service center or another qualified service center or repair shop.

## Overview

The oil filler neck is located in the engine compartment, refer to page 364.

## Adding engine oil

1. Open the hood, refer to page 365.
2. Open the lid counterclockwise.



3. Add engine oil.
4. Close the cap.

## Engine oil types to add

### General information

The engine oil quality is critical for the life of the engine.

Only add the types of engine oil which are listed.

### Safety information

#### **NOTICE**

Oil additives can damage the engine. There is a risk of damage to property. Do not use oil additives.

#### **NOTICE**

Incorrect engine oil can cause malfunctions in the engine or damage it. There is a risk of damage to property. When selecting an engine oil, make sure that the engine oil has the correct oil rating.

## Suitable engine oil types

Add engine oils that meet the following oil rating standards:

### Gasoline engine

BMW Longlife-01 FE.

BMW Longlife-14 FE+.

BMW Longlife-17 FE+.

The BMW Longlife-14 FE+ and BMW Longlife-17 FE+ oil ratings are not suitable for the 50i gasoline engine.

## Alternative engine oil types

If an engine oil suitable for continuous use is not available, up to 1 US quart/liter of an engine oil with the following oil rating can be added:

**Oil rating**

API SL.

API SM.

API SN.

**Viscosity grades****Viscosity grades**

SAE 0W-20.

SAE 0W-30.

Viscosity grade SAE 0W-20 is not suitable for the 50i gasoline engine.

More information about suitable oil ratings and viscosity grades of engine oils can be requested from a dealer's service center or another qualified service center or repair shop.

**Engine oil change**** NOTICE**

Engine oil that is not changed in timely fashion can cause increased engine wear and thus engine damage. There is a risk of damage to property. Do not exceed the service data indicated in the vehicle.

The vehicle manufacturer recommends that you have a dealer's service center or another qualified service center or repair shop change the engine oil.

**BMW recommends  
Original BMW Engine Oil.**

**Coolant****General information**

Coolant consists of water and additives.

Not all commercially available additives are suitable for the vehicle. Information about suitable additives is available from a dealer's service center or another qualified service center or repair shop.

**Safety information**** WARNING**

With the engine hot and the cooling system open, coolant can escape and lead to scalding. There is a risk of injury. Only open the cooling system with the engine cooled down.

** WARNING**

Additives are harmful and incorrect additives can damage the engine. There is a risk of injury and risk of damage to property. Do not allow additives to come into contact with skin, eyes or articles of clothing. Use suitable additives only.

**Coolant level****General information**

Vehicles with gasoline engine feature two cooling circuits. Always check the coolant levels of both coolant reservoirs and refill as needed.

The coolant level is indicated using minimum and maximum markings in the filler neck of the coolant reservoir.

Depending on the engine installation, the coolant reservoir is located on the right side or the left side of the engine compartment, refer to page [364](#).

## Checking the coolant level

1. Let the engine cool.
2. Open the hood, refer to page 365.
3. Turn the lid of the coolant reservoir slightly counterclockwise to allow any excess pressure to dissipate, then open it.
4. Open the coolant reservoir lid.
5. The coolant level is correct if it lies between the minimum and maximum marks in the filler neck.

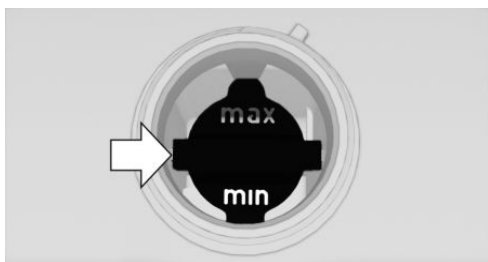

6. Close the cap.

## Adding

1. Let the engine cool.
2. Open the hood, refer to page 365.
3. Turn the lid of the coolant reservoir slightly counterclockwise to allow any excess pressure to dissipate, then open it.
4. Open the coolant reservoir lid.
5. If the coolant is low, slowly add coolant up to the specified level; do not overfill.
6. Close the cap.
7. Have the cause of the coolant loss eliminated as soon as possible.

## Disposal



Comply with the relevant environmental protection regulations when disposing of coolant and coolant additives.

## Washer fluid

### General information

All washer nozzles are supplied from one reservoir.

Use a mixture of tap water and windshield washer concentrate. If desired, a windshield washer concentrate containing antifreeze can be used.

Recommended minimum fill quantity:  
0.2 US gal/1 liter.

### Safety information

#### WARNING

Some antifreeze agents can contain harmful substances and are flammable. There is a risk of fire and a risk of injury. Follow the instructions on the containers. Keep antifreeze away from ignition sources. Do not refill operating materials into different bottles. Store operating materials out of reach of children.

United States: the washer fluid mixture ratio is regulated by the U.S. EPA and many individual states; do not exceed the allowable washer fluid dilution ratio limits that apply. Follow the usage instructions on the washer fluid container.

Use of BMW's Windshield Washer Concentrate or the equivalent is recommended.

#### WARNING

Washer fluid can ignite and catch fire on contact with hot engine parts. There is a risk of injury or risk of damage to property. Only add washer fluid when the engine is cooled down. Next, fully close the lid of the washer fluid reservoir.

**⚠ NOTICE**

Silicon-containing additives in the washer fluid for the water-repelling effect on the windows can lead to damage to the washing system. There is a risk of damage to property. Do not add silicon-containing additives to the washer fluid.

**⚠ NOTICE**

Mixing different windshield washer concentrates or antifreeze can damage the washing system. There is a risk of damage to property. Do not mix different windshield washer concentrates or antifreeze. Follow the information and mixing ratios provided on the containers.

## Overview



The washer fluid reservoir is located in the engine compartment.

## Malfunction

The use of undiluted windshield washer concentrate or alcohol-based antifreeze can lead to incorrect readings at temperatures below +5 °F/-15 °C.

# Maintenance

## Vehicle features and options

---

This chapter describes all standard, country-specific and optional features offered with the series. It also describes features and functions that are not necessarily available in your vehicle, e.g., due to the selected options or country versions. This also applies to safety-related functions and systems. When using these functions and systems, the applicable laws and regulations must be observed.

## BMW maintenance system

---

The maintenance system indicates required maintenance measures, and thereby provides support in maintaining road safety and the operational reliability of the vehicle.

In some cases, scopes and intervals of the maintenance system may vary according to the country version. Replacement work, spare parts, fuels and lubricants, and wear materials are calculated separately. Further information is available from a dealer's service center or another qualified service center or repair shop.

## Condition Based Service CBS

---

### Concept

Sensors and special algorithms take into account the driving conditions of the vehicle. CBS uses these to calculate the need for maintenance.

The system makes it possible to adapt the amount of maintenance corresponding to your user profile.

### General information

Information on service requirements, refer to page 159, can be displayed on the Control Display.

### Service data in the remote control

Information on the required maintenance is continuously stored in the remote control. The dealer's service center can read this data out and suggest a maintenance scope for the vehicle.

Therefore, hand the service advisor the remote control with which the vehicle was driven most recently.

### Storage periods

Storage periods during which the vehicle battery was disconnected are not taken into account.

If this occurs, have a dealer's service center or another qualified service center or repair shop update the time-dependent maintenance procedures, such as checking brake fluid and, if necessary, changing the engine oil and the microfilter/activated-charcoal filter.

## Service and Warranty Information Booklet for US models and Warranty and Service Guide Booklet for Canadian models

---

Please consult your Service and Warranty Information Booklet for US models and Warranty and Service Guide Booklet for Canadian models for additional information on service requirements.

The manufacturer of your vehicle recommends that maintenance and repair be performed by a dealer's service center or another qualified serv-

ice center or repair shop. Records of regular maintenance and repair work should be retained.

## Socket for OBD Onboard Diagnosis

### General information

Devices connected to the OBD socket trigger the alarm system when the vehicle is locked. Remove any devices connected at the OBD socket before locking the vehicle.

### Safety information

#### NOTICE

The socket for Onboard Diagnosis is an intricate component intended to be used in conjunction with specialized equipment to check the vehicle's primary emissions system. Improper use of the socket for Onboard Diagnosis, or contact with the socket for Onboard Diagnosis for other than its intended purpose, can cause vehicle malfunctions and creates risks of personal and property damage. Given the foregoing, the manufacture of your vehicle strongly recommends that access to the socket for Onboard Diagnosis be limited to a dealer's service center or another qualified service center or repair shop or other persons that have the specialized training and equipment for purposes of properly utilizing the socket for Onboard Diagnosis.

### Position

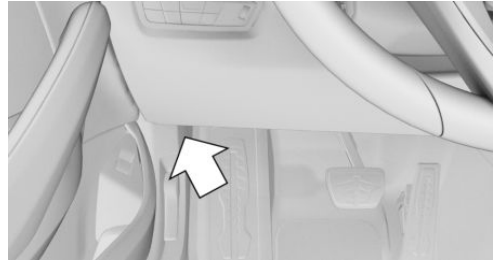

There is an OBD socket on the driver's side for checking the primary components in the vehicle's emissions.

### Emissions



- ▶ The warning light lights up:

Emissions are deteriorating. Have the vehicle checked as soon as possible.

- ▶ The warning light flashes under certain circumstances:

This indicates that there is excessive misfiring in the engine.

Reduce the vehicle speed and have the system checked immediately; otherwise, serious engine misfiring within a brief period can seriously damage emission control components, in particular the catalytic converter.

# Replacing components

## Vehicle features and options

This chapter describes all standard, country-specific and optional features offered with the series. It also describes features and functions that are not necessarily available in your vehicle, e.g., due to the selected options or country versions. This also applies to safety-related functions and systems. When using these functions and systems, the applicable laws and regulations must be observed.

## Onboard vehicle tool kit

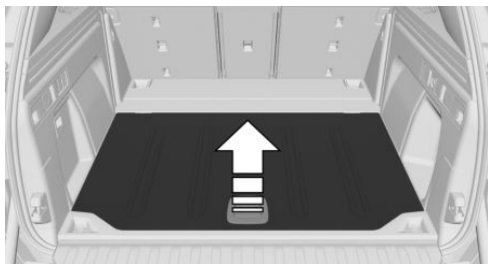

The onboard vehicle tool kit is located under the cargo floor panel.

## Wiper blades

### Safety information

#### **NOTICE**

The window may sustain damage if the wiper falls onto it without the wiper blade installed. There is a risk of damage to property. Hold the wiper firmly when changing the wiper blade. Do

not fold or switch on the wiper without a wiper blade installed.

#### **NOTICE**

Folded-away wipers can be jammed when the hood is opened. There is a risk of damage to property. Make sure that the wipers with the wiper blades mounted are folded down onto the windshield before opening the hood.

## Replacing the front wiper blades

1. To change the wiper blades, fold up the wiper arms, refer to page 142.
2. Lift the wiper all the way off of the windshield.



3. Press the button, arrow 1, and pull out the wiper blade, arrow 2.

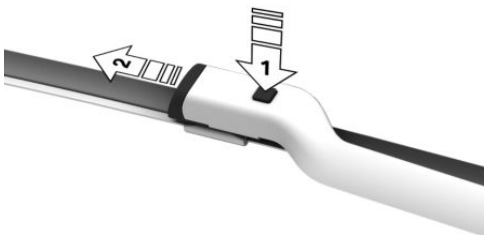

4. Insert the new wiper blade and press it on until you hear it snap into the holder.
5. Fold down the wipers.



## Replacing the rear wiper blade

The wiper blade is engaged at the end of the wiper arm.

1. Lift off the wiper fully and pull off the wiper blade, arrow.



2. Attach a new wiper blade. The wiper blade must engage audibly.
3. Fold down the wipers.

## Lights and bulbs

### General information

Lights and bulbs make an essential contribution to vehicle safety.

All headlights and lights are made using LED or laser technology.

Some items of equipment use light-emitting diodes installed behind a cover as a light source. These light-emitting diodes are related to conventional lasers and are officially designated as Class 1 light-emitting diodes.

The manufacturer of the vehicle recommends that you let a dealer's service center or another qualified service center or repair shop perform the work in case of a malfunction.

## Safety information

### WARNING

Focused laser light can irritate or permanently damage the retina of the eye. There is a risk of injury. The manufacturer of your vehicle recommends that the work on the lighting system including bulb replacement be performed by a dealer's service center or another qualified service center or repair shop.

### WARNING

Intensive brightness can irritate or damage the retina of the eye. There is a risk of injury. Do not look directly into the headlights or other light sources. Do not remove the LED covers.

## Headlight glass

Condensation can form on the inside of the headlight glass in cool or humid weather. When driving with the lights switched on, the condensation evaporates after a short time. The headlight glass does not need to be changed.

If despite driving with the headlights switched on, increasing humidity forms, for instance water droplets in the light, have the headlights checked.

## Vehicle battery

### General information

The battery is maintenance-free.

More information about the battery can be requested from a dealer's service center or another qualified service center or repair shop.

The manufacturer of your vehicle recommends that you have a dealer's service center or another qualified service center or repair shop register the vehicle battery to the vehicle after the battery has been replaced. Once the battery has been

registered again, all comfort features will be available without restriction and any Check Control messages displayed which relate to comfort features will disappear.

## Safety information

### WARNING

Vehicle batteries that are not compatible can damage vehicle systems and impair vehicle functions. There is a risk of personal and property damage. Only vehicle batteries that are compatible with your vehicle type should be installed in your vehicle. Information on compatible vehicle batteries is available at your dealer's service center.

## Charging the battery

### General information

Make sure that the battery is always sufficiently charged to guarantee that the battery remains usable for its full service life.



A discharged battery is indicated by a red indicator light.

The battery may need to be charged in the following cases:

- ▶ When making frequent short-distance drives.
- ▶ If the vehicle is not used for more than a month.

## Safety information

### NOTICE

Battery chargers for the vehicle battery can work with high voltages and currents, which means that the 12 volt on-board network can be overloaded or damaged. There is a risk of damage to property. Only connect battery chargers for the vehicle battery to the starting aid terminals in the engine compartment.

## Starting aid terminals

In the vehicle, only charge the battery via the starting aid terminals, refer to page 384, in the engine compartment with the engine off.

## Power failure

After a power loss, some equipment needs to be newly initialized or individual settings updated, for example:

- ▶ Memory function: store the positions again.
- ▶ Time: update.
- ▶ Date: update.
- ▶ Glass sunroof: initialize the system.

## Disposing of old batteries



Have old batteries disposed of by a dealer's service center or another qualified service center or repair shop or take

them to a collection point.

Maintain the battery in an upright position for transport and storage. Secure the battery so that it does not tip over during transport.

## Fuses

### Safety information

#### WARNING

Incorrect and repaired fuses can overload electrical lines and components. There is a risk of fire. Never attempt to repair a blown fuse. Do not replace a nonworking fuse with a substitute of another color or amperage rating.

## Accessing the fuses

The fuses are located in the cargo area on the right side behind a cover.

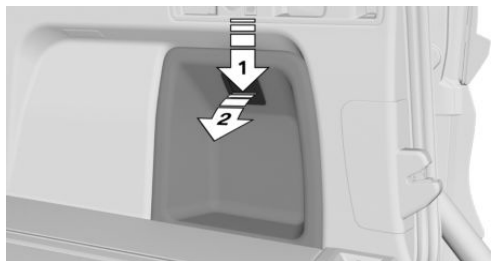

Press the button, arrow 1, and open the cover, arrow 2.

Information on the fuse types and locations, as well as the positions of any other fuse boxes, is found on a separate sheet in the fuse box.

## Replacing fuses

The vehicle manufacturer recommends that you have a dealer's service center or another qualified service center or repair shop replace the fuses.

# Breakdown assistance

## Vehicle features and options

This chapter describes all standard, country-specific and optional features offered with the series. It also describes features and functions that are not necessarily available in your vehicle, e.g., due to the selected options or country versions. This also applies to safety-related functions and systems. When using these functions and systems, the applicable laws and regulations must be observed.

## Hazard warning flashers



The button is located in the center console.

The red light in the button flashes when the hazard warning flashers are activated.

## Warning triangle

1. Unlock the cover of the left side panel, arrow 1, and fold open, arrow 2.

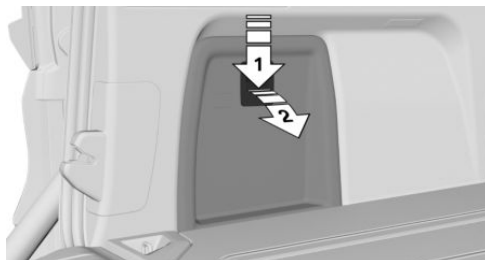

2. Take the warning triangle out in the direction of the car's interior.

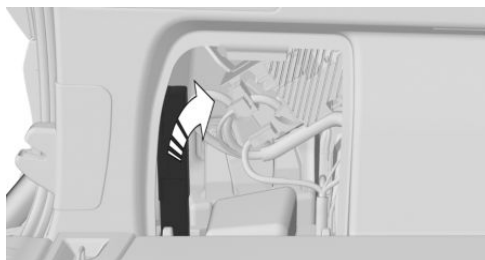

## First-aid kit

### General information

Some of the articles have a limited service life.

Check the expiration dates of the contents regularly and replace any expired items promptly.

## Storage

1. Unlock the cover of the left side panel, arrow 1, and fold open, arrow 2.

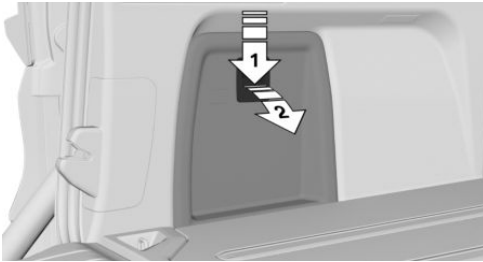

2. Remove the first-aid kit.



## BMW Roadside Assistance

### Concept

Contact the BMW Group Roadside Assistance if assistance is needed in the event of a breakdown.

### General information

In the event of a breakdown, data on the vehicle's condition is transmitted to the BMW Roadside Assistance.

BMW Roadside Assistance can also be contacted via a Check Control message, refer to page [154](#).

## Functional requirements

- ▶ Active ConnectedDrive contract, equipment version with Intelligent emergency call or BMW ConnectedDrive services.
- ▶ Cellular network reception.
- ▶ Standby state is switched on.

## Starting Roadside Assistance

If the vehicle is equipped with Teleservices, support is offered through Teleservice Diagnosis.

Via iDrive:

1. "COM"
2. "BMW Assist"
3. If necessary, "BMW Roadside Assistance"  
A voice connection is established.

## Teleservice Diagnosis

Teleservice Diagnosis enables the wireless transmission of detailed vehicle data that is important for vehicle diagnosis. This data is transmitted automatically.

## Starting Teleservice Help

Depending on the country, Teleservice Help enables an in-depth diagnosis of the vehicle by BMW Roadside Assistance via wireless transmission.

You can launch Teleservice Help by requesting it through BMW Roadside Assistance.

1. Park the vehicle in a safe place.
2. Set the parking brake.
3. Control Display is switched on.
4. "Start TeleService Call"

## BMW Accident Assistance

### Concept

BMW Group Accident Assistance can be contacted if assistance is needed in the event of an accident.

### General information

If the vehicle sensors detect a minor to moderately severe accident, which did not trigger any airbags, a Check Control message appears on the instrument cluster. In addition, a text message appears on the Control Display.

When BMW Accident Assistance is activated, data on the vehicle's condition is sent to BMW.

### Functional requirements

- ▷ Active ConnectedDrive contract, equipment version with Intelligent emergency call or BMW ConnectedDrive services.
- ▷ Cellular network reception.
- ▷ Standby state is switched on.

## Starting BMW Accident Assistance

### If an accident is detected automatically

A text message relating to BMW Accident Assistance appears on the Control Display.

The connection can be established directly:

"Call BMW Accident Assistance"

The Check Control message for BMW Accident Assistance can also be called up from the stored Check Control messages, refer to page 154, for a certain length of time.

### Starting manually

BMW Accident Assistance can also be contacted independently of the automatic accident detection function.

Via iDrive:

1. "COM"
2. "BMW Assist"
3. "Call BMW Accident Assistance"

Follow the displays on the Control Display. A voice connection is established.

## Emergency Request

### Intelligent emergency call

#### Concept

In case of an emergency, an Emergency Request can be triggered automatically by the system or manually.

#### General information

Only press the SOS button in an emergency.

The Intelligent Assist system establishes a connection with the BMW Response Center.

For technical reasons, the Emergency Request cannot be guaranteed under unfavorable conditions.

### Overview



SOS button.

### Functional requirements

- ▷ Standby state is switched on.
- ▷ The Assist system is functional.

- ▶ If the vehicle is equipped with intelligent emergency call: the SIM card integrated in the vehicle has been activated.

## Automatic triggering

Under certain conditions, for instance if the airbags trigger, an Emergency Request is automatically initiated immediately after an accident of corresponding severity. Automatic Collision Notification is not affected by pressing the SOS button.

## Manual triggering

1. Touch the cover.
  2. Press and hold the SOS button until the LED in the area of the button illuminates green.
- ▶ The LED is illuminated green when an Emergency Request has been initiated.

If a cancel prompt appears on the Control Display, the Emergency Request can be aborted.

If the situation allows, wait in your vehicle until the voice connection has been established.

- ▶ The LED flashes green when a connection to the BMW Response Center has been established.

The BMW Response Center then makes contact with you and takes further steps to help you.

Even if you are unable to respond, the BMW Response Center can take further steps to help you under certain circumstances.

For this, data is transmitted to the BMW Response Center which serves to determine the necessary rescue measures. E.g., the current position of the vehicle, if it can be established.

Even if you can no longer hear the BMW Response Center through the loudspeakers, the BMW Response Center may still be able to hear you.

The BMW Response Center ends the Emergency Request.

## Jump-starting

### General information

If the battery is discharged, the engine can be started using the battery of another vehicle and two jumper cables. Only use jumper cables with fully insulated clamp handles.

### Safety information

#### **DANGER**

Contact with live components can lead to an electric shock. There is a risk of injuries or danger to life. Do not touch any components that are under voltage.

#### **WARNING**

If the jumper cables are connected in the incorrect order, sparking may occur. There is a risk of injury. Pay attention to the correct order during connection.

#### **NOTICE**

In the case of body contact between the two vehicles, a short circuit can occur during jump-starting. There is a risk of damage to property. Make sure that no body contact occurs.

### Preparation

1. Check whether the battery of the other vehicle has a voltage of 12 volts. The voltage information can be found on the battery.
2. Switch off the engine of the assisting vehicle.
3. Switch off any electronic systems/power consumers in both vehicles.

## Starting aid terminals

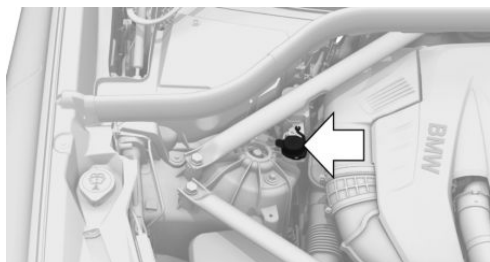

The starting aid terminal in the engine compartment acts as the battery's positive terminal.

Open the cover of the starting aid terminal.

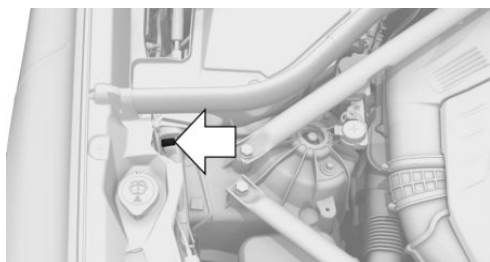

A special connection on the body acts as the battery negative terminal.

## Connecting the cables

Before you begin, switch off all unnecessary electronic systems/power consumers, such as the radio, on the assisting and receiving vehicle.

1. Open the cover of the starting aid terminal.
2. Attach one terminal clamp of the positive jumper cable to the positive terminal of the battery, or to the corresponding starting aid terminal of the vehicle providing assistance.
3. Attach the terminal clamp on the other end of the cable to the positive terminal of the battery, or to the corresponding starting aid terminal of the vehicle to be started.
4. Attach one terminal clamp of the negative jumper cable to the negative terminal of the

battery, or to the corresponding engine or body ground of assisting vehicle.

5. Attach the second terminal clamp to the negative terminal of the battery, or to the corresponding engine or body ground of the vehicle to be started.

## Starting the engine

Never use spray fluids to start the engine.

1. Start the engine of the assisting vehicle and let it run for several minutes at an increased idle speed.
2. Start the engine of the vehicle that is to be started in the usual way.

If the first starting attempt is not successful, wait a few minutes before making another attempt in order to allow the discharged battery to recharge.

3. Let both engines run for several minutes.
4. Disconnect the jumper cables in the reverse order.

Check the battery and recharge, if needed.

## Tow-starting and towing

### Safety information

#### WARNING

Due to system limits, individual functions can malfunction during tow-starting/towing with the Intelligent Safety systems activated. There is a risk of an accident. Switch all Intelligent Safety systems off prior to tow-starting/towing.

## Transporting the vehicle

### General information

The vehicle is not permitted to be towed.



## Safety information

### NOTICE

The vehicle can be damaged when towing the vehicle with a single lifted axle. There is a risk of damage to property. The vehicle should only be transported on a loading platform.

### NOTICE

The vehicle can become damaged when lifting and securing it.

There is a risk of damage to property.

- ▷ Lift the vehicle using suitable means.
- ▷ Do not lift or secure the vehicle by its tow fitting, body parts, or suspension parts.

## Pushing the vehicle

To remove a broken-down vehicle from the danger area, it can be pushed for a short distance.

Roll or push, refer to page 144, the vehicle.

## Tow truck

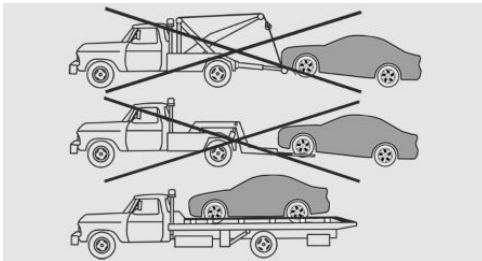

The vehicle should only be transported on a loading platform.

## Towing other vehicles

### General information

Switch on the hazard warning system, depending on local regulations.

If the electrical system has failed, clearly identify the vehicle being towed by placing a sign or a warning triangle in the rear window.

## Safety information

### WARNING

If the approved gross vehicle weight of the towing vehicle is lighter than the vehicle to be towed, the tow fitting can tear off or it will not be possible to control the vehicle's response. There is a risk of an accident. Make sure that the gross vehicle weight of the towing vehicle is heavier than the vehicle to be towed.

### NOTICE

If the tow bar or tow rope is attached incorrectly, damage to other vehicle parts can occur. There is a risk of damage to property. Correctly attach the tow bar or tow rope to the tow fitting.

## Tow bar

The tow fittings used should be on the same side on both vehicles.

Should it prove impossible to avoid mounting the tow bar at an offset angle, please follow the following:

- ▷ Maneuvering capability is limited going around corners.
- ▷ The tow bar will generate lateral forces if it is secured with an offset.

## Tow rope

When starting to tow the vehicle, make sure that the tow rope is taut.

Use nylon ropes or straps, which will enable the vehicle to be towed without jerking.

## Tow fitting

### General information



The screw-in tow fitting should always be carried in the vehicle.

The tow fitting can be screwed in at the front or rear of the vehicle.

The tow fitting is located beneath the cargo floor panel.

- ▶ Use only the tow fitting provided with the vehicle and screw it all the way in.
- ▶ Use the tow fitting for towing on paved roads only.
- ▶ Avoid lateral loading of the tow fitting, for instance do not lift the vehicle by the tow fitting.

### Safety information

#### NOTICE

If the tow fitting is not used as intended, there may be damage to the vehicle or to the tow fitting. There is a risk of damage to property. Follow the notes on using the tow fitting.

## Screw thread for tow fitting



Press on the mark on the edge of the cover to push it out.

For covers which have an opening instead of a marking, pull the cover out by the opening.

## Tow-starting

Do not tow-start the vehicle.

Start the engine by jump-starting, refer to page [383](#), if possible.

Have the reasons for the starting difficulties corrected by a dealer's service center or another qualified service center or repair shop.

# Care

## Vehicle features and options

This chapter describes all standard, country-specific and optional features offered with the series. It also describes features and functions that are not necessarily available in your vehicle, e.g., due to the selected options or country versions. This also applies to safety-related functions and systems. When using these functions and systems, the applicable laws and regulations must be observed.

## Washing the vehicle

### General information

Regularly remove foreign objects such as leaves in the area below the windshield when the hood is raised.

Wash your vehicle frequently, particularly in winter. Intense soiling and road salt can damage the vehicle.

### Steam blaster and high-pressure washer

#### Safety information

##### NOTICE

When cleaning with high-pressure washers, components can be damaged due to the pressure or temperatures being too high. There is a risk of damage to property. Maintain sufficient distance and do not spray too long continuously. Follow the operating instructions for the high-pressure washer.

### Distances and temperature

- ▶ Maximum temperature: 140 °F/60 °C.
- ▶ Minimum distance from sensors, cameras, seals: 12 in/30 cm.
- ▶ Minimum distance from glass sunroof: 31.5 in/80 cm.

### Automatic vehicle washes

#### Safety information

##### NOTICE

Improper use of automatic vehicle washes can cause damage to the vehicle. There is a risk of damage to property. Follow the following instructions:

- ▶ Give preference to cloth vehicle washes or those that use soft brushes in order to avoid paint damage.
- ▶ Before driving into the vehicle wash, make sure that the vehicle is not too large.
- ▶ Avoid vehicle washes with guide rails higher than 4 in/10 cm to avoid damage to the chassis.
- ▶ Observe the tire width of the guide rail to avoid damage to tires and rims.
- ▶ Fold in exterior mirrors to avoid damage to the exterior mirrors.
- ▶ Deactivate the wiper and, if necessary, rain sensor to avoid damage to the wiper system.

## Driving into a vehicle wash with a Steptronic transmission

### Safety information

#### NOTICE

Selector lever position P is automatically engaged when standby state is switched off. There is a risk of damage to property. Do not switch standby state off in vehicle washes.

### General information

In a vehicle wash, the vehicle must be able to roll freely.

Roll or push the vehicle, refer to page 144.

Some vehicle washes do not permit persons in the vehicle. The vehicle cannot be locked from the outside when in selector lever position N. A signal sounds when an attempt is made to lock the vehicle.

### Driving out of a vehicle wash

Make sure that the remote control is in the vehicle.

Switch on drive-ready state, refer to page 44.

### Headlights

Do not rub wet headlights dry and do not use abrasive or acidic cleaning agents.

Soak areas that have been dirtied, for instance from insects, with shampoo and wash off with water.

Thaw ice with de-icing spray; do not use an ice scraper.

### After washing the vehicle

After washing the vehicle, apply the brakes briefly to dry them; otherwise, braking action can be reduced. The heat generated during braking dries brake discs and brake pads and protects them against corrosion.

Completely remove all residues on the windows, to minimize loss of visibility due to smearing and to reduce wiper noises and wiper blade wear.

## Vehicle care

### Vehicle care products

#### General information

BMW recommends using vehicle care and cleaning products from BMW. Suitable care products are available from a dealer's service center or another qualified service center or repair shop.

### Safety information

#### WARNING

Cleansers can contain substances that are dangerous and harmful to your health. There is a risk of injury. When cleaning the interior, open the doors or windows. Only use products intended for cleaning vehicles. Follow the instructions on the container.

### Vehicle paint

#### General information

Regular care contributes to driving safety and value retention. Environmental influences in areas with elevated air pollution or natural contaminants, such as tree resin or pollen can affect the vehicle's paintwork. Tailor the frequency and extent of your vehicle care to these influences.

Aggressive substances such as spilled fuel, oil, grease or bird droppings, must be removed immediately to prevent the finish from being altered or discolored.

## Safety information

### WARNING

Improperly performed work on the vehicle paint can lead to a failure or malfunction of the radar sensors and thereby result in a safety risk.

There is a risk of accidents or risk of damage to property. Have paintwork or paintwork repairs on bumpers of vehicles with radar sensors performed by a dealer's service center or another qualified service center or repair shop only.

## Matte finish

Only use cleaning and care products suitable for vehicles with matte finish.

## Leather care

Remove dust from the leather regularly, using a cloth or vacuum cleaner.

Otherwise, particles of dust and road grime chafe in pores and folds, and lead to increased wear and premature degradation of the leather surface.

To guard against discoloration, such as from clothing, clean leather and provide leather care roughly every two months.

Clean light-colored leather more frequently because soiling on such surfaces is substantially more visible.

Use leather care products; otherwise, dirt and grease will gradually break down the protective layer of the leather surface.

## Upholstery material care

### General information

Vacuum the upholstery regularly with a vacuum cleaner.

If upholstery is very dirty, for instance with beverage stains, use a soft sponge or microfiber cloth with a suitable interior cleaner.

Clean the upholstery down to the seams using large sweeping motions. Avoid rubbing the material vigorously.

## Safety information

### NOTICE

Open Velcro® fasteners on articles of clothing can damage the seat covers. There is a risk of damage to property. Ensure that any Velcro® fasteners are closed.

## Caring for special components

### Light-alloy wheels

When cleaning the vehicle, use only neutral wheel cleaners having a pH value from 5 to 9. Do not use abrasive cleaning agents or steam jets above 140 °F/60 °C. Follow the manufacturer's instructions.

Aggressive, acidic or alkaline cleaning agents can destroy the protective layer of adjacent components, such as the brake disc.

After cleaning, apply the brakes briefly to dry them. The heat generated during braking dries brake discs and brake pads and protects them against corrosion.

### Chrome surfaces

Carefully clean Chrome surfaces, especially in case of exposure to road salt, with plenty of water and added cleanser as needed.

### Rubber components

Environmental influences can cause surface soiling of rubber parts and a loss of gloss. Use only water and suitable cleaning agents for cleaning.

Treat especially worn rubber parts with rubber care agents at regular intervals. When cleaning rubber seals, do not use any silicon-containing vehicle care products in order to avoid damage or noises.

## Fine wood parts

Clean fine wood facing and fine wood components only with a moist rag. Then dry with a soft cloth.

## Plastic components

### NOTICE

Cleaners that contain alcohol or solvents, such as lacquer thinners, heavy-duty grease removers, fuel, or such, can damage plastic parts. There is a risk of damage to property. Clean with a microfiber cloth. Dampen cloth lightly with water.

Plastic components are e.g.:

- ▷ Imitation leather surfaces.
- ▷ Roofliner.
- ▷ Light lenses.
- ▷ Matt black spray-coated components.
- ▷ Painted parts in the car's interior.

Clean with a microfiber cloth.

Dampen cloth lightly with water.

Do not soak the roofliner.

## Safety belts

### WARNING

Chemical cleansers can destroy the safety belt webbing. Missing protective effect of the safety belts. There is a risk of injuries or danger to life. Use only a mild soapy solution for cleaning the safety belts.

Dirty belt straps impede the reeling action and thus have a negative impact on safety.

Use only a mild soapy solution for cleaning the installed belt straps.

Safety belts should only be allowed to retract if they are dry.

## Carpets and floor mats

### WARNING

Objects in the driver's floor area can limit the pedal distance or block a depressed pedal. There is a risk of an accident. Stow objects in the vehicle such that they are secured and cannot enter into the driver's floor area. Use floor mats that are suitable for the vehicle and can be safely attached to the floor. Do not use loose floor mats and do not layer several floor mats. Make sure that there is sufficient clearance for the pedals. Ensure that the floor mats are securely fastened again after they were removed, for instance for cleaning.

The floor mats can be removed from the car's interior for cleaning.

If the floor carpets are very dirty, clean with a microfiber cloth and water or a textile cleaner. To prevent matting of the carpet, rub back and forth in the direction of travel only.

## Mount for trailer hitch

Keep the mount clean.

Regularly grease or oil bearings and sliding surfaces with resin-free greases or oils.

Before using steam cleaners or high pressure cleaners on the vehicle, remove the ball head and insert the cover into the mount.

## Sensor/camera lenses

To clean sensors and camera lenses, use a cloth moistened with a small amount of glass detergent.

## Displays, screens, and protective glass of the Head-up Display

### NOTICE

Chemical cleansers, moisture or fluids of any kind can damage the surface of displays and screens. There is a risk of damage to property. Clean with a clean, antistatic microfiber cloth.

### NOTICE

The surface of displays can be damaged with improper cleaning. There is a risk of damage to property. Avoid pressure that is too high and do not use any scratching materials.

Clean with a clean, antistatic microfiber cloth.

Clean the protective glass of the Head-up Display, refer to page 165, using a microfiber cloth and commercially available dish-washing soap.

## Long-term vehicle storage

When the vehicle is shut down for longer than three months, special measures must be taken. Further information is available from a dealer's service center or another qualified service center or repair shop.







## 🔍 REFERENCE

Technical data .....	394
Appendix .....	397
Everything from A to Z .....	398

# Technical data

## Vehicle features and options

This chapter describes all standard, country-specific and optional features offered with the series. It also describes features and functions that are

not necessarily available in your vehicle, e.g., due to the selected options or country versions. This also applies to safety-related functions and systems. When using these functions and systems, the applicable laws and regulations must be observed.

## General information

The technical data and specifications in the Owner's Manual are used as guidance values. The vehicle-specific data can deviate from this, for instance due to the selected special equipment, country version or country-specific meas-

urement method. Detailed values can be found in the approval documents, on labels on the vehicle or can be obtained from a dealer's service center or another qualified service center or repair shop.

## Dimensions

The dimensions can vary depending on the model version, equipment or country-specific measurement method.

The specified heights do not take into account attached parts, for instance a roof antenna, roof

racks or spoiler. The heights can deviate, for instance due to the selected special equipment, tires, load and chassis version.

### BMW X5

Width with mirrors	in/mm	87.3/2,218
Width without mirrors	in/mm	78.9/2,004
Height	in/mm	68.7-69/1,744-1,753
Length	in/mm	194.3/4,936
Wheelbase	in/mm	117.1/2,975
Smallest turning radius diam.	ft/m	41.3/12.6

## Weights

### X5 xDrive40i with two rows of seats

Approved gross vehicle weight	lbs/kg	6,162/2,795
Load	lbs/kg	849/385
Approved front axle load	lbs/kg	2,921/1,325
Approved rear axle load	lbs/kg	3,616/1,640
Approved roof load capacity	lbs/kg	220/100

### X5 xDrive40i with three rows of seats

Approved gross vehicle weight	lbs/kg	6,691/3,035
Load	lbs/kg	1,246/565
Approved front axle load	lbs/kg	2,943/1,335
Approved rear axle load	lbs/kg	3,858/1,750
Approved roof load capacity	lbs/kg	220/100

### X5 xDrive50i

Approved gross vehicle weight	lbs/kg	6,460/2,930
Load	lbs/kg	871/395
Approved front axle load	lbs/kg	3,175/1,440
Approved rear axle load	lbs/kg	3,737/1,695
Approved roof load capacity	lbs/kg	220/100

## Trailer towing

The trailer load only applies to vehicles with a factory-installed mount for trailer hitches.

### X5 xDrive40i with two rows of seats

Details about possible increases can be requested from a dealer's service center or another qualified service center or repair shop.

Without brakes	lbs/kg	1,653/750
----------------	--------	-----------

**X5 xDrive40i with two rows of seats**

With brakes on uphill grades of up to 12 %	lbs/kg	7,209/3,270
Maximum drawbar nose weight	lbs/kg	551/250
Approved rear axle load	lbs/kg	3,616/1,640
Approved gross vehicle weight	lbs/kg	6,162/2,795

**X5 xDrive40i with three rows of seats**

Details about possible increases can be requested from a dealer’s service center or another qualified service center or repair shop.

Without brakes	lbs/kg	1,653/750
With brakes on uphill grades of up to 12 %	lbs/kg	7,209/3,270
Maximum drawbar nose weight	lbs/kg	551/250
Approved rear axle load	lbs/kg	3,858/1,750
Approved gross vehicle weight	lbs/kg	6,691/3,035

**X5 xDrive50i**

Details about possible increases can be requested from a dealer’s service center or another qualified service center or repair shop.

Without brakes	lbs/kg	1,653/750
With brakes on uphill grades of up to 12 %	lbs/kg	7,209/3,270
Maximum drawbar nose weight	lbs/kg	551/250
Approved rear axle load	lbs/kg	3,737/1,695
Approved gross vehicle weight	lbs/kg	6,460/2,930

**Capacities**

**BMW X5**

Fuel tank, approx.	US gal/liters	21.9/83.0
--------------------	---------------	-----------

Observe further information on fuel quality, refer to page [367](#).

# Appendix

## General information

---

Any updates to the Owner's Manual of the vehicle are listed here.

## Updates made after the editorial deadline

---

These chapters of the printed Owner's Manual contain updates made after the editorial deadline.

- ▶ Quick Reference Guide: Buttons on the remote control, refer to page [20](#).
- ▶ General settings: Apple CarPlay preparation.
- ▶ Remote control: Overview, refer to page [77](#).
- ▶ BMW display key: Overview, refer to page [81](#).
- ▶ Tailgate: Lower tailgate.
- ▶ Displays: Trip data.
- ▶ Driving comfort: xOffroad package, refer to page [264](#).
- ▶ Enlarging the cargo area: Folding down the rear seat backrest electrically, refer to page [305](#).

# Everything from A to Z

## Index

### 0-9

2-axle air suspension [262](#)

### A

A/C button, see Air conditioning [271](#)

ABS, Antilock Brake System [213](#)

Acceleration Assistant, see Launch Control [147](#)

Accessories and parts [10](#)

Accident Assistance [382](#)

Accident prevention, see Active Protection [210](#)

ACC, see Active Cruise Control with Stop&Go function [223](#)

Activated charcoal filter [274](#)

Activating trailer towing [319](#)

Active Blind Spot Detection [201](#)

Active Cruise Control with Stop&Go function, ACC [223](#)

Active damping control, see Adaptive suspension [267](#)

Active Guard Plus, see Intelligent Safety [179](#)

Active Guard, see Intelligent Safety [179](#)

Active M sport differential [216](#)

Active PDC, see Emergency brake function [239](#)

Active Protection [210](#)

Active roll stabilization [267](#)

Active seat ventilation [126](#)

Active Sport suspension, see Adaptive M Suspension Professional [268](#)

Active Steering, integral [218](#)

Adaptive brake assistant [213](#)

Adaptive Light Control [171](#)

Adaptive M chassis [267](#)

Adaptive M suspension Professional [268](#)

ADAPTIVE, see Driving Dynamics Control [150](#)

Adaptive suspension [267](#)

Additives, engine oil types [370](#)

Adjustable speed limiter, see Manual speed limiter [219](#)

Airbags [176](#)

Airbags, indicator and warning light [178](#)

Air circulation, see Recirculated-air mode [272](#)

Air conditioning [271](#)

Air distribution, manual [273](#)

Air flow, automatic climate control [273](#)

Air outlets, see Ventilation [274](#)

Air pressure, tires [332](#)

Air suspension [262](#)

Alarm system [105](#)

Alarm, unintentional [106](#)

Alertness assistant [211](#)

All-season tires, see Winter tires [342](#)

All-wheel-drive, see xDrive [215](#)

Ambient air package [283](#)

Ambient light [174](#)

Animal detection, see Night Vision [194](#)

Antifreeze, see Washer fluid [372](#)

Antilock Brake System, ABS [213](#)

Anti-slip control, see DSC [213](#)

Anti-slip rails [302](#)

Anti-theft protection, see Lug bolt lock [359](#)

Apple CarPlay, connection to the vehicle [72](#)

Approach control warning with City light braking function [181](#)

Approach control warning with light braking function [181](#)

Approved axle load [395](#)

Apps, see Owner's Handbook for Navigation, Entertainment, Communication [8](#)

Armrest heating [125](#)

Ashtray [290](#)

Ashtray, front [290](#)

Assistance when driving off, see Drive-off assistant [213](#)

Assistance with breakdown [380](#)

ASSIST button, see Active Cruise Control [223](#)

ASSIST button, see Cruise control [221](#)

AUC Automatic Recirculating Air Control [272](#)

Audio, see Owner's Manual for Navigation, Entertainment and Communication [8](#)  
 AUTO H button, see Parking brake [136](#)  
 Automatic climate control [269](#)  
 Automatic cruise control with Stop&Go function [223](#)  
 Automatic Curb Monitor, exterior mirror [122](#)  
 Automatic deactivation, front-seat passenger airbags [178](#)  
 Automatic Differential Brake [216](#)  
 Automatic headlight control [168](#)  
 Automatic Hold, see Parking brake [136](#)  
 Automatic locking [103](#)  
 Automatic Recirculating Air Control AUC [272](#)  
 Automatic Soft Closing [97](#)  
 Automatic tailgate [95](#)  
 Automatic transmission, see Steptronic transmission [143](#)  
 Automatic unlocking [103](#)  
 Automatic vehicle wash [387](#)  
 AUTO program, automatic climate control [271](#)  
 AUTO program, intensity [272](#)  
 Auto Start/Stop function [133](#)  
 Axle loads, weights [395](#)

## B

Backrest curvature, see Lumbar support [113](#)  
 Backrest, seats [111](#)  
 Backrest tilt [112](#)  
 Backrest, width [113](#)  
 Bad road trips [312](#)  
 Bandages, see First-aid kit [380](#)  
 Bar for tow-starting/towing [385](#)  
 Basic position, rear seats [115](#)  
 Battery, changing, remote control of the vehicle [79](#)  
 Battery, disposing of [378](#)  
 Battery, vehicle [377](#)  
 Being towed, see Tow-starting and towing [384](#)  
 Belts, see Safety belts [117](#)  
 Beverage holder, see Cup holders [298](#)  
 Blocking, power window, see Safety switch [108](#)  
 Bluetooth connection [69](#)  
 Blu-ray, see Owner's Handbook for Navigation, Entertainment, Communication [8](#)

BMW Assist, see Owner's Manual for Navigation, Entertainment and Communication [8](#)  
 BMW Digital Key [91](#)  
 BMW display key [81](#)  
 BMW display key, malfunction [84](#)  
 BMW Gesture Control [57](#)  
 BMW maintenance system [374](#)  
 Bonus range, ECO PRO [324](#)  
 Bottle holder, see Cup holders [298](#)  
 Brake assistant [213](#)  
 Brake assistant, adaptive [213](#)  
 Brake Controller [320](#)  
 Brake discs, breaking in, see Brake system [312](#)  
 Brake pads, breaking in, see Brake system [312](#)  
 Brake system [312](#)  
 Braking, information [314](#)  
 Breakdown assistance [380](#), [381](#)  
 Breakdown, see FTM Flat Tire Monitor [355](#)  
 Break-in [312](#)  
 Break recommendation, see Alertness Assistant [211](#)  
 Brightness, Control Display [67](#)  
 Bulbs, replacing, see Lights and bulb [377](#)  
 Buttons on the steering wheel [38](#)  
 Button, SOS, see Intelligent emergency call [382](#)  
 Button, Start/Stop [133](#)  
 Bypassing, see Jump-starting [383](#)

## C

Cable for tow-starting/towing [385](#)  
 Calendar, see Owner's Handbook for Navigation, Entertainment, Communication [8](#)  
 California Proposition 65 Warning [11](#)  
 Camera-based assistance systems, see Intelligent Safety [179](#)  
 Camera-based cruise control, see Active Cruise Control with Stop&Go function [223](#)  
 Camera lenses, care [390](#)  
 Camera, rearview camera, without Surround View [242](#)  
 Camera, see Surround View [245](#)  
 Can holder, see Cup holders [298](#)  
 Care, Head-up Display [391](#)  
 Care of displays, screens [391](#)  
 Care, see Washing the vehicle [387](#)

- Care, vehicle [388](#)
- Cargo area [301](#)
- Cargo area, enlarging [304](#)
- Cargo area, loading, see Stowing and securing cargo [302](#)
- Cargo area, storage compartments [303](#)
- Cargo cover [306](#)
- Cargo cover electric [307](#)
- Cargo, stowing and securing [302](#)
- Cargo straps, see Lashing eyes in the cargo area [302](#)
- Carpet, care [390](#)
- CarPlay, connection to the vehicle [72](#)
- Car seats, see Transporting children safely [128](#)
- Cartridge replacement, see Ambient air package [283](#)
- Car wash [387](#)
- Car washing [387](#)
- Catalytic converter, see Hot exhaust gas system [313](#)
- CBS Condition Based Service [374](#)
- Cell phone, see Owner's Manual for Navigation, Entertainment and Communication [8](#)
- Center armrest [297](#)
- Center armrest, front [297](#)
- Center console [41](#)
- Central Information Display (CID), see Control Display [49](#)
- Central locking system [86](#)
- Central screen, see Control Display [49](#)
- Changes, technical, see For Your Own Safety [10](#)
- Changing parts [376](#)
- Changing wheels [358](#)
- Changing wheels/tires [341](#)
- Chassis number, see Vehicle identification number [15](#)
- Check Control [153](#)
- Checking the engine oil level electronically [368](#)
- Checking the oil level electronically [368](#)
- Children, seating position [128](#)
- Children, transporting safely [128](#)
- Child restraint system LATCH [130](#)
- Child restraint systems, mounting [129](#)
- Child restraint systems, see Transporting children safely [128](#)
- Child safety locks [132](#)
- Child seat, mounting [129](#)
- Child seats, see Transporting children safely [128](#)
- Chrome-plated surfaces, care [389](#)
- Chrome surfaces, care [389](#)
- Cigarette lighter [291](#)
- Cigarette lighter, front [291](#)
- Cigarette lighter, rear [291](#)
- Cleaning displays, screens [391](#)
- Cleaning, Head-up Display [391](#)
- Climate control [269](#)
- Clothes hooks [300](#)
- Coasting [325](#)
- Coasting with engine decoupled, see Coasting [325](#)
- Coasting with idling engine [325](#)
- Combination switch, see Turn signals [139](#)
- Combination switch, see Washer/wiper system [140](#)
- Comfort Access [87](#)
- COMFORT, see Driving Dynamics Control [148](#)
- Communication, see Owner's Manual for Navigation, Entertainment and Communication [8](#)
- Compact wheel, see Emergency wheel [362](#)
- Comparison of entries, see Entry comparison [47](#)
- Compartments in the doors [296](#)
- Compatible devices, see Suitable devices [69](#)
- Compressor [344](#)
- Concierge Service, see Owner's Handbook for Navigation, Entertainment, Communication [8](#)
- Condensation, removing from the windows [274](#)
- Condensation water under the parked vehicle [315](#)
- Condition Based Service CBS [374](#)
- Confirmation signal from the vehicle [103](#)
- ConnectedDrive, see Owner's Manual for Navigation, Entertainment and Communication [8](#)
- Connecting device [68](#)
- Connecting electrical devices, see Sockets [292](#)
- Connecting, mobile devices [68](#)
- Connecting mobile phone [68](#)
- Connecting smartphone [68](#)
- Connecting telephone [68](#)
- Connections, Screen Mirroring [73](#)
- Consumption display, ECO PRO [324](#)



- Consumption display, widget in the instrument cluster [153](#)
- Consumption, see Current consumption [153](#)
- Consumption, see Trip data [163](#)
- Contacts, see Owner's Handbook for Navigation, Entertainment, Communication [8](#)
- Container for washer fluid [372](#)
- Continued driving with a flat tire [353](#), [357](#)
- Control Display [49](#)
- Control Display, settings [63](#)
- Controller [49](#)
- Control systems, driving stability [213](#)
- Convenient closing with the remote control [78](#)
- Convenient opening with the remote control [77](#)
- Coolant [371](#)
- Coolant level [371](#)
- Coolant temperature [158](#)
- Cooling, maximum [271](#)
- Cooling system [371](#)
- Cornering light [171](#)
- Corrosion on brake discs [315](#)
- Cosmetic mirror [290](#)
- Cross-country mobility, see xOffroad package [264](#)
- Crossing traffic warning [259](#)
- Cruise control [221](#)
- Cruise control, active with Stop&Go function [223](#)
- Cruise control with distance control, see Active Cruise Control with Stop&Go function [223](#)
- Cruise control without distance control, see Cruise control [221](#)
- Cruising range [159](#)
- Cup holder [298](#)
- Cup holder, front [298](#)
- Cup holder, rear [299](#)
- Current consumption [153](#)
- D**
- Damage, tires [340](#)
- Damping control, active, see Adaptive suspension [267](#)
- Data memory [12](#)
- Data protection, settings [67](#)
- Data, see Deleting personal data in the vehicle [67](#)
- Data, technical [394](#)
- Date [64](#)
- Daytime running lights [170](#)
- DCC, see Cruise control [221](#)
- Defogging the windows [274](#)
- Defrosting the windows [274](#)
- Deleting personal data [67](#)
- Departure time, parked-car ventilation [279](#)
- Departure time, stationary climate control [282](#)
- Device list, displaying [74](#)
- Devices, managing [74](#)
- Diagnosis connection [375](#)
- Differential lock [216](#)
- Digital Key [91](#)
- Dimensions [394](#)
- Dimensions, see Technical data [394](#)
- Dimmable exterior mirrors [122](#)
- Dimmable interior mirror [123](#)
- Direct dial buttons, see Programmable memory buttons [48](#)
- Direction indicator, see Turn signals [139](#)
- Display in the windshield, see Head-up Display [165](#)
- Display key, malfunction [84](#)
- Display key, see BMW display key [81](#)
- Display lighting, see Instrument lighting [173](#)
- Displays [151](#)
- Displays and symbols [9](#)
- Displays, ECO PRO [324](#)
- Displays, screens [391](#)
- Disposal, coolant [372](#)
- Disposal, vehicle battery [378](#)
- Distance control, see PDC [237](#)
- Door handle lighting, see Welcome lights [170](#)
- Door lock, see Remote control [76](#)
- Door opening angle, Surround View [247](#)
- Downhill control, see HDC Hill Descent Control [216](#)
- Drawbar nose weight [395](#)
- Drink holder, third row of seats [300](#)
- Drive-off assistant [213](#)
- Drive-off assistant, see DSC [213](#)
- Driver activity, see Driver Attention Camera [66](#)
- Driver assistance, see Intelligent Safety [179](#)

Driver Attention Camera [66](#)  
 Drive-ready state, idle state, and standby state [43](#)  
 Drive-ready state, see Starting the engine [44](#)  
 Driver profiles [97](#)  
 Driver profiles, welcome screen [98](#)  
 Driving [133](#)  
 Driving Assistant, see Intelligent Safety [179](#)  
 Driving comfort [262](#), [267](#)  
 Driving Dynamics Control [148](#)  
 Driving instructions, break-in [312](#)  
 Driving mode, ECO PRO [322](#)  
 Driving mode, see Driving Dynamics Control [148](#)  
 Driving notes, general [313](#)  
 Driving on bad roads [312](#)  
 Driving on racetracks [316](#)  
 Driving stability control systems [213](#)  
 Driving style analysis, ECO PRO [326](#)  
 Driving tips [313](#)  
 Drying air, see Air conditioning [271](#)  
 DSC Dynamic Stability Control [213](#)  
 DTC Dynamic Traction Control [215](#)  
 DVD, Video, see Owner's Handbook for Navigation, Entertainment, Communication [8](#)  
 Dynamic damping, see Adaptive suspension [267](#)  
 Dynamic Stability Control DSC [213](#)  
 Dynamic Traction Control DTC [215](#)

## E

ECO PRO [322](#)  
 ECO PRO bonus range [324](#)  
 ECO PRO displays [324](#)  
 ECO PRO driving style analysis [326](#)  
 ECO PRO INDIVIDUAL, see Driving Dynamics Control [148](#)  
 ECO PRO, see Driving Dynamics Control [148](#)  
 Efficient4x4, see xDrive [215](#)  
 Electronic oil measurement [368](#)  
 Electronic Stability Program ESP, see DSC [213](#)  
 E-mail, see Owner's Handbook for Navigation, Entertainment, Communication [8](#)  
 Emergency brake [209](#)

Emergency brake function when parking, Active PDC [239](#)  
 Emergency service, see Accident Assistance [382](#)  
 Emergency service, see Breakdown assistance [381](#)  
 Emergency stop assistant [209](#)  
 Emergency unlocking, fuel filler flap [331](#)  
 Emergency unlocking, rear seat backrest [116](#)  
 Emergency unlocking, transmission lock [147](#)  
 Emergency wheel [362](#)  
 Energy recovery [153](#)  
 Energy savings, see Gear shift indicator [160](#)  
 Engine, automatic Start/Stop function [133](#)  
 Engine compartment [364](#)  
 Engine compartment, working in [365](#)  
 Engine coolant [371](#)  
 Engine idling when driving, see Coasting [325](#)  
 Engine oil, adding [369](#)  
 Engine oil change [371](#)  
 Engine oil filler neck [369](#)  
 Engine oil temperature [158](#)  
 Engine oil types to add [370](#)  
 Engine start, jump-starting [383](#)  
 Engine start, see Drive-ready state [44](#)  
 Engine stopping, see Drive-ready state [44](#)  
 Engine temperature [158](#)  
 Entering a destination, see Owner's Handbook for Navigation, Entertainment, Communication [8](#)  
 Entering an address, navigation, see Owner's Manual for Navigation, Entertainment and Communication [8](#)  
 Entertainment, see Owner's Manual for Navigation, Entertainment and Communication [8](#)  
 Entry comparison, navigation [47](#)  
 Equipment, interior [287](#)  
 Error indicators, see Check Control [153](#)  
 ESP Electronic Stability Program, see DSC [213](#)  
 Evasion assistance [185](#)  
 Exchanging wheels/tires [341](#)  
 Exhaust gas system [313](#)  
 Exhaustion warner [211](#)  
 Exhaust, see Exhaust gas system [313](#)  
 Exterior lighting during unlocking [77](#)  
 Exterior lighting with the vehicle locked [78](#)

Exterior mirror, Automatic Curb Monitor [122](#)  
 Exterior mirror, automatic dimming feature [122](#)  
 Exterior mirrors [121](#)  
 Exterior mirrors, malfunction [122](#)  
 External start [383](#)  
 External temperature [158](#)  
 Eyelet for towing [386](#)  
 Eyes, see Lashing eyes in the cargo area [302](#)

## F

Factory settings [75](#)  
 Failure message, see Check Control [153](#)  
 False alarm, see Avoiding unintentional alarms [106](#)  
 Fan, see Air flow [273](#)  
 Fastening safety belts, see Safety belts [117](#)  
 Fault indicators, see Check Control [153](#)  
 Filler neck for engine oil [369](#)  
 Finding charging stations, see Charging stations and points of interest, see Owner's Handbook for Navigation, Entertainment, Communication [8](#)  
 Fine wood parts, care [390](#)  
 First-aid kit [380](#)  
 Fittings for trailer safety chain, trailer towing [320](#)  
 Flat tire, changing wheels [358](#)  
 Flat tire, continued driving [353](#), [357](#)  
 Flat tire message, FTM [356](#)  
 Flat tire message, TPM [351](#)  
 Flat Tire Monitor FTM [355](#)  
 Flat tire, repairing [343](#)  
 Flat tire, see Tire Pressure Monitor TPM [348](#)  
 Flat tire warning light, FTM [356](#)  
 Flat tire warning light, TPM [351](#)  
 Flooding [314](#)  
 Floor carpet, care [390](#)  
 Floor mats, care [390](#)  
 Fog, removing from the windows [274](#)  
 Fold-away position of the wipers [142](#)  
 Fold back rear seat backrests [304](#)  
 Foot brake [314](#)  
 For Your Own Safety [10](#)  
 Fragrance cartridge, see Ambient air package [283](#)  
 Fragrance, see Ambient air package [283](#)

Fragrancing, see Ambient air package [283](#)  
 Front airbags [176](#)  
 Front fog light, replacing, see Lights and bulbs [377](#)  
 Front fog lights [173](#)  
 Front lights, replacing, see Lights and bulbs [377](#)  
 Front passenger seat, adjusting, see Gentleman function [114](#)  
 Front-seat passenger airbags, automatic deactivation [178](#)  
 Front-seat passenger airbags, indicator light [179](#)  
 Front seats [111](#)  
 FTM Flat Tire Monitor [355](#)  
 Fuel [367](#)  
 Fuel cap [330](#)  
 Fuel filler flap [330](#)  
 Fuel filler flap, unlocking manually [331](#)  
 Fuel gage [157](#)  
 Fuel quality [367](#)  
 Fuel recommendation [367](#)  
 Fuel, tank capacity [396](#)  
 Fuel, tank capacity, see Technical data [394](#)  
 Fuses [378](#)

## G

Garage door opener, see Integrated Universal Remote Control [287](#)  
 Gasoline [367](#)  
 Gear change, Steptronic transmission [143](#)  
 Gear shift indicator [160](#)  
 General driving notes [313](#)  
 General settings [63](#)  
 Gentleman function [114](#)  
 Gesture Control [57](#)  
 Gestures, see BMW Gesture Control [57](#)  
 Glare shield, see Sun visor [290](#)  
 Glass sunroof, electric [108](#)  
 Glass sunroof, initialize the system [110](#)  
 Glove compartment [295](#)  
 GPS geolocation, vehicle position [66](#)  
 GPS, navigation, see Owner's Handbook for Navigation, Entertainment, Communication [8](#)  
 Gross vehicle weight, approved [395](#)  
 Gross weight, permissible for trailer towing [395](#)  
 Ground clearance, see xOffroad package [264](#)

## H

Handbrake, see Parking brake [136](#)  
 Hand-held transmitter, alternating code [288](#)  
 Hands-free device, see Owner's Handbook for Navigation, Entertainment, Communication [8](#)  
 Hazard warning flashers [380](#)  
 HDC Hill Descent Control [216](#)  
 Head airbags [177](#)  
 Headlight control, automatic [168](#)  
 Headlight courtesy delay feature [170](#)  
 Headlight courtesy delay feature, switching on [79](#)  
 Headlight flasher [139](#)  
 Headlight glass [377](#)  
 Headlights, care [388](#)  
 Headlights, replacing, see Lights and bulbs [377](#)  
 Head restraint pillow [121](#)  
 Head restraints and seats [111](#)  
 Head restraints, front [119](#)  
 Head restraints, rear [120](#)  
 Head-up Display [165](#)  
 Head-up Display, care [391](#)  
 Head-up Display, see Memory function [124](#)  
 Head-up Display, standard view [165](#)  
 Heated steering wheel [124](#)  
 Heating, see Stationary climate control [280](#)  
 Heavy cargo, stowing cargo [302](#)  
 High-beam Assistant [171](#)  
 High beams [139](#)  
 High beams/low beams, see High-beam Assistant [171](#)  
 Hill Descent Control HDC [216](#)  
 Hills [315](#)  
 Hill start assistant, see Drive-off assistant [213](#)  
 Holder for beverages, see Cup holders [298](#)  
 HomeLink, see Integrated Universal Remote Control [287](#)  
 Homepage [8](#)  
 Hood [365](#)  
 Horn [38](#)  
 Hot exhaust gas system [313](#)  
 Hotline, see Owner's Handbook for Navigation, Entertainment, Communication [8](#)  
 Humidity in the headlight, see Headlight glass [377](#)

Hydroplaning [314](#)

## I

iBrake – PostCrash [211](#)  
 Ice warning, see External temperature [158](#)  
 Icy roads, see External temperature [158](#)  
 Identification marks, tires [338](#)  
 Identification number, see Vehicle identification number [15](#)  
 Idle state, standby state, and drive-ready state [43](#)  
 iDrive [46](#)  
 Ignition key, see Remote control [76](#)  
 Indicator/warning lights [155](#)  
 Individual air distribution [273](#)  
 Individual settings, see Driver profiles [97](#)  
 Inductive charging of a smartphone, see Wireless charging tray, see Owner's Manual for Navigation, Entertainment, Communication [8](#)  
 Inflation pressure monitor, see Tire Pressure Monitor TPM [348](#)  
 Inflation pressure, tires [332](#)  
 Inflation pressure warning FTM, tires [355](#)  
 Information [8](#)  
 Information window, Control Display [66](#)  
 Initialization, Flat Tire Monitor FTM [356](#)  
 Initialize, Tire Pressure Monitor TPM [350](#)  
 Instrument cluster [151](#)  
 Instrument lighting [173](#)  
 Integral Active Steering [218](#)  
 Integrated key [85](#)  
 Integrated Owner's Manual in the vehicle [16](#)  
 Integrated Universal Remote Control [287](#)  
 Intelligent Auto Start/Stop function [135](#)  
 Intelligent emergency call [382](#)  
 Intelligent Safety [179](#)  
 Intended use [10](#)  
 Intensity, AUTO program [272](#)  
 Interior camera, see Driver Attention Camera [66](#)  
 Interior equipment [287](#)  
 Interior lights [174](#)  
 Interior lights during unlocking [77](#)  
 Interior lights with the vehicle locked [78](#)  
 Interior mirror [121](#)  
 Interior mirror, automatic dimming feature [123](#)

Interior motion sensor [106](#)  
Internet connection [72](#)  
Internet page [8](#)  
Intersection warning with City light braking function [187](#)  
Interval display, see Service requirements [159](#)  
Ionization, see Ambient air package [283](#)

## J

Jacking points for the vehicle jack [360](#)  
Jam protection system, glass sunroof [110](#)  
Jam protection system, windows [107](#)  
Joystick, Steptronic transmission [143](#)  
Jump-starting [383](#)  
Jump-starting terminals [384](#)

## K

Keyless Go, see Comfort Access [87](#)  
Key, mechanical [85](#)  
Key, see BMW display key [81](#)  
Kickdown, Steptronic transmission [143](#)  
Knee airbag [177](#)

## L

Label on recommended tires [341](#)  
Lane control assistant, see Steering and lane control assistant [231](#)  
Lane control assistant with active side collision protection, see Side collision warning [205](#)  
Lane departure warning [198](#)  
Lane lines, Surround View [247](#)  
Lane threshold, warning [198](#)  
Language, set on Control Display [65](#)  
Laser headlights, replacing, see Lights and bulbs [377](#)  
Laser high beams [173](#)  
Lashing eyes in the cargo area [302](#)  
LATCH child restraint fixing system [130](#)  
Launch Control [147](#)  
Leather care [389](#)  
LED front fog light, replacing, see Lights and bulbs [377](#)

LED headlights, replacing, see Lights and bulbs [377](#)  
LED light carpet, see Welcome light [170](#)  
LEDs, light-emitting diodes, replacing, see Lights and bulbs [377](#)  
Letters and numbers, entering [51](#)  
Light-alloy wheels, care [389](#)  
Light control, adaptive [171](#)  
Light-emitting diodes, LEDs, replacing, see Lights and bulbs [377](#)  
Lighter, cigarettes [291](#)  
Lighting [168](#)  
Lighting, speakers [175](#)  
Light in the exterior mirror, see Active Blind Spot Detection [201](#)  
Light in the exterior mirror, see Crossing traffic warning [259](#)  
Light replacement, see Lights and bulbs [377](#)  
Lights [168](#)  
Lights and bulbs [377](#)  
Light switch [168](#)  
LIM button, see Manual Speed Limiter [219](#)  
List of all messages [63](#)  
Load [302](#)  
Loading [301](#)  
Location, vehicle position [66](#)  
Locking, automatic [103](#)  
Locking, see Opening and Closing [76](#)  
Locking, settings [103](#)  
Locking using the remote control [77](#)  
Lock, lug bolts [359](#)  
Locks, child safety [132](#)  
Low beams [169](#)  
Low beams, automatic, see High-beam Assistant [171](#)  
Lower back support [113](#)  
Lower tailgate [96](#)  
Lug bolt lock [359](#)  
Luggage rack, see Roof-mounted luggage rack [315](#)  
Lumbar support [113](#)

## M

Maintenance [374](#)

Maintenance requirements, see Condition Based Service CBS [374](#)

Maintenance, see Service requirements [159](#)

Maintenance system, BMW [374](#)

Make-up mirror [290](#)

Malfunction, BMW display key [84](#)

Malfunction, remote control [80](#)

Manual air distribution [273](#)

Manual air flow [273](#)

Manual brake, see Parking brake [136](#)

Manual mode, Steptronic transmission [143](#)

Manual operation, fuel filler flap [331](#)

Map update, see Owner's Handbook for Navigation, Entertainment, Communication [8](#)

Marking, run-flat tire [342](#)

Massage seat, front [125](#)

Master key, see Remote control [76](#)

Matte finish [389](#)

Maximum cooling [271](#)

Maximum speed display, see Speed Limit Info [160](#)

Maximum speed of winter tires [342](#)

M chassis, adaptive [267](#)

Measurement, units of [65](#)

Media of the Owner's Manual [16](#)

Medical supplies, see First-aid kit [380](#)

Memory function [124](#)

Menu, instrument cluster, see Selection lists [162](#)

Menus, operating, see iDrive [46](#)

Messages [63](#)

Messages, see Check Control [153](#)

Microfilter [274](#)

Minimum tread depth, tires [340](#)

Mirror [121](#)

Mirror, see Memory function [124](#)

Mobile communication devices in the vehicle [314](#)

Mobile devices, managing [74](#)

Mobile phone, see Owner's Manual for Navigation, Entertainment and Communication [8](#)

Mobility System [343](#)

MODE button, see Active Cruise Control [223](#)

MODE button, see Cruise control [221](#)

Mode, ECO PRO [322](#)

Modifications, technical, see For Your Own Safety [10](#)

Monitor, see Control Display [49](#)

Mount for trailer hitch, care [390](#)

Mounting for trailer hitch [319](#)

Mounting of child restraint systems [129](#)

MP3 player, see Audio, see Owner's Handbook for Navigation, Entertainment, Communication [8](#)

M sport differential, active [216](#)

Multi-function hook [303](#)

Multifunction steering wheel, buttons [38](#)

Multimedia, see Owner's Manual for Navigation, Entertainment and Communication [8](#)

Music hard disk, see Owner's Handbook for Navigation, Entertainment, Communication [8](#)

## N

Navigation, see Owner's Manual for Navigation, Entertainment and Communication [8](#)

Neck restraints, front, see Head restraints [119](#)

Neck restraints, rear, see Head restraints [120](#)

Net, cargo area [303](#)

Neutral cleaner, see Light-alloy wheels [389](#)

New wheels and tires [341](#)

Night Vision device, see Night Vision [194](#)

Night Vision with pedestrian and animal detection [194](#)

Nose weight, see Drawbar nose weight [395](#)

Notes, see Owner's Handbook for Navigation, Entertainment, Communication [8](#)

No-touch opening and closing of the tailgate [89](#)

Nylon rope for tow-starting/towing [385](#)

## O

OBD Onboard Diagnosis [375](#)

Object detection, see Night Vision [194](#)

Obstacle marking, rearview camera [243](#)

Obstacle marking, Surround View [247](#)

Octane rating, see Recommended fuel grade [368](#)

Oil, adding [369](#)

Oil change [371](#)

Oil change interval, see Service requirements [159](#)  
Oil filler neck [369](#)  
Oil types to add, engine [370](#)  
Onboard Computer, see Trip data [163](#)  
Onboard Diagnosis OBD [375](#)  
Onboard literature, printed [16](#)  
Onboard vehicle tool kit [376](#)  
On-call service, see Accident Assistance [382](#)  
On-call service, see Breakdown assistance [381](#)  
Online Entertainment, see Owner's Handbook for Navigation, Entertainment, Communication [8](#)  
Opening and closing [76](#)  
Operating concept, iDrive [46](#)  
Outside air, see AUC [272](#)  
Overheating of engine, see Coolant temperature [158](#)  
Overwintering, see Long-term vehicle storage [391](#)  
Owner's Manual, printed [16](#)

## P

Paint, vehicle [388](#)  
Pairing, mobile devices, see Connections [68](#)  
Panic alarm, see Panic mode [106](#)  
Panic mode [106](#)  
Panorama View, see Surround View [245](#)  
Panoramic glass sunroof, see Glass sunroof [108](#)  
Park Distance Control PDC [237](#)  
Parked-car ventilation [278](#)  
Parking aid, see PDC [237](#)  
Parking Assistant [252](#)  
Parking assistant Plus, see Surround View [245](#)  
Parking brake [136](#)  
Parking lights [169](#)  
Parking with Automatic Hold, see Parking brake [136](#)  
Parts and accessories [10](#)  
Passenger's side mirror, tilting, see Automatic Curb Monitor, exterior mirror [122](#)  
Pathway lines, rearview camera [243](#)  
PDC Park Distance Control [237](#)  
Pedestrian detection, see Night Vision [194](#)  
Performance Control [268](#)

Performance display, see Sport displays [164](#)  
Personal data, deleting [67](#)  
Personal profile, see Driver profiles [97](#)  
Person warning with braking function [191](#)  
Pillow for head restraints in the rear [121](#)  
Plastic parts, care [390](#)  
PostCrash – iBrake [211](#)  
Power failure [378](#)  
Power windows [107](#)  
Pressure monitor, see Tire Pressure Monitor TPM [348](#)  
Pressure, tires [332](#)  
Pressure warning FTM, tires [355](#)  
Printed onboard literature [16](#)  
Profiles, see Driver profiles [97](#)  
Programmable memory buttons, iDrive [48](#)  
Protective function, glass sunroof, see Jam protection system [110](#)  
Protective function, windows, see Jam protection system [107](#)  
Push-and-turn reel, see Controller [49](#)

## Q

Queuing Assistant, see Steering and lane control assistant [231](#)

## R

Racetrack operation [316](#)  
Radiator fluid [371](#)  
Radio-operated key, see Remote control [76](#)  
Radio, see Owner's Manual for Navigation, Entertainment and Communication [8](#)  
Rain sensor [141](#)  
Rear automatic climate control [276](#)  
Rear axle steering, see Integral Active Steering [218](#)  
Rear center armrest [297](#)  
Rear collision prevention [208](#)  
Rear collision warning, see Rear collision prevention [208](#)  
Rear lights, replacing, see Lights and bulbs [377](#)  
Rear seat backrest inclination [115](#)  
Rear seat backrest tilt [115](#)  
Rear seats [114](#)

Rear ventilation, third row of seats, ventilation, third row of seats [275](#)

Rearview camera, see Surround View [245](#)

Rearview camera, without Surround View [242](#)

Rear window defroster [274](#)

Rear window wiper, operation [142](#)

Recirculated-air filter, see Microfilter/activated-charcoal filter [274](#)

Recirculated-air mode [272](#)

Recommended fuel grade [368](#)

Recommended tire brands [341](#)

Refueling [330](#)

Remote 3D View [252](#)

Remote control [76](#)

Remote control, additional [79](#)

Remote control for audio, see Owner's Handbook for Navigation, Entertainment, Communication [8](#)

Remote control, integrated key [85](#)

Remote control, loss [79](#)

Remote control, malfunction [80](#)

Remote control of the vehicle, changing the battery [79](#)

Remote control, universal [287](#)

Remote control with display, malfunction [84](#)

Remote control with display, see BMW display key [81](#)

Remote services, app, see Owner's Handbook for Navigation, Entertainment, Communication [8](#)

Remote Software Upgrade [60](#)

Removable ball head [319](#)

Replacing parts [376](#)

Replacing wheels/tires [341](#)

Reporting safety malfunctions [15](#)

RES CNCL button, see Active Cruise Control with Stop&Go function [223](#)

RES CNCL button, see Cruise control [221](#)

Reserve warning, see Range [159](#)

Reset settings [75](#)

Reset, Tire Pressure Monitor TPM [350](#)

Reset vehicle configuration [75](#)

Reset vehicle settings [75](#)

Retreaded tires [342](#)

Reversing Assistant, see Parking Assistant [252](#)

Roadside Assistance, see Accident Assistance [382](#)

Roadside Assistance, see Breakdown assistance [381](#)

Roadside parking lights [169](#)

Roller sunblinds, rear side windows [108](#)

Rolling code hand-held transmitter [288](#)

RON recommended fuel grade [368](#)

Roofliner [42](#)

Roof load capacity [395](#)

Roof-mounted luggage rack [315](#)

Rope for tow-starting/towing [385](#)

Route, navigation, see Owner's Handbook for Navigation, Entertainment, Communication [8](#)

RSC Run-flat System Component, see Run-flat tires [342](#)

RSU, see Remote Software Upgrade [60](#)

RTTI, see Owner's Handbook for Navigation, Entertainment, Communication [8](#)

Rubber components, care [389](#)

Run-flat tire [342](#)

## S

Safe braking [314](#)

Safety belt reminder for driver's seat and front passenger seat [118](#)

Safety belt reminder for the rear seats [118](#)

Safety belts [117](#)

Safety belts, care [390](#)

Safety locks, doors and windows [132](#)

Safety package, see Active Protection [210](#)

Safety switch, windows [108](#)

Safety systems, see Airbags [176](#)

Safety systems, see Intelligent Safety [179](#)

Saving fuel [321](#)

Screen Mirroring, connection [73](#)

Screen, see Control Display [49](#)

Screwdriver, see Onboard vehicle tool kit [376](#)

Sealant, see Mobility System [343](#)

Seat and armrest heating [125](#)

Seat heating [125](#)

Seating position for children [128](#)

Seats and head restraints [111](#)

Seat, see Memory function [124](#)

Seats, front [111](#)



- Seats, rear [114](#)
- Seat ventilation, active [126](#)
- Securing cargo [302](#)
- Selection list in instrument cluster [162](#)
- Selector lever, Steptronic transmission [143](#)
- Self-leveling suspension, see 2-axle air suspension [262](#)
- Self-supporting tires, see Run-flat tires [342](#)
- Sensors, care [390](#)
- Service and warranty [11](#)
- Service Center, see Accident Assistance [382](#)
- Service requirements [159](#)
- Service requirements, see Condition Based Service CBS [374](#)
- Services, ConnectedDrive, see Owner's Manual for Navigation, Entertainment and Communication [8](#)
- SET button, see Active Cruise Control with Stop&Go function [223](#)
- SET button, see Cruise control [221](#)
- Set speed, see Active Cruise Control with Stop&Go function [223](#)
- Settings, locking/unlocking [103](#)
- Settings on Control Display [63](#)
- Settings, seats and head restraints [111](#)
- Setting up a driver profile [98](#)
- Setup assistant [98](#)
- Shift paddles on the steering wheel [143](#)
- Shift point indicator, tachometer [157](#)
- Side airbag [176](#)
- Side collision warning [205](#)
- Side protection, Surround View [247](#)
- Side protection without Surround View [240](#)
- Signaling, horn [38](#)
- Signals when unlocking, see Confirmation signals from the vehicle [103](#)
- Sitting safely [111](#)
- Size [394](#)
- Sizes, see Technical data [394](#)
- Slide/tilt glass roof, see Glass sunroof [108](#)
- Smartphone, see Owner's Manual for Navigation, Entertainment and Communication [8](#)
- Smoker's package [290](#)
- SMS, see Short messages, see Owner's Handbook for Navigation, Entertainment, Communication [8](#)
- SMS text message, supplementary [154](#)
- Snow chains [347](#)
- Socket for OBD Onboard Diagnosis [375](#)
- Sockets [292](#)
- Software Upgrade, see Remote Software Upgrade [60](#)
- SOS button, see Intelligent emergency call [382](#)
- Sound output, see Owner's Handbook for Navigation, Entertainment, Communication [8](#)
- Spare tire, see Emergency wheel [362](#)
- Speaker lighting [175](#)
- Special equipment, see Vehicle features and options [9](#)
- Speed Limit Device, see Manual speed limiter [219](#)
- Speed limit display, see Speed Limit Info [160](#)
- Speed limiter, manual [219](#)
- Speed Limit Info [160](#)
- Speed warning [65](#)
- Sport chassis/suspension, see Adaptive M chassis [267](#)
- Sport displays [164](#)
- SPORT INDIVIDUAL, see Driving Dynamics Control [148](#)
- SPORT PLUS, see Driving Dynamics Control [148](#)
- Sport program, Steptronic transmission [143](#)
- SPORT, see Driving Dynamics Control [148](#)
- Sport suspension, active, see Adaptive M Suspension Professional [268](#)
- Stability control systems [213](#)
- Standard equipment, see Vehicle features and options [9](#)
- Standard view, Head-up Display [165](#)
- Standby state, idle state and drive-ready state [43](#)
- Start/stop, automatic function [133](#)
- Start/Stop button [133](#)
- Starting aid terminals [384](#)
- Starting, see Drive-ready state [44](#)
- Starting the engine, see Drive-ready state [44](#)
- Stationary climate control [280](#)
- Stations, AM/FM, see Owner's Handbook for Navigation, Entertainment, Communication [8](#)
- Status control display, tires [350](#)
- Status information, iDrive [47](#)

Status of Owner's Manual [9](#)  
 Status, vehicle [164](#)  
 Steering and lane control assistant incl. Traffic Jam Assist [231](#)  
 Steering, see Integral Active Steering [218](#)  
 Steering wheel, adjusting [123](#)  
 Steering wheel, buttons [38](#)  
 Steering wheel, see Memory function [124](#)  
 Steptronic Sport transmission, see Steptronic transmission [143](#)  
 Steptronic transmission [143](#)  
 Stopping the engine, see Drive-ready state [44](#)  
 Storage compartment in the center console [297](#)  
 Storage compartments [295](#)  
 Storage compartments in the cargo area [303](#)  
 Storage compartments, locations [295](#)  
 Storage, tires [342](#)  
 Storing the vehicle [391](#)  
 Stowing and securing cargo [302](#)  
 Straps for cargo, see Lashing eyes in the cargo area [302](#)  
 Suitable devices [69](#)  
 Suitable mobile phones [69](#)  
 Summer tires, tread [340](#)  
 Sun visor [290](#)  
 Sun visor, sliding [290](#)  
 Supplementary Owner's Manuals [16](#)  
 Supplementary SMS text message [154](#)  
 Surface heating, see Seat and armrest heating [125](#)  
 Surround View [245](#)  
 Suspension settings, see Driving Dynamics Control [148](#)  
 Swinging of trailer, see Trailer stabilization control [319](#)  
 Switches, see Cockpit [38](#)  
 Switch for driving dynamics, see Driving Dynamics Control [148](#)  
 Symbols and displays [9](#)  
 SYNC program, automatic climate control [273](#)

## T

Tachometer [157](#)  
 Tailgate, automatic [95](#)  
 Tailgate, opening and closing with no-touch activation [89](#)  
 Tailgate via remote control [78](#)  
 Tail lights, replacing, see Lights and bulbs [377](#)  
 Technical changes, see For Your Own Safety [10](#)  
 Technical data [394](#)  
 Telephone, see Owner's Manual for Navigation, Entertainment and Communication [8](#)  
 Teleservices, see Owner's Handbook for Navigation, Entertainment, Communication [8](#)  
 Television, TV, see Owner's Handbook for Navigation, Entertainment, Communication [8](#)  
 Temperature, automatic climate control [270](#)  
 Temperature display, see External temperature [158](#)  
 Temperature, engine oil [158](#)  
 Theft alarm system, see Alarm system [105](#)  
 Thermal camera, see Night Vision [194](#)  
 Thigh support [112](#)  
 Third row of seats [115](#)  
 Tilt alarm sensor [106](#)  
 Tilt, backrest [112](#)  
 Tilting the passenger's side mirror, see Automatic Curb Monitor, exterior mirror [122](#)  
 Time [63](#)  
 Tire brands, recommended [341](#)  
 Tire damage [340](#)  
 Tire identification marks [338](#)  
 Tire inflation pressure [332](#)  
 Tire inflation pressure monitor, see FTM Flat Tire Monitor [355](#)  
 Tire pressure [332](#)  
 Tire Pressure Monitor TPM [348](#)  
 Tire repair kit, see Mobility System [343](#)  
 Tires and wheels [332](#)  
 Tires, changing [341](#)  
 Tire sealant, see Mobility System [343](#)  
 Tire settings [349](#)  
 Tires, run-flat [342](#)  
 Tire tread [340](#)  
 Tone, see Owner's Manual for Navigation, Entertainment and Communication [8](#)  
 Tool [376](#)  
 Torque display, see Sport displays [164](#)  
 Total vehicle weight [395](#)  
 Tow bar [385](#)

- Tow fitting [386](#)
  - Towing [384](#)
  - Tow rope [385](#)
  - Tow-starting [384](#)
  - TPM Tire Pressure Monitor [348](#)
  - Traction control [215](#)
  - TRACTION, driving dynamics [215](#)
  - Traffic bulletins, see Owner's Handbook for Navigation, Entertainment, Communication [8](#)
  - Traffic Jam Assist, see Steering and lane control assistant [231](#)
  - Trailer hitch, care [390](#)
  - Trailer hitch, removable ball head [319](#)
  - Trailer hitch, view of rearview camera [243](#)
  - Trailer hitch, view of Surround View [247](#)
  - Trailer loads [395](#)
  - Trailer stabilization control [319](#)
  - Trailer towing [317](#)
  - Trailer towing, activation [319](#)
  - Trailer towing, data [395](#)
  - Transmission lock, electronic unlocking [147](#)
  - Transmission, see Steptronic transmission [143](#)
  - Transporting children safely [128](#)
  - Travel & Comfort System [294](#)
  - Tread, tires [340](#)
  - Trip data [163](#)
  - Triple turn signal activation [139](#)
  - Turning circle line, Surround View [247](#)
  - Turning radius lines, rearview camera [243](#)
  - Turn signal, indicator light [156](#)
  - Turn signal, replacing bulbs, see Lights and bulbs [377](#)
  - Turn signals, high beams, headlight flasher [139](#)
  - TV, see Owner's Handbook for Navigation, Entertainment, Communication [8](#)
- U**
- Unintentional alarm, avoiding [106](#)
  - Units of measurement [65](#)
  - Universal remote control [287](#)
  - Unlock button, Steptronic transmission [143](#)
  - Unlocking, automatic [103](#)
  - Unlocking, see Opening and Closing [76](#)
  - Unlocking, settings [103](#)
  - Unlocking with the remote control [77](#)
  - Unpaved roads, cross-country trips [312](#)
  - Updates made after the editorial deadline [9](#)
  - Upgrade, see Remote Software Upgrade [60](#)
  - Upholstery material care [389](#)
  - Upper backrest, front [113](#)
  - USB connection [71](#)
  - USB interface, position in vehicle [293](#)
  - Used battery, disposing of [378](#)
  - Use, intended [10](#)
  - Using a smartphone via voice activation [56](#)
- V**
- Vanity mirror [290](#)
  - Variable steering, see Integral Active Steering [218](#)
  - Vehicle battery [377](#)
  - Vehicle breakdown, see Breakdown assistance [380](#)
  - Vehicle, break-in [312](#)
  - Vehicle care [388](#)
  - Vehicle care products [388](#)
  - Vehicle features and options [9](#)
  - Vehicle identification number [15](#)
  - Vehicle key, see Remote control [76](#)
  - Vehicle paint [388](#)
  - Vehicle position, vehicle location [66](#)
  - Vehicle status [164](#)
  - Vehicle storage [391](#)
  - Vehicle wash [387](#)
  - Vehicle, washing [387](#)
  - Ventilation [274](#)
  - Ventilation, see Parked-car ventilation [278](#)
  - Ventilation, see Stationary climate control [280](#)
  - Venting, see Ventilation [274](#)
  - Vent, see Ventilation [274](#)
  - Version, see Remote Software Upgrade [60](#)
  - Video, see Owner's Manual for Navigation, Entertainment and Communication [8](#)
  - VIN, see Vehicle identification number [15](#)
  - Voice activation system [54](#)
  - Voice command response, see Owner's Handbook for Navigation, Entertainment, Communication [8](#)

## W

Warning/indicator lights [155](#)  
 Warning against cross traffic [259](#)  
 Warning light in the exterior mirror, see Active Blind Spot Detection [201](#)  
 Warning light in the exterior mirror, see Crossing traffic warning [259](#)  
 Warning messages, see Check Control [153](#)  
 Warning triangle [380](#)  
 Warranty [10](#)  
 Washer fluid [372](#)  
 Washer nozzles, windshield [142](#)  
 Washer system [140](#)  
 Washing the vehicle [387](#)  
 Wash view, Surround View [247](#)  
 Water on roads [314](#)  
 Water, see Condensation water under the parked vehicle [315](#)  
 Website [8](#)  
 Weights [395](#)  
 Weights, see Technical data [394](#)  
 Welcome light during unlocking [77](#)  
 Welcome lights [170](#)  
 Welcome screen, driver profiles [98](#)  
 Wheel cleaner, light-alloy wheels [389](#)  
 Wheels and tires [332](#)  
 Wheels, changing [341](#)  
 Wheels, see FTM Flat Tire Monitor [355](#)  
 WiFi connection [72](#)  
 WiFi hotspot [72](#)  
 WiFi hotspot, see Internet connection [72](#)  
 Window defroster, rear [274](#)  
 Window, defrosting and defogging [274](#)  
 Windows, powered [107](#)  
 Windshield washer fluid, see Washer fluid [372](#)  
 Windshield washer nozzles [142](#)  
 Windshield washer system, see Washer/wiper system [140](#)  
 Windshield wiper, see Wiper system [140](#)  
 Winter storage, see Long-term vehicle storage [391](#)  
 Winter tires [342](#)  
 Winter tires, tread [340](#)  
 Wiper blades, replacing [376](#)  
 Wiper fluid, see Washer fluid [372](#)

Wiper, fold-away position [142](#)  
 Wiper, see Washer/wiper system [140](#)  
 Wiper system [140](#)  
 Wireless charging of a smartphone, see Wireless charging tray, see Owner's Manual for Navigation, Entertainment, Communication [8](#)  
 Wireless charging tray, see Owner's Manual for Navigation, Entertainment, Communication [8](#)  
 Wood parts, care [390](#)  
 Wordmatch principle, see Entry comparison [47](#)  
 Wrench, see Onboard vehicle tool kit [376](#)

## X

xDrive [215](#)  
 xOffroad package [264](#)



01402896765 ue



# California Proposition 65 Warning

---

For vehicles sold in California:

## California Proposition 65 Warning



### **WARNING**

Operating, servicing and maintaining a passenger vehicle or off-highway motor vehicle can expose you to chemicals including engine exhaust, carbon monoxide, phthalates, and lead, which are known to the State of California to cause cancer and birth defects or other reproductive harm. To minimize exposure, avoid breathing exhaust, do not idle the engine except as necessary, service your vehicle in a well-ventilated area and wear gloves or wash your hands frequently when servicing your vehicle. For more information go to [www.P65Warnings.ca.gov/passenger-vehicle](http://www.P65Warnings.ca.gov/passenger-vehicle).



The Ultimate  
Driving Machine®



# BMW DRIVER'S GUIDE APP.

Your customized information about the vehicle in an app.  
Optimized for smartphones & tablets. Can be used offline.



Download on the  
**App Store**



GET IT ON  
**Google Play**



01402896765 ue

Online Edition for Part no. 01402896765 - X/18